

# WIRELESS WORLD

AND

# RADIO REVIEW

No.181. [No. 18.  
VOL. XI.]

3rd FEBRUARY, 1923.

Registered at the G.P.O.  
as a Weekly Newspaper.

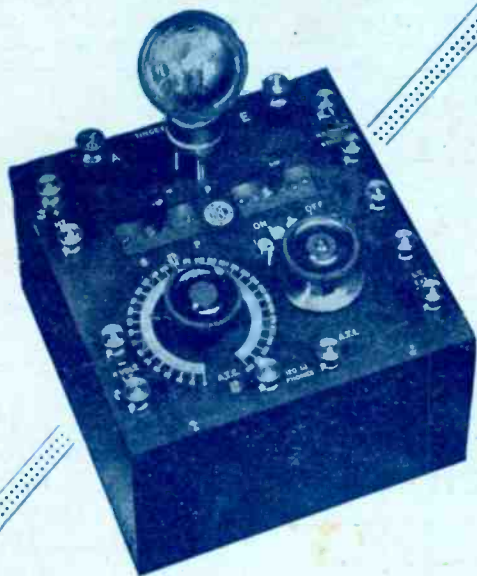

**You may depend upon it**

that if the name TINGEY is on a wireless instrument, it is perfectly efficient in every detail. Here is a selection from the splendid TINGEY range.

### SINGLE VALVE BROADCAST RECEIVING SET.

Wavelength 300 to 2,800 metres.

**PRICE** (as illustrated, less valve) **£9 : 12 : 6**  
including Broadcasting Fees

ALL TINGEY Broadcast Receivers bear the B.B.C. stamp.

All "TINGEY" Valve Apparatus is duly licensed under Marconi Patents for Amateur use in Great Britain.

*Illustrated Catalogue of 1, 2, 3, 4 and 5 valve Broadcast Receivers and Experimental Unit System, with all accessories, price 6d. post free.*

'Phone : Hammersmith 1916.  
Telegrams : "Tingoidar, London."

Offices and Showrooms :

**92, QUEEN STREET, HAMMERSMITH,  
LONDON, W.6.**

**TINGEY WIRELESS LTD.**



We guarantee that all Broadcast Radio Apparatus sold by us conforms with the conditions of the Broadcaster's Licence issued by the Postmaster-General.

PRICE  
**£6 : 17 : 6**

WRITE FOR NEW  
PUBLICATION No. 342  
Sterling  
Radio Receiving  
Sets.

Call at our Showroom for a Demonstration.

**STERLING No. 1 CRYSTAL RECEIVER.**  
Complete with pair of Double Head Telephones and  
Coil for Paris Time Signals. Range 25 miles.

To be obtained from all Dealers or direct from—

**STERLING TELEPHONE & ELECTRIC CO., LTD.**  
210/212, TOTTENHAM COURT ROAD, LONDON, W.1  
Telephone No. : 4144 Museum (7 lines).      Telegrams : "Cucunia, Wesdo, London."      Works—DAGENHAM, ESSEX  
Branches—NEWCASTLE-ON-TYNE, 9 Clavering Place;      CARDIFF, 8 Park Place      MANCHESTER, 14 St. Peter's Sq.

# Ediswan Valves



have over forty years' of lamp making experience embodied in their manufacture. The AR Valve illustrated is specially made for amateur reception.

Plate voltage 30-80. Filament volts 3.5-6.0. Filament current 0.75 amperes. High amplification. Silent working.

**15/- each**

**THE EDISON SWAN ELECTRIC Co., Ltd.**

Contractors to H.M. Admiralty, War Office, Royal Air Force.

Head Office · 123/5 Queen Victoria Street, E.C.4

London Showrooms : 123/5, QUEEN VICTORIA ST., E.C.4  
71, VICTORIA ST., S.W.1

Works : PONDERS END, MIDDLESEX

BRANCHES :—

Aberdeen	Bristol	Edinburgh	Leicester	Nottingham
Belfast	Cardiff	Glasgow	Liverpool	Sheffield
Birmingham	Dublin	Hull	Manchester	Southampton
Brighton	Dundee	Leeds	Newcastle	Swansea
Melbourne	Brisbane	Sydney	Adelaide	

If you are unable to obtain Ediswan supplies from your usual dealer, write to us for the name and address of the nearest supplier.

**EDISWAN BATTERIES H.T. and L.T.**

are all manufactured with the same care and attention to details as other Ediswan products. Always insist on "Ediswan" when purchasing Accumulators or Dry Batteries.

# Wireless Apparatus at less than Cost Prices!

# GAMAGE'S SALE

Large Surplus Stocks must be cleared before Stocktaking, so prices are drastically reduced to the lowest possible level—many below cost. All goods offered are new and perfect, being regular stock lines.

## FINAL OFFERS—IMMEDIATE ORDERING ESSENTIAL

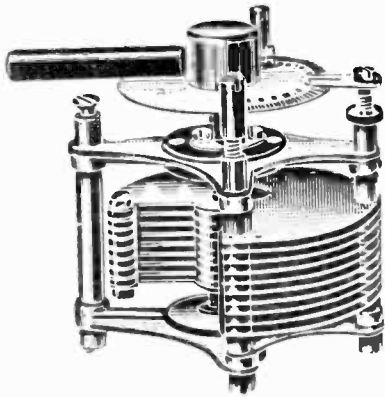

### Skeleton Type Panel Mounting Variable Condensers

Strongly made and very reliable. The illustration shows one type of condenser, but our stock includes several types, all of which can be recommended.

Capacity.	Sale Price.	List Price.
.001	19/6	30/-
.0005	13/6	21/-
.00045	12/-	19/8
.0003	10/-	18/6
.00008 (Vernier)	5/6	8/-

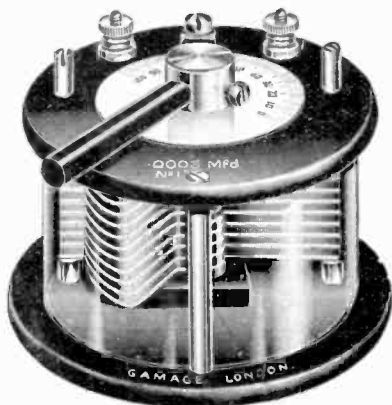

**Special offer of Gamage's "HOME" Crystal Receiving Sets (No. 2)**

Fully licensed by the P.M.G., Regd. No. 194

Made in Polished Mahogany, and of superior workmanship throughout. Designed to cover a range of wavelengths from 300 to 2,000 metres, and to receive telephony messages from broadcasting stations over 20 miles. Spark telegraphy up to 200 miles. Ship and station messages—all can be obtained. No complicated circuits to join up. A complete unit (as shown) ready for working.

Usual price . . . £4 19s. 6d.      **Sale Price 79/6**

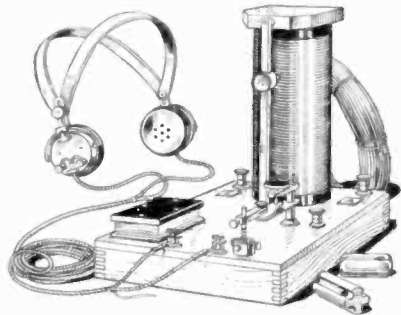

### Filament Resistances

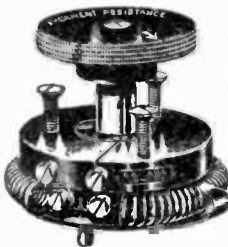

Special offer of Filament Resistances for panel mounting. Resistance of wire, 7 ohms.

Usual price . . 4/6

**Sale Price**

**3/-**

### Switches



Ebonite knob with four-leaf spring, spindle and lock nuts.

**2/9** (Post 3d.)

### Air Dielectric Type Variable Condensers

Faraday House Calibration. One of the neatest and best obtainable. Electrically and mechanically perfect. Top and base panels of matt ebonite with polished rounded edges. Enclosed in celluloid. Fitted with engraved ivory scale. The illustration shows one type, but our stock includes several types, all of which can be recommended.

Capacity.	Sale Price.	List Price.
.001	25/6	40/-
.0005	16/6	25/-
.00045	14/9	23/6
.0003	13/-	22/-
.00008	8/6	12/6



### FIXED CONDENSERS

Made of the finest copper foil and mica. Mounted in polished mahogany containers with ebonite top, and filled with paraffin wax to insure good insulation. Stocked in the following capacities:—0001, 0002, 0003, 0004, 0005, 001, 002, 003, 004, 005 mfd. Capacities guaranteed.

Usual price 6/9      **SALE PRICE 3/-**

**A. W. GAMAGE, LTD., HOLBORN, LONDON, E.C.1**

# BULLERS' Tubular Steel Mast Sets and Wireless Insulators

for  
**Broadcasting Reception**  
and  
**Low Power Transmission**

## INSULATORS

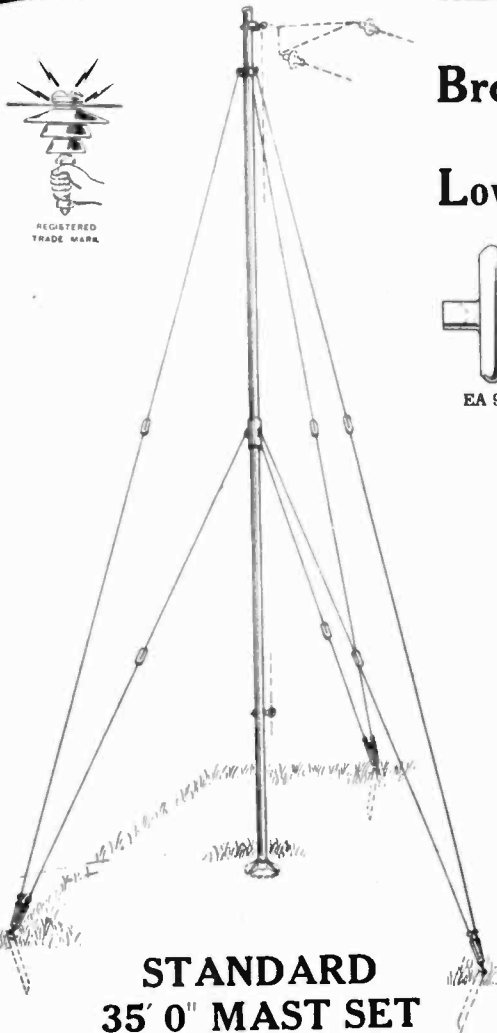

REGISTERED  
TRADE MARK

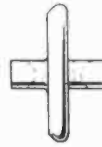

EA 9340

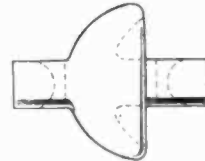

EA 9342

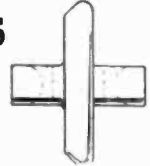

EA 9341

Type.	Diam.	Weight.	Tests.	Retail Price.
EA9340 -	3 1/2"	6 oz.	40,000 volts 500 lbs.	1/4 each
EA9341 -	4"	11 oz.	52,000 volts 600 lbs.	2/- each
EA9342 -	3 11/16"	18 oz.	52,000 volts 800 lbs.	2/6 each

### ADVANTAGES OVER OTHER TYPES.

1. Very low capacity.
2. Instant shedding of rain.
3. Highest insulation possible.
4. Negligible weight.
5. Great tensile strength.
6. Easy to attach to aerial or halyard.

**THESE MASTS** are light, strong and the general arrangement is based on sound engineering practice. The design is as economical as is possible, consistent with necessary strength and weathering capabilities; sufficient stay wire is provided to enable the erector to vary the staying points within a reasonable margin.

These Masts can conveniently be erected on a base of 20' diameter.

40' Masts can be supplied at slight extra cost.

**RETAIL £3-15-0 PRICE**

PER SET COMPLETE DELIVERED GT. BRITAIN.

SPECIAL TERMS TO THE TRADE.

## STANDARD 35' 0" MAST SET

Each set consists of:—

One top tube, one bottom tube with shoe and joint socket. Six double swivels for adjusting the stay wires. One 3-way stay clip. Three stay pegs of angle iron, 2' long, pointed at one end and provided with a hole in each flange for independent adjustment of stays. 180' of No. 12 flexible steel wire rope. Six guy Insulators, Patt. EA.8760. One aerial halyard pulley and eye bolt for securing halyard. The whole of the metalwork is galvanised except the stay pegs which are oiled.

TOTAL WEIGHT OF TUBES AND SOCKET, 59 LBS.

**BULLERS LTD.,** 6, Laurence Pountney Hill,  
LONDON—E.C.4.

Phone—  
CITY 985/6

# W. J. HENDERSON

351, FULHAM ROAD  
SOUTH KENSINGTON

(Bus Routes Nos. 14 and 96 pass the door.)  
(Nearest Stations, Earl's Court and South Kensington.)

## Accessories of Quality

AERIAL WIRE, 7/22 Enamelled Copper, per 100'	5/-
AERIAL INSULATORS, Porcelain, "Shell" Type, each	1/-
" Egg " Type, each 2/d., 5 for 1/-	
AERIAL STAY WIRE, galvanised, suitable for masts up to 50' high, per 100'	4/-
ANODE REACTANCE COILS (Radio Instruments), 150-4,000 m.	20/-
150-20,000 m.	25/-
ACCUMULATORS, 4v. 30 a.h. (suitable for one or two valves)	14/6
6v. 40 a.h.	29/6
6v. 60 a.h.	39/2
COILHOLDERS, for three coils, panel mounting, complete with terminals	each 14/6 and 18/-
Extension handles for above	per pair 1/6
COILHOLDERS, Igranite, table stand, complete with extension handles, patent spring terminals	each 21/-
COILS, Igranite (De Forest), duolateral	from 5/-
CONDENSERS, fixed, .0003 and .0005	each 1/6
CONDENSERS, fixed, Dubilier	each 2/6 and 3/-
CONDENSERS, Variable, high grade, for panel mounting, complete with knob and pointer—Vernier, 5/-; .0003, 12/-; .0006, 15/-; .001, 20/-	
DUCON, Special "Electric-light Aerial" attachment, each	10/-
FILAMENT RHEOSTATS, for panel mounting, one valve	each 3/6
Three valves	each 4/6
GRID CONDENSER AND LEAK, Dubilier	5/-
HIGH TENSION BATTERIES, 15-volt blocks, with flexible leads, long life	each 3/-
INSULATED SLEEVING, Red, Green, Brown, Yellow, per yard	5d.
IVORINE SCALES, semi-circular, engraved 0-180, best quality	each 1/-
LOUD SPEAKERS, Amplion, 120 ohms, 50-; 2,000 ohms, 52/6.	
POTENTIOMETERS, circular type for panel mounting, complete with knob and pointer, 350 ohms	each 12/6
TRANSFORMERS (Radio Instruments), Intervalve	25/-
Telephone	20/-
TRANSFORMERS (IGRANIC), Intervalve	22/6
TRANSFORMERS, HIGH FREQUENCY, to fit Valveholders, Broadcast wavelengths	5/6
600 m.	6/-
1,000 m.	6/6
2,000 m.	7/-
Etc., etc.	
VALVEHOLDERS, mounted in ebonite, fitted with washers and nuts	each 1/-
VALVES, M.O., "R" Type	each 17/6
VALVES, ORA	each 15/-

The above are only a few selected items from our large stocks.

Terms, Cash with order; goods above £2 in value carriage paid.

Post Orders are despatched on day of receipt.

Lists on request, post free, 3d.

## Dry Batteries for Wireless Sets

No. 1 W. Standard Pocket-lamp size, 4½ volts (as illustration), with patent spiral wire terminals for connecting in series.

Insert straight terminal in spiral of next battery and bend same, no soldering required.

PRICE 7/- Per doz.

NOTE.—(1 doz.—54 volts).

NEW TYPE.  
No. 2 W. Slab.

15 volts, 1 screw terminal, 5 plug sockets, 3-volt tappings with wander plug.

Size 9" x 7" x 2½" high.

PRICE  
3/-  
EACH

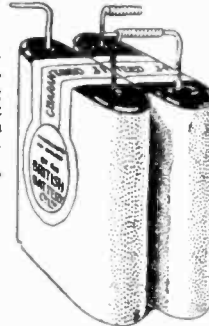

NEW TYPE.  
No. 4 W

36 volts, 1 screw terminal, 12 plug sockets, 3-volt tappings with wander plug. Size 9½" x 1½" x 2½" high.

PRICE  
7/-  
EACH

No. 1 W.  
Connect as illustration.  
(Patent applied for).

BRITISH MADE—CARRIAGE PAID.

Manufactured by—  
**THE BRITISH BATTERY Co., Ltd.**  
Clarendon Rd., WATFORD, HERTS.  
(Telephone : Watford 617.)

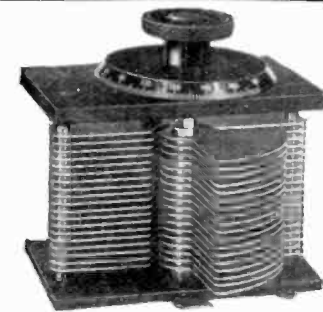

Specification of our well-known CONDENSERS. Highest grade Aluminium Plates, Brass Washers machined to a limit of + or - .001" Adjustable Brass Bush at bottom, Fixed Brass Bush at top. These Condensers are built to stand HARD continuous usage and we GUARANTEE THEM.

Value in M.F.	Panel Mounting in Parts	Panel Mounting Assembled	Cabinet Mounting in Parts	Cabinet Mounting Assembled	Cabinet Mounting Assembled in Cabinet	Polished Mahogany Cabinet
.0015	23/-	25/6	24/-	26/6	33/-	6/6
.001	18/9	19/6	17/9	21/-	26/-	5/6
.00075	13/6	16/3	14/6	18/6	22/-	5/6
.0005	10/8	13/-	11/9	13/9	18/-	4/6
.0004	10/-	12/6	11/-	13/3	17/6	4/6
.0003	9/-	11/6	10/-	12/-	16/-	4/-
.0002	7/-	9/-	8/-	9/6	13/6	4/-
.0001	6/-	8/-	7/-	8/6	12/6	4/-
Vernier	—	4/6	—	5/-	9/-	3/6

Fitted with Bevelled Ebonite Dial 1/9 extra.  
Special Sizes made to Order. Price list on request.  
ALL SUNDRIES AND COMPONENTS IN STOCK.  
ORDERS OVER 20/- CARRIAGE PAID.  
TRADE ENQUIRIES SOLICITED.

**THE "BROADWAY" RADIO WORKS**  
DEVONSHIRE ROAD, BEKLEYHEATH, KENT.

## Accessories of QUALITY at Competitive Prices

**ACCUMULATORS. Remarkable Line—**  
 4 Volt 40 amp. 18/- 6 Volt 40 amp. 30/-  
 4 Volt 60 amp. 26/- 6 Volt 60 amp. 40/-  
**AERIAL INSULATORS. Shell, 6d.; Egg, 3d.; Reel, 2d.**  
**AERIAL PULLEYS. Aluminium copper bush 1/4**  
**BATTERIES. 16.5 Volt with tapplings, 3/6; 36 Volt, 7/-**  
 60 Volt 14/-  
**CONDENSERS, FIXED. All capacities 1/6**  
**CONDENSERS, VARIABLE—**

Capacity.	No. Plates.	Parts.	Panel assembled.
.001	57	6/8	15/-
.00075	43	5/6	12/9
.0005	29	4/6	11/6
.0003	19	3/-	9/-
.0002	13	2/3	7/-
.0001	7	2/-	5/-
Vernier	3	1/9	4/-

Drilled ebonite end plates per pair 1/-  
**CONDENSER DIALS, engraved 1/3**  
**CRYSTALS, Bornite, Carborundum, Galena, 4d. a box.**  
 Zincite, 1/- Hertzite, 1/9.  
**CRYSTAL CUPS, Plain, 1d. Three screw 2 1/2d.**  
**CONTACT STUDS, with nut and washer per doz. 7d.**  
**COILS, BASKET, 5/- set of seven. Range 150 to 4,500 metres.**  
**COILS, SLAB, 7/6 set of eight. Range 300 to 30,000 metres.**  
**COIL HOLDERS, for above coils—Two-way with holders 10/-**  
 Three-way with holders 15/-  
 For Honeycomb coils, two-way, 9/-; three-way 13/-  
**EBONITE SHEET per lb. 3/6**  
**FILAMENT RESISTANCES. Smooth action, positive contact each 2/6**  
**GRID LEAK AND CONDENSER. First quality only, we do not sell a cheap line each 3/-**  
**GRID LEAKS. Cartridge pattern. State resistance required each 1/6**  
**HEADPHONES. 4,000 ohms. Clear as a bell. French or British make £1 1/-**  
**INDUCTANCE SLIDERS, 4 1/2d. each. Slider Rods, brass, each 4 1/2d.**  
**IVORINE LABELS. Earth, Aerial, 'Phones, React., Tuner, L.T. and H.T. each 2d.**

**IVORINE SCALES, 0-180 each 4d.**  
**LOUD SPEAKERS. All types supplied. Special line in Loud Speaker Horns. Curved with N.P. bent arm and base. Polished inside and out. Trumpet 10" diameter by 10 1/2" high each 10/6**  
 Straight Type as above each 8/3  
**POTENTIOMETERS. Good and Efficient each 7/6**  
**RECTIFIERS. Special Rotary Type, 200/100 Volts, 50/60 Cycles to 8 1/2 Volts, 3 amperes, £7. Write for special list.**  
**SWITCHES. Knife. S.P.S.T., 1/- S.P.D.T., 1/6. D.P.S.T., 2/- D.P.D.T., 2/6.**  
**SWITCH ARMS. Complete. First quality, 1/6. Second quality 1/-**  
**SYSTOFLEX SLEEVING. 1mm., 5d. yard. 1.5 mm., 6d. yard.**  
**TERMINALS. Complete with nut and washer, 1 1/2d. Telephone type, 1 1/2d. each.**  
**TRANSFORMERS. L.F. Intervalve, 15/- Telephone 13/6**  
**VALVES. All types supplied. We recommend Ediswan AR as the ideal type for all purposes. Ediswan Type A.R. each 15/-**  
**VARIOMETER. As used exclusively by a well-known firm of Government Contractors. Range from 300 m. to 3,000 m. Mounted on ebonite panel with graduated dial and milled knob, 25/- each. Unmounted, each 17/6**  
**VARIOMETER FORMERS. Complete with all brass parts and terminals 7/6**  
**VALVE HOLDERS. First quality, 1/3. Second quality, 1/- Third quality, 9d.**  
**VALVE LEGS. Complete with nut and washer, and shoulder doz. 1/3**  
**VALVE PINS, 1d. each, 10d. a dozen.**  
**COMPLETE CRYSTAL SET. Mounted on handsome cabinet. Variometer tuning. Complete with one pair of headphones and aerial material. Including broadcasting fee £4 10/-**  
**SINGLE VALVE SET. Desk type. Complete with accumulator, H.T. Battery, Headphones, Aerial, Insulators and Tuning Coil £7 5/-**  
 Royalties, 32/6. Valve, 15/- each extra.

Orders over £1 post paid. Under, please include ample postage

**HALL & BRENDAR**

**DISTRIBUTORS OF RADIO ESSENTIALS. All post orders: (DEPT. W.) 10, MANOR GARDENS, PURLEY, SURREY. Tel.: CROYDON 975.**

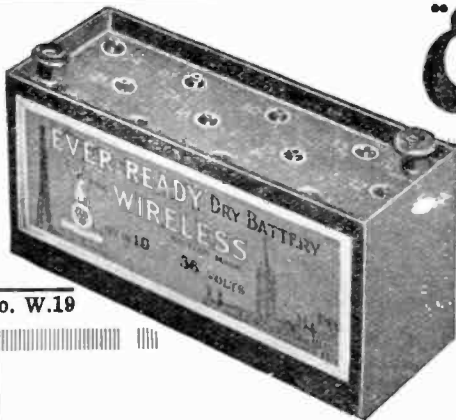

No. W.19

*Ever-Ready*  
*British Make*

**DRY CELLS  
 and BATTERIES  
 for High & Low Tension**

THE STANDARD OF QUALITY



UW.1

### HIGH TENSION BATTERIES

Any size or voltage with any tapplings or sockets at 3 or 6 volt intervals for use with Wander Plugs can be supplied to order

With 13 sockets as illustrated.

No. W.19, 36 volts, 24 cells, 8/6 each. Size 6 1/4 x 2 1/2 x 3 1/2.  
 Weight 2 lb. 8 ozs.

Wander Plugs 1/- per pair. With 2 Spring Contacts.  
 No. W.11, 15 volts, 11 cells, 3/6 each. Size 9 1/4 x 1 1/4 x 2 1/2.  
 Weight 1 lb. 2 ozs.

### THE UNIT DRY CELL

"Build up your batteries as you build up your Marconi Sets."

Unlimited flexibility in size, voltage and intermediate tapplings. Each cell is fitted with brass screw terminal and looped wire, and they are efficiently insulated to prevent current leak.

No. UW. 1, 7/6 per dozen. E.M.F. 1 1/2 volts  
 Weight, 3 1/2 ozs. Dimensions 2 1/4 x 1 5/16 diam.

Art Catalogue of Standard Sizes and Voltages and list of Accumulators for Valve Filament Supply sent on request. Dept. D.L

**THE EVER-READY WORKS, Hercules Place, Holloway, N. 7.**

# Doing away with the aerial

## THE "DUCON"

Where there is electric light, an aerial is unnecessary. Plug a "Ducon" into an ordinary lamp holder or wall socket, connect to the wireless receiver and you will receive the broadcasting perfectly.

The set is quiet, there is no noise from the mains, and the "Ducon" is perfectly safe to use, consumes no current and does not affect the electric light in any way.

The "Ducon" gives satisfactory results with all types of receivers, from crystal to multi-valve.

## The DUCON 10%

is obtainable from all leading wireless dealers, electrical contractors and stores, or direct from the makers.

*Dealers not yet stocking are invited to write for trade terms.*

**Over 50,000 In use.**

**THE DUBILIER CONDENSER CO. (1921) LTD.,**  
Ducon Works, Goldhawk Road, Shepherd's Bush, London, W. 12.  
Telephone—Hammersmith 1084. Telegrams—"Hivolcon, Phone, London."

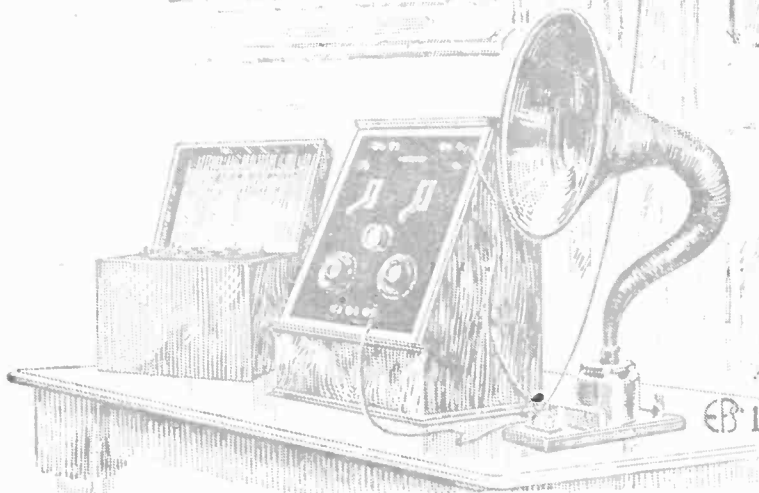
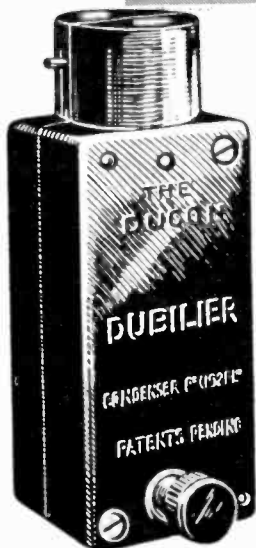

Note the reduced prices, 25% to 30% less.

## You'll get better results with far less trouble

if you use Fuller Patent Block Batteries for Wireless Work. Not only is the output *double* that of ordinary plate type batteries but the charge is retained for months on end when not in use—representing a great saving of time and money.

In addition the cells are assembled in Solid Ebonite Containers, so that the risk of fire from spontaneous combustion is eliminated.

The Fuller High Tension Block Battery is so constructed that there is complete absence of noise, giving clear reception. The Ebonite Containers used are far superior to Glass, which are always liable to break, and allow the acid to sink through the case, damaging furniture and carpets. Our High Tension Battery is good for eight years, and the cost of re-charging, normally required for every 4/5 months, is only a matter of a shilling or two. Dry Batteries on the other hand, are thrown away when exhausted, and have to be replaced by new Batteries from time to time, which of course proves very expensive.

These are only a few of the many reasons why Fuller Block Batteries are recognised as "*Perfect for Wireless Work.*" If you're keen on making the best of your Set see about getting one without delay. There's a Fuller Battery Service Agent near you.

*Sold by Wireless Dealers, Electricians and over 300 Fuller Battery Service Agents throughout the Country.*

## FULLER'S UNITED ELECTRIC WORKS LTD.

WOODLAND WORKS, CHADWELL HEATH - - ESSEX

Manufacturers for the Admiralty, Air Ministry and War Office for Wireless Components  
Telegrams: "Fuller, Chadwell Heath."

ELECTRICAL WORKS

# Fuller

CHADWELL HEATH, LONDON E.

## BLOCK BATTERIES

ACCUMULATORS - SOLID - NO PLATES



6-VOLT L.T. BATTERY.

In ebonite case with strap handle.

B.W.6/10 - - - 25/-  
B.W.6/20 - 40/- B.W.6/30 - 52/6



30-VOLT H.T. BATTERY.

Impregnated Wood Case with outside Terminals and sliding lid.

H.T.1 - - - 30/-

Dealers who are not fully stocked with these batteries should write us at once.

Telephone: Ilford 1200 (6 lines.)



# Reach out for Greater Distance

*A Test is Best with the Reliaphone Receiver*

## EFFICIENCY

This is the quality required in the modern Radio Receiver. The RELIAPHONE is a SUPER RECEIVER, designed by experienced RADIO ENGINEERS. It is for those who demand

modern Radio Apparatus of scientific construction, and is a revelation to those who have tried it out. Our method of assembling the various units assures perfection in operation.

*Type tested and approved  
by Postmaster-General*

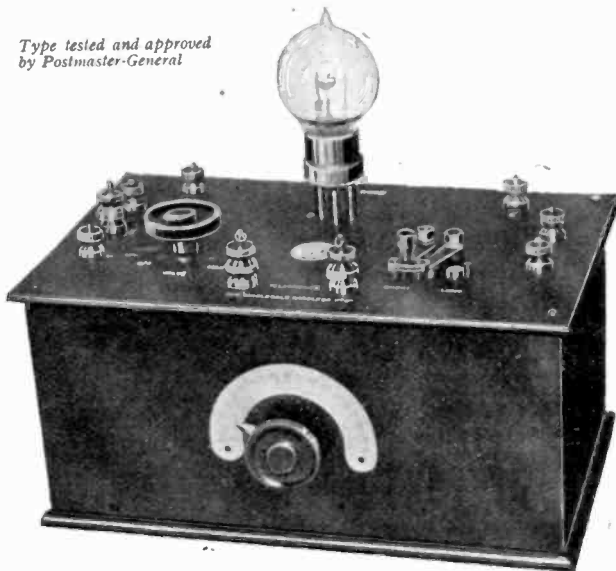

Range 50 miles  
P.O. Registered No. 1011.

PRICE :

**£7 : 10 : 0**

Including all Royalties.

Price, complete  
with accessories

**£12 : 10 : 0**

Including all Royalties.

A Wireless Set for Everyone, at a price anyone can afford.

Its outward beauty puts the RELIAPHONE in a class by itself, and its mechanical perfection is as beautiful to the Radio Engineer as its fine appearance to the layman.

Simple to operate, it is offered to you only after exhaustive tests have satisfied us that this Receiver gives the best possible results under all conditions.

### RELIAPHONE MEANS POWER OVER DISTANCE

It is a guarantee of Reliability.

#### ILLUSTRATED CATALOGUE SENT POST FREE

Containing full particulars of:—

<b>CRYSTAL SETS</b> —Phonotorall. Range 20 miles..	£2 9 6	<b>VALVE SETS</b> —Super Reliaphone No. 3, 200 miles	19 10 0
Simpliphone. Range 30 miles..	£2 17 6	Super Reliaphone No. 4, 175 miles	19 10 0
<b>VALVE SETS</b> —Super Reliaphone, No. 1, 100 miles	£14 10 0	Reliaphone Note Magnifier	5 5 0
Super Reliaphone No. 2, 75 miles..	14 10 0	Reliaphone Double Note Magnifier	8 10 0

The last instrument if connected to the Simpliphone gives excellent results with a Loud Speaker. Prices include all royalties.

**CALL AND HAVE A DEMONSTRATION. TRADE ONLY.**

*We invite application from firms desirous of handling our products.*

*Liberal terms and sole agencies offered to those possessing suitable connections and selling organisations*

**THE WHOLESALE WIRELESS CO., LTD.**

103, FARRINGDON ROAD, LONDON, E.C.1

Telephone: CLERKENWELL 5312.

WRITE  
FOR

OUR  
CATALOGUE

# WIRELESS TELEGRAPHY AND TELEPHONY

FIRST PRINCIPLES, PRESENT PRACTICE AND TESTING

By

H. M. DOWSETT, M.I.E.E.

Price **9/-** net. 331 Pages Post free **9/9**

*305 diagrams and illustrations.*

This book was written with a view to its acting as a connecting link between the elementary textbook and the advanced treatise or the specialised textbook.

It has behind it the long standing reputation of The Wireless Press, Ltd., and can be thoroughly relied upon.

## CONTENTS :

The Nature of Electricity and of the Atom—On Phase Displacement Effects in Elementary Circuits—The Spark Discharge—Continuous Wave Transmitters—Thermo-Ionic Effects and Oscillation Valve Phenomena—The Special Apparatus used for High-Speed Transmission and Reception—The Measurement of Electric Current and of Electro Motive Force—The Measurement of Resistance—The Measurement of Capacity—The Measurement of Inductance—The Measurement of Frequency—The Measurement of Dielectric Strength—The Measurement of Decrement—The Measurement of the Direction, and the Distance of Transmitting Stations, and the Intensity of Received Signals.

**THE WIRELESS PRESS, LTD.**

THE PIONEER HOUSE FOR WIRELESS PUBLICATIONS  
12 - 13, Henrietta Street, ——— London, W.C.2

OF  
**65**

WIRELESS  
BOOKS



**1/6**  
NET  
(Postage 2d.)

**MAST AND AERIAL CONSTRUCTION for AMATEURS**

By F. J. AINSLEY, A.M.I.C.E.

88 pages. Over 70 photos and diagrams.

This book is one which the amateur will read with gratitude to the author who has rendered a great service in removing the difficulties of mast and aerial construction. With the use of a few ordinary tools and by following the instructions given in the book this will be found a simple matter.

**1/6**  
NET  
(Postage 2d.)

**CRYSTAL RECEIVERS for BROADCAST RECEPTION**

By PERCY W. HARRIS.

80 pages. Over 70 photos and diagrams.

An explanation in popular language of the principles upon which the numerous receiving Sets now on the market are designed, the reasons for the differences between them, and how all of them can be adjusted for the greatest efficiency. Full Directions for building a simple Crystal Receiver for Wireless Telephone Broadcasting are also given.

**4**  
"HOW TO MAKE" BOOKS

The Wireless Press, Ltd.  
12-13 Henrietta St.  
London,  
W.C.2

**Construction of Amateur Valve Stations**

By ALAN L. M. DOUGLAS.

78 pages. 55 photographs and diagrams.

The aim of the author in compiling this volume has been to place within the reach of the amateur who is interested in wireless telegraphy and telephony a handbook which will enable him to obtain data that he has otherwise difficulty in acquiring, in order that he may construct for himself apparatus which he desires to make, but does not quite know how to design correctly.

**1/6**  
NET.  
(Postage 2d.)

**The Radio Experimenter's Handbook**

By PHILIP R. COURSEY, B.Sc.

113 Pages. 99 diagrams and illustrations.

The aim of the true wireless experimenter should not be merely to purchase a complete installation or to build one up from a complete set of working drawings, but rather to design his set to meet his own requirements. The object of this handbook is to foster, if possible, such an attitude by indicating the chief features of such design work and the principles upon which it depends.

**3/6**  
NET.  
(Postage 6d.)

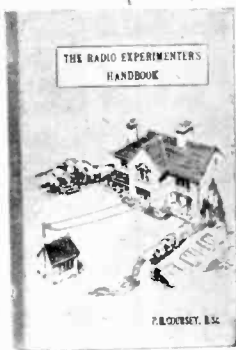

# OH, LOOK!

## A Variable Condenser without Spacing Washers

The **PERFECTA** Condenser has been approved of by the leading Radio Instrument Manufacturers because of its accuracy, efficiency and **PRICE**. This is not a Die Casting. The usual aluminium plates are assembled in a manner that is appreciated by all engineers, and any number of plates can be removed without affecting the general working.

Sold by all the leading Stores:—Selfridges, Ltd.; Brown Bros.; R. Melhuish, Ltd., etc.

National Physical Laboratory calibrations tests have been made, and the Min. and Max. capacity obtained.

**A FEW ADVANTAGES**:—Simple in construction. All bearings adjustable, all soldering dispensed with, unbreakable.



Patent Nos. 21108/22.  
App. Nos. 30667/22.

Plates inserted into polished aluminium cases—any capacity quoted for.

All wireless accessories quoted for at keen prices.

Special Discount given to Factors and manufacturers of Radio Instruments.

### PRICES.

Type.	Capacity.	Assembled for Panel or cabinet mounting.	Complete Knob and Dial. Specially finished polished Mahogany Cabinet.
No. 3	.001	12/9	22/-
No. 3	.0005	10/6	17/6
No. 3	.0003	9/-	15/-
No. 3	.0002	8/-	14/-
No. 3	.0001	6/9	13/-
Vernier		6/-	

Type.	Capacity.	Assembled for Panel or Cabinet.	Complete Knob and Dial. Specially finished Mahogany Cabinet.
No. 2	.001	25/-	30/-
No. 2	.0005	18/-	22/-
No. 2	.0003	14/-	17/-

**G. F. Barrington & Co. Ltd.** REG. OFFICES, 30 Red Lion Square, London, W.C.1

## Modern Radio Operation

By J. O. SMITH

Price **10/6** Nett Post free 11/-

### A BOOK of AMERICAN PRACTICE

#### List of Chapters.

1. The Radio Telephone.
2. Transmitting Equipment Used in Radio Telephony and Its Operation.
3. Typical High Power Broadcasting Stations.
4. Receiving Equipment for all Purposes and Its Operation.
5. Spark v. Continuous Wave Transmission.
6. Vacuum Tube Fundamentals.
7. Operating Characteristics of Vacuum Tubes.
8. Methods of Obtaining Plate Potentials, and Types of Continuous Wave Transmitters.
9. Continuous Wave Transmission by Amateurs.
10. Tube Transmitters in Commercial Work.
11. Advantages of a Counterpoise Ground in Connection with Tube Transmitters.

150 Pages.

Over 50 Illustrations.

**The Wireless Press, Ltd.**  
12/13, Henrietta St., London, W.C.2

### American

## THE A.B.C. of VACUUM TUBES USED IN RADIO RECEPTION

by **E. H. LEWIS**

132 Pages.

48 diagrams and illustrations.

Price **6/-** Nett

(Post Free 6/5)

Written particularly for those who know nothing about wireless, but who desire an understanding of the elementary principles of operation of vacuum tubes, and various circuits in which they are used for reception of wireless telegraph signals, music and speech by wireless telephone.

**The Wireless Press, Ltd.**  
12/13 Henrietta St., London, W.C.2

# R.E.C. HEADPHONES

TYPE A.1.

**25/-**

**EACH**

including cords  
(Subject)



4000  
ohms

BRITISH  
MANUFACTURE  
BY TEST  
THE BEST

## The Radio Equipment Co., Ltd.

329, HIGH HOLBORN : : LONDON, W.C.1

Telephone : Holborn 1229.

Telegrams : "Exportation, Holb. London."

## WIRELESS BARGAINS

Lam. Switch Arms with bush for panel	1/-
Filament Rheostats, for panel mounting, complete with pointer	2/8
Crystal Detectors on ebonite bases	2/-
Ivoryine Scales, 0-180	6d.
Engraved Condenser Scales with Knob, 0-180, with locking screw	2/6
Valve-holders, screwed legs with nuts	9d.
1 and 2 mf. Condensers	1/9
3 Mf. Condensers	2/6
120 Watch Type Receivers with cords	4/-
Ediswan R Valves, 15/-, sent at customer's risk	15/-
Microphones with replaceable Insets	2/6
Telephone Cords for double headphones	2/6
Silk Wire Stranded Broadcasting Coils, per set	2/9
4-Section Portable Masts, 11' 6" strong brass sockets	5/6
H.T. 16-Volt Wander Plug, H.T. Batteries	3/-
Mark III* Crystals, in cups	per doz. 3/6
Telephone Magnets, wound to 60 ohms each	per pair 1/-
H.T. Battery Boxes, polished teak, etc., well made, with plugs and 9 sockets and hinged door, 10 1/2" x 13 1/2" x 5"	6/-
Instrument Cases, Walnut, with hinged lid and carrying handle	5/-
Ericsson Nickel-plated Microphones	5/-
2" Reel Insulators	2d.
H.T. Plugs, with cord and tay	6d.
H.T. Sockets with nuts	3d.
W.O. Pattern 4 B.A. Terminals with nut and washer	2d.
Radio Lightning Arresta with Terminals	1/9 and 2/9

OTHER LINES IN STOCK.

Carriage paid on orders over 20/- All goods guaranteed.

**C. S. SWAN,**  
**191, Bishopsgate, E.C.2**

(Under Brandon's, Tailors) and 65, Windsor Road, Leyton, E.10.  
Phone, Bishopsgate 1556.

# STOP

When passing our Show Rooms  
and obtain a piece of the famous

## ELECTRONITE CRYSTAL

Your signals will be louder  
and your pleasure greater.

PRICE 5/- per oz. or 1/- per piece.

ESTABLISHED — 1920

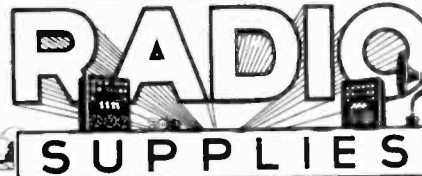

234, HIGH HOLBORN, LONDON, W.C.1

Phone: Holborn 2188

# RADION

MAHOGANITE

This is the latest product of our Factories—a superior insulating material for high grade sets, which in grain and colour closely resembles mahogany. Its high insulating and non-warping properties, combined with a beautiful finish, make it an ideal material for Panels.

The Trade are warned against imitations—ordinary mottled Ebonite is *NOT* RADION - MAHOGANITE. All genuine Sheets are stamped "RADION".

*Enquiries from bona-fide Manufacturers and Wireless Dealers solicited.*

AMERICAN HARD RUBBER  
COMPANY (Britain) LIMITED,  
13a, Fore Street, London, E.C.2

TELEPHONE—18754 CENTRAL.



TRADE MARK

The **WHITECROSS**  
COMPANY, LIMITED  
:: WARRINGTON ::

Manufacturers of All Descriptions of  
**WIRE ROPES**  
**AND WIRES**

# SIEMENS

## WIRELESS ACCESSORIES



**TELEPHONE HEAD SETS** (approved by Postmaster General) specially designed for wireless work. Terminals enclosed to prevent receiving circuit being interfered with. Earpieces are provided with groove on surface to minimise condensation of moisture.

**VACUUM PROTECTORS** for protection against fire or damage by lightning. Will operate many times before renewal is necessary.

**AERIAL WIRES & INSULATORS**  
**EARTHING DEVICES, FUSES,**  
**SWITCHES, JACKS & PLUGS,**  
**H.T. BATTERIES,**  
etc. etc.

ALSO MANUFACTURERS OF  
**BROADCASTING WIRELESS RECEIVING SETS**

Descriptive pamphlet and prices on application to  
**SIEMENS BROTHERS & CO., LTD.**  
**WOOLWICH, LONDON, S.E. 18**

Telegrams—Siemens, Woolwich.

Telephone—City 6400

And at

BELFAST—36, Mill St. BIRMINGHAM—111, New St.  
BRISTOL—30, Bridge St. CARDIFF—57-59, St. Mary St.  
GLASGOW—40, Wellington St. & 141, St. Vincent St.  
LEEDS—129, Park Lane. LIVERPOOL—81, Dale St.  
LONDON—38-39, Upper Thames St. MANCHESTER—  
196, Deansgate. NEWCASTLE-ON-TYNE—64-68, Colling-  
wood Bldgs. & Exchange Bldgs., Quayside. SHEFFIELD—  
22, High St. SOUTHAMPTON—46, High St.

**SEA, LAND & AIR** THE AUSTRALIAN MONTHLY JOURNAL  
of Aviation, Radio-Telegraphy and Radio-Telephony

Price 1/9 Post Free.

Annual Subscription 21/-

THE WIRELESS PRESS, LIMITED, 12-13, HENRIETTA STREET, STRAND, W.C.2

# THE WIRELESS WORLD AND RADIO REVIEW

THE OFFICIAL ORGAN OF THE RADIO SOCIETY OF GREAT BRITAIN  
A MAGAZINE DEVOTED TO WIRELESS TELEGRAPHY AND TELEPHONY

## CONTENTS

The Radio Conference	- - - - -	587
A Chat with "The Voice" at 2 LO	- - - - -	589
Experimental Station Design	- - - - -	592
Electrons, Electric Waves and Wireless Telephony (XVIII). By Dr. J. A. Fleming, F.R.S.	- - - - -	596

*Contents continued on next page.*



### GREAT BARGAIN OFFER

4,000 ohm PHONES (NEW)  
at 17/6 Per Pair. Postage 9d. extra.

Fitted headbands and cords, beautifully finished, thoroughly efficient. Each pair care fully packed in box. SATISFACTION GUARANTEED.

**BROADCASTING RECEIVING APPARATUS.**  
The "JOYPHONE" (Reg. No. 0138) approved type, 2 Valve Set, complete from  
**£15 : 0 : 0**

Special Offer at Reduced Prices of our

### NEW INTERVALVE TRANSFORMER

Owing to the unexpectedly large sale of these instruments we are enabled to reduce the price to "Wireless World" readers to

**12/4**

Postage 9d. extra.

Fitted with panel fixing plate and earthing wire for iron core. Fully tested. Ratio 5 : 1.

All valve apparatus manufactured by us is duly licensed under Marconi's Patents for amateur use in Great Britain. Approved by Postmaster-General.



**TERMINALS.**  
4 B.A. Double Solid Brass or Plated 2/- per doz. (post extra).  
2 B.A. Single Solid Brass or Plated 9d. per doz. (post extra).  
We have enormous stocks of ex-WD WIRELESS GEAR, too numerous to mention, at absurdly low prices. Write for particulars of your requirements, or better still, call and see our enormous stocks.

**J. LIPOWSKY & CO.** 614, OLD FORD ROAD.  
Near Old Ford Station N.L.Rly. Telephone : EAST 3345. Nos. 8 or 39 'Bus.

**STALLOY** **TRANSFORMER LAMINATIONS**  
 SOLE MANUFACTURERS **JOSEPH SANKEY & SONS LTD** AND SUPPLIERS  
 WORKS: BILSTON, STAFFS. London Office: 168 RECENT ST. W.L.  
**TELEPHONE RECEIVER DIAPHRAGMS**

## CONTENTS *(Continued)*

Refinements in Receiving Circuits	- - - - -	601
A Simple Type of Filament Resistance	- - - - -	602
A Simple Reinartz Tuner	- - - - -	604
Wireless Club Reports	- - - - -	606
Notes	- - - - -	610
Calendar of Current Events	- - - - -	612
Questions and Answers	- - - - -	613

THE WIRELESS WORLD AND RADIO REVIEW is published weekly on Saturdays.

All correspondence relating to contributions should be addressed to THE EDITOR, THE WIRELESS WORLD AND RADIO REVIEW, 12-13, Henrietta Street, Strand, London, W.C.2.

No responsibility can be taken for MSS. or photographs sent without stamps to defray cost of return postage.

Editorial and Publishing Offices: 12-13, Henrietta Street, Strand, London, W.C.2.

Telegraphic Address: "Radionic, Rand, London." Telephone No.: Gerrard 2807.

Advertisement Managers, Bertram Day & Co., Ltd., 9 and 10, Charing Cross, S.W.1.

Telephone No.: Gerrard 8063 and 8064.

### SUBSCRIPTION RATES.

28s. per annum, post free. Single Copies 6d., or post free 7d.

Registered at the G.P.O. for transmission by Magazine Post to Canada and Newfoundland.



**WHY NOT LET YOUR FRIENDS HEAR?**

We have a NEW TYPE of 2-valve Amplifier that will easily attach to a CRYSTAL or VALVE SET. Mounted in Mahogany Case.

PRICE £5  
with Valves 3  
Royalties £8

Phone :  
Gerrard  
8806

Offices and Showrooms :  
**110, STRAND, LONDON, W.C.2**

Phone :  
Gerrard  
8806



# THE WIRELESS WORLD AND RADIO REVIEW

THE OFFICIAL ORGAN OF THE RADIO SOCIETY OF GT. BRITAIN

No. 181 [No. 18.  
VOL. XI.]

FEBRUARY 3RD, 1923.

WEEKLY

## The Radio Conference

ON the afternoon of Wednesday, January 24th, at the Institution of Electrical Engineers, was held the Annual Conference of Societies affiliated with the Radio Society of Great Britain.

It sometimes happens that with a well-established event the circumstances under which it originated may be overlooked. It may therefore not be out of place to consider for a moment what led to the inauguration of the Annual Conference of Wireless Societies, particularly for the information of those who have only during the past year begun to interest themselves in wireless matters.

The Radio Society of Great Britain, in former years known as "The Wireless Society of London," had taken upon itself the work of representing the amateurs and experimenters of Great Britain, to voice their wishes and feelings wherever it was necessary to give expression to them. In fact, one of the objects of the Society is to act as the champion of the amateur and experimenter in this country in protecting his interests wherever such action is necessary.

The idea of affiliation of Provincial Societies to the London Society was the outcome of the endeavour to represent in one voice the opinion of the amateurs all over the country.

The conference of delegates from provincial societies with the officers of the Radio Society of Great Britain, was very naturally a part of the general affiliation scheme, and therefore these conferences may be regarded as the means adopted for feeling the pulse of the amateurs. These Conferences present the opportunity for an expression of opinion, not only to form a guide to the Radio Society of Great Britain in its policy, but also to arrive at decisions regarding any action which the amateurs as a collective body may wish to take. The Conference may be said to result in direct

action, since the very purpose of the Conference is for the expression of opinions of amateurs as a body, and it would be unreasonable to suppose that a definite resolution passed by that Conference would not be put into effect at the earliest possible moment.

It is perhaps well to emphasise that this Annual Conference has no power to concern itself with the internal organisation or policy of either the Radio Society of Great Britain or of any of the societies affiliated, and represented at the Conference. Mention is made of this point since, for amongst the delegates from affiliated societies at the Conference just held, there was one who apparently misunderstood the purpose of the Conference, and supposed, until corrected, that the delegates from other societies were invited to make suggestions regarding internal affairs of individual societies.

The Conference on this occasion was even more fully attended than usual. No doubt this is partly due to the very considerable increase in public interest in wireless during the past year. It is somewhat surprising that, after so busy a year, the items on the agenda for discussion should not have been more numerous than was the case.

A report of the proceedings of the Conference will be published in this journal in due course, but it is perhaps of interest to summarise briefly the matters which claimed attention, and, with this object in view, they will be considered in the order in which they were dealt with. The Radio Society of Great Britain had felt for some time that the views of the provincial societies on matters of importance could perhaps be more adequately expressed if conferences were held at more frequent intervals than once a year, and with this object in mind, some tentative suggestions were circulated to the affiliated societies for

their views in order that the matter might be discussed at the Conference.

The net result of the expression of these views, and the subsequent discussion at the Conference, indicated that the present arrangements were considered to be adequate for the time being, and many delegates spoke to the effect that their societies were well satisfied with the arrangements as they stood at present.

The next matter which was dealt with was the British Wireless Relay League. It will be remembered that in a recent issue of *The Wireless World and Radio Review* reference was made to the fact that the Manchester Wireless Society had requested that the subject of the British Wireless Relay League should be included on the agenda of the Conference in order that its organisation might be discussed and the way paved for fuller co-operation of all societies in the organisation of the League. The formation of such a League met with very considerable support from the delegates present at the Conference, and the Radio Society of Great Britain intimated its desire to associate itself with the development of the scheme. It was, however, pointed out that whereas in the U.S.A. the American Radio Relay League is a very large organisation formed expressly for the purpose of relaying messages from point to point, work of this nature would be more restricted in Great Britain. This is largely due to the fact that the area over which these transmissions are to be conducted is small in this country in comparison with the vast stretches of country in the United States of America. It was indicated, however, that a wider field was open, since co-operation in some such scheme had been invited by amateurs in France and elsewhere, and therefore, with the assistance of the American amateurs, and especially in view of the extraordinary success of the recent Transatlantic Tests, there appeared to be scope for the Relay League to develop on international lines.

Mr. P. R. Coursey who, as readers of this journal are aware, has conducted on this side the work of organising the Transatlantic Tests, indicated that there was much additional work which a Relay League could undertake beyond the mere relaying of messages, and his proposals will be given in the report of the Conference to be published later.

The subject of broadcasting was included on the agenda, and was divided under two headings: (1) How broadcasting affects the

amateur licensed to transmit, and (2) the amateur licensed for experimental reception only. Many opinions were expressed on this subject, and it was generally recognised that the work of the amateur, particularly in experimental transmissions, had been considerably affected by the introduction of broadcasting, but at the same time it was realised that there were many compensations provided by broadcasting itself. In many cases of experimental work it was extremely valuable to have telephony transmissions on which one could rely, both as regards time and wavelength, and this was particularly useful in conducting experimental work with distortionless amplifiers, loud speakers, and other types of speech reproducing instruments.

Mr. Reith, General Manager of the British Broadcasting Company and a member of the Radio Society of Great Britain, was present and took upon himself to reply to some points which were raised. His remarks did much to clear up certain matters with regard to some of the difficulties which had arisen between the experimenter and the Broadcasting Company, and his clear statements satisfactorily defended the action of the Company. He emphasised the debt which the Broadcasting Company and the public generally owe to the work of the amateur and experimenter, and in his capacity as General Manager of the Broadcasting Company he assured the Conference that his Company, far from having any antagonistic feelings towards the activities of amateurs and experimenters generally, welcomed and valued their co-operation, and under no circumstances would the Broadcasting Company ever take any steps which would adversely affect the work of the experimenter.

For the first time in the history of these Conferences no special resolutions were passed, and no new proposals for the conduct of amateur activities were outlined. The first impression might be that on this account the Conference had not achieved so much as in past years, but on reflection one realises that it is a strong indication that there are no serious grievances to give voice to. It is of course realised by every amateur in the country that everything is not quite as it might be, but at the same time it is understood that, in all development and progress, perfection cannot be attained in the initial stages, and it behoves everyone to exercise reasonable patience and to contribute what he can to facilitate the tasks of others.

## A Chat with "The Voice" at 2 LO.

**A** MIDST a sequence of telephone calls and visitors, Mr. Burrows was able to give *The Wireless World and Radio Review*, at Magnet House, Kingsway, the other afternoon, some ideas of his experiences to date.

"As broadcast wireless telephony goes, I suppose I can claim to be a veteran," he said. "My views on this subject were expressed in the *Year Book of Wireless Telegraphy*, 1918, and in an article written some months before. My first serious essay in this direction was a week's programme transmitted in North Atlantic at the end of July, 1920. The C.P.O.S. *Victorian* was then equipped with a 3-kilowatt telephony transmitter, and our concerts were heard at ranges up to 1,200 miles. As the *Victorian* was riding light, and I am not a good sailor, the voyage will remain long in my memory. The North Atlantic programmes were freely encored, ships from all points of the compass up to 600 or 800 miles

'chipping in' on 600 metres at the end of each item and passing an opinion. Needless to state, after the 1920 experience, it was somewhat irksome to have to sit tight in London and watch the growth of broadcasting in America.

"We are hoping to show that England, though late, as usual, in starting systematically, will not be long in overtaking her rivals. By singular good fortune and with the collabora-

tion of Mr. W. J. Crampton, the Covent Garden engineer, we were able to mark the opening of our official duties by arranging for the broadcasting of the excellent performances of Grand Opera by the British National Opera Company, Ltd., at Covent Garden. Mr. Crampton will be known to many of your readers as a most keen experimenter; his station has been heard, I understand, as far distant as Nice.

"Only an agreement amongst the principal members of the Broadcasting Company whereby the several companies sink their identity in the one title restrains me from mentioning those to whom we are particularly indebted for the technical success of the experiments. In view of the fact that we had no choice in the selection of sites for the two microphones employed, I think it may safely be classed amongst the most ambitious and most successful series of transmissions yet attempted on this or the other side of the Atlantic.

"The effect upon the British industry, I am told, has been very marked. This is very gratifying to one whose business it is to provide from behind the scenes such a standard of programme as will not merely maintain, but will intensify the interest now created.

"Have I had any unusual experiences to date? Yes, many of a most pleasant character, some amusing, and one or two sad. The most delightful, unquestionably, have been the nume-



*Mr. A. R. Burrows whose voice at 2 LO is so familiar. Copies of this picture can be obtained from the Publishers of The Wireless World. See announcement under Notes in this issue.*

rous letters of appreciation, seasonable cards and gifts to charities, to my staff and myself from 'children of all ages.' We broadcasters have struck a world of live fairies, open-hearted folk quite apart from the world as presented in everyday life. I can assure you that no day is too long in which to work for such a community. I only wish it were possible, too, to reproduce some of the hundreds of letters expressing in 'baby language' the delight our bedtime antics have given to the young folk.

has caused many a smile amongst those concerned.

"Midway between humour and the pathetic are to be found such things as requests in all good faith that we should broadcast messages to the planetary system, or jam certain other stations alleged to be exerting a malign influence over those within range.

"A few days ago as I was leaving for lunch, a stranger requested an interview on an urgent matter. He approached me in a most business-like way, stated that despite the character of

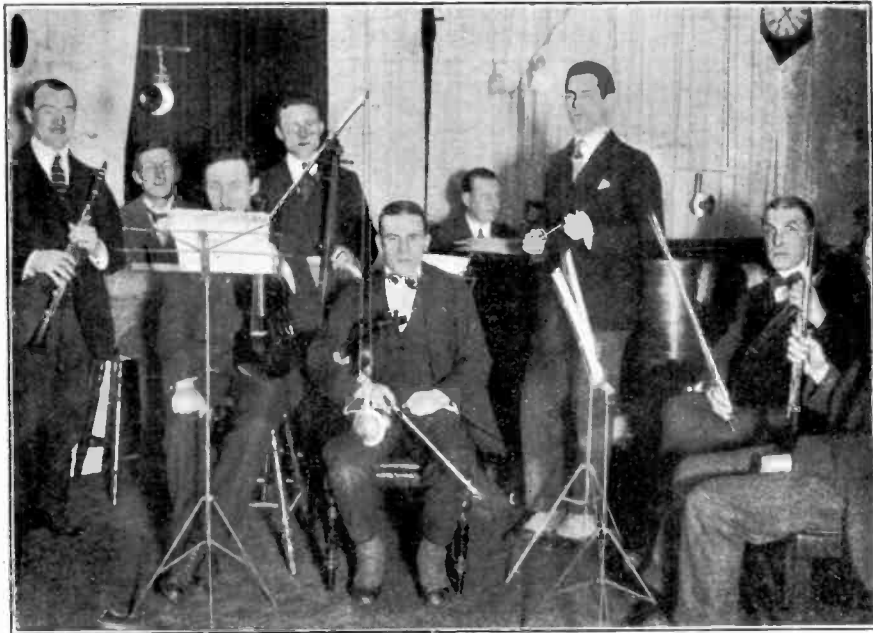

"The Wireless Orchestra" at 2LO poses for "The Wireless World." Standing on the right is Mr. Stanton Jeffries, Musical Director of the British Broadcasting Company.

"Wireless humour takes many forms. During the last week of Grand Opera we were threatened with shooting if we permitted interpolations during the performance of 'Valkyrie.' You noticed, perhaps, that there were no interpolations. This was not due to the threat, but to the fact that 'Valkyrie' did not lend itself to such treatment.

"Amongst the humours of broadcasting we can class many amusing criticisms in prose and rhyme, not excepting letters sometimes suspiciously feminine in origin respecting the identity and domestic life of those who take part in the wireless programmes. The erroneous suggestion, too, that we have come under church influence in our decision not to broadcast during the hours of Divine worship,

his story he would come to the point at once. Would I kindly broadcast without delay the fact that his wife and £40,000, their joint property, had just been abducted?

"What are our plans for the future? Well, the first business is to get all the necessary stations functioning. Cardiff is practically ready, and may start any day. Glasgow will have a station working before the end of March.

"Our ambition then will be to so ring the changes in the style of programme that every popular interest will be catered for at reasonable intervals. We hope to settle our programmes a week and possibly a fortnight ahead, so that listeners-in can adjust their several engagements so as to meet their wireless

tastes. There is no form of entertainment under the sun that can claim the attention of its adherents seven nights a week and yet not surfeit them.

"Whilst the concert side of broadcasting will always have a strong appeal, I believe the permanence of this new development will depend rather on the manner in which the instructional and educational sides are developed. The wealth of romance yet untouched which lends itself peculiarly to treatment by wireless, is enormous; our task is to find persons capable of recognising the raw material, refining it, and able to present it in an attractive form.

"It may be taken for granted that the success of the Covent Garden experiment will lead to other equally important applications. We have shown that intricate musical sounds can be collected from a building without any interference with its structural or acoustic arrangements. How much less difficult should be the broadcasting by similar means of human speech, and how great the field here awaiting development.

"I would, however, ask indulgence in one respect. We are yet without permanent offices, owing to certain circumstances of a technical character. Until our new and permanent studio

is ready, there are limitations upon our programmes which would not otherwise exist, difficulties which only arise when dealing with music on a large scale.

"*The Wireless World and Radio Review*, which I regard as specially catering for the experimenter, will perform a kindness if it permits me to express to those possessing transmitting licences, my high appreciation of the sacrifices which they must have made in foregoing transmission during broadcasting hours on the wavelength fringing the broadcasting band. No one is more sensitive than myself to the kindness of these experimenters, and I regret if in calling isolated defaulters to order, we may have attached to others in any one locality a suspicion that was unjustified. We would like the class of true experimenter to know that they have friends and not enemies in the staff of the British Broadcasting Company, who are appreciative of the fact that the progress made by Britain will be dependent to a marked degree upon the co-operation of all followers of this fascinating branch of applied science.

"Now I think it is time for a repetition of the old formula—except for this elaboration—2 LO, 5 IT, 2 ZY and 5 NO closing down."

#### EXAMINING BROADCAST INSTRUMENTS AT THE G.P.O.

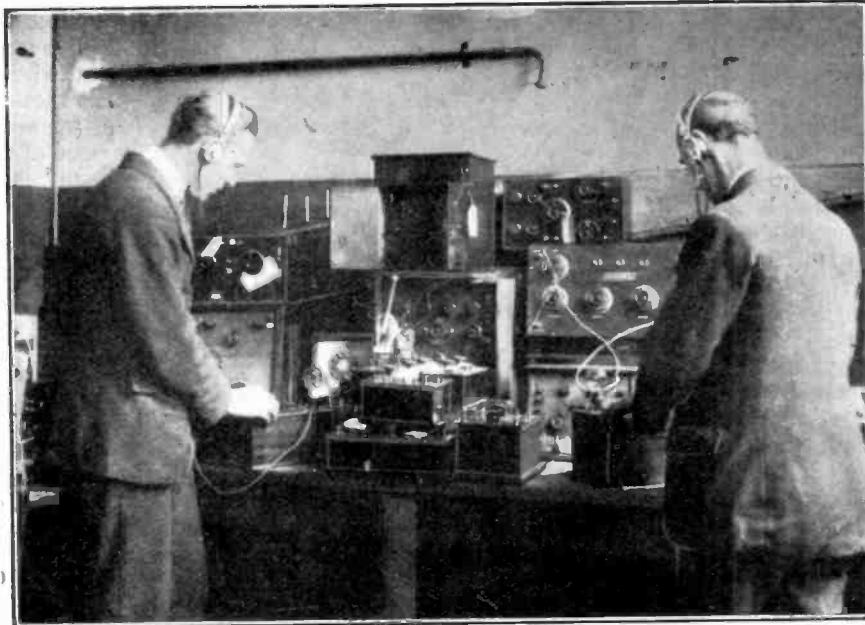

*Some of the Apparatus submitted to the Post Office for approval by manufacturers of broadcast receiving equipments.*

# Experimental Station Design

## XIX.—RECTIFIED H.T. FOR C.W. AND TELEPHONY TRANSMITTER.

**I**N the last instalment under this heading a description was given of the method of setting up a low power C.W. and telephony transmitter. The present article describes a method of obtaining the necessary high potential current required by such a transmitter, and is based on the principle of stepping up moderately high frequency alternating current and rectifying by means of suitable valves.

The first consideration is the transformer which provides the requisite current for heating the filaments of the rectifying valves. It is a low voltage transformer of course, but it is essential that very good insulation be provided between the primary and secondary, as the full high tension potential exists between these windings. Fig. 1 shows the general principles to be adopted in building up a transformer of this kind. Insulation is effected between the windings by means of an ebonite tube having a wall thickness of about  $\frac{5}{8}$  in., whilst the secondary winding does not completely cover the primary winding in order to leave insulating surfaces at the ends. These surfaces can be further increased and insulation thus improved, if screw threads are cut upon them, the threads serving also for attaching the end cheeks of the

secondary winding. Definite data as to the windings cannot be given, as it will depend upon the power and frequency to be employed, and must be estimated or calculated, final adjustment being made by experiment and the use of a series choke coil if required. The amount of iron employed in the design

given is quite suitable for powers up to 100 watts on frequencies exceeding 250 cycles. The core wires of the two limbs are assembled centrally around the soft iron rod and are wrapped tightly together by means of a layer of adhesive insulating tape upon which the primary, which should be a wire having a double cotton covering, is wound. The end primary turns should be held in by means of tapes as was shown in the issue of September 30th last. Tape may also be wrapped over the primary winding, if necessary, in order to make the insulating tube fit tightly. The secondary winding is put on after the cheeks have been fitted in position,

the end turns being secured by means of tapes as before. If the making of the screw threads is not convenient the cheeks may be held together by means of an insulating tube which fits over the top of them, and to which they are attached by a number of 6 BA screws. If

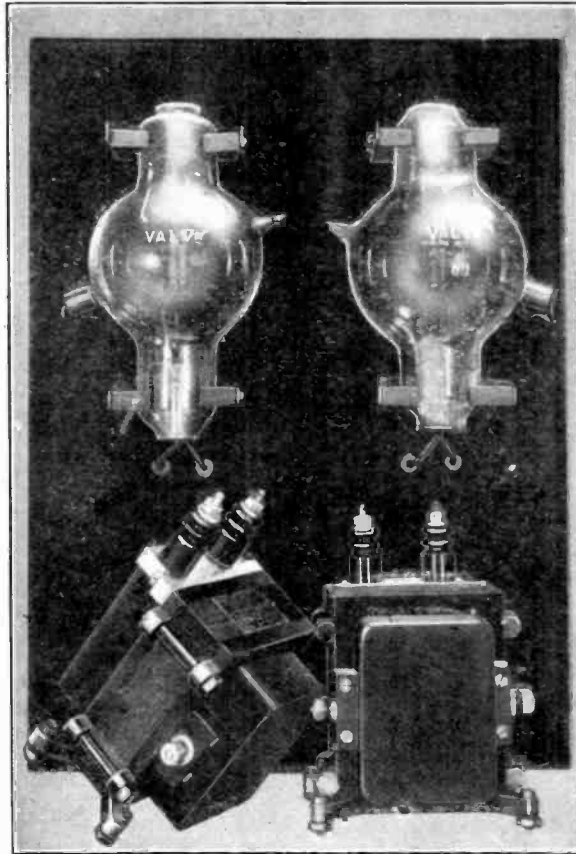

*Rectifier Panel with a pair of step-up transformers, which when connected in series, provide a mid-point tap.*

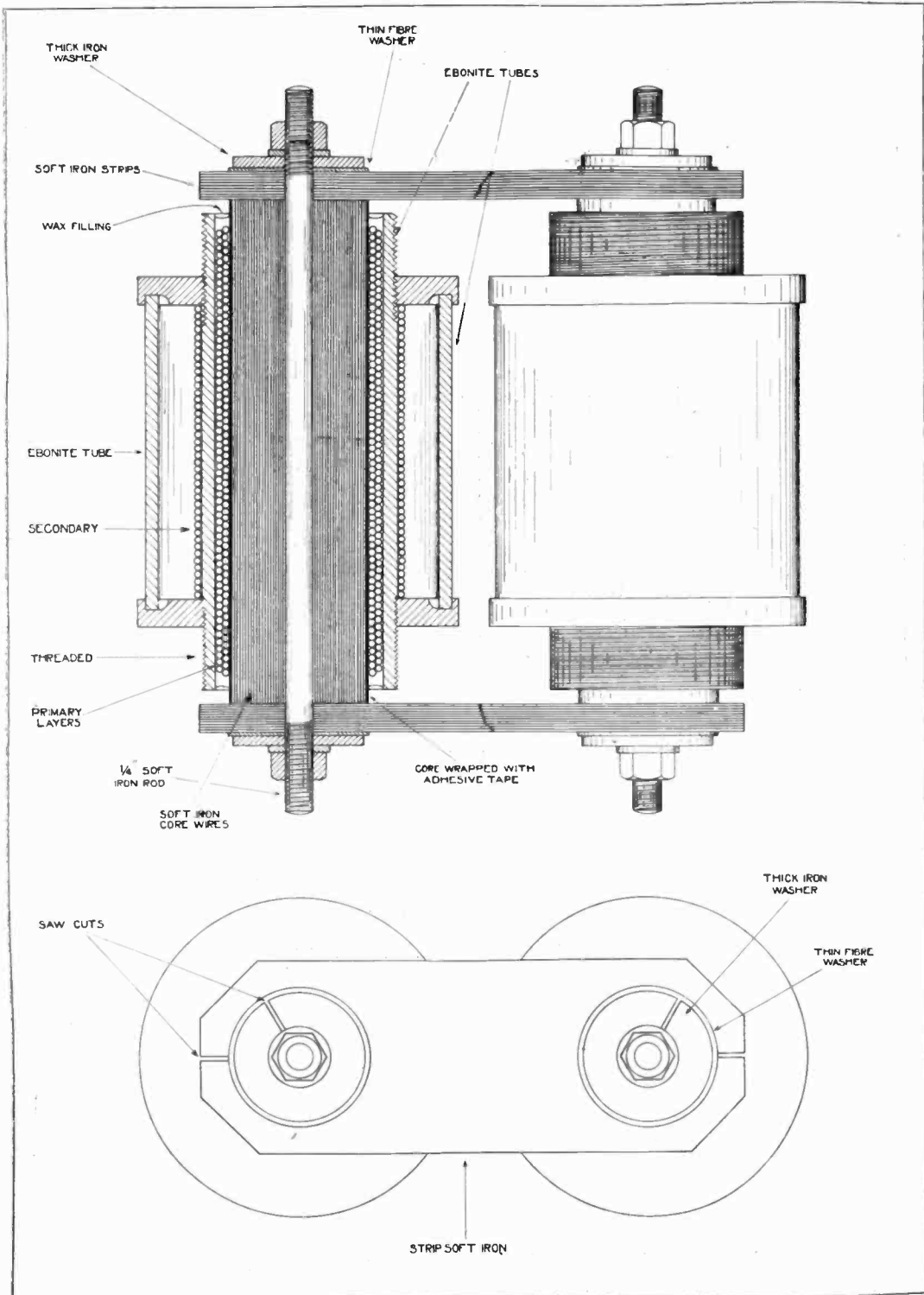

Fig. 1. Filament Heating Transformer. High insulation is provided between primary and secondary winding. Approximately half full size.

this latter arrangement is adopted the cheeks must be a good fit on the tube which covers the primary. With patience these cheeks may be made without a lathe by carefully filing down to scratch lines, and as the screw threads cannot be made without a lathe, it is assumed that a tube will be fitted over the cheeks and consequently the grooves on their inner faces will not be required. On the completion of the cores with the windings hot wax is run into the ends of the primary.

The end plates are cut from soft iron strip, which can easily be obtained in almost any width. Each plate is drilled in turn, and the saw cuts which are provided in order to minimise eddy current loss are made when the plates are clamped together in the vice. Stiff washers are placed under the end nuts, and in order to provide a little "give," thin fibre washers are arranged under them. There is no difficulty in assembling, if the core wires are all true to length, and there should be no difficulty in this respect as they can be purchased already cut to any exact inch.

A second transformer will be required to provide a step-up in potential. In outline it may be similar to the one described above except that the secondary winding will consist of a large number of turns of No. 30 or 32 S.W.G. single silk-covered wire. The secondary will consist of a number of flat disc windings about  $\frac{1}{8}$  in. in width. These must

of this transformer in order to eliminate any chance of sparking across.

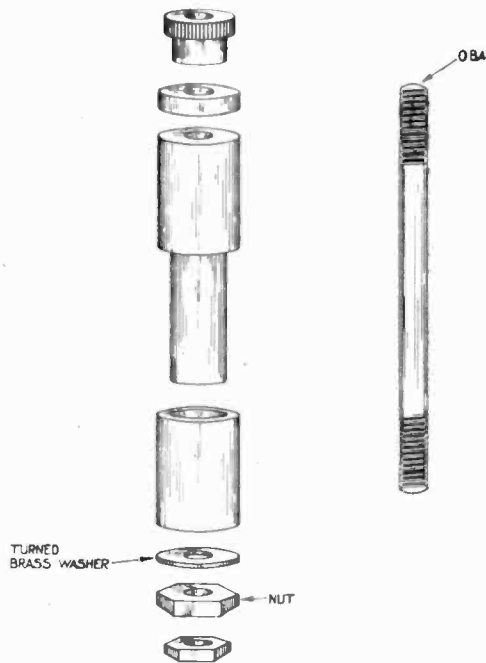

Fig. 3. Insulating Bushes.

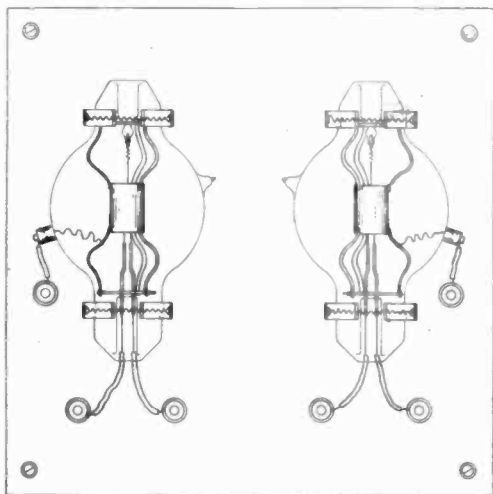

Fig. 2. Lay-out of Rectifier Panel.

be wound on a former consisting of spindle, spacing washer and two flat plates. A larger space must be given between the two limbs

The type of valve adopted for rectification obviously governs the design of the panel. The reader is recommended to adopt valves of liberal rating with regard to the power he proposes to use. The panel shown in Fig. 2 is arranged to carry valves rated up to 100 watts capacity, though they can be operated with a much smaller output. The panel is of polished slate, such as can be obtained from specialists in this class of work, and who advertise from time to time in this journal. Slate can be easily drilled with an ordinary Morse drill and brace, though it should be remembered that the size of the hole will be slightly larger than the size of the drill with which it is made. This is important when making the holes which carry the ebonite bushes for the filament and plate leads. A design for these bushes is given in Fig. 3, being turned in ebonite. For simplicity ebonite tube  $\frac{1}{2}$  in. in diameter, and having a  $\frac{1}{4}$ -in. hole, may be adopted, and the actual leads from the valves passed through these tubes, which must fit tightly in the holes made in the slate.

Holders for the valves are shown in Fig. 4, in which sufficient detail is included to show the method of construction. Fig. 5 is the



circuit diagram of the rectifier. The condenser shown across the secondary of the plate current transformer may not be necessary, as will be shown by experiment, and in any case should not have a value exceeding  $0.0003 \mu\text{F}$ . The other condensers which are for the purpose of smoothing out ripple, must, like the one just mentioned, be capable of standing high potentials, and consequently should consist of a number of mica condensers assembled together and connected in series. If the reader attempts to make condensers of this sort himself, he must select the best ruby mica for the purpose. If it has a thickness of  $0.002$  in. then four condensers in series should be suitable for voltages not exceeding 1,800. The capacity of these condensers will depend upon the frequency of the generator and for a frequency of 300 cycles condensers having a value of  $0.2 \mu\text{F}$  will suffice. One is cautioned against operating the rectifier without taking a load. If this is done there is a great danger of breaking down the condensers. The choke coil shown between the condensers may have similar core construction to that adopted in Fig. 1, but possessing only one winding of No. 28 S.S.C. on each limb, and if these windings are well insulated from

that they are correctly connected as to direction. The outfit described above might appear to involve a big expenditure, but the reader

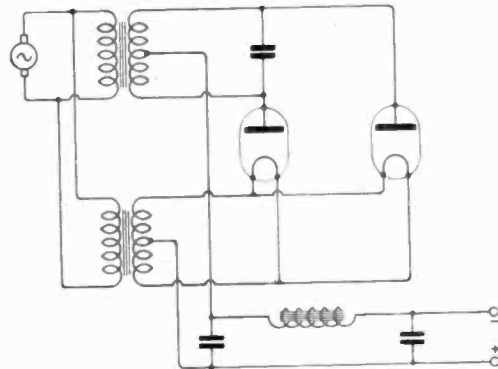

Fig. 5. Circuit of Rectifier.

whose purse is limited is reminded that there is still a great deal of second-hand high tension transformer apparatus on the market which is admirably suitable for stepping-up or choke purposes, or if rewound can be used for filament heating. Owing to the somewhat limited demand for this class of apparatus, the prices are by no means excessive. F. H. H.

*Note.—Although it was the original intention in articles under this heading to give designs of special value to the beginner, departure has had to be made owing to the widespread demand for particulars of simple telephony transmitting apparatus. Now that the information has been placed on record, this space can in future issues be allotted to articles of a less advanced nature.*

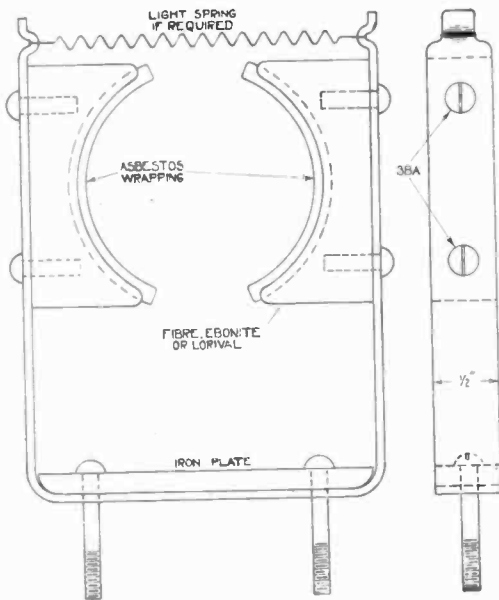

Fig. 4. Clips for supporting valves.

one another, better smoothing effects may be obtained by correcting one in each lead from the rectifier, making sure, by experiment,

### Dimensions of the Amateur Aerial

Although the regulations relating to dimensions of aerials permitted for amateur and broadcast reception purposes have been published in this Journal, and also frequently stated in replies to queries in the Questions and Answers columns, there still appears to exist some doubt on the matter. The maximum aerial length is stated as 100 feet, as measured from the far end of the aerial to the aerial terminal of the apparatus. Multiple aerials, consisting of a number of wires, each totalling 100 feet with the down lead, may be adopted, and from this point of view it would appear that when a "T" pattern aerial is employed, only one-half of the horizontal length is taken, in estimating an aerial arrangement conforming to the regulations.

# Electrons, Electric Waves and Wireless Telephony—XVIII.

By Dr. J. A. FLEMING, F.R.S.

The articles appearing under the above title are a reproduction with some additions of the Christmas Lectures on Electric Waves and Wireless Telephony given by Dr. J. A. Fleming, F.R.S., at the Royal Institution, London, in December and January, 1921-1922. The Wireless Press, Ltd., has been able to secure the serial rights of publication, and any subsequent re-publication. The articles are therefore copyright, and rights of publication and reproduction are strictly reserved.

## 4. RECEPTION OF WIRELESS TELEPHONIC SPEECH.

We have then to describe the arrangements in the practical receiving apparatus. The use of a single rectifying valve or a crystal in the receiving circuit as already described is only suitable for short ranges of 10 or 20 miles, or so, from fairly powerful transmitters. In actual wireless telephony over great ranges it is necessary to employ amplifying valves to magnify the oscillatory currents in the receiving circuits.

We have already explained that this amplification can take place on the high frequency currents set up in the aerial wire and associated circuits by the carrier waves, or it may be effected after rectification of the high frequency

C and inductance coil S. A three-electrode valve has its grid and filament respectively connected to the terminals of the tuning condenser C.

The variations of potential thus produced in the grid cause similar changes in the plate current of that valve supplied by the high tension battery as already explained.

This plate current may include the primary coil of a transformer consisting merely of two insulated wires wound on a bobbin, but without any iron core.

The secondary circuit of this transformer may have its terminals connected respectively to the grid and filament of a second valve, and the same arrangements may be made for a third valve. If, then, the first valve and associated transformer magnify the grid-potential variations say 5 times, the coupling of two valves and transformers will magnify it 25 times, and a third set 125 times, and so on.

We can, in this manner use several amplifying valves for radio amplification.

If we employ two-coil transformers as shown in Fig. 96, we need then only one high tension battery or dynamo to supply the high potential for the anodes or plates of all the amplifying valves. It is then necessary to explain in the next place the methods by which the three-electrode valve operates as a detector of oscillations. The reader will bear in mind that the carrier electric waves which arrive from the sending station are high frequency electric waves of a certain wavelength and amplitude, or wave height. The effect of speaking to the microphone in the transmitting plant is to alter the amplitude of these waves, but not their wavelength. The amplitude varies in accordance with the wave form of the speech sound, so that we may say that the oscillations produced by the carrier waves in the receiving aerial consist of very rapid or high

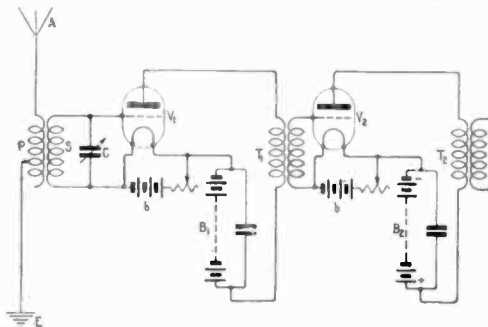

Fig. 96. Arrangement of two or more amplifying valves for magnifying the feeble oscillations in the aerial wire A.  $V_1$ ,  $V_2$ , are the thermionic amplifiers  $T_1$ ,  $T_2$ , the coupling transformers and  $B_1$ ,  $B_2$ , the plate batteries.

currents into low frequency or speech frequency varying currents. The former is termed *radio-amplification* and the latter *audio-amplification*. In the case of radio-amplification the feeble currents set up by the carrier waves in the aerial wire A (see Fig. 96), are caused to induce other similar currents in an associated and tuned coupled circuit, comprising a condenser

frequency electric currents, which also have slow or low frequency variations of amplitude superimposed. These slow variations of current correspond to the speech waves made at the sending end. The radio-amplification increases or magnifies these currents all in the same ratio.

We have then to impress these slow variations upon a receiving telephone. It would be no use, however, to insert a telephone receiver in the plate circuit of the last radio-amplifying valve, because a telephone receiver contains a coil of wire of many turns wound upon the iron pole pieces of a magnet. Such a circuit has a very large inductance, which means that rapid changes of current cannot take place in it. Hence the telephone coil will not permit the passage through it of a high frequency alternating current. It offers too much *impedance*, as it is called, to such a current. Moreover, the mean value of these high frequency oscillations of varying amplitude is constant. We have therefore to insert in the valve receiving arrangement a rectifying valve to change these high frequency currents of fluctuating strength or amplitude into pulsating electric currents always flowing in one direction. This can be done by taking advantage of the form of the characteristic curve of the valve.

It has already been explained that when we give to the plate or anode of the valve a positive potential, electrons are drawn away from the filament, and this electron stream is generally increased by giving the grid a still greater positive charge. There is, however, a limit to this electron current which is fixed by the temperature of the filament, and it cannot be increased beyond a certain amount at any given filament temperature. This limiting current is called the *saturation current* at that temperature. Corresponding to this saturation stage the characteristic curve has, therefore, a bend or change of direction. In the same manner, if we give the grid a gradually increasing negative charge, and thus steadily diminish the electron flow from the filament, we find the characteristic curve at the lower end bends over. Suppose, then, that we give the grid of a valve a negative potential, say about 4 volts compared with the filament, and then superimpose on this steady grid voltage a feeble high frequency alternating voltage. It will be clear that when the small alternating potential makes the grid negative, the thermionic current or electron stream from the filament

cannot be much reduced because the grid has already been made strongly negative. When the alternating potential applied to the grid is positive, then the electron stream is sensibly increased. The result, then, of imposing a

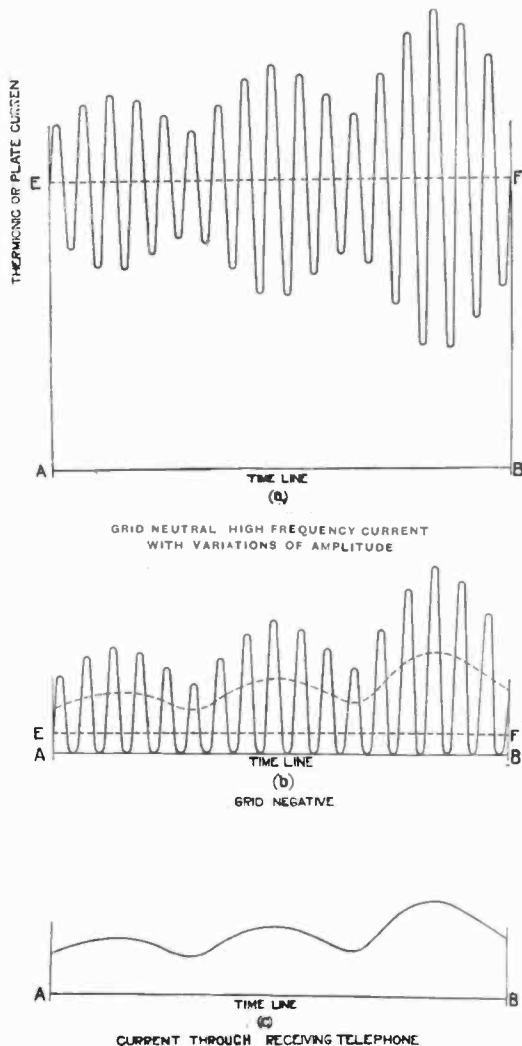

Fig. 97. Diagrammatic representation of rectification and the mean value of the rectified currents which operate the diaphragm of the telephone.

feeble alternating potential on the grid in addition to a steady negative potential is to increase on the whole the electron stream from the filament.

If, then, the alternating potential suffers changes of amplitude, as it does when the carrier electric waves are changed in height by speaking to the microphone in the transmitter, the electron stream of the detecting valve will experience similar increases in mean strength, although there are also rapid variations in the current. The actual changes produced in the currents will be best understood by a series of diagrams.

In Fig. 97 in the upper diagram (a) the ordinates of the curve represent the high frequency current in the receiving circuit as magnified by the radio-amplification. This current has low frequency variations of amplitude superimposed upon its high frequency, but the mean value of the current is always the same. The second diagram (b) shows the effect on this current of the detecting valve, the grid of which has a steady negative charge given to it. Since the electron current cannot then be much decreased, the effect of the additional negative charge given to the grid produced by the superimposed alternating potential is extremely small, but the effect of the positive charges is to increase the electron current.

The mean value of the current therefore fluctuates, as shown by the ordinates of the dotted line in diagram (b). If then the plate circuit of the detecting valve has included in it the coils of a receiving telephone, the rapid variations of current would produce no effect in the telephone, but the slow variations of the mean current cause the diaphragm of the telephone to vibrate, and its motions correspond to the slow or audio-variations in the amplitude of the carrier waves. Hence the receiving telephone will reproduce the speech sounds made to the transmitting microphone, the energy being conveyed by the carrier waves as above described. We can also employ one or more amplifying valves to increase the amplitude of the rectified low frequency speech current variations, which is termed audio-amplification.

For this purpose one or more three-electrode valves are placed after the detector valve, and have induction coils inter-connecting their grid and plate circuits exactly as in the case of the radio-amplifying valves. These induction coils or transformers may have cores composed of bundles of fine iron wires, which increases their effect, and has no disadvantage in the case of the transformation of low frequency oscillations. We can thus employ two or three

audio-amplifying valves and put the telephone receiver in the plate circuit of the last valve, as shown in the diagram in Fig. 98.

A multiple valve receiver may therefore comprise two or three radio-amplifying valves, a detector valve, and one or two audio-amplifying valves. The Marconi Company have designed a seven-valve receiver, in which six of the valves are radio-amplifying, and the seventh and last valve the detector valve (see Fig. 99).

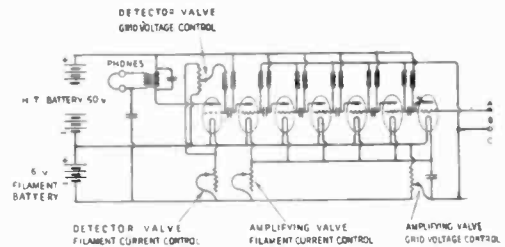

By Courtesy of M. W. T. Co., Ltd.

Fig. 98. Scheme of circuits of a seven-valve thermionic receiver with amplifying valves and detector or rectifying valve.

A simple form of valve-receiving circuit comprises a single detector valve, the grid of which is connected to one terminal of the tuning condenser in the receiving circuit, and also a single audio-amplifying valve with a telephone receiver in its plate circuit. The necessary negative potential is given to the grid of the detector valve by means of an arrangement called a *potentiometer*.

A long fine wire wound on a suitable support has its terminals connected to a few cells of a battery, which may be the filament heating battery. By means of a sliding contact we can connect a point on this wire to the grid, and by changing the position of this slider apply to the grid a negative potential, or two or three volts or more, as required, to bring the plate or electron current of the valve to that point on the characteristic curve which corresponds to the beginning of the lower bend of the curve.

In order that telephonic speech may be transmitted without distortion, it is essential that the radio-amplifying valves should have a characteristic curve which is nearly straight or flat in the central part. It is only under this condition that the complicated changes in the plate current will follow exactly the complicated changes in grid potential, and hence amplify without distorting the wave form of the

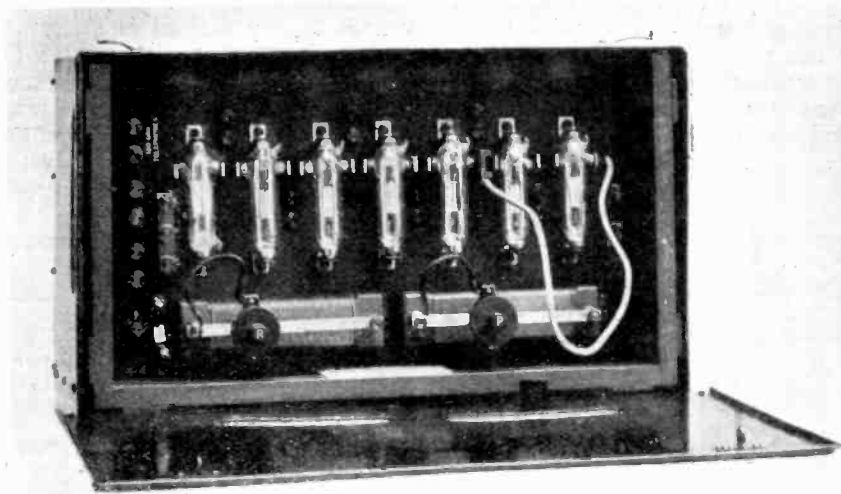

By courtesy of—M. W. T. Co., Ltd.

Fig. 99. A view of a seven valve receiver as made by Marconi's Wireless Telegraph Company.

oscillatory currents. This result is achieved by certain precautions in the design of the amplifying valves.

We have already explained that in a valve transmitter for wireless telephony there must be a valve, the plate and grid circuits of which

are coupled inductively to produce high frequency oscillations in the plate circuit and radiate carrier waves from an associated aerial as in Fig. 101. We have then to modulate the amplitude of these carrier waves by means of a carbon microphone in accordance with the

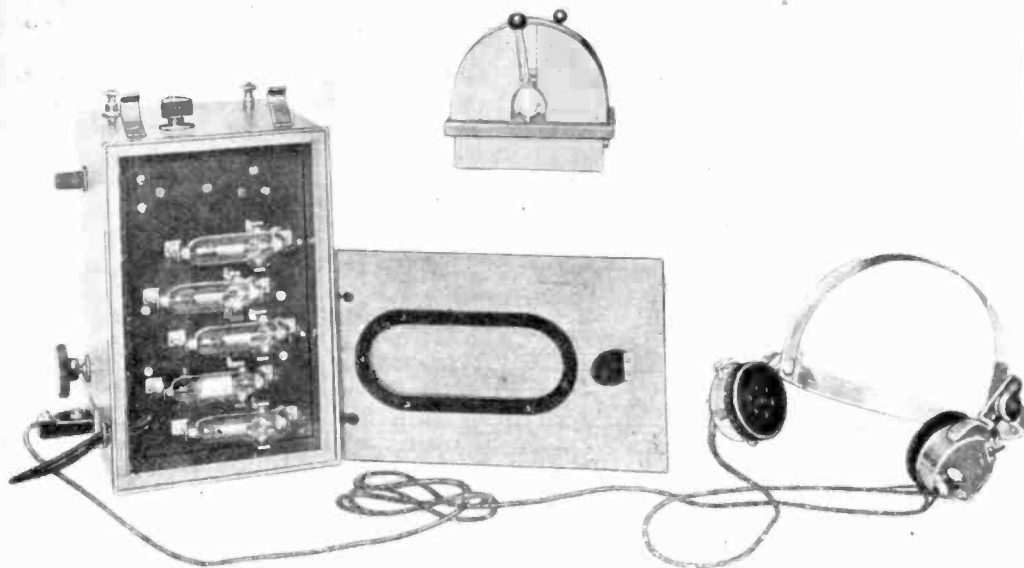

By courtesy of—M. W. T. Co., Ltd.

Fig. 100. Aircraft receiving set comprising three high frequency amplifying valves, a detecting valve and one low frequency amplifying valve connected to the head telephones through an induction coil.

wave form of the speaking voice. One way of doing this is by coupling a microphone *M* inductively, that means by means of an inductance coil or transformer to the plate circuit of the generating valve as shown in Fig. 101. This method has disadvantages in practice.

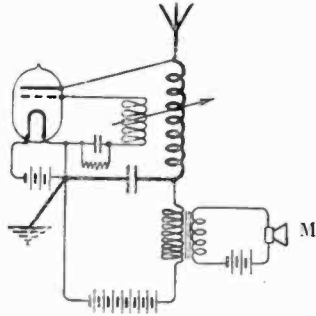

Fig. 101. Circuits of a simple form of Wireless telephone transmitter with the microphone *M* inductively connected to the plate circuit of the valve.

A better method of varying the amplitude of the carrier waves by means of the speech microphone has been called *choke control*. It has been found very suitable for the telephone transmitters of aeroplanes on account of its great simplicity.\* It employs a power and a control valve, which both derive their filament heating and plate currents from the same low and high voltage batteries (see Fig. 102). The plate or anode of the control valve is connected to one end of a large inductance or choking coil having an iron core, marked *L* in the diagram. The high frequency currents set up in the aerial wire by the power valve cannot pass through this choking coil, but find their way to earth through a condenser *C*.

The steady or direct current from the high voltage battery marked H.T., can, however, pass through the choking coil. When speech is made to the microphone the potential of the grid of the control valve is varied, and also low frequency variations are produced in the plate current of the control valve. These changes of current strength produce large

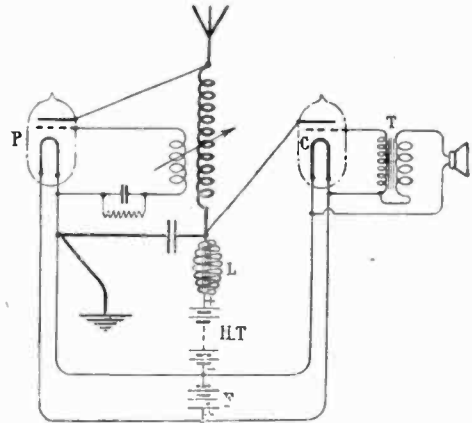

Fig. 102. Arrangement of circuits in a wireless telephone valve transmitter called a "choke control" because it employs a choking coil *L* or large inductance.

variations in the potential at the upper end of the choking coil *L*, which increase or diminish in a very marked and corresponding manner the plate current of the power valve. These surges react through the inductive coupling of the grid and plate circuit of the power valve upon the grid potentials. Hence the effect of speaking to the microphone is to make large percentage changes in the amplitude of the high frequency oscillations set up in the aerial, and therefore upon the amplitude of the radiated waves.

\* See Major C. E. Prince, O.B.E., "Wireless Telephony on Aeroplanes."—*The Journal of the Institution of Electrical Engineers*. Vol. 58, p. 377. May, 1920.

(To be continued)

## Elementary Lecture and Demonstration.

An Elementary Lecture entitled "Fundamental Principles of Radio Reception," with Experiments, will be given on Friday, February 16th, at 6.30 p.m., by Mr. Maurice Child at the Institution of Electrical Engineers, Victoria Embankment. This is the second of a series of Elementary Lectures arranged by the Radio Society of Great Britain.

# Refinements in Receiving Circuits

IT is the object of the present note to bring out one or two points in connection with a valve receiver which make for louder and better quality signals. The diagram Fig. 1 gives the connections of the four-valve receiver.

The switch in the aerial circuit is for the purpose of connecting the aerial tuning con-

The anode circuits are supplied with potential from the tapped H.T. battery, and generally 60 volts will be found best.

A large number of wireless enthusiasts are now using a loud speaker to render signals audible throughout a room. The loud speaker is a power operated instrument, and signals cannot be properly reproduced when there is

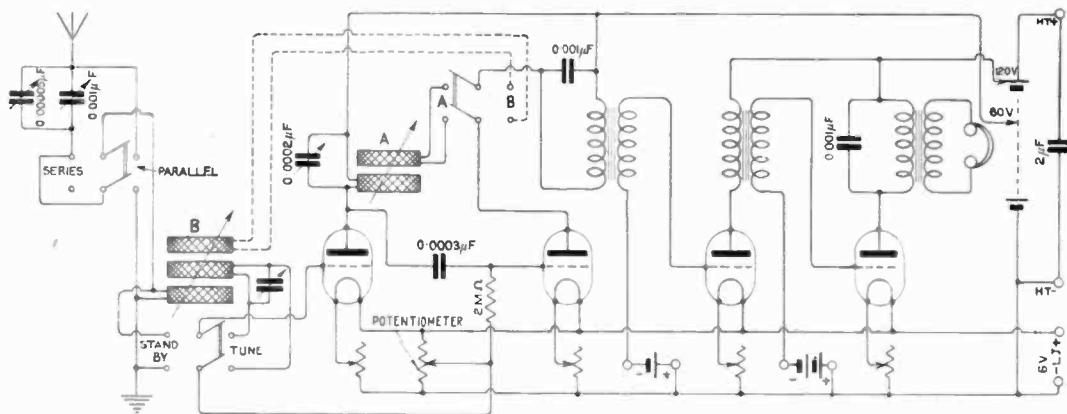

Fig. 1. A four-valve receiver embodying several refinements.

denser and inductance in series or parallel for short or long wave reception respectively. A small condenser, which may consist of two fixed and one moving plates, is connected for fine tuning.

The secondary circuit is connected one side with the grid and the other with the potentiometer. The potentiometer has a resistance of the order of 350 to 450 ohms. A two-coil holder is used to accommodate the anode inductance and reaction coil, and a throw-over switch is provided for the purpose of transferring the reaction connections from position A to B. When receiving broadcast transmissions, the reaction coil A should be used; when receiving longer wavelength signals, the switch may be moved to B, and a coil plugged into one of the three coil holders.

By operating the potentiometer, the potential of the grids of the first two valves may be varied for maximum signal strength.

If the receiver possesses an inherent tendency to oscillate easily, the grids may be made slightly positive, with the result that a small grid current will flow and tend to prevent the generation of oscillations.

insufficient power available. An ordinary "R" type valve is rarely used in a manner such that its full capacity is utilised.

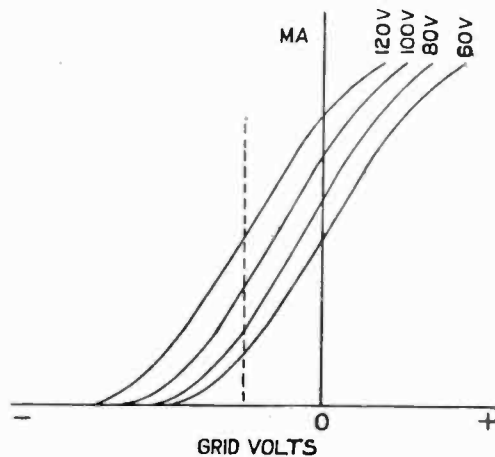

Fig. 2. Typical characteristic curves of a receiving valve.

Referring to the figure, the last two valves are provided with a tapping plug, and voltages

up to 120 may generally be safely used, provided good transformers are employed.

If characteristic curves showing the relationship between grid potential and anode current are examined, it will be found that increase in the anode potential moves the curve to the left. In Fig. 2 it will be seen the higher the H.T. voltage the further is the central point of the curve shifted from the line of zero potential, and a negative potential should be applied to the grid, otherwise the tops of the portion of signals to the right of the normal grid potential will be cut off.

A few grid cells are therefore shown connected in Fig. 1, for the purpose of preventing distortion, and to obtain the full output from the valve. Generally two or three dry cells are sufficient. To prevent saturation of the valve, the filament must be sufficiently heated. In general the filaments of the last two valves will be brighter than those of the previous valves, although the filament should be no brighter than is required by the signal. The life of a valve filament is greatly reduced by only a small increase in the temperature.

## A Simple Type of Filament Resistance

THE accompanying drawings show a type of filament resistance which not only possesses some rather original features, but is also of a design which can easily be made up by the experimenter who does not possess elaborate workshop facilities.

is wanted. For instance, if the wider portion of the resistance is thrown in circuit first, the percentage change in resistance value will be uniform as the sliding contact advances. When the filament is bright and the amount of resistance in circuit small, only a very

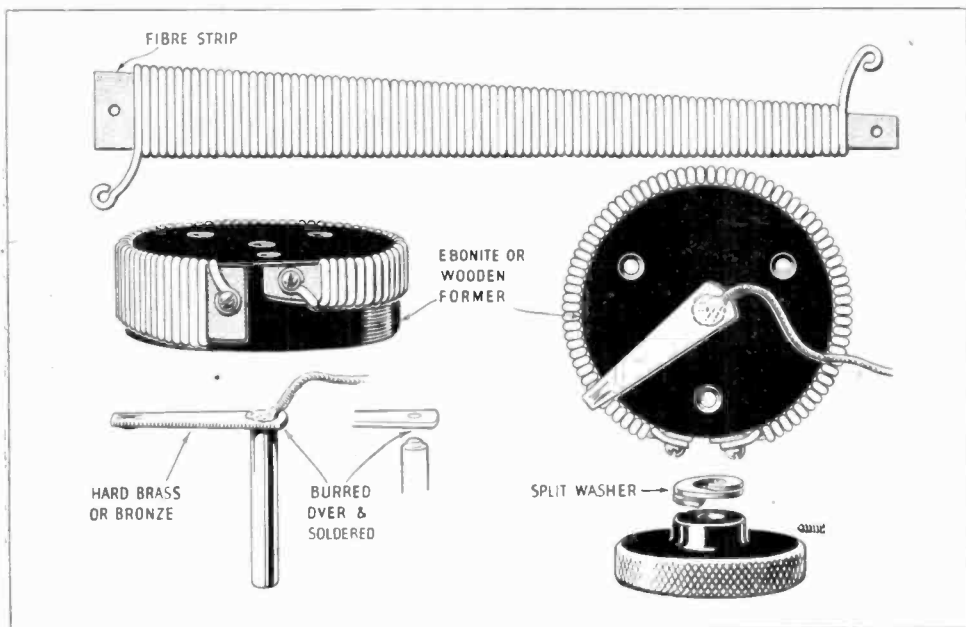

*Constructional details of rheostat, showing method of obtaining uniform current adjustment.*

A special feature is that the former on which the resistance wire is wound is made to taper in order that the resistance change for a given movement of the adjusting knob may be uniform. It is thus possible to give the desired degree of critical adjustment just where it

slight change in resistance is required to cause a somewhat big change in the value of the current flowing, thus the end of the maximum current is made narrower.

The resistance wire should be about 22 gauge for controlling a single valve, and 20



gauge for two or three valves operated by a common rheostat. It should be wound on a piece of fibre of about 1/16 in. in thickness, carefully filed smooth at the edges, and if desired, file marks may be made for the purpose of holding the turns of resistance wire in position.

A cylindrical piece of wood or ebonite of about 1 3/4 ins. in diameter and 1/2 in. thick, may be employed to support the resistance winding. The fibre with the wire wrapped upon it should be bent tightly round the former, and care must be taken to avoid breaking the fibre by giving too much bend at one point. It may be attached by two No. 5 by 1/2 in. screws if the former is of wood, or by 4 BA screws if ebonite is used. These screws also serve to terminate the ends of the resistance wire.

The rubbing contact is made from a piece of phosphor-bronze spring, German silver, or hard brass. The end which makes contact with the resistance wire may be tapered in order that it may not short circuit too many turns, and if a bend is made so as to form a curved surface, the contact will have a smooth movement.

The spindle to which it is attached is reduced in diameter at its end by careful filing in order to present a shoulder. The small diameter portion is made to just pass through a hole in the contact arm, and then, by careful hammering, the spindle may be reverted to the arm.

Using a suitable flux, a wire may be soldered to the reverted end of the spindle for the purpose

of making contact, and also to ensure a solid union between arm and spindle.

Other details of design will depend upon how the experimenter proposes to assemble the rheostat to his panel. If there is no objection to a number of screw heads appearing on the face of the instrument, three holes (tapped in the case of ebonite) are made in the former to which the resistance winding is attached. Alternatively, clearance holes may be made in this former, the panel itself being tapped to take the screws (probably 4 BA) which hold the former to the face of the panel.

The experimenter who does not desire to make use of tapped holes, can use long 4 BA screws with back nuts. The hole in the centre of the former being 1/2 in. in length, will serve as an excellent bearing for the spindle, which should be a good fit. If a split bronze washer is placed on the face of the panel and held down by the knob, it will help to pull the spindle forward, and so ensure a satisfactory spring contact between the contact arm and the resistance wire. The knob may be held by means of a small grub screw, or threaded on to the spindle with lock nut.

This type of rheostat is of easy construction, and it may be adopted by the man who constructs his own apparatus, as a standard fitment.

By increasing the diameter of the former, the length of the fibre strip this time having parallel edges, and winding with finer resistance wire, say No. 30 S.W.G., the same principle can be adopted for the construction of a reliable type of potentiometer.

## Barretter Tubes.

A device of considerable interest to the experimenter, and largely used on the Continent, is shown in the adjoining photograph. It is a small tube with end connecting lugs and filled with hydrogen. In circuit between the lugs is a fine wire of a special alloy, the resistance of which rapidly increases with an increase of the current passing through it.

It will thus be seen that such a device, when connected in series with a valve filament, is very useful for limiting the amount of current that will pass, and consequently reduces the danger of burning it out.

These tubes are designed and rated to pass a given current, and the variation in current

flow, over a wide range of battery potential is extremely small, so small in fact that the

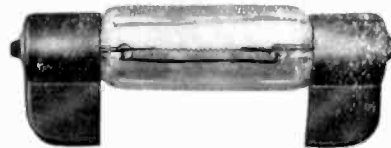

*A familiar type of Barretter tube of foreign manufacture.*

filament brightness may be relied upon to be of a given degree, irrespective of the battery voltage, within certain wide limits.

## A Simple Reinartz Tuner.

THE article on the Reinartz tuner, which appeared in the May 13th, 1922, issue, fired the writer's ambition to make up one of these tuners. This has turned out

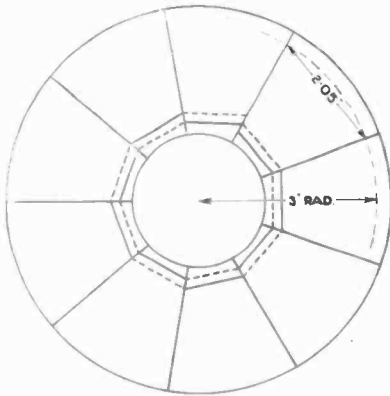

Fig. 1. Dimensions of card former.

so well that probably other readers may like to benefit by the experience gained.

First a coil was wound on a card, after the

produce nine equal divisions (other sizes in proportion).

The card actually used was of  $3\frac{1}{4}$  ins. radius, and the slots were deep enough to start winding at  $\frac{3}{4}$  ins. radius. The following procedure was gone through and reference should be made to Fig. 1:—

Beginning, labelled "30"; wind 10 turns, tap and label "20"; wind 10 more turns, tap and label "10"; next, 10 more turns, and then cut off and label "0" leaving enough wire to run to terminal "R.C. 1." Start afresh, labelling beginning "9"; 1 turn, label "8," and so on to "0" and leave enough wire to run to terminal "E and - T.C." Do not break the wire but wind on 24 more turns, label "24"; 6 more and label "30" and so on to 36, 42, 49 and 56.

The switch centre for the "24" to "56" tappings is connected to a terminal labelled "G.C."

The switch arm of the "0" to "9" tappings is connected to the terminal labelled "R.C. 2" and that of the "0" to "30" tappings to a terminal labelled "P."

For telephony on 400 metres the tuner is

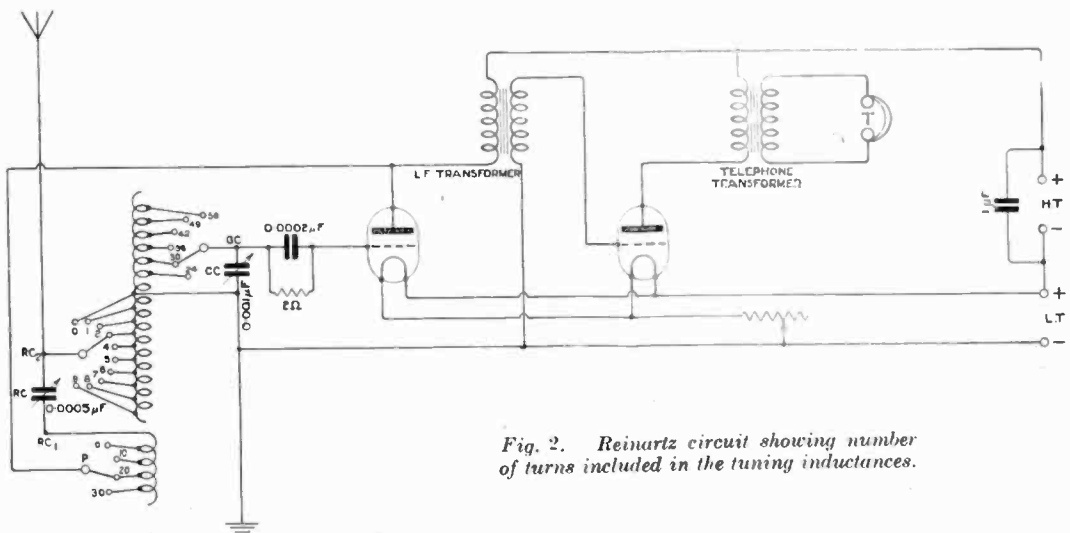

Fig. 2. Reinartz circuit showing number of turns included in the tuning inductances.

fashion described in "Experimental Station Design II," June 10th issue. A  $\frac{1}{4}$  lb. of No. 26 D.C.C. was more than enough.

Let anyone repeat an early error of the writer's, it should be remembered that the card must have an *odd* number of slots. Round a circle of 3 ins. radius, steps of 2.05 ins.

ideal with two valves. When connected to an aerial of the usual amateur dimensions, and the three switches set at 56, 3 and 30; R.C. at about 0.0005 mfd., and C.C. at about 0.0001 mfd., the following come in very clearly at Shoeburyness, Essex:—2 MT, 2 LO, 2 IF, 2 ON and others.

If speech is not clear, less reaction should be used.

A slight improvement has been made by adding a card (wound with 44 turns of No. 26 D.C.C. from  $\frac{3}{4}$  in. to  $1\frac{1}{2}$  ins. radius) below the main card and connected in circuit at R.C. 1. Probably it would have been better to start the main card at 2 ins. radius, and wind the "o" to "56" turns on a second card, starting again at 2 ins. radius. This should make the addition of 44 turns to the "o to 30" coil unnecessary.

The second valve is simply connected as shown in the diagram, Fig. 2.

Using the ordinary slab inductances it was found that the same circuit worked well up to 8,000 metres. No trial was made on higher wavelengths. Attention should be drawn to the fact that this circuit is liable to cause interference by radiation, though with a suitable adjustment of coupling of the plate circuit inductance and reaction condenser, the tendency to oscillate can be critically controlled.

The writer feels sure that he is not alone in being grateful for his introduction to the Reinartz tuner.

B. H. E.

## The Ideal Home Exhibition

**I**N the last issue of *The Wireless World and Radio Review*, an announcement was made regarding the Ideal Home Exhibition.

This Exhibition, which is being organised by the *Daily Mail*, will be open from March 1st to 24th inclusive. It should be of special interest to those associated with wireless, since arrangements have been made for a section of the Exhibition to be devoted entirely to wireless exhibits, and every effort will be made to present wireless telephony to the public visiting the Exhibition in an attractive manner.

The organisers of the Exhibition have assigned to the National Association of Wireless Manufacturers the entire arrangements for the wireless section of the Ideal Home Exhibition, and the principal manufacturers of apparatus will be exhibiting. The interest of the wireless section will naturally centre around broadcasting, and for the special use of the wireless manufacturers there has been set apart a concert hall in the Exhibition with seating accommodation for 1,000, and here manufacturers will organise continuous free demonstrations of wireless telephony reception. Every opportunity will be given to the public to appreciate the value of wireless telephony in the home, and one feels confident that every visitor to the Exhibition will leave it with the impression that no home can be ideal unless the benefits to be derived from wireless telephony are taken advantage of.

The following is a list of some of the principal firms who will exhibit:—

Siemens Brothers & Co., Ltd.  
Rogers, Foster & Howell, Ltd.  
Igranic Electric Co., Ltd.  
Radiophones, Ltd.  
Marconi Scientific Inst., Co., Ltd.

Automatic Telephone Mfg., Co., Ltd.,  
jointly with  
Ashley Wireless Telephone Co., Ltd.  
Dubilier Condenser Co. (1921), Ltd.  
General Electric Co., Ltd.  
Metropolitan-Vickers Electrical Co., Ltd.  
Radio Instruments, Ltd.  
Telephone Mfg. Co., Ltd.  
Western Electric Co., Ltd.  
S. G. Brown, Ltd.  
The Wireless Press, Ltd.  
Radio Press, Ltd.  
Fellows Magneto Co., Ltd.  
British Thomson-Houston Co., Ltd.  
L. McMichael, Ltd.  
Electric Appliances Co., Ltd.  
Tingey Wireless, Ltd.  
Burndept, Ltd.  
C. F. Elwell, Ltd.  
Marconi's Wireless Telegraph Co., Ltd.  
Radio Communication Co., Ltd.  
Sterling Telephone & Electric Co., Ltd.  
A. W. Gamage, Ltd.  
H. Stanley Prince, Ltd.  
General Radio Co.  
Alfred Graham & Co.  
L. A. Coomes & Co.  
Tomlinson (London), Ltd.

It will therefore be seen that the Exhibition is strongly supported by wireless manufacturers, and there will undoubtedly be displayed the finest selection of wireless receiving apparatus in the world.

This will be the seventh Exhibition under the name of "The Ideal Home Exhibition," to be organised by the *Daily Mail*, and it is a matter of interest that so important a part should be played in the coming Exhibition by wireless telephony.

## Wireless Club Reports

*NOTE.—Under this heading the Editor will be pleased to give publication to reports of the meetings of Wireless Clubs and Societies. Such reports should be submitted without covering letter and worded as concisely as possible, the Editor reserving the right to edit and curtail the reports if necessary. The Editor will be pleased to consider for publication papers read before Societies. An Asterisk denotes affiliation with the Radio Society of Great Britain.*

*Correspondence with Clubs should be addressed to the Secretaries direct in every case unless otherwise stated.*

### **Aberdeen and District Wireless Society.\***

Hon. Joint Secretary, Mr. James S. Duthie, 148, Forest Avenue, Aberdeen.

During the month of December some very interesting lectures were given by members of this Society.

On December 8th, Mr. W. W. Inder, M.I.R.E., lectured on the valve, Mr. Robert Cumming presiding, and the lecturer was awarded a very hearty vote of thanks for his interesting and instructive lecture.

A beginning has been made with Morse practice under the tuition of different members of the Society.

On December 22nd a most interesting lecture was given by Mr. Newsam, manager of the Aberdeen Branch of Ediswan Electrical Company, on the construction, action, maintenance and care of accumulators. On the motion of the President, Dr. Fyvie, a cordial vote of thanks was accorded to the lecturer.

### **The Ilford and District Radio Society.\***

Hon. Secretary, Mr. A. E. Gregory, 77, Khedive Road, Forest Gate, E.7.

A meeting was held on January 11th at headquarters, St. Mary's Hall, Ilford. Mr. J. E. Nickless, A.M.I.E.E., occupying the chair.

Mr. Grover gave a very interesting lecture on "Elementary Electrostatics." The characteristic curves of two valves were also plotted and Mr. Grover explained the practical uses to which such data could be put.

On Thursday, January 18th, a successful Concert and Demonstration of Wireless Telegraphy was held.

Mr. L. L. Vizard operated his five-valve receiving set and signals were made audible to the whole of the audience by means of a loud speaker kindly lent by Messrs. Radio Instruments, Ltd.

### **Lambeth Field Club and Morley College Scientific Society.\***

(PHYSICS AND WIRELESS SECTION.)

Hon. Secretary, Mr. F. W. Ling, Physics Laboratory, Morley College, Waterloo Road, S.E.1.

On Saturday, January 13th, the members of the above Society held their first practical evening of the year. The meeting was a great success, and plans for the making of the Society's receiving set were fully discussed.

Messrs. A. E. and V. C. Perry and the Secretary helped several members by explaining how they could make their sets, also giving diagrams of the wiring. Several experiments and demonstrations were given during the evening and a L.F. panel which was being made as a part of a unit set was on view.

The next practical evening was on Saturday, January 27th, when the work on the Society's set was begun.

The Secretary would be pleased to hear from persons interested in wireless.

### **The Finchley and District Wireless Society.\***

Hon. Secretary, Mr. A. E. Field, 28, Holmwood Gardens, Finchley, N.3.

The above Society met on Monday, January 15th, when Mr. Wilck gave the first of his elementary lectures on "Electrostatics." This was followed by a descriptive lecture and demonstration of a Burndept "Ultra III" tuner, by Mr. Trussler, at which the concert from Marconi House was picked up and clearly heard all over the hall.

At the close of the meeting a committee meeting was held, and many points discussed, among these being broadcasting problems and the coming meeting of the Radio Society of Great Britain, to which the Society hoped to send three representatives.

### **Borough of Tynemouth Radio and Scientific Society.\***

Hon. Secretary, Mr. J. S. Littlefield, 37, Borough Road, North Shields.

The Society's third annual Exhibition of wireless telegraph and telephone apparatus was held recently at the headquarters, Y.M.C.A. Buildings, North Shields.

The opening ceremony was performed by Councillor A. E. Hill, B.A., Vice-President of the Society, who congratulated the members upon the splendid results of their energies. Councillor Hill was supported by the Deputy Mayor of the Borough.

The Exhibition proved to be an unprecedented success, not only in the number of visitors, but also in the splendid array of exhibits, which were kindly lent by Messrs. Radio Communication Co., Ltd., Burndept Ltd., Mr. H. W. Sullivan, Western Electric Co. Ltd., North Eastern Instrument Co., "Chase Radio," and Radio Instruments, and in addition many members' exhibits.

The thanks of the Committee are due to all those who gave their valuable help in making the Exhibition such a success.

### **The Manchester Radio Scientific Society.\***

Hon. Secretary, Mr. H. D. Whitehouse, 16, Todd Street, Manchester.

An ordinary meeting of the Society was held on January 10th at headquarters. In the absence of the Chairman, Mr. J. R. Halliwell took the chair. A discussion was opened on the subject of "Broadcasting," and members present gave their views.

The next meeting of the above Society was held on Wednesday, January 17th, with Mr. Boulton in the chair. As no lecturer had been appointed, the meeting was thrown open to general discussion on wireless matters, and many interesting experiences of members were discussed, including the reception of Covent Garden Opera in Manchester.

### **Proposed Doncaster Radio Society.**

It is proposed to form a Radio Society in the Doncaster district, and all those interested in wireless are invited to communicate with Mr. Ernest F. Brett, 51, Highfield Road, Doncaster.

**The Warrington Radio Association.**

Hon. Secretary, Mr. W. Whittaker, 68, School Brow, Warrington.

A meeting of the Warrington Radio Association was held in the Y.M.C.A. Lounge on Thursday, January 11th, Mr. F. V. L. Mathias presiding. A very interesting address was given by Mr. W. Whittaker on "Morse Reception" following which Mr. B. Nadin discussed "Hints on Set Making." Both speakers were accorded a hearty vote of thanks.

Before the meeting closed, the Hon. Secretary mentioned that the committee would spare no efforts to make the demonstration on January 25th a great success.

**Birkenhead Radio Society.**

Hon. Secretary, Mr. R. Watson, 35, Fairview Road, Oxtou.

The fourth general meeting of the Birkenhead Radio Society was held at 36, Hamilton Square, on January 4th.

The chair was taken by Mr. Goodyear. After the usual morse practice, held from 7.15 to 8 p.m., a lecture on "Rectification" was given by Mr. Austin, one of the technical advisers of the Society. The lecture was given mainly for the junior members of the Club, of whom a good many were present. In the lecture given by Mr. Hill at the previous meeting, the production of high frequency oscillations was dealt with. Mr. Austin showed in his paper how these waves were rectified. He dealt with spark transmitters, showing first the action of a crystal in rectifying damped waves, and afterwards the action of a valve.

After the conclusion of this paper, the Chairman explained a few points which were likely to arise and give trouble to the younger members. Mr. Hughes then said, that if any of the members were in any difficulty with their apparatus either he or Mr. Austin would be only too pleased to give any assistance in their power.

**Guildford and District Wireless Society.**

Hon. Secretary, Mr. R. T. Bailey, 148, High Street, Guildford.

The above Society opened its new headquarters at 148, High Street, on Friday, January 12th, with a general meeting. Mr. S. G. Clarke was voted to the chair, as the Chairman, Ald. W. T. Patrick, J.P., was unavoidably absent. At the conclusion of business the members adjourned to a neighbouring café, where the Chairman (Ald. W. T. Patrick) had very kindly arranged for coffee to be provided.

The new rooms will very shortly be regularly open for members' use, and it is sincerely hoped all

local amateurs will become members and avail themselves of the facilities which will be provided.

**The Wireless Society of East Dorsetshire.**

Hon. Secretary, Mr. E. T. Chapman, Associate I.R.E., Abbotsford, Serpentine Road, Poole, Dorset.

At a general meeting held in Wimborne Council Schools on Wednesday, January 17th, 1923, a unanimous decision was taken against the proposed amalgamation with the newly formed Bourne-mouth and District Radio and Electrical Society.

Meetings and instructional lectures are being held fortnightly in the Wimborne Council Schools on Wednesdays at 7 p.m., the date of the next meeting being therefore on February 7th. In the event of the rooms not being available on specified day, notice will be circularised by the Secretary.

**Swansea and District Radio Experimental Society.**

Hon. Secretary, Mr. Herbert T. Morgan, 218, Oxford Street, Swansea.

A very successful meeting of the above Society was held at headquarters, the Y.M.C.A., on Wednesday, January 10th, when a very interesting lecture and demonstration was given by Mr. D. W. Walters, of Gowerton, entitled "Hints on Tuning."

By permission of the Postmaster-General, an aerial was erected, and a wireless receiving set had been installed, and this was used by the lecturer for demonstration purposes.

The President of the Society, Capt. Hugh Vivian, occupied the chair, and gave a very encouraging address, prophesying a very bright future for the Society. Later in the evening, Continental telephony was listened to on a loud speaker.

The Society has a very interesting programme for the season, and all interested in wireless are invited to join.

**Birmingham Experimental Wireless Club.**

Hon. Secretary, Mr. A. Lancaster, c/o Lancaster Bros. & Co., Shadwell Street, Birmingham.

An instructive and enjoyable lecture was given before the above Club on January 12th by Mr. B. A. Matthews, the subject being "The Construction of Three-Valve Receivers." The lecturer gave a very successful demonstration with a three-valve set of his own construction, and the methods of wiring for various circuits were lucidly explained.

Mr. Matthews described his experiments with various circuits, and the means by which the apparatus had been evolved from the original single valve set by slow stages was of special interest to the new members present who are busily engaged on building sets of their own.

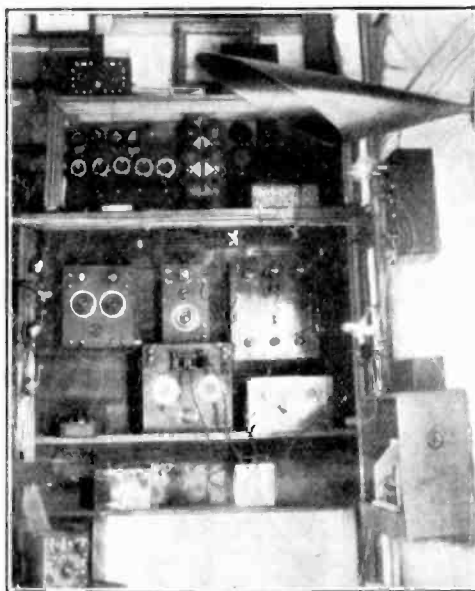

*Station of Mr. W. G. Fulger (The Picture Palace, Station Road, Godalming, Surrey). Since the photograph was taken the station has undergone considerable development.*

**The North Essex Radio Society.**

Hon. Secretary, Mr. F. T. Smith, Felsted, Essex. Demonstrations and lectures organised by the above Society and conducted by the Secretary are being given in outlying districts in aid of charities. The last occasion was on Wednesday, January 3rd, when the hall at Felsted was crowded out, and a good sum resulted for the benefit of Dr. Barnardo's Homes.

The apparatus used on these occasions has been kindly lent by Mr. Gordon Castagnoli of Braintree. The audiences were much interested in the fact that the same instruments used for the demonstrations had also received American broadcasting, and some seemed desirous of continuing the performance until 1.30 a.m. on the chance of hearing W.J.Z.

**Wanstead Wireless Society.**

Hon. Secretary, Mr. A. B. Firman, 18, Clavering Road, Wanstead Park, E.12.

At the meeting of the society held on Thursday, January 11th, Mr. Hunt, B.Sc., a member of the Society, read an extremely interesting paper, his subject being the "Genesis of Wireless."

Aptly illustrated by descriptions of experiments and analogies, the lecture was much appreciated by all those present.

Members were reminded of Major Parker's visit to the Society on January 25th, when he delivered an extremely interesting lecture on "C.W. Oscillation and the Functions of Component Parts of a Receiving Set," and which was illustrated by lantern slides.

Meetings are held every Thursday evening at St. Gabriel's Church Hall, Aldersbrook Road, E.12., at 8 p.m.

**Watford and District Radio Society.**

Hon. Secretary, Mr. F. A. More, 175, Leavesden Road, Watford.

This Society has been very fortunate in securing the services, as lecturer, of Mr. Christie, late wireless instructor Royal Navy. His opening lectures, entitled "The Evolution of Wireless" and "Detectors," were followed on Friday, January 5th, by a lecture on the Fleming valve. He gave a brief survey of his previous lecture, describing the action of the coherer, the electrolytic detector, the magnetic detector and the crystal, finally bringing his audience to the two-electrode valve.

A most interesting and instructive lecture was concluded by some helpful hints on operating single valve sets, particular emphasis being laid on the control of reaction.

On Friday, January 12th, Mr. Christie, by special request, gave a lecture on the construction of receiving apparatus. He had brought a large number of home-made instruments, including basket coils, tuning stands, honeycomb coils and coil-winding machine, transformers, condensers and crystal detectors. The apparatus was splendidly constructed and Mr. Christie's excellent lecture was in keeping with the quality of his work. Subsequently the apparatus was passed round for inspection, and the lecturer answered several questions.

Members are reminded that the subscription for the current quarter is now due, and should be forwarded to the Hon. Treasurer as early as possible.

**Eastern Enfield Wireless and Experimental Society.**

Hon. Secretary, Mr. I. Dabbs, 315, High Road, Ponders End.

On Thursday, January 11th, an extraordinary general meeting of the above Society was held at the headquarters, the Falcon Inn, to discuss the programme for the present year.

After considerable discussion it was decided to have a programme of lectures and demonstrations of members' apparatus to commence next week.

The remainder of the time was devoted to general discussion, particularly on efficient earthing.

Wireless enthusiasts will be heartily welcomed at the Society headquarters any Thursday evening at 8 o'clock.

**Mount Pleasant Radio Society.**

Hon. Secretary, Mr. Walter R. Fleming, 156, Upton Park Road, Forest Gate, E.7.

On January 13th a meeting was held at headquarters, 21a, John Street, Theobalds Road, W.C.1., when the Secretary gave a lecture on "Primary and Secondary Cells."

The Society has obtained an experimental licence, and a crystal receiver with a three-valve amplifier has been purchased.

Several new members have recently been enrolled.

**The Hornsey and District Wireless Society.**

Hon. Secretary, Mr. H. Hyams, 188, Nelson Road, Hornsey, N.8.

A general meeting of the Society was held on Monday, January 8th, at 8 p.m. The present accommodation of the Society being considered unsuitable, it was decided to transfer the headquarters to the Queen's Hotel, Broadway Parade, Crouch End, where more comfortable accommodation has been arranged. In future, meetings will be held there each Monday at 8 p.m. Mr. W. L. Carter was elected Chairman, and Mr. H. Hyams elected Hon. Secretary.

Applications for membership will be welcomed and full particulars supplied by the Hon. Secretary.

**The Tottenham Wireless Society.**

Hon. Secretary, Mr. R. A. Barker, 22, Broadwater Road, Tottenham, N.17.

The chief feature of the meeting held on January 10th, 1923, at 10, Bruce Grove, Tottenham, was an excellent lecture by the Chairman, Mr. F. A. Bourne, on the subject of "Crystal Detectors." Mr. Bourne not only fully explained the theoretical side of the question, but also fully explained the construction of a crystal set that everyone could make for themselves.

Presentations were made to the Society of a crystal set, set of coils and coil holder, and a battery of accumulators. It is hoped shortly to give a demonstration on wireless subjects for the benefit of the local public.

At the last meeting held by the above Society a very interesting lantern lecture was given by Mr. R. A. Barker, who gave a short biography of Senatore Marconi and Dr. Fleming, two of the pioneers of wireless telegraphy, and showed a number of slides illustrating the history of wireless. All the slides were kindly lent by the Marconi Scientific Instrument Co., Ltd.

**Nottingham and District Radio Experimental Association.**

Hon. Secretary, Mr. D. F. Robinson, 99, Musters Road, West Bridgford, Nottingham.

A meeting was held on January 4th, at Bennett's Garage, Shakespeare Street, Nottingham, Mr. Thornton being the Chairman.

Mr. Gill occupied the evening by explaining and demonstrating with a five-valve set, constructed by himself, and all members present thoroughly appreciated his efforts. The remaining time was given up to listening to the Birmingham Broadcasting Station, and altogether a most enjoyable and interesting evening was spent.

A cordial invitation is given to all wireless enthusiasts not yet members of the Society to the meetings held each Thursday at 7.30 p.m.

#### The Wireless Society of Hull and District.

Hon. Secretary, Mr. H. Nightscapes, 79, Balfour Street, Hull.

There was a large attendance of members at the meeting held on January 8th, when a lecture was given by Mr. Lax. Mr. Lax went deeply into the question of the action of valves as rectifiers and amplifiers, and explained the characteristic curves of the various makes of valves which are at present on the market, as well as pointing out their advantages and disadvantages. By the aid of black-board diagrams he then gave his hearers some interesting and useful information about the various circuits at present in use in connection with valve receiving apparatus, and at the close, ably replied to a number of questions which had been asked.

On the proposition of the Chairman, Mr. G. H. Strong, and seconded by Mr. C. B. Snowdon, the lecturer was accorded a hearty vote of thanks for one of the best lectures yet given. This was supported by Messrs. J. Brazendale and W. J. Featherstone, and Mr. Lax in replying, promised to give a further lecture and practical demonstrations at some future date.

The officials of the Society are hoping to see every experimenter and listener-in in Hull and District a member of the Society. Would-be members will be welcomed at the club-room, at the Signal Corps headquarters in Park Street, on the second Monday and fourth Friday in each month.

Any wireless operators who happen to be in the port will be made welcome at the meetings of the Society.

#### Sutton and District Wireless Society.

Hon. Secretary, Mr. E. A. Pywell, "Stanley Lodge," Rosebery Road, Cheam, Surrey.

The annual general meeting of the Society was held on Wednesday, January 10th, 1923. Mr. D. C. W. Howard, B.Sc. has now been elected Chairman for the coming year, and owing to the large increase in the numbers of members since the last election, another member has been elected to the Committee. At the conclusion of the business proceedings, Mr. R. E. V. Ely gave a very interesting lecture on X-ray work and was accorded a hearty vote of thanks.

A series of short instructional lectures will be given by various members at meetings during the next three months, and it is hoped that these meetings will be well attended. All interested in radio work of any description are given a hearty welcome and those desirous of becoming members can obtain full particulars from the Hon. Sec.

#### Cheltenham and District Wireless Association.

Hon. Secretary, Mr. E. Cole, A.R.I.B.A., 28, Milton Road, Cheltenham.

At the weekly meeting of the Association on January 15th, Mr. A. Moulder gave a short lecture

on "Non-Radiating Circuits," and also an extremely interesting account of his experiences during the war as a Naval wireless operator.

It was mentioned that several of the members have been successful in receiving parts of radio concerts transmitted from America.

After the lecture the members listened in on the Association's four-valve set to 5 IT, the Birmingham Broadcast Station.

#### Oldham Amateur Radio Society.

Hon. Secretary, Mr. W. Schofield, 92, Sharples Hall Street.

On Friday, January 12th, an interesting lecture on "Aerial Construction" was given by the Chairman, Mr. J. Everett, who dealt with the subject in a very thorough manner. He explained how the aerial poles should be erected, and how the stays should be arranged to withstand the strain of the aerial. The precautions to be taken against leakages to earth were not forgotten, and Mr. Everett showed several effective ways of making joints with copper wires.

It is gratifying to be able to report a steady increase in the membership of the Society, and anyone desirous of joining should apply personally at 56, Bottom o' th' Moor, Oldham, any Friday evening at 8.30 p.m., when the weekly meeting is held.

#### Bexhill and District Radio Society.

Hon. Secretary, Mr. A. J. Hill, 15a, Sea Road, Bexhill-on-Sea.

A successful opening meeting of the above Society was held on January 9th, at 15a, Sea Road, Bexhill-on-Sea.

Mr. A. J. Hill opened the meeting by explaining the object of forming the Society, and Mr. L. E. Owen gave an address on "Wireless from the Popular Standpoint."

A Committee (*pro. tem.*) was formed, Mr. S. L. Taylor being elected Chairman.

#### The Wireless Society of Winchester.

Hon. Secretary, Mr. Albert Parsons, A.M.I.R.E., 65, Cromwell Road, Winchester.

The meetings held at Tower House since Christmas have been of a practical nature. The Secretary occupied two evenings by showing various methods of hand-coil winding.

Members having since wound their own coils speak of having obtained good results from them, especially the kind termed by the Secretary as the one, two, three or four diamond coil, which present very little self capacity.

The Society has now erected an aerial of the approved P.M.G. type, being 60 ft. high and 40 ft. long, in a position free from any screening.

By kind permission of Mr. R. Ayton, M.I.E.E., the members recently had an extremely interesting evening at the local power station. It was an opportune time in that shops, etc., were closing, and the demand for power decreasing, such that the closing down of one turbine and dynamo for the night was witnessed among other features.

Members spoke highly of the cleanliness of the station and of the efficient organisation.

An addition has been made to the rules of the Society to the effect that holders of broadcast licences are to be classed as Associate Members. Membership is still growing, and anyone desiring to join the Society may obtain particulars from the Secretary.

## Notes.

### Broadcasting and Experimental Licences.

Some dismay has been caused among owners of portable wireless receiving sets by the discovery that a licence does not entitle the holder to use his apparatus at any other place than that stated on the licence. This fact does not appear to have been stated specifically in any new regulation, but apparently the Post Office authorities expect literal observance of the terms of the broadcast licence. The official attitude is that this limitation of the movement of private wireless apparatus is necessary if the Post Office is to maintain control. Movement is permitted, however,

### Developments in Canada.

The plans of the Marconi Company with regard to the development of wireless communications in Canada involve the erection of a powerful station at Vancouver, British Columbia, which is estimated to entail an expenditure of two million dollars. This station, it is said, will be one of the giant stations of the world, exceeding in power any other Marconi station at present in existence, and will in effect make Western Canada an important factor in world wireless communication, linking it up on one side with Australia and the Orient and on the other with Europe.

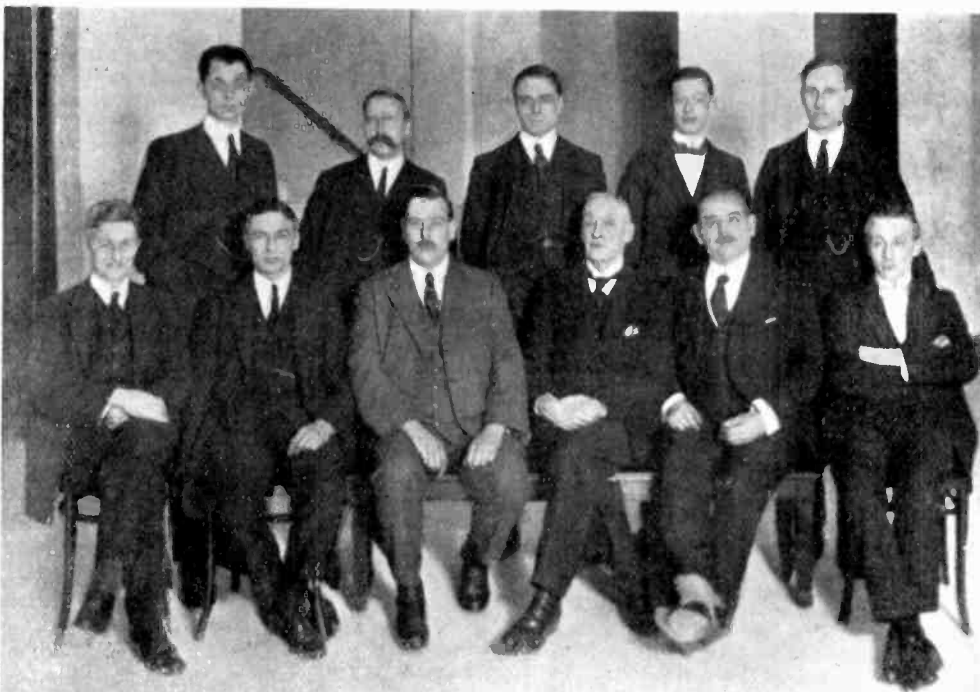

*Group of Officers and Committee of the Radio Society of Great Britain. Back row (left to right): Maurice Child, Philip R. Coursey, G. G. Blake, A. Hambling, Hugh S. Pocock. Front row (left to right): C. F. Phillips, Major N. Hamilton, Leslie McMichael (Hon. Secretary), Admiral of the Fleet Sir Henry B. Jackson, G.C.B., F.R.S. (Retiring President); F. Hope-Jones (Chairman), and L. F. Fogarty (Hon. Treasurer).*

to agents of wireless firms, bona fide lecturers and demonstrators, these exceptions being covered in most cases by so-called "pedlars' licences." The issue of "experimenters' licences" for those who wish to construct their own sets is temporarily held up pending the introduction of a new class of licence which is under consideration. It will be remembered that this course was first advocated by *The Wireless World and Radio Review* (page 395, December 23rd, 1922).

### "Annales des Postes" to Become a Monthly.

The *Annales des Postes, Télégraphes et Téléphones*, a bulletin of technical information issued by the French Ministry of Posts and Telegraphs, will appear in future each month, beginning with the January number. As a consequence the field which this valuable publication covers will be considerably increased. The annual subscription however will remain unaltered, viz., 24 francs for France and 27 francs for abroad.



### Sir Oliver Lodge's Lecture on "Wireless Communication."

The Silvanus Thompson Memorial Lecture on "The Basis of Wireless Communication," to be delivered by Sir Oliver Lodge, F.R.S., at the Finsbury Technical College, Leonard Street, E.C.2, is to take place on Thursday, February 1st. and not on January 26th, as previously reported in the Press. Among the demonstrations to be given by old students after the lecture are the following:— Mr. Mordey, the oldest-known student, will show some effects of alternating magnetism; Prof. Coker will demonstrate the strains set up by cutting tools, as shown under polarised light; Prof. Desch will project microphotographs of various alloys. Prof. Eccles will show novel applications of the thermionic valve, and the ladies will be entertained by a wireless concert, the reception being arranged for by Mr. Franklin. The plant of the College will be operated by present students.

### Reception of Eiffel Tower Weather Reports.

A Wireless operator at Eiffel Tower, when sending out his weather report a few days ago, requested the recipients to send him postcards. The response resulted in several mail bags containing over 56,000 postcards.

### Photograph of Mr. A. R. Burrows.

Mr. A. R. Burrows, an interview with whom is reported in this issue, is now so well known in wireless circles that it is thought that many readers may like to have a copy of the photograph which appears on page 589 of this issue, where he is seen announcing at 2 LO. Arrangements have therefore been made to supply readers with cabinet size silver prints of this photograph, unmounted, at the price of 9d. post free. Application, with remittance, should be made to the Editorial Offices of this Journal.

### Wireless Communication and Trade.

A special committee of the Federation of British Industries has forwarded to the Prime Minister a resolution urging the Government immediately to grant facilities for the rapid development of long distance wireless communication, adding that they are strongly of the opinion that this would be best accomplished by private enterprise. A system of cheap wireless communication, they maintain, is essential to the trade of the country.

### Broadcasting Stations in Great Britain.

The erection of the broadcasting station at the Port Dundas Corporation's Electricity Station at Glasgow has been begun, and it is expected that broadcasting will be commenced early in March. Cardiff broadcasting station is said to be practically complete, and should be ready to begin transmissions by the beginning of February.

### The Growing Demand for Broadcast Licences.

The public interest in wireless as a result of the successful institution of broadcasting is growing rapidly, as indicated by the number of licences issued. At the time of going to press it was reported that some 10,000 licences had been issued by the Postmaster-General in the past week, whereas the total number of such licences issued in the month of December was only 6,000.

### The Radio Society of Great Britain Presidential Address by Dr. W. H. Eccles, F.R.S.

A Presidential Address was delivered by Dr. W. H. Eccles, F.R.S., before the Radio Society

of Great Britain on Wednesday, January 24th, at 6 p.m., at the Institution of Electrical Engineers. The address was directed to the stimulation of research by experiments, and an indication of some useful lines of investigation was given. Publication will be given to this address in due course.

### A Wireless Club for Ceylon.

A correspondent writing from Colombo states that a wireless club has just been formed, and is receiving strong support throughout the island. Permission to use wireless has not yet been granted by the Ceylon Government, but it is confidently hoped that this obstacle will soon be removed.

### Annual Dinner of the Radio Society of Great Britain.

The Annual Dinner of the Radio Society of Great Britain was held as previously announced at the Waldorf Hotel, on Wednesday, January 24th, at 8 p.m. About sixty persons were present, including many members of the Society and delegates from affiliated Societies who had attended the Annual Conference earlier in the day. During the dinner it was the pleasant duty of the retiring President, Admiral of the Fleet Sir Henry B. Jackson, to make a presentation to Mr. and Mrs. Philip R. Coursey of a clock in commemoration of the successful transatlantic tests, 1922. The presentation was from the members of the Committee of the Society as a mark of appreciation of the work done by Mr. Coursey, assisted by Mrs. Coursey, in the organisation of the tests, and particularly the transmissions from this side of the Atlantic. An announcement was made on this occasion which will be of great importance to all members of the Society. It will be remembered that at the November meeting of the Society a member, Mr. I. Davidson, made the suggestion that the Society should give a wireless medal annually. This proposal has received the consideration of the Officers and Committee of the Society, and the announcement was made that the medal will be given each year for the most important British achievement during the year.

### Insuring Wireless Sets.

The risk of damage to wireless apparatus and of personal injuries arising to third parties therefrom has naturally given rise to insurance schemes. The Liverpool Marine and General Insurance Company, Ltd., who claim to have been the first to have drawn up a contract of this kind to meet the requirements of private persons, issue policies to provide compensation for damage to the wireless apparatus itself and to indemnify the owner in respect of claims by third parties as a result of personal injury or damage to property. Under the arrangement of this Company a premium of 7s. 6d. insures apparatus up to £50 in value and covers third party damage up to £500 (any one accident), including damage to property belonging to or under the control of the insured. Wear and tear, however, and such mishaps as the burning out of valves through wrong connections, are not insurable.

### Radio Stations in West Africa.

Some 250 posts have been actually opened or are under construction in French West Africa, and it is proposed soon to link up French Africa with the Soudan and Egypt.

## Calendar of Current Events

### Sunday, February 4th.

At 3.5 p.m. *Daily Mail* Concert from PCGG, The Hague, on 1,050 metres.

### Monday, February 5th.

9.20 to 10.20 p.m. Dutch Concert, from PCGG, The Hague, on 1,050 metres.

IPSWICH AND DISTRICT WIRELESS SOCIETY.

At 8 p.m. At 55, Fomereau Road. Lecture on "Land Line Telephone Practice," by Mr. B. Waters.

THE NORTH LONDON WIRELESS ASSOCIATION.  
Lecture on "The Production of Oscillations by Means of the Neon Lamp," by Mr. E. H. Robinson.

### Tuesday, February 6th.

Transmission of Telephony at 8 p.m. on 400 metres, by 2MT, Whittle.

ROYAL SOCIETY OF ARTS.

At 4.30 p.m. At John Street, Adelphi, W.C. Lecture on "The Base Metal Resources of the British Empire," by Sir Richard Redmayne.

THE INSTITUTION OF ELECTRICAL ENGINEERS.

At 7.0 p.m. At the Hotel Cecil, Strand, W.C. Annual Dinner and Reunion.

### Wednesday, February 7th.

THE ROYAL SOCIETY OF ARTS.

At 8 p.m. At John Street, Adelphi, W.C. Lecture on "Electrical Resistance Furnaces and their Uses," by Mr. C. R. Darling, F.Inst.P.

INSTITUTION OF ELECTRICAL ENGINEERS  
(WIRELESS SECTION).

At 6 p.m. At Savoy Place, Victoria Embankment, W.C.2. Experimental Demonstration. "The Measurement of the Electric Intensity of Received Radio Signals," by Mr. J. Hollingworth.

MANCHESTER WIRELESS SOCIETY.

At 7.30 p.m. At Houldsworth Hall. Elementary Lecture No. 3. By Mr. Y. W. P. Evans.

HALIFAX WIRELESS CLUB AND RADIO SCIENTIFIC SOCIETY.

At Clare Hall. Elementary Instruction Evening.

EDINBURGH AND DISTRICT RADIO SOCIETY.

At 8 p.m. At 117, George Street. Business Meeting. Lecture on "Wireless Transmission of Photographs," by Mr. F. Wyndham.

TOTTENHAM WIRELESS SOCIETY.

Lecture on "Valves," by Mr. Kaine-Fish.

### Thursday, February 8th.

At 9.20 to 10.20 p.m. Dutch Concert from PCGG, The Hague, on 1,050 metres.

LUTON WIRELESS SOCIETY.

At 8 p.m. Visit to Electricity Works.

ILFORD AND DISTRICT RADIO SOCIETY.

Lecture on "Accumulators," by Mr. C. G. Rope.

HACKNEY AND DISTRICT RADIO SOCIETY.  
At the Y.M.C.A., Mare Street, E.8. Informal meeting.

### Friday, February 9th.

SHEFFIELD AND DISTRICT WIRELESS SOCIETY.

At 7.30 p.m. At the Dept. of Applied Science, St. George's Square. Elementary Class.

LEEDS AND DISTRICT AMATEUR WIRELESS SOCIETY.

Lecture (Part II) on "Inductance and Capacity."

By Mr. W. G. Marshall.

BELVEDERE AND DISTRICT RADIO SCIENTIFIC SOCIETY.

Discussion on "Proposed Transmitting Apparatus," opened by Mr. S. Burman.

## BROADCASTING STATIONS.

Regular evening programmes, details of which appear in the daily press, are now conducted from the following stations of the British Broadcasting Company:—

London	2LO	369 metres.
Birmingham	5IT	420 "
Manchester	2ZY	385 "
Newcastle	5NO	400 "

Cardiff (5WA), 395 metres, we understand is to be working by the time this issue appears.

## Correspondence

To the Editor of THE WIRELESS WORLD AND RADIO REVIEW.

SIR,—A remarkable phenomenon that has been observed at my station many times during the past 12 years, was again repeated on the morning of December 20th, between 1 a.m. and 2 a.m.

It was the day of the great gale, and the barometer at the time stood at 28.7.

As frequently happens during these storm periods, there was considerable rise and fall in strength of some of what might be termed the nearer distant coast stations, but more pronounced than usual.

I was intercepting on 600 metres, and both GMH (Malin Head) and FFU (Ushant) were at work, the former communicating with Cullercoats, and the latter with ships. The strength of both stations was varying from moderate to very loud, but the curious point is this: *immediately* the Ushant signals began to increase, the signals of Malin Head would fade away, and *vice versa*, just as if they were at each end of a see-saw.

These two stations *have always behaved in exactly the same way* during periods of waxing and waning, as heard in London.

After many years' close observation, this is the only instance of consistency with regard to this phenomenon that I have come across.

Unfortunately, these investigations require a skilled knowledge of Morse and an intimate acquaintance with all coast stations within 1,500 miles, as they can only be made on the 600 metres wave, where a number of stations in different directions can be heard simultaneously.

It will be interesting to hear if the interception of American amateurs was good on this date.

B. S. T. WALLACE,  
P. O. Telegraphs.

## Questions and Answers

*NOTE.—This section of the magazine is placed at the disposal of all readers who wish to receive advice and information on matters pertaining to both the technical and non-technical sides of wireless work. Readers should comply with the following rules:—(1) Each question should be numbered and written on a separate sheet on one side of the paper, and addressed "Questions and Answers," Editor, THE WIRELESS WORLD AND RADIO REVIEW, 12/13, Henrietta Street, London, W.C.2. Queries should be clear and concise. (2) Before sending in their questions readers are advised to search recent numbers to see whether the same queries have not been dealt with before. (3) Each communication sent in to be accompanied by the "Questions and Answers" coupon to be found in the advertisement columns of the issue current at the time of forwarding the questions. (4) The name and address of the querist, which is for reference and not for publication, to appear at the top of every sheet or sheets, and unless typewritten, this should be in block capitals. Queries will be answered under the initials and town of the correspondent, or, if so desired, under a "nom de plume." (5) In view of the fact that a large proportion of the circuits and apparatus described in these answers are covered by patents, readers are advised before making use of them, to satisfy themselves that they would not be infringing patents. (6) Where a reply through the post is required every question sent in must be accompanied by a postal order for the amount of 1s., or 3s. 6d. for a maximum of four questions. (7) Four questions is the maximum which may be sent in at one time.*

"A.C.W." (Chelmsford) submits a diagram of his receiver and asks for a diagram of connections showing the addition of two note magnifying valves.

A diagram of connections is given in Fig. 1. Suitable values are indicated in the figure.

"J.J." (Glos.) submits a diagram of connections of his receiver and asks (1) What wavelength range will the receiver cover, the A.T.I. being wound with wire similar to the sample submitted. (2) Is the circuit suitable. (3) Is it necessary to use a variable condenser in the circuit.

(1) The sample of wire submitted is No. 22 enamelled copper wire, and with an average aerial the coil should tune from 200 to 3,000 metres. (2) The circuit is a very simple one, and is quite correct. (3) A variable condenser having a maximum capacity of 0.001 mfd. can be connected in series with the aerial. A small increase in signal strength may be expected.

"WAVY" (Sussex) wishes to make a basket coil suitable for the broadcast transmissions, and asks for particulars.

We suggest you wind 40 turns on a 2" diameter former and use the aerial condenser in series. The reaction coil may consist of 30 turns on the same diameter former. The wire in your possession is fairly suitable, but it would be better to use No. 22 D.C.C.

"W.T." (Smethwick) submits a diagram of his receiver and asks (1) Whether it is suitable, and (2) Suitable values for the high frequency transformer and reaction coil.

(1) The diagram of connections is quite suitable although it is somewhat involved. (2) The primary, secondary and reaction coils may form part of a three-coil holder. If it is desired to use the plug-in type of high frequency transformer, the reaction coil may be made to rotate close to the top surface of the transformer. The battery required for the detector circuit may consist of two dry cells.

"A.F.W." (Morpeth) asks (1) Is a potentiometer necessary to give the grid of the detector valve a suitable potential. (2) Is the circuit submitted and are the values given suitable. (3) Is a grid leak and condenser necessary.

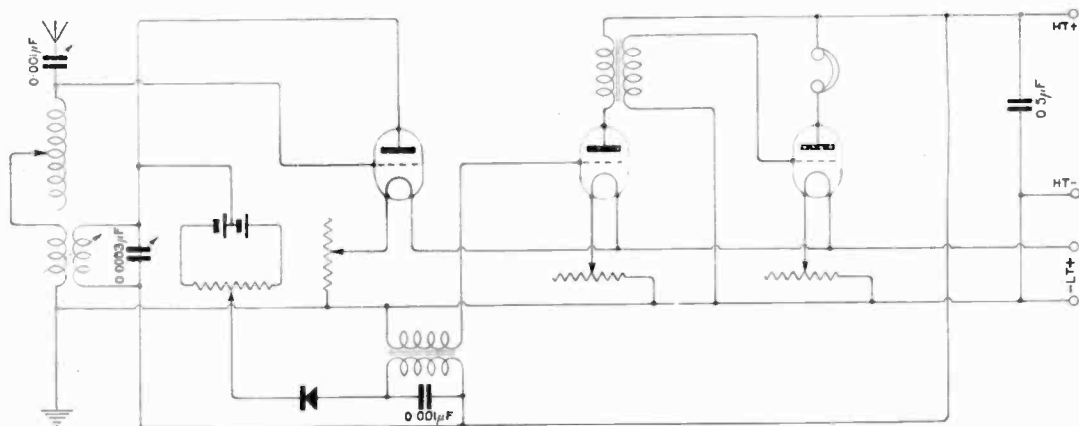

Fig. 1.

(1) It is not always necessary to use a potentiometer for controlling the grid potentials of valves. When a number of valves are used, there is an advantage in using a potentiometer, but with only a one-valve receiver, there would be no advantage gained. (2) We suggest you join the aerial condenser which has a maximum capacity of 0.001 mfd. in series with the aerial tuning inductance. A smaller inductance coil, which could be 4" in diameter and 5" long, wound full of No. 22 D.C.C. with 12 tapings, would be more suitable for short wavelength work than the large coil which you have at present. (3) A grid leak and condenser is necessary, and it would be better to connect a small fixed condenser across the telephone terminals. This condenser could be 0.001 mfd.

"D.N.B." (Beds).—(1) The wavelength of a frame aerial and condenser is calculated by the formula

$$\lambda = 1884 \sqrt{LC}$$

where L is the inductance of the frame aerial in microhenries, and C is the capacity of the condenser in microfarads. Given the wavelength and the capacity, the value L may be calculated directly without difficulty. To increase the wavelength range of the aerial circuit you should add a few more turns and bring them to a switch for putting them in or out according to the wavelength desired. We suggest 18 turns, or you could increase the size of the frame to 4' 6", and use 15 turns with tapings. When using a frame aerial, it is generally better to use a number of H.F. valves, depending upon the stations whose transmissions you wish to receive. We suggest the use of 2 H.F., 1 detector, and 1 L.F. valves when the stations are rather far distant. For broadcast reception we think 1 H.F., 1 detector and 1 L.F. connected valves will be quite suitable. (2) A suitable scheme of connections is given in Fig. 2. The first valve is connected as a H.F. amplifier. A crystal detector

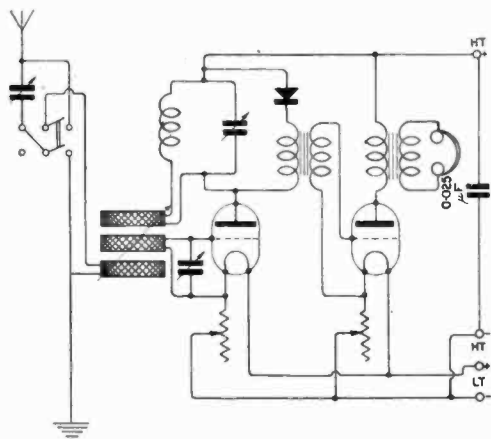

Fig. 2.

is joined across the anode circuit for rectification and the second valve is a note magnifier. The

H.T. and L.T. potentials may be 60 volts and 6 volts respectively. The aerial tuning condenser has a maximum value of 0.001 mfd. and the closed circuit condenser 0.0005 mfd. The anode tuning condenser has a maximum value of 0.0002 mfd.

"W.B." (Barnsley) asks for a diagram showing the connections of two H.F. valves with a crystal detector.

See Fig. 3. Suitable values are indicated in the figure.

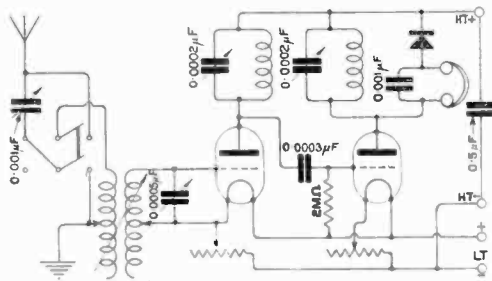

Fig. 3.

"C.W.R." (Kent) submits a diagram of his receiver and asks (1) How to prevent oscillations being generated. The aerial coil and anode coil are widely separated. (2) How may the effects of A.C. lighting in the house be eliminated. (3) What type of receiver would be the best for operating a loud speaker for the transmissions. (4) Why does placing an earthed body near the tuning condensers cause a greater wavelength change when receiving C.W. than when receiving spark signals.

(1) It would be advisable to connect the potentiometer across the + and -L.T. The earth lead and one end of the grid leak could then be brought to the sliding point of the potentiometer and adjustments made to prevent the set oscillating. When the aerial and anode circuits are tuned to the same wavelength, oscillations are usually generated, and it is necessary to provide a small current in the grid circuit as a rule to prevent the oscillations. (2) Special attention should be paid to the lead-in aerial wire and the earth connection. The wires should be run well away from other bodies, and in the case of the earth wire, should be as short as possible and make connection with a good ground connection, which should not be used for any other purpose. The low frequency portion of the amplifier may be screened by being placed in a metal box. (3) We suggest you use one high frequency, one detector, and two L.F. connected valves for the reception of broadcasting. The signals could be sufficiently amplified with this combination to properly operate the loud speaker. (4) The reason why capacity effects are more noticeable when receiving C.W. signals is because C.W. signals are very much more sharply tuned than spark signals. Small changes in the capacity of the circuit, which cause small wavelength changes are thus more noticeable.

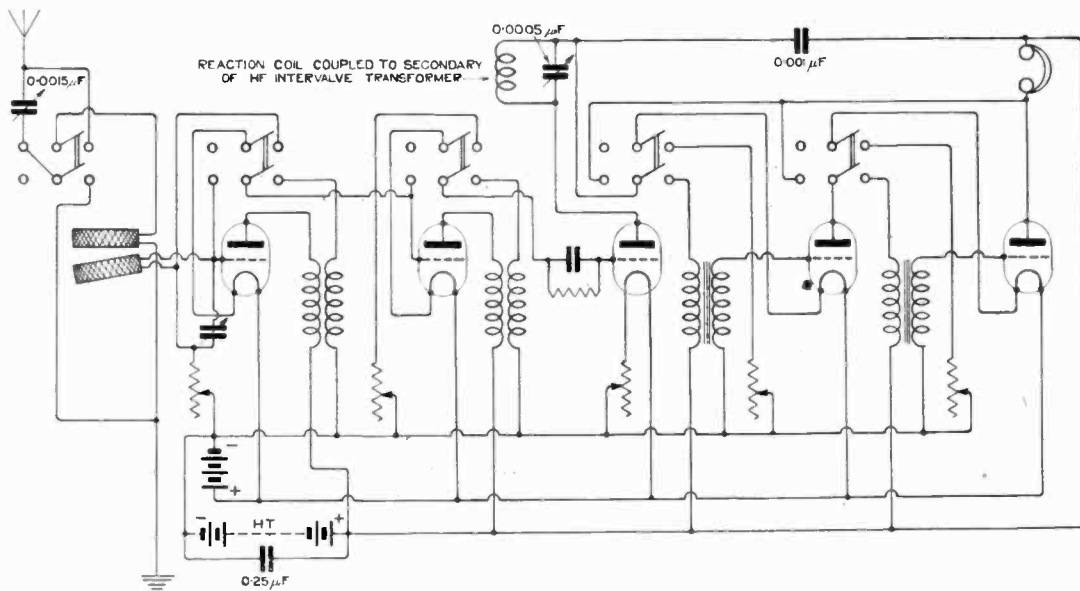

Fig. 4.

"J.B." (Sheffield) asks for criticism of his set, particulars of which are submitted.

The only modification required in the aerial circuit is that the tuning condenser will usually have to be connected in series instead of in parallel with the aerial tuning inductance. Fig. 4 indicates the method of connecting apparatus. We think you will require a five-valve set, but the sketch shows the switching arrangements in case you do not always require this number of valves to give signals of comfortable strength.

"S.F.W." (Berwickshire) asks (1) Whether a "V.24" type valve is a good amplifying valve and a poor detecting valve. (2) If the "V.24" type valve is a poor rectifying valve, is there another valve having the general shape of "V.24" type valve which is a good rectifier.

(1) The "V.24" type valve is a good amplifying valve, and is very useful for high frequency amplification. It is not such a good rectifying valve as other valves. (2) The "Q" type valve was specially designed for rectification, and is somewhat similar in shape to the "V.24" type valve.

"N.T." (Barrow-in-Furness) submits particulars of his receiver and asks (1) Whether the circuit is suitable. (2) May Burndept type coils be used in place of the duolateral type coils in an Armstrong super-regenerative receiver. (3) Capacity of the variable condenser. (4) Whether it is necessary to get permission before one can erect an aerial across the street.

(1) The proposed arrangement is fairly suitable although the reaction coil is coupled with the closed circuit coil, and unless care is exercised when making adjustments, oscillating energy will be transferred to the aerial circuit to the detriment of other people who are receiving. (2) Provided the inductance value of the Burndept coils is similar

to the inductance value of the duolateral coils they may, of course, be used. (3) The capacity of the variable condenser is of the order of 0.0012 mfd. (4) You are obliged to secure the permission of the District Surveyor before you may erect an aerial across the street, but we believe there will be no objection provided the aerial is 30 feet above the street level.

"A.C.B." (E.15) submits a diagram of a transmitting circuit, and asks for criticism.

The circuit submitted is suitable, but you could hardly expect to get good telephone transmissions when using rectified 50 cycles alternating current, unless you have a very efficient smoothing system. The condenser across the secondary of the microphone transformer should be variable, as the adjustment of the condenser affects the quality of the speech transmitted.

"E.J.S." (Dorset) asks advice as to the best method of erecting his aerial to avoid the power wires.

We suggest you run the aerial at right angles to the power line, even although this means that the aerial must be 25' above them. This construction would certainly be more satisfactory than the alternative arrangement.

"F.G.S." (N.8) submits particulars of his receiver and asks for suitable sizes of A.T.I. and closed circuit inductance.

The A.T.I. coil may consist of a winding 4" long and 5" in diameter, wound full of No. 22 D.C.C. Eight tappings should be taken, the first one after 1" of winding, and the remainder may be equally spaced. The secondary circuit may consist of a winding 4" in diameter and 5" long, of No. 28 D.C.C., with eight tappings, equally spaced after the first 1½" of winding.

"E.L." (Devonport) asks (1) For the weight of wire to use as a primary and secondary winding on L.F. transformer. (2) Is the proposed arrangement for winding a coil to be used in the anode circuit of the H.F. connected valve suitable. (3) Why is it that when listening to some transmissions the carrier wave is heard very strongly and the telephony rather weakly. (4) For a diagram showing the connections of a potentiometer connected to control the grid potentials of the H.F. valves.

(1) The primary winding may consist of  $3\frac{1}{2}$  ozs. of the wire in your possession, and the secondary 5 ozs. of the same diameter wire. (2) The proposed

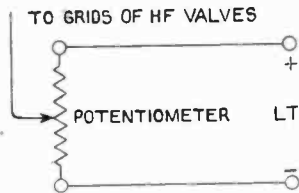

Fig. 5.

arrangement for building a coil to be used as a tuned anode coil is not very suitable. The self capacity of a coil constructed on the principle suggested would be very large indeed. We suggest you use an ordinary honeycomb winding. (3) The reason why you hear the carrier wave of the transmitting station very loudly and the telephony only faintly is due largely to the adjustment of the transmitting apparatus. Modulation is very incomplete, and the speech waves produce more or less a ripple upon the continuous waves transmitted. (4) The arrangement is given in Fig. 5. The grid connections are taken to the sliding contact of the potentiometer which is joined across the L.T. battery.

"M.H.H." (Birmingham) asks (1) For dimensions, gauge of wire, number of turns, and the number of tappings for a coil which will tune from 200 to 2,000 metres, with a 0.0002 mfd. tuning condenser. (2) For particulars of a suitable reaction coil to work with the above coil. (3) How much would the plate voltage be increased when resistance capacity coupling is used.

(1) We suggest you make the coil 4" in diameter and 7" long, wound full of No. 32 D.C.C. Twenty tappings should be taken. (2) The reaction coil may consist of 150 turns wound on the 3" diameter former which you have, with three tappings. (3) The high tension voltage should be approximately doubled, when a resistance of the order of 50,000 ohms is connected in the anode circuit.

"F.S.R." (Catford) asks (1) For a diagram of a three-valve receiver. (2) What is the natural wavelength of an aerial 40' high and 45' long. (3) What wavelength is obtainable when 45 turns of No. 25 D.C.C. from the basket coil are connected with the above aerial. (4) What is the capacity of a fixed condenser which consists of six plates of copper foil,  $1\frac{1}{2}'' \times \frac{1}{2}''$ .

(1) See Fig. 5, page 356, December 9th issue. (2) The natural wavelength is of the order of 120

metres. (3) Without knowing the dimensions of the coil referred to, we cannot calculate its inductance and so get the wavelength to which it will tune when connected with the aerial mentioned in (2). The wavelength is probably 300 metres. (4) The capacity of the fixed condenser is roughly 0.006 mfd., but we cannot work it out exactly, as you have not given us sufficient particulars. We suggest you work this out for yourself. The capacity  $C$  mfd. of a fixed condenser is equal to

$$0.0885 KA(N-1)$$

where  $A$  equals the area of overlap in square centimetres.

$K$  is the specific inductive capacity of the dielectric.

$N$  is the total number of foils, and

$T$  is the thickness of the dielectric in centimetres.

"A.E." (Ashby de la Zouch) submits particulars of a proposed arrangement and asks for criticism.

The proposed arrangement for attaching the Skinderviken button to the receiver diaphragm is quite suitable, although a little experimental work will be necessary before the adjustments are correct. Four dry cells will provide sufficient current to energise the microphone and loud speaker. The low resistance telephone should have a resistance of the order of 60 ohms, otherwise a transformer should be used. On account of the steady direct current which will be flowing through the receivers, it will be well to reverse the connections to see that best results are being obtained.

"H.G." (N.W.6) asks which coils should be used when tuning in.

When receiving broadcast transmissions, we suggest you use the No. 35 coil in the aerial circuit, No. 50 coil in the closed circuit, and No. 75 for reaction coil. It may be found the reaction coil is too large, in which case the No. 25 should be used. The amount of reaction required depends entirely upon the method of wiring up the set, and whether it has an inherent tendency to freely oscillate or not. The same ratio in general should be used throughout the range of wavelengths covered by the coils, although on higher wavelengths it will generally be found necessary to use a coil for the reaction circuit which is smaller than that used in the aerial circuit.

## SHARE MARKET REPORT.

Prices as we go to press on January 26th, are:—

Marconi Ordinary .. ..	£2 10 0
.. Preference .. ..	2 4 0
.. Debentures .. ..	107 0 0
.. Inter. Marine .. ..	1 9 8
.. Canadian .. ..	11 0

Radio Corporation of America:—

Ordinary .. ..	16 0
Preference .. ..	13 6

For the Discriminating Amateur

# WJZ on a Broadcast Receiver

The Marconi Scientific Instrument Company, Ltd., continuing its policy of providing the discriminating amateur with the best possible apparatus for all experimental work, has now produced a remarkably efficient three-valve broadcast receiver, containing one high-frequency, one detecting and one note-magnifying valve—the combination which has proved by far the most popular with experienced amateurs.

Distinguishing features of this instrument are:—

- (1) **Wide Range of Wavelength** (300 to 2,600 metres, thus including the Dutch and French broadcasting, as well as the British).
- (2) **Variable Reaction on all Wavelengths in a Circuit approved by the Postmaster-General as non-radiating.**
- (3) **Tuned High Frequency Coupling, without Peaks on particular wavelengths and Loss of Amplification on others.**
- (4) **Remarkable Selectivity enabling local Broadcasting Stations to be tuned out and Distant Stations received when desired.**
- (5) **Equal efficiency in the Reception of Continuous Wave Signals, Telephony and Spark Stations.**



Although only just placed on the market, it has already been successfully used for the reception of **WJZ**, the famous American broadcasting station in New Jersey. This was effected by a purchaser in **South Kensington**, within a few days of receiving the set, on an aerial measuring 70' long and 35' high, temporarily erected for the attempt.

As an example of the selectivity of this instrument, a customer situated four miles from the Manchester broadcasting station is able to tune out Manchester completely and receive London or Birmingham at will. This is a remarkable achievement, for a receiver bearing the BBC stamp, which is often thought to indicate that the receiver must necessarily be inefficient.

The price of this receiver, including three valves, is **£35**, plus **£2 : 5 : 0** royalty to the British Broadcasting Company if it is desired to use the instrument with a Broadcast Licence. Accessories, including high and low tension batteries, aerial wire, insulators, leading-in tube and one set of telephone headgear **£7 : 7 : 6** extra.

**The Marconi Scientific Instrument Co. Ltd.**

Telegrams : **Themasinco, Westcent.** 40 Dean Street, Soho, W.1

Telephone : **Gerrard 7745.**

# A Surprising Story of an Accumulator.

In writing to order another "Ideal" Accumulator, a user says:—

"When I left—last July, one of your batteries (glass) was left, and though it had been in work it held the remainder of its charge for over three months, and with a similar one worked a valve at the end of that time, giving its usual ampere hour service."

A wonderful example of soundness of construction which goes to prove our claim that for long life and reliability the "IDEAL" is without equal.

CAPACITY—50 ampere hours intermittent  
25 " " continuous

PRICE :

4 Volt - - - 24/- (carriage 2 -)  
6 Volt - - - 35/- (carriage 3 -)

(In wooden case with leather carrying handle)

ORDER TO-DAY. Post Orders executed in 24 hours.  
Or call at our Showrooms — they will interest you.

**Wates Bros.** 13-14, Great Queen St.  
Kingsway, London, W.C.2

'Phone—Gerrard 576.

'Grams—Zyvalensg, Westcent.



### Crystal Receiving Set.

Receives Broadcasting for 30 miles  
£5 : 0 : 0 complete (no extras.)

Filament Resistances	3/6
Pyramid H.T. Battery (15 volt)	3/6
30 Volt (with variable plug connection)	7/-
Variable Condensers (of various capacities)	from 6/-
Fixed Condensers	2/6
3-Coil Holder, complete Unit for use with Standard Coils	20/-

**ECONOMIC ELECTRIC LIMITED**

ESTAB. 1896

Turned Ebonite  
Condenser Dials

High Frequency  
Interchangeable  
Transformers

Low Frequency  
Interval  
Transformers

*We will mail  
you our 40  
Page Radio  
Catalogue  
for a remit-  
tance of 4d.  
Apply now!*

**FITZROY SQUARE, LONDON, W.1**  
Telephone—MUSEUM 1055. Branch—TWICKENHAM

## J. BURNS, LTD.

Wangye Works,  
Chadwell Heath, Essex.

---

We are actual manufacturers and  
can offer special advantages to  
the trade—send us your enquiries.

---

CONDENSERS.	Retail price
.001 mfd.	each 12/6
.0005 "	each 10/-
.0003 "	each 9/-
.00005 "	each 4/6
Filament Resistances	each 2/-
Terminals with high base	doz. 1/6
Contact Studs, with nuts	doz. 9d.
Sliders, with springs and studs	each 9d.
Ebonite Coil Holders	each 12/6
Ebonite Knobs	doz. 4/-
Ebonite Panels, Prices on application.	

### Single Valve Panels

Fitted with Variable Condenser, Filament Resistance, Grid Leak and fixed Condenser, Engraved Panel and Rosewood Finished Box, ready for use

# £4

**Vulcanised Fibre and Ebonite  
Sheets, Rods & Tubes from stock.**



# TOMLINSON LONDON, LIMITED.

*Demonstrations  
Daily.*

*Demonstrations  
Daily*

3, FINCHLEY ROAD, ST. JOHN'S WOOD, N.W.8

*Hampstead 1844*

- Complete 4-Valve Experimenter's Set, with Loud Speaker, phones, H.T. and L.T. . . . . £45
- Complete 4-Valve Set, stamped B.B.C., with all accessories . . . £32 10/-
- The famous Marconiphone V.2 2-Valve Set, complete, ready for use . . . . . £25
- Crystal Valve Set using Crystal Rectification and Valve Amplification . . . . . £13 10/-
- OUR SPECIAL 3-COIL HOLDERS.** . . . . 20/-
- Potentiometers in teak box . . . . . 7 6
- H.T. Batteries, 36 Volts . . . . . 7 6
- Variometer Formers (unwound), per set . . . . . 7 6
- Crystal Sets, from . . . . . £4 4/-
- Aerial Wire, 100' 7 22 . . . . . 5 6

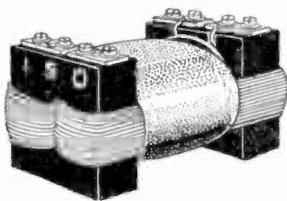

**HIGHLY EFFICIENT  
L.F. TRANSFORMER**  
12/6 (Postage 4d.)

- Aerial Insulators . . . . . 1/-
- Leading-in Tubes . . . . . 2/9
- Filament Resistances . . . . . 4/6
- Valve Holders . . . . . 1/-
- Connecting Wire, tinned, per 10. 16 and 18 S.W.G. . . . . 1 3
- Grid Leaks and Condensers from 5/-
- Fixed Condensers, any capacity 2/6
- Rubber-covered Wire for wiring-up, per hank . . . . . 2/-
- Double Throw, Double Pole Switch . . . . . 5 6
- Five Contact Switch . . . . . 4 6
- Ten Contact Switch . . . . . 5 6
- Condenser Vanes, per pair . . . . . 2d.
- Terminals . . . . . each 2d.
- Telephone Terminals . . . . . each 3d.
- "XTRAUDION" Valves . . . . . 15/-

**ALL ORDERS OVER 40/- POST FREE.**

## COMPLETE RECEIVING STATION

*Ready  
for use*  
**£69/11/0**

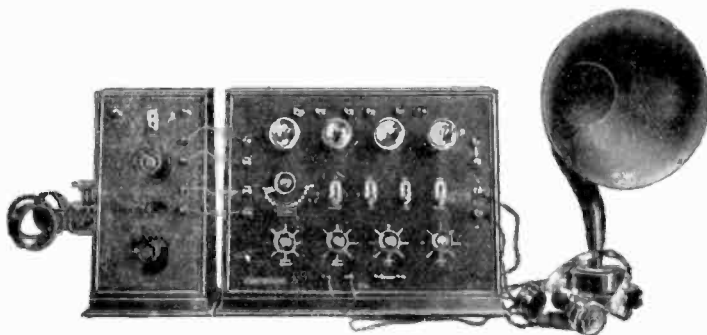

The results given by this set are simply marvellous. The various concerts can be received anywhere in the United Kingdom, and can be rendered on a Loud Speaker with sufficient strength to fill a small hall; within fifty miles or so of a high-power broadcast station music on the Loud Speaker is so loud that it can be heard five hundred yards away.

**Ethophone Crystal Broadcast Receivers from £3. Ethophone Valve Broadcast Receivers from 25 Guineas. Burndept Experimental Receivers from £5.**

*We are authorised agents for all Burndept Wireless Apparatus and Accessories.*

**CHARD & CO., 24a, Great Portland Street, London, W.1.**

Phone : Gerrard 6602.

More and More Wireless  
Manufacturers are specifying

**BROWN'S**  
Super - Sensitive  
TELEPHONE  
RECEIVERS  
Types A and D



THERE MUST BE REASONS FOR THIS. It is because, with the "BROWN" TYPE A Headphones the range is much increased, and signals difficult to detect with the use of the usual telephonic receivers are clear and distinct when these instruments are used.

These headphones possess an efficiency of three times that of other telephonic headgears. Their extreme lightness and ease of adjustment make them the most comfortable of all headphones to wear.

TYPE D is also recommended for wireless telephony or for ordinary telephone work in which the extreme sensitiveness of Type A is not essential.

<b>PRICE: Type A (with Cords)</b>		<b>The Pair.</b>	<b>PRICE: Type D (with Cords)</b>	
120 ohms	.. ..	£2 18 0	120 ohms, the pair	.. .. £2 8 0
Over 120 ohms to 4,000 ohms	.. ..	3 2 0	Over 120 to 4,000 ohms, the pair	.. .. 2 12 0
4,000 ohms to 8,000 ohms	.. ..	3 6 0		
Carriage Paid in U.K.			Carriage Paid in U.K.	

OBTAINABLE FROM ALL WIRELESS DEALERS.

*In universal use. Supplied to British and Foreign Governments.  
Illustrated Catalogue of our Headphones, Loud Speakers and Amplifier post free from—*

**S. G. BROWN, Ltd.**

London Offices and Showrooms (RETAIL ONLY)—

**19, MORTIMER ST., LONDON, W.1**

TRADE COMMUNICATIONS ONLY TO—  
HEAD OFFICE AND WORKS: VICTORIA ROAD, NORTH ACTON, LONDON, W.3.  
Telegrams—"Sadbrownix, London." Telephone—Chiswick 1469.  
Sole Agent for the Argentine—Horacio D. Guerrero. Las Heras, 2186, Buenos Aires.

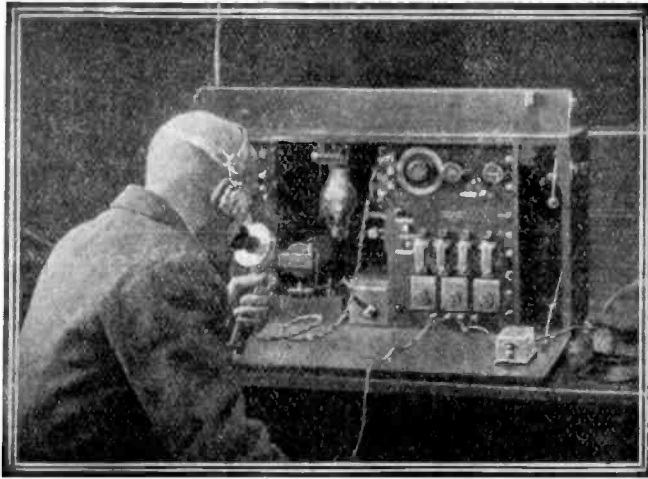

## *The First Commercial Wireless Telephone Service in Great Britain*

*is used for*

*Communications between the offices of the Mersey Docks & Harbour Board in Liverpool and the Bar Lightship beyond the mouth of the Mersey. The Marconi apparatus in each case is operated by the ordinary Harbour Board staff and has been in continual use since its installation over a year ago. — "Calling up" is performed by means of the*  
 •• Marconi wireless bell ••

MARCONI'S WIRELESS TELEGRAPH CO., LTD.  
 MARCONI HOUSE, STRAND, LONDON, W.C.2  
 Telephone: CITY 8710.

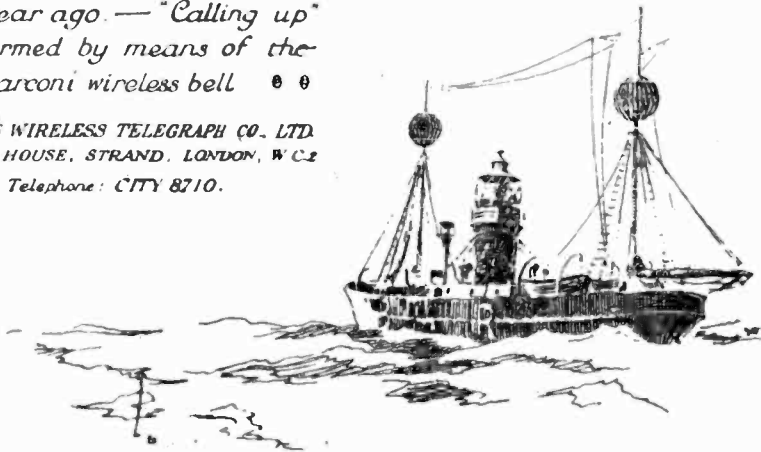

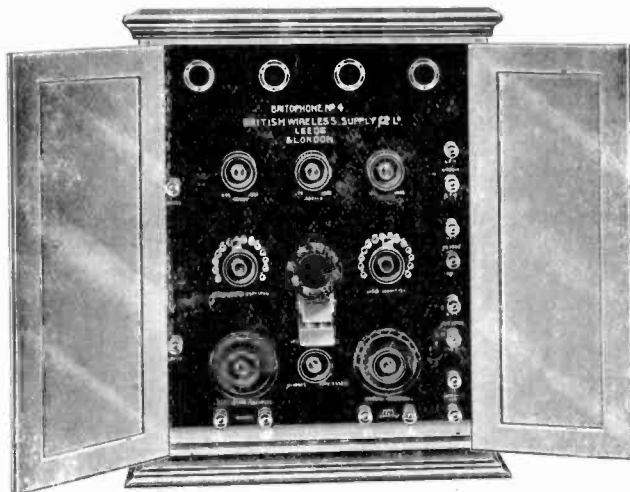

P.O. Regd. No. 0181.

## "BRITPHONE" No. 4

Cabinet Measurements, 20 $\frac{1}{2}$ " x 16 $\frac{1}{2}$ " x 9 $\frac{1}{2}$ ". Range covers 200-25,000 metres wavelength.

**A**N excellent four-valve Broadcast Receiver in polished mahogany cabinet, with folding panelled doors fully in keeping with the general appearance of the instrument. The receiving panel is of Radion Mahoganite.

The four valves include 1 H.F., 1 Rect., and 2 L.F. steps. The last valve by means of a switch acts as either an ordinary magnifier or a power valve for use with any loud speaker. The high tension voltage on this valve can be anything up to 400 volts, thereby obtaining tremendous increase in volume of sound, suitable for entertainments in large halls or out in the open.

**PRICE** complete with all accessories, including four Valves and Coils up to 4,000 metres, **40 Gns.**

All "Britophone" Apparatus is approved by the Postmaster-General and is manufactured under Marconi licence.

**BRITISH WIRELESS SUPPLY Co. Ltd.**

Head Office - - - 6, BLENHEIM TERRACE, LEEDS.  
Phone—26926.

London Showrooms - - - 64, FRITH STREET, W.  
(off Shaftesbury Avenue).  
Phone—Gerrard 2789.

**DEMONSTRATIONS DAILY.**

And at—  
18, Eldon Square, Newcastle.  
Phone—Newcastle-on-Tyne, 160 City.  
4, Pembroke Square, Above Bar, Southampton.  
Phone—Southampton 403.

And at—  
11, Church Street, West Hartlepool.  
Phone—West Hartlepool, 373.  
8, Corporation Street, Belfast.

**EXPERIENCE**

# HIGH POWER SETS

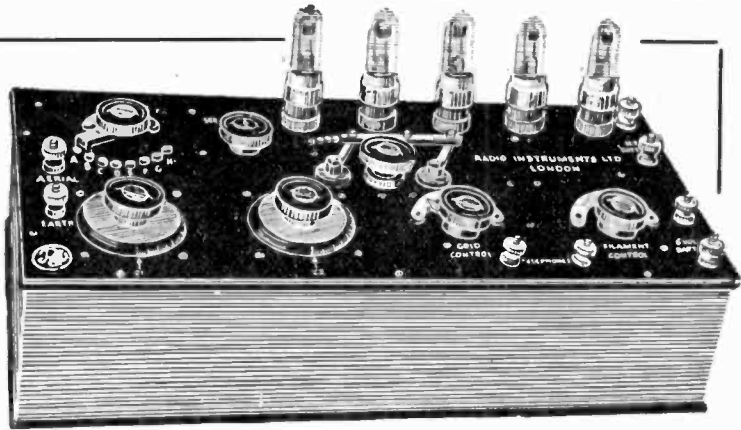

## IMPORTANT

All our valve sets have a wave-length range up to 4000 metres, bringing in the Hague, Paris and the principal continental telephony.

R.I. valve sets are universally recognised as the most efficient broadcasting amplifying receivers obtainable. They are sold on results.

Our instruments are designed by well-known radio engineers of proved experience who are thoroughly familiar with broadcasting problems.

*Hence the phenomenal success of our productions.*

Broadcasting seal on all sets.

**IMMEDIATE DELIVERY.**

Complete catalogue on application.

Booklet of "Lyrian" Cabinet Receivers now ready.

Attractive poster for the dealer sent free.

A superfine five valve set .. .. .	£40 : 0 : 0
Five valve amplifying receiver alone, without Accessories .. .. .	£32 : 0 : 0
A four valve set of the highest grade .. .. .	£33 : 10 : 0
Four valve amplifying receiver alone, without Accessories .. .. .	£27 : 10 : 0

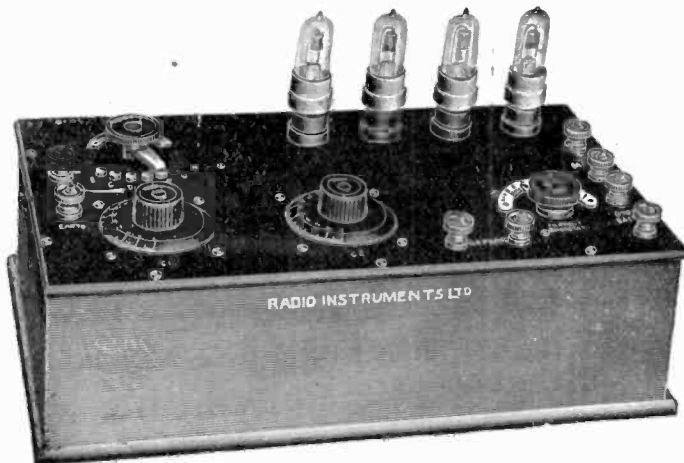

### ONE OF OUR MANY FINE TESTIMONIALS.

Messrs. Radio Instruments, Ltd.

Peterborough.

Dear Sirs,

On Wednesday last Mr. Laxton of Lincoln Road, Peterborough, supplied and fixed a four valve receiving set, Type V.H.A., Series No. 138, Reg. No. 0012, for me at the above address.

On Thursday, without any previous experience or knowledge of wireless, I listened in to London, Birmingham, Manchester, Paris and the Hague. On Saturday we heard the whole of the Opera, the last act and speeches following were exceptionally clear.

I think my success with this instrument is a clear proof of the simplicity and efficiency of your receiver.

Yours faithfully,  
(sgd.) W. PEARCE.

Call and see our showrooms.

## RADIO INSTRUMENTS LIMITED.

Managing Director: J. JOSEPH, M.I.E.E. late Manager to Mr. H. W. SULLIVAN.

Chief Designer: W. A. APPLETON, M.B.E., M.I.R.E., late Admiralty Technical Research Officer.

ONLY ADDRESS: Works, Offices and Showrooms: 12, Hyde Street, NEW OXFORD STREET, W.C.1

Telephone—Regent 1908.

Telegrams—Instradio, London.

(E.P.S. 23a.)

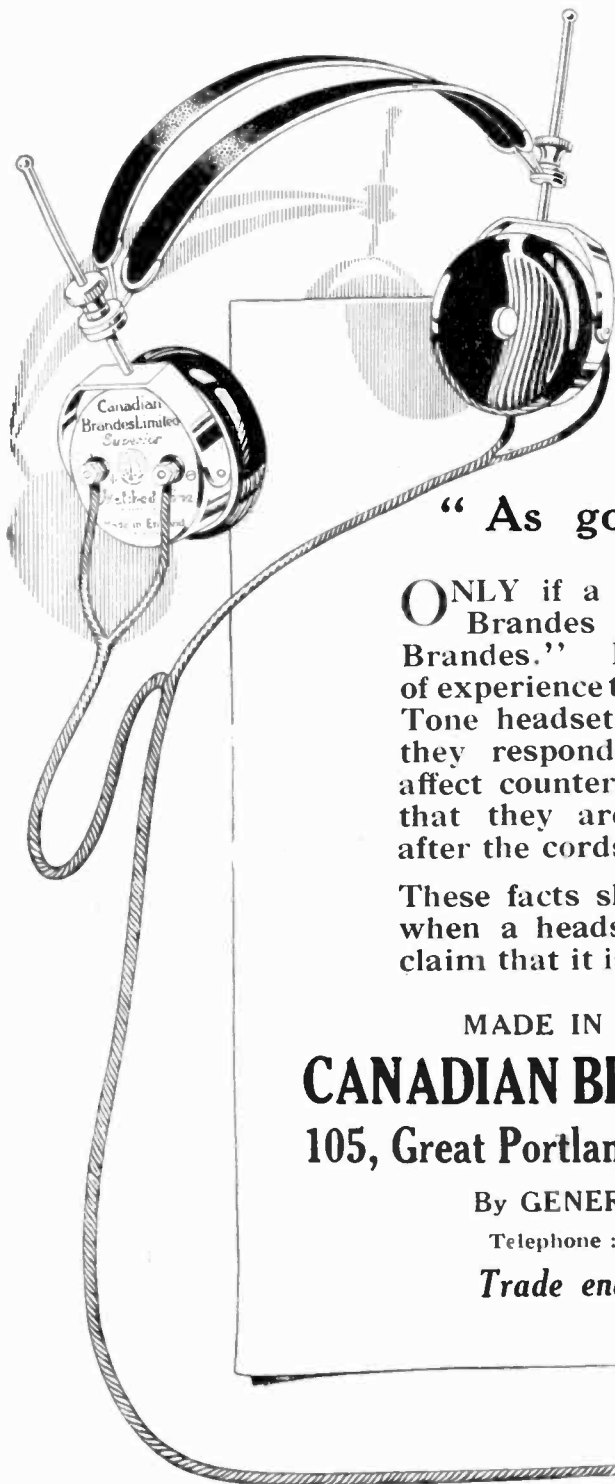

*Result of  
14 Years' Experience*

**“As good as Brandes”**

**O**NLY if a headset bears the name Brandes can it be “as good as Brandes.” It took fourteen years of experience to make Brandes Matched Tone headsets so supersensitive that they respond to signals that cannot affect counterfeits, and are so durable that they are still serviceable long after the cords have worn away.

These facts should be borne in mind when a headset is offered with the claim that it is “as good as Brandes.”

MADE IN ENGLAND FOR

**CANADIAN BRANDES LIMITED**

**105, Great Portland Street, London, W.1**

By GENERAL RADIO CO.

Telephone : LANGHAM 1145.

*Trade enquiries invited.*

"WE REPLY BY RETURN."

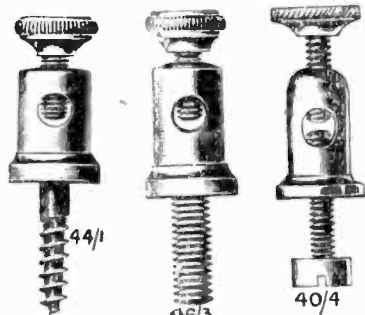

**SOLID BRASS TERMINALS.**  
 No. 44/1, 1" 1½d.  
 1" 2d.  
 1½" 2½d.  
 1½" 3d.  
 No. 46/3, 1" 2d.  
 1½" 2½d.  
 1½" 3d.  
 No. 40/4, 1" 1½d.  
 1" 2d.  
 1½" 2½d.  
 1½" 3d.  
 No. 56, 1" 2d.  
 No. 58, 1½" 3d.  
 No. 42/4, 1" 2d.  
 1½" 3d.  
 1½" 3½d.  
 1½" 4d.

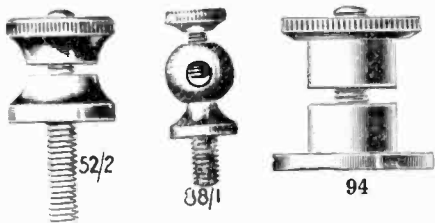
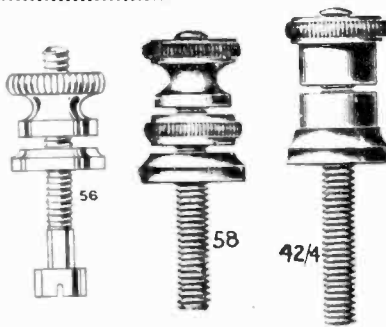

**COMPLETE ILLUSTRATED LISTS POST FREE.**  
 No. 52/2, 1½" 2½d.  
 No. 88/1, 1" 1½d.  
 No. 94, 1" 4d.  
 No. 45/1, 1" 1d.  
 No. 52/1, 1" 2d.  
 No. 49/1, 1" 1½d.

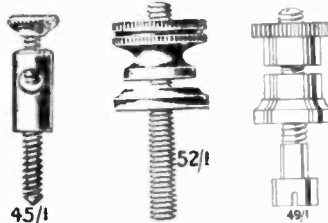

**ELECTRICAL SUPPLY STORES,**

**5, ALBERT TERRACE, KING CROSS, HALIFAX.**

(R. PALMER)

**WIRELESS TRAINING**

Most thorough training in Wireless Telegraphy or Telephony given under ideal conditions.

Special Postal Course for Amateurs.  
*Prospectus Free.*

**WIRELESS APPARATUS**

Complete stocks of all Wireless Instruments and Accessories. Prompt Deliveries. List 1½d. stamp.

**WIRELESS COLLEGE COLWYN BAY**

**"WHALE FOR WIRELESS"**

'PHONES—Brown's 4,000 or 120	30/-
Brunet 4,000	21/8
VALVES—R Type	11/-
Q or V24	12/6
INSULATORS—Reel	1½d.
Egg	3d.
Coil Mounts, Ebonite	1/8
Condenser Plates 24	1/-
Condenser, enclosed Vernier	6/-
Valve Holders from	1/-
Accumulators from	3/-
'Phonophone holders	4/-

N.B.—Do away with your crystal or valve detector and fit our PHONOPHANE, 15/- each. Call for demonstration.

**THE WHALE WIRELESS CO.**  
 321, VAUXHALL BRIDGE ROAD, LONDON, S.W.1  
 'Phone: Victoria 5413. (Victoria)

**BUTLER'S RELIABLE MANUFACTURES.**

**Broadcast Sets**

BEFORE BUYING ELSEWHERE  
 SEND FOR OUR FULLY  
 ILLUSTRATED  
 LIST.

Post **4<sup>D</sup>** Free.

**H. D. BUTLER & Co., Ltd.**

Showrooms: 222, Great Dover Street.  
 Telephone—HOP 3029.

Offices and Works—HALTON ROAD, CANONBURY.  
 Telephone—NORTH 1838 Extension.

# EBONITE OF QUALITY

As actual manufacturers of Ebonite, we are able at all times to produce a quality that will meet every condition of the job in hand. That is why we are pleasing all our customers among the wireless manufacturers at home and abroad.

WHOLESALE ONLY. WRITE FOR LIST.

- |        |                 |
|--------|-----------------|
| SHEET  | COIL HOLDERS    |
| ROD    | VALVE HOLDERS   |
| TUBING | CONDENSER DIALS |
| KNOBS  | RHEOSTAT DIALS  |
| PANELS | EBONITE HORNS   |

**HIGHTENSITE LTD.**  
Normandy Works, Custom House, E.16

'Phone: EAST 3153.

## BROADCASTING RECEPTION SETS

One-Valve Set, Complete, for Working .. .. £7 10s.  
Passes for  
Broadcasting  
Licence  
G.P.O. No.  
1038.

**DESCRIPTION.**  
Single Valve, mounted on polished Ebonite Panel with Variable Condenser, smooth acting resistance, grid leak and condenser and all terminals clearly engraved in white, in a Mahogany Polished Cabinet, 9" x 5" x 5".  
£3 15s.

SEND FOR CATALOGUE

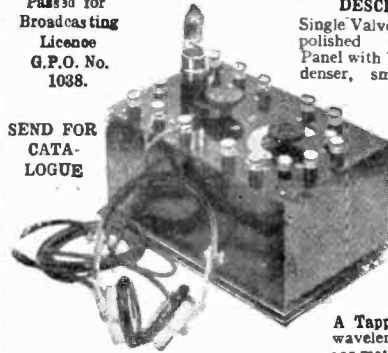

A Tapped Coil for wavelengths up to 900 metres with 2 terminals for coils for any higher wavelengths. The coil is enclosed and the tapings are brought out to an 8-way switch mounted in the front of the cabinet.

**ACCESSORIES INCLUDED:**

- |   |         |
|---|---------|
| Siemens' 54 volt high-tension battery with plugs for altering the voltage .. .. | 15s.    |
| 4 Volt 50 Amp. hour low tension accumulator in case with carrying strap .. ..   | £1 4s.  |
| One pair of sensitive head 'phones of 4,000 ohms resistance .. ..               | £1 1s.  |
| One detecting valve .. ..   | 15s.    |
| <b>PLUS B.B.C. ROYALTIES.</b>   |         |
| Total .. ..   | £7 10s. |

**WIRELESS INSTALLATIONS LTD.**  
Dept "C," 81, TURNMILL STREET, LONDON, E.C.  
(Nearly opposite Farringdon St. Station, Metropolitan Railway.)

## "RADIO - WAVE" CONCERT RECEIVERS.

TWO-VALVE RECEIVER: BROADCAST RANGE 100 MILES.



The Radio-Wave One Valve Receiver meets the needs of those living within 30 miles of a Broadcasting Centre. For those living at greater distances there are the Radio-Wave Multi-Valve Sets described in a 24 page illustrated Catalogue post free to you.

*A customer writes from Herne Bay:*  
I have received Manchester and get London and Birmingham loudly with the 3 Valve Radio-Wave Receiver. I am delighted with the appearance of the set.

Price **£16 16 0**, no extra charge for B.B.C. or Marconi Royalties.

**The MEDICAL SUPPLY ASSOCIATION Ltd.**

167-185, GRAY'S INN ROAD, LONDON, W.C.



*We beg to announce*

that at the request of the Manchester Wireless Traders' Association we are now organising the

# MANCHESTER ALL-BRITISH WIRELESS EXHIBITION AND CONVENTION

which will take place at the  
**BURLINGTON HALL**  
BURLINGTON ST., MANCHESTER

## 17th—24th MARCH

(Saturday to Saturday inclusive)

The Convention will be held under the auspices of the **Manchester Wireless Society**. The solid co-operation of the Trade is fully assured.

Further particulars will be announced shortly.

*Wireless Publicity Specialists. Advertising Agents & Contractors, Printers & Publishers. Organisers of the First All-British Wireless Exhibition—London, 1922.*

Applications for space are now being dealt with in rotation by

THE ORGANISERS:

**B**  
**D** **BERTRAM DAY & CO., Ltd.**  
9 and 10, Charing Cross, London, S.W.1  
Gerrard 8063-4-5. "Adbertrada, Westrand, London."  
Manchester Office: E. G. DUNN, 27a OXFORD STREET, MANCHESTER

## AN INTRODUCTION TO

TWO VOLUMES **RADIO** Pocket Size

Price **6/-** nett.

Post free 6/3.

*An American publication for the Beginner in Wireless.*

### CONTENTS.

- Vol. 1. Chapter I. An introduction to Radio.  
" II. Radio Telephony.  
" III. The various Instruments used in Radio Transmitting and Receiving Outfits.
- Vol. 2. Chapter IV. Technical Terms Explained.  
" V. How to set up Receiving Outfits.  
" VI. Primer of the Vacuum Tube.  
" VII. How to set up Radio Transmitters.

**The Wireless Press, Ltd.**  
12/13 Henrietta St., London, W.C.2

*AT LAST!*

## Complete Receiving Stations Even to the last screw

All sets are stamped with the B.B.Co., seal and are fully approved by H.M. Postmaster-General. Prices include B.B.Co. fees and royalty to the Marconi Co.

- No. 1 **SINGLE BAR SLIDER CRYSTAL SET**, P.O. No. 180, Ericsson Headphones, complete indoor installation, and aerial mast and complete aerial outfit, **£5 5s.**
- No. 2. **DOUBLE BAR** ditto, P.O. No. 181, **£6 6s.**
- No. 3. **IMPROVED PANEL TYPE**, complete with Ericsson Headphones in close-up cabinet, B.B.C. No. 333 (Registration applied for), complete indoor installation, aerial mast and complete outdoor aerial outfit **£7 7s.**
- No. 7. **IMPROVED TYPE 2-VALVE SET** (H.F. and Detector), P.O. No. 2058, with Ericsson Headphones in handsome close-up cabinet, Hart Accumulator, H.T. Battery and complete indoor installation, Aerial Mast, and complete aerial outfit, **£21.**

Terms, cash with order.

Liberal discounts allowed to Retailers and factors on application to—

**THE AERIAL & RADIO EQUIPMENT WORKS**

Trenmar Gardens, Willesden Junction, N.W.10



Series No. 2

Makers of over Half  
the World's Telephones.



# Western Electric

CRYSTAL  
RECEIVING  
SET.

The Western Electric Crystal Pattern Receiving Set has been specially designed and developed to meet the demand for a simple and inexpensive apparatus which will enable the amateur—without electrical knowledge—to take advantage of the local "Broadcast" programme. It is simple, inexpensive, and in its polished mahogany box with hinged lid, is compact and handy and looks well. A partition is included which holds the double head receivers. The set is complete with two spare crystals and has quite an excellent range. A most popular set.

## *Western Electric Company Limited.*

Connaught House, Aldwych, W.C.2

Telephone—Central 7346.

WORKS:—

North Woolwich, London, E.16

Telephone—East 3840 (10 lines)

Also at BEXLEYHEATH, KENT, and NEW SOUTHGATE, N.11

Birmingham—Grenville Buildings, 12, Cherry St. Manchester—Northern Assurance Buildings.  
Leeds—Standard Buildings, City Square. Newcastle—20, Saville Row.  
Cardiff—Motor House Chambers, 1, Wood St. Glasgow—49, West Campbell Street.



# BINDING CASES

(INCLUDING INDEX)

VOL. 9

## The Wireless World

Price **3/6** nett.

(Post free 4/-)

## INDEX (SOLD SEPARATELY)

Price **8d.** Post free.

The Wireless Press, Ltd.,

Dept. W.W., 8/4,

12-13, Henrietta Street, London, W.C.2

# THE AUDIOPHONE

EMPLOYING THE UNIT SYSTEM.

### SPECIFICATION.

Highly skilled hand labour throughout. Bare, tinned internal wiring, bent on formers, and soldered at all connections, thus ensuring a noiseless circuit. Polished ebonite panel, engraved white. Polished mahogany cabinet. Wavelength range 300-550 m.

Higher wavelengths obtained by means of plug-in-coils.

Fully approved by P.M.G.

**IMPORTANT:** Fixed Reaction is a feature of this Receiver.

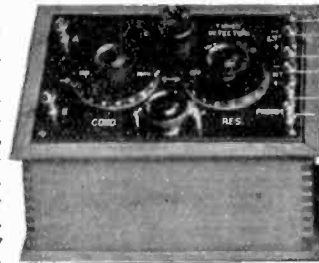

P.M.G. Reg. No. 1018.

### TUNER DETECTOR.

Price as shown £7 7s.  
Complete with all accessories £11 15s.  
All components & accessories supplied.

Prices include Marconi Royalty and commission to B.B.C.

**TERMS.** Cash with order, or five days' approval against full deposit.

Manufactured under Marconi Licence by—

## J. R. WRIGHT

Head Office and Factory 10, Carton St., Baker St., W.1

Demonstration Showrooms:  
3, New Quebec Street, W.1. (Phone 3848 Paddington.)



# Two Symbols



When these two symbols appear in conjunction on a Broadcasting Receiver, no further recommendation is necessary. The one signifies that the instrument has been approved by the Postmaster-General.

The other tells you that the greatest brains in Wireless have directed its manufacture. Look for *both* signs always. You will find them only on

# The Marconiphone

*The Triumph of the Master Mind.*

You local dealer can supply you. In case of difficulty apply to

**MARCONI'S WIRELESS TELEGRAPH COMPANY, LIMITED**  
(Marconiphone Department), MARCONI HOUSE, STRAND, LONDON, W.C.2

# T.M.C. WIRELESS

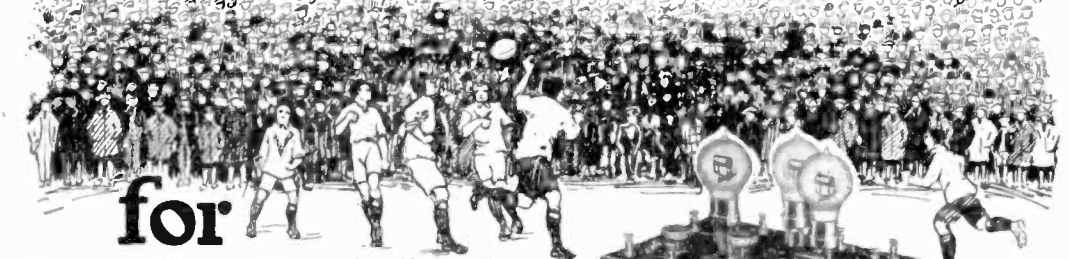

for  
football results

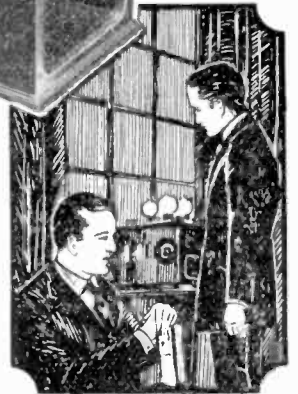
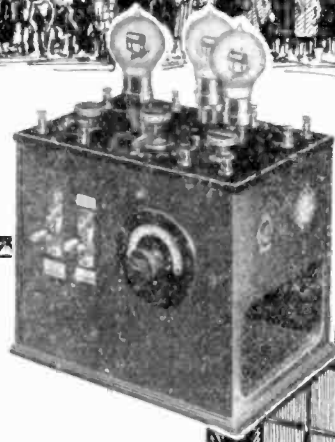

A T.M.C. Wireless Set will enable you to follow your favourite team and hear the results of each match practically as soon as the match is over.

Or you may be interested in boxing, the latest news, stock exchange quotations, the weather forecast, delightful concerts or an evening of dancing.

You can have all these, enjoyably and pleasantly in the comfort of your own home with a T.M.C. Wireless Receiver.

There is no trouble to you—T.M.C. have engineers in every large town to advise you, free of cost and without obligation, as to the best apparatus to use.

Your choice having been made—T.M.C. engineers will install the apparatus and periodically inspect it.

T.M.C. Wireless Receivers, which are fully approved by the Postmaster-General, bear the seal of the British Broadcasting Company.

The wide variety of models are entirely British Made.  
**From £4 : 5 : 0 upwards, including all Royalties.**

*London, Birmingham, Manchester and Newcastle are broadcasting now.*

Come and listen to them any evening up to 10 p.m. at our showrooms in:—London, Birmingham, Belfast, Bristol, Cardiff, Dublin, Glasgow, Leeds, Liverpool, Manchester, Newcastle, Sheffield.

*Write to us for our nearest address.*



The "Everset" Crystal  
No adjustment necessary  
Fits any Crystal Receiver  
**10/- each**

**T.M.C.**  
Makes Wireless  
Worth While

ES  
51

**TELEPHONE MFG. CO. LTD.**  
HOLLINGSWORTH WORKS, DULWICH, LONDON, S.E. 21.

# TRANSFORMERS

(and where they come from)

DESCRIBED IN OUR CATALOGUE. 4d. POST FREE



See our Stand at the Manchester All-British Wireless Exhibition, March 17th-24th, Burlington Hall, Burlington Street Manchester.

## LOW FREQUENCY TRANSFORMERS

In designing our Low Frequency Transformers we have endeavoured to combine efficiency with a high rate of production, enabling them to be sold at a reasonable price.

The core is of laminated stalloy iron, each lamination being insulated with a special insulating material—not paper—and is of correct weight.

The windings are in correct ohmic proportions. They are moisture proof and no reliance whatever is placed on the insulation of the wire itself as each turn is separated from its neighbour with silk. The windings are all subjected to a flash test and other tests prove that they are practically immune from breakdown, heavy wire being employed in winding.



By using our L.F. Transformers you are assured of obtaining maximum amplification without distortion.

Price - - 22/6 each

## TELEPHONE TRANSFORMERS

Built on the same lines as our L.F. Transformer. These Telephone Transformers are the most efficient yet offered.

Price - - 20/- each



## HIGH FREQUENCY INTERVAL TRANSFORMERS. Plug-in Type

The design and construction of these has been given the utmost consideration, resulting in great selectivity and maximum results, valve for valve. They can be tuned over a big margin without noticeable loss and must not be confused with the ordinary single grooved type.

A real scientific product.

No. 1	Optimum Wavelength,	350 metres	6/6
No. 2	"	550 "	7/-
No. 3	"	930 "	7/6
No. 4	"	1,400 "	8/-
No. 5	"	2,000 "	8/6
No. 6	"	3,500 "	9/-
No. 7	"	10,000 "	10/6

Or the complete set for ... £2 15 0

We are the Cheapest Firm on Earth for stamped, turned or moulded components.

The Best Firm on Earth for Scientific Components.

If you haven't got our Catalogue (4d. post free) you are wasting money.

Please include ample Postage with orders. Balance will be returned. Special Terms to the Trade.

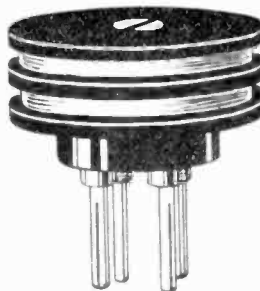

# J. L. CARTWRIGHT & CO.,

(Dept. W.) 24, London Road, MANCHESTER.

Business Hours. 9 a.m. to 6 p.m., except Fridays, 9 a.m. to 8 p.m. Saturdays, 9 a.m. to 1 p.m.  
 'Phone. CENTRAL 4209. Works: Berry Street. 'Grams: " PLADURAM." Manchester.  
 Wholesale Distributing Agents for Scotland - J. CORSTON SINCLAIR & CO., 47, Waterloo Street, Glasgow.

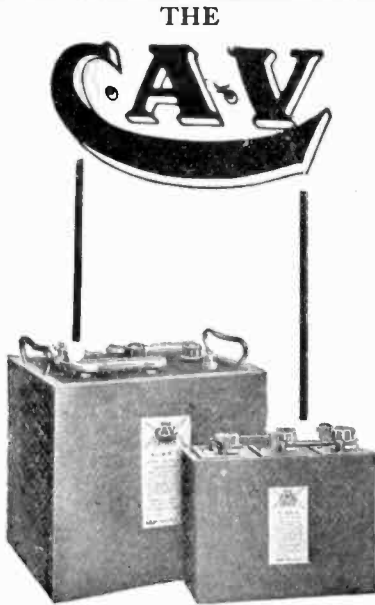

**Wireless Batteries** with the famous "Willard" Threaded Rubber Separators is greatly superior to all others. We have the exclusive right to manufacture batteries so fitted throughout Great Britain and Ireland, confident that they will supersede all other types.

**6 VOLT WIRELESS RANGE.**

MODEL	CAPACITY (Actual)	PRICE		
		£	s.	d.
W.R.1	12 amp. hours	1	10	6
W.R.2	15 " "	1	12	0
W.R.3	20 " "	2	2	0
W.R.4	30 " "	2	17	6
W.R.5	48 " "	4	3	0
W.R.6	64 " "	5	1	6
W.R.7	80 " "	5	18	0
W.R.8	96 " "	6	10	0
W.R.9	112 " "	7	13	0

**CA Vandervell & Co. Ltd.**  
ACTON VALE LONDON W.3



2,000 ohms,  
pair 31/-  
4,000 ohms,  
pair 32/-  
All resistances  
in stock.

"The Services  
use them."

## Poor 'Phones mar the Programme.

RECEIVING broadcast music thro' bad 'phones is like trying to read F.L. Telephony on a crystal—the results are the same—very poor.

Fit *Ericsson 'Phones*—and listen. Hear the sigs come thro' like a flute. No metallic sounds or distortion. Mark how the natural tone of voice and instrument is preserved.

**A user writes—"I am fortunate enough to possess a pair of your 'phones."**

Light and easy to the head, well-balanced and delicately accurate, yet withal robust in construction, *Ericsson 'Phones* connect up as the ideal 'phones for your receiver.

WRITE TO-NIGHT FOR FREE ILLUSTRATED LIST.

The BRITISH L. M. ERICSSON  
MANUFACTURING Co., Ltd.

International Buildings,  
67/73, Kingsway, W.C. 2

# Ericsson

## Telephones

# CONDENSERS

*DELIVERY FROM STOCK*

High in Quality.

Low in Price.

Un-  
assembled

- 001 .. 6/6
- 00075 5/3
- 0005 .. 4/-
- 0003 .. 3/-
- 0002 .. 2/6
- 0001 .. 2/3
- 00005 2/-

Turned Ebonite  
Plates 1/8 per  
pair extra.

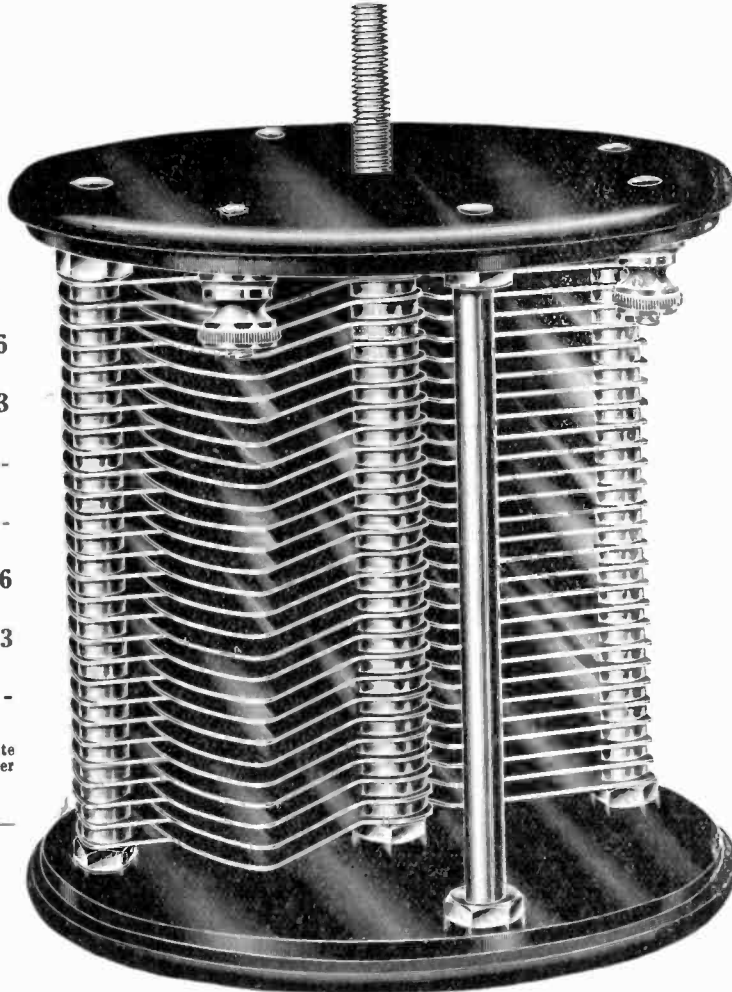

Assembled

- 001 10/6
- 00075 7/6
- 0005 .. 7/-
- 0003 .. 6/6
- 0002 .. 6/-
- 0001 .. 5/6
- 00005 4/6

Complete



## ORMOND ENGINEERING CO.

199, Pentonville Road, King's Cross, N.1.

Telegrams : Ormondengi.

Telephone : Holborn 1812.



**TUBE, SHEET,  
WIRE, STRIP,  
ROD & CASTINGS**  
IN  
**PHOSPHOR BRONZE,  
COPPER, BRASS, &c., &c.**

**CHARLES CLIFFORD & SON, LTD.,  
BIRMINGHAM.**

**F. WIGGINS & SONS**  
Telephone 1  
**MICA** Avenue 2248  
Largest Stock  
in the World.  
**FOR CONDENSERS  
AND ALL PURPOSES.**  
102, 103 & 104, Minories, London, E.1

**PRESSLAND ELECTRIC  
SUPPLIES LIMITED.**

Managing Director:  
**CLIFFORD PRESSLAND, A.M.I.E.E.,**  
Hampton-on-Thames.

*Wholesale only.*

Our 1923 Radio Catalogue is now ready  
and will be sent on application to any  
*bona fide* Trader.

**SKINDERVIKEN BUTTON.**

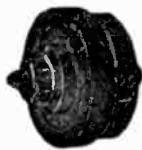

**THE SUPERSENSITIVE MICROPHONE.**  
World-wide Patents.  
ENGLISH Manufacture.  
For LOUD SPEAKERS, MICRO AMPLIFIERS,  
ELECTRICAL GRAMOPHONE REPRODUCERS.  
Invaluable as Detectophone, as it can be  
used in ANY POSITION, i.e., either  
HORIZONTAL or VERTICAL.

**PRICES.**

Type "A"—Carbon Electrodes (eliminating all  
"trying" noises) .. .. . each 7/8  
Type "B"—Brass Electrodes .. .. . " 5/-  
Receivers (special Low Resistance) .. .. . " 10/-  
Gramophone Attachment (for Electrical Reproduction) .. 1/-  
BOOKLET (18 Pages fully illustrated) containing much  
useful information for all interested in Electrical Sound  
Transmission. .. .. . POST FREE 6d.

Sole Proprietors—  
**MICRO, LTD., 274/276, Pentonville Road, London, N.1.**  
(Opposite King's Cross (Met.) Railway Station).

**CAPPER BROS.**  
**FOR ALL RADIO REQUISITES**

Agents for **LESLIE McMICHAEL, LTD.,**  
for Woking and district.

Single Valve Sets .. .. . £5 5 0  
Two Valve Sets .. .. . 8 8 0  
Three Valve Sets .. .. . 14 14 0  
Four Valve Sets .. .. . 25 0 0

**89-93, CHERTSEY ROAD, WOKING**

**L. W. DOUTHWAITE & CO.,**

Electra House,  
28, ST. JOHN'S STREET, BRADFORD.

**HIGH-CLASS CONDENSERS, .025" AIR GAP.**

Capacity.	Aluminium for Panel Mounting.	In Polished Mahogany Box.
.001	14/-	16/-
.0005	12/-	14/-
.0003	10/-	12/-
Zinc Vane Condensers, .025" air gap.		
.001	10/-	12/-
.0005	8/-	10/-
.0003	5/-	7/-

Ebonite Dials, 1/9 each extra. Postage 9d. on single units.  
Ivory Scale, knob and pointer, 1/- each extra.  
Every Condenser Guaranteed.

Used by largest Makers as standard Fitments on their  
Receiving Sets.  
Quotations submitted for all press work, and repetition turned  
parts. Liberal discounts to the trade.



**TRANSFERS**  
for Radio Instruments  
are our Speciality.

If you wish to save money,  
and mark your manufactures  
neatly and well, write to

**J. H. BUTCHER & CO.,**  
Solito Works, 498/506, Moseley Rd.,  
BIRMINGHAM.

Offices: 6, Holborn Viaduct, London.  
31, Pall Mall, Hanley, Staffs.

**"WHALE FOR WIRELESS"**

'PHONES—Brown's, 4,000 or 120 .. .. . 30/-  
Brunet, 4,000 .. .. . 21/8  
VALVES—"R" Type .. .. . 11/-  
"Q" or V24 .. .. . 12/8  
INSULATORS—Reel .. .. . 1d.  
Egg .. .. . 3d.  
Coil Mounts, ebonite .. .. . 1/3  
Condenser Plates, 24 .. .. . 1/-  
Condenser enclosed Vernier .. .. . 6/-  
Valve Holders .. .. . from 1/-  
Accumulators .. .. . from 3/-  
Phonophone holders .. .. . 4/-

N.B.—Do away with your crystal or valve detector and fit our  
PHONOPHANE, 15/- each. Call for demonstration.

**A. WHALE & CO.,**

201, POWIS STREET, WOOLWICH, S.E.18.  
Phone: Woolwich 548.



# L. McMICHAEL, LTD.

HASTINGS HOUSE, NORFOLK ST., STRAND, LONDON, W.C.

Telephone:  
Central 8198.

RETAIL SHOWROOMS RADIO CORNER  
(STRAND AND NORFOLK STREET)

Telegrams:  
"Radiether, Estrand."

## TRADE NOTICE

OUR new Trade Showrooms are located at the above address. To our old clients and also to future clients we extend a cordial invitation to inspect and have demonstrated our complete range of Broadcast and Experimental Sets.

To those desiring accessories, both new and ex-Government, we offer a splendid selection.

Our policy is—as always—that of assisting the Trade to build up the Wireless Department of their businesses on sound lines. Expert technical assistance, and general advice as to the best lines to stock, are at your command, should same be desired.

The new era of Broadcasting is creating a new buying public throughout Great Britain. The time is opportune for increase of trade.

### RADCOM TRIPLUG TUNERS

Consisting of three separate units for Panel Mounting, complete with spring clip terminals

Price 8/6

Extension Handles, extra per pair 1/6

Triplug units assembled on base, ready for Panel Mounting, complete with spring clip terminals

Price 16/-

Extension Handles, extra per pair 1/6

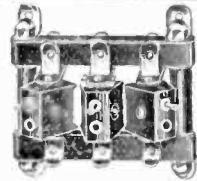

RADCOM RHEOSTATS, TRANSFORMERS, BATTERIES, COILS, ACCUMULATORS.



Assembled Type.

# Radio

COMPONENTS LTD.

WRITE FOR CATALOGUE.

DEPT. 4.

19, RATHBONE PLACE, LONDON, W.1

'Grams : Radponents, Westcent, London.

'Phone : Museum 3485.

WITH GOOD APPARATUS YOU  
CAN GET GOOD RESULTS  
THE "W.P."

## Morse Practice Key

Well Made. First-class Finish. Thoroughly Reliable.

Price 7/6 Post Free

THE WIRELESS PRESS, LTD.  
12-13, Henrietta Street, London, W.C.2

## Questions and Answers COUPON

To accompany Questions  
sent in during the week  
commencing Feb. 3rd, 1923.

VOL. XI, NO. 18

See Conditions on Page 613.

# THE WIRELESS WORLD EXCHANGE AND MART

**TARIFF.** Advertisements are accepted for this Section at the rate of twopence per word, with a minimum charge of two shillings. The advertiser's name and address will be charged for and single letters and single figures will be counted as words. Compound words will be counted as two words.

**DEPOSITS.** All advertisements must be prepaid in the form of Postal Orders, the remittance being forwarded to Messrs. Bertram Day & Co., Ltd., 9 & 10 Charing Cross, S.W.1.

Intending purchasers may deposit the purchase money of any article advertised or sold by advertisers with Messrs. Bertram Day & Co., Ltd., who will acknowledge its receipt to the vendor and the depositor, the full addresses of whom should be given. Subject to special agreement between the parties, it is understood that all goods are sent on approval, each party paying carriage one way in the event of the goods being returned. The deposit will be retained until due advice of the completion of the purchase has been given or until the articles have been retained and accepted. In order to cover postage, etc., a fee of 6d. in respect of sums of £1 and under and 1s. for sums in excess of £1, must be paid at the same time as the deposit.

TRADE **Grelco** MARK

SEND NOW  
FOR OUR

**100**

PAGE ILLUSTRATED  
CATALOGUE

LATEST  
IMPROVEMENTS.

POST 3<sup>d</sup>. FREE

LOWEST  
PRICES.

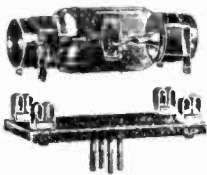

SIEMENS-HALSKE VALVES 7/6 each.  
ADAPTORS FOR "R" VALVE HOLDERS.  
3/- each. POSTAGE EXTRA.

**Grafton Electric Company**

Showrooms—54, GRAFTON STREET,  
TOTTENHAM COURT ROAD,  
LONDON, W.1. Telephone—Museum 241.  
Works—Slough.

## FOR SALE.

**Wire.**—Best English make, gauge 18, tinned copper, rubber and double cotton, 10d. Double cotton, 8d. Single cotton, 6d. per dozen yards. 110 yard coils, 5s., 4s. 3d., and 3s. 6d. respectively. Trade supplied.—MOORE, 25, Eltham Hill, London.

**Condensers for Panel Mounting.** .001, 11s. 6d.; .0005, 8s.; Vernier, 4s. 6d. Carriage paid. Satisfaction or money back.—J. P. STANLEY, 159, Sumatra Road, West Hampstead, London, N.W.6.

**New 12-Volt Miniature Holder Metal Filament Lamps,** 10s. 6d. doz. Post free. Sale or exchange for L.F. Transformers, following gent's imitation platinum and gold dress Albert, 7s. 6d. Tie-pin, 8-stone, with centre pearl, imitation platinum, 4s. 6d. New gilt demi-hunter dress watch, 20s., worth 50s. Cash returned if dissatisfied.—E. MARTIN, 75, Winter Road, Portsmouth.

**Marconiphone V.2 Ethophone 3,** complete, as new.—JONES, Chemist, Wotton-under-Edge.

**Crystal Detectors,** 2s. Crystals, 6d. Cups, 3d. Condensers, all capacities, 2s. Tuning coils, 500 metres, 3s. tapplings, 3s., unassembled 2s. Formers, 9d. Loose couplers, 500 metres, fourteen tapplings, 5s. 6d. Unassembled, 4s. Formers, 2s. Condenser vanes, 1s. dozen. Spring terminals 1½d. Resistance wire, 6d. yard. Formers, pliable, ¼, 2d. inch. Enamel wire, 24, 8d., 28, 10d. ounce., ¼, 2d. inch. Glass condenser plates, any shape, 2s. square foot. Waxed paper, .004, 6d. Tinfoil, 1s. square foot. Brass wire, 4d. foot. Wood's metal, 6d. stick. Aerial wire, 2d. yard. Insulators, 4d. Valve legs, 2d. Earth wire, 3d. yard. Six plug switches, 1s. 6d. Square wooden rods, ¼, ½, ¾, 3d. foot. Wire, 46 s.w.g., 2s. 6d. ounce.—R. LLOYD, Sion House, Wolverley, Kidderminster.

**Round Ebonite,** ½" to 2½" diam., A.1 quality, 3s. per lb., carriage paid. 14lb. lots.—VELOX ENGINEERING CO., 255, Westgate Road, Newcastle.

**New Marconiphone V.2,** complete with 2 pairs telephones, H.T. and L.T., dry batteries (low temperature valves). £24 or near offer. Below:

**New Junior Magnavox** and 2-valve power amplifier with valves and H.T. battery, cost £34 12s. 6d. £25 or near offer.—KERSHAW, Maiden Vale, Broad Campden, Glos.

**Marconi Single Valve Set,** .0015 variable condenser, valve, accumulator and high tension battery. New, £10.—LONG, Lostock, Bolton.

**2 P.Y. Complete Transmitting and Receiving Station,** for sale in its entirety, 1,000 v. generator, motor, dynamo, nine-volt and ammeters, all G.E.C. instruments, transmitter and all valves, keys and best microphones, H.F. receiver, four-valve, complete with full set Burndept coils, two-holders, three accumulators, new, the set is in use every day and can be seen and inspected by appointment.—Letters to H. CARTER BOWLES, 51, Gunterstone Road, West Kensington.

**Fine Five-Valve Receiver,** mounted on desk panel. Complete with batteries and pair phones. Two H.F., two L.F. and detector. Price £45 or nearest.—BATLEY, Pickwick, Corsham, Wilts.

**Two-Valve Set,** all accessories, accumulator, H.T. telephones, Dr. Forest Coils, Coil Holder, Valves, etc., £16.—TAYLOR, 41, Newlyn Road, Lordship Lane, Tottenham.

**Amateur has for sale one Marconi unit 12.5-valve receiving panel (3 H.F. detector and 1 L.F.), with valves. Bargain, £25. One Ashley Radio 5-valve unit receiving set, in solid mahogany polished case, 4' 6" long, with glass doors. Comprising three-coil holder and var. con., sec. con., 2 H.F. det. and 2 L.F., with valves, chokes and full set duo-lateral coils (coils alone cost over £8). Bargain, £35. Both recently examined by makers and passed perfect.—HAROLD HOLT, 14, Knowsley Buildings, 15, Tilthbarne Street, Liverpool.**

**Brown's 6,000 ohms,** adjustable telephones, 40s. Two L.F. transformers in metallic cases, with valve holders, 22s. 6d. each. Set slab inductances, 6s.—H., 44, Carew Road, Eastbourne.

## Wireless Parts at Keenest Prices !!

To the Trade and Agents:—

**THE BEST AND CHEAPEST HOUSE FOR YOUR PURPOSE**

IS

**YOUNG'S** (Dept. 7),  
84, CITY RD., LONDON, E.C.1

A visit to our Warehouse  
(the oldest Metal Warehouse in London) will well repay you.

Extraordinary value in:—

Condensers, Vanes, Knobs, Valve-Holders, Aerial Wire, Spacing Washers, Crystal Detectors, Knife Switches, Rheostats, Coil-Holders, Terminals, Screwed Rod, Sliders, etc., etc.

LET US QUOTE YOU.

SATISFACTION GUARANTEED.

PROMPT DELIVERY.

:: TERMS, CASH. ::

## IN YOUR OWN INTEREST

Secure UNBIASSED ADVICE before purchasing your WIRELESS SET. We supply ANY WELL KNOWN MAKE, and are only too pleased to give you our full attention whether you be NOVICE or EXPERIMENTER. This business is, and always has been fully devoted to Wireless, and our object is to supply you with what is best for your particular requirements, and at the same time to SUIT YOUR POCKET.

We also make up Sets or supply PARTS FOR THE EXPERIMENTER. All made up Sets have been PASSED BY THE P.M.G. COMPLETE reliable Sets at all prices from £4 3s. to 100 Guineas.

All parts are supplied at LOWEST COMPETITIVE PRICES. DEMONSTRATIONS DAILY.

CALL OR WRITE, stating your requirements. Lists sent by return.

**H. C. DALY,**

95, GT. PORTLAND ST., W. 1

(Next to Philharmonic Hall).

Phone: Mayfair 3249.

# THE WIRELESS WORLD EXCHANGE AND MART

## “INVINCIBLE” PRODUCTS.

### L.F. INTERVALVE TRANSFORMERS

- Type A, upright pattern . . . . . 17 6
- Type B, upright pattern . . . . . 16 -
- New "Hedgehog" upright pattern . . 13 6

H.F. Plug in type TRANSFORMERS, SPECIALLY DESIGNED TO COVER BROADCAST WAVELENGTHS . . . . . 4/-

IMPORTANT.—As the actual manufacturers of these Transformers WE GUARANTEE THEM ABSOLUTELY FREE FROM DISTORTION HIGHLY EFFICIENT AND RELIABLE. PERFECT IN EVERY DETAIL. Full cash refunded if not satisfied. SEND A P.C. FOR OUR LIST.

Wholesale enquiries for samples and prices of our CONDENSERS, variable and fixed, filament rheostats, etc.

**WOODMASON,**  
3, Stanwell Street, COLCHESTER.

### Portland's Parts by Post.

## “EBONITE”

	s.	d.		s.	d.
8 x 1 ..	0	7	12 x 10 ..	7	6
4 x 4 ..	1	3	17½ x 8½ ..	9	8
7 x 5½ ..	2	8	18 x 18 ..	12	10
10 x 6 ..	3	9	36 x 18 ..	£1	3 0
17 x 5 ..	5	3	7 lbs. ..	£1	3 0

Quarter Mat, British. Postage Free.  
Any size cut.

## JAMES PORTLAND

39, Sinclair Road, Olympia, W.14

Mr. Portland stocks over 200 Wireless Parts

## ENGRAVING

for every style of instrument on any material.

### F. OSBORNE & CO., LTD.

27, Eastcastle St., Oxford St., London, W.1  
Est. 1874. Museum 2264

### FOR SALE—continued.

**Genuine Offer 'Phones,** 4,000 Ohms, new, British manufacture, excellent quality, very efficient. 1,000 pairs each at 19s. 6d., postage 9d. Intervalve L.F. Transformers, highest grade, thoroughly tested, 320 only, each 11s., postage 6d. Variable Condensers, .0003 for panel mounting, absolutely perfect and accurate, complete, 12s. 6d., postage 9d. All guaranteed, cannot be purchased elsewhere at my price. Send now to R. CRITCHER, 54, Pember Road, N.W.10.

**Variometers, 300 to 600 m.,** 25s., post free.—ROBSON & Co., 26, Sefton Street, Southport.

**Wireless Transmitters,** less cases, type No. 1, fittings include one high-class variable spark gap, condenser and tuning, 1" Sterling spark coil and helix, range 100 to 500 metres. work on 1 to 6 volts, price to clear. 10s. each. Below.

**Tungsten Rivets.** Specification, heads approx. 1" diam. 1 16" thick, and shanks screwed 9 B.A. 1/2" long, 1s. 6d. doz.; or 15s. gross. CADNEY BROS., Alpha News, Alpha Road, New Cross.

**Wireless Factory in Clapham.**—For sale, wireless factory. Covered area, 11,146 square ft. Yards, 13,458 square ft., three large workrooms, stores, offices, engine house, cloak rooms, lavatories, etc. Sound repair. Electric light and power. Gas, water, main drains. Lease 67 years. Ground rent 125. Low price. Possession on completion. Full particulars apply Box 1186, c o S. DAVIS & Co., 30 and 31, St. Swinith's Lane, London, E.C.

**New Inductance Tuner,** 150-4,000 metres, with reactance coil, as listed Radio Instrument Compt., cost 71, accept 51 guineas.—CINLOS, Melbury Park, Dorchester

**Machinery for Wireless Manufacturers.** The Newtonia Wireless Factory have for sale machines recently purchased from a wireless manufacturer in liquidation, consisting of milling machines, forge, grinders, capstans, lathes, etc. Write for list—13 15, Whitcomb Street, Pall Mall, London, near Trafalgar Square.

**All Wireless and Electrical Goods** stocked at 9, Colonial Avenue, Minorities, near Aldgate Station. Hauliest place for City buyers.—LESLIE DIXON & Co., Telephone No. Avenue 4166.

**Intervalve Transformers,** 17s. 6d. each. Adjustable telephones, 4,000 ohms, 35s. each. Ebonite Variometer Balls, 4s. each, new, not W.D. 12-Way switch, 7s. 500 to 2,500 voltmeter, 35s.—B. CALVER, 52, Linver Road, Hurlingham, London.

**High Tension Condensers,** 3 Dubilier mica condensers, tested 1,000 volts by makers, suitable smoothing circuits in transmitters, cost £5 each. What offers.—Box H.9, BERTRAM DAY'S ADVERTISING OFFICES, 9 and 10, Charing Cross, S.W.1.

### TRADE INQUIRIES.

**Instrument Maker** requires repair and constructional work in radio apparatus and small electrical gear. Telephone repairs and rewinding a speciality. Enquiries welcomed.—C. BOXWELL Beech Hill, nr. Reading, Berks.

**Accumulators Charged,** collected and delivered at reasonable rates, send P.C. for tariff.—BATTERY SERVICE Co., Dryburgh Works, Putney, S.W.15.

**To Factors and Others** requiring crystal or valve sets, assembled or made complete, to any design or specification, at keen prices, and best workmanship, write or call. Output guaranteed to any quantity per month.—WORKS, 93a, Falkland Road, Harringay, N.8.

**Manufacturers of Receivers,** accessories, components, wire, are invited to send lists and terms to BETTLEY, 47, Stafford Street, Willenhall, Staffs.

**Manufacturers of Wireless Accessories** and component parts are invited to send catalogues, terms, etc., to ELMs ENGINEERING, Christchurch Street, Chelsea, S.W.3.

Advertiser, having small electrical works, wishes to meet gentleman with small capital, with a view to developing wireless business. Technical knowledge not essential. Letters only.—63, Ross Road, Wallington, Surrey.

## BROADCASTING

is now in full swing, and every user of a valve set realises that a

## FOOLPROOF CHARGING SET

will end the annoyance, inconvenience and expense incurred in sending accumulators to be re-charged.

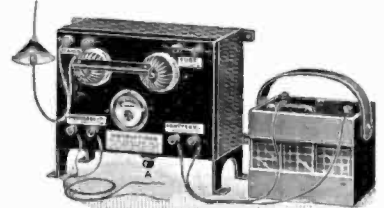

## THE TRIUMPH ACCUMULATOR CHARGING SET

can be connected in two minutes to any Direct Current Lighting or Power Circuit from 25 to 250 volts, and when once connected requires no attention whatever.

It is only necessary to pull down the switch to charge Accumulator, and to push up the switch to use Wireless

It can be instantly adjusted to charge at any rate desired, and any number of accumulators can be charged at the same time without extra cost.

No. 1, suitable for 1, 2 or 3 Valve Sets  
**£4 17s. 6d.**

No. 2, suitable for 1 to 7 Valve Sets  
**£5 17s. 6d.**

AGENTS WANTED IN EVERY TOWN

Manufacturers—

**CINEMA TRADERS LTD.,**  
26, Church Street, London, W.1

# THE WIRELESS WORLD EXCHANGE AND MART



*Keep it handy*

As indispensable to the listener-in as the teleph. directory is to a subscriber. This book gives over 12,000 Call Signs of all land and ship stations as well as a very full list of British Amateurs. Keep a copy handy and know who is sending—you'll get much more enjoyment from your Set. Sold by all Booksellers and Newsagents. Published by

2/6

post free 2/8

**Radio Press Ltd**  
PUBLISHERS OF AUTHORITY WIRELESS LITERATURE  
DEVEREUX COURT, STRAND, W.C.2

**The Proprietors of the Patents:**  
 129238 "Improvements in or relating to radio oscillation generators."  
 131581 "Improvements in or relating to radio-telegraphic transmission systems."  
 133901 "Improvements in or relating to radio telegraphic transmission systems."  
 135111 "Improvements in or relating to radio telegraphic transmission systems."  
 136059 "Improvements in or relating to radio telegraphic transmission systems."  
 are desirous of entering into arrangements by way of licence and otherwise on reasonable terms for the purpose of exploiting the same, and ensuring their full development and practical working in this country. All communications should be addressed in the first instance to **HASELTINE LAKE & CO.**, Chartered Patent Agents, 28, SOUTHAMPTON BUILDINGS, CHANCERY LANE, LONDON, W.C.2.

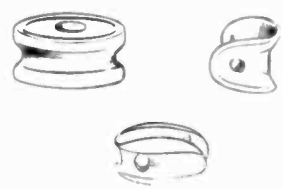

TRADE ONLY  
SUPPLIED

RALPH H. WINTER

4, Little Titchfield Street,  
LONDON, W.1

### MISCELLANEOUS.

Rectifiers for Charging Accumulators from an alternating supply.—ALUMINIUM RECTIFIERS CO., 28A, Basinghall Street, E.C.2.

Nameplates, engraving of all descriptions.—STILWELL & SONS, Little Park Street, Coventry.

Wireless Inventors.—Patents and Trade Marks Advice. Handbooks and Consultations free.—KING, Regd. Patent Agents, 146A, Queen Victoria Street, London. Phone, 682 Central.

East Ham, Wanstead, Ilford, Manor Park and Forest Gate. Amateurs should not fail to come to the **RADIORENDEZVOUS**, 709, Manor Park Broadway (over Liptons). Club open till 10 p.m. nightly.

Keys (the well-known motor cycle firm) will take your present instrument in part payment for the latest model. Send particulars.—173, Great Portland Street, London.

Working Drawings. Designs for power and Wireless. Works visited to advise.—PUCKLE, Buckhurst Hill, Essex. Telephone, Woodford 400.

### SITUATIONS VACANT.

Demonstrator required. Good knowledge wireless instruments, broadcast and experimental. Must be good salesman. Write only.—Box A.11, BERTRAM DAY'S ADVERTISING OFFICES, 9 and 10, Charing Cross, S.W.1.

### SITUATIONS REQUIRED.

Wireless.—Young man, fully trained three systems, sending, receiving, demonstrating, building sets, etc., seeks situation.—MILLER, The Manse, Bulford, Wilts.

### AGENTS WANTED.

Old-established London Firm, making one to five-valve broadcast receivers, desires provincial agents. Every assistance and good terms offered.—Box 76, c/o F. ALDRIDGE, 26, Paternoster Row, E.C.4.

### PATENTS FOR SALE.

Proprietors are desirous of selling their Patent 2687, for economic improvements and scientific construction of efficient dry batteries.—Apply C. A. SMITH, 28, Julien Road, Ealing, W.5.

### EXCHANGE.

Peugeot Motor Cycle, 2 speed, for complete 3-valve and loud speaker.—BUTTRISS, 4, Radnor Cottages, Loughborough.

Wanted Four-Valve Set, exchange motor cycle. W. YARD, Llanarth Square, Risca, Mon.

## RESULTS

Whether as a source of practical information for the Amateur or as a valuable medium for every Advertiser, the best results are invariably obtained through the "WIRELESS WORLD"

For full particulars and advertising rates apply to  
**BERTRAM DAY & Co. Ltd.**  
 Complete Advertising Service,  
 9 & 10, CHARING CROSS, S.W.1  
 Gerrard 8063 and 8064.

## Electradix Radios.

**MARCONI** 50 D.C. Ex Government Sets. Desk Pattern. Carbor. Detector and 1 valve, £6 10s., ditto 2 Valves £8, ditto 3 Valves, £9 10s.

**Mark III RECEIVERS**, £7 5s., quite new.

**Mark IV 3 Valve AMPLIFIERS**, £5. **WAVEMETERS**.—Townsend, £6, Forward 300-3,000, £5 10s., ditto 200-8,000, £7 10s., Teak or Leather case.

**INSTRUMENTS**.—Cent. Zero, Mov. Coil Milli - Ammeters, £6-0-6, Evershed, 32/6. Standard Voltmeter, 2 range, 250 and 25 volts, 42 6, 5" Switchboard Types, 25/-.

**DYNAMOS**.—6 volt to 1,000 volt, 50 m/a to 50 amps., from £3-10-0.

**NEW TELEPHONES**.—Sterling Marconi, 8,000 to 2,000 ohms. Magnavox Loud Speakers, £10, Small L.S., 27 6, Sullivan L.R. Phones, 12/6 pair.

**TRANSMITTERS**.—30 watt valve with H.T. unit £6 10s., 100 watt valve £8 10s., Morse Inkers, 40/ H.T. Battery Boxes with plugs, 6/6, Valves from 5/-.

The above are a few items from our huge stock.

Send us particulars of your requirements or call and see us.

Every Radio requirement stocked.

**LESLIE DIXON & CO.**  
 9, Colonial Avenue, Minorities, E. 1  
 (N. Aldgate Station, Met. Rly., first turning on left in Minorities).

**WIRELESS CABINETS**  
 PROMPT DELIVERIES  
 COMPETITIVE PRICES

**PICKETT BROS.,**  
 Albion Rd., BEXLEYHEATH, S.E.

### BEGINNER'S GUIDE TO WIRELESS

Explains in plain, everyday language, everything beginners wish to know about Wireless Telegraphy.

### HOW TO ERECT, CONNECT AND MAKE

all the apparatus required for reception of telephony or morse, and full instructions and diagrams for making coils, tuners, and complete valve and crystal sets. 112 pages, price 1/- post free.

**SAXON RADIO CO. (Dept. W.), South Shore, Blackpool.**

32 page Catalogue of Wireless Apparatus 2d. post free.

# THE WIRELESS WORLD EXCHANGE AND MART

**COMPARE THESE PRICES.**

**CONDENSERS**

Good quality and finish, complete with knob.

001	10/-
0005	6/6
0003	6/-

CASH WITH ORDER. TRADE SUPPLIED.  
THE SUFFOLK WIRELESS SUPPLY,  
FELIXSTOWE.

**TERRA AURORA OPTICAL CO.**

Instrument Works, 2a, ASEDOWN STREET, KENTISH TOWN, N.W.5, are open to manufacture in their up-to-date factory, WIRELESS APPARATUS and parts for the trade on receipt of samples or specifications, prompt attention, special low prices for large quantities. Phone, Hampstead, 487E.

**HEATH & Co., Ltd.**

Instrument Works, New Eltham, S.E.9 are prepared to undertake in their fully equipped works—Wireless Apparatus and Parts for the trade. Quotations given to Blue Prints. Immediate attention.

Phone—Lee Green 301. Wire—Pekarski, Lanes.

*Wireless Insurance!*

**LIVERPOOL MARINE AND GENERAL INSURANCE CO., LTD.**

London Office: 7, Angel Court, Throgmorton St., E.C.2.

**FIRE. ACCIDENT. MARINE.**

Write for particulars of our SPECIAL WIRELESS POLICY (Annual Premium 7/6) which covers fire and other damage to the complete Wireless Set and also indemnifies the Owner against claims arising from damage to property or persons through the breakdown of outside aerial and its supports.

**FOR SALE.**

10,000 Telephone Receivers, 135 Ohms each. Watch Pattern. Ex War Office, suitable for Crystal Sets without conversion, 20s. doz. Carriage forward or would consider offer to clear the lot.  
10,000 1/18 M.F. Condensers at 3d. each  
5 Tons Admiralty Bronze Aerial Wire, at £5 per cwt. (100' weighs 1 1/2 lbs.).  
5 Tons W.O. Bronze Earth Wire, 1/14 gauge, 100 lbs. per mile, 90/- cwt.  
Valves. W.O. Pattern by G.E.C., Ediswan, etc., 5/- each, in doz. lots.  
Steel Stranded Telephone Wire (7 strands steel 1 strand copper) does for earth wire or for holding, poles or masts, 15/- per mile, drums free. All other sizes. Cable in stock.  
Sivertown Relays, £1 each All  
Galvanometers from 5/- each G.P.O.  
Double Current Keys, 17/6 each Pattern.  
Souders, 17/6 each  
Litholite Insulators as sold by G.E.C., 4/- per doz.  
Bobbin Insulators, 9d. doz.  
Ebonite Blocks, 1/- doz., 3 1/2" x 2" x 1/2".  
Leather cases with straps in quantities, 1/- each.  
Boxes for Wireless Sets.  
Wireless Dealers, please note it will pay you to call on  
**D. S. BURLEIGH,**  
BROWNSWOOD WORKS, G.N.R. YARD,  
45, HORNSEY ROAD, HOLLOWAY, N.7.

This instrument, which has achieved such wonderful success as a long distance Broadcast Receiver, is fully approved by H.M. Postmaster-General and is manufactured under licence from Marconi's W.T Co., Ltd.

PRICE (including all Royalties)

**£12 : 7 : 6**

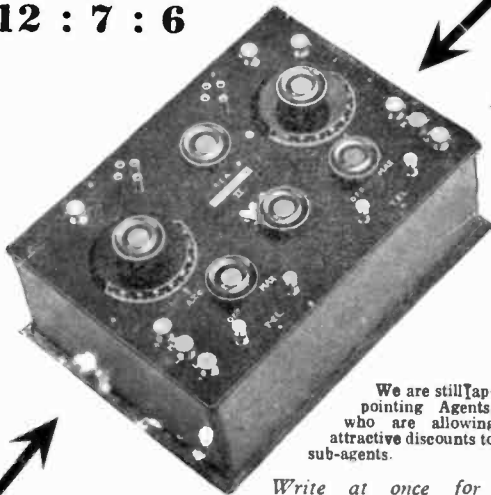

We are still appointing Agents, who are allowing attractive discounts to sub-agents.

Write at once for Catalogues and Terms

**THE**

G.P.O. Reg.

**HESTAVOX II**

No. 2049

**2-VALVE BROADCAST RECEIVER WILL RECEIVE**

**All English Broadcasting**

as the following letter from G. D. Hinks of Yeovil (now our Agent for Somerset) proves:—

W.T call G. D. HINKS, A.M.J.I.E., A.I. Radio E.,  
SAX WIRELESS DEPT.,  
HARDINGTON, YEovil.  
January 17th, 1923.

Messrs. HESTIA ENGINEERING Co.,  
Acton, W.3.

DEAR SIR,—I have now carefully tested your latest instrument (Hestavox II), and am pleased to state that it works quite well and brings in LONDON, BIRMINGHAM and MANCHESTER, and NEWCASTLE in the far distance. I trust you are in receipt of my order for three note magnifiers.

The locality is very interested to hear it with note magnifiers as I have tested a dozen broadcast receivers and yours is the only one that has received anything in the way of telephony, and I consider the clear reception of the above stations a record for two valves.

Birmingham is our best station, and it is fine on 2 pairs of 'phones.

Yours truly,  
(Sgd.) E. D. HINKS.

**The "HESTIA" Engineering Co. 32 Palmerston Road, Acton, LONDON - - W.3**

## *The Perfect Loud Speaker at Last !*

We have acquired the sole manufacturing rights for the United Kingdom of a Wonderful New Loud Speaker, in principle entirely different to any yet placed on the market. Instead of the unsightly horn which causes distortion of the music and speech, this instrument comprises a handsome cabinet, the top of which is so designed and manufactured from specially tested timber, which is attacked by a volume of air. The principle can be incorporated into any cabinet wireless set, the lid of the cabinet forming the Loud Speaker. It can also be used as a separate instrument as illustrated.



*The*  
**“VIOLINA”**  
 LOUD SPEAKER DE LUXE.

Patented in all countries throughout the world.

**PRICE**

**£5 : 5 : 0** Complete

(Packing and Carriage in U.K. 5/- extra)

When once you have heard this instrument, you will not tolerate any other make. Ask your wireless dealer for a demonstration.

*It is not like a Trombone ! It is not like a Klaxon !! It is as delightful as a Violin!!!*

With this instrument you can hear the voice of the artist, the note of any instrument and the words of the speaker faithfully and perfectly reproduced.

In addition it is an elegant piece of furniture, handsomely French polished, mahogany finished. Before buying your Loud Speaker make a point of hearing this instrument. Agents wanted in all parts. Enquiries from Manufacturers desirous of incorporating the “Violina” into existing wireless sets cordially invited.

**IF EARLY DELIVERY IS DESIRED, PLACE YOUR ORDER AT ONCE.**

### Important Notice to all Wireless Manufacturers, Retailers, Experimenters and Amateurs. Ex-Government Wireless Apparatus.

A FEW WEEKS AGO, we advertised the purchase of a complete Government Wireless Depot, and offered the same for re-sale at astonishingly low prices in accordance with our invariable business rule to **SHARE OUR BARGAINS WITH OUR CUSTOMERS.**

The immediate response to our advertisement resulted in our being “snowed under” with enquiries and orders from all over the country, and it was only through despatch staffs working night and day at full pressure that we were able to keep faith with our customers in respect of our promise to execute all orders **WITHIN 48 HOURS OF RECEIPT.**

It was impossible to deal with the thousands of enquiries as expeditiously as we should have wished, and we again take the opportunity of tending our apologies to all those who unfortunately were kept waiting.

We have now purchased, outright for spot cash, the whole of the Wireless Material recently offered for sale at **WOOLWICH DOCKYARD AND KIDBROOKE R.A.F. DEPOT.**

The work entailed in compiling price-lists of the multitudinous variety is colossal, and it will be two or three weeks before these are available. You can help us considerably by **FILLING IN THE FORM AT THE FOOT OF THE OPPOSITE PAGE.** You will then **RECEIVE COMPLETE LISTS AS SOON AS AVAILABLE.**

## **The City Accumulator Co.** **79, MARK LANE, E.C.**

Phone : Avenue 1316.

# SOME STARTLING OFFERS

Complete 5 Valve Set, 2 H.F., 1 Detector and 2 L.F. The famous R.A.F. 10 made by the General Electric Co., U.S.A., for the Royal Air Force.

Ideal for Broadcasting. Can be used with Loud Speaker with indoor aerial, within 20 miles of the Broadcasting Station. We guarantee his instrument to be more effective than any instrument costing up to £75.

Brand New, exactly as received from the manufacturers

## Our Price £15-0-0

(Limited quantity only).

Valves and Accessories extra. Fuller particulars on application.

**RECEIVERS C.W. MARK III.**—This set comprises a complete two-valve receiving set with a wavelength range of 350-1,800 metres. The addition of high and low tension batteries, valves and 'phones, completes the entire receiving station. For the reception of broadcast concerts this set is ideal, the strength and clarity of the signals being absolutely wonderful ... .. £9 9 0

Complete with 4-volt 40-amp. Fuller block accumulator, 60-volt H.T. battery, 2 valves, and pair of Brown "A" Type headphones, complete with cords ... £15 10 0

**C.W. TRANSMITTERS, MARK III, 30 WATT.**—Complete with aerial ammeter, platinum-pointed Morse key, in mahogany case. One valve: wavelength 350-1,400 metres; Two valves; wavelength 700-2,000 metres. (For transmission of telephony all that is required is to remove ammeter and insert microphone) ... £3 5 0

NOTE.—These instruments can be easily altered to any desired wavelength.

**MARK III\* S.W. TUNERS.**—Wavelength 50-700 metres. Ideal for broadcasting. Being sold elsewhere at £10. Complete with one pair of Sullivan 8,000 ohm 'phones and cords. Limited number only ... .. £8 0 0

**FILL UP THIS FORM NOW**

and post to us immediately; ½d. stamp only required.

**Messrs. THE CITY ACCUMULATOR CO.**

Mall Order Department, 79, MARK LANE, LONDON, E.C.3

Please include my name on your Mailing List. I am particularly interested in

(Signed).....

Full Postal Address.....

w.w. Date..... 19.....

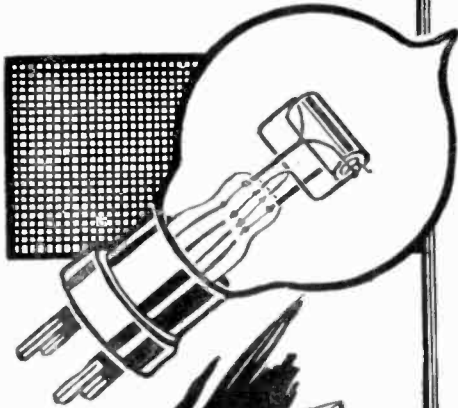

CHAPTER VI  
OSCILLATOR RECEPTION OF SIGNALS

**Reaction Amplification.** We have seen in the previous chapter that by transferring energy from the anode circuit of the three electrode valve to the grid circuit we are enabled to lessen the damping of the grid circuit. This phenomenon is clearly of great advantage when receiving wireless signals. The receiving circuits normally possess an appreciable resistance which lessens the strength of the oscillations; by transferring energy from the output to the input side of the valve we can strengthen the oscillations in the grid circuit, particularly in the case of speech signals.

Fig. 34 shows a circuit in which reaction amplification is used for receiving signals. The incoming signals produce oscillations in the circuit  $L_1C_1$ . The oscillating potentials across  $C_1$  cause the grid  $G$  to become alternately positive and negative, these grid potential variations produce magnified anode current variations in the anode circuit of the valve, and these anode current variations pass through the inductance  $L_2$ , which may, if desired, be shunted by a tuning condenser  $C_2$ . Across the oscillatory circuit  $L_2C_2$  is a crystal detector  $D$  and telephone  $T$ . If the circuit  $L_2C_2$  has no inductive or other coupling effect on the circuit  $L_1C_1$ , the oscillations in  $L_2C_2$  will be of the ordinary amplified strength; that is to say, they will be several times as strong

as the oscillations existing prior to  $L_1$ . If the incoming signals are due to damped waves, such as waves from a spark station, each group of waves will be magnified and the magnified oscillations in  $L_2C_2$  will be received by the detector  $D$  and give an audible note in the telephone  $T$ . If now we bring the inductance  $L_2$  close to the inductance  $L_1$ , so that there is magnetic coupling between them, the incoming signals will appear very much louder.

FIG. 34.—A high frequency oscillator using a valve to supply the amplified oscillations, in which the anode coil coupled to the grid coil to obtain a reaction effect.

this is because the incoming oscillations in  $L_1C_1$  are built up to a very much greater strength than normally on account of the magnified oscillations induced by  $L_2$  into the circuit  $L_1C_1$ . These oscillations, being exactly in time with those existing in  $L_2C_2$ , increase the effect on the grid  $G$  and the final oscillations in  $L_2C_2$  will be several times stronger than the magnified signals which would be obtained merely by using the radio frequency amplification properties of the valve. In addition to the incoming damped oscillations being supplied,



# Reaction

—here's a simple explanation you will understand

THE use of Reaction gives almost the additional strength of another Valve, but carelessly used it is a source of great annoyance to all other receiving stations within two or three miles. Therefore the P.M.G. has rightly banned all reaction coupled to Aerial Circuits on Broadcast wavelengths.

## WIRELESS VALVES

shows that it is quite easy to arrange Circuits employing Reaction which do not cause oscillation in the Aerial Circuit.

If you are not now using Reaction, get this new book by John Scott-Taggart, F.Inst.P.—the eminent authority on the Thermionic Valve—you will find that the explanation of its principles is given lucidly and clearly in language you can understand.

Get this book—it will certainly help you to understand your Set better. From all Booksellers and Newsagents, or direct from

**Radio Press, Ltd.**  
PUBLISHERS OF AUTHORITATIVE WIRELESS LITERATURE  
DEVEREUX COURT, STRAND, W.C.2.

**CONTENTS**

- The Theory of the Thermionic Valve.
- The 3-Electrode Valve and its applications.
- Cascade Valve Amplifiers.
- Principles of Reaction Amplification and Self-oscillation.
- Reaction reception of Wireless Signals.
- Continuous Wave Receiving Circuits.
- Valve Transmitters.
- Wireless Telephone Transmitters Using Valves.
- Broadcast Receivers.

**2/6**

Marshall Ad.

or 2/8, post free from Publishers.



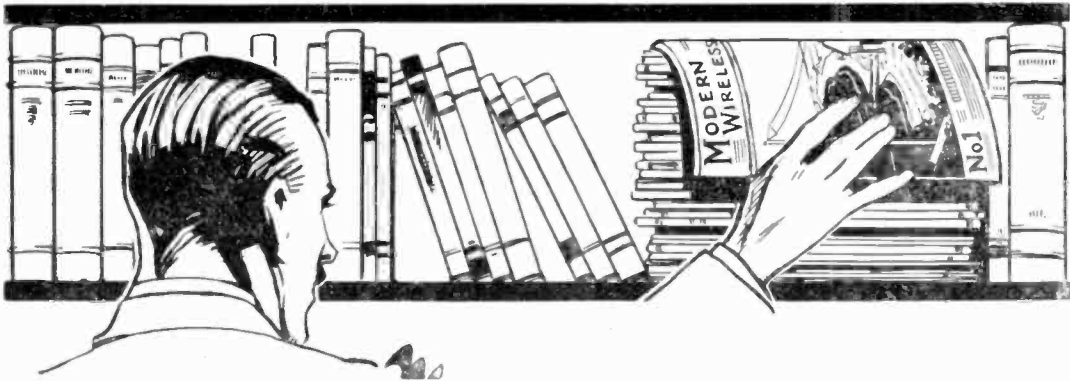

If you had difficulty  
in obtaining No 1  
— We apologise

**T**HOUSANDS of Wireless enthusiasts were disappointed in not being able to get their copies of MODERN WIRELESS owing to the totally unexpected demand. The whole edition of 20,000 copies was sold right

out within a few hours of its appearance. A reprint of a further 50,000 copies has been produced and is now on sale—thus making the extraordinary total of 70,000 copies.

**MODERN WIRELESS**

should be bought by every reader of the "Wireless World" if only for its splendid constructional articles. In No. 1 for instance there are actually ELEVEN articles ranging from the construction of a Broadcast

Receiver to a 5-Valve super-efficient Set with a range of 4,000 miles. If you like building your own apparatus you must certainly take care that you do not miss No. 1.

Published by  
**RADIO PRESS Ltd.**  
DEVEREUX COURT, STRAND,  
M.A.S. W.C.2

**1/-**

Edited by John Scott-Taggart, F.Inst.P.,  
assisted by E. Redpath and Paul D. Tyers,  
and published on the 15th of every month

# The Mail Order House

**SERIES-PARALLEL SWITCH.**

With brass bush, two nuts and spring washer ... 3/-



**RADIAL SWITCH.**  
4 leaf laminated. Complete with bush, nuts and washer 2/-

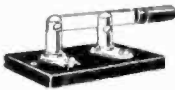

**KNIFE SWITCH.**  
Single pole, single throw. On ebonite base ... 2/3 each.

**KNIFE SWITCH.**  
Double pole, single throw. 3/6

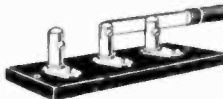

**KNIFE SWITCH.**  
Single pole, double throw. 2/9

**KNIFE SWITCH**  
Dbl. pole, dbl. throw 4/6

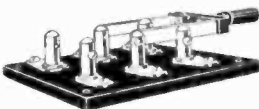

**INSULATORS.**



**BARREL.**

Very high breaking strain, each 7d.



**EGG**  
Small size and light weight, each 4d.

**SHELL.**  
Green Vitreous China, each 1/-, Miniature size each 5d.



**AERIAL WIRE.**

7/22 stranded hard drawn Copper, per 100 ft. coil... 3/6  
per 150 ft. coil... 5/-

7/25 stranded hard drawn Copper, per 150 ft. coil... 4/-

18 SWG Silicon Bronze, per 150 ft. coil ... 3/-

16 SWG Enamelled Copper, per 150 ft. coil ... 2/-

**REEL.**  
2 in. diameter, good quality, each 3d.



## Extracts from our new 32-page CATALOGUE.

Below are given some typical examples of Peto-Scott Valve. Each article carries our full guarantee of complete satisfaction or money willingly refunded.

32 pages with list of Amateur stations and call signs ... 3d.

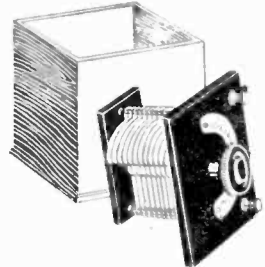

**PETO-SCOTT CONDENSERS.**

Complete in Polished Mahogany Cabinet, ready for use.	0015 ...	24/3
	001 ...	18/3
	00075 ...	16/9
	0005 ...	14/9
	0003 ...	13/6
	0002 ...	12/3
	0001 ...	11/-
	00005 ...	9/-

**SETS OF PARTS.**

*For Panel mounting.*

0015 ...	12/6
001 ...	9/6
00075 ...	8/3
0005 ...	7/-
0003 ...	6/3
0002 ...	5/6
0001 ...	4/9

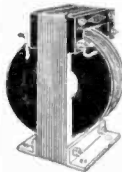

**THE MAX-AMP.**

Finest quality intervalve Transformer. Fully guaranteed. Tested to 500 volts between windings. Very silent in action and free from all distortion ... each 21/-

**THE MULTI-WAVE AMPLIFIER.**

For H.F. Amplification on all wave lengths above 1000 metres. No. 1 for coupling between H.F. and Detector and No. 2 for use where more than one stage of H.F. Amplification is used.

No. 1 ... 8/6 No. 2 ... 12/6



**THE "TUNODE" PLUG.**

Permits the usual type of honeycomb coil to be used as a tuned anode coil with exceptionally good results. Simply plug in H.F. Holder and add suitable honeycomb coil. each 3/6

**IGRANIC COILS.**

L25 ...	5/-	L300 ...	9/5
L35 ...	5/-	L400 ...	10/3
L50 ...	5/2	L500 ...	10/6
L75 ...	5/6	L600 ...	11/-
L100 ...	7/-	L750 ...	11/10
L150 ...	7/10	L1000 ...	12/8
L200 ...	8/8	L1250 ...	14/-
L250 ...	9/-	L1500 ...	15/-

**SLAB COIL PLUG.**

To take Slab Coils. Solid ebonite through-out. ... each 2/6

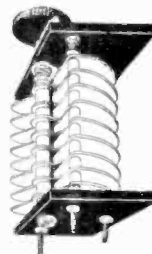
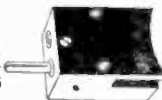

**ROTARY PLATES.**  
per doz. 6d.



**FIXED PLATES.**  
per doz. 6d.



**CONDENSER WASHERS.**  
per doz.  
Small size ... 2d.  
Large size ... 3d.

**ACCUMULATORS.**

4 volts, 10 amp. hrs. continuous, 14/6  
4 volts, 20 amp. hrs. continuous, 17/6  
4 volts, 40 amp. hrs. continuous, 27/6  
6 volts, 10 amp. hrs. continuous, 20/-  
6 volts, 20 amp. hrs. continuous, 27/6  
6 volts, 40 amp. hrs. continuous, 42/-  
All Accumulators add 1/- for packing.

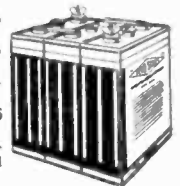

HEAD OFFICE AND SHOW-ROOMS

# SCOTT CO For all Radio Components

**CIRCULAR  
IVORINE SCALE.**

Very neat pattern,  
each 4d.



**IVORINE SCALE**

Engraved 0-180  
each 1/-



**EBONITE DIAL.**

Superior pattern in  
solid Ebonite,

each 2/-

American  
pattern.  
Engraved 0-180  
each 2/6



**EXTENSION  
HANDLES.**

for any Condenser,  
each 9d.



**WANDER  
PLUGS.**

each 1. 6d.



**H.T. BATTERIES.**

Very silent and thor-  
oughly reliable. Fitted  
with two Wander Plugs  
15 volts ... 3/-  
36 " ... 7/6  
60 " ... 14/-



**GRID LEAK AND  
CONDENSER.**

Guaranteed accurate and  
mounted with clips.  
Any value ... 4/6

**COIL WINDING WIRES.**

S.W.G.	S.C.C.	D.C.C.
12	1/10	1/11
16	2/-	2/1
20	2/2	2/3
24	3/-	3/6
28	4/4	4/7
32	6/-	7/3
36	8/8	10/2

Bobbins Free. Postage Extra. Reels 3d.  
extra if under one pound of any size. For  
quantities less than 1/2 lb., add 10 per cent.

**SYSTOFLEX COVERING.**

With tinned copper wire to fit  
per yard 5d.  
per doz. yds. 4/6



## We want you to compare these prices.

The success of the Peto-Scott Company  
is due entirely to its policy of selling a  
good article at the lowest possible price.  
Compare these prices and then order right  
away. You risk nothing—every article  
carries our full guarantee.

† Postage extra but paid on  
all Orders of £2 and over.

**3-COIL HOLDER.**

Best  
solid  
ebonite  
through-  
out.  
Fitted  
with  
either  
knobs  
or long  
handles.  
Price. 17/6

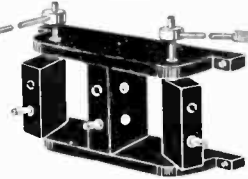

The PETO-SCOTT Standardised Unit System.

**No. 4. DETECTOR  
UNIT.**

Full Set of parts  
for home construc-  
tion ... 17/6

Less Valve.

Mahogany Cabinet  
to fit, extra 3/6



**No. 3.**

**H.F. AMPLIFYING  
UNIT.**

Full Set of parts  
for home construc-  
tion ... 13/6

Less Valve.

Mahogany Cabinet  
to fit, extra 3/6

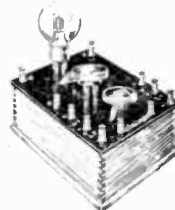

**No. 5.**

**L.F. AMPLIFYING  
UNIT.**

Full Set of Parts  
for home construc-  
tion ... 33/6

Less Valve.

Mahogany Cabinet  
to fit, extra ... 3/6



† Booklet describing  
the whole system, 6d.

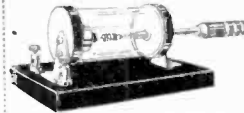

**CRYSTAL DETECTOR.**

Totally enclosed and mounted  
on polished Ebonite and all  
fittings plated ... 8/6



**EBONITE  
SLIDER.**

As shown  
each 5d.

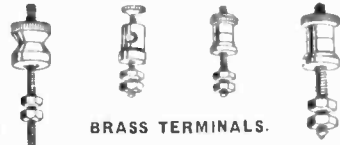

**BRASS TERMINALS.**

MK III. pat-  
tern. Small.  
2/3 doz.  
Large,  
2/6 doz

Divided pat-  
tern. Large,  
3/6 per doz.  
Small,  
2/- per doz.

Telephone  
pattern.  
Small.  
2/6 doz.



**SWITCH STOPS.**  
Brass, fitted with  
two nuts.  
per doz. 1/-



**SWITCH STUDS.**  
Brass, fitted with  
two nuts.  
per doz. 9d.



**VALVE SOCKETS.**  
Brass, fitted with two  
nuts ... each 1 1/2d.  
per doz. 1/4

**THE "PETO-PAN,"  
LOUD SPEAKER.**

A superlative Loud Speaker.  
Fitted with adjustable  
diaphragm which controls  
pitch of note. Price 50/-  
Broadcast Co.'s Seal,  
extra 3/-



**CRYSTAL RECEIVER.  
(De Luxe  
pattern).**

Complete with  
best quality  
phones, aerial  
wire and insu-  
lators. Nothing  
more to buy.  
Price, £6 6s. 0d.

64, HIGH HOLBORN, LONDON, W.C.1.

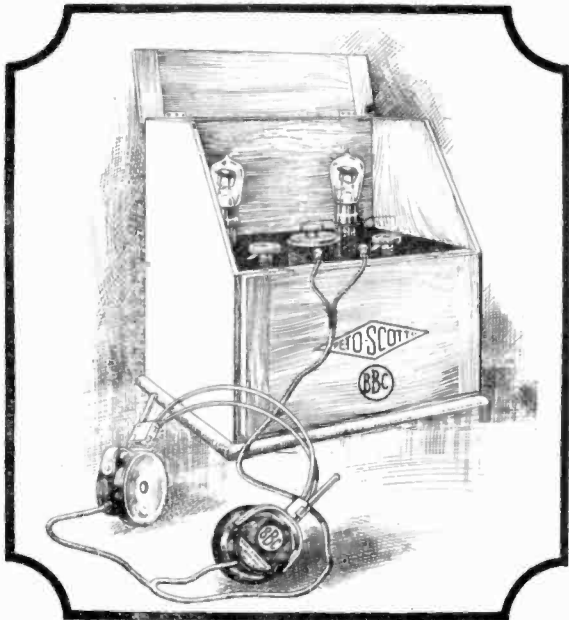

# FIVE

people were listen-  
ing-in at one time

## Read this remarkable testimonial to the efficiency of the BROADCAST MAJOR

(Passed by P.M.G.)

**T**HE acid test of a Receiving Set is performance—a handsome Cabinet is poor compensation for weak reception. If you live within 25/30 miles from any of the four Broadcasting Stations—London, Birmingham, Manchester and Newcastle—this is just the Set you need for perfect reception of music and speech.

Its solid mahogany, hand-polished Cabinet is a worthy addition to any room, and as all connections are at the rear nothing disturbs its handsome and symmetrical appearance.

**You cannot purchase a better instrument, although you may be asked to pay very much more.**

Remember every Instrument besides bearing a Certificate of actual Test, carries our full guarantee of complete satisfaction after 7 days trial in your own home, or money willingly refunded.

### Read the Specification

The Tuning is controlled by one rotating dial from 350-550 metres—all the Concert wavelengths. The L.F. Transformer is the MAX-AMP—our own design and manufacture. Included with the Set is an Accumulator (6 volt 40 amp. hours), and H.T. Battery (60 volts) both of best British Manufacture, and a pair of Western Electric Headphones. A complete Aerial outfit, including 150' of aerial wire together with Insulators, is supplied without extra charge. With the exception of the Valves, which, owing to the risk of breakage should be purchased locally, there is nothing more to buy. . .

**£9-9-0**  
Valves 15/- each extra

**Q** When this Set is required for use with Broadcast Licence, a royalty of 35/- must be paid at time of purchasing. The royalty of 25/- due to the Marconi Co. is being paid by us.

The Cottage  
Grove, Green  
South Harrow  
Middlesex N12 8JN

January 15th 1923

Dear Sirs

I enclose the Petto-Scott Co  
24 High Holborn, W.C.1

No doubt you will be pleased to hear of personal experience with the Broadcast Major which I obtained from you a few days ago on behalf of a friend.

Having had considerable experience in the design of radio instruments, the present set being the fourth I have constructed, was certainly rather "sensitive" to the aerials likely to be obtained in the Broadcast Major.

After a thorough trial, however, during which I received the London Broadcasting Station with perfect clarity and at excellent strength on 400 metres, and at several other stations, I was able to offer you my hearty congratulations as incorporating excellent two-wave sets at a very moderate figure.

I need hardly state that my friend, on whose behalf I purchased the instrument, is equally pleased with it, and is rightly receiving the excellent Concert Programme at his home some 20 miles from London.

Yours every day,  
I am yours truly,

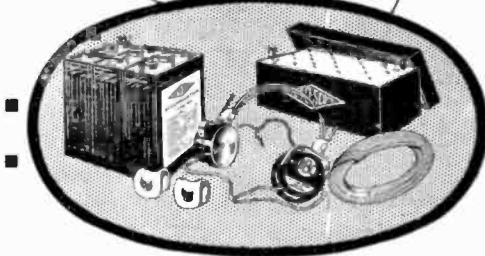

**THE PETTO-SCOTT CO.**

Head Office & Showrooms  
64 High Holborn W.C.1

# An Improved Coil Holder.

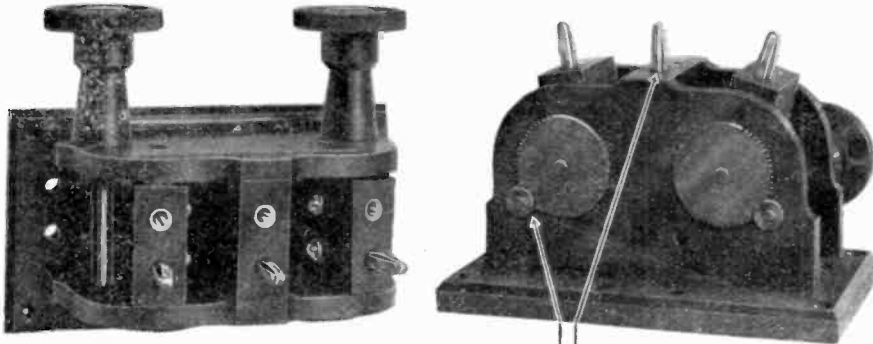

**T**HE new Burndept Coil Holder is a great improvement on the previous model which it now supersedes.

The outstanding feature of this model is its particularly smooth action, the moving holders are operated through a five-to-one gear, thus rendering close adjustment very simple.

The unreversible coil holders are fitted with smooth running spring contacts which ensure good electrical contact at all times, and make it a quick and easy matter to change from one coil to another. Burndept coils are fitted with plugs which also carry spring contacts, therefore, for ideal working, Burndept coils should be used with the Burndept coil holder.



No. 135. Holder for three coils for mounting on box or panel - - - **£1-10-0A.**

**BURNDEPT LTD.** London Office and Showrooms:—  
 15, BEDFORD STREET, STRAND, W.C. 1  
 City Depot: 79, MARK LANE, E.C. 3. Central London Depot: 228, SHAFTESBURY AVENUE  
 AERIAL AND EASTNOR WORKS, BLACKHEATH, S.E. 3

London Assurance House, 249, George Street, 93, Holm Street,  
 Bond Place, LEEDS. ABERDEEN. GLASGOW.

Bank Buildings,  
 Middle Street,  
 YEOVIL.

Exchange Buildings,  
 133, New Street,  
 BIRMINGHAM.

61, Bridge Street,  
 MANCHESTER.

# BURNDEPT

WIRELESS APPARATUS



# 66 POLAR 99

*Chosen for GOOD*

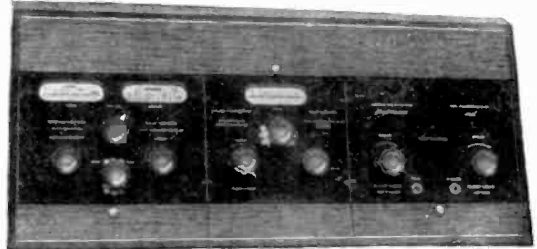

"POLAR" RADIOPHONE, R.A. 33, 34, 35

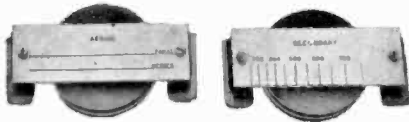

The interchangeable tuning and transformer coils carry wavelength scales which are invaluable to the broadcasting licensee.

Highly selective tuning over a wide range of wavelengths, with maximum efficiency in the H.F. amplification, necessitates simultaneous tuning of five different circuits. This is usually a highly skilled operation, but the unique wavelength scales reduce it to a process of the utmost simplicity.

## The most powerful set yet available for the broadcasting licensee.

The "Polar" Radiophone R.A. 33, 34, 35 is a brilliant example of the highly technical instrument, successfully adapted for use by the non-technical, everyday listener-in.

Every experimenter knows the advantage of such features as double circuit tuning, 3-stage H.F. amplification, condenser tuning with each H.F. transformer, interchangeable tuning coils and H.F. transformer coils.

Every wireless experimenter appreciates the difficulties such features present even in skilled hands. In the "Polar" Radiophone R.A. 33, 34, 35, all these important technical features are included, while the design of the controls is such that any unskilled person can operate them successfully.

This model has seven valves in all, of which the first three are H.F. valves available at the will of the operator by the turn of a switch.

The last valve is provided with separate control and extra H.T. for use as a power valve on loud speaker work.

Price, without accessories . . . . . £47 11s. 6d.  
Or complete with all accessories, including loud speaker and mounted in sectional bookcase cabinet . . . . . £85 10s. 8d.

*All prices carriage paid.  
Full particulars on application.*

## THE RADIO COMMUNICATION CO. LTD

*(Suppliers of the G.P.O. Installations at North Foreland (G.N.F.) and Seaforth (G.L.V.), of Coastal Stations for various Colonial Governments, and of Ship's Radio for most of the Great Shipping Companies.)*

**34/35, NORFOLK STREET, LONDON, W.C.2**

BRANCHES: NEWCASTLE—17 Sandhill. GLASGOW—116 Hope Street. LIVERPOOL—67 Dale Street.  
CARDIFF—Atlas Chambers, James Street. SOUTHAMPTON, 19, Queen's Terrace.  
WARRINGTON—37, Bridge Street.









TYPE A.I. Cap. .0005  
IN CELLULOID CASE.

## SINGLE CONDENSERS AT WHOLESALE PRICES

Direct from the Makers—Saving Middlemen's Profits. Complete in EVERY respect and exactly as illustrated, to the following specification.

Rotary, Air Dielectric, 22 Gauge Aluminium Vanes. Metal to Metal Adjustable Bearings, Contact to moving vanes by copper strip. Spacing between plates sufficient for pressure up to 1,000 volts. Built upon Ebonite. Best Ebonite insulation throughout. Engraved Ebonite Dial.

### PRICES :

Type A.I.		Type A.II.	
.001	12/6	.001	10/-
.0005	10/6	.0005	8/6
.0003	8/9	.0003	6/9
.0002	7/6	.0002	5/6

Vernier Condensers, 3 plate, 3/9; 5 plate, 4/6

Postage extra:—

1 Condenser 9d., 2 Condensers 1/-, 4 Condensers 1/3; after that WE pay carriage in Great Britain and Ireland.

Don't allow our low prices to prejudice you. They are no criterion whatever of the value we offer. Our Motto is QUALITY FIRST, and every Condenser carries our money-back guarantee. No waiting. Delivery from stock. Cash with order.

# FALLONS

THE CONDENSER PEOPLE

230a, HERMITAGE ROAD, LONDON, N.4.



Type A.II. Cap. .0005.

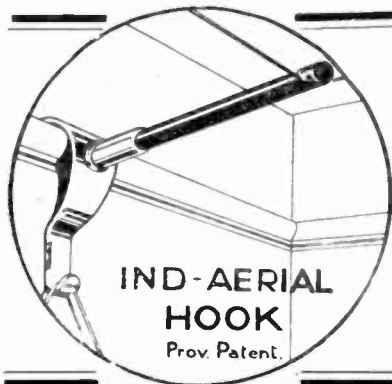

IND-AERIAL HOOK  
Prov. Patent.

## SAYS MR. MAN:—

“I WANT the Broadcasting and am prepared to buy a Radio set, but I live in a flat and may not have an outside aerial. What can you do for me?”

**DEALERS!** the answer is **IND-AERIAL HOOKS**

They are essential for a neat, efficient and portable **INDOOR AERIAL**. Attached in a moment to the picture rail of any room they can be taken down just as easily. They support the aerial **ONE FOOT** from the wall on insulated arm, and are no disfigurement.

2/9 each; 31 6 doz. Post Free.

Some Agencies still open in Broadcasting Towns.

**IND-AERIAL CO., 47, Victoria Street, London, S.W.1**

# The FELLOPHONE



## 2-VALVE RECEIVING CABINET

A high grade instrument at a very low price. This set has been especially designed for receiving broadcasting, and complies with all the Postmaster-General's regulations. It can be used either for listening in with headphones or with a loud speaker.

Additional interest and use is secured because it will receive all amateur transmitting stations within a range of 20 miles. The "Fellophone" is mounted in a handsome oak cabinet and is sent out complete with H.T. battery, 6 volt Accumulator, 100 foot aerial, 2 shell insulators and one pair of Fellows 4000 ohms double headphones, but without valves.

*British Made Throughout.*

*Made under Marconi Licence and fully approved by the Postmaster-General and British Broadcasting Co.*

PRICE COMPLETE **£12:0:0**  
 (Without Valves) (Carriage 2/-)  
*(Inclusive of all Taxes).*

EXTRA for 2 VALVES, 30/- (postage 1/-).  
 HEADPHONES - - - - - 21/6  
*(Inclusive of all Taxes). (Postage 1/-).*

**FELLOWS MAGNETO Co., Ltd.**  
 LONDON, N.W.10

Telephone : Willerden 1560-1. Telegrams : Quixmaz, Phone, London.

EB 8

*For they are jolly good Fellows*

## The OHMER INSULATION TESTING SET (COX'S PATENT)

This is the lightest, cheapest and best instrument of its kind on the market. It consists of an Ohmeter and Generator mounted in one case. The Ohmeter is of the Electrostatic type, giving extreme lightness. Absolutely unaffected by external fields. It reads directly in Megohms and is independent of the voltage or speed of the generator.

**NALDER BROS. & THOMPSON, LTD.,**  
**97a, DALSTON LANE, LONDON, E.S.**



## BUY THE BEST

### PHONES

Use the headphones which picked up the recent TRANS-ATLANTIC SPEECH.

#### WESTERN ELECTRIC

They are not cheap, but they are the BEST because they are backed by an organisation which has produced *Half the World's* Telephones.

P.O. for 32/- brings you these wonderful headphones.



*Mr. E. Blake, A.M.I.E.E., wireless expert to the "DAILY MAIL," writes in that famous paper :-*

"If you are compelled to deliver your cells to a garage, buy a Voltmeter . . . A common experience in some garages is to place cells on charge at an excessive rate, and they 'gas' before they are fully charged. They should when brought home be tested with a Voltmeter."

### VOLTMETERS

Combined Double Scale for Filament and Plate Volts.

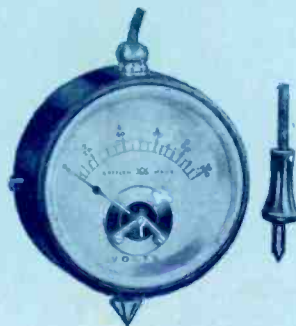

Portable Double Scale Instrument (as illustrated) 0/6; 0/100 Volts 20/- post free.

OF RELIABLE DEALERS OR DIRECT FROM :-  
**LIONEL ROBINSON & CO.**

WIRELESS SUPPLIES DEPT.

**3a, Staple Inn, Holborn, W.C. 1**

Telephone—Holborn 6323.

Registered "NIPHAN" Trade Mark.

## WATER-TIGHT PLUGS and CABLE COUPLINGS TO MEET HOME OFFICE REQUIREMENTS



COUPLING CONNECTING CABLES

Phones !  
 2600 Gerrard 12061 Central.

Telegrams !  
 "Niphon, London."  
 Patented in England and Abroad.

As used by H.M. War Office, Electric Supply Companies, Railway Companies, Marconi's Wireless Telegraph Company  
**SIMMONDS BROS., LTD.**  
 4, 6 & 8, NEWTON STREET, HOLBORN, W.C.



SIX WAY TEE CONNECTORS

ELWELL  
High Power  
Wireless  
Stations

Oxford

Cairo

Northolt

Horsea  
Island

Eiffel  
Tower

Lyons

Nantes

Rome

& others

ELWELL  
WIRELESS

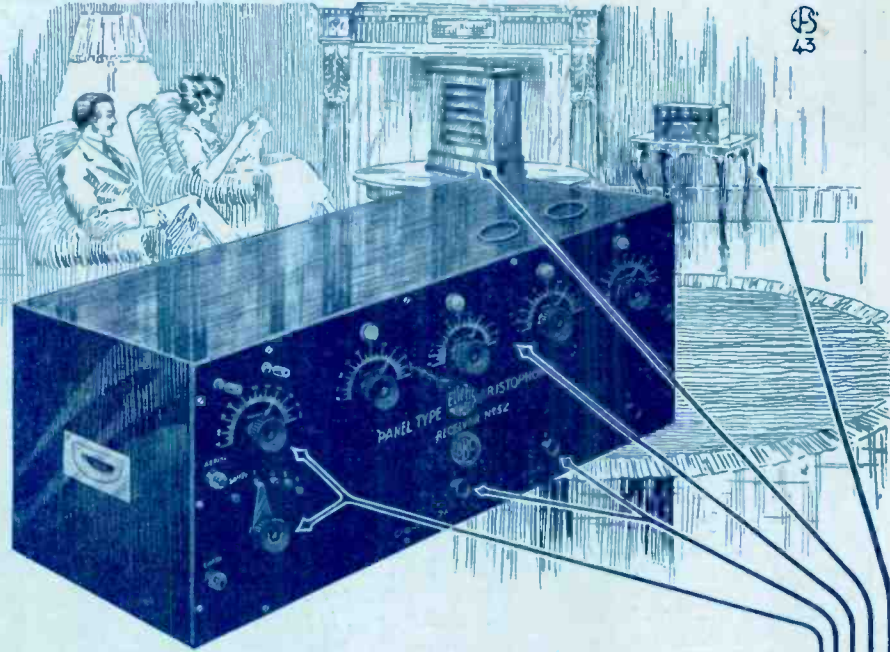

**COMPLETE.**

Aristophone Panel 52 is essentially the complete receiver.

You can quickly and readily listen to the Broadcasting, Shipping, Aeroplane Telephony, Amateurs and the usual High Power Stations.

You can listen on two, three, or four valves as you desire, and if you wish to obtain particularly loud reproduction, you can use power valves in the last two valve holders.

You will also appreciate both batteries being self-contained within the case. The only external leads are the aerial and earth.

Wherever you live, Panel 52 will give you satisfactory reception from at least one Broadcasting Station, and probably the choice of three.

Panel 52 is entirely British made and approved by the Postmaster-General.

Four position and fine adjustment switches for tuning in to Broadcasting, Amateurs, Shipping, or Aeroplane Telephony as desired.

Elwell Jacks for connecting the Loud Speaker or Head Telephones to 2, 3 or 4 valves at will. Only the valves in use are alight, ensuring economy in battery current. Separate filament control on each of the 4 valves, ensuring maximum efficiency and range.

The Aristophone Loud Speaker for which this panel has been specially designed, ensures perfect reproduction.

Aristophone Panel 52 is a completely self-contained receiver. Both L.T. and H.T. Batteries are included in the case. There are no untidy battery leads.

**Aristophone Panel No. 52.**

Comprising 4 "Ora" Valves, one pair supersensitive head telephones, 36 volt H.T. battery, 6 volt 50 A.H. filament battery, aerial, lead in insulators, earth connection and everything ready for reception.

**£40**

Complete as above, but with 120 volt anode battery and larger valves, suitable for demonstrations or where maximum volume is desired.

**£42 10 0**

**Aristophone Loud Speaker,**

**£10 extra.**

*Ask for the name and address of the nearest Elwell Service Agent.*

**C. F. ELWELL, LTD.,** Radio Engineers,  
(Dept. W.), CRAVEN HOUSE, KINGSWAY, LONDON, W.C.2  
Telephone: Museum 1384.

# WIRELESS WORLD

AND

## RADIO REVIEW.

No.182. [No. 19.  
VOL. XI.]

10th FEBRUARY, 1923.

Registered at the G.P.O.  
as a Weekly Newspaper.

### PERFECTION!

#### THE IDEAL HIGH TENSION BATTERY ENSURES NOISELESS RADIO CIRCUITS

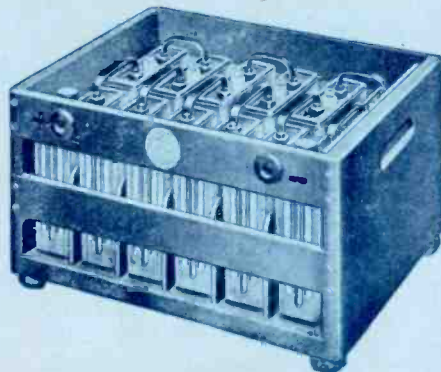

OUR Latest Type High Tension Battery  
in sealed Glass Boxes as illustrated  
has been

#### UNIVERSALLY ACCLAIMED

*Its many Special Features include:—*

High Insulation. Glass Cell Containers.  
Constant Voltage. No Electrical Leakage.  
Reliable Service.

Unequalled by any High Tension  
Battery now made. Unprecedented  
demands.

**HART ACCUMULATOR CO., LTD.,** Stratford, London, E.15



OBTAIN THE BEST RESULTS  
BY INSTALLING RELIABLE  
RECEIVING APPARATUS.

STERLING No. 1  
CRYSTAL RECEIVING SET

*Specially designed to receive  
the Broadcast Programmes.*

£6 : 17 : 6

Complete with pair of Double Head Telephones and  
Coil for Paris Time Signals. Range 25 miles.

*To be obtained from all Dealers or direct from—*

**STERLING TELEPHONE & ELECTRIC CO., LTD.**  
210/212, TOTTENHAM COURT ROAD, LONDON, W.1

Telephone No. : 4144 Museum (7 lines). Telegrams : "Cucurnia, Wesdo, London." Works—DAGENHAM, ESSEX  
Branches—NEWCASTLE-ON-TYNE, 3 Clavering Place; CARDIFF, 8 Park Place; MANCHESTER, 14 St. Peter's Sq.

*We guarantee that all Broadcast Radio Apparatus sold by us conform with  
the conditions of the Broadcaster's Licence issued by the Postmaster-General.*

“Wireless for all”

Before you decide on the  
construction of your set.  
It will pay you to have  
particulars of—

**Condensite Celoron**

For PANELS and OTHER PARTS.

This material is waterproof, immune to atmospheric and climatic conditions, will not warp, has high surface and volume resistivity, high di-electric strength, low specific gravity.

LET US QUOTE YOU

SEND PARTICULARS OF YOUR EXACT REQUIREMENTS TO  
THE MANUFACTURERS

**DIAMOND FIBRE CO. LTD.**  
WORKS HIGH ROAD  
MAIDSTONE, KENT. SOUTH TOTTENHAM, NJS.



G.P.O. Regd.  
No. 0177

Each instrument  
individually certi-  
fied & guaranteed

# H.P.R. HILOPHONE

## The Ideal 3-Valve Instrument for Music and Telephony

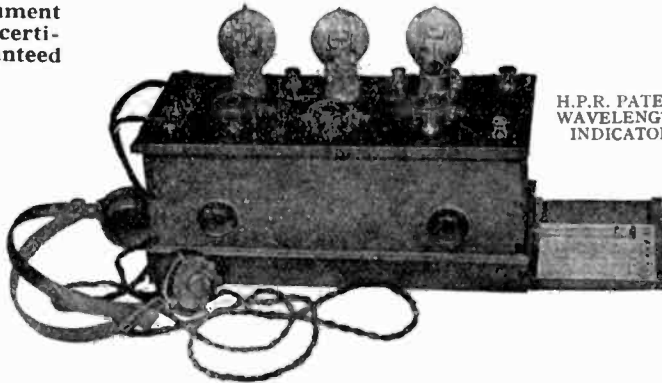

H.P.R. PATENT  
WAVELENGTH  
INDICATOR

Range of Wavelengths 300 to about 1,000 metres, covering all British Broadcasting transmissions—ship and coast stations (spark and C.W.)—aeroplane telephony. Readily tuned to incoming wavelength by the H.P.R. Patent Wavelength Indicator. The patent H.P.R. tuned high frequency coupling inductances, combined with fully variable reaction (non-interfering), render the Hilophone extremely selective. It is so sensitive that it may be tuned to receive even

## AMERICAN BROADCAST MUSIC

audibly and clearly in the headphones under first class receiving conditions.

Price of H.P.R. Hilophone . . . . .	£25 0 0
British Broadcasting Co.'s Charge . . . . .	2 5 0
	<u>£27 5 0</u>
With all accessories . . . . .	£34 0 0
British Broadcasting Co.'s Charge . . . . .	2 5 0
	<u>£36 5 0</u>

Suitable for use with a Loud Speaker.

# H.P.R. WIRELESS, LTD.

*Pioneer Designers and Makers of Fine Valve Receiving Instruments for Amateurs.*

Head Office and Demonstration Room :

**CARLTON HOUSE, GREAT QUEEN STREET,  
KINGSWAY, LONDON, W.C.2**

Tel. : REGENT 1719.

(Opposite Kingsway Theatre)

Phone—  
CENT. 1313  
and Extensions.

## SCOTLAND'S PREMIER RADIO EXPERTS

The most recent noteworthy successes have been obtained on apparatus supplied from our comprehensive stock of Efficient Radio Goods.

*Distributing Agents for Scotland for the Famous*

## BURNDEPT ULTRA RECEIVERS AND ETHOPHONES.

We keep an extensive stock of all parts required for making up customer's own sets. Send your enquiries—we will quote competitive prices by return. Our advice is always at your disposal.

## W. A. C. SMITH,

236, ARGYLE STREET (Retail) and  
93/99, HOLM STREET (Office and Warehouse)

## GLASGOW.



TYPE F. "Featherweight."  
Actual weight, including cords,  
is 6ozs. only.

# BROWN'S

*"Featherweight"*

## HEADPHONES

British and Best

The Finest Headphones Procurable for

# 30/-

This price is for one pair of either  
120 or 4000 ohm 'phones, including  
cords of good quality.

OBTAINABLE FROM ALL WIRELESS DEALERS.

*Catalogue Post Free.*

Head Office and  
Works:  
Victoria Road,  
North Acton, W.8

# S. G. BROWN, Ltd.

London  
Showrooms:  
19 Mortimer St.,  
London, W 1



# BURNDEPT Ultra IV

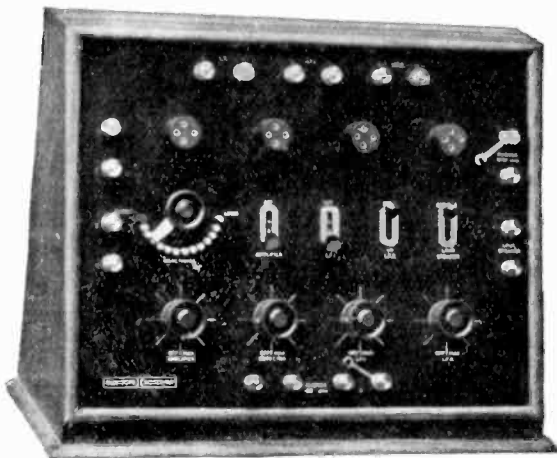

Covent Garden  
Opera

Christiania, Norway

Madrid, Spain

**I**N Madrid—in the heart of Spain, and listening to London Opera—this was the unique experience of one of our clients who possesses an Ultra IV Receiver. He writes that the singing and orchestration was perfect and undistorted. Similar letters have come in from all parts, from Christiania in Norway to the Riviera. With an Ultra IV, distance does not matter—except to make you appreciate, more than ever, a really good instrument. The Ultra IV is a four valve Receiver, 1 H.F., a Detector and two note magnifiers. Each valve is separately switched and controlled so that it is possible to use any number of valves with the Detector.

No. 104s. BURNDEPT ULTRA IV RECEIVER £35 A.  
(WITHOUT VALVES)

*Write for our fully illustrated 40 page Catalogue of Amateur and Experimental Apparatus, which will be sent post free.*

**BURNDEPT LTD.** London Office and Showrooms:—  
15, BEDFORD STREET, STRAND, W.C. 1  
AERIAL AND EASTNOR WORKS, BLACKHEATH, S.E.3

London Assurance House, 249, George Street, 93, Holm Street, 119, George Street, Exchange Buildings, 133, New Street, 61, Bridge Street,  
Bond Place, LEEDS. ABERDEEN. GLASGOW. EDINBURGH. BIRMINGHAM. MANCHESTER.

## BURNDEPT

WIRELESS APPARATUS

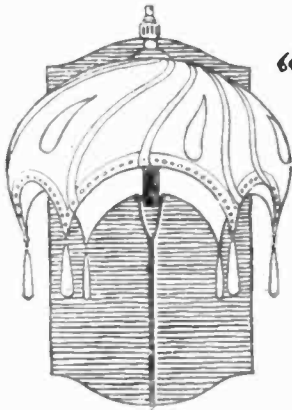

# “Better than a frame aerial”

## The “Ducon”

If you have electric light, the “DUCON” gives you all the advantages of a frame aerial, such as neatness, compactness, no outside aerial and far better results. All you have to do is to plug the “DUCON” into a lampholder or wall socket and connect to your wireless set.

For all electric light circuits, the “DUCON” ... 10/- each, of all leading wireless dealers, electrical contractors and stores, or direct from the makers.

Dealers not yet stocking should write for trade terms.

*Over 50,000 in use.*

The DUBILIER CONDENSER CO. (1921) Ltd.

Ducon Works, Goldhawk Road,  
Shepherd's Bush, London, W.12

Telephone : : Hammersmith 1084.  
Telegrams : “Hivollcon, Phone, London.”

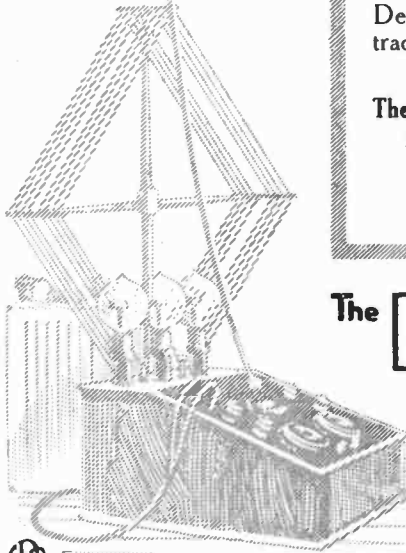

# The DUCON



**FOR USE WITH ANY SET**

8



**PATENT**



**BATTERIES**

*Note the Reduced Prices for 1923*

**THE WORLD'S MOST PERFECT BATTERIES FOR WIRELESS WORK**

**100% GREATER OUTPUT.** Comparative tests with Plate Batteries of the same rated capacity when used intermittently with one or more valves for 1, 2 and 3 hours daily shows 100% greater output due to the wonderful recuperative properties of these Block Batteries.

**NO TROUBLE.** Fuller Block Batteries retain their charge during long periods of inactivity and are always ready for use. Ebonite Containers do not break, thus preventing acid or current leakage.

**QUIET WORKING.** There are no plates to buckle, no risk of accidental shorting or sulphation. Hence noise is eliminated, resulting in perfectly clear reception.

**LOW UPKEEP.** Long life and steady reliable service means economy. The Fuller H.T. Battery is good for 8 years, and recharging, normally required every 4 to 5 months, costs only a shilling or two.

*Fuller Block Batteries are sold by Wireless Dealers, Electricians, and over 300 Fuller Battery Service Agents. See about getting one to-day. It will mean better results with less trouble and expense.*

*Dealers who are not fully stocked should write us at once.*



**6-VOLT L.T. BATTERY.**

In ebonite case with strap handle.

H.W. 6 volt. 20 amp. . . . . 25/-  
 B.W. 6 volt 40 amp., 40/-      B.W. 6 volt. 60 amp., 52/6



**30-VOLT L.T. BATTERY.**

Impregnated wood case with outside terminals and sliding lid.

H.T.1 . . . . . 30/-

**FULLER'S UNITED ELECTRIC WORKS**

LIMITED

**WOODLAND WORKS, CHADWELL HEATH, ESSEX**

*Manufacturers for the Admiralty, Air Ministry and War Office for Wireless Work*  
 Telegrams : " Fuller, Chadwell Heath."      Telephone: Ilford 1200 (6 lines)

EXPERIENCE

# THE PERFECT Audio Frequency TRANSFORMER

Designed and built on scientific lines.  
Now tested between windings at 1,500 volts.

## 25/-

Telephone Transformer - - - 20/-

For use :—

1. As an intervalve Transformer.
2. For power amplification for the large Loud Speaker.
3. On the Armstrong Regenerative Circuit.

This transformer\* is used by more manufacturers of wireless sets than any other make of transformer for the following reasons :—

**BECAUSE** it is wound with heavy gauge wire, thus avoiding the unreliability of the ordinary transformer, which being wound with fine wire, carries only a small factor of safety.

**BECAUSE** whatever may be used on Wireless Instruments, it pays only to use the best possible transformer.

**BECAUSE** although of excellent design and sound construction it is sold at a very low price.

**BECAUSE** its exceptional absence of noise and vibration allows a larger range of amplification to be employed.

*Beware of imitations of this famous transformer. Only those which bear the name 'R.I.Ltd.' are genuine.*

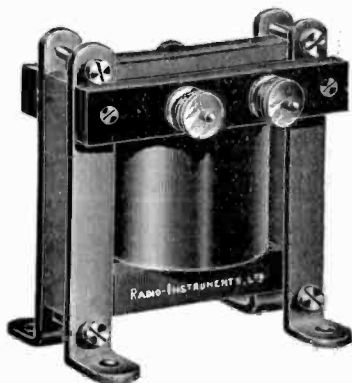

**WINDING AND INSULATION** is by a patented process, every individual turn being specially insulated from adjacent turns as well as between layers. Insulation resistance is now increased so that 1,500 volts can be safely applied between the windings.

**DIMENSIONS** are reduced to the smallest limit consistent with absolute reliability;  $3\frac{1}{2}$ " wide,  $2\frac{1}{4}$ " over feet,  $3\frac{1}{4}$ " deep. The unusually heavy wire eliminates a common weakness in other designs where efficiency and reliability are sacrificed to space.

**CONSTRUCTION** is on exactly similar lines to power transformers. The closed core is built up from best quality Stalloy iron laminae.

**IMMUNITY FROM BREAKDOWN** is assured by scientific design and careful construction, coupled with high insulation, large gauge wire, and efficient dimensions. Comparative tests confirm the superiority of our designs.

Order at Once to Secure early Delivery.

TELEPHONE TRANSFORMERS at 20/- each.

Many testimonials from satisfied customers (originals of which can be seen at our works) prove this transformer to be considerably in advance of anything previously designed for audio frequency amplification. It is the ideal transformer for amplification with a crystal set.

*A customer writes—*

*"You may be interested to know that I have heard a New York Station (on R.I.) on a two-valve set—one Detector Valve and one L.F. Needless to remark the L.F. Transformer was one of yours. Up to now I have found nothing to beat them."*

Write for a copy of the 24 page R.I. Catalogue of Wireless Apparatus.

Art Brochure of "Lyrian" Cabinet Receivers sent on application.

## RADIO INSTRUMENTS LIMITED

Managing Director: J. Joseph, M.I.E.E., late Manager to Mr. H. W. Sullivan. Chief Designer: W. A. Appleton, M.B.E., M.I.R.E., late Admiralty Technical Research Officer.

ONLY ADDRESS.  
Works, Offices and Showrooms: 12, Hyde Street, NEW OXFORD ST., W.C.1  
Telephone: Regent 1908. Telegrams: Instradio, London.

# The New Star in the Radio World

## THE SUPER RELIAPHONE No. 4.

The most popular receiver for use with a loud speaker.

**RANGE**  
175 miles

Registered P.O.  
No. 0195.

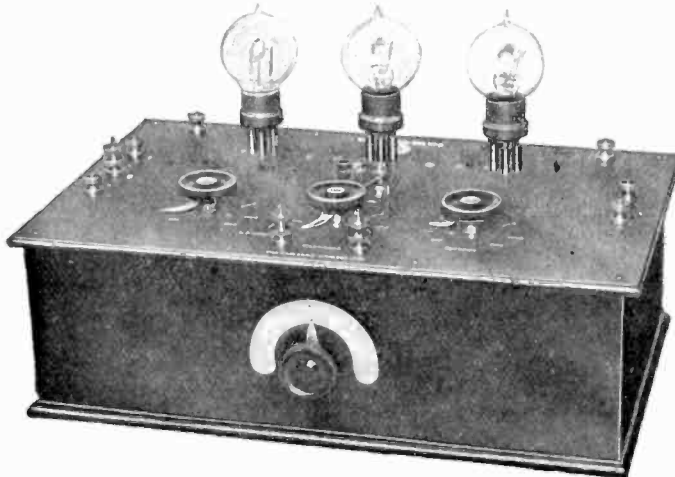

**PRICE**

£19 : 10 : 0  
Including all  
Royalties.

£25 : 10 : 0  
Complete with  
Accessories.

INDEFINITE WAVELENGTH

IMMEDIATE DELIVERY.

The recognised symbol of superior performance.

It will not only bring in radio waves from distances but will amplify them hundreds of times, giving strong, clear, accurate reception. Yet so simple, so free from confusing adjustments, that a child can tune and operate it as easily as a radio expert.

### ILLUSTRATED CATALOGUE SENT POST FREE

Containing full particulars of—

<b>CRYSTAL SETS</b> —Phonotorall. Range 20 miles..	£2 9 6	<b>VALVE SETS</b> —Super Reliaphone No. 2. Range	
Simpliphone. Range 30 miles ..	2 17 6	75 miles..	£14 10 0
<b>VALVE SETS</b> —Reliaphone. Range 50 miles ..	7 10 0	Super Reliaphone No. 3. Range 200 miles	21 10 0
Super Reliaphone No. 1. Range 100 miles	16 10 0	Reliaphone Note Magnifier ..	5 5 0
		Reliaphone Double Note Magnifier..	8 10 0

The Reliaphone Double Note Magnifier if connected to the Simpliphone gives excellent results with a Loud Speaker.  
Prices include All Royalties.

DEMONSTRATIONS DAILY.

TRADE ONLY.

**THE WHOLESALE WIRELESS CO., LTD.**  
103, FARRINGDON ROAD, LONDON, E.C.1

Telephone: CLERKENWELL 5312.

READY

Price **6/-** Nett**The Year Book  
Telegraphy****19**

SPECIAL

FOR **EXPERIMENTERS, AMATEURS****Phenomenal Demand**

As a result of the tremendous demand for the Year Book, we have decided to issue a special edition for Experimenting Amateurs apart from the complete edition usually published.

The new edition will contain all the information given in the complete work, with the exception of matter of sole interest to Commercial Companies.

ALL YOU WANT TO KNOW IS IN THE YEAR BOOK

**The Year Book of Wireless**Price **15/-** Nett — **COMPLETE**

Practically the whole of this edition is already

**The Wireless Press, Ltd.**

MARCH

**of Wireless  
& Telephony****23**

EDITION

Post **6/9** Free**AND ALL "LISTENERS-IN"****Order Immediately**

## BRIEF SUMMARY OF CONTENTS.

Directory of over 450 Amateur and Experimental Stations: Laws and Regulations governing Experimental, Amateur and Broadcast Wireless; Call Letters of over 16,000 Air, Land and Ship Wireless Stations of the World: Sixty-four Pages of Maps in Two Colours, showing position of all known Land Stations, indicating whether Direction Finding, Broadcasting, Public or Official; Complete History of Wireless from its Birth to Date, with full details of Progress made in 1922; Meteorological Section, showing all Regular Transmissions of Hydrographic, Meteorological and Time Signals, with detailed explanation of the Codes used and their Meanings; Useful Data Section; Dictionary of Wireless Terms in Five Languages, Tables and Formulae for Wireless Calculations, Graphical Symbols for Radio Diagrams; Classified Traders Directory for the benefit of Purchasers of Component Parts, etc.; Full Morse Code, International and Continental; etc., etc.

THE SUPPLY IS LIMITED—PLACE YOUR ORDER NOW

**Telegraphy and Telephony**EDITION — Post **16/-** Free

sold. To avoid disappointment order at once.

**12-13 Henrietta St., London, W.C.2**

## To the Trade Only.

TERMINALS, VALVE SOCKETS AND PINS,  
STUDS, SPACING WASHERS, B.A. AND  
WHIT. SCREWS, THREADED RODS, NUTS  
AND WASHERS. FROM STOCK.

WEEKLY DELIVERIES OF ANY QUANTITY CAN BE  
GIVEN, COMMENCING AT ONCE.

**ASK FOR CATALOGUES.**

SPECIAL SCREWS & TURNED PARTS, TAPS, DIES AND DRILLS

**T. L. CASTLE,** 2 CRICKLEWOOD BROADWAY,  
LONDON N.W.2

Telephone : Hampstead 2699.

Telegrams : Skrusadys, Phone, London

# Ediswan Valves



have over forty years' of lamp making experience embodied in their manufacture. The AR Valve illustrated is specially made for amateur reception.

Plate voltage 30-80. Filament volts 3.5-6.0. Filament current 0.75 amperes. High amplification. Silent working.

**15/- each**

**THE EDISON SWAN ELECTRIC Co., Ltd.**

Contractors to H.M. Admiralty, War Office, Royal Air Force.

Head Office · 123/5 Queen Victoria Street, E.C.4

London Showrooms : 123/5, QUEEN VICTORIA ST., E.C.4  
71, VICTORIA ST., S.W.1

Works : PONDERS END, MIDDLESEX

BRANCHES :-

If you are unable to obtain Ediswan supplies from your usual dealer, write to us for the name and address of the nearest supplier.

Aberdeen  
Belfast  
Birmingham  
Brighton

Bristol  
Cardiff  
Dublin  
Dundee  
Melbourne

Edinburgh  
Glasgow  
Hull  
Leeds  
Brisbane

Leicester  
Liverpool  
Manchester  
Newcastle  
Sydney

Nottingham  
Sheffield  
Southampton  
Swansea  
Adelaide

**EDISWAN  
BATTERIES  
H.T. and L.T.**

are all manufactured with the same care and attention to details as other Ediswan products. Always insist on "Ediswan" when purchasing Accumulators or Dry Batteries.





**GUARANTEED EFFICIENT**

“APOLLOPHONE No. 1”

Reg. Design No. 693330.  
P.O. Reg. No. 1033.



The best that high-class material and expert craftsmanship can create—in fact a better instrument cannot be made at the price. So simple to operate that no previous wireless knowledge is required.

The wavelength range is 300-1000 metres—a much greater range than that usually allowed by a single valve set. The “Apollophone No. 1” is therefore the set for the experimenter who wishes to add magnifiers and get longer distance messages.

The Detector Panel is always available for magnification by L.F. Magnifiers.

PRICE . . . . . £10 12 6

Also supplied as COMPLETE RECEIVING SET, with all high quality accessories. £16 10 0 Carr. Paid U.K.

Also supplied as 2 or 3 valve set.  
Two Valve Set, less valves . . . . . £18 12 6  
do. do. with all accessories . . . . . 24 0 0  
Three Valve Set, less valves . . . . . 22 12 6  
do. do. with all accessories and small size Loud Speaker 37 10 0

All prices include Broadcasting Fees.  
All our Valve Sets are issued under Marconi Patents.  
Catalogue and full particulars post free.  
Agents for our specialities wanted in all large towns.

**The Manchester Radio Co., Ltd.**  
RADIO ENGINEERS,

F. H. McCrea, Managing Director,  
W. R. Burne, Directing Experimental Department,  
155, OXFORD ROAD, MANCHESTER  
Phone: Central 4935. (Entrance Boundary Street East.)  
Agents for Dubilier Condenser Co.'s Specialities.  
Delivery ex stock, Manchester.

**SIEMENS**

**H.T. DRY BATTERIES**



**RETAIL PRICES**

No.	Volts.	No. of Cells.		Price each.	
				s.	d.
643	15	11	spring clip terminals	3	6
789	15	11	“ “ -	6	0
826	30	21	plug sockets	7	0
827	36	24	“ “ -	8	0
828	50	36	“ “ -	11	0
829	60	44	“ “ -	13	6
830	90	66	“ “ -	20	6
831	100	72	“ “ -	21	6

Removal Plug Terminals 9d. extra per pair.

Schedule of trade prices will be sent on receipt of trade card.

Catalogue No. 595 Accessories for Private Wireless Installations will be sent on application to the manufacturers

**SIEMENS BROTHERS & Co. LTD.**  
**WOOLWICH, LONDON, S.E.18**

Telegrams—Siemens, Woolwich. Telephone—City 6400  
Stocks held at  
BELFAST—36, Mill Street. BIRMINGHAM—111, New Street.  
BRISTOL—30, Bridge Street. CARDIFF—57-59, St. Mary Street.  
GLASGOW—40, Wellington Street and 144, St. Vincent Street.  
LEEDS—129, Park Lane. LIVERPOOL—81, Dale Street.  
LONDON—38-39, Upper Thames St. MANCHESTER—196, Deansgate. NEWCASTLE-ON-TYNE—64-68, Collingwood Buildings and Exchange Buildings, Quayside.  
SHEFFIELD—22, High Street. SOUTHAMPTON—46, High Street.

# TONS

of EBONITE SHEET in Stock for immediate delivery in qualities suitable for all classes of WIRELESS WORK.

## SHEETS - RODS TUBES - PANELS

TUBES and ROTORS for Variometers. MOULDED KNOBS (various patterns), COMBINED DIALS AND KNOBS, 3", 3½" and 4" diameters. Do. for Fil. Res. and Vario-Couplers. AERIAL INSULATORS.

Wholesale only.

AMERICAN HARD RUBBER COMPANY (Britain) LIMITED, 13a, Fore Street, London, E.C.

Telegraph: "Eboniseth, Ave. London." Phone: Central 12754.

# J. BURNS, LTD.

Wangye Works,  
Chadwell Heath, Essex.

We are actual manufacturers and can offer special advantages to the trade—send us your enquiries.

CONDENSERS.		Retail price
.001 mfd.	each	13/6
.005 "	each	10/-
.003 "	each	9/-
.0005 "	each	4/6
Filament Resistances.	each	2/-
Terminals with high base	doz.	1/6
Contact Studs, with nuts	doz.	9d.
Sliders, with springs and studs	each	9d.
Ebonite Coil Holders.	each	12/6
Ebonite Knobs	doz.	4/-
Ebonite Panels, prices on application.		

### Single Valve Panels

fitted with Variable Condenser, Filament Resistance, Grid Leak and fixed Condenser. Engraved Panel and Rosewood finished Box, ready for use

# £4

Vulcanised Fibre and Ebonite Sheets, Rods & Tubes from stock.

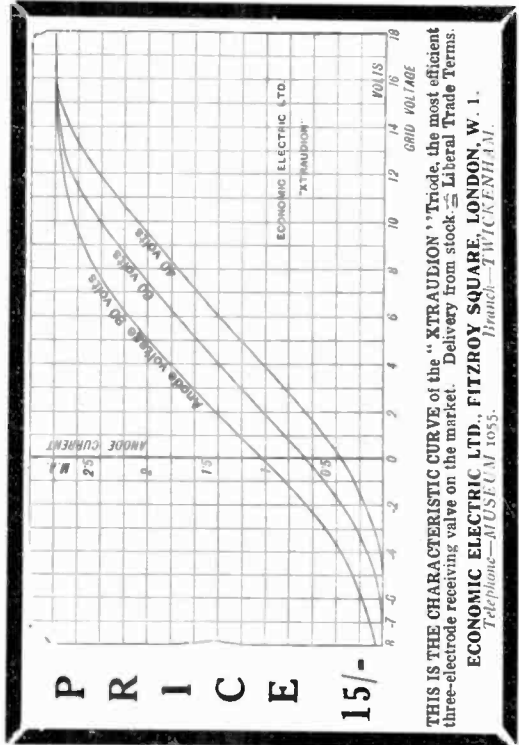

PRICE 15/-

THIS IS THE CHARACTERISTIC CURVE of the "XTRAUDION" Triode, the most efficient three-electrode receiving valve on the market. Delivery from stock. Liberal Trade Terms. ECONOMIC ELECTRIC LTD., FITZROY SQUARE, LONDON, W. 1. Telephone—MUSEUM 1055. Branch—TWICKENHAM.

ESTABLISHED — 1920

# RADIO SUPPLIES

We have this famous TRANSFORMER in STOCK

Price 10/- Postage 4d.  
Trade Supplied.

234, HIGH HOLBORN, LONDON, W.C. 1  
Phone: Holborn 2188

<p><b>P. ORMISTON &amp; SONS</b>                  (P. H. ORMISTON) :: ESTABLISHED 1793                  79 Clerkenwell Rd., London, E.C.1                  "Ormiston, London." :: :: 13259 Central.</p>	<p>Silk and Cotton Covered H.C. Copper Wire, Resistance Wires, Fuse Wire, Binding Wires, Charcoal Iron Core Wire, Asbestos Covered Wire, Braided and Twisted Wires, Bare Copper Strand and Flexibles of any Construction, Wire Ropes, and Cords (fine sizes) in Galvanized Steel, Phosphor Bronze, &amp;c.</p>
---	--

# THE WIRELESS WORLD AND RADIO REVIEW

THE OFFICIAL ORGAN OF THE RADIO SOCIETY OF GREAT BRITAIN  
A MAGAZINE DEVOTED TO WIRELESS TELEGRAPHY AND TELEPHONY

## CONTENTS

	Page
The Barrel Switch - - - - -	617
The Application of Wireless to Commercial Flying. By "Aeraden" - - - - -	620
Some Simple Methods for Controlling L.F. Valves - - - - -	624
Electrons, Electric Waves and Wireless Telephony (XIX). By Dr. J. A. Fleming - - - - -	626

*Contents continued on next page.*

### Boxes, Packing Cases and Packing Materials for WIRELESS SETS and Accessories.

WE design special cases in corrugated or solid fibreboard to carry delicate instruments safely, and we shall be glad to do so for your productions.

We also manufacture corrugated paper—supplied in rolls, sheets, or pieces. Inductance tubes a speciality. Let us quote you for any cardboard goods you require.

**Hugh Stevenson & Sons, Ltd.**  
 Summerstown Works - - London, S.W.17  
 Victoria Mills, Pollard Street, Manchester.

Phone—  
Manchester.  
Central  
6967

Phone—  
London,  
Wimbledon  
1375

Factories also at BIRMINGHAM, LEITH, PERTH and GLASGOW

# STALLOY

**TRANSFORMER LAMINATIONS**

SOLE MANUFACTURERS AND SUPPLIERS  
**JOSEPH SANKEY & SONS LTD**  
 WORKS: BILSTON, STAFFS. London Office: 168 REGENT ST. W.I.

**TELEPHONE RECEIVER DIAPHRAGMS**

## CONTENTS *(Continued)*

Wireless Club Reports	- - - - -	630
A Broadcast Talk from a Wireless Pioneer	- - - - -	634
The Construction of a Crystal Detector	- - - - -	637
Notes	- - - - -	638
Correspondence	- - - - -	640
Calendar of Current Events	- - - - -	642
Questions and Answers	- - - - -	643

THE WIRELESS WORLD AND RADIO REVIEW is published weekly on Saturdays.

All correspondence relating to contributions should be addressed to THE EDITOR, THE WIRELESS WORLD AND RADIO REVIEW, 12-13, Henrietta Street, Strand, London, W.C.2.

No responsibility can be taken for MSS. or photographs sent without stamps to defray cost of return postage.

Editorial and Publishing Offices : 12-13, Henrietta Street, Strand, London, W.C.2.

Telegraphic Address : "Radionic, Rand, London." Telephone No. : Gerrard 2807.

Advertisement Managers, Bertram Day & Co., Ltd., 9 and 10, Charing Cross, S.W.1.

Telephone No. : Gerrard 8063 and 8064

### SUBSCRIPTION RATES.

28s. per annum, post free. Single Copies 6d., or post free 7d.

Registered at the G.P.O. for transmission by Magazine Post to Canada and Newfoundland.

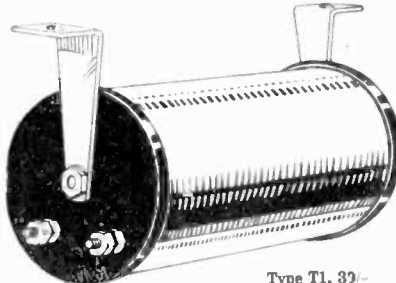

Type T1, 39/-

**FROM OUT THE STILLNESS !**

A LISSEN TRANSFORMER, a background of absolute silence, and speech, song and music coming through in a perfectly sustained column of pure natural tone. Type T1 has a most expensive coil. With its exceptionally large impedance value in the primary it should always be used immediately after the Detector Valve. For those who do not need a Transformer with such expensive windings, we recommend our Type T2. This is also absolutely distortionless, has a larger ratio, and is widely used by the average amateur.

Note new works address—

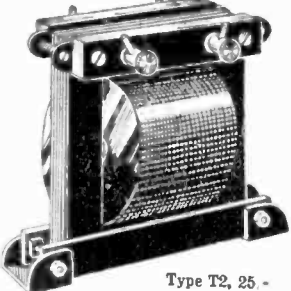

Type T2, 25. -

**LISSEN COMPANY, Woodger Rd., Goldhawk Rd.,**

" LET'S LISSEN-IN." SHEPHERD'S BUSH, LONDON, W.

# THE WIRELESS WORLD AND RADIO REVIEW

THE OFFICIAL ORGAN OF THE RADIO SOCIETY OF GREAT BRITAIN.

No. 182 [No. 19  
VOL. XI.]

FEBRUARY 10TH, 1923.

WEEKLY

## The Barrel Switch. HOW TO USE IT IN WIRELESS CIRCUITS.

**T**HE complicated circuits now so frequently adopted in wireless receiving work, bring about difficulties in the design of suitable switches necessary to make the required circuit changes.

The most reliable type of switch, carrying a number of contacts and capable of giving a variety of combinations is shown in Fig. 1. This type of switch is not receiving a great deal of attention in this country, probably

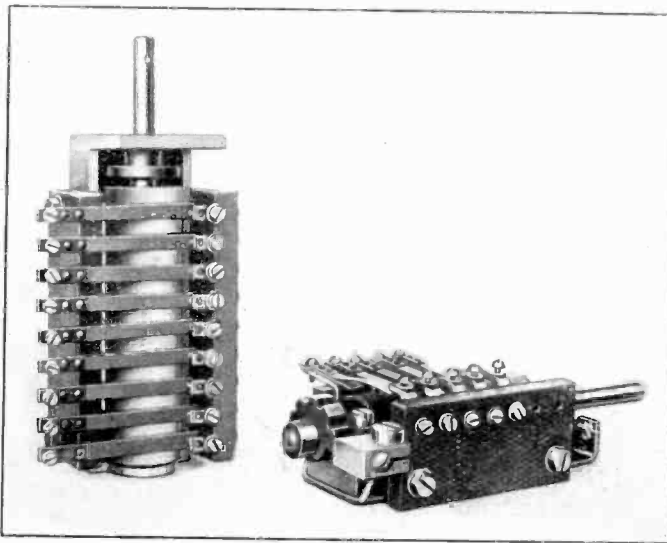

Fig. 1. A somewhat elaborate barrel switch capable of a variety of combinations.

Many types of switches are available, but most of them present difficulties with regard to the simultaneous changing of many circuits.

The mechanical construction of switches which have to carry a number of contact arms or make simultaneous contact at many points, must be so well carried out that they are necessarily costly.

because of the absence of a design embodying only few component parts.

A simple design suitable for experimental use is given in Fig. 2 and 3. It consists essentially of two ebonite plates which carry a number of contacts and held together by ebonite end pieces which serve as bearings for a revolving drum. On this a number of pegs are

arranged for forcing the lower springs, when required, in contact with the upper ones.

In constructing a switch of this type, the first consideration is to procure suitable springy metal for making the contact pieces and it is necessary, as these springs may be required to remain bent for a long while, that the metal employed should have properties which can be relied upon to restore it to its original position. Phosphor bronze or German

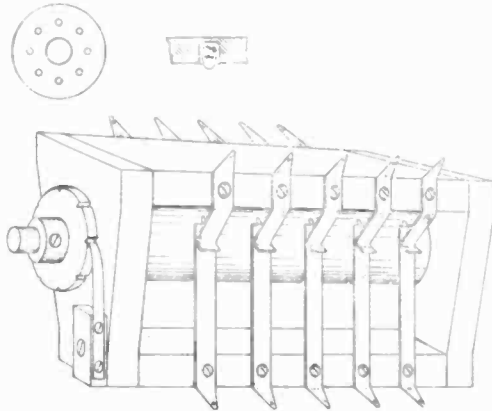

Fig. 2. A simple rotating switch.

silver of about No. 26 wire gauge should be adopted. The pieces are cut to length and drilled where required, and the tapering tag ends may be made by clipping or filing. The bends which are required can be made with round-nosed pliers in order to obviate an acute angle which is liable to cause a fracture after the contact pieces have been moved a few times. With this type of switch it is not essential that special non-oxidising contacts be adopted, as ample contact surface can easily be arranged, and fairly hard pressure can be made between the contacts. If it is thought advisable to fit special contacts, this can easily be arranged by drilling small holes in the spring pieces at the points of contact, and fitting in small pieces of silver wire, and hammering over. The design shown is fitted with a number of spring contacts on each side, so that many circuits may be changed out, but in certain cases it may be better to arrange contacts on one side only. Contacts should only be fitted at both sides when a large number of circuits have to be made or broken by a single movement of the operating handle. The spindle to which the operating handle is attached carries an ebonite cylinder, into which holes

are drilled to carry small screw-in pegs. It is as well to drill a number of rows of holes in the cylinder and tap them so that the pegs can be inserted just where required, depending upon the circuit in which the switch is to be connected.

The best way of securing the ebonite cylinder to the spindle is by drilling a hole right through the centre and driving home a slightly tapered pin.

In order that the cylinder may move through a required distance from one change to the next, a disc of brass about 1 in. in diameter and  $\frac{1}{8}$  in. thick may be secured by means of a grub screw to an extension on the spindle at the opposite end to the operating knob. The disc may have a number of slots cut around the circumference to which a spring can engage.

Alternatively, holes can be made in the face of the disc with the point of a large drill, and a ball may be pressed into the holes by a spring which is carried in the ebonite end plate. This arrangement will cause the spindle to revolve with a jerky motion, halting at each point at which a number of contacts are made.

The design shown in Fig. 1 is rather beyond the scope of many experimenters to make up. In principle it is of course similar to that just described, though it is perhaps more durable. Each of the springs is supported by a small brass bracket held to an ebonite support by a single screw and prevented from turning by being placed in a slot made in the ebonite. The other set of contacts are quite rigid, and consists of brass brackets held in slots in a piece of ebonite on the opposite side.

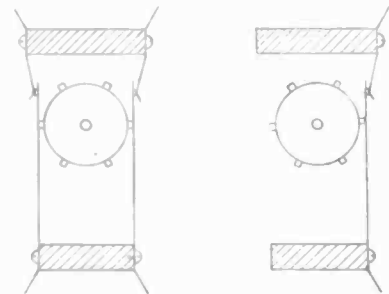

Fig. 3. Sectional view of simple barrel switches.

As it is lighter in operation, this type of switch may operate many more contacts than the one previously described, and as many as fifteen to twenty contacts may be arranged.

The cylinder which carries the pins is in this case about 1 in. in diameter, but if more positions are required, it may be extended to about  $1\frac{1}{2}$  ins. It cannot be made larger than this, for any increase in diameter will decrease the curvature, and consequently the closeness of the studs will be limited.

The switch shown in Fig. 4 is of American manufacture and embodies an arrangement by which, when contact is broken with one spring, it is made with an opposite one as it is forced outwards. This is particularly useful as it may be desirable that certain contacts are made in all but one position of the switch, and with the previous type it would be necessary under such circumstances to insert pins in the revolving cylinder nearly the whole way round.

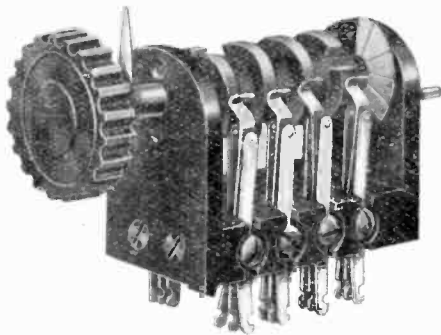

Fig. 4. A revolving switch of American manufacture.

Such a condition is required when switching in or out of circuit a number of valves. For instance, it would be necessary for the second valve filament current to be off in one position, whilst on in all other positions of the switch, which may be arranged for introducing the third, fourth or fifth valves, and so on.

One of the most useful applications of a switch of this sort, is for tapping out an inductance coil. It is possible, by means of a large number of contacts, to introduce inductance at either end of the coil so that the extent of coupling between the inductance which is being tapped and an adjoining one

may remain at a suitable value, as the inductance value is changed. It is also possible to provide for short circuiting sections of the coil, such as is frequently the case when tuning to short wavelengths.

A barrel switch may be used to tap out simultaneously the tuned anode circuits of a multi-valve high frequency amplifier, and of course when used for switching any form of inductance, it may easily be arranged to avoid "dead-end" effects. There is no better way for switching multi-valve circuits than by means of the barrel type switch. It permits, if desired, the switching of grid circuits, which can scarcely be safely introduced with any other type of switch owing to insulation and capacity difficulties, and moreover, all the complicated operations, by introducing the required number of valves, may be effected by the turning of one handle. A switch of this kind is particularly suitable for making and breaking circuits as may be occasioned when changing over from receiving to transmitting apparatus, as one simple movement of a lever attached to the spindle can be made to change out a large number of circuits.

Barrel switches may be employed with advantage in the design of apparatus specially intended for broadcast reception, and be operated by persons not possessing a great knowledge of the principles of wireless reception. One handle may be arranged to revolve the cylinder, and in so doing change the proportions of inductance and capacity in the circuit in ratios which will produce the best results. The absence of contacts on the front of the instrument is another advantage particularly desirable in receivers of the broadcast type.

Further applications of the barrel switch will readily present themselves to the experimenter, and the designer of commercial type apparatus is reminded that such a switch might receive more attention now that wireless receiving circuits are becoming so involved.

## Elementary Lecture and Demonstration.

An Elementary Lecture entitled "Fundamental Principles of Radio Reception," will be given on Friday, February 16th, at 6.30 p.m., by Mr. Maurice Child at the Institution of Electrical Engineers, Victoria Embankment. This is the second of a series of Elementary Lectures arranged by the Radio Society of Great Britain. An invitation to attend is extended to anyone interested.

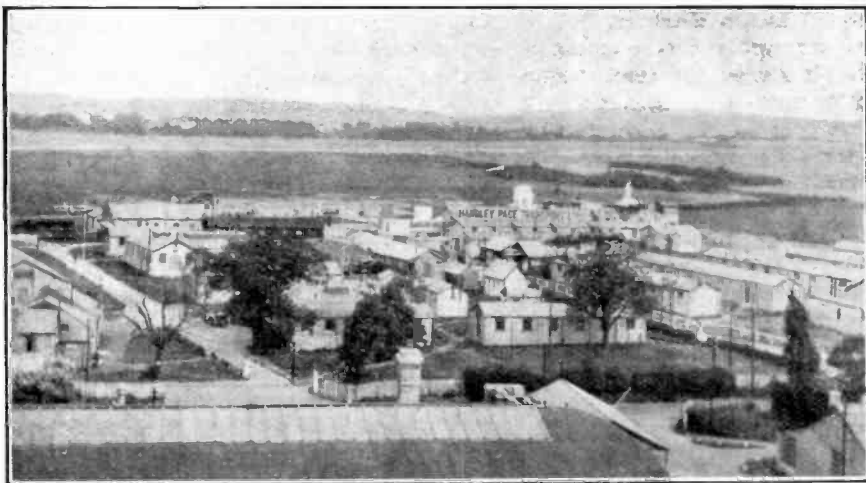

*General view  
of the  
Croydon  
Aerodrome,  
the London  
Terminus of  
British Civil  
Air Routes.*

## The Applications of Wireless to Commercial Flying.

By "AERADEN."

**T**O the ever increasing number of amateurs in this country who so frequently listen-in to the conversations between the pilots and operators on the various air expresses and the traffic controllers on the ground, an explanation of what is actually going on will no doubt be welcome. They will be better in a position to appreciate the operation of an air route, and some of the problems which confront the aircraft radio-engineer to-day; and they will be enabled to comprehend the headway that has been made, at times against apparently insurmountable difficulties, since the close of the late war in building up, by wireless, a system of signalling which would form so valuable an aid towards establishing the airways on a basis at least comparable with those of the other methods of modern transport.

The average person, with little knowledge of the Morse code, who possesses a small receiving circuit will be most interested in the application of radiotelephony. The more enthusiastic amateur will want to know the ground which is being covered by the use of telegraphy. The more serious experimenter still will be looking for the technical applications of both branches of the work, and will expect to hear something of how aircraft are navigated by wireless.

Before remarking upon the adaptabilities of each of these three classes of wireless, it will be well to consider the factors governing them.

The modern passenger-carrying aircraft has an average cruising speed of 90-100 miles per hour, so that in the space of one minute it can have moved approximately a mile and a half. Under favourable weather conditions, when the pilot has an undisturbed view over many miles of country, this speed is such as to give the machine one of its chief advantages over other forms of transport, and it can continue its journey in perfect safety. Such a speed is not, however, either so fascinating or so useful when the air journey has to be carried out through low-lying clouds or mist, when the visibility is impaired, and it is not always possible to see distinguishing features and landmarks along the route. Sense of direction can become inaccurate, flying by compass difficult, and distance readily misjudged.

It is essential, therefore, that the most rapid means of communication possible must be arranged between the aircraft and ground stations, in order that navigational assistance, or other messages, may be passed to the pilot with the least delay.

Given that all enunciation is clear, and that signalling conditions are good, radiotelephony



possesses every advantage over Morse signalling or radiotelegraphy, for fulfilling this condition of speedy communication. There is nothing faster than the spoken word, and provided it is not misunderstood, whole conversations can be exchanged between ground and air in the same time that it would take to telegraph a single sentence. Conditions for wireless signalling in the air are distinctly different from those on the ground. There is the noise of the engine, the rush of the air, the rattling of metallic parts and the hum of the wind in the struts and stays. The pilot has in addition several things other than wireless which require practically constant attention, and from his point of view alone, it is more desirable to listen to speech which he can almost subconsciously follow and memorise than to Morse signals.

Signalling between the terminal aerodromes of the routes, comprising the messages giving details of the arrivals and departures of the various aircraft and information relating to them, together with reports on weather conditions at different points, is the other big consideration for which provision has to be made. On a busy route, and every air route is comparatively busy to-day, there are many such messages. Here great accuracy is essential, but rapidity not quite of such importance, and telegraphy is employed. The scheme is divided under the two groups of traffic signalling and weather signalling, each group having its own particular wavelength. All the traffic messages are passed direct from one terminal point to the others on 1,400 metres, while 1,680 metres is the wave allocated for the dissemination of the appropriate meteorological data.

Assistance for navigation by direction finding methods is carried out on the wave upon which the aircraft communicate with the ground, and no doubt this wavelength is familiar to everyone who has ever heard the Croydon station. It is 900 metres.

The fundamental division the classes of work is, then, apparent.

#### RADIOTELEPHONY.

Bearing in mind that the application of radiotelephony on air routes is limited to conversations between aircraft and the ground stations, and, through the latter, the controlling staffs, let us consider its scope.

The airway is divided into lengths of no actual fixed mileage. The approximate

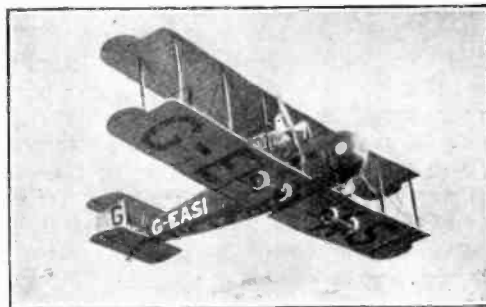

*The "City of London." A similar machine flew the Atlantic from Newfoundland to Ireland in 15 hrs. 57 mins.*

distance between any two ground stations happens, at the present time, to be in the vicinity of 100 miles, and a figure somewhat under this distance may be assumed to represent the greatest range at which aircraft will normally be required to converse with the different aerodrome stations. An aircraft equipped with transmission and reception apparatus, capable of ensuring certain working during any period of the flight and under any climatic condition, will therefore fulfil the requirement. The question of range is a difficult matter to decide, however, in connection with a known input energy. Range in transmission depends largely upon such factors as the enunciation of the speaker, which brings a very personal element into the matter. Cases have occurred where it has been impossible to understand the operator on a machine speaking only a few miles away, while, simultaneously, every word spoken by a pilot working an exactly similar instrument at a much greater distance has been heard perfectly. This is just as much a detrimental factor in radiotelephonic working as the development of a fault in the control or power circuits of the transmitting unit. Again, the range over which a given transmission can be intelligibly picked up varies considerably under different conditions. The pilot of the aircraft, apart from the disturbing noises already referred to, may be receiving on circuits which, owing to continuous shaking to which they may have been subjected, are experiencing interference from various sources; or he may be flying in a neighbourhood of localised atmospheric disturbance. He may not even be getting the best out of his receiver, for he has not the opportunity of absolute concentration upon the task of accurate tuning that is afforded to the ground operator. As

passenger-carrying aircraft increase in size and capacity, and as the present financial difficulties decrease, there is not the slightest doubt that it will be possible to employ operators in aircraft in precisely the same manner as they are at present employed in the Mercantile Marine. To-day, for reasons of general economy, the aircraft wireless operator exists practically entirely in imagination, and it is therefore a condition of the air pilot's licence that he should be capable of operating wireless in the air.

Range in this class of work can, then, be an elastic quantity and to ensure that every aircraft shall be in touch at the given maximum distance, the capability of the least efficient operator and aircraft set must be taken as the standard for that distance. At the same time matters must not be allowed to go to an extreme where excessive powers are employed for the desired range. Generally speaking, the ability of a given set in a given machine can be accurately gauged, and success therefore rests to a large extent in the hands of the man working it.



*Interior of an Instone Air Liner showing the elaborate arrangements for the comfort of passengers.*

In addition to enabling communication between ground and air to be effectively carried out, radiotelephony can in necessity permit of conversation between the personnel of different machines, an event which may be said to increase the factor of safety of the air route. Of the few accidents which have occurred since the inception of the London Continental Airways one at least might be said to be directly attributable to a lack of information on the part of the pilot, and, had full advantage been taken of the use of wireless, might possibly never have occurred at all. An organisation is now in force whereby in operating along a given route, an aircraft must fly at least 100 metres to the right of it,

and if wishing to cross, must do so at right angles, thereafter keeping to a distance of some miles on the opposite side. The purpose of such a regulation is, naturally, to reduce whatever chances of collision exist to an absolute minimum; but it will occur to the mind that, even so, with the additional assistance of wireless, and with the ability, if necessary, to speak to any other aircraft in the vicinity, the journey can be carried out in a far more satisfactory fashion. A pilot in doubt, who knows that another scheduled machine should be in his neighbourhood, can readily call that machine on his telephone and determine the height at which it is flying, at the same time giving information concerning himself. Each can then fly to give the other sufficient clearance.

The direction in which telephony renders its two most important non-navigational aids to commercial flying, are in checking the passage of aircraft over sections of the airway, and in furnishing the air personnel with weather reports and forecasts.

As an example of the former, consider the case of an ordinary passenger machine, of registered number G-EABC, which leaves Croydon for Paris let us say at 1005. The departure of this aircraft is known, of course, to the Controller of the Air Port, and he has taken the necessary steps to advise the port of destination, Le Bourget, and, as necessary, the intermediate aerodromes—Lymgne and St. Inglevert. The wireless stations along the route then are told that G-EABC is on its way between London and Paris. When well away from the ground the person operating the wireless on the machine releases his aerial and the long stranded wire, many feet in length and carrying a lead plummet of nearly a pound weight, hangs beneath the machine. Croydon is then called and a message of the form:—

“G-EABC London for Paris,”

is passed. That ground station may be fully aware of the fact, having probably already been advised by the Air Port Traffic Officer, but the process of calling the station and receiving its reply constitutes at least a suitable test for the wireless apparatus on the aircraft. The news of the receipt of this signal by Croydon is at once passed to Lymgne by radiotelephony, as:—

“G-EABC left Croydon for Paris 1005,” which signal is acknowledged by the latter

station. When about 30 miles distant from Lympe the aircraft calls and reports:—

"G-EABC, London for Paris,"

which is duly acknowledged. And so the aircraft proceeds on its way, conversing, if possible, with the French stations in their own language, though, if the pilot or other person operating the telephone is unfamiliar with French, those stations can reply in English.

After G-EABC had once left Croydon, in the example under consideration, all communication with that machine would have been done through Croydon or Lympe on the 900 metre wave by telephony. Had the pilot wished to obtain information about the weather over the Channel or on the French side of the water he would have asked for the latest weather conditions in these districts when reporting himself to Lympe. Or, had it been known that it would be difficult or dangerous for him to continue the journey owing to very adverse weather at some portion of the route, he could have been called by the nearest ground station and ordered to land at a certain aerodrome. Abbreviated and long weather reports are made out hourly by each route aerodrome and exchanged with neighbouring aerodromes, so that any aircraft fitted for radiotelephonic working has merely to call the first aerodrome of any sector of the route that he is about to enter to learn exactly what weather he can expect in that sector. The abbreviated report gives him only a few important details, such as the visibility and height of the lowest cloud, while the long report furnishes him with a complete statement of current weather.

Had any trouble been experienced, or anything become necessary on the journey, he could have called a suitable station and informed the Traffic Officer of his requirements, and, upon landing some time later, any necessary arrangements would have been complete.

The chances of accident or loss of time on the airways due to negligence seem almost less than those upon the railways; in fact, the percentage of fatal European accidents is apparently actually lower, comparatively speaking, on the former than on the latter. Perhaps flying is not so dangerous as some would have us believe?

The routine of navigating aircraft by means of telephony will be discussed under the third section of this article, but there is one more application of the radiotelephone which is very important. At the present day telephony

does not lend itself to more than a few simultaneous transmissions close together. The nature of a radiotelephonic transmission closely resembles that of the original spark system, and the desirable features of very sharp tuning, great selectivity and lack of mutual interference which are to be found in most C.W. systems do not exist. As a consequence but few telephony transmissions can usefully occur together without interfering with one another very seriously on a given wavelength, or on wavelengths of only a few kilocycles difference.

This latter application of radiotelephony, one which cannot, until such an objectionable drawback is eliminated be employed commercially, is known as "line-switching," and consists of connecting the ordinary line telephone system to the wireless circuits through a small exchange board, so that speech in one direction is relayed by radio. The advantages of such an arrangement are obvious. The manager of one of the aircraft firms can ring up the London Air Port, ask to speak to a certain pilot, and be told that he has already left for Paris, flying one of the regular expresses. If the matter is one of considerable urgency, he can be connected to the wireless station. The operator on watch can call the aircraft in question, and having established communication, switch the line telephone call through



*Air Liner with Complement of Passengers about to leave the ground.*

to the wireless, and manager and pilot can converse, the station operator changing from "send" to "receive" as requisite. Immediate "two-way" telephony by wireless, similar to that available on the line circuits, is not yet available, though it is probably but a matter of time before such an arrangement will be invented. It can be done now, but the apparatus necessary is as yet too cumbersome and costly to warrant its use on a commercial basis. Line switching will some day

open up possibilities of additional comfort and security to the air traveller. It will become possible for the passenger on the larger aircraft to pick up the telephone in his private cabin and ask the wireless exchange on board for practically any number for many hundred miles round. He will be connected by wireless to a local radiotelephone station, and from thence relayed by line or wireless to the exchange of the number required, and the conversation will proceed as normally as the modern line call. Business men will be able to continue their daily routine while flying across Europe or the Atlantic, for the wireless telephone will certainly be developed along lines giving greater privacy in conversation; untappable radiotelephony will by that time have come also. There is practically no limit to the extent of such calls, for wherever

there is a radiotelephonic instrument installed it will be possible to include it in the system. It is not a wild flight of imagination to conceive the passenger on the aerial liner over mid-atlantic to be speaking to the passenger on the express roaring along the Canadian prairies.

Already music of an excellent quality can be picked up nightly on the simplest receiving sets, and so, in the most distant future, the orchestra heard at dinner in the air liner's saloon will be the one playing many miles away at some central broadcasting station. After three years of hard pioneer work commercial flying is nothing like the impossibility that it at one time seemed. The small existing wireless telephone gives a range between ground and air of something like 150 miles. Who knows what it will have done even within the next decade?

## Some Simple Methods of Controlling L.F. Valves.

ONE often wishes to have easy control over the number of valves employed in a receiver, and if switching arrangements are included for this purpose, a number of arrangements are possible.

Thus it sometimes happens that one possesses several pairs of low resistance telephones, and it is desired to switch them in circuit as required. The arrangement is very simple, and is given in Fig. 1 on the next page.

If it is desired to switch in a pair of high resistance telephones, as well as those of low resistance, the connections given in Fig. 2 may be used. The H.R. telephones are connected with a plug, and the jack is so connected that, with the plug out, the telephone transformer is in circuit. When the plug is inserted the H.R. telephones are joined in series with the telephone transformer.

When it is desired to use H.R. telephones

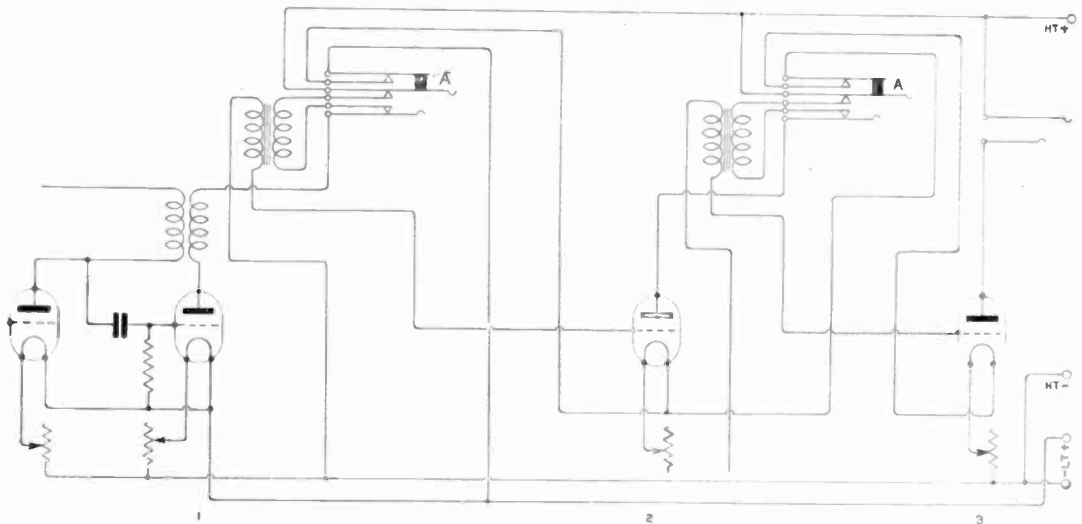
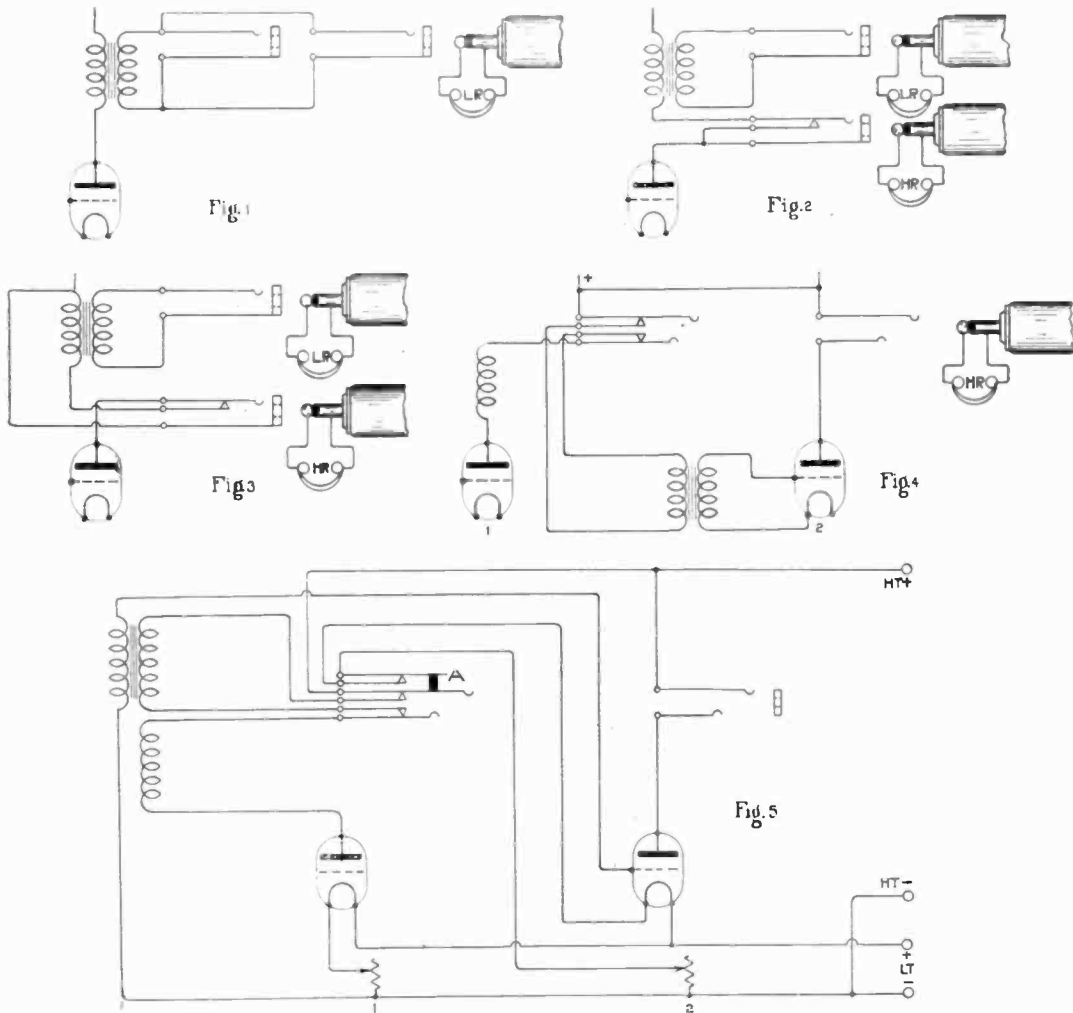

Fig. 6. Arrangement for switching more than two L.F. valves.



Figs. 1 to 5. Various arrangements for controlling L.F. Valves.

alone, the connections in Fig. 3 may be used. When the plug to which the H.R. telephones are connected is inserted, the telephone transformer is disconnected.

In Fig. 4 are given the connections for plugging the telephones into either L.F. valve circuit. With the plug in jack 1, the intervalve transformer primary winding is disconnected, and the anode circuit is complete through the H.R. telephones.

Of course the plug may have connected with it a telephone transformer and L.R. telephones if required. With the telephone plug in jack 2, the valve circuit 1 is connected. This arrangement does not provide control of the valve filaments, which is an undesirable

feature. If two more spring contacts are provided, the circuit Fig. 5 may be arranged. Here the springs "A" control the filament current of valve 2, so that when the telephone plug is in the valve 1 circuit, the filament of valve 2 is disconnected.

A slightly different arrangement should be employed when there are more than two L.F. valves. The arrangement is given in Fig. 6. Here it will be noticed the jack employed is identical with that used in Fig. 5, but the main filament current lead is connected with springs "A." When the plug is engaging the springs of valve 1 circuit, the filaments of valves 2 and 3 are cut off.

W. J.

# Electrons, Electric Waves and Wireless Telephony—XIX.

By Dr. J. A. FLEMING, F.R.S

*The articles appearing under the above title are a reproduction with some additions of the Christmas Lectures on Electric Waves and Wireless Telephony given by Dr. J. A. Fleming, F.R.S., at the Royal Institution, London, in December and January, 1921-1922. The Wireless Press, Ltd., has been able to secure the serial rights of publication, and any subsequent re-publication. The articles are therefore copyright, and rights of publication and reproduction are strictly reserved.*

## 5. DUPLEX WIRELESS TELEPHONY.

Another matter of considerable importance in connection with wireless telephony is the arrangements necessary to allow the two correspondents to "cut in" and interrupt each other in course of a conversation. We know that when two people are conversing through a single speaking tube they have to be careful not to interrupt each other, for if both try to speak at once, or both listen at once, only confusion results. On the other hand, in the ordinary use of the exchange telephones we listen and speak at the same time. The listener can cut in with an interjection or question, or assure the speaker he is hearing, or ask for a word or sentence to be repeated. In the first forms of wireless telephony this cutting in was impossible. The aerial wire at each station had to be switched over from the transmitter to the receiver as required, and each correspondent had to be certain his distant colleague was ready to listen before he began to speak. This difficulty is to some extent obviated by the use of two slightly different wavelengths for sending and receiving, and the separation of the sending and receiving stations at each post by a certain distance. This was done in the case of the wireless telephone demonstrations across the North Sea conducted by Marconi's Wireless Telegraph Company between Southwold on the east coast of England and Landvoort, near Haarlem, in Holland, in 1921.

The distance between these places is 112 miles. At each place a transmitting and receiving station was established about 700 yards apart. Let us call these stations  $T_1$  and  $R_1$  in England, and  $T_2$  and  $R_2$  in Holland. The station  $T_1$  telephones to station  $R_2$  with a wave of 98 metres wavelength, and the station

$T_2$  transmits to  $R_1$  with a wave 94 metres wavelength. This difference of wavelength (4 metres) was found to be sufficient to prevent the transmitter "jamming" the near-by receiver on the same side. At each transmitting station there was a valve transmitter made as above described, and a transmitting aerial 18 metres high, in which was created an aerial current of 5—8 amperes, which was modulated by an ordinary telephone exchange microphone.

The total power taken up by the transmitter was about 5 kilowatts, and of this 10 per cent., or 0.5 kilowatt, was radiated from the aerial in the form of carrier waves. Underground wires were brought from the receiving station to the transmitting station, so that the actual speech and hearing on each side of the sea was conducted from one place, and the receiving valves could have their filament currents and high voltage circuits switched on from the speaking station. In this manner ordinary telephonic conversation was carried on perfectly.

The problem of duplex wireless telephony, meaning by that the ability of the two conversationalists to speak and hear at the same time and "cut in" as they please, cannot be considered as completely solved by the two-wave and separate station system, because such method could not be applied in the case of aeroplanes or ships for want of space. Accordingly the problem has engaged much attention. The difficulty of it will be realised when it is noted that in many cases where wireless telephony is of the utmost importance, as in speaking to or by aeroplanes from or to the ground station, only a single aerial is practicable on the aeroplane, and therefore the act of sending sets up strong oscillations in it, which,

if they have access to the receiving apparatus tuned for the same frequency, may completely jam the latter and set it out of order. Hence the real problem is to find a method of connecting the receiving apparatus to the aerial in such a fashion that the strong oscillations set up on sending shall not have access to it.

permanent oscillations defeats the very thing that it is desired to achieve, viz., the immunity of the receiver from the effect of the transmitter. We cannot, therefore, say that, as far as the confined space of aeroplanes is concerned, the problem of duplex telephony has been completely solved. As far as ground stations

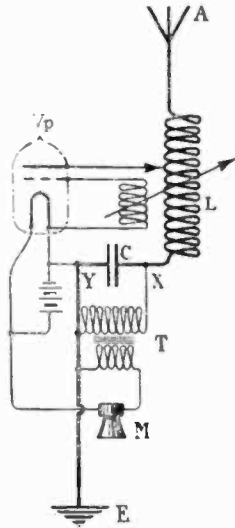

Fig. 103. A type of quiescent aerial with valve transmitter in which the microphone M supplies the plate voltage in the act of speaking.

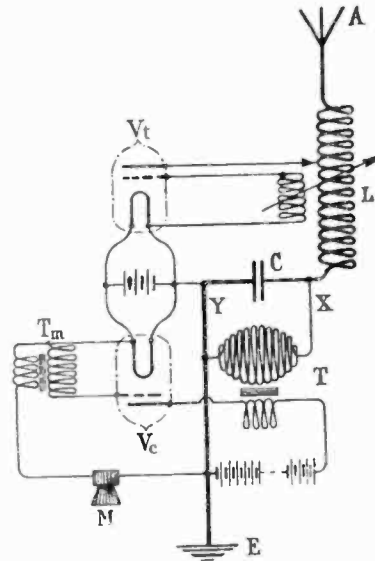

Fig. 104. A type of quiescent aerial with valve transmitter. The microphone M controls the supply of plate voltage in the transmitting valve V.

One solution which has been suggested, but which is only an imperfect solution, is that often called the quiescent aerial. In this case the permanent high frequency oscillations are not maintained all the time in the sending aerial and modified in amplitude by the speech microphone on speaking, but the high electromotive in the plate circuit of the generating valve is applied only by the microphone when it is actually in operation by speech being made to it (see Figs. 103 and 104). The method, however, is not very successful unless a certain supplementary steady voltage is applied by a battery in the plate circuit of the generating valve. The reason for the imperfection is that the transformer in connection with the microphone takes a little time to build up the voltage in the plate circuit of the valve which is necessary to set up oscillations, and there is therefore a want of response unless there is a certain minimum of constantly maintained oscillations in the aerial, and the employment of these

are concerned, it is worthy of notice that for not very great ranges with no very great differences in the wavelengths, for example, two wavelengths of 110 and 113 metres, and the transmitting and receiving stations only 100 yards apart, it has been found possible to conduct good duplex telephony.

#### 6. DIRECTIONAL SHORT - WAVE WIRELESS TELEPHONY.

Another question of great practical interest in connection with wireless telephony is the employment of very short electric carrier waves of a wavelength of only 12 or 15 metres, and of reflecting mirrors to make a beam of electric radiation like an electric searchlight. This "wireless beam" limits the lateral spread of the waves so that it conduces to privacy of speech. We have already explained in the section dealing with Hertzian waves that these waves can be reflected like rays of light from suitable surfaces.

In the case of an electric searchlight the arc lamp is placed in the focus of a parabolic silvered glass mirror, and this reflects all the rays falling on it in a direction parallel to the axis of the parabola (see Fig. 105). In the same manner, if we bend a large sheet of metal round two formers of wood so as to make a

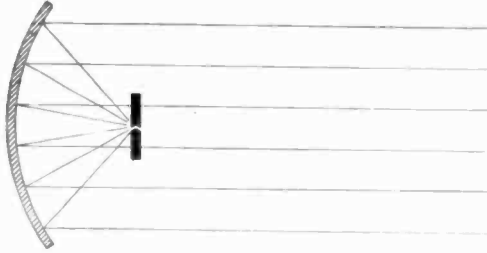

Fig. 105.

parabolic cylindrical mirror, and place a Hertzian linear oscillator on the focal line of the mirror, then, provided the dimensions of the mirror are not small compared with the wavelength, we shall project a beam of electric radiation, or of Hertzian waves, parallel to the axis of the mirror.

Experiments of this kind were made many years ago by Hertz and other physicists, and in the early days of wireless telegraphy Senatore Marconi employed parabolic mirrors in the initial attempts to use Hertzian waves as a means of signalling.

It is not, however, very easy to produce continuous electromagnetic waves for the purposes of wireless telephony of wavelength much shorter than 10 to 15 metres. It is essential then that the dimensions of the mirror should be something of the order of 20 to 30 metres. If mirrors of solid metal were employed, these would not only be heavy to move, but would offer such surface to the wind that they would be dangerous to erect. It has been found, however, that if a number of wires are stretched parallel to each other on a frame, and at a small distance apart, this grid will reflect electric waves if the electric force in the wave is parallel to the direction of the wires.

Accordingly we can make a parabolic electric wave mirror which does not offer much surface to the wind as follows:—If we stretch a number



Fig. 106. The Parabolic Reflector at Inchkeith, Firth of Forth, Scotland, as used for directional short wave wireless telephony.

By Courtesy of M. W. T. Co., Ltd.



of wires parallel to each other round the edge of two frames of parabolic form placed at a distance, the wires being held in such positions that they lie on a parabolic sectioned surface, and if we place parallel to these wires, and on the focal line of the parabolic surface, a Hertzian linear oscillator, we can project a wireless beam (see Fig. 106). It is easy to construct such skeleton parabolic reflectors of considerable dimensions, and since the wavelength of the waves radiated from a linear oscillator, or two rods placed in line, is about twice the total length of the rods, we only require a linear oscillator of about 25 ft. or so in length to radiate electric waves of 15 metres wavelength.

Parabolic reflectors of this kind, with linear oscillators in their focal line, have been employed by Mr. C. S. Franklin in important experiments made for Marconi's Wireless Telegraph Company on directive short wave wireless telephony.\* The carrier wave was 15 metres in wavelength, and the oscillations were generated by a couple of power thermionic valves having a power consumption of 700 watts, having 4,000 volts on their plate circuits, producing a plate current of 175 milliamperes. These valves created in a linear, or Hertzian oscillator, continuous oscillations of twenty million per second, and radiated a power of about 300 watts in the form of 15-metre electric waves. This oscillator was placed in the focal line of a skeleton wire

parabolic mirror of about 30 metres aperture and a corresponding receiving aerial in the focal line of a similar reception mirror employed in reception by a usual amplifying valve detector

After some preliminary and successful experiments at Carnarvon, a site was chosen at Hendon, and another at Frankley, near Birmingham, in February, 1921. These stations are 97 miles apart. With this plant telephonic speech was well conducted. Measurements indicated that the energy received with the directive mirrors up was about 200 times greater than when the mirrors were not used. Also it was found that very decided limitation to the lateral spread of the waves was obtained, so that places much outside the line of transmission could not overhear the speech.

It is quite practicable to employ still shorter wavelengths of less energy. Carrier waves, even as short as 4 metres in length, have been used for such reflector transmission of telephonic speech over seven miles. It is expected that the employment of this "wireless beam" in nautical wireless telephony will prove to be of great utility in giving ships direction and location during fogs.

As these articles are intended to deal only with the elementary principles of the subject, and to be within the range of knowledge of the general reader or would-be amateur in wireless telephony, it is not possible or necessary to extend them to cover more highly technical matters, such as long distance wireless telephony or the influence on it of such factors as soil absorption or atmospheric disturbances, which are sufficiently treated in various textbooks.

\* For a full description of these experiments the reader is referred to *The Wireless World and Radio Review*, of May 20th, 1922, Vol. X, p. 219, and also to the Paper read by Mr. C. S. Franklin before *The Institution of Electrical Engineers*, May 3rd, 1922.

(To be continued.)

### Ideal Home Exhibition.

The *Daily Mail* Ideal Home Exhibition will be held at Olympia from March 1st to 24th.

### Manchester Wireless Exhibition.

The Manchester All-British Wireless Exhibition has been arranged to take place at Burlington Hall, Burlington Street, Manchester, from March 17th to 24th.

## Wireless Club Reports.

*NOTE.*—Under this heading the Editor will be pleased to give publication to reports of the meetings of Wireless Clubs and Societies. Such reports should be submitted without covering letter and worded as concisely as possible, the Editor reserving the right to edit and curtail the reports if necessary. The Editor will be pleased to consider for publication papers read before Societies. An Asterisk denotes affiliation with the Radio Society of Great Britain.

*Correspondence with Clubs should be addressed to the Secretaries direct in every case unless otherwise stated.*

### Stoke-on-Trent Wireless and Experimental Society.\*

Hon. Secretary, Mr. F. T. Jones, 360, Cobridge Road, Hanley.

At a meeting of the Stoke-on-Trent Wireless and Experimental Society on Thursday, January 18th, Mr. L. F. Fogarty, A.M.I.E.E. (Treasurer of the Radio Society of Great Britain), gave a lecture on "Rectifiers."

Mr. Fogarty described the principles of rectifica-

### Bradford Wireless Society.\*

Hon. Secretary, Mr. J. Bever, 85, Emm Lane, Bramley, Bradford.

A meeting was held on Friday, January 12th, with the President, A. Liardet, Esq., in the chair.

After the business had been despatched several new members were elected, and the meeting was then thrown open for general discussion, questions which had been sent in to the Secretary previously being dealt with first.

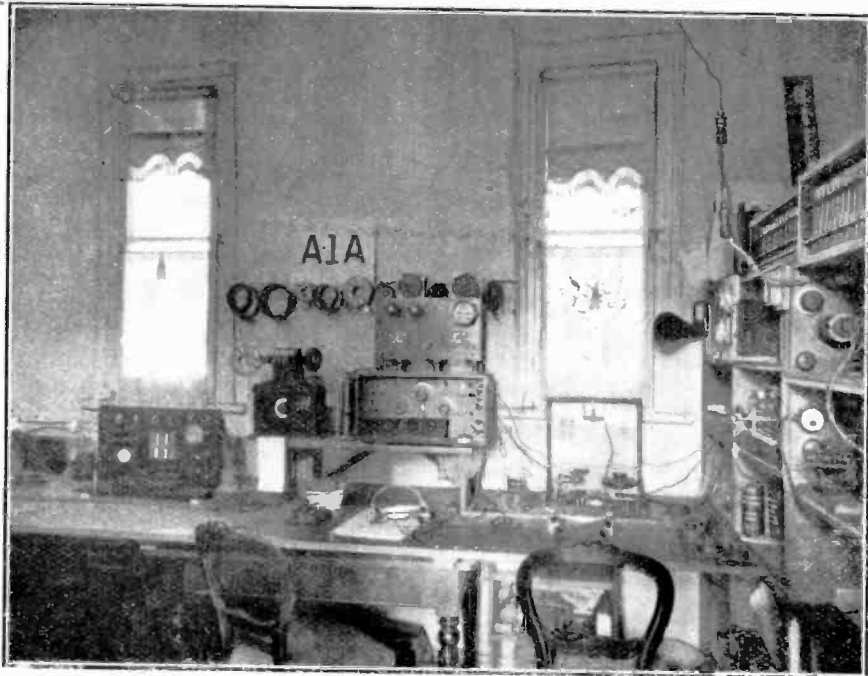

*The receiving set of Mr. J. S. Streeter, Observatory Road, Cape Town, one of the first among the enthusiastic band of amateurs in South Africa to receive the overseas stations.*

tion, and illustrated various types of rectifiers. The Nodon valve, the Ferranti rectifier, the "Aedic" rectifier, the "Tungar" rectifier, and several other rectifiers were clearly explained at length, and comparisons drawn between them.

A "Tungar" rectifier, and an "Aedic" rectifier were shown under working conditions, while a rectifier of the vibrating type was on view.

Mr. Fogarty's kindness in coming down from London was fully appreciated, and a hearty vote of thanks was accorded on the motion of Mr. Steel, seconded by Mr. Whalley, and supported by the Chairman, Mr. F. Jenkinson.

This discussion was participated in by various members and was much enjoyed.

Subscriptions are now due and should be remitted without delay to the Hon. Treasurer, Mr. E. Brown, 8, Glenholme Road, Manningham, Bradford.

Those wishing to join the Society can obtain application forms on writing to the Secretary.

### Harwich Radio Society.

Hon. Secretary, Mr. P. Ashurst, 51, Mary Street, East Horwich, near Bolton, Lanes.

A successful meeting of the above was held on January 16th, when a committee was formed comprising the following:—Mr. Ravis, Dr. Sewell,

Messrs. C. Gray, Wynne Hopwood and F. Greenhalgh. It is hoped to hold future meetings in the club-room in the Reform Club as soon as the room is decorated. The arrangements for fixing the aerial over the club-room were left in the hands of Mr. Holt. Mr. Rivis delivered a lecture on "Aerials," which resulted in a lively discussion. The membership is increasing steadily.

#### The Leicestershire Radio and Scientific Society.\*

Hon. Secretary, Mr. J. R. Crawley, 269, Mere Road, Leicester.

The first meeting of the elementary section of the Leicestershire Radio Scientific Society was held on Monday, January 15th, 1923, at headquarters, the *Leicester Mercury* office, the chair being occupied by the Vice-President, Mr. H. E. Dyson. The inaugural address was delivered by the Chairman, who explained that the aims of the elementary branch of the Society were to foster an interest in Radio, to assist beginners and to furnish the parent Society with many enthusiastic and brilliant members. The President, Mr. C. T. Atkinson, followed with a lecture on "Elementary Wireless," which was highly commendable for its simplicity and lucidity. Illustrations and diagrams illumined the many points dealt with, and combined to make the lecture highly interesting and successful, and questions arising from the lecture were dealt with very thoroughly by the President. At the conclusion a hearty and unanimous vote of thanks was accorded the speaker.

#### The Leeds and District Amateur Wireless Society.\*

Hon. Secretary, Mr. D. E. Pettigrew, 37, Mexton Avenue, Chapeltown Road, Leeds.

At an instructional meeting held at the Grammar School on January 12th, the Hon. Treasurer lectured on "Some Apparatus Used in Telegraphy," paying particular attention to the Wheatstone bridge method of determining values of resistances and inductances, such as may be used in radio circuits. Insulation and ohmic resistance of an aerial system were considered, amongst many other very usual applications of the bridge for wireless purposes.

A general meeting was held at the Grammar School on January 19th, Mr. G. P. Kendall, B.Sc. (Vice-President) being in the chair. After the usual business had been discharged, the Chairman called upon Mr. H. F. Yardley, M.I.R.E., to give a paper and demonstration on "The Armstrong Super-regenerative Receiver."

The discussion which followed was keen and prolonged, many members relating their experiences and theories on the subject. Mr. J. Croysdale has been particularly successful with his circuit, having succeeded in raising U.S. broadcast and 8 AB on a frame using two valves. The meeting was of the opinion that the radiation from the super-regenerative set was not nearly so bad as generally supposed, since the current limiting property of the valves would ensure that no excessive H.F. currents would flow in an ordinary aerial system, should such be used in place of a frame.

#### The Coventry and District Wireless Association.\*

Hon. Secretary, Mr. T. Y. Fletcher, 60, Summerland Place, The Butts, Coventry.

Under the auspices of the above Association, an interesting and instructive lecture on the "Principles of Radio Telegraphy and Telephony," was delivered by Mr. Clinker, M.I.E.E., of the B.T.H. Works, Rugby, on January 17th, to an audience of well over two hundred people.

In introducing the lecturer, the Chairman, Mr. A. P. Young, O.B.E., M.I.E.E., M.I.A.E.E., told of the valuable pioneer work done by Mr. Clinker in radio-communication in all its phases, the results of which could be clearly seen and appreciated in all the apparatus which the lecturer demonstrated and explained.

Commencing with a lucid explanation of the basic laws relating to oscillation, it was shown by means of practical experiments and lantern slides exactly how these electro-magnetic oscillations which cause the wave motion in the ether are propagated, and passing on, the lecturer dealt with the various discoveries of the early pioneers of wireless and many other important points, chief among them being wavelength and tuning. "Direction Finding" by wireless was explained and demonstrated, and it was remarkable to note the precision with which the apparatus located the transmitting station, Leafield being the station in question.

At the conclusion a very hearty vote of thanks was accorded Mr. Clinker, after which members of the audience were able to inspect the apparatus at close quarters, whilst listening on a loud speaker to the Opera from Covent Garden.

#### The Wireless and Experimental Association.\*

Hon. Secretary, Mr. G. Sutton, A.M.I.E.E.

The meeting of the Association at the Central Hall, Peckham, on Wednesday, January 17th, was mainly occupied by the consideration of the forthcoming meeting of the Radio Society of Great Britain and the election of delegates to attend that meeting to represent the Association.

Messrs. Knight, Joughin, Voigt and Webb were unanimously elected to attend the meeting, and the other members felt that their interests, and the interests of other amateurs in the vicinity were safe in their keeping. It was hoped that some means would be devised for making use of the Amateur Radio Associations in eliminating some of the valve noises which tend to spoil the enjoyment of the freedom of the ether. Communications with regard to membership and similar matters should be addressed to the Hon. Asst. Secretary, Mr. G. H. Horwood, 557, Lordship Lane, S.E.22.

#### Huddersfield Radio Society.\*

Hon. Secretary, Mr. C. Dyson, 14, John William Street, Huddersfield.

An enjoyable evening was spent at the Society's club-room on January 16th. The first part of the evening was spent in listening to the broadcasting concerts on a Gecophone broadcasting receiver and loud speaker, kindly lent for the occasion by Messrs. George Garton and Son, Market Place. The demonstration was by Mr. Lynn, of the General Electric Company, Ltd., of Leeds. Mr. J. A. Badham was

Chairman. The opera selections from the Covent Garden Opera, transmitted from Marconi House, were very clearly received. During the second part of the evening Mr. W. H. Hirst, of Huddersfield, lectured on "Esperanto as Applied to Wireless." The lecture was concluded by a conversation in Esperanto, which was translated into English by Mr. Darnell.

#### Bath Radio Club.

Hon. Secretary, Mr. Geo. J. Barron Curtis, 6, Pierrepont Street, Bath.

The above Club, although only a few months old, already possesses over seventy members, and is beginning to show signs of becoming one of the leading radio clubs in the west.

At the first meeting of the year, held at the Old Red House, New Bond Street, Bath, on Wednesday, January 17th, members spent a very interesting and instructive two hours.

Following the usual half-hour's buzzer practice, under the tuition of Mr. F. Bird (2 KP), the Chair-

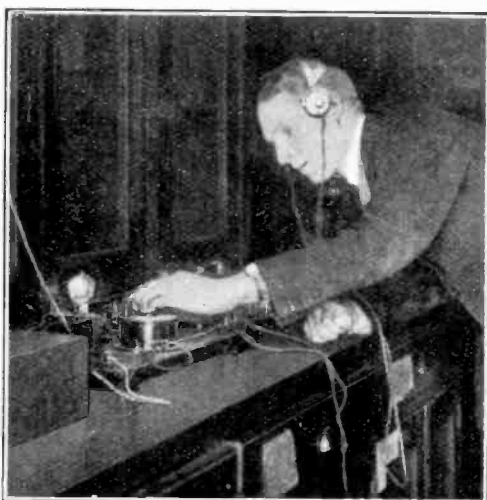

*Testing apparatus at the Post Office intended for broadcast reception. Instruments are carefully examined as to the generation of oscillations. It must be remembered that approval of apparatus by the Post Office implies no endorsement of efficiency.*

man, Mr. J. G. Young, made some very interesting announcements.

The first of these was to the effect that the following gentlemen had kindly consented to be Vice-Presidents of the Bath Radio Club:—The Mayor of Bath (Alderman Cedric Chivers, J.P.), the Rev. Francis Hardy, M.A., Councillor A. H. W. Taylor, Messrs. F. C. Barber, E. Taylor, A. W. Cunningham and W. S. Pearce.

The Chairman also intimated that the Club had been very fortunate in securing the services of Mr. Claude Wilcocks, of Warrminster (2 FL) as Hon. Consulting Engineer.

Following the election of new members, a discussion ensued as to the advisability of adopting the Committee's proposal to hold a special social night in the near future to which ladies would be welcomed. The Chairman felt that the atmosphere

of happy informality which would necessarily attend such a function would do much towards promoting that spirit of fellowship which the Committee are so anxious shall prevail at Club meetings. After a certain amount of opposition the proposal was carried.

Business over, the meeting settled down to enjoy an unusually capable lecture by Mr. L. E. R. Boxwell, of Bradford-on-Avon, Wilts. This lecture was the first of a series of six lectures which Mr. Boxwell will give to the Club, and which are intended to tell enthusiasts all they wish to know about their pet hobby in such a manner as to be perfectly comprehensible to the merest beginners.

A question-box was installed by means of which the Committee will deal with any questions which members may wish to be enlightened upon.

#### Bexleyheath and Welling Radio Society.

Hon. Secretary, Mr. J. O'Keefe, Spring Villas, Long Lane, Bexleyheath.

A meeting of the above Society was held on Thursday, January 18th, at 8 p.m., at the temporary headquarters, "The Hut," Welling, Mr. J. P. Pragnell being in the chair.

When the election of officers and committee took place, approximately thirty-five members were present.

The following officers and committee were elected for the present year:—President, Mr. W. Dickinson; Vice-Presidents, Mr. J. P. Pragnell and Mr. C. Haskell Thomas; Chairman, Mr. O. G. M. Atkins; Vice-Chairman, Mr. T. Griffiths; Hon. Treasurer, Mr. L. W. Smith; Assistant Hon. Secretary, Mr. C. Smith; Committee, Messrs. C. A. Beech, R. Forsdyke and J. Ripper.

The draft of the rules was passed and the amount of the yearly subscription decided, viz., 10s. 6d. per annum; Juniors 18 years and under to pay 5s. 6d. first half year and 5s. second half year.

Any wireless amateur or others wishing to join should write to the Chairman at "St. Aubyns," Burnell Avenue, Welling, or to the Hon. Secretary.

Meetings are held every Thursday at the temporary headquarters until further notice.

"The Hut," which has kindly been placed at the disposal of the Society (gratis) by Mr. Smith, High Street, Welling, is open Mondays, Tuesdays, Fridays and Saturdays, for the use of the members who wish to carry out experiments or to use as a workshop.

#### Norwich and District Radio Society.

Hon. Secretary, Mr. H. R. Greenfield, 160, Queen's Road, Norwich.

On Friday, December 19th, the above Society held its weekly meeting at the new headquarters, Bracondale House School, Bracondale, Norwich, by kind permission of the Principal, F. B. Williams, Esq.

The Chairman of the Society, Capt. H. J. B. Hampson, in his opening remarks made mention of the excellent room that had been accorded to the Society, and asked for a vote of thanks to the Principal.

Mr. J. G. Hayward proposed, seconded by Mr. W. G. Hurrell, that the Society take immediate steps to become affiliated to The Radio Society of Great Britain.

During the evening Mr. J. G. Hayward gave an interesting lecture on "The Valve," and by the

aid of the blackboard and chalk gave diagrams to show the function of each part.

At the last meeting the members were asked to bring along various sets or parts that they had made, and as a result much interesting data was obtained by members describing their experiences.

The Society is running a competition in the nature of an Aerial Hunt, the suggestion of Mr. C. H. Moore. The conditions are that members should find out the position of aeriels erected in and around Norwich and report the discovery to the Secretary on postcards. The one who discovers most will be the winner. The first prize will be a valve kindly presented by Mr. J. G. Hayward, and the second prize an H.T. battery presented by Mr. C. H. Moore.

#### Hackney and District Radio Society.

Hon. Secretary, Mr. C. Phillips, 247, Evering Road, N.16. (*Letters only.*)

The weekly meeting of the Society took place on Thursday, January 18th, at the headquarters, Y.M.C.A., Mare Street, Hackney, E.8., when a good number of members were present. An interesting lecture on the Morse code was given by Mr. J. Wilson, an expert in telegraphy. At the close of his lecture, Mr. Wilson gave a preliminary lesson in Morse, and the Chairman announced that arrangements had been made to place the instruction on a proper basis. A half-hour lesson is to be given every week especially for beginners, and speed practice will also be given for others.

Although the Society has a fairly large membership, there are many Hackney residents with receiving sets who have not yet joined, and these are cordially invited to visit the Society. The new subscription came into force at the beginning of the year, and there is an appreciable reduction on the previous subscription.

The Society is greatly in need of outside lecturers on any subject connected directly or indirectly with Radio. Up to the present they have relied on members of the Society for this purpose. Anyone able and willing to give a lecture is requested to communicate with the Secretary. Expenses will be willingly paid.

It is hoped to organise in the near future a Social Evening and Exhibition of Radio Apparatus, particulars of which will be announced later.

#### Salisbury and District Radio Society.

Joint Hon. Secretaries, Messrs. H. F. Fitcher and S. W. Johnson, 19, Fisherton Street, Salisbury.

This Society has now been formed, with Capt. J. E. Alcock as President and Sir James Macklin, Capt. A. E. Hussey, F. H. Trethowan, A. B. Randall, M.I.E.E., and his Worship the Mayor as Vice-Presidents, with headquarters at the Old Billiard Room, The Chough Hotel, Salisbury.

The inaugural meeting was held on Thursday, January 18th, when about 40 members and friends were present. Capt. J. E. Hobbs, of Wareham, gave an interesting and instructive description of a four-valve receiving set constructed by himself and using the tuned anode with reaction on the tuned anode coil, for which he claimed 20 per cent. extra efficiency over coupling the reaction coil to the A.T.I. as well as complying with the P.M.G. regulations, and making it impossible to interfere with anyone else by radiation. 2 LO, 2 ZY and 5 IT were in turn successfully tuned in.

The Chairman, after proposing a vote of thanks to Capt. Hobbs, appealed to all interested in wireless to join the Society, the subscription being only 10s. Meetings are held every Thursday at 8 p.m.

#### The Thames Valley Radio and Physical Association.

Hon. Secretary, Mr. Eric A. Rogers, 17, Leinster Avenue, East Sheen, S.W.14.

A meeting of the Association took place on January 18th, Mr. G. Dowse being elected to the chair.

After the minutes were confirmed, the Hon. Secretary gave the meeting a report on the various local hospitals visited by members of the Association and the pleasure it gave to the patients of hearing the opera and concerts broadcasted by the B.B.C.

The association takes this opportunity of commending the idea to many other Societies who are near hospitals, as the trouble taken is well recompensed by the gratitude of those unable to hear such concerts by any other means.

The Chairman then called upon the lecturer to give his short address on "The Making of Radio Receivers," showing the members how, with a cigar box, two home-made basket coils and a crystal detector, he was able to receive perfectly 2 LO on two sets of 'phones at the cost of a few shillings. He also showed a one-valve panel he had constructed on the lid of a cigar box, which left nothing to be desired in the workmanship and efficiency.

Mr. Dowse was heartily thanked for his lecture.

#### King's Norton and District Radio Society.

Hon. Secretary, Mr. Richard H. Price, 7, Hawthorn Road, King's Norton, Birmingham.

The first general meeting of the above Society was held at 8 p.m. on Thursday, January 18th, 1923, at Rowheath Farm, Selly Oak Road, King's Norton.

Eighteen members attended, and after considerable discussion, suitable rules were formulated, and the various officers and committeemen elected. Meetings of the Society are to be held regularly on alternate Wednesday evenings at 7 o'clock.

The Society has been fortunate in securing a room at Rowheath Farm, Selly Oak Road, for its meetings. A hearty welcome is extended to all enthusiasts living in the district. Full particulars may be obtained from the Secretary.

#### The Isle of Man Radio Society.

Joint Hon. Secretaries, Messrs. J. S. Craine, 6, Belmont Terrace, and J. P. Johnson, 16, Hildesley Road, Douglas.

A public meeting under the Chairmanship of the Society's President, Mr. F. R. Grundey, B.Sc., F.C.S., was held recently in St. Andrew's Schoolroom. The occasion was a demonstration and popular exposition of wireless by Messrs. E. H. Vick and A. L. Downward, and the extent of public interest in radio was evidenced by an attendance of probably some 250 people. It was hoped to render the Manchester Broadcast Concert audible to all present by means of a Magnavox loud speaker, but unfortunately a fault developed in the circuits just as proceedings were about to commence, and results entirely ceased. Later, however, the Magnavox found voice, and the last few news items and part of a musical item were heard.

## A Broadcast Talk from a Wireless Pioneer.

*Admiral Sir Henry B. Jackson discourses on the present position of wireless telephony and forecasts for the new method of communication an important future as an educative influence in civilised life.*

THOSE who listened in to Broadcasting from 2 I O on the evening of Monday, the 29th January, will have enjoyed listening to a short discourse given by Admiral of the Fleet, Sir Henry B. Jackson.

Admiral Jackson is well-known as a pioneer in wireless work, and as President of the Radio Research Board. To readers of this journal he is perhaps better known as a President of the Radio Society of Great Britain, from which office he has just retired. Below is published, with the permission of Admiral Jackson, the address given from 2 L.O.

"For one not habituated to addressing large but invisible audiences, the position I now occupy in front of this microphone is an important event in my daily life, especially as it is my first attempt to speak into a Radio telephone for other than experimental or testing purposes. Thinking of what to say on such an occasion has brought to my memory, for some inexplicable cause, an incident, entirely unconnected with Radio work, that occurred to me one night about twenty-five years ago, in which, however, I was a spectator only.

"I was serving as Naval Attaché to our Embassy in Paris at that time, but was visiting the Naval works in the vicinity of Nantes. Nantes has now an important Wireless Station whose URSI signals and call sign, UA, are probably well-known to some of those now listening to me this evening.

"There were strong demonstrations against the French Government at that time on account of the unfortunate 'Dreyfus Affair,' and I was amongst the crowd one evening in the streets of Nantes when their violent feelings almost caused a riot. Amongst the cries and yells from the mob, by far the most penetrating and most frequent were the words 'Conspuez Zola,' and 'A bas les Juifs!'

"Mounted troops charged the mob to disperse them and eventually did so very effectually. I, willy nilly, found myself swept with many others down a side street, and eventually found peace and something else to think about, in an open space. Here on one side was a white washed hoarding on which a bright circle of light was being thrown from a large magic lantern erected on a stand near to it.

"Suddenly, the sheet depicted moving figures, and I found myself watching for the first time what are now familiarly known as the 'movies.' The images were somewhat blurred and slow in their movements, but they were an early example of an advertising 'stunt' of the modern cinematograph. I think few of those present at this scene realised the enormous possibilities of development which have taken place in this industry since that date, and the influence it is now having on the character of many of those young people who spend so much of their time and pocket money at the picture palaces. Personally, I was much struck by the fidelity of this representation of moving life, which was better than I had thought possible at that date.



*A recent photograph of Sir Henry Jackson in his uniform as an Admiral of the Fleet.*

"There is in my opinion much that is in common between the cinema and the radio telephone, broadcasting speech and music. Different as they are in their methods of reproduction, yet they both depend for their existence on the electro-magnetic waves so thoughtfully provided by Nature. Both are popular means of entertaining large numbers of persons simultaneously at a moderate cost, and both are of educational value, because

is concerned. These technical improvements are due to careful scientific and very practical research organised by those interested in commercial development.

"The cinema is now established as a successful business enterprise and may be left to its own efforts to maintain its popularity. It has an advantage in one respect over radio-telephony, in that it can use the electro-magnetic waves of light which are of a length

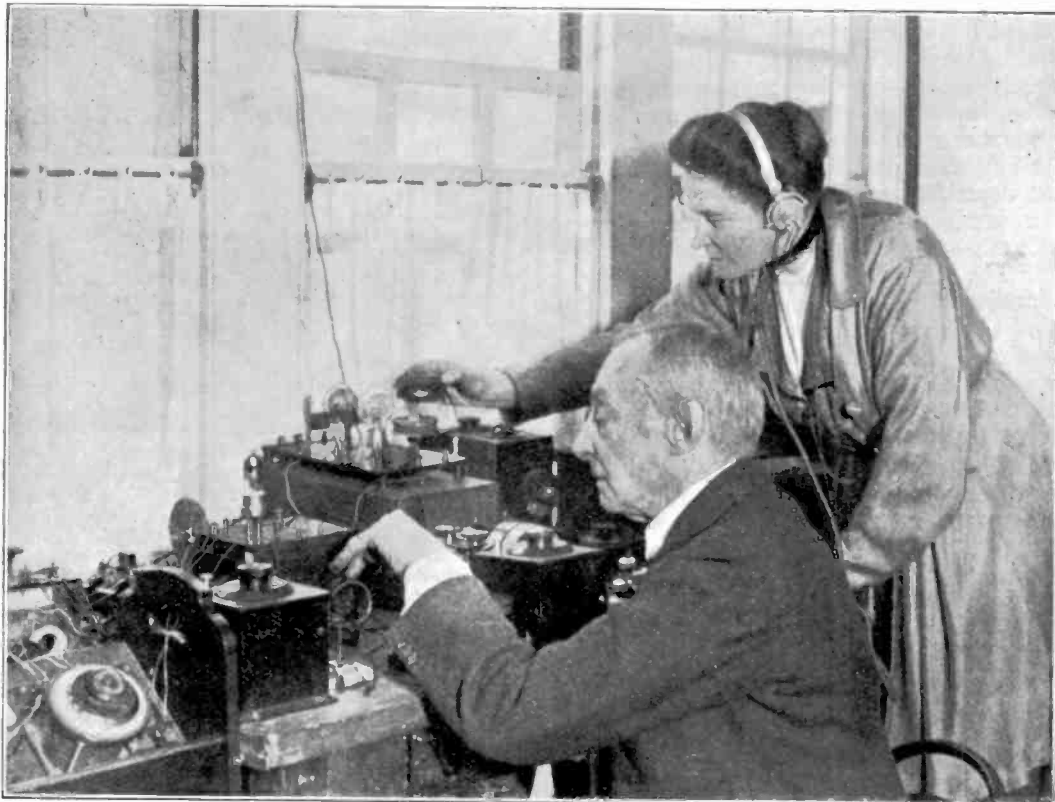

*Admiral Jackson carrying out experimental work with a special direction finding set in his laboratory, assisted by Lady Jackson.*

they can keep us informed of what has happened in distant places, whilst nearly everyone wants to know also how it is done. Those who manipulate apparatus must of necessity acquire this knowledge.

"The clarity of the tones now produced by radio telephony has already passed the stage of development of those shadowy 'movies' I saw that night in Nantes, and the modern cinematograph has probably neared perfection, at least in so far as black-and-white reproduction

which are not the subject of Government restriction.

"Radio telephony broadcasting had not yet had time to become a successful business enterprise, and is sadly restricted in the use of wavelengths it could but may not at present employ, for the reason that it has been forestalled by the previous Governmental allocation of most of these to its sister art of radiotelegraphy.

"The human ear, sensitive and flexible as

it is, is also very greedy as to the band of sound wavelengths it requires for intelligible speech, compared with the band of lengths of E.M. waves required by the eye for perfect vision. These demands add to the difficulties of radio-telephony.

"In spite of these difficulties, the British Broadcasting Company have brought their apparatus and organisation to a high state of efficiency in a very short time, and it now rests with them, and with the radio enthusiasts who listen in, to get the public to accept broadcasting as part of their daily life, and so with a good word here and there, timely spoken by their supporters, help the Company to bring it up to a standard level with that of the cinema. Radio-telephony in no way clashes with the cinema, though both are dependent on the same laws of nature for the production of their two very different effects.

"The cinema appeals to the eye only, is reproducible at will, and may therefore be used again and again for years to come. The deaf can get as much pleasure from it as those with normal hearing. The exhibition of the pictures, however, is concentrated, and cannot be broadcasted from one central station like the radiotelephone.

"From broadcasting, however, the blind can get as much pleasure as those with the acutest vision, and this is, I venture to say, one good reason of itself for supporting broadcasting, so as to add to the brightness of the lives of those afflicted with blindness. Opinions probably differ as to which can give the most pleasure to the normal individual. It is really a question of whether *sight* or *hearing* affects our senses the most, and also, for the mass, whether concentrated or scattered audiences will prove to be the best paymasters.

"Personally, I incline to the view that radio-telephony should have the greatest effect of these two on our feelings. The most striking drama on the screen often seems forced and mechanical, and being generally only a staged piece, leaves *me* cold and unsatisfied.

"But the *voice* or *music* actually being produced at the moment by living beings can also convey their own feelings and affect ours, who are listening to them, and this sort of telepathy which passes between us is a much more potent factor in this matter than the mere sight of past actions and gestures.

"Only time will show which will get the ascendancy, but whichever it may be, I hope

you will join with me in hoping that British broadcasting will advance, in much less than twenty-five years, as fast as that first cinema I saw in Nantes so long ago.

"In conclusion, I wish the British Broadcasting Company every success in their plucky effort to popularise this art, and with the energy, scientific skill, and commercial ability at their disposal, I feel sure of their ultimate prosperity. I hope those who have listened to me this evening will do what they can to help not only for them, but also for the general benefit of the community."

## The Experimental Licence.

The position of the wireless experimenter with regard to the Post Office licence to receive signals is somewhat vague at the present time, and consequently the following list of conditions which accompany the issue of the form of licence now in use may be of interest.

1. The licensee shall not allow the station to be used for any purpose other than that of receiving messages.

2. The station shall be subject to the approval of the Postmaster General, and shall be open to inspection at all reasonable times by duly authorised officers of the Post Office.

3. The combined height and length of the external aerial shall not exceed 100 ft.

4. The station shall not be used in such a manner as to cause interference with other stations. In particular between the hours of 5 p.m. and 11 p.m. on weekdays and all day Sunday, any oscillating valve or valve circuit employing magnetic or electrostatic reaction must not be directly coupled to the aerial or the aerial secondary circuit over the range of wavelengths between 300 and 500 metres. The use of separate heterodyne circuits coupled to the aerial or aerial secondary circuit over the range of wavelengths between 300 and 500 metres is similarly restricted.

5. The licensee shall not divulge or allow to be divulged to any person (other than a duly authorised officer of His Majesty's Government or a competent legal tribunal) or make any use whatsoever of any message received by means of his apparatus, except messages in connection with his experiments received from another experimental station, time signals, musical performances, etc.

6. A fee of ten shillings is payable annually in advance so long as the licence remains in force. The period covered by the first payment expires as follows:—

If the licence is taken out during the three months ended; 31st March—on the 31st December in the following year; 30th June—On the 31st March in the following year; 30th September—On the 30th June in the following year; 31st December—On the 30th September in the following year.

7. Any breach of the foregoing conditions will render it necessary for the permit to be cancelled.



# Construction of a Crystal Detector.

A PAGE FOR THE BEGINNER.

THESE is considerable scope in the design of crystal detectors, and the extent of elaboration adopted will not necessarily produce greater signal strength, but only facilitate critical adjustment. Several designs have been put forward in the *Wireless World and Radio Review* from time to time, but that shown in the accompanying diagram is specially arranged to suit the inexperienced amateur, and may even be taken as a preliminary exercise in wireless instrument making.

The base and its under supports are made from polished ebonite sheet 3/16 in. in thickness, carefully cut to size with a fine-toothed tenon saw and filed true. The edges may be finished by rubbing on a piece of emery paper secured down to a flat surface. It should be the aim of the elementary worker to make all edges and faces at exact right angles to each other, and to ensure this, a small steel square should be frequently applied to the work. The location of the holes should be accurately plotted out by means of a centre punch, a dot being marked on the ebonite to act as a guide for the point of the drill. Drilling is

carried out with a morse twist drill and hand brace. A piece of strip ebonite or hard wood clamped tightly behind the ebonite base piece will prevent fracturing at the back while drilling.

In order to obtain good insulation, it is desirable that the polished surfaces should be removed, and this can be done by rubbing the surfaces down with fine emery paper. If the rubbing is done in small circles, it is possible to produce a fine matt surface free from scratches.

The right angle supports are made from angle brass, such as can be bought from most iron-mongers. If a piece about 2 in. or 3 in. in length is obtained, two supports can be easily made by sawing through at distances to provide the required width, leaving a small piece over which may be placed in the scrap box and prove very handy for some subsequent job.

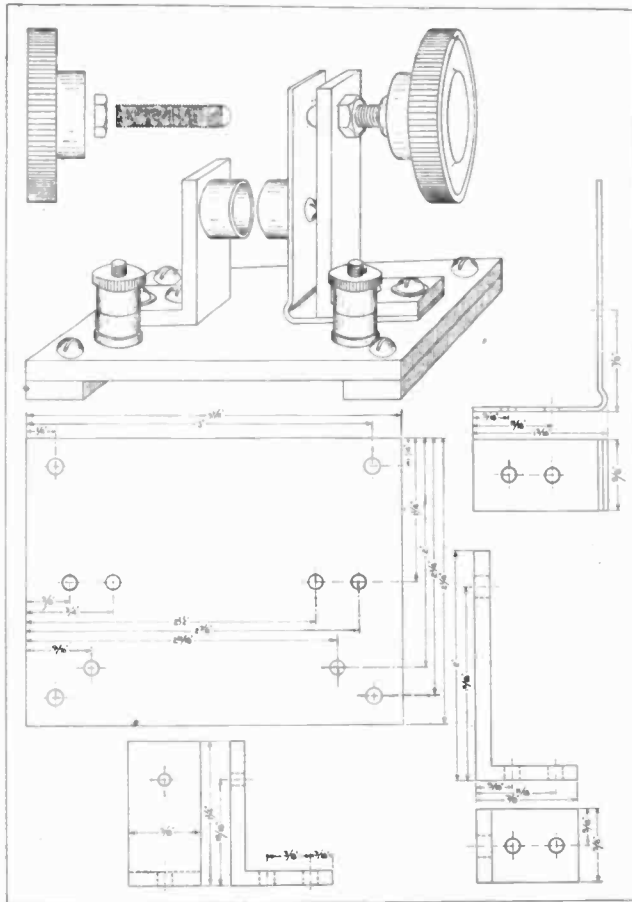

Dimensional Drawing of the Component Parts.

Each piece should be filed clean and square prior to the marking out of the position of the holes for drilling. Centre punch marks should be made, of course, to guide the point of the drill. The upper hole in the longer bracket must be made sufficiently large to give clearance

to the piece of 2 BA screw which passes through. A 2 BA nut is soldered over the hole so as to provide a thread. The surfaces to be soldered must be filed quite flat, and then treated with "killed salts," made by dissolving pieces of scrap zinc in strong hydrochloric acid. If the nut is held in position with a pair of pliers and the end of the bracket heated in a gas flame, it will be quite easy to make the solder run round the nut and fix it securely to the bracket. Any excess of solder can be shaken off while hot, and that which adheres to the surfaces can be removed by filing. The two brass pieces should be finished by rubbing down with emery cloth. A piece of emery cloth should be laid on the bench and the brass pieces drawn across it, whilst the less accessible faces can be rubbed with a file around which a piece of emery cloth is wrapped.

The spring piece is made from hard phosphor bronze, 1/16 in. in thickness and requires very little description except that it must be borne in mind that the bend should not be too sharp.

The crystal cups can easily be purchased with back screws. The knob also is of a type now on the market and has a threaded hole in the centre. The threaded portion can be sawn from a 2 BA screw and is held into the knob by means of a lock nut.

The most suitable crystals for use in this detector are zincite, which is dark red in colour, and copper pyrites, which has a greenish yellow metallic appearance.

The two crystals are secured in the cups by means of Wood's metal. This combination of crystals is known as the Perikon detector, which, in addition to being very stable, is simple to set to a sensitive adjustment.

## Notes.

### A Polish Honour for Senatore Marconi.

Senatore Marconi has been unanimously elected an Honorary Member of the Société des Radio-techniciens Polonais, and has accepted this honour.

### French Stock Exchange Quotations to be Broadcast.

The Paris Bourse and exchange quotations, it is stated, are soon to be broadcast each day from Eiffel Tower.

### Collaborators Wanted for Sheffield Experimenter.

Captain L. A. K. Halcomb, of South Dene, 106, Millhouses Lane, Sheffield, is anxious to get into touch with experimenters holding transmitting licences and living within about 60 miles of Sheffield, who would be willing to carry out some experimental work with him. He states that his station (5 DN) is licensed for 10 watts, and operates on a length of 200 metres using C.W. and telephony.

### Week-end Wireless Service to United States.

Marconi's Wireless Telegraph Company announce that they have introduced a Week-end Wireless Letter Service to the United States at the rate of threepence per word without minimum. Telegrams sent by this service must reach Radio House, 2/12, Wilson Street, E.C.2, either by hand or post before midnight on Saturdays, and will be delivered in New York City on Monday by messenger. Week-end telegrams to destinations in the United States beyond New York City will be mailed without extra charge, but they must bear the full postal address.

### Wireless Transmission of Letters.

The French Post Office, it is reported, has announced that after February 10th, "radio letters" will be accepted at all telegraph offices in France for transmission by wireless to the French colonies and certain foreign countries. The wireless rate will vary from 55 centimes (about 2d.) a word plus the ordinary postal rates.

### The Wireless Dinner Club.

The second annual dinner of the British Wireless Dinner Club was held at the Trocadero Restaurant on January 27th, the President, Admiral Sir Henry Jackson being in the chair. About 130 members were present, the total membership being about 240. The organisation of the Club was discussed, and it was decided to broaden the qualification for membership, which at present is limited to those who were engaged as officers during the war in the services, so as to include all those who are actively interested in wireless engineering.

### A Danish Experimenter Intercepts Communication between 2 KQ and 8 BM.

A correspondent writing from his station at Hellerup, near Copenhagen, reports that at 0920 (G.M.T.) on January 15th he heard communication between 2 KQ and 8 BM. His own station, he explains, is a four-valve set consisting of four parallel wires 32 ft. above the ground, the total amount of wire used in the aerial being 450 ft. 2 KQ, the writer states, is one of the usual 10-watt stations, but 8 BM was using one amp. in the aerial. The latter station's signals were loud enough to work the loud speaker over a fairly large room.

**The New Broadcasting Stations.**

The Cardiff station of the British Broadcasting Company, Limited, which it is hoped will be functioning by Monday, February 12th, will have the call letters "5 WA," and a wavelength of 395 metres. The Glasgow station of the British Broadcasting Company, which is expected to be in service about the middle of March, will have the call letters "5 SC" and a wavelength of 415 metres.

**Silvanus Thompson Memorial Lecture.**

On Thursday, February 1st, was held the first Silvanus Thompson Memorial Lecture at the Finsbury Technical College, with which the name of Dr. Silvanus Thompson was so long associated.

The first lecturer was Sir Oliver Lodge, F.R.S., who had been a close friend of Dr. Silvanus Thompson. Sir Oliver Lodge chose as the subject of his discourse "The Basis of Wireless Communication," and he traced the development of researches which ultimately resulted in the discovery of the possibilities of wireless as a means of communication.

The chair was taken by Sir Charles Parsons, Dr. W. A. Eccles, F.R.S., who is principal of the College, during the evening referred to the work of the lecturer and the Chairman, describing them as the "two immortals," one the immortal Physicist and the other the immortal Engineer.

The lecture was extremely well attended by an enthusiastic audience. Following the lecture was a demonstration and conversazione, whilst many water-colour paintings, the work of the late Dr. Silvanus Thompson, were exhibited.

**Writtle Transmissions Discontinued.**

It is announced that Writtle transmitting station has now been closed down by the Post Office authorities and consequently the usual Tuesday transmissions are no longer carried out.

**The Manchester Wireless Exhibition.**

The Manchester All-British Wireless Exhibition and Convention will open at the Burlington Hall, Burlington Street, Manchester, on Saturday, March 17th, and remain open until Saturday, March 24th. At this exhibition, which is being organised by Messrs. Bertram Day & Co., Ltd., of 10, Charing Cross, London, at the request of the Manchester Wireless Traders Association, radio apparatus and accessories of all kinds will be displayed and demonstrations arranged. In connection with the Exhibition it has also been

decided to hold a Convention under the auspices of the Manchester Wireless Society.

**Inspection of Wireless Licences**

A warning has been issued by the Post Office authorities that action will be taken against owners of wireless sets who have failed to take out the necessary Post Office licence. Different areas will be selected in turn, it is understood, and all sets inspected by members of the telephone engineering staff armed with the proper authority.

**The Writtle Concerts and their Organiser.**

Wireless amateurs and the "first 100,000" broadcast "listeners-in" will learn with regret that they will no longer be entertained by those inimitable burlesques and parodies from the Writtle wireless station which have been enjoyed so much each Tuesday evening during the last twelve months.

These transmissions, it will be remembered, were inaugurated by the Radio Society of Great Britain and affiliated Societies, and conducted through the courtesy of the Marconi Scientific Instrument Company, Limited, from their station at Writtle near Chelmsford, in February, 1922, to provide British amateurs with material for experimental purposes which had not previously been available in this country, and they proved to be of great value to the 12,000 amateurs who were interested in wireless before the broadcasting boom set in.

Captain P. P. Eckersley, who has contributed articles to this journal, is well known as the organiser of the Writtle transmissions. Readers will be interested to learn that he has been appointed Chief Engineer of the British Broadcasting Company, Limited.

**Radio Society of Great Britain.**

The following is a list of new members of the Society elected at the meeting held on January 24th:—Members: A. H. Baldry, E. C. Young, Charles H. Denny, Cecil Wilfred Clarabut, J. C. W. Reith, M.Sc., Major Frank Stanley Morgan, Stanley S. Dawes, J. Wright, A. C. Goddard, R. P. G. Denman, Charles Lezell, P. Charles Raphael, A. E. Basford, A. S. Brown. Associate Members: S. P. Beucher, Major Henry G. Harris, C. Percy Moss, H. Thorpe. The following Societies were accepted for affiliation: The Portsmouth and District Amateur Wireless Association, Norwich and District Radio Society, Ipswich and District

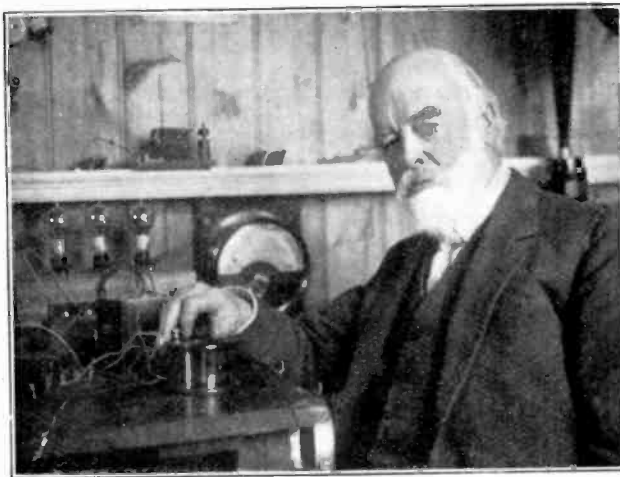

Photo: E. O. Hoppé.

Sir Oliver Lodge, F.R.S., D.Sc., who gave the first Silvanus Thompson Memorial Lecture at Finsbury Technical College on February 1st.

Wireless Club, Northampton and District Amateur Radio Society.

#### New Wireless Societies.

It is proposed to form in the Borough of Wednesbury a wireless society for experimenters and wireless enthusiasts, to be known as "The Wednesbury Wireless Society." An inaugural meeting will be held shortly, the date of which will be announced later.

All those interested are asked to communicate with Mr. J. H. Lavender, F.C.S., 49, Stafford Street, Wednesbury, as early as possible.

The Carlisle and District Radio Society has recently come into being, and already a strong committee has been appointed. The Hon. Secretary is Mr. Charles E. Crompton, 107, Warwick Road, Carlisle.

#### A Loud Speaker Used in the County Hall Experiments.

Owing to the acoustic difficulties experienced in the Council Chamber of the New County Hall, London, experiments have been carried out recently with the object of improving audibility. At a meeting at the County Hall, on January 30th, two microphones were arranged on the Clerk's table. The sounds were carried by wires and amplified by thermionic valves in the Press gallery, for the benefit of the reporters. The results, however, were not very satisfactory, partly owing to the conflict between the actual voice in the Council Chamber and the reproduced voice in the gallery; and partly to the fact that the valves amplified indiscriminately all the sounds received by the microphones.

## Correspondence

In the first two letters of the following correspondence a phenomenon of particular interest at the present time is discussed by Dr. J. A. Fleming in the form of a reply to a suggestion put forward by Mr. Robert Tingey, whose letter appears below. The latter ventures an explanation of the successful use of low power which was one of the most striking features of the recent Transatlantic experiments. This explanation Dr. Fleming proceeds to criticise by analogy with waves in water and air. Dr. Fleming's plea for serious and systematic investigation of the problems involved will undoubtedly be endorsed by all wireless experimenters.

*To the Editor of THE WIRELESS WORLD AND RADIO REVIEW.*

SIR,—I was interested in an article in *The Times* in connection with the transatlantic amateur wireless telegraphy and telephony. In this article it suggested that the authorities in connection with the transatlantic telegraphy were taking this low power communication very seriously. It is a fact that very much greater ranges are being done on short waves and low power than were done last year, and it is not entirely due to the increased efficiency of the apparatus and the experimenters, and I have, up to date, seen very few suggestions to account for this extraordinary improvement, for after all there is an enormous difference between 1,500 watts and 350,000 watts.

I would like to suggest that this increase in range is due to the enormous increase in the number of high power C.W. stations which are operating throughout the 24 hours, and that these long wave stations are in some way acting as carriers for the short waves, or perhaps putting the ether in a more suitable condition for the transference of the short waves. If there be anything in this suggestion, these low power stations are not getting over on their own power alone, but are, in some way effecting the high power transmission on whose power they are relying for their communication.

This might also account for the extraordinary fading effect which is being experienced from all broadcasting stations from a distance. The fact that the rhythm of the fading is regular seems to point to some bad interference such as these stations might cause. For this increased range is not entirely limited to communication with the United States; quite exceptional distances seem to be attained in the British Isles on single valve reception.

I have not seen this suggestion made before, and I trust it is worthy of criticism, and may form an interesting discussion.

If this theory be in any way correct, then should

the high power stations cease, the low power communications would not be possible over such distances.

If this suggestion is worthy of further consideration, the Radio Society of Great Britain could make some very interesting tests by collecting data from various amateurs throughout Great Britain and noting the different effects in different areas on low amplification receiving sets.

ROBERT TINGEY.

*To the Editor of THE WIRELESS WORLD AND RADIO REVIEW.*

SIR,—I am afraid it would take more space than you can spare and more time than I can give just at present to comment fully upon the letter of Mr. W. R. Tingey. He raises some interesting questions, but it is, to say the least, doubtful whether his premises are sound or conclusions justified. It is a safe rule in seeking explanations of natural phenomena to make sure of the facts first before troubling about explanations. Mr. Tingey states with great confidence that "very much greater ranges are being done on short waves and less power than were done last year, and it is not entirely due to the increased efficiency of the apparatus and experimenters."

This is a very sweeping statement, and would, I think, require a large amount of careful, widespread quantitative measurement of signal strength to establish. We all know that extraordinary distances are covered at times by low power transmitters, but this freak transmission is a very different thing from a general and universal improvement in range with standard apparatus and experimentalists of equal skill. Until the fact of such improvement is established, it seems hardly worth while to try to invent explanations or to controvert the suggestions of Mr. Tingey.

It is difficult to understand what he means by "long waves acting as carriers for short waves" in connection with radio working. We do not

find any such effect in studying waves on water or waves in air. Ripples do not travel further on an ocean surface tossed by storms into billows. The loud sounds of thunder, explosions, or the deep notes of a dozen brass bands would not enable a feeble whistle of shrill note to be heard at a greater distance.

Why, then, should long stray waves in the aether, 20,000 metres in wavelength, assist the propagation of the 300 or 400 metre wave allotted to amateurs?

I do not wish to suggest that there are not causes at work promoting secular variation in signal strength. If observations on this matter had gone on long enough it is possible we might find that there are good and bad radio years, just as there are wet and dry summers, periods of sunspot, maximum and minimum, and good and bad harvests. But the first thing is to make sure of facts. This leads me then to make a suggestion. We have now an enormous number of competent, enthusiastic and scientific radio amateurs and workers all over the country, and radio societies and wireless clubs innumerable. The question is, can we not make better use of all this talent for combined scientific work and the advancement of knowledge, than by merely being content to listen-in for bed-time stories or broadcast concert music? Would it not be possible to organise some programme of quantitative measurements on a wide scale on the subject of signal strength as received from certain broadcasting stations, and also a systematic study of atmospheric disturbances and the effects of locality?

It was recently stated in *The Times* that London broadcast is better heard in Scotland than in Yorkshire, and that from Manchester better heard in Southampton than in London. Is this a fact definitely established? If so, what is the reason?

The broadcasting from fixed centres with standard transmitters, and with receivers scattered all over the country, makes it possible by suitable organisation to conduct invaluable team work in radio research. Let us hope that wireless broadcasting will not degenerate like the cinema and motion picture business into a mere amusement for the frivolous unscientific public, but that serious students may do serious work in connection with it.

The present Radio Society of Great Britain in London might find it possible to stimulate the provincial radio societies to unite in such work, and then perhaps might find it possible to hold an annual conference, something on the lines of the British Association Meeting, in various towns, once a year, where radio problems and results are described and discussed and wireless men and women might meet to exchange information and organise the new campaigns.

University College, J. A. FLEMING.  
London.

To the Editor of THE WIRELESS WORLD AND  
RADIO REVIEW.

SIR,—Now that International Amateur Radio communication is becoming an everyday affair, would it not be opportune to devise some means of distinguishing between stations located in different countries and having the same call letters?

In an article which appeared in *L'Onde Electrique* of August, 1922, I proposed a plan to this

effect and note that the American magazine "Q.S.T." in its issue of December, discusses this plan at some length and puts forward some other interesting suggestions to the same effect.

What is the British amateur's point of view on this question? Could it not be expressed by competent amateurs in the columns of your widely circulated magazine for the benefit of everybody?

My plan is that when amateur stations use enough power to be likely to be heard abroad, they put the initial of their country before their call letters. Thus if anyone hears: "F8AB de B2OD," he will at once know that French 8AB is being called by British 2OD, while had he heard: "A8AB de C2OD," he would have immediately understood that he had picked up Canadian 2OD calling American 8AB.

This seems to me the most practical solution of this problem, but no doubt there are many other good ways of dealing with it, and it would be very interesting to hear from those to whom they have occurred.

LEON DULOY.

"F8AB," Nice.

To the Editor of THE WIRELESS WORLD AND  
RADIO REVIEW.

SIR,—I read with great interest a letter from your correspondent, Mr. L. F. Fogarty, in to-day's issue of *The Wireless World and Radio Review*, in which he says:—"I am convinced that it will ultimately be possible to operate a wireless receiving set entirely from alternating current, using some form of rectifier."

I have been experimenting for some considerable time in this direction and have come to the conclusion that the problem is to be solved by the direct use of alternating current rather than by rectification, since the necessary smoothing presents many difficulties. I am here referring, of course, to the filament current supply. No doubt the trouble could be overcome in part by the use of specially constructed valves, but this would not be of much use to the ordinary experimenter.

However, I am convinced that it should be possible to use ordinary valves with the filaments working direct from alternating current. In support of this view, I may say that for broadcast reception my receiver is operated entirely from alternating current. Once the receiver is correctly tuned and adjusted it is only necessary to connect it to the nearest lampholder, and switching on lights the filaments and also supplies the anode circuits with rectified and smoothed current. Little trouble is experienced with hum from a valve operating at radio frequency, but with detecting and audio frequency valves the problem is more difficult.

The results obtained, however, are encouraging, since the particular receiver employs low frequency amplification followed by a power amplifier. By placing one's ear to the mouth of the loud speaker it is possible to hear a slight amount of hum, but this is entirely drowned by the speech or music, the quality of which is not in any way affected. The circuits employed are more or less conventional, special arrangements being made to counteract the effects produced by the alternating current on the filaments.

PAUL D. TYERS.

## Calendar of Current Events

### Thursday, February 8th.

9.20 to 10.20 p.m. Dutch Concert from PCGG. The Hague, on 1,050 metres.

LUTON WIRELESS SOCIETY.

At 8 p.m. Visit to Electricity Works.

ILFORD AND DISTRICT RADIO SOCIETY.

Lecture on "Accumulators," by Mr. C. G. Rope.

HACKNEY AND DISTRICT RADIO SOCIETY.

At the Y.M.C.A., Mare Street, E.8. Informal Meeting.

### Friday, February 9th.

SHEFFIELD AND DISTRICT WIRELESS SOCIETY.

At 7.30 p.m. At the Dept. of Applied Science, St. George's Square. Elementary Class.

LEEDS AND DISTRICT AMATEUR WIRELESS SOCIETY.

Lecture (Part II) on "Inductance and Capacity."

By Mr. W. G. Marshall.

BELVEDERE AND DISTRICT RADIO SCIENTIFIC SOCIETY.

Discussion on Proposed Transmitting Apparatus, opened by Mr. S. Burman.

BIRMINGHAM EXPERIMENTAL WIRELESS CLUB.

At 7.45 p.m. General Discussion on Wireless Troubles and Difficulties.

### Sunday, February 11th.

At 3.5 p.m. *Daily Mail* Concert from PCGG, The Hague, on 1,050 metres.

### Monday, February 12th.

9.20 to 10.20 p.m. Dutch concert, PCGG, The Hague, on 1,050 metres.

IPSWICH AND DISTRICT WIRELESS SOCIETY.

At 8 p.m. At 55, Fonnereau Road. Lecture by Mr. S. A. Notcutt, B.A., LL.D.

WIRELESS SOCIETY OF HULL AND DISTRICT.

At 7.30 p.m. At Signal Corps Headquarters, Park Street. Paper on "The Construction of a Single-valve Set and Note Magnifier," by Mr. J. Brazendale.

### Tuesday, February 13th.

LOWESTOFT AND DISTRICT WIRELESS SOCIETY.

At St. Margaret's Institute, Alexandra Road. Lecture on "Accumulators," by Mr. C. H. Garrod.

### Wednesday, February 14th.

HALIFAX WIRELESS CLUB AND RADIO SCIENTIFIC SOCIETY.

At Clare Hall. Lecture by Mr. P. Denison.

EDINBURGH AND DISTRICT RADIO SOCIETY.

At 8 p.m. At Heriot-Watt College. Lecture on "Capacity and Inductance," by Professor F. G. Baily, M.A., D.Sc., M.I.E.E., F.R.S.E.

STREATHAM RADIO SOCIETY.

Annual Dinner.

### Thursday, February 15th.

9.20 to 10.20 p.m. Dutch Concert, PCGG, The Hague, on 1,050 metres.

LUTON WIRELESS SOCIETY.

At 8 p.m. At Hitchin Road Boys' School. Practical Work and Experiments.

MANCHESTER WIRELESS SOCIETY.

At 7.30 p.m. At Houldsworth Hall. Lecture by Mr. J. Hollingworth, M.A., B.Sc.

STOKE-ON-TRENT WIRELESS AND EXPERIMENTAL SOCIETY.

Lecture on "A Two-Valve Broadcasting Set," by Mr. F. T. Jones.

THE THAMES VALLEY RADIO AND PHYSICAL ASSOCIATION.

At 8 p.m. Lecture on "Valves and Their Manufacture," by Mr. J. Waide.

### Friday, February 16th.

RADIO SOCIETY OF GREAT BRITAIN.

At 6.30 p.m. At the Institution of Electrical Engineers, Victoria Embankment. Elementary Lecture (II), on "Fundamental Principles of Radio Reception," by Mr. Maurice Child.

SHEFFIELD AND DISTRICT WIRELESS SOCIETY.

At 7.30 p.m. At the Dept. of Applied Science, St. George's Square. Meeting.

LEEDS AND DISTRICT AMATEUR WIRELESS SOCIETY.

Lecture on "The Design of a Tuner," by Mr. G. B. Kendall, B.Sc.

### Saturday, February 17th.

NATIONAL ASSOCIATION OF SUPERVISING ELECTRICIANS.

At 6.30 p.m. At Holborn Restaurant, Newton Street, W.C.1. Annual dinner.

### Monday, February 19th.

THE WALTON-ON-THAMES AND DISTRICT AMATEUR RADIO SOCIETY.

General Meeting at the Headquarters, St. Michael's, Burwood Park Road, Walton-on-Thames.

## BROADCASTING STATIONS.

Regular evening programmes, details of which appear in the daily press, are now conducted from the following stations of the British Broadcasting Company:—

London	2LO	369 metres.
Birmingham	5IT	420 "
Manchester	2ZY	385 "
Newcastle	5NO	400 "
Cardiff	5WA	395 "

The Cardiff station is expected to be working by about Monday, February 12th.

## NEW CATALOGUES.

Messrs. J. H. Taylor and Company, Electrical Engineers, Macaulay Street, Huddersfield: Catalogue of receiving sets and parts, instrument wires, etc.

The Elandem Company, Limited, Electrical and Mechanical Engineers: Catalogue of patent spring clip connections for wireless apparatus.

## BOOK RECEIVED.

THE RADIO YEAR BOOK. (London: *Sir Isaac Pitman & Sons, Ltd.*, Parker Street, Kingsway, W.C.2. Price 1s. 6d. net.)

## Questions and Answers

**NOTE.**—This section of the magazine is placed at the disposal of all readers who wish to receive advice and information on matters pertaining to both the technical and non-technical sides of wireless work. Readers should comply with the following rules:—(1) Each question should be numbered and written on a separate sheet on one side of the paper, and addressed "Questions and Answers," Editor, THE WIRELESS WORLD AND RADIO REVIEW, 12/13, Henrietta Street, London, W.C.2. Queries should be clear and concise. (2) Before sending in their questions readers are advised to search recent numbers to see whether the same queries have not been dealt with before. (3) Each communication sent in to be accompanied by the "Questions and Answers" coupon to be found in the advertisement columns of the issue current at the time of forwarding the questions. (4) The name and address of the querist, which is for reference and not for publication, to appear at the top of every sheet or sheets, and unless typewritten, this should be in block capitals. Queries will be answered under the initials and town of the correspondent, or, if so desired, under a "nom de plume." (5) In view of the fact that a large proportion of the circuits and apparatus described in these answers are covered by patents, readers are advised before making use of them, to satisfy themselves that they would not be infringing patents. (6) Where a reply through the post is required every question sent in must be accompanied by a postal order for the amount of 1s., or 3s. 6d. for a maximum of four questions. (7) Four questions is the maximum which may be sent in at one time.

"A.B." (Taunton) refers to the diagram given on page 474, October 29th issue, 1921, and asks (1) How the circuit may be arranged so that connections may be made with the last transformer of his valve receiver. (2) How are the resistance coils of a Wheatstone bridge usually constructed. Are the two resistances of 10,000 ohms shown constructed after the manner of a potentiometer with a slider. (3) The gauge, size and quantity of resistance wire to make the resistances. (4) What voltage is required to satisfactorily operate a 10" spark coil.

(1) The arrangement given in Fig. 1 will meet your requirements. The diagram is slightly modified to the arrangement and works very well indeed. (2) and (3) The coils of a Wheatstone bridge are usually doubly wound. The windings are wound

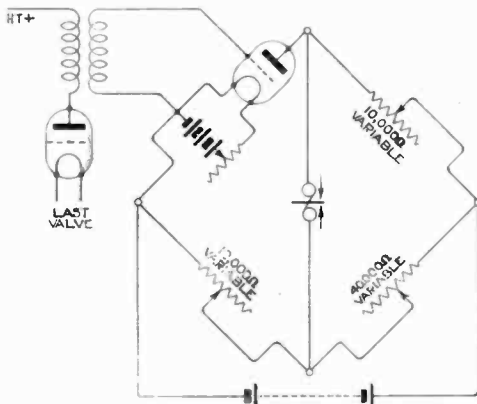

Fig. 1.

upon bobbins suitably mounted. The resistances shown in the diagram need not be continuously variable. The variation may be carried out with the aid of stud switches. We suggest you use No. 44 Eureka wire, which has a resistance of 2,800 ohms per 100 ft. (4) The voltage necessary for the successful operation of a 10" spark coil varies slightly with different designs of coil, but we suggest you use 40 volts.

"R.W.S." (Manchester) submits a diagram of his receiver and asks (1) Why the amplification is so small. (2) How to make tuning very selective.

(1) The diagram of connections submitted is incorrect. The grid and filament of the first valve

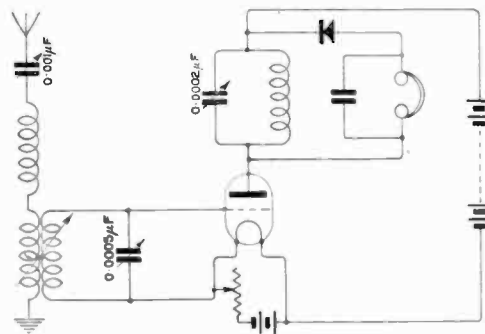

Fig. 2.

should be connected across the inductance only. If the connections are made to include the inductance and capacity, very little or no voltage will be applied to the valve. The anode winding should be tuned with a small condenser having a maximum value of 0.0002 mfd. The aerial condenser should have a maximum value of 0.0002 mfd. The aerial condenser should have a maximum value of 0.001 mfd. (2) We suggest you rewire the circuit according to Fig. 2. You will note that we have added a closed circuit comprising a coil and condenser. The condenser has a maximum value of 0.0005 mfd., and the coil should be similar in size to the aerial coil to which it is coupled.

"L.C.C.R." (N.13) asks (1) For particulars of a number of tuning coils which will enable him to tune from 150 to 30,000 metres; the coils to be built upon the principle given on page 392 of the issue of December 23rd.

We cannot give you precise instructions, because the inductance value of these coils depends essen-

tially upon the spacing of the wires, but you should have no difficulty in building up a set yourself, experimentally determining the most suitable values. The inductance values of a set of honeycomb coils could be taken as a basis to work upon.

"EXPERIMENTER" (Glasgow) submits a diagram of his receiver and asks (1) For criticism of the diagram. (2) For suitable values for the aerial, closed circuit, reaction coil, and anode coil.

(1) The arrangement is quite suitable, except that it would be better to use a closed circuit, but the anode coil should of course be tuned with a small variable condenser having a maximum capacity of the order of 0.0002 mfd. (2) The tuning arrangements which you have at present should be quite suitable, but we suggest the closed circuit coil should have 40 turns on a 2" diameter former, the No. 34 S.S.C. wire which you have by you being used. It would be better if you rewound all the coils, using heavier gauge wire—No. 22 for the aerial circuit, No. 24 for the closed circuit, and No. 32 for the reaction coil and the anode coil.

"G.W.S." (Atherstone) submits a diagram of a crystal receiver which he has constructed, and asks (1) Whether he may expect to obtain an experimenter's licence. (2) Could it be altered and made suitable for the reception of broadcast wavelengths with the addition of valves. (3) Does the direction of the aerial affect the strength of signals received to any extent. (4) What is reaction.

(1) In view of question (4), we do not think you would obtain an experimenter's licence.

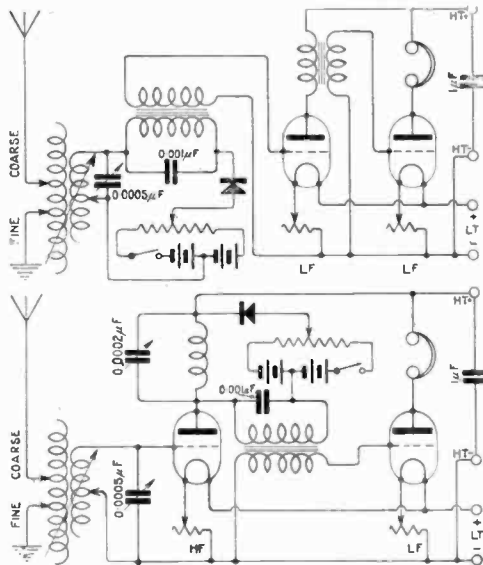

Fig. 3.

The experimental licence is granted to persons who in the opinion of the Post Office have sufficient knowledge to enable them to operate receiving apparatus without causing interference to other wireless users. Why not become a member of the local Wireless Society, where you would receive much

help. (2) The receiver could easily be altered. In Fig. 3 the upper diagram shows how two note magnifiers are added to the receiver, and in the lower diagram one high frequency valve is connected with a crystal detector and note magnifier. (3) Outdoor aerials have slight directional properties. To receive the maximum strength

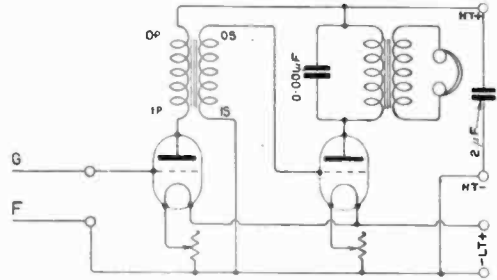

Fig. 4.

of signal, due consideration being paid to other factors, the lead-in end of the aerial should be nearest the transmitting station, and the direction of the horizontal portion of the aerial should point towards the transmitting station. (4) A valve is capable of amplifying, therefore more energy is available in the output circuit of the valve than is applied to the input. Reaction consists in transferring a small amount of the output energy to the input circuit, thus reinforcing the input signals. If reaction is carried too far, that is to say, if a large proportion of energy is transferred back to the input circuit, valves will generate oscillations, and if the input circuit is coupled with the aerial circuit, energy will be radiated.

"VIC. E." (Coventry) asks for a diagram of a two-valve low frequency amplifier.

We would refer you to Fig. 4. The diagram is very straightforward and easy to follow.

"A.J." (Yorks) refers to the diagram on page 387 of December 16th issue, and asks (1) What is the dimension of the anode coil. (2) Is the anode coil a fixed inductance, or should it be tapped or inductively coupled with any other coil. (3) With the A.T.I. and C.C.I. of given dimensions, should it be possible to receive the broadcast transmissions. (4) What is the wavelength range of the station.

(1) and (2) The anode coil X, together with the 0.0002 variable tuning condenser, should tune to the wavelength of the signals; that is, the coil X should have approximately twice as many turns with the same diameter as the closed circuit coil. The anode coil is fixed in position, and should not couple with any other coil in the receiver, otherwise regenerative effects would be obtained. (3) You should certainly receive the broadcast transmissions. (4) The wavelength range of your station is from about 200 to 8,000 metres.

"A.S.P." (London, E.C.3.) asks (1) For criticism of a proposed crystal set. (2) Whether a frame aerial may be used. (3) Whether he would get good results with a Reinartz tuner to tune up to



8,000 metres. (4) *The best aerial which he can erect in his circumstances.*

(1) We suggest you build a set yourself and wire the components as indicated in Fig. 5. The aerial tuning inductance may consist of a winding of No. 22 D.C.C. on a former 4" in diameter and 6" long. The secondary tuning inductance may consist of a winding 3" in diameter and 8" long of No. 30 D.C.C. (2) It is useless to expect signals when the crystal set is connected with a frame aerial. We suggest you build an open aerial as advised in No. 4. (3) We suggest you do not build a Reinartz tuner, but a standard valve receiver. Particulars of many have appeared recently in these columns. (4) We suggest you secure a pole to the house and then erect a 35 ft. pole in the garden as suggested. The higher the aerial the better it will be for your purpose.

"H.C.H." (London, S.W.1.) asks (1) *For a diagram of a four-valve receiver using one H.F., one detector and two L.F. connected valves for a switch cut out of the first H.F. valve and provision for plug-in telephones into either of the L.F. valves.* (2) *What is the smallest current which will operate the P.O. telegraph relay.* (3) *The minimum number of valves required for recording Paris Spark signals.* (4) *Is a Brown adjustable telephone, rewound with No. 47 enamelled wire, useful for recording purposes as described in a recent issue of "The Wireless World and Radio Review."*

(1) The diagram given in Fig. 6 is quite suitable for your purpose. (2) The P.O. telegraph relay will operate well with a current of 0.2 milliamperes. (3) We suggest you use a three-valve receiver for this purpose. (4) The arrangement suggested is quite suitable.

"H.W." (Manchester) asks for advice regarding an experimenter's licence.

We think your information concerning the conditions under which experimental licences

which you have built yourself, but must purchase one which bears the stamp B.B.C. If you hold

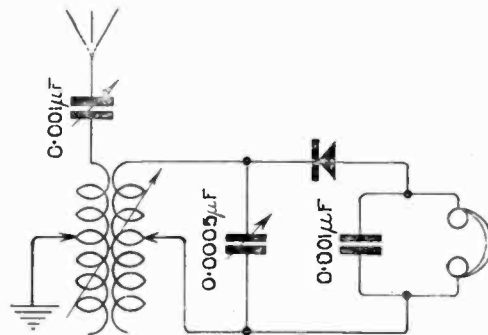

Fig. 5.

an experimenter's licence, it is a condition that you shall not cause your receiver to oscillate while listening to the broadcasting transmissions.

"R.W.McW." (Glasgow) proposes to use a frame aerial and asks (1) *Whether a three-valve receiver comprising one high frequency, one detector, and one L.F. connected valves would be useful.* (2) *Whether it would be better to use more valves.*

(1) We consider you will hear the local broadcasting stations using the three-valve set, but you will probably only faintly receive the transmissions from the more distant broadcasting stations, and we suggest that for good reception you add two high frequency connected valves. See circuit given on page 315, December 2nd issue. The frame in this case takes the place of the secondary tuning coil, and of course the aerial circuit is not required.

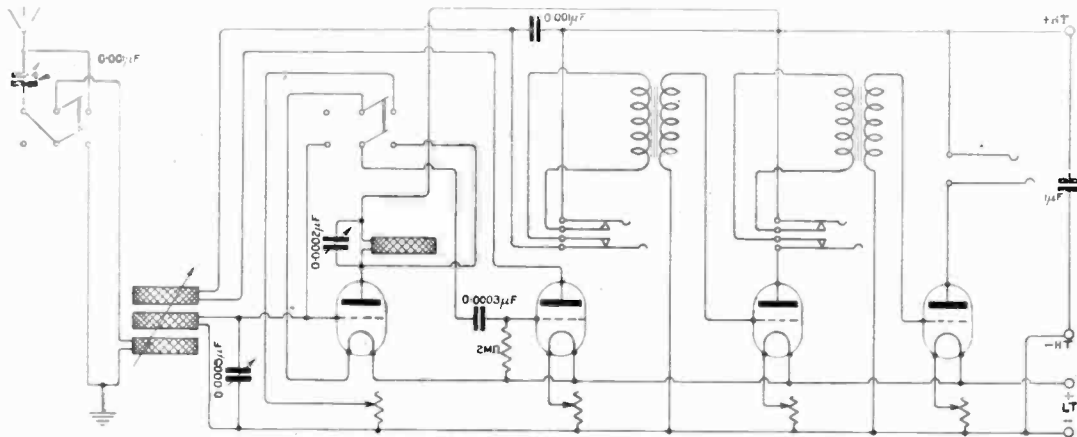

Fig. 6.

are granted is incorrect. If you build your own set, you must possess an experimenter's licence. If the Post Office will not grant you an experimenter's licence, you are not allowed to use a receiver

"D.G.K." (Herts) asks (1) *For a diagram of a five-valve receiver employing two H.F., one detector, and one L.F. connected valves. High resistance telephones are to be used, and it is desired*

to be able to switch on or off the valves as required. (2) What are the dimensions of the tinfoil plates of the fixed condensers to be used in the receiver.

(1) See Fig. 8. A number of arrangements similar to this have recently appeared. (2) The telephone transformer may consist of a bundle

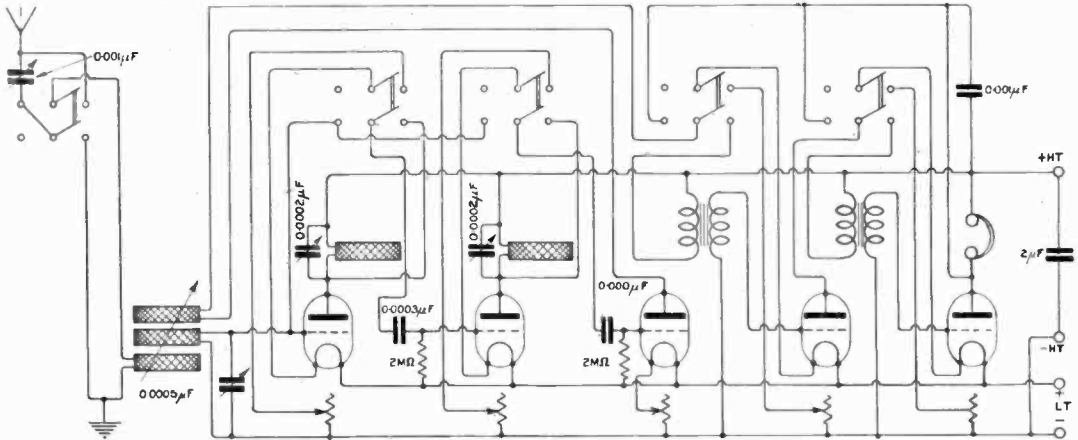

Fig. 7.

(3) What are suitable capacities for the variable condensers.

(1) A suitable diagram is given in Fig. 7. The tuned anode method of H.F. amplification is used. You will notice the grid-leak connections are made with + L.T. (2) 0.0003 mfd. condensers may consist of two plates with an overlap of 3 cm × 1 cm., the mica being 2 mils. thick. The 0.001 mfd. condenser may consist of six plates with an overlap of 2 cm. × 1 cm.; mica 2 mils. thick. (3) Suitable values for the variable condensers are indicated in the diagram.

of soft iron wires built up to a diameter of  $\frac{3}{8}$ " and 5" long. The primary winding may consist of 5,000 turns of No. 42 S.S.C. wire, and the secondary of 1,000 turns of No. 34.

"R.A.M." (Barrow-in-Furness) asks the number of turns required in honeycomb coils to tune in conjunction with 0.00075 variable condenser over a wide wavelength range.

We suggest you wind 25, 35, 50, 100, 200, 500, 750, 1,000, 1,250, and 1,500 turns. For the smaller coils we suggest you use No. 22 D.C.C., and for the larger coils No. 26 D.C.C.

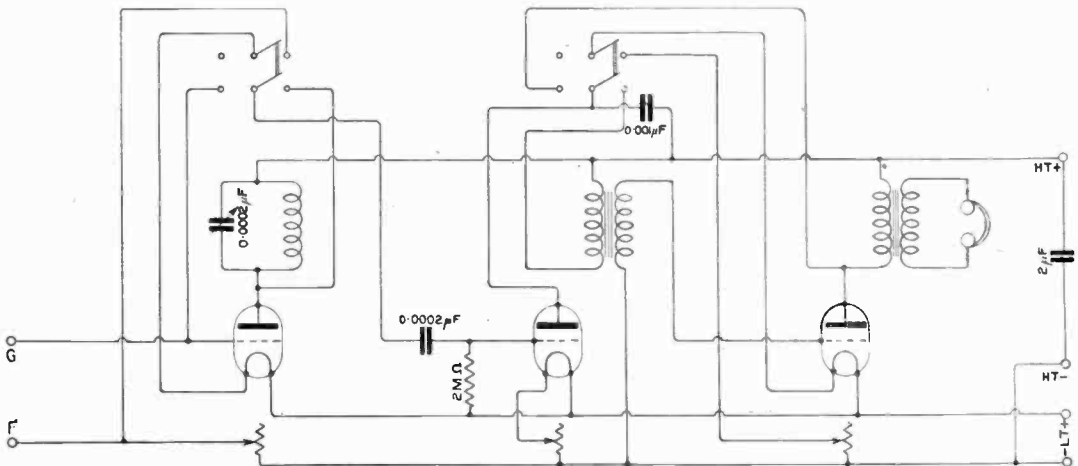

Fig. 8.

"W.A.T." (Sheffield) refers to the broadcast receiver described in this journal and asks (1) For a diagram showing how two double pole throw switches can be connected. (2) How to construct a telephone transformer.

"M.A.H." (London, S.E.24) asks how to add a H.F. connected valve using a plug-in type transformer to his detector valve with switch for cutting in or out the H.F. valve.

See Fig. 9. Suitable valves are indicated.

**"F.A.M." (N.W.11)** asks (1) *Whether it matters which way round the coils are connected in a three-coil holder.* (2) *Why is it signals appear quite as strong when no grid leak is used.*

(1) It does not greatly matter which way round the aerial and closed circuit coils are connected,

and is not likely to set up oscillations in the aerial circuit if the reaction coil is coupled with the anode coil. If, however, the reaction and aerial coils are coupled together, you may be sure oscillations will be generated in the aerial circuit sometimes, and interference will be caused.

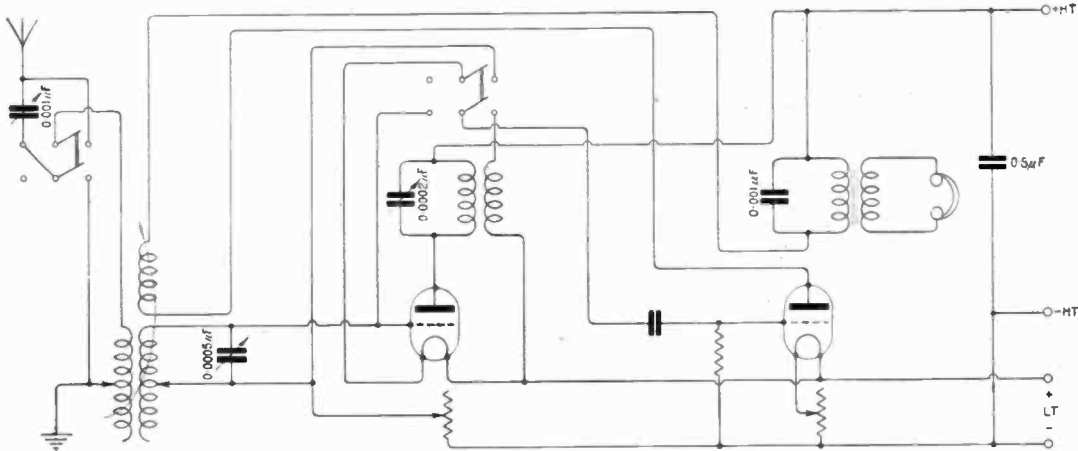

Fig. 9.

but it does matter which way the reaction coil is joined. With one connection, the current flowing in the reaction coil will assist that flowing in the closed circuit coil, and with the reverse connection it will oppose the closed circuit. (2) You probably have a leak or a low insulation between the grid and filament terminals of the valve. This may happen through poor ebonite, or because of pencil marks, dust, dirt, and so on. The back of the panel should be cleaned, and lines scratched round the various terminals to prevent surface leakage. It is not satisfactory to work without the grid leak, because one does not know the value of the leak resistance.

**"Z.H." (Southall)** asks (1) *What publication gives the definition of signal strength such as is used by a man reporting the reception of a certain station, strength R 6.* (2) *Is there any record of the smallest amount of power that has been amplified and received as a wireless signal.*

(1) The strength of signal referred to by R 6 is not a definite signal strength, in so far that it has no definite value. It is simply a convenient way of expressing a signal with an apparent intensity of a certain value. The signal strengths were referred to in this manner in the Army and Navy Signal Services, and convey sufficient meaning. (2) We have no record of the smallest amount of power that has been amplified and rendered audible by a valve receiver.

**"N.B." (Lancs.)** asks (1) *What size of duolateral coils would be required for British broadcasting.* (2) *Is the receiver (diagram of which is submitted) connected so that it is unlikely that oscillations would be generated in the aerial circuit.*

(1) We suggest you use Nos. 35, 50 and 75 duolateral coils. (2) The diagram submitted is quite suitable for the reception of broadcast transmissions

**"E.T.W." (Lincoln)** asks (1) *Suitable dimensions of an aerial tuning inductance.* (2) *A suitable secondary coil.* (3) *A suitable reaction coil.*

(1) The A.T.I. may be a coil 3" in diameter, wound with No. 18 D.C.C.; 144 turns may be used with tappings taken at every twelfth turn. (2) The secondary winding may be 2" in diameter, and wound with 250 turns of No. 22 D.C.C., with five tappings. The reaction coil may be 2" in diameter, and have a winding of 100 turns of No. 26 D.C.C.

**"K.H.F." (India)** submits a diagram of his receiver and asks (1) *Whether it is suitable.* (2) *Whether it is possible to reduce interference caused by a near-by power station.*

(1) We have examined the diagram of connections, and the connections are quite suitable. We would point out, however, that the inclusion of so many switches in the high frequency portion of a receiver is apt to seriously cut down the signal strength. (2) We suggest you use a frame aerial, or if you prefer to use the open aerial, to use the counterpoise in place of the earth. If trouble is still experienced, the low frequency portion of the amplifier should be screened by being placed in a metal box.

**"E.J.M." (Derby)** asks (1) *Whether the use of a Dewar type switch in the aerial circuit and as a stand-by switch, is likely to reduce signal strength.* (2) *Is the resistance capacity type of high frequency amplifier more efficient on long wavelengths than an impedance capacity amplifier.* (3) *Is 8 AB transmitting. If so, at what times and on what wavelength.*

(1) Provided the switch springs are well spaced no serious losses are likely to occur, although the practice is not recommended. (2) When receiving very long wavelength signals, it is better to use the reactance capacity method of high frequency

amplification. (3) The French amateur station 8 AB transmits at irregular intervals, and if you are interested in these transmissions, we suggest you communicate with him.

"E.J.P." (Kent) asks (1) For a diagram of a two-valve receiver, comprising two high frequency valves with crystal detector.

See the diagram Fig. 10. Suitable values for the condensers are indicated.

"N.E.K." (Belgium) asks (1) Whether it is possible to replace high frequency transformers with tuning coils for reception up to 2,000 metres, and above that to use the resistance capacity method of high frequency amplification. (2) What values of inter-valve capacities should be used, the grid leak being 6 megohm. (3) What should be the H.T. voltage. "R" type valves are used. (4) Is it better to connect a low value capacity between the last high frequency and the rectifier grid.

(1) We suggest you adopt the tuned anode method of coupling high frequency valves, up to

valve, and for this purpose a tuning condenser having a maximum value of 0.0002 mfd. should be used. In general, the smaller the value of this condenser the stronger will be the signals. The aerial tuning condenser is of suitable value, and all future adjustments should be made with the coils. We suggest you use "R" type valves with 45 volts on the anode of the high frequency and detector valves, and 60 volts on the anode of the L.F. connected valves.

"COIL" (Edinburgh) submits particulars of the coils he has wound, and asks whether they have sufficient inductance to enable him to secure from 350 to 450 metres.

We think the coils have sufficient inductance to enable you to tune over the required wavelength range, provided the aerial tuning condenser has a maximum capacity of 0.001 mfd., and the closed circuit contains a maximum value of 0.0004 mfd.

"G.E." (Cumberland) refers to the figure of a former on page 130, October 28th issue, and asks how to connect the two windings.

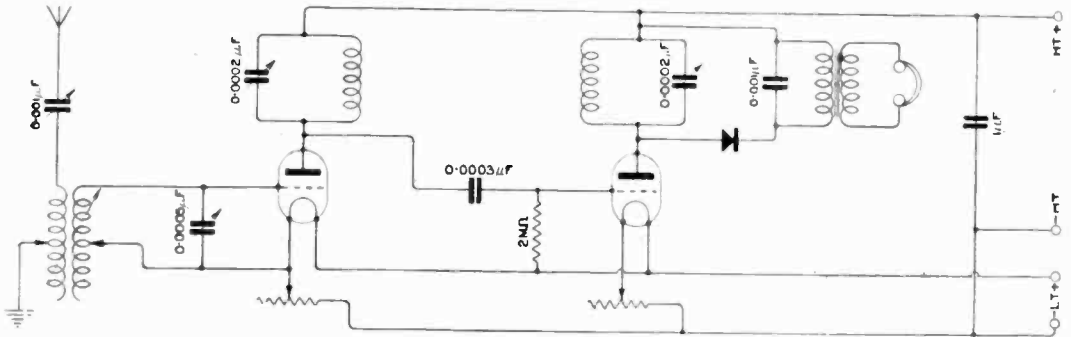

Fig. 10.

a wavelength of 2,000 metres, above which use the resistance capacity method. (2) We suggest you employ coupling condensers of 0.0002 mfd. (3) The H.T. voltage applied to the high frequency valves should be of the order of 50 volts. The low frequency valves may have a much higher voltage, although in this case it is advisable to connect a few cells in the grid circuit, in order to ensure that the grids shall be sufficiently negative. When the anode resistances are used, the H.T. voltage should be increased to allow for the voltage drop through the resistance. (4) It is sometimes better to use a smaller coupling condenser between the last high frequency valve and the rectifying valve, but you should determine the best condensers by experiment.

"P.S.B." (Walsall) submits particulars of his receiver, and asks for any suggestions.

We suggest you use a different set of receiving coils when attempting to receive the London broadcast transmissions. It would be an advantage to tune the anode winding for the high frequency

The winding should be connected in series, so that the two windings are wound in the same direction. The inductance will then be added. Alternatively, for smaller inductance value, the two windings may be connected in parallel.

### SHARE MARKET REPORT

Prices as we go to press on February 2nd, are:—

Marconi Ordinary	.. ..	£2 12 6
.. Preference	.. ..	2 3 9
.. Debentures	.. ..	107 0 0
.. Inter. Marine	.. ..	1 8 3
.. Canadian	.. ..	11 3

Radio Corporation of America:—

Ordinary	.. ..	15 0
Preference	.. ..	13 3

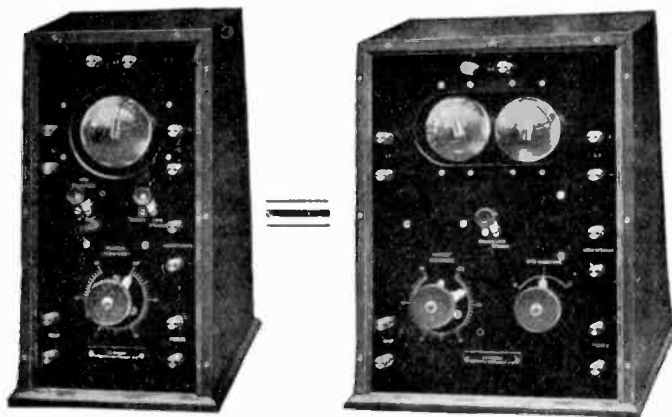

For the  
Discriminating  
Amateur

## Note Magnifiers for Your Present Set

TWO NEW ADDITIONS TO A REMARKABLE SERIES.

Here are two more instruments in the wonderful series of Broadcast Receivers now being placed on the market by the Marconi Scientific Instrument Company, Ltd. Once more high efficiency is combined with a fine appearance, while the special features of these note magnifiers will appeal to every discriminating amateur.

Many owners of single or two-valve receivers are anxious to add note magnifying valves to their sets so that a loud speaker may be used. They will find in the MARCONI SCIENTIFIC TWO-VALVE MAGNIFIER an instrument which will fulfil all requirements. For those who are not satisfied with the strength of speech and music obtainable with their present set, but who do not require the great amplification obtainable with two further valves, the MARCONI SCIENTIFIC SINGLE VALVE MAGNIFIER will admirably meet the case.

Possessors of the MARCONI SCIENTIFIC TWO-VALVE BROADCAST RECEIVER can convert it into a three or four-valve set by adding one or other of these Magnifiers, which are designed to match in size and style the instrument referred to. The Marconi Scientific Three-Valve Broadcast Receiver can similarly be converted into a four-valve set by adding the single-valve magnifier.

### Special Features of these Magnifiers :

Valves fit into recessed sockets, which greatly improve the appearance of the instrument. Separate terminals for loud speaker, and switch to change automatically from telephones to loud speaker. Switch on single-valve magnifier to cut off magnifier valve and work straight from receiver when required. Switch on two-valve magnifier so that one or both of the valves can be cut out if desired. High efficiency intervalve transformers, specially designed to suit the valves supplied. Marconi Scientific filament resistances, giving perfect control of filament brightness.

<b>Prices :</b>	Marconi Scientific Single-valve Magnifier, as illustrated, complete with Marconi "R" Valve	£7 17 6
	Royalty payable to the B.B.Co. . . . .	£1 0 0
	Marconi Scientific Two-valve Magnifier as illustrated, with two Marconi "R" Valves	£12 15 0
	Royalty payable to the B.B.Co. . . . .	£1 15 0

**The Marconi Scientific Instrument Co., Ltd.**

Telegrams :  
Themasinco, Westcent.

40, Dean Street, Soho, W.1

Telephone :  
Gerrard 7745

# Wates Crystal Receiving Set

Costs but £5 : 0 : 0 Complete.

Receives Broadcast Music for 30 Miles.

Easy to manipulate.

Filament Resistances	3 9
"Ideal" Valve Accumulators in cases—	
4-Volt 50 amp. (Carriage 2/)	24/-
6-Volt 50 amp. (Carriage 3/)	35/-
Variable Condensers (of various capacities) from	6/-
Fixed Condensers	2 6
3-Coil Holder, complete unit for use with Standard Coils	20/-

The crystal is enclosed in a glass case, one adjustment being almost permanent. The movement of one switch arm is all that is necessary to tune for reception of any particular wavelength.

The price of £5 includes everything, and there are no upkeep costs.

You can add to this set, step by step, by the Wates Unit System of Note Magnifiers.

This system produces signals of remarkable strength and clarity of tone, without atmospheric disturbance or distortion, and enables you to use a Loud Speaker.

Not only do we supply complete Receiving Sets (Crystal or Valve) but also all component parts.

A visit to our Showrooms will interest you.

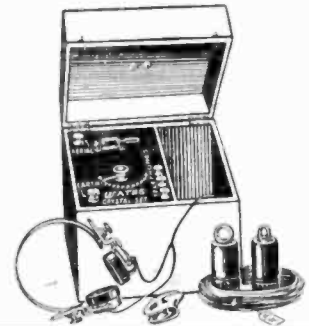

DEMONSTRATIONS GLADLY GIVEN.

## WATES BROS.

13-14 Great Queen St., Kingsway,  
London - - - W.C.2

\*Phone—Gerrard 576.

\*Grams—Zywaleseng, Westcent.

## ELECTRONITE IS

the only Crystal if you want real signals.

(BRITISH MADE)

We are the sole distributing agents for the World.

Price 5/- per oz. or 1/- per piece.

TRADE SUPPLIED

ESTABLISHED — 1920



234, HIGH HOLBORN, LONDON, W.C.1

Phone: Holborn 2188.

## EBONITE AND VULCANITE

TUBES—RODS—SHEETS

LARGE STOCKS

BRITANNIA RUBBER AND KAMPTULICON CO., LTD.

7, NEWGATE ST., LONDON, E.C.1

Telephone : 2168 Central

Telegrams : Britannia, London

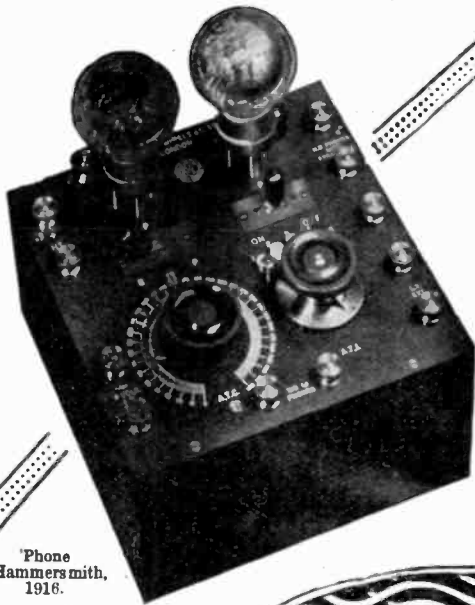

Phone  
Hammersmith,  
1916.

Telegs.  
"Tingoidar, London."

## Uniformly Efficient

THE supreme excellence of TINGEY Wireless instruments under all conditions and tests is now universally appreciated. A splendid example is the 2 Valve Model, which is claimed to represent the highest attainment in mechanical perfection and capacity.

**Two Valve Broadcast Receiving Set**  
Wavelength 300 to 2,800 metres.

**PRICE** (as illustrated, less valves) **£17 : 12 : 6**  
including Broadcasting Fees

ALL TINGEY Broadcast Receivers bear the B.B.C. stamp.

All "TINGEY" Valve Apparatus is duly licensed under Marconi Patents for Amateur use in Great Britain.

Illustrated Catalogue of 1, 2, 3, 4 and 5 valve Broadcast Receivers and Experimental Unit System, with all accessories, Price 6d. post free.

Offices & Showrooms:  
92, QUEEN ST.,  
HAMMERSMITH  
LONDON, W.6.

**TINGEY WIRELESS LTD.**

# TOMLINSON

## LONDON, LIMITED.

3, FINCHLEY ROAD, ST. JOHN'S WOOD, N.W.8  
Hampstead 1844

Phones, 4000 ohms	22/6
H.T. Batteries, 36 volts	7/6
5-Contact Switches	4/6
Aerial Wire, 100ft. 7/22	5/6
Connecting Wire, Tinned per 1/4-lb. 16 & 18 s.w.g.	1/3
Double throw, Double Pole Switch	5/6
Variable Condensers, .001 enclosed	26/-
Variable Condensers, .001 for Panel Mount- ing	13/-

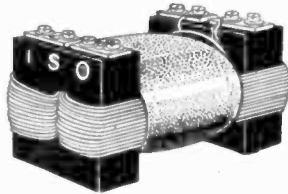

Highly efficient L.F.  
**TRANSFORMERS**  
**12/6** Postage 4d.

DEMONSTRATIONS  
DAILY.

Complete Installations from	£25 to £150
Fixed Condensers, any capacity	2/-
Our special 3-coil Holders	20/-
Variometer Formers, Unwound, per set	7/6
Potentiometers in Teak Box	7/6
10-Contact Switches	5/6
Aerial Insulators	1/-

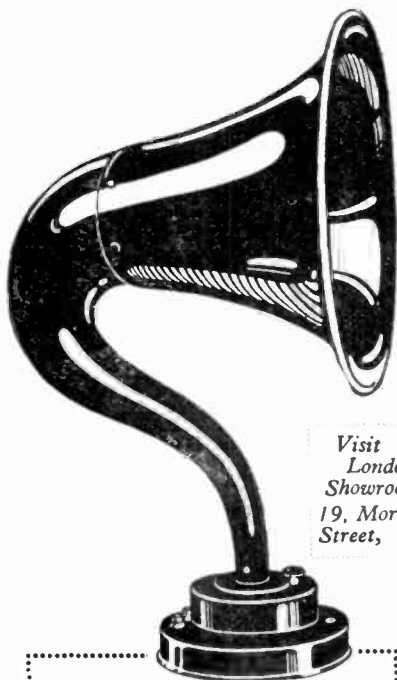

Visit Our  
London  
Showrooms:  
19, Mortimer  
Street, W.1

## PRICES

### LOUD SPEAKERS

H.1 (Large) Low Resistance,  
120 ohms, height 21" ... £8 5 0  
H.2 (Small) Low Resistance,  
120 ohms, height 12" ... £3 0 0  
(High Resistances for either size  
2/6 to 5/- extra)

### MICROPHONE AMPLIFIERS

For use with L.R. Loud Speakers  
(120 ohms output).  
120 ohms input - £6 0 0  
2,000 ohms input - £6 2 6  
For H.R. input and output £6 10 0

## The "BROWN" LOUD SPEAKERS

With New Improved Curved Horns

THE requisites of a Loud Speaker are pure tone, clear articulation, and good volume of sound. The "BROWN" Loud Speakers possess these qualities, and they are enhanced by the new improved curved horn.

THE NEW HORN of dull blacked aluminium used with both H.1 and H.2 is constructed on the logarithmic law of increasing openings and is acoustically perfect.

### THE "BROWN" MICROPHONE AMPLIFIER

THIS AMPLIFIER magnifies signals, speech or music, without distortion, and is of considerable interest to amateurs and scientific investigators. This magnification is much greater than that obtained from a two-valve amplifier. In construction, this instrument is much more robust than other relays.

This instrument satisfies the urgent demand for a reliable, inexpensive amplifier, which the most inexperienced amateur can use, and which the most experienced requires. The necessary transformers are included in the base.

OBTAINABLE FROM ALL WIRELESS DEALERS.

Illustrated Catalogue of our Headphones, Loud Speakers & Amplifier post free from

## S. G. BROWN, LTD.

London Offices and Showrooms (RETAIL ONLY)—

19, MORTIMER ST., LONDON, W.1

TRADE COMMUNICATIONS ONLY TO :—

HEAD OFFICE & WORKS: VICTORIA RD., NORTH ACTON, LONDON, W.3

Telegrams—"Sidbrownix, London."

Telephone—Chiswick. 1.466

Sole Agent for the Argentine—Horacio D. Guerrero, Las Heras, 2486, Buenos Aires.



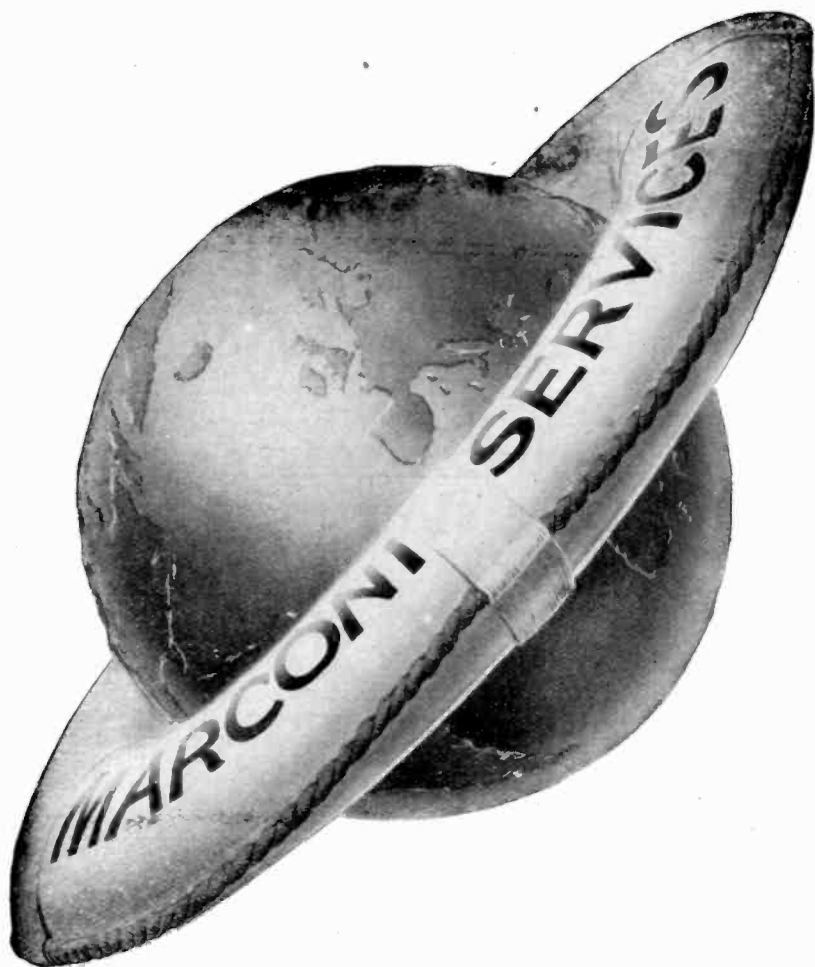

MARCONI  
GIVES  
UNRIVALLED  
WIRELESS  
SERVICE

*THE* MARCONI INTERNATIONAL  
MARINE COMMUNICATION CO. LTD.  
MARCONI HOUSE, STRAND, LONDON

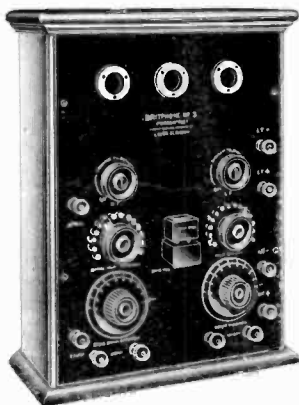

## BRITPHONE No. 3

A three-valve Receiver of very excellent performance, consisting of one H.F. stage, one detector, one low frequency, conforming in every way with the P.M.G. requirements, and bearing the British Broadcasting Company's mark.

The most efficient form of high frequency amplification possible is used, and the whole design of the instrument is one which gives the maximum efficiency over a large band of wavelengths with perfectly simple and noiseless operation.

The valves are mounted behind the panel, inspection windows being provided, thus preventing damage to valves and minimising the glare effect while operating the receiver. A socket is provided into which BRITWIRE coils can be inserted, enabling the reception of telephony from Hague, Paris, Berlin, etc. Range on Broadcasting, 100 to 150 miles under normal conditions. The receiver is mounted in a well-finished highly-polished mahogany case and can be used in an upright or flat position.

**PRICE** including B.E.C. Royalty **£25 : 4 : 0**

## BRITISH WIRELESS SUPPLY CO. LTD.

Head Office—6, **BLenheim TERRACE, LEEDS.**

Phone—26926

London Showrooms—64, Frith Street, W. (off Shaftesbury Avenue)

Phone—Gerrard 2789

DEMONSTRATIONS DAILY.

And at—18, Eldon Square, Newcastle.

Phone :

Newcastle-on-Tyne, 360 City.

4, Pembroke Square,

Above Bar, Southampton.

8, Corporation Street, Belfast.

11, Church Street, West Hartlepool.

Phone :

West Hartlepool, 373.

# Exide

## BATTERIES

THE suitability of Exide Batteries for wireless work is demonstrated by the fact that for many years they have been standard in Marconi equipment. The leading apparatus manufacturers are to-day standardising Exide Batteries.



6 Volt 40 amp. hour Exide Battery.

We also manufacture H.T. Batteries.

THE resources of the world's largest battery manufacturers, their facilities for research and their modern factory equipment mean that were it possible to effect any improvement in battery design or construction, that improvement would appear in the Exide Battery.

THE **Chloride** ELECTRICAL STORAGE COMPANY LIMITED

CLIFTON JUNCTION,  
Nr. MANCHESTER.

219/229, SHAFTESBURY  
AVENUE, W.C.2.

58, DALE END,  
BIRMINGHAM.

OBTAINABLE FROM ELECTRICAL CONTRACTORS & STORES OR FROM

300 EXIDE BATTERY SERVICE AGENTS DISPLAYING THIS SIGN.



IF YOU DON'T KNOW YOUR NEAREST EXIDE AGENT ASK US FOR LIST.

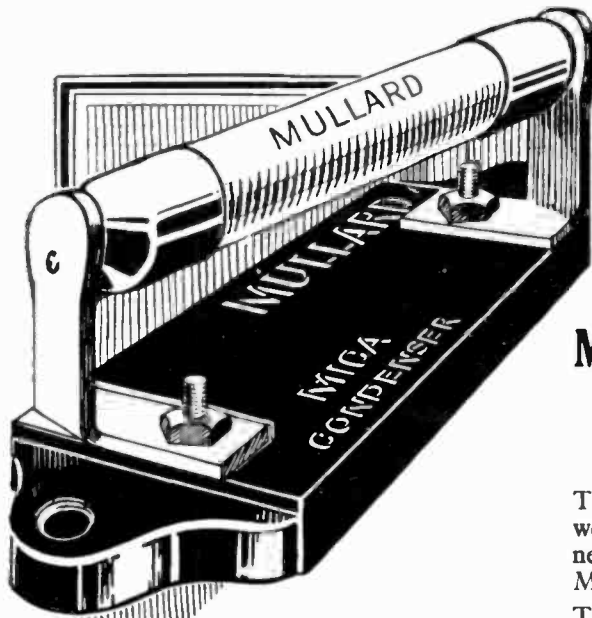

## MULLARD COMBINED GRID LEAK AND CONDENSER.

This useful accessory comprises the well-known Mullard patent resistance neatly combined with a standard Mullard Mica Condenser.

The resistance is of the grid B pattern. It is practically indestructible, perfectly "silent," steady and permanent. The condenser is well-made, compact and easily fitted. Insulation tested up to 1,000 volts.

*Particulars and prices of other Mullard products on application.*

MULLARD GRID LEAK .. 3/-  
MULLARD CONDENSER .. 2/6

The combined unit, like every MULLARD product, is thoroughly dependable and the best of its class.

**SPECIALY REDUCED PRICE FOR 1923**  
**5/6 each**

The demand for this item has been so much increased by the considerable reduction in price that it is advisable to ORDER AT ONCE to secure prompt delivery.

**THE MULLARD RADIO VALVE COMPANY LTD.**  
(Dept. W.W.), 45, Nightingale Lane, Balham, S.W.12

Contractors to H.M. Admiralty, War Office, Royal Air Force & Post Office.

Telephone: Codes: Telegrams:  
Battersea ABC (6th Ed.) Radiovalve,  
1068 Beasley's Wandsworth, London

Name and Address.....		Please send me post free		W.W. 10/2/23	
To the MULLARD RADIO VALVE CO., LTD., 45, Nightingale Lane, Balham, S.W. 12		Quantity.....	Description.....	Type.....	Price.....
		.....	Telephone Head Sets.....	.....	27/6
		.....	"O.R.A. Valves.....	.....	15/- each
		.....	Grid A Resistances.....	.....	3/- "
		.....	Grid A or B Resistances.....	.....	2/6 "
		.....	BA Condensers 0003 mfd.....	.....	2/6 "
		.....	Combined Resistance.....	.....	5/6 "
		.....	Valve Condenser.....	.....	5/6 "
		.....	Valve Bases with Terminals.....	.....	3/6 "
		.....	Terminal Clips.....	.....	9d. per pair
Name of usual Wireless Dealer.....		I enclose (Cheque, Money Order, P.O.) value.....		to cover the cost.	
SEND THIS TO-DAY					

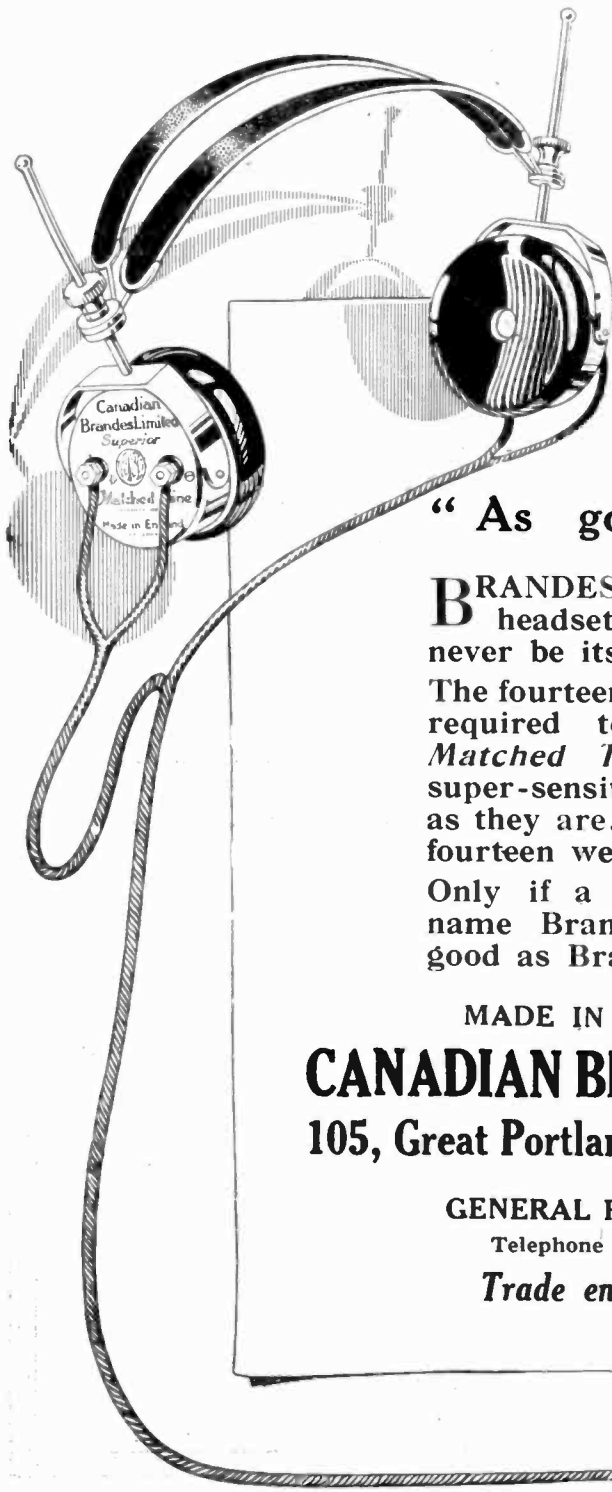

*Result of  
14 Years' Experience*

**“ As good as Brandes ”**

**B**RANDES is the standard headset. A counterfeit can never be its equal.

The fourteen years' experience required to make Brandes *Matched Tone* headsets as super-sensitive and as durable as they are, is not acquired in fourteen weeks.

Only if a headset bears the name Brandes can it be “ as good as Brandes.”

MADE IN ENGLAND FOR

**CANADIAN BRANDES LIMITED**

**105, Great Portland Street, London, W.1**

By  
**GENERAL RADIO COMPANY**

Telephone : LANGHAM 1145.

*Trade enquiries invited.*

*If it's a G.R.C.  
it's a better set!*



**G.R.C.**

**RECEIVING EQUIPMENT**

is so far in advance that it is recognised to-day as the standard by which all Radio Receiving Equipment is judged.

Look for the makers' name-plate when you purchase radio apparatus. If it bears the name GENERAL RADIO COMPANY you are assured that the instrument represents the highest efficiency combined with the most advanced design—at a price that is always reasonable.

*Any G.R.C. Dealer will be pleased to demonstrate so that you can judge for yourself the superiority of G.R.C. APPARATUS*

*There is a G.R.C. Radiophone for every purse and purpose. Our CATALOGUE will interest you—write for it—it's free.*

Our Manchester Agents, Messrs. MOTTERSHEAD & Co., are showing at the All-British Wireless Exhibition, Manchester, March 17th to 24th.

**GENERAL RADIO COMPANY**

**TWYFORD ABBEY WORKS, ACTON LANE, HARLESDEN, N.W.10**

**Telephone:**  
**Willesden 3055 (3 lines).**

**SHOWROOMS:**  
105, Great Portland Street, W.1

**Telegrams:**  
**"Milliamp, 'Phone, London."**

**BRANCHES:**  
Edinburgh and Bradford.

# Maximum Efficiency

Maximum efficiency is obtained for any given range of wavelengths in either single circuit or coupled circuit receivers by using

## HONEYCOMB INDUCTANCE COILS (DE FOREST PATENT No. 141344.)

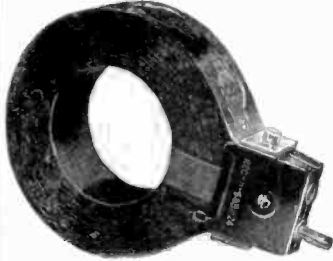

Honeycomb Inductance Standard Plug Mounting.

Low Self-Capacity.  
No Losses due to dead ends.

### "TRIPLUG" COIL HOLDERS

for use with Honeycomb Coils.

Supplied in following types :  
PANEL MOUNTING  
TABLE STAND  
INDEPENDENT UNITS.

Write for leaflets U.3.

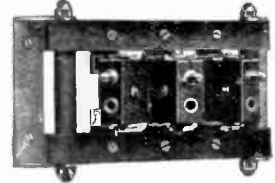

Triplug Panel Mounting Coil Holder.  
Regd. No. 692935.

GLASGOW.  
MANCHESTER.  
BIRMINGHAM.

149, Queen Victoria St.,  
LONDON.



BRADFORD.  
NEWCASTLE.  
CARDIFF.

Works :  
Elstow Road, BEDFORD

# A NEW ORMOND LINE

HIGH IN  
QUALITY

**3/6**  
EACH

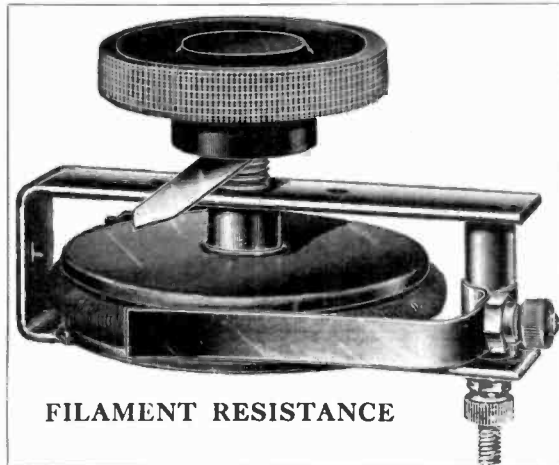

FILAMENT RESISTANCE

LOW IN  
PRICE

**3/6**  
EACH

ORMOND ENGINEERING CO.  
199 PENTONVILLE ROAD, KING'S CROSS, N.1

Telephone—Holborn 1812.

Telegrams—"Ormondengi, Kingcross."



**I**N extending to every reader of the *Wireless World* a hearty invitation to visit Radio Corner, our new Retail and Demonstration Showrooms, we have every confidence in stating that no matter what your Wireless requirements may be, we are in a position to supply them to your entire satisfaction. Should it be Broadcast or Experimental Receiving Sets, we have a splendid range for you to select from. The same applies to accessories for building up any radio apparatus whatever. This means your requirements can be met in every way.

If unable to pay us a visit, by all means write for our two illustrated and descriptive catalogues "G" and "H."

We manufacture our own sets under Marconi Licence; they also have the full approval of the Postmaster-General. May we have the pleasure of seeing you or hearing from you?

WE ARE AT YOUR SERVICE.

**L. MC MICHAEL LTD.**

RETAIL & DEMONSTRATION SHOWROOMS:

**RADIO CORNER (NORFOLK STREET & STRAND), W.C.2**

HEAD OFFICE, TO WHICH ALL CORRESPONDENCE SHOULD BE ADDRESSED;

**HASTINGS HOUSE, NORFOLK STREET, STRAND, W.C.2**

# WIRELESS

Component parts for Wireless a Speciality  
 :: :: Complete Cabinet Crystal Sets :: ::  
 :: :: Build Your Set by Degrees :: ::  
 All Suitable Tools and Materials in Stock

*Wireless List now ready sent  
 post free on application.*

**RICHARD MELHUISS LTD.**  
 Tool, Machine & Hardware Merchants, Electrical Engineers  
 50, 51 & 84, Fetter Lane, E.C.4

Telephone: 1611 (3 lines) Holborn. Established 1828. Telegrams: "Workfolk, London."  
 Awards for Excellence of Tools and Machines:  
 Bronze Medal 1884. Gold Medal 1890.



## T. E. C.



Patent  
 Spring  
 Connec-  
 tions  
 are  
 specially  
 adaptable  
 for  
 Wireless  
 Work.

**PATENT**

**SPRING CONNECTIONS**  
 IN NUMEROUS SIZES & DESIGNS

<p><b>SIMPLE                  STRONG                  CHEAP                  EFFECTIVE</b></p>		<p><b>LARGE                  STOCKS                  PROMPT                  DESPATCH</b></p>
--	---	---

**The EFANDEM CO. LTD**

PHONE 1123 FALLINGS PARK WORKS WOLVERHAMPTON TELEGRAMS "EFANDEM"

**Ask for Samples and Illustrated Price List.**

Patent  
 Spring  
 Connec-  
 tions  
 are  
 specially  
 adaptable  
 for  
 Wireless  
 Work.



## COMBINED VOLTMETER FOR H.T. & L.T. BATTERY.

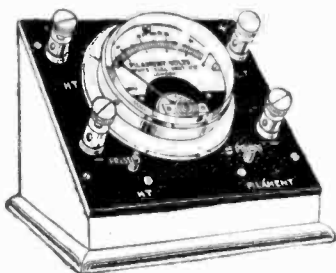

High Resistance. Foolproof.  
Neat and Compact.  
Terminals marked in plain  
letters.

Reads to 100 volts on H.T.  
and 10 volts on L.T. Battery  
by merely pressing the button.

**Price £4 each**

POST FREE. CASH WITH ORDER

(For higher readings, prices on application).

### WHITE ELECTRICAL INSTRUMENT CO. LTD.

2, 4 and 6, Gloucester Street, Clerkenwell, London, E.C.1

Telegrams : Voltograph, London.

'Phone : City 8660.

## RADIO & MODEL ENGINEERING

Edited by

M. B. SLEEPER.

Price **7d.** monthly. Post free **8d.**

Subscription **7/-** per annum.

An American magazine of good quality devoted exclusively to the Construction of Radio Apparatus which can be built at home.

Each article is illustrated with excellent photographs and diagrams.

Several Receiving Circuits are given in every issue.

Sole European Agents :—

**The Wireless Press Ltd.**

12/13 Henrietta St., London, W.C.2

## SEA, LAND and AIR

THE AUSTRALIAN  
MONTHLY JOURNAL  
of Aviation, Radio-Tele-  
graphy & Radio-Telephony

Price  
**1/9**  
Post Free

Annual  
Subscription  
**21/-**

**THE WIRELESS PRESS LIMITED**

12/13, Henrietta St., London, W.C.2

# PRELIMINARY ANNOUNCEMENT

*A HIGHLY EFFICIENT AND  
EXQUISITE LOUD-SPEAKING  
RECEIVING CABINET  
IS NOW OFFERED  
TO THE PUBLIC*

WRITE TO-DAY FOR ILLUSTRATED BROCHURE  
GIVING FULL PARTICULARS OF THIS  
REMARKABLE **4** VALVE

# LISTOLEON

RADIOPHONE  
DE LUXE CABINET

TRADE BUYERS ARE REQUESTED  
TO PLACE ORDERS IMMEDIATELY  
: TO ENSURE EARLY DELIVERY :

RADIOPHONES L<sup>TD.</sup>

"SIMPLICITY  
WITH  
SATISFACTION."

1a GRANVILLE PLACE  
MARBLE ARCH  
LONDON, W.1

TELE { 'Phone-MAYFAIR 1250  
'Grams—RADPHOLIM,  
BAKER, LONDON

The Famous  
"Ashdown"



Resistance  
Price Reduced from Feb. 1

Regd. No. 691772

By our improved methods of manufacture we are now able to supply the ASHDOWN Filament Resistance at a reduced price, while at the same time using Erinoid instead of ebonite for the former, which makes for higher efficiency and a still more substantial job. At the reduced price the ASHDOWN is by far the best value in the country—

**Now 3/6** The attention of the trade is drawn to the fact that this is a Registered Design

Traders should send (on printed note heading) for sample Resistance, and liberal discount rates, post free 2/9. Many of the largest manufacturers are now fitting ASHDOWN Filament Resistances as standard to their sets.

Send in your orders NOW, as there is a huge demand. London Representative: Mr. J. O. Maddock, 11, Bayham Road, Bedford Park, W.

**H. E. Ashdown (Birmingham) Ltd.**  
**Perry Barr—Birmingham.**

\*Phone: Northern 859. Tel.: Segment.  
Code: ABC 5th Edition, Western, etc.

BUTLER'S RELIABLE  
MANUFACTURES.  
**Broadcast Sets**

BEFORE BUYING ELSEWHERE  
SEND FOR OUR FULLY  
ILLUSTRATED  
LIST.

Post **4<sup>d</sup>** Free.

**H. D. BUTLER & Co., Ltd.**

Showrooms and Offices: **222, Great Dover Street.**

Telephone—HOP 3029.

Works—HALTON ROAD, CANONBURY.

**Variable H.T. Batteries**



The W.A.S. Variable H.T. Batteries will increase the efficiency of your set, and give you undistorted speech and music.

These batteries being made from a special formula have a longer life than any other make on the market, and are perfectly SILENT in working.

**PRICES.**

30-VOLT, tapped every 3 volts . 7/-  
60-VOLT, " " " " " 13/6

Trade Supplied.

The above prices include insulated Wander Plus.

To be obtained from most Radio Dealers, or Post Free from Sole Manufacturers—

**W. A. SAXBY & CO.**

3, Gayford Road, Shepherd's Bush, London, W.12.  
Telephone: Hammersmith 443.

**AN EFFICIENT 2-VALVE RECEIVER**

Complete with Valves, Telephones (4,000 ohms), H.T. Battery, L.T. Accumulator, and Aerial.

**The RE-ECHO £12 (Plus Tax)**

**Special Offer**

**CRYSTAL SET**  
complete with  
phone, aerial,  
etc.

**£3 : 10 : 0**  
(Plus Tax)

For perfect reception of broadcasting & also Morse from very long distances—We are the actual manufacturers of all our wireless receiving sets and spare parts.

EVERY RECEIVING SET IS:—

- (a) Thoroughly tested by experts before leaving our works.
- (b) Guaranteed to be highly efficient in every respect.
- (c) Stamped with the Registered Number of the G.P.O., and bears the B.B.C. Stamp.

**THE RE-ECHO WIRELESS MANUFACTURING Co., Ltd.**

(Dept. B.)

**16a HATTON WALL, LONDON : E.C.1**

\*Phone: Holborn 6081.



Send for an Illustrated Price List free. Trade enquiries invited.



66 **POLAR** 99

*Chosen for GOOD*

## CONCENTRATED EFFICIENCY



### —the Condenser Condensed

The new "Polar" Variable Condenser embodies *maximum efficiency* with *minimum dimensions* at *minimum cost*.

Made in three ranges :—

- 0001 to ·001 mfd.
- 00005 to ·0005 mfd.
- 00005 to ·0003 mfd.

All types are of the same dimensions, 3" × 3½" × 1", and sold at the same price :—

- 14/9 for panel mounting. Post free.
- 20/9 mounted in polished wood case. Post free.

## POLAR THREE-COIL TUNING STAND

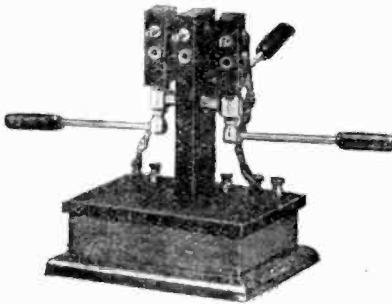

Of sound design, good workmanship and fine finish.

The centre coil is rigid while the outer ones can be rotated independently about their axes of support, or swung both together in planes parallel to that of the fixed coil. The former movement is controlled by two independent handles, one at each side, the latter by a single handle at the rear. The length of the handles is such as to prevent the hands of the operator from adding temporarily to the capacity while making the adjustments.

The coil holders are of ebonite arranged for standard coil-plugs. They are carried on solid brass swivels. The whole is mounted on an ebonite panel supported by a polished wood base. All brass parts are highly lacquered and the complete instrument is finished in a first-class manner.

Price 31/- Post free.

## THE RADIO COMMUNICATION CO. LTD

*(Suppliers of the G.P.O. Installations at North Foreland (G.N.F.) and Seaforth (G.L.V.), of Coastal Stations for various Colonial Governments, and of Ship's Radio for most of the Great Shipping Companies.)*

**34/35, NORFOLK STREET, LONDON, W.C.2**

BRANCHES—NEWCASTLE—17 Sandhill. GLASGOW—116, Hope Street. LIVERPOOL—57 Dale Street.  
CARDIFF—Atlas Chambers, James Street. SOUTHAMPTON, 19, Queen's Terrace.  
WARRINGTON—37, Bridge Street.

## ACCUMULATOR RUN DOWN?

You must have experienced this nuisance just in the midst of a perfect concert.

Why not **CHARGE** your own cells **AT HOME** from the **Lighting Supply**?

We offer you the necessary so that this is possible at a cost equal to one lamp burning only.

For Direct Current Supply **£9:0:0**

For Alternating ,, ,, **£7:0:0**

**GUARANTEED SATISFACTION** or money returned. Full details,

**G.W.I. Ltd.** (Electrical Dept.)

**IMPERIAL WORKS, SHANKLIN RD.,  
CROUCH END, LONDON, N.8.**

Tel. : Hornsey 3065.

## A GREAT SUCCESS Valve Renewal SOLVED

You must have experienced the annoyance and disappointment by your favourite **VALVE** failing suddenly—"filament burn-out"

**The renewal problem has now been solved.**

We undertake to renew your broken filaments and return valves guaranteed equal to new. **TRY A SAMPLE—NO RISK.**

**7/6** EACH. POST FREE.

*Sole Distributors (London & South of England)*

**G.W.I. Ltd.**

**IMPERIAL WORKS, SHANKLIN ROAD,  
CROUCH END - - - LONDON, N.8**

*Tele.—HORNSEY 3065.*

## THE AUDIOPHONE EMPLOYING THE UNIT SYSTEM.

### SPECIFICATION.

Highly skilled hand labour throughout. Bare, tinned internal wiring, bent on formers, and soldered at all connections, thus ensuring a noiseless circuit. Polished ebonite panel, engraved white. Polished mahogany cabinet. Wavelength range 300-550 m.

Higher wavelengths obtained by means of plug-in-coils.

Fully approved by P.M.G.

**IMPORTANT:** Fixed Reaction is a feature of this Receiver.

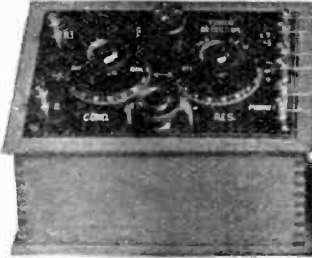

P.M.G. Reg. No. 1018.

### TUNER DETECTOR.

Price as shown . . . . . **£7 7s.**  
Complete with all accessories **£11 15s.**  
All components & accessories supplied.

Prices include Marconi Royalty and commission to B.B.C.

**TERMS.** Cash with order, or five days' approval against full deposit.

Manufactured under Marconi Licence by—

**J. R. WRIGHT**

Head Office and Factory **10, Carton St., Baker St., W.1**

Demonstration Showrooms:  
**3, New Quebec Street, W.1. (Phone 3848 Paddington.)**

## ENGRAVING

Machine Engraving  
on Ebonite Boards

Your Ebonite Boards neatly  
and accurately engraved.

No Order too large or too small  
**SPEEDY DELIVERIES  
CHEAPEST IN LONDON**

Ebonite boards supplied, drilled  
and engraved accurately to your  
dimensions.

**SEND US A TRIAL ORDER.**

**S. MARKS & SON**

*Engraving Works,*

**7-8, Carthusian St., Aldersgate St., E.C.1**

*Telephone No: CITY 5040.*

**SKINDERVIKEN BUTTON.**

**THE SUPERSENSITIVE MICROPHONE.**  
World-wide Patents.  
ENGLISH Manufacture.  
For LOUD SPEAKERS. MICRO AMPLIFIERS, ELECTRICAL GRAMOPHONE REPRODUCERS.  
Invaluable as Detectiphone, as it can be used in ANY POSITION, i.e., either HORIZONTAL or VERTICAL.

**PRICES.**

Type "A"—Carbon Electrodes (eliminating all "frying" noises) . . . . . each 7/6  
Type "B"—Brass Electrodes . . . . . " 5/-  
Receivers (special Low Resistance) . . . . . " 10/-  
Gramophone Attachment (for Electrical Reproduction) . . 1/-  
BOOKLET (16 Pages fully illustrated) containing much useful information for all interested in Electrical Sound Transmission. . . . . POST FREE 6d.

Sole Proprietors—  
MICRO, LTD., 274/276, Pentonville Road, London, N.1.  
(Opposite King's Cross (Met.) Railway Station).

## PRESSLAND ELECTRIC SUPPLIES LIMITED.

*Managing Director:*  
**CLIFFORD PRESSLAND, A.M.I.E.E.,**  
Hampton-on-Thames.

*Wholesale only.*

Our 1923 Radio Catalogue is now ready and will be sent on application to any *bona fide* Trader.

## REPUTATION

WIRELESS SETS FIXED FREE ANYWHERE IN LONDON  
YOU are INVITED to "LISTEN-IN" at OUR SHOWROOM ANY EVENING, 7-10 p.m.

1 VALVE SET COMPLETE, £11 (plus Royalties).  
2 VALVE SET COMPLETE, £14 (plus Royalties).  
3 VALVE SET COMPLETE, £26 5s. (plus Royalties).  
Rotary Switches, from 3/6 Brunet " Headphones 22/6  
Filament Resistances . . 3/6 H.F. Transformers from 6/-  
Valve Holders . . 1/-, 1/3 Intervalve Transformers 17/3  
Insulators, Egg 3d., Shell 5d.  
EBONITE PANELS, cut to any size, 1d. per square inch.  
COILS wound to any specification.  
ALL WIRELESS Parts in Stock.

**ROBERT WRIGHT & CO.,** 34/36, OXFORD STREET, W.  
Telephone: Museum 5134.  
(Next Frascati's)  
*Immediate Delivery by Return of Post. Terms: Cash with Order.*

## Really Satisfactory BROADCAST RECEIVING SETS

Including all Royalties Complete  
FROM . . . . . **£3 15 6**

Full particulars and details from

**G. W. I. Ltd. (Wireless Dept.),**

Imperial Works, Shanklin Road, Crouch End, London, N.8

*Tel.: Hornsey 3065.*

## CAPPER BROS. FOR ALL RADIO REQUISITES

Agents for **LESLIE McMICHAEL, LTD.,**  
for Woking and district.

Single Valve Sets . . . . .	£5 5 0
Two Valve Sets . . . . .	8 8 0
Three Valve Sets . . . . .	14 14 0
Four Valve Sets . . . . .	25 0 0

**89-93, CHERTSEY ROAD, WOKING**

## RADIO MASTS

Send for full specification and drawings of my LIGHT STEEL MASTS, in 10' sections. Easily Transported. Easily Assembled. Easily Erected.

**PRICES.**

Complete, ready for erection, including galvanised fittings, stay wires and tighteners, ground anchors, etc., and CARRIAGE PAID any Railway Station in England or Wales,  
30' . . . . . £3 15s.      40' . . . . . £4 10s.      50' . . . . . £5 10s.  
Carriage Paid Scotland, above prices plus 6 per cent

**H. LONGTON, A.M.I.Mech.E.,**  
43, Johnson Street, Westminster, S.W.1.  
(See also adverts in "Wireless World" of November 18th and December 30th.)

## Radcom Intervalve Transformer.

An Instrument of superior design and efficiency, the result of extensive research.

Core of best quality coated Stalloy Iron. Coil of enamelled wire in spaced layers insulated with glassine paper, and the whole impregnated and covered with polished ebonite sheet.

Patent Spring Clip Terminals.

## Radcom Rheostats, Coils, Tuners, Batteries.

Retail orders value £2, not exceeding 11 lb. weight, carriage paid.

**Radio COMPONENTS LTD.**

**19, RATHBONE PLACE,  
LONDON - W.1**

Telephone - Museum 3485.  
Telegrams - Radpunits,  
Westrent, Lon L.N.

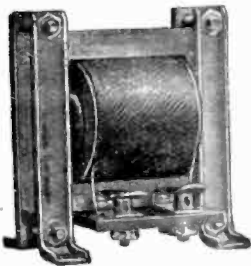

Price **22/6** each.

# The London Telegraph Training College, Ltd.

Telephone: WESTERN 2606. Morse House, Earl's Court, S.W. ESTABLISHED 25 YEARS  
 OFFICIALLY RECOGNISED BY THE WAR OFFICE AND POST OFFICE AUTHORITIES  
**CABLE AND WIRELESS TELEGRAPHY.**

**P**ARENTS desirous of placing their sons in either of the above Services and of affording them the best training facilities should apply for particulars of Courses and the methods of instruction which place this Institution in the first rank. Cable Telegraphy offers at the present time excellent prospects to youths from 15 years of age and upwards, and the College has exclusive facilities for obtaining posts for qualified students in the leading Cable Companies at commencing salaries of £150 to £300 per annum, with yearly increments of £12 to £25, and ultimate possibilities of obtaining positions as Supervisors, Assistant Superintendents, Managers, etc. In the Wireless Telegraph Service the commencing remuneration at the present time is approximately £150 per annum, and operators when qualified are nominated by the College for appointments as and when they occur. No correspondence classes or branches.

### DAY AND EVENING CLASSES.

Prospectus containing all information will be forwarded on application to THE SECRETARY (Daez. H.), 26a, Earl's Court Road, Earl's Court, London, S.W.3.  
 Sole Proprietors of the "Scott" Training Disc, which contains useful formulae and other information for Wireless Telegraph Operators and is invaluable to Army Signalling Officers for range finding, etc.  
 Price, complete with instructions for use 1/- Postage 2d.

Our new 24 page catalogue, 4d. post free, gives the price of everything from a Transformer to a contact stud.

## CARTWRIGHT'S SCIENTIFIC COMPONENTS

Made by experts in our own works.  
 You cannot afford to buy inferior apparatus.

### LOW FREQUENCY TRANSFORMERS

In designing our Low Frequency Transformers we have endeavoured to combine efficiency with a high rate of production, enabling them to be sold at a reasonable price.

The core is of laminated stalloy iron, each lamination being insulated with a special material—not paper—and is of correct weight.

The windings are in correct ohmic proportions. They are moisture proof, and no reliance whatever is placed on the insulation of the wire itself, as each turn is separated from its neighbour with silk. The windings are all subjected to a flash test and other tests prove that they are practically immune from breakdown, heavy wire being employed in winding.

By using our L.F. Transformers you are assured of obtaining maximum amplification without distortion.

Price 22/6 each.



We are the **CHEAPEST FIRM ON EARTH** for stamped, turned or moulded components  
 Complete Sets shortly ready. Special Terms to the Trade.

## J. L. CARTWRIGHT & CO.

(DEPT. W.)

24, LONDON ROAD, MANCHESTER

'Phone: CENTRAL 4209. Works: Berry Street. 'Grams: "PLADURAM," Manchester.  
 Business Hours, 9 a.m. to 6 p.m., except Fridays, 9 a.m. to 8 p.m. Saturdays, 9 a.m. to 1 p.m.  
 Wholesale Agents for Scotland—J. CORSTON SINCLAIR & CO., 47, Waterloo Street, Glasgow.



See our stand at the forthcoming All-British Wireless Exhibition, Burlington Hall, Burlington Street, Manchester.

WITH GOOD APPARATUS YOU  
 CAN GET GOOD RESULTS  
 THE "W.P."

## Morse Practice Key

Well Made First-class Finish. Thoroughly Reliable.

Price 7/6 Post Free

THE WIRELESS PRESS, LTD.  
 12-13, Henrietta Street, London, W.C.2

## Questions and Answers COUPON

To accompany Questions sent in during the week commencing Feb. 10th, 1923.

VOL. XI, NO. 19.

See Conditions on Page 643.

# We Know you'll keep it

**BECAUSE**—The **RADIONETTE** offers the highest efficiency with a specification and equipment second to none, and therefore we will send it to you for a **SEVEN DAYS FREE TRIAL IN YOUR OWN HOME**.  
If you are not satisfied return it and we will refund your money.



## 'TIS RESULTS THAT MATTER!

THE **RADIONETTE** GUARANTEES MAXIMUM RESULTS IRRESPECTIVE OF PRICE AT MINIMUM COST, AND INCLUDES PAIR OF **SIEMENS 8,000 OHM HEADPHONES**, TWO **CRYSTOR** AERIAL INSULATORS, 100 ft. Copper Aerial Wire.

———— YOU "LISTEN IN" at ONCE! NO EXTRAS. ————

———— PRICE, **£3 : 10 : 0** inclusive of B.B.C. DUTY. ————

**Stocked by all Leading Wireless Stores Everywhere**

SOLE DISTRIBUTING AGENTS :

**WIRELESS AGENCIES, Ltd.**  
64, Mortimer Street, London, W.1.

\*Phone—MUSEUM 2672.

\*Grams—Astragonax, Wesdo, London.



FILAMENT RESISTANCES	..	each	2/8
SWITCH ARMS	..	each	1/9
CONTACT STUDS	..	doz.	9d.
TERMINALS	..	doz.	1/4
FIXED CONDENSERS	..	each	2/5
IVORINE SCALES	..	each	5d.
EBONITE SLIDERS	..	each	5d.

## DOUBLE HEADPHONES

4000 OHMS. STAMPED B.B.C.  
21/6

ORDERS IN STRICT ROTATION.  
TRADE ENQUIRIES INVITED.

We are devoting our Coach Building Dept. to the manufacture of Cabinets of every description; for the smallest Crystal Set or for the de luxe Cabinet. Quantities from a dozen upwards only.

**ABRO MOTOR COMPANY**  
184 & 186, London Road, and  
73 & 75, Downing St., Manchester.  
Works—Hague St. Phone : 6142 Central.



### 'PHONES

**NEW ARMY**  
for Crystal or Valve Sets,  
without Transformer, 10/-.  
Double Cord, extra 2/-  
Postage 9d.

Single Earpieces, 4,000  
ohms .. .. . 9/-

**THE BARGAIN HOUSE  
FOR ACCESSORIES.**  
SEND FOR OUR COM-  
PLETE LIST.

Intervalve Transformers,  
10/6. Postage 9d.

Intervalve Transformers,  
Army, 15/- and 18/6.  
Postage 4d.

Intervalve Transformers,  
British, 16/6. Postage 6d.

Condenser Vanes, doz. prs.  
3½d. Postage 2d.

Condenser, Plate top and  
bottom bushed, 9d. each.  
Postage 3d.

Broadcast Coils for sliders.  
2/6. Postage 6d.

Sliders, ebonite, with  
plunger, 4d. Postage, 1d.

Brass Rod, drilled, ½" 13"  
square, 4d. Postage 2d.

As illustration, 22/6.  
Postage, 9d.

Coil-Holders, 2-way, 7/6.  
Postage 3d.

Coil-Holders, 3-way, 10/6.  
Postage 3d.

Detectors, Crystal, com-  
plete, 2/9. Postage 3d.

Spacer Washers, large, 4d.,  
small, 2½d. doz. Postage  
3d.

Volt and ammeter com-  
bined watch patt., special  
purchase, 8/6. Postage  
3d.

**PUGH Bros.,** 95/101, Holloway  
Road, London, N.7

# WIRELESS

Ideal Homes Exhibition  
Edinburgh

JANUARY 31 to FEBRUARY 17

Continuous Demonstration  
ON

**STAND No. 150**

1.0 P.M. — 5.0 P.M.  
LOCAL TRANSMISSION By  
Special Permission from Post-  
master-General.

5.0 P.M. — 10.0 P.M.  
PARIS, HOLLAND, LONDON,  
BIRMINGHAM and MAN-  
CHESTER.

**SPENSERS (SCOTLAND)**  
LIMITED,  
119, GEORGE STREET, EDINBURGH

## Try "Erinoid"

THE PERFECT INSULATOR

**Non-Inflammable**  
For Panels, Cabinet Tops,  
Knobs, Handles and Small  
Parts :: Panels Cut and  
Drilled to any Template.

*Trade only.*

**E. DAY (St. Albans) LTD.**

*Manufacturers of Erinoid Articles,*

**ST. ALBANS.**

London Office (V. H. COHEN) :

9, Trump Street, E.C.

Telephone : City 9157.

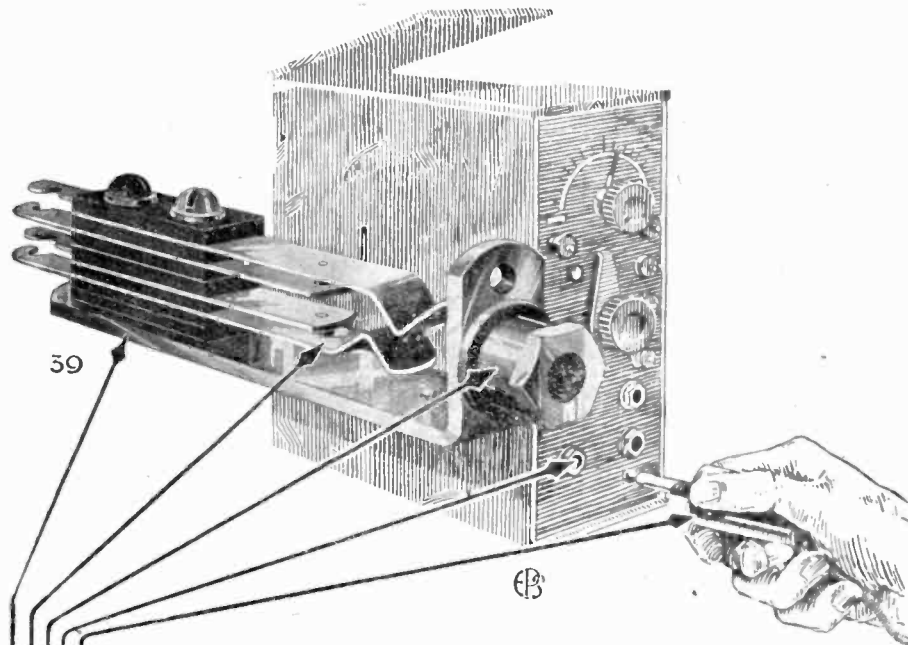

GET THE BEST OUT OF YOUR SET BY USING

## THE ELWELL JACK SYSTEM.

(a) Any standard telephone plug can be used but preferably the special spiral Elwell plugs which are fitted with self-tightening connection grips.

(b) The Jacks fit neatly on the panel and being heavily nickel plated add considerably to its appearance.

(c) They are easily fixed to any panel up to  $\frac{1}{8}$  inch thick. No fixing screws are required.

(d) Five types of jacks are available from a simple telephone jack to one controlling telephone, transformer and filament battery.

(e) Insulation tested up to 1,000 volts.

Once connected up on the Elwell Jack System your receiving set becomes far more convenient to use both for broadcast reception and for experimental purposes. The following operations become quite automatic:—

1. Filaments switched on.
2. Telephones or loud speaker put across any desired number of valves.
3. Intervalve transformers disconnected at point of insertion thus ensuring maximum efficiency.
4. Only the required number of valves light "p". The remainder stay out of circuit.
5. Removing Plug completely switches off set. No errors can afterwards be made in connections or switching. Loose contacts and broken leads are permanently prevented. Comparative tests of telephones and loud speakers can be made with ease and accuracy.

*Write for descriptive leaflets.*

*Ask for the name and address of the nearest Elwell Service Agent.*

**C. F. ELWELL, LTD.,** *Radio Engineers,*  
(Dept. W.W.) CRAVEN HOUSE, KINGSWAY, LONDON, W.C. 2  
Telephone: MUSEUM 1384.

ELWELL  
High Power  
Wireless  
Stations

Oxford

Cairo

Northolt

Horsea  
Island

Eiffel  
Tower

Lyons

Nantes

Rome

& others

ELWELL  
WIRELESS

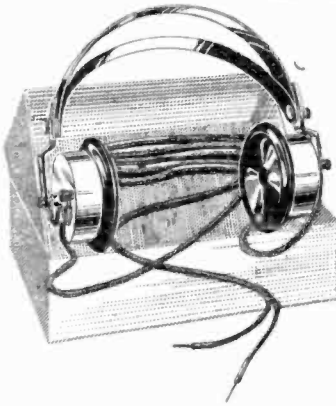

## GREAT BARGAIN OFFER

### 4,000 ohm PHONES (NEW)

at 17/6 Per Pair.

Postage 9d. extra.

Fitted headbands and cords, beautifully finished, thoroughly efficient. Each pair carefully packed in box. SATISFACTION GUARANTEED.

### BROADCASTING RECEIVING APPARATUS.

The "JOYPHONE" (Reg. No. 0138) approved type, 2 Valve Set, complete from £15 : 0 : 0

Special Offer at Reduced Prices of our

### NEW INTERVAL VALVE TRANSFORMER

Owing to the unexpectedly large sale of these instruments we are enabled to reduce the price to "Wireless World" readers to

**12/4**

Postage 9d. extra.

Fitted with panel fixing plate and earthing wire for iron core. Fully tested. Ratio 5 : 1.

All valve apparatus manufactured by us is duly licensed under Marconi's Patents for amateur use in Great Britain. Approved by Postmaster-General.

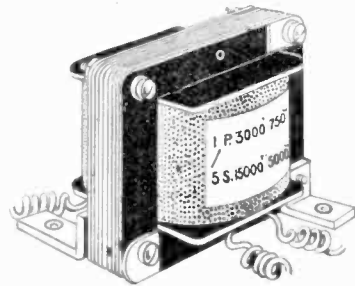

#### TERMINALS

4 B.A. Double Solid Brass or Plated 2/- per doz. (post extra).  
2 B.A. Single Solid Brass or Plated 9d. per doz. (post extra).

We have enormous stocks of ex-W.D. WIRELESS GEAR, too numerous to mention, at absurdly low prices. Write for particulars of your requirements, or better still, call and see our enormous stocks.

**J. LIPOWSKY & CO.** 814, OLD FORD ROAD,  
Near Old Ford Station N.L.Rly. Telephone : EAST 3345. BOW :: LONDON, E.3  
Nos. 8 or 39 'Bus.

## Neat Lettering

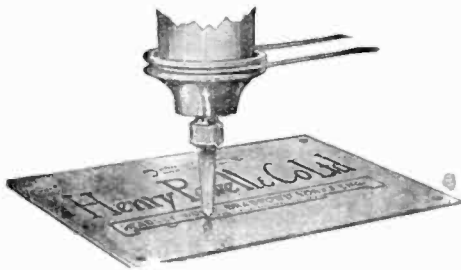

Cutter at Work.

gives that finished appearance to a wireless set which often attracts the customer.

The Taylor-Hobson Engraving Machine engraves letters and figures on wireless apparatus accurately and at surprisingly low cost.

The machine is easy to operate. Hundreds of letters and figures can be engraved per hour, and with an accuracy which is impossible by hand.

Send for a descriptive catalogue to-day.

**TAYLOR, TAYLOR & HOBSON, LTD.**

74a, Newman Street, London, W.1  
Works : LEICESTER.

# EVERYTHING FOR WIRELESS

Crystal Sets	“ “ “	from	£2 0 0
Valve Sets	“ “ “	“	£2 10 0
Telephones	“ “ “	“	£1 10 0
Transformers	“ “ “	“	£1 0 0

Honeycomb Inductances, Batteries, Accumulators, Loud Speakers, Amplifiers, Tuners, Valves, Detectors.

## BROADCAST RECEIVERS

24 page illustrated catalogue free.

The MEDICAL SUPPLY ASSOCIATION Ltd.

167-185, GRAY'S INN ROAD, LONDON, W.C.

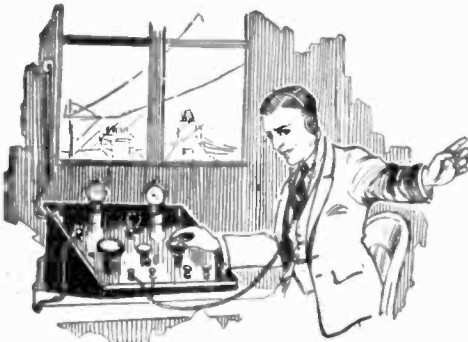

2,000 ohms pair :£1/-  
 4,000 ohms pair :£2/-  
 (All resistances in stock.)

“The Services use them.”

“ S S H!—PCGG  
 is coming through!”

IT'S waste of time trying to tune continental or distant stations through inferior 'phones. Perhaps you're using reconditioned headpieces. As often as not they're pure “junk.” And however expensive and selective your set may be, “dud” 'phones won't pick out weak signals.

Fit ERICSSON 'PHONES. *The Services use them—* for their never-failing selectivity, sensitivity and ability to stand up to the hardest test. The Admiralty adopted them as standard in 1909, the R.A.F. in 1917.

Light and easy to the head, robust in construction, delicate and sensitive in operation.

Write for free illustrated list.

BRITISH L. M. ERICSSON MANUFACTURING Co., Ltd  
 International Buildings,  
 67/73, Kingsway, W.C.2.

**Ericsson**  
 TELEPHONES

**“ WHALE FOR WIRELESS ”**

PHONES—Brown's, 4,000 or 120 .. 30/-  
 Brunet, 4,000 .. 21/6  
 VALVES—“ R ” Type .. 12/6 & 14/-  
 “ Q ” or V24 .. 15/-  
 INSULATORS—Reel .. 13d.  
 Egg .. 3d.  
 Coil Mounts, ebonite .. 1/3  
 Condenser Plates, 24 .. 1/-  
 Condenser enclosed Vernier .. 8/-  
 Phonophane holders .. 4/-  
 Receiving set complete from 25/- Complete with Aerial  
 Wire, Insulators and pair of Phones, £2 10 0.  
 N.B.—Do away with your crystal or valve detector and fit  
 our PHONOPHANE, 15/- each. Call for demonstration.

**A. WHALE & CO.,**

201, POWIS STREET, WOOLWICH, S.E.18.  
 Phone: Woolwich 548.

**ACCUMULATORS**

HIGHEST QUALITY. LOWEST PRICES.

4 Volt 40 Amp. 18/6    6 Volt 40 Amp. 26/3  
 4 „ 100 „ 30/-    6 „ 100 „ 43/6  
 In celluloid cases.  
 4 Volt 24 Amp. (celluloid) 11/9.  
 2 Volt 16 Amp. (in ebonite) 3/9.

**SPECIAL.**

6 Volt 40 ACTUAL Amp. full in 3 Glass Cells,  
 sealed tops in solid teak crate, 11 plates per cell

**49/6**

**GOOD TRADE DISCOUNT**

**WIRELESS GOODS.**

**COIL PLUGS MOUNTS 1/9 each**

**Knife Switches**

on Ebonite and on Porcelain.

Large stock. Low prices.

**VARIOMETERS**

in Ebonite for panel mounting wound for

200 metres max. wavelength  
 600 „ „ „  
 1,300 „ „ „

Price **14/6** each.

Complete with knob and dial.

Write for Price Lists.

**F. YATES & SON, LTD.**

WHOLESALE ELECTRICIANS,

144 Church St., Kensington, London, W.8

Phone: Park 4276.

One minute from Notting Hill Gate Station.

**THE MARK OF**

**RELIABILITY**

Filament Resistances

**2/-**

EACH

Panel Type with Knob and Pointer



Potentiometer 300 ohms

**4/6**

EACH

Panel Type of Ebonite

1 to 12 Volts.

1 to 35 amps.

**VOLT & AMMETER**

Combined Dead Beat Pocket Type. New and not German. Splendid Instrument in Nickel Plated Case. Ideal for Testing Cells and Filament Current.

POST PAID **5/6** NUMBER LIMITED

**OTHER EXCEPTIONAL VALUES**

Aerial Wire, Bright Hard Drawn, 7/22's, copper, 3/6 per 100'. Enamelled, 7/22's, 4/9 per 100'.  
 Aerial Insulators, Shell Type, 2" x 2 1/2" 9d. Reel 2d.  
 Igranite Coils. Full range stocked from 5/-  
 H.F. Transformers (Ooiah), plug in type, 300 and 700 metres, 4/6 each; 1,000 metres, 5/8; 2,600 8/-  
 Ebonite 3-Coil Holder, 10/- 2-Coil 8/-  
 H.F. Transformers. Formers only, with pins, each 1/6  
 Telephone Transformers (Army type), 9/- each.  
 L.F. Transformers, 15/- each. Radio Inst. make, 25/-  
 Vernier Condenser, 5-Plate for panel mounting, 4/-  
 3-Plate, 3/6; 001, 10/6; 0005, 7/-; 0003, 8/6  
 Wireless Jacks, with plugs, 1/6 the pair. Jacks only, each 1/-  
 High Note Buzzer (Army type), worth treble, 3/-  
 Tapping keys, 2/- Aluminium cased, 2/6  
 Lightning Arresters. Carbon block type .. each 1/-  
 Valve Holders. Flanged "A" type, 1/- Ebonite with 8 nuts, 1/- each. Unequalled quality, 1/3.  
 Ebonite Panel, fitted with 3 valve holders, complete 2/9  
 Ebonite Panel, fitted with 2 valve holders, complete .. 2d.  
 Valve Sockets, per set of 4 with 8 nuts, 6d. Pins, each 3/-  
 Transformer Holder, with 4 terminals and wired, each 1/6  
 Mica, clear ruby .002" thick, 3" x 2", doz. pieces 8d.  
 Inductance Slider Rod, 1/2" square, 13" long, drilled, each 6d.  
 Slider, complete with plunger for 1/2" rod .. each 6d.  
 Contact Studs, fitted with nut and washer .. doz. 1/-  
 Condenser Vanes, best aluminium, 3 1/2", doz. pairs 1/-  
 Condenser Spacing Washers, small, 3d.; large, 5d. doz.  
 Condenser Screwed Rod, brass, 12" long, 1/4", 4d.; 3/16", 6d.  
 Terminals, Mark 3N, plated or P. brass, 4 B.A., doz. 2/6  
 Terminals, small pattern, 9d. doz.; spade type, doz. 6d.  
 Dubilier Condensers. All capacities at prices advertised.  
 Skinderviken Microphone Buttons .. each 5/-  
 Fellows 4,000 ohms Headphones, with cords .. 21/-  
 Brown's Featherweight Phones, 4,000 or 120 ohms .. 30/-  
 Valves, Marconi-Osram R .. 17/6  
 Guaranteed safe delivery, 3 Valves.

Ebonite Panels, matt surface, ground edges 3/16", 9" x 6", 2/-, 12" x 9", 4/-, 1 1/2", 9" x 6", 2/6, 12" x 9", 5/-  
 Ebonite Engraved Dials, bevelled edge .. each 9d.  
 Ebonite Engraved Dials, bevelled edge with knob .. 1/3  
 Ebonite Standard Coil Plugs, 1/3, moulded .. 9d.  
 R.A.F. Microphones, exceptional value .. each 2/-  
 Ooiah Basket Coils, set of 7, 150-4,500 m. .. 5/-  
 Ooiah Slab Coils, set of 8, 300-3,000 m. .. 7/8  
 Condensers, fixed type, 1/6, with leak .. each 1/9  
 Sistoflex Insulating Tube, all colours and sizes .. yard 5d.  
 Condenser Scales, engraved, 5d., ebonite do. .. 7d.  
 Accumulators, 2 volt 45 amp. hr., fully charged, 10/-  
 H.T. Batteries. Ever-ready and Siemens all sizes.  
 H.T. Batteries, 1 terminal, 6 sockets, 15 volt. .. each 2/3  
 Dewar Switches. D.P.Co. (New) .. each 13/-

Write for "Complete Supplementary Price List of Exceptional Values," sent Post Free.

All goods sent CARRIAGE PAID, but with orders under 5/6 add 6d. for postage.

**J. H. Taylor & Co.** Electrical & Radio Engineers, Macaulay St., Huddersfield. Telephone: 341. Telegrams: "Thorough," Huddersfield.

## *The Perfect Loud Speaker at Last !*

We have acquired the sole manufacturing rights for the United Kingdom of a Wonderful New Loud Speaker, in principle entirely different to any yet placed on the market. Instead of the unsightly horn which causes distortion of the music and speech, this instrument comprises a handsome cabinet, the top of which is so designed and manufactured from specially tested timber, which is attacked by a volume of air. The principle can be incorporated into any cabinet wireless set, the lid of the cabinet forming the Loud Speaker. It can also be used as a separate instrument as illustrated.

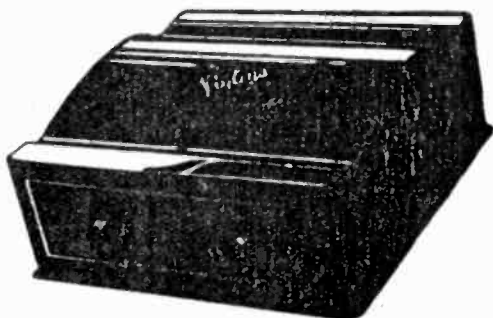

### *The* "VIOLINA" LOUD SPEAKER DE LUXE.

Patented in all countries throughout the world.

#### PRICE

**£5 : 5 : 0** Complete

(Packing and Carriage in U.K. 5/- extra)

When once you have heard this instrument, you will not tolerate any other make. Ask your wireless dealer for a demonstration.

*It is not like a Trombone ! It is not like a Klaxon !! It is as delightful as a Violin!!!*

With this instrument you can hear the voice of the artist, the note of any instrument and the words of the speaker faithfully and perfectly reproduced.

In addition it is an elegant piece of furniture, handsomely French polished, mahogany finished.

Before buying your Loud Speaker make a point of hearing this instrument. Agents wanted in all parts. Enquiries from Manufacturers desirous of incorporating the "Violina" into existing wireless sets cordially invited.

**IF EARLY DELIVERY IS DESIRED, PLACE YOUR ORDER AT ONCE.**

#### READ THIS TESTIMONIAL, TYPICAL OF HUNDREDS RECEIVED.

GATESHEAD.

Dear Sirs,

Many thanks for set (5 valve R.A.F. 10) to hand and also Loud Speaker. This is "the goods" and the finest Loud Speaker in the world. I have tried all makes and I am in a position to know. I am a telephone engineer to trade and can truthfully state it to be the finest and clearest in the world and cheap at twice its price.

Yours truly, A. I. S.

#### IMPORTANT NOTICE.

A FEW WEEKS AGO, we advertised the purchase of a complete Government Wireless Depot, and offered the same for re-sale at astonishingly low prices in accordance with our invariable business rule to **SHARE OUR BARGAINS WITH OUR CUSTOMERS.**

The immediate response to our advertisement resulted in our being "snowed under" with enquiries and orders from all over the country, and it was only through despatch staffs working night and day at full pressure that we were able to keep faith with our customers in respect of our promise to execute all orders **WITHIN 48 HOURS OF RECEIPT.**

It was impossible to deal with the thousands of enquiries as expeditiously as we should have wished, and we again take the opportunity of tending our apologies to all those who unfortunately were kept waiting.

We have now purchased, outright for spot cash, the whole of the Wireless Material recently offered for sale at **WOOLWICH DOCKYARD AND KIDBROOKE R.A.F. DEPOT.**

The work entailed in compiling price-lists of the multitudinous variety is colossal, and it will be two or three weeks before these are available. You can help us considerably by **FILLING IN THE FORM AT THE FOOT OF THE OPPOSITE PAGE.**

You will then **RECEIVE COMPLETE LISTS AS SOON AS AVAILABLE.**

## The City Accumulator Co.

79, MARK LANE, E.C.

Phone: Avenue 1316.

# COMPLETE WIRELESS RECEIVING STATIONS

Including all the necessary wire leads, etc., nothing extra to buy  
**COMPLETE EVEN TO THE LAST SCREW**

All our sets are stamped with the B.B.C. Seal and have been fully approved and passed by H.M. Postmaster-General, and all our Valve Sets are made under Marconi licence.

Crystal Sets numbers 1, 2 and 3 are capable of tuning in all Broadcasting Stations, Amateurs and Ships within a distance of 15 to 25 miles.

**SET No. 1** (P.O. Reg. No. 180), comprising single bar slider, well finished and tested crystal set, mounted on highly polished mahogany platforms . . . . . **£1 12 6**  
 One pair of "Ericsson" double head 'phones, specially wound and designed for crystal set reception . . . . . **1 10 0**  
 18' Aerial Mast, 100' length of our special 12-strand aerial wire, guaranteed 80% superior reception to 7/22 bare copper, insulators, patent lead in attachment which can be fixed in any position on aerial, E. and A. Switch, earth lead and plate, specially designed fixture for upper floor window frame, insulated lead in, screws, etc. . . . . **1 15 0**  
 B.B.C. Fee . . . . . **0 7 6**  
**COMPLETE STATION . . . . . £5 5 0**



**SET No. 2** (P.O. Reg. No. 181), comprising double bar slider, well finished and tested crystal set, with an improved type crystal detector mounted on highly polished mahogany platform . . . . . **£2 8 6**  
 One pair of "Ericsson" double head 'phones as in No. 1 Set . . . . . **1 10 0**  
 Aerial mast and outfit as in No. 1 Set, but 20' high . . . . . **2 2 0**  
 B.B.C. Fee . . . . . **0 7 6**  
**COMPLETE STATION . . . . . £6 6 0**

**SET No. 7** (Reg. No. 2058), comprising an improved type 2-Valve Set (1 detector and 1 high frequency), with variable reaction change-over (long and short) switch, a specially designed tuning circuit capable of tuning in all broadcasting stations, amateurs and ships anywhere in the United Kingdom, and fitted with terminal connections for adding 1, 2 or more L.F. amplifying valves, fitted in highly polished mahogany case . . . . . **£12 0 0**  
 One pair of "Ericsson" double head 'phones, 4,000 ohms . . . . . **1 11 0**  
 Two Ediswan valves (1 detector, 1 high frequency) . . . . . **1 10 0**  
 One special wireless "Lead Hydrate" L.T. battery, 6 volt 40 amp. hours capacity (actual), can be recharged in 10 minutes and the charge is guaranteed to last twice as long as an ordinary accumulator (the battery is also guaranteed two years), complete in enamelled crate with leather carrying strap . . . . . **3 8 6**  
 One H.T. 45 volt battery . . . . . **0 12 6**  
 Aerial mast and outfit as in No. 1 set, but 25' high . . . . . **3 0 0**  
 B.B.C. Fees and Marconi Co. royalties . . . . . **3 0 0**  
**COMPLETE STATION . . . . . £25 0 0**

**SET No. 3** (P.O. Reg. No. 333), comprising a specially designed and tested panel type of crystal set with improved tuning circuit contained in a registered design, solid mahogany sliding lid cabinet with space for head 'phones . . . . . **£3 3 0**  
 One pair of "Ericsson" Double Head 'Phones, as in No. 1 set . . . . . **1 10 0**  
 Aerial Mast and outfit as in No. 1 Set, but 22' high . . . . . **2 8 8**  
 B.B.C. Fee . . . . . **0 7 6**  
**COMPLETE STATION . . . . . £7 7 0**

**SET No. 7a.** As above, specially designed for broadcast reception, fitted in handsome registered design, highly polished solid mahogany close-up cabinet, 21" high, 24" long, with nest for head 'phones and cupboards below for batteries, etc. . . . . **£15 0 0**  
 One pair of "Ericsson" double head 'phones, 4,000 ohms . . . . . **1 11 0**  
 Two valves, as in No. 7 set . . . . . **1 10 0**  
 One L.T. battery as in No. 7 set, but 6 volt 60 amp hours (actual) . . . . . **3 14 0**  
 One H.T. battery 60 volt . . . . . **0 15 0**  
 30' High aerial mast and outfit as in No. 7, but superior quality fittings, etc. . . . . **4 10 0**  
 B.B.C. fees and Marconi Co. royalties . . . . . **3 0 0**  
**COMPLETE STATION . . . . . £30 0 0**

Liberal Discounts Allowed to Retailers, Factors and Exporters.  
 Provincial and Suburban Agents Wanted. Terms, Cash with Order.

**THE AERIAL AND RADIO EQUIPMENT WORKS**  
 WIRELESS MANUFACTURERS & ENGINEERS,  
 TRENMAR GARDENS, LONDON, N.W.10

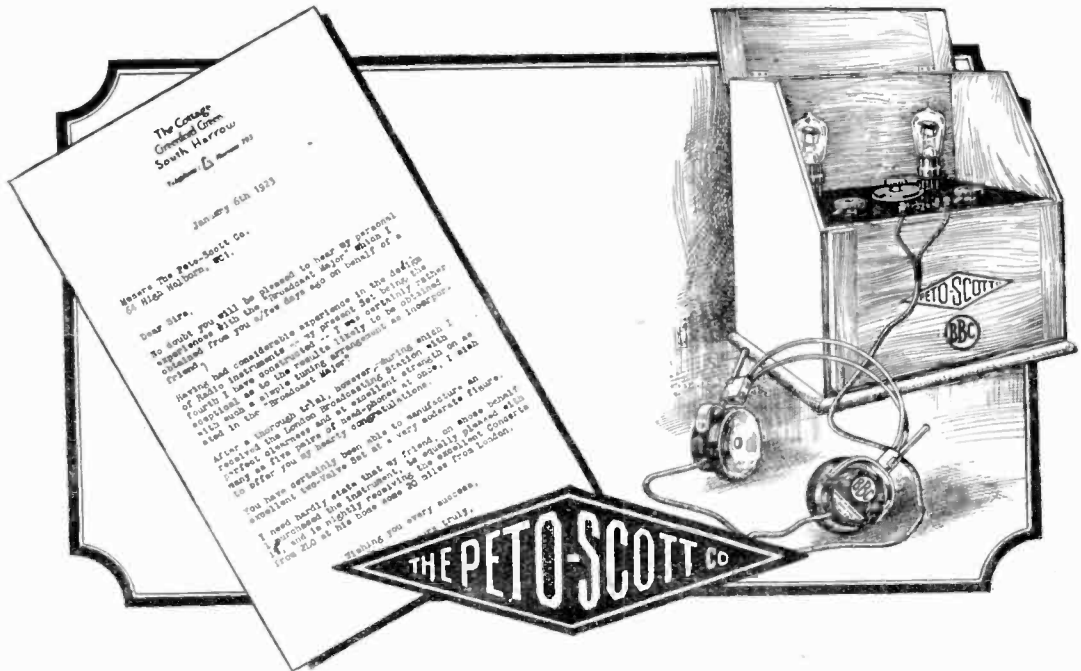

## Sold under a Guarantee which means something !

**I**F you are situated within 25-30 miles from any of the four Broadcasting stations—London, Manchester, Birmingham and Newcastle—you will find that the 2-Valve BROADCAST MAJOR is ideal for you. Not only does it receive loudly and clearly—as many as five pairs of headphones can be in use at one time—but its tuning arrangement is simplicity itself. Merely rotate one dial and any wavelength from 300 to 500 metres—all the Concert wavelengths—is found immediately.

Every instrument, besides being subjected to a critical test on our own Aerial, carries our full Guarantee of complete satisfaction after a seven days trial in your own home or money willingly refunded.

## BROADCAST MAJOR

*Passed by P.M.G.*

The Cabinet is built from solid mahogany, hand-polished throughout, and is fitted with a hinged top and a drop-down front. Included with every instrument is a complete equipment consisting of one pair of Western Electric Headphones, a 6-volt 40 amp. Accumulator and a 60 volt H.T. Battery—both made specially for wireless work to our own specification. The Aerial equipment—also included without extra charge—consists of 150' of copper wire, and two superior insulators.

There is absolutely nothing more to buy, with the exception of the Valves which should be purchased locally owing to risk of breakage in the post.

When this Set is to be used with a Broadcast License, it must be stamped B.B.C., and a royalty of 35/- must be paid at time of purchasing.

The royalty of 25/- due to the Marconi Co., Ltd., is being paid by ourselves.

COMPLETE  
**£9:9:0**

Valves 15/- each extra.

# THE PETO SCOTT CO., LTD.

64, HIGH HOLBORN : : W.C.1



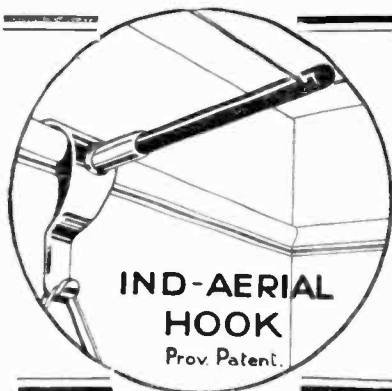

## SAYS MR. MAN:—

“I WANT the Broadcasting and am prepared to buy a Radio set, but I live in a flat and may not have an outside aerial. What can you do for me?

**DEALER!** the answer is **IND-AERIAL HOOKS**

They are essential for a neat, efficient and portable **INDOOR AERIAL**. Attached in a moment to the picture rail of any room they can be taken down just as easily. They support the aerial **ONE FOOT** from the wall on insulated arm, and are no disfigurement.

2/9 each; 31/6 doz. Post Free.

Some Agencies still open in Broadcasting Towns.

**IND-AERIAL CO., 47, Victoria Street, London, S.W.1**

### BROADCASTING RECEPTION SETS

One-Valve Set, Complete for Working .. £7 10s.

Passed for  
Broadcasting  
Licence  
G.P.O. No.  
1038.

SEND FOR  
CATA-  
LOGUE

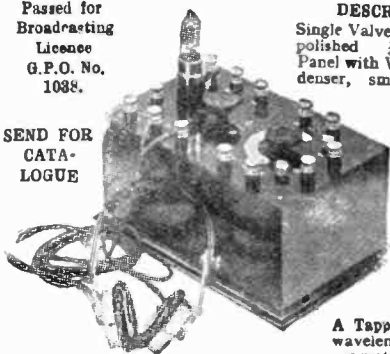

**DESCRIPTION.**  
Single Valve, mounted on polished Ebonite Panel with Variable Condenser, smooth acting resistance, grid leak and condenser and all terminals clearly engraved in white, in a Mahogany Polished Cabinet, 9" x 5" x 5"

A Tapped Coil for wavelengths up to 900 metres with 2 terminals for coils for any higher wavelengths. The coil is enclosed and the tappings are brought out to an 8-way switch mounted in the front of the cabinet.

#### ACCESSORIES INCLUDED:

Siemens' 54 volt high-tension battery with plugs for altering the voltage  
4 volt 50 amp. hour low-tension accumulator in case with carrying strap  
One pair of sensitive head 'phones of 4,000 ohms resistance  
One detecting valve

PLUS B.B.C. ROYALTIES

.. £7 10s.

### WIRELESS INSTALLATIONS LTD.

Dept "O," 81, TURNMILL STREET, LONDON, E.C.  
(Nearly opposite Farringdon St. Station, Metropolitan Railway)

## GENTS'

### "DISCOL" H.F. TRANSFORMER

has become a  
**STANDARD FITTING**  
in the **RADIO WORLD**



and is  
in  
constant  
demand  
by every class  
of user.

We will send  
literature on  
receipt of p.c.

Ask your dealer for

GENTS' "DISCOL" H.F. TRANSFORMER,  
6/8 each, also  
GENTS' "TANGENT" L.F. TRANSFORMER,  
22/6 each.

"Each is packed in cardboard container and easily warehoused"

RADIO DEPT.

**GENT & CO. LTD., Faraday Wks., LEICESTER**

London: 25, Victoria Street, S.W.1.  
Newcastle-on-Tyne: Tangent House, Blackett Street.

## POLISHED EBONITE SHEETS

Wholesale trade only

### PIDGEN BROS.

25, Helmet Row, Old St.,  
LONDON, E.C.1

### "WHALE FOR WIRELESS"

PHONES—Brown's, 4,000 or 120 .. .. .	30/-
Brunet, 4,000 .. .. .	21/8
VALVES—"R" Type .. .. .	12/6 & 14/-
or V <sub>24</sub> .. .. .	15/-
INSULATORS—Ree .. .. .	1½d.
Egg .. .. .	3d.
Coil Mounts, ebonite .. .. .	1/3
Condenser Plates .. .. .	1/-
Condenser enclosed Vernier .. .. .	6/-
Phonophone holders .. .. .	4/-
Receiving set complete from 25/- Complete with Aerial Wire, Insulators and pair of Phones, £2 10 0.	

N.B.—Do away with your crystal or valve detector and fit our PHONOPHANE, 15/- each Call for demonstration.

### THE WHALE WIRELESS CO.

321, VAUXHALL BRIDGE ROAD, LONDON, S.W.1  
Phone: Victoria 5413. (Victoria)

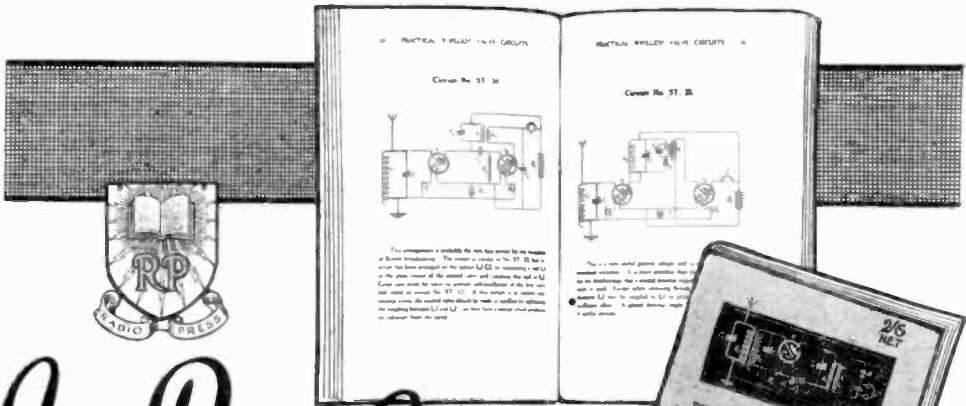

**No Paper Circuits**  
 —every one the result  
 of practical tests.



IN this new book by John Scott-Taggart, F.Inst.P., Editor of *Modern Wireless* and the well-known authority on the Thermionic Valve—there are 67 tested circuits. Every one can be confidently relied upon as being the best for its particular purpose.

**PRACTICAL WIRELESS VALVE CIRCUITS**

is just the Book you will need if you are building your own set, in order to ensure that your wiring will be the best possible arrangement based on the latest laboratory tests. In addition, all Condenser and Resistance values are given where necessary. Essential to every amateur taking more than a superficial interest in Radio.

- SECTIONS.**
1. Crystal Detector Circuits.
  2. Single-Valve Circuits.
  3. Two-Valve Circuits.
  4. Three-Valve Circuits.
  5. Four-Valve Circuits.
  6. Five-Valve Circuits.
  7. Local Oscillators for heterodyne reception of C.W.
  8. Valve Transmitter and Radiophone Circuits.
- 2/6**

**Radio Press, Ltd**  
 PUBLISHERS OF AUTHORITATIVE WIRELESS LITERATURE  
 DEVEREUX COURT, STRAND, W.C.2.

from all Booksellers,  
 or 2/8 post free from  
 the Publishers.

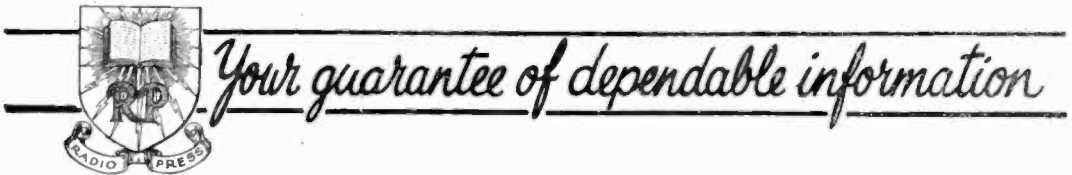



# It speaks for itself in a loud, clear and perfectly natural tone

With the highest amplification of all Wireless reception and particularly of Vocal and Instrumental music, the clarity and tonal purity of the AMPLION is unapproached in any other form of Loud Speaker.

The adjustment is simplicity itself and "Volume" may be regulated to a nicety.

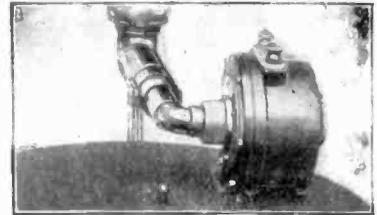

*Loud Sounding Receiver with adaptor for connection with tone arm of a gramophone. Illustration above shows it fitted.*



# AMPLION

## LOUD SPEAKERS

*The World's Standard*

are supplied in a series of 10 models, suited to every service—the Home, Laboratory and Concert Hall—and the prices range from fifty shillings to fifteen guineas.

The registered Trade Mark AMPLION on a Loud Speaker is a guarantee of efficiency and reliability and an assurance of Improved and Perfected Reception.

ASK FOR FOLDER W.W.

DAILY DEMONSTRATIONS AT THE GRAHAM SHOWROOMS:

*The Algraphone Salon,*  
25-26, Savile Row, Regent Street, W.1

'Phone : Regent 1075.

**ALFRED GRAHAM & CO.**  
St. Andrew's Works, Crofton Park,  
London - - - - - S.E.4

'Phone : Sydenham 952 and 1700.  
'Grams : Navalhada, Brock, London.

SCOTLAND—Mr. F. M. Milligan, 25, Renfrew Street, Glasgow.

IRELAND—Mr. Alexander R. Munday,  
41, Chichester Street, Belfast.

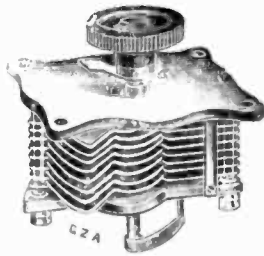

*Table Type 14" Bell Mouth with Independent Receiver, from*  
**£5 : 2 : 6**



*Concert Grand with 23" Bell Mouth, in polished oak, from*  
**£15 : 12 : 6**

# AUCKLAND'S



## THE MOST RIGID CONDENSER ON THE MARKET.

Fitted with Aluminium Top & Bottom Plates. Vane Spacing .072"

·001 .. .. .	24/-
·0005 .. .. .	18/-
·0003 .. .. .	16/-
·0002 .. .. .	15/-

Limehurst,  
Sale, nr. Manchester.

Dear Sirs,

I should like to say how pleased I am with your Precision Condensers illustrated on page 8 of your Catalogue, and I have not come across any better at the price, the nearest being the Mark III made to Government specification regardless of cost.

I cannot understand why you keep them in the background.

Yours truly,  
(Signed)

## AUCKLAND'S INTERVALVE TRANSFORMERS

Core of Stalloy and correctly designed to give maximum amplification.

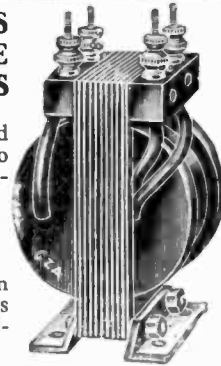

Thousands are now in use, and many traders are fitting them to well-known Receivers.

A Testimony to their superiority over the cheaper rubbish now offered.

PRICE  
**20/-**  
EACH.

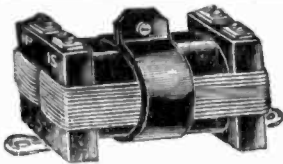

## TELEPHONE TRANSFORMERS.

For use with 120 ohm. phones core impregnated, D.S.C. throughout. Resistance Guaranteed.

Unmounted .. .. .	13/6
Mounted .. .. .	17/6

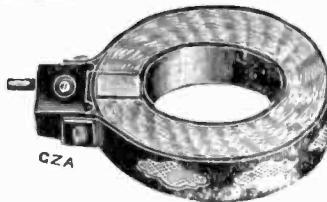

## DE FOREST COILS.

Fitted with Standard Plugs. Most neat and compact method of A.T.I. Anode Coils. H.F. Coupling, etc., etc.

PRICES FROM **5/-** EACH.



## SMOOTH CONTACT FIL. RESISTANCES

With Long Bearing Bush. With Fixing Screws.

**4/-**

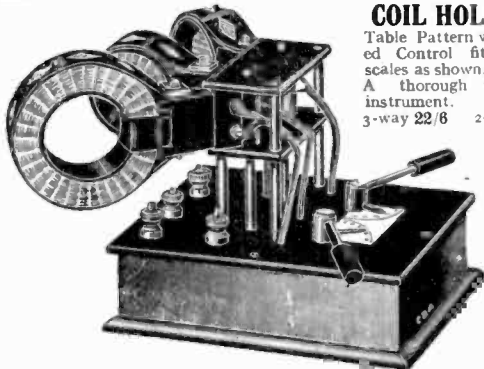

## COIL HOLDERS

Table Pattern with Geared Control fitted with scales as shown. A thorough well-made instrument.  
3-way 22/6 2-way 18/6



## POTENTIOMETERS.

Useful for Grid Potential, Crystal work, etc., etc. Typical of all Auckland Products. Finished in Instrument style.

PRICE (as Illustrated)  
**8/6**

**G. Z. AUCKLAND & SON, 395, St. John Street, E.C.1**

Factories BRINGTON, N. WIRELESS INSTRUMENT MAKERS. 'Phone - - 3173 CLEVERLY WELL

# T.M.C WIRELESS



for  
**Enjoyable Concerts**

You can hear the best singers, excellent orchestral music, or first-rate entertainers with a T.M.C. Wireless Set. Or you may be interested in football, boxing, the latest news, stock exchange quotations, the weather forecast, or an evening of dancing. You can have all these, enjoyably and pleasurably in the comfort of your own home, with a T.M.C. Wireless Receiver. There is no trouble to you—T.M.C. have engineers in every large town to advise you, free of cost and without obligation, as to the best apparatus to use. Your choice having been made, T.M.C. engineers will install the apparatus and periodically inspect it. T.M.C. Wireless is particularly simple to work and gives every satisfaction. T.M.C. Wireless Receivers, which are fully approved by the Postmaster-General, bear the seal of the British Broadcasting Company. The wide variety of models are entirely British made.

FROM **£4 5 0** UPWARDS  
 Including all Royalties

*London, Birmingham, Manchester and Newcastle are "broadcasting" NOW*

Come and listen to them any evening up to 10 p.m. at our Showrooms in

LONDON	BIRMINGHAM	BELFAST	BRISTOL	CARDIFF	DUBLIN
GLASGOW	LEEDS	LIVERPOOL	MANCHESTER	NEWCASTLE	SHEFFIELD

Write to us for our nearest address.

**T.M.C**  
 Makes Wireless  
 Worth While

The "Everset" Crystal.  
 No adjustment necessary.  
 Fits any crystal receiver.

10/- each

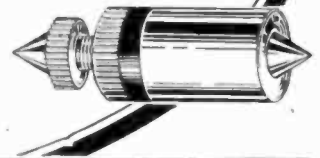

**TELEPHONE MFG., & LTD.**  
 HOLLINGSWORTH WORKS, DULWICH, LONDON, S.E.21.

# RAPID WIRELESS TRAINING

DAY AND EVENING CLASSES: Correspondence Classes with Instrument work at School if desired. **Postal Course on Valves.** Classes for Amateurs and Experimenters.

CABLE AND INLAND TELEGRAPHY.

Our Students get appointments

'Phone: North 3604. **ELECTRICAL TRAINING COLLEGE, Radio House, Manor Gdns., Holloway, London, N 7.**

# BINDING CASES

INCLUDING INDEX

## Vol. X. The Wireless World

PRICE **2/6** NET. POST FREE **2/11**

**INDEX** (Sold separately)

PRICE **8d.** POST FREE

**THE WIRELESS PRESS LTD., Dept. W.W. 12-13 Henrietta St., London, W.C.2**



## Two Symbols



When these two symbols appear in conjunction on a Broadcasting Receiver, no further recommendation is necessary.

The one signifies that the instrument has been approved by the Postmaster-General.

The other tells you that the greatest brains in Wireless have directed its manufacture.

Look for *both* signs always. You will find them only on

# The Marconiphone

*The Triumph of the Master Mind.*

You local dealer can supply you. In case of difficulty apply to

**MARCONI'S WIRELESS TELEGRAPH COMPANY, LIMITED**  
(Marconiphone Department), **MARCONI HOUSE, STRAND, LONDON, W.C.2**

# THE WIRELESS WORLD EXCHANGE AND MART

**TARIFF.** Advertisements are accepted for this Section at the rate of twopence per word, with a minimum charge of two shillings. The advertiser's name and address will be charged for and single letters and single figures will be counted as words. Compound words will be counted as two words.

**DEPOSITS.** All advertisements must be prepaid in the form of Postal Orders, the remittance being forwarded to Messrs. Bertram Day & Co., Ltd., 9 & 10 Charing Cross, S.W.1.

Intending purchasers may deposit the purchase money of any article advertised or sold by advertisers with Messrs. Bertram Day & Co., Ltd., who will acknowledge its receipt to the vendor and the depositor, the full addresses of whom should be given. Subject to special agreement between the parties, it is understood that all goods are sent on approval, each party paying carriage one way in the event of the goods being returned. The deposit will be retained until due advice of the completion of the purchase has been given or until the articles have been retained and accepted. In order to cover postage, etc., a fee of 6d. in respect of sums of £1 and under, and 1s. for sums in excess of £1, must be paid at the same time as the deposit.

**FOR SALE.**

Agate Cylinders, etc., for loud speaking apparatus from JAMES R. GREGORY & Co., Mineralogists, 139, Fulham Road.

Lathes, 6" new "Star" American Screw Cutting lorch lathes, all sizes, drilling machines, wood pulleys, shafting, belting, etc., send for lists.—PIDGEN BROS., 25, Helmet Row, Old Street London, E.C.1.

All Wireless and Electrical Goods stocked at 9, Colonial Avenue, Minories, near Aldgate Station. Handiest place for City buyers.—LESLIE DIXON & Co., Telephone No. Avenue 4166.

B.A. Screws, Nuts and Washers, assorted gross, 2s. lists 2d.—J. H. BENNETT, Station Road, Willesden Junction.

Round Ebonite, 1" to 2 1/2" diam., A.1 quality, 3s. per lb., carriage paid, 14lb. lots.—VELOX ENGINEERING CO., 255, Westgate Road, Newcastle.

Wireless Apparatus.—Manufacturers buy Selzach terminals, screws, contact studs, valve keys, spacers, coil plugs and sockets, etc. All turned parts in every kind of metal for wireless apparatus. Send samples by quoting quantities to—LONDON OFFICE, EDGAR GISIGER, 7 Bentinck Terrace, Regent's Park, N.W.8.

Burndept 5-Valve Receiver (1 H.F., 1 Detector, 3 L.F.), complete with self-contained tuner, the whole fitted into handsome oak cabinet. Price £35 without valves, coils or batteries. Also two Burnham 2-Valve 1,000 metres transmitters, equal new. Price £12 10s. each.—Box O.7, BERTRAM DAY'S ADVERTISING OFFICES, 9 and 10, Charing Cross, S.W.1.

Accumulators, 4 volt 40, 16s. 6d.; 6 volt 40, 25s. High tension batteries, 15 volt, 2s. 8d.; 36, 6s. 6d.—60, 10s. 6d. List free.—POTTS, 9, Charterhouse Street, London, E.C.

Burndept 2-Valve Panel, as new, £10 or nearest offer.—MIDDLETON, 9, Heron's Lane, Lochee, Dundee.

French Six-Valve Amplifier L1. Perfect order, £15.—GULL, Church Lane, Heckmondwike.

Mackie Generator and 1/2 H.P. Motor Set with switch the whole in perfect condition, a bargain, £25.—SECRETAN & MALLETT, LTD., Barnes, S.W.13.

Wireless Sets, 15s. complete. Unassembled, full instructions. Crystal detectors, 2s. Crystal and cup, 7/6d. Condensers, .0001 to .0005, 2s. Tuning coils, 500 metres. Six tappings, 3s. Complete with switch and base, 6s. 6d. Loose couplers, wound formers only, 7s. Complete with switches, base, etc. 15s. 6d. Six stud switches, 2s. Switch arms, 1s. Aerial wire, galvanised, 2s. 8d. 100' Frame aerials, 6s. 6d. Contact studs, 1s. 6d. doz. Formers, multilayer type, 9d. Loose couplers, 2s. Spring terminals, 1s. 6d. doz. List, 2d.—R. LLOYD, Stonehill, Wolverley, Kidderminster.

New "R" Type Valves, 10s. each. Post free sent at purchaser's risk.—POCOCK, 29, Northam Street, Lewisham Road.

Crystal Receiver, latest cabinet type, by Sullivan, new stamped B.B.C., 50s.—GREEN END WORKS, Willingham, Cambs.

French Phones, 4,000 ohms, best quality, 18s. 6d. per pair.—C. BRAYBROOK, 1, Chesham House, Broadway, Deptford, S.E.

Calibrated Milli-Microfarads, .001 Variable Condenser by Paul, two guineas only. Transmitting high tension unit, 1,000 volts, 30s. Large shell insulators, 9d. Small, 6d. Egg, 3d.—MAURICE, HORSPOOL, Marton Road, Bridlington.

Portable 3-Valve Receiver, including two Mk. III variable air condensers. Bargain 10 guineas. No accessories. Write for particulars.—BIRD, 13, Henrietta Park, Bath.

B.A. Screws, Nuts, etc., assorted gross, 2s. post free.—FRANKLYN, Corn Exchange, Leeds.

Aerial Current Ammeters, 1 to 10 amp., Everett Edgumbe, very steady zero, connections parallel to hot wire, back and front terminals, iron cases, £2 and 30s. Sullivan Universal Galvanometer and movement, £5, separate movements £1. Ex-Government Headphones, low resistance, 9s.—THURSTON, 3, Lydford Road, W.9.

## ELECTRADIX RADIOS

Everything for Wireless.

Ebonite, Dynamos & Insulated Wires

RELAYS, RELAYS, Siemens and Western Electric Co., Complete, 10/6. Small type for remote Control, 2/6. Ordinary M.C. Weston Relays, 20/- to 22.

RIGID BASKET COILS, set of 7, 200/L, 800, 7/6. Three-coil holder for same, 7/6.

L.R. PHONES, 9/- pair.

FIXED CONDENSERS, .0001 to 2 m.f., 2/-.

MURDOCK VARIABLE CONDENSERS, all sizes.

WAVEMETERS for Transmission and Reception from 300/3,000, £4. 130/3,000, £8 10s.

ANGLE PLOTTERS, in leather case, 8/6.

TEAK, 18 x 12 x 5 panels, ebonite top, 10/-.

THREE-VALVE AMPLIFIERS, £5.

M.C. MILLI-AMMETERS, 3s/-

LARGE AMMETERS AND VOLTMETERS, 2s/-

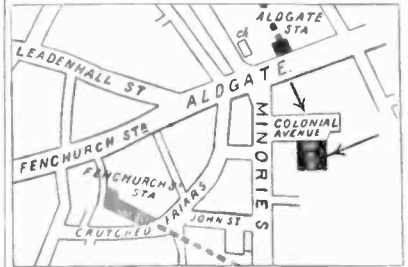

## LESLIE DIXON & CO.

9, Colonial Avenue, Minories, E.1.

Nr. Aldgate Station, Met. Ry.

## CAPITAL REQUIRED.

Wireless Manufacturer with factory fully equipped for manufacturing high quality instruments, requires a moderate capital for marketing highly efficient lines.—Box D.12.

BERTRAM DAY'S ADVERTISING OFFICES, 9 and 10, CHARING CROSS, S.W.1.

HOW TO MAKE YOUR OWN WIRELESS RECEIVING SET, AMPLIFIERS AND DETECTORS. Remarkably out, full size diagrams and all wiring details, accurately given, success guaranteed. All Broadcasting stations received. In two series 2/6 each, to be obtained from

THE ECONOMIC ELECTRIC CO., LTD., 10, FITZROY SQUARE, LONDON, W.1. who will supply any part for constructing same.



SEND NOW FOR OUR

# 100

PAGE ILLUSTRATED CATALOGUE

LATEST IMPROVEMENTS.

LOWEST PRICES

POST 3<sup>d</sup>. FREE

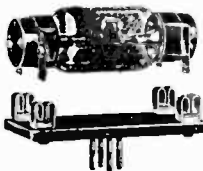

SIEMENS-HALSKE VALVES 7/6 each. ADAPTORS FOR "R" VALVE HOLDERS. 3/- each. POSTAGE EXTRA.

## Grafton Electric Company

Show-rooms—54, GRAFTON STREET, TOTTENHAM COURT ROAD, LONDON, W.1. Telephone—Museum 241. Works—Slough.



# THE WIRELESS WORLD EXCHANGE AND MART



**RADIO PRESS**  
**WIRELESS DIRECTORY**

Keep it handy

As indispensable to the listener in as the telephone directory is to a subscriber. This book gives over 12,000 Call Signs of all land and ship stations as well as a very full list of British Amateurs. **Keep a copy handy and know who is sending—you'll get much more enjoyment from your Set.** Sold by all Booksellers and Newsagents. Published by

**2/6**

**Radio Press Ltd**  
PUBLISHERS OF AUTHENTICATIVE WIRELESS LITERATURE  
DEVEREUX COURT, STRAND, W.C2

**FOR SECURING YOUR AERIALS**  
and a Thousand Purposes where Great  
Strength and Strain is needed  
**FLEXIBLE STEEL WIRE ROPE.**



Aeroplane Cable made to Govt. specification to specified breaking strains. Orders of 10' and over carriage paid, otherwise please add 1/- for postage.

**PRICES BELOW COST.**

No.	Dia.	Breaking Strain.	Price per 100 ft.
3	1/4"	20 cwt.	8-
51	5/32"	25 cwt.	10-
53	7/32"	45 cwt.	12-
5	1/2"	70 cwt.	14-
6	9/32"	80 cwt.	15-
7	11/32"	100 cwt.	20-
8	1"	120 cwt.	21-
9	1 1/8"	140 cwt.	22/6
10	7/16"	160 cwt.	24-

**STRAINERS** for use with above, right and left hand threads, 9d. each, or 8/6 per doz.  
**SMITH & ELLIS**  
(Dept. 65), 11, LITTLE BRITAIN,  
ALDERSGATE STREET, E.C.1

**TO MANUFACTURERS OF CRYSTAL SETS, Etc.**

We can quote you attractive prices for **STRAWBOARD INDUCTANCE TUBES.** All diameters from 2" to 8". Enquiries solicited.  
**A. EATON LEE & CO.,**  
4, LITTLE COLLEGE ST., LONDON, E.C.4  
Central, 4839. Near Cannon Street Station.

**FOR SALE—continued.**

Experimenter has number new duolateral plug-in coils for sale, from 3s. 6d. Also loose coupler. Stamp for particulars, NICHOLSON, 9, St. Peter's Place, Fleetwood.

**Metal for Condensers.** Minimum shrinkage on cooling. As supplied to leading firms.—**PAVYERS & BULLENS, LTD.,** 119, Cromer Street, W.C.1.

**Home Cinematograph Machine,** complete with films. 21s. 6d. post free.—**CINEMA, 114, Fernlea Road, Balham.**

**Loose Coupler Inductance,** tunes 200 to 2,500 metres, 28 tappings on ebonite, mahogany base, 50s. Crystal set, in oak cabinet, loose coupled tuning, 150 to 1,100 metres, 26 tappings on ebonite panel, .0003 variable condenser, £3.—4, Kyford Road, Wimbledon Park, S.W.19.

**50 W.O. Tuners, C.W.** 60 watts, wavelength 2,000, 5,000 as new, complete in case, C.O. switch (std. and tune), but without condensers, 35s. each, carriage 2s.—**HOLEMAN HYLAND, Burnt Ash Road, Lee Green.**

**Tingey 8-Valve Receiver,** complete with pair, .001 condensers, pair "A" coils, valves, two vernier condensers, almost new, £11 10s.—167, Plumstead Common Road, S.E.18.

**Phones (new)** Double 4,000 ohm complete, 20s. Batteries H.T., 15 volt, 3s. 3d.; 36 volt, 6s. 9d.; 63 volt 15 tappings and wander plugs, 12s. All post free.—**RADIO TRADING COMPANY, 22, Tormount Road, London, S.E.18.**

**SITUATIONS VACANT.**

**SALESMEN REQUIRED.**—Must possess sound technical knowledge and business aptitude and reside in London area. Good address and appearance essential. **WRITE ONLY,** stating experience and salary required.—"APPOINTMENTS." **The Marconi Scientific Instrument Co., Ltd., Soho, W.1.**

**SITUATIONS WANTED.**

**Ex-Public Schoolboy (24)** willing invest few hundreds in return for employment in sound business with prospects. Strictest confidence and fullest investigation both sides essential.—**Box G.11, BERTRAM DAY'S ADVERTISING OFFICES, 9 and 10, Charing Cross, S.W.1.**

**Live Sales Manager** for Wireless Business seeks progressive position. Smart, energetic, well educated. Thorough practical and theoretical knowledge. Unique experience covering exceptionally wide range of wireless activities. Highest references.—**A. Y., 26A, Algiers Road, S.E.13.**

**TRADE ENQUIRIES.**

**Best Offer Invited** for Wireless Concern, two shops, London and District, both busy thoroughfares. Goodwill exceeds £5,000. Present stock exceeds £1,200. Owner holder of several patents or would float company.—**ADVERTISER, Box D.13, BERTRAM DAY'S ADVERTISING OFFICES, 9 and 10, Charing Cross, S.W.1.**

**Advertiser** has showroom and wireless stock in North London, cannot give necessary time at present, would like to meet gentlemen with small capital to develop business and push sales.—**Write H., 18, Boilean Road, North Ealing, W.**

**If you are running a Wireless Department,** and want to buy your parts at the right factory prices, write for our list of raw materials and partly manufactured parts.—**THE NEWTONIA WIRELESS FACTORY, 13/15, Whitcomb Street, Pall Mall, London, near Trafalgar Square.**

**AGENTS WANTED.**

**Old-established London Firm,** making one to five-valve broadcast receivers, desires provincial agents. Every assistance and good terms offered.—**Box 76, c/o F. ALDRIDGE, 26, Paternoster Row, E.C.4.**

**EXCHANGE.**

**Burndep Ultra III** for Burndep L.F. 11 (1075). **MONKS, "Brightholme," Norboro Road, Doncaster**

## EX-GOVERNMENT STOCK TO CLEAR

**FOUR-VOLT WIRELESS TRANSMITTING SETS, TEN MILES RADIUS.**

Contents of Set: 1" Sterling Spark Coil. Adjustable Spark Gap. Block Condenser, Tuning Helix, Terminals, etc. These sets are worth double to break up for the parts.  
**PRICE, 15/- EACH TO CLEAR.**

**SINGLE WATCH RECEIVERS, 120 ohms, 2/6 each. Post 6d.**

**VERY SENSITIVE MICROPHONES, 2/- each. Post 6d.**

**D III COMBINATION HAND PHONES, TELESCOPIC TYPE, 3/8 each. Post 6d.**

**500 OHM CHOKE COILS.** Make good telephone transformers, 2/- each. Post 6d.

**ONE-INCH SPARK COILS, 8/- each. Post 9d.**

## NEW GOODS

**VARIABLE CONDENSERS COMPLETE WITH KNOB AND POINTER—**

.00005	.0003	.0005	.001
4/6	7/-	9/-	12/-

<b>FILAMENT RESISTANCE</b>	2/6
<b>VALVE LEGS</b>	1/-
<b>BLOCK CONDENSERS (any capacity)</b>	1/8
<b>CRYSTAL DETECTORS</b>	2/6
<b>7-22 AERIAL WIRE</b>	100' 3/6
<b>HEAD PHONES</b>	4,000 ohms 20/-
<b>INTERVALVE TRANSFORMERS</b>	18/-
<b>TERMINALS</b>	from 1d.
<b>INSULATORS</b>	2d., 3d. and 4d.
<b>SLIDERS</b>	6d. and 9d.
<b>2 MEGOHM GRID LEAKS</b>	1/-
<b>SWITCH ARMS</b>	1/6 and 2/-
<b>CONTACT STUDS</b>	per doz. 9d.
<b>CONDENSER VANES</b>	per pair 1d.
<b>SPACER WASHERS</b>	per doz. 2d. and 4d.
<b>EBONITE</b>	per lb. 5/-
<b>KNOBS</b>	each 6d.
<b>TIN FOIL, COPPER FOIL, INSTRUMENT WIRES, ETC., ETC.</b>	

**WRITE FOR LIST.**  
**CASH WITH ORDER.**

## E. J. GALPIN

**16, Loampit Hill, Lewisham, London, S.E.13.**

'Phone: Lee Green 1531.

# THE WIRELESS WORLD EXCHANGE AND MART

**Bamboo Poles for Aerials**  
 AND BAMBOO OF EVERY DESCRIPTION  
 :: FROM TWIGS TO YACHT MASTS ::  
 Large Stocks always on hand.  
**A. E. DAVIES & CO. (Importers),**  
 164, LEVER ST., CITY RD., LONDON, E.C.1

**HEATH & Co., Ltd.**  
 Instrument Works, New Eltham, S.E.9  
 are prepared to undertake in their fully  
 equipped works—**Wireless Apparatus**  
 and Parts for the trade. Quotations given  
 to Blue Prints. Immediate attention.  
 Phone—Lee Green 301. Wire—Pelarski, London.

**Portland's Parts by Post.**  
**"EBONITE"**

8 x 1 ..	s. d.	12 x 10 ..	s. d.
4 x 4 ..	0 7	17 1/2 x 8 1/2 ..	7 6
7 x 5 1/2 ..	1 3	18 x 18 ..	9 6
10 x 6 ..	2 8	36 x 18 ..	12 10
17 x 5 ..	3 9	7 lbs. ...	£1 3 0
	5 3		£1 3 0

Quarter Mat, British. Postage Free.  
 Any size cut.

**JAMES PORTLAND**  
 39, Sinclair Road, Olympia, W.14  
 Mr. Portland stocks over 200 Wireless Parts

**Strawboard**  
**INDUCTANCE TUBES**  
 AND  
**WOOD CASES**  
 and **CABINETS**  
 COVERED OR POLISHED  
 FOR WIRELESS SETS  
 WHOLESALE TRADE SUPPLIED  
**The Underwood Manufacturing Co.**  
 25, Underwood Street, London, N.1.

**WIRELESS SETS**  
 SUPPLIED AND INSTALLED.  
 Aerials Erected. Accumulators Charged. Com-  
 ponent Parts of every description stocked.  
**C. J. WILKIN & SON,**  
 143, HIGH STREET, WOOLWICH, S.E.18.  
 Estb. 1881. (Corner of Powis Street)  
 TRADE SUPPLIED. Tel. No. Woolwich 320.

**WANTED.**  
 Townsend Wavemeter, calibrated and in thorough  
 working order. Particulars to Spensers (Scotland),  
 Ltd., 119, George Street, Edinburgh.  
**Wanted.**—Partner, with thorough technical  
 knowledge and experience of wireless, to take finan-  
 cial interest in organising wireless retail business  
 in London district. Excellent prospects. Highest  
 reference given and expected.—Apply Box G.10,  
 BERTRAM DAY'S ADVERTISING OFFICES, 9 and 10,  
 Charing Cross, S.W.1.  
**Wanted.**—T.T. and H. Engraving machine,  
 C. of C.B. patt. Box P.9, BERTRAM DAY'S  
 ADVERTISING OFFICES, 9 and 10, Charing Cross,  
 S.W.1.

**MISCELLANEOUS.**  
 Keys (the well-known motor cycle firm) will  
 take your present instrument in part payment  
 for the latest model. Send particulars.—173,  
 Great Portland Street, London.  
 Nameplates, engraving of all descriptions.—  
 STILWELL & SONS, Little Park Street, Coventry.  
**Wireless Inventors.**—Patents and Trade Marks  
 Advice. Handbooks and Consultations free.—  
 KING, Regd. Patent Agents, 146A, Queen Victoria  
 Street, London. Phone, 682 Central.  
 East Ham, Wanstead, Ilford, Manor Park and  
 Forest Gate. Amateurs should not fail to come to  
 the **RADIORENDEZVOUS**, 709, Manor Park  
 Broadway (over Liptons). Club open till 10 p.m.  
 nightly.  
**Working Drawings.** Designs for power and  
 Wireless. Works visited to advise.—PUCKLE,  
 Buckhurst Hill, Essex.—Telephone, Woodford 400.  
**Telephone Receivers Rewound**, up to 1,000 ohms,  
 5s.; 2,000 ohms, 7s. 6d. Cash with order.—  
 M. E. HAMPSHIRE, 139, Sydenham Road, S.E.26.

*Wireless Insurance!*

**LIVERPOOL MARINE**  
**AND GENERAL**  
**INSURANCE CO., LTD.**  
 London Office: 7, Angel Court,  
 Throgmorton St., E.C.2.

**FIRE. ACCIDENT. MARINE.**  
 Write for particulars of our **SPECIAL**  
**WIRELESS POLICY** (Annual  
 Premium 7/6) which covers fire and  
 other damage to the complete Wireless  
 Set and also indemnifies the Owner  
 against claims arising from damage to  
 property or persons through the break-  
 down of outside aerial and its supports.

**BEGINNER'S GUIDE TO WIRELESS**  
 Explains in plain, everyday language, everything beginners  
 wish to know about Wireless Telegraphy.  
**HOW TO ERECT, CONNECT AND MAKE**  
 all the apparatus required for reception of telephony or morse, and full instructions and diagrams  
 for making coils, tuners, and complete valve and crystal sets. 112 pages, price 1/- post free.  
**SAXON RADIO CO. (Dept. W.), South Shore, Blackpool.**  
 32 page Catalogue of Wireless Apparatus 2d. post free.



**WHOLESALE WIRELESS**  
**SUPPLIES**  
**ASHTON BREMNER**  
 No. 1, Margaret Street,  
 LONDON, W.1

**ESTABLISHED TWENTY-FIVE YEARS.**  
**J.W.B.**  
**ACCUMULATORS**  
**RESULT OF OVER 40 YEARS' EXPERIENCE.**  
**BEST FOR**  
**WIRELESS**  
**PLATES, SETS, BOXES, SEPARATORS,**  
**REPLACEMENTS, EXPERT REPAIRS.**  
**J. W. BARNARD & HAYNES**  
 LIMITED.  
**WORKS: 45, GT. ORMOND STREET,**  
**LONDON, W.C.1, and 4, GT. WINCHESTER**  
**STREET, LONDON, E.C.2**

**KNOBS**  
 We specialise in brass bushed com-  
 position knobs for all classes of instrument.  
 In quantities. Send us particulars of your  
 requirements.  
**FRASER & GLASS,**  
 Middle Lane, Hornsey, N.8.

**WIRELESS CABINETS**  
 PROMPT DELIVERIES  
 COMPETITIVE PRICES  
**PICKETT BROS.,**  
 Albion Rd., BEXLEYHEATH, S.E.



*The best-spoken  
fellow in the world*

## THE CLARITONE LOUD SPEAKER

"CLARITONE" LOUD SPEAKER. For volume, clarity and purity of tone, the "Claritone" Loud Speaker is unequalled. Used in conjunction with valve receiving sets and Ashley Valve Sets in particular, it gives improved reception more than equivalent to an extra valve without the distortion inseparable from excessive valve amplification. The "Claritone" is of pleasing design and high grade finish. A convenient lever in the base facilitates fine adjustment to suit any class of reception desired.

PRICE—

2,000 ohms	..	..	..	£6	2	6	each
120 "	..	..	..	£6	0	0	"



**A.T.M. LONG RANGE RADIO HEADPHONES.** Second to none, these headphones have been adopted as standard by the leading manufacturers of Radio Receiving Sets.

They are of light weight (8½ ozs.) instantaneously adjusted to the ears, and comfortable in prolonged wear. The receivers are individually detachable, enabling two persons to listen in on one head-set if desired.

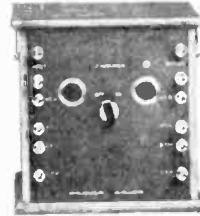

**THE ASHLEY 2-VALVE RECEIVING SET.** Embodies REACTION and unlimited wavelength, the most efficient combination, comprising one high frequency amplifying valve and one detector valve. Simplified and easily manipulated controls. High grade finish and readily accessible interior. Includes a set of interchangeable aerial tuning and H.F. transformer coils. Will receive on all wavelengths up to 3,000 metres.

PRICE—£21 (Valves, Batteries and 'Phones extra.)

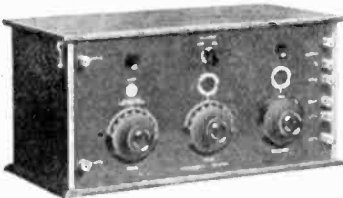

**THE ASHLEY 3-VALVE RECEIVING SET.** Embodies REACTION and unlimited wavelength, the most efficient combination, comprising two high frequency amplifying valves and one detector valve. Simplified and easily manipulated controls. High grade finish and readily accessible interior. Includes a set of interchangeable aerial tuning and H.F. Transformer Coils. Will receive on all wavelengths up to 3,000 metres.

PRICE—£27 (Valves, Batteries and 'Phones extra.)

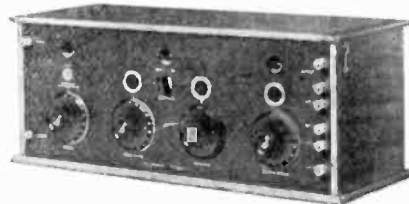

**THE ASHLEY 2-STAGE LOW FREQUENCY AMPLIFIER.** Embodies two low frequency amplifying valves and is conveniently adapted for direct coupling to the Ashley 2-Valve and 3-Valve Receiving Set, thereby converting them respectively into 4 and 5-Valve Combinations and facilitating the use of the "Claritone" Loud Speaker, for both British and Continental reception. High-grade finish and readily accessible interior.

PRICE—£10 (Valves extra.)

**ASHLEY WIRELESS TELEPHONE CO., LTD.**  
69, RENSHAW STREET, LIVERPOOL.

# The IONOPHONE VARIOMETER TUNED BROADCASTING SETS



## Three Valve Set

This is the cheapest and best three valve Set on the market. Owing to the restrictions of the P.M.G., Broadcasting reception has been made very inefficient for the public. This Set has been specially designed to give practically as good results as Sets having variable retroaction which are only available to those who can obtain experimental licences.

Range 300-3,000 metres. Receives all Broadcasting, including the Hague and Paris Concerts.

**PRICE (including phones and H.T. battery) £14**

Plus Broadcasting Licence £2 5s.

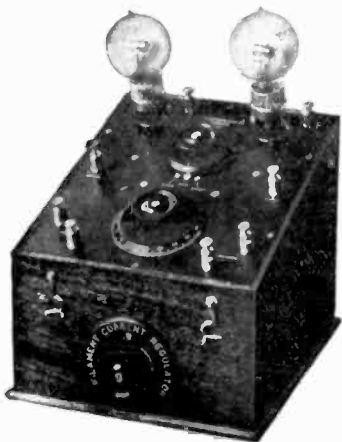

## Two Valve Set

The above is designed on the same lines as the three valve Set and will find its way into many homes on account of its marvellous value and efficiency.

Range 300-3,000 metres. Reception range the same as three valve set.

**PRICE (including phones) £10**

Plus Broadcasting Licence £1 15s.



## Loud Speaker Adaptor

An ebonite horn with attachment for Headphones.

**PRICE £2 15s.**

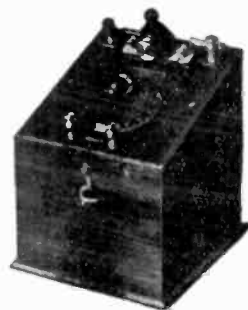

## Crystal Set

An ideal Set for receiving local broadcasting clear and distinct, suits everyone's purse.

Reception up to 25 miles.

**PRICE (with phones) £5**

Broadcasting Licence 7/6.

*'Demonstrations of all the above given daily.'*

**J. A. Coomes & Co., Ltd., 41, New Oxford St., W.C.**

(Opposite Muidie's)

Museum 3642.

## THE SINGLE VALVE RECEIVER

for those applying for or holding an Experimental Licence

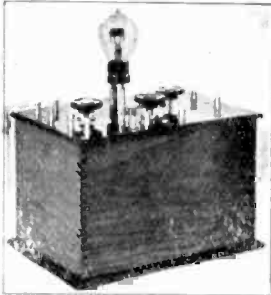

This instrument is fitted with Aerial Tuning Induction, complete with nine stud switch for adjustment to the various wavelengths, reaction coil, filament resistance, grid condenser and leak. It is well constructed, of excellent workmanship, and is in a highly finished and polished cabinet with ebonite panel.

Wavelength, 350-3,000 metres. (Manufactured under Marconi Licence.)

With P.O. Standard Aerial this set will receive the Hague Concerts in London, and British

**PRICE £5** (excluding Valve) Broadcast Stations at proportionate distance (approx. 150-200 miles), according to transmitting power used.

**TO MAKE A COMPLETE STATION** which would include this Single Valve Receiver the accessories required would cost £6 5s., making a total cost for complete station of £11 11s.

Further details on application; also special leaflet on one, two and three-valve amplifiers for those wishing to increase strength of all speech and signals received.

**T. H. ISTED, Radio Works, TERLING - - WITHAM - - ESSEX**

Telegrams: Wireless, Terling, Essex.

## THE FIRM THAT KEEPS THE FLAG FLYING

We are offering the following selections from our stock at specially low prices. **FOR ONE WEEK ONLY. BE JUST IN TIME.**

Switch Arms. Highest finish. Four laminations in copper contact blade	2/-
Crystal Detectors. Fine adjustments. Stock limited at this price	2/9
Without Crystal.	
Crystal Detector, as above, but fitted with Hertzite Crystal	3/9
Porcelain Insulators. Egg type	3d.
Porcelain Insulators. Reel type	2d.
Wire. Wire. Wire. Buy to-day and save money. 100' tinned copper, 18's. Makes a splendid and efficient aerial	2/6
100' Drawn Copper, 7/22's	4/-
100' Silicon Bronze, 7/22	4/6
100' Enamelled, 7/22	5/6

Retail orders can be immediately supplied from stock. To find the shop for **GOOD RELIABLE** parts at the Lowest Price, look for the **WIRELESS** Flag on our Aerial Mast.

**The Manchester Radio Supply Stores, 184, CITY RD., MANCHESTER.**

## BROADCASTING

B.R.C.3 Crystal Receiving Sets, designed by our Technical Director, ex-Marconi Engineer and Chief Inspector to the Government Telegraphs. 19 years' experience.

### SPECIFICATION.

Brown's 4,000 ohm double headphones, variable tuning inductance, range 1,500 metres, ebonite engraved panel, lacquered terminals, provision made for several persons to listen in, crystal detector with solid gold contact, complete with 100' aerial and earth equipment. The set is compact and enclosed in a dovetailed polished oak box with hinged lid. It will receive telephony up to 30 miles. No batteries required. Approved by the Postmaster-General. The instrument has the B.B.C. Seal affixed.

Price including the Broadcasting Fee

**£3 : 7 : 6** complete.

Agents Wanted.

## THE BIRMINGHAM RADIO COMPANY

Carlton House, High St., BIRMINGHAM.

Telephone: Central 8085.



Specification of our well-known **CONDENSERS**. Highest grade **Aluminium** Plates. Brass Washers machined to a limit of + or - .001". Adjustable Brass Bush at bottom. Fixed Brass Bush at top. These Condensers are built to stand **HARD** continuous usage and we **GUARANTEE** THEM.

Value in M.F.	Panel Mounting in Parts	Panel Mounting Assembled	Cabinet Mounting in Parts	Cabinet Mounting Assembled	Cabinet Mounting Assembled in Cabinet	Polished Mahogany Cabinet
0015	23/-	25/6	24/-	26/6	33/-	6/6
001	16/9	19/6	17/9	21/-	26/-	5/6
00075	13/6	16/3	14/6	16/6	22/-	5/6
0005	10/6	13/-	11/9	13/9	18/-	4/6
0004	10/-	12/6	11/-	13/3	17/6	4/6
0003	9/-	11/6	10/-	12/-	16/-	4/-
0002	7/-	9/-	8/-	9/6	13/6	4/-
0001	6/-	8/-	7/-	8/6	12/6	4/-
Vernier	-	4/6	-	5/-	9/-	3/6

Fitted with Bevelled Ebonite Dial 1/9 extra. Special Sizes made to Order. Price list on request.

ALL SUNDRIES AND COMPONENTS IN STOCK.

ORDERS OVER 20/- CARRIAGE PAID.

TRADE ENQUIRIES SOLICITED.

**THE "BROADWAY" RADIO WORKS**  
DEVONSHIRE ROAD, BEXLEYHEATH, KENT.  
Phone: BEXLEYHEATH 186.

# 40 MILES RANGE GUARANTEE

## THE ENTLEY SUPER 1 CRYSTAL RECEIVER.

**Entley Super 1  
Crystal Receiver  
£4 17s. 6d.**

All Entley Broadcast Receivers have the Postmaster - General's approval.

Ask your Dealer for Entley Receivers, from one to seven valves, for all requirements.

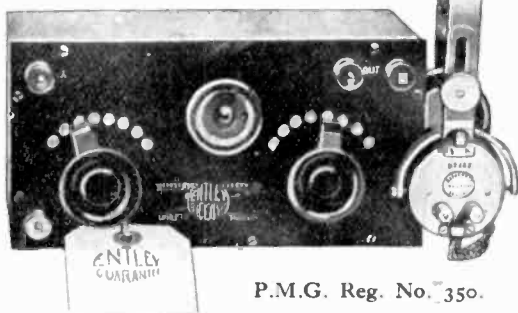

P.M.G. Reg. No. 350.

**Approximate Range  
45-50 Miles.**

Complete with aerial wire, insulators, and Brown's headphones ready for instant use

**£6 17s. 6d.**

The Crystal Receiver illustrated has a guaranteed range of 40 miles, for the reception of music and speech. Entley Crystal Receivers are tested at works for the reception of Birmingham Broadcasting, a distance of over 45 miles. Efficient and well-finished in black with clean white engraving and plated fittings.

### JOSEPH HOPLEY & SON, Whitchurch, Salop.

## The "Sound Wave" AND Gramophone Journal TRADE AND TECHNICAL

The most authoritative Journal in the Kingdom on matters pertaining to the Gramophone.

**SPECIAL ARTICLES ON  
MUSIC - - - ACOUSTICS  
SOUND BOXES  
TONE ARMS  
TONE CHAMBERS - STYLI**

and all other accessories incidental to Gramophone construction.

**100 Pages. 4<sup>d</sup> Monthly.**

From usual newsagents or direct from the publishers—Messrs. DUNLOP & CO., 1 & 2, Whitfield St., Tabernacle St., London, E.C.2

## "The Model Engineer"

A special paper for young Engineers, Apprentices, Students and Amateurs interested in Mechanics, Electricity and Model Making. It contains practical articles by experienced writers on Electrical and Mechanical subjects. Locomotives, Motor Cycling, Model Aeroplanes and Wireless Telegraphy.  
*Published every Thursday. 5d. post free.*

## "Junior Mechanics & Electricity"

The paper for beginners of all ages in Mechanics, Electricity and Model Making. All the articles are written in simple language so that everybody can read and understand them. It is well illustrated. There is also a Queries and Replies section, from which much valuable information can be obtained.  
*Published on 1st of each month. 4d. post free.*

### SOME USEFUL BOOKS.

Practical Lessons in Metal Turning ..	2/9	Small Accumulators ..	10jd
Engineering Mathematics Simply Explained ..	2/3	Electric Bells & Alarms ..	10jd
Practical Dynamo and Motor Construction ..	1/0	Electric Batteries ..	10jd
Practical Induction Coil Construction ..	1/9	Small Dynamos and Motors ..	10jd
Petrol Motors Simply Explained ..	1/9	Induction Coils for Amateurs ..	10jd
Workshop Wrinkles and Recipes ..	1/9	Small Electric Motors ..	10jd
		Alternating Currents ..	10jd
		Windmills and Wind Motors ..	10jd
		Wireless Telegraphy Simply Explained ..	10jd

*Every Boy's Book of Electricity, 3d.*

*Every Boy's Book of Engines, 3d.*

Book List sent post free on receipt of card.  
**PERCIVAL MARSHALL & CO.,**  
66m, FARRINGTON ST., LONDON, E.C.

# VARIOMETER

Giving an Inductance Ratio of over 9 to 1

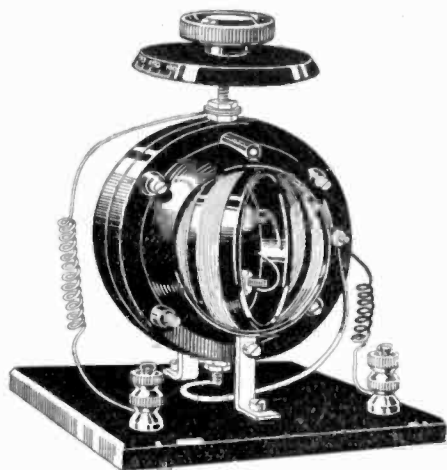

**Price: 27/6**

Fully mounted as indicated, connections made and carried to double terminals.

*In response to demand, we are now mounting all Variometers vertically (as shown), horizontally, or suspended through panel.*

TRADE TERMS ON APPLICATION.

## McCLELLAND & COMPANY

MAKERS OF RADIO INSTRUMENTS,

14, Sun Street, Finsbury Square, London, E.C.2.

Telephone: London Wall 7725.

Wires and Cables: Exonerator, London.

The Inductance range given is from 55 microhenries minimum to 530 maximum approximately. Thus with a standard P.O. aerial of 100 feet having approximately .0003 mfd. capacity the wavelength range is 245 metres to 755 metres. Any such proportional range of wavelength may be obtained by tuning with fixed condensers in parallel.

The Rotor is of the Ball type, and as the Internally wound Stator lies closely round the Rotor, the unusually large Inductance Ratio of over 9 to 1 is obtained.

The instrument is as strong and durable as good craftsmanship can make it, and its handsome ebonite finish throughout renders it very attractive. It is suitable for use in Crystal Sets, Tuners, Amplifier Circuits, Armstrong Circuits, etc., and is recommended for use with capacity reaction in H.F. Amplification. Any information on these matters will be given gladly to intending purchasers.

WRITE  
FOR

OUR  
CATALOGUE

# WIRELESS TELEGRAPHY AND TELEPHONY

FIRST PRINCIPLES, PRESENT PRACTICE AND TESTING

By

H. M. DOWSETT, M.I.E.E.

Price **9/-** net. 331 Pages Post free **9/9**

*305 diagrams and illustrations.*

This book was written with a view to its acting as a connecting link between the elementary textbook and the advanced treatise or the specialised textbook.

It has behind it the long standing reputation of The Wireless Press, Ltd., and can be thoroughly relied upon.

## CONTENTS :

The Nature of Electricity and of the Atom—On Phase Displacement Effects in Elementary Circuits—The Spark Discharge—Continuous Wave Transmitters—Thermo-Ionic Effects and Oscillation Valve Phenomena—The Special Apparatus used for High-Speed Transmission and Reception—The Measurement of Electric Current and of Electro Motive Force—The Measurement of Resistance—The Measurement of Capacity—The Measurement of Inductance—The Measurement of Frequency—The Measurement of Dielectric Strength—The Measurement of Decrement—The Measurement of the Direction, and the Distance of Transmitting Stations, and the Intensity of Received Signals.

**THE WIRELESS PRESS, LTD.**

THE PIONEER HOUSE FOR WIRELESS PUBLICATIONS  
12 - 13, Henrietta Street,——— London, W.C.2

OF  
**65**

WIRELESS  
BOOKS



We claimed  
**BIG THINGS**  
 for the  
**CONQUEST**  
 2-VALVE RECEIVER  
 described in the last  
 number (January) and  
 readers' results have  
**FULLY JUSTIFIED**  
 our claim.

Price  
**1/-**  
 Monthly

Post  
**1/3**  
 Free

Read the FEBRUARY number of  
**CONQUEST**  
 for FULL CONSTRUCTIONAL DETAILS  
 of a  
**2-Valve Note Magnifier**

It is extremely simple and easy to make.  
 No switches. No elaborate wiring.  
 It can be used as a ONE or TWO  
 valve magnifier.

**CAN BE ATTACHED  
 TO ANY EXISTING  
 RECEIVER WHETHER  
 CRYSTAL OR VALVE**

thus enabling a Loud Speaker  
 to be used.

12-13,  
 Henrietta  
 Street,

Every detail of the  
 apparatus described in  
**CONQUEST**  
 is fully tested and  
 tried out.  
 There is no fear of  
**CONQUEST**  
 sets not working satis-  
 factorily, provided you  
 follow the very simple  
 instructions.

Strand,  
 London,  
 W.C.2.

**THE ONLY BOOK  
 GIVING FULL DETAILS  
 ON THIS SUBJECT**  
 IS  
**Direction**  
 AND  
**Position Finding**  
 BY  
**Wireless**

BY  
**R. KEEN, B.Eng. (Hons.) Sheffield,**  
**A.M.I.C.E.**  
 363 pages, 254 Photographs & Diagrams.

PRICE **9/-** NETT.  
 (Postage 9d.)

This book deals not only with the principles  
 of the subject but with the constructional  
 details of direction finding installations. It  
 describes the principles of Direction and  
 Position Finding in this country in such a  
 way that the subject may be grasped easily  
 by engineers tackling this field of wireless  
 work for the first time.

CONTENTS :

Introduction ; Theory of the Wireless Direc-  
 tion Finder ; Valve Amplifiers and  
 Detectors ; Maps ; Position Finding ; Night  
 Effect and other Freak Phenomena ; The  
 Shore D.F. Station ; The Ship D.F.  
 Station ; Aircraft D.F. Station ; Fault  
 Clearing and Maintenance ; Notes on Field  
 and Nautical Astronomy ; Bibliography.

**The Wireless Press, Ltd.,**  
 Dept. W.W. 1  
 12/13, HENRIETTA ST., LONDON, W.C.2

# MANCHESTER ALL-BRITISH WIRELESS EXHIBITION AND CONVENTION

BURLINGTON HALL  
BURLINGTON ST. MANCHESTER.

## 17th — 24th MARCH

*(Saturday to Saturday inclusive)*

The success of this Exhibition—  
which we are now organising at the  
request of the MANCHESTER  
WIRELESS TRADERS ASSO-  
CIATION—is already fully assured.

The Convention will be held under  
the auspices of the MANCHES-  
TER WIRELESS SOCIETY.

Applications for Stands are now  
being dealt with in strict rotation by  
the organisers.

The Exhibition CATALOGUE  
(with 3-colour cover) will probably  
run to over 100 pages. Estimated cir-  
culation over 10,000 copies. Appli-  
cations are now being accepted for  
advertising space. Price £.4 per  
page. Printing space  $7\frac{1}{2}'' \times 4\frac{1}{2}''$  wide.

THE ORGANISERS

### BERTRAM DAY & CO. LTD

9 and 10, Charing Cross, London, S.W.1.

GERRARD 8063, 8064, 8065.

"ADBERTRADA, WESTRAND, LONDON."

*Manchester Office :*

E. G. DUNN,  
27a, Oxford Street,  
MANCHESTER.

*Wireless Publicity Specialists,  
Advertising Agents & Contractors,  
Printers & Publishers.*

*Organisers of the First All-British  
Wireless Exhibition—London, 1922*

**B**  
  
**D**

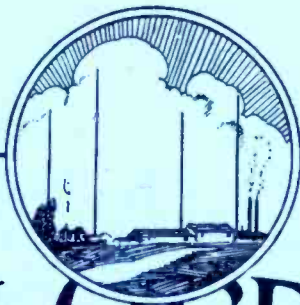

# The FELLOCRYST

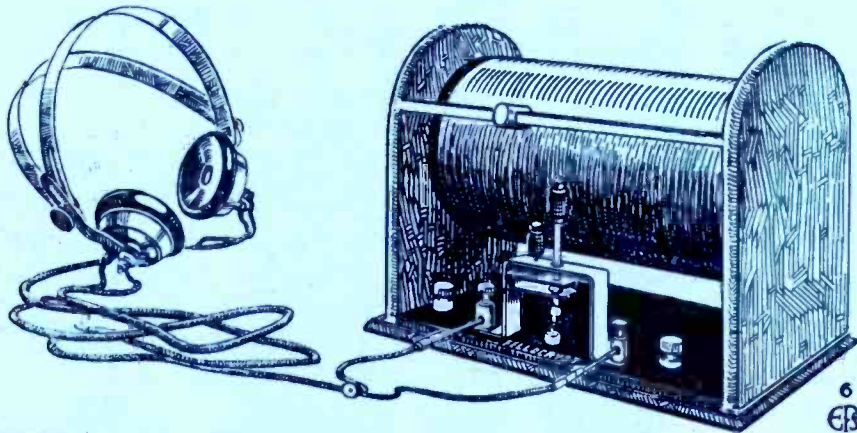

**T**HIS is an excellent crystal receiving set, which gives very good results on all wavelengths from 300-1,500 metres, and is suitable for receiving broadcasting, ships and long distance stations.

The adjustments are simple and easily made, and the silicon crystal detector well maintains its sensitive state. No batteries are required.

The set is sent out complete and includes 100 ft. coil of 7/22 stranded copper aerial wire, 2 shell insulators and one pair 4,000 ohms double headphones.

Every set is tested and guaranteed to receive broadcasting up to 15 to 20 miles and Morse signals from a much greater distance.

**The "FELLOCRYST" is British Made Throughout.**

Made under Marconi License and fully approved by the Postmaster General and British Broadcasting Company,

**PRICE COMPLETE £3 : 15 . 6**

inclusive of all taxes

Postage 1/6 extra.

Additional double headphones [(4,000 ohms), inclusive of all taxes, 21/6

Postage 1/-

*For they are jolly good Fellows*

**FELLOWS MAGNETO CO., LTD.,  
LONDON, N.W.10**

Telephone : Willesden 1560-1.

Telegrams : Quixmag, Phone, London.

# Broadcasting Reception

Can only be thoroughly enjoyed by the use of highly sensitive, distortionless and matched tone Telephone Receivers.

## SULLIVAN'S PATENT TELEPHONE RECEIVERS

For Radio Telephony and Telegraphy possess these qualities, and owing to increased demand the prices have been considerably

### REDUCED

#### PRICES

- 120 ohms 30/-
- 2000 ohms 34/-
- 4000 ohms 35/-
- 8000 ohms 36/-

*All Previous Prices Cancelled.*

*Trade Terms and Special Rates for Quantities on application.*



*Without public advertisement of any kind over one quarter of a million sets of "Sullivan" phones have been made and sold for WIRELESS alone.*

**DEMONSTRATION AND SHOWROOMS: Liverpool House, Middlesex Street, E. 1**

DEMONSTRATIONS DAILY from 5 to 6 p.m.

Two minutes walk from Liverpool Street and Broad Street Stations.

TRADE TERMS ON APPLICATION

## H. W. SULLIVAN, LTD.

FORMERLY H. W. SULLIVAN FOUNDED IN 1900

Works and Showrooms: LIVERPOOL HOUSE, MIDDLESEX ST., LONDON, E. 1. Phone: Avenue 4871  
Offices: WINCHESTER HOUSE, LONDON, E. C. 2. London Wall 3518

Telegrams: "Deedbeef, Stock, London"

**BIRMINGHAM :**  
The Birmingham  
Radio & Engineering Co. Ltd.  
8, Newhall Street.

*Representatives :*  
**GLASGOW :**  
Meridian Electric Co.  
29, Renfrew Street.

**LIVERPOOL :**  
Messrs. Pulford Bros., Ltd  
106-110, Whitechapel.



Printed by Sanders Phillips & Co., Ltd., Chryssell Road, London, S.W.9, for the Proprietors and Publishers, The Wireless Press, Ltd., 12-13, Henrietta Street, London, W.C.2; Sydney, N.S.W., 97, Clarence Street; Melbourne, 422-24, Little Collins Street; New York, 326, Broadway.



17th FEBRUARY, 1923.

THE

PRICE 6D. NET.

# WIRELESS WORLD

AND

## RADIO REVIEW

No.183. [No. 20.  
VOL. XI.]

17th FEBRUARY, 1923.

Registered at the G.P.O.  
as a Weekly Newspaper.

### *The BURNDEPT Power Amplifier*

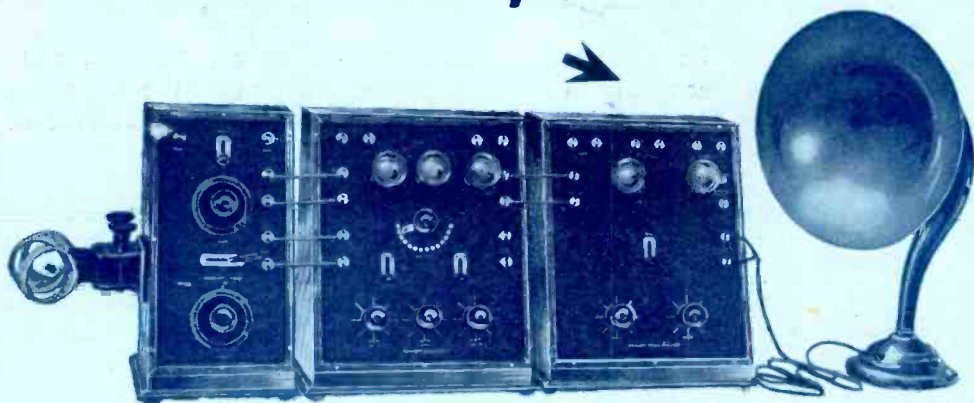

The Burndept Power Amplifier used in conjunction with a Mark III  
Tuner and Ultra III Receiver. See full-page description inside.

*Call at our Stand No. 1 New Gallery Ideal Home Exhibition.*

*All Burndept Valve Apparatus is duly licensed under Marconi Patents for Amateur use in Great Britain*

**BURNDEPT, LTD.** London Office and Showrooms: 15 BEDFORD ST., STRAND.  
Aerial and Eastnor Works, Blackheath, S.E.3

# BURNDEPT

WIRELESS APPARATUS

# WESTON ELECTRICAL MEASURING INSTRUMENTS

## The WESTON Filament Voltmeter for Receiving Sets

MODEL 301.

Simplified tuning by eliminating guesswork as to valve adjustments.

Filament voltage control increases the life of the valve from two to three times.

The Western Filament Voltmeter is accurate and can be relied upon for duplication of results.

ALL THIS MEANS

### BETTER RECEPTION!

List Price £2 : 9 : 0.

**WESTON ELECTRICAL INSTRUMENT CO., LTD.**

**Audrey House, Ely Place, Holborn, E.C.1**

Telephone: Holborn 2029.

Telegrams: "Pivoted, Smith, London."



MODEL 301.

Typical Flush Type Instrument.

# Ediswan Valves



Its silent working, robustness of construction, and economy in current consumption, make the Ediswan A.R. the ideal Valve both for the serious experimenter and the ordinary Broadcast receptionist.

With a single Ediswan Valve telephony from W J Z (Newark, N.J.) was recently received at Burnham-on-Sea, thus proving its high sensitivity.

## 15/- each

**THE EDISON SWAN ELECTRIC Co., Ltd.**

Head Office: 123/5 Queen Victoria Street, E.C.4

London Showrooms: 123/5, QUEEN VICTORIA ST., E.C.4  
71, VICTORIA ST., S.W.1

Works: PONDERS END, MIDDLESEX.

BRANCHES:—

If you are unable to obtain Ediswan supplies from your usual dealer, write to us for the name and address of the nearest supplier.

Aberdeen  
Belfast  
Birmingham  
Brighton

Bristol  
Cardiff  
Dublin  
Dundee  
Melbourne

Edinburgh  
Glasgow  
Hull  
Leeds  
Brisbane

Leicester  
Liverpool  
Manchester  
Newcastle  
Sydney

Nottingham  
Sheffield  
Southampton  
Swansea  
Adelaide

### EDISWAN BATTERIES H.T. and L.T.

are all manufactured with the same care and attention to details as other Ediswan products. Always insist on "Ediswan" when purchasing Accumulators or Dry Batteries.

# GAMAGES

## RELIABLE WIRELESS APPARATUS

In Wireless Equipment the all-important thing [to-day is Reliability. Wireless is overrun with goods of irresponsible makers. Your only protection is the standard brand of an established manufacturer. Gamages were making Amateur Wireless in 1908. To-day they are unequalled for high-grade apparatus at reasonable prices.



Write now for a Copy of Gamage's **WIRELESS CATALOGUE** Profusely illustrated and giving full details and prices. Post Free on request

### Special Offer of Ex-Government TESTED

## BROWN'S PHONES

12 Ohms. In perfect condition. Ideal for reception on either Crystal or Valve Set. Wonderful value.

PRICE **42/6**

Ditto, with new Telephone Transformer in Iron Case (value 25/-). PRICE Complete

**55/-**

Postage free.

### SPECIAL OFFER OF FILAMENT RESISTANCE

The Ideal Vernier Filament Resistance. Perfect movement and absolutely silent. Very efficient and will take two valves satisfactorily. Fitted with On-and-Off switch.

PRICE (Post Free) **5/6**

### SPECIAL SET of TOOLS FOR WIRELESS

Set 1, comprising 1 set of B.A. stocks and dies, with taps Nos. 2 and 4; 1 set carbon steel twist drills, 1/16, 5/64, 3/32, 1/8, 5/32, 3/16; set of 6 engineer's files; pair of polished combination pliers; combination drill chuck, tap wrench and tool holder; soldering iron; solder; bradawl; box 70 lengths hard brass wire; centre punch; jeweller's turnscrow, with three extra blades; forged steel metal snips; nickel-plated fixed turnscrow.

PRICE, complete in wooden box **30/-**

Set 2, comprising 1 set B.A. stocks and dies, taps; 1 set of twist drills; 1 set of 6 engineer's needle files; 1 set of 3 1/2" files; 1 combination drill chuck, tap wrench and tool holder; Lancashire brooch; solder iron; solder; 2' rule; electrician's turnscrow; pliers; long-nose pliers; bradawl; 1 box of 70 lengths hard brass wire; pattern-maker's hammer; pin tongs; pin vice; jeweller's turnscrow with 3 extra blades; nickel-plated fixed turnscrow; tweezers, etc., etc.

PRICE, complete in Teak Box **52/6**

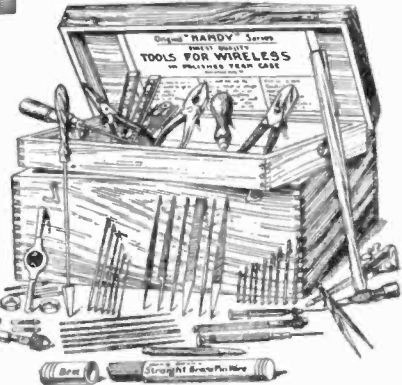
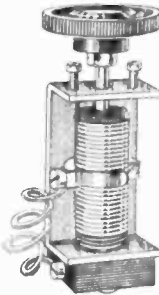

### NEW SEASON'S PRICES IN WIRELESS SUNDRIES.

Single Valve AMPLIFIERS for increasing volume of sound	42/-
Improved SONUS Type, Model A.1	50/-
Single Valve High Frequency AMPLIFIERS for increasing the range	70/-
"ORA" or "EDISWAN" Valves	15/-
"MARCONI OSRAM" Valves	17/6
Intervalve TRANSFORMERS, low frequency, maximum efficiency	25/-
FIXED CONDENSERS, best quality	
.002, .0003, .0004	3/-
VALVE HOLDERS, good quality	1/6
FILAMENT RESISTANCE	3/-
CONTACT STUDS, per doz.	1/6
TELEPHONE CORDS, per pair	4/-
High-class Dustproof CRYSTAL DETECTORS, complete with crystal	7/-
Permanite CRYSTAL	per piece 1/6
Silicon CRYSTAL	per piece 1/-
Zincite CRYSTAL	per piece 2/6
Bornite CRYSTAL	per piece 1/-
Copper Pyrites CRYSTAL	per piece 1/-
Wood's Metal	1/- and 2/-
EBONITE PANELS, cut to size	per lb. 5/- and 1/6
SHELLAC VARNISH, per tin, 1/2 lb.	5/- and 1/6
EARTHING SWITCHES on porcelain	4/6
ON-OFF SWITCHES, High-class	3/9
AERIAL INSULATORS, Reel Type	3d.
AERIAL INSULATORS, Barrel type	6d.
AERIAL INSULATORS, Shell type	1/-
AERIAL INSULATORS, superior types	1/6 and 1/9
AERIAL WIRE, 7,22 enamelled, per 100' coil	5/-
AERIAL WIRE, 7,22 enamelled, per 150' coil	7/6

Visit Our Stand No.

**26**

(NEW GALLERY) at the 1923 **Ideal Home Exhibition OLYMPIA**

March 1—24

and inspect the very latest designs in Wireless Broadcast Receiving Sets. Every detail has been studied with a view to maximum efficiency at a minimum cost.

**A. W. GAMAGE, LTD., HOLBORN, LONDON, E.C.1**

**For those who want the BEST**

**"DUNHAM" instruments will particularly appeal**

Illustrated and  
fully descriptive  
brochure of all  
our sets sent  
free.

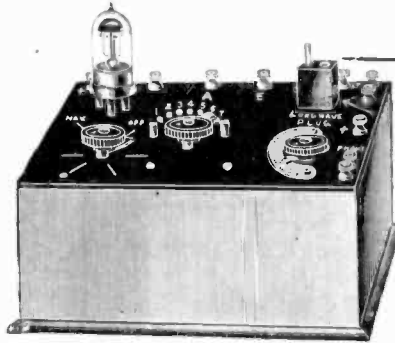

SPECIAL LONG  
WAVE PLUG  
FOR RECEIVING  
PARIS, ETC.

**£3 : 18 : 6**

This single-valve set receives broadcasting on 20' of wire hung across our showrooms at Brixton, and no outdoor aerial is needed. It is arranged so that amplifiers can be easily added if and when desired. Reaction is fitted, and being directly coupled to the aerial coil boosts up the receiving range and strength of reception. It cannot possibly radiate and cause interference. These and other special features make it without a doubt the finest single valve set on sale to-day. Approved by the P.M.G., No. 1087, and guaranteed by us. Price, complete with 'phones, accumulator, valve, H.T. batteries, etc., £7 8s. (plus B.B.C. fee of £1).

**C. S. DUNHAM (Radio Engineer) late of Marconi Scientific Instrument Co.**

234-6, BRIXTON HILL, S.W.2.

Phone: Brixton 3325.

Agent for BUCKINGHAMSHIRE: H. Geary, 77, Broad Street, Chesham, Buckinghamshire.

Trade Notice.

**VALVES**

BURNDEPT, Ltd., can give special terms on Marconi-Osram valves to members of the British Broadcasting Company.

Address enquiries to Sales Dept.,

BURNDEPT, LTD. — *Aerial and Eastnor Works* —  
BLACKHEATH, LONDON, S.E.3

**BURNDEPT**

**WIRELESS APPARATUS**



# The **BURNDEPT** Power Amplifier

**A** NEW instrument designed to furnish the power required to produce a really great volume of distortionless speech and music in large halls at dances, etc. Two special valves are used together with an H.T. battery of 100 up to 300 volts; a grid battery is used to reduce plate current (so prolonging the life of the H.T. battery). A unique feature in design is that the plate current does not pass through the Primary Windings of the Intervalve Transformer, thus obviating "burn outs" and reducing distortion.

### A New Principle.

Most good Table Pattern Loud Speakers (120 ohms) will produce speech and music of ordinary volume without distortion. Distortion, however, DOES OCCUR when Loud Speakers (of whatever design) are asked to produce a big volume of sound. Hence, to produce a big volume of sound it is much better to use as many ordinary loud speakers as may be necessary, so that each one can do its job without being overloaded up to the distortion point. The Burndept Power Amplifier will operate from one to twelve Loud Speakers in parallel, and will produce up to 60 milliamperes of modulated current.

Write for leaflet number 118 giving full particulars.

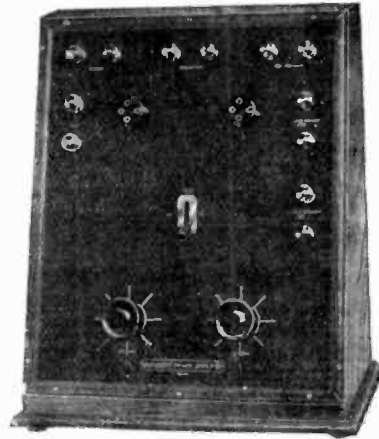

				£	s.	d.
No. 118.	In flat polished walnut case, to match all flat patterns of Burndept Receivers .. .. .	..	..	18	16	0 A.
No. 118s.	In sloping cabinet to match all sloping Burndept Receivers (extras) .. .. .	..	..	18	0	0 A.
No. 116.	Power amplifier valves, Types L.S.2 (two are required) .. .. .	..	each	1	15	0 E.
No. 179.	Special H.T. battery in polished cabinet, with four terminals giving 120, 180, 240 volts .. .. .	..	..	5	10	0 A.
No. 200.	Special grid battery, 30 volts, variable voltage .. .. .	..	..	0	7	0 F.

**BURNDEPT LTD.** London Office and Showrooms :-  
15, BEDFORD STREET, STRAND, W.C.1  
AERIAL AND EASTNOR WORKS, BLACKHEATH, S.E.3

London Assurance House, 249, George Street, 93, Holm Street, 110, George Street, 133, New Street, 91, Bridge Street,  
Bond Place, LEEDS. ABERDEEN. GLASGOW. EDINBURGH. BIRMINGHAM. MANCHESTER.  
BURNDEPT OF CANADA, LTD., 172, King Street West, Toronto, CANADA.

**BURNDEPT**  
WIRELESS APPARATUS

# BROADCASTING COMES IN WITH A SHOUT

## WITH OUR NEW SUPER RELIAPHONE No. 2

To operate it is to experience a new thrill in listening in.  
Quick and Easy Tuning. Clear and Loud Reception.

**GREAT RECEIVING RANGE.**

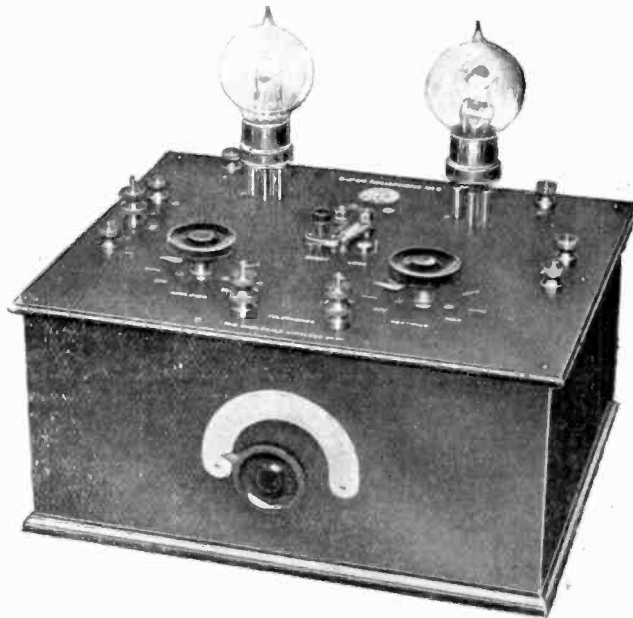

Reg. P.O.  
No. 0149.

Type approved  
by Postmaster-  
General.

Indefinite  
Wavelength.

RECEIVER  
as illustrated

**£14 : 10 : 0**

Complete with  
Accessories

**£20 : 0 : 0**

All Royalties  
included.

Super Reliaphone No. 2.

**Exquisite in design. Better value is unobtainable.  
IMMEDIATE DELIVERY.**

*Now that our new additional factory is completed the RELIAPHONE high standard of QUALITY will still be maintained and production quadrupled.*

ILLUSTRATED CATALOGUE POST FREE.

TRADE ONLY.

**THE WHOLESALE WIRELESS CO. LTD.**

103, FARRINGDON ROAD

LONDON, E.C.1

Telephone—Clerkenwell 5312.

# L. McMICHAEL, LTD.

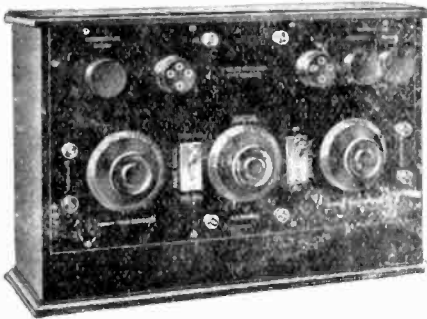

Two-Valve Broadcast Set, No. M.H./B.R.2.

## Two - Valve Broadcast Set, No. M.H./B.R.2.

G.P.O. Registered No. 2033.

THIS Two-Valve Broadcast Set is the result of careful experiments; we claim that in results it is superior to any other Two-Valve Broadcast set on the market. This set has one high frequency tuned anode valve which is adjusted by a variable condenser (marked secondary). A primary variable condenser controls the main tuning inductance. There are internal coils embodied in the set which enable the user to get all wavelengths up to 1,000 metres. Plugs are provided so that higher wavelengths up to 30,000 may be obtained by means of duolateral coils. The condenser marked "reaction" controls the reaction which is taken off from the high frequency side. On this set all Broadcasting Stations can be received with an average aerial.

The price of this set is £18 18 0

The accessories necessary are as follows:—

2 Valves, 17s. 6d. each	..	1 15 0
4-Volt Accumulator, 30s.	..	1 10 0
Aerial Wire (100 ft. enamelled)	..	6 0
H.T. Battery, 15s. each	..	15 0
Telephones from £1	..	1 0 0
Insulators (2) at 1s. each	..	2 0

£5 8 0

TOTAL COST, therefore, for COMPLETE STATION is £24 6 0  
(Carriage paid).

A. G. Mills, Esq.,  
63, Chart Road,  
Morehall, Folkestone, Kent.

Dear Sir,

You will be interested to know that I received on three consecutive nights the telephony and morse transmissions from W J Z (America) on your two-valve broadcast set M.H./B.R.2.

## Two - Valve Broadcast Amplifier, No. M.H./B.R.2A.

If further amplification is desired our M.H./B.R.2A. amplifier is recommended. This is a Two-Valve amplifier of similar size and design to the Broadcast set above mentioned and is arranged so that the terminals are easily connected. Means are provided so that one or two valves on this amplifier can be used at will.

A loud speaker can be used with this apparatus.

The price of the amplifier is . . . . . 9 9 0  
Accessories required are two valves at 17s. 6d. each . . 1 15 0  
The same H.T. battery and accumulator can be used that operates with the Broadcast Set.

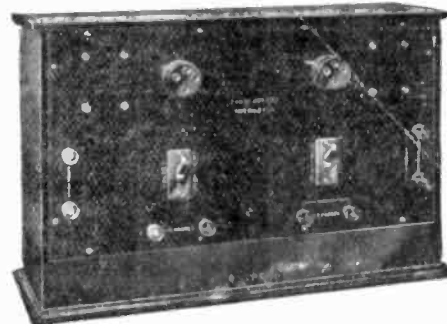

Two-Valve Broadcast Amplifier, No. M.H./B.R.2A.

Full details of our other M.H. Sets, 1 to 4 valves, of similar and unsurpassed efficiency are mentioned in detail in our NEW M.H. Booklet, 6d. post free. (All our valve apparatus is manufactured under Marconi Licence.)



# LESLIE McMICHAEL LTD.

RETAIL SHOWROOMS.

179, STRAND (Corner of Norfolk St). LONDON. W.C.2

Head Office (to which all correspondence should be sent):  
HASTINGS HOUSE, NORFOLK STREET, STRAND, LONDON, W.C.2

# An Epoch-making achievement in wireless



**A**FTER months of patient experimental work in our laboratory, we have perfected 2, 3 and 4 valve sets employing reactance, but conforming with the latest regulations for broadcasting licences and definitely approved by the Postmaster-General, giving truly marvellous results, which are the wonder of the wireless world. Orders for these are pouring in from all parts of the country.

### ***Selectivity***

Even if used practically on top of a broadcasting station in full operation, it is possible to tune out the local station and select other concerts in progress with well-sustained, clear and rich telephony without the slightest distortion. The design allows a range of reception from 200 to 3000 metre waves. Each receiver will effectively operate a loud speaker on either station.

### ***Range***

In range and efficiency a R F H 2-valve set of the new design is equal to most other 4-valve sets.

### ***What other set can compare with it?***

R F H sets are procurable in various types from five to one hundred guineas.

*Buying Agencies for these wonderful sets are being established throughout the country.*

**ROGERS, FOSTER & HOWELL, LTD.**

*Radio Engineers* ————— **EDWARD ROAD, BIRMINGHAM**

*Telegrams : Autowire.*

*Telephone : South 265.*

See our Exhibits at the Daily Mail Ideal Homes Exhibition in March.

*This Battery*

**DOUBLES THE EFFICIENCY  
OF YOUR WIRELESS SET**

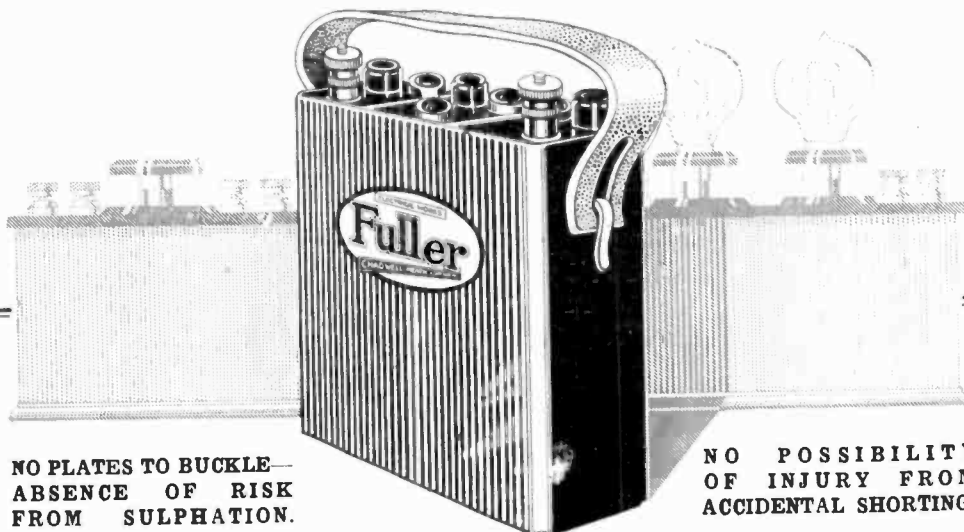

**NO PLATES TO BUCKLE—  
ABSENCE OF RISK  
FROM SULPHATION.**

**NO POSSIBILITY  
OF INJURY FROM  
ACCIDENTAL SHORTING.**

**FULLER **BLOCK** BATTERIES**

ACCUMULATORS - SOLID - NO PLATES.

As a result of their definitely established superiority Fuller Block Batteries are being universally used for Wireless work. Every day adds to their reputation. Not only is the output *double* that of ordinary plate type batteries, but the charge is retained for months on end when not in use. If you want better results with far less trouble and expense ask for a Fuller Block Battery, New Model Wireless Type.

*Sold by Wireless Dealers, Electricians and  
over 300 Fuller Battery Service Agents.*

*Dealers who are not fully stocked with these  
batteries should write us immediately.*

**In ebonite containers with leather handles.**

**B/W. 6/20. (5½" × 1½" × 6½") .. 25/-**

**B/W. 6/40. (7½" × 2½" × 7½") .. 40/-**

**B/W. 6/60. (9½" × 3½" × 8½") .. 52/6**

**N.B. Use EBONITE Cells and eliminate fire risks.**

**FULLER'S UNITED ELECTRIC WORKS, LTD.**  
**WOODLAND WORKS, CHADWELL HEATH, ESSEX.**

*Manufacturers for the Admiralty, Air Ministry and War Office for Wireless Work.*

Telephone: "Ilford 1200 (6 lines)

Telegrams: "Fuller, Chadwell Heath."



*The sign of superior*

*Battery Service.*

READY

Price **6/-** Nett

# The Year Book Telegraphy 19

**SPECIAL**

**FOR EXPERIMENTERS, AMATEURS**

## Phenomenal Demand

As a result of the tremendous demand for the Year Book, we have decided to issue a special edition for Experimenting Amateurs apart from the complete edition usually published.

The new edition will contain all the information given in the complete work, with the exception of matter of sole interest to Commercial Companies.

ALL YOU WANT TO KNOW IS IN THE YEAR BOOK

### **The Year Book of Wireless**

Price **15/-** Nett — **COMPLETE**

Practically the whole of this edition is already

# The Wireless Press, Ltd.

MARCH

# of Wireless & Telephony

# 23

EDITION

Post **6/9** Free

## AND ALL "LISTENERS-IN"

### Order Immediately

#### BRIEF SUMMARY OF CONTENTS.

Directory of over 450 Amateur and Experimental Stations (18 pages); Laws and Regulations governing Experimental, Amateur and Broadcast Wireless (52 pages); Call Letters of over 16,000 Air, Land and Ship Wireless Stations of the World (270 pages); Sixty-four Pages of Maps in Two Colours, showing position of all known Land Stations, indicating whether Direction Finding, Broadcasting, Public or Official; Complete History of Wireless from its Birth to Date, with full details of Progress made in 1922 (20 pages); Meteorological Section, showing all Regular Transmissions of Hydrographic, Meteorological and Time Signals, with detailed explanation of the Codes used and their Meanings (131 pages); Useful Data Section (46 pages); Dictionary of Wireless Terms in Five Languages, Tables and Formulae for Wireless Calculations, Graphical Symbols for Radio Diagrams; Classified Traders Directory for the benefit of Purchasers of Component Parts, etc. (4 pages); Full Morse Code, International and Continental; Direction Finding Section (20 pages); Who's Who in Wireless (35 pages); Wireless Literature (28 pages); etc., etc.

THE SUPPLY IS LIMITED—PLACE YOUR ORDER NOW

### **Telegraphy and Telephony**

EDITION— Post **16/-** Free

sold. To avoid disappointment order at once.

## 12-13, Henrietta St., London, W.C.2

### INTERVALVE TRANSFORMER

The resistance of our Intervalve Transformer is, primary 1600 ohms approximately, and secondary 9200 ohms approximately, step-up 4 to 1. This has proved in actual use to be one of the most efficient Low Frequency Transformers for use with Wireless Sets and Amplifiers. It can be easily mounted, has nickel-plated fittings, and great attention has been given to insulation throughout. All are carefully tested before leaving the Works, and are thoroughly guaranteed.

PRICE 25/-

### TELEPHONE TRANSFORMER

Made on the same lines as the Intervalve Transformer, step-down 4 to 1. A low priced but very reliable instrument.

PRICE 17/-

### MOUNTED TRANSFORMERS

Either of the above Transformers can be mounted on an ebonite panel, suitably engraved and enclosed in a highly finished figured oak box.

PRICE EXTRA 3/-

### THE ACME PRODUCTION CO., LTD.

73, COLESHILL STREET ——— BIRMINGHAM

Telephone : 4298 Central.

Telegrams : "Multum, Birmingham."

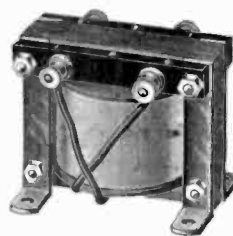

Fully approved by H.M. Postmaster-General for use with a Broadcast Licence.

PRICE (Receiver only) including all Royalties

**£12 : 7 : 6**

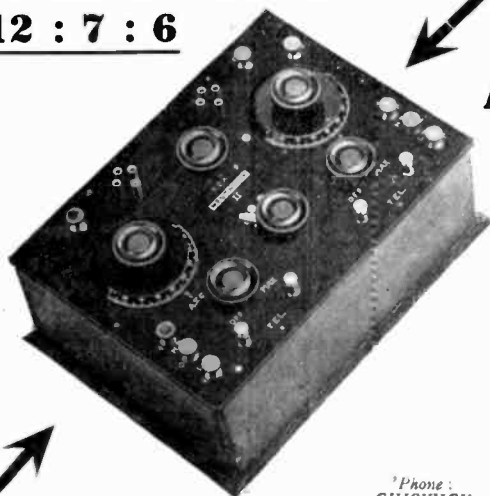

Phone : CHISWICK 586.

BUY A

G.P.O. Reg.

**HESTAVOX II**

No. 2049

2-VALVE BROADCAST RECEIVER and listen to

**All the British Broadcasting** in your own home.

This receiver, fitted with one high frequency amplifying valve and variable reaction, represents the most efficient form of long distance receiving instrument. The following agents, amongst others, are daily giving demonstrations :—

J. V. WALLIS, 28, Regent Street, Cambridge.  
BARDENS, Ltd., 62, Sizewell Road, Leiston, Suffolk.

TILY & BROWN, Ltd., 185/6, High Street, Guildford.

G. D. HINKS, Hardington, Yeovil.

J. P. PARRY, 68, George Street, Oldham.

TAMPLIN & MAKOVSKI, Ltd., Bell Street, Reigate.

WRITE FOR AGENCY & SUB-AGENCY TERMS & CATALOGUES.

**The "HESTIA" Engineering Co.** 32 Palmerston Road, Acton, LONDON W.3





TYPE A.I. Cap. .0005  
IN CELLULOID CASE.

**APPRECIATION FROM PEOPLE WHO MATTER.**

11, Albert Grove, Southsea, Hants.

Gentlemen,  
The quality of your products is good and the price is very reasonable.  
Yours faithfully,  
John H. C. Harrold,  
Radio Engineer and Lecturer.  
116, Verdon St., Sheffield.

Dear Sirs,  
We have tested your Condensers in the circuits we propose to use and we find them O.K.  
Yours truly,  
Brookes Bros.,  
Manufacturers of Scientific Apparatus.  
The Manor, Willenhall.

Dear Sirs,  
I thank you for Condensers as per invoice enclosed dispatched to Park Engineering Co., Willenhall. These are eminently satisfactory . . .  
Yours faithfully,  
W. Harvey-Marston,  
Manufacturer of Wireless Components.  
Francis Law, Ltd.,  
Electric Light and Power Engineers, Ilkley.

Dear Sirs,  
We are keeping the samples in question and are highly satisfied . . .  
Yours faithfully,  
Francis Law, Ltd.

**FALLONS**  
THE CONDENSER PEOPLE  
230a, HERMITAGE ROAD, LONDON, N.4.

**SINGLE CONDENSERS AT WHOLESALE PRICES**

Direct from the Makers—Saving Middlemen's Profits.

Complete in EVERY respect and exactly as illustrated, to the following specification.

Rotary, Air Dielectric, 22 Gauge Aluminium Vanes. Metal to Metal Adjustable Bearings. Spacing between plates sufficient for pressure up to 1,000 volts. Built upon Ebonite. Engraved Ebonite Dial.

**PRICES :**

Type A.I.	Plates.	Type A.II.
.001 .. 15/-	57	.001 .. 10/-
.0005 .. 12/6	29	.0005 .. 8/6
.0003 .. 11/3	19	.0003 .. 6/9
.0002 .. 10/-	13	.0002 .. 5/6

Vernier Condensers, 3 plate, 3/9 ; 5 plate, 4/6

*Postage and Packing :*

1, 1/- ; 2, 1/3 ; 3, 1/6

If more than 3 kindly include ample for packing and carriage.

Don't allow our low prices to prejudice you. They are no criterion whatever of the value we offer. Our Motto is **QUALITY FIRST**, and every Condenser carries our money-back guarantee.

No waiting.

Delivery from stock.

Cash with order.



Type A.II. Cap. .0005

# RADION

**MAHOGANITE**

This is the latest product of our Factories— a superior insulating material for high grade sets, which in grain and colour closely resembles mahogany. Its high insulating and non-warping properties, combined with a beautiful finish, make it an ideal material for Panels.

The Trade are warned against imitations— ordinary mottled Ebonite is *NOT* RADION - MAHOGANITE. All genuine Sheets are stamped "RADION".

*Enquiries from bona-fide Manufacturers and Wireless Dealers solicited.*

**AMERICAN HARD RUBBER COMPANY (Britain) LIMITED,**  
13a, Fore Street, London, E.C.2

TELEPHONE—1874 CENTRAL

## A BARGAIN £85

Original Cost : : : £205

**ELECTRIC LIGHTING & POWER PLANTS**  
for Country Houses, Workshops & Cinemas

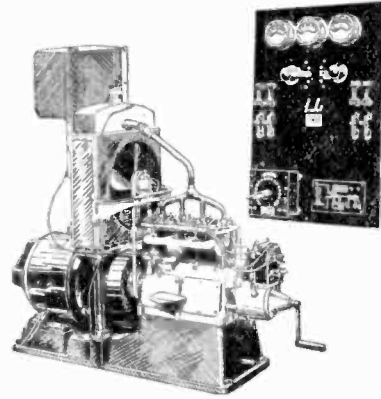

Austin, Standard and Douglas 3½ kw. and 4½ kw. 110 volt and 50/57 volt direct coupled generating plants. Price £80, £85 and £95. With special switchboard as illustrated, £16 extra. Every set guaranteed. Ideal for country houses, cinemas, workshops, etc. New spare parts for above always in stock.

**C. H. & L. O. SMITH, 75 Canal St., Nottingham**



TRADE MARK

**The WHITECROSS COMPANY, LIMITED**  
:: WARRINGTON ::

Manufacturers of All Descriptions of  
**WIRE ROPES AND WIRES**

The World's most *FAMOUS CRYSTAL*

## ELECTRONITE

(BRITISH MANUFACTURE)

(When used in conjunction with TORDINODIUM wire gives the maximum results.)

Can be obtained from us.

We are the sole distributing agents for the World

Price: Single Crystals, 1/-  
5/- per oz. Postage 2d.

As used by all the best firms in the Radio Business

TRADE SUPPLIED

ESTABLISHED — 1920

**RADIO SUPPLIES**

234, HIGH HOLBORN, LONDON, W.C.1

Phone: Holborn 2188.

# SEA, LAND & AIR

THE AUSTRALIAN MONTHLY JOURNAL  
of Aviation, Radio-Telegraphy and Radio-Telephony

Price 1/9 Post Free.

Annual Subscription 21/-

THE WIRELESS PRESS, LIMITED, 12-13, HENRIETTA STREET, STRAND, W.C.2

# THE WIRELESS WORLD AND RADIO REVIEW

THE OFFICIAL ORGAN OF THE RADIO SOCIETY OF GREAT BRITAIN  
A MAGAZINE DEVOTED TO WIRELESS TELEGRAPHY AND TELEPHONY

## CONTENTS

The American Broadcasting Station, WGY	- - - - -	649
The Antenna. By W. J.	- - - - -	652
An Experimental Single-Valve Receiver. By Percy W. Harris	- - - - -	656

*(Contents continued on next page)*

### BOXES, PACKING CASES & PACKING MATERIALS FOR WIRELESS SETS AND ACCESSORIES.

WE design special cases in corrugated or solid fibreboard to carry delicate instruments safely, and we shall be glad to do so for your productions.

### INDUCTANCE TUBES A SPECIALITY.

We also manufacture corrugated paper—supplied in rolls, sheets, or pieces  
Let us quote you for any cardboard goods you require.

### Hugh Stevenson & Sons, Ltd.

Summerstown Works - - London, S.W.17

Victoria Mills, Pollard Street, Manchester.

Factories also at BIRMINGHAM, LEITH, PERTH and GLASGOW.

Phone—  
Manchester.  
Central  
6967

Phone—  
London,  
Wimbledon  
1373

**STALLOY****TRANSFORMER LAMINATIONS**SOLE MANUFACTURERS **JOSEPH SANKEY & SONS LTD** AND SUPPLIERS

WORKS: BILSTON, STAFFS. London Office: 168 RECENT ST. W.I.

**TELEPHONE RECEIVER DIAPHRAGMS**

## CONTENTS *(Continued)*

The Problem of Atmospheric. By Dr. W. H. Eccles, F.R.S.	- - - -	661
Electrons, Electric Waves and Wireless Telephony (XX). By Dr. J. H. Fleming	- - - -	666
Notes	- - - -	669
Wireless Club Reports	- - - -	671
Calendar of Current Events	- - - -	675
Questions and Answers	- - - -	676

THE WIRELESS WORLD AND RADIO REVIEW is published weekly on Saturdays.

All correspondence relating to contributions should be addressed to THE EDITOR, THE WIRELESS WORLD AND RADIO REVIEW, 12-13, Henrietta Street, Strand, London, W.C.2.

No responsibility can be taken for MSS. or photographs sent without stamps to defray cost of return postage.

Editorial and Publishing Offices: 12-13, Henrietta Street, Strand, London, W.C.2.

Telegraphic Address: "Radionic, Rand, London." Telephone No.: Gerrard 2807.

Advertisement Managers, Bertram Day & Co., Ltd., 9 and 10, Charing Cross, S.W.1.  
Telephone No.: Gerrard 8063 and 8064

### SUBSCRIPTION RATES.

28s. per annum, post free. Single Copies 6d., or post free 7d.

Registered at the G.P.O. for transmission by Magazine Post to Canada and Newfoundland.

**HARRING CLAPTON**  
**WIRELESS SPECIALISTS**

Gerrard

8806

## H.F. AMPLIFICATION

We have just placed on the Market a NEW TYPE of impedance coil coupling for H.F. Amplification, made entirely of ebonite.

Complete unit £1 15 0 Panel mounting type (without switch) 15/-

Write for  
Illustrations

110, STRAND, W.C.2

# THE WIRELESS WORLD AND RADIO REVIEW

THE OFFICIAL ORGAN OF THE RADIO SOCIETY OF GT. BRITAIN

No. 183 [No. 20.  
VOL. XI.] FEBRUARY 17th, 1923.

WEEKLY

## The American Broadcasting Station WGY

*A description of this station is of special interest, as it is one of the American broadcasting stations frequently mentioned by British amateurs in their reports of Transatlantic broadcast reception.*

THE accompanying description is intended to give some idea of the manner in which WGY, the General Electric Company's station at Schenectady, New York, operates.

The transmitting apparatus and the studio

where the artists perform are not located in the same building, but are about three-fifths of a mile from each other.

The transmitting apparatus proper is located on the top floor of one of the factory buildings. A multiple tuned antenna has been erected

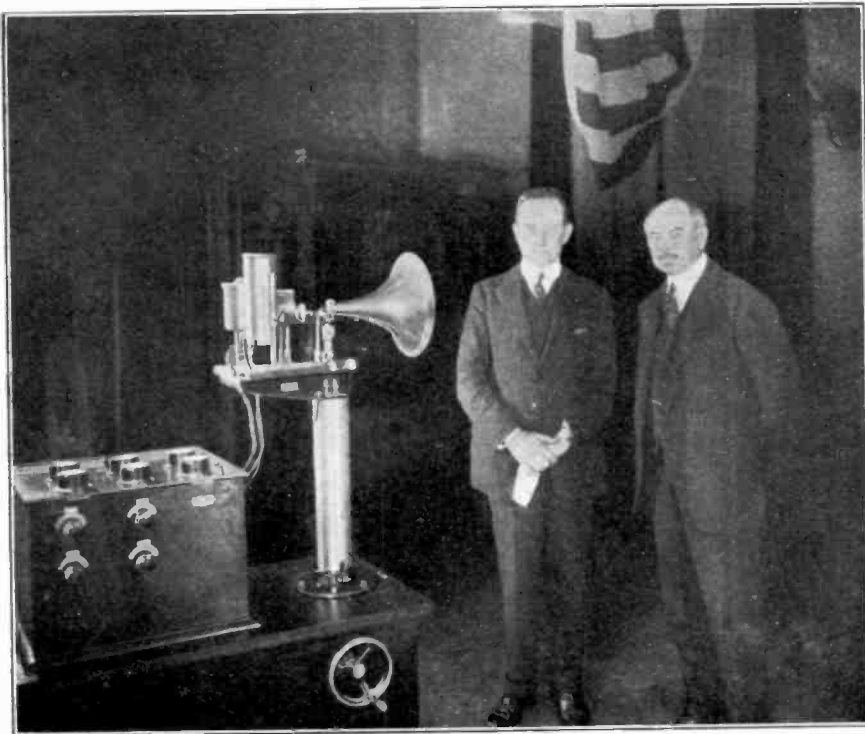

*Senatore G. Marconi with Mr. E. W. Rice, Jr., Honorary Chairman of the Board of Directors of the General Electric Company, in the studio of WGY, from which Senatore Marconi delivered an address to the American people, speaking through the microphone on the left.*

on the roof of this building. The antenna is 350 feet long and is supported at each end by a steel tower 180 feet high. A counterpoise system has also been installed a few feet above the roof. This consists of a network of wires that act as a "ground" for the antenna and results in a considerable decrease in the effective resistance of the whole antenna system.

The power supply for the transmitter is three phase, 60 cycles, at a potential of 110 volts. This source furnishes practically all the power for the entire equipment. Two types of vacuum tubes are used, namely, kenotrons or two element tubes and radiotrons or three element tubes. The filament

of the kenotron is heated from the secondary of a step down transformer. A small direct current generator is used to supply the radiotron filaments.

The plate circuit of the radiotron power tube requires high voltage direct current at a potential of about 12,000 volts. This is obtained from the kenotrons which are connected through a suitable rectifying circuit to the secondary of the high voltage plate transformer. A filter system is connected in the rectifying circuit in order to remove the A.C. hum that would otherwise be present. The high voltage output of the kenotron rectifier then passes into the radiotron tubes, where by means of the proper oscillating circuits it is converted into radio frequency energy on a wavelength of 360 metres.

Three rooms are utilised at the studio, one being used as a reception room, one containing pianos, organs and other musical instruments, and the third containing the controlling and amplifying apparatus. The only apparatus located in the room where the artists perform are small microphones which are mounted on stands so that they may be placed in the best position for the particular selection to be broadcast. These microphones have been very carefully designed so that the true tone qualities of music, voice, etc., will be clearly reproduced. The minute current fluctuations set up in the microphones are then transferred to the apparatus room, where they pass to amplifiers. Various controls are provided on the amplifiers so that the degree of magnification may be varied at will.

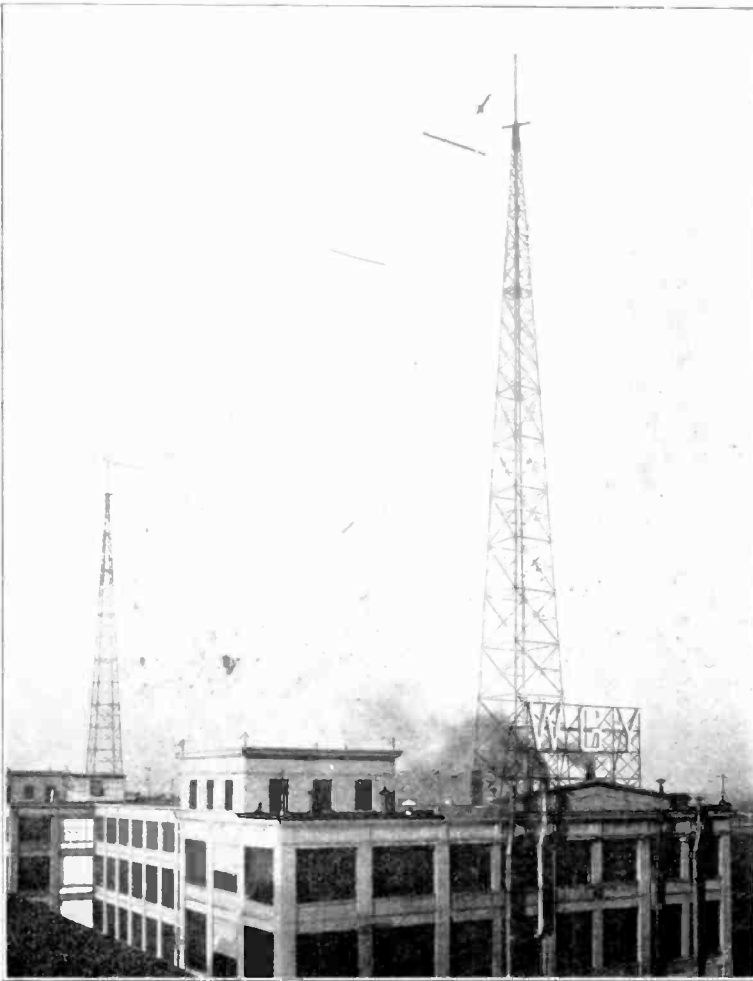

*A general view of the antenna system of the American Broadcasting Station, WGY, at Schenectady, N. Y.*

The amplified current fluctuations are next transmitted over a pair of wires to the modulator tubes located in the transmitting station proper, which are so connected that they may control the antenna current by varying the plate potential impressed on the oscillator tubes. The censorship and supervision that is exercised over the broadcasting is of some interest. The studio director has at his disposal a control switch which cuts the microphones in or out of the circuit. As soon as this switch is closed a red lamp is illuminated, which warns those in the room that everything

All circuit adjustments are, however, under the complete control of the censor and no changes are made without his consent.

It is interesting to note that this station has been listened to by a number of amateurs in this country, and in the issue of this journal for January 27th, on pp. 579 to 580, is given a list of some British stations which were successful in reception of American broadcasting. WGY is here mentioned as being heard by three amateurs, W. R. Stainton, Leigh, Lancs.; J. W. Partington, Camborne,

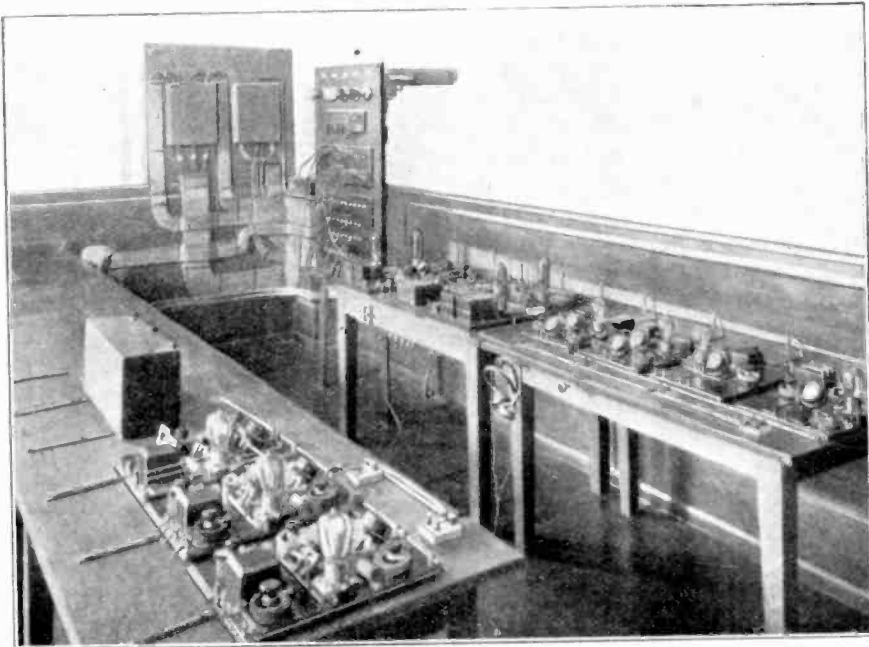

*The Censor's room adjoining the studio. The Censor determines the quality of the music and directs the amplification necessary to carry the speech and music over wire lines to the transmission equipment three-fifths of a mile away.*

spoken will be transmitted to the invisible audience. The "censor," or man in charge of the amplifiers in the apparatus room, listens continually to the concert or selection being broadcast so that he may make any adjustments necessary to improve the tone quality of the transmission. The censor is also in telephonic communication with the transmitting equipment, keeping a constant watch on the operator, who in turn keeps a constant watch on his apparatus, and by means of an oscillograph can determine the amount of modulation which is taking place in the antenna circuit.

Cornwall; and V. M. Cartnell, Southport. Other reports of reception have since been received from B. Caldwell, nr. Warrington, Lancs.; Colin Sarbuck, nr. Wigan, Lancs.; S. W. F. Cardell, Newquay, Cornwall; R. S. Smith, Erdington, Birmingham; and H. J. Jarrold, Norwich.

Other Broadcasting stations heard include WJZ, Newark, New Jersey; WDY, Roselle Park, New Jersey; WEY, Wichita, Kansas; WDAC, Springfield, Illinois; WDAF, Kansas City, Kansas; WEAS, Washington, D.C.; WIP, Philadelphia; and WOR, Newark.

# The Antennæ.

## THE TRANSMITTING STATION'S RADIATING SYSTEM.

IT is a matter for comment that while an experimenter will devote hours in making circuit adjustments in order to increase the current indicated by his aerial ammeter by a part of an ampere, little time or trouble is given to improving his radiating system—aerial, earth and counterpoise. From a consideration of the usual radiating structures it is apparent that in many cases great improvement is possible, and it is hoped in these notes to show why an improvement may be obtained and then to show the methods by which improvement may be achieved.

An antenna possesses resistance, capacity and inductance, and it is proposed to deal with resistance first.

Suppose we have a transmitter which is capable of putting 50 watts into the aerial circuit. The power radiated, which of course we desire to be as large a percentage of the 50 watts as possible, is equal to  $C^2R$ , where  $C$  is the current measured with a hot wire ammeter placed at the point of maximum current, *i.e.*, generally in the earth lead, and  $R$  is the radiation resistance. The radiation resistance in ohms is given by

$$1580 \left(\frac{h}{\lambda}\right)^2 \dots \dots (1)$$

where  $h$  = the effective height of the aerial, and  $\lambda$  is the wavelength of the energy in metres. From this equation it will be noticed the radiation resistance is proportional to the effective height, and varies with the wavelength. Now the total resistance of the radiating system is  $R_r$  ohms, and is considerably greater than  $R$ . With an antenna of 25 ohms

total resistance, the current will be  $\sqrt{\frac{\text{watts}}{R_r}}$

which is in this case  $\sqrt{2}$  or 1.41 amperes. If the radiation resistance for the wavelength of the energy is 3 ohms, the power radiated will be  $C^2R = 6$  watts.

The efficiency of the antenna is  $\frac{6}{50} \times 100\% = 12\%$ . The resistance values used here of course include that due to the tuning inductance and condenser if one is used.

The current received by an antenna is given by the formula  $h_r I_r = \frac{\lambda d R I_r}{377 h_r} \dots \dots (2)$

where  $I_r$  = current in transmitting aerial in amperes.

$I_r$  = current in receiving aerial in amperes.

$h_r$  = effective height of transmitting aerial in kilometres.

$h_r$  = effective height of receiving aerial in kilometres.

$\lambda$  = wavelength in kilometres.

$d$  = distance in kilometres.

$R_r$  = total resistance of receiving circuit in ohms.

The formula may be re-written

$$\frac{h_r I_r}{\lambda} = \frac{d R I_r}{377 h_r} \dots \dots (3)$$

Now  $\frac{h_r I_r}{\lambda}$  concerns the transmitter, and

it is at once evident that  $I_r$  which is the aerial current should be as high as possible, and as in the radiation resistance formula above,  $h_r$  should be large. The factor  $\lambda$  appears in the denominator of the expression, and it would seem at first sight that the shorter the wavelength the greater the received signal current, other factors remaining undisturbed; but this is not so on account of absorption, which is far more serious at short wavelength than long. Formula (3) is accurate for short distances, say up to 40 or 50 miles, but beyond that range the effects of absorption cannot be neglected, and the expression for the received current is reduced by a quantity determined by the nature of the intervening country and other factors.

It will be seen that it is desirable to make the ratio  $\frac{R}{R_r}$  as great as possible, as in this way

the antennæ current is larger, and a larger proportion of the power delivered to the antennæ is radiated. The difference between  $R_r$  and  $R$ , which is wasted, may be called  $R_w$ , and is made up of a number of components.

We have first of all the ohmic loss, due to the ohmic resistance of the aerial wires, lead-in,



loading coil, and perhaps series condenser, and earth or counterpoise. The loss is manifest as heat, and is reduced by using conductors which have a low value of high frequency resistance. The second loss is due to dielectric absorption, and is brought about by imperfect dielectrics lying in the field of the antennæ. In addition we have losses due to eddy currents, leakage, and brush discharges.

Curves which may be drawn showing the variation of total resistance with wavelength, are similar to Fig. 1. The figure shows roughly how the resistances vary with wavelength. The copper loss, in which is included that due to eddy currents and skin effect, is slightly greater the higher the frequency, and is represented by curve (1). The loss due to imperfect dielectrics is proportional to the wavelength, the higher the wavelength the greater the loss, and is represented by curve (2). The radiation resistance is repre-

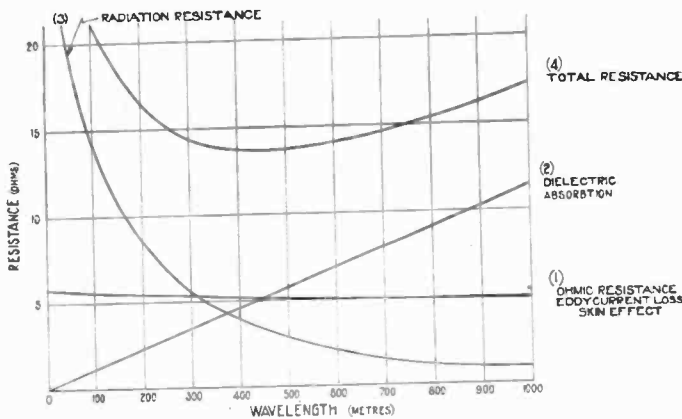

Fig. 1. The curves indicate the variation in antennæ resistance with wavelength. The sum of the magnitude of the resistances shown by curves 1, 2 and 3 at a given wavelength give the total antennæ resistance at that wavelength. In practice the total resistance only is measurable.

sented by curve (3), and it will be noticed, varies inversely as the wavelength. The total resistance is indicated by curve (4).

It is now proposed to deal with each source of resistance in turn and indicate, it is hoped, how the radiation efficiency may be increased.

From curve (1), it is seen that the high frequency resistance of the conductors used should be as low as possible, and in particular that due to poor contact with the earth. The wires used for the aerial should, when possible, be stranded, since the high frequency resistance of fine wires is not so greatly in excess of the direct current resistance as in the case of

thick wires. A good conductor, though unfortunately expensive, consists of stranded copper woven round a central non-conducting core. The next best conductor is probably a stranded conductor of fine wires, the wires being properly woven so that each appears on the outside of the cable an equal number of times, and for those who cannot afford a great deal, ordinary stranded 7/18 copper. The wires should be enamelled to prevent corrosion, and the formation of a high resistance skin.

Proper attention should of course be given to the design of the loading coil and condensers when used.

The eddy current loss, which is caused by currents flowing in neighbouring conductors such as stay wires, metal masts, and the earth surface, may be reduced by inserting insulators in each end of the stay wires, mounting the mast upon an insulator, and by the provision of a really good earth and counterpoise. The construction of the aerial and lower capacity, which includes the earth and counterpoise, will be dealt with later. In general, losses due to the use of a metal mast may be neglected by the experimenter with a small station.

The lower capacity should be directly below the aerial wires, otherwise the earth below the aerial will be the cause of losses.

From curve (2) one should remember that such objects as trees, buildings, wooden masts, neighbouring walls, fences, and the insulators themselves are the cause of great losses. So far as possible the space around the

aerial should be free from other objects, and care should be taken with the lead-in and lower capacity wires. The lead in should be as far removed from objects as practical, and ideally would leave the aerial and run directly to the lead-in insulator located in the roof of the building housing the transmitter. The lead-in is often a source of loss, particularly at the point of entry into the building.

The insulator should be large, so that the imperfect dielectric of the roof of the building is not the seat of losses.

The losses due to leakage and brush discharges also should be considered. Leakage

may be reduced by the provision of good insulators with high dielectric strength. The design should be such that the surface is long and irregular, so that dampness and rain will not cause surface leakage.

The brush discharge is reducible by the use of large diameter wires, but is very seldom the cause of loss with amateur transmitting plant.

The radiation resistance (3), it is seen, varies with the wavelength, and it is desired to make this quantity as high as possible by good antenna design. From the equations it is seen the effective height of the antenna should be as great as possible. With an antenna of a given height, the effective height is raised by attention to the preceding points. All things considered, it appears that maximum energy will be radiated when the wavelength

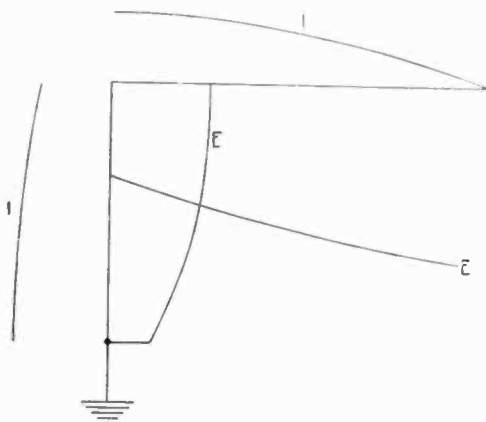

Fig. 2. The curves show the relative magnitude of the voltage and current along the unloaded antenna when oscillating.

used is of the order of 1.5 the natural wavelength. It is sometimes stated provision should be made for radiating at the natural wavelength of the aerial by connecting a series condenser to neutralise the effect of the added inductance which is essential for the transfer of energy from the oscillator to the aerial circuit. It does not seem to the writer that any advantage is gained, since the condensers generally used, besides being costly, are the seat of losses due to the ohmic resistance and dielectric loss.

The antenna, besides resistance, possesses capacity and inductance, and therefore a natural wavelength. The natural wavelength of a vertical antenna is a little over four times its length in metres. That of an inverted L

aerial is from 4.4 to 4.8 times the length from the free end to the lower capacity, and that of a T type aerial is from 4.5 to 5.2 times the length measured from one free end to the centre point plus the length from this point to the lower capacity. In the case of the inverted L and T aeriels, the capacity is largely due to the top portion, and the current in the down lead is almost uniform. It is not always satisfactory to calculate the capacity and inductance of the antenna on account of the dielectric present in its field, and the closeness of neighbouring buildings, etc. The capacity and natural wavelength may be measured, and it is then easy to find the inductance. It is pointed out here that lengthening the aerial wires increases the capacity and inductance, while putting more wires in parallel increases the capacity but reduces the inductance, the actual amount of variation depending upon the spacing of the wires. The wires should be preferably spaced six feet or more in the case of a flat-topped aerial. The increase in capacity is almost balanced by the reduction in inductance, so the natural wavelength remains unchanged or may be slightly increased.

The effect of loading an antenna is to change the wavelength at which it will radiate and the current and voltage distribution. When inductance is added the wavelength will be

$$\lambda = 1884 \sqrt{\left(L + \frac{L_0}{3}\right) C_0}$$

where  $\lambda$  is in metres,  $L$  = added inductance in microhenries,  $L_0$  = the low frequency inductance of the antenna and  $\omega$  the low frequency capacity in microfarads. The capacity  $C_0$  is assumed to be constant at all wavelengths, although actually it varies a little. The quantity  $L_0$  may be obtained from a knowledge of the natural wavelength, and the natural capacity  $C_0$ , and is obtained from the formula

$$\lambda = 1199 \sqrt{L_0 C_0}$$

It should be noticed that although two antennæ may have identical natural wavelengths one may have a larger capacity than the other, with the result that the addition of a given loading coil will result in the new wavelength being greater in the case of the aerial with the larger capacity. This is obvious from the wavelength formula.\*

\* The reader is referred to Circular No. 74 of the Bureau of Standards for further information dealing with the calculation of antenna constants.

It is instructive to consider the voltage and current distribution in antennæ with a view to bringing out special points which should be borne in mind when constructing the antennæ.

The voltage and current distribution of an inverted L type antenna is given in Fig. 2.

The aerial is represented by the inverted L earthed at one end. The curves marked I represent the distribution of aerial current,

its insulation should be such that it will safely withstand the voltage. The lead-in insulator obviously also requires to be able to withstand great potentials which it should be noticed may be greatly in excess of the voltage of the source of power. The line *a b* represents the pressure of the power supplied to the antenna, while *a c* represents that developed at the top of the coil.

In Fig. 3(ii) is indicated how the distributio

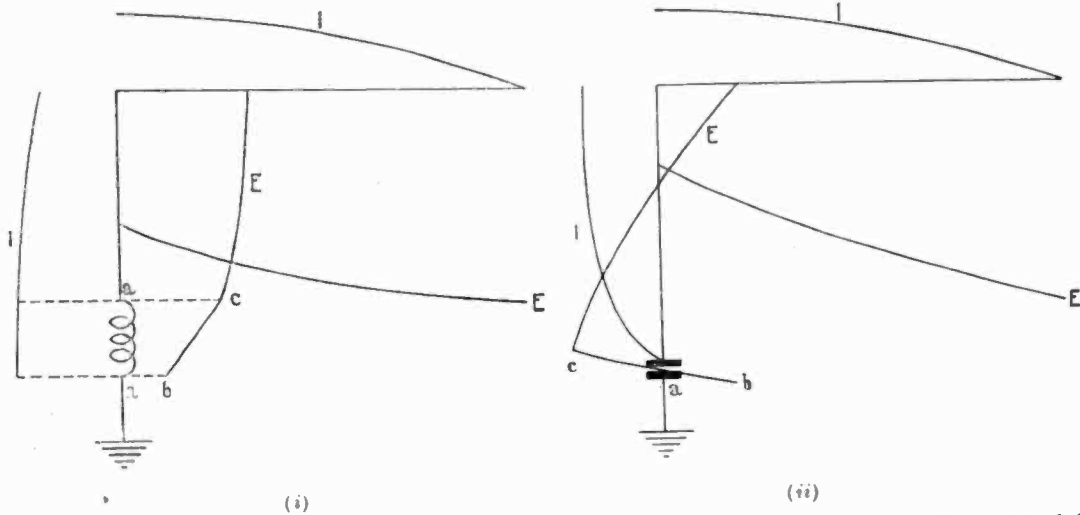

Fig. 3: The curves show the relative magnitude of the voltage and current when (i) the antenna is loaded with an inductance and (ii) loaded with capacity. The curves are instructive and should be examined.

the magnitude of the current being indicated by the distance from the line representing the antenna at the point considered. In the same manner the distance between the line representing the antenna and the curve marked *E*, indicates the magnitude of the voltage at the point considered.

It will be noticed the vertical portion has a nearly uniform current distribution, and the current falls off to zero at the free end. Here the voltage is a maximum, which emphasises the fact that great care should be taken with insulation at this point. When a series loading coil is connected, the conditions are roughly indicated in Fig. 3(i). It will be noticed the current in the coil is practically uniform, while the voltage across it is very high. The inductance should therefore be carefully designed to carry the current, and

may be expected to change when capacity is inserted for the purpose of shortening the wavelength. It will be noticed the pressure *c a b* across the condenser may be very much greater than that applied as represented by *a b*.

The magnitude will depend upon the capacity of the series condenser and upon that of the antenna. If a relatively small value condenser is used the voltage developed may be expected to reach a high value. The point where the voltage curve *E* crosses the antenna line, called a potential node, depends entirely upon the ratio of the added capacity to that of the antenna. The larger the ratio, the lower down the aerial the potential node. It will be noticed the current has its maximum value at the potential node, and *vice versa*.

W.J.

(To be concluded)

# An Experimental Single-Valve Receiver.

FOUR INSTRUMENTS COMBINED IN ONE.

By PERCY W. HARRIS.

THE beginner in wireless is frequently advised first of all to obtain a crystal receiver, so that he may learn the rudiments of the subject with the simplest apparatus, leaving the purchase of a more sensitive valve set to a later date when he feels more sure of his ground. There is much to commend in this advice, but the fact remains that few people relish having to abandon a set for which they have paid several pounds and spend still more money to start again with a complete valve installation. A discussion with a friend regarding this point led the writer to consider whether it would be simple to devise a small instrument that could be connected to existing crystal sets so as to allow the use of a valve. In thinking the matter over it was apparent that either high frequency or note magnification could be used.

To apply a note magnifier to an existing crystal set is of course a simple matter, as it is only necessary to attach the telephone terminals of the crystal set to the input terminals of the magnifying unit to obtain the desired result. Such an arrangement is satisfactory when the signals to be rectified by the crystal are already fairly strong, but the actual receiving range is not in any way increased by such an addition, as unless the signals are strong enough to pass the crystal they cannot be further magnified.

The other alternative is to precede the crystal by a high-frequency amplifying valve. This

arrangement is far more satisfactory when the user is situated at some distance from the station he wishes to receive, as the signals can then be magnified up to a strength sufficient to pass the rectifying crystal. Strangely enough, high frequency units for attachment to existing crystal sets are rarely constructed by the amateur, although they offer an interesting field for experiment. The instrument described in this article is designed to precede any existing crystal receiver so that efficient high frequency amplification can be obtained over the whole broadcast band of wavelengths. With the addition of any good intervalve transformer it can be used for low frequency amplification after rectification, while it also forms a useful single valve receiver without reaction. The fourth use of this little

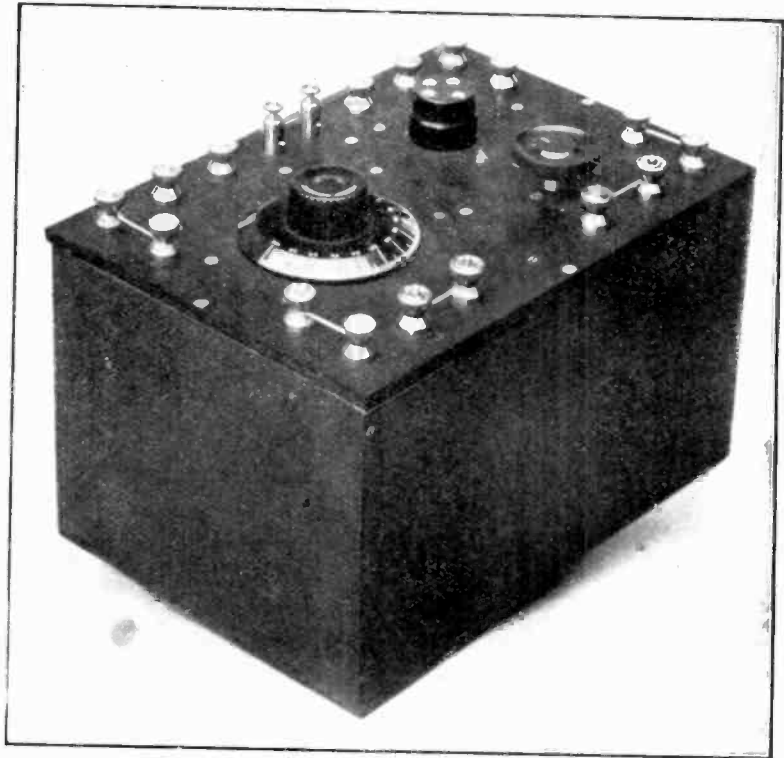

Fig. 1. Exterior view of the single-valve receiver.

instrument is as a short wave heterodyne, functioning from 100 to 225 metres or more.

Little need be said regarding the actual constructional work, as this is made clear in the photographs and diagrams. It will be noticed that tuning is effected by means of a variometer. This was purchased ready-made. Any variometer that will cover the broadcast band will do, but those who wish to construct it themselves will find the following data useful:—

Outer former, 4 ins. diameter ebonite tube.

Inner former, 3 ins. diameter ebonite tube.

Outer former wound with 32 turns in two sets of 16 turns No. 22 double cotton covered wire. Separation between two sets of windings  $\frac{3}{8}$  in.

Inner former wound with same number of turns in same way.

The rotor is carried on a split shaft to which the two ends of the inner winding are soldered. Contact with this shaft is made by means of rubbing spring contacts as shown. One end of the stator winding is connected to a terminal and the other *via* the spring contact to the shaft, the second spring contact making connection with the opposite end of the winding. The construction of a good variometer by the beginner is not easy, and in most cases a ready-made article is to be preferred.

A point of novelty in this instrument is the simple method of connecting a fixed condenser either in series or parallel. This method can be used equally effectively in any tuner. The writer does not remember having seen it described elsewhere, but it is certainly very convenient. Viewing the top of the panel, four terminals on the left will be seen. The two upper and the two lower can be joined with straps or wires. If when using the instrument as a single-valve receiver or a high frequency amplifier we open the top strap, connect the aerial to top terminal and the

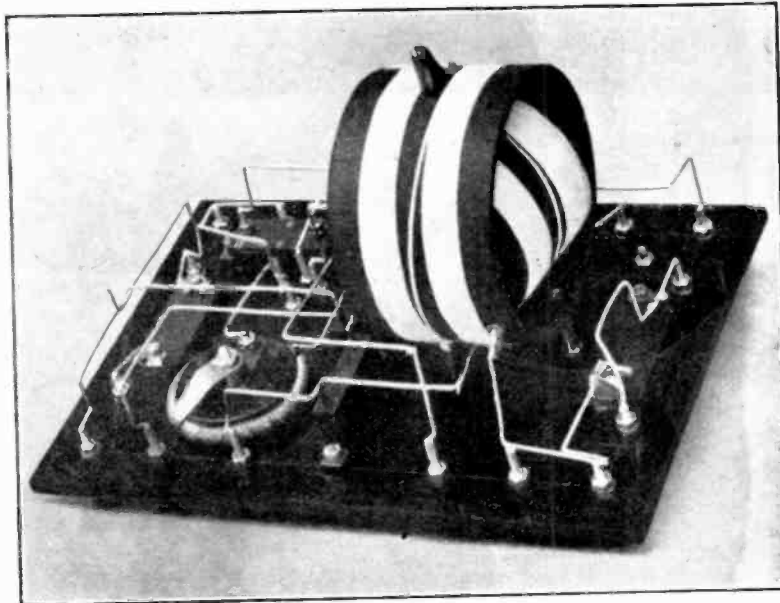

Fig. 2. Underside of panel showing method of wiring with stiff wire. Note: Since this photograph was taken the wiring has been slightly altered, and is now as in Fig. 4.

earth to the terminal immediately beneath it, leaving the lower strap in position, no condenser is in circuit. Opening the lower strap inserts a 0.0005 fixed condenser in series, while closing the top strap and connecting the earth to the bottom terminal (with the lower strap open) places this condenser in parallel with the variometer. The range of the particular instrument can thus be brought up to about a thousand metres. As the two middle terminals are connected together permanently, one may be dispensed with.

When used as a single valve receiver the strap short-circuiting the grid condenser is of course opened. A second alternative grid condenser is provided, and can be substituted by shorting the first and opening a strap across the second. This, however, is designed for other uses, as will be seen later.

If it is desired to use the instrument as a high frequency magnifier, the grid condensers are short-circuited and the crystal receiver connected to the upper right-hand terminals. The lower right-hand terminals are arranged so that when a strap is across them a 0.0003 mfd. condenser is connected across the output terminals. This value was chosen as it corresponds with the capacity of the average amateur aerial, thus allowing the usual adjustments

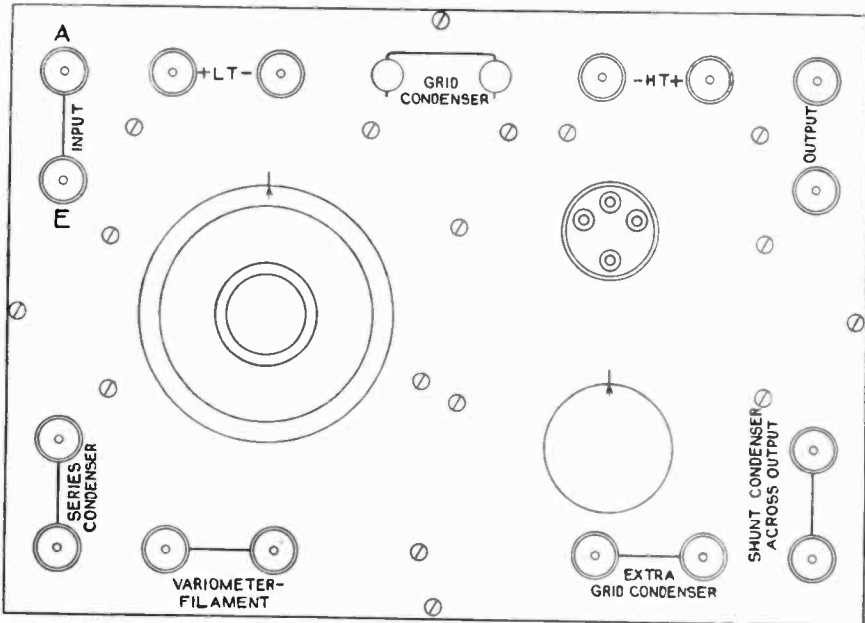

Fig. 3. Top of instrument showing terminal markings.

on the crystal receiver to be used. If possible the inductance of the crystal tuner should be tuned to the wavelength desired without the use of this condenser. It is, however, very useful when the wavelength range of the crystal set is limited.

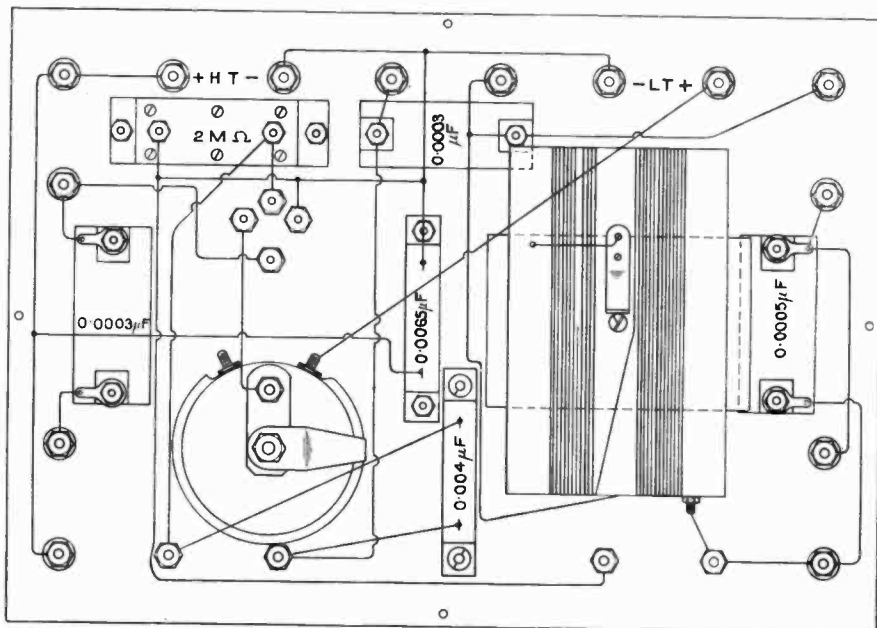

Fig. 4. Wiring diagram of the underside of panel.

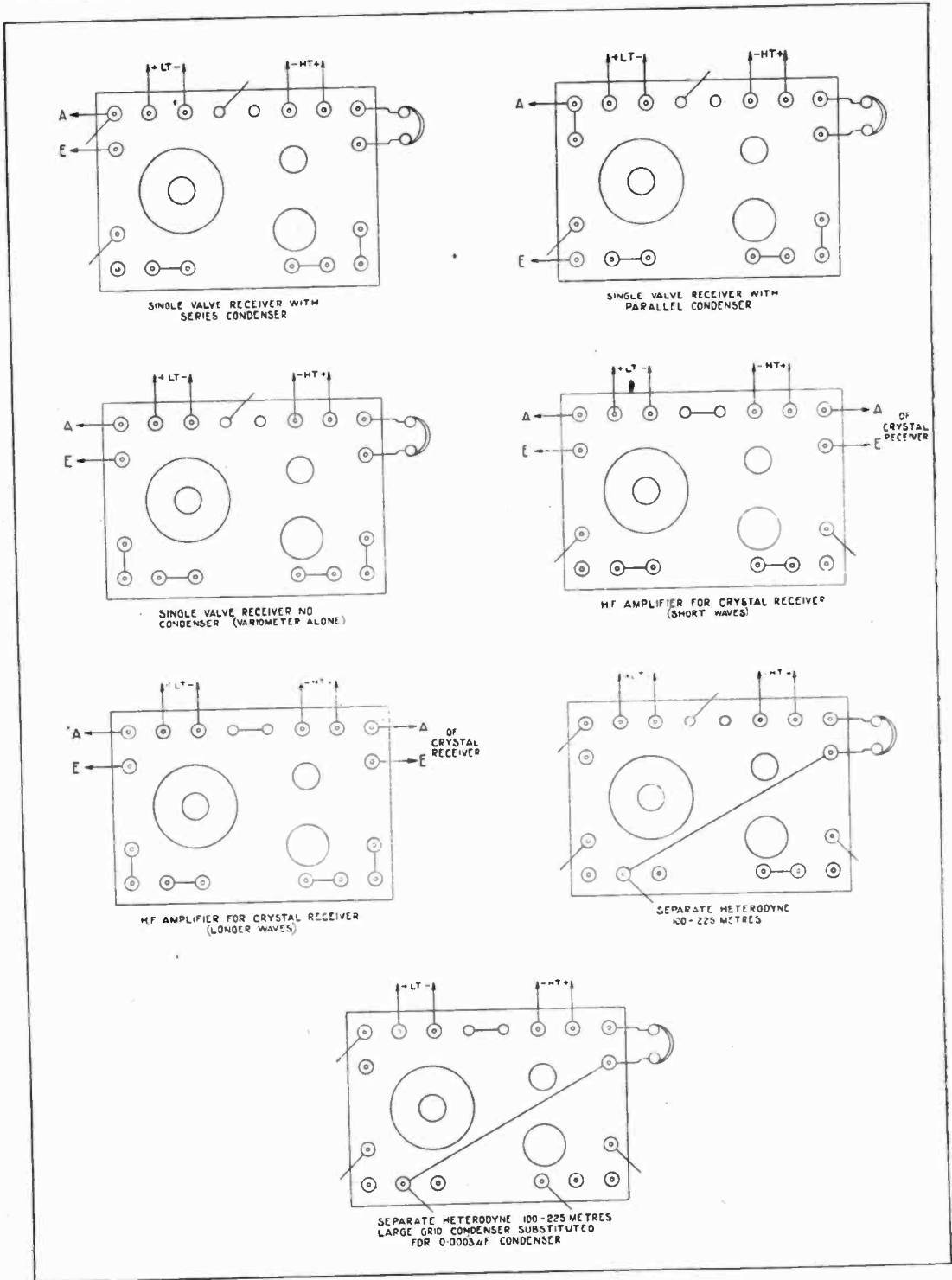

Fig. 5. Methods of connecting the instrument for various purposes.

To use this instrument as a note magnifier after rectification, the telephone terminals of the crystal set are connected to the input terminals of an intervalve transformer, while

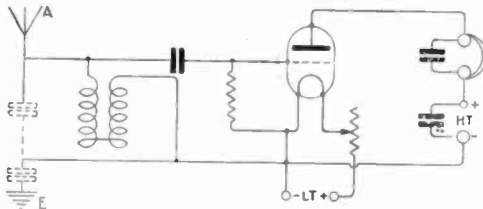

Fig. 6.

*Theoretical diagram of set used as single-valve receiver.*

the output terminals of the transformer are connected to the aerial terminal (strap open) and to the right-hand of the two terminals immediately beneath the variometer dial (strap open). The grid leak must be disconnected for this purpose. Terminals could have been provided to effect this disconnection, but as this use of the instrument is not often desired, they were not considered necessary. The grid leak is connected between the grid and the filament, and not across the grid condenser for a particular reason which will be seen in describing the heterodyne circuit.

The remaining use of this panel is as a separate heterodyne for short waves. The particular circuit is little used by amateurs in this country. It is known as the De Forest Ultraudion circuit, and is shown in the dia-

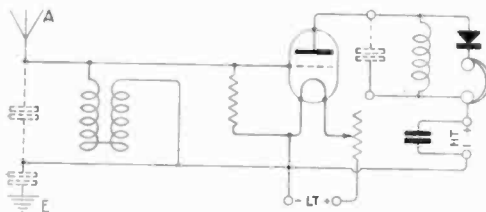

Fig. 7.

*Theoretical diagram of set when used with crystal receiver as H.F. Amplifier.*

gram. Unlike most circuits, connection is made from the variometer to the grid and the plate, not to the grid and the filament. If so connected, leaving the phones in circuit and with the telephone shunting condenser cut off, the set will oscillate freely, if not particularly vigorously,

over the whole range of the variometer, using an R type with 60 volts on the plate. In the particular variometer the range is from 100 to 225 metres. If the valve is one which oscillates very readily, it is possible to use the 0.0005 mfd. aerial condenser in shunt, and thus increase the range considerably. However, the chief use of this heterodyne is round about 200 metres.

The grid condenser must be left in circuit when using this arrangement, so that the grid may be insulated from the plate voltage. For this reason the grid leak runs from grid to filament instead of across the grid condenser. The larger grid condenser was inserted to see what effect it would have used in this way. It is by no means essential, and the normal grid condenser functions quite satisfactorily.

Values are given for the various condensers actually used, these being available at the

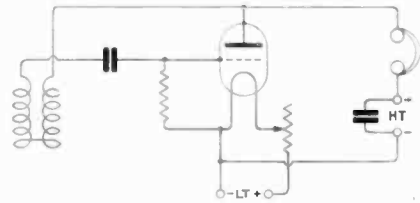

Fig. 8.

*Theoretical diagram of set used as short wave heterodyne.*

moment, but some may be altered without detriment to the working of the instrument. The aerial condenser can have a different value, and the condenser across the H.T. terminals can with advantage be larger. The shunt condenser across the output terminals should be kept at the value given, as this corresponds with the average aerial used. The additional grid condenser was the largest that happened to be available, and it would be interesting to experiment with several different values here.

Used on my own aerial as a H.F. stage in front of a single-slider crystal receiver, Birmingham can be heard distinctly, and on 600 metres the additional amplification is very considerable. No doubt readers will be able to find further uses for this little set, which in any case is handy to have available for experimental work.



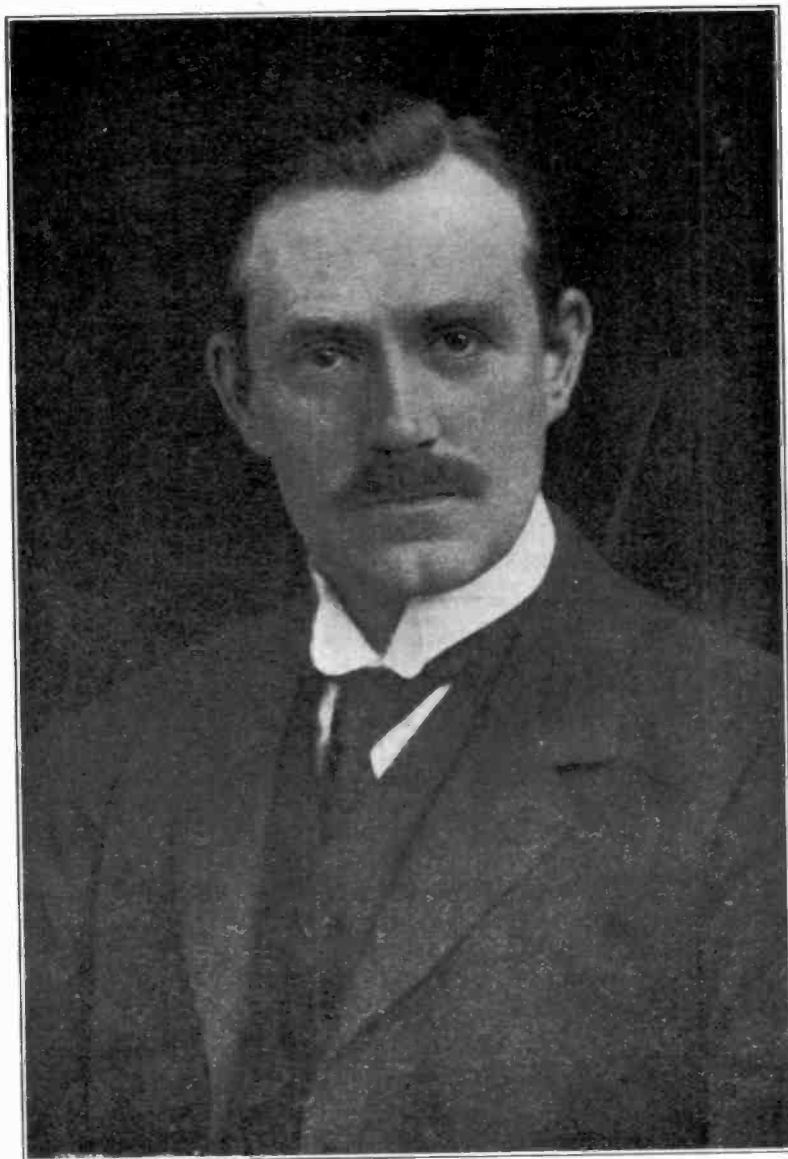

*Dr. W. H. ECCLES, F.R.S.  
President of The Radio Society of Great Britain.*

# The Problem of Atmosphericics and some Suggestions for Experimental Investigation\*

By Dr. W. H. ECCLES, F.R.S.

It is my privilege, and duty also, to thank the Radio Society for the honour they have done me in inviting me to fill the chair. The previous occupants have been very distinguished men, and I feel it will be difficult to live up to their standard of strenuousness. The honour appeals to me especially because in this Society there are all types of lovers of wireless: there is the professional man, the scientific man, the commercial man, the experimentalist, and the person who merely uses wireless as a recreation; and there are also those who are not interested in wireless itself, but are interested in what it can give them—the "broadcasters." All these members are welcomed to this very catholic body, and therefore I think it gives the President of this Society a breadth of basis that no other society in wireless does give. No society in the world. This is especially true after the important change that has occurred this year in the name of the Society. As is usual in other cases of change of name, the implications are that alliances have been formed, that individual interests have been drawn nearer together than they were. The smaller wireless societies all over the country are now drawn somewhat closer than before, and a machinery is being built up by which a kind of parliament will sit under the auspices of the Radio Society; there they can make their complaints, their demands, their recommendations or suggestions.

Another important event in wireless as a whole has happened during the past year in the advent of broadcasting. Those of us who have been interested in wireless for many years, welcome the advent of broadcasting, and the proposals for more and more broadcasting, very cordially. Just as in other subjects, the greater the public interest taken in wireless the better for the subject. For one thing, the spread of knowledge is always beneficial. The number of people who will now be learning something real about wireless is augmenting extremely rapidly. Hitherto the powers of wireless have been very much exaggerated, for instance, in the ordinary press; but actual contact with wireless reception, which is being brought to the general public by broadcasting, cannot but help in showing the public what the limitations are, and will help to avoid the great disappointments which may occur by non-fulfilment of some of the promises that have been made with this wonderful subject of ours. Beside that, I think that this widening of the area of people interested in wireless which broadcasting has conferred, will undoubtedly enable the country to draw more persons of all ages into the stage of trying to invent, or trying to discover. It will help to get the boys with elec-

trical minds into the right places, for I think there is no subject which teaches electricity so much as wireless, and there is no subject so important as electricity in our modern civilisation. For good or for bad, this modern civilisation of ours is becoming more and more electrical, and therefore we want more and more of our population trained electrically, and unless that is done, we, the nation, are sure to fall very much behind. I therefore think that it is of national importance to welcome the broadcaster, but at the same time it is also of national importance to make sure that the experimentalist retains the widest possible freedom for his receiving apparatus and his transmitter, and to ensure that there is no mutual interference between the two classes. They say that necessity is the mother of invention. I am not sure that I understand that, but I think I do know that research is the father of invention; and unless we can keep experimentation going with full vigour in this country, invention will be stifled. I remember that my old friend, Mr. Duddell, used sometimes to speak very despondently of the prospects of wireless in this country from the point of view of discovery and invention. It seemed to him, he used to say, that we were being far outdistanced in both discovery and invention, and that some vigorous campaign ought to be initiated to call the attention of the general public to this deplorable condition, as he called it. I have had that called to mind in recent months, in the progress of various visits I have made abroad. For instance, in America, during visits to a large number of stations—especially the big stations—it is noticeable that in these stations there is no invention of English origin of later date than 1904. The whole of the remaining inventions in the stations are non-English. The main inventions that we can see plainly in these stations are of course the Marconi elevated antennae, which we may claim as partly English, and there is also the Lodge 1897 invention; and there is the Fleming valve of 1904. Except for these older inventions, we cut a very poor figure nationally in the American stations. In the French stations the same story can be told, and also in the Italian stations. I do not know what there is in the German stations, but I question if, excepting those inventions I have named, there are any English patents at all in use in any foreign-built stations. On the other hand, when you take the other side of the picture and visit a large English station, you find that there are certain English patents in use there, because of the natural fact that an inventor employed by the owner is specially favoured; but the great bulk of the inventions in use, even in an English station, Governmental or private, are of foreign origin. One might bring it home even more closely by mentioning the fact that the British Broadcasting Company's apparatus is largely of foreign invention;

\* A Presidential address delivered before the Radio Society of Great Britain on Wednesday, January 24th, 1923.

and if you turn to your receiving apparatus, the same story must be told, with one or two exceptions, such as the Franklin back coupling patent, which has saved our face nationally to some extent.

Now that explains to you why I feel especially strongly that this Society ought to keep its policy fixed on free experimentation; that it ought to encourage its members to write and discuss as many papers as possible, to urge them to try and keep their apparatus and methods changing and moving; never being satisfied with the old; but always trying to improve or to find alternatives. If we can do that, we can till the national soil in such a way that from it there may sprout some man or men of genius who will restore our national prestige.

Now the first query occurring to many members of this Society who have not bothered to do much investigation or much invention will be the question. What shall we start upon? And I hope it will serve a useful purpose if I just run over two things that occur to me as problems capable of being handled with simple apparatus. There are innumerable openings, it seems to me, but I am going, in view of the fact that time is limited, to speak only of two of them. The first is the problem of atmospheric disturbance to wireless reception, and I am going to take it as an illustration of scientific investigation rather than from the point of view of invention. Then I will illustrate two or three simple possibilities to which I think future inventors and discoverers might turn as a beginning.

To deal with atmospherics first. What we must first do, I suppose, before recommending anybody to start work, is to summarise for them what has already been found out. It is always useful to know what has been done by your predecessors; it will at least save travelling over the same ground. Now a good deal has happened of recent years in connection with atmospherics, but I had better just point out that a good deal has been known about them since the very beginning of wireless telegraphy—in fact, before wireless telegraphy began, atmospherics were being received and remarked upon in laboratories. In 1895 people were tracking the storms over the continent of Europe by the aid of coherers. Later, the early wireless experimenters found their tape marked by blurred dot and dash signs in an irregular manner, and the cause of these markings was traced to be connected with thundery weather—thunderstorms passing across Europe, which caused more disturbance as they approached the observing station, and as they passed away less and less. So that it has been known for very many years that thundery weather causes atmospherics. But there are so many other possibilities that it is not right to say that all atmospherics are due to lightning. For instance, they might be due to the picking up of small meteorites, for these falling through the air and getting hot produce electric charges and discharges which will affect antennæ. There might also be violent electrical storms in the sun which could send "atmospherics" to us; and there might be (as the journalists thought a year or two ago) messages from Mars which might cause disturbances. These possibilities existed, and had to be gradually sifted out in the course of years.

One thing suggests that all atmospherics are due to lightning discharges near the surface of the earth.

The statistics available show that the conditions giving good propagation of signals give rise also to many atmospherics as a rule, which seems to show that if the air is electrically clear, atmospherics can be gathered from a larger area, or in other words, the larger the area you can receive from, the more atmospherics there are to be picked up. This indicates that they are all lightning discharges relatively near the surface of the globe.

Another thing that points to the same fact is that long wave receiving apparatus is troubled more with atmospherics than short wave receiving apparatus in general. Now, it is well known that long waves do travel greater distances than short waves, which suggests that long wave atmospherics are often due to distant lightning discharges, and short wave ones due to near discharges.

But the matter has received a great amount of aid from the methods of directional reception which were developed during the war. The receiving frame with which one can point out the direction from which signals are coming, can also be used for detecting the direction from which atmospherics are coming; and particularly in America, a great deal of work has been done by direction finders with regard to atmospherics. To summarise the results briefly; on the Atlantic coast most of their atmospherics seem to come from the Allegheny mountains and from the Mexican mountains; on the Pacific coast they come mostly from the mountains quite near, and sometimes it is found in California that many are coming quite definitely from one mountain peak only a few hundred miles away. In Porto Rico, Austin has found that they come from the South American mountains and from Mexico. In France, a good deal of work was done in 1920 to 1922, and published about a year ago, in which storms were traced over Europe and the adjacent seas by the aid of direction finders, and it was proved that most of them were due to the front edge of cyclonic disturbances following their usual course across the continent.

Then again, there is the work of the Radio Research Board. Mr. Watt, working under the Radio Research Board, has analysed a great many of the statistics accumulated during the war from direction finding stations. When two or more stations reported that atmospherics were bad from a certain direction, the lines could be drawn on a chart, and the point of origin found. This enabled Mr. Watt to give a formula showing how the angle from which atmospherics come varies with the time of day and the season.

Well, there are a great many other observations; it would be tedious to enumerate them all; but this is the kind of conclusion to which I, in going through them, have been driven, and which I am going to suggest some of the members of this Society might gradually, as opportunity allows, carry through the testing stage. I will first generalise, and say that apparently all atmospherics of importance originate in mountainous areas, and especially where high land dips suddenly to the sea, as in Mexico, the Andes, the Rocky Mountains, and also in Central Africa, and in Western and Eastern Africa. All these produce very considerable atmospheric disturbances at certain times of day and at certain seasons, and from such obser-

vations as I have been able to collect, the striking thing is the influence of the position of the sun on the display of atmospherics. But suppose I take first our English summer season. Most of the atmospherics are local. They are due, as has long been known, to the sudden rising of moist air through unstable conditions of the atmosphere. When the air rises, it cools and expands, the moisture condenses, and in that process electrical effects occur which charge large masses of air, and these charged masses produce local atmospherics in discharging. I dare say you have heard the description of the English summer as three fine days and a thunderstorm? Well, this is fairly true, and in summer you will find that our atmospherics come from all sorts of directions, according to where the storms are moving. The only directions that do stand out prominently are the Vosges, the Alps, and perhaps the Pyrenees to some extent. There are days on which the atmospheric conditions are stable, when there is no thundery weather in Europe, and then atmospherics come from more distant places, usually somewhere in Africa. Consider, now, the spring or autumn season, when the sun travels along the equator. As it passes over India a certain amount of atmospherics is picked up in England, apparently from this west coast of India. As it gets nearer to Africa, the eastern African mountains and the Abyssinian mountains get to work, and the electrical discharges that occur there are also picked up. When the sun gets to the west side of Africa, the whole of the continent has been heated, and the air which begins to flow in from the Bight of Benin is forced to rise by the mountains, and you can pick up with your direction finder in England atmospherics from this part of Africa.

The next great maximum seems to be due to a time when the sun is fairly near the extreme western side of Africa, the mountains on this coast come into play, and the atmospherics appear to come from this direction. Later in the day there is a lull, but later still, when the sun has traversed South America, a lot of atmospherics come from the Andes and the Mexican mountains. They can be located by the ordinary direction finder so far as direction goes, but the distances they are from England, of course, cannot be determined. I am merely suggesting from what I have seen, that as the sun moves round the equator and warms the air on the land, the consequent meteorological phenomena produce atmospherics in England. This heating of the land areas has an enormous effect on signals, I may say. I was told, in fact, when I was in France a little while ago, that a station in the Argentine can receive signals from the American naval station in the Philippines during certain parts of the day from the easterly direction, that is the short way, namely, 165°. At another part of the day it receives from the opposite direction the longer way round the globe. A study of the times of the day when these phenomena occur shows that immediately the sun gets round to the Indian side of the globe, and begins to heat up the continent of Africa, the signals stop going across the continent of Africa and take the longer way round across the dark Pacific—it is a much longer way round, amounting to about 30 degrees. This shows that heated land has a great influence on the propagation of waves, and I am importing

this little illustration to justify what I said about atmospherics. I may say, by the way, that in the Argentine the direction of atmospherics is mostly from Africa when the sun is over the South Atlantic, and is mostly from Central America when the sun has passed 20 or 30 degrees across the Pacific.

Consider now the season when the sun travels along the Tropic of Capricorn, that is our English winter. There are very few local atmospherics. The whole field is open for the observation of distant atmospherics. It is found that as the sun goes along the tropic, India sends a few atmospherics, while the high plateau north of the Rand, or perhaps the more northerly area, sends enormous quantities. The sun, when it comes over the west coast later in the day, causes that coast to come into operation, and later the South American mountains play their part; perhaps the Mexican also assist, and we may receive atmospherics from that direction. Thus the changes of season from winter to spring, etc., move the source of atmospherics, and it seems to be for that reason that the seasonal directions in atmospherics have been found. I am describing this theory in order to make the suggestion that those who have leisure to make directional observations of atmospherics would find here a very interesting subject of a scientific character, which of course has its bearing on the commercial operation of stations, but could be treated as a purely scientific problem here at home. This reminds me that one thing wanted very much for this purpose is an instrument which would record the direction from which atmospherics are coming. Suppose one has two equal frame or coil antennæ fixed in perpendicular vertical planes, with precisely similar detecting apparatus. Let the indicating apparatus be designed with a single pen capable of motion in two perpendicular directions by the respective receiving sets. An atmospheric perpendicular to one frame would be arranged to move the pen parallel to the other frame. Then, of course, the pen would move in an intermediate direction when the atmospherics were coming from any direction inclined to both frames.

I think it ought to be possible to develop an instrument which would write with a pen in this manner if one ignored the small atmospherics and only recorded the big ones. We should then have a sort of sundial operated by atmospherics produced by the progress of the sun along a parallel of latitude as it crossed the mountain chains and coastal lines of the globe.

Now that is one subject that occurred to me, and which I have treated very lightly, as a subject open for investigation by amateurs. Amateurs have already contributed a considerable amount to the work of the British Association Committee. A great deal of the information I have given you just now is the results of the analyses of the records made in various parts of the world by the amateurs who were working for the British Association in 1912, 1913 and 1914.

Now to come to quite a different matter, let me give an illustration of the kind of thing which could be done by amateurs in ordinary laboratory wireless in the course of the next two or three years. It has occurred to me that we have become slaves to the habit of using the Morse code, especially the Morse code with dots and dashes, and it seems to me to be worth while questioning whether dots

and dashes are the best means of sending signals either under good conditions or through atmospheric disturbances. For instance, Bright's telegraphic apparatus which I remember seeing some thirty or forty years ago, used to have two bells in it. When a dot came, one bell—the right-hand bell—would ring, and when a dash came the left hand bell would ring. Of course, they did not use dots and dashes, they used lefts and rights, and the dot was just as long as the dash. It was simply a matter of the ear detecting a high note or a low one. Now I am told by expert telegraphists that that method of signalling was quicker than dots and dashes. It is obvious, besides, to the engineer that there must be less power expended in a code in which the dash is no longer than the dot. The present day heterodyne system of reception seems to lend itself remarkably fully to a scheme of that kind, and so I thought I would set up and listen to a piece of apparatus which would give me, instead of dots and dashes, a high note and a low note. I have on this table two simple oscillating sets which have come straight from my laboratory, so adjusted that one generator is a transmitter, the other a receiver. An extra coil is associated with the transmitter, so that when a key short circuits portions of it we get two notes. It seems to me that if two friends in wireless touch would set up such a system of signalling, they could find out by experiment whether it was quicker than longs and shorts, and whether it passed easily through atmospherics. Thus they might bring about a reform in the ordinary methods of wireless signalling. *(At this point a demonstration was given of this method of signalling, when two different notes were produced.)*

Someone to whom I was speaking about it thought that it would require a musical ear, and it is perhaps because it requires a musical ear that longs and shorts are used. I don't know if this next method, which I suggest as a possibility, requires a more musical ear. It is a three-note method in which the middle is the steady note. The higher frequency gives the dot, and the lower frequency gives the dash. Now that note is steady all the time the station is going, and the distant receiver will be tuned to that note. Now, if we move the key to the right you get a dot. A dot means a departure to the right, and a dash would mean a departure to the left, so that if you sound the letter A—dot and dash—it is a little tune. Now I find that I can learn these tunes faster than I can learn new combinations of longs and shorts. It takes a few months to learn to read fast longs and shorts, and only patient trial can decide whether this proposed code can be learned more quickly. If it is easier for the beginner to learn it may shorten the training of operators, and, best of all, there is a possibility that it gets through atmospherics better than the dot and dash method. This is a thing that could be very easily tried out by any two people who could arrange to co-operate on such a job. It is a thing that no commercial company would undertake to do because a commercial company does not like to disturb business by making a revolution in its method of transmission, and having to re-train all its operators. A commercial company will plod along with what it has got, so long as it is not forced by progress to change it. This is a thing which may necessarily have to

be done by amateurs. That leads us on to other systems. It would cumber our table too much to bring the three-note system which I have tried over; but you can use three notes, and you can get a very short code with three notes. I mean that you do not need to have four efforts in letters such as L, which in Morse uses a dot, a dash, and two dots; but you can do everything with at most three efforts if you have a three-note system. But that requires a more musical ear than this last one.

The next thing that suggests itself to everyone is to use chords—that is to send two notes at once. To send two tones means that you are sending on two wavelengths, wavelengths which are only 5 metres apart in some of these cases, and it is very difficult to detect them except by the ear. The range of wavelength taken up is not so great as is usually monopolised by the spacing wave method, so that I do not think any objection arises to sending chords, except that very few people can identify chords rapidly. I suppose a little training—a little teaching—would enable a person to identify a sufficient number of chords to make up a code. But there is a system of chords that requires no musical ear for identification. At any rate, everybody I know, musical and unmusical, can identify the kind of chord I am going to suggest. I have known people who did not know "Home Sweet Home" from "God Save the King," who could distinguish the chords I am going to mention. These chords are called vowels. If you sound any note and then superimpose upon it a certain two frequencies, making a chord of three notes, then you get a vowel. I have a paper here, which was written quite recently by Sir Richard Paget, and he gives the combinations of notes that make the different vowels. I think he has taken the analysis of the vowels further than anyone else. Now it seems to me that it would be possible to transmit a vowel, and I therefore designed an electrical circuit, which I tried on Monday. It gave me two vowels quite well. It gave me the vowel "ah," and when I altered the setting it gave the German modified ü. I wanted to make other vowels before attempting to show it; and if one can succeed in making several vowels, and I think it is quite feasible to make any vowel by this system, it would be possible to signal by saying "a, o, oo," and so on, because any two vowels could represent any letter of the alphabet by a sort of bilateral cipher. The vowels can be produced either by the voice or by a machine. In that way you get a briefer system than those I have already mentioned. The vowels are easily recognised. In wireless telephony, for instance, it is the vowels which come through best. I dare say most of us have experienced on the ordinary telephone the annoyance of obtaining the wrong number. The number 4375 is asked for, and you get 4379. The thing that has misled the operator is the vowel in the five and nine; it is the vowel that carries, and the consonants cause all the confusion. If we could abolish consonants, and signal by a new vowel system, we might achieve something worth doing. I make this final suggestion as another illustration of something that could be accomplished by members of the Radio Society of Great Britain.

# Electrons, Electric Waves and Wireless Telephony—XX.

By Dr. J. A. FLEMING, F.R.S.

*The articles appearing under the above title are a reproduction with some additions of the Christmas Lectures on Electric Waves and Wireless Telephony given by Dr. J. A. Fleming, F.R.S., at the Royal Institution, London, in December and January, 1921-1922. The Wireless Press, Ltd., has been able to secure the serial rights of publication, and any subsequent re-publication. The articles are therefore copyright, and rights of publication and reproduction are strictly reserved.*

## 7. WIRELESS TELEPHONE TRANSMITTERS.

We may in conclusion make a brief reference to the construction of large transmitters intended for broadcasting and to improvements in thermionic valves employed as generators of powerful oscillations. No other type of generator is at the present time so suitable for this purpose. High frequency oscillations of great power can be produced by dynamo machines called high frequency alternators, but the regulation of their speed which is necessary to produce carrier waves of perfectly constant wavelength and amplitude by them, requires some rather complicated apparatus, and it is not nearly so easy to modulate the amplitude by a speech microphone as is the case with the thermionic valve. Again, we can produce oscillations by means of an electric arc of a certain kind called a Poulsen arc, but this type of generator is liable to irregularities which, though not seriously disadvantageous to its use as a generator of oscillations for radiotelegraphy, are a decided impediment in the employment of it as a generator in wireless telephony.

The thermionic valve, on the other hand, gives or can be made to produce oscillations of perfectly pure simple harmonic wave form and therefore carrier waves of the same type.

Furthermore, the thermionic valve as a generator of oscillations is perfectly silent and the amplitude of the oscillations produced by it very easily controlled by the speech microphone. It is for all these reasons an ideal oscillation generator for wireless telephony.

We have already described in a previous section the manner in which the three-electrode valve is employed to create electric oscillations and these explanations need not be repeated here.\*

There are, however, great differences in construction and power consumption between

valves used as amplifiers and valves used as generators of oscillations, which must be explained. The valve as a generator must have a considerable output of power, that is, we must be able to draw off from the circuit connecting the plate or anode of the valve and the filament an amount of electrical power which is only limited by our requirements. This implies that the so-called plate current must be, relatively speaking, large.

But the internal resistance of the valve, that is, of the space between the filament and anode cylinder, is also large, amounting to some thousands of ohms, generally speaking. Hence it requires a high voltage to drive the required plate current across the vacuous space that is to compel the negative electrons to move away from the filament and through the apertures in the grid and strike the plate or cylinder.

Then again, this impact of torrents or millions of electrons bombarding the anode cylinder or plate heats it very quickly and may in fact soon make it red hot. Hence special construction is necessary to prevent this heat from cracking the glass or loosening the sealing-in wire which makes connection between the anode cylinder and the external plate circuit.

On referring back to Fig. 93, which shows the view of a large transmitting valve of a very usual type, it will be seen that there is a large glass bulb which may be even of the size and shape of a Rugby football, has two re-entrant glass tubes at the ends which are closed at the inner ends, and at the outer ends are sealed to the bulb.

Around these re-entrant tubes are clamped metal collars, one of which carries the large cylinder made of sheet nickel, which forms the anode, and the other of which in a similar manner carries the inner cylinder of nickel wire gauze which forms the grid of the valve. This latter re-entrant tube carries also the tungsten wire filament.

\* See article XIII., *The Wireless World and Radio Review*, December 30, 1922 (page 433).

The current is conveyed to and from this filament by platinum wires sealed through the glass tube and similar platinum sealing-in wires are employed to connect the external circuits to the cylinder and the grid. The filament wires have to carry fairly large currents up to 10 or 20 amperes, but the sealing-in wire to the cylinder has only to carry currents from about one-tenth to one ampere or so, and the grid requires feeding with a much smaller current.

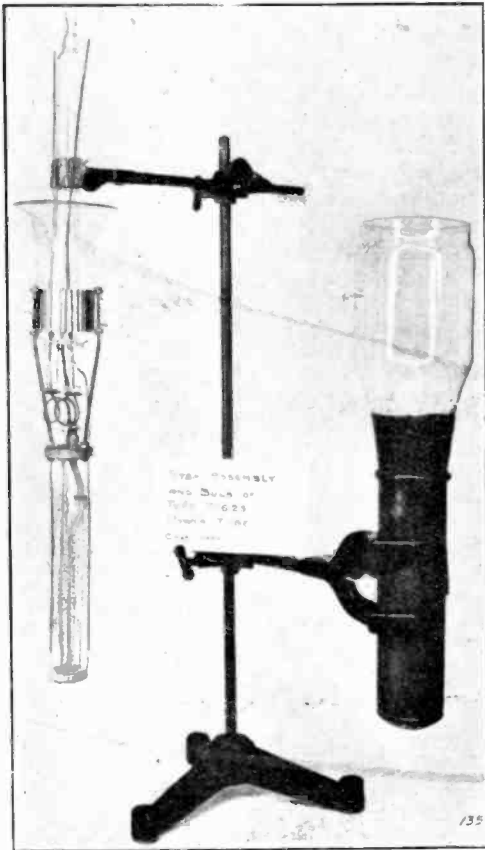

Fig. 107. The arrangement before sealing in the re-entrant glass tube carrying the filament and the grid.

The electron power is supplied to the valve in the form of direct current. Direct current at rather low voltage, 20-25 volts or so, is employed to incandesce the filament. Direct current at high voltage, 1,000 to 10,000 volts or so, is supplied to the plate circuit to create the electron stream. We then draw off from the plate circuit high frequency alternating current.

In large valves 70 to 80 per cent. of the power supplied can in this manner be recovered. The deficit is expended as heat in the valve. Hence a large valve yielding say 5 kilowatts or 7 horse power would take in 7 kilowatts or 10 horse power, and the difference or 2 kilowatts is transformed into heat.

This heat must be radiated, and therefore large valves get fairly hot. One of the problems connected with large valve manufacture is to obviate any danger from the cracking of the bulb, which is liable to happen with glass bulb valves.

It must be remembered that these valves have to be very highly exhausted of their air, in order that no sensible amount of air may be left to be ionised by the electrons emitted by the filament, for this would create positively electrified ions or molecules of oxygen or nitrogen which have lost an electron, and these would be attracted to the filament very strongly, and would bombard it and soon destroy it.

It would occupy too much space to describe the methods by which the extremely high vacuum required is made in these valves. One result of this, however, is to create a very great air pressure on the outside of the bulb which, in a large valve, may amount to two or three tons. Hence if such a valve breaks it generally does so with a rather startling explosive noise. Invention has therefore, of late years, been directed to the problem of constructing a high power valve which shall be less fragile and liable to accidents than a glass bulb valve. In other words, to make a valve which shall be more of an engineering job than the present glass bulb type.

It has been found possible to make the bulb of pure silica (flint) in place of glass. This material has so small an expansion with temperature that a silica bulb can be made red hot and then be plunged into cold water without cracking.

A still more important improvement, however, has come to us recently from the United States in the form of a thermionic valve of which the greater part of the bulb is formed of sheet copper. The copper not only forms part of the bulb but also constitutes the anode cylinder, and can be kept cool by cold water.

The foundation of this improvement is the technical discovery of a method of sealing copper to glass in such fashion that it does not crack away on cooling or subsequent heating

The reason the expensive metal platinum has hitherto been used for wires which must be sealed airtight through the wall of a glass bulb is that platinum possesses three essential qualities for this purpose. First, it has nearly the same coefficient of expansion with heat as lead glass. In the second place, hot platinum is "wetted" by molten glass; that is, sticks to it, and lastly, platinum is not oxidized when heated in a blowpipe flame, but retains a bright and clean metallic surface.

No other metal has been found which possesses all these properties, but the discovery was made some years ago that if copper is kept unoxidized in a flame containing reducing gases, it is when very hot "wetted" by molten glass, which sticks to it. Copper, however, has not the same coefficient of thermal expansion as glass and the only way to attach a copper tube to a glass tube of the same size is to give the copper a sharp knife edge.

If then a sort of copper thimble is made, closed at one end but with the edge of the open end made sharp like a knife, this thimble can be sealed airtight to a glass tube of the same diameter as the thimble, and the joint will not crack away in cooling and can be made vacuum-tight. The glass tube terminates in a

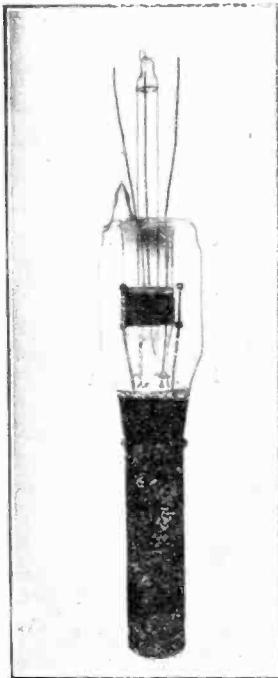

Fig. 108. The complete instrument.

re-entrant portion through which are sealed wires to which are sealed the wires which carry the ends of the filament of the valve and also the leading-in wire for the grid.

Fig. 107 shows the arrangement before sealing in the re-entrant glass tube carrying the filament and the grid. Fig. 108 shows the completed instrument. The copper tube part (shown in black in the diagrams) forms at the same time the anode cylinder and also part of the bulb.

Externally it is surrounded by a water jacket, as shown in Fig. 109,

by which it is kept cool by circulating water.

Valves of this description, of a size to yield 10 and 20 kilowatts output or 14 horse power, have been already made, and valves to yield 100 or 150 kilowatts may soon be obtainable. At the present time broadcasting in connection with wireless telephony is conducted by large valve transmitters comprising a number of glass bulb valves, which are connected so that their plate currents are added together.

The high voltage required for the

plate currents is obtained by rectifying by means of two-electrode valves as already explained, a low frequency alternating current of high voltage (7,000 to 10,000 volts). A single ordinary carbon microphone, such as is used in an ordinary wire telephone, is employed to modulate the grid potentials of one or more three-electrode valves called the control valves, and the correspondingly modulated plate current of the control valves which fluctuates in accordance with the wave form of the speech sounds made to the microphone, is employed to modulate the output current of the generator valves. The result is that the height or amplitude of the carrier waves radiated from the sending aerial fluctuates also in accordance with the speech currents sent through the microphone. We have already explained the manner in which these radiated waves create corresponding but much feebler currents in the receiving aeri-als, and are made to reproduce the speech sounds in the receiving telephones. The development of wireless telephony, and especially the public use of broadcasting, introduces a new factor into modern life which is bound in time to make its effect felt.

The purpose of these articles will have been fulfilled if the broad general principles of the art have been elucidated sufficiently for the instruction of the general reader.



Fig. 109. The valve anode inserted in a water circulated cooling jacket.



## Notes.

### Automatic Wireless Reception at Sea.

The Cunarder *Berengaria* has been fitted out with the Creed apparatus for automatic reception and transmission of wireless messages which will thus appear continuously recorded on paper tape in ordinary Roman characters as in the familiar tape machine.

### Wireless Telephony on Trains.

The successful reception of wireless telephony in motor cars travelling at high speed has already been demonstrated and experiments carried out recently show that even on express trains and in spite of tunnels and varying topography reception of wireless entertainments is now practicable. By an arrangement between the Marconi Company and the London, Midland and Scottish Railway Company, an experiment was carried out on the 5.30 p.m. express train from Euston to Liverpool on February the 6th. A special saloon was fitted up with outside and inside aerials, the former being merely a length of wire fixed temporarily on the roof of the train and the latter an ordinary frame aerial. It was found, however, that the dynamo used for electric lighting on the train caused bad interference and the outside aerial had to be abandoned. Using the frame aerial, while travelling at between 60 and 70 miles an hour, at 6.12 an amateur transmitter was picked up, though his voice was rather faint. London was picked up about 50 miles out from Euston and at 7.30 the Birmingham Broadcasting station was received. The news bulletin and other broadcasting items, it is reported, were clearly heard throughout the journey and there was no noticeable interference from passing trains. The experiments were carried out by Captain G. R. Willans, manager of the Marconiphone Department, and Mr. G. S. Hagate, technical manager to Captain Willans, in the presence of Mr. J. D. Billington and Mr. C. N. Heath, who represented Mr. F. A. Cortez Leigh, of the Electrical Engineers' Office at Euston.

### The Opening of Cardiff Broadcasting Station.

By the time this note appears if all goes well, the new station of the British Broadcasting Com-

pany at Cardiff will be in operation. This station to which the call letters 5 WA have been assigned, and which operates on a wavelength of 395 metres, is to be formally opened at 7.30 p.m. on Tuesday, January 13th, by the Mayor of Cardiff, who will officially inaugurate the service. The station will actually begin operations at 5 o'clock with a children's programme, followed by the weather report and a news bulletin. Ordinarily at 7.30 the musical programme will begin, including operatic, instrumental and vocal music, and a Sunday programme will be given from 8.30 to 10 p.m. The opening of the Cardiff Station marks

the completion of five of the eight stations contemplated in the original broadcasting scheme. The sixth will be opened at Glasgow on or about March 19th.

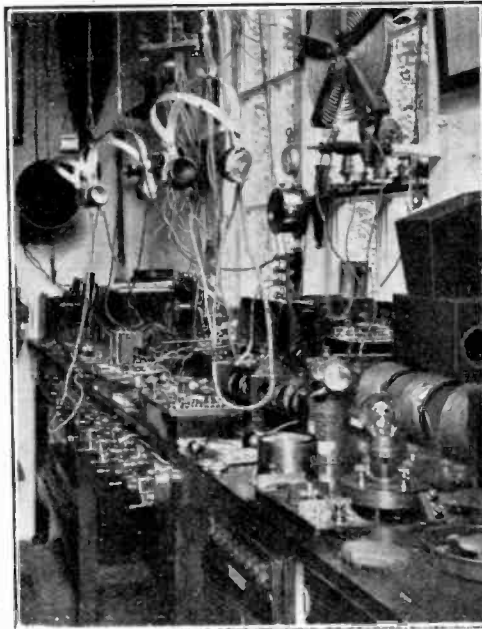

*The wireless cabin of Alderman Fentum Phillips, of Guildford, in which an interesting feature is the unusual provision to ensure efficient insulation. The walls are insulated from the floor with felt. A cork carpet is laid on this flooring an inch thick, while the work benches are insulated by glass insulators filled with paraffin wax.*

that the total number of wireless sets now licensed is in the neighbourhood of 60,000.

### The Amateur Experimenter's Licence.

In a recent letter to the London *Evening News*, Mr. Leslie McMichael, Hon. Secretary of the Radio Society of Great Britain, offered a suggestion to those amateur wireless enthusiasts who are anxious to construct their own sets, but are faced with the difficulty of furnishing the necessary evidence as to their fitness to hold the experimental licence issued by the Post Office. "Without laying down any hard and fast rules," Mr. McMichael says, "it

### The Demand for Wireless Licences

An extraordinary increase in the number of licences issued by the Post Office has been noticed in the past few weeks. In November 3,000 licences for broadcast reception were issued, and in December 6,000. In a single week in January, nearly 10,000 licences were granted, and the estimated total for the month is placed at about 25,000. The applications for experimental licences are also showing a remarkable increase. In the last week of December 3,500 applications were received, while in January licences were issued at the rate of about 6,000 a week, and in the last week of that month the figure had risen to 11,000. Taking into account the number of licences already issued it is calculated

would be strong *prima facie* evidence of genuine intention to do experimental work if the applicant could tell the G.P.O. that he had definitely joined either the special grade of Associates of the Radio Society of Great Britain or that he had joined one of the Affiliated Radio Clubs in Greater London or the Provinces, of which there are now some 150."

#### A Broadcasting Station for Dublin.

A wireless telephony transmitting station is shortly to be erected in Dublin. It will be entirely a Government enterprise and will probably be situated in Phoenix Park.

#### A Wireless Journal for the Trader.

An announcement of considerable interest, and we might add, importance, arises from the new venture of the proprietors of this journal, namely, the production of another weekly, to be known as *The Wireless and Allied Trades Review*. The first number will bear the date of March 3rd. It will be for the trade only, and we suggest that all readers of *The Wireless World and Radio Review* connected with the trade should make a point of obtaining a copy. This new journal will supply information relating to everything which affects the interest both of the manufacturer and the retailer.

#### An Impost on Wireless Apparatus for South Africa.

Wireless telegraph apparatus and broadcasting sets imported into South Africa are to be taxed 20 per cent. *ad valorem*, subject to a rebate of 3 per cent. *ad valorem* on the products of the British Empire.

#### Measuring Instruments for Wireless.

A folder entitled "Handy Instruments for Everyday Use," giving information for instrument users about its line of portable ammeters and voltmeters, which are especially well suited for radio testing, has recently been issued by the Westinghouse Electric and Manufacturing Company.

#### A World List of Scientific Periodicals.

Definite plans were made at a meeting of the Conjoint Board of Scientific Societies held on January 24th to prepare and issue a list of all scientific periodicals containing the results of original research. At present no accurate list of the many thousands of such periodicals written in many languages exists, and no single library contains even a large proportion of them. The list, which will probably be published before the end of the year, will be compiled by the Keeper of Printed Books, an official connected with the British Museum.

#### Australian Manufacturers' Association Formed.

Australian manufacturers of wireless instruments, traders and others interested have formed themselves into an association for the development of wireless in Australia. The first President is Mr. G. A. Taylor, who is a well-known figure in connection with wireless matters in the Commonwealth.

#### Wireless Heard on U.S. Tube Railways.

The New York correspondent of *The Times* reported recently that engineers of the Interborough Rapid Transit Company, with a receiving set only 18 ins. long and 7 ins. wide and a loop aerial 4 ft. high, captured part of a concert being given in New York while their train was travelling at 40 miles an hour under the bottom of the East River. Later they caught the programme of the Kansas City broadcasting station 1,300 miles away. During most of the time the engineers heard with perfect clearness, though there was considerable interference by induction from passing trains and the motors in the train on which they were travelling.

#### The Imperial Wireless Chain Report.

The Cabinet Committee appointed recently to consider the question of the completion of the Imperial Wireless Chain have now finished their duties, and agreed upon their report which is ready to be presented to the Cabinet. It is understood that the report favours the employment of private enterprise for the undertaking.

#### A CORRECTION.

##### Electrostatic Capacity in Radio Circuits.

In the issue dated January 27th, on page 573, formula (2) should read:—

$$Z = \frac{1}{\sqrt{\left(\frac{R}{R^2 + \omega^2 L^2}\right)^2 + \left(\frac{\omega L}{R^2 + \omega^2 L^2} - \omega C\right)^2}} \dots (2)$$

and the last line of the same column should read:—

"we get  $Z = 2992$  ohms at 100,000 cycles per . . . ."

#### BOOK REVIEW,

METAL TURNING MADE EASY. (London: Cassell and Co., Ltd., La Belle Sauvage, E.C.4. pp. 152. 177 Illustrations. Price 1s. 6d. net.)

Belonging as it does to the well-known series of "Work" handbooks published by Cassells, this volume needs little in the way of introduction. "Metal Turning Made Easy" is a companion volume to "The Simple Lathe and Its Accessories," published a short time ago, and its object is to provide a handy, up-to-date guide to modern lathe work practice for the amateur's or the professional's workshop. The various operations of turning, boring, drilling, screw cutting, and gear cutting in the lathe, and the subsidiary processes connected with them are explained in detail in eleven chapters, and clearly illustrated by numerous drawings and photographs. It is evident, on even a cursory glance, that the information presented in this little volume is drawn from a fund of sound and practical experience. Among the subjects treated and not indicated by the title are the turning of scallops, ovals and curves; turning ebonite; and the measurement of turned and bored work. An index of subjects adds the finishing touches to an attractively produced volume.

#### BOOK RECEIVED.

THE SIMPLE LATHE AND ITS ACCESSORIES. (London: Cassell & Co., Ltd., La Belle Sauvage, E.C.4. Illustrated. Price 1s. 6d. net.)

## Wireless Club Reports.

**NOTE.**—Under this heading the Editor will be pleased to give publication to reports of the meetings of, *Wireless Clubs and Societies*. Such reports should be submitted without covering letter and worded as concisely as possible, the Editor reserving the right to edit and curtail the reports if necessary. **The Editor will be pleased to consider for publication papers read before Societies.** An Asterisk denotes affiliation with the Radio Society of Great Britain.

*Correspondence with Clubs should be addressed to the Secretaries direct, in every case unless otherwise stated.*

### The Thames Valley Radio and Physical Association.\*

Hon. Secretary, Mr. E. A. Rogers, 122, Wood Street, London, E.C.2.

A most enjoyable evening was spent with the staff and patients of Queen Mary's Hospital for Disabled Soldiers on Tuesday, January 23rd, at Roehampton.

On behalf of the Association, Messrs. Driver, Davy, Harris and Rogers took up the receiving set and gave one of the most perfect reproductions of the broadcasting concerts that have yet been heard, although they had to use a capacity earth in the room, owing to the strong hum received through the ordinary earth due to the many heavy electrical cables in the grounds. About 200 were present.

During an interval the Birmingham station was heard, in which the patients were thoroughly interested.

At 9 p.m. Mr. Appleton Smith, G.O.C. Pierrot troupe, introduced the members who were kindly adding to the enjoyment of the evening, viz., Miss Betty Southam, Miss Wrightson and Miss Stanley, whose personal attractions were only exceeded by the charming way they rendered their songs and parts, and Messrs. N. and A. Smith.

The thanks of the Association are tendered to the above-mentioned ladies and gentlemen for helping to provide such excellent fare for the most worthy of our institutions, and to the manufacturers of the Easi-Fix aerial used.

Meetings take place at the Hut, Wigan Institute, every Thursday, at 8 p.m.

### The Finchley and District Wireless Society.\*

Hon. Secretary, Mr. A. E. Field, 28, Holmwood Gardens, Finchley, N.3.

The Society met at 8 p.m. on January 22nd, at St. Mary's Schools, when Mr. Campion demonstrated his home-made four-valve receiver. Very strong signals were received from 2 LO, 2 OM, and the Radiola near Paris, on a Brown's loud speaker and relay used in conjunction with Mr. Campion's set.

Mr. Trussler exhibited a small crystal receiver and a junior Marconiophone made by Mr. Brown.

Later the Committee met and discussed the final arrangements for the sending of the delegates to the Radio Society of Great Britain. The elementary Morse class was taken by Mr. Field twenty minutes before the close of the meeting.

### The Belvedere and District Radio and Scientific Society.\*

Hon. Secretary, Mr. S. G. Meadows, 1, Kentish Road, Belvedere, Kent.

The eighteenth general meeting of the Belvedere and District Radio and Scientific Society was held at the Erith Technical Institute on Friday, January 19th.

The Secretary read the minutes of the previous meeting, and reported that the official transmitting authority had arrived, and that the call signal allotted to this station is 5 OY. The making of the various components is being proceeded with, and it is hoped that very shortly experimental C.W. and telephony transmission will take place from this station.

It is proposed shortly to hold a dinner as the first social function of the Society. Various items in connection with this were generally discussed at the meeting.

The next meeting of the Society was held on Friday, January 26th, when Mr. S. Burman read the second part of his paper on "High Frequency."

At the conclusion of the paper the Chairman (Mr. T. E. Morriss), after making a few appropriate remarks, passed a vote of thanks to Mr. Burman for his very interesting paper.

The Secretary gave a report on his visit to the annual conference of the Radio Society of Great Britain and Affiliated Societies, held in London on January 24th, where he and Mr. C. E. Morriss acted as delegates for the Society. He mentioned that no decision was arrived at with regard to the suggested quarterly Radio Conferences to be held in London and provincial centres.

### The Ilford and District Radio Society.\*

Hon. Secretary, Mr. A. E. Gregory, 77, Khedive Road, Forest Gate, E.7.

At a meeting held on January 25th, Mr. A. P. Welch lectured on "Wireless Waves and Harmonics." The lecturer dealt with the question



A group of the Uitenhage (South Africa) Radio Society with their receiving apparatus on the occasion of a recent field day.

of harmonics in a most able manner, and certainly cleared up some of the more obscure points relating to this subject. Mr. Welch also lectured on "Atmospherics," and dealt in particular with the "Heavyside Layer."

#### The Radio Society of Highgate.\*

Hon. Secretary, Mr. J. F. Stanley, B.Sc., A.C.G.I. 49, Cholmeley Park, Highgate, N.6.

On Friday, January 12th, a lecture was given by Mr. J. F. Stanley on "The Historical Development of Radiographic and Radiophonical Communication." The early attempts at communication without wires were first described, and although these experiments had nothing to do with radio they were certainly wireless. The investigations of Hughes, Hertz, Maxwell and others were fully dealt with, and later on the work of Sir Oliver Lodge.

On January 13th, the occasion of the broadcasting of the opera "Faust," a public demonstration was given, and many people, on hearing the wonderful clearness of the words and music, decided to make wireless sets of their own.

On January 19th a very successful sale of apparatus was held. Several members brought along all their spare junk, and a brisk trade was done.

#### The West London Wireless and Experimental Association.\*

Hon. Secretary, Mr. Horace W. Cotton, 19, Bushey Road, Harlington, Middlesex.

The first meeting after the Christmas vacation was held on Tuesday, January 9th. Morse practice was taken by many present. Messrs. H. S. Walker (2 OM), A. Pike (2 YR) and A. Rolfe, of the Hounslow and District Wireless Society, visited the meeting by invitation of the committee, for the purpose of talking over the "impossibility of carrying out amateur transmission and experimental work generally, during the hours of broadcasting, on the 440 metres wavelength." After hearing their views, it was decided to await further suggestions from their Society.

At a meeting held on January 16th, after the reading of various items of correspondence, the meeting was thrown open for general discussion to give the members present an opportunity of exchanging their views in connection with any experiments made during the last week or two.

It is hoped shortly to hold a social evening of entertainment, and the committee have left this in the hands of Mr. Mullings, who is sure to make the experiment a successful one, and further announcements will be made later in respect of this venture.

Several well-known lecturers and demonstrators have been approached in regard to demonstrating before this Association in the near future.

The Secretary will have much pleasure in replying to all applications as regards objects of and subscriptions to the Association, and it is hoped that possessors of the many new aerials appearing in the district will come forward for membership.

#### Walthamstow Amateur Radio Society.\*

Hon. Secretary, Mr. R. H. Cooke, 49, Ulverston Road, E.17.

The Society, on Monday January 15th, gave a demonstration to the Walthamstow Literary

and Debating Society, at the Hut, Y.M.C.A., Church Hill.

A crowded audience enjoyed radiotelephony from 2 LO through Mr. Pearson's home-made three-valve set with loud speaker. Mr. Allan, of the Radio Society, answered many questions from the audience, as did Mr. Pearson and Mr. Trott. Councillor V. L. McEmtee, the local M.P., and other local notabilities, were greatly interested in the apparatus displayed, and a host of new friends and many new members were made.

On Thursday, January 18th, Professor E. M. Baker, B.Sc., M.I.E.E., gave a lecture on "Telephony and Broadcast Reception." Members gathered in great force to hear what proved to be a splendid exposition of the theory and practice of radiotelephony. The lecturer spared no pains to make his points absolutely clear, both with diagrams and formulæ. The club is now well over 100 strong, and a very fine body of earnest workers are to be found in its ranks.

#### The Southend and District Radio Society.\*

Hon. Secretary, Mr. A. L. Whurr, 4, Wimborne Road, Southend-on-Sea.

On Friday, January 26th, 1923, at headquarters, 76, Queen's Road, Southend-on-Sea, a most interesting lecture was given by Mr. Percy Barnes, M.R.S., on "Transformers and Induction Coils." Various methods of making them and the uses to which they are put were explained by the lecturer.

Afterwards, a demonstration and lecture was given by Mr. A. C. Hugh, on his set, consisting of one H.F., tuned anode valve, one detector valve, and two L.F. valves, using a reaction coil coupled to the tuned anode valve. The concert at 2 LO by Australian artists was received on the loud speaker.

The Chairman, Mr. D. L. Plaistowe, announced that the P.M.G. had granted the Society's application for a portable transmitting and receiving licence, and that the station call of the Society is 5 QK. Arrangements will be made as soon as possible to make a portable experimental transmitting and receiving set.

#### Proposed Wireless Club for Wimbledon.

A wireless club is to be formed in Wimbledon. All those in the district who are interested in wireless are invited to communicate with C. G. Stokes, Esq., 6, Worples Avenue, Wimbledon, S.W.19, or E. W. Webb, Esq., 14, Denmark Avenue, Wimbledon, S.W.19.

#### The Liverpool Wireless Society.\*

Hon. Secretary, Mr. G. H. Miller, 138, Belmont Road, Anfield, Liverpool.

The annual general meeting of the Liverpool Wireless Society was held at the Royal Institution, Colquhoun Street, Liverpool, on Thursday, January 25th, Mr. E. B. Grindrod occupying the chair.

The Secretary read a report of a special impromptu meeting of the Society, which met to discuss the question of a new and up-to-date receiver, and it was unanimously decided that the Society's present apparatus, being somewhat prehistoric (the Society having been established before the war), it was now urgently necessary to have a special "whip round" for the necessary funds. One of the members present very kindly

offered to provide the greater portion of the necessary funds, and guaranteed a cheque for £50, which was handed over the following day. Promises were also made by the members present at this impromptu meeting to the extent of £23, and the Secretary was then instructed to write to the members not present inviting them to join in the subscription list. As an expression of appreciation of the generosity of the principal donor, Mr. C. R. Honiball, this gentleman was elected the first Honorary Life Member of the Society.

It was decided to put the receiver in hand without delay, and after some discussion the type was finally decided upon. This will be built by one of the members of the Society, and will comprise two H.F. valves, detector valve, and three L.F. valves. Separate controlling switches and filament rheostats are to be provided for each valve. Tuned anode H.F. coupling will be employed up to 2,600 metres, and resistance capacity from 2,000 to 25,000 metres. Provision will also be made so that the apparatus, by use of switches, can immediately be converted to plug-in tuned H.F. transformer coupling up to 2,600 metres. A three-coil tuning system will be employed, and the whole set will be of the very highest quality of construction possible, and will fit into a sloping mahogany cabinet, with drawers to lock up at the base to hold the necessary short-wave and duolateral coils, plug-in transformers, etc.

The election of officers for the present year then took place and there was no important change other than that of the position of Hon. Secretary. Mr. C. L. Lyons, who regretted that it would be impossible for him to offer himself for re-election. Mr. G. H. Miller was unanimously elected in his place. Votes of thanks were passed in favour of the retiring Hon. Secretary's efforts, and in favour of the new Secretary for accepting the appointment. Mr. N. D. B. Hyde declined to serve on the committee during 1923, and consequently retired, and Mr. C. R. Honiball was elected in his place. Mr. S. W. Philpott was also elected to serve on the committee as the representative of the broadcast licensees of the Society.

#### Cheltenham and District Wireless Association\*

Hon. Secretary, Mr. Eric Cole, A.R.I.B.A., 28, Milton Road, Cheltenham.

At the weekly meeting of the Association on January 22nd, Mr. W. G. H. Brown (5 BK) gave an extremely interesting lecture on "Transmission," illustrated by blackboard sketches and diagrams, and some of his transmitting apparatus rigged up temporarily at the lecture hall.

He gave practical demonstrations of spark, tonic train, and C.W. transmission, and also lucidly explained telephony transmission, the various methods of modulation being made quite clear to members.

Mr. Brown also described his experiences listening for American broadcasts.

A vote of thanks was passed to the lecturer for an extremely instructive evening.

The Hon. Secretary pointed out at the conclusion of the meeting that subscriptions for 1923 were now due and should be paid to the Hon. Treasurer.

#### Birmingham Experimental Wireless Club.\*

Hon. Secretary, Mr. A. L. Lancaster, c/o Lancaster Bros. & Co., Shadwell Street, Birmingham.

An interesting lecture specially designed for those just taking up wireless broadcasting, was delivered at the Digbeth Institute on January 26th, by Mr. Jennings, the subject being "The Working of Broadcasting Sets." Mr. Jennings ably traced in simple terms the theory of the electron and its bearing on modern wireless—describing the propagation of magnetic waves and the means we have of reception both by crystal and valve apparatus. The object of tuning and the methods used and also the meaning of inductance and capacity were clearly explained.

The lecture was closely followed by the members present, and a hearty vote of thanks was passed to Mr. Jennings.

#### The Manchester Radio Scientific Society.\*

Hon. Secretary, Mr. H. B. Whitehouse, The Grotto Café, Manchester.

On Wednesday, January 24th, the Society, at the regular weekly meeting, was favoured by a visit from Mr. Bell, of the Metropolitan-Vickers Electrical Co., Ltd. (better known, perhaps, locally as Mr. "X" of 2ZY), who came down to discuss with the members the transmissions from the broadcasting station at Trafford Park.

The Hon. Treasurer, Mr. J. R. Halliwell, opened the discussion by explaining the reasons for inviting Mr. Bell. He said that the Society had felt for some time that co-operation between its members and the men of the Research Department of Metro-Vickers could not be anything else but beneficial to British broadcasting, and this feeling had prompted the invitation. Mr. Halliwell made some excellent criticisms of the transmissions, and desired it to be understood that everything he said was in the nature of constructive and not destructive criticism.

The Chairman, Mr. G. G. Boullen, then called on other members to continue, and several gentlemen gave their opinions and made suggestions whereby they thought the programmes could be improved. Certain members had been deputed to make careful observations of 2ZY's strength, clearness, etc., over the preceding week's concerts. Mr. Lomas gave a very interesting account of his experiences in reception.

Mr. "X," who was received with much applause, then proceeded to deal with the many questions asked in a very able manner. He outlined some of the many problems which had to be solved and said that gradually they were being overcome. He then dealt briefly with the history of the station, and informed his audience that it had been erected and run chiefly by local men, and had been built up as it were from first principles.

Mr. J. E. Kemp then rose, and in proposing a vote of thanks, said that he felt the Society had been honoured by Mr. Bell's visit, and much good was bound to result from the interchange of ideas which had taken place. He further proposed that Mr. Bell be forthwith made an honorary member. These propositions were suitably seconded and passed unanimously.

Meetings of the Society are held each Wednesday at 7 p.m. at the Grotto Café, Todd Street.

## An Amateur-Built Cabinet Receiver.

The accompanying photographs of the receiving equipment of Mr. A. G. Foster, of West Hampstead, indicate the degree of perfection that can be achieved by the amateur worker.

The apparatus, as will be seen, has been designed especially for experimental reception. Switches are suitably arranged for providing any combination of high and low frequency amplifying circuits. The tuning range is covered by means of interchangeable plug-in coils and a series parallel aerial circuit switch. Extension handles from the coil holder bracket permit of critical coupling adjustment, and the tuning can be accomplished step by step as additional circuits are brought into operations by the key switch. Various types of valves are employed, according to the circuits in which they are connected.

The fine arrangement of the outfit not only greatly facilitates manipulation, but allows of the intrusion of the experimental apparatus into the drawing-room.

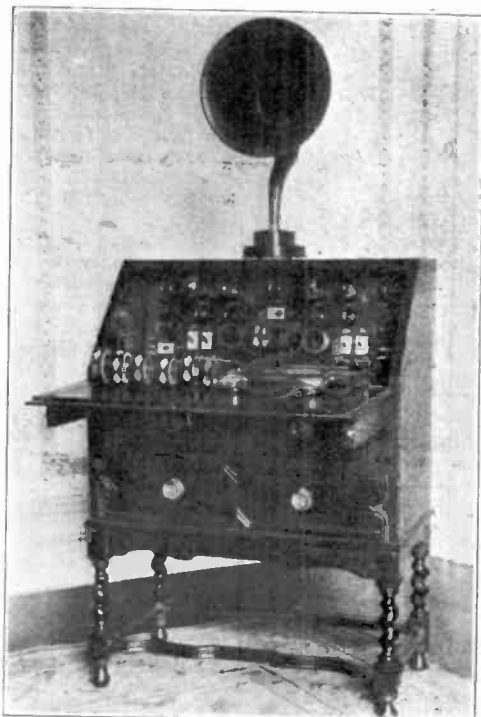

*The Cabinet Receiver.*

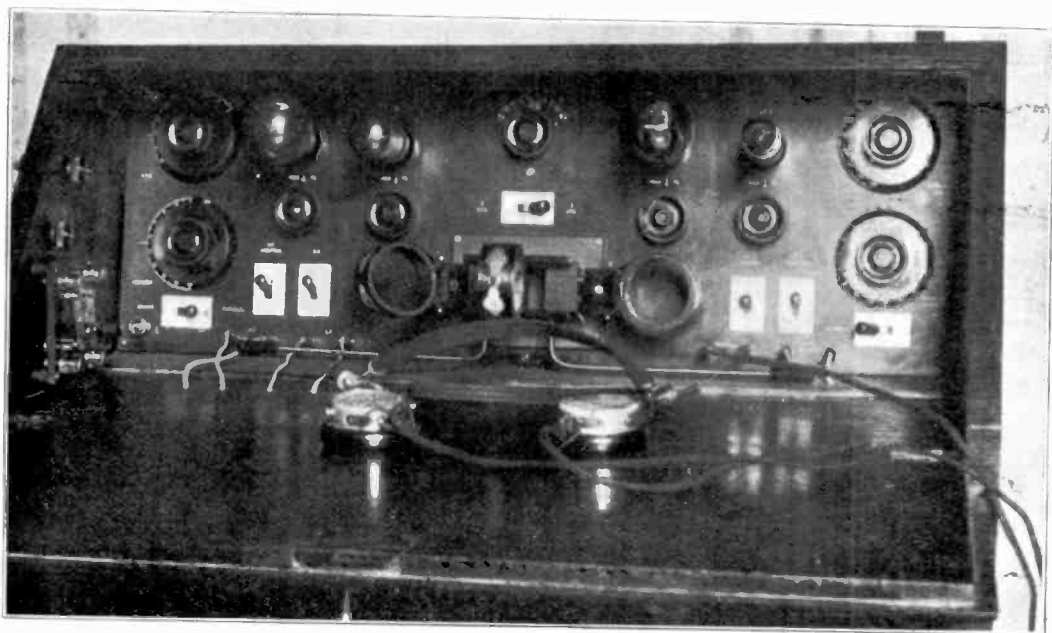

*The Layout of the Apparatus.*

## Calendar of Current Events

### Friday, February 16th.

**RADIO SOCIETY OF GREAT BRITAIN.**  
At 6.30 p.m. At the Institution of Electrical Engineers, Victoria Embankment. Elementary Lecture on "The Fundamental Principles of Radio Reception." By Mr. Maurice Child.

**SHEFFIELD AND DISTRICT WIRELESS SOCIETY.**  
At 7.30 p.m. At the Dept. of Applied Science, St. George's Square. Meeting.

**LEEDS AND DISTRICT AMATEUR WIRELESS SOCIETY.**  
Lecture on "The Design of a Tuner." By Mr. G. B. Kendall, B.Sc.

**BELVEDERE AND DISTRICT RADIO AND SCIENTIFIC SOCIETY.**  
Lecture on "The Armstrong Super-Regenerative Receiver." By Mr. A. H. Norman.

### Saturday, February 17th.

**NATIONAL ASSOCIATION OF SUPERVISING ELECTRICIANS.**  
At 6.30 p.m. At Holborn Restaurant, Newton Street, W.C.1. Annual Dinner.

### Sunday, February 18th.

At 3.5 p.m. *Daily Mail* Concert from PCGG, The Hague, on 1,050 metres.

### Monday, February 19th.

9.20 to 10.20 p.m. Dutch Concert from PCGG, The Hague, on 1,050 metres.

**IPSWICH AND DISTRICT WIRELESS SOCIETY.**  
At 8 p.m. At 55 Fonnereau Road. Lecture on "A New Secondary Cell." By R. Walsh.

**WALTON-ON-THAMES AND DISTRICT AMATEUR RADIO SOCIETY.**  
General Meeting at Headquarters, St. Michael's, Burwood Park Road.

### Tuesday, February 20th.

**PLYMOUTH WIRELESS AND SCIENTIFIC SOCIETY.**  
Meeting.

**EAST LONDON RADIO SOCIETY.**  
Meeting.

### Wednesday, February 21st.

**HALIFAX WIRELESS CLUB AND RADIO SCIENTIFIC SOCIETY.**  
Elementary Mutual Instruction Evening.

**EDINBURGH AND DISTRICT RADIO SOCIETY.**  
At 8 p.m. At R.S.S.A. Hall. Lecture on "Tele-control." By R. Mr. Ogilvie Crombie.

**SWANSEA AND DISTRICT RADIO EXPERIMENTAL SOCIETY.**  
Exhibition of Wireless Apparatus.

### Thursday, February 22nd.

At 9.20 to 10.20 p.m. Dutch Concert from PCGG, The Hague, on 1,050 metres.

**LUTON WIRELESS SOCIETY.**  
At 8 p.m. At Hitchin Road Boys' School. Exhibit and Demonstration. By Mr. F. Halstead.

**ILFORD AND DISTRICT RADIO SOCIETY.**  
Demonstration of Reception. By Mr. C. H. Andrews.

**HACKNEY AND DISTRICT RADIO SOCIETY.**  
Informal meeting and sale and exchange of wireless apparatus.

### Friday, February 23rd.

**SHEFFIELD AND DISTRICT WIRELESS SOCIETY.**  
At 7.30 p.m. At the Dept. of Applied Science, St. George's Square. Elementary Class.

**MANCHESTER WIRELESS SOCIETY.**  
At 7.30 p.m. At Houldsworth Hall. Discussion.

**LEEDS AND DISTRICT AMATEUR WIRELESS SOCIETY.**  
"Receivers and Loud Speakers." By Mr. A. M. Bage (President).

**BIRMINGHAM EXPERIMENTAL WIRELESS CLUB.**  
At 7.45 p.m. Lecture on "Wireless Procedure."

**HULL AND DISTRICT WIRELESS SOCIETY.**  
At the Memorial Institute Schoolroom, Dewsbury Street. Smoking Concert.

## BROADCASTING STATIONS.

Regular evening programmes, details of which appear in the daily press, are now conducted from the following stations of the British Broadcasting Company;—

London	2LO	369 metres.
Birmingham	5IT	420 "
Manchester	2ZY	385 "
Newcastle	5NO	400 "
Cardiff	5WA	395 "

The Cardiff station is expected to be working by about Monday, February 12th.

## Correspondence.

To the Editor of THE WIRELESS WORLD AND RADIO REVIEW.

SIR,—I was much interested in an article by Mr. E. H. Robinson in a recent issue of your journal, recommending the use of a chemical rectifier in order to supply plate voltage for thermionic tubes. Chemical rectifiers have claimed a great deal of my attention during the last 38 years, but notwithstanding this long acquaintance I do not feel much affection for them as they are practically the most unreliable piece of electrical apparatus it is possible to come across.

I have used them in all ranges, from currents of a few milliamps. up to nearly 50 amps. I have used every known combination and chemical in connection with them but reliability has not been achieved.

The point I wish to make, however, is that in the first place the use of these rectifiers in connection with vacuum tubes dates back now some twenty-five years, when they were employed for a short time only to rectify high potentials in connection with induction coils; secondly, that there is one very important point which Mr. Robinson has not mentioned in his article, namely, that in order to act as rectifiers, it is necessary to maintain their polarisation, and this can only be done by connecting them to the supply some time before they are required for use. Personally, with all my experience of such rectifiers, and though my supply is A.C., I prefer to feed my anodes with some reliable make of dry cell or H.T. accumulator

A. W. ISENTHAL.

## Questions and Answers

**NOTE.**—This section of the magazine is placed at the disposal of all readers who wish to receive advice and information on matters pertaining to both the technical and non-technical sides of wireless work. Readers should comply with the following rules:—(1) Each question should be numbered and written on a separate sheet on one side of the paper, and addressed "Questions and Answers," Editor, THE WIRELESS WORLD AND RADIO REVIEW, 12/13, Henrietta Street, London, W.C.2. Queries should be clear and concise. (2) Before sending in their questions readers are advised to search recent numbers to see whether the same queries have not been dealt with before. (3) Each communication sent in to be accompanied by the "Questions and Answers" coupon to be found in the advertisement columns of the issue current at the time of forwarding the questions. (4) The name and address of the querist, which is for reference and not for publication, to appear at the top of every sheet or sheets, and unless typewritten, this should be in block capitals. Queries will be answered under the initials and town of the correspondent, or, if so desired, under a "nom de plume." (5) In view of the fact that a large proportion of the circuits and apparatus described in these answers are covered by patents, readers are advised before making use of them, to satisfy themselves that they would not be infringing patents. (6) Where a reply through the post is required, every question sent in must be accompanied by a postal order for the amount of 1s., or 3s. 6d. for a maximum of four questions. (7) Four questions is the maximum which may be sent in at one time.

"G.E.M." (Essex) asks for a diagram of a three-valve receiver comprising one detector and two L.F. connected valves.

The diagram is given in Fig. 1, and suitable values are indicated.

"T.H." (Scotland) submits particulars of his receiver and asks (1) for a suitable reaction coil. (2) for a suitable A.T.I.

(1) As suggested, the reaction coil may be coupled with the coil  $L_2$ , and the method of coupling may be either with the aid of a sliding coil or a basket coil. If it is convenient, we suggest you use a sliding coil 2" in diameter and 4" long. This former may be wound full of No. 30 D.C.C. and three tapplings may be taken. (2) The A.T.I. may consist of a winding 4" in diameter and 6" long, of No. 22 D.C.C., and six tapplings may be taken. The secondary circuit may be 3" in diameter and 6" long, of No. 28 D.C.C., with six tapplings. The aerial tuning condenser should have a maximum

"E.D." (Belgium) asks (1) For suitable intervalve transformer dimensions. (2) For particulars of a telephone transformer.

(1) An intervalve transformer may consist of a winding of 3 ozs. of No. 42 S.S.C. wire for the primary, and 3 ozs. of No. 46 S.S.C. for the secondary. The core should be closed, and may consist of a bundle of iron wires built up to a diameter of  $\frac{1}{2}$ ". The iron wires should be 18" long and the cheeks should be spaced 3" apart. The primary winding is wound on first. (2) The telephone transformer may consist of the primary winding of 3 ozs. of No. 42 S.S.C. wire, and the secondary of 3 ozs. of No. 34 S.S.C. copper wire. The core is constructed of a bundle of soft iron wires, built up to a diameter of  $\frac{1}{2}$ " and 4" long. The core should be open, that is, the iron wire is not bent back over the transformer winding.

"R.H." (Nottingham) asks (1) For particulars of a microphone transformer. (2) For dimensions

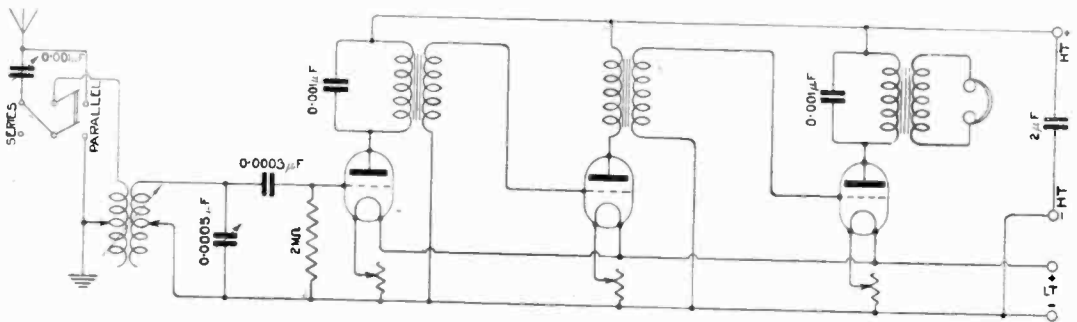

Fig. 1.

value of 0.001 mfd., and should be connected to join in series or parallel with the A.T.I. The closed circuit inductance is tuned with a condenser, having a maximum value of 0.0005 mfd. The proposed arrangement of A.T.I. and secondary coil is quite suitable.

of a suitable choke coil. (3) For a suitable A.T.I. and reaction coil. (4) For the capacity of a suitable by-pass condenser.

(1) A microphone transformer may consist of an iron core composed of a bundle of wires built up to a diameter of  $\frac{1}{2}$ ", and 4" long. The



core should be left open. The primary winding may consist of 200 turns of No. 22 S.S.C. copper wire, and the secondary 10,000 turns of No. 36 S.S.C. wire. (2) The choke coil "B" should consist of a winding of 12,000 turns of No. 34 S.S.C. wire wound on an iron core having a dia-

method of winding, as well as the dimensions of the coil, determine this value, and it is therefore not possible to accurately predict the precise inductance. The 600 turn coil should be wound with No. 24 D.C.C. wire. The 150 turn coil should be wound with No. 22 D.C.C., and the 100 turn coil is

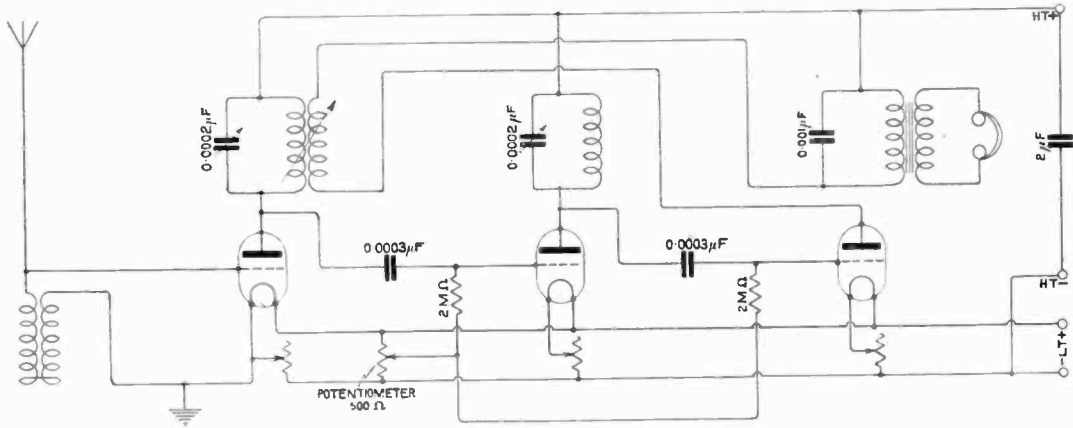

Fig. 2.

meter of  $1\frac{1}{2}$ ". The core should be practically closed. If the coil is built up of sheet stampings to form a closed circuit, it is better to put a very narrow saw-cut right through one limb of the stampings to break the magnetic circuit. If the core is built up of iron wires, the wires may be placed in contact on one half of the choke, and on the other half left slightly separated. (3) The aerial circuit should contain a winding of 30 turns of No. 12 gauge bare copper wire, and the winding should be spaced a distance equal to the thickness of the wire. About 35 turns wound on a former 5" in diameter will be suitable. The reaction coil may consist of a winding of No. 30 D.C.C. and consist of 80 turns wound on a former 3 $\frac{1}{4}$ " in diameter. (4) The condenser "D" should have a very small value and be capable of withstanding the H.T. potential. 0.0005 mfd. is generally quite suitable.

"BITTON" (Hove) submits a diagram of his receiver and asks (1) How to connect a potentiometer to control two H.F. valves in the grid circuits, and for particulars of suitable grid and grid-leak values. (2) Why is it that, although signals are received very loudly when a variometer is used in the aerial circuit, the signals are weak when tuning coils and a series connected condenser are used.

(1) A suitable diagram of connections is given in Fig. 2, and the values of the components are marked. (2) Without a knowledge of the tuning condensers and coils used we cannot say why there should be such a great difference in signal strength. Of course, better results should be obtained from the use of a variometer, but if the series condenser has a large maximum value, there should be no such great difference of signal strength noticeable.

"M.G." (Dorset).—It is a very difficult matter to determine the inductance of a duolateral coil by calculation. Factors such as the space between the turns of the wire due to the

also wound with No. 22 D.C.C. wire. When the coils and the condenser are assembled, a certain amount of experimental work will be necessary in order to cover the range of wavelengths required. If, however, you wind the coils with a few more turns than given in the article to which you refer, you will have no difficulty. This is necessary in

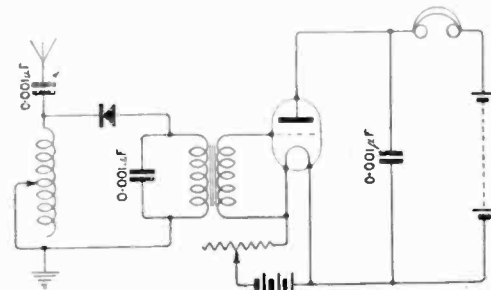

Fig. 3.

any case, because in all probability your tuning condenser would not be similar to the one which the writer of the article employed in his wavemeter.

"H.R." (S.E.7) asks (1) For a suitable diagram showing the connections of a crystal detector with one low frequency magnifier. (2) Where may low current consumption valves be obtained.

(1) See diagram Fig. 3. Suitable values are indicated in the diagram. (2) We suggest you communicate with the manufacturers of the valve in question, The Marconi-Osram Valve Company, Ltd., Osram Works, Brook Green, Hammersmith.

"H.G.S." (Leicester) asks (1) For a diagram of a receiver using the components which he has already by him.

(1) The diagram is given in Fig. 4, and suitable values are indicated. The method of connecting the high frequency transformer is the same whether it is tapped or untapped.

of this journal. (4) A 0.0003 mfd. variable condenser will have approximately fifteen plates, the number of plates of course being determined by the area of the plates and the spacing.

"CATHODE" (Yorks) asks (1) For the wavelength range of a tuning coil, particulars of which are submitted. (2) Whether 0.0003 mfd.

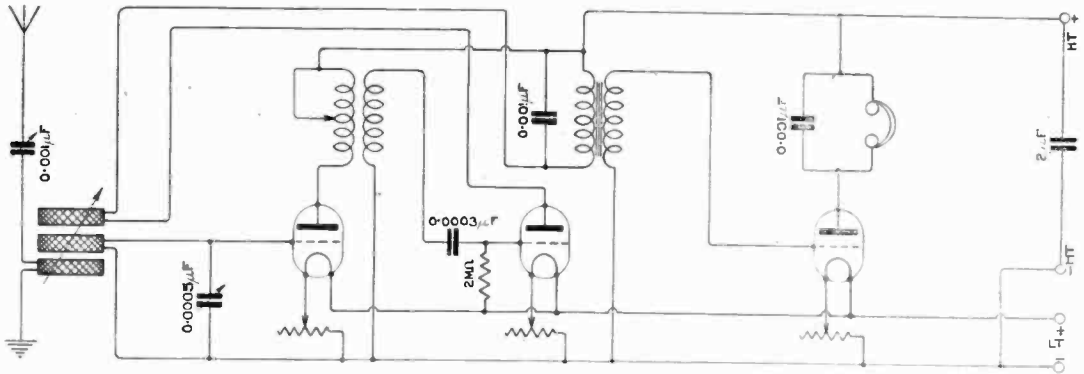

Fig. 4.

"J.W.K." (Middlesex) asks (1) For a diagram showing two L.F. valves added to a detector valve, with the values of the condensers. (2) Would the grid condenser and leak used at present be suitable for use with the new arrangement. (3) Should the Dutch Concerts be received with a receiver of this description. (4) How many plates are there in a 0.0003 mfd. variable condenser.

(1) The diagram is given in Fig. 5, and suitable values for the condensers are indicated. (2) The grid condenser and leak used in your present receiver is quite suitable. (3) The addition of L.F. valves does not enable you to receive from greater distances. Low frequency valves magnify

variable condenser is suitable for tuning. (3) For the dimensions of a suitable reaction coil. (4) Why it is not possible to receive telephony even though the carrier wave is strongly heard.

(1) The wavelength range of the tuning coil when connected to the aerial, and the 0.0003 mfd. tuning condenser is from 200 to 6,000 metres. (2) The tuning condenser is quite suitable for tuning the aerial circuit. (3) The reaction coil may be 2½" in diameter and 5" long wound full of No. 32 D.C.C. with three tappings. (4) The reason why you are unable to receive telephony transmissions is because too much reaction is used in the circuit. We suggest you reduce the reaction coil by half.

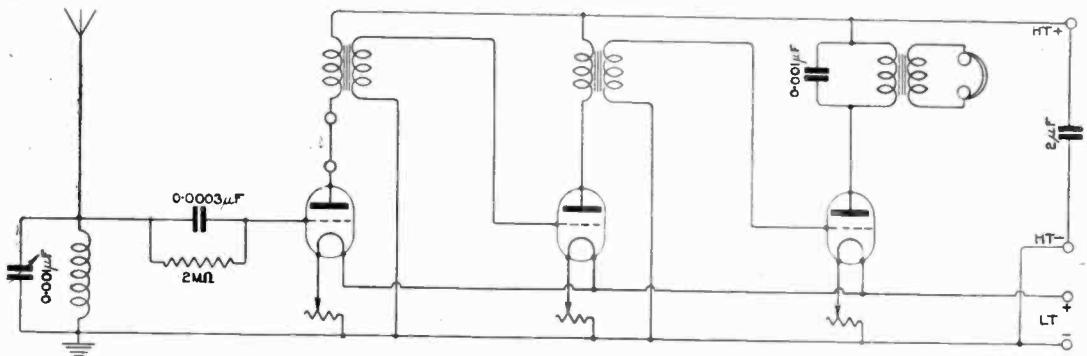

Fig. 5.

signals which are of sufficient strength to be efficiently rectified. To amplify very weak signals it is necessary to use one or two stages of high frequency amplification in the manner shown in many issues

You may be sure that when a circuit of the type described oscillates, energy is being transferred to the aerial circuit and interference is being caused to your neighbours.

"A.G." (Folkestone) submits a diagram of his five-valve receiver and asks (1) Is the circuit correct. (2) Would a variable condenser across the reaction coil be an improvement. (3) Can we suggest any improvements. (4) Should he be able to receive PCGG transmissions.

(1) The proposed circuit is not correct. The anode of the detector valve should be connected through the reaction coil to the primary of the low frequency transformer, and the low frequency transformer should be shunted with a 0.001 mfd. fixed condenser. We would point out that the telephones are joined so that the whole of the anode current from the valve passes through them. We assume this to be a clerical error. (2) A variable condenser connected across the reaction coil would be helpful, especially when receiving long wavelength signals. (3) We suggest you connect a switch in the aerial circuit for connecting the aerial tuning condenser in series or parallel with the aerial tuning inductance. A closed circuit is very useful and should be coupled with the aerial tuning inductance. It may be tuned with a 0.0005 mfd. condenser. It would be better to use a filament rheostat in the filament circuit of each valve, instead of using one to control the filament current of them all. (4) We consider you should have no difficulty in receiving PCGG transmissions.

"A.D.La T." (Yorkshire) submits a diagram of his receiver and asks (1) For criticism of circuit. (2) The most suitable way of connecting a separate heterodyne circuit for receiving long wavelength C.W. signals. (3) Is proposed arrangement for using reaction suitable when receiving short wavelength signals. (4) Why is 6 volts recommended for the L.T. battery when most valves operate with 4 volts across the filament.

(1) We suggest you employ a reaction condenser with a maximum capacity of 0.0005 mfd. The aerial tuning condenser may have a maximum value of 0.001 mfd., and the closed circuit 0.0005 mfd. The primaries of the high frequency intervalve transformers should be tuned with a small variable condenser; one having a maximum capacity of 0.0002 mfd. would be suitable. The by-pass condenser labelled "B" may have a value of 0.0005 mfd. The remainder of the circuit is quite suitable. (2) We suggest you connect the heterodyne with the third high frequency transformer. The small coil from the heterodyne should be coupled with the secondary coil of the high frequency transformer. A very loose coupling will in all probability suffice. (3) The small reaction condenser should be connected with the grid of the second valve when receiving short wavelength signals. (4) It is generally necessary to use a 6-volt accumulator for the L.T. supply, since most valves operate best when the potential across the filaments is 4 volts. When the valve is old, a little over 4 volts is required, and in order to provide this voltage and also to allow for the voltage drop in the wiring and the filament resistances, it is necessary that the filament supply should be 6 volts.

"CIRCUIT" (Co. Dublin) asks (1) How many yards of No. 50 S.S.C. copper wire are required for a resistance of 2,000 ohms, and what is approximately the weight of this wire. (2) How many yards of No. 47 S.S.C. wire are required to give a resistance

of 2,000 ohms, and what is the approximate weight. (3) and (4) Which is the correct way of connecting the two windings of a telephone receiver together.

(1) 200 feet of No. 50 copper wire gives a resistance of 2,000 ohms. The weight of 200 feet of this wire will be approximately 0.2 ozs. (2) 800 feet of No. 47 copper wire has approximately a resistance of 2,000 ohms. The weight is approximately 2.6 ozs. The No. 50 wire will just fill up the bobbin having the dimensions given. (3) and (4) The correct method of winding is indicated in your Fig. 1.

"H.W." (York) refers to a receiver described in the issues of September 16th and 23rd, and asks how it may be modified.

We suggest you construct the receiver exactly as described in the articles referred to. It is not satisfactory to make alterations to a receiver before one has had experience with reception.

"K.V.W." (Devon) asks (1) For particulars of a variometer. (2) What is the Customs tax on imported French "R" type valves. (3) Whether a list of amateur transmitting stations is published.

(1) A variometer was described on page 317 of the December 2nd issue, to which we would refer you for particulars. (2) We have no knowledge of the duty payable on imported French "R" type valves. (3) A very complete list of amateur transmitting licence holders is published by the Wireless Press, Ltd., and may be obtained from the Mail Order Department, The Wireless Press, Ltd., 12 1/3, Henrietta Street, London, W.C.2.

"HALENDER" (E.17) asks (1) Whether he should use a telephone transformer in the anode circuit of the last valve of his valve receiver. (2) Which is the input side of a transformer.

(1) Under the circumstances, we think it would be better if you connected the telephones directly in the anode circuit, and no serious harm will result. It is not very helpful to wind a transformer having a ratio of 1 to 1, as you suggest. (2) The input side of a transformer, when applied to an intervalve transformer, is the side which is connected in the anode circuit, and is labelled the primary. The output side of the transformer which is the secondary, is connected with the grid and filament, or the input circuit of the next valve.

"H.T.S." (Cornwall) submits a diagram and asks (1) For criticism. (2) Whether it would be approved by the P.O. (3) How to obtain an experimental licence.

(1) The diagram submitted is quite suitable as no reaction is shown. (2) The P.O. would probably approve of a receiver wired according to this diagram. (3) We suggest you communicate with the Secretary of the G.P.O., London.

"JOHN R.G." (Oundle) asks (1) Whether aluminium is a suitable substance upon which to wind a variometer winding. (2) At what speed must a motor connected with the Johnson Rahbek loud speaking amplifier rotate.

(1) Aluminium is not suitable for the former of a variometer. The fact of its being insulated with wax paper will not make it suitable. We suggest you use dry wood or ebonite. (2) The best speed

for the motor of the Johnsen Rahbek loud speaker should be determined by experiment. The diameter of the agate cylinder is  $\frac{3}{8}$ ". 30 revolutions a minute is suitable.

"RADIOMAD" (Salisbury) submits particulars of his aerial, and asks whether it may be improved in any way.

We suggest you erect a two-wire aerial at right-angles to the telephone wires; the length of the aerial will then be 45'. The aerial should be as high as possible.

"J.W.H.C." (Manchester) asks (1) Why signals are as loud whether connected to earth or disconnected. (2) Why adding H.F. connected valves does not materially increase the signal strength. (3) What is the tuned anode method of high frequency amplification. (4) Is it possible to make a loud speaker with the aid of a microphone.

(1) The reason why a connected or disconnected earth lead from your receiver does not affect the signal strength is because the earth lead is so long. We suggest you reduce the lead to 6'. Owing to your peculiar situation, however, we think you would find the signal strength improved by using a frame type aerial. The frame may be 4' square wound with 10 turns of No. 18 D.C.C. The wire should be spaced  $\frac{1}{4}$ " and the last five turns should be tapped and taken to a switch for coarse tuning. The two leads from the frame aerial will then go to the filament and grid connections of the first valve. The frame aerial should be tuned with a variable condenser having a maximum value not exceeding 0.0005 mfd. (2) With the modification suggested in (1), the addition of H.F. connected valves will greatly increase the signal strength provided the tuning in the anode circuit of the added valves is suitably carried out. (3) The tuned anode method of H.F. amplification employs a tuned coil in the anode circuit. When the tuned circuit has a frequency corresponding with that of the signal to be amplified, the impedance of the circuit is very high, consequently large potential variations are set up across it. These are transferred to the grid of the next valve through the grid condenser. The leak is connected between the grid and the filament to stabilise the normal grid potential. Many diagrams showing the methods of connecting high frequency valves by means of tuned anode coils, have been recently given; in particular we would refer you to page 601, February 3rd issue. (4) It is not always possible to construct a loud speaker. However, the receiver may be connected with one side of the microphone, the other side being secured to a rigid framework. The primary of the transformer and a few dry cells should be connected in series with the microphone and the transformer secondary connected with the telephones. See Microphone Amplifier on page 130, October 28th issue.

"C.F." (Northwood) submits a diagram of connections and asks (1) For criticism. (2) Is the aerial (particulars of which are submitted) likely to be useful. (3) Is it necessary to secure adjustments for a portable receiver or will an ordinary experimental licence suffice.

(1) The diagram of connections submitted is correct, and is quite a standard circuit. (2) The proposed aerial is not very suitable, and we think

you would get far better results from a frame. The frame should be 4' in diameter wound with 10 turns of No. 18 D.C.C. The wires should be spaced  $\frac{1}{4}$ ", and the last five turns brought to a switch. (3) When applying for an experimental licence, you are asked whether the receiver is to be portable or whether it is to be used as a fixed station. We therefore suggest that you apply to the G.P.O. for permission to use a portable receiver.

"W.G." (Durham) asks how an intervalve transformer works.

When a transformer is connected in a circuit, variations in the primary voltage are reproduced in the secondary circuit. If the primary voltage is an alternating voltage, the secondary circuit will deliver an alternating voltage. If the primary circuit contains a steady direct current, superimposed upon which is an alternating voltage, only the alternating voltage will appear in the secondary circuit, because the voltage of the secondary circuit is induced by the varying current producing a varying flux which cuts the secondary winding. A continuous current flowing through the primary circuit cannot cause a voltage across the secondary winding. The primary voltage and secondary voltage are 90° out of phase. When no load is connected to the secondary of the transformer and a voltage is applied to the primary, the current flowing in the primary circuit, which magnetises the primary winding, is 90° out of phase with the primary voltage: the current is lagging 90°. The secondary voltage is in phase with the magnetising current, and the phase of the secondary current is determined by the nature of the load upon the secondary. If the secondary winding is inductive, the secondary current will lag behind the secondary voltage. If the secondary circuit is purely resistance, the secondary current and voltage will be in phase. The primary current lags behind the applied voltage simply because of the predominance of inductance in the circuit. The lag of the current behind the voltage is in no way affected by the frequency of the applied voltage. The product of the volts and amperes measured in the D.C. circuit supplying energy to the valve gives the apparent watts in the circuit. The true watts would be given by the product of the reading of a hot wire ammeter and D.C. voltmeter. When the D.C. current is pulsating, the D.C. ammeter will indicate an average value, while the hot wire ammeter will indicate the R.M.S. value. The ratio between the apparent watts and the true watts depends upon the adjustment of the valve circuit.

## SHARE MARKET REPORT.

Prices as we go to press on February 9th, are:—

Marconi Ordinary .. ..	£2 14 0
„ Preference .. ..	2 5 0
„ Debentures .. ..	107 0 0
„ Inter. Marine .. ..	1 9 0
„ Canadian .. ..	11 0
Radio Corporation of America:—	
Ordinary .. ..	15 6
Preference .. ..	13 0

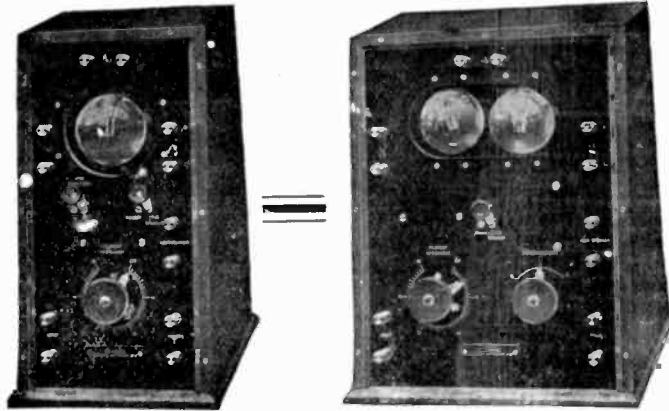

For the  
Discriminating  
Amateur

# Note Magnifiers for Your Present Set

TWO NEW ADDITIONS TO A REMARKABLE SERIES.

Here are two more instruments in the wonderful series of Broadcast Receivers now being placed on the market by the Marconi Scientific Instrument Company, Ltd. Once more high efficiency is combined with a fine appearance, while the special features of these note magnifiers will appeal to every discriminating amateur.

Many owners of single or two-valve receivers are anxious to add note magnifying valves to their sets so that a loud speaker may be used. They will find in the MARCONI SCIENTIFIC TWO-VALVE MAGNIFIER an instrument which will fulfil all requirements. For those who are not satisfied with the strength of speech and music obtainable with their present set, but who do not require the great amplification obtainable with two further valves, the MARCONI SCIENTIFIC SINGLE VALVE MAGNIFIER will admirably meet the case.

Possessors of the MARCONI SCIENTIFIC TWO-VALVE BROADCAST RECEIVER can convert it into a three or four-valve set by adding one or other of these Magnifiers, which are designed to match in size and style the instrument referred to. The Marconi Scientific Three-Valve Broadcast Receiver can similarly be converted into a four-valve set by adding the single-valve magnifier.

### Special Features of these Magnifiers :

Valves fit into recessed sockets, which greatly improve the appearance of the instrument. Separate terminals for loud speaker, and switch to change automatically from telephones to loud speaker. Switch on single-valve magnifier to cut off magnifier valve and work straight from receiver when required. Switch on two-valve magnifier so that one or both of the valves can be cut out if desired. High efficiency intervalve transformers, specially designed to suit the valves supplied. Marconi Scientific filament resistances, giving perfect control of filament brightness.

<b>Prices :</b>	Marconi Scientific Single-valve Magnifier, as illustrated, complete with		
	Marconi " R " Valve .. .. .	£7	17 6
	Royalty payable to the B.B.Co. .. .. .	£1	0 0
	Marconi Scientific Two-valve Magnifier as illustrated, with two Marconi		
	" R " Valves .. .. .	£12	15 0
	Royalty payable to the B.B.Co. .. .. .	£1	15 0

**The Marconi Scientific Instrument Co., Ltd.**

Telegrams :  
Themasinco, Westcent.

40, Dean Street, Soho, W.1

Telephone :  
Gerrard 7746

# Perfect Broadcast Reception

## Total Outlay £5 : 0 : 0

**WHATEVER YOUR WIRELESS NEEDS, WE CAN SUPPLY.**

The following is a much abridged list of component parts and accessories, which we have in stock:—

- "Ideal" Valve Accumulators. Rating 50 hours intermittent, 25 hours continuous.
- 4-Volt, in wooden case with carrying handle (Carriage 2/-) . . . . . 24/-
- 6-Volt, in wooden case with carrying handle (Carriage, 3/-) . . . . . 35/-
- 3-Coil Holder, complete unit . . . . . 20/-
- Pyramid H.T. Batteries—
- 15-Volt . . . . . 3 6
- 30-Volt (with variable plug connection and 2 wander plugs) . . . . . 7 -
- Filament Resistances . . . . . 3 9
- Fixed Condensers . . . . . from 2 -
- Variable Condensers (of various capacities) . . . . . from 6/-

Broadcasting orchestras—Speeches from Celebrities—Morse from Ships, etc., all these are at your disposal every day, once you install this wonderful little Crystal Set.

### WATES CRYSTAL SET

The movement of one switch arm is the only adjustment necessary to receive any particular wavelength. The crystal is enclosed in a glass container—one adjustment being almost permanent.

The cost of **£5 : 0 : 0**

**INCLUDES EVERYTHING—NO EXTRAS—NO UPKEEP COSTS.**

You can add to this set step by step by the Wates Unit System of Note Magnifiers.

This system produces signals of remarkable strength and clarity of tone without atmospheric disturbance or distortion, and enables you to use a Loud Speaker.

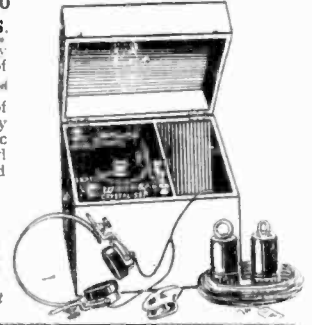

**WATES BROS.** 13-14, Great Queen Street, Kingsway, London, W.C.2

'Phone : Gerrard 576

'Grams : Zywaleseng, Westcent

**E** **C** **ESTAB. 1896**

**E** **L** **E** **C**

LIMITED

**"XTRAUDION"**

**THREE ELECTRODE VALVE**

Oscillates  
Rectifies  
Amplifies

Filament consumption 5 amps at 4 volts; Anode potential 50 volts.

**PRICE 15/-**

Phenomenal Value new No. 30 Weston Relays. Price 20/-, not a sixth of their cost Operate on a current of 50 microamperes.

Write to-day for 40 page Radio Catalogue mailed post free 4d.

Head Office—10, FITZROY SQUARE, LONDON, W.1 | Showroom: 303, EUSTON RD., N.W.1

**J. BURNS, LTD.**

Wangye Works,  
Chadwell Heath, Essex.

We are actual manufacturers and can offer special advantages to the trade—send us your enquiries.

<b>CONDENSERS.</b>	<b>Retail price</b>
.001 mfd. . . . .	each 13/6
.0005 " . . . . .	each 10/-
.0003 " . . . . .	each 9/-
.00005 " . . . . .	each 4/6
Filament Resistances . . . . .	each 2/-
Terminals with high base . . . . .	doz. 1/6
Contact Studs, with nuts . . . . .	doz. 9d.
Sliders, with springs and studs . . . . .	each 9d.
Ebonite Coil Holders . . . . .	each 12/6
Ebonite Knobs . . . . .	doz. 4/-
Ebonite Panels, prices on application.	

**Single Valve Panels**

fitted with Variable Condenser, Filament Resistance, Grid Leak and fixed Condenser. Engraved Panel and Rosewood finished Box, ready for use

£4

**Vulcanised Fibre and Ebonite Sheets, Rods & Tubes from stock.**

# TOMLINSON

## LONDON, LIMITED.

3, FINCHLEY ROAD, ST. JOHN'S WOOD, N.W.8  
Hampstead 1844

'Phones  
in Stock.

'Phones  
in Stock.

Complete installations  
from £10 to £100

Aerial Insulators 1/1

**IDEAL HOME  
EXHIBITION  
STAND 27**

Postage paid on all orders  
over £2.

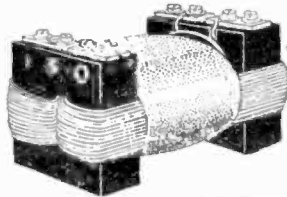

L.F. Trans-  
formers

**12/6**

Postage 4d.

Headphones  
4,000 Ohms

**22 6** each  
Postage 9d.

4000 Ohm Phones ... 22 6

4000 Ohm Phones  
(special) ... 25 6

Condensers, any capacity 2 6

Variometer Formers ... 7 6

**IDEAL HOME  
EXHIBITION  
STAND 27**

Postage paid on all orders  
over £2.



### An Outstanding Instrument

In common with all the TINGEY Broadcast Receivers,  
this

### Three-Valve Broadcast Receiver

is distinguished by its uniform efficiency, its simplicity  
of operation, and the clarity and strength of the  
reception it gives. In addition it is readily adaptable  
for further amplification when required.

The wavelength range—300-3,000 metres—embraces  
the wavelengths of all the British and Continental  
Broadcasting Stations.

The set comprises 1 H.F., 1 H.F. and Rect., and  
1 L.F. Amplifying Valve.

All TINGEY Valve Apparatus is duly licensed under  
Marconi Patents for Amateur use in Great Britain and  
all Broadcast Receivers bear the B.B.C. Stamp.

Illustrated Catalogue of 1, 2, 3, 4 and 5 Valve Broad-  
cast Receivers and Experimental Unit System with  
all accessories, Post Free, 6d.

**£25 5 0**

**Price**  
(as illustrated, less  
valves), including  
Broadcasting Fee,

Telephone :  
Hammersmith 1916  
Telegs :  
"Tingoidar, London."

92, QUEEN ST.,  
HAMMERSMITH  
LONDON. W.6

**TINGEY WIRELESS LTD.**

More and More Wireless  
Manufacturers are specifying

**BROWN'S**  
Super - Sensitive  
**TELEPHONE**  
**RECEIVERS**  
Types A and D



THERE MUST BE REASONS FOR THIS. It is because, with the "BROWN" TYPE A Headphones the range is much increased, and signals difficult to detect with the use of the usual telephonic receivers are clear and distinct when these instruments are used.

These headphones possess an efficiency of three times that of other telephonic headgears. Their extreme lightness and ease of adjustment make them the most comfortable of all headphones to wear.

TYPE D is also recommended for wireless telephony or for ordinary telephone work in which the extreme sensitiveness of Type A is not essential.

<b>PRICE: Type A (with Cords)</b>	<b>The Pair.</b>	<b>PRICE: Type D (with Cords)</b>	
120 ohms .. .. .	£2 18 0	120 ohms, the pair .. .. .	£2 8 0
Over 120 ohms to 4,000 ohms .. .. .	3 2 0	Over 120 to 4,000 ohms, the pair .. .. .	2 12 0
4,000 ohms to 8,000 ohms .. .. .	3 6 0		
Carriage Paid in U.K.		Carriage Paid in U.K.	

OBTAINABLE FROM ALL WIRELESS DEALERS.

*In universal use. Supplied to British and Foreign Governments.  
Illustrated Catalogue of our Headphones, Loud Speakers and Amplifier post free from—*

**S. G. BROWN, Ltd.**

London Offices and Showrooms (RETAIL ONLY)—

**19, MORTIMER ST., LONDON, W.1**

TRADE COMMUNICATIONS ONLY TO:—  
HEAD OFFICE AND WORKS: VICTORIA ROAD, NORTH ACTON, LONDON, W.3.  
Telegrams—"Sadbrownix, London." Telephone—Chiswick 1469.  
Sole Agent for the Argentine—Horacio D. Guerrero, Las Heras, 2486, Buenos Aires.



**IMPORTANT NOTICE**

**FOR THE  
TRADE  
ONLY**

**On 1st March, 1923**  
will appear the  
**FIRST NUMBER**  
of the

**WIRELESS**  
**AND ALLIED TRADES' REVIEW**

*The only weekly publication devoted exclusively to Wireless Trade interests*

**PRICE 4<sup>D</sup>. WEEKLY**

*Subscription Rates and full particulars will be supplied on receipt of Trade Card addressed to the proprietors*

**THE WIRELESS PRESS LTD.**  
12-13 Henrietta Street, Strand, W.C.2

The Proprietors and Publishers  
of the  
**WIRELESS & ALLIED  
TRADES' REVIEW**  
**THE WIRELESS PRESS,  
LTD.**

**12 & 13 Henrietta St., W.C.2**

are already well-known to every section of the community interested in wireless. As Proprietors of the **WIRELESS WORLD** and Publishers of Wireless Literature, **The WIRELESS PRESS, LTD.** has had over ten years' experience. This new trade organ will thus possess from the outset the unique advantage of a practical knowledge of wireless trade requirements, in addition to a wide acquaintance with the public point of view.

At no time in the history of Wireless has there been a greater demand for a journal capable of catering in a thoroughly comprehensive manner for the rapidly growing interests of the trade. The attitude of the Public towards Wireless has reached a stage when the united efforts of Manufacturers and Dealers can advantageously be directed towards promoting its development along mutually progressive lines. It will be the guiding policy of the **WIRELESS AND ALLIED TRADES REVIEW** to foster a healthy and productive trade co-operation beneficial to all concerned. Constructive articles of current interest, technical and otherwise, will be a prominent feature, while in all other respects the Review will be fully representative of up-to-date Wireless interests from all sides.

*Applications for Advertisement Rates should be addressed to:*

**BERTRAM DAY & CO., LTD.**

*Advertisement Managers,*

**9 & 10, CHARING CROSS, LONDON, S.W.1**

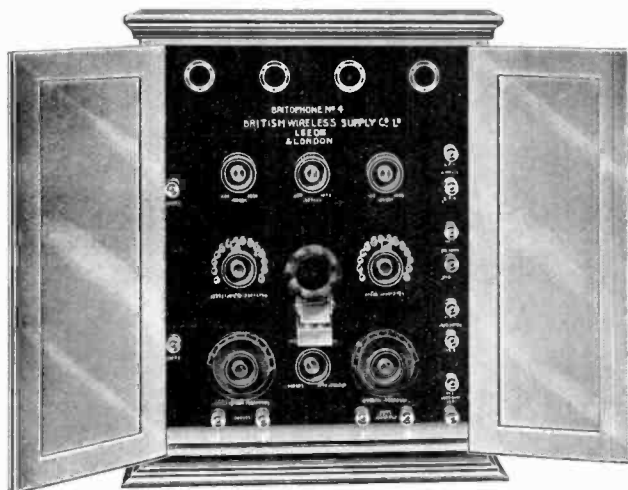

P.O. Regd. No. 0181.

## “BRITPHONE” No. 4

Cabinet Measurements, 20½" x 16½" x 9½". Range covers 200-25,000 metres wavelength.

**A**N excellent four-valve Broadcast Receiver in polished mahogany cabinet, with folding panelled doors fully in keeping with the general appearance of the instrument. The receiving panel is of Radion Mahoganite.

The four valves include 1 H.F., 1 Rect., and 2 L.F. steps. The last valve by means of a switch acts as either an ordinary magnifier or a power valve for use with any loud speaker. The high tension voltage on this valve can be anything up to 400 volts, thereby obtaining tremendous increase in volume of sound, suitable for entertainments in large halls or out in the open.

**PRICE** complete with all accessories, including four Valves and Coils up to 4,000 metres, **40 Gns.**

All "Britphone" Apparatus is approved by the Postmaster-General and is manufactured under Marconi licence.

ILLUSTRATED CATALOGUE NOW READY—3d. POST FREE.

### BRITISH WIRELESS SUPPLY Co. Ltd.

Head Office - - - 6, BLENHEIM TERRACE, LEEDS.

Phone—26926.

London Showrooms - - 64, FRITH STREET, W.

(off Shaftesbury Avenue).

Phone—Gerrard 2789.

DEMONSTRATIONS DAILY.

And at—  
18, Eldon Square, Newcastle.  
Phone—Newcastle-on-Tyne, 360 City.  
4, Pembroke Square, Above Bar, Southampton.  
Phone—Southampton 403.

And at—  
11, Church Street, West Hartlepool.  
Phone—West Hartlepool, 373.  
8, Corporation Street, Belfast.

ANOTHER OPPORTUNITY TO OBTAIN "IGRANIC" SECURITY DEMAND "IGRANIC" INTERVALVE TRANSFORMERS

OVER A QUARTER MILLION HONEYCOMB COILS ARE NOW IN USE.

For particulars send for Leaflet 2236-U4.

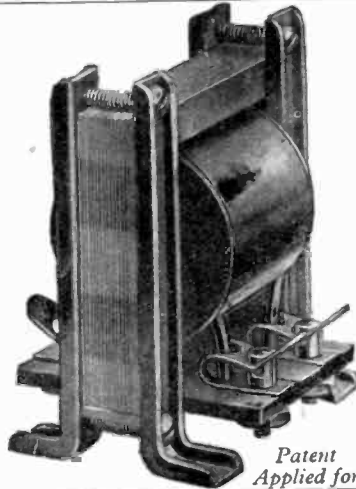

Patent Applied for

THE SAME APPLIES TO "IGRANIC" FILAMENT RHEOSTATS AND WILL SOON APPLY TO "IGRANIC" INTERVALVE TRANSFORMERS

GLASGOW. MANCHESTER. BIRMINGHAM.

149, Queen Victoria St., LONDON.



BRADFORD. NEWCASTLE. CARDIFF.

Works : Elstow Road, BEDFORD.

Our new 24-page Illustrated Catalogue, 4d. post free, gives the price of everything from a transformer to a contact stud.

CARTWRIGHT'S SCIENTIFIC COMPONENTS

MADE BY EXPERTS IN OUR OWN WORKS. YOU CANNOT AFFORD TO BUY INFERIOR APPARATUS.

HIGH FREQUENCY INTERVALVE TRANSFORMERS. Plug-in Type.

The design and construction of these has been given the utmost consideration, resulting in great selectivity and maximum results, valve for valve. They can be tuned over a big margin without noticeable loss, and must not be confused with the ordinary single-grooved type.

A Real Scientific Product.

No. 1	Optimum	wavelength,	350	each	6/8
	metres				
No. 2	Optimum	wavelength,	550	each	7/-
	metres				
No. 3	Optimum	wavelength,	930	each	7/6
	metres				
No. 4	Optimum	wavelength,	1,400	each	8/-
	metres				
No. 5	Optimum	wavelength,	2,000	each	8/6
	metres				
No. 6	Optimum	wavelength,	3,500	each	9/-
	metres				
No. 7	Optimum	wavelength,	10,000	each	10/6
	metres				

Or the complete set for £2 15s. These transformers must be tuned with variable condenser.

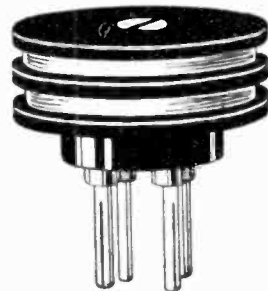

We are the CHEAPEST FIRM ON EARTH for stamped, turned or moulded components. Complete Receiving Sets shortly ready. SPECIAL TERMS TO THE TRADE.

J. L. CARTWRIGHT & CO.,

Manufacturing Electrical Engineers

(Dept. W.) 24, London Road, MANCHESTER.

Works : BERRY STREET.

Phone : Central 4209.

Grams : Pladuram, Manchester.

Business Hours, 9 a.m. to 6 p.m., except Fridays, 9 a.m. to 8 p.m.

Saturdays, 9 a.m. to 1 p.m.

Wholesale Agents for Scotland :—J. CORSTON SINCLAIR & CO., 47, Waterloo Street, Glasgow.



See our Stand at the forthcoming All-British Wireless Exhibition, March 17th-24th, Burlington Hall, Burlington Street Manchester.



*Result of  
14 Years' Experience*

**“ As good as Brandes ”**

**O**NLY if a headset bears the name Brandes can it be “as good as Brandes.” It took fourteen years of experience to make Brandes Matched Tone headsets so supersensitive that they respond to signals that cannot affect counterfeits, and are so durable that they are still serviceable long after the cords have worn away.

These facts should be borne in mind when a headset is offered with the claim that it is “as good as Brandes.”

MADE IN ENGLAND FOR

**CANADIAN BRANDES LIMITED**

**105, Great Portland Street, London, W.1**

By

**GENERAL RADIO COMPANY**

Telephone : LANGHAM 1145.

*Trade enquiries invited.*

# A Radiophone in Every Home.



Broadcasting links up your home with all the latest news of the day. It brings to your own fireside whenever you wish a wonderful entertainment—opera, plays, concerts, lectures, speeches—in endless variety.

All that you need and your only expense is a G.R.C. RADIOPHONE, of which there are models to suit every purse and purpose—each one a masterpiece of efficient construction and advanced design. Look for the name "GENERAL RADIO COMPANY" on every genuine set. It is your guarantee of reliability and mechanical perfection.

Any G.R.C. Dealer will be pleased to demonstrate so that you can judge for yourself the superiority of G.R.C. Apparatus. Write for name of nearest Dealer and FREE ILLUSTRATED CATALOGUE.



*G.R.C. Apparatus will be shown by Messrs. Mottershead & Co., at the Manchester All-British Wireless Exhibition, 17th—24th March. We are also exhibiting at the Ideal Home Exhibition, Olympia, 1st—24th March.*

G.R.C. 16 TWO-VALVE RECEIVER.

## GENERAL RADIO COMPANY

**TWYFORD ABBEY WORKS, ACTON LANE, HARLESDEN, N.W.10**

Telephone :  
Willesden 3055 (3 lines).

SHOWROOMS :  
105, Great Portland Street, W.1

Telegrams :  
"Milliamp, 'Phone, London."

BRANCHES :  
Edinburgh and Bradford.

# CONDENSERS

*DELIVERY FROM STOCK*

High in Quality.

Low in Price.

Un-  
assembled

·001 ..6/6

·00075 5/3

·0005 ..4/-

·0003 ..3/-

·0002 ..2/6

·0001 ..2/3

·00005 2/-

Turned Ebonite  
Plates 1/8 per  
pair extra

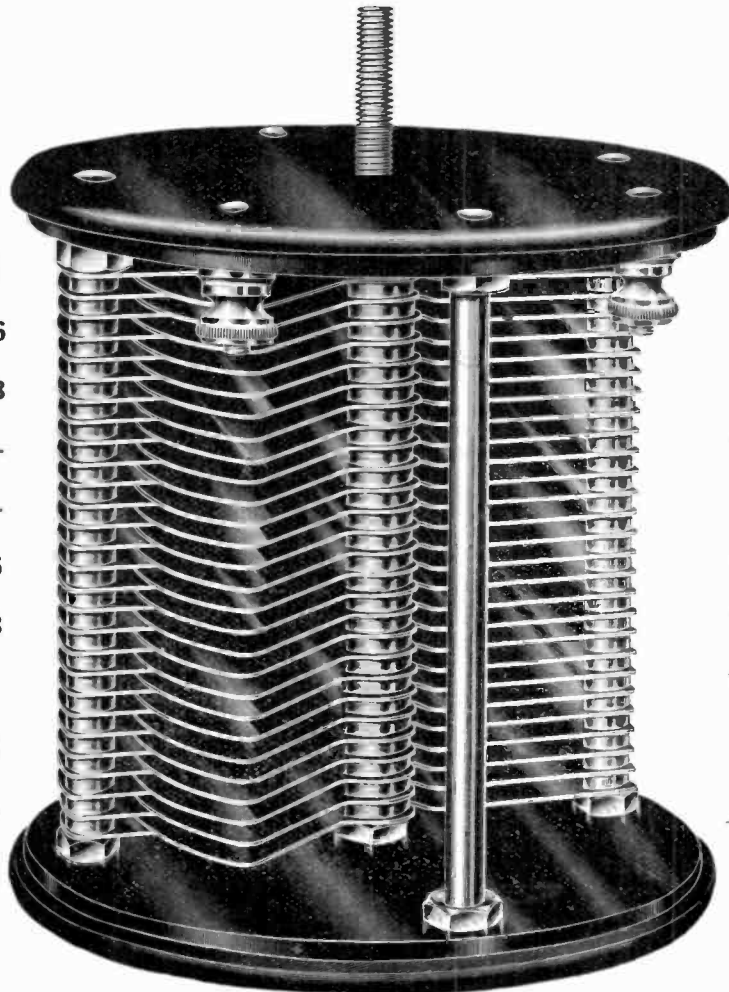

Assembled

·001 10/6

·00075 7/6

·0005 ..7/-

·0003 ..6/6

·0002 ..6/-

·0001 ..5/6

·00005 4/6

Complete



**ORMOND ENGINEERING CO.**  
199, Pentonville Road, King's Cross, N.1.

Telegrams : Ormondengi.

Telephone : Holborn 1812.



COMBINED INVERSE BIAS CURRENT AND GRID-LEAK RECTIFICATION



VARIABLE GRID-LEAK RECTIFICATION

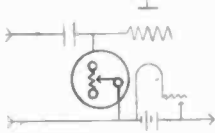

VARIABLE GRID CURRENT AND CONDENSER LEAK RECTIFICATION



POTENTIOMETER

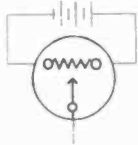

Combined Variable Grid Condenser with Variable Grid Leak  
7/6

Eliminate *DISTORTION* prevent *ANEMICS* and avoid Gramaphonics in your reception of Radiophony by using a

# FILTRON

## VARIABLE GRID LEAK

Zero to 7 Megohms

5/- each. Post paid. Cash with order

57a, Deubigh Street, Pimlico, S.W.1.

DEAR SIR,

A **FILTRON** employed as a **VARIABLE GRID LEAK** affords a purely ohmic resistance which may be varied from **ZERO** to 7 megohms, and provides a critical control to the Rectifying Valve, ensuring extreme purity and the utmost accuracy of conversion from Radio to Audio Frequency by filtering away the electronic cunuli from the Grid in precise abbreviated syncopation with the input modulation.

It should be clearly understood that the modulation of each voice and every musical instrument is entirely different and needs distinct filtration adjustment of the Grid.

Whilst operating a **FILTRON** you will be able to mentally visualise the most minute electronic function and will be astounded by the improvement in your reception.

Filtrons are provided with three terminals, the connections to which enable it to be employed as a purely ohmic, non-capacitive, non-inductive and variable H.R. choke, filter, bypass, potentiometer, grid leak, vernier shunt for filament or anode resistance, aperiodic coil or transformer intensifier, etc., with the utmost efficiency.

This long-felt want in Radio Apparatus, which tends to afford an improvement in reception beyond all recent developments, can be delivered to you within 48 hours of order.

Yours faithfully, PHIL TRON.

Postal Orders or Cheques to be crossed "*& Co.,*" and made payable to

**RADIO SPECIALITIES, 57a, Denbigh Street, Pimlico, S.W.1**

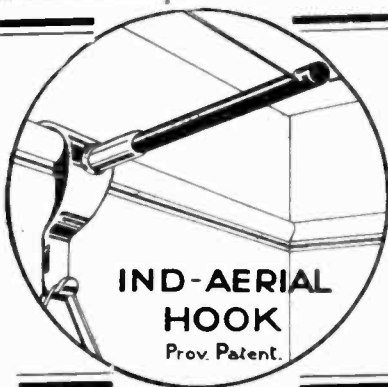

**IND-AERIAL HOOK**  
Prov. Patent.

## SAYS MR. MAN:—

"I WANT the Broadcasting and am prepared to buy a Radio set, but I live in a flat and may not have an outside aerial. What can you do for me?"

**DEALER!** the answer is **IND-AERIAL HOOKS**

They are essential for a neat, efficient and portable **INDOOR AERIAL**. Attached in a moment to the picture rail of any room they can be taken down just as easily. They support the aerial **ONE FOOT** from the wall on insulated arm, and are no disfigurement.

2/9 each; 31/6 doz. Post Free.

Some Agencies still open in Broadcasting Towns.

**IND-AERIAL CO., 47, Victoria Street, London, S.W.1**

## Doing away with the aerial

### THE "DUCON"

Where there is electric light, an aerial is unnecessary. Plug a "Ducon" into an ordinary lamp holder or wall socket, connect to the wireless receiver and you will receive the broadcasting perfectly.

The set is quiet, there is no noise from the mains, and the "Ducon" is perfectly safe to use, consumes no current and does not affect the electric light in any way.

The "Ducon" is applicable to all types of receivers, from crystal to multi-valve.

## The DUCON 10%

is obtainable from all leading wireless dealers, electrical contractors and stores, or direct from the makers.

Dealers not yet stocking are invited to write for trade terms. Over 50,000 in use.

**THE DUBILIER CONDENSER CO. (1921) LTD.,**  
Ducon Works, Goldhawk Road, Shepherd's Bush, London, W. 12.  
Telephone—Hammersmith, 1084. Telegrams—"Hivoltcon, Phone, London."

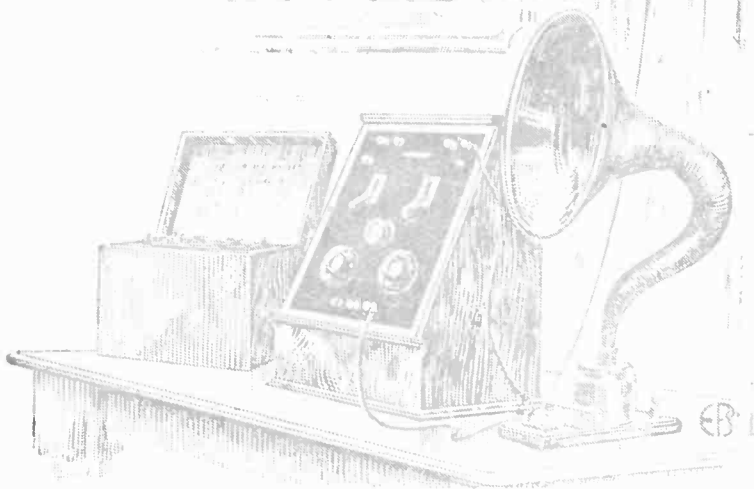
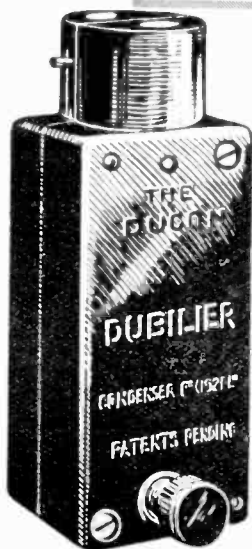



## ANNOUNCING

**THE**  
**WIRELESS**  
 FOR THE  
 TRADE  
 ONLY  
**DEALER**

*A Trade Journal devoted to the interests  
 of Makers, Factors and Dealers engaged  
 in the Wireless Industry.*

By Subscription **8/-** per annum, post free.

**TO BE PUBLISHED MONTHLY**  
 First issue to be ready in March.

**T**HE Wireless Industry having made such rapid strides, the point has undoubtedly been reached when it is desirable that Makers, Factors and Dealers in Wireless Apparatus should be efficiently served by a Journal devoted solely to their interests.

"THE WIRELESS DEALER" will be issued by a firm which has been engaged in the publication of the trade journals for the past 28 years, and will have the advantage of the wide experience gained and the complete and efficient organisation that has been built up in all that period.

It will be conducted editorially by a competent technical staff, and produced in an attractive style similar to the well-known and old-established trade journals already being published by The Trader Publishing Company, Ltd., its main object being the consolidating and safeguarding of purely trade interests.

In order to promote a more widespread interest in this new industry the early issues of the "Wireless Dealer" will contain much technical information, written both from the point of view of those traders who have considerable experience in the working of wireless, and of those who are as yet unacquainted even with its first principles.

*A Specimen Copy of No. 1 when published will be forwarded on request to any interested dealer.*

Advertisement space can now be booked. Particulars and tariff will be forwarded on request.

*Proprietors and Publishers:*

**The Trader Publishing Company Ltd.**  
 139-140, Fleet Street - - - London, E.C.4

*Telephone No. CENTRAL 7713 (4 lines).*

# T.M.C. WIRELESS

PS  
52

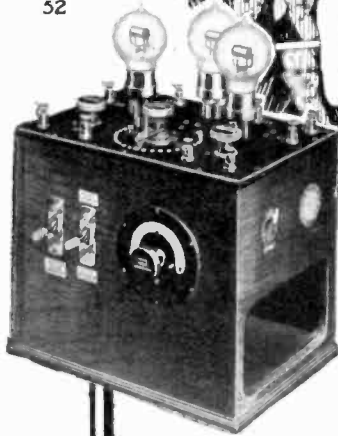

## for boxing

A T.M.C. Wireless Set will give you the full account of the fight as it proceeds, round by round. Or you may be interested in football, the latest news, Stock Exchange quotations, the weather forecast, delightful concerts, or an evening of dancing.



You can have all these, enjoyably and pleasantly, in the comfort of your own home, with a T.M.C. Wireless Receiver. There is no trouble to you—T.M.C. have engineers in every large town, who will install and periodically inspect the apparatus. T.M.C. Wireless is particularly simple to work, and gives every satisfaction. T.M.C. Wireless Receivers, which are fully approved by the Postmaster-General, bear the seal of the British Broadcasting Company. The wide variety of models are entirely British made.

From **£4 : 5 . 0** upwards  
including all Royalties.

London, Birmingham, Manchester and Newcastle are Broadcasting now! Come and listen to them any evening up to 10 p.m. at our showrooms in London, Birmingham, Belfast, Bristol, Cardiff, Dublin, Glasgow, Leeds, Liverpool, Manchester, Newcastle, Sheffield.

Write to us for our nearest address.



The "Everset" Crystal. No adjustment necessary. Fits any crystal receiver.

**10/-**  
each.

**T.M.C.**  
Makes Wireless  
Worth While

**TELEPHONE MFG., CO. LTD.**  
HOLLINGSWORTH WORKS, DULWICH, LONDON, S.E.21.

NEW SUPPLY JUST RECEIVED FROM THE PRINTERS.

# THE RADIO EXPERIMENTER'S HANDBOOK

By PHILIP R. COURSEY,  
B.Sc. (Eng.), F. Inst. P.

113 pages. 99 Diagrams and Illustrations.

PRICE **3/6** NETT.

(Postage 6d.)

CONTENTS—

General Considerations—Components of Wireless Installation—The Aerial Circuit—Receiving Tuners—Receivers, including detailed instructions on the making of the many types of inductances and useful Mark III tuner modifications, Amplifiers and Valve Detectors with circuits of high-frequency, low-frequency and resistance—Capacity Coupled Amplifiers—Heterodynes, giving working instructions for making up a long range heterodyne wavemeter—Appendix: High Frequency Measurements and Calculations with valuable data and tables.

**The Wireless Press, Ltd.**

Dept. W.W.

12-13, Henrietta St., Strand, London, W.C.2

**CONDENSER VANES  
BRASS TERMINALS  
VALVE LEGS & STUDS  
EBONITE DIALS  
(Complete with Knobs)  
EBONITE VALVE HOLDERS**

*We Supply all Wireless Accessories. Large stock on hand. Send for Catalogue to the Manufacturers.*

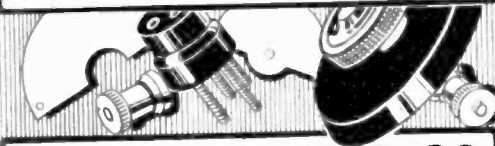

**H. CLARKE & CO.**  
(MANCHESTER) LIMITED.

Atlas Works, Eastnor St., Old Trafford, Manchester.  
\*Phone: 683 & 793 Trafford Park. \*Grams: "Pitoid, Manchester."



# Two Symbols



When these two symbols appear in conjunction on a Broadcasting Receiver, no further recommendation is necessary. The one signifies that the instrument has been approved by the Postmaster-General.

The other tells you that the greatest brains in Wireless have directed its manufacture. Look for *both* signs always. You will find them only on

# The Marconiphone

*The Triumph of the Master Mind.*

You local dealer can supply you. In case of difficulty apply to

**MARCONI'S WIRELESS TELEGRAPH COMPANY, LIMITED**  
(Marconiphone Department), MARCONI HOUSE, STRAND, LONDON, W.C.2



“POLAR”

*Chosen for GOOD*

# SETS SERVICE SIGNALS

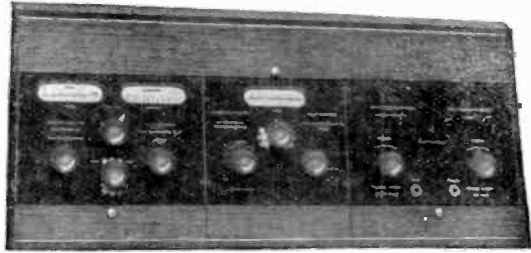

7-Valve "Polar" Radiophone, Type R.A. 33, 34, 35.  
Price £58.

## DESIGN.

NOTE THESE SPECIAL FEATURES:—

1. Wavelength scales on all tuned circuits.
2. Three stage H.F. can be switched in or out of circuit.
3. Three stage L.F. with power valve connections for loud speaker.

## APPEARANCE.

Against the handsome polished teak case, the sloping panel of rich ebonite with its polished knobs has a very sales-inviting effect.

## MANUFACTURE.

"Polar" Radiophones are made throughout at our own works, which have for years been engaged in the manufacture of commercial wireless sets for the leading ship owners, P.O., Colonial Governments, etc.

## SERVICE.

In future all purchasers of "Polar" combined Receivers will be visited by appointment, free of charge, by one of our staff of trained experts, who will adjust the set to secure the best possible results on the actual aerial. He will demonstrate its performance and give advice and instruction upon its treatment in use.

We invite applications from the trade for further particulars of these and other "Polar" broadcasting specialities

## THE RADIO COMMUNICATION CO. LTD

*(Suppliers of the G.P.O. Installations at North Foreland (G.N.F.) and Seaforth (G.L.V.), of Coastal Stations for various Colonial Governments, and of Ship's Radio for most of the Great Shipping Companies.)*

34/35, NORFOLK STREET, LONDON, W.C.2

BRANCHES—NEWCASTLE—17 Sandhill. GLASGOW—116 Hope Street. LIVERPOOL—67 Dale Street.  
CARDIFF—Atlas Chambers, James Street. SOUTHAMPTON. 19, Queen's Terrace.  
WARRINGTON—37, Bridge Street.

## ACCUMULATOR RUN DOWN?

You must have experienced this nuisance just in the midst of a perfect concert.

Why not CHARGE your own cells AT HOME from the Lighting Supply?

We offer you the necessary so that this is possible at a cost equal to one lamp burning only.

For Direct Current Supply £9:0:0

For Alternating ,, ,, £7:0:0

GUARANTEED SATISFACTION or money returned. Full details,

**G.W.I. Ltd.** (Electrical Dept.)

IMPERIAL WORKS, SHANKLIN RD.,  
CROUCH END, LONDON, N.8.

Tel. : Hornsey 3065.

## A GREAT SUCCESS Valve Renewal SOLVED

You must have experienced the annoyance and disappointment by your favourite VALVE failing suddenly—"filament burn-out"

The renewal problem has now been solved.

We undertake to renew your broken filaments and return valves guaranteed equal to new.

TRY A SAMPLE—NO RISK.

**7/6** EACH. POST FREE.

TUBULAR TYPE VALVE 1 - EXTRA.

Sole Distributors (London & South of England)

**G.W.I. Ltd.**

IMPERIAL WORKS, SHANKLIN ROAD  
CROUCH END - - LONDON, N.8

Tel.—HORNSEY 3065.

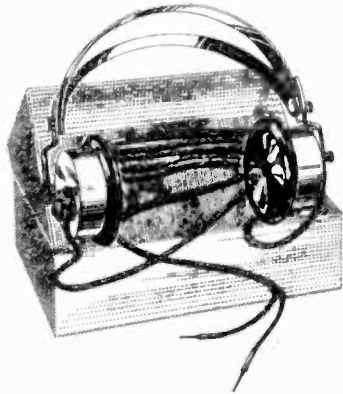

## GREAT BARGAIN OFFER

4,000 ohm PHONES (NEW)

at **17/6** Per Pair.

Postage 9d. extra.

Fitted headbands and cords, beautifully finished, thoroughly efficient. Each pair carefully packed in box. SATISFACTION GUARANTEED.

**BROADCASTING RECEIVING APPARATUS.**

The "JOYPHONE" (Reg. No. 0138, approved type, 2 Valve Set, complete from **£15 : 0 : 0**

Special Offer at Reduced Prices of our

### NEW INTERVALVE TRANSFORMER

Owing to the unexpectedly large sale of these instruments we are enabled to reduce the price to "Wireless World" readers to

**12/4**

Postage 9d. extra.

Fitted with panel fixing plate and earthing wire for iron core. Fully tested.

Ratio 5 : 1.

All valve apparatus manufactured by us is duly licensed under Marconi's Patents for amateur use in Great Britain. Approved by Postmaster-General.

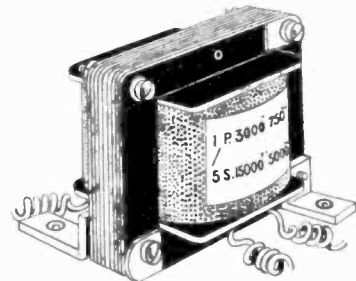

#### TERMINALS

4 B.A. Double Solid Brass or Plated 2/- per doz. (post extra).

2 B.A. Single Solid Brass or Plated 9d. per doz. (post extra).

We have enormous stocks of ex-WD WIRELESS GEAR, too numerous to mention, at absurdly low prices. Write for particulars of your requirements, or better still, call and see our enormous stocks.

**J. LIPOWSKY & CO.** 614, OLD FORD ROAD, BCW :: LONDON, E.3

Near Old Ford Station N.L.Rly.

Telephone : EAST 3345.

Nos. 8 or 39 'Bus.



**SELLING AGENTS.**  
 Scotland: 57, Robertson Street, Glasgow.  
 N.E. England: North British Engineering Equipment Co., Milburn House, Newcastle-on-Tyne

We also make Crystal Sets—range 15/25 miles. With 'Phones £5 0s. 0d.

## Listen-in to all the British Broadcasting

This wonderfully selective 2-valve receiver has the *utmost reactance allowed* by the G.P.O. It has two carefully calibrated circuits which allow of the most minute tuning plus the utmost simplicity in manipulating.

Beautifully finished in lacquered or nickelled brass, mounted on matt-finished ebonite, all mounted in a polished walnut case.

Panel £13 14s. 0d. M.O. Valves 17/6 each. Pair 4000 ohm Ericsson 'Phones. 80 volt H.T. Battery. 4 volt 30 ampere hour Accumulator. 100 ft. Aerial 7/22 Enamelled Copper and Insulators.

**Price from Aerial to 'Phones, packing and delivery . . . £20**

*Write to-day for full particulars.*

**THE BRITISH L. M. ERICSSON MFG. CO., LTD.**  
 International Buildings, 67/73, Kingsway W.C.2.

# Ericsson

**WIRELESS APPARATUS**

## PITFALLS OF WIRELESS—A FEW WORDS OF WARNING:—



**BURNDEPT INTERVAL TRANSFORMERS** designed to give maximum amplification with minimum distortion. Coils former wound and vacuum impregnated, mounted on laminated stalloy core. Will not burn out when used with anode potentials up to 150 volts. Tested at 500 volts, winding to winding and frame. Minimum resistance 250 megohms.

No. 226 in cardboard box with diagram of connections £1 5 0 E  
 No. 283 in polished walnut box, ebonite panel and terminals £1 15 0 E



One defective or poorly made part may spoil the efficiency of your whole set. See, therefore, that your parts are made by a leading manufacturer, such as **BURNDEPT**. **THE NAME 'BURNDEPT' IS YOUR GUARANTEE**



**BURNDEPT PATENT COILS** (Patent 168249) are the most efficient for the reception of wireless speech and telephony. In these multi-layer coils ample air space is provided between each layer, thus ensuring a minimum self-capacity. Coils S.1 to S.4 are single layer coils, wound on ebonite, wavelength range 150 to 800 metres. Set of 4 concert coils S.1-S.4—£1 0 0 K  
 Coils, 75-1,500, multi-layer coils with wavelength range 750-25,000 metres. Set of 9 . . . £4 10 0 K

**BURNDEPT TELEPHONE TRANSFORMER.** For use with 120 ohm Telephones and Loud Speaker, each one tested at a pressure of 500 volts winding to winding. Distortion and leakage noises reduced to a minimum.  
 No. 227 unmounted . . . £1 0 0 E  
 No. 285 in polished walnut box—£1 7 6 E



**BURNDEPT VALVE HOLDER** turned out of solid ebonite rod, fixed to panel by single screw.  
 No. 241 . . . £0 2 0 A  
 No. 280 mounted on ebonite panel and boxed . . . £0 10 6 A  
 No. 284 as No. 280, with addition of grid leak and condenser, forming a complete detector unit £1 0 0 A



**BURNDEPT RHEOSTAT**  
 Moulded block of special heat-resisting composition, ebonite knob. No. 270 7 ohms 1 amp. £0 5 0 A

**ALL BURNDEPT APPARATUS** with the exception of Valves and Telephones is made at their Model Factories, Aerial and Eastnor Works, Blackheath.  
 Write for our fully illustrated Catalogues. Section I (F) Amateur and Experimental Receiving Apparatus. Section III (F) Broadcast Receiving Apparatus.

DELIVERY BY RETURN OF POST.

## CHARD & CO., 24a, Great Portland Street, W.1

# ENGRAVING

## Machine Engraving on Ebonite Boards

Your Ebonite Boards neatly and accurately engraved.

No Order too large or too small  
**SPEEDY DELIVERIES  
CHEAPEST IN LONDON**

Ebonite boards supplied, drilled and engraved accurately to your dimensions.

SEND US A TRIAL ORDER.

## S. MARKS & SON

*Engraving Works,*

7-8, Carthusian St., Aldersgate St., E.C.1

Telephone No: CITY 5040.

# WIRELESS BARGAINS

Weston Relays, moving coil, new, for cases	21/-
Switch Arms with bush, four leaf	1/-
Filament Rheostats for panel mounting, complete with pointer	2/6
Series Parallel Switches on ebonite base	3/6
Silk Wire, intervalve transformers, stand 1,000 volt between windings	20/-
Ditto. Telephone	15/-
Ivory Scales, 0-180	6d.
Variable Condensers, enclosed type. .001, 17/8; .0005,	14/-
Grid Leaks, fit standard condensers	1/8
Valve Holders, with screwed legs, with nuts	10d.
Crystal Detectors on ebonite base	1/9
Microphones with replaceable insets	2/8
Silk wire Broadcasting Coils	per pair 2/9
1 and 3 Mf. Condensers	1/9
3 Mf. Condensers, Mainsbridge, can be used as 1, 2 or 3 mf.	2/6
Mark III Crystals in cups	per doz. 3/8
120 ohm watch type Receivers with Cord, good makers	4/-
Double Headphone Cords, good make	2/6
H.T. Battery Boxes, polished teak, well made with plugs and sockets, hinged lid, 10 1/2 x 13 1/2 x 5"	6/-
Moving Coil Ammeters, 0-10 amps., 4' dial, back connections	17/8
Carriage Paid on orders over £2. All Goods Guaranteed.	

## C. S. SWAN,

**191, Bishopsgate, E.C.2**

Under Brandon Tailors, and 65, Windsor Road, Leyton, E.10  
Phones: Bishopsgate, 1158.

## THE AUDIOPHONE EMPLOYING THE UNIT SYSTEM.

### SPECIFICATION.

Highly skilled hand labour throughout. Bare, tinned internal wiring, bent on formers, and soldered at all connections, thus ensuring a noiseless circuit. Polished ebonite panel, engraved white. Polished mahogany cabinet. Wavelength range 300-550 m. Higher wavelengths obtained by means of plug-in-coils. Fully approved by P.M.G.

**IMPORTANT: Fixed Reaction is a feature of this Receiver.**

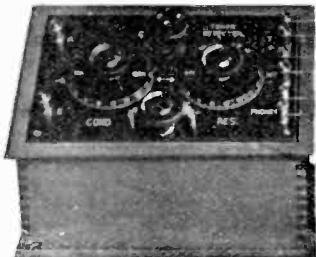

P.M.G. Reg. No. 1018.

### TUNER DETECTOR.

Price as shown £7 7s. Complete with all accessories £11 16s. All components & accessories supplied.

Prices include Marconi Royalty and commission to B.B.C.

**TERMS.** Cash with order, or five days' approval against full deposit.

Manufactured under Marconi Licence by—

## J. R. WRIGHT

Head Office and Factory 10, Carton St., Baker St., W.1

Demonstration Showrooms:  
3, New Quebec Street, W.1. (Phone 3848 Paddington.)

## Variable H.T. Batteries



The W.A.S. Variable H.T. Batteries will increase the efficiency of your set, and give you undistorted speech and music.

These batteries being made from a special formula have a longer life than any other make on the market, and are perfectly SILENT in working.

### PRICES.

30-VOLT, tapped every 3 volts . 7/-  
60-VOLT, " " 9 " " 13/6

Trade Supplied.

The above prices include insulated Wander Plugs.

To be obtained from most Radio Dealers, or Post Free from Sole Manufacturers:—

**W. A. SAXBY & CO.**

3, Gayford Road, Shepherd's Bush, London, W.12.  
Telephone: Hammersmith 443.



On the transatlantic telephone test, when the American Telegraph and Telephone Company's officials in New York addressed a distinguished assembly of experts and others at New Southgate, London,

**Western Electric**  
**Head Receivers**  
 and  
**Western Electric**  
**Loud Speaking Receivers**  
 only were used at the London end for the reception of the messages.

**Western Electric Company Limited.**

WHOLESALE ONLY.

Connaught House, Aldwych, W.C.2

Telephone—Central 7346.

Also at BEXLEYHEATH, KENT, and NEW SOUTHGATE, N.11

Birmingham—Grenville Buildings, 12, Cherry St.  
 Leeds—Standard Buildings, City Square.  
 Cardiff—Motor House Chambers, 1, Wood St.

Manchester—Northern Assurance Building.  
 Newcastle—20, Saville Row.  
 Glasgow—49, West Campbell Street.



Series No. 3.

# Western Electric

MAKERS OF OVER

## HALF THE WORLD'S TELEPHONES

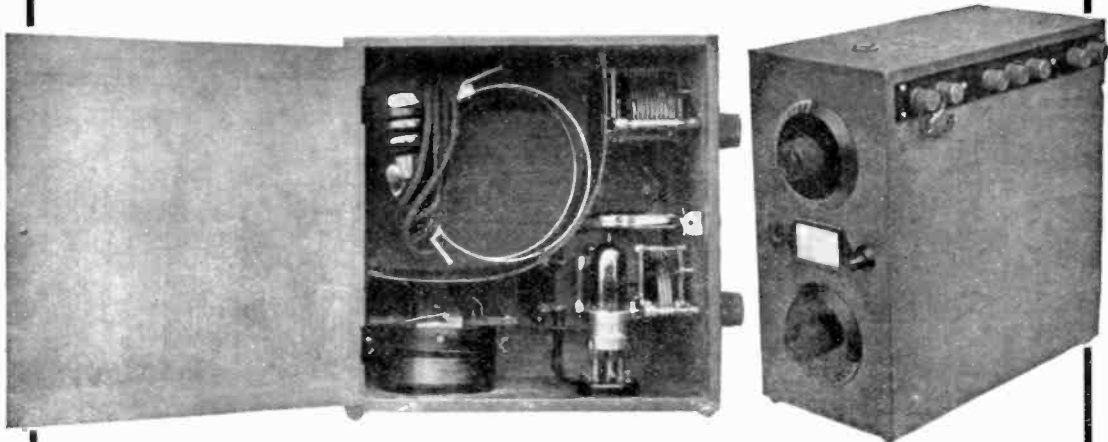

### Western Electric

#### VALVE DETECTOR AND TUNER

is contained in a polished mahogany case and provides for the inclusion of Double Head Receivers, while a spring button is fitted on the top of the case to open the receiver compartments. The valve filaments can be seen through a specially designed mica window, and ventilation discs are provided to fully ventilate the interior of the case. At one end of the case a small card is fitted which gives particulars of various wavelengths together with the respective condenser settings, and above and below are the Variable Condenser Handles. The set is simplified by the use of only one handle for fine tuning, and the filament key is conveniently placed on the right-hand side of the wavelength index. The valves used are specially made to Western Electric specification, and the whole set is built to give the greatest possible efficiency.

### Western Electric Company Limited.

(WHOLESALE ONLY)

Connaught House, Aldwych, W.C.2

Telephone—Central 7345.

WORKS:—

North Woolwich, London, E.16

Telephone—East 3840 (10 lines)

Also at BEXLEYHEATH, KENT, and NEW SOUTHGATE, N.11,

Birmingham—Grenville Buildings, 12, Cherry St.  
 Leeds—Standard Buildings, City Square.  
 Cardiff—Motor House Chambers, 1, Wood St.

Manchester—Northern Assurance Buildings.  
 Newcastle—20, Saville Row.  
 Glasgow—49, West Campbell Street.



## Listen in — with the Fellows

Handphone which has been specially designed for ladies. It has no headband to catch or tear the hair. Beautifully finished and very comfortable to use and wound to 4000 ohms.

**HANDPHONE - 15/3 each**

Inclusive of all taxes.

Postage 1/-

He will use Fellows **Headphones** with two earpieces in light die cast non-ringing metal wound to 4000 ohms.

**HEADPHONE - 2 1/6 per pair**

Inclusive of all taxes.

Postage 1/-

*All Fellows radio instruments are British  
Made throughout and guaranteed.*

**FELLOWS MAGNETO Co., Ltd.**

LONDON, N.W.10

Telephone: Willesden 1560-1.

Telegrams: Quixmag, Phone, London



11.

*For they are jolly good Fellows*

# EBONITE OF QUALITY

As actual manufacturers of Ebonite, we are able at all times to produce a quality that will meet every condition of the job in hand. That is why we are pleasing all our customers among the wireless manufacturers at home and abroad.

WHOLESALE ONLY. WRITE FOR LIST.

SHEET	COIL HOLDERS
ROD	VALVE HOLDERS
TUBING	CONDENSER DIALS
KNOBS	RHEOSTAT DIALS
PANELS	EBONITE HORNS

## TIGHTENSITE LTD.

Normandy Works, Custom House, E.16

\*Phone: EAST 3153.

## BUTLER'S RELIABLE MANUFACTURES.

# Broadcast Sets

BEFORE BUYING ELSEWHERE  
SEND FOR OUR FULLY  
ILLUSTRATED  
LIST.

Post **4<sup>D</sup>** Free.

### H. D. BUTLER & Co., Ltd.

Showrooms and Offices: 222, Great Dover Street.

Telephone—HOP 3029.

Works—HALTON ROAD, CANONBURY.

## GENTS'

### "DISCOL" H.F. TRANSFORMER

has become a  
**STANDARD FITTING**  
in the **RADIO WORLD**

and is  
in  
constant  
demand  
by every class  
of user.



We will send literature on receipt of p.c.

Ask your dealer for  
GENTS' "DISCOL" H.F. TRANSFORMER,  
6/8 each, also  
GENTS' "TANGENT" L.F. TRANSFORMER,  
22/6 each.

"Each is packed in cardboard container and easily warehoused."

RADIO DEPT.

### GENT & CO. LTD., Faraday Wks., LEICESTER

London: 25, Victoria Street, S.W.1.  
Newcastle-on-Tyne: Tangent House, Blackett Street.

# ACCUMULATORS

4 Volt 40 Amp. . . . .	18/6	6 Volt 40 Amp. . . . .	26/3
4 " 60 " . . . . .	21/6	6 " 60 " . . . . .	32/9
4 " 80 " . . . . .	28/2	6 " 80 " . . . . .	37/3
4 " 100 " . . . . .	30-	6 " 100 " . . . . .	43/6

Metal carrying cases for above, with strong strap handle. from 2/- each.

### SPECIAL OFFER.

6 Volt 20 Amp. Accumulators in celluloid at 18- each, absolutely new, but shop soiled.

### WIRELESS GOODS.

Headphones, 4000 ohms . . . . .	each	22/6
L.F. Transformers . . . . .		14/6
Coil Plugs . . . . .	each	2/-

Special Line of KNIFE SWITCHES on Ebonite and on Porcelain at lowest prices. **WRITE FOR LISTS.**

GOOD DISCOUNTS TO TRADE.

## F. YATES & SON, LTD.

WHOLESALE ELECTRICIANS,

144 Church St., Kensington, London, W.8

\*Phone: Park 4270. (One minute from Notting Hill Gate Central London & District Rly.)

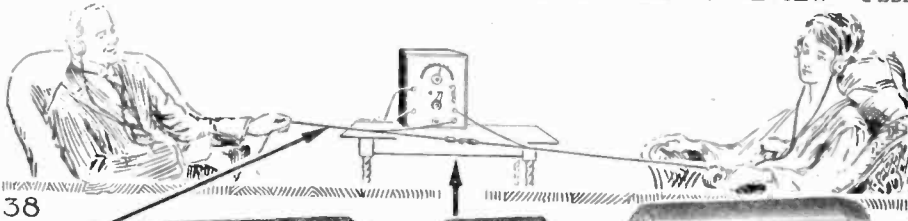

38

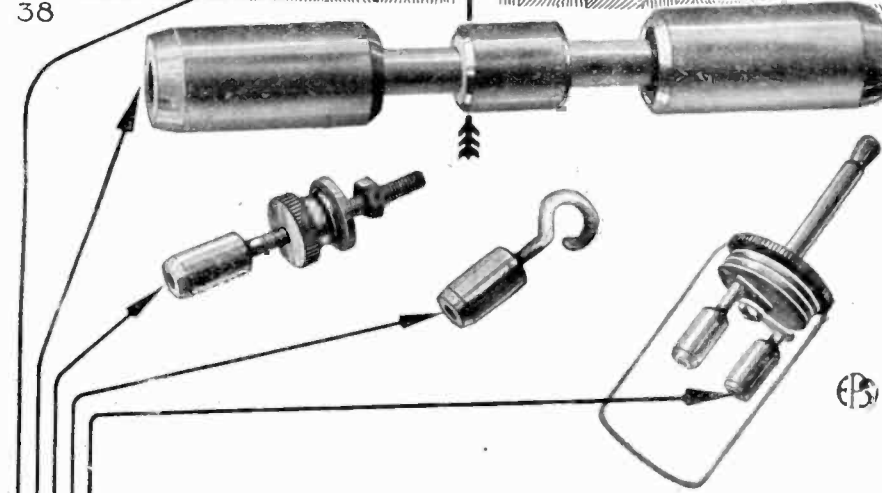

- (1) The self-tightening bull-dog grip fitted to the Elwell plug enables telephones or loud speaker connections to be changed in a moment.
- (2) By the terminal adaptor, the bull-dog grip connector can be added to any existing terminals.
- (3) For fitting to the face of a panel this pattern is recommended. It combines a standard terminal for fixed connections with a bull-dog fitting for connections which you require to change.
- (4) A series connector with a bull-dog grip at each end. Invaluable for connecting telephones in series.
- (5) The series connector in use. Telephones can be connected in series in an instant. No amount of pulling can break the connection. It thus avoids those annoying interruptions caused by involuntary movements.

## BULL DOG GRIP CONNECTORS

Elwell patented self-tightening grip fittings are a big convenience. Without soldering, tightening of nuts or screws or the use of any tools whatever, electrical connections can be made, broken or changed in a moment.

Moreover, the connections when made are electrically perfect and self-tightening. **The more you pull them the tighter they grip.** But they can be released in a moment when desired.

*Ask to see them at your wireless dealer or write for descriptive leaflet. Write to us for the name and address of the nearest Elwell Service Agent.*



**C. F. ELWELL, LTD.,** *Radio Engineers,*  
**CRAVEN HOUSE, KINGSWAY, LONDON, W.C.2**

Telephone : Museum 1384

# Everything wireless at Autoveyors

Parts and accessories of all kinds, including the famous "Au oveyors" 3-Electrode Variable Condenser, the most efficient precision controller of oscillations in Radio circuits.

Marconiphones and all leading Broadcasting Sets in stock. Catalogues on application. Advice and Installations by Experts.

## AUTOVEYORS LTD

RADIO SUPPLIES AND SERVICE,

84, Victoria Street, Westminster, S.W. 1

Phone: Victoria 309

### THE MARK OF

### RELIABILITY

Filament Resistances

2/-

EACH

Panel Type with Knob and Pointer



Potentiometer 300 ohms

4/6

EACH

Panel Type on Ebonite

1 to 12 Volts.

1 to 35 amps.

#### VOLT & AMMETER

Combined Dead Beat Pocket Type. New and not German. Splendid Instrument in Nickel Plated Case. Ideal for Testing Cells and Filament Current.

POST PAID **5/6** NUMBER LIMITED

#### OTHER EXCEPTIONAL VALUES

- Aerial Wire, Bright Hard Drawn, 7/22's, copper, 3/8 per 100'. Enamelled, 7/22's, 4/9 per 100'.
- Aerial Insulators, Shell Type, 2" x 2 1/2" 9d. ... Reel 2d.
- Igranic Coils. Full range stocked ... from 5/-
- H.F. Transformers (Oojah), plug in type, 300 and 700 metres, 4/6 each; 1,000 metres, 5/6; 2,600 6/-
- Ebonite 3-Coil Holder, 10.-. 2-Coil with tension screws 8/-
- H.F. Transformers. Formers only, with pins, each 1/6
- Telephone Transformers (Army type), 9/- each.
- L.F. Transformers, 15/- each. Radio Inst. make, 25/-
- Vernier Condenser, 5-Plate for panel mounting, 4/-
- 3-Plate, 3/6; .001, 10/6; .0005, 7/-; .0003, 6/6
- Wireless Jacks, with plugs, 1/6 the pair. Jacks only, 5d.
- High Note Buzzer (Army type), worth treble, 3/- each. Tapping keys, 2.-. Aluminium cased, 2/6.
- Lightning Arresters. Carbon block type ... each 1/-
- Valve Holders. Flanged "A" type, 1/- Ebonite with 8 nuts, 1/- each. Unequalled quality, 1/8.
- Ebonite Panel, fitted with 3 valve holders, complete 2/9
- Ebonite Panel, fitted with 2 valve holders, complete 1/9
- Valve Sockets, per set of 4 with 8 nuts, 6d. Pins, each 2d.
- Transformer Holder, with 4 terminals and wired, each 3/-
- Mica, clear ruby, .002" thick, 3" x 2", doz. pieces 1/-
- Inductance Slider Rod, 1/2" square, 1 1/2" long, drilled, each 6d.
- Slider, complete with plunger for 1" rod ... each 6d.
- Contact Studs, fitted with nut and washer ... doz. 1/-
- Condenser Vanes, best aluminium, 3 1/2", doz. pairs 1/-
- Condenser Spacing Washers, small, 3d.; large, 5d. doz. 6d.
- Condenser Screwed Rod, brass, 1 1/2" long, 1/8", 4d.; 3/16", 6d.
- Terminals, Mark 3N, plated or P. brass, 4 B.A., doz. 2/6
- Terminals, small pattern, 9d. doz.; spade type, doz. 6d.
- Dublilier Condensers. All capacities at prices advertised.
- Skinderviken Microphone Buttons ... each 5/-
- Fellows 4,000 ohms Headphones, with cords ... 21/-
- Brown's Featherweight 'Phones, 4,000 or 120 ohms ... 30/-
- Valves, Marconi-Osram R 17/6, V 24 26/6, R4B 26/-
- Guaranteed safe delivery, 3 Valves.
- Ebonite Panels, matt surface, ground edges 3/16", 9" x 6", 2.-. 1 1/2" x 9", 4/-; 1", 9" x 6", 2/6, 1 1/2" x 9", 5/-
- Ebonite Engraved Dials, bevelled edge ... each 9d.
- Ebonite Engraved Dials, bevelled edge with knob ... 1/3
- Ebonite Standard Coil Plugs, 1 3/4, moulded ... 9d.
- R.A.F. Microphones, exceptional value ... each 2/-
- Oojah Basket Coils, set of 7, 150-4,500 m. ... 5/-
- Oojah Slab Coils, set of 8, 300-30,000 m. ... 7/6
- Condensers, fixed type, 1/8, with leak ... each 1/9
- Sistoflex Insulating Tube, all colours and sizes ... yard 5d.
- Condenser Scales, engraved, 5d., ebonite do. ... 7d.
- Accumulators, 2 volt 45 amp. hr., fully charged. 10/-
- H.T. Batteries. Ever-ready and Siemens all sizes.
- H.T. Batteries, 1 terminal, 6 sockets, 15 volt. ... each 2/3
- Dewar Switches. D.P. (changeover) new ... each 3/-
- Basket Coil Boxes, fitted standard coil plug ... 1/9
- Ducon Adaptors, Dublilier make ... 10/-
- Ebonite Switches, S.P. tumbler type 1 1/2 in. diameter Plug and Socket Twinwire Connectors, "Malenco" pattern ... 7d.
- Pocket Voltmeters, nickel plated, 0-6 v. ... 4/-
- Pulley Blocks, aluminium, ex-govt. 1/6, galvanised ... 9d.
- Aerial Insulators. Econ. patent pattern ... 1/6

Write for "Complete Supplementary Price List of Exceptional Values," sent Post Free. All goods sent CARRIAGE PAID, but with orders under 5/6 add 6d. for postage.

**J. H. Taylor & Co.** Electrical & Radio Engineers, 5, Macaulay St., Muddersfield. Telephone: 341. Telegrams: "Thorough," Muddersfield.

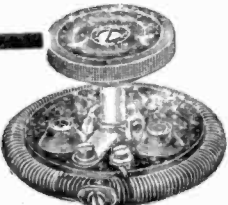

Regd. No. 601772

## The Famous "Ashdown" Resistance

## Price Reduced from Feb. 1

By our improved methods of manufacture we are now able to supply the ASHDOWN Filament Resistance at a reduced price, while at the same time using Erinoid instead of ebonite for the former, which makes for higher efficiency and a still more substantial job. At the reduced price the ASHDOWN is by far the best value in the country.

Now **3/6**

The attention of the trade is drawn to the fact that this is a Registered Design

Traders should send (on printed note heading) for sample Resistance, and liberal discount rates, post free 2/9. Many of the largest manufacturers are now fitting ASHDOWN Filament Resistances as standard to their sets.

Send in your orders NOW, as there is a huge demand. London Representative: Mr. J. O. Maddock, 11, Bayham Road, Bedford Park, W.

## H. E. Ashdown (Birmingham) Ltd. Perry Barr—Birmingham.

Phone: Northern 859. Tel.: Segment. Code: ABC 5th Edition, Western, etc.

# AN IMPORTANT BIG EXTENSION OF WORKS

Crystal Set Model No. 1,  
up to 700 metres.

£4 17 6

Crystal Set Model No. 2,  
up to 4,000 metres,

£8 12 6

2-Valve Set. Price complete

£23 15 0

Valve Amplifying Receiver alone, without accessories

£18 5 0

P.O. Registered No. 2003.

3-Valve Set. Price

£30 15 0

Valve Amplifying Receiver alone, without accessories,

£23 15 0

P.O. Registered No. 0109

IDEAL  
HOMES  
EXHIBITION

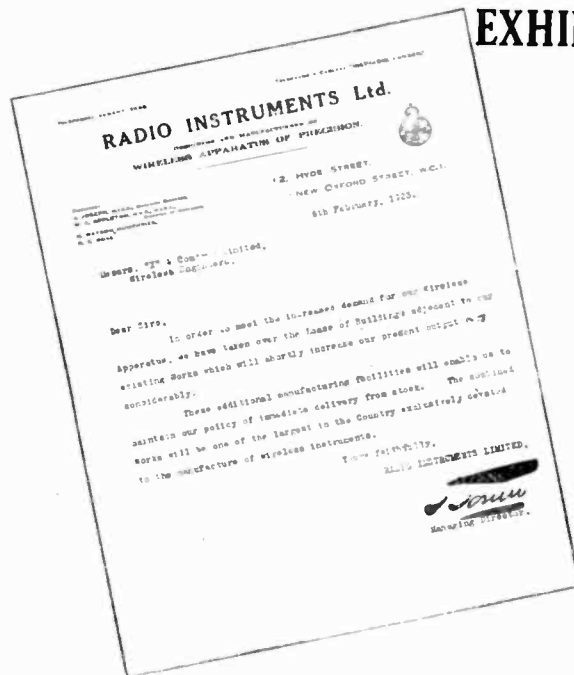

A COMPLETE RANGE OF MODELS FROM CRYSTAL  
TO 7-VALVE, LYRIAN CABINETS AND ALL  
COMPONENT PARTS.

## RADIO INSTRUMENTS LTD.,

Managing Director: J. Joseph, M.I.E.E.

Chief Designer: W.A. Appleton, M.B.E., M.I.R.E., late Admiralty Technical Research Officer

# ANNOUNCEMENT

## “ DELIVERY FROM STOCK ”

**GALLERY  
STAND  
41**



4-Valve Set. Price  
**£33 10 0**  
Valve Amplifying Receiver alone, without accessories,  
**£27 10 0**  
P.O. Registered No. 0112.

5-Valve Set. Price  
**£40 0 0**  
Valve Amplifying Receiver alone, without accessories,  
**£32 0 0**  
P.O. Registered No. 1108.

7-Valve Set. Price complete with all Accessories,  
**£75 0 0**  
Price of Instrument alone  
**£66 0 0**  
Valves extra.  
P.O. Registered No. 0140.

The Lyrian Cabinet 4-Valve Amplifying Receiver. Price  
**£47 5 0**  
P.O. Registered No. 0112.

ALL SETS APPROVED BY THE P.M.G. & B.B.C.  
WRITE FOR CATALOGUE TO-DAY.

### RADIO INSTRUMENTS LTD.,

ONLY ADDRESS: Works, Offices and Showrooms:  
12 Hyde Street, New Oxford Street, W.C.1  
Telephone: Regent 1908. Telegrams: Instradlo, London.

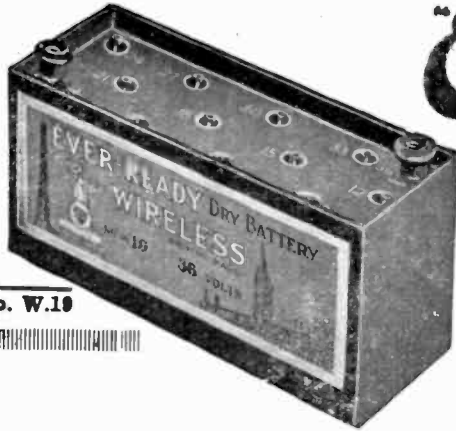

**Ever-Ready**  
*Brite Made*

**DRY CELLS  
and BATTERIES  
for High & Low Tension**



No. W.19

THE STANDARD OF QUALITY

UW.1

**HIGH TENSION BATTERIES**

Any size or voltage with any tappings or sockets at 3 or 6 volt intervals for use with Wander Plugs can be supplied to order  
With 13 sockets as illustrated.

No. W.19, 36 volts, 24 cells, 8/6 each. Size 6 1/2 x 2 1/2 x 3 1/2.  
Weight 2 lb. 8 ozs.

Wander Plugs 1/- per pair. With 2 Spring Contacts.  
No. W.11, 15 volts, 11 cells, 3/6 each. Size 9 1/2 x 1 1/2 x 2 1/2.  
Weight 1 lb. 2 ozs.

**THE UNIT DRY CELL**

"Build up your batteries as you build up your Marconi Sets."

Unlimited flexibility in size, voltage and intermediate tappings. Each cell is fitted with brass screw terminal and looped wire, and they are efficiently insulated to prevent current leak.

No. UW. 1, 7/6 per dozen. E.M.F. 1 1/2 volts  
Weight, 3 1/2 ozs. Dimensions 2 1/2 x 1 5/16 diam.

Art Catalogue of Standard Sizes and Voltages and list of Accumulators for Valve Filament Supply sent on request. Dept. D.L

**THE EVER-READY WORKS, Hercules Place, Holloway, N. 7.**

WITH GOOD APPARATUS YOU  
CAN GET GOOD RESULTS  
THE "W.P."

**Morse Practice Key**

Well Made First-class Finish. Thoroughly Reliable.

Price 7/6 Post Free

**THE WIRELESS PRESS, LTD.**  
12-13, Henrietta Street, London, W.C.2

**" WHALE FOR WIRELESS "**

PHONES—Brown's, 4,000 or 120 .. .. .	30/-
Brunet, 4,000 .. .. .	21/6
VALVES—"R" Type .. .. .	12/6 & 14/-
"Q" or V24 .. .. .	15/-
INSULATORS—Reel .. .. .	13d.
Egg .. .. .	3d.
Coil Mounts, ebonite .. .. .	1/3
Condenser Plates, 24 .. .. .	1/-
Condenser enclosed Vernier .. .. .	8/-
Phonophane holders .. .. .	4/-

Receiving set complete from 25/- Complete with Aerial Wire, Insulators and pair of Phones, £2 10 0.

N.B.—Do away with your crystal or valve detector and fit our PHONOPHANE, 15/- each. Call for demonstration.

**A. WHALE & CO.,**

801, POWIS STREET, WOOLWICH, S.E.18.  
Phone: Woolwich 548.

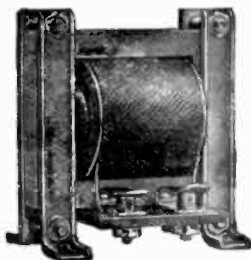

Price 22/6 each.

**Radcom Intervolve Transformer.**

An Instrument of superior design and efficiency, the result of extensive research.

Core of best quality coated Stalloy Iron. Coil of enamelled wire in spaced layers insulated with glassine paper, and the whole impregnated and covered with polished ebonite sheet.

Patent Spring Clip Terminals.

**Radcom Rheostats, Coils, Tuners, Batteries.**

Retail orders value £2, not exceeding 11 lb. weight, carriage paid.

**Radio COMPONENTS LTD.**

19, RATHBONE PLACE.  
LONDON

Telephone—Museum 3485.

Telegrams—Radponents,  
Westcent, London.



# CHAS. BAKER AND CO.'S STORES, LTD

LARGEST OUTFITTERS IN LONDON



## High-class Tailoring

AT MODERATE PRICES

INDIAN COLONIAL &  
FOREIGN OUTFITS

## Regulation Uniforms

Head Depot 271-274 HIGH HOLBORN  
City Branch 41, 43 LUDGATE HILL  
37-140 Tottenham Court Rd., 256 Edgware Rd., &c.

# MAST SERVICE

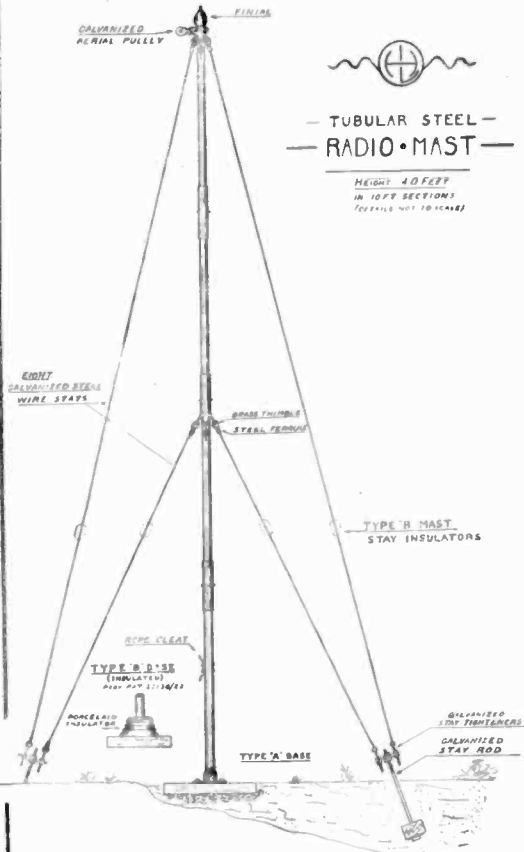

Made of best quality solid drawn steel tubes, to aircraft specification for strength and lightness. Designed for EASY ERECTION.

### PRICES :

Complete in every way, ready for erection and Carriage Paid any railway station, England or Wales—

30 ft. 8 stays	40 ft. 8 stays	50 ft. 12 stays
£3 15 0	£4 10 0	£5 10 0

Carriage Paid, Scotland: Above Prices plus 6 per cent. Mast Completely Insulated (Type B) 21/- Extra.

Full specification sent on request.

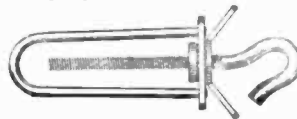

Prov. Pat. 27891/22.

Electro-Galvanized STAY-TIGHTENERS  
Give 3" of Adjustment.  
Price 1/8 each.

Manufacturer :

**H. LONGTON, A M.I.Mech.E.**  
43, Johnson St., WESTMINSTER, S.W.1

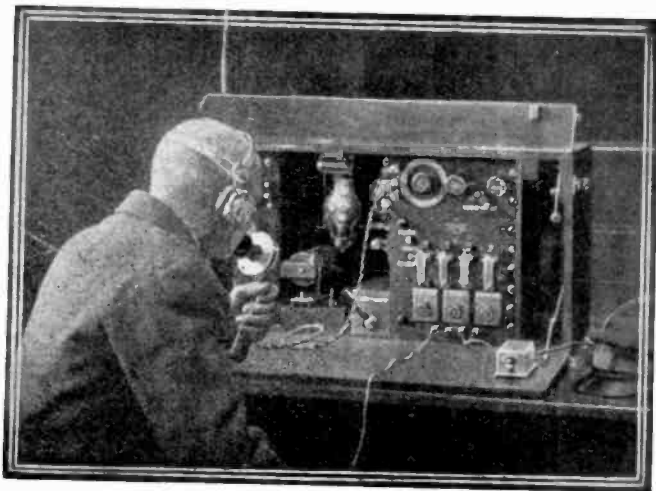

*The First Commercial Wireless Telephone Service in Great Britain*

*is used for*

*Communications between the offices of the Mersey Docks & Harbour Board in Liverpool and the Bar Lightship beyond the mouth of the Mersey. The Marconi apparatus in each case is operated by the ordinary Harbour Board staff and has been in continual use since its installation over a year ago. — "Calling up" is performed by means of the*  
 •• Marconi wireless bell ••

MARCONI'S WIRELESS TELEGRAPH CO., LTD.  
 MARCONI HOUSE, STRAND, LONDON, W.C.2  
 Telephone: CITY 8710.

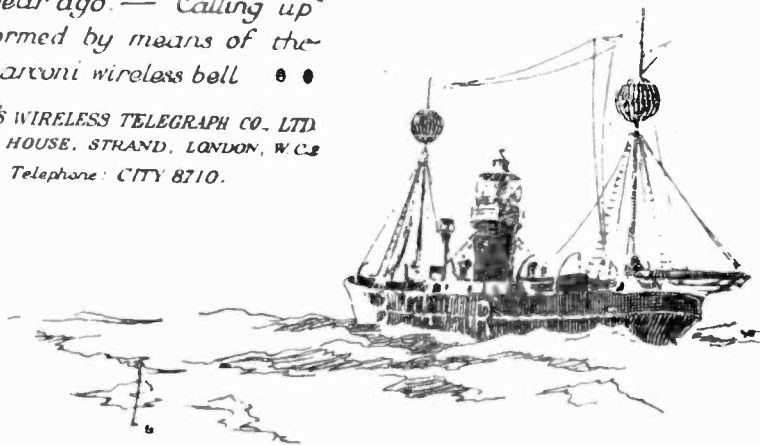



**TUBE, SHEET,  
WIRE, STRIP,  
ROD & CASTINGS**

IN  
**PHOSPHOR BRONZE,**

**COPPER, BRASS, &c., &c.**

**CHARLES CLIFFORD & SON, LTD.,  
BIRMINGHAM.**

**L. W. DOUTHWAITE & CO.,**

Electra House,  
28, ST. JOHN'S STREET, BRADFORD.

**HIGH-CLASS CONDENSERS, .025" AIR GAP.**

Capacity.	Aluminium for Panel Mounting.	In Polished Mahogany Box.
.301	14/-	18/-
.0005	12/-	14/-
.0003	10/-	12/-
Zinc Vane Condensers, .025" air gap.		
.001	10/-	12/-
.0005	8/-	10/-
.0003	5/-	7/-

Ebonite Dials, 1/9 each extra. Postage 9d. on single units.  
Ivory Scale, knob and pointer, 1/- each extra.

Every Condenser Guaranteed.

Used by largest Makers as standard Fitments on their Receiving Sets.  
Quotations submitted for all press work, and repetition turned parts. Liberal discounts to the trade.

**PRESSLAND ELECTRIC  
SUPPLIES LIMITED.**

*Managing Director :*

**CLIFFORD PRESSLAND, A.M.I.E.E.,  
Hampton-on-Thames.**

*Wholesale only.*

Our 1923 Radio Catalogue is now ready and will be sent on application to any *bona fide* Trader.

**F. WIGGINS & SONS**

**MICA**

Telephone 1  
Avenue 2248

Largest Stock  
in the World.

**FOR CONDENSERS  
AND ALL PURPOSES.**

102, 103 & 104, Minories, London, E.1

**CAPPER BROS.  
FOR ALL RADIO REQUISITES**

Agents for **LESLIE McMICHAEL, LTD.,**  
for Woking and district.

Single Valve Sets .. .. .	£5	5	0
Two Valve Sets .. .. .	8	8	0
Three Valve Sets .. .. .	14	14	0
Four Valve Sets .. .. .	25	0	0

**89-93, CHERTSEY ROAD, WOKING**

**SKINDERVIKEN BUTTON.**



**THE SUPERSENSITIVE MICROPHONE.**  
World-wide Patents.  
ENGLISH Manufacture.

For **LOUD SPEAKERS, MICRO AMPLIFIERS, ELECTRICAL GRAMOPHONE REPRODUCERS.**

Invaluable as Detectiphone, as it can be used in ANY POSITION, i.e., either HORIZONTAL or VERTICAL.

**PRICES.**

Type "A"—Carbon Electrodes (eliminating all "frying" noises) .. .. .	each	7/6
Type "B"—Brass Electrodes .. .. .	"	5/-
Receivers (special Low Resistance) .. .. .	"	10/-
Gramophone Attachment (for Electrical Reproduction) .. .. .	"	1/-

**BOOKLET** (16 Pages fully illustrated) containing much useful information for all interested in Electrical Sound Transmission. **POST FREE 6d.**

Sole Proprietors—  
**MIKRO, LTD., 274/276, Pentonville Road, London, N.1.**  
(Opposite King's Cross (Met.) Railway Station).

**Really Satisfactory  
BROADCAST RECEIVING  
SETS**

Including all Royalties Complete  
FROM **£3 15 6**

Full particulars and details from

**G. W. I. Ltd. (Wireless Dept.),**

Imperial Works, Shanklin Road, Crouch End, London, N.8

Tel. : Hornsey 3065.

**Questions and Answers  
COUPON**

To accompany Questions sent in during the week commencing Feb. 17th, 1923.

VOL. XI, NO. 20.

See Conditions on Page 676.

THE WIRELESS WORLD EXCHANGE AND MART

TARIFF. Advertisements are accepted for this Section at the rate of twopence per word, with a minimum charge of two shillings.

DEPOSITS. All advertisements must be prepaid in the form of Postal Orders, the remittance being forwarded to Messrs. Bertram Day & Co., Ltd., 9 & 10 Charing Cross, S.W.1.

Intending purchasers may deposit their purchase money of any article advertised or sold by advertisers with Messrs. Bertram Day & Co., Ltd., who will acknowledge its receipt to the vendor and the depositor, the full addresses of whom should be given. Subject to special agreement between the parties, it is understood that all goods are sent on approval, each party paying carriage one way in the event of the goods being returned. The deposit will be retained until due advice of the completion of the purchase has been given or until the articles have been retained and accepted.



SEND NOW FOR OUR 100 PAGE ILLUSTRATED CATALOGUE

LATEST IMPROVEMENTS

LOWEST PRICES

POST 3d. FREE

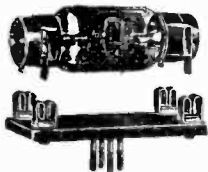

SIEMENS-HALSKES VALVES 7/6 each. ADAPTORS FOR "R" VALVE HOLDERS. 3/- each. POSTAGE EXTRA.

Grafton Electric Company

Showrooms—54, GRAFTON STREET, TOTTENHAM COURT ROAD, LONDON, W.1. Telephone—Museum 241. Works—Slough.

FOR SALE.

"Affa" Potentiometers for your experiments. Assembled slate and ebonite, panel mounting, 450 ohms, 7s. 6d. by post 8s. Guaranteed.—A. FORTY, 61, Corinne Road, London, N. 19.

Wireless Bargains, complete finished parts, make 10 mile receiver, includes—Phones, aerials, crystal detector, tuner, mahogany cabinet, 30s. Post Free.—Write particulars, MANAGER, "Popular Wireless Service," 12, Northwood Road, Highgate, London.

Weston Loud Speaker, brand new, 120 ohms, massive teak base, 24" horn, 70s.—S. DOBSON, Richmond Place, Ilkley.

Armstrong 3-Valve Receiver for sale, particulars 51, Upleatham Road, Saltburn, Yorks.

"Wireless World." Complete to June, 1921. What offers? Telephone transformer, 10s.—SINCLAIR, Mayfield, Murdieston Street, Greenock.

Amateur has for disposal various receiving parts. Stamp for particulars and photo.—RODGMAN, 92, Railway Street, Cardiff.

4-Valve Receiving Cabinet, 1 H.F., 1 Detector, 2 L.F. tuned anode system, very efficient set. £25, no offers, seen by appointment.—B.V., 10, Parsifal Road, Hampstead, N.W. 6.

High Tension Transmitting Transformers by Wilson and Indo-European. Various ratings. Specially suitable for amateur transmitting stations. Wound with strip wire and guaranteed. Get two and arrange midpoint tap. £3 each, carriage paid.—RANDALL, 5, Regent Square, W.C.

"Wireless Accessories" Lists Free.—PENNEY, 169, Ombersley Road, Worcester.

Special Offer of 200 C.A.V. 6v. 66a. (actual) Accumulators. These are all brand new and were made for Ministry but received direct from makers, 50/- each. List price, £5.—H. E. ASHDOWN (Birmingham), LTD., Wireless Apparatus Mfgs., Perry Barr, Birmingham.

Special Offer 2-Valve B.E.C. Sets prior to change of design. Mahogany sloping front. £6 Cash with order.—H. E. ASHDOWN (Birmingham), LTD., Wireless Apparatus Mfgs., Perry Barr, Birmingham.

Works suitable for making Wireless Sets, fully equipped and plating and polishing shops, with electrical engineers and contractors' old established valuable lease, stock, plant, lease and goodwill at valuation.—83, Camberwell Road, S.E. Tel. 1560 Hop.

"Hart" 4-Volt Accumulators, in metal case with handle. New and unused. Only 12s. 6d. each. Below:—

"Revolution Counters" by Harding, Rhodes & Co., with reciprocating motion, suitable for counting coil turns up to one million and repeat, easily coupled to lathe or winder. Extraordinary bargain, only 21s. each.—St. GEORGE'S MOTORS, 16, Fulham Road, London, S.W.3. 'Phone. Kens. 5441.

Experimental Set.—4-Valve, factory built, separate units. Gives excellent results. Ideal type for experimental work, £13 10s.—D. W. R. RICHARDSON, The Beeches, Saxmundham, Suffolk.

New Brown Amplifier, £4 15s. Also Radio Instruments one-valve note mag., with telephone transformer, £4 15s.—MARLOW, High Street, Noblethorpe, Lincs.

For Sale by Private Treaty, complete experimental reception station, containing 3-valve high frequency set, 3-valve low frequency set and tuner, 3-valve note magnifier, Brown loud speaker, 3 accumulators, complete with set of tuning coils, 200 to 24,000 metres. For further particulars and to view apply H. VICKERS, 75 Charles Street, Shetfield.

Rotary Converter, 120 kilowatt 10 amps 22 volts, gives 3 1/2 amps 35 volts A.C. £3 3s. Transformer, £1 10s. with heavy laminated closed core, giving 2,500 volts.—YOUNG, 23, Holcombe Road, Ilford.

Amateur has Junior Magnavox (New), £8 10s. crystal receiver complete, 25s. Morse clockwork buzzer, variable speed for learner, 37s. 6d. Wanted, Brown speaker, microphone relay.—BENSON, 9, Queen Street, Cardiff.

All Wireless and Electrical Goods stocked at 9, Colonial Avenue. Minorities, near Aldgate Station. Handiest place for City buyers.—LESLIE DIXON & Co. Telephone No. Avenue 4166.

ENGRAVING

for every style of instrument on any material.

F. OSBORNE & CO., LTD.

27, Eastcastle St., Oxford St., London, W.1 Est. 1874. Museum 2264

Table listing various electronic components like Brown's A Type Phones, Crystal Detectors, Morse Keys, etc. with prices.

CARTER & AKROYD, ATKINSON'S COURT, NORTH PARADE, HALIFAX.

EXECUTOR HAS FOR DISPOSAL LATE WIRELESS EXPERIMENTER'S GEAR

Brown's Phones, 120, 20/-, Relay, 70/- Tuners.—Marconi M.39, £7. Sullivan, £5. Marconi Unit 3, 50/- M.3, £11. 2-Valve set, £4. Q Valves, 6/- H.F. Transformer, 25/- Other Gear very cheap to sell quickly.

G. H. WATSON, 78, Kimberley Road, Southsea, Hants.

'PHONES FOR ALL

Let ALL your friends listen in with SULLIVAN HEADPHONES—Double, complete with double adjustable headbands and cords. 120 ohms. Perfect condition. Each pair in box. Supply Per Pair 12 6 Post Free. Limited. 3 Pairs for 35 - Post Free. Prompt Delivery. Send Cash with Order NOW

F. HARRISON, 48, Brooke Road, Walthamstow, E.17

FOR SALE.

10,000 Telephone Receivers, 135 Ohms each. Watch Pattern. Ex War Office, suitable for Crystal Sets without conversion, 20s. doz. Carriage forward or would consider offer to clear the lot.

10,000 1 1/2 M.F. Condensers at 3d. each 5 Tons Admiralty Bronze Aerial Wire, at 25 per cwt. (100' weighs 1 1/2 lbs.).

5 Tons W.O. Bronze Earth Wire, 1/4 gauge, 100 lbs. per mile, 90/- cwt.

Valves. W.O. Pattern by G.E.C., Ediswan, etc., 5/- each, in doz. lots.

Steel Stranded Telephone Wire (7 strands steel 1 strand copper) does for earth wire or for holding, poles or masts, 15/- per mile, drums free. All other sizes. Cable in stock.

Silvertown Relays, £1 each All Galvanometers from 5/- each G.P.O. Pattern.

Double Current Keys, 17/6 each Sounders, 17/8 each

Litholite Insulators as sold by G.E.C., 4/- per doz.

Bobbin Insulators, 9d. doz. Ebonite Blocks, 1/- doz., 3 1/2" x 2" x 1/2"

Leather cases with straps in quantities, 1/- each.

Boxes for Wireless Sets. Wireless Dealers, please note it will pay you to call on

D. S. BURLEIGH, BROWNSWOOD WORKS, G.N.R. YARD, 45, HORNSEY ROAD, HOLLOWAY, N.7.



# THE WIRELESS WORLD EXCHANGE AND MART

## Electradix Radios

Everything for Wireless.

Ebonite, Dynamos & Insulated Wires

- RELAYS, RELAYS, Siemens, Western Electric &c., Complete, 10/6. Small type for remote Control, 2/6. M.C. Weston Relays, 20/- to 2/2.
- RIGID BASKET COILS, set of 7, 200/1,800. 7/6. Three-coil holder for same, 7/6.
- L.R. 'PHONES, 9/- pair. Cords, 2/6.
- MURDOCK VARIABLE CONDENSERS, all sizes.
- WAVEMETERS for Transmission and Reception from 300/3,000, 2/4. 130/9,000, 2/6 10s.
- ANGLE PLOTTERS, in leather case, 8/6.
- TEAK, 13 x 12 x 5 panels, ebonite top, 10/-
- THREE-VALVE AMPLIFIERS, 2/5 10s.
- M.C. MILLI-AMMETERS, 35/-
- LARGE AMMETERS AND VOLTMETERS, 25/-
- AERIAL OUTFIT, 10/- INDOOR, 7/6.

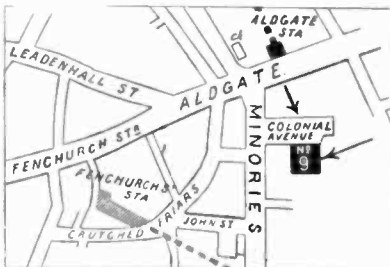

Enormous Variety of Goods.  
Call and see us.

### LESLIE DIXON & CO.

9, Colonial Avenue, Minories, E.1  
Nr. Aldgate Station. Met. Rly.

### SITUATIONS WANTED.

Wireless Petty Officer, 14 years' experience, all types and departments required situation, any capacity.—WILLIAM JAMES, 1A, Trinity Place, Borough, S.E.1.

### TO LET.

TO LET (heart of Charing Cross, where thousands pass daily), our bold window and use of shop (fitted showcases) to firm who can make good display of WIRELESS sets at competitive prices. Aerial fitted. Also dry, clean basement for assembling or storage. Selected firm's sets pushed at our Ashford branch. What offers? HOAD & Co., Electrical Engineers, 36, St. Martin's Court, Charing Cross Road, and Imperial Garage, Ashford, Middlesex.

### BOOKS.

Technical Books.—Second-hand and New Books on every conceivable subject. Catalogue free. State wants. Books sent on approval. Books bought.—FOYLE, 121, 125, Charing Cross Road, London.

### MISCELLANEOUS.

Rectifiers for Charging Accumulators from an alternating supply.—ALUMINIUM RECTIFIERS CO., 28A, Basinghall Street, E.C.2.

Nameplates, engraving of all descriptions.—STILWELL & SONS, Little Park Street, Coventry.

Wireless Inventors.—Patents and Trade Marks Advice. Handbooks and Consultations free.—KING, Regd. Patent Agents, 140A, Queen Victoria Street, London. 'Phone, 682 Central.

Fast Ham, Wanstead, Ifford, Manor Park and Forest Gate. Amateurs should not fail to come to the RADIOPROFESSIONALS, 709, Manor Park Broadway (over Liptons). Club open till 10 p.m. nightly.

Telephone Receivers Rewound, up to 1,000 ohms, 5s.; 2,000 ohms, 7s. 6d. Cash with order.—M. E. HAMPSHIRE, 139, Sydenham Road, S.E.26.

Wireless Insurance Agencies granted to dealers in wireless apparatus and electricians. Apply WIRELESS DEPT. "A," LIVERPOOL MARINE & GENERAL INSURANCE CO., LTD., 7, Angel Court, London, E.C.2. The Pioneers of Wireless Policies.

### IMMEDIATE DELIVERY.

Sheet Ebonite, matt surface, 1" thick. Price per square foot, 8/-. Post free orders of 8/- and over. Any size cut. Terms cash with order.

### CHADWICK,

61, RIPPINGHAM ROAD, WITHERTON,  
MANCHESTER.

### TERRA AURORA OPTICAL CO.,

Instrument Works, 2a, ASHDOWN STREET,  
KENTISH TOWN, N.W.5, are open to manufacture in their up-to-date factory, WIRELESS APPARATUS and parts for the trade on receipt of samples or specifications. Prompt attention, special low prices for large quantities. Phone, Hampstead, 4875.

### PILKINGTON TRANSMITTER CAN NOT PACK

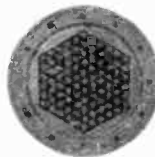

For Wireless or ordinary Telephones. An entirely new principle, having a Definite Resistance, Highly Sensitive, used with any receiver. Functions with less than One Milliampere, Definite Capacity, Long Range. Patents granted in Great Britain and applied for abroad. Small complete transmitters, 7/6. Larger, over 20 M.A., 10/-.

BASIL A. PILKINGTON,  
13, Melville Place, Edinburgh.

### BEGINNER'S GUIDE TO WIRELESS

Explains in plain, everyday language, everything beginners wish to know about Wireless Telegraphy.

### HOW TO ERECT, CONNECT AND MAKE

all the apparatus required for reception of telephony or morse, and full instructions and diagrams for making coils, tuners, and complete valve and crystal sets. 112 pages, price 1/- post free.

### SAXON RADIO CO. (Dept. W.), South Shore, Blackpool.

32 page Catalogue of Wireless Apparatus 2d. post free.

### " WHALE FOR WIRELESS "

- 'PHONES—Brown's, 4,000 or 120 .. .. 30/-
- Brunet, 4,000 .. .. 21/6
- VALVES—"R" Type .. .. 12/6 & 14/-
- or V24 .. .. 15/-
- INSULATORS—Ree .. .. 14d.
- Egg .. .. 3d.
- Coil Mounts, ebonite .. .. 1/8
- Condenser Plates, 24 .. .. 1/-
- Condenser enclosed Vernier .. .. 8/-
- Phonophone nolders .. .. 4/-
- Receiving set complete from 25/- Complete with Aerial Wire, Insulators and pair of Phones, 22 10 0

N.B.—Do away with your crystal or valve detector and fit our PHONOPHONE, 15/- each. Call for demonstration.

### THE WHALE WIRELESS CO.

321, VAUXHALL BRIDGE ROAD, LONDON, S.W.1  
Phone: Victoria 5413. (Victoria)

### WIRELESS PARTS All Parts are supplied Post Free

- Filament Rheostats, Fireproof base, solid resistance former, with two terminals. Best value ever offered, each 4/3
- Filament Rheostats, ebonite base, two terminals .. 3/3
- Switches, single pole, copper contacts, fibre base .. each 2/-
- Switches, double pole, copper contacts, fibre base .. each 3/-
- H.F. Transformers, plug-in type, broadcast 300-500 metres 4/3
- H.T. Batteries, 30-volt units (special offer) .. each 5/-
- Grid Leaks, tubular pattern, 2 meg. with clips .. each 1/6
- Ebonite Knobs, with 2 B.A. brass inset .. 3 for 1/6
- Ebonite Lead-in, ebonite tube, brass conductor, 9" long each 3/-
- Terminals, for panel, 1" x 1 1/2" .. doz. 2/3
- Terminals, small, 1/2" x 1" .. doz. 2/-
- Contact Studs, 1/2" x 1/4" .. doz. 1/-

CASH WITH ORDER. POST FREE.

A. HARTLEY & CO., Wireless Dept. W.  
37, Standish Street, BURNLEY

**BARGAINS FOR THE PANEL**

Are you on the Panel? Then get 9d. for 4d.

British manufacture throughout, cheapest, efficient and Best. All our goods are guaranteed. An extract from our stock:

Aerial Insulators Strainer, 2½" × 1½" approx.	each	6d.
Brass Rod, 2 B.A. and 4 B.A., 12" lengths,	per ft.	5d. and 4d.
Brass Washers, 2 to 5 B.A.	doz.	2½d.
Condenser Plates, 2½" diam. in .022 hard-drawn aluminium	doz. pairs	1/-
Crystal Detectors (none to beat it)	each	3/9
Contact Studs, ½" × ¼", with nut and washer	doz.	10d.
Contact Stops	doz.	1/3
Coil Mounting Plugs, with screw connections	each	1/6
Ebonite Engraved Dials	each	1/6
Ebonite Sheet (the best quality)	lb.	4/6
Grid Leaks, complete	each	2/9
Ivory Scales (engraved)	each	9d.
Ivory Tablets (sets of seven, earth, aerial, phones, etc.)	set	9d.
Knobs, ebonite, 1½" diam.	each	5d.
Tin Foil (free from lead, sheets 26" × 13")	each	4d.
Terminals	from per doz.	1/9
Valve Pins, complete with nut and washer	doz.	1/3
Valve Holders, complete with nut and washers	each	1/3

(And everything else for the panel on the same basis of cost.)

Crystal Sets, "Websonphone" G.P.O. Reg. No. 206.

Six can listen in at one time. Just the set for 30 miles radius of Broadcasting Stations. Write or call for full particulars. Please include ample postage on all orders up to £2, postage paid over this amount.

**SPECIAL TERMS TO THE TRADE.**

28, Deansgate. **JONES'S** The Electrical Depot  
Top Floor, MANCHESTER.

**I want the Earth!**

How often Wireless Amateurs feel like that.

But we only want you to call or write for the Goods we advertise because they are of high quality and we can give IMMEDIATE DELIVERY.

Crystal Detectors, best finish, without crystal	each	2/9
3-Coil Holders, for panel mounting. Fine adjustment, matt finish ebonite, exceptional value	doz.	10/6
Ebonite, cut any size	per lb.	4/-
Hertzite Crystals, very sensitive. We test every piece before selling, and guarantee results.		
Headphones. Brown's lightweight type in stock	each	30/-
Insulators. Egg type	each	2½d.
Aerial Wire, tinned copper, 18-gauge, 100'	2/6	

And every description of wire used in radio work always in stock at correspondingly low prices.

Please remit postage. Balance will be refunded. Satisfaction guaranteed, or cash returned.

Beneath the WIRELESS Flag, at

**The Manchester Radio Supply Stores**  
184, CITY ROAD, MANCHESTER.

PROMPT DELIVERY OF  
**CABINETS, PANELS,**  
**BATTERY BOXES, Etc.**

FOR

**WIRELESS APPARATUS**

From our London Factory  
FURNISHED IN OAK,  
MAHOGANY, ETC.

Upon receipt of sketch with  
dimensions we will immediately  
quote you for any quantity desired.

**HENRY JOSEPH & Co.**  
96, Victoria St., London, S.W.1.

Telephone: VICTORIA 12. Telegrams: JOSKIWOLF, S.W.1, London.

**Modern**  
**Radio Operation**

By J. O. SMITH

Price **10/6** Nett Post free 11/-

**A BOOK of AMERICAN PRACTICE**

List of Chapters.

1. The Radio Telephone.
2. Transmitting Equipment Used in Radio Telephony and Its Operation.
3. Typical High Power Broadcasting Stations.
4. Receiving Equipment for all Purposes and Its Operation.
5. Spark v. Continuous Wave Transmission.
6. Vacuum Tube Fundamentals.
7. Operating Characteristics of Vacuum Tubes.
8. Methods of Obtaining Plate Potentials, and Types of Continuous Wave Transmitters.
9. Continuous Wave Transmission by Amateurs.
10. Tube Transmitters in Commercial Work.
11. Advantages of a Counterpoise Ground in Connection with Tube Transmitters.

150 Pages.

Over 50 Illustrations.

**The Wireless Press, Ltd.**  
12/13, Henrietta St., London, W.C.2

# We Know you'll keep it

**BECAUSE**—The **RADIONETTE** offers the highest efficiency with a specification and equipment second to none, and therefore we will send it to you for a **SEVEN DAYS FREE TRIAL IN YOUR OWN HOME**. If you are not satisfied return it and we will refund your money.



## 'TIS RESULTS THAT MATTER!

THE **RADIONETTE** GUARANTEES MAXIMUM RESULTS IRRESPECTIVE OF PRICE AT MINIMUM COST, AND INCLUDES PAIR OF **SIEMENS 4,000 OHM HEADPHONES**, TWO **CRYSTOR AERIAL INSULATORS**, 100 ft. Copper Aerial Wire.

———— YOU "LISTEN IN" at ONCE! NO EXTRAS. ————

———— PRICE, **£3 : 10 : 0** inclusive of B.B.C. DUTY. ————

**Stocked by all Leading Wireless Stores Everywhere**

SOLE DISTRIBUTING AGENTS :

# WIRELESS AGENCIES, Ltd.

64, Mortimer Street, London, W.1.

\* Phone—MUSEUM 2672.

\* Grams—Adragonax, Wesdo, London.



## THE LEADING MAIL ORDER HOUSE FOR WIRELESS ENTHUSIASTS

We have organised a Mail Order section to cater particularly for the requirements of Wireless Amateurs and Experimenters throughout the country. We hold large stocks of complete sets, spares and accessories of all well-known and reliable makes. Our policy is to obtain samples of anything that may interest the amateur, test it thoroughly at our laboratories, and if reliable and reasonable in price purchase a large stock for offer to our customers.

If there is anything worth buying on the market we can offer it to you. If you select all your apparatus and parts from our catalogue you know that you are buying reliable goods on best terms. Should any article purchased from us prove to be in any way defective or fail to give the performance we claim for it, we will either replace it or accept return with full refund of purchase price.

### A SPECIAL OFFER

We have just received a consignment of Head Telephones of improved design which we are placing on the market AT COST PRICE. These Adjustable Diaphragm phones give better articulation results and can be adjusted for a higher degree of sensitiveness than others now on the market at double the price. See the illustration, read the specification, and send us your order at once. WE HAVE A LIMITED NUMBER AND CANNOT REPEAT THE OFFER.

### SPECIFICATION.



Headbands of best quality polished horn slotted for length adjustment of earpieces. Vulcanite earpieces large and specially shaped for comfortable fitting to which is screwed a threaded metal ring supporting diaphragm.

Earpiece cases are highly nickel plated and contain a patented device for fine adjustment of the diaphragm spacing; this adjustment when made can be locked. Total resistance of windings 3,000 ohms. Leads are run through an ebonite collet to an insulated terminal block inside the earpiece casing.

Earpieces are fixed to headbands by means of robust metal strip forming a socket at lower end to move on a universal ball joint.

Cords four feet long with tags bound red and black to indicate polarity.

PRICE 30/9 POST FREE.

ASK FOR OUR CATALOGUE AND PLACE YOUR NAME ON OUR LIST.

## LONDON RADIO COLLEGE, LIMITED

Mail Order Dept., "Stafford House" 82-83, High Street, Brentford, Mx.

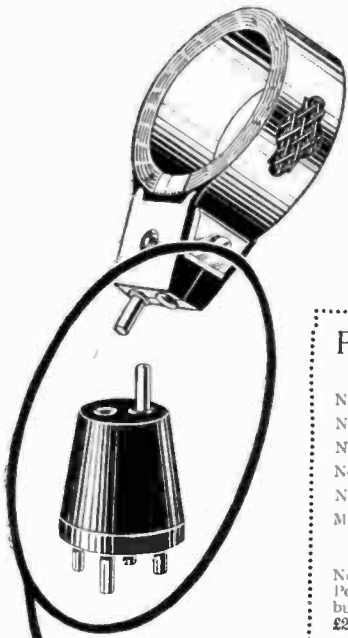
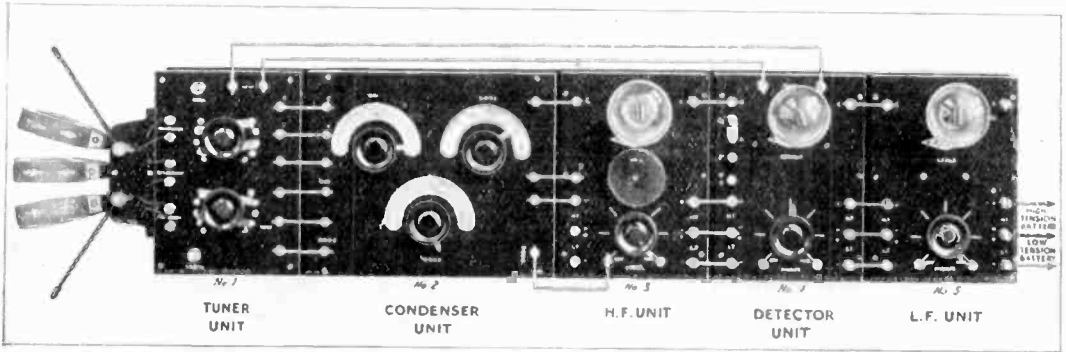

# Those who know use the tuned Anode Circuit —and here's a way to use it without altering your set

PRICE LIST OF SETS OF PARTS	
No. 1 Tuner Unit . . .	27/6
No. 2 Condenser Unit . . .	42/-
No. 3 H.F. Amp. Unit . . .	13/6
No. 4 Detector Unit . . .	17/6
No. 5 L.F. Amp. Unit . . .	33/6
Mahogany Cabinets to fit Nos. 1, 2, 3, 4 and 5 . . . . . each	3/6
No. 2 . . . . .	7/-
Postage 9d. per unit extra, but paid on all orders over £2.	
TUNODE Plug, each	3/6
Honeycomb Coils (see Catalogue).	
32 page Illustrated Catalogue Post free, 3d.	

For effective high-frequency amplification there is nothing better than a tuned anode circuit in preference to the use of a H.F. Transformer. But many who would use it do not because it involves re-wiring the Set.

Here is the Peto-Scott solution of the difficulty—use the "TUNODE" Plug and any standard Honeycomb Coil (correct values are quickly found by trial). Plug in the "TUNODE" in place of the H.F. Transformer and all the connections are made—it is simplicity itself.

Of course, the Peto-Scott Unit System provides the experimenter with the only sensible method of adding as many Valves to his Set at the minimum of expense and without discarding any of his present apparatus.

For a more detailed account of this well-thought-out System, send 6d. for a copy of "Radio," a 24-page Booklet describing how each Unit is constructed.

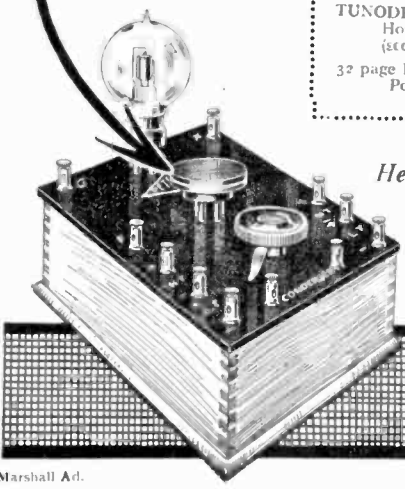

Head Offices & Showrooms:

64 HIGH HOLBORN, W.C.1

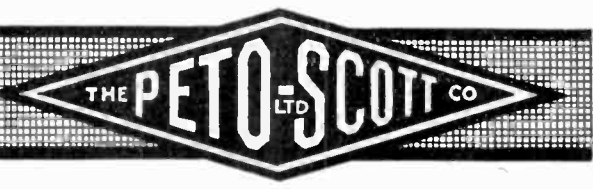



**'PHONES**  
**NEW ARMY**

for Crystal or Valve Sets, without Transformer, 10/- Double Cord, extra Postage 9d.

500 Western Electric Light-weight Phones, 3,000 ohms, special price, 30/- pr.

**THE BARGAIN HOUSE FOR ACCESSORIES. SEND FOR OUR COMPLETE LIST.**

Aerial Wire, 7/22 copper, 100', 2/11. Postage 9d. Lead-in Wire, 50', 2/- Postage 6d.

Rubber Covered Flex (copper), 50', 2/- Postage 6d.

Interval Transformers Army, 12/6. Postage 4d.

Condenser Vanes, doz. prs., 9/6. Postage 2d.

Broadcast Coils for sliders, 2/6. Postage 6d.

Sliders, ebonite, with plunger, 4d. Postage, 1d.

**CAMBRIAN NO. 1.** Crystal Set polished mahogany case, ebonite panel.

Reg. No. 357. Our own manufacture, 25/- B.B.C. Licence extra, 7/8. Postage 1 6.

Volt and ammeter combined watch patt., special purchase, 8 6. Postage 3d.

As illustration, 8,000 ohms, 22 6. Postage 9d.

Brass Rod, drilled, 1', 13" square, 4d. Postage 2d.

Coil-Holders, 2-way, 7/6. Postage 3d.

Detectors, Crystal, complete, 2/9. Postage 3d.

**CAMBRIAN NO. 6.** Single Valve Low Frequency Amplifier, to use with crystal set. Reg. No 3124.

£2 2s. B.B.C. Licence extra, £1. Postage 1 6. Our own manufacture.

**PUGH Bros.,** 95/101, Holloway Road, London, N.7

*The*  
**Bowyer - Lowe**  
**Variometer**  
*for*  
**Fine Tuning**



The Bowyer-Lowe Variometer is so constructed that when connected to the standard amateur aerial it will tune satisfactorily over the whole broadcast band. It is strongly made with ebonite formers and heavy gauge wire so that the resistance is reduced to a minimum. The design of this Variometer is such that panel mounting is very simple, only three holes in the panel being required. Supplied complete with high-grade knob, 3 in. graduated dial and screws for mounting.

**£ 1 : 2 : 6**

Postage 9d.

Complete set of parts for above, 15/- Postage 9d.

Stocked by A. W. GAMAGE, LTD., Holborn, E.C.1, and R. MELHUIS, LTD., Fetter Lane, E.C.4.

Trade Inquiries Invited.



G.P.O. Box No. 519.

**OUR**  
**Single**  
**Valve**  
**Panel**  
**at**



**84/-**

Gives remarkably good results.

Broadcasting fee extra, 20/-.

Marconi Osram "R" Type Valve, 17/6.

Pair of Double Head Receivers, 4000 ohms, 6 volt 40 amp. Accumulator and 80 volt H.T. Battery, £4 15s.

Full particulars together with other sizes will be found in our Clarophon pamphlet post free on request.

Readers contemplating the purchase of a complete Wireless Instrument should write for our interesting illustrated booklet, "The Charm of Wireless."



The quality of your Reception is determined by the Quality of your Set—Use Bowyer-Lowe Parts. Everything supplied.

**The Bowyer-Lowe Co. Ltd.**

Manufacturers and Suppliers of High-grade Wireless and Scientific Instruments.

Members of the British Broadcasting Company.

**The Radio Works,**  
**Commerce Avenue,**  
**Letchworth, Herts.**

Telephone: Letchworth 246.

Telegrams: "Bowyer-Lowe Co., Letchworth."

# STEVENS'S AUCTION ROOMS Ltd.

(Established 1760)

38, King Street, Covent Garden, London, W.C.2

## A Great Sale by Auction of Ex-Government Wireless Apparatus

INCLUDING

C.W. Mark III 3-valve Amplifiers, Mark III\* Short Wave Tuners, B. Mark II 2-valve Receiving Sets, B. Mark I 2-valve Detector Amplifiers, 50 Watt Transmitting and Receiving Sets, 60 Watt Transmitters, Loud Speakers, Wave Meters, Variable Condensers, Brown's Reed Type Telephones, 120, 1,500 and 8,000 ohms. Buzzers, Voltmeters, 15 ft. Mast and a large quantity of Miscellaneous Wireless Apparatus Specially catalogued in lots to appeal to Amateurs

will be held at the above address on  
**WEDNESDAY, 21st FEBRUARY, 1923 at 12.30 o'clock**

Catalogues Free on Application.

Telephone: Gerrard 1824.

Telegrams: Auks, Rand, London.

## Accessories of QUALITY at Competitive Prices

CONDENSERS, FIXED. All capacities .. .. .				1/6	
CONDENSERS, VARIABLE—					
Capacity.	No. Plates.	Parts.	Panel assembled.		
.001	57	8/6	15/-		
.00075	43	5/6	12/6		
.0005	29	4/6	11/8		
.0003	19	3/-	9/-		
.0002	13	2/3	7/-		
.0001	7	2/-	5/-		
Vernier	3	1/6	4/-		
Drilled ebonite end plates per pair				1/-	
CRYSTALS, Bornite, Carborundum, Galena, 4d. a box.					
CONTACT STUDS, with nut and washer .. .. .			per doz.	7d.	
COILS, SLAB. 7/6 set of eight. Range 300 to 30,000 metres.					
COIL HOLDERS, for above coils—Two-way with holders			10/-		
EBONITE SHEET .. .. .			per lb.	3/6	
FILAMENT RESISTANCES. Smooth action, positive contact .. .. .			each	2/6	
GRID LEAK AND CONDENSER. First quality only, we do not sell a cheap line .. .. .				each	3/-
HEADPHONES. 4,000 ohms. (Clear as a bell. French or British make .. .. .)				£1 1/-	
SWITCHES. Knife. S.P.S.T., 1 1/-.				S.P.D.T., 1/6.	
D.P.S.T., 2/-.				D.P.D.T., 2/6.	
TRANSFORMERS. L.F. Intervalve, 15/-.			Telephone	13/6	
VALVE HOLDERS. First quality, 1/3. Second quality, 1/-.				Third quality, 9d.	

Orders over £1 post paid. Under, please include ample postage.

## HALL & BREARD

DISTRIBUTORS OF RADIO ESSENTIALS.  
10, MANOR GARDENS, PURLEY, SURREY.

All post orders: (DEPT. W.) Tel.: CROYDON 975.

## The VOICE at 2LO

You hear the "Voice," shall we send you a "speaking" likeness of "it"?

Unmounted cabinet size silver prints of Mr. Arthur R. Burrows' photograph are for sale.

Only a limited number is available, so hurry up and send 9d., and a copy will be sent by return of post.

The Wireless Press, Ltd.  
12-13, HENRIETTA ST., LONDON, W.C.2

# AT LAST!

## A PERFECT LOUD SPEAKER

### AT A MODERATE PRICE



THIS loud speaker is manufactured for us by Siemen Bros., whose name appears on every instrument as a guarantee of efficiency.

It is made throughout from a specially prepared and tested alloy—hence there is no resonance or gramophone effect, the sound reproduced being of pure tonal quality and in no way distorted.

Diameter of trumpet at base  $5\frac{3}{4}$  ins.  
Height „ „ „  $18\frac{1}{2}$  ins.

Every loud speaker fitted with diaphragm regulator.

#### Complete Prices :

4,000 ohms £3 5 0

2,000 ohms £3 2 6

Recognised as THE perfect loud speaker.

WE STOCK SIEMEN PHONES, EDISWAN VALVES, ETC. MAKERS' FULL DISCOUNTS.

## WIRELESS INSTALLATIONS Ltd.

NOTE NEW ADDRESS :

81, TURNMILL STREET, E.C.

## *The Perfect Loud Speaker at Last !*

We have acquired the sole manufacturing rights for the United Kingdom of a Wonderful New Loud Speaker, in principle entirely different to any yet placed on the market. Instead of the unsightly horn which causes distortion of the music and speech, this instrument comprises a handsome cabinet, the top of which is so designed and manufactured from specially tested timber, which is attacked by a volume of air. The principle can be incorporated into any cabinet wireless set, the lid of the cabinet forming the Loud Speaker. It can also be used as a separate instrument as illustrated.

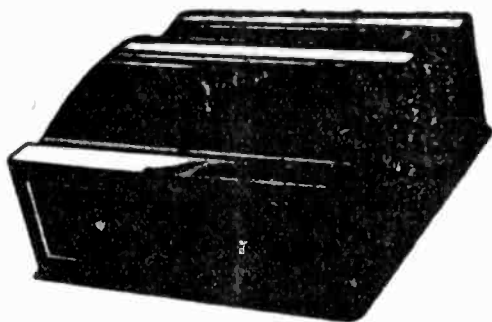

The  
**“VIOLINA”**  
 LOUD SPEAKER DE LUXE.

Patented in all countries throughout the world.

PRICE

**£5 : 5 : 0** Complete

(Packing and Carriage in U.K. 5/- extra)

When once you have heard this instrument, you will not tolerate any other make. Ask your wireless dealer for a demonstration.

*It is not like a Trombone ! It is not like a Klaxon !! It is as delightful as a Violin!!!*

With this instrument you can hear the voice of the artist, the note of any instrument and the words of the speaker faithfully and perfectly reproduced.

In addition it is an elegant piece of furniture, handsomely French polished, mahogany finished.

Before buying your Loud Speaker make a point of hearing this instrument. Agents wanted in all parts. Enquiries from Manufacturers desirous of incorporating the “Violina” into existing wireless sets cordially invited.

**IF EARLY DELIVERY IS DESIRED, PLACE YOUR ORDER AT ONCE.**

**READ THIS TESTIMONIAL, TYPICAL OF HUNDREDS RECEIVED.**

GATESHEAD.

Dear Sirs,

Many thanks for set (5 valve R.A.F. 10) to hand and also Loud Speaker. This is “the goods” and the finest Loud Speaker in the world. I have tried all makes and I am in a position to know. I am a telephone engineer to trade and can truthfully state it to be the finest and clearest in the world and cheap at twice its price.

Yours truly, A. I. S.

**IMPORTANT NOTICE.**

A FEW WEEKS AGO, we advertised the purchase of a complete Government Wireless Depot, and offered the same for re-sale at astonishingly low prices in accordance with our invariable business rule to **SHARE OUR BARGAINS WITH OUR CUSTOMERS.**

The immediate response to our advertisement resulted in our being “snowed under” with enquiries and orders from all over the country, and it was only through despatch staffs working night and day at full pressure that we were able to keep faith with our customers in respect of our promise to execute all orders **WITHIN 48 HOURS OF RECEIPT.**

It was impossible to deal with the thousands of enquiries as expeditiously as we should have wished, and we again take the opportunity of tending our apologies to all those who unfortunately were kept waiting.

We have now purchased, outright for spot cash, the whole of the Wireless Material recently offered for sale at **WOOLWICH DOCKYARD AND KIDBROOKE R.A.F. DEPOT.**

The work entailed in compiling price-lists of the multitudinous variety is colossal, and it will be two or three weeks before these are available. You can help us considerably by FILLING IN THE FORM AT THE FOOT OF THE OPPOSITE PAGE.

You will then RECEIVE COMPLETE LISTS AS SOON AS AVAILABLE.

**The City Accumulator Co.**  
 79, MARK LANE, E.C.

'Phone: Avenue 1316.

# SOME STARTLING OFFERS

Complete 5 Valve Set, 2 H.F., 1 Detector and 2 L.F. The famous R.A.F. 10 made by the General Electric Co., U.S.A., for the Royal Air Force.

Ideal for Broadcasting. Can be used with Loud Speaker with indoor aerial, within 20 miles of the Broadcasting Station. We guarantee this instrument to be more effective than any instrument costing up to £75.

Brand New, exactly as received from the manufacturers

## Our Price £15-0-0

(Limited quantity only).

Valves and Accessories extra. Fuller particulars on application.

**RECEIVERS C.W. MARK III.**—This set comprises a complete two-valve receiving set with a wavelength range of 350-1,800 metres. The addition of high and low tension batteries, valves and 'phones, completes the entire receiving station. For the reception of broadcast concerts this set is ideal, the strength and clarity of the signals being absolutely wonderful ... .. £9 9 0

Complete with 4-volt 40-amp. Fuller block accumulator, 60-volt H.T. battery, 2 valves, and pair of Brown "A" Type headphones, complete with cords ... £15 10 0

**C.W. TRANSMITTERS, MARK III, 30 WATT.**—Complete with aerial ammeter, platinum-pointed Morse key, in mahogany case. One valve: wavelength 350-1,400 metres; Two valves; wavelength 700-2,000 metres. (For transmission of telephony all that is required is to remove ammeter and insert microphone) ... £3 5 0

NOTE.—These instruments can be easily altered to any desired wavelength.

**MARK III\* S.W. TUNERS.**—Wavelength 50-700 metres. Ideal for broadcasting. Being sold elsewhere at £10. Complete with one pair of Sullivan 8,000 ohm 'phones and cords. Limited number only ... .. £8 0 0

**FILL UP THIS FORM NOW**  
and post to us immediately; 1/4 stamp only required.

**Messrs. THE CITY ACCUMULATOR CO.**  
Mail Order Department, 79, MARK LANE, LONDON, E.C.3  
*Please include my name on your Mailing List. I am particularly interested in*

.....

.....

(Signed).....

Full Postal Address.....

.....

w.w. Date.....19.....



**HOW TO MAKE A SIMPLE BROADCAST RECEIVER USING A CRYSTAL DETECTOR**

**A SIMPLE BROADCAST RECEIVER**

**A Two Valve Broadcast Receiver**

**Some**

## The Constructional —No. 1 runs

Successive reprints have brought the sale of No. 1 of *Modern Wireless* up to the huge total of 100,000 copies. Even at this figure, it is quite possible that those who delayed buying a copy until the last moment will be disappointed. Those who have been privileged to see the Contents of No. 2, say that it is even better than No. 1. At this stage we cannot publish its contents, but we can say that the constructional articles are a very strong feature.

- A large map of Europe showing wireless stations is presented free with No. 2.

As before, no constructional articles are published until the actual instruments

# MODERN

## THE GREAT NEW WIRELESS



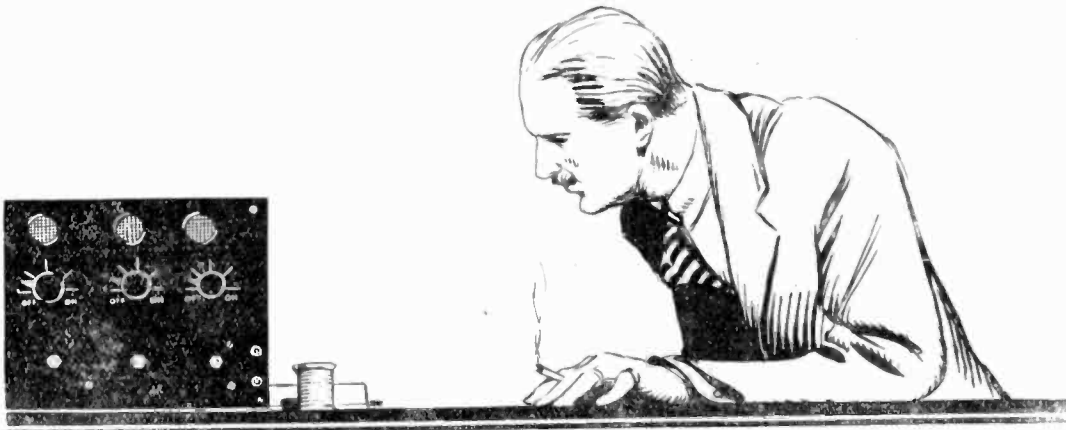

**Articles in No. 2 are even better to an edition of 100,000 copies**

they purport to describe have been **made and tested** — readers can appreciate the importance of this fact.

Here are some of the How-to-make Articles from No. 1.

- A two-valve Broadcast Receiver.
- A simple Crystal Broadcast Receiver.
- A Receiver with a range of 4,000 miles.
- A Valve Panel.
- A Low Frequency Amplifier.
- A Grid Leak.
- A simple Telephone Transmitter.
- A Winder for Honeycomb Coils.

*Modern Wireless* is edited by John Scott-Taggart, F.Inst.P., assisted by Paul D. Tyers and E. Redpath. It is published by

**RADIO PRESS, LTD.**  
Devereux Court : STRAND, W.C.2

To avoid being disappointed place your order for No. 2 **TO-DAY**

Please { deliver No.2 and successive numbers of **MODERN WIRELESS** until order countermanded.  
Name .....  
Address .....

**WIRELESS** 1/-  
MONTHLY MAGAZINE.

No. 2 out Feb. 26th instead of Feb. 15th



*Want to pick up  
American Concerts?*

—this book gives full working details of suitable circuits

**CONTENTS**

1. Crystal Detector Circuits.
2. Single Valve Circuits.
3. Two-valve Circuits.
4. Three-valve Circuits.
5. Four-valve Circuits.
6. Five-valve Circuits.
7. Local Oscillators for Heterodyne Reception of C.W.
8. Valve Transmitter and Radiophone Circuits.

**2/6**

2/6 from all book-sellers or 2/8 post free from the Publishers.

To receive American Broadcasting with any degree of certainty, you must use at least one H.F. Valve.

The wide choice of Circuits embodying H.F. Amplification is apt to present a difficulty to the man constructing his own Set. It is to assist him that we have published this new book by John Scott Taggart, F.Inst.P., Editor of "Modern Wireless," and the well known authority on the Thermionic Valve. In it details are given of only the most successful Circuits—and so that it shall be as helpful as possible, typical Condenser and Resistance Values are given

**Practical Wireless  
Valve Circuits**

is the Book you need if you are thinking of building or improving your own Set. Over 60 different tested Circuits are shown. Get a copy to-day—you'll need it often for reference.

**Radio Press, Ltd**  
PUBLISHERS OF AUTHORITATIVE WIRELESS LITERATURE  
DEVEREUX COURT, STRAND, W.C. 2.

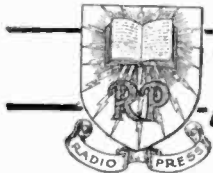

*Your guarantee of dependable information*

MARSHALL AD-

## The Calculation & Measurement of Inductance & Capacity

By W. H. NOTTAGE, B.Sc.

PRICE 3/6 NETT.

POST FREE 3/11

Wireless Experimenters will find this book particularly interesting, the more generally useful formulæ and methods of calculation being brought together in a convenient form.

*CONTENTS*—*Calculation of Inductance ; Calculation of Capacity ; Measurement of Inductance ; Measurement of Capacity ; High Frequency Measurements ; Appliances for use in measuring Inductance and Capacity ; Tables.*

SEND FOR OUR CATALOGUE OF 65 BOOKS ON WIRELESS

## A Short Course in Elementary Mathematics

*And their application to Wireless Telegraphy*

By S. J. WILLIS

PRICE 5/- NETT.

POST FREE 5/5

The author has concentrated on the points of his subject which have an immediate application in Wireless Telegraphy, thereby rendering the book well suited to the requirements of Radio workers.

*CONTENTS*—*Logarithms ; Geometry ; Algebra ; Trigonometry ; Vectors ; Use of Squared Paper ; Solutions to Examples ; Useful Constants ; Tables.*

**THE WIRELESS PRESS, LIMITED**  
12-13, HENRIETTA STREET, STRAND, LONDON, W.C.2

# U.S.A. BROADCASTING in CARNARVON

*First Attempt! Perfect Reception!*

## THE L.F. TRANSFORMER

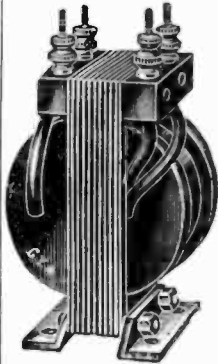

L.F. TRANSFORMER

is of our own well known manufacture with Core of Stalloy and correctly designed to give maximum amplification. Price **20/- each** INSIST on having "AUCKLAND" TRANSFORMERS.

Carnarvon, N. WALES,

*It may be of interest to you to know that recently, while "Listening-In" after midnight, we picked up clear speech and music from an American Broadcasting Station. All the panels (3) (1 H.F., 1 Dect., 1 L.F.) were made up entirely of parts supplied by you, including the H.F. and L.F. Transformers. Our aerial being a poor one we have to rely on the good design of our units for results, which adds credit to the design of your transformers, etc. This was the first and only occasion we have listened for U.S.A. Broadcasting.*

*Yours faithfully,*



### Pin Type H.F.

- 1. 150-600 - 5/-
- 2. 380-800 - 6/-
- 3. 570-1,300 - 6/6
- 4. 1,000-2,175 - 7/-
- 5. 1,600-3,200 - 7/6

## THE H.F. TRANSFORMER

These Transformers allow Critical Tuning which is necessary for the Reception of U.S.A. Broadcasting

used was our Pin Type interchangeable pattern, tuned with a small condenser.



Price : 7/6

### Crystal Reception of Broadcast Music is Perfect Reproduction.

Illustrated is our Universal Adjustment Detector, Fitted with 2 Crystals, finished as a High Class Instrument, mounted.

### Spade Terminals

PER DOZ.  
2 sizes :

4d.

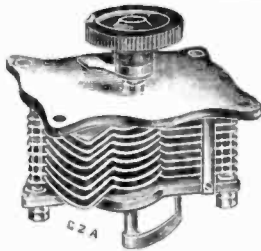

### THE MOST RIGID CONDENSER ON THE MARKET.

Fitted with Aluminium Top & Bottom Plates. Vane Spacing .072"

- .001 .. .. 24/-
- .005 .. .. 18/-
- .003 .. .. 16/-
- .002 .. .. 15/-

Limehurst,  
Sale, nr. Manchester.

Dear Sirs,

*I should like to say how pleased I am with your Precision Condensers illustrated on page 8 of your Catalogue, and I have not come across any better at the price, the nearest being the Mark III made to Government specification regardless of cost.*

*I cannot understand why you keep them in the background.*

*Yours truly,*  
\_\_\_\_\_(Signed)



### POTENTIOMETERS.

Useful for Grid Potential Crystal work, etc., etc. Typical of all Auckland Products. Finished Instrument style.

PRICE (as Illustrated)

**8/6**

SEE ALSO  
BACK PAGE



**G. Z. AUCKLAND & SON, 395, St. John Street, E.C.1.** LONDON OFFICES:  
Factories—ISLINGTON, N. WIRELESS INSTRUMENT MAKERS. Phone : - - 3173 CLERKENWELL.

WRITE  
FOR

OUR  
CATALOGUE

# WIRELESS TELEGRAPHY AND TELEPHONY

FIRST PRINCIPLES, PRESENT PRACTICE AND TESTING

By

H. M. DOWSETT, M.I.E.E.

Price **9**|-net. 331 Pages Post free **9**/**9**

*305 diagrams and illustrations.*

This book was written with a view to its acting as a connecting link between the elementary textbook and the advanced treatise or the specialised textbook.

It has behind it the long standing reputation of The Wireless Press, Ltd., and can be thoroughly relied upon.

### CONTENTS :

The Nature of Electricity and of the Atom—On Phase Displacement Effects in Elementary Circuits—The Spark Discharge—Continuous Wave Transmitters—Thermo-Ionic Effects and Oscillation Valve Phenomena—The Special Apparatus used for High-Speed Transmission and Reception—The Measurement of Electric Current and of Electro Motive Force—The Measurement of Resistance—The Measurement of Capacity—The Measurement of Inductance—The Measurement of Frequency—The Measurement of Dielectric Strength—The Measurement of Decrement—The Measurement of the Direction, and the Distance of Transmitting Stations, and the Intensity of Received Signals.

**THE WIRELESS PRESS, LTD.**

THE PIONEER HOUSE FOR WIRELESS PUBLICATIONS

12 - 13, Henrietta Street, ——— London, W.C.2

OF  
**65**

WIRELESS  
BOOKS

We claimed  
**BIG THINGS**  
 for the  
**CONQUEST**  
 2-VALVE RECEIVER

described in the last  
 number (January) and  
 readers' results have  
**FULLY JUSTIFIED**  
 our claim.

Price

**1/-**

Monthly

Post

**1/3**

Free

Read the FEBRUARY number of

# CONQUEST

for FULL CONSTRUCTIONAL DETAILS

of a

## 2-Valve Note Magnifier

It is extremely simple and easy to make.  
 No switches. No elaborate wiring.  
 It can be used as a ONE or TWO  
 valve magnifier.

**CAN BE ATTACHED  
 TO ANY EXISTING  
 RECEIVER WHETHER  
 CRYSTAL OR VALVE**

thus enabling a Loud Speaker  
 to be used.

Every detail of the  
 apparatus described in  
**CONQUEST**  
 is fully tested and  
 tried out.

There is no fear of  
**CONQUEST**  
 sets not working satis-  
 factorily, provided you  
 follow the very simple  
 instructions.

12-13,  
 Henrietta  
 Street,

Strand,  
 London,  
 W.C.2.

# THE ONLY BOOK GIVING FULL DETAILS ON THIS SUBJECT

IS

## Direction

AND

## Position Finding

BY

## Wireless

BY

R. KEEN, B.Eng. (Hons.) Sheffield.  
 A.M.I.C.E.

363 pages, 254 Photographs & Diagrams.

PRICE **9/-** NETT.

(Postage 9d.)

This book deals not only with the principles of the subject but with the constructional details of direction finding installations. It describes the principles of Direction and Position Finding in this country in such a way that the subject may be grasped easily by engineers tackling this field of wireless work for the first time.

### CONTENTS :

Introduction ; Theory of the Wireless Direction Finder ; Valve Amplifiers and Detectors ; Maps ; Position Finding ; Night Effect and other Freak Phenomena ; The Shore D.F. Station ; The Ship D.F. Station ; Aircraft D.F. Station ; Fault Clearing and Maintenance ; Notes on Field and Nautical Astronomy ; Bibliography.

**The Wireless Press, Ltd.,**

Dept. W.W.

12/13, HENRIETTA ST., LONDON, W.C.2

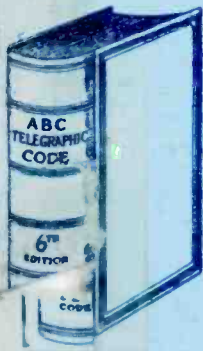

AN ENTIRELY NEW WORK.  
**The ABC Telegraphic CODE 6th Edition**

FIVE-LETTER CODE.

An up-to-date Work, containing Five-letter Artificial Code Words with at least a TWO-letter difference and a **TERMINAL-INDEX** of the words at the end of the Book.

Cost of Cabling Brought to a Minimum :: Simple to use.

PRICE **£3 3s. 0d.** net (U.K. and Colonies.)

Inland Parcel Postage **1/6** per copy. Continental Book Post **2/-** per copy.

Publishers—

**EDEN FISHER & CO., LTD.,** 6, 7 & 8, Clements Lane, E.C.4  
 And 95, 96 & 97, Fenchurch Street, London, E.C.3.

**STOCKS**

FOR IMMEDIATE DELIVERY OF

**EBONITE SHEET**

AND

**PANELS**

**RADIO EBONITE SUPPLIES, LTD.,**

4 LITTLE COLLEGE STREET, LONDON, E.C.4  
 'Pho—Central 4839. (1 min. Cannon Street Station)

**THE TURNEY AUTOMATIC MORSE BUZZER**

(Prov. Patent 22768.)

is the easiest and most fascinating means of mastering the code. By simply turning a small handle a travelling tape connects two 4½ volt dry batteries with a loud buzzer. This tape is set to transmit the sounds in Morse for the alphabet, figures, signs, calls, etc., at a slow rate of speed for learners, but can be re-set by the operator to his own message at any speed, thus making same invaluable for practice for all stages of tuition.

Price complete **30/-** post free.

**TURNBULL BROS.,** 28, COWPER STREET, LEEDS

**WIRELESS — SPARE PARTS**

THE WILKINSON SWORD CO., LTD., are manufacturing at their Works, Southfield Road, Acton, various parts for Wireless Apparatus, and are prepared to quote for large contracts.

Orders and enquiries to :

**The Wilkinson Sword Company, Ltd.**

Oakley Works, Southfield Road, Acton Green, London, W.4.

Registered "NIPHAN" Trade Mark.

**WATER-TIGHT PLUGS**  
**and CABLE COUPLINGS**  
 TO MEET HOME OFFICE REQUIREMENTS



COUPLING CONNECTING CABLES

Phones :  
 2600 Gerrard 12061 Central.

Telegrams :  
 "Nippon, London."

As used by H.M. War Office, Electric Supply Companies,

Railway Companies, Marconi's Wireless Telegraph Company

**SIMMONDS BROS., LTD.**

4, 6 & 8, NEWTON STREET, HOLBORN, W.C.



SIX WAY TEE CONNECTORS

Patented in England and Abroad.

# AUCKLAND'S



Typical Example of Our Receivers, comprising 4 valves, 1 H.F., 1 Rect. and 2 L.F. the H.F. is our well-known Pin Type interchangeable. A most suitable set for all European and many foreign long-distance stations.

Complete: 4 valves, 16 tuning coils, H.T. Batt., L.T. Batt., telephones, set of H.F. Transformers and necessary aerial equipment, ready for use, **£40**

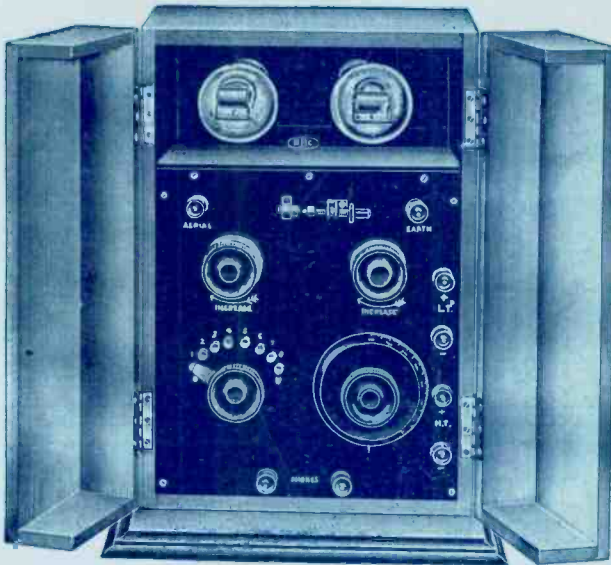

Broadcast Receiver '0222, for Cardiff, Birmingham, Newcastle, Manchester or London. Crystal rectifying, and 2 valve amplifying. In these districts a loud speaker can be used with this set. With all accessories, and royalties paid **£21**



## VALVE AMPLIFIERS

1 Valve	£3 5 0
2 ..	£5 12 6
3 ..	£7 10 0

These prices are without valves but **INCLUDE ALL ROYALTIES**

**COMPARE THE PRICES.**

**G. Z. AUCKLAND & SON, 395, St. John Street, E.C.1**

Factories—ISLINGTON, N.

WIRELESS INSTRUMENT MAKERS.

LONDON OFFICES:

395, St. John Street, E.C.1

\*Phone: 8173 CLERKENWELL





# WIRELESS WORLD

AND

# RADIO REVIEW

No. 184. [ VOL. XI. ]

24th FEBRUARY, 1923.

Registered at the G.P.O. as a Weekly Newspaper.

*Doing away with the aerial*

When there is electric light, an aerial is unnecessary. Plug a "Ducon" into an ordinary lamp holder or wall socket; connect to the wireless receiver and you will receive the broadcasting perfectly. The "Ducon" gives satisfactory results with all types of receivers, from crystal to multi-valve.

Dealers not yet stocking are invited to write for trade terms. Obtainable from all leading wireless dealers, electrical contractors and stores or direct from the makers.

Over 50,000 in use.

## DUCON 10%

The DUBILIER CONDENSER Co. (1921) Ltd.

Ducon Works, Goldhawk Road.  
SHEPHERD'S BUSH, LONDON, W.12  
Telephone .. .. Hammersmith 1084.  
Telegrams .. .. "Hivolcon. Phone. London."



# THE WORLD'S FINEST LOUD SPEAKER

## “Magnavox”



The Reproducer with a big voice  
“Radio brings it Magnavox tells it”

To be obtained from all dealers or direct from the  
Manufacturers and Sole Licensees :

**STERLING TELEPHONE & ELECTRIC CO., LTD.,**  
**210/212, TOTTENHAM COURT ROAD, LONDON, W.1**

Telephone No. : 4144 Museum (7 lines).      Telegrams : “Cucumis, Wesdo, London.”      Works—DAGENHAM, ESSEX  
Branches—NEWCASTLE-ON-TYNE, 9 Clavering Place;      CARDIFF, 8, Park Place;      MANCHESTER, 14, St. Peter's Square  
We guarantee that all Broadcast Radio Apparatus sold by us conform with the conditions of the Broadcaster's Licence issued by  
the Postmaster-General.

# VULCANIZED FIBRE

**SHEETS**  
(010 - 2")

**RODS**  
(1/8 - 2")

**TUBES**  
(1/8 - 4")

PANELS, CONDENSER TOPS.  
KNOBS, INSULATING BUSHES,  
TRANSFORMER BOBBINS,  
SWITCH & TRANSFORMER BASES,  
FIL.RES. FORMERS, WASHERS,  
TUBES FOR INDUCTANCES etc.

THE MANUFACTURERS.

**DIAMOND FIBRE CO. LTD.**

WORKS:  
MAIDSTONE, KENT.

HIGH ROAD  
SOUTH TOTTENHAM, N.15.



G.P.O. Regd.  
No. 0177

Each instrument  
individually certified  
& guaranteed.

# H.P.R. HILOPHONE

## The Ideal 3-Valve Instrument for Music and Telephony

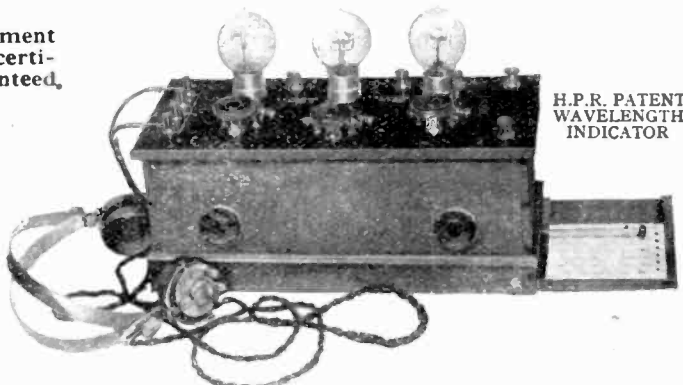

*The following is an extract from a letter received from the North of Scotland Wireless Co.,  
13, Bridge Street, Aberdeen :*

"Yesterday evening with the HILOPHONE 3-Valve Set we picked up London in Ballater, forty-two miles from Aberdeen, and had the concert loudly and clearly. We added a Simplex Magnifier (Single Low Frequency) and put London on a Loud Speaker, filling the room. This is certainly the best result we have ever had with a Broadcast Receiver, and we were most pleased with the absence of extraneous noises and the clearness of the speech and music, over five hundred miles away."

Range of Wavelengths 300 to about 1,000 metres, covering all British Broadcasting transmissions—ship and coast stations (spark and C.W.)—aeroplane telephony. Readily tuned to incoming wavelength by the H.P.R. Patent Wavelength Indicator. The patent H.P.R. tuned high frequency coupling inductances, combined with fully variable reaction (non-interfering), render the Hilophone extremely selective. It is so sensitive that it may be tuned to receive even

## AMERICAN BROADCAST MUSIC

audibly and clearly in the headphones under first-class receiving conditions.

Price of H.P.R. Hilophone ..	£25 0 0
British Broadcasting Co.'s Charge..	2 5 0
	<u>£27 5 0</u>
With all accessories ..	£34 0 0
British Broadcasting Co.'s Charge..	2 5 0
	<u>£36 5 0</u>

Suitable for use with a Loud Speaker.

# H.P.R. WIRELESS, LTD.

*Pioneer Designers and Makers of Fine Valve Receiving Instruments for Amateurs.*

Head Office and Demonstration Room :

**CARLTON HOUSE, GREAT QUEEN STREET,  
KINGSWAY, LONDON, W.C.2**

Tel.: REGENT 1719.

(Opposite Kingsway Theatre)

# The BURNDIPT II RECEIVER

## A 2-Valve Panel with remarkable qualifications

This set is of original design, and is in effect a single-valve receiver, to which can be added, by the movement of a single-key switch, a note-magnifying valve and transformer, thus allowing very weak signals when tuned in to be sufficiently strongly magnified so as to be easily read. The terminals x and y are intended to be connected to a Reaction Coil or Tuned Plate Circuit for regenerative radio-frequency amplification. The panel is 5/16" thick, and the set contains a Telephone Transformer, Rheostat, Grid Condenser and H.T. Condenser (1/4 mfd.). It also contains a new Inter-Valve Transformer of our own manufacture which gives extraordinary and distortionless magnification of telephony. A separate rheostat is fitted for each valve, thus giving the most complete control.

When used with a Burndipt Tuner and Coils this instrument forms a perfect All-Wave Receiver, capable of receiving high-power concerts within two hundred miles, most European stations, amateur telephony, etc., etc.

No. 102 £12 : 10 : 0 without valves

# CHARD & CO.

24a, GREAT PORTLAND STREET, LONDON, W.1

ESTABLISHED 1889

No. 102

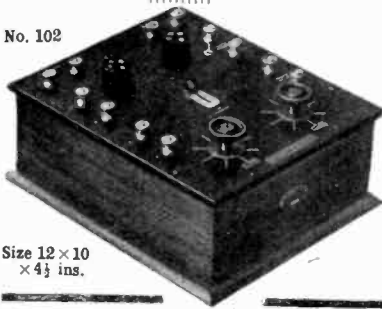

Size 12 x 10 x 4 1/2 ins.

### " WHALE FOR WIRELESS "

PHONES—Brown's, 4,000 or 120	.. .. .	30/-
Brunet 4,000	.. .. .	21/6
VALVES—" R " Type	.. .. .	12/6 & 14/-
or V24	.. .. .	15/-
INSULATORS—Ree	.. .. .	1 1/2d.
Egg	.. .. .	3d.
Coil Mounts, ebonite	.. .. .	1/3
Condenser Plates, 24	.. .. .	1/-
Condenser enclosed Vernier	.. .. .	6/-
Phonophone holders	.. .. .	4/-

Receiving set complete from 30/- Complete with Aerial Wire, Insulators and pair of Phones, £3  
 N.B.—Do away with your crystal or valve detector and fit our PHONOPHANE, 15/- each. Call for demonstration.

**THE WHALE WIRELESS CO.**  
 821, VAUXHALL BRIDGE ROAD, LONDON, S.W.1  
 Phone: Victoria 6413. (Victoria)

### ACCUMULATOR CHARGING RESISTANCES

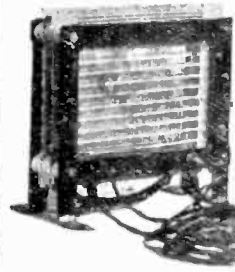

MATT UNITS mounted in a steel framing. Practically indestructible under ordinary conditions.  
 Supplied complete with flexible cable and plug adapter to charge from any convenient lamp holder.

PRICES.

1 Amp.	-	22 6
2 "	-	25 "
3 "	-	27 6
4 "	-	30 "
5 "	-	32 6

**THE WALTHAM MFG. CO.,**  
 2, JACKSON RD., HOLLOWAY, LONDON, N.



### "Western Counties" Accumulators

Send for Complete Lists **for Wireless Use.** Send for Complete Lists  
**THE MOST RELIABLE AND MODERATE PRICED ACCUMULATOR ON THE MARKET.**

6 Volts.	
60 amp hours	- 1 17 6
120 " "	- 2 12 6
4 Volts.	
80 amp hours	- 1 8 6

Packed in non-returnable cases at 9d. each.

**The WESTERN COUNTIES**  
 Electrical & Engineering Company,  
 MIDLAND BANK CHAMBERS,  
 Wire Electron, Yeovil. 'Phone: 223 Yeovil.

BRANCH FOR MESSRS. BURNDIPT, LTD.

# BURNDEPT

## Note Magnifiers Are of superlative design and finish

THE addition of one of our note magnifiers is recommended to those who possess our Burndept II, Ultra III, Ultra IV or H.F. I Receivers, and who are desirous of obtaining still greater magnification.

These instruments are of similar size and appearance to the Burndept Tuning Panels, and are the same height and outward design as the Burndept Receivers mentioned above.

They are supplied in either flat or sloping cases. For those who wish to fill a large concert or dance hall with music or speech, we recommend the Burndept Power Amplifier, which is capable of working a "gang" of loud speakers without distortion. Write for leaflet No. 118.



Mark I. The simplest form of instrument without switching devices.  
No. 111. In flat case. Price £10 10s. A.

Mark II. This model is provided with a key switch giving an "OFF" position, and an optional 1 or 2-valve.  
No. 112. In flat case. Price £12 A.

Mark III. Can be connected to Receiver but not in use, a "through" switch for 'phones supplied.  
No. 113. In flat case. Price £12 A.

Mark IV. Similar to Mark III, but with additional switch allowing one or two valves to be used.  
No. 114. In flat case. Price £13 A.

These prices include valves.

If supplied in sloping cabinets, £1 more. Full details in our New Catalogue, which will be forwarded post free.

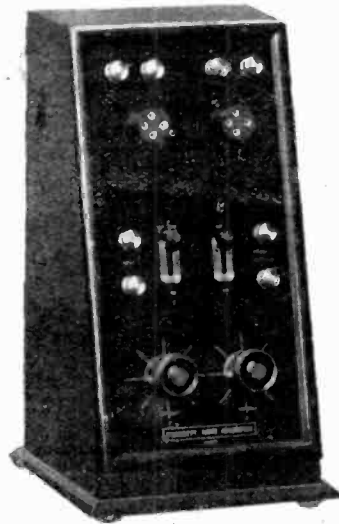

114 S



**BURNDEPT LTD.** London Office and Showrooms :—  
15. BEDFORD STREET, STRAND, W.C.1  
AERIAL AND EASTNOR WORKS, BLACKHEATH, S.E.3

London Assurance House, 249, George Street, 93, Holm Street, 119, George Street, 133, New Street, 91, Bridge Street,  
Bond Place, LEEDS. ABERDEEN. GLASGOW. EDINBURGH. BIRMINGHAM. MANCHESTER.  
CANADIAN OFFICES: 172, King Street West, Toronto, CANADA.

**We reply by return**

## WE HAVE OUTGROWN OUR PREMISES

Aerial Wire, 7/22s, copper, per 100'	4/6
Aerial Wire, 7/22s, copper, enamelled per 100'	5/-
Aerial Insulators, egg pattern, each	4d.
Aerial Insulators, shell pattern	1/-
Aerial Pulleys, aluminium	1/6
Accumulators, 4v. 40 amps.	22/6
Accumulators, 6v. 40 amps.	35/-
Accumulators, 6v. 60 amps.	50/-
Accumulators, 6v. 80 amps.	60/-

Brass Rod, Square, 1/2" x 1/2", per ft.	6d.
Brass Rod, Round, 1/2" diam.	6d.
Brass Rod, Round, 3/16"	5d.
Brass Rod, Round, 1/8"	3d.
Brass Rod, screwed, 4 BA	4d.
Brass Rod, screwed, 2 BA	5d.
Brass Strip, 1/2" x 1/8"	6d.
Brass Lacquer per bottle	1/-
Buzzers, small pattern, all metal, each	2/6
Batteries, High Tension Units, 15v.	3/6

Condensers, fixed, .0001-9	2/-
Condensers, fixed, .001-9	2/6
Condenser Valves, fixed or moving, per doz.	9d.
Condenser Separators, for fixed plates, per doz.	3d.
Condenser Separators, for moving plates, per doz.	6d.
Condenser Spindles, for .0003, .0005, or .001, each	6d.
Crystal Detector, single cup ball and socket joint on ebonite	2/9
Crystal Detector, two cup, suitable for Bornite, zincite, etc.	3/-
Crystals - Bornite, zincite, sillcon, galena, copper pyrites, etc. per packet	6d.
Crystal Cups, complete with fixing screws, each	6d.
Copper Foil, per square ft.	8d.

Ebonite Rod, 1/2" diam., per ft.	6d.
Ebonite Rod, 1/4" diam.	1/-
Ebonite Rod, 3/8" diam.	2/6
Ebonite Rod, 1" diam.	3/6
Ebonite Tube, 3/8" bore	1/-
Filament Resistances, panel pattern, each	2/6
Filament Resistances, Ashdownes Thor	3/6
Grid Leaks, 2 Megs.	1/9

*Once again we have outgrown our premises and they have become too small to accomodate our staff and to ensure our giving the quick despatch we boast of.*

*We have therefore moved to larger premises where, with the aid of increased staff, and up-to-date office appliances, we intend to keep up our reputation for prompt service.*

**NOTE  
NEW  
ADDRESS**



Inductance sliders to fit 1/4" rod, each	9d.
Insulated sleeving per yard	6d.
Ivoryine Scales, engraved not printed, 2 1/2"	9d.
Ivoryine Labels, all wordings in black or white	2d.
Mica Sheets, 4" x 4" x .001", each	4d.
Potentiometers, 300 ohms, instrument finish	17/6
Potentiometers, 300 ohms (Disposal pattern in mahogany case with switch)	15/-
Paraffin Wax, best white, per lb.	10d.
Switches, rotary pattern, 1 1/2" radius, laminated arm	2/3
Switches, knife pattern, single pole single throw	2/3
Switches, knife pattern, single pole, double throw	3/-
Switches, knife pattern, double pole, single throw	4/-
Switches, knife pattern, double pole, double throw	5/6
Switches, series parallel, on ebonite	3/6
Switch Levers, 1 1/2" radius, each	1/6

Transformers, low frequency, each	25/-
Transformers, high frequency, pin type, 300m., 6/-; 600m., 6/3; 1,200m., 6/9; 1,800m., 7/6; 2,500m., 8/3; 6,000m., 9/9	
Tapping Keys, solid brass instruments on polished wood base	5/6
Tapping Keys, cheap pattern	1/6
Terminals, from per doz.	10d.

Valves, Marconi "R" "Q" V24, QX, Ora, and Ediswan, always in stock	
Valve Holders, turned ebonite, best quality	1/9
Valve Holders, cheaper pattern, moulded	1/3
Valve Holders, on square base, with terminals	3/6
Valve Leg Sockets, complete with nuts and washer	1/4d.
Valve Pins, complete with nuts and washer	1/4d.
Voltmeters, pocket pattern	5/-
Voltmeters, switchboard pattern	9/6
Wood's Metal, for fixing crystals, per stick	8d.
Telephones, all makes at the makers' prices.	
Loud Speakers, Magniphone type "A," 15" high	£3 10s.

*Order from this list, or send post card for COMPLETE list.*

## ELECTRICAL SUPPLY STORES

(R. PALMER)

## 11, FOUNTAIN STREET, HALIFAX

# **TO WIRELESS SET MANUFACTURERS**

WE ARE MAKERS OF ALL CLASSES OF  
CABINETS, BOXES, AND TURNERY  
**FOR WIRELESS SETS**

Your Enquiries are solicited.

**DELIVERY GUARANTEED. PROMPT EXECUTION**

## **Caxton Wood Turnery Co.**

(Proprietor - WALTER HADDON)

**Wood Turners for BRUSH  
RUBBER, ELECTRICAL and  
SMALL-EDGE Tool Trades**

**REPETITION WOOD  
TURNERY for all Trades  
by Automatic Machinery**

*Address all Enquiries to:*

**Caxton Wood Turnery Co., Market Harborough**

Telegrams and Cablegrams: **HADDON, MARKET HARBORO'**

Telephone: **MARKET HARBORO' 59**



TYPE F. "Featherweight."  
Actual weight, including cords,  
is 6ozs. only.

# BROWN'S

*"Featherweight"*

## HEADPHONES

British and Best

The Finest Headphones Procurable for

### 30/-

This price is for one pair of either  
120 or 4000 ohm 'phones, including  
cords of good quality.

OBTAINABLE FROM ALL WIRELESS DEALERS.

*Catalogue Post Free.*

Head Office and  
Works:  
Victoria Road,  
North Acton, W.8

## S. G. BROWN, Ltd.

London  
Showrooms:  
19 Mortimer St.,  
London, W.1

## COMBINED VOLTMETER FOR H.T. & L.T. BATTERY.

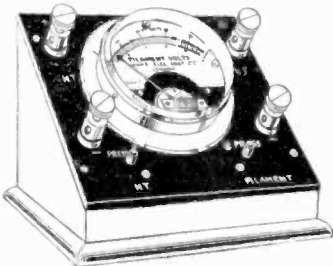

High Resistance. Foolproof.  
Neat and Compact.  
Terminals marked in plain  
letters.

Reads to 100 volts on H.T.  
and 10 volts on L.T. Battery  
by merely pressing the button.

### Price £4 each

POST FREE. CASH WITH ORDER

(For higher readings, prices on application).

## WHITE ELECTRICAL INSTRUMENT CO. LTD.

2, 4 and 6, Gloucester Street, Clerkenwell, London, E.C.1

Telegrams: Voltograph, London.

'Phone: City 8660.



# IGRANIC MEANS STANDARDISATION

CUT OUT THIS STANDARD DATA FOR REFERENCE

## IGRANIC HONEYCOMB INDUCTANCE COILS

*De Forest Patent No. 141344.*

For further particulars of other standard units write for Pamphlet U.5.

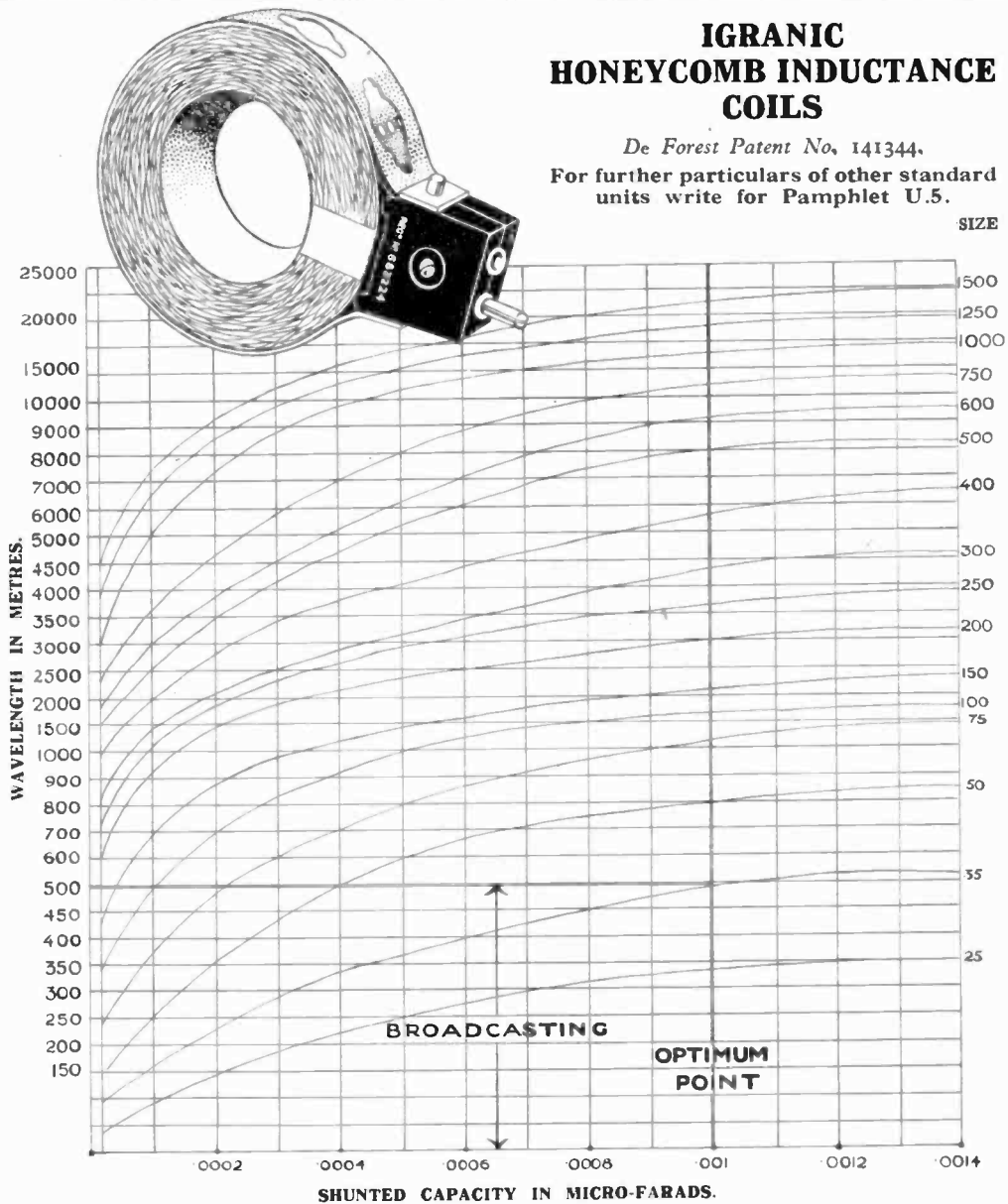

147, Queen Victoria St.,  
LONDON.

GLASGOW,  
MANCHESTER,  
NEWCASTLE.



Works :  
Elstow Road, BEDFORD.

BRADFORD,  
BIRMINGHAM,  
CARDIFF.

READY

Price **6/-** Nett**The Year Book  
Telegraphy****19**

SPECIAL

**FOR EXPERIMENTERS, AMATEURS****Phenomenal Demand**

As a result of the tremendous demand for the Year Book, we have decided to issue a special edition for Experimenting Amateurs apart from the complete edition usually published.

The new edition will contain all the information given in the complete work, with the exception of matter of sole interest to Commercial Companies.

ALL YOU WANT TO KNOW IS IN THE YEAR BOOK

**The Year Book of Wireless**Price **15/-** Nett — **COMPLETE**

Practically the whole of this edition is already

**The Wireless Press, Ltd.**

MARCH

# of Wireless & Telephony

Post **6/9** Free

# 23

EDITION

## AND ALL "LISTENERS-IN"

### Order Immediately

#### BRIEF SUMMARY OF CONTENTS.

Directory of over 450 Amateur and Experimental Stations (18 pages); Laws and Regulations governing Experimental, Amateur and Broadcast Wireless (52 pages); Call Letters of over 16,000 Air, Land and Ship Wireless Stations of the World (270 pages); Sixty-four Pages of Maps in Two Colours, showing position of all known Land Stations, indicating whether Direction Finding, Broadcasting, Public or Official; Complete History of Wireless from its Birth to Date, with full details of Progress made in 1922 (20 pages); Meteorological Section, showing all Regular Transmissions of Hydrographic, Meteorological and Time Signals, with detailed explanation of the Codes used and their Meanings (131 pages); Useful Data Section (46 pages); Dictionary of Wireless Terms in Five Languages, Tables and Formulae for Wireless Calculations, Graphical Symbols for Radio Diagrams; Classified Traders Directory for the benefit of Purchasers of Component Parts, etc. (4 pages); Full Morse Code, International and Continental; Direction Finding Section (20 pages); Who's Who in Wireless (35 pages); Wireless Literature (28 pages); etc., etc.

THE SUPPLY IS LIMITED—PLACE YOUR ORDER NOW

## **Telegraphy and Telephony**

EDITION— Post **16/-** Free

sold. To avoid disappointment order at once.

# 12-13 Henrietta St., London, W.C.2

**E** **C** **E** **C**  
**CONOMI** **ESTAB.**  
**1896**  
**E** **C**  
**ELECTRIC**  
**LIMITED**

Telephone :  
 MUSEUM 1065.

**DOUBLE  
 WIRELESS  
 RANGE  
 VOLTMETER**



fitted with three terminals and two scales for measuring 0-10 and 0-100 volts. Fitted into strong oak case, with glass front.

Size. 3½ in. × 3½ in. × 2 in.

**Price 25/-**

Write to-day for our 40 page Radio Catalogue 280 illustrations. Mailed post free for 4d.

**EEL**  
 ECONOMIC ELECTRIC LIMITED, 10 FETTER LANE, LONDON, W.C.1

## Whatever's the matter with Bill ?

Bill's the foreman of the Assembly Dept. Some small metal parts for No. C 536 have been delivered from stores. We cannot print here exactly what he said !!

What a help true-to-gauge, accurate, well finished metal details are to Bill !

See that he gets them

Just send along to :—

**BAKER & FINNEMORE, Ltd.**

Steel Pen Makers for over 70 years,  
 BAK-FIN Works, Birmingham.

**"PRESSWORK AT ITS BEST"**

The World's most famous **CRYSTAL**  
**ELECTRONITE**  
 British Manufacture.  
**IT GIVES THE RESULT**

COLCHESTER.

It might interest you to know that on Monday night, 5th inst., at about 9.30 p.m., I received Newcastle Station (5 N.O.) on a Crystal which was your Electronite using the special Tordinodium wire. I was so astonished that I immediately write you as I thought perhaps this information might be of use to you.

Yours faithfully, B. L. ARMSTRONG.

Original can be seen at our Office.  
 We are the Sole Distributors for the World.  
 PRICE: Single Crystal, with length of Tordinodium Wire, 1/6.  
 Crystals, 5/- per oz. Postage 2d.  
 Trade Supplied.

ESTABLISHED — 1920

**RADIO**  
**SUPPLIES**

234, HIGH HOLBORN, LONDON, W.C.1  
 Phone: Holborn 2188

## WIRELESS Telegraphy & Telephony

An Outline for Electrical Engineers and Others.  
 By L. B. TURNER, M.A., M.I.E.E., Member  
 of the Imperial Wireless Telegraphy Committee,  
 1919-20. With 24 plates and 119 text-figures.  
 Demy 8vo. 20s net.

"The originality of the treatise consists in the method of management, the selection and skilful dovetailing of the varied materials and the omission of non-essentials. The ground covered is thoroughly explored, and from first to last one is in the hands of a master."

*Engineering.*

"A really excellent outline of the subject."—*The Telegraph & Telephone Journal.*

**CAMBRIDGE UNIVERSITY PRESS**  
 FETTER LANE - - LONDON, E.C.4  
 C. F. CLAY, Manager

# L. McMICHAEL, LTD.



Two-Valve Broadcast Set, No. M.H./B.R.2.

## Two - Valve Broadcast Set, No. M.H./B.R.2.

G.P.O. Registered No. 2033.

THIS Two-Valve Broadcast Set is the result of careful experiments; we claim that in results it is superior to any other Two-Valve Broadcast set on the market. This set has one high frequency tuned anode valve which is adjusted by a variable condenser (marked secondary). A primary variable condenser controls the main tuning inductance. There are internal coils embodied in the set which enable the user to get all wavelengths up to 1,000 metres. Plugs are provided so that higher wavelengths up to 30,000 may be obtained by means of duolateral coils. The condenser marked "reaction" controls the reaction which is taken off from the high frequency side. On this set all Broadcasting Stations can be received with an average aerial.

The price of this set is £18 18 0

The accessories necessary are as follows:—

2 Valves, 17s. 6d. each	..	..	1 15 0
4-Volt Accumulator, 30s.	..	..	1 10 0
Aerial Wire (100 ft. enamelled)	..	..	6 0
H.T. Battery, 15s. each	..	..	15 0
Telephones from £1 each	..	..	1 0 0
Insulators (2) at 1s. each	..	..	2 0

£5 8 0

TOTAL COST, therefore, for COMPLETE STATION is £24 6 0  
(Carriage paid).

25, Grosvenor Road,  
Manningham, Bradford.  
Dear Sirs,  
The 4 Valve Broadcasting Set, viz.: 2 Valve Set M.H./B.R. 2 and 2 Valve Amplifier M.H./B.R. 2A., received from you gives every satisfaction and are pleased to say we can recommend it with every confidence to our customers.  
We nightly receive London and Newcastle and also the Hague Concerts on Sundays through a Loud Speaker clearly.  
In our opinion your sets are equal to any on the market.  
Yours truly, NELSON & HALEY.

## Two - Valve Broadcast Amplifier, No. M.H./B.R.2A.

If further amplification is desired our M.H./B.R.2A. amplifier is recommended. This is a Two-Valve amplifier of similar size and design to the Broadcast set above mentioned and is arranged so that the terminals are easily connected. Means are provided so that one or two valves on this amplifier can be used at will.

A loud speaker can be used with this apparatus.

The price of the amplifier is .. .. . 9 9 0  
Accessories required are two valves at 17s. 6d. each .. 1 15 0  
The same H.T. battery and accumulator can be used that operates with the Broadcast Set.

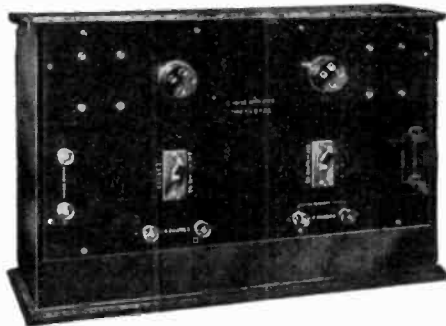

Two-Valve Broadcast Amplifier, No. M.H./B.R.2A.

Full details of our other M.H. Sets, 1 to 4 valves, of similar and unsurpassed efficiency are mentioned in detail in our NEW M.H. Booklet, 6d. post free. (All our valve apparatus is manufactured under Marconi Licence.)



## LESLIE McMICHAEL LTD.

RETAIL SHOWROOMS.

179, STRAND (Corner of Norfolk St). LONDON. W.C.2

Head Office (to which all correspondence should be sent):  
HASTINGS HOUSE, NORFOLK STREET, STRAND, LONDON, W.C.2

## TONS

of EBONITE SHEET in Stock for immediate delivery in quantities suitable for all classes of WIRELESS WORK.

## SHEETS - RODS TUBES - PANELS

TUBES and ROTORS for Variometers.  
MOULDED KNOBS (various patterns),  
COMBINED DIALS AND KNOBS,  
3", 3½" and 4" diameters.  
Do. for Fil. Res. and Vario-Couplers.  
AERIAL INSULATORS.

*Wholesale only.*

AMERICAN HARD RUBBER  
COMPANY (Britain) LIMITED,  
13a, Fore Street, London, E.C.  
Teleg. : "Eboniseth, Ave. London." Phone : Central 12754.

## CONDENSER VANES BRASS TERMINALS VALVE LEGS & STUDS EBONITE DIALS (Complete with Knobs) EBONITE VALVE HOLDERS

*We Supply all Wireless  
Accessories. Large stock on  
hand. Send for Catalogue  
to the Manufacturers.*



## H. CLARKE & CO. (MANCHESTER) LIMITED.

Atlas Works, Eastnor St., Old Trafford, Manchester.  
Phone: 683 & 793 Trafford Park. Grams: "Pittoid, Manchester."

# SIEMENS

## WIRELESS ACCESSORIES



**TELEPHONE HEAD SETS.** Give best results with all types of receiving sets. Fitted with enclosed terminals, preventing leakage.

**VACUUM PROTECTORS** for protection against damage by lightning. Will operate many times before renewal is necessary.

**AERIAL WIRES & INSULATORS  
EARTHING DEVICES, FUSES,  
SWITCHES, JACKS & PLUGS,  
H.T. BATTERIES, etc.**

ALSO MANUFACTURERS OF  
**BROADCASTING WIRELESS RECEIVING SETS**

*Showing at the Wireless Section,  
Ideal Home Exhibition, March 1st to 24th*

## SIEMENS BROTHERS & CO., LTD WOOLWICH, LONDON, S.E. 18

Telegrams—Siemens, Woolwich. Telephone—City 6400

And at

BELFAST—36, Mill St. BIRMINGHAM—111, New St.  
BRISTOL—30, Bridge St. CARDIFF—57-59, St. Mary St.  
GLASGOW—40, Wellington St. & 144, St. Vincent St.  
LEEDS—120, Park Lane. LIVERPOOL—81, Dale St.  
LONDON—38-39, Upper Thames St. MANCHESTER—  
196, Deansgate. NEWCASTLE ON-TYNE—64-68, Colling-  
wood Bldgs. & Exchange Bldgs., Quayside. SHEFFIELD—  
22, High St. SOUTHAMPTON—46, High St.

# STALLOY

**TRANSFORMER LAMINATIONS**  
 SOLE MANUFACTURERS AND SUPPLIERS  
**JOSEPH SANKEY & SONS LTD**  
 WORKS: BILSTON, STAFFS. London Office: 168 RECENT ST. W.  
**TELEPHONE RECEIVER DIAPHRAGMS**

## THE WIRELESS WORLD AND RADIO REVIEW

THE OFFICIAL ORGAN OF THE RADIO SOCIETY OF GREAT BRITAIN  
A MAGAZINE DEVOTED TO WIRELESS TELEGRAPHY AND TELEPHONY

### CONTENTS

Semi-Aperiodic H.F. Transformers. By J. H. Reeves, M.B.E.	- - - -	681
Making a Simple Crystal Receiver	- - - -	685
Transatlantic Tests: Preliminary Report of British Reception. By Philip R. Coursey, B.Sc. (Eng.), F.Inst.P.	- - - -	689



We have L.F.  
**TRANSFORMERS**  
in Stock

Price **12/6** each  
Postage 9d.

Let us quote you  
for your new set

We are specialists

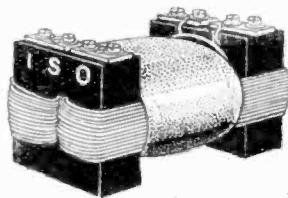

We can now give  
immediate de-  
livery of

**HEADPHONES**  
4000 ohms at

**25/-**

Postage 9d.

**DUCON** Works with-  
out Aerial **10/-**

**234, HIGH HOLBORN (2nd Floor), LONDON, W.C.1**

*(A few doors to the East of Kingsway).*

# THE WIRELESS AGE

THE AMERICAN MONTHLY JOURNAL OF  
WIRELESS TELEGRAPHY AND TELEPHONY

A "Go-ahead" Magazine for Operators and Amateurs.

Sole European Agents: THE WIRELESS PRESS LTD., 12-13 Henrietta St., Strand, London, W.C.2

## CONTENTS *(Continued)*

Dr. Fleming on the Thermionic Valve	- - - - -	693
Wireless Club Reports	- - - - -	695
Notes	- - - - -	699
Circuit of a 7-Valve Receiver.	- - - - -	702
The Radio Society of Great Britain Conference	- - - - -	703
The British Wireless Radio Relay League	- - - - -	706
Calendar of Current Events	- - - - -	708
Questions and Answers	- - - - -	709
Share Market Report	- - - - -	714

THE WIRELESS WORLD AND RADIO REVIEW is published weekly on Saturdays.

All correspondence relating to contributions should be addressed to THE EDITOR, THE WIRELESS WORLD AND RADIO REVIEW, 12-13, Henrietta Street, Strand, London, W.C.2.

No responsibility can be taken for MSS. or photographs sent without stamps to defray cost of return postage.

Editorial and Publishing Offices 12-13, Henrietta Street, Strand, London, W.C.2.

Telegraphic Address: "Radionic, Rand, London." Telephone No.: Gerrard 2807.

Advertisement Managers, Bertram Day & Co., Ltd., 9 and 10, Charing Cross, S.W.1. Telephone No.: Gerrard 8063 and 8064.

### SUBSCRIPTION RATES.

28s. per annum, post free. Single Copies 6d., or post free 7d.

Registered at the G.P.O. for transmission by Magazine Post to Canada and Newfoundland.

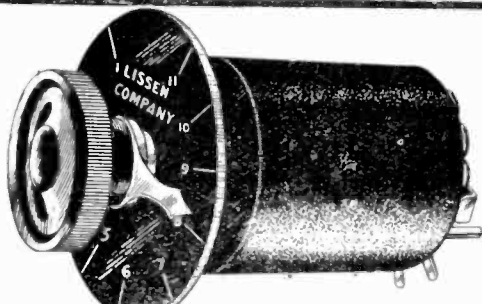

### RADIO FREQUENCY AMPLIFICATION

This self-tuned Anode Reactance (provisional patent) with switch combined is the most satisfactory method of short-wave H.F. amplification. Increases the range of a set and brings in distant stations. The outstanding features are the degree of efficiency attained and the ease of assembly. Only one hole to drill in panel, and two soldered connections to make to tinned tags provided. The work of hours is done in a few minutes.

Two ranges—150 to 600 metres . . . . . 27 6  
150 to 10,000 metres . . . . . 32 6

Simple wiring diagram sent out with each.

LISSEN ROTARY SWITCH (provisional patent) for use with tapped inductances, etc., does away with nuts, washers, contact studs, etc., saves drilling, makes a smooth wiping contact, 10-. These two components save makers and amateurs hours of work. Dealers and makers should send for samples. Cash with order for new accounts avoids delay.

**LISSEN COMPANY,**  
WOODGER ROAD, GOLDHAWK ROAD, LONDON, W.12

LISSEN COMPONENTS—WELL THOUGHT OUT,  
THEN WELL MADE.



# THE WIRELESS WORLD AND RADIO REVIEW

THE OFFICIAL ORGAN OF THE RADIO SOCIETY OF GREAT BRITAIN.

No. 184 [No. 21  
VOL. XI.]

FEBRUARY 24TH, 1923.

WEEKLY

## Semi-Aperiodic H.F. Transformers.

By J. H. REEVES, M.B.E.

THESE notes are the outcome of an attempt to build a multivalve H.F. amplifier to cover the broadcasting band and under. They formed the subject of a lecture given to the Kensington Radio Society.

The nature of the method was formed on the writer's experience in the use of a Marconi seven-valve amplifier Type 55D. The band claimed for this instrument runs from 1,500 metres to the upper limit. It was designed not so much for high efficiency per valve,

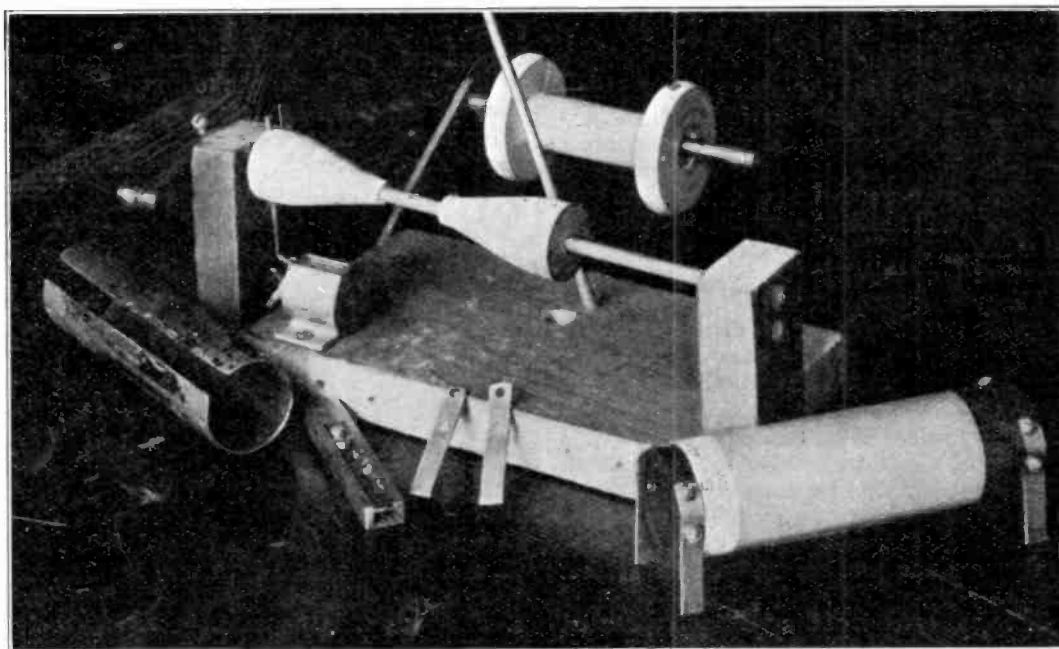

*A photograph showing all the equipment necessary in constructing the transformers and a finished transformer on the right. Note the cyclometer mounted on the base to register the number of turns when winding. On the right are the jigs for cutting and drilling the ebonite tube and brass connectors.*

but rather to give great ease of working over a wide range. It is a fact that this instrument has given good results down to 600 metres, and the writer's argument was that if an amplifier with optimum point in the neighbourhood of 4,000 metres will give good results down to 600 metres, what will be the result of constructing one on exactly similar lines with an optimum of 900 metres? The reader is forewarned that he may have to use one more valve, possibly two, than he would have to do in the case of a tuned reactance capacity, or of the multi-pointed self-tuned reactance capacity coupling, but on the other hand, if he wishes to use several H.F. valves in cascade, for instance for use with a small frame aerial, he will most probably agree that the cost of the extra battery power required is still outweighed by the elimination of that

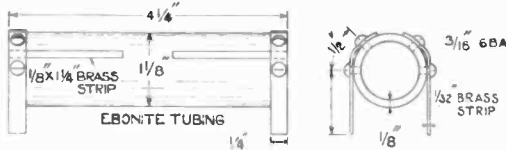

Fig. 1. The body carrying the transformer windings.

bugbear of the tuned anode multiple circuit, *i.e.*, its extreme liability to self oscillation.

The writer experimented with the popular four-pin type of disc transformer, but found against this the mechanical difficulty of making the body, and more particularly the difficulty of turning out three or more identical in electrical properties.

The type to be described is cheaper to make, irregularities in mechanical construction are unimportant, while with ease any number can be made almost identical electrically. The form requires a reconstruction of the panel, though by means of an adapter it can be used on a panel fitted with valve sockets, but an experiment will later be described from which it would appear that the capacity of the four pins and the four sockets, almost infinitesimal as they are, can produce markedly observable effects.

The transformer is of the two-layer cylindrical type, very tightly coupled, and wound with high resistance fine wire. The body is formed of tubing  $1\frac{1}{8}$  in. diameter, walls  $\frac{1}{8}$  in. thick and of length  $4\frac{1}{4}$  ins. The writer used ebonite,

but thinks possibly other material may be better electrically. This body is supported on four legs made from brass strip  $\frac{1}{4}$  in.  $\times$   $\frac{3}{32}$  in., and these are held in small spring clips of a type which has been advertised in this journal.

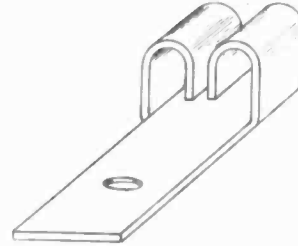

Fig. 2. Three clips to support the transformers.

The body is shown in Fig. 1. and the clip in Fig. 2. It will be seen that to the legs are soldered fine brass strips projecting along the body parallel to its axis. These may be of tinned wire, and form the base on which is soldered the winding wire. The length of these depends on whether the body is to be wound full (900 metres), about half full (400 metres), or with about 100 turns (200 metres).

The making of this body presents no great difficulty to one whose hands are skilful, but even to such the work is greatly facilitated by the use of two jigs, one to form the body (Fig. 3), the other the legs.

Fig 1.—The tube was rubbed smooth with fine emery cloth, oiled. A piece of fairly stout brass tubing was found of internal diameter

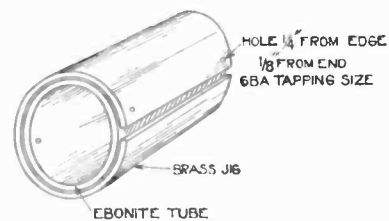

Fig. 3. The jig for the body.

just under  $1\frac{1}{8}$  in. A length of  $4\frac{3}{8}$  ins. was cut off, and the ends trued by a file or against an emery wheel, till the length was exactly  $4\frac{1}{4}$  ins. This jig was then fixed in a large vice as nearly as the eye could gauge parallel to the jaws, and then, aided by one jaw as a guide, a longitudinal cut was made with a hack-saw which was thus closely parallel to the axis.

The edges of this cut were filed smooth, and then, slightly expanding the cut tube, it was slipped over the ebonite tube, which was then cut so that a small length projected at each end. The ebonite ends were now similarly trued to the guide of the brass surround. Next, at the same distance from one cut edge of the brass and  $\frac{1}{8}$  in. from each

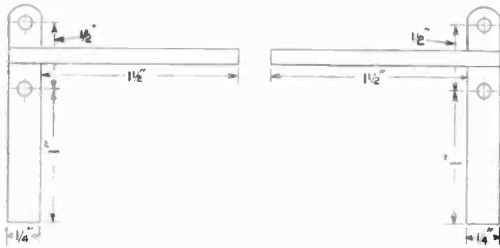

Fig. 4. The legs with arms soldered on.

end, two centre-punch marks were made, and at the opposite ends of the cross sectional diameter through these marks two others were made. Through these, four holes were drilled 6 BA. tapping size. The inner tube was pushed out by sliding over the main ebonite tube and the first body was ready, with the jig in position to make another.

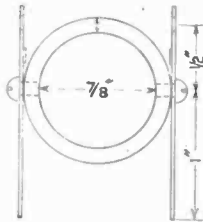

Fig. 5. End appearance with legs fitted.

Jig 2 (Fig. 4). This is to help make the legs identical. A full description is unnecessary and it is not difficult to construct from brass strip. It will be found that when the two holes have been drilled (6 BA clearance), the burr formed will prevent the finished legs from dropping out. A pair of small flat-nose pliers will get over this difficulty and for this reason the opening must be somewhat deeper than the  $\frac{1}{32}$  in., the thickness of the leg, and the upper flap must be flexible. When one or two dozen legs have been made

the ends are rounded or trued by file or emery wheel and the thin arms soldered on as in Fig 4.

To the body, four legs are now attached with screws 6 BA,  $\frac{3}{16}$  in. The end appearance now is as in Fig. 5.

The legs being carefully squared with the body, the top ends are bent round the circumference and the four remaining necessary holes are drilled and tapped 6 BA and screwed home. Any ends of the  $\frac{3}{16}$  in. screws which project internally are filed off, and the body is now ready for winding. For this a device is required as shown in Fig. 6, and in the photograph.

It may seem at first sight that this winding will be difficult. This is not the case and after a little practice a rate of about 100 turns per minute can be reached. In practice there is a little trouble in getting the first few turns to lie close together, but it is simpler to let this irregularity alone and when the coil is finished to press the erring turns into contact with the rest.

The next step is the testing and measurement of the transformer.

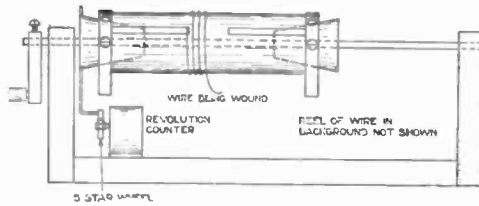

Fig 6. The winding device.

The method used gave results good enough to form a working basis. A small panel was put together of one H.F. and one detector valve. No connections were made beneath the panel except as regards L.T. battery and potentiometer, but all the terminals of the parts were brought up to the top so that changes of connections could be made easily.\* The arrangement is shown in Fig. 7.

A buzzer wavemeter must be supposed to be some distance on the left. The transformer under test was put in the clips, a suitable coil was inserted on the left and its shunt

\* Since this was written these transformers have been tested on another panel with very low capacity valves and the difference of the optimum wavelength far exceeded expectations. This shows the necessity of calibrating every transformer on the panel and with the valves with which it is to be used.

condenser placed at zero. The tuning condensers on the panel were disconnected. The wavemeter was now tuned in and the magnitude of the sound in the telephones was noted. The buzzer wavelength was now increased step by step and the receiver tuned in to each adjustment. If correct wavelengths had been selected the strength of signals rose fairly rapidly to a maximum and then with further increase of wavelength the strength began to fall away.

Maximum strength of signals should be accurately noted and if the assumption be correct that the energy of the oscillations were the same at all wavelengths—an assumption probably untrue—the result would give the absolute optimum point for each transformer, and the rates of falling off on either side of this point would give an estimate of the useful range over which the transformer could be

In this connection an interesting point was noted, and as this led to winding throughout with high resistance wire, it may be described. It was found that some coils would not oscillate under any adjustment of the potentiometer, so a reaction coil was brought into use and by its means, in conjunction with the potentiometer, the measurement by self oscillation could always be made. Now at the start both layers had been wound with fine copper, but as the band of efficient amplification proved very narrow, H.R. wire was substituted for the primary winding and two transformers were wound identical in number of turns, but in one the secondary was copper, in the other it was H.R. The latter was markedly more difficult to get to oscillate, but the efficiency of the former at optimum point, which was about the same, was somewhat higher. As

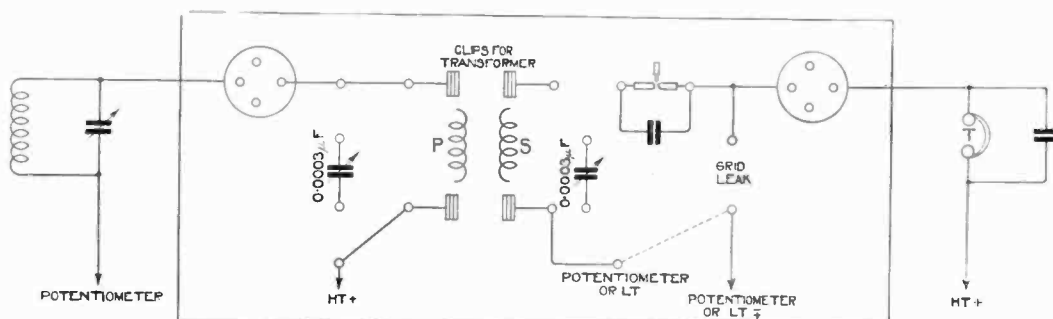

Fig. 7. The circuit used for testing wavelength ranges.

used. Even if not absolutely correct, this method does give a useful and fairly close approximation. While certain of these measurements were being made another phenomenon was noted. Under a certain potentiometer adjustment the system broke into self oscillation over a limited swing of the tuning condenser, above and below which the buzzer note came through clearly. By careful manipulation of the potentiometer this swing could be limited to about 10 degrees and even less, and finally eliminated. The point of greatest ease of self-oscillation was credited as being that of the natural wavelength of the transformer in its setting, and the fact that various points as thus determined agreed well with the optimum point as found by the former method, seems to indicate that the respective theories are in the main accurate.

the writer is prepared to sacrifice some efficiency in eliminating his great bugbear, oscillation, all secondaries are now wound with H.R.

Another point which has been partially investigated is that of winding more turns on the secondary. The writer will in a further instalment of this article give numbers of turns, but he warns the reader that experiments will be related showing that even minute capacity effects may completely alter the optimum point of the same transformer used on two different panels, e.g., one transformer adjusted on the writer's panel for work at 400 metres was found on a friend's panel to be at its best, and wonderfully good at that, on ship signals.

(To be concluded).

# Making A Simple Crystal Receiver.

A CONSTRUCTIONAL ARTICLE FOR THE BEGINNER.

**S**IMPLICITY, without sacrificing efficiency, has been the foremost consideration in the design of this crystal receiving set, and the arrangement can be recommended as embodying the best principles of crystal reception.

The design is arranged so as not to be beyond the skill of the beginner, and to come within the scope of those without experience

- 6 brass screws No. 4 × ½" countersunk heads.
- 3 " " No. 6 × 1¼" round-headed.
- 4 4BA terminals with back nuts and washers.
- 2 lengths (nearly 1 yard each) of "Sistoflex" insulating tubing.
- 6 ft. No. 20 bare copper wire.

The total expenditure on materials should not exceed ten or twelve shillings.

The winding of the two inductances is the first step in the construction of the receiver. The dimensions of the coil on which the wire is wound appeared in an article on "Experimental Station Design," in *The Wireless World and Radio Review* of June 10th, 1922, and from which article Figs. 1 and 4 are reproduced. A card should be placed beneath Fig. 1, and all of the corner points pricked through so that it can be cut exactly to the shape indicated. It should be observed that an odd number of slots is employed. Care must be taken that the slots are not made too deep, for any cuts which are too long will considerably weaken the segments and probably cause them to break off during winding. Two holes are pricked through at the points shown, and by mounting the reel of wire on

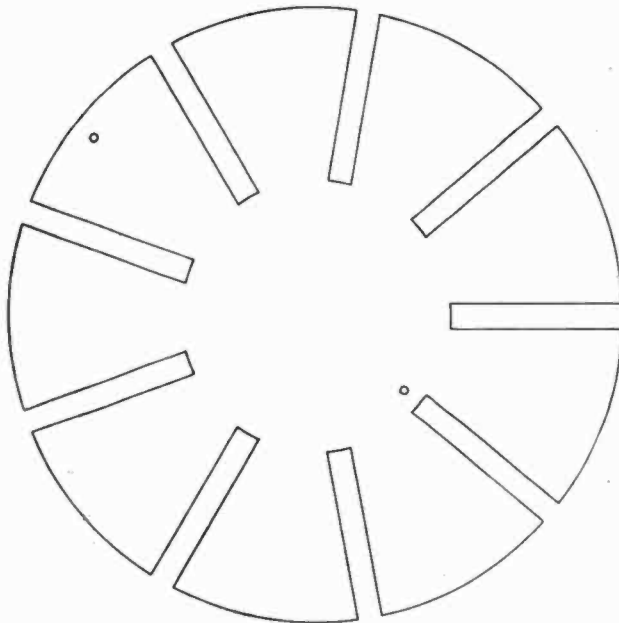

Fig. 1. The card on which the wire is wound. It is drawn exact full size.

in wireless constructional work. It is intended for the man about to start in wireless, and who is desirous, in the first instance, of receiving broadcast.

The materials required are as follows:—

- Piece of wood ½" thick.
- Polished ebonite sheet 1" × 6" × ¼".
- 4 ozs. No. 26 D.C.C.
- 2 cards.
- 1 condenser 0.0003 microfarads.
- 1 " " 0.001 " "
- A crystal detector.
- Shellac varnish (about 1 gill).
- 18 brass screws No. 4 × ⅜" round-headed

a spindle it is quite easy to wind the wire in and out of the slots until it resembles Fig. 4. The wire should be pulled quite tightly while winding, and the card flattened out from time to time as may be required. Two inductances will be needed. One of the inductances is attached to a strip of wood about 9 ins. long and ½ in. wide by ⅜ in. in thickness, by means of two of the ½ in. screws. A disc of cardboard is placed over the inductance prior to attaching it to the wooden arm so as to hold it securely, and reduce the liability to bend. Two small holes are drilled through the arm prior to securing the inductance, in order to pass the leads.

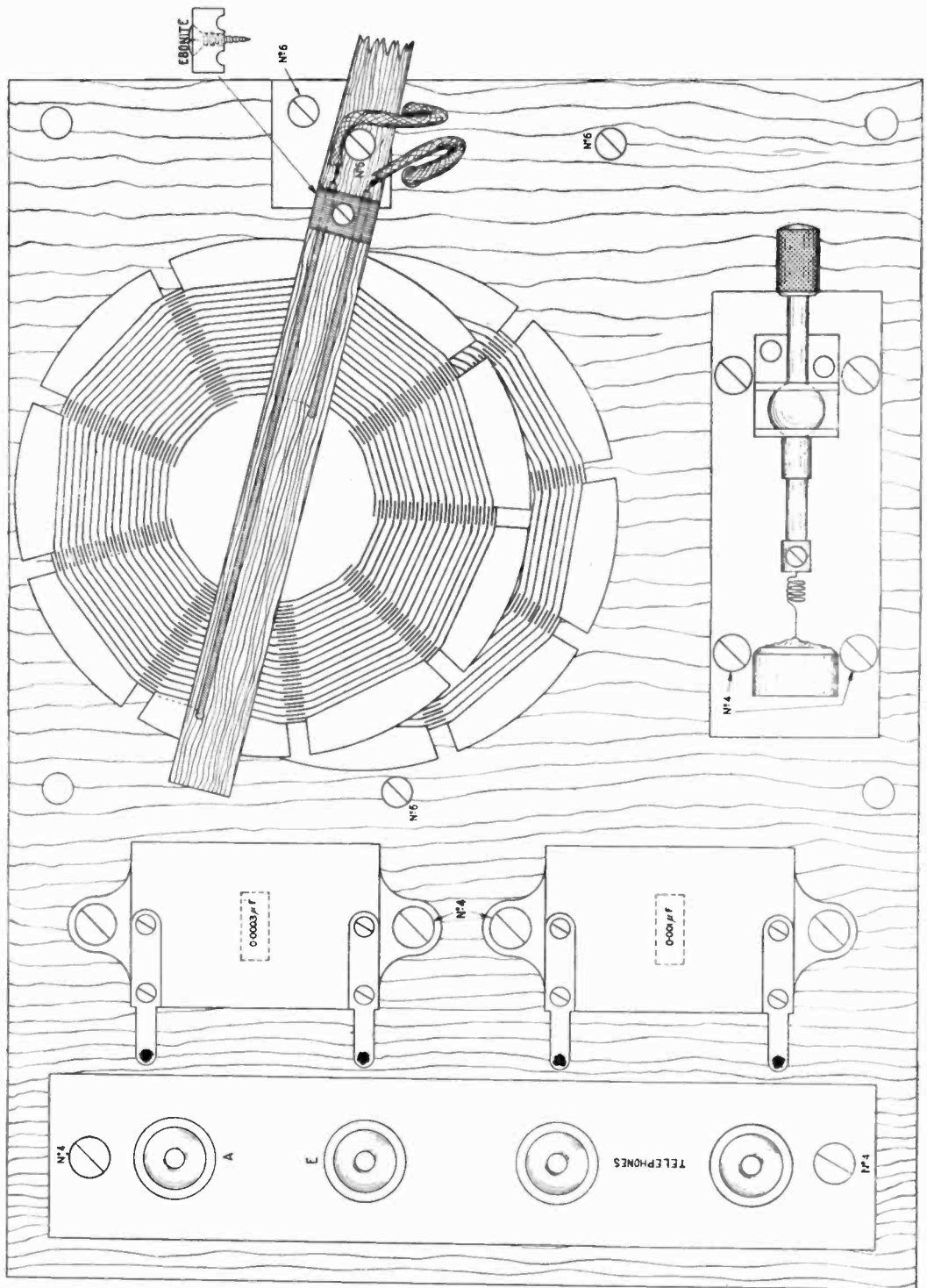

Fig. 2. The layout of the complete receiver.

It is just as well to mark out the positions for all the holes in the base and arm in the first instance and drill them, in order to reduce the chance of splitting, after which a coat of varnish will make the surface of the wood more durable and improve its insulating properties, which is particularly desirable where it is in contact with the inductances.

The terminal strip may next be constructed. The ebonite is sawn to size by marking it with a scratch line and cutting with a fine toothed saw. The edges may be finished by filing. Six holes are drilled at the points shown in Fig. 5 by means of a small hand brace and morse twist drill, and breaking away of the ebonite at the back may be avoided by drilling down on to a piece of hard wood and pressing the ebonite tightly in contact with it. To those unaccustomed to working in ebonite, it should be borne in mind that it is a fairly brittle substance, and must not be allowed to vibrate during sawing or filing, neither must it be subjected to heavy pressure while drilling.

The polished surface, which may possibly tend to destroy the insulating properties of the ebonite, may be removed by rubbing with emery cloth, and by careful treatment it is possible to give the ebonite a good matt surface which considerably improves the appearance. The terminals are held in position with back nuts.

If parts only are purchased for the crystal detector, it will be necessary to make up an ebonite piece for assembling it and insulating it from the main wooden base.

The dimensions of the base can be seen in Fig. 2, and the construction is left to

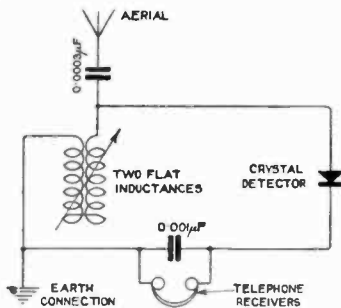

Fig. 3. Circuit Diagram.

the ingenuity of the reader according to his experience and the tools in his possession. It should be noted that the grain of the wood is parallel with the long slot, and cross pieces are arranged to reduce the chance of splitting. The wooden base may be rubbed down with glass paper and the corners given a slight rounding or bevelling, after which, treatment with shellac varnish will add to the appearance and insulation.

The method of assembling the components on the base is clearly indicated in Fig. 2. The lower inductance is secured to the surface of the board with three of the 1/2 in. screws,

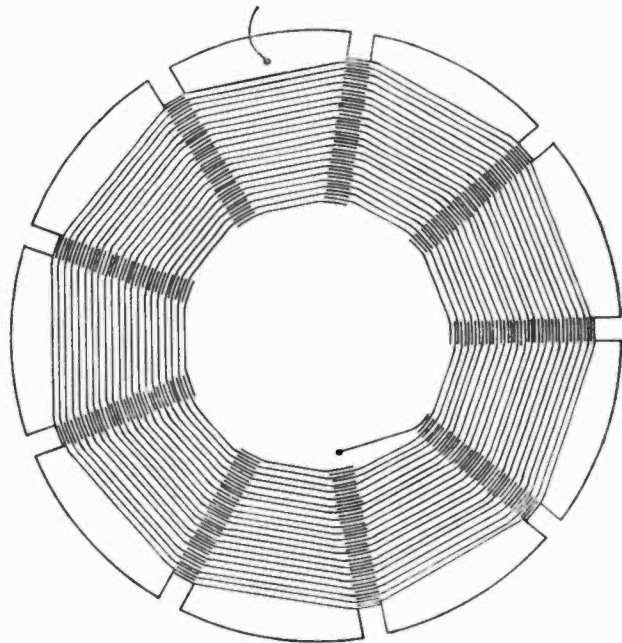

Fig. 4. A wound tuning coil.

and the leads pass through the wood for wiring up. The wiring is shown in Fig. 6, and a wiring diagram representing the circuit in a form in which the connections of wireless apparatus is usually represented, is shown in Fig. 3.

A difficulty which the beginner will experience in operating a receiver of this sort, is the sensitive setting of the crystal detector. The best way of doing this is to arrange a buzzer and battery close to the receiver, and to vary the crystal detector until the buzz is loudly heard in the telephones.

Crystal receivers, although entirely satisfactory for broadcast reception, do not give very loud signals, and hence it is necessary

for the highest grade of telephone receivers to be employed, and the beginner is strongly advised to procure those of reliable manufac-

The resistance of the receivers should be between 2,000 and 4,000 ohms.

Should the reader be unacquainted with the

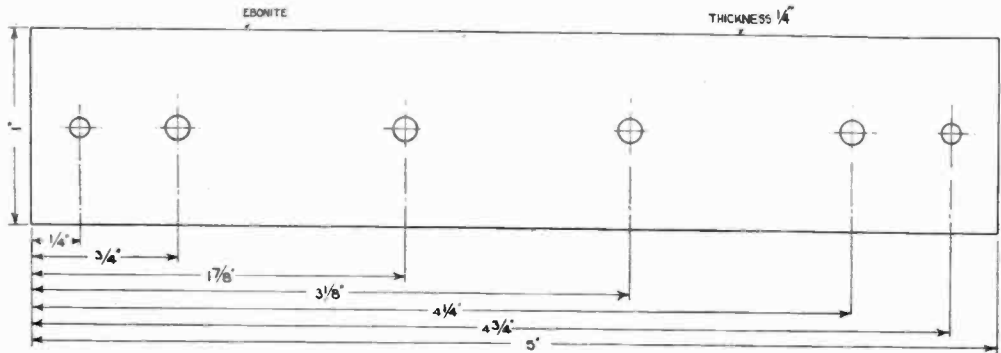

Fig. 5. The ebonite piece for mounting the terminals. The thickness is  $\frac{1}{4}$ ".

ture. A good test when purchasing telephone receivers is to moisten the tags and touch them together. If the receivers are really sensitive a strong click should be heard.

best method of erecting an aerial, he is referred to an article dealing very thoroughly with the subject which appeared in the issue of this journal of May 27th, 1922.

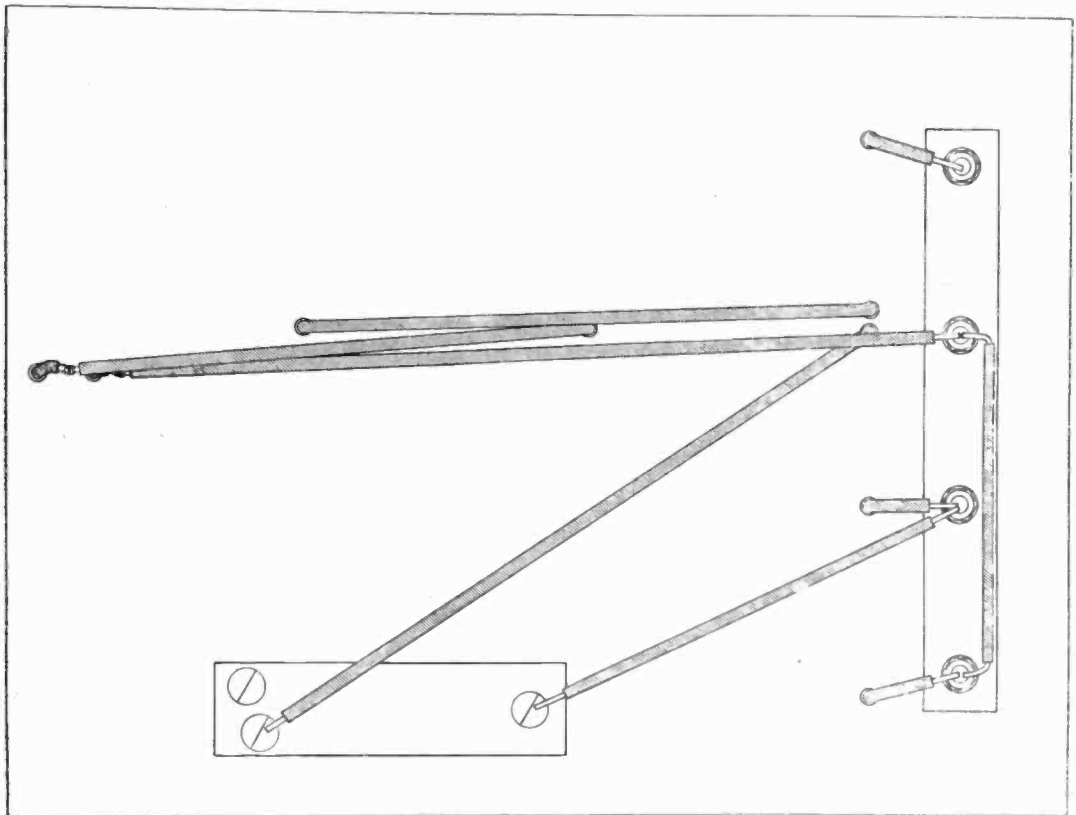

Fig. 6. Underside of receiver showing wiring.



# Transatlantic Tests.

## RESULTS OF BRITISH AND FRENCH TRANSMISSIONS, 1922.

By PHILIP R. COURSEY, B.Sc., F.Inst.P., A.M.I.E.E.

**A**S has already been announced in these columns, during the second part of the Transatlantic Tests between December 22nd and 31st, British and French radio amateurs transmitted test signals to America and Canada. All the British stations which were allocated special transmitting periods were given a code word in order to verify their receptions. The French transmitters also had code words, but arranged their three-hour periods as free-for-all times during which any of their transmitters were free to operate.

Some of the results of the American receptions were reported by radiogram *via* New Brunswick and Carnarvon during the tests. The texts of these messages as received are as follows:—

### December 23rd.

"OUR STATIONS JAMMED NO SIGNALS REPORTED HEARD FROM ENGLAND OR FRANCE TWENTY SECOND. SCHNELL."

### December 24th.

"HEARD TWO FOX ZED TWENTYTHIRD STOP OTHERS BADLY JAMMED BY OUR TRANSMITTERS STOP NO FRENCH SIGNALS REPORTED. SCHNELL."

### December 25th.

"TWENTYFOURTH SIX AMATEURS REPORT FIVE WATCH SAIL CODE VERIFIED XMAS MESSAGE COPIED STOP ALSO NOUGHT ONE FIVE SIX GREENWICH FIVE SAIL WATCH THIRD\* TRANSMITTING CODE ASSIGNED FIVE WATCH. SAIL CONGRATULATIONS STOP NO FRENCH SIGNALS RECORDED. SCHNELL."

### December 27th.

"ADDITIONAL TWENTYFIFTH HEARD FIVE WATCH SAIL CODE VERIFIED MESSAGE RECEIVED STOP TWENTYSIXTH HEARD FIVE WATCH SAIL STOP NO FRENCH SIGNALS. SCHNELL."

### December 28th.

"ADDITIONAL REPORTS FIVE WATCH SAIL TWENTY FOUR AND TWENTYSIX CODE VERIFIED STOP TWENTYSEVEN FRENCH EIGHT ABLE BOY COMPENSATED WAVE PROBABLE. SCHNELL."

### December 30th.

"NO BRITISH FRENCH SIGNALS TWENTYEIGHTH STOP TWO FOX ZED NO FRENCH TWENTYNINTH. SCHNELL."

### December 31st.

"THIRTIETH FRENCH EIGHT ABLE BOY HEARD ONE HOUR STEADILY CODE VERIFIED NO BRITISH SIGNALS. SCHNELL."

\* Probably a mistransmission for HEARD.

### January 1st.

"THIRTYFIRST NO BRITISH OR FRENCH SIGNALS REPORTED FINAL REPORT TOMORROW.† SCHNELL."

From the above it will be noted that the reception of two British stations is reported in addition to one French, but the accuracy of some of these claimed receptions has been doubted, since the British station 2 FZ was not in operation during the tests.

The official report of the receptions has, however, now been received from the traffic manager of the American Radio Relay League, under the following covering letter which may perhaps be of interest as throwing a little light upon the conditions under which the tests were carried on:—

To the Sub-Committee of

The Radio Society of Great Britain.

Gentlemen, we congratulate you!

The Transatlantic Tests were highly successful, and on behalf of the members of the American Radio Relay League, I beg to extend our cordial thanks for your superb co-operation in making the tests successful.

Your reception reports were far in excess of anything we had ever hoped to get from your amateurs. No one dared even dream of such splendid work. Our reception was badly jammed by our own stations, but we offer no alibis, your stations performed much better than ours in reception of signals. Our amateurs did not observe the periods of quiet air as we expected. As far as future Transatlantic Tests are concerned, we do not believe it will be necessary to repeat our transmission to you, as you have demonstrated beyond any question of doubt that you can copy our signals almost at will. However, we would like to have another chance at copying your signals at some future date. In that respect it is only fair to say that transmission on wavelengths of 440 metres is subjected to severe jamming from ship and shore stations which continually use that wave, and their sparks cause tremendous interference. We rather listen on wavelengths between 160 and 290 metres simply because wavelength bands above 290 metres are being used for some other service and interference is to be expected.

Before listing our reception reports by days, the following corrections are to be made:—

December 23rd, the reception of 2 PO is reported. Can you verify transmission of any British station signing 2 PO?

December 25th, add reception of French 8 AB and British 2 JZ. We are under the impression that 2 JZ in this particular case may have been British 2 FZ.

December 26th, add reception of British 2 FZ.

† NOTE.—No additional radio report was received.—P.R.C.

December 29th, cancel report of reception of British 2 FZ.

December 31st, add reception British 5 WS.  
Cordially yours,

F. H. SCHNELL.

January 10th, 1923.

(Traffic Manager.)

The corrections noted at the end of this letter are corrections to the above radiograms, which corrections were incorporated in the official report sent with the letter, and which reads as follows:—

### TRANSATLANTIC AMATEUR RADIO TESTS, 1922.

Reception report by days, with call letters of receiving stations, types of receivers and tube equipment, and names and addresses of successful receiving stations.

December 22nd, 1922.

No signals reported (many of our transmitting stations were confused because of G.M.T., and therefore continued testing).

December 23rd, 1922.

G.M.T.	Heard	Heard by	Remarks.
0218	2 FZ	9 DRR	Sending "test." Wave about 200 metres. Receiver - super - regenerator and two-step A.F. amplifier.
0333	2 FZ	3 HS	Sending "test" (receiver - detector and one-step A.F. amplifier).
0345	2 FZ	8 AMD	Sending "test." Wave about 250 metres.
0400	8 AB	8 FQ	Receiver - detector and one-step A.F. amplifier. Wave about 240 metres.
?	2 PO	8 FQ	Wave about 180 metres.
?	2 FZ	2 BML	Also other British stations heard, but jammed by our transmitters.

December 24th, 1922.

0156	5 SW	1 RU	(The writer listened at 1 RU with the owner, and both of us distinctly heard the code letters AFGCX (assigned to 5 WS) and the sign 5 SW several times. Apparently the transmitting operator was confused. The signal was perfectly clear, steady and easily readable on regenerative tuner, detector and one-step A.F. amplifier. The manipulation at the transmitter was perfect machine-like precision.
------	------	------	--

G.M.T. (about)	Heard	Heard by	Remarks.
0200	5 WS	3 BEC	Code verified.
0220	5 WS	2 BBB	Code verified. Wave about 215 metres. Receiver - Reinartz, and one detector tube.
0220	5 WS	1 ANA	Code verified. Message to American amateurs received. Beverage antenna, Reinartz tuner.
0230	5 WS	1 XP	Code verified. Three-step R.F. detector and one-step A.F. amplifier.
0230	5 WS	L. D. Warner.	Code verified. Wave 200 — 210 metres.
?	5 WS	1 BFG	Code verified.
?	5 WS	1 BQD	Code verified.
?	5 WS	1 OR	Code verified.

December 25th, 1922.

0150	8 AB	8 FQ	Wave 240 metres.
0435	2 FZ	2 BSK	Wave about 200 metres.
0435	2 FZ	2 GK	Wave about 200 metres. Receiver - Reinartz tuner, detector one - step A.F. amplifier.
0440	2 FZ	8 FQ	Wave about 200 metres.
0440	2 JZ	8 FQ	(Probably 2 FZ.)
0445	5 WS	1 ANA	Code verified.

December 26th, 1922.

0025	2 FZ	2 CQO	Wave about 245 metres. Sending "V's." Receiver - Grebe Cr.9, detector and one-step A.F. amplifier.
0154	5 WS	1 MO	Sending "Radio Society of Great Britain." Receiver - regenerative tuner, detector and one-step A.F. amplifier. (K. B. Warner and the writer listening. Manipulation of transmitter not quite

G.M.T.	Heard	Heard by	Remarks.
			up to standard. Characters were hard to copy, although signal was good and steady.)
		December 27th, 1922.	
?	2 FZ	1 ANA	Fading in and out.
		December 28th, 1922.	
0432	?	1 ANA	Code unreadable o/c jamming.
		December 29th, 1922.	
—	—	—	No signals.
		December 30th, 1922.	
0310-0410	8 AB	C.A. Service.	Code verified. Wave about 190 metres. 25 cycle plate supply. Signals readable for 1 hour. Receiver - regenerative, detector and two-step A.F. amplifier.
		December 31st, 1922.	
0453	5 WS	3 ADP	Detector.

Summary.

2 FZ Heard by	5 SW Heard by	5 WS Heard by	2 PO Heard by	2 JZ Heard by	8 AB Heard by
8 AMD	1 RU	1 BFG	8 FQ	8 FQ	8 FQ
9 DRR		1 BQD			C.A.
3 HS		1 OR			Service.
2 BML		1 XP			
8 FQ		1 ANA			
2 BSK		L. D. Warner.			
2 GK		3 BEC			
2 CQO		2 <sup>o</sup> BBB			
1 ANA		1 MO			
		3 ADP			

Location of Receivers.

Call.	Name.	Adress.
1 ANA	R. B. Bourne	.. Chatham, Mass.
1 BFG	E. B. White	.. Belfast, Me.
1 BQD	G. M. Mathewson	.. Newport, R.I.
1 MO	F. H. Schnell	.. Hartford, Conn.
1 OR	Plymouth Radio Club.	.. Plymouth, Mass.
1 RU	R. S. Miner	.. Hartford, Conn.
1 XP	L. W. Bishop	.. Athol, Mass.
2 BBB	G. C. Engel	.. Ridgewood, N.J.
2 BML	H. H. Beverage	.. Riverhead, L.I., N.Y.
2 BSK	E. St. John	.. Schenectady, N.Y.
2 GK	A. G. Kastenmayer	.. Schenectady, N.Y.
3 ADP	J. W. Burn	.. Chester, Pa.
3 BEC	A. M. Young	.. Radnor, Pa.
3 HS	F. Kral	.. Washington, D.C.
8 AMD	E. L. Murrill	.. Lewisburg, W. Va.

Call. Name. Address.  
 8 FQ F. A. Baumgarten Pittsburg, Pa.  
 9 DRR R. S. Rose .. Marquette, Mich.  
 2 CQO H. M. Zimmerman Elizabeth, N.J.  
 C. A. Service .. South Manchester, Conn.  
 L. D. Warner .. Schenectady, N.Y.  
 (Signed) F. H. SCHNELL.

Since receiving this report enquiries have been made in order to ascertain if possible whether the reported reception of 2 FZ could possibly have been receptions of some other British station having a call sign which might be misread as 2 FZ. such, for instance, as 2 FQ or 2 FP, both of which stations were transmitting during the tests, but the times of these reported receptions do not apparently fit in at all with the times of any transmissions made from this side, and it can therefore only be concluded that some confusion has arisen in these receptions. Possibly the signals that have been reported in this manner may have really had their origin at an American transmitting station or else a transmitter has been employing an incorrect call sign.

The reported reception of 2 JZ is also apparently in error, since 2 JZ was unable to operate his station during every night of the tests and did not transmit any signals at all on the date reported.

No British station having the call letters 2 PO was taking part in any of the individual transmissions in this country, and no station having these call letters can be traced in any of the published lists of British amateur transmitting stations.

It therefore appears that the only British station unquestionably heard in America with verified code words and other transmission was the special station of the Radio Society of Great Britain, 5 WS, which was erected at Wandsworth for the tests, and that the only French station heard was 8 AB, which is operated by M. Deloy, at Nice, France.

A general description of the erection of this special station, 5 WS, has already been published,\* and a technical description of the arrangement of the installation will be given shortly.

It is also of interest to know that two other reports have been received of the reception of the test signals sent out from this country, one report emanating from the operator of a vessel bound from New York to Europe, and the other from the operator of a station at Reykjavik, Iceland. These reports are as follows:—The ship operator was listening-in on a receiver using a single detecting valve, the fundamental wavelength of his relatively large ship aerial being reduced by means of a series condenser. Signals from 5 WS were first heard on the morning of December 24th, when the vessel was 900 miles East of New York, and therefore approximately 2,500 miles West of London, taking a Great Circle measurement. On Christmas morning, at about 2,200 miles from London, 8 AB, a French station, was heard, and signals from a British amateur station were intercepted, sending Christmas greetings, the call letters of this station being doubtful, but thought to be 2 SH. It is interesting to note that this was probably the

\*Wireless World and Radio Review, Vol. XI, pp. 525-527, January 20th, 1923.

case, as **2 SH** located at Highgate, North London, was one of the British stations which was allotted an individual period during the tests. On the morning of the 26th, signals were again heard, including the code word **MUPZN**, which was apparently of British origin. This code word was the one allocated to British **2 OM** located at Brentford, Middlesex. At this time the vessel was approximately 1,900 miles from London. On the morning of December 27th, when the vessel was another 200 miles nearer England, signals from **5 WS** and **2 SH** were again copied. On the morning of December 28th **5 WS** was heard again by the vessel which was then another 200 miles nearer England. On December 30th, when still some 1,100 or 1,200 miles away, signals from the following British stations were heard:—

**2 AW** Wakefield, Yorkshire.

**2 OM** Brentford, Middlesex.

**2 SH** Highgate, London.

**5 MS** Manchester Wireless Society.

**5 WS** Radio Society of Great Britain.

A French station **8 RRX** was also heard.

The operator at Reykjavik, Iceland, who was only able to listen-in on one or two nights, as the set was borrowed, reported that, using a single valve only, the signals from **5 WS** including the code word, were heard on December 24th, while later on the same morning the code word of **2 AW** was heard also.

Doubtless the American listeners had many sources of interference with as had also the British amateurs listening for their signals in the first part of the tests, and as several stations in this country had been granted by the Post Office special permission to use a transmitting power comparable with that employed by the American amateurs, the difference in the receptions in the two countries would seem probably to be due to the much greater use of radio-frequency amplification on this side. The general use of low-power transmitting stations in this country has doubtless been the cause of the development of the most sensitive type of receiver equipment suitable for the reception and amplification of short wave length signals.

### Accumulator Charging.

Where D.C. mains exist for house lighting it is possible to disconnect one of the main leads at the fuse-board and connect the accumulators to be charged in series with the supply. The lead which is at earth potential should be the one utilised, though the precaution should always be taken of well insulating the accumulators from earth, as a slight difference in potential may arise where a heavy current is passing along the mains.

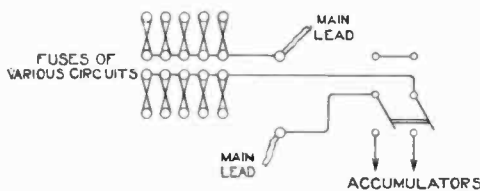

This method of accumulator charging is costless and ensures a slow charging rate. The very slight diminution in the amount of light given out by the lamps in circuit is imperceptible. By means of a double-pole two position switch it is possible to connect the accumulators without interrupting the lighting. An article dealing with accumulator charging from D.C. mains appeared in the issue of January 27th, 1923.

### Amateur Crystal Receiver.

A very simple yet effective receiver made up by a reader after studying an article in this

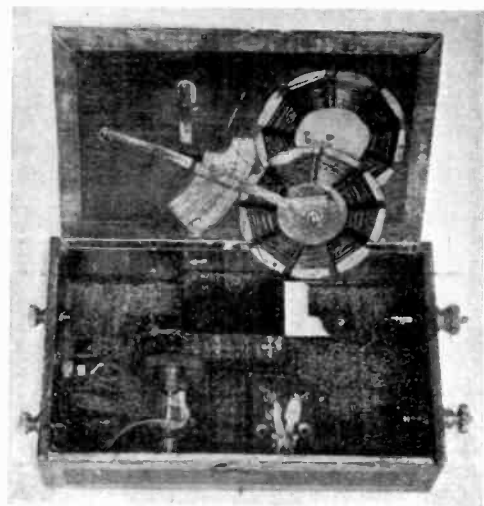

*Official Crystal Receiving Set built in a cigar box and employing variometer tuning.*

Journal. The principle is very similar to that employed in a constructional article for the beginner which appears on another page.

# Dr. Fleming on the Thermionic Valve

A TALK BY THE INVENTOR ON ITS DEVELOPMENT AND ITS APPLICATION TO WIRELESS.

THE following is an address which was broadcasted from the London station of the British Broadcasting Company (2LO) on the evening of February 16th by Dr. J. A. Fleming, F.R.S.

"Although it is my privilege at frequent intervals to address large audiences in scientific lectures, it is a new and interesting experience to speak by wireless telephony to an audience of hidden hearers scattered over a wide area, not one of whom can be seen or heard by the speaker. Wireless telephony is the very last word in the application of scientific knowledge to increase the convenience and pleasure of human life, and it is capable of being made a powerful implement of popular education. Its development is entirely the result of the invention of a wonderful instrument, the thermionic valve, which is a veritable Aladdin's Lamp, annihilating distance and making all the world a theatre through which a single voice can reach. There are many to whom it is a sufficient pleasure merely to have music or speech from distant places laid on in their homes like gas or water for quiet enjoyment. They do not feel any curiosity to know how it is done or what were the stages of invention and discovery by which this modern miracle has been made possible. Others, however, are desirous to understand if possible, the means by which the astonishing feat is accomplished of listening-in without any wire connection to the singers at a distant opera or a concert performed perhaps hundreds of miles away.

"As the earliest stages in the invention of the wireless valve were made by me at

University College, London, between 1889 and 1904, it may interest some of those who are now listening to these remarks of mine by means of valve receivers, to have some short account of the beginnings of that invention.

"In 1882 the electric incandescent lamp so familiar to us all, was perfected by Edison and Swan. The first lamp consisted of a carbon

filament or thread enclosed in a glass bulb from which all the air was pumped out. When an electric current was sent through the thread it glowed with a brilliant light. It was soon found that the bulb became blackened on the inside as the lamp was used, and the filament or thread was after a certain time burnt through at some place by excessive heating. In the course of my experience as scientific adviser of the Edison Electric Light Company, I noticed that in some lamps there was a clear line on the glass bulb on



A recent photograph of Dr. J. A. Fleming, F.R.S.

which no blackening took place, which indicated that the carbon particles had been shot off from the overheated point in the filament in straight lines. The undamaged half of the hairpin-shaped filament by intercepting this shower of carbon atoms caused a sort of shadow or line of no black deposit to be produced on the inner surface of the bulb. A little later on I found that these particles thus shot off were all electrified with so-called negative electricity, that is the kind of electricity produced by rubbing a stick of sealing wax with a bit of flannel.

"At that time it seemed that these charged particles were atoms of carbon, but we did not know then that chemical atoms are built up of still smaller particles called electrons.

"For the sake of those who are not scientific, a few things may be mentioned which are definitely established by countless experiments in modern chemistry. All material substances we know are composed of little particles called molecules. A molecule may be described as the smallest portion which has the distinctive qualities of that substance. Thus a molecule of table salt is the smallest possible part which has the properties of salt. But molecules in turn are built up of atoms of elementary substances. We are acquainted with about 82 different kinds of atoms, and little groups or bunches of these form all the vast variety of substances we know, just as little groups of selections of the 26 letters of the alphabet build up all the thousands of different words we write.

"It used to be thought that atoms were not capable of being divided. The very word atom comes from two Greek words signifying not able to be cut up. The great discovery was, however, made about 1898 or 1899, by Sir Joseph Thomson, the present Master of Trinity College, Cambridge, that chemical atoms of matter are built up of still smaller atoms of electricity called electrons, and it was soon found that the incandescent filament of an electric lamp is sending out vast numbers of these little electrons. An atom of matter is a very small thing—it would take about 25 million of them, put in a row like marbles, to make up the length of a single inch. But an electron is as much smaller than a chemical atom as a grain of dust is smaller than the dome of St. Paul's Cathedral.

"The next step of invention was made in 1904, when I placed around the filament of an electric lamp a cylinder of metal sealed inside the bulb, and found that a current of negative electricity could be sent from the filament to the cylinder but not in the opposite direction. This at once gave us a means for converting the feeble but rapid to-and-fro motions of electricity in an aerial wire, which are set up when electric waves from a distant transmitting station strike the aerial wires, into a current of electricity all in the same direction by including in the circuit such a lamp with cylinder round the filament. I therefore called the instrument a valve because it acts, as regards electricity, as a valve in a pump acts for air or water. It is now called a thermionic valve.

"Next a word must be said as to the processes of wireless telephony. At the transmitting station there are special kinds of valves

called three-electrode or transmitting valves, which create in the aerial wires at the broadcasting station powerful to-and-fro or oscillatory or vibratory electric currents. These in turn create in all surrounding space effects called electric carrier waves, which fly out in all directions. At the broadcasting station there is also a device called the microphone, which picks up the sound of the speaker's voice or of the music and causes the carrier waves to be increased or diminished in amplitude or strength in accordance with the ever varying amplitude or pressure of the air waves of the speaking voice. When the modulated carrier waves strike the aerials of listeners they produce in them electric currents which are a feeble copy of those in the transmitting aerials. If, then, the receivers contain a rectifying valve or a crystal detector, these pulsatory currents are converted into a flow of electricity all in one direction through the receiving telephones, and this causes them to emit a sound of the kind made to the transmitting microphone.

"Subsequently to my invention of the two-electrode valve, De Forest, in America, introduced the grid or spiral of wire placed between the filament and the metal cylinder, which converted it into a so-called three-electrode valve. This enabled the valve to amplify electric oscillations as well as rectify or detect them. In its most recent types, which are the outcome of the work of many able inventors, the valve can perform three duties—it can detect electric vibrations, amplify or magnify them, and also create them, and it can truthfully be described as the master weapon of the radio engineer. Without it wireless telephony would be only the occasional feat of experts. With it wireless telephony has become the everyday amusement of thousands of amateurs in their own homes."

#### Radio Society of Great Britain.

At the next Meeting, to be held at 6 p.m. (tea at 5.30 p.m.) on Wednesday, February 28th, at the Institution of Electrical Engineers, Mr. Philip R. Coursey will describe the Society's station used in the Transatlantic Tests.

The second of a series of lectures, especially arranged for associates, took place on February 16th, when Mr. Maurice Child gave an elementary lecture and demonstration. Much benefit can be derived from these attractive instructional lectures by those new to wireless. Associateship is open to all interested in the subject, and the annual subscription is five shillings.

## Wireless Club Reports.

*NOTE.—Under this heading the Editor will be pleased to give publication to reports of the meetings of Wireless Clubs and Societies. Such reports should be submitted without covering letter and worded as concisely as possible, the Editor reserving the right to edit and curtail the reports if necessary. The Editor will be pleased to consider for publication papers read before Societies. An Asterisk denotes affiliation with the Radio Society of Great Britain.*

*Correspondence with Clubs should be addressed to the Secretaries direct in every case unless otherwise stated.*

### Kensington Radio Society.\*

Hon. Secretary, Mr. John Murchie, 2, Sterndale Road, West Kensington, W.14.

The annual meeting was held at headquarters on January 4th, when the Secretary presented a report of the Society's activities during the past year.

The new President, Mr. J. H. Reeves, M.B.E., gave an address and followed this up by a lecture on his experiments with the design of H.F. transformers for short wavelengths. Later, a most interesting discussion took place on the points raised.

The minutes of the last annual meeting were read and confirmed. The balance carried forward was £5 15s. 1d.

The present officers submitted their resignations and the following were elected for 1923:—President, Captain C. T. Hughes, R. E.; Vice Presidents, Lt.-Col. K. E. Edgeworth, D.S.O., M.C., Mr. A. F. Hogg, M.A., F.C.S., Mr. A. Vinycomb, D.Sc., Mr. W. L. McPherson, B.Sc., Mr. W. T. James, Mr. Goldstone; Hon. Secretary, Mr. H. J. South; Hon. Asst. Secretary, Mr. A. G. Beeson; Hon. Treasurer, Mr. G. Powling; Librarian, Mr. P. Smith; Custodians of Apparatus, Mr. M. A. G.



*Police Constable William Wooding of the Metropolitan Police Force with his home-made seven-valve set unit and four-valve amplifier on which he has received broadcast telephony from America.*

The Hon. Secretary will be pleased to give particulars to any person desirous of joining the Society (whether in the possession of a broadcast or experimental licence).

### Woolwich Radio Society.\*

Hon. Secretary, Mr. H. J. South, 42, Greenvale Road, Eltham, S.E.9.

The annual meeting of the above Society was held at the Y.M.C.A., Woolwich, on Friday evening, January 26th, 1923, at 8 p.m. Captain C. T. Hughes, R.E., Vice-President, being in the chair.

Beeson and Mr. F. Cameron; Committee, Messrs. Houghton Frazer, Potter, F. W. Smith and Cameron.

A hearty vote of thanks was passed to all the gentlemen who had rendered valuable services during the year, and to Mr. Ellam and Mr. Morley for gifts of apparatus.

The result of the competition organised for the crystal set of home construction which was the most simple and efficient, was then announced. The first prize, a pair of Brown's H.R. telephones,

was awarded to Master F. Edwards; the second prize, a W. & M. variable condenser, to Mr. G. Dowling; the third prize, a complete aerial, to Mr. F. W. Smith.

Intending members are welcomed at any weekly meeting on Wednesday evenings at 8 p.m., at the Y.M.C.A., Thomas Street, Woolwich.

#### The East London Radio Society.\*

Hon. Secretary, Mr. S. D. Simmons, 60, East Ferry Road, London, E.14.

On Tuesday, January 30th, two interesting short lectures were given in the Lecture Hall, Woodstock Road, E.14, by Mr. A. J. Alexander and Mr. J. Keens.

Mr. Alexander gave a lucid description of a non-radiating two-valve (H.F. and Detector) set, from which he had had excellent results. He impressed upon the members the necessity for all amateurs holding experimental licences, to use some such circuit as this when conducting experiments during broadcasting hours.

Mr. J. Keens followed with very informative details as to the construction of an accumulator H.T. unit.

The Secretary of the Society will be pleased to hear from all amateurs in the district, and visitors to the Lecture Hall, Woodstock Road, E.14, will receive a cordial welcome any Tuesday or Friday evening after 7.30 p.m.

#### Ramsgate, Broadstairs and District Wireless Society.\*

Joint Hon. Secretaries, Mr. F. Harrison, "Rochester Cottage," St. Lawrence, Ramsgate (Ramsgate), and Mr. F. C. Marshall, 6, Ramsgate Road, Broadstairs (Broadstairs and District).

During the month of February, Mr. James Hunt, who has been elected to the Committee, gave some very interesting lectures on "Transformers" with practical demonstrations. Mr. Hunt, who has evidently studied his subject with much care, has been keenly followed by the members week by week, and all state that much valuable information has been received. Mr. Hunt has been cordially thanked by the Society for the trouble and time he has devoted to making his lectures so lucid and instructive. The Society is pleased to state that Mr. Hunt has received with great clearness the American Concert transmitted on Saturday, January 20th, from WJZ, which included music and a speech on the "Ruhr Question" by a Mr. Abbott, the concert being transmitted from a Studio at 11, West 49th Street, New Jersey City.

The Society's membership shows an increase over that of last month, and the membership list is now nearing fifty. Mr. W. R. Greatwich of "St. Benets" Ramsgate, has been elected a Vice-President of the Society.

#### Wolverhampton and District Wireless Society.\*

Hon. Secretary, Mr. J. A. H. Devey, 232, Great Brickkiln Street, Wolverhampton.

An exceedingly interesting and instructive lecture was given to the above Society by the Vice-President, W. E. Fisher, Esq., D.Sc., on Wednesday, January 31st, entitled "Oscillations," a large number of wireless experimenters being present.

Dr. Fisher, in his discourse, treated the subject of oscillations from several standpoints, including those of sound and light, mentioning that most

of our ideas on the subject have been evolved from sound, giving as illustrations the vibrations of a tuning fork or of a fiddle string, and explaining that the medium through which vibrations pass fixes the speed, also pointing out that the transmission of light across space proves that there is a medium.

The lecturer went on to say that we cannot have an electric current without an effect on space. Emphasis was laid on the fact that there was a marked resemblance between the transmitter and the receiver, and that good radiators were also good absorbers.

The theory of the wave motion was dealt with in a most scientific manner, showing why wireless waves differed from other kinds, and the reasons for the use of long and short wavelengths, etc.

The appreciation of the audience was shown by the applause and the thanks accorded to Dr. Fisher at the conclusion of the lecture.

#### Smethwick Wireless Society.\*

Hon. Secretary, Mr. R. H. Parker, F.C.S., Radio House, Wilson Road, Smethwick, Staffs.

At a meeting held at the Society's headquarters on January 12th, the syllabus of forthcoming lectures was discussed, some sixteen lectures, visits and field days being arranged.

#### Watford and District Radio Society.

Hon. Secretary, Mr. F. A. Moore, 175, Leavesden Road, Watford.

On Friday, January 26th, the above Society made a break in the usual programme of lectures, and gave a wireless demonstration at headquarters, a four-valve set with Amphon loud speaker being kindly lent by Mr. Christie for the occasion.

The fact that the large room used by the Society was packed with visitors proves the popularity of the subject in the town.

Mr. Christie commenced proceedings at 8 p.m. with a general survey of the basic principles of wireless telephony. Later on 2 LO was tuned in and music and speech were plainly audible all over the room.

In view of the popularity of this demonstration, the Society propose giving others in the near future.

#### Haileybury College Wireless Society.

Hon. Secretary, Mr. D. H. Carter.

This Society was formed last term (October, 1922) with Dr. Thomas, M.A., B.Sc., LL.B., Ph.D. as President; J. C. Yule, Esq., as Vice-President and Hon. Treasurer and D. H. Carter as Hon. Secretary. Other members of the Committee are Messrs. R. R. C. Armour, R. Griffith, C. H. Lankester, H. R. Mappin, J. B. Miller, and R. F. Wilson. The total membership for the greater part of last term was 87.

The object of the Society is educational, and with this end in view, lectures were held fortnightly last term; and this term an aerial is to be at the disposal of members, on which to use their own and the Society's apparatus.

#### Cricklewood Radio Club.

The first meeting of the above club in their new rooms at the old Billiard Hall, St. Peter's Church was held on February 3rd, at 8 p.m.

The Chairman, Mr. James C. Fisk, in opening the meeting, set forth briefly for the benefit of new members the objects of the club and promised



attractions in the shape of lectures, experiments, and demonstrations each week. At 8.45 p.m., Mr. H. Stopher of the Technical Committee was called upon to give the first of a series of progressive lectures which proved to be very instructive.

#### The Wisbech and District Radio Society.

Hon. Secretary, Mr. A. Hopkin, 13, Victoria Road, Wisbech.

The above Society has been formed, and those interested who reside in the district are invited to join.

#### Swansea and District Radio Experimental Society.

Hon. Secretary, Mr. Herbert T. Morgan, 218, Oxford Street, Swansea.

On January 24th at their headquarters, the Y.M.C.A., a very interesting lecture on "The Thermionic Valve" was given by Mr. H. Mactaggart, of the General Electric Company.

He concluded his lecture by answering many questions and clearing up debatable points. The lecturer also referred to the four-electrode valve, and has promised a demonstration and lecture on this valve at an early date.

#### Leeds Y.M.C.A. Wireless Society.

Hon. Secretary, Mr. N. Whiteley, Y.M.C.A., Albion Place, Leeds.

A meeting was held at headquarters at 7.45 p.m. on January 22nd, with Mr. G. Boocock in the chair. After the minutes of the previous meeting had been read and accepted, the Chairman called upon Mr. Toynbee to give his paper entitled "Accumulators, their Construction, Action and Treatment." Mr. Toynbee dealt with his subject in an exceedingly able manner, and at the close dealt with various questions asked regarding the Edison Nickel Cell, etc. The lecturer was thanked with much enthusiasm.

To stimulate an interest in telegraphy, Mr. Whiteley then gave an interesting description of commercial working, and announced the formation of a Morse class.

The meeting room has now been fitted up with all the necessary tools and appliances, and work has been commenced on the Society's four-valve set, so that operations can be commenced when the licence arrives.

The next meeting was held on January 29th, at 7.30 p.m., the chair being taken by Mr. G. Boocock. The evening was devoted to general discussion, one item, the proposed aerial, bringing forth a storm of suggestions. The club-room is situated in the basement of the building, and does not hold a very ideal position for the use of an outside aerial. Experiments will be made with frame aerials and also lighting mains.

Mr. R. H. Toynbee was elected Chairman for the ensuing month.

The following are the present arrangements:— Monday nights, at 7.30, lecture or discussion; Wednesday nights, at 7.30, workshop night and Morse class; Saturday afternoon and other times as required, workshop practice.

#### Radio Society of Birkenhead.

Hon. Secretary, Mr. R. Watson, 35, Fairview Road, Oxtou, Birkenhead.

A meeting of the Radio Society of Birkenhead took place on January 18th. Buzzer practice was held at 7.30, taken by Mr. McKinlay, a skilled operator, and at 8 p.m. the Chairman, Mr. King, called upon Mr. McKinlay to deliver a lecture on accumulators. The lecturer, in a very able

manner, described the action and construction of an accumulator, showing the difference between the dry battery and the accumulator.

Mr. McKinlay has very kindly presented the Society with some excellent diagrams of various ship sets. A very lively discussion took place after the lecture, and many questions were asked as to the mysterious fading effect of 2 LO which is experienced in these parts.

#### Hoylake, West Kirby and District Wireless Association.

Hon. Secretary, Mr. J. D. Wood, 7, Grosvenor Road, Hoylake.

A general meeting was held at the Green Lodge Hotel, Hoylake, on January 22nd, when the chair was taken by the Vice-President, Mr. S. Evans, A.M.I.E.E. In the course of his opening remarks, Mr. Evans referred to the ladies' meeting held on February 5th, when through the courtesy of Mr. G. V. Wall, members and their lady friends were enabled to listen-in to a concert from one of the B.B. Company's stations. The Chairman then called upon Mr. Waygood, A.M.I.E.E., to give his lantern lecture on "Transformers."

The lecture, with its many excellent lantern views, was thoroughly appreciated by all present, a detailed and lucid exposition being given of the theory, construction, and evolution of the modern transformer. Among the lantern views of large transformers was one of a three-phase transformer weighing 2 tons 17 cwt., which is cooled by immersion in a tank containing 5 tons of oil. The terminals on this transformer measure 8 ft. in length and are built in the form of a condenser in order to cope with the pressure of 100,000 volts.

Questions were answered by Mr. Waygood at the conclusion of his very informative lecture. Mr. J. H. Harley proposed a vote of thanks, which was seconded by Mr. S. Evans, who also proposed a vote of thanks to Mr. S. H. Cocks for his handling of the lantern.

#### The Portsmouth and District Wireless Association.

Hon. Secretary, Mr. S. G. Hogg, 9, Pelham Road, Southsea.

Undoubtedly the best resolution this Association could have made to begin the New Year was its application for affiliation to the Radio Society of Great Britain.

At the annual meeting of the club held in December, Mr. J. H. C. Harrold, A.M.I.E.E., was elected President of the Club for the present year, and at the meeting of the Association held on January 24th Mr. Harrold delivered his Presidential address.

After returning thanks for his election as President, Mr. Harrold promised to do his utmost for the club, and be worthy of the honour of the Presidential Chair. He then gave a short address on wireless telegraphy in general, explaining the advancement that it had made. Upon request, the President then explained that a single aerial is preferable, but there are limits to the heights to which they may be erected. There was a tendency to erect them as high as possible, which, however, only increased the number of spark signals, and decreased the C.W. signals.

Meetings are held at the Club-rooms, situated at The John Pile Memorial Rooms, 44, Fratton Road, Portsmouth, on Wednesday evenings at 7.30 p.m.

**Huddersfield Radio Society.\***

Hon. Secretary, Mr. C. Dyson, 14, John William Street, Huddersfield.

An interesting evening was spent by the members of the Huddersfield Radio Society on Tuesday, January 23rd, in listening to Mr. J. L. Goss's explanation of the Society's receiving set. Mr. J. A. Badham occupied the chair, and there were about 30 members present.

Mr. Goss stated that the set had been designed and built by the technical committee. Three valves were employed, and provision was made for the addition of two more valves. The set was housed in a polished mahogany cabinet, and each valve was mounted on a separate panel, in order that any combination of circuits could be tested. The tuning unit was separate, and of the well-known three-coil type. This was designed and constructed by Mr. J. W. Jowett, of the technical committee. The moving of the tuning coils was operated by heavy brass gears, and all terminals, switches, and other fittings were nickel plated. The instruments worked exceedingly well, and Manchester broadcasting could be heard with the 'phones on the table.

A vote of thanks was proposed by Mr. P. Priest.

**Durham City and District Wireless Club.\***

Hon. Secretary, Mr. E. H. Chapelow, 2, Brierville, Durham.

At the meeting held on January 26th the Chairman announced that on account of business changes, Mr. G. Barnard had tendered his resignation. Pending the annual general meeting, the Committee have appointed Mr. E. H. Chapelow, of 2, Brierville, Durham, to succeed to the office. Mr. Chapelow is a well-known local citizen, and will commence his duties with the best wishes and active support of his club colleagues.

Mr. Chas. Donaldson, of the Postal Service, gave a lecture on the "Electron Theory." The lecturer gave much valuable information, and concluded by giving some very interesting illustrations of the uses to which "wireless" was put during the war. A hearty vote of thanks was accorded to Mr. Donaldson at the conclusion.

**Radio Society of Wallasey.\***

Hon. Secretary, Mr. C. D. M. Hamilton, 24, Vaughan Road, New Brighton.

The annual general meeting, held on December 20th, 1922, brought to a close a most successful session. The election of officials for 1923 was arranged, and the vacancies were filled as follows:—President, Mr. J. C. Mason; Vice-President, Mr. F. Cowan; Hon. Treasurer, Mr. W. F. Mills; Hon. Secretary, Mr. C. D. M. Hamilton; Assistant Hon. Secretary, Mr. W. Smith; Committee, Messrs. Bellas, Martin, McBride, Taylor, Roscoe and Wood.

The Presidential address was delivered on December 27th, Mr. Mason selecting "Ohms Law" as the subject of a most interesting lecture.

January 3rd was an open night, the evening being devoted to the settlement of various difficulties advanced by the members.

Mr. Roberts very kindly gave a continuation of his lecture, "The Earth in the Aether and Unsolved Problems" on January 10th. As usual Mr. Roberts' lecture raised many points of interest which were discussed at length.

On January 16th a valuable lecture on "Direction Finding" was delivered by Mr. R. H. Taylor.

**The Working Men's College Wireless Club.**

Hon. Secretary, Mr. A. Fryatt.

A dance was given by the above club on January 5th, 1923, to aid the club's funds, and thanks to the efforts of members of the College and their friends, it was a great success.

With the proceeds it is proposed to install a powerful receiving set, and to convert the present cabin into a cosy parlour in order that members can invite their friends to listen in on specified evenings to the broadcasted performances now being given by Marconi House and other stations in England.

The club greatly appreciated the broadcasting of the Covent Garden Opera, which was splendidly received.

All who wish further particulars of the Club are asked to communicate with the Secretary, at the Working Men's College, Crowndale Road, N.W.

**The Hinckley and District Radio Society.**

Hon. Secretary, Mr. W. Bliss, The Haven, Cleveland Road, Hinckley.

The recently formed Society held its first meeting on January 16th at the premises of Messrs. W. Ward & Son, who have placed a room at the disposal of the Society until suitable accommodation is forthcoming. Rules of the Society had previously been drawn up by the committee, and these were explained to the meeting and copies distributed.

The Secretary reported that several prominent gentlemen had been approached with a view to their election as Vice-Presidents, but there had not been time to receive replies.

The question of securing permanent premises was discussed, and the Secretary instructed to ascertain whether a room was available at the Grammar School. Several new members were enrolled, and it was decided to form a Morse class.

Meetings will be held on alternate Tuesdays.

**St. Bride Radio and Experimental Society.**

A meeting was held on Tuesday, January 9th, at St. Bride Foundation Institute, Bride Lane, E.C.4, when a Formation Committee was established to make preliminary arrangements, draft rules, etc. The Committee met again on Tuesday, January 23rd, and have now completed all the details necessary to place before a general meeting. This meeting, which will be held at a date in the near future, will be preceded by a short address and demonstration by an influential gentleman who has kindly consented to become President of the Society. Due notice will be given in the technical Press, but anyone interested should send his name to the Hon. Secretary at the above address, when notice of meeting will be posted.

**Proposed Radio Club at Grays (Essex).**

In connection with the proposed formation of a radio club for Grays and District, a meeting was held at the Victoria Hall, Grays, on February 1st. It is hoped that all wireless enthusiasts in the district, whether already possessors of sets or not, will communicate with Mr. L. Freeman, of the Empire Theatre, Grays, and help to make the club the success it already promises to become.

## Notes.

### The Opening Ceremony at 5 WA.

The opening of the new Cardiff Broadcasting station 5 WA, and the formal inauguration of the Service, was performed by the Lord Mayor of Cardiff, Alderman Dr. J. J. Biggs, on the evening of Tuesday, February 13th.

### The Progress of British Broadcasting.

With the addition of the Cardiff station (5 WA), which was opened on February 13th, there are now five broadcasting stations in operation in Great Britain. The sixth will be the Glasgow station, which is expected to be opened on Monday, March 19th. This station will have the call letters 5 SC, and will carry out transmissions on a wavelength of 415 metres. There is also some talk of establishing a station at Plymouth in accordance with the Postmaster General's original plan, but up to the present no decision has been reached.

### Reserve of Air Force Officers.

The Air Ministry announces a decision to expand the reserve of officers by the entry as officers of a number of ex-officers of the Flying Services and others with special qualifications for flying and technical duties. The Air Ministry is accordingly prepared to receive applications for enrolment from officers who served as pilots in the R.F.C., R.A.F. or R.N.A.S. in the war, and gentlemen qualified as civilian pilots or possessing technical qualifications, including wireless telegraphy and signals. Full details and forms of application may be obtained from the Secretary, Air Ministry, Kingsway, W.C.2.

### Bamberger Broadcasting Station (WOR).

Experimental telephony transmissions will be made commencing at 12 p.m. (New York time) on February 23rd, with a view to bridging the Atlantic. A special concert is being arranged, and it is hoped on this occasion that reports of successful reception will be forthcoming from experimenters in Europe.

### The 450 metre French Telephony.

L'Ecole Supérieure des Postes, Télégraphes et Téléphones de Paris, is conducting, from its technical laboratory, special telephonic transmissions. This laboratory conducts research work in all branches of wireless telegraphy and telephony. At the present time the experiments consist in trying out from the point of view of volume and quality all possible types of wireless telephone transmitters, and in order that these tests shall be as exhaustive



*The Mayor of Cardiff speaking into the microphone on the occasion of the opening of the Cardiff Broadcasting Station. Among those present are:—Sir William Noble, Lord Gainsford, Mr. Cory and Mr. J. C. W. Reith.*

as possible, transmissions of all kinds, such as speech, music, and songs, are included in the programmes. The transmissions take place regularly on Tuesday and Thursday evenings from 7.45 to 10 o'clock, and on Saturday afternoons from 4.30 to 7.30. The wavelength used is 450 metres with 500 watts in the antenna. The transmissions commenced on January 23rd last. Many reports are received in this country of these transmissions, whilst in Paris and neighbourhood reception is excellent on a crystal. This station is proposing to transmit lectures of an educational nature, which will undoubtedly be very much appreciated.

### Four Broadcasting Stations Received on a Crystal Set.

A Burnham-on-Sea reader, Mr. L. Lott, using a Pericon crystal receiver only, has succeeded in hearing four of the five British Broadcasting Stations. Birmingham and Manchester, as would be expected, were heard loudest with Newcastle fainter, but as far as the music was concerned fairly distinct. These results were obtained by using a single-valve circuit with no reaction, and then changing over to the crystal. Another experimenter, Dr. Burns, President of the Burnham, Highridge and District Wireless Society has also been successful in receiving three of the five stations on a similar circuit.

### Death of Professor Röntgen.

Professor Wilhelm von Röntgen, the well-known German physicist and discoverer of X-rays, has died at Munich at the age of 78. Röntgen was born at Lennep in Rhenish Prussia, and became Professor of Physics in the University of Würzburg in 1885. It was while carrying out some experiments with the Crookes tube that Röntgen discovered the existence of what he called "X"-rays,



*Professor Wilhelm von Röntgen.*

and which are now associated with his own name. It was readily perceived by Röntgen himself and many other physicists that his discovery must give a new turn to the then current view of the constitution of matter. Other workers correlated this and subsequent discoveries with their own

observations in electrical science, and the movement may be said to have culminated in the epoch-making discoveries of Bragg and Rutherford and our present achievements in wireless telegraphy and telephony. The application of Röntgen rays to the treatment of disease is a familiar feature in present-day surgery and their use in the industries as a means of examining opaque bodies for internal structure and defects is extending rapidly.

### Wireless Sets Wanted for Hospitals.

The good work carried on by the Alexandra Musical Society in providing entertainments for the wounded soldiers and sailors still in hospital and other sick persons in hospitals and sanatoria demands the greatest support and encouragement. Wireless entertainments have been successfully introduced, and have met with great appreciation and the President of the Alexandra Musical Society, The Rt. Hon. Lord Leigh, makes an appeal for gifts of wireless receiving sets for the hospitals of the West Midlands, etc. Firms willing to help in this direction should write to Mr. E. C. Thomas, 249, Albert Road, Aston, Birmingham.

### Wireless Developments in Brazil.

Rapid developments in radiotelephony are expected to take place in Brazil with a consequent wide demand for receivers. Radio apparatus hitherto entering Brazil has mainly been of German or United States origin. Importers of wireless apparatus are at present required to obtain a special permit issued by the Department of Transportation and Public Works, but the Government has been approached upon the question of abolishing or modifying such restrictions so as to admit of a wider market for radio apparatus. A wireless service has been established between the Republics of Brazil and Mexico under treaties concluded between the two states. German enterprise, it is reported, is seeking to obtain a concession for the introduction into Mexico of radiotelephone broadcasting.



*A party on the Euston to Liverpool express train listening to a broadcast entertainment. The experiment was carried out by Captain G. R. Willans, of the Marconi Company.*

**The Sterling Telephone Company's Booklet.**

Publication No. 342 of the Sterling Telephone and Electric Co., Ltd., Tottenham House, Tottenham Court Road, London, is an illustrated catalogue of this well-known firm's radio receiving sets from crystal to multivalve.

**A Leeds Firm's New Branch.**

The British Wireless Supply Co., Ltd., of Leeds, has added to its branches showrooms at 64, Frith Street, Shaftesbury Avenue, London, where demonstrations are held daily, and a full line of the firm's manufactures can be examined. This concern has also opened a new experimental laboratory and test department at Virginia Mills, Leeds.

**Messrs. Burndepts' New Catalogue.**

In the form of a well printed and artistic booklet, Messrs. Burndept, Limited, of Eastnor Works, Blackheath, S.E.3, have issued a catalogue of the amateur and experimental receiving equipment manufactured by them. Descriptive details and numerous illustrations make this publication, the price of which is 1s., an attractive and useful guide to all who are interested in wireless.

**A Handy New Terminal.**

The Birmingham Products Co., of 11, Summer Row, Birmingham, are manufacturing a new type of small terminal which is particularly useful in experimental work.

## A Year Book for the Amateur and Experimenter.\*

THE enormous increase in the serious interest taken in Wireless in all its branches has added to the ranks of the Amateur and Experimenter to such a degree that it was felt that a Year Book specially devoted to their interests was not only desirable but absolutely necessary. The publishers of *The Year-Book of Wireless Telegraphy and Telephony*,† have therefore filled the gap with a special edition devoted solely to these interests. Its 864 pages are chock-full of wireless interest arranged in a systematic and concise form facilitating easy reference to any Wireless Want.

In addition to the usual Year Book contents there is a complete Historical Survey of Wireless from its birth up to the present day, written by J. St. Vincent Pletts, a well-known authority on Wireless. A specially compiled section giving the Laws and Regulations of the countries of the world regarding Amateur, Experimental and Broadcast wireless shows at a glance the position of the Amateur, the Experimenter and the Broadcast Receiver, with regard to the laws of the particular country in which he is domiciled. A Directory of Wireless Traders, included at the end of this section, should prove of considerable value to those who wish to purchase either complete sets or accessories for making up their own instruments.

Every listener-in wants to know who and what the signals are that he is receiving; the Directory of the World's Wireless Stations, containing every known land, ship and air station, in conjunction with the specially drawn map section, printed in two colours, forms the most complete and detailed information yet published. Ready reference is obtained at a glance to any station from its call letters, or *vice versa*.

Similarly, a section containing the most up-to-date information on Hydrographic, Meteorological, Time and General Signals, with explanation and tabular transmission lists for every country of the world, enables any such signal to be recognised and decoded. The section has been prepared by W. G. W. Mitchell,

\* *The Year-Book of Wireless Telegraphy and Telephony*. 6s. nett. The Wireless Press, Ltd., 12-13, Henrietta Street, W.C.2.

† *The Year-Book of Wireless Telegraphy and Telephony*. 15s. nett. The Wireless Press, Ltd., 12-13, Henrietta Street, W.C.2.

whose articles in this journal have been so much appreciated.

Direction Finding is a subject of growing importance, and is taken care of in a special section where an instructive article by R. L. Smith-Rose is followed by the Regulations and Procedure in force for Direction Finding in the various countries of the world. "Recent Progress in Automatic Reception," "Aerials," "Valve Design and Manufacture," and "Multiple Aerial Arrangements," form the subject matter of the four special articles specially written for this Year Book. A complete Patent section, with an article on the Valve Patents of 1922 and British and American Patent Specifications for the past year, give the Patent situation to date.

Progress in Aviation Wireless has been consolidating during the past year, and an article by an official of the Air Ministry gives, in a clear and interesting manner, the position of Wireless in its relation to Civil Aviation. Much other useful information combines to form an Aviation Section.

Ready reference to data for necessary wireless calculations is difficult and involves, usually, perusal of several publications. A Useful Data Section giving Definitions, Foreign Equivalents, Useful Tables and Graphical Symbols for Wireless Diagrams, should do much to obviate this and bring to hand much that takes precious time to search for.

Company Notices, Biographies, Obituary Notices, a Literary Index, and a Code Section are self explanatory from their titles, and are more complete than has yet been possible to produce in the advance of the science and practice of Radio.

Mentioned last, but by no means least in importance, is the extensive Amateur and Experimental Section in which the Editor of *The Wireless World and Radio Review* gives a *résumé* of the Amateur and Experimental situation. This is followed by a Directory of the World's Wireless Societies, Call Signs and particulars of British and French Experimental Transmitting Stations, and a List of Regular Transmissions.

Every Wireless enthusiast should obtain a copy of this Year Book. By so doing he will save much anxious thought and render his experiments all the more interesting by reason of his having to hand reliable information for ready reference.

E. A. G.

CIRCUIT OF A SEVEN-VALVE RECEIVER.

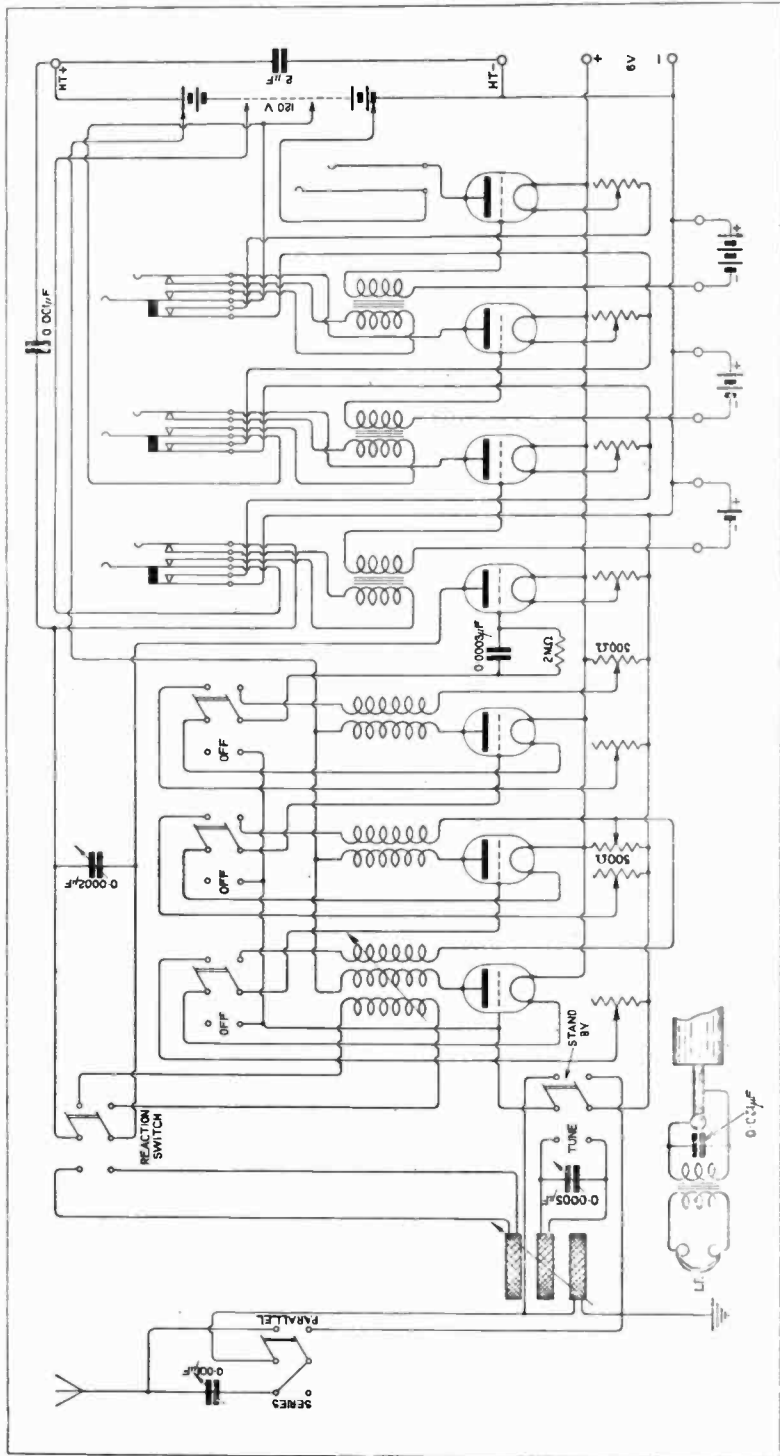

The diagram gives the connections of a seven-valve receiver—three H.F. transformer coupled, detector and three L.F. stages. The aerial circuit has a series-parallel and a stand-by and tune switch to facilitate tuning. The number of H.F. stages in circuit may be varied by the double-pole, throw over switches. The normal grid-potential of these valves is variable with the potentiometer. The detector valve is always in circuit. With certain types of H.F. transformers, the primary windings are tuned with a variable condenser having a maximum value of 0.0002 mfd. The telephones are connected with a telephone transformer to a plug, which may be inserted in any of the jacks connected to the anode circuit of the L.F. valves. The H.T. voltage applied to different portions of the circuit is variable. Cells are connected in the grid circuits of L.F. stages to secure best operation. When valves are cut out by the operation of the switches, the filament circuits are disconnected. By means of the reaction switch, reaction may be obtained by coupling the reaction coil with either the secondary tuner coil, or with a H.F. transformer. The circuit should be of great assistance to those who wish to connect switches and jacks to a receiver. From a study of the diagram it should be an easy matter to provide for one's own particular requirements.

# Radio Society of Great Britain.

## REPORT OF ANNUAL CONFERENCE HELD ON JAN. 24th, 1923.

The Annual Conference of Wireless Societies affiliated to the Radio Society of Great Britain took place on Wednesday, January 24th, at 2.30 p.m. at the Institute of Electrical Engineers.

Admiral of the Fleet Sir Henry B. Jackson, retiring President, at the commencement of the proceedings took the chair in the absence of the President, Dr. W. H. Eccles, F.R.S., who was unavoidably absent. After the minutes of the last Annual Conference held on January 25th, 1922, had been read and confirmed,

**Admiral Sir Henry Jackson**, addressing the Conference, said:—

It gives me great pleasure again on behalf of the Radio Society of Great Britain to welcome the delegates from the affiliated societies, and I can only reiterate the views which I expressed last year and hope that the delegates will unhesitatingly give voice to their opinions. In the absence of our President, Dr. Eccles, I am taking the chair, but as I have to leave in less than an hour, I am going to ask our Chairman, Mr. Hope-Jones, to conduct the proceedings.

We have had a busy year, and we in the Society in London have done our best to meet the difficult situation we have been faced with. I hope you will bear in mind that in working for the good of all people interested in wireless, especially the amateur experimenters, the Society has done good and valuable work, and that in all matters we have had the interests of you all in front of us.

I will now ask Mr. Hope-Jones to take the chair and conduct the proceedings of this Conference.

**Mr. F. Hope-Jones.**

This is the fourth Annual Conference and it has been prepared for in the ordinary manner by circularising the various affiliated societies (of which there are now one hundred and twenty-five), with suggestions for the Agenda to be discussed. From that circular has of course arisen a very considerable mass of correspondence from the various Secretaries, particularly of those societies who either are too far off, or for other causes have been unable to send delegates. I think it is only fair that I should read some part at any rate of their letters, extracts from which will suggest matters for discussion which are not necessarily on the Agenda, and I desire that any subject within the range of our interests may be discussed if time permits.

You will see the first item on the Agenda is the better organisation of this Annual Conference, supposing it is thought to be desirable. In order to test the views of the Societies on this subject, and to encourage a free expression of opinion, we put forward the following suggestions, the first relating to the organisation of these Conferences as follows:—

### 1. Organisation of the Conferences:—

(a) That a General Committee be formed consisting of delegates from the Affiliated Socie-

ties, one delegate from each Society, and one additional delegate for every 50 members beyond the first 50; delegates from the Radio Society of Great Britain to attend in the same proportion.

(b) That this general Committee hold quarterly meetings alternatively in London and in some Provincial centre; thus the meetings in one year might be in (1) London; (2) say, Birmingham; (3) London; and (4) say, Leeds.

(c) Each meeting to elect its own Chairman and to select the rendezvous for the next alternate meeting.

(d) Instead of an Affiliation Fee of a guinea from each Society, it is proposed that each Affiliated Society shall pay in proportion to its membership, viz., 1s. per head.

(e) The Secretarial Expenses (hire of hall, etc. for the meetings of the General Committee), to be met by the Radio Society of Great Britain.

The Chairman then read extracts of letters on this subject from the Secretaries of the Societies at Leeds, Hounslow, North Shields, and Willesden, and announced that opinion revealed by this correspondence was practically unanimous against increase of subscription in the form of a *per capita* charge of 1s. per head—vulgarily and popularly spoken of as “a bob a nob.”

I think (he continued) a slight increase of affiliated societies' subscriptions would be necessary and it can be done in another form.

The main question for you to consider is: Do you want a more frequent conference than one a year in January, as it has been held in the past? If so, how many, and where? And do you wish to endow it with authority and executive ability? Personally I think the method has worked very well in the past by which you have the Committee of the Radio Society of Great Britain meeting frequently with their ears cocked up to catch the slightest whisper of what is wanted from any part of the country, in order to give effect to those wishes. So far, that to my mind has given us sufficiently close touch, but on the other hand, if it was thought that an executive authority of your own was desired, we are only too anxious to hear what your views are on any of these subjects comprised under the headings of item (1).

The meeting was then thrown open to the delegates.

**Mr. H. A. Epton** (Hackney and District Radio Society).

My Society has gone into this question, and I wrote a note giving our views, but perhaps I might put one or two before you. The first thing that we considered when we were discussing the question was this: What position will this General Committee, referred to in this item of the agenda, have in the Radio Society of Great Britain? Will it be a supreme body or will it be only an advisory body? I notice from the letter heading of the Society that there is a Committee. This is re-elected annually. I should like to know whether

this proposed General Committee is to supersede that Committee now in existence, or whether it can only convey its suggestions to the Committee of the Radio Society of Great Britain. If the General Committee is not the supreme power, our Society consider its purpose cannot be very important, but if it will have the power to carry out the ideas on which it has opinions then I can see that this General Committee will be able to do very useful work. My Committee has requested me to ask this question before any decision is made so that we may know the purpose of this new Committee.

**Mr. H. Taylor** (Derby Wireless Club).

We are in favour of holding the meeting in London as heretofore.

**Mr. A. J. Dixon** (North Middlesex Wireless Society).

My Committee thinks that the idea of the Committee being formed as suggested is quite a good one, but I, personally, more or less agree with the first speaker that it would be well to know what is the precise position of that Committee. As regards the meeting in the provinces, this is nearly the same as our suggestion two years ago, but we do not think we need to have four conferences. Probably one in the North or one in the Midlands would do. As regards the capitation fee, we suggest a subscription which is a percentage of the subscription income of the club. Some clubs have a very nominal subscription, of say 5s., and obviously it is unfair for those clubs with 5s. subscriptions to have to pay out of their funds the same as the club which has a half-a-guinea subscription or more. We suggest that you have say a five per cent. subscription on the income of the club. That is to say on the club's net subscription for the year.

**Mr. Y. P. Evans** (Manchester Wireless Society).

My Committee have asked me to propose, with regard to this item on the Agenda, first paragraph, with reference to the General Committee, that one delegate per society including the Radio Society of Great Britain, should form that Committee. That two meetings be held annually, in addition to the Annual Conference, and at the Annual Conference as many delegates may attend as possible, say one for the first fifty and one for each fifty afterwards.

My Committee agree that the meetings should take place at different towns, to be decided upon by the Committee at its first meeting. They agree with the suggestion that the meeting should elect its own chairman.

Regarding the affiliation fees I am to say that our suggestion is £1 for the first fifty, and £1 for every fifty afterwards. The last item to the effect that Secretarial expenses should be met by the Radio Society of Great Britain was quite agreeable to them.

**Mr. Platt** (Wanstead Wireless Society).

We have a Society comprising adults and juveniles; the Society is only six months old. Our subscription fees are only 10s. entrance and 5s. annually, and we are on this account prevented from accepting any higher expenses as regards our affiliation to the Society. The information

we have received from time to time has been very satisfactory, and we hope to continue to get such information in the future.

With regard to the question of a General Committee. I asked our Secretary if he had any information which suggested why the Radio Society of Great Britain had caused such a minute to be put on the agenda for debate. I really think that your own Committee would do well to give some reasons why these subjects were coming up for discussion to-day, because it is only your present Committee that has had that experience which enables them to say whether it is necessary to extend or increase the activities in this direction. We delegates do not know whether it is necessary or not.

On the question of finance, I really think, if more money is required, an appeal might bear good results. There are men in my own Society who may be able to afford a further amount, but some cannot afford even a shilling.

**Mr. Watkins** (Maidenhead District Wireless Society).

Is there not some confusion arising out of the term "General Committee." The General Committee is in regard to the Conference of Affiliated Societies, and is quite distinct from the Committee which acts in an advisory capacity to the Radio Society of Great Britain. As far as we in Maidenhead are concerned we are quite anxious that everybody in the Societies in the country should be represented at this Conference, and I take it that the motive of the Radio Society is that there should be better facilities in getting the members together. The delegates here, on that account, do not fully represent the Societies of Great Britain. Some arrangements should be made for meetings in different parts of the country so that the Conference should be fully representative. I should like to ask the Committee to give us some particulars of the financial requirements which necessitate the suggestion of a shilling per head.

**Mr. R. H. Parker** (Smethwick Wireless Society).

My Society agrees with this proposal in principle, but why is it suggested that they should hold two meetings in London? Why not in the provinces, Cardiff, or Sunderland, so that it would be more convenient for the amateurs extending over the country? We agree with (c), but not with (d).

**Mr. S. Sugden** (Birkbeck College Wireless Society).

I just want to put one point in connection with (d). In our college, as in many other colleges, the whole of the monies for students' societies are raised from a central fee which is paid with the ordinary tuition fees. It is impossible for us, therefore, and perhaps for a number of other Societies associated with schools and colleges, to define our particular number of members. Every student can belong to all the societies, or he may not do so, but the funds of each individual society of the college or school is not affected by its membership total.

**Mr. Watt** (Dartford and District Wireless Society).

My Committee are agreed upon the general proposals for the Conference. As regards representation, this might be one for 50, and two for 100.



With reference to (d), my Society also wish me to state that an increase in our case would be equal to fifty per cent. of our total, and they think that half that amount should be ample.

**Mr. C. T. Atkinson** (Leicestershire Radio and Scientific Society).

With regard to this question our Society is generally in favour in principle, but we are not quite sure exactly on the various details which have been raised. We feel that the affiliated societies should have as much power as is possible, and if a number of conferences are necessary, then they must of course be held. We do, however, feel that if the number of conferences can be limited it will be the better for all concerned, providing the work can be expeditiously carried out, and therefore if we can cut the number down by two conferences a year, one to be held in London and one in a place farther north so as to be better as regards attendance for the Societies in the North of England, it would be perhaps the best way.

With regard to (c), this is satisfactory.

As regards (d), like most of the other Societies, we object to the amount suggested, not knowing exactly what money would be required. We have not fixed any amount to bring before you, but we do feel that it is very essential that the amount should be the absolute minimum necessary, and below the amount figuring in the agenda. We have endeavoured to keep our funds as low as possible because of the large number of people we have in our Society who have not too much of this world's goods. A payment of (in our case) twenty per cent. of the annual subscription to the Radio Society of Great Britain would be excessive. On this account item (e) has been well received.

**Mr. J. H. Reeves** (Kensington Wireless Society).

On the subject of the number and powers of the Conference General Committee. We have certainly thought that the Committee members of the Radio Society of Great Britain, as we know them, are very much overworked. They have a tremendous amount to do, and the general idea seems to be that while the Radio Society of Great Britain is going to take care of the amateurs in bulk, this Conference of all the Societies has for its primary object the direct personal concerns of the Societies and of the individual. If one may argue from an analogy—some years ago, in the motoring world, the Royal Automobile Club found there was a very large group of provincial bodies, and it became very necessary to arrange some local conferences so that they could act in closer touch all over the country.

Now this organisation will probably develop very largely on the same lines. I think there is a good deal to be done which is particularly suitable for a general conference of all the societies of the Kingdom. For that reason I fall in with the suggestion, and so does my Society of Kensington—that this Conference be held rather more frequently. The meetings should be, say alternately in London and the provinces. If four are too many, I think we could have three at any rate. The success of the Radio Show in the autumn of last year is going to be repeated. It is going to be bigger in the future, and I think it will attract people all over the country. It would be no hardship for every Radio Society in England to find a

member who would be very glad to have the excuse to come to London and attend the Conference, and also the exhibition. I think as a start there might be three conferences, one during the Exhibition in London, the Annual Conference in January, and one meeting in the provinces during the summer months.

There could never be what one might call a clash of powers. If a point is not voted unanimously it is hardly ever voted at all. These conferences meet together to discuss and to advise the Radio Society of Great Britain on important matters, on the same lines as the various motoring societies meet together monthly in order to advise the Royal Automobile Club, and between them they come to unanimous decisions.

**Mr. H. A. Epton** (Hackney and District Radio Society).

I had expected that my earlier question would have been answered so that the matter might be clear to us. No answer was given to it then, and there was a suggestion of closing the discussion.

Mr. Reeves seems to speak with an air of authority. I think he has had experience of meetings which we are not all in the position of having had. In a businesslike body like ours, we should know exactly what we are going to do. The question of power must come up. At present, as far as I understand it, the affiliated societies have no definite standing. Now, if this General Committee has no power beyond that of an advisory Committee, I cannot see how we are going to have any control over the running of this Society. If we have to pay an annual fee, surely we ought to have some representation either on the original Committee or else our new Committee must have full power.

As regards the representation by delegates, my Society maintains this figure is too high (the figure of fifty); it should be reduced to twenty-five. I do not think there are many societies in this country who have one hundred members or more. Fifty to seventy-five is the average. The great majority of societies would only have one delegate and a very few indeed two delegates.

*(Here the Chairman interrupted, as Mr. Reeves had not completed his remarks.)*

**Mr. J. H. Reeves**, after emphasising that he was not speaking with authority, continued:

I happen to know the members very well, and I am sure they do an enormous amount of work, and put in an enormous amount of time, and if there is much more to be done, that Committee must, it seems, be enlarged or else we, the Societies who want these things done, have got to do more to assist in the work ourselves. I think the Radio Society of Great Britain have done a very wise thing in bringing this matter forward. As regards the power which the conferences will have, let us think what is going to happen if the one hundred and twenty-five Radio Societies are unanimous on something which the Radio Society of Great Britain does not agree with? Surely either the Radio Society goes out, or the result of such a strong expression of opinion will convince the Committee of the Radio Society of Great Britain. Personally I am only suggesting that. I feel there is no possibility of a clash of voting. It would certainly be well to define the powers of the proposed Committee.

*(To be concluded)*

## The British Wireless Relay League.

**T**HE announcements which have appeared in this Journal in connection with the British Wireless Relay League have stimulated a very considerable interest in the matter. A large number of applications for membership have been received, and there is every indication that it fills a gap which should do much to bring into closer association the amateurs, and particularly those holding experimental licences, of this country. The work of the League should go farther, for it is intended that it shall co-operate as far as possible with similar organisations abroad.

In a recent letter received from Mr. Léon Deloy, so well known as one of the leading amateurs in France, mention is made of the fact that at the last meeting of the Comité de la Société des Amis de la T.S.F. Mr. Deloy brought up the subject of the handling of such traffic by amateurs in France, and states that Général Ferrié expressed approval of the proposals outlined. Dr. Pierre Corret, President of the Comité Français des Essais Transatlantiques was asked to request his committee to get in touch with the postal authorities on the matter. Let us hope that the near future will bring good news of the result of their negotiations.

There is little need here to refer to the work of the American Radio Relay League since their activities are already so well known to British amateurs, and already the British Wireless Relay League is assured of their hearty support and co-operation in any experimental transmissions or other work to be undertaken.

The British League cannot, of course, ever aspire to the same membership as the American League, but nevertheless, if all those who have an interest in the work will come in, a very efficient organisation should result. Below are published the provisional rules of the British Wireless Relay League for the information of readers of this Journal :

### BRITISH WIRELESS RELAY LEAGUE.

#### NAME.

The League shall be named the "British Wireless Relay League."

#### OBJECTS.

Intercommunication between members with a view to improving existing transmitting circuits.

Relaying of messages through stations owned by members, at times to be regulated by headquarters, the object of which will be the efficient organisation of all amateur transmitting stations, whereby a service of excellent utility will be maintained. All messages shall be confined to the business of the League.

Strict observance of all laws and regulations applicable to wireless telegraphy and telephony.

Co-operation with wireless leagues of other countries.

The advancement of wireless science generally.

#### RULES.

1. The League shall consist of members and associate members, and shall be governed by a central committee consisting of the officers and four committee members, assisted by a local committee elected by members.

2. Members shall possess an Experimental Transmitting Licence.

3. Associate members shall possess an Experimental Receiving Licence, and may transfer to full membership on compliance with rule 2.

4. Members and associate members shall be eligible for any office of the League and shall receive all circulars and printed matter concerning the League.

5. Prospective members shall apply to the Hon. Secretary for the necessary application form, and after completing and returning same, with remittance, shall receive a certificate of Membership.

#### SUBSCRIPTIONS.

6. An entrance fee of five shillings shall be paid by each member on election, and the annual subscription shall be ten shillings, payable in advance, and due on the 1st January each year.

7. Associate members shall pay an entrance fee of five shillings on election, and the annual subscription shall be five shillings payable as in rule 6.

8. Any member whose subscription is one month in arrears shall be notified by the Hon. Treasurer. Should his subscription not be paid at the expiration of one month from the date of such notice, the committee shall have power to erase his name from the list of members.

9. The committee shall have power to reprimand any member who, in the opinion of one or more members, has wilfully acted in contravention of the rules of the League, or the laws and regulations governing wireless telegraphy, after such an act has been investigated.

10. Should any member wilfully break these rules or regulations a second time the committee shall have power to expel him from the League.

11. Until other rules are drawn up for the management of the League, the above provisional rules shall be considered binding.

12. In these rules the word member includes associate members unless otherwise stated or where the context does not so admit.

Applications for membership or associate membership should be made to the Hon. Secretary, The British Wireless Relay League, care of this Journal, 12-13, Henrietta Street, London, W.C.2.

# Ideal Home Exhibition.

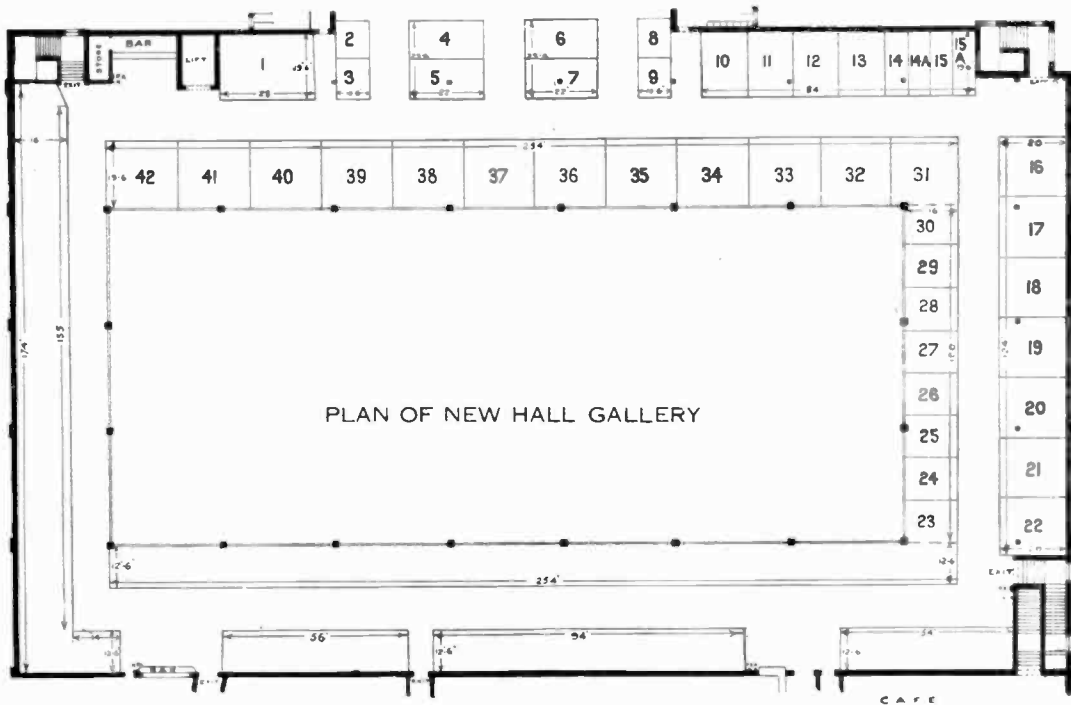

The *Daily Mail* Ideal Home Exhibition, which will be open at Olympia on March 1st to 24th, will include as an important feature a Wireless Section situated in the New Hall Gallery. The following are the firms exhibiting in this section with the numbers of their Stands:—

- |   |  |
|---|--|
| <ol style="list-style-type: none"> <li>1. Burndept, Ltd.</li> <li>2. H. Stanley Prince &amp; Co.</li> <li>3. Electric Appliances Co., Ltd.</li> <li>4. Amalgamated Press, Ltd.</li> <li>5. Radio Press, Ltd.</li> <li>6. Cassell &amp; Co., Ltd.</li> <li>7. Wireless Press, Ltd.</li> <li>8. Tingey Wireless, Ltd.</li> <li>9. Igranic Electric Co., Ltd.</li> <li>10. Wates Brothers.</li> <li>11. Gambrell Brothers, Ltd.</li> <li>12. Perophone, Ltd.</li> <li>13. Rogers Foster &amp; Howell, Ltd.</li> <li>14. ———</li> <li>14A A. H. Hunt, Ltd.</li> <li>15. ———</li> <li>15A Abbey Industries, Ltd.</li> <li>16. General Radio Company.</li> <li>17. L. McMichael, Ltd.</li> <li>18. Telephone Mfg. Co., Ltd.</li> <li>19. A. W. Gamage, Ltd.</li> <li>20. Radio Society of Great Britain.</li> </ol> | <ol style="list-style-type: none"> <li>21. ———</li> <li>22. Peto &amp; Radford.</li> <li>23. Beaver Electric Company.</li> <li>24. Alfred Graham &amp; Co.</li> <li>25. J. A. Coomes &amp; Co., Ltd.</li> <li>26. Siemens Brothers &amp; Co., Ltd.</li> <li>27. Tomlinson, London, Ltd.</li> <li>28. Fellows Magneto Co., Ltd.</li> <li>29. Dubilier Condenser Co. (1921), Ltd.</li> <li>30. Radiophones, Ltd.</li> <li>31. Sterling Telephone &amp; Electric Co., Ltd.</li> <li>32. Automatic Telephone Mfg. Co., Ltd.</li> <li>33. British Thomson-Houston Co., Ltd.</li> <li>34. Western Electric Co., Ltd.</li> <li>35. General Electric Co., Ltd.</li> <li>36. Marconi Scientific Instrument Co., Ltd.</li> <li>37. Marconi's Wireless Telegraph Co., Ltd.</li> <li>38. Metropolitan-Vickers Electrical Co., Ltd.</li> <li>39. C. F. Elwell, Ltd.</li> <li>40. Radio Communication Co., Ltd.</li> <li>41. Radio Instruments, Ltd.</li> <li>42. S. G. Brown, Ltd.</li> </ol> |
|---|--|

## Calendar of Current Events

### Thursday, February 22nd.

INSTITUTION OF ELECTRICAL ENGINEERS.  
At 6 p.m. At Savoy Place, Victoria Embankment, W.C.2 Lecture on Transoceanic Wireless Telephony, by Dr. H. W. Nichols.

### Friday, February 23rd.

MANCHESTER WIRELESS SOCIETY.  
At 7.30 p.m. In Council Chamber, Houldsworth Hall. Discussion.  
LEEDS AND DISTRICT AMATEUR WIRELESS SOCIETY.  
Lecture on "Receivers and Loud Speakers." By Mr. A. M. Bage (President).  
BIRMINGHAM EXPERIMENTAL WIRELESS CLUB.  
At 7.45 p.m. Lecture by Mr. Abbott.  
HULL AND DISTRICT WIRELESS SOCIETY.  
At 8 p.m. At the Memorial Institute Schoolroom, Dewsbury Street. Smoking Concert.

### Saturday, February 24th.

MOUNT PLEASANT RADIO SOCIETY.  
At 7 p.m. At Lecture Hall, 21A, John Street, Theobald's Road, W.C.1. Lecture on "A Beginner's Difficulties in Receiving anything but Broadcasting." By Mr. A. Hinderlich, M.A.

### Sunday, February 25th.

At 3.5 p.m. Concert from PCGG, The Hague, on 1,050 metres.

### Monday, February 26th.

9.20 to 10.20 p.m. Dutch Concert from PCGG, The Hague, on 1,050 metres.

### Tuesday, February 27th.

LOWESTOFT AND DISTRICT WIRELESS SOCIETY.  
At St. Margaret's Institute, Alexandra Road, Lowestoft. Lecture by Mr. L. Burcham.  
THE EAST LONDON RADIO SOCIETY.  
Lecture on "Charging Accumulators on the House Lighting Mains." By Mr. J. Keens.

### Wednesday, February 28th.

ROYAL SOCIETY OF ARTS.  
At 8 p.m. At John Street, Adelphi, W.C. Lecture on "Heat Resisting Glasses." By Professor W. E. S. Turner.  
HALIFAX WIRELESS CLUB AND RADIO SCIENTIFIC SOCIETY.  
Lecture by Lieut. H. E. H. Burbury.  
EDINBURGH AND DISTRICT RADIO SOCIETY.  
At 8 p.m. At R.S.S.A. Hall. Lecture on "Detection and Measurement of Minute Electric Currents." By Dr. H. Dryerre, M.R.C.S., L.R.C.P.

### Thursday, March 1st.

Daily Mail Ideal Home Exhibition, with Radio Section, Opening Day (March 1st-24th inclusive).  
At 9.20 to 10.20 p.m. Dutch Concert from PCGG, The Hague, on 1,050 metres.  
LUTON WIRELESS SOCIETY.  
At 8 p.m. At Hitchin Road Boys' School. Practical Work and Demonstration.  
STOKE-ON-TRENT WIRELESS AND EXPERIMENTAL SOCIETY.  
Lecture: "Half-an-hour with a Technical Dictionary." By F. Bew.

### THAMES VALLEY RADIO AND PHYSICAL ASSOCIATION.

At 8 p.m. Film on Radio Transmission and Reception.

### Friday, March 2nd.

SHEFFIELD AND DISTRICT WIRELESS SOCIETY.  
At 7.30 p.m. At the Dept. of Applied Science, St. George's Square. Lecture on "The Progress of Telephony and its Bearing on Modern Life." By Mr. W. Davies.  
LEEDS AND DISTRICT AMATEUR WIRELESS SOCIETY.  
Lecture on "The Evolution of Receiving Valve Amplifiers." By Mr. H. H. T. Burbury.

### Saturday, March 3rd.

IPSWICH AND DISTRICT WIRELESS SOCIETY.  
At 8 p.m. At 55, Fonnereau Road. Lecture by Mr. A. Southgate, A.M.I.E.E.

## BROADCASTING STATIONS.

Regular evening programmes, details of which appear in the daily press, are now conducted from the following stations of the British Broadcasting Company:—

London	2LO	369 metres.
Birmingham	5IT	420 "
Manchester	2ZY	385 "
Newcastle	5NO	400 "
Cardiff	5WA	395 "

Glasgow Broadcasting Station (5 SC) is expected to be in operation on March 19th.

## Correspondence.

To the Editor of THE WIRELESS WORLD AND RADIO REVIEW.

SIR,—As I have been experimenting with chemical rectifiers for some considerable time I read with interest Mr. Rushton's investigations on the well-known Tungar Rectifier.

Although the article sets forth with considerable aptitude the scientific side of the subject, there are several points which need consideration from the practical or commercial point of view. These are:—

1. The cost of valve replacements.
2. Only one wave of the supply current is "rectified," the other wave being repressed.
3. The low overall efficiency.

I understand that the cost of replacing the valve or bulb is over £4, and that such bulbs are guaranteed only for a maximum of 600 hours.

Taking this at the 5 ampere rate for a 6-volt cell of 50 ampere hours capacity, the cost per charge is 1s. 6d. for the bulb alone, to which must be added a certain amount towards the first cost of the apparatus, and then the cost of the current consumed from the mains at 29 per cent. efficiency, that is, rather over 100 watts input.

In comparison with chemical and other rectifiers this does not appear to me to be sufficiently good, but doubtless improvements will be effected in course of time.

MORTIMER A. CODD.

## Questions and Answers

**NOTE.**—This section of the magazine is placed at the disposal of all readers who wish to receive advice and information on matters pertaining to both the technical and non-technical sides of wireless work. Readers should comply with the following rules:—(1) Each question should be numbered and written on a separate sheet on one side of the paper, and addressed "Questions and Answers," Editor, THE WIRELESS WORLD AND RADIO REVIEW, 12/13, Henrietta Street, London, W.C.2. Queries should be clear and concise. (2) Before sending in their questions readers are advised to search recent numbers to see whether the same queries have not been dealt with before. (3) Each communication sent in to be accompanied by the "Questions and Answers" coupon to be found in the advertisement columns of the issue current at the time of forwarding the questions. (4) The name and address of the querist, which is for reference and not for publication, to appear at the top of every sheet or sheets, and unless typewritten, this should be in block capitals. Queries will be answered under the initials and town of the correspondent, or, if so desired, under a "nom de plume." (5) In view of the fact that a large proportion of the circuits and apparatus described in these answers are covered by patents, readers are advised before making use of them, to satisfy themselves that they would not be infringing patents. (6) Where a reply through the post is required every question sent in must be accompanied by a postal order for the amount of 1s., or 3s. 6d. for a maximum of four questions. (7) Four questions is the maximum which may be sent in at one time.

"G.T." (Leeds) asks for a diagram of a telephony and C.W. transmitter for short wave work. It is proposed to use about 5 watts of H.T.

The diagram is given in Fig. 1. The aerial inductance will be determined from the constants of your aerial, but will generally be 6" in diameter and 6" long, of No. 16 D.C.C. The closed circuit coil may be 8" in diameter and 6" long, of No. 18 D.C.C., the wire in each case being spaced. The grid circuit coil should be a winding 5" in diameter and 3" long, of No. 20 D.C.C. The air choke

"SIGIL" (Cheshire) asks (1) For diagram of a three valve circuit capable of later extension. (2) Where detailed instructions for making such components as are desired may be obtained.

(1) We would refer you to Fig. 5, page 356, December 9th. issue. The diagram is a very good one, and may be thoroughly recommended. (2) We do not know of any text-book which deals with the construction of such components as you would require, in a suitable manner. We suggest you obtain the last volume of *The Wireless World*

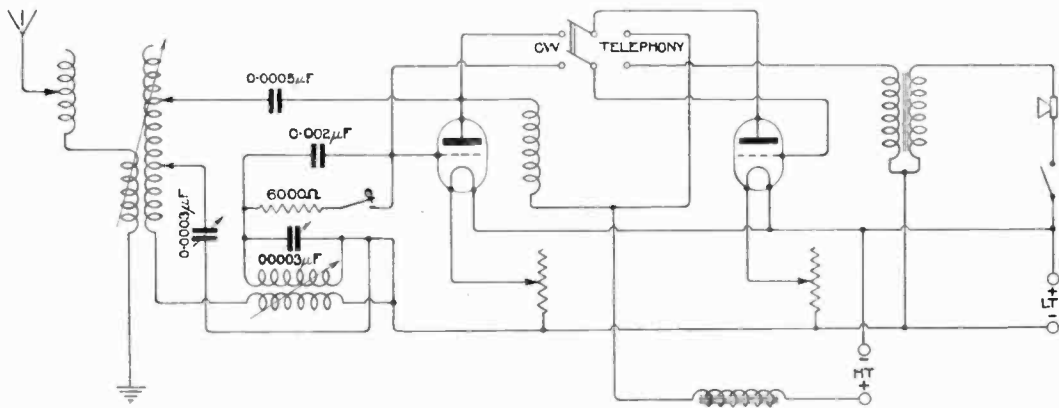

Fig. 1.

coil in the anode circuit of the first valve may be a winding 2" in diameter and 3" long of No. 28 S.S.C. The key is connected to join the grid leak across the grid condenser. When it is required to use the transmitter for telephony, the key is screwed down, and the switch is thrown over to the right-hand side. 200 volts anode potential would be suitable. Some experimental work will be necessary before the best values for the components are obtained.

and Radio Review, where you will find a number of constructional articles, and in particular articles dealing with "Experimental Station Design," which appeared in every other issue.

"PUZZLED" (Pendleton) asks (1) What type of Dewar switch would perform the same functions as a double pole throw-over switch. (2) Could the three-valve receiver illustrated in the issue of October 28th, 1922, be converted into a cabinet set.

(1) A Dewar switch, which has six contacts,

comprising two moving contacts and four fixed, may be used in place of the double pole throw-over switch. The Devar switch would be such that with the springs in one position contact is made in a similar manner to when the double pole throw-over switch is thrown over into one of its contact positions. (2) The three-valve receiver referred to may of course be assembled to form a cabinet receiver, provided the components are suitably mounted. Any receiver may of course be mounted in a cabinet in this manner.

"W.B." (Bristol) is interested in telephony transmission, and asks (1) Where he can find information. (2) Where to obtain microphones. (3) For criticism of diagram submitted. (4) What power is required to transmit ten miles, the receiver to be a one-valve receiver.

(1) We suggest you look through back numbers of *The Wireless World and Radio Review*, where you will find a considerable amount of useful information. In particular we would refer you to the issue of December 23rd, where you will find, under the heading of "Experimental Station Design," a constructional article dealing with a small telephone and C.W. transmitter. (2) We suggest you communicate with the Automatic Telephone Manufacturing Company of Liverpool. (3) The diagram submitted is quite suitable for a beginner, although the arrangement is very inefficient, and it cannot be expected that one would be able to transmit for any great distances with such a transmitter. In addition, the tuning adjustments are shown. (4) If you use 10 watts of high tension, your transmissions should be heard over a ten miles radius.

"RESISTA" (Mont) asks (1) Whether the licence purchased from the General Post Office, London, is an experimental or a broadcast licence. (2) Is he allowed to use a receiver purchased some time ago, and may he add to it; and will he be called upon to pay the British Broadcasting Company's fees. (3) Is he allowed to give demonstrations, say in the local village. (4) May a power valve be used in the last note magnifier panel.

(1) We think the licence which was sent to you is an experimental licence. (2) If you hold an experimenter's licence, you are of course able to experiment with apparatus just as you desire, provided the conditions under which the licence is granted are borne in mind. You will not be called upon to pay any fees to the British Broadcasting Company. (3) You will probably have to gain the permission of the Post Office before you are able to give wireless concerts. We suggest you write to the Secretary of the Post Office, London. (4) The power valve is connected in the circuit in the same manner as an ordinary receiving valve, but the anode is supplied with a higher potential, which is tapped off the H.T. battery. This is the only alteration required. The aerial may, as you suggest, be either 60' long and 40' high, or it could be 60' long, two wires, and 40' high.

"ULTRA FIXED" (Rugby) asks (1) For suitable values of components to use in the circuit wired according to the diagram submitted. (2) Whether a certain book has been published. (3) How can a reactance coil be made so that it is reasonably efficient, and tuned by taps only.

(1) and (3) The A.T.C. may be a winding 4" in diameter and 3" long, of No. 22 D.C.C., with six

tappings. The A.T.C. should have a maximum value of 0.001 mfd. The tuned anode winding may be 4" in diameter and 5" long, of No. 26 D.C.C., and the tuning condenser should have a maximum value of 0.0002 mfd. The reaction coil may be a winding 3" in diameter and 3" long of No. 26 D.C.C. with threeappings. The grid leak and condenser have values of 0.0003 mfd. and 2 megohms. (2) The volume referred to has not yet been published.

"B.H.H." (E. Yorks.) proposes to use a frame aerial, and asks (1) For a diagram showing how to connect two high frequency, one detector, and one L.F. (2) Is there any serious objection to the use of a frame aerial.

(1) A suitable diagram is given in Fig. 2, page 72, in the issue of October 14th, 1922. (2) As your open aerial is rather poor, you will probably find no very great decrease in signal strength with the use of a frame aerial, it being borne in mind that one can take advantage of the directional properties of the frame.

"G.R.B." (Essex) refers to the diagram given on page 418 of December 23rd issue and asks (1) What would be suitable dimensions for the anode and reaction coil. (2) Which valves give best results in a circuit of this description.

(1) The anode and reaction coils may be plug-in coils if desired, in which case a two-coil holder is very useful. For the reception of broadcast transmissions two small single layer coils may be used, but the anode coil should be 3" in diameter and 3" long of No. 28 D.C.C., and the reaction coil could be 2" in diameter and 3" long of No. 28 D.C.C. Ten and threeappings should be taken from the coils. (2) "R" valves are quite suitable for use in a circuit of this description.

"MARRIED QUARTERS" (Halesowen) submits particulars of his proposed aerial arrangement and asks (1) Are the results from the arrangement likely to be as good as from an outdoor aerial, 30 yds. long and 25' high. (2) With condenser plates of the size given, and the distance between the plates 1/16", what is the capacity. (3) Is the proposed layout satisfactory. (4) What capacity is considered desirable, if at any time the set is used on a 250-volt D.C. main.

(1) We think stronger signals will be obtained with the outdoor aerial. (2) The capacity of the condenser would be of the order of 0.00005 mfd. (3) The lay-out is not very satisfactory, and it is not safe to use air dielectric condensers for work of this description. (4) We suggest you use mica dielectric condensers with a capacity of the order of 0.0005 mfd.

"W.J.T." (Surrey) asks (1) Can we say why when listening in to French and Dutch amateur transmissions, the signals appear to fade occasionally. (2) What power is put into the aerial at Ongar, GLO.

(1) When listening in to short wave transmissions it is often noticed that the signals appear to fade away at times. This is due to absorption, which is very pronounced at short wavelengths. (2) This station is operated by a private company, and we have no definite information of the power employed.

"P.L.B." (Bucks) submits a sketch of his receiver and asks (1) Whether the circuit is suitable

for general purposes. (2) How to add two L.F. connected valves.

(1) The circuit submitted is quite suitable for short wave telephony, although it would be better to couple the reaction coil with the secondary of the intervalve transformer instead of the aerial tuning inductance. (2) The method of connecting L.F. valves is given in all issues. In particular we would refer you to Fig. 4, page 386, December 16th issue.

"E.W.C." (Birmingham) asks (1) For an explanation of the tuned anode method of H.F. amplification. (2) For particulars of the construction of an anode coil suitable for a wide range of wavelengths.

(1) The tuned anode method of H.F. amplification works on very similar principles to the resistance method, but in the former case the high impedance is brought about by tuning the anode winding to the frequency of the signal it is desired to amplify. When the frequency of the winding and the frequency of the signal coincide the tuned circuit offers very high impedance to the signal, and consequently there are large voltage variations across it. These are transferred to the grid of the next valve through a small condenser. (2) We suggest that you wind a cylindrical coil 3" in diameter and 6" long full of No. 36 S.S.C. wire and take twelve tappings. The winding should be tuned with a variable condenser having a maximum value of 0.0003 mfd.

"A.H." (Purley) (1) Wishes to construct a two-valve high frequency panel to add to a single

necessary if the reaction coil is made to swing over the plug-in transformers. (3) What would be a suitable basket coil winding for the reaction coil suitable for use over a wavelength range of 400 to 5,000 metres.

(1) A crystal may be used in place of the detecting valve, but we do not recommend it. The advantage of having a detector valve is the stable adjustment. This cannot be claimed for a crystal. (2) No wiring changes will be necessary. The reaction coil will simply be moved and the reaction leads will be taken to the foot of the stand on which the sliding reaction coil is mounted. (3) A suitable reaction coil would be one consisting of 60 turns of No. 32 S.S.C. wire with a mean diameter of 3". For the higher wavelengths we suggest a coil having 120 turns of No. 36 S.S.C. wire with a mean diameter of 3 1/2".

"TYLER" (Huddersfield) asks (1) For diagram of a three-valve receiver, comprising one high frequency, one detector, and one L.F. valve (2) For criticism of the receiver, particulars of which are submitted. (3) May honeycomb coils be used in place of a loose coupler. (4) What honeycomb coil should be used to receive WJZ.

(1) We would refer you to Fig. 5, page 147, of the issue of October 28th. Suitable values are indicated in the diagram. (2) and (3) We suggest you secure the single-wire aerial from the house chimney to the post. Honeycomb coils may, of course, be used in place of the loose coupler. Basket coils work equally as well as honeycomb, but are

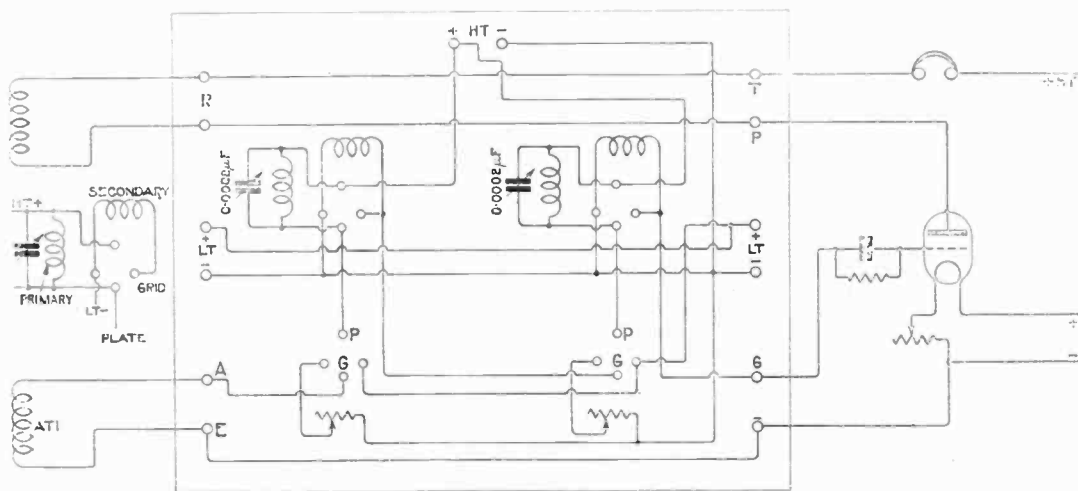

Fig. 2.

valve unit which he has by him, and (2) Asks for a diagram of connections, using certain components.

(1) and (2) See Fig. 2. Suitable values are indicated in the sketch.

"F.G." (Scarborough) asks (1) Whether a crystal may be used in place of a detecting valve. (2) Whether any alteration of the wiring will be

a little more difficult to mount. (4) The wavelength of WJZ is 360 metres, and you will use the first set of honeycomb coils mentioned. We would point out that the reception of the transmissions from this station is in the nature of a freak; that is, the transmissions cannot be received except under the most favourable conditions.

"W.A." (Windermere) asks (1) Why, when anyone touches the headphones, the tuning is altered. (2) Is it possible to put a milliammeter in series with the telephones and + H.T. to indicate when the receiver is on the point of oscillation. (3) What is the maximum number of telephones which may be connected in series in the anode circuit of the last valve.

(1) The reason why tuning is altered when the telephones are touched may be because the telephones have low insulation, and because they are connected directly in the anode circuit. A telephone transformer should be used if possible, and the receivers should be tested for low insulation. The loud-speaker circuit is correct because a telephone transformer is used. (2) We do not think much would be gained by inserting a milliammeter in series with the telephones as suggested. (3) Three or four pairs of telephones may be connected in the anode circuit of the last valve without any great loss of signal strength.

"E.C.H." (Doncaster) asks (1) The capacity of a 33 plate condenser built up from plates of the dimensions of the samples submitted. (2) The capacity of an 11 plate condenser. (3) The dimensions of a suitable anode coil.

(1) The 33 plate condenser will have a maximum value of 0.0005 mfd. (2) The 11 plate condenser has a maximum value of 0.00016 mfd. (3) The anode coil may consist of a winding 4" in diameter and 6" long of No. 30 S.S.C. wire, 18 windings being taken.

"N.G.C." (S.E.) asks (1) Whether the diagram submitted is correct. (2) Whether good results will be obtainable, it being desired to receive signals other than the broadcast transmissions. (3) Is a reaction coil tuning condenser and a high frequency transformer tuning condenser necessary.

(1) The diagram submitted is quite correct, and it is a standard circuit. (2) Good results will be possible over all wavelengths, provided suitable tuning coils are used. (3) The reaction condenser may have a value of 0.0002 mfd., and the high frequency transformer primary should also be tuned with a small condenser, one having a maximum value of 0.0002 mfd. being suitable.

"PIPACAC" (Harpندن) submits a diagram of connections and asks (1) Would it be useful to include a switch so that the tuned anode or the high frequency transformer may be used as desired. (2) What connections are necessary so that a Dewar switch may be connected for throwing the high frequency valve out of circuit when not required.

(1) If desired, a switching arrangement may be included for the purpose of using the high frequency transformer or the tuned anode method of amplification as desired. A suitable diagram is given in Fig. 1, page 129 of October 28th issue. (2) The method of switching valves with a circuit of the description submitted is given in most issues of this journal.

"SPARKS" (Yorks) asks (1) For criticism of the circuit submitted. (2) What is the reason for the distortion of speech which is received from a broadcasting station. (3) With reference to the

diagram of aerial submitted, is it to be expected that interference will result, due to telephone and tram wires. (4) Are any additional tuning arrangements suggested.

(1) and (4) The diagram of connections is correct, except that a wire is connected across the reaction coil, which is presumably an error. The tuning arrangements are quite correct, and with the high frequency transformer in use, it is not desirable to connect a small tuning condenser across the primary winding. It would probably be better if the secondary coil were connected between the grid and filament negative instead of filament +. (2) The distortion may be caused by a number of reasons, and you should find for yourself the best values of anode voltage and filament current. One or two small cells may be connected in the grid circuit of the last valve, for the purpose of giving the grid a small negative potential. Distortion may be caused through allowing grid current to flow through the grid becoming too positive. The normal grid potential may not be correct, resulting in the operating point on the characteristic not being central. The filament temperature may be too low. (3) It is very likely that some interference will be caused by the telephone wires running close to the aerial, and if possible we suggest the aerial be removed round a little, so as to form an angle with the telephone wires, which at the present time are running practically parallel.

"H.F.W." (Leeds) submits a diagram of his receiver with particulars of the components used, and asks for criticism.

The diagram of connections submitted is quite correct, although it is sometimes an advantage to tune the primary of the high frequency transformer with a two-plate condenser. The high frequency transformer has suitable dimensions, but the L.F. transformer has rather a high ratio to be efficient. The tuning coils are of suitable dimensions, but it is difficult to see why such peculiar results are obtained when the aerial tuning condenser is in series with the A.T.I. If care is taken that the right tuning coil is used, the results may be accounted for by your aerial lead being rather long, and perhaps the aerial has a large capacity.

"D.G.B." (S.W.15) asks (1) What is the meaning of the expressions "R4," "R5," etc. (2) With reference to the diagram submitted, how many turns of wire, using No. 20 enamelled, would be required on the aerial coil to tune between 200 and 300 metres, the former to be 6" in diameter.

(1) The terms "R4," "R5," etc., mean that signals of a certain strength are being received. In the military service only the odd numbers were used, and the following meanings are attached: R9, Signals clear and strong; R7, signals strong; R5, signals readable; R3, Signals weak; R1, signals heard but not readable. (2) We suggest you wind 40 turns of No. 20 enamelled wire upon the 6" diameter former. The wire should be spaced slightly, a suitable spacing being the thickness of the wire itself. With the arrangement suggested, it is only possible to modulate a small amount of power without the microphone being heated.



"G.F.H." (Epsom) submits a diagram of connections and asks (1) Are the connections correct and suitable for the reception of telephony. (2) Is it necessary to have a filament rheostat connected with each valve. (3) Is it better to connect the grid leak across the grid condenser or across the grid and L.T.

(1) The proposed arrangement is quite suitable, although instead of coupling part of the high frequency transformer with the aerial coil, it would be better if a reaction coil were used. The reaction coil should be connected in series with the low frequency transformer connected in the anode circuit of the detector valve. (2) It is better to have a filament resistance to control the temperature of each filament, because each valve will have slightly different characteristics, and it is desirable to be able to adjust the filament temperature of each valve separately. (3) It is generally better to connect the grid leak between the grid and plus or minus L.T. The correct connection depends upon the valve in use, and one should try whether best results are obtained with the leak connected to + or - L.T.

"WELSHMAN" (Woking) asks (1) Whether he may expect to receive the London broadcast transmissions, using a frame aerial and the single valve receiver. (2) What are suitable dimensions for a frame aerial. (3) Which type of frame aerial is the better. (4) Is it necessary to obtain an experimental licence before one may use a receiver built up from parts.

(1) We do not think you could expect to receive the London broadcast transmissions using a frame aerial and a one-valve receiver. We suggest you use an outdoor aerial, or if you cannot fix an outdoor aerial, use a three-valve receiver in conjunction with the frame aerial. (2) The frame aerial may be 4' square, wound with eight turns of No. 20 D.C.C., the turns being spaced a  $\frac{1}{4}$ " apart. (3) The form suggested in your sketch B is preferred. (4) An experimental licence is necessary.

"TELEPHONY" (Scotland) asks (1) Are the two diagrams submitted suitable for the reception of wireless telephony. (2) Would "R" type valves be suitable for use with the receivers referred to. (3) Would a C Mark II or A Mark IV low frequency amplifier be suitable as a note magnifier with this combination. (4) What size of wire and how many turns are required for the construction of the A.T.I. and closed circuits.

(1) As the receivers give excellent reception of spark signals, we think you should certainly hear telephony transmissions. (2) "R" type valves may be used with a receiver wired according to the diagram submitted. (3) As suggested, a low frequency amplifier may be added to the receiver, but it should be borne in mind that the purpose of a high frequency connected valve is to amplify very weak signals before applying them to the detector. The low frequency amplifier is to magnify the rectified currents. The high frequency amplifier enables one to obtain a greater range, while the low frequency gives stronger signals. We suggest you use the first valve as a high frequency connected valve, the crystal detector, and a two or three-valve low frequency amplifier. (4) The aerial circuit may be a winding 4" in diameter

and 4" long of No. 20 D.C.C. The anode winding may be 3" in diameter and 4" long of No. 30 S.S.C. with 12 tappings in each winding.

"O.W.M." (Brighton) asks who are the stations with call signs GGB, GGC, and FNB.

The first two calls have probably been allotted for special experimental or test purposes. We have no record of them being in permanent or regular use. FNB is the call sign of the ship station "Aviateur Roland Garros."

"ZULU" (Catford) submits a lay-out of a three-valve receiver and asks (1) Whether the wiring is correct. (2) Whether double-pole throwover switches will do what is required. (3) Could a diagram of connections showing the correct values of the components, which would be suitable for the arrangement proposed in (1), be given. (4) Which method is recommended to safeguard the H.T. and L.T. batteries from short circuits.

(1) The lay-out is quite suitable from the point of view of ease of wiring and arrangement of apparatus. We do not recommend the wiring of a Dewar type switch for the purpose of connecting or disconnecting coils in the aerial and closed circuits. When it is desired to receive short wave telephony, we suggest you use a three-coil holder, but use coils having a small inductance. The complication and the loss of signal strength occasioned by the inclusion of switches in the aerial and closed circuits is not accompanied by any great gain. (2) Suitable diagrams are given in many recent issues, together with suitable values for the condensers. (3) If desired, a small flash lamp may be used in series with the H.T. battery. The dry cells should be well insulated at all times, and they should not be kept in a damp place. It is as well to disconnect the various units when they are not in use. In the event of a short circuit the flash lamp will burn out, and this will to some extent protect the battery. If you wish to protect the accumulators from short circuits, we suggest you use a small fuse. Suitable fuses may be purchased from several of the manufacturers who advertise in this journal.

"RADIO" (Stourbridge) refers to the diagram Fig. 2, page 780, September 16th issue, and asks (1) Is the high frequency intervalve transformer properly connected when it is desired to use a plug-in type transformer. (2) May a variable 0.005 mfd. condenser be used in place of the 0.001 mfd. fixed condenser shown in the diagram. (3) May the reaction coil have the same number of turns as the aerial coil, or will the results be poor if the number of turns is a little different. (4) Is a Vernier condenser suitable for use across the primary of the high frequency transformer.

(1) As the high frequency transformer is of the plug-in type, the L.T. should be connected with the plate; I.P. with + H.T.; I.S. with grid; and O.S. to - L.T. (2) A 0.0005 mfd. variable condenser may be used in place of the fixed condenser if desired. (3) The reaction coil need not have the same number of turns as the aerial coil. In some cases it will require more turns, and in others less. The coil could be provided with two or three tappings for this purpose. (4) A Vernier condenser may be used in place of the 0.0001 mfd. condenser shown in the diagram if desired.

**"ZODIACAL"** (London) asks (1) How to add a high frequency connected valve before the crystal detector. (2) How to prevent the noises which are heard in the receivers.

(1) We suggest you connect the high frequency valve as shown in Fig. 3. Suitable valves are indicated in the diagram. The anode coil may be a winding 4" in diameter and 6" long of No. 30 S.S.C. wire with 18 tappings. The reaction coil

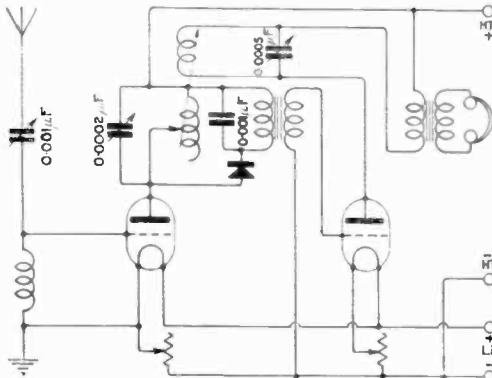

Fig. 3.

may be 3" in diameter and 4" long of No. 30 S.S.C. wire with six tappings. The remainder of the apparatus is connected up as shown in the diagram submitted. (2) We suggest you connect the 3 mfd. condenser across the H.T. battery, and a 0.001 mfd. condenser across the telephone transformer, and another 0.001 mfd. condenser across the low frequency transformer which is in circuit with the crystal detector.

**"L.B.B."** (Weston-super-Mare) asks whether we can tell him which transmitting station he heard transmitting music and speech in French, while listening in a short time ago. The wavelength was 440 metres.

Without a knowledge of the call sign, we cannot identify this station. We would point out that several British experimenters appear to have been transmitting music and speech in French recently, and of course there are a number of French amateurs who are engaged in telephone transmissions.

**"T.C.P."** (Treorchy) submits a diagram of connections and asks (1) Is the diagram correct; if not, kindly point out the fault. (2) Is the aerial quite suitable.

(1) The diagram of connections is quite correct, but you are not making use of reaction. We suggest you use a 6-volt L.T. battery, and put the aerial tuning condenser marked B in your diagram in series with the A.T.I. The grid condenser and leak should have values of 0.0003 mfd. and 2 megohms. If the tuning arrangement, which is the condenser and plug-in coil, will tune to the wavelength of the signals you wish to receive, you should certainly hear signals. (2) The aerial is quite large enough, but we suggest you take the lead-in from the end nearest the house instead of from the mast end. The lead-in will then drop straight down from the aerial to the lead-in in-

ductor fastened to the house. Great care should be taken with the earth connection, which should be as short as possible and go directly to an earth. A waterpipe may be used if there is one convenient, and the connection with the waterpipe should preferably be soldered. If an earth clip is used, the waterpipe must be thoroughly cleaned and the earth clip securely fastened, otherwise a high resistance earth will result. If the waterpipe is not conveniently situated, we suggest you construct an earth by burying a sheet of galvanised iron of as large an area as possible, two or three feet in the earth. A heavy wire such as 7/22 should be soldered with the earth plate and brought to the instrument.

**"H.W."** (Birmingham) refers to the diagram on page 128, October 28th issue, and asks whether the wiring is correct.

The diagram referred to has a small error. The leads to the negative terminals of the high frequency and the detector valves should be interchanged, when it will be found that the wiring is correct. The operation of the circuit is best seen from the previous figure, which is a theoretical diagram.

**"W.R.C."** (St. Margarets) asks whether we have any particulars of multiple microphones.

We would refer you to the article by Mr. Deloraine, page 156, in November 4th issue. We regret we are unable to give you much information concerning the construction of this type of microphone.

**"ROBIN HOOD"** (Staffs) submits a diagram of his receiver and asks (1) Whether the anode coil may be used as a reaction coil, or should a second coil be used for reaction. (2) Are the tuning arrangements correct. (3) How many tappings should be taken off the coils.

(1) The proposed arrangement is quite suitable, and the anode coil may be used as the reaction coil as desired. It would be better to connect a fixed condenser with a capacity of 0.001 mfd. across the telephone terminals. The tuning arrangements are correct, and you should be able to tune to just beyond 4,000 metres. It would be better, of course, if the aerial circuit were wound with No. 22 D.C.C., the closed circuit with No. 26, and the anode coil with No. 32, but no great loss in signal strength will be noticed, due to the use of a little finer wires. (3) We suggest you take 16 equally spaced tappings from the aerial coil, 8 tappings from the closed circuit coil, and 16 from the anode coil.

## SHARE MARKET REPORT

Prices as we go to press on February 16th, are:—

Marconi Ordinary .. ..	£2 12 0
.. Preference .. ..	2 5 6
.. Debentures .. ..	108 0 0
.. Inter. Marine .. ..	1 8 3
.. Canadian .. ..	11 0

Radio Corporation of America:—

Ordinary .. ..	15 4
Preference .. ..	13 3

*For the Discriminating Amateur.*

# A Precision Condenser

For Home-built Sets.

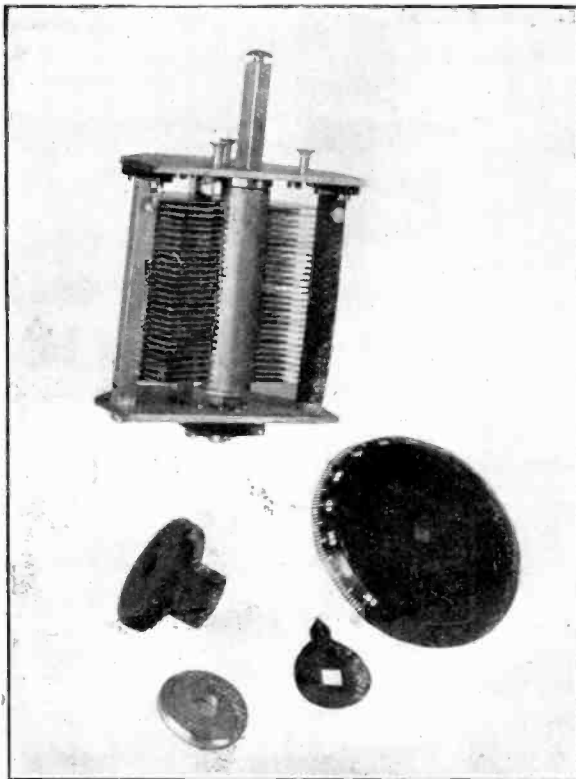

Patent applied for.

clearance holes for No. 4 BA metal screws. The top plate is ready tapped to take these screws, which are provided with the condenser. A pointer is also supplied for those who wish to use it instead of the dial.

The price of this high-grade precision instrument is

## 30/-

COMPLETE AND POST FREE

Capacity .001 microfarad. .0005 microfarad, 27 6.

The Marconi Scientific Instrument Company, Ltd., in pursuance of its policy of providing the discriminating experimenter with high-grade component parts, has prepared a new type variable condenser possessing features which will appeal to every serious amateur. As will be seen from the photograph, there are NO WASHERS, the plates and supports are of BRASS, while both fixed and moving plates are SOLDERED TO THE SUPPORTS, ensuring perfect conductivity and a minimum of resistance loss. The end plates are also of brass and POSITIVE CONNECTION with the moving plates is made by means of copper strip.

The condenser is supplied ready for panel mounting complete with dial, bushing and ebonite knob. To mount the condenser, it is only necessary to drill a central hole  $\frac{3}{8}$  diameter and three

## The Marconi Scientific Instrument Co., Ltd.

40, Dean Street, Soho, W.1.

Telegrams - THEMASINCO, WESTCENT.  
Telephone - - - - - GERRARD 7745.

# TOMLINSON

## LONDON, LIMITED.

3, FINCHLEY ROAD, ST. JOHN'S WOOD, N.W.8  
Hampstead 1844

Phones, 4000 Ohms... 22/6  
Ebonite, cut to any size, per lb. ... 3/6  
Aerial Wire, 100 ft. 7/22 5/6  
Ducon, no aerial required... 10/-

**HEADPHONES**  
4000 Ohms,  
and we have them  
**IN STOCK**

Complete Installations from  
**£25 to £150.**

Fixed Condensers any capacity.

Special 3-coil Holders,  
"Claritone" Loud Speaker  
**£6 : 2 : 6**

**STAND No. 27**  
Ideal Home Exhibition  
**OLYMPIA**  
MARCH 1st to 24th.

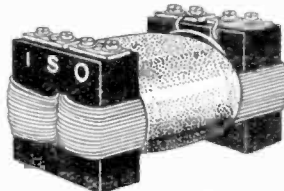

L.F. TRANSFORMER  
12/6 (Postage 4d.)

**STAND No. 27**  
Ideal Home Exhibition  
**OLYMPIA**  
MARCH 1st to 24th.

## J. BURNS, LTD.

Wangye Works,  
Chadwell Heath, Essex.

We are actual manufacturers and can offer special advantages to the trade—send us your enquiries.

CONDENSERS.	Retail price
001 mfd. . . . .	each 13/6
0005 .. . . .	each 10/-
0003 .. . . .	each 9/-
00005 .. . . .	each 4/6
Filament Resistances . . . . .	each 2/-
Terminals with high base . . . . .	doz. 1/6
Contact Studs, with nuts . . . . .	doz. 9d.
Sliders, with springs and studs . . . . .	each 9d.
Ebonite Coil Holders . . . . .	each 12/6
Ebonite Knobs . . . . .	doz. 4/-
Ebonite Panels, prices on application.	

**Single Valve Panels**  
fitted with Variable Condenser, Filament Resistance, Grid Leak and fixed Condenser. Engraved Panel and Rosewood finished Box, ready for use

**£4**

Vulcanised Fibre and Ebonite  
Sheets, Rods & Tubes from stock.

## E BONITE AND VULCANITE

TUBES—RODS—SHEETS

LARGE STOCKS

BRITANNIA RUBBER AND KAMPTULICON CO., LTD.  
7, NEWGATE ST., LONDON, E.C.1  
Telephone : 2168 Central  
Telegrams : Britannia, London

# Further Price reductions

On and after January 1st, 1923, Mullard Patent Resistances will be greatly reduced in price, as shown in the table below :

TYPE	OLD PRICE	NEW PRICE
Grid A	5/- each	3/- each
Grid B	5/- each	3/- each
Anode B	5/- each	3/- each
Anode A	5/- each	3/- each
Grid B Combined with '0002 mfd. Condenser B.A.	7/6 each	5/6 each

Particulars and prices of other Mullard productions on application.

MULLARD PATENT RESISTANCES are practically indestructible, perfectly "silent," steady and permanent.

Like all MULLARD products they are thoroughly dependable and the best of their class.

At the new 1923 price, these Resistances are remarkably good value.

A big increase in demand will undoubtedly follow this important reduction in price. To secure early delivery, order NOW.

## THE MULLARD RADIO VALVE COMPANY, LIMITED

(Dept. W.W.)

45, Nightingale Lane, Balham, S.W. 12

Contractors to H.M. Admiralty, War Office, Royal Air Force and Post Office.

Telephone : Battersea 1068  
 Codes : A B C (6th Ed.) Bentley's  
 Telegrams : Radiovalve Wandsworth, London

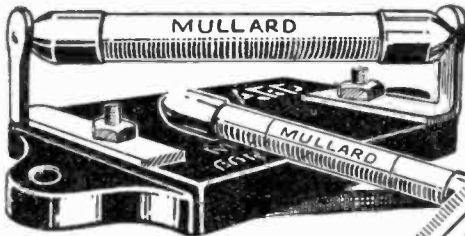

EB 36

Name and Address .....

Please send me post free

Quantity	Description	Price
.....	Telephone Valves Type B	2/8
.....	OR "Valves	15/- each
.....	Grid A Resistances	3/- each
.....	Anode A or B Resistances	3/- each
.....	BA Condensers '0003 mfd.	2/6
.....	Combined Resistance and Valve Condenser	9/8
.....	Valve Bases with Terminals	5/6
.....	Terminal Clips	1/3
.....		8d. per pair

Name of usual Wireless Dealer .....

I enclose (Cheque Money Order, P.O.) value .....

W.W. 24/2/23

to cover the cost

**SEND THIS TO-DAY**

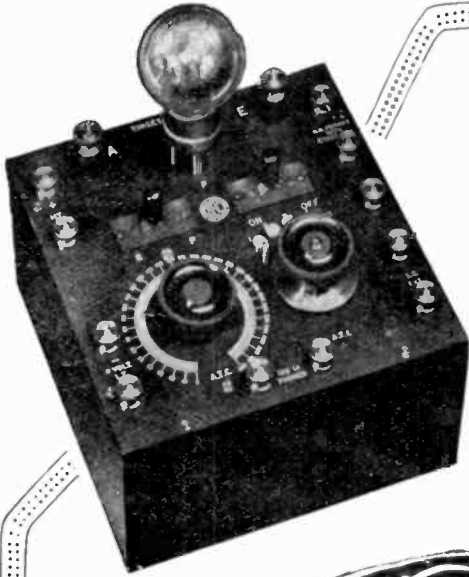

**You may depend upon it** that if the name **TINGEY** is on a wireless instrument, it is perfectly efficient in every detail. Here is a selection from the splendid **TINGEY** range.

**SINGLE VALVE BROADCAST RECEIVING SET.**

Wavelength 300 to 2800 metres.

**PRICE** (as illustrated, less valve) **£9 : 12 : 6** including Broadcasting Fees.

**ALL TINGEY Broadcast Receivers** bear the B.B.C. Stamp. All "**TINGEY**" Valve Apparatus is duly licensed under Marconi Patents for Amateur use in Great Britain.

*Illustrated Catalogue of 1, 2, 3, 4, and 5 valve Broadcast Receivers and Experimental Unit System, with all accessories, price 6d. post free.*

*Offices and Showrooms :*

**92, Queen Street, Hammersmith, London, W.6.**

*Phone : Hammersmith 1916. Telegrams : "Tingoidar, London."*

**TINGEY WIRELESS LTD.**

**THE PERFECT VALVE BATTERY**

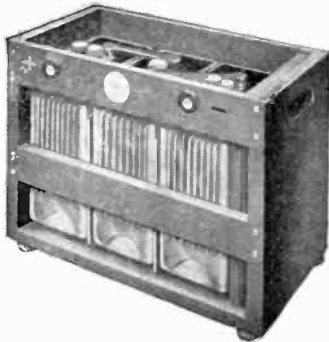

**HART**

**LOW TENSION**

**BATTERIES**

**"MEG" TYPE IN GLASS.**

Made in 4 and 6 volts of 20, 30, 40 and 50 Amp. Hours (actual) Capacity.

The plates in these Batteries are contained in **GLASS BOXES** with sealed ebonite lids, terminals and screwed vent plugs.

The cells are fitted in strong waxed teak crates with rubber feet as illustrated, and are insulated from the crate by rubber buffers.

**NO CELLULOID IS USED IN THE CONSTRUCTION OF THESE CELLS**

**HART ACCUMULATOR CO., LTD.,**  
**STRATFORD - - LONDON, E.15.**

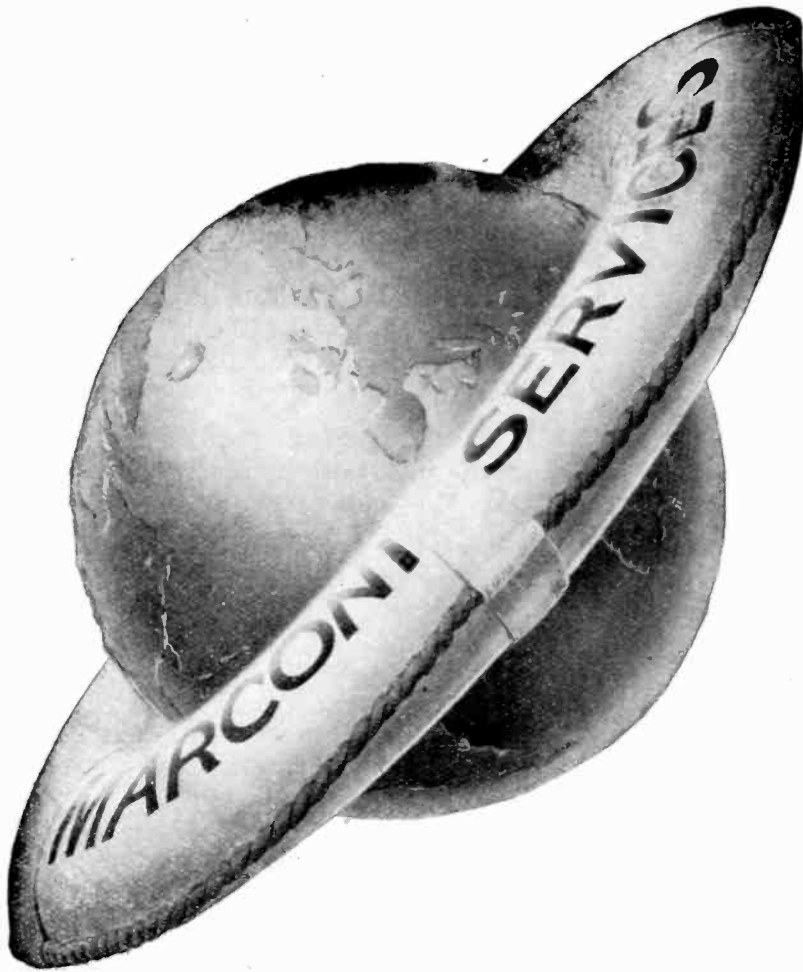

MARCONI  
GIVES  
UNRIVALLED  
WIRELESS  
SERVICE

*The* MARCONI INTERNATIONAL  
MARINE COMMUNICATION CO. LTD  
MARCONI HOUSE, STRAND, LONDON

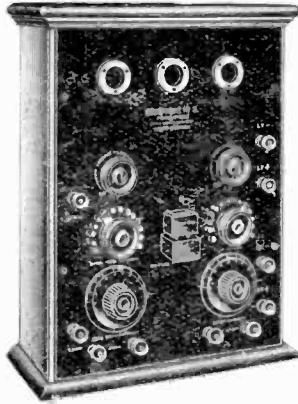

## BRITPHONE No. 3

A three-valve Receiver of very excellent performance, consisting of one H.F. stage, one detector, one low frequency, conforming in every way with the P.M.G. requirements, and bearing the British Broadcasting Company's mark.

The most efficient form of high frequency amplification possible is used, and the whole design of the instrument is one which gives the maximum efficiency over a large band of wavelengths with perfectly simple and noiseless operation.

The valves are mounted behind the panel, inspection windows being provided, thus preventing damage to valves and minimising the glare effect while operating the receiver. A socket is provided into which BRITWIRE coils can be inserted, enabling the reception of telephony from Hague, Paris, Berlin, etc. Range on Broadcasting, 100 to 150 miles under normal conditions. The receiver is mounted in a well-finished highly-polished mahogany case and can be used in an upright or flat position.

**PRICE** including B.B.C. Royalty **£25 : 4 : 0**

ILLUSTRATED CATALOGUE 3d. POST FREE.

## BRITISH WIRELESS SUPPLY CO. LTD.

Head Office—6, **BLenheim TERRACE, LEEDS.**

Phone—26926

London Showrooms—64, Frith Street, W. (off Shaftesbury Avenue)

Phone—Gerrard 2789

DEMONSTRATIONS DAILY.

And at—18, Eldon Square, Newcastle.

Phone:

Newcastle-on-Tyne, 360 City.

4, Pembroke Square,  
Above Bar, Southampton.  
8, Corporation Street, Belfast.

11, Church Street, West Hartlepool.  
Phone: West Hartlepool, 373.  
26, Newport Road, Middlesboro.

# Exide

## BATTERIES

THE suitability of Exide Batteries for wireless work is demonstrated by the fact that for many years they have been standard in Marconi equipment. The leading apparatus manufacturers are to-day standardising Exide Batteries.

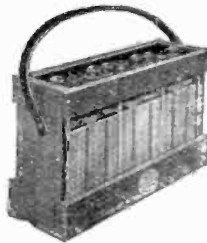

6 Volt 40 amp. hour Exide Battery.

We also manufacture H.T. Batteries.

THE resources of the world's largest battery manufacturers, their facilities for research and their modern factory equipment mean that were it possible to effect any improvement in battery design or construction, that improvement would appear in the Exide Battery.

Stand No. 37 at British Wireless Exhibition, Manchester, March 17th to 24th, 1923

Stand No. 37 at British Wireless Exhibition, Manchester, March 17th to 24th, 1923

THE **Chloride** ELECTRICAL STORAGE COMPANY LIMITED

LIFTON JUNCTION,  
Nr. MANCHESTER.

219/229, SHAFTESBURY AVENUE, W.C.2.

58, DALE END,  
BIRMINGHAM.

OBTAINABLE FROM ELECTRICAL CONTRACTORS & STORES OR FROM

300 EXIDE BATTERY SERVICE AGENTS DISPLAYING THIS SIGN.



IF YOU DON'T KNOW YOUR NEAREST EXIDE AGENT ASK US FOR LIST.



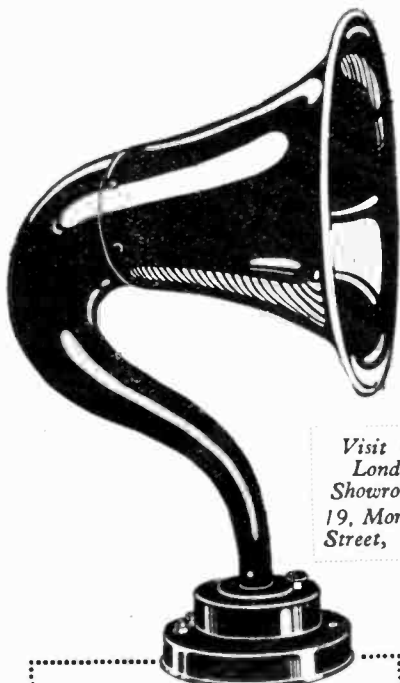

Visit Our  
London  
Showrooms  
19, Mortimer  
Street, W.1

## PRICES

### LOUD SPEAKERS

H.1 (Large) Low Resistance.  
120 ohms, height 21" ... £6 5 0  
H.2 (Small) Low Resistance.  
120 ohms, height 12" ... £3 0 0  
(High Resistances for either size  
2/8 to 5/- extra)

### MICROPHONE AMPLIFIERS

For use with L.R. Loud Speakers  
(120 ohms output).  
120 ohms input - £6 0 0  
2,000 ohms input - £6 2 6  
For H.R. input and output £6 10 0

# The "BROWN" LOUD SPEAKERS

With New Improved Curved Horns

THE requisites of a Loud Speaker are pure tone, clear articulation, and good volume of sound. The "BROWN" Loud Speakers possess these qualities, and they are enhanced by the new improved curved horn.

THE NEW HORN of dull blacked aluminium used with both H.1 and H.2 is constructed on the logarithmic law of increasing openings and is acoustically perfect.

## THE "BROWN" MICROPHONE AMPLIFIER

THIS AMPLIFIER magnifies signals, speech or music, without distortion, and is of considerable interest to amateurs and scientific investigators. This magnification is much greater than that obtained from a two-valve amplifier. In construction, this instrument is much more robust than other relays.

This instrument satisfies the urgent demand for a reliable, inexpensive amplifier, which the most inexperienced amateur can use, and which the most experienced requires. The necessary transformers are included in the base.

OBTAINABLE FROM ALL WIRELESS DEALERS.

Illustrated Catalogue of our Headphones, Loud Speakers & Amplifier post free from

## S. G. BROWN, LTD.

London Offices and Showrooms (RETAIL ONLY)—

### 19, MORTIMER ST., LONDON, W.1

TRADE COMMUNICATIONS ONLY TO—

HEAD OFFICE & WORKS: VICTORIA RD., NORTH ACTON, LONDON, W.3

Telegrams—"Siddbrownix, London."

Telephone—Chiswick. 1460

Sole Agent for the Argentine—Horacio D. Guerrero, Las Heras, 2486, Buenos Aires.



**Result of  
14 Years' Experience**

**"As good as Brandes"**

**What "Matched Tone" means:**

Counterfeits strive to duplicate only the best. That is why many headsets are sold with the claim that they are "as good as Brandes." But to be "as good as Brandes" the phones must be matched in tone, otherwise the listener concentrates on one and the advantage of having two is lost.

Brandes Headsets are "Matched Tone" Headsets, hence the faintest sound is heard distinctly by both ears.

MADE IN ENGLAND AND BEARS B.B.C. STAMP.

**CANADIAN BRANDES LIMITED**  
105, Great Portland Street, London, W.1

Telephone : LANGHAM 1145.

*Trade enquiries invited.*

# Typical of G. R. Co. Superiority.



## G.R.C.16

### FILAMENT.

Separate Rheostats. As a result of which finer control of Valves is made possible.

### TERMINAL BOARD.

Outside leads are brought to terminal board at rear of cabinet. No wires showing.

### TUNING VARIOMETER.

Any station can be easily tuned in by merely revolving the variometer dial.

### SHORT AND LONG SWITCH.

Wide latitude in aerial design is permitted by simple adjustment of this switch.

### REACTION VARIOMETER.

Reaction controlled to any degree by revolving this dial to the position required.

### EXTRA TERMINALS.

This permits addition of amplifiers at any time without extra connections.

### VALVE WINDOWS.

No danger of breakage. Improved appearance. Correctly placed for perfect visual indication of valves in operation.

### ON AND OFF SWITCH.

Completely disconnects H.T. and L.T. Batteries by one simple operation

### HINGED DOOR.

These doors embodied at top of cabinet allow Easy Inspection of Interior.

The above model, together with many others, can be seen either at our Showrooms or at the All-British Wireless Exhibition, Manchester, 17th—24th March (shown by our Manchester Agents, Messrs. Mottershead & Co.) or at the "Ideal Home" Exhibition, Olympia, 1st—24th March.

Write for name of nearest G.R.O. Dealer and Illustrated Catalogue.

# GENERAL RADIO COMPANY

TWYFORD ABBEY WORKS, ACTON LANE, HARLESDEN, N.W.10

Telephone: Willesden 3055 (3 lines).

SHOWROOMS:  
105, Great Portland Street, W.1

Telegrams: "Milliamp, 'Phone, London."

BRANCHES:  
Edinburgh and Bradford.

## VACANCIES.

In view of the very rapid expansion of the business of RADIO PRESS, Ltd., there are several openings for young men who possess the necessary qualifications.

*Those possessing some or all of the following qualifications are invited to apply by letter only.*

1. Thorough knowledge of wireless (practical and theoretical).
2. Accustomed to experiment with, construct and operate wireless receivers.
3. Experience of editorial routine work.
4. Experience in writing technical articles.
5. First-class education.
6. Ability to get on with the job.
7. Ability to work to a time-table and periodically at high pressure.
8. Absolute accuracy and a keenness to see that everything published is thoroughly authoritative.

The possession of the last four qualifications is imperative.

There are also two junior vacancies suitable for boys, of superior type and education, who have recently left school and who are enthusiastic wireless experimenters.

Immediate application by letter only should be made to:

**The Managing Director, RADIO PRESS, Ltd., Devereux Court, Strand, London, W.C. 2.**  
All applications treated in the strictest confidence. Applications should state age, education, experience and salary required.

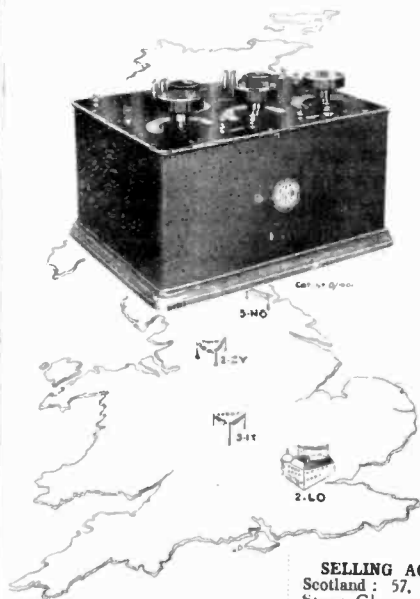

We also make Crystal Sets—  
range 15 to 25 miles.  
With 'Phones £5 Cs. Od.

**SELLING AGENTS.**  
Scotland: 57, Robertson  
Street, Glasgow.  
N.E. England: North  
British Engineering Equip-  
ment Co., Milburn House,  
Newcastle-on-Tyne

## Listen-in to all the British Broadcasting

This wonderfully selective 2-valve receiver has the *utmost reactance allowed* by the G.P.O. It has two carefully calibrated circuits which allow of the most minute tuning plus the utmost simplicity in manipulating.

Beautifully finished in lacquered or nickelled brass, mounted on matt-finished ebonite, all mounted in a polished walnut case.

Panel £13 14s. Od. M.O. Valves 17/8 each. Pair 4000 ohm Ericsson 'Phones. 60 volt H.T. Battery. 4 volt 30 ampere hour Accumulator. 100 ft. Aerial 7/22 Enamelled Copper and Insulators.

Price from Aerial to 'Phones,  
packing and delivery . . . . . **£20**

*Write to-day for full particulars.*

THE BRITISH L. M. ERICSSON  
MFG. CO., LTD.

International Buildings, 67/73, Kingsway  
W.C.2.

# Ericsson

**WIRELESS  
APPARATUS**

APPEARING 1st MARCH



FOR THE  
TRADE ONLY

PRICE  
4d.  
WEEKLY

*The only Weekly Publication devoted exclusively to Wireless Trade interests.*

In catering week by week for the rapidly growing interests of the Wireless Trade the "Wireless and Allied Trades Review" promises to supply a definite demand. Prospective traders will find no better means of keeping well abreast of current developments and events. Because of its comprehensive scope and thoroughly representative standpoint, the first number of this new publication should be in the hands of every Wireless Manufacturer and Dealer.

*Subscription rates and full particulars will be supplied on receipt of Trade Card addressed to the*  
**PROPRIETORS AND PUBLISHERS**

**THE WIRELESS PRESS LIMITED**  
**12/13, Henrietta Street W.C.2**

As Proprietors of the "WIRELESS WORLD" and Publishers of Wireless Literature, the WIRELESS PRESS, LTD., has had over ten years' experience. This new trade organ will thus possess from the outset the unique advantage of a practical knowledge of wireless trade requirements, in addition to a wide acquaintance with the public point of view.

*Applications for Advertisement Rates should be addressed to:*  
**BERTRAM DAY & CO., LTD.**  
*ADVERTISEMENT MANAGERS.*

**9 and 10, Charing Cross, London, S.W.1**

GERRARD 8063, 8064, 8065

"ADBERTRADA, WESTRAND, LONDON."

**ORDER YOUR COPY NOW**

# T.M.C. WIRELESS

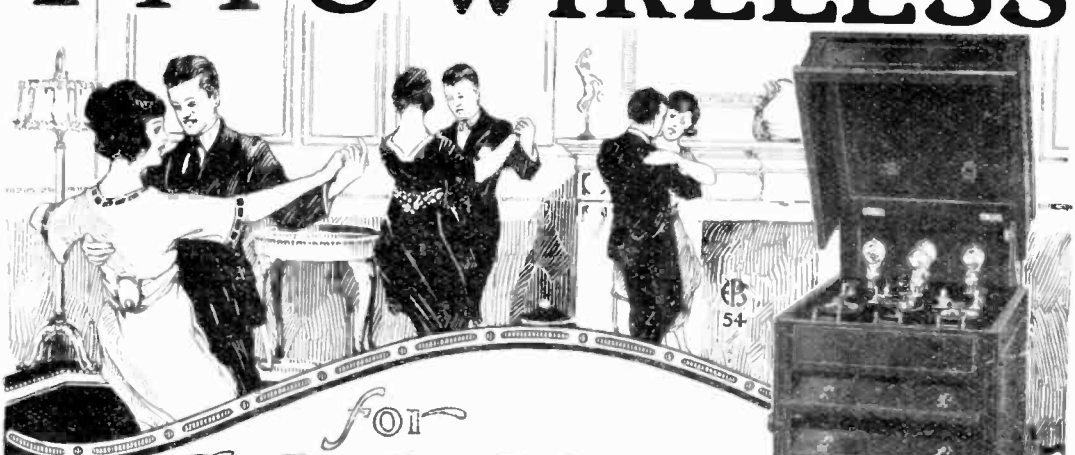

for  
*Delightful*  
 DANCING

What more pleasurable than a dance at home to a first-class orchestra? Circumstances in which you have all the enjoyment of a dance and none of the fatigue of going to it. Or it may be that you are interested in boxing, football, the latest news, stock exchange quotations, the weather forecast, or delightful concerts. You can have all these, enjoyably and pleasurable, in the comfort of your own home with a T.M.C. Wireless Receiver. There is no trouble to you—T.M.C. have engineers in every large town who will install and periodically inspect the apparatus. T.M.C. Wireless is particularly simple to work and gives every satisfaction. T.M.C. Wireless Receivers, which are fully approved by the Postmaster-General, bear the seal of the British Broadcasting Company. The wide variety of models are entirely British made.

FROM **£4 : 5 : 0** UPWARDS  
 INCLUDING ALL ROYALTIES

*London, Birmingham, Manchester, Newcastle and Cardiff are "Broadcasting" now.*  
 Come and listen to them any evening up to 10 p.m. at our Showrooms in:—London, Birmingham, Belfast, Bristol, Cardiff, Dublin, Glasgow, Leeds, Liverpool, Manchester, Newcastle, Sheffield.  
 London Showrooms: 68, Newman St., W.C. 1. Museum 5581.

*Write to us for our nearest address.*

Ideal Home Exhibition,  
 March 1st—24th.



Stand 11, Row D, Main Hall.  
 Stand 18, New Gallery Hall.



The "Everet" Crystal.  
 No adjustment necessary.  
 Fits any crystal receiver.  
**10/-** each

**TELEPHONE MFG., & LTD.**  
 HOLLINGSWORTH WORKS, DULWICH, LONDON, S.E. 21.



TYPE A.I. Cap. .0005  
IN CELLULOID CASE.

## SINGLE CONDENSERS AT WHOLESALE PRICES

Direct from the Makers—Saving Middlemen's Profits.

**Complete in EVERY respect and exactly as illustrated, to the following specification.**

Rotary, Air Dielectric, 22 Gauge Aluminium Vanes. Metal to Metal Adjustable Bearings. Spacing between plates sufficient for pressure up to 1,000 volts. Built upon Ebonite. Engraved Ebonite Dial.

### PRICES :

Type A.I.	Plates.	Type A.II.
.001 .. 15/-	57	.001 .. 10/-
.0005 .. 12/6	29	.0005 .. 8/6
.0003 .. 11/3	19	.0003 .. 6/9
.0002 .. 10/-	13	.0002 .. 5/6

Vernier Condensers, 3 plate, 3/9 ; 5 plate, 4/6

### Postage and Packing :

1, 1/- ; 2, 1/3 ; 3, 1/6

If more than 3 kindly include ample for packing and carriage.

Don't allow our low prices to prejudice you. They are no criterion whatever of the value we offer. Our Motto is **QUALITY FIRST**, and every Condenser carries our money-back guarantee.

### APPRECIATION FROM PEOPLE WHO MATTER.

11, Albert Grove, Southsea, Hants.

Gentlemen,  
..... The quality of your products is good and the price is very reasonable.  
Yours faithfully,  
John H. C. Harrold,  
Radio Engineer and Lecturer  
116, Verden St., Sheffield.

Dear Sirs,  
..... We have tested your Condensers in the circuits we propose to use and we find them O.K.  
Yours truly,  
Brookes Bros.,  
Manufacturers of Scientific Apparatus.  
The Manor, Willenhall.

Dear Sirs,  
I thank you for Condensers as per invoice enclosed dispatched to Park Engineering Co., Willenhall. These are eminently satisfactory....  
Yours faithfully,  
W. Harvey-Marston,  
Manufacturer of Wireless Components.  
Francis Law, Ltd.,  
Electric Light and Power Engineers,  
Ilkley.

Dear Sirs,  
..... we are keeping the samples in question and are highly satisfied...  
Yours faithfully,  
Francis Law, Ltd.

Prompt  
Delivery

Cash with  
order.

# FALLONS

THE CONDENSER PEOPLE

230a, HERMITAGE ROAD, LONDON, N.4.

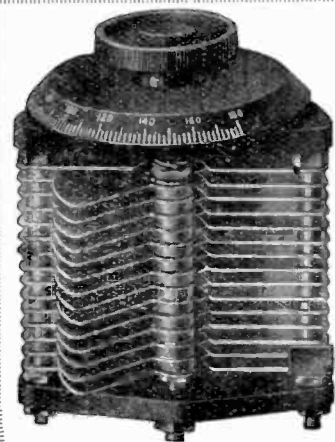

Type A.II. Cap. .0005.



66 POLAR 99

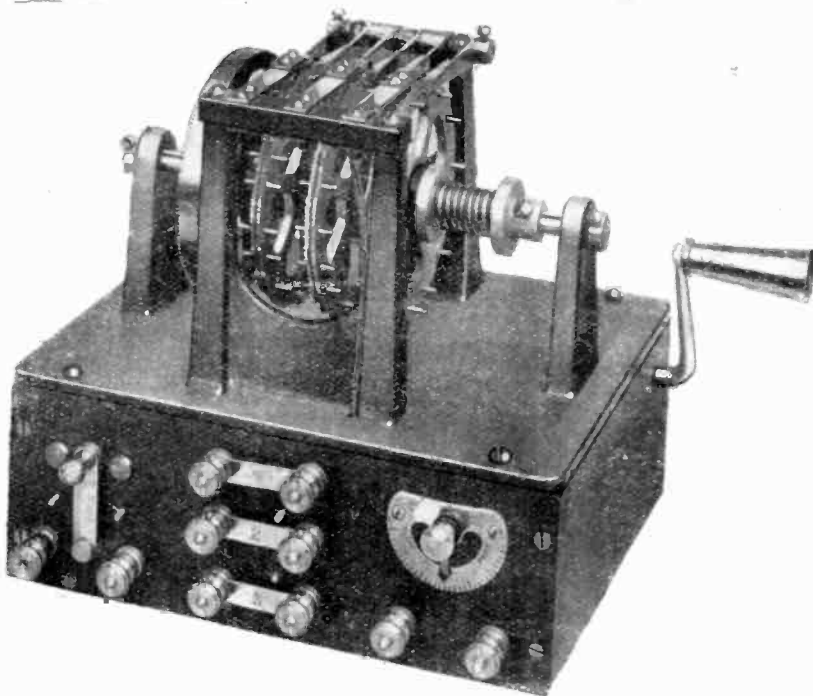

## “POLAR” Automatic Morse Instructor

This ingenious mechanical device—the result of many years' patient development work—makes it possible for a person to become proficient in the reception and transmission of Morse signals by practising at home during spare time, without the assistance of an experienced telegraphist.

It can transmit either buzzer or sounder signals at any desired speed from a few letters a minute up to 40 words per minute. It transmits in cypher groups and has tens of thousands of permutations, thus avoiding any recognisable repetitions.

By adjusting the links marked 1, 2 and 3 on the illustration the instrument may be set to transmit combinations of letters and figures, figures alone, or letters alone.

When set to work very slowly it transmits a letter at a normal speed, pauses, then transmits another letter—it does not draw out or distort characters when working at beginner's speed.

Any number of head telephones may be connected to it, thus making it an ideal class instructor.

A hand key is combined in the instrument for sending practice.

No wireless society should fail to add one or these instruments to their club equipment for the use of members who wish to learn Morse.

PRICE £10 - 10 - 0

*Full descriptive leaflet will be forwarded on request.*

# RADIO COMMUNICATION CO. LTD

34 and 35, NORFOLK STREET, STRAND, LONDON, W.C.2  
 NEWCASTLE: 17, Sandhill. LIVERPOOL: 67, Dale St. CARDIFF: Atlas Chambers, James St.  
 SOUTHAMPTON: 19, Queens Terrace. GLASGOW: 10, Blythswood Square.



# The IONOPHONE VARIOMETER TUNED BROADCASTING SETS

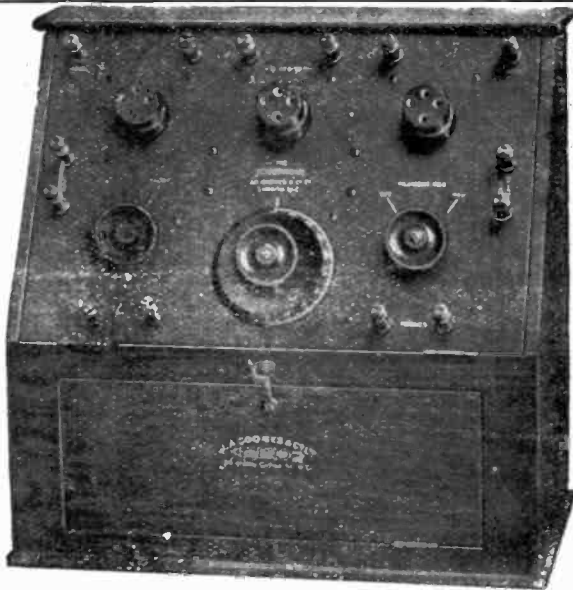

## Three Valve Set

This is the cheapest and best three valve Set on the market. Owing to the restrictions of the P.M.G., Broadcasting reception has been made very inefficient for the public. This Set has been specially designed to give practically as good results as Sets having variable retroaction which are only available to those who can obtain experimental licences.

Range 300-3,000 metres. Receives all Broadcasting, including the Hague and Paris Concerts.

**PRICE (inclusive of all Royalties)**  
£16 : 5 : 0

*Valves, Phones and Batteries extra.*



## Crystal Set

An ideal Set for receiving local broadcasting clear and distinct, suits everyone's purse.

Reception up to 25 miles.

**PRICE (inclusive of all Royalties)** .. £5 : 0 : 0

*Phones extra.*

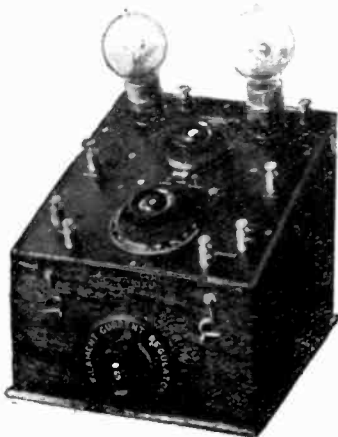

## Two Valve Set

The above is designed on the same lines as the three valve Set and will find its way into many homes on account of its marvellous value and efficiency.

Range 300-3,000 metres. Reception range the same as three valve set.

**PRICE (inclusive of all Royalties)**  
£11 : 15 : 0

*Valves, Phones and Batteries extra.*



## Loud Speaker Adaptor

An ebonite horn with attachment for Headphones.

**PRICE** £2 15s.

*Demonstrations of all the above given daily.*

**J. A. Coomes & Co., Ltd.,** 41, New Oxford St., W.C.  
(Opposite Mudge's) Museum 3642.  
*(Also at Stand 25, Gallery, New Hall. Ideal Home Exhibition, Olympia.)*

# BROADCASTING RECEPTION SETS

OF EVERY DESCRIPTION, and everything for wireless at everybody's price



**THE "ORPHEUS"**  
**2-VALVE RECEIVING SET**  
 Designed for Broadcasting only  
 This Set has a patent coupling and will not radiate.  
 The High Tension Battery is enclosed, and there are only six external terminals, aerial, earth, 'phones, and low tension. We claim that this Set is the easiest 2-Valve Set to manipulate on the market.  
 Price, complete, all accessories for working—  
 Including 'Phones, Batteries, H.T. and L.T. Aerial Wire, Insulators Total £10 15s. 0d.  
 B.B.C. Royalty Stamp, £1 15s. ex.



**THE "PERFECTO"**  
**VALVE SET**  
 Comprises one D.T. valve and one L.F. valve. Functions alternatively to the Orpheus, this Set giving Volume where the other gives Range.  
 A Powerful Set for local Broadcasting. Complete 'Phones, Batteries, Accumulator, Valves, Aerial Wire and Insulators for—  
 £10 15s. 0d.  
 B.B.C. Royalty Stamp.  
 £1 15s. 0d.

ALL INSTRUMENTS  
 PASSED FOR  
 BROADCASTING  
 LICENCE BY G.P.O.



**THE "ALDERSGATE"**  
 Single Valve Set, complete with all Accessories, including 'Phones, Accumulators, H.T. Battery and Valve . . . . . £7 10s. 0d.  
 B.B.C. Royalty Stamp . . . . . £1 0s. 0d.  
 If Aerial Wire and Insulator required, 5s. extra.  
 Hundreds of Testimonials for Efficient Working.

SEND FOR  
 CATALOGUE

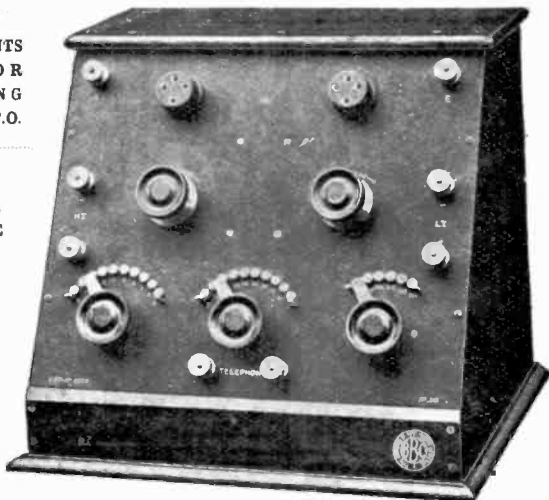

**A TWO-VALVE SET WITH REACTION APPROVED BY POSTMASTER-GENERAL FOR BROADCASTING, No. 0236.**  
 Comprises one D.T. valve and one L.F. valve mounted in a handsome slope back cabinet. Separate filament control for each valve, wavelength range 200-4,000 miles. Price complete with phones, battery, accumulator, and valves, aerial wire and insulator £13 13s. 0d.

**WIRELESS INSTALLATIONS LIMITED**  
 (Dept. C.) 81, Turnmill Street, London, E.C.  
 (Nearly opposite Farringdon Street Station, Metropolitan Railway), five minutes from Holborn Viaduct.

# Discriminating Amateurs

—SHOULD VISIT—

## THE AMATEUR WIRELESS SUPPLY CO.

2, MACCLESFIELD STREET  
SHAFTESBURY AVENUE  
LONDON, W.1

*Where you can obtain the best quality components at the right prices—will save you money and ensure your station being efficient.*

### A SELECTION FROM OUR LIST:—

L.F. INTERVALVE TRANSFORMERS .. .. .	each	14/6	CRYSTAL DETECTORS .. .. .	each	2/6
FILAMENT RHEOSTATS .. .. .	each	2/6	GRID LEAKS, 2 MEG. .. .. .	each	1/-
FIXED CONDENSERS (any capacity) .. .. .	each	1/3	VALVE HOLDERS WITH 8 NUTS AND 4 WASHERS .. .. .	each	1/1
FIXED CONDENSERS AND GRID LEAKS .. .. .	each	2/9	DITTO, PLAIN LEGS .. .. .	each	8/1
EGG INSULATORS .. .. .	each	3d.	9" EBONITE LEAD-IN TUBES WITH WING NUTS, each		2/-
CONDENSER KNOBS, BRASS BUSHED 2B.A. .. .. .	each	4d.	4-VOLT 20 AMP. HOUR EVER-READY ACCUMU-		
4 B.A. TERMINALS WITH NUTS AND WASHERS each		2d.	LATORS .. .. .	each	18/-
4 B.A. TERMINALS WITH NUTS AND WASHERS, Smaller .. .. .	each	1½d.	6-VOLT 40-AMP. HOUR EVER-READY ACCUMU-		
H.T. 15-VOLT EVER-READY BATTERY .. .. .	each	3/6	LATORS .. .. .	each	37/6
H.T. 36-VOLT EVER-READY BATTERY (Plug Sockets) .. .. .		15/-	12 × 4" FORMERS WOUND 24 S.W.G. ENAM. WIRE .. .. .	each	3/6
H.T. 60 VOLT EVER-READY BATTERY (Plug Sockets) .. .. .		25/-	1" SQ. × 13" DRILLED SLIDER RODS .. .. .	each	4d.
HERTZITE, 1- GALENA, 2d.; BORNITE, 6d.; CARBORUNDUM .. .. .	each	2d.	SLIDER PLUNGER, COMPLETE .. .. .	each	4d.
SWITCH ARMS, COMPLETE WITH KNOB, etc. 1- and 1/8			7 22 H.C. COPPER AERIAL .. .. .	10'	2/9

### VARIABLE CONDENSERS

Complete all parts but unassembled.			Complete assembled.		
'001 .. .. .	each	6/6	'001 .. .. .	each	12/6
'0005 .. .. .	each	4/6	'0005 .. .. .	each	8/6
'0003 .. .. .	each	3/-	'0003 .. .. .	each	7/6
'00005 .. .. .	each	2/-	'00005 .. .. .	each	3/9

(Ebonite bases and tops 1/- extra.)

### SPECIAL OFFER.

Very Sensitive 3,000 ohm Double Headphones, Marked "B.B.C." 22/6 Pair, with cords.

Orders despatched *BY RETURN* and delivered free if to the Value of 30/-.  
Send ample postage if under this value. Excess will be refunded.

SEND FOR LATEST PRICE LIST.

THE AMATEUR WIRELESS SUPPLY COMPANY, 2, Macclesfield Street,  
Shaftesbury Avenue, London, W.1.

## AN APPOINTMENT.

The Advertiser desires to receive applications from thoroughly competent wireless Engineers for a responsible position in connection with patent work.

A substantial salary would be offered to a suitable applicant.

Applications, which should state age and experience, should be addressed to Box 1365, Sells Advertising Offices, Fleet Street, E.C. 4.

BRITISH  
TEC  
MAKE

# T. E. C.

BRITISH  
TEC  
MAKE

Patent  
Spring  
Con-  
nections  
are  
specially  
adaptable  
for  
Wireless  
Work.

**PATENT**

## SPRING CONNECTIONS

IN NUMEROUS SIZES & DESIGNS

<p><b>SIMPLE STRONG CHEAP EFFECTIVE</b></p>		<p><b>LARGE STOCKS PROMPT DESPATCH</b></p>
---	---	--

**The EFANDEM CO. LTD**

PHONE 1123 · FALLINGS PARK WORKS · WOLVERHAMPTON · TELEGRAMS "EFANDEM"

**Ask for Samples and Illustrated Price List.**

Patent  
Spring  
Con-  
nections  
are  
specially  
adaptable  
for  
Wireless  
Work.

To get the utmost possible out of your Receiving Set

USE

# RIMAR TUNING COILS

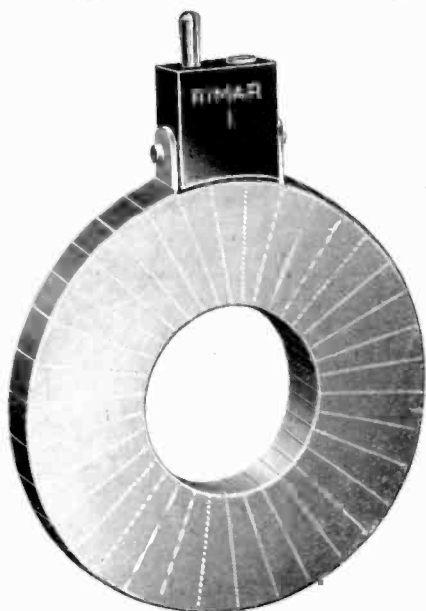

Rimar Coils are specially designed to give maximum efficiency obtainable without reaction. They have solid polished ebonite plugs and plated fittings; they are damp proofed with synthetic resin; they have lower resistance than any other plug-in coil with negligible self-capacity.

Small sizes are wound with 18-20 S.W.G. wire without wax. Nos. 1, 2 and 3 can be supplied wound with 7/36 cottoned Litz.

**WITH 100ft. SINGLE AERIAL IN CLOSED CIRCUIT.**

	Min. 40 MMF.	'0005	'001	Min. 40 MMF.	'0005	'001	Price.
1	320	420	550	104	241	365	4/9
2	340	460	643	126	322	468	5/-
3	384	710	910	232	580	850	5/6
4	660	1010	1340	325	820	1210	5/9
5	730	1120	1480	370	915	1335	6/-
6	1070	1610	2150	485	1200	1760	6/6
7	1220	1980	2620	625	1660	2370	7/3
8	1790	2725	3935	930	2215	3270	8/-
9	2415	3530	4535	1150	2780	4060	8/3
10	3360	4685	6105	1600	3860	5580	8/6
11	4645	7115	9550	2570	6240	9000	9/6

**PRICES**

Condenser in parallel.  
Price per complete set of 11, 70/-. Coils for super-regenerative circuits, No. 1250, 12/-. No. 1500, 14/-. Coils, No. 750, 10/6. No. 1,000 11/3. Postage extra, packing free.

Obtainable from Selfridges (Oxford Street), H. W. Sullivan, Ltd., Middlesex Street, E.C. and John Robertson Ltd., May Street, Belfast.

*Insist on having Rimar Coils, if you have any difficulty in obtaining them send us the name of your local dealer.*

We are also manufacturers of the famous Rimaride—the synthetic galena which is carefully prepared from specially selected ingredients. Price 3/- per oz.

*Trade Enquiries invited.*

**THE RIMAR COIL MANUFACTURING CO.**  
11, VOWLER STREET, LONDON, S.E.17

HOP 6467.

# The Mail Order House **THE PETO-SCOTT Co.** For all Radio Components

## Some items from our new 32-page Catalogue

Below are given some typical examples of Peto-Scott value. Each article carries our full guarantee of complete satisfaction or money willingly refunded. 32 pp. Catalogue with full list of Amateur Stations and Call Signs.

3d.

### SERIES-PARALLEL SWITCH.

With brass bush, two nuts and spring washer ... 3/-



**RADIAL SWITCH.**  
4 leaf laminated. Complete with bush, nuts and washer 2/-

**KNIFE SWITCH.**  
Single pole, single throw. On ebonite base ... 2/3 each.

**KNIFE SWITCH.**  
Double pole, single throw. 3/6

**KNIFE SWITCH.**  
Single pole, double throw. 2/6

**KNIFE SWITCH.**  
160 pole, full throw 4/6

**INSULATORS. BAREL.**  
Very high breaking strain, each 7d.

**SHELL.**  
Green Vitreous China, each 1 1/2. Miniature size, each 5d.

**AERIAL WIRE.**  
7/25 stranded hard drawn Copper, per 100 ft. coil ... 3/6  
per 12 1/2 ft. coil ... 5/-

7/25 stranded hard drawn Copper, per 150 ft. coil ... 4/-

18 SWG Silicon Bronze, per 150 ft. coil ... 3/-

18 SWG Enamelled Copper, per 150 ft. coil ... 2/-

**M.T. BATTERIES.**  
Very silent and thoroughly reliable. Fitted with two Wander Plugs 15 volts ... 3/-  
38 " ... 7/6  
46 " ... 14/-

**GRID LEAK AND CONDENSER UNIT.**  
50,000 ohms, 2/6  
80,000 ohms, 2/6

**GRID LEAK AND CONDENSER.**  
Guaranteed neutral and mounted with clips. Any value ... 4/6

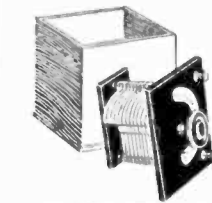

**PETO-SCOTT CONDENSERS.**  
Complete in Polished Mahogany Cabinet, ready for use.

0015	24/3
001	18/3
00075	16/9
0005	14/6
0003	12/6
0002	12/3
0001	11/-
00005	9/-

**SETS OF PARTS.**  
For Panel mounting.

0015	12/6
001	9/6
00075	8/3
0005	7/-
0003	6/3
0002	5/6
0001	4/9

**ROTARY PLATES.**  
per doz. 6d.

**FIXED PLATES.**  
per doz. 6d.

**CONDENSER WASHERS.**  
Small size ... 2d.  
Large size ... 3d.

**ACCUMULATORS.**  
4 volts, 10 amp. hrs. continuous, 14/6  
4 volts, 20 amp. hrs. continuous, 17/6  
4 volts, 40 amp. hrs. continuous, 27/6  
6 volts, 10 amp. hrs. continuous, 20/-  
6 volts, 20 amp. hrs. continuous, 27/6  
6 volts, 40 amp. hrs. continuous, 42/-  
All Accumulators add 1/- for packing.

**SLAB COIL PLUG.**  
To take Slab Coils. Solid ebonite through-out ... each 2/6

**CRYSTAL DETECTOR.**  
Totally enclosed and mounted on polished Ebonite and all fittings plated ... 8/6

**EBONITE SLIDER.**  
As shown, each 5d.

**BRASS TERMINALS.**  
Mk III pattern, Small, 2/3 doz. Large, 2/6 doz.  
Divided pattern, Large, 3/6 per doz. Small, 2/- per doz.  
Telephone pattern, Small, 2/6 doz.

**SWITCH STOPS.**  
Brass, fitted with two nuts ... per doz. 1/-

**SWITCH STUDS.**  
Brass, fitted with two nuts, per doz. 9d.

**VALVE SOCKETS.**  
Brass, fitted with two nuts ... each 1 1/2d.  
per doz. 14

**THE "PETO-PAN" LOUD SPEAKER.**  
A superlative Loud Speaker. Fitted with adjustable diaphragm which controls pitch of note. Price 50/-  
Broadcast Co.'s Seal, extra 3/-

**THE MAX-AMP.**  
Finest quality intervalve Transformer. Fully guaranteed. Tested to 500 volts between windings. Very silent in action and free from all distortion ... each 21/-

**EBONITE DIAL.**  
Superior pattern in solid Ebonite, each 2/-  
American pattern, Engraved 0-180 each 2/6

**3-COIL HOLDER.**  
Test solid ebonite through-out. Fitted with either knobs or long handles. Price 17/6

**The PETO-SCOTT Standardised Unit System.**

**No. 4. DETECTOR UNIT.**  
Full Set of parts for home construction 17/6  
Less Valve, Mahogany Cabinet to fit, extra 9/6

**No. 3. H.F. AMPLIFYING UNIT.**  
Full Set of parts for home construction ... 13/6  
Less Valve, Mahogany Cabinet to fit, extra 9/6

**No. 5. L.F. AMPLIFYING UNIT.**  
Full Set of Parts for home construction ... 33/6  
Less Valve, Mahogany Cabinet to fit, extra 3/6  
1 Booklet describing the whole system, 6d.

**THE MULTI-WAVE AMPLIFIER.**  
For H.F. Amplification on all wave lengths above 1000 metres. No. 1 for coupling between H.F. and detector and No. 2 for use where more than one stage of H.F. Amplification is used.

No. 1 8/6 No. 2 ... 12/6

**THE "TUNODE" PLUG.**  
Permits the usual type of honeycomb coil to be used as a tuned anode coil with exceptionally good results. Simply plug in H.F. Holder and add suitable honeycomb coil, each 3/6

**IGRANIC COILS.**

L25	5/-	L300	9/6
L35	5/-	L400	10/3
L50	5/2	L500	10/6
L75	5/6	L600	11/-
L100	7/-	L750	11/10
L150	7/10	L1000	12/8
L200	8/8	L1250	14/-
L250	9/-	L1500	15/-

**CRYSTAL RECEIVER (De Luxe pattern).**  
Complete with best quality phones, aerial wire and insulators. Nothing more to buy. Price, £6 8s. 0d.

**POSTAGE : POSTAGE EXTRA ON ALL ITEMS BUT PAID ON ALL ORDERS OF £2 AND OVER**

The PETO-SCOTT Co., Ltd., Featherstone House, 64 High Holborn, W.C.1

# Output!

With the Fuller High Tension Battery you can count on five or six months' service on one charge alone. Re-charging costs you only a few pence, and with ordinary care the Battery will last 10 years in normal service. That is just one of many reasons why

## FULLER BLOCK BATTERIES

are universally recognised as "perfect for Wireless Work." There are no plates to buckle, no possibility of injury from accidental shorting, and complete absence of fire risks.

*Sold by Wireless Dealers, Electricians and over 300 Fuller Battery Service Agents. Dealers who are not fully stocked should write us at once.*

## FULLER'S UNITED ELECTRIC WORKS LTD.

WOODLAND WORKS, CHADWELL HEATH, ESSEX.

*Manufacturers for the Admiralty, Air Ministry and War Office for wireless work.*

Telegrams—Fuller, Chadwell Heath. Telephone—Ilford 1200 (6 lines).

## FULLER BLOCK BATTERIES

### 6 VOLT L.T. BATTERY

in ebonite case with strap handle  
 B.W. 6/20 ..... 25/-  
 B.W. 6/40 ..... 40/-  
 B.W. 6/60 ..... 52/6

### 30 VOLT H.T. BATTERY

impregnated wood case with outside terminals and sliding lid  
 H.T. 1 ..... 30/-

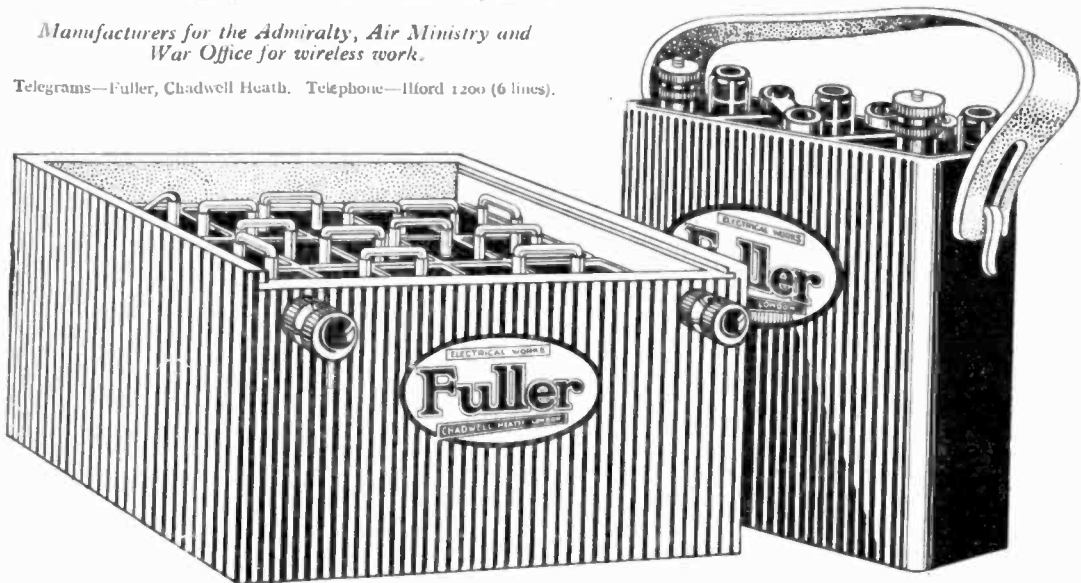

# A NEW ORMOND LINE

HIGH IN  
QUALITY

**3/6**  
EACH

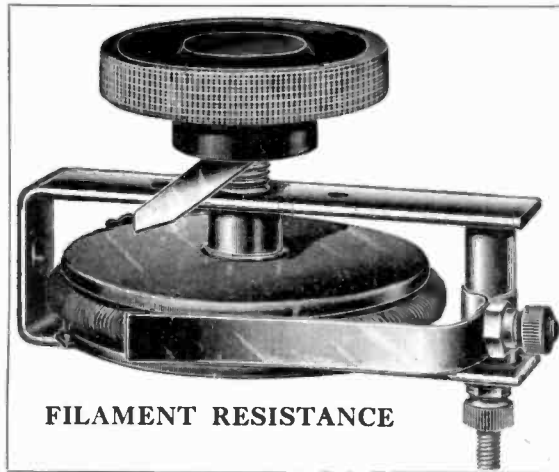

FILAMENT RESISTANCE

LOW IN  
PRICE

**3/6**  
EACH

ORMOND ENGINEERING CO.  
199 PENTONVILLE ROAD, KING'S CROSS, N.1

Telephone—Holborn 1812.

Telegrams—"Ormondengi, Kingcross."

# THE GRAMAPHIX LOUD SPEAKER

We have a large  
stock of Component  
Parts and Materials.  
Demonstrations  
given free.

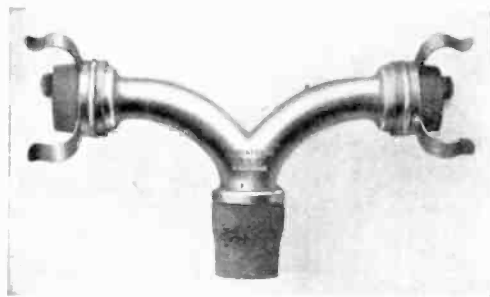

Crystals and Valve  
Sets B. B. C. in  
Stock.  
Wireless List Post  
Free.

Established 1828

Bronze Medal 1884.  
Gold Medal 1890.

This is a most efficient device to which the ordinary headphones are clipped and the Gramaphix mounted on the tone arm of a gramophone. Straight or curved horns are supplied to fit from 6/6, the Gramaphix 10/6, making a complete loud speaker for 17/-.

Awards for Excellence  
of Tool & Machines.

# RICHARD MELHUISE, LTD.

TOOL, MACHINE & HARDWARE MERCHANTS, ELECTRICAL ENGINEERS

Telephone— 50, 51 & 84, Fetter Lane, E.C. 4  
1611 (3 lines) Holborn. "Workfolk, London."



# W. J. HENDERSON

351, FULHAM ROAD  
SOUTH KENSINGTON

(Bus Routes Nos. 14 and 96 pass the door.)  
(Nearest Stations, Earl's Court and South Kensington.)

## Accessories of Quality

- AERIAL WIRE, 7/22 Enamelled Copper, per 100' .. 5/-
- AERIAL INSULATORS, Porcelain, "Shell" Type, each 1/-  
"Egg" Type, each 2 1/2, 5 for 1/-
- AERIAL STAY WIRE, galvanised, suitable for masts up  
to 50' high, per 100' .. 4/-
- ANODE REACTANCE COILS (Radio Instruments),  
150-4,000 m. .... 20/-  
150-20,000 m. .... 25/-
- ACCUMULATORS, 4v. 30 a.h. (suitable for one or two  
valves) .. each 14/6  
6v. 40 a.h. .... each 29/6  
6v. 60 a.h. .... each 39/2
- COILHOLDERS, for three coils, panel mounting, com-  
plete with terminals .. each 14/6 and 18/-  
Extension handles for above .. per pair 1/6
- COILHOLDERS, Igranitic, table stand, complete with  
extension handles, patent spring terminals .. each 21/-
- COILS, Igranitic (De Forest), duolateral.. from 5/-
- CONDENSERS, fixed, .0003 and .0005 .. each 1/6
- CONDENSERS, fixed, Dubilier .. each 2/8 and 3/-
- CONDENSERS, Variable, high grade, for panel mounting,  
complete with knob and pointer—Vernier, 5/-; .0003,  
12/-; .0006, 15/-; .001, 20/-.
- DUCON, Special "Electric-light Aerial" attachment,  
each 10/-
- FILAMENT RHEOSTATS, for panel mounting, one  
valve .. each 3/6  
Three valves .. each 4/6
- GRID CONDENSER AND LEAK, Dubilier .. 5/-
- HIGH TENSION BATTERIES, 15-volt blocks, with  
flexible leads, long life .. each 3/-
- INSULATED SLEEVING, Red, Green, Brown, Yellow,  
per yard 5d.
- IVORINE SCALES, semi-circular, engraved 0-180, best  
quality .. each 1/-
- LOUD SPEAKERS, Amplion, 120 ohms, 50/-; 2000  
ohms, 52/6.
- POTENTIOMETERS, circular type for panel mounting,  
complete with knob and pointer, 350 ohms .. each 12/6
- TRANSFORMERS (Radio Instruments), Intervolve .. 25/-  
Telephone .. 20/-
- TRANSFORMERS (IGRANIC), Intervolve .. 22/6
- TRANSFORMERS, HIGH FREQUENCY, to fit Valve-  
holders, Broadcast wavelengths .. 5/6  
600 m. .... 8/-  
1,000 m. .... 8/6  
2,000 m. .... 7/-  
Etc., etc.
- VALVEHOLDERS, mounted in ebonite, fitted with  
washers and nuts .. each 1/-
- VALVES, M.O., "R" Type .. each 17/6
- VALVES, ORA .. each 15/-

The above are only a few selected items from our large stocks.

Terms, Cash with order; goods above £2 in  
value carriage paid.

Post Orders are despatched on "day" of receipt.

Lists on request, post free, 3d.

### THE MARK OF

### RELIABILITY

Filament  
Resistances  
**2/-**  
EACH  
Panel Type  
with Knob  
and Pointer



Potentiometer  
300 ohms  
**4/6**  
EACH  
Panel Type on  
Ebonite

1 to 12 Volts.

1 to 35 amps.

#### VOLT & AMMETER

Combined Dead Beat Pocket Type. New and not German.  
Splendid Instrument in Nickel Plated Case.  
Ideal for Testing Cells and Filament Current.

POST PAID **5/6** NUMBER LIMITED

#### OTHER EXCEPTIONAL VALUES

- Aerial Wire, Bright Hard Drawn, 7/22's, copper,  
3/8 per 100'. Enamelled, 7/22's, 4/8 per 100'
- Aerial Insulators, Shell Type, 2" x 2 1/2" 9d. ... Reel 2d.
- Igranitic Coils, Full range stocked .. from 5/-
- H.F. Transformers (Oojah), plug in type, 300 and  
700 metres, 4/6 each; 1,000 metres, 5/6; 2,600 6/-
- Ebonite 3-Coil Holder, 10/- 2-Coil with tension screws 8/-
- H.F. Transformers, Formers only, with pins, each 1/6
- Telephone Transformers (Army type), 9/- each.
- L.F. Transformers, 15/- each. Radio Inst. make, 25/-
- Vernier Condenser, 5-Plate for panel mounting, 4/-  
3-Plate, 3/6; .001, 10/6; .0005, 7/-; .0003, 8/6
- Wireless Jacks, with plugs, 1/6 the pair. Jacks only, 5d.
- High Note Buzzer (Army type), worth treble, 3/-  
each. Tapping keys, 2/- Aluminium cased, 2/6
- Lightning Arresters, Carbon block type .. each 1/-
- Valve Holders, Flanged "A" type, 1/- Ebonite  
with 8 nuts, 1/- each. Unequalled quality, 1/3.
- Ebonite Panel, fitted with 3 valve holders, complete 2/9
- Ebonite Panel, fitted with 2 valve holders, complete .. 1/9
- Valve Sockets, per set of 4 with 8 nuts, 6d. Pins, each 2d.
- Transformer Holder, with 4 terminals and wired, each 3/-
- Mica, clear ruby, .002" thick, 3" x 2", doz. pieces 1/-
- Inductance Slider Rod, 1/2" square, 13" long, drilled, each 6d.
- Slider, complete with plunger for 1/2" rod .. each 6d.
- Contact Studs, fitted with nut and washer .. doz. 1/-
- Condenser Vanes, best aluminium, 3 1/2", doz. pairs 1/-
- Condenser Spacing Washers, small, 3d.; large, 5d. doz.
- Condenser Screwed Rod, brass, 12" long, 1/8", 4d.; 3/16", 6d.
- Terminals, Mark 3N, plated or P. brass, 4 B.A., doz. 2/6
- Terminals, small pattern, 9d. doz.; spade type, doz. 6d.
- Dubilier Condensers. All capacities at prices advertised.
- Skinderviken Microphone Buttons .. each 5/-
- Fellows 4,000 ohms Headphones, with cords .. 21/-
- Brown's Featherweight Phones, 4,000 or 120 ohms .. 30/-
- Valves, Marconi-Osram R 17/6, V 24 28/6, R4B 28/-  
Guaranteed safe delivery, 3 Valves.
- Ebonite Panels, matt surface, ground edges  
3/16", 9" x 6", 2/-, 12" x 9", 4/-, 1 1/2" x 6", 2/6, 12" x 9", 5/-  
Ebonite Engraved Dials, bevelled edge .. each 9d.
- Ebonite Engraved Dials, bevelled edge with knob .. 1/3
- Ebonite Standard Coil Plugs, 1.8, moulded .. 9d.
- R.A.F. Microphones, exceptional value .. each 2/-
- Oojah Basket Coils, set of 7, 150-4,500 m. .... 5/-
- Oojah Slab Coils, set of 8, 300-30,000 m. .... 7/8
- Condensers, fixed type, 1/6, with leak .. each 1/9
- Sistoflex Insulating Tube, all colours and sizes .. yard 5d.
- Condenser Scales, engraved, 5d., ebonite do. .... 7d.
- Accumulators, 2 volt 45 amp. hr., fully charged. 10/-
- H.T. Batteries. Ever-ready and Siemens all sizes.
- H.T. Batteries, 1 terminal, 6 sockets, 15 volt. .. each 2/3
- Dewar Switches. D.P. (changeover) new .. each 3/-
- Basket Coil Boxes, fitted standard coil plug .. 1/9
- Ducon Adaptors, Dubilier make .. 10/-
- Ebonite Switches, S.P. tumbler type 1 1/2 in. diameter 1/3
- Plug and Socket Twinwire Connectors, "Malenco"  
pattern .. 7d.
- Pocket Voltmeters, nickel plated, 0-6 v. .... 4/-
- Pulley Blocks, aluminium, ex-govt. 1/6, galvanised .. 9d.
- Aerial Insulators. Econ. patent pattern .. 1/6

Write for "Complete Supplementary Price List of Excep-  
tional Values," sent Post Free.

All goods sent CARRIAGE PAID, but with orders under  
5/8 add 8d. for postage.

**J. H. Taylor & Co.** Electrical & Radio Engineers,  
Macaulay St., Huddersfield.  
Telephone: 341. Telegrams: "Thorough," Huddersfield.

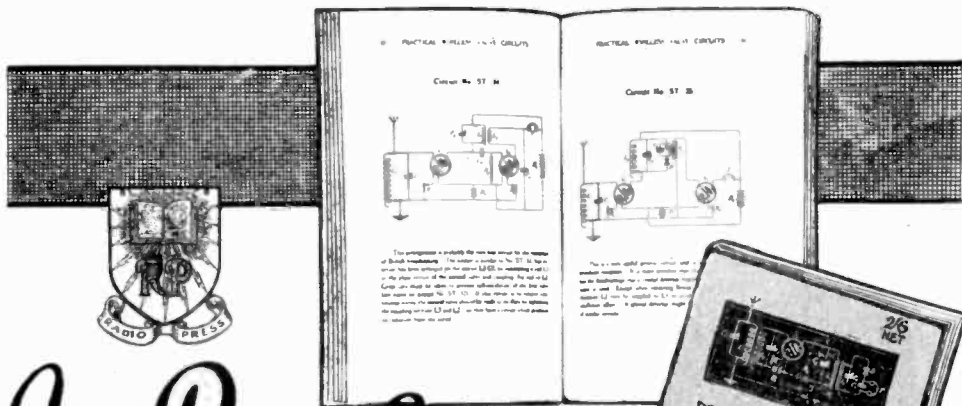

**No Paper Circuits**  
 —every one the result  
 of practical tests.



**I**N this new book by John Scott-Taggart, F.Inst.P., Editor of **Modern Wireless** and the well-known authority on the Thermionic Valve—there are 67 tested circuits. Every one can be confidently relied upon as being the best for its particular purpose.

## Practical Wireless Valve Circuits

is just the Book you will need if you are building your own set, in order to ensure that your wiring will be the best possible arrangement based on the latest laboratory tests. In addition, all Condenser and Resistance values are given where necessary. Essential to every amateur taking more than a superficial interest in Radio.

### SECTIONS

1. Crystal Detector Circuits.
2. Single Valve Circuits.
3. Two-valve Circuits.
4. Three-valve Circuits.
5. Four-valve Circuits.
6. Five-valve Circuits.
7. Local Oscillators for Heterodyne Reception of C.W.
8. Valve Transmitter and Radiophone Circuits.

**2/6**

**Radio Press, Ltd.**  
 PUBLISHERS OF AUTHORITATIVE WIRELESS LITERATURE  
 DEVEREUX COURT. STRAND. W.C.2.

from all Booksellers,  
 or 2/8 post free from  
 the publishers.



*Your guarantee of dependable information*

# LISTOLEON

RADIOPHONE  
DE LUXE CABINET

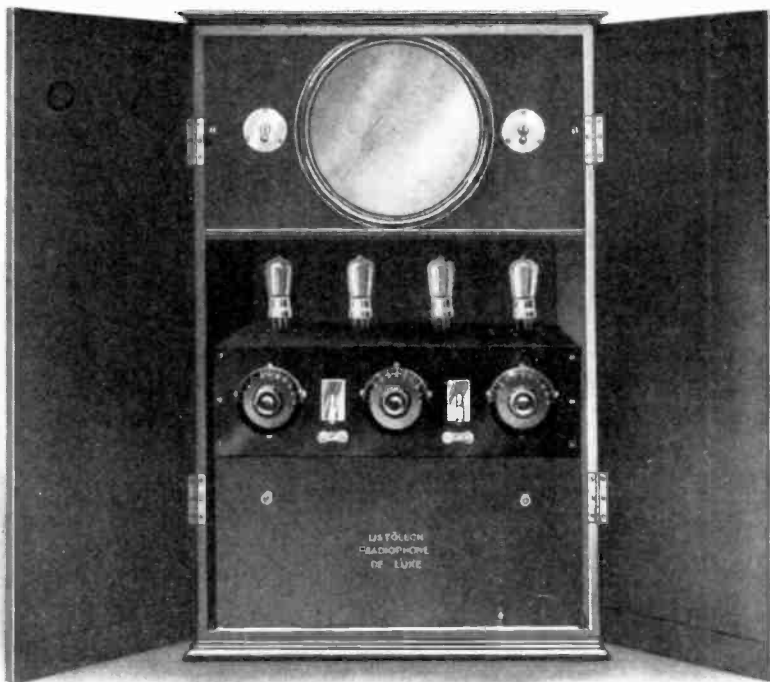

A Superb 4 Valve Loudspeaking Receiving Cabinet employing one High Frequency, one Detector and two Note Magnifying Valves. This combination of valves will give excellent results over a very wide area.

Price including all accessories **£52 : 10 : 0.**

Beautifully polished mahogany table specially made for cabinet **£7 : 10 : 0**

Write to-day for illustrated Brochure.

MANUFACTURED BY

**RADIOPHONES LTD.**

1a, GRANVILLE PLACE  
MARBLE ARCH  
LONDON, W.1

"SIMPLICITY  
WITH  
SATISFACTION."

TELE { 'Phone—MAYFAIR 1250  
'Grams—RADPHOLIM,  
BAKER, LONDON.



My  
Advice  
Costs  
Nothing

**Can I help you?**  
**I WILL GIVE YOU £50**  
if I fail to produce over 7,000 testimonials from others I have helped to  
**A SUCCESSFUL CAREER**

Yours to success,

*Every man is the architect of his own Fortune!*  
If you are not in a trade, learn one; if you are already in a trade or profession, reach the top of it.

**ARE YOU QUALIFIED ?**  
for the **JOB YOU SEEK**

**WE TEACH  
BY POST**

**ADVICE FREE.**  
Most Moderate  
Charges.  
Payable Monthly.

**LEARN A TRADE  
OR  
PROFESSION.**

Write for one of our **FREE BOOKLETS** on any of the following subjects:

Architectural Drawing  
Building Construction  
Clerk of Works' Duties  
Aviation  
Boiler Engineering  
Boiler Making  
Chemistry  
Civil Engineering  
Concrete and Steel  
Draughtsmanship  
Electricity  
Engineering  
Foundry Work  
Internal Comb. Engines  
Marine Engineering  
Mathematics

Matriculation  
Metallurgy  
Mining  
Mine Surveying  
Motor Engineering  
Naval Architecture  
Pattern Making  
Salesmanship  
Sanitation  
Shipbuilding  
Structural Engineering  
Surveying and Levelling  
Telegraphy & Telephony  
Wireless Telegraphy  
Special Course  
for Apprentices

If you have any ambition tell me what it is and let me advise you free.

We specialise in all exams. connected with technical subjects. If you are preparing for any exam., ask our advice. All particulars free of charge. Parents should seek our advice for their sons. If you are interested in any of the subjects mentioned above, write naming the subject, and we will send you our **FREE BOOKLET**. Please state your age. (Courses specially combined to meet all requirements.)

Established  
over 20  
Years.



Department 129

No 2 out Feb 26<sup>th</sup>

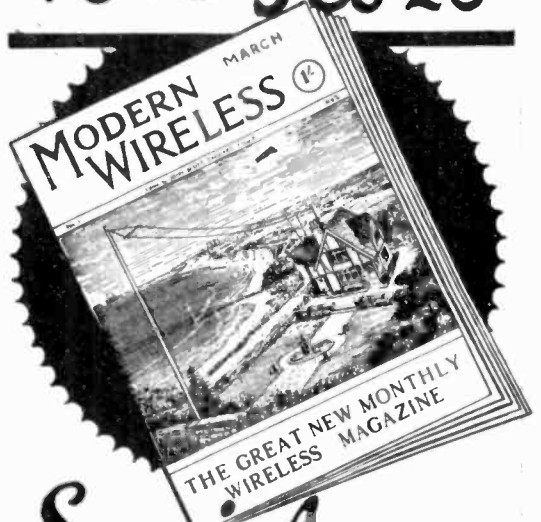

*Special  
Constructional  
Number*

100,000 Readers considered No. 1 an excellent Shillingsworth, and it is safe to say that they will think No. 2 even better. It consists of 112 pages of interesting and profusely illustrated articles by some of Britain's best wireless men. Place your order at once for a copy—you cannot afford to risk being unable to obtain one—the constructional articles alone will save you pounds.

From all Booksellers and Newsagents.

Some of the Constructional Articles:

- A Transatlantic Receiving Set.
- A Variable Grid Leak.
- A 2-Valve Note Magnifier.
- A compact Broadcast Receiver.
- A new Variable Inductance.
- A 3-Valve Panel.

**Radio Press, Ltd**

PUBLISHERS OF AUTHORITATIVE WIRELESS LITERATURE  
DEVEREUX COURT, STRAND, W.C.2.

**MODERN WIRELESS 1/-**

## Neat Lettering

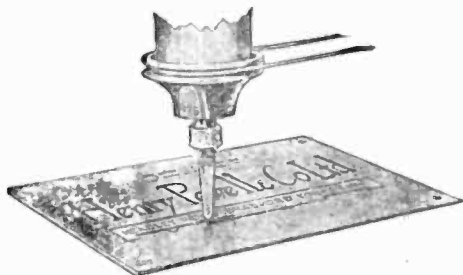

Cutter at Work.

gives that finished appearance to a wireless set which oftens attracts the customer.

The Taylor-Hobson Engraving Machine engraves letters and figures on wireless apparatus accurately and at surprisingly low cost.

The machine is easy to operate. Hundreds of letters and figures can be engraved per hour, and with an accuracy which is impossible by hand.

Send for a descriptive catalogue to-day.

**TAYLOR, TAYLOR & HOBSON, LTD**

74a, Newman Street, London, W.1

Works: LEICESTER.



## GREAT BARGAIN OFFER

4,000 ohm PHONES (NEW)

at **19/6** Per Pair. Postage 9d. extra.

Fitted headbands and cords, beautifully finished, thoroughly efficient. Each pair carefully packed in box. **SATISFACTION GUARANTEED.**

### BROADCASTING RECEIVING APPARATUS.

The "JOYPHONE" (Reg. No. 0138) approved type, 2 Valve Set, complete from **£15 : 0 : 0**

Special Offer at Reduced Prices of our

### NEW INTERVALVE TRANSFORMER

Owing to the unexpectedly large sale of these instruments we are enabled to reduce the price to "Wireless World" readers to

**12/4**

Postage 9d. extra.

Fitted with panel fixing plate and earthing wire for iron core. Fully tested.

Ratio 5 : 1.

All valve apparatus manufactured by us is duly licensed under Marconi Patents for amateur use in Great Britain. Approved by Postmaster-General.

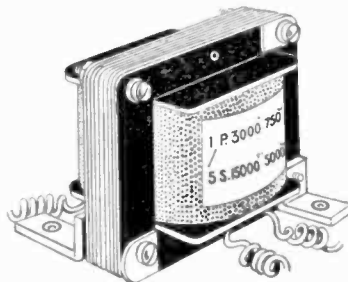

#### TERMINALS

- 4 B.A. Double Solid Brass or Plated 2/- per doz. (post extra).
- 2 B.A. Single Solid Brass or Plated 9d. per doz. (post extra).

We have enormous stocks of ex-WD WIRELESS GEAR, too numerous to mention, at absurdly low prices. Write for particulars of your requirements, or better still, call and see our enormous stocks.

**J. LIPOWSKY & CO.** 614, OLD FORD ROAD, BOW :: LONDON, E.3

Near Old Ford Station N.L.Rly.

Telephone: EAST 3345.

Nos. 8 or 39 'Bus.

# SETS WITH RADIO INSTRU

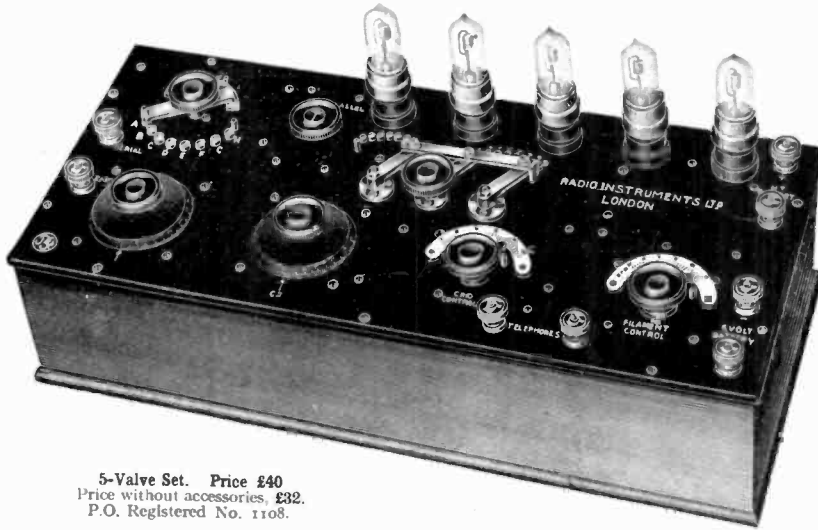

All our  
**300-**  
ALLBEAR  
Made  
High Fre  
ALL

5-Valve Set. Price £40  
Price without accessories, £32.  
P.O. Registered No. 1108.



7-Valve Set. Price complete with all accessories . . . £75  
Price of instrument alone, £66. Valves-extra.  
P.O. Regd. No. 0140.

A Visit to our Showrooms will convince you that R.I. Sets are the finest on the British Market.

The most experienced designers of High Power Receivers in the World. Write for illustrated Brochure containing full particulars of cabinet models.

Our latest attractive Showcard will be

## RADIO INSTRU

Managing Director : J. JOSEPH, M.I.E.E.

12, HYDE STREET, NEW

Chief Designer : W. A. APPLETON, M.B.E., M.I.R.E.,  
late Admiralty Technical Research Officer.

# A NAME MENTS, LIMITED.

Broadcasting Models

# 4,000 metres

BROADCASTING SEAL.

under Marconi Licence.

quency Amplification on  
SETS

Our own Engineers will demonstrate these instruments. Everything up-to-date is here shown and demonstrations given of every type of loud speaker on the market.

The completion of our new extension is rapidly proceeding and we will shortly be able to resume delivery ex stock.

sent free upon receipt of post-card.

## MENTS Limited,

ONLY ADDRESS: Works, Offices & Showrooms:

## OXFORD STREET, W.C.1

Telephone—Regent 1908.

Telegrams—Instradio, London.

**2-Valve Set.** Price complete, £25 6s  
Valve Amplifying Receiver alone,  
without accessories, £18 15s.  
P.O. Registered No. 2008.



**3-Valve Set.** Price £30 15s. Valve  
Amplifying Receiver alone, without  
accessories £23 15s.

P.O. Registered No. 0109.  
The set illustrated is the one that  
helped to bring "Sheila" back to  
health as recorded in the *Daily Mail*  
of February 9th, 1923.



**4-Valve Set.** Price £33 10s.  
Valve Amplifying receiver  
alone, without accessories,  
£27 5s. P.O. Registered No.  
0112.



# THE WIRELESS DEALER

FOR THE TRADE ONLY

*A Trade Journal devoted to the interests of Makers, Factors and Dealers engaged in the Wireless Industry.*

*By Subscription 8/- per annum, post free.*

**TO BE PUBLISHED MONTHLY**

**First issue ready early in March.**

**T**HE first announcement of "The Wireless Dealer" has aroused a considerable amount of interest throughout the trade, and in order to give some idea of the ground to be covered in the first issue we give below a brief outline of the editorial contents:

**THE EXHIBITS AT OLYMPIA EXHIBITION.** A detailed description of wireless goods shown, preceded by a general review of tendencies.

**NEWS ITEMS.** Announcing the latest trading and technical developments throughout the country.

**CATALOGUES.** A review of new trade lists.

**ARTICLES FOR THE DEALER.** "Distance from a Broadcasting Station and its effect on stock." "A 'Portable' Licence and its uses."

"**THE WIRELESS DEALER**" will be conducted on the same principles as the other well known trade publications of The Trader Publishing Co., Ltd., the circulation being strictly confined to the Trade only, having for their object the furtherance and safeguarding of trade interests.

**FREE WIRELESS TRADE INFORMATION.**

An Information Bureau has been established in conjunction with "The Wireless Dealer" to assist the dealer to solve any technical, commercial, or legal difficulties in connection with his business.

*To ensure your copy of the first and subsequent issues, post your subscription at once.*

**Advertisement space can now be booked. Particulars and tariff will be forwarded on request.**

*Proprietors and Publishers:*

Telephone No.  
**CENTRAL**  
7713  
(4 lines).

**The Trader Publishing Co., Ltd.**  
139-140, FLEET ST., LONDON, E.C.4

*And at*  
**Birmingham**  
*and*  
**Manchester.**



# CARTWRIGHT'S SCIENTIFIC COMPONENTS

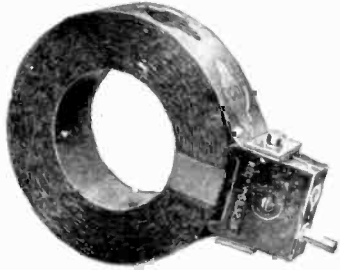

## HONEYCOMB INDUCTANCES

Capacity given includes capacity between Poles of plug and dielectric losses.

Coil No.	True Inductance Micro Henries	Distributed Capacity Micro Mfds.	Wavelengths in Metres obtained when shunted by the Capacity Indicated.				£	s.	d.
		Natural OMfds.	.0001	.0005	.001				
25	30.2	26	53	116	237	330	0	5	0
35	60.3	34	85	170	338	471	0	5	0
50	134	47	148	265	510	706	0	5	2
75	297	38	200	381	752	1046	0	5	6
100	517	43	281	512	1000	1383	0	7	0
150	1151	31	355	732	1473	2053	0	7	10
200	2150	28	462	987	2010	2800	0	8	8
250	3480	22	522	1230	2540	3560	0	9	0
300	4980	27	692	1495	3040	4268	0	9	5
400	8980	26	910	2005	4085	5720	0	10	3
500	14510	25	1135	2538	5210	7273	0	10	6
600	20110	25	1337	2970	6122	8545	0	11	0
750	32300	22	1588	3775	7720	10825	0	11	10
1000	59740	22	2160	5080	10450	14725	0	12	8
1250	91830	22	2680	6310	13100	18240	0	14	0
1500	136400	21	3190	7635	15900	22210	0	15	0
Total for set .. .. .							£7	7	10

The above data is prepared by The National Physical Laboratory

These world-famed coils are manufactured under De Forest Patents, Low self capacity and high frequency resistance combined with low absorption factor, permit of the transference to the detector of the maximum amount of energy received.

Send for our catalogue post free 4d.

## J. L. CARTWRIGHT & CO.

'Phone, Cent. 4209. Head Office: Works: Grams., Pladuram Man. 24, LONDON RD., BERRY ST. Code, ABC 5th. MANCHESTER. LONDON RD.

Our Scientific Components may be obtained from all high-class dealers.

Wholesale distributing agents for Scotland: Corston Sinclair, 47, Waterloo Street, Glasgow.

# The Famous "Ashdown" Resistance



Regd. No. 691772

## Price Reduced from Feb. 1

By our improved methods of manufacture we are now able to supply the ASHDOWN Filament Resistance at a reduced price, while at the same time using Erinold instead of ebonite for the former, which makes for higher efficiency and a still more substantial job. At the reduced price the ASHDOWN is by far the best value in the country:—

**Now 3/6**

The attention of the trade is drawn to the fact that this is a Registered Design

Traders should send (on printed note heading) for sample Resistance, and liberal discount rates, post free 2/0. Many of the largest manufacturers are now fitting ASHDOWN Filament Resistances as standard to their sets.

Send in your orders NOW, as there is a huge demand. London Representative: Mr. J. O. Maddock, 11, Bayham Road, Bedford Park, W.

**H. E. Ashdown (Birmingham) Ltd. Perry Barr—Birmingham.**

'Phone: Northern 859. Tel.: Segment. Code: ABC 5th Edition, Western, etc.

## BARGAINS FOR THE PANEL

DID YOU SEE LAST WEEK'S LIST? PLEASE LOOK IT UP.

British Manufacture throughout, cheapest, efficient and best. All our goods are guaranteed.

An extract from our stock:—

Aerial Insulators, egg pattern	each	4d.
Aerial Insulators, reel pattern	each	3d.
Switch Arms	each	2/3
Ebonite Rod, best quality	lb.	4/6
Paraffin Wax	lb.	1/-
Crystal Cups with screw to fix crystal	each	3d.
Ebonite Tuners and Sliders	each	9d.
Inductance Tubes, 12" long, wound with 24 S.W.G. enamelled wire (beautiful finish)	each	5/-
Variable Condensers, .0003 Mfds., 19 vanes (10 fixed, 9 moving), brass work polished and gold lacquered. Finish and efficiency perfect	each	10/6
Copper Foil (uniform thickness, 12 x 3)	each	3d.
Insulator sleeving (1/4" min. All colours)	yard	6d.
Condenser Spacing Washers—accurate	large, doz.	6d.
	small, doz.	4d.
Valve Pins, split leg complete with nut and washer	doz.	1/3
Brass Contacts	each	1d.
Mica, clear cut, 2 1/2" x 2 1/2" .002	per piece	3d.

And everything else for the panel on the same basis of cost. CRYSTAL SETS "WEBSPHONE" BEARS B.B.C. STAMP.

G.P.O. Reg. No. 206. Price £4 17s. 6d., including royalties. Six can listen in at one time. Please include ample postage on all orders up to £2. Postage paid over this amount.

SPECIAL TERMS TO THE TRADE.

28, Deansgate Top floor Mawson Chambers

**JONES'S** MANCHESTER

The Electrical Depot

# CAPPER BROS.

## FOR ALL RADIO REQUISITES

Agents for **LESLIE McMICHAEL, LTD.**,  
for Woking and district.

Single Valve Sets .. .. .	£5 5 0
Two Valve Sets .. .. .	8 8 0
Three Valve Sets .. .. .	14 14 0
Four Valve Sets .. .. .	25 0 0

**89-93, CHERTSEY ROAD, WOKING**

### SKINDERVIKEN BUTTON.

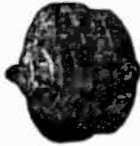

THE SUPERSENSITIVE MICROPHONE.  
World-wide Patents.  
ENGLISH Manufacture.  
For LOUD SPEAKERS, MICRO AMPLIFIERS, ELECTRICAL GRAMOPHONE REPRODUCERS.  
Invaluable as Detectiphone, as it can be used in ANY POSITION, i.e., either HORIZONTAL or VERTICAL.

#### PRICES.

Type "A"—Carbon Electrodes (eliminating all "frying" noises) .. .. .	each	7/6
Type "B"—Brass Electrodes .. .. .	"	5/-
Receivers (special Low Resistance) .. .. .	"	10/-
Gramophone Attachment (for Electrical Reproduction) .. .. .	"	1/-

BOOKLET (16 Pages fully illustrated) containing much useful information for all interested in Electrical Sound Transmission. POST FREE 6d.

Sole Proprietors—  
**MIKRO, LTD.**, 274/276, Pentonville Road, London, N.1.  
(Opposite King's Cross (Met.) Railway Station).

## Really Satisfactory BROADCAST RECEIVING SETS

Including all Royalties Complete  
FROM . . . . . **£3 15 6**

Full particulars and details from

**G. W. I. Ltd. (Wireless Dept.),**

Imperial Works, Shanklin Road, Crouch End, London, N.8

Tel. : Hornsey 3065.

# EBONITE

## PARTS FOR WIRELESS

SPECIALLY TURNED TO  
INDIVIDUAL REQUIREMENTS

Enquiries for wholesale Quantities invited.

**A. H. CLACKSON, LTD.** Vulcanite Manufacturers  
White Hart Works, London, N.22

## PRESSLAND ELECTRIC SUPPLIES LIMITED.

Managing Director :

**CLIFFORD PRESSLAND, A.M.I.E.E.,**  
Hampton-on-Thames.

Wholesale only.

Our 1923 Radio Catalogue is now ready and will be sent on application to any bona fide Trader.

## WIRELESS TRAINING

Most thorough training in Wireless Telegraphy or Telephony given under ideal conditions.

Special Postal Course for Amateurs.

Prospectus Free.

## WIRELESS APPARATUS

Complete stocks of all Wireless Instruments and Accessories. Prompt Deliveries. List 1½d. stamp.

## WIRELESS COLLEGE COLWYN BAY

THROUGH ITS EFFICIENCY

## GENTS' "TANGENT"

## L.F. TRANSFORMER

HAS EARNED A REPUTATION FOR ITSELF AND IS IN CONSTANT DEMAND BY EVERY CLASS OF USER—

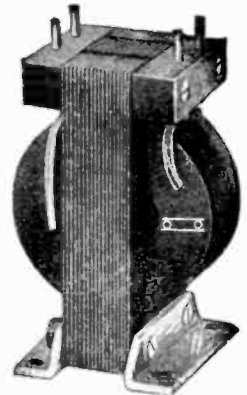

Ask your dealer for same.  
Price 22/6 each.

Also  
GENTS' "DISCOL"  
H.F. TRANSFORMER  
Price 6/8 each.

All fittings contained in cartons  
Convenient for Stockists.

Let us send you literature.

RADIO DEPT.,  
**GENT & Co. Ltd. FADADAY WORKS LEICESTER**  
LONDON : 25, Victoria Street, S.W.1.  
N.W. CASTLE-ON-TYNE : Tangent House, Blackett Street.

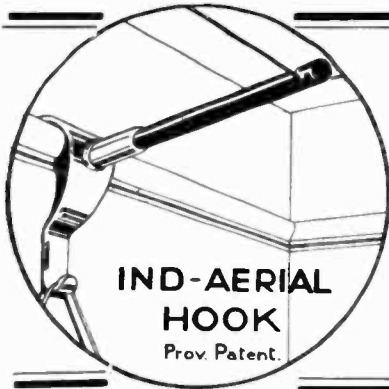

**IND-AERIAL HOOK**  
Prov. Patent.

**SAYS MR. MAN:—**

"I WANT the Broadcasting and am prepared to buy a Radio set, but I live in a flat and may not have an outside aerial. What can you do for me?"

**DEALER!** the answer is **IND-AERIAL HOOKS**

They are essential for a neat, efficient and portable **INDOOR AERIAL**. Attached in a moment to the picture rail of any room they can be taken down just as easily. They support the aerial **ONE FOOT** from the wall on insulated arm, and are no disfigurement.

2/9 each; 31/6 doz. Post Free.

Some Agencies still open in Broadcasting Towns.

**IND-AERIAL CO., 47, Victoria Street, London, S.W.1**

**AMPLIFYTONE AERIAL**  
FOR THOSE WHO CANNOT ERECT OUTSIDE AERIAL

Gives you better results from your receiving set. You get louder, clearer signals, and increase your receiving range. Verify these results by actual use. Made of 1/4 in. tinned copper, a silver ribbon that presents a broad surface to the incoming waves. Has a much greater capacity than ordinary copper wire or stranded wire. Brings in all signals without leakage. No need for aerial spreaders or double strand. A single 100 ft. length of "Amplifytone Aerial" put up in your attic or around the moulding of your room will make you a better aerial than copper wires strung on your roof.

100 feet in neat coiled roll. 10/-. Postage. 9d.

Postal Address:—**TAYLOR, 64, Strone Road, Forest Gate, London, E.7**

**" WHALE FOR WIRELESS "**

PHONES—Brown's, 4,000 or 120 .. .. .	30/-
Brunet, 4,000 .. .. .	21/8
VALVES—"R" Type .. .. .	12/6 & 14/-
"Q" or V24 .. .. .	15/-
INSULATORS—Reel .. .. .	1s.
Egg .. .. .	3d.
Coil Mounts, ebonite .. .. .	1/3
Condenser Plates, 24 .. .. .	1/-
Condenser enclosed Vernier .. .. .	6/-
Phonophone holders .. .. .	4/-
Receiving set complete from 30/- Complete with Aerial Wire, Insulators and pair of Phones, £3	

N.B.—Do away with your crystal or valve detector and fit our PHONOPHANE, 15/- each. Call for demonstration.

**A. WHALE & CO.,**  
801, POWIS STREET, WOOLWICH, S.E.18.  
Phone: Woolwich 548.

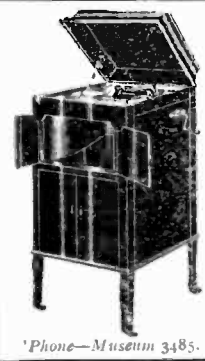

**Rondo**  
GRAMOPHONES.

So refined and sweet in tone that it is used for Choir & Singing Lessons. Call and Hear it!

**Radio**  
COMPONENTS. LTD

19, RATHBONE PLACE, LONDON, W.1  
Telegs—"Radponents, Westcent, London."  
Phone—Museum 3485.

**The London Telegraph Training College, Ltd**

Telephone: WESTERN 2896. **Morse House, Earl's Court, S.W.** ESTABLISHED 25 YEARS  
OFFICIALLY RECOGNISED BY THE WAR OFFICE AND POST OFFICE AUTHORITIES  
CABLE AND WIRELESS TELEGRAPHY.

PARENTS desirous of placing their sons in either of the above Services and of affording them the best training facilities should apply for particulars of Courses and the methods of instruction which place this Institution in the first rank. Cable Telegraphy offers at the present time excellent prospects to youths from 15 years of age and upwards, and the College has exclusive facilities for obtaining posts for qualified students in the leading Cable Companies at commencing salaries of £150 to £300 per annum, with yearly increments of £12 to £25, and ultimate possibilities of obtaining positions as Supervisors, Assistant Superintendents, Managers, etc. In the Wireless Telegraph Service the commencing remuneration at the present time is approximately £150 per annum, and operators when qualified are nominated by the College for appointments as and when they occur. No correspondence classes or branches.

**DAY AND EVENING CLASSES.**

Prospectus containing all information will be forwarded on application to THE SECRETARY (Darr. H.), 262, Earl's Court Road, Earl's Court, London, S.W.5. Sole Proprietors of the "Scott" Training Disc, which contains useful formulae and other information for Wireless Telegraph Operators and is invaluable to Army Signalling Officers for range finding, etc. Price, complete with instructions for use 1/- Postage 2d.



# THE WIRELESS WORLD EXCHANGE AND MART

## Bamboo Poles for Aerials

AND BAMBOO OF EVERY DESCRIPTION  
 :: FROM TWIGS TO YACHT MASTS ::

Large Stocks always on hand.

**A. E. DAVIES & CO. (Importers),**  
 184, LEVER ST., CITY RD., LONDON, E.C.1

## HEATH & Co., Ltd.

Instrument Works, New Eltham, S.E.9  
 are prepared to undertake in their fully  
 equipped works—**Wireless Apparatus**  
 and Parts for the trade. Quotations given  
 to Blue Prints. Immediate attention.  
 Phone—Lee Green 303. Wire—Polaris, London.

ESTABLISHED TWENTY-FIVE YEARS.

## J.W.B.

## ACCUMULATORS

RESULT OF OVER 40 YEARS' EXPERIENCE.

### BEST FOR WIRELESS

PLATES, SETS, BOXES, SEPARATORS,  
 REPLACEMENTS, EXPERT REPAIRS.

**J. W. BARNARD & HAYNES**  
 LIMITED.

WORKS: 45, GT. ORMOND STREET,  
 LONDON, W.C.1, and 4, GT. WINGHESTER  
 STREET, LONDON, E.C.2

## Portland's Parts by Post.

# "EBONITE"

8 x 1 ..	s. d.	12 x 10 ..	s. d.
4 x 4 ..	0 7	17½ x 8½ ..	7 6
7 x 5½ ..	1 3	18 x 18 ..	9 6
10 x 6 ..	2 8	18 x 18 ..	12 10
17 x 5 ..	3 9	7 lbs. ..	£1 3 0

Quarter British. Postage Extra.  
 Any size cut.

## JAMES PORTLAND

6, Cheapside, E.C.

Mr. Portland stocks over 200 Wireless Parts

## WIRELESS CABINETS

PROMPT DELIVERIES  
 COMPETITIVE PRICES

**PICKETT BROS.,**

Albion Rd., BEXLEYHEATH, S.E.

### FOR SALE—continued.

**Experimenter's Panel Set.** Tubed anode H.F. detector, .001 and .0005 condensers, and 3-coil holder, tune, stand-by switch—45, less valves and coils. Also .0007, .0005 and vernier in one box, £1.; and 2-Valve H.F. panel for plug-in transformers, £1, less transformers and valves. Take £6 for the lot.—F. H. ROBINSON, Langmead, Pirbright, Surrey.

### SITUATIONS REQUIRED.

**Young Lady** seeks position with good company selling broadcasting apparatus, understands broadcasting receiving with crystal and valve sets. Six years' commercial experience, able typewriter. Salary, £4. weekly. Box G.13, BERTRAM DAY'S ADVERTISING OFFICES, 9 and 10, CHARING CROSS, S.W.11.

**Operator**, four years' service, desires change. Excellent practical and theoretical knowledge of radio.—Box M.10, BERTRAM DAY'S ADVERTISING OFFICES, 9 and 10, CHARING CROSS, S.W.1.

**Energetic Man** with ten years' technical and commercial experience, desires appointment as Manager Wireless Dept. or works. WIRELESS, 385A, Upper Richmond Road, Putney.

### SITUATIONS VACANT.

\* **Salesmen Required.** Some technical knowledge preferred. Good prospects. Letters only. State salary, experience, connection. LISSON COMPANY, Woodger Road, Goldhawk Road, London, W.12.

### WANTED.

**Townsend Wavemeter**, calibrated, thorough working order, 300 to 4,000 meters.—CROWTHER, 18, Linden Avenue, Woodseats, Sheffield.

**Wanted.** Large quantity of jacks and plugs at very low prices. Full particulars to BRITISH CENTRAL ELECTRIC CO., LTD., 6 and 8, Rosebery Avenue, E.C.1.

### TRADE ENQUIRIES.

**Instrument Maker** requires work in radio and electrical apparatus, small turning, repairs and construction.—H. NUNN, 49, Leigh Road, Highbury, N.5.

**Bournemouth and District Readers**, please note for anything Wireless, including repairs or rebuilding, try THE DEE RADIO SUPPLIES, 2, Iris Road, Winton. Started, 12 years ago not yesterday.

**Wireless Parts and Raw Materials** for amateurs and the trade, at the right price, direct from the factory.—THE NEWTONIA WIRELESS FACTORY, 13 15, Whitcomb Street, London, near Trafalgar Square.

**Manufacturers of Wireless Sets and Accessories.** Please send trade terms, advertising matter to—SERVICE MOTOR SUPPLY DEPOT, Station Parade, Wilsden Green, London.

**Wireless Factor**, requires manufacturers, lists and lowest prices of wireless accessories and complete sets, condenser vanes, insulators, terminals, etc.—Box Q.7, BERTRAM DAY'S ADVERTISING OFFICES, 9 and 10, CHARING CROSS, S.W.1.

**Manufacturers of Wireless Accessories** and component parts are invited to send catalogues, terms, etc., to CALEDON CO., 482, Rathgar Road, London, S.W.9.

## RADIO ENGINEER

With office and aerial, central Leeds, requires to represent high class radio firm, would undertake travel Yorkshire district, commission basis only. Full investigation invited. Address letters in first instance to BOX Q.6, BERTRAM DAY'S ADVERTISING OFFICES, 9 and 10, CHARING CROSS, S.W.1.

## 'PHONES FOR ALL

Let ALL your friends listen-in with  
**SULLIVAN HEADPHONES**—Double, complete with double adjustable headbands and cords. 120 ohms. Perfect condition. Each pair in box.  
 Supply Per Pair 12/6 Post Free.  
 limited. 3 Pairs for 35 - Post Free.  
 Prompt Delivery. Send Cash with Order NOW  
**F. HARRISON,**  
 48, Brooke Road, Walthamstow, E.17

**HOW TO MAKE YOUR OWN WIRELESS RECEIVING SET, AMPLIFIERS AND DETECTORS.** Remarking out, full size diagrams and all wiring details, accurately given, success guaranteed. All Broadcasting stations received. In two series 2/6 each, to be obtained from THE ECONOMIC ELECTRIC CO., LTD., 10, FITZROY SQUARE, LONDON, W.1, who will supply any part for constructing same.

## WIRELESS SETS

SUPPLIED AND INSTALLED.

Aerials Erected. Accumulators Charged. Component Parts of every description stocked.

**C. J. WILKIN & SON,**

143, HIGH STREET, WOOLWICH, S.E.18.  
 Estb. 1881. (Corner of Powis Street)  
 TRADE SUPPLIED. Tel. No. Woolwich 320.

## GRIFFIN'S

The Mail Order Stores

### CATALOGUE

Just Published — FREE

## GRIFFIN WIRELESS SUPPLIES CO.

82, Newington Causeway, S.E.1

### BEGINNER'S GUIDE TO WIRELESS

Explains in plain, everyday language, everything beginners wish to know about Wireless Telegraphy.

### HOW TO ERECT, CONNECT AND MAKE

all the apparatus required for reception of telephony or morse, and full instructions and diagrams for making coils, tuners, and complete valve and crystal sets. 112 pages, price 1/- post free.

**SAXON RADIO CO. (Dept. W.), South Shore, Blackpool.**

32 page Catalogue of Wireless Apparatus 2d. post free.

# THE WIRELESS WORLD EXCHANGE AND MART

**2-VALVE BROADCAST** Sets with variable reaction, range 200-250 miles, price including royalties, 59.  
**MULTIPHONE CONNECTORS**, for connecting four 'phones to any type of terminal, 2/6 per pair, post free.  
**TELEPHONE EXTENSION CORDS** with screw sockets and tags, 6 ft. for 12/6 and 6d. per extra yard.  
**VERNIER CONDENSERS**, 5 -.  
**3-VALVE SET**, 2 H.F. Detectors, with coupled tuning circuits, one transformers, and one resistance impedance coupling with coils and plug-in transformers, ranges 300 to 3,000 metres. Polished teak case - one only, £10.  
**J. S. B. CLARKE,**  
**41, HATCHLANDS ROAD, REDHILL.**

**Q.X. and V.24 Adaptors** . . . . . 4 -  
**Insulating Sleeving**, 2 mm. bore, per yard 5d.  
**Crystal Detectors**, on ebonite, instrument finish 7/8  
**Silvertown Polarised Relays**, differentially wound, total 400 ohms, new . . . . . £2 5 -  
**Inverting Relays** on P.O. Sounders, platinum contacts, new . . . . . £1 10 -  
**Silvertown Galvanometers**, 100 ohms, differentially wound . . . . . £1 5 -  
**Carriage extra** on all the above. Lists Free.  
**CARTER & AKROYD, ATKINSON'S COURT,**  
**NORTH PARADE, HALIFAX.**

## FRAME AERIAL.

As described in "Wireless World" of 27 1/23, Fig. 3, without wire, carriage paid . . . . . 15 -  
 Polished, extra . . . . . 2/6  
 Boxes, frames and any description of woodwork made to customers' own specification.  
 Estimates Free.  
**COMLEY & SON, COVENTRY.**

## ACCURATE WOODWORK.

WE CAN QUOTE YOU KEEN PRICES FOR REPETITION WORK.  
**WOODCRAFT LTD.**  
 Publicity House,  
 Bucknall Street : : W.C.2  
 Telephone - Gerrard 9648.

## RESULTS

Whether as a source of practical information for the Amateur or as a valuable medium for every Advertiser, the *best results* are invariably obtained through the "**WIRELESS WORLD**"  
 For full particulars and advertising rates apply to  
**BERTRAM DAY & Co. Ltd.**  
**Complete Advertising Service,**  
**9 & 10, CHARING CROSS, S.W.1**  
 Gerrard 8063 and 8064.

### TRADE ENQUIRIES.

**Best Offer Invited for Wireless Concern**, two shops, London and District, both busy thoroughfares. Goodwill exceeds £5,000. Present stock exceeds £1,200. Owner holder of several patents or would float company.—ADVERTISER, Box D.13, BERTRAM DAY'S ADVERTISING OFFICES, 9 and 10, Charing Cross, S.W.1.  
**Working Drawings.** Designs for power and Wireless. Works visited to advise.—PUCKLE, Buckhurst Hill, Essex. Telephone, Woodford 400

### MISCELLANEOUS.

**Wireless Workshop** with living rooms to let.—198, Blackstock Road, Highbury.  
**Accumulators Charged**, collected and delivered at moderate rates. Send P.O. or 'phone for tariff. BATTERY SERVICE CO., 174, Estcourt Road, S.W.6. 'Phone, Hammersmith, 1285.  
**Accumulator Charging Resistances**, complete with flexible cable and adaptors to charge from any convenient lampholder. 1 Amp., 27s. 6d.; 2 Amp., 25s.; 3 Amp., 27s. 6d.; 4 Amp., 30s.; 5 Amp., 32s. 6d.—WALTHAM MANUFACTURING CO., 2, Jackson Road, Holloway, London, N.  
**Wireless Insurance Agencies** granted to dealers in wireless apparatus and electricians. Apply WIRELESS DEPT. "A" LIVERPOOL MARINE & GENERAL INSURANCE CO., LTD., 7, Angel Court, London, E.C.2. The Pioneers of Wireless Policies.  
**Nameplates, Engraving** of all descriptions.—STEWELL & SONS, Little Park Street, Coventry.  
**Wireless Inventors.** Patents and Trade Marks Advice. Handbooks and Consultations free.—KING, Regd. Patent Agents, 140A, Queen Victoria Street, London. 'Phone, 682 Central.

*East Ham, Wanstead, Ilford, Manor Park and Forest Gate. Amateurs should not fail to come to the RADIORENDEZVOUS, 709, Manor Park Broadway (over Liptons). Club open till 10 p.m. nightly.*

**Telephone Receivers Rewound**, up to 1,000 ohms, 5s.; 2,000 ohms, 7s. 6d. Cash with order.—M. E. HAMPSHIRE, 139, Sydenham Road, S.E.26.

### Ex-Government Morse Tappers.

Beautifully made and enclosed in dust-proof cases supplied complete with 2½ yards of twin flex.  
 Honestly worth 15 - each.  
 Our price, 3 - each. Post Free.  
 Money refunded if not absolutely satisfied.  
**LIGHTFOOT BROS.**  
 5, ST. GEORGE'S ROAD, S.E.1.

### FOR SECURING YOUR AERIALS and a Thousand Purposes where Great Strength and Strain is needed :: FLEXIBLE STEEL WIRE ROPE.



**Aeroplane Cable** made to Govt. specification to specified breaking strains. Orders of 10/- and over carriage paid, otherwise please add 1/- for postage.

#### PRICES BELOW COST.

No.	Dia.	Breaking Strain.	Price per 100 ft.
1	3/32"	10 cwt.	6/-
3	4	20 cwt.	8/-
51	5/32"	25 cwt.	10/-
53	7/32"	45 cwt.	12/-
5	1	70 cwt.	14/-
6	9/32"	80 cwt.	15/-
7	11/32"	100 cwt.	20/-
8	1 1/8"	120 cwt.	21/-
9	1 3/32"	140 cwt.	22/6

**STRAINERS** for use with above, right and left hand threads, 9d. each, or 8/6 per doz.  
**SMITH & ELLIS**  
 (Dept 65), 11, LITTLE BRITAIN, ALDERSGATE STREET, E.C.1

### VALVES - - 10/9 each

**Hard or Soft** (Post Free)  
 Buy these magnificent new and perfect valves now while you have the chance.  
 (Trade Supplied)

### HEADPHONES (2,100 ohms)

A SPECIAL LINE of high efficiency instruments giving results equal to 4,000 ohm 'phones; this means that you can use two pairs without reducing signal strength.  
 PRICE 25 -  
 We also have 'phones, 4,000 ohms, PRICE 22/6  
 Single 'phones, 2,000 ohms with handle and cord PRICE 10/6  
**EVERY WIRELESS WANT SUPPLIED.**

**RADIAX, Ltd., 4, Percy Street, Tottenham Court Rd., London, W.1**

### Variable Condensers.

.001 . . . . . 10/-  
 .0005 . . . . . 6/6  
**Knobs** . . . . . 4d.  
**H.F. Transformers, Plug-in Type** . . . . . 3/6  
 Other Sizes in proportion. List Free. Cash with order. **TRADE SUPPLIED.**  
**THE SUFFOLK WIRELESS SUPPLY, FELIXSTOWE.**

### PILKINGTON TRANSMITTER CAN NOT PACK

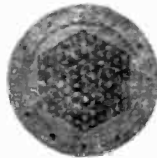

For Wireless or ordinary Telephones. An entirely new principle, having a Definite Resistance, Highly Sensitive, used with any receiver. Functions with less than One Milliampere, Definite Capacity, Long Range. Patents granted in Great Britain and applied for abroad. Small complete transmitters, 7/6. Larger, over 20 M.A., 10/-.  
**BASIL A. PILKINGTON,**  
 13, Melville Place, Edinburgh.

### Strawboard INDUCTANCE TUBES AND

### WOOD CASES and CABINETS

COVERED OR POLISHED FOR WIRELESS SETS

WHOLESALE TRADE SUPPLIED

**The Underwood Manufacturing Co.**  
 25, Underwood Street, London, N.1.

# ENGRAVING

## Machine Engraving on Ebonite Boards

Your Ebonite Boards neatly and accurately engraved.

No Order too large or too small  
**SPEEDY DELIVERIES**  
**CHEAPEST IN LONDON**

Ebonite boards supplied, drilled and engraved accurately to your dimensions.

SEND US A TRIAL ORDER.

## S. MARKS & SON

Engraving Works,

7-8, Carthusian St., Aldersgate St., E.C.1

Telephone No: CITY 5040.

## Dry Batteries for Wireless Sets

No. 1 W. Standard Pocket-lamp size, 4½ volts (as illustration), with patent spiral wire terminals for connecting in series.

Insert straight terminal in spiral of next battery and bend same, no soldering required.

**PRICE 7/- Per doz.**

NOTE.—(1 doz.—54 volts).

**NEW TYPE.**  
No. 2 W. Slab.  
15 volts, 1 screw terminal, 5 plug sockets, 3-volt tappings with wander plug.

Size  
6" x 1½" x 2½"  
high.

**PRICE**  
**3/-**  
**EACH**

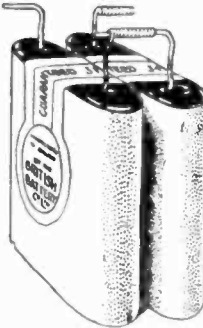

**NEW TYPE.**  
No. 4 W

36 volts, 1 screw terminal, 12 plug sockets, 3-volt tappings with wander plug. Size  
9½" x 1½" x 2½"  
high.

**PRICE**  
**7/-**  
**EACH**

No. 1 W.  
Connect as illustration.  
(Patent applied for).

**BRITISH MADE—CARRIAGE PAID.**

Manufactured by—

**THE BRITISH BATTERY Co., Ltd.**  
Clarendon Rd., WATFORD, HERTS.

(Telephone: Watford 617.)

## ACCUMULATORS

4 Volt 40 Amp. ..	18/6	6 Volt 40 Amp. ..	26/3
4 .. 60 .. ..	21/6	6 .. 60 .. ..	32/9
4 .. 80 .. ..	28/2	6 .. 80 .. ..	37/3
4 .. 100 .. ..	30/-	6 .. 100 .. ..	43/6

Metal carrying cases for above, with strong strap handle from 2/- each.

### SPECIAL OFFER.

6 Volt 20 Amp. Accumulators in celluloid at 18/- each, absolutely new, but shop soiled.

### WIRELESS GOODS.

Headphones, 4000 ohms .. .. .	each	22/6
L.F. Transformers .. .. .	.. .. .	14/6
Coil Plugs .. .. .	each	2/-

Special Line of KNIFE SWITCHES on Ebonite and on Porcelain at lowest prices. WRITE FOR LISTS.

GOOD DISCOUNTS TO TRADE.

## F. YATES & SON, LTD.

WHOLESALE ELECTRICIANS,

144 Church St., Kensington, London, W.8

Phone: Park 4276.

(One minute from Notting Hill Gate Central London & District Rly.)

## ACCUMULATORS,

## H.T. BATTERIES AND VALVES.

NEW AND GUARANTEED.

4-Volt, 25-Amp., Celluloid .. .. .	(postage 1/-)	11/3
4-Volt, 40-Amp. .. .. .	.. .. .	25/6
4-Volt, 60-Amp. .. .. .	.. .. .	31/-
4-Volt, 80-Amp. .. .. .	.. .. .	36/-
4-Volt, 100-Amp. .. .. .	.. .. .	45/-

Packing 1/6 extra. Packing 2/- extra.

MULLARD ORA VALVES .. .. .	(Postage 6d.)	15/-
MARCONI "R" VALVES .. .. .	(postage 6d.)	17/6
36-V. H.T. Battery, Hellesden, with Plugs (postage 1/-)	.. .. .	8/6
60-V. H.T. Battery, Hellesden, with Plugs (postage 1/-)	.. .. .	14/-

Cash with Order. Goods despatched per return.  
**Lowke & Sons, Ltd., Northampton.**

## Questions and Answers COUPON

To accompany Questions sent in during the week commencing Feb. 24th, 1923.

VOL. XI, NO. 21.

See Conditions on Page 709.

ELWELL  
High Power  
Wireless  
Stations

Oxford

Cairo

Northolt

Horsea  
Island

Eiffel  
Tower

Lyons

Nantes

Rome

& others

ELWELL  
WIRELESS

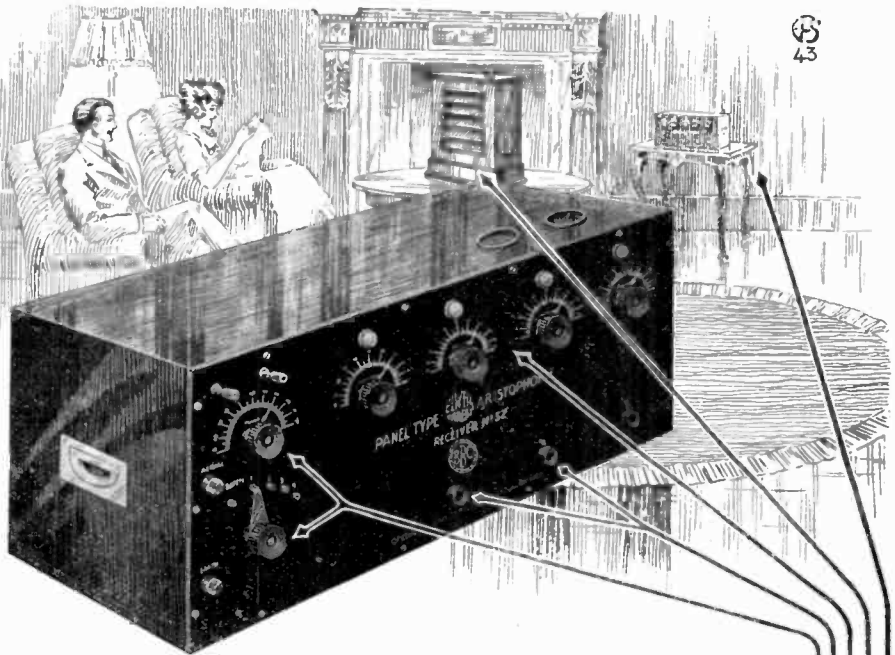

## COMPLETE.

Aristophane Panel 52 is essentially the complete receiver.

You can quickly and readily listen to the Broadcasting, Shipping, Aeroplane Telephony, Amateurs and the usual High Power Stations.

You can listen on two, three, or four valves as you desire, and if you wish to obtain particularly loud reproduction, you can use power valves in the last two valve holders.

You will also appreciate both batteries being self-contained within the case. The only external leads are the aerial and earth.

Wherever you live, Panel 52 will give you satisfactory reception from at least one Broadcasting Station, and probably the choice of three.

Panel 52 is entirely British made and approved by the Postmaster-General.

Four position and fine adjustment switches for tuning in to Broadcasting, Amateurs, Shipping, or Aeroplane Telephony as desired.

Elwell Jacks for connecting the Loud Speaker or Head Telephones to 2, 3 or 4 valves at will. Only the valves in use are alight, ensuring economy in battery current.

Separate filament control on each of the 4 valves, ensuring maximum efficiency and range.

The Aristophane Loud Speaker, for which this panel has been specially designed, ensures perfect reproduction.

Aristophane Panel 52 is a completely self-contained receiver. Both L.T. and H.T. Batteries are included in the case. There are no untidy battery leads.

### Aristophane Panel No. 52.

Comprising 4 "Ora" Valves, one pair supersensitive head telephones, 36 volt H.T. battery, 6 volt 50 A.H. filament battery, aerial, lead in insulators, earth connection and everything ready for reception.

£40

Complete as above, but with 120 volt anode battery and larger valves, suitable for demonstrations or where maximum volume is desired.

£42 10 0

### Aristophane Loud Speaker,

£10 extra.

Ask for the name and address of the nearest Elwell Service Agent.

**C. F. ELWELL, LTD.,** Radio Engineers,  
(Dept. W.), CRAVEN HOUSE, KINGSWAY, LONDON, W.C.2  
Telephone: Museum 1384.



# For those who want the BEST

"DUNHAM" instruments will particularly appeal

Illustrated and fully descriptive brochure of all our sets sent free.

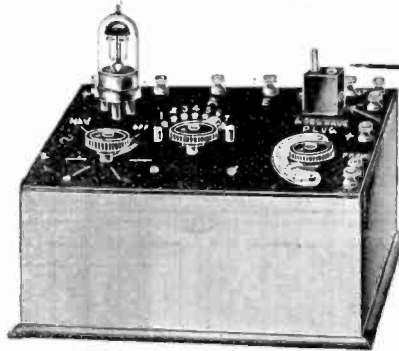

SPECIAL LONG WAVE PLUG FOR RECEIVING PARIS, E.T.C.

£3 : 18 : 6

This single-valve set receives broadcasting on 20' of wire hung across our showrooms at Brixton, and no outdoor aerial is needed. It is arranged so that amplifiers can be easily added if and when desired. Reaction is fitted, and being directly coupled to the aerial coil boosts up the receiving range and strength of reception. It cannot possibly radiate and cause interference. These and other special features make it without a doubt the finest single valve set on sale to-day. Approved by the P.M.G., No. 1087, and guaranteed by us. Price, complete with 'phones, accumulator, valve, H.T. batteries, etc., £7 8s. (plus B.B.C. fee of £1).

**C. S. DUNHAM (Radio Engineer) late of Marconi Scientific Instrument Co.**

234-6, BRIXTON HILL, S.W.2.

Phone: Brixton 3325.

Agent for BUCKINGHAMSHIRE: H. Geary, 77, Broad Street, Chesham, Bucks.

## "FERRY" FILAMENT RESISTANCES

Give your Filament Resistances that "FERRY" feeling!

"FERRY" is a British product with TWENTY years' reputation.

Wireless manufacturers can obtain—with "FERRY"—*reliability of service*, the same service which this remarkable resistance material renders in Motor Starters, Controllers, Regulators, Cinema Resistances, Instrument, etc.

"FERRY" is specified by the British Admiralty.

Write for Technical Booklet and List of Reduced Prices.

All gauges in wire and ribbon form.

**HENRY WIGGIN & CO., Ltd.,**  
55, George Street,  
Birmingham.

Sole Agents for the Electrical Trade—

**LIONEL ROBINSON & Co., 3b, Staple Inn, London, W.C.1.**

Telephone—Holborn 6323.

## The WILKINSON SWORD CO., LTD.

are manufacturers of WIRELESS PARTS

*Special Quotations for Terminals and all Metal Parts*

**WIRELESS 2 Valve £25 Manufactured under**  
**RECEIVING SETS 3 ,, £35 B.B.C. Licence**

*Each set complete with Brown's Headphones, Valves, Batteries, Aerial and all accessories.  
 Ready for immediate use with complete instructions.*

**53, PALL MALL, LONDON, S.W.1**



### The "BLACK PRINCE" Series.

The "BLACK PRINCE" Crystal Receiver is exceptionally efficient and gives excellent results on telephony up to a range of about 20 miles. It is beautifully finished in a polished Black Cabinet, and tuning up to 500 metres is controlled by a simple switch movement requiring no skill to operate.

*Price, ready to connect to aerial 17/6*

*Postage and Packing 2/- extra.*

*See our wire prices in next week's issue.*

**The Radio Rendezvous,**  
709 Romford Road, Manor Park, E.



### L.F. Intervale TRANSFORMERS OF THE RADE

*Keen Prices Quoted.*

These transformers are the result of careful study and experiment. They are absolutely distortionless and yet give a transformation ratio of 4-1. We can guarantee complete satisfaction to any purchaser.

*Price 14/- each.*

*Postage 1/- extra.*

**The Radio Rendezvous,**  
709 Romford Road, Manor Park, E.

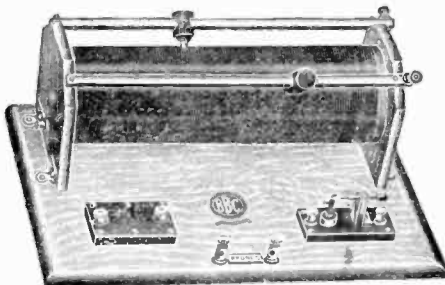

## RADCOM CRYSTAL SETS

*Approximate Range 30 miles.*

Double Slider Tuner, handsomely mounted on polished base. Tested and guaranteed, complete with 100 ft. aerial wire, 2 insulators, 1 pair B.B.C. Headphones, and B.B.C. royalty - - **£4**

**Radio**  
COMPONENTS, LTD

**19, RATHBONE PLACE,  
LONDON, W.1**

Telephone - - - - - Museum 3485  
 Telegs. Radponents, Westcent, London

# VARIOMETER

Giving an Inductance Ratio of over 9 to 1

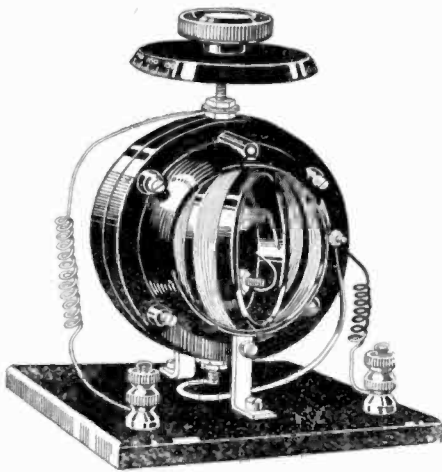

**Price: 27/6**

Fully mounted as indicated, connections made and carried to double terminals.

(Overall size  $5\frac{1}{2}$ " high by 3" wide.)

*In response to demand, we are now mounting all Variometers vertically (as shown), horizontally, or suspended through panel.*

TRADE TERMS ON APPLICATION.

Telephone  
London Wall 7725.

**MCCLELLAND & CO.**  
RADIO INSTRUMENTS

Wires and Cables:  
Exonerator, London.

The Inductance range given is from 55 microhenries minimum to 530 maximum approximately. Thus with a standard P.O. aerial of 100 feet having approximately .0003 mfd. capacity the wavelength range is 245 metres to 755 metres. Any such proportional range of wavelength may be obtained by tuning with fixed condensers in parallel. For example: using .0006 fixed condenser, wavelength range is 350-1050 metres; or, with .005 fixed condenser, wavelength range is 1000-3150 metres.

The Rotor is of the Ball type, and as the Internally wound Stator lies closely round the Rotor, the unusually large Inductance Ratio of over 9 to 1 is obtained.

The instrument is as strong and durable as good craftsmanship can make it, and its handsome ebonite finish throughout renders it very attractive. It is suitable for use in Crystal Sets, Tuners, Amplifier Circuits, Armstrong Circuits, etc., and is recommended for use with capacity reaction in H.F. Amplification. Any information on these matters will be given gladly to intending purchasers.

**14, Sun Street, Finsbury Square, London, E.C.2.**

**THE ONLY BOOK  
GIVING FULL DETAILS  
ON THIS SUBJECT**

IS

**Direction**

AND

**Position Finding**

BY

**Wireless**

BY

**R. KEEN, B.Eng. (Hons.) Sheffield,  
A.M.I.C.E.**

363 pages, 254 Photographs & Diagrams.

PRICE **9/-** NETT.

(Postage 9d.)

This book deals not only with the principles of the subject but with the constructional details of direction finding installations. It describes the principles of Direction and Position Finding in this country in such a way that the subject may be grasped easily by engineers tackling this field of wireless work for the first time.

**CONTENTS :**

Introduction ; Theory of the Wireless Direction Finder ; Valve Amplifiers and Detectors ; Maps ; Position Finding ; Night Effect and other Freak Phenomena ; The Shore D.F. Station ; The Ship D.F. Station ; Aircraft D.F. Station ; Fault Clearing and Maintenance ; Notes on Field and Nautical Astronomy ; Bibliography.

**The Wireless Press, Ltd.,**

Dept. W.W.

12/13, HENRIETTA ST., LONDON, W.C.2

**ACCUMULATORS**

(CELLULOID)

Best British make, Guaranteed

**EXCEPTIONAL  
STOCKTAKING BARGAINS**

4 volts 60 amps.	19/6	(usual 35/6)
4 " 80 "	24/-	" 42/-
4 " 100 "	27/6	" 48/6
6 " 60 "	29/6	" 53/3
6 " 120 "	58/6	" 110/-
in Teak Box		

— APPROVAL —

against cash. Carriage forward.

**H. SMYTH, LIMITED**

53, Museum Street, Bloomsbury, W.C.1

'Phone—Gerrard 9153. Tel. Add.—Nativities, London.

**EBONITE**  
OF  
**QUALITY**

As actual manufacturers of Ebonite, we are able at all times to produce a quality that will meet every condition of the job in hand. That is why we are pleasing all our customers among the wireless manufacturers at home and abroad.

WHOLESALE ONLY. WRITE FOR LIST.

SHEET	COIL HOLDERS
ROD	VALVE HOLDERS
TUBING	CONDENSER DIALS
KNOBS	RHEOSTAT DIALS
PANELS	EBONITE HORNS

**HIGHTENSITE LTD.**

Normandy Works, Custom House, E.16

'Phone: EAST 3153.

# FOR SALE.

5,000 Telephone Receivers, ex W.D., 135 Ohms each, Watch Pattern, suitable for Crystal Sets without conversion, 20/- per dozen (carriage 2/- doz.), over 5,000 sold in one week.

8,000 1/36 " Mansbridge " Condensers. at 36/- per gross.

Aerial Wire, 3/18 Bronze, as used by Admiralty and W.D., 90/- per cwt.. 100' weighs about 1½ lbs.

Special Braided Aerial Wire, bare hemp string through centre. This wire is Aerial Wire de Lux 500 yard coils, £3.

Valves, Admiralty and W.O. Pattern, R4, V24 and Marconi's, etc., 5/- to 8/6 each (not sold by post).

ACCUMULATORS, 460 New 120 amp. 2 volt d.p., Ship Type, complete in Lead Lined Wood Containers, with all internal fittings, block-type lids, and flexible connectors, at 27/6 each for quantities, or packed in tens in special wood crates at £14 complete.

Bronze Earth Wire, 40 lbs. to mile, in coils averaging 30 lbs. each, 1/- lb.

Bronze Wire, 1/14 S.W.G., 90/- cwt.

Telephone Wire, 7 Strands Steel, 1 strand copper, V.I.R. and braided, does for temporary lighting.

Earth Wire, Bell Wire, for holding upmasts and posts, fencing, etc., 15/- per mile, carriage forward, on drums, drums free, cheaper than string.

Volt Meters, 3.0.3, for Cell Testing, in Teak Case with leather handle, 15/- each, worth £4.

Litholite Insulators, similar as sold by G.E.C., 48/- per gross, worth 1/6 each.

Bobbin Insulators, 9/- per gross.

Leather Cases with leather shoulder straps, suitable for Accumulators, size 8" x 6" x 4½", 12/- doz., dozen lots or over

Ebonite Blocks, 3½" x 2" x ½", 12/- gross.

12 m/m High Tension Wire for leading in from aerial, 100 yard coils, £1 each, sold elsewhere at 10d. per yard.

Heterodyne Wavemeter, ex W.D., 70/- each.

Several Telephone Sets, including Magneto Sets, at £1 each.

G.P.O. Detectors, 7/6 each.

New Simplex Sets in cases comprising Relay, Galvanometer, Double Current Key and Sounder, prices on application.

New Duplex Sets, Rheostats and Condenser, suitable for Colonial Governments, Railways, etc.

10,000 Fuller Leclanche Cells (brand new), in Ebonite Containers, unspillable, will last a lifetime, cost 8/- each, our price 15/- per doz., or 10 Cells in special Padded Wood Chest, with handles and hasp staples, £1 per set, cost £6 10s.

Rushmore Accumulators, 2v. 10 amp. in Ebonite Cases, with pure rubber outer case, 48/- per doz.

Fuller Block Type Accumulators, 2v., 48/- per doz.

New Watertight Graham Ship Gongs (6"), 12v. Single Stroke, 12/6 each.

New Watertight Graham Trembler Ship Gongs (6"), 12v., 15/- each. Worth £3 each.

New Graham Ship and Motor Boat Rattlers (Electric Horns), 12v., do for Motor Cars, etc., 15/- each.

Electric Cables and Wire V.I.R. Lead Covered and Armoured, every size in stock. I hold the largest stock in England at unheard of prices. Please let me have your enquiries.

Large quantities S.H. Telegraph Relays. Galvanometers. Double Current Keys. Sounders.

AMPLIFIERS. Having just purchased ex-Admiralty 100 new type Oak-cased 3-Valved Amplifiers by the Western Electric Co., we can offer these while they last at the extremely low price of £9 12s. 6d. each, f.o.r. These instruments must have cost the Admiralty about £100 each and are the finest set of Amplifiers we have ever seen.

COLONIAL AND FOREIGN GOVERNMENTS SUPPLIED.

Wireless Dealers, please note it will pay you to give me a call  
G.N. RAILWAY YARD,  
(Opposite Holloway Tube Station.)

**D. S. BURLEIGH**  
HORNSEY ROAD, HOLLOWAY  
Telephone : North 1675.

# R.F.H. Reaction Sets.

## The Guarantee

**That** *the new design R.F.H. Wireless Receiving Sets embodying reaction and the improved circuit, when used in the immediate vicinity of a broadcasting station, will receive from other stations without distortion or loss of volume.*

**That** *on a 2-Valve R.F.H. Reaction instrument used within three miles of the Birmingham station 5 IT, telephony is received perfectly from Paris, the Hague, London, Newcastle, Manchester, Cardiff, &c., entirely cutting out the local broadcasting station.*

### ORDERS.

The success of these new sets has been so marvellous that we are compelled to state that orders will be executed strictly in rotation. A definite promise of delivery will be given upon receipt of enquiry specifying size required.

### IDEAL HOMES EXHIBITION.

A full range of our wonderful new sets will be on view at the Ideal Homes Exhibition in March, on Stand No. 13.

**ROGERS, FOSTER & HOWELL, Ltd**  
Radio Engineers :: Edward Road :: Birmingham

Telegrams : "AUTOWIRE."

Telephone : SOUTH 265.

# R.F.H. Reaction Sets.

## The Guarantee

**That** the new R.F.H. Reaction Sets conform in every way with the regulations governing broadcasting licences, and that they are approved by the Postmaster-General.

**That** the wonderful selectivity of the new sets is obtained without changing coils or transformers.

**That** all BBC broadcasting fees are included in the prices quoted, and that users are free from any liability for infringement.

### PRICES.

Model O, Class "A" Crystal set .....	5 guineas
Model 2, Class "B" Complete set, 2-valve embodying reaction and the new circuit, as above described and guaranteed .....	25 guineas
Model 3, Class "B" Complete 3-valve set, as above .....	30 guineas
Model 4, Class "B" Complete 4-valve set, as above .....	40 guineas

*Prices and particulars will be gladly furnished of other Sets varying in price from 5 to 100 guineas. New Catalogue is just issued.*

## ROGERS, FOSTER & HOWELL, Ltd

Radio Engineers :: Edward Road :: Birmingham

Telegrams : "AUTOWIRE."

Telephone : SOUTH 265.

# U.S.A. BROADCASTING in CARNARVON

*First Attempt! Perfect Reception!*

## THE L.F. TRANSFORMER

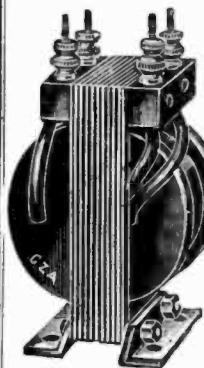

L.F. TRANSFORMER

is of our own well known manufacture with Core of Stalloy and correctly designed to give maximum amplification. Price **20/- each** *INSIST* on having "AUCKLAND" TRANSFORMERS.

Carnarvon, N. WALES,

*It may be of interest to you to know that recently, while "Listening-In" after midnight, we picked up clear speech and music from an American Broadcasting Station. All the panels (3) (1 H.F., 1 Dect., 1 L.F.) were made up entirely of parts supplied by you, including the H.F. and L.F. Transformers. Our aerial being a poor one we have to rely on the good design of our units for results, which adds credit to the design of your transformers, etc. This was the first and only occasion we have listened for U.S.A. Broadcasting.*

*Yours faithfully,*



### Pin Type H.F.

- |    |             |     |
|----|-------------|-----|
| 1. | 150-600     | 5/- |
| 2. | 380-800     | 6/- |
| 3. | 570-1,300   | 8/6 |
| 4. | 1,000-2,175 | 7/- |
| 5. | 1,600-3,200 | 7/6 |

## THE H.F. TRANSFORMER

These Transformers allow Critical Tuning which is necessary for the Reception of U.S.A. Broadcasting

used was our Pin Type interchangeable pattern, tuned with a small condenser.



Price : 7/6

### Crystal Reception of Broadcast Music is Perfect Reproduction.

Illustrated is our Universal Adjustment Detector, Fitted with 2 Crystals, finished as a High Class Instrument, mounted.

### Spade Terminals

PER DOZ.  
2 sizes :

4d.

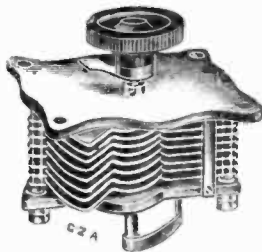

### THE MOST RIGID CONDENSER ON THE MARKET.

Fitted with Aluminium Top & Bottom Plates. Vane Spacing .072"

- |      |       |      |
|------|-------|------|
| .001 | .. .. | 24/- |
| .005 | .. .. | 18/- |
| .003 | .. .. | 16/- |
| .002 | .. .. | 15/- |

Limehurst,  
Sale, nr. Manchester.

Dear Sirs,

*I should like to say how pleased I am with your Precision Condensers illustrated on page 8 of your Catalogue, and I have not come across any better at the price, the nearest being the Mark III made to Government specification regardless of cost.*

*I cannot understand why you keep them in the background.*

*Yours truly,*  
*(Signed)*



### POTENTIOMETERS.

Useful for Grid Potential Crystal work, etc., etc. Typical of all Auckland Products. Finished in Instrument style.

PRICE (as Illustrated)

8/6



**G. Z. AUCKLAND & SON, 395, St. John Street, E.C.1.**  
 Factories—ISLINGTON, N. WIRELESS INSTRUMENT MAKERS. 'Phone : - - 3173 CLERKENWELL.  
 LONDON OFFICES:



# BUTTLO Broadcasting Sets

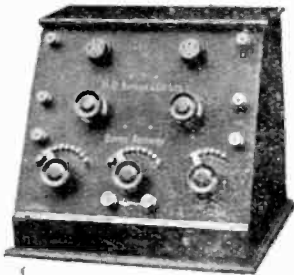

B.B.C. 3

Licensed by Marconi Co. for Amateur use in Great Britain and Ireland.

2-Valve Set highly finished in solid mahogany cabinet £11 : 15 : 0. All fees paid. Valves, etc., not included.

FULLY ILLUSTRATED LIST POST FREE 6d.

## H. D. BUTLER & Co. Ltd.

Showrooms: BARCLAYS BANK BUILDINGS,  
222, Great Dover Street, Borough, S.E.1.

Telephone: 11-p 3029

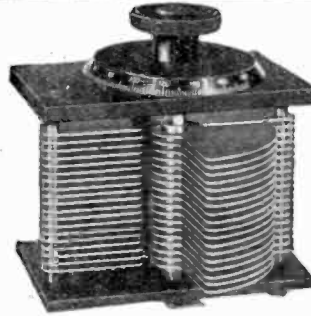

Specification of our well-known CONDENSERS. Highest grade Aluminium Plates, Brass Washers machined to a limit of + or - .001" Adjustable Brass Bush at bottom, Fixed Brass Bush at top. These Condensers are built to stand HARD continuous usage and we GUARANTEE THEM.

Value in M.F.	Panel Mounting in Parts	Panel Mounting Assembled	Cabinet Mounting in Parts	Cabinet Mounting Assembled	Cabinet Mounting Assembled in Cabinet	Polished Mahogany Cabinet
.0015	23/-	25/6	24/-	26/6	33/-	6/3
.001	18/9	19/8	17/9	21/-	26/-	5/6
.00075	13/6	16/3	14/6	16/6	22/-	5/6
.0005	10/6	13/-	11/9	13/9	18/-	4/6
.0004	10/-	12/6	11/-	13/3	17/6	4/6
.0003	9/-	11/6	10/-	12/-	16/-	4/-
.0002	7/-	9/-	8/-	9/6	13/6	4/-
.0001	6/-	8/-	7/-	8/6	12/6	4/6
Vernier	—	4/6	—	5/-	9/-	3/6

Fitted with Bevelled Ebonite Dial 1/9 extra. Special Sizes made to Order. Price list on request.

ALL SUNDRIES AND COMPONENTS IN STOCK.

ORDERS OVER 20/- CARRIAGE PAID.

TRADE ENQUIRIES SOLICITED.

**THE "BROADWAY" RADIO WORKS**

DEVONSHIRE ROAD, BEXLEYHEATH, KENT.

Phone: BEXLEYHEATH 186.

# EDISWAN VALVES

The essential part of the receiving Set is the Valve.

## EDISWAN VALVES

by their actual performance have proved themselves to be the best on the market for sensitivity, silence in working and robustness.

Type A.R. 15/- each.

Type R. 17/6 each.

Why not send us your name and address? We can probably tell you something of interest regarding wireless matters. Ask for Leaflet S when writing.

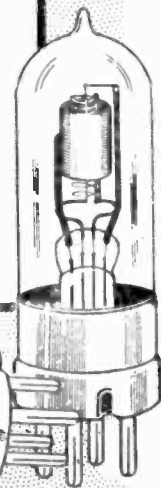

THE EDISON SWAN ELECTRIC Co., Ltd.

Head Office: 123,5 Queen Victoria Street, E.C.4

London Showrooms: 71, VICTORIA ST., S.W.1

Works: PONDERS END, MIDDLESEX

BRANCHES  
Aberdeen Bristol  
Belfast Cardiff  
Birmingham Glasgow  
Brighton Dublin  
Dunfermline Leeds  
Hull London  
Liverpool Manchester  
Newcastle Nottingham  
Plymouth Southampton  
Sheffield Swansea  
Sydney Adelaide

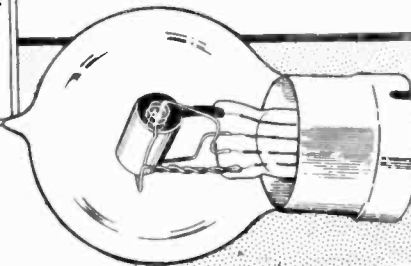

G.  R.

BY DIRECTION OF THE DISPOSAL BOARD.

## SALE BY AUCTION IN LOTS OF Wireless Material, Electrical Equipment, Plant and Machinery, Etc.,

At THE ROYAL DOCKYARD, WOOLWICH, S.E.18

(Close to Woolwich Dockyard Station on the S.E. &amp; C. Railway. Trams Nos. 36, 38 and 40, and Buses Nos. 53 and 53a, pass the Gates).

**On MONDAY, MARCH 12th, and Following Days,**

AT 11 A.M. PRECISELY EACH DAY,

INCLUDING —

13 Generators from 2-2-3 k.W., 10 Armatures, Receiver Sets, 128 POWER BUZZER AMPLIFIER UNITS, 11,500 SULLIVAN'S HEADPHONES, SWITCHBOARDS, 8-h.p. PETROL ENGINE, 31,000 TELEPHONE CORDS, 372 500-Milliamp. H.F. Ammeters (by W. R. Morris), Choke Coils, Discs, Cracker and other Type Resistances, Rotary and other Spark Gaps, Rotors, Electrodes, Tachometers, Speaking Tubes, Switches, Detectors, Receiving Boxes, Spares for Generators, Insulators, Inductances, Plugs, Terminals, Intensifiers, Condensers, Earcushions, Tuners, Batteries, Control Keys, Condenser Tubes, Earth Arrestors, Transformers, Turret Heads, Fullerphones, Field Projectors, Telephone Sets, 12,000 Daylight Signalling Lamps, Galvanometers, Voltmeters, 1,600 Hand Telephones, 20,000 MILES OF ELECTRIC CABLE AND WIRE, 350 yards of Aluminium Wire, 10 tons of Galvanised ditto, 4 tons of Copper ditto, 63,500 ELECTRIC BULBS, 607 DISTRIBUTION BOARDS, Bell and Bell Sets, Buzzers, Switchboards, Switches, Galvanised Fibre, Terminals, Bells, Vibrators, Separators, Buzzer Sets, Rheostats, Insulators, Telegraph Poles, Micanite Sheet, Lenses, Carbons, Transmitters, Voltmeters, Ammeters, Arc Lamps, Field Telegraph Lanterns, 2 tons 15 cwt. of Sheet and Rod Ebonite, Lucas and other Lamps, 2,834 Cable Drums, Spares for No. 44 Telephone Sets, Inspection Mirrors, Battery Boxes, Microphones, Magneto, Generators, Earth Pin Cases, 876 Round Nose Pliers, 1,445 Leather Lamp Cases.

On View WEDNESDAY, THURSDAY AND FRIDAY, prior to and on mornings of Sale.

Catalogue and Orders to View can be obtained from the auctioneers, Messrs.

**BRADSHAW BROWN & CO.** (Partners—Geo. E. Nye & Walter K. Meyers, F.A.I.),

Billiter Square Buildings, London, E.C.3.

Phone Avenue 144

American

### THE A.B.C. of VACUUM TUBES USED IN RADIO RECEPTION

by  
E. H. LEWIS

132 Pages.

48 diagrams and illustrations.

Price **6/-** Nett

(Post Free 6/5)

Written particularly for those who know nothing about wireless, but who desire an understanding of the elementary principles of operation of vacuum tubes, and various circuits in which they are used for reception of wireless telegraph signals, music and speech by wireless telephone.

**The Wireless Press, Ltd.**  
12/13 Henrietta St., London, W.C.2

**AN INTRODUCTION TO**TWO VOLUMES **RADIO** Pocket SizePrice **6/-** nett.

Post free 6/3.

*An American publication for the Beginner  
in Wireless.***CONTENTS.**

- Vol. 1. Chapter I. An introduction to Radio.  
" II. Radio Telephony.  
" III. The various Instruments used in Radio Transmitting and Receiving Outfits.
- Vol. 2. Chapter IV. Technical Terms Explained.  
" V. How to set up Receiving Outfits.  
" VI. Primer of the Vacuum Tube.  
" VII. How to set up Radio Transmitters.

**The Wireless Press, Ltd.**  
12/13 Henrietta St., London, W.C.2

# The Perry Auto-Time Morse System

By F. W. Perry.

Crown 8vo.

16 Pages.

PRICE **6<sup>d</sup>** NET. (Postage 1d.)

An aid to the rapid acquirement of speed in the transmission and reception of the Morse Code. Learn Morse and you will never get tired of wireless. Far more interesting even than the wonderful broadcasting telephony concerts and events. The constantly changing personal messages sent by wireless telegraphy open up a vast field of interest, amusement and knowledge. The Perry system teaches you Morse interestingly so that its study is a real hobby.

# The Wireless Telephone

What it is, and How it works.

By Philip R. Coursey,

B.Sc. (Eng.), A.M.I.E.E.

128 Pages.

78 Diagrams and Illustrations.

PRICE **2/6** NET. (Postage 4d.)

The author sets out in a simple manner, not only the essentials of the radiotelephone, but how it operates and how its parts are built up, including directions for building a simple valve receiver for wireless telephone broadcast.

**Contents.**—Introduction. Wire and Wireless Speech Transmission. The Fundamental Principles of Radiotelephony. The Radiophone Transmitter. The Receiver. Some uses for Radiotelephony. A Simple Radiotelephone Receiver for "Broadcast" Transmissions.

## THE NEW FOUR

THE WIRELESS PRESS, LTD.

Dept. W.W.

12-13, HENRIETTA ST., LONDON, W.C.2

# Mast and Aerial Construction for Amateurs

By F. J. Ainsley,

A.M.I.C.E.

88 Pages.

70 Photographs & Diagrams

PRICE **1/6** NET. (Postage 2d)

This book is one which the amateur will read with gratitude to the author who has rendered a great service in removing the difficulties of mast and aerial construction. With the use of a few ordinary tools and by following the instructions given in the book this will be found a simple matter.

**Contents.**—Various Types Masts. General Information. Scaffold-pole Masts. Plank Masts. Stayed Lattice Mast. Self-support-Mast. Tubular Mast. Aerial System.

# Crystal Receivers

## for Broadcast Reception

By Percy W. Harris.

80 Pages.

75 Photographs and Diagrams.

PRICE **1/6** NET. (Postage 2d.)

This book includes directions for building a simple crystal receiver for wireless telephone broadcasting.

**Contents.**—General Principles of Wireless Reception. Crystal Rectifiers and their Properties. Tuners for Crystal Receivers. Practical Crystal Detectors. Telephone Headpieces. Aerials and Earth Connections. What you may Expect to Hear. How to Adjust a Crystal Detector. Making Signals Louder.

We claimed  
**BIG THINGS**  
 for the  
**CONQUEST**  
 2-VALVE RECEIVER

described in the last  
 number (January) and  
 readers' results have

**FULLY JUSTIFIED**  
 our claim.

Price

**1/-**

Monthly

Post

**1/3**

Free

Read the FEBRUARY number of

# CONQUEST

for FULL CONSTRUCTIONAL DETAILS

of a

## 2-Valve Note Magnifier

It is extremely simple and easy to make.  
 No switches. No elaborate wiring.  
 It can be used as a ONE or TWO  
 valve magnifier.

**CAN BE ATTACHED  
 TO ANY EXISTING  
 RECEIVER WHETHER  
 CRYSTAL OR VALVE**

thus enabling a Loud Speaker  
 to be used.

12-13,  
 Henrietta  
 Street,

Every detail of the  
 apparatus described in  
**CONQUEST**  
 is fully tested and  
 tried out.

Strand,  
 London,  
 W.C.2.

There is no fear of  
**CONQUEST**

sets not working satis-  
 factorily, provided you  
 follow the very simple  
 instructions.

## The VOICE at 2LO

You hear the "Voice,"  
 shall we send you a "speak-  
 ing" likeness of "it"?

Unmounted cabinet size  
 silver prints of Mr. Arthur  
 R. Burrows' photograph are  
 for sale.

Only a limited number is  
 available, so hurry up and  
 send 9d., and a copy will be  
 sent by return of post.

The Wireless Press, Ltd.

12-13, HENRIETTA ST., LONDON, W.C.2

## The Construction of Amateur Valve Stations

By ALAN L. M. DOUGLAS

78 pages. 55 Diagrams and Illustrations.

PRICE **1/6** NET.

(Postage 2d.)

*The aim of the author in compiling this volume has been to place within the reach of the amateur who is interested in Wireless Telegraphy and Telephony a Handbook which will enable him to obtain data that he has otherwise difficulty in acquiring, in order that he may construct for himself apparatus which he desires to make, but does not quite know how to design correctly.*

The Wireless Press Ltd.,

12/13 Henrietta St., London, W.C.2

## The Calculation & Measurement of Inductance & Capacity

By W. H. NOTTAGE, B.Sc.

PRICE **3/6** NETT.

POST FREE **3/11**

Wireless Experimenters will find this book particularly interesting, the more generally useful formulæ and methods of calculation being brought together in a convenient form.

*CONTENTS*—*Calculation of Inductance ; Calculation of Capacity ; Measurement of Inductance ; Measurement of Capacity ; High Frequency Measurements ; Appliances for use in measuring Inductance and Capacity ; Tables.*

SEND FOR OUR CATALOGUE OF **65** BOOKS ON WIRELESS

## A Short Course in Elementary Mathematics

*And their application to Wireless Telegraphy*

By S. J. WILLIS

PRICE **5/-** NETT.

POST FREE **5/5**

The author has concentrated on the points of his subject which have an immediate application in Wireless Telegraphy, thereby rendering the book well suited to the requirements of Radio workers.

*CONTENTS*—*Logarithms ; Geometry ; Algebra ; Trigonometry ; Vectors ; Use of Squared Paper ; Solutions to Examples ; Useful Constants ; Tables.*

**THE WIRELESS PRESS, LIMITED**  
 12-13, HENRIETTA STREET, STRAND, LONDON, W.C.2

IF YOU WANT A  
**GOOD**  
 BOOK ON RADIOTELEPHONY  
 GET  
**TELEPHONY**  
**WITHOUT WIRES**

BY  
 PHILIP R. COURSEY, B.Sc. (ENG.), A.M.I.E.E.

Price **15/-** nett  
 (Postage 9d.)

It contains a complete collection of information on the various schemes, proposed and tried, relative to the electrical transmission of the sound of voices through space without wires.

An excellent list of references to papers and articles, forms a complete bibliography of the whole subject.

**THE WIRELESS PRESS, LTD.**

Dept. W.W.

12-13, Henrietta St., London, W.C.2

*Revised and Enlarged Edition*

**AMATEURS** This is just  
 what you want

THE VEST POCKET  
**DICTIONARY**

OF

**TECHNICAL TERMS**

USED IN

**WIRELESS WORK**

By Harold Ward

Over 1500 definitions

Price **2/6** nett. Post free **2/9**

**The Wireless Press, Limited**

Dept. W.W.

12-13, Henrietta Street, Strand, London, W.C.2

**NOW READY**

**BINDING CASES**  
 VOL. X.

The

**Wireless World  
 & Radio Review**

(INCLUDING INDEX)

Price **2/6** nett.

(Post free 2/11.)

**INDEX** (IF PURCHASED SEPARATELY)

Price **8d.** Post free.

*A limited number only of*  
**COMPLETE BOUND VOL. X**

(April—September, 1922)

Price **25/-** nett.

(Post free 26/-)

For the benefit of those of our readers who desire to have their parts bound, we shall be glad to undertake this for them upon receipt of the copies and remittance of 8/6 which includes cost of Binding Case, Index and return postage.

**The WIRELESS PRESS Ltd.**

12-13, Henrietta St., London, W.C.2

# The FELLOCRYST SUPER



## WIRELESS BROADCASTING

This is a high grade crystal detector especially designed for receiving broadcasting, and complies with all regulations. Beautiful pure clear speech and music are received, and as many as 3 pairs of Fellows 4,000 ohms double headphones can be simultaneously used. The "Fellocryst Super" is mounted in a highly polished oak cabinet and is sent out complete with 100 ft. coil of 7/22 stranded copper aerial wire, two shell insulators and one 4,000 ohms double headphone, and is **British Made Throughout**. Under Marconi Licence and approved by the B.B.C. and Postmaster-General.

PRICE complete,  
inclusive of all taxes.

£4 : 15 : 6  
POSTAGE 2/- EACH

Extra 4,000 ohms double head-  
phones (inclusive of all taxes).

21/6  
POSTAGE 1/-

**FELLOWS MAGNETO Co., Ltd.**

LONDON, N.W.10.

Telephone: Willesden 1560-1.

Telegrams: Quixmag, Phonc, London

*For they are jolly good Fellows*

# Broadcasting Reception

Can only be thoroughly enjoyed by the use of highly sensitive, distortionless and matched tone Telephone Receivers.

## SULLIVAN'S PATENT TELEPHONE RECEIVERS

For Radio Telephony and Telegraphy possess these qualities, and owing to increased demand the prices have been considerably

### REDUCED

#### PRICES

- 120 ohms 30/-
- 2000 ohms 34/-
- 4000 ohms 35/-
- 8000 ohms 36/-

*All Previous Prices Cancelled.*

*Trade Terms and Special Rates for Quantities on application.*



*Without public advertisement of any kind over one quarter of a million sets of "Sullivan" phones have been made and sold for WIRELESS alone.*

**DEMONSTRATION AND SHOWROOMS: Liverpool House, Middlesex Street, E. 1**

DEMONSTRATIONS DAILY from 5 to 6 p.m.

Two minutes walk from Liverpool Street and Broad Street Stations.

TRADE TERMS ON APPLICATION

# H. W. SULLIVAN, LTD.

FORMERLY H. W. SULLIVAN, FOUNDED IN 1900

Works and Showrooms: LIVERPOOL HOUSE, MIDDLESEX ST., LONDON, E.1. Phone Avenue 4871

Offices: WINCHESTER HOUSE, LONDON, E. C. 2. London Wall 3518

Telegrams: "Deafbeat, Stock, London."

**BIRMINGHAM :**  
The Birmingham  
Radio & Engineering Co. Ltd.  
8, Newhall Street.

**Representatives :**  
**GLASGOW :**  
Meridian Electric Co.  
29, Renfrew Street.

**LIVERPOOL :**  
Messrs. Pulford Bros., Ltd.  
106-110, Whitechapel.



Printed by Sanders Phillips & Co., Ltd., Chryssell Road, London, S.W.9, for the Proprietors and Publishers, The Wireless Press, Ltd., 12-13, Henrietta Street, London, W.C.2; Sydney, N.S.W., 97, Clarence Street; Melbourne, 422-24, Little Collins Street; New York, 326, Broadway.

