

GENERAL LIBRARY

JUL 26 1920

UNIV. OF MICH.

The WIRELESS WORLD



VOL. VIII No. 8. NEW SERIES

10th JULY, 1920

[FORTNIGHTLY

CONTENTS

GUGLIELMO MARCONI.

THE SIZE AND SHAPE OF THE ELECTRON.

A WET COTTON GRID LEAK.

TIME SIGNALS AND WEATHER REPORTS.

PRICE 6^D NET

NOW READY

THE YEAR BOOK OF WIRELESS TELEGRAPHY AND TELEPHONY FOR 19

PRICE 10/6 NETT.

POST FREE 11/3

ABROAD 11/9

THE WIRELESS PRESS LTD., 12-13, HENRIETTA STREET, STRAND, LONDON, W.C.2

WESTON

STUDENT'S GALVANOMETER

Model 375 Galvanometer is a moving coil instrument with a uniformly divided scale 2.35 inches long. Its resistance is approximately 29 ohms and the current required for a millimeter (1 scale division) deflection is 20-25 micro-amperes.

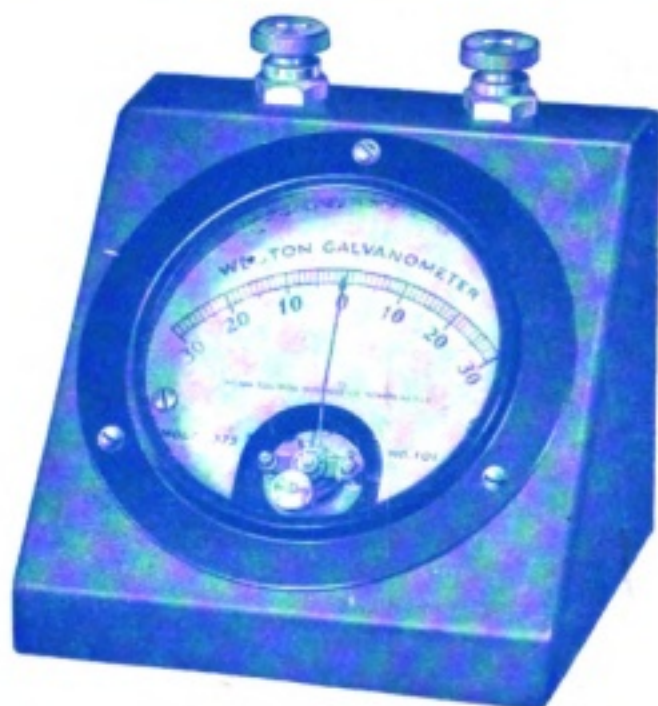

WESTON ELECTRICAL INSTRUMENT CO., LTD.
Audrey House, Ely Place, Holborn, E.C.

Telephone: HOLBORN 2029.

Telegrams and Cables: "PIVOTED, LONDON."



THE BRITISH SCHOOL
of TELEGRAPHY *Ltd.*
179, CLAPHAM RD
LONDON, S.W.

EXPERT TRAINING FOR YOUNG GENTLEMEN (15-25) IN INLAND, CABLE & WIRELESS TELEGRAPHY. Good appointments are open to our students as soon as qualified, the demand for Skilled Operators in all Services being greater than the supply. Special Short Course suitable for men wishing to obtain Government Certificate and enter the service of the Marconi Co. At several recent Government Exams, all candidates obtained 1st Class Government Certificate. No Branches or Postal Tuition. Fees moderate. Recognised by the War Office, Admiralty, Wireless Telegraph and Cable Companies.

WRITE FOR PROSPECTUS. A. W. WARD (Manager). 'Phone: BRIXTON 215

THE WIRELESS WORLD

THE OFFICIAL ORGAN OF THE WIRELESS SOCIETY OF LONDON

VOL. VIII. No. 8.

JULY 10TH, 1920

FORTNIGHTLY

GUGLIELMO MARCONI

By E. BLAKE, A.M.I.E.E.

§ I.

THE middle nineties of the nineteenth century saw the fruitful Victorian era drawing to its close. Its monarch was about to celebrate the sixtieth year of her reign, its giants were either dead or had travelled very far towards the sunset slopes, and the tide of scientific invention and discovery seemed to pause. Tyndall, Darwin and Huxley were dead, Clerk Maxwell and Hertz, beloved of the gods, had died young and full of honours, Lord Kelvin had passed three score and ten years, Crookes was sixty-four and his most famous researches were two decades old. The stimulus imparted by the great British Victorians to the scientific fraternity all over the world was apparently exhausted, and the full flow of scientific revelation had not ceased but had diminished to a trickle. The electronic theory of electricity had thrown new light upon physical problems, with the result that the younger generation of scientists were faced with tasks of reconstruction and many fresh avenues for research, whilst in their ears sounded the creaking and clatter of toppling hypotheses, for the atom, the rock on which our chemical system was reared, had been split into more than twain.

The discovery of the electron, the smallest and most wonderful created thing, set men afresh to groping across the borderland between matter and that ultra-atomic stuff, the hypothetical aether. Excited by the

conception of the electron, a particle some 2000 times smaller than the hydrogen atom, the scientific mind strove to become dissociated from the grosser physical phenomena and to obtain a grip on the world of aether, the sphere of vibrations transcending those of any material system. These aspirations were greatly encouraged by the discovery of the Rontgen rays and radio-active minerals. At the same period other men, inspired by Clerk Maxwell's electromagnetic theory of light and Hertz's researches on electromagnetic radiation, were feeling their way towards wireless telegraphy, and already an enormous mass of relevant data had been amassed. As early as 1892 Sir Wm. Crookes had clearly foreseen the coming of the age of radio-communication. He wrote:—

"This is no mere dream of a visionary philosopher. All the requisites needed to bring it within the grasp of daily life are well within the possibilities of discovery, and are so reasonable and so clearly in the path of researches which are now being actively prosecuted in every capital of Europe that we may any day expect to hear that they have emerged from the realms of speculation into those of sober fact. Even now, indeed, telegraphing without wires is possible within a restricted radius of a few hundred yards, and some years ago I assisted at experiments where messages were transmitted from one part of a house to another without an intervening wire. . . ."

As a matter of fact, wireless telegraphy had been accomplished by Professor D. E. Hughes in 1877, who had detected electromagnetic energy ("wireless waves") at a distance of some hundreds of yards from its place of origin, but Professor Hughes was probably unconscious of the potentiality of the apparatus

he used. The same might be said of Lodge, who in 1894 was demonstrating with improved apparatus, yet was apparently blind to what lay so close to his hand. The fruit of the genius of Maxwell and Hertz was being used to make instructive parlour-tricks.

Briefly, the situation was that although the scientific world had the egg in its grasp, yet, to borrow the late Sir Wm. Preece's phrase, it knew not "how to make it stand on its end." Imagination, skill, knowledge and genius were there in plenty, richly-equipped laboratories administered by first-class physicists and mathematicians were the scenes of classic researches, yet there emerged no whisper of the news for which the world was ripe and waiting. It seemed as though the acknowledged masters of the game were boggling over the next move, when there stepped into the picture a slim Italian aged twenty-two years. Guglielmo Marconi, the modern Pied Piper, as I like sometimes to fancy him, came quietly into the council chamber with his magic, saying in effect, "Please let me show you how to do it." What Crookes, the Englishman, had prophesied, the Italian had come to fulfil.

§ II.

To gauge the quality of Marconi, to analyse his mentality and to "place" him, one must first consider two facts. In 1895 when he was just over twenty-one years old he began to experiment with Hertzian waves. *In 1896 he was in England with a complete, patented system of wireless telegraphy.* These and the facts of his earliest experiments prove to me that he had from the outset worked towards a clearly foreseen end, having glimpsed in a flash of inspiration, from some eminence whereon his own peculiar genius had placed him, the transcendent uses of the aether. He believed in his vision and went straight to the mark. Taking the lecture-hall-demonstration appliances of his contemporaries, with capable hands following his unerring scientific insight he began to develop them swiftly from toys into tools. While men wrote of wireless communication over a few hundred yards,

Marconi was thinking in hundreds of miles. His was the sublime, confident audacity which expunges the word "impossible" from the dictionary. He knew what could be done and was concerned only with the actual means of accomplishment. In less than six months after beginning his work he was telegraphing through space for a distance of $1\frac{1}{2}$ miles and the technical obstacles to practical wireless communication, which on the surface were so formidable as to have completely misled earlier workers, were vanishing from his path.

Wireless telegraphy is the transference of electrical energy across space by the creation of aetheric vibrations, which are radiated in long and short "trains" or series corresponding to the dots and dashes of the Morse or other pre-arranged code, and the reception of these signals by interposing in the path of the vibrations a wire or other metallic body designed to absorb sufficient of the radiated energy to actuate an electrical device which reproduces the dots and dashes either audibly or visibly. The distance over which wireless communication can be effected depends chiefly upon the power of the transmitter and the sensitiveness of the receiver and not on the ability of the aether waves to reproduce themselves at a certain distance from their point of origin, because it is theoretically established that once an aether wave is created it is propagated to infinity. In 1895 Marconi knew that the wireless transmitter as evolved up to then was sufficiently powerful to transfer a large amount of energy to distances much greater than those at which his contemporaries had succeeded in communicating. His first care, therefore, was to produce an improved detector or receiver, and this he did after considerable experimentation with the existing type, the coherer, which had been devised by Branly, developing it into a much more sensitive, reliable and precise instrument. At the same time he was modifying the form of transmitter as originally employed by Hertz, in an endeavour to discover some fundamental law regulating the distance at which a given transmitter can affect a given receiver. These researches led him to employ the elevated wire,

GUGLIELMO MARCONI

the aerial, which is a feature of the modern wireless station, and also to the law he sought, which is that the range of transmission increases with the height of the aerial. He also discovered that transmission was greatly improved by means of an earth connection between the stations. These were two of the master-secrets which, with his apparatus, he brought to England in 1896, having, within the space of a few months, raised wireless

his system, realised the novelty and worth of what he saw and no time was lost in arranging further demonstrations. Very soon Marconi was covering a distance of nine miles over the sea. In 1897 he raised his range to twelve miles, and shortly afterwards to fourteen miles. By 1899 he had bridged the English Channel, between the South Foreland and Boulogne, and broken down all serious doubts as to the importance of the new means of

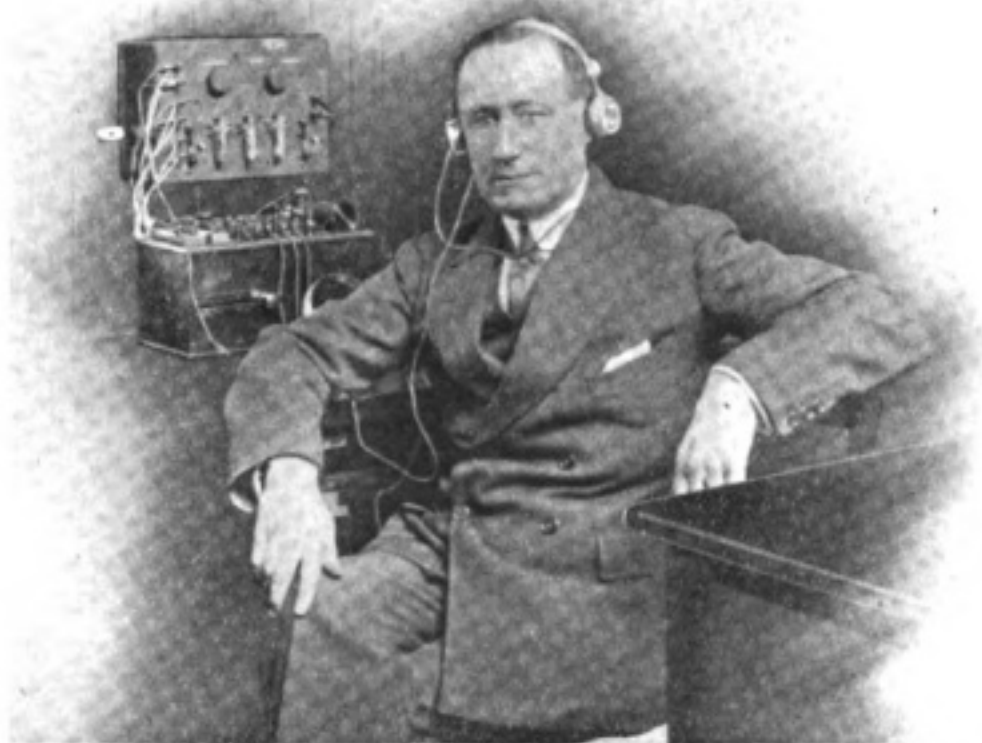

Photo.

Guglielmo Marconi—1920.

Topical Press.

communication from being a scientific curiosity of doubtful utility to the status of an epoch-making application of physics.

The arrival in this country of Marconi and his system of telegraphy created a flutter in the scientific dovecotes of Europe, and the men who were the most capable of passing an expert opinion, the very men who had been forestalled by the brilliant young investigator, were unanimous in their generous and outspoken recognition of his achievement. Preece, the Engineer-in-Chief of the British Post Office, to whom Marconi first demonstrated

transmitting intelligence. Less than two years after this, in 1901, he proved the efficiency of his system to cope with really great distances by communicating 200 miles, between the Isle of Wight and the Lizard. This exploit revealed the supreme significance of his invention, for it was patent to all that a ship-board installation with a range of 200 miles would be an incalculable aid to the preservation of life at sea.

But Marconi's great work was now only beginning. It seems fairly certain that ever since the days of his pioneer researches in the

quiet of his father's home near Bologna, he had pursued a far more ambitious intention than the public yet conceived. He must have known, in common with his fellow students of Maxwell's hypotheses, that the limitless expanse of aether is a perfect medium for the transference of energy through space. He knew that immeasurable quantities of energy are received here every second in the form of light from the sun, over a distance of ninety-three million miles, and that light is a series of aetheric vibrations. Maxwell had shown that these vibrations are electromagnetic in nature, and Hertz, working along the lines indicated by Maxwell's conclusions, had succeeded in producing long aether waves by electromagnetic means, and in detecting at a short distance the presence of the energy thus radiated. Marconi was aware, therefore, that it was possible artificially to create aether waves and to detect them with a man-made device, but that for the process to be of the greatest benefit to mankind, it must be operative over wide stretches of the earth's surface. Such was his vision—space conquered by eternal waves of aether, swift as light, yet created and controlled by man—and although his attempt in 1901 to transmit across the Atlantic electromagnetic waves sufficiently powerful to operate the receiving instruments at his disposal seemed at the outset to be a magnificent piece of bravado, it was in reality nothing but a logical step in the development of his original plan.

Thus in December, 1901, Marconi succeeded in his enterprise, surely the most marvellous ever devised by the wit of man, and established wireless communication from Poldhu, in Cornwall, to St. Johns, in Newfoundland, singularly enough the very town from which, eighteen years later, Alcock and Brown were to set forth on their great Atlantic flight. Even then there were not lacking those who disbelieved, condemning the performance as a "fake," or alleging that he had not accomplished it entirely with his own inventions. The latter contention is perfectly true, for he *supported his aerial wire at St. Johns by means of a kite*, and his most

ardent admirer cannot claim that Marconi invented kites! Even more damning are the facts that he did not invent the aether or discover electricity!

Marconi's triumph now attracted the serious attention of physicists in all parts of the world, for he had opened up far-reaching vistas of research. Facts previously gathered together by the toilers in the world's laboratories now were able to be co-ordinated and the new art of radio-communication was eagerly attacked from every conceivable aspect. Swiftly wireless telegraphy became a world-fact, and the name of Marconi a household word. In 1919 wireless signals transmitted from Carnarvon were received at Sydney, Australia, thus spanning the globe itself.

§ III.

It must not for a moment be imagined that modern wireless in all its wonderful applications is the sole work of Marconi and his assistants. During the past fifteen years an army of experimenters representing almost every country under the sun has been at work, and the five years of the Great War has advanced wireless work to a degree which it would have taken some ten years of peace to reach. Marconi's system still exists and holds its own outstanding position, but his apparatus perforce keeps pace with the knowledge and experience gained year by year. Of the other co-existing systems and appliances and their relative merits it would be inappropriate to write here; no system is perfect, or embodies the best of all the many wireless inventions now available, and the discussion as to which is the best belongs properly to the technical and commercial men. In fairness, however, to all concerned, and in order to correct the erroneous idea so largely current amongst ninety per cent of the general public, that Marconi "invented wireless," it must be pointed out that the art of aetheric communication is like a coral reef, inasmuch as it represents the work of many. Wireless was not invented, but, like Topsy, it grew.

What then is it which places Marconi amongst the immortals? By what right will

GUGLIELMO MARCONI

he be numbered with Volta, Galvani, Faraday, Maxwell, Hertz and Kelvin? It is that he led men to conquer another domain of nature at a time when they halted. He it was who first scaled the barriers and his was the hand to make the breach through which the rest poured. The study of electromagnetic waves did not originate with him, but he infused into it light and life, bending with his masterly hand the astonishing properties of aether and electricity to serve the two highest works of civilisation, the preservation of human life and the communication of thought. Life is a heritage, not alone of mind and body, but of stored up wisdom. Each generation picks up the tools of the generation it succeeds, leaving them in due time modified and improved, and those who come later read in the design of them the needs they served. All knowledge is a chain of which we, the living, are forging the latest links. These links are joined up by great men. Of the inestimable benefits to the race which have resulted from Marconi's genius and labour we may say that he had the seeds by right of his inheritance of the ages; he planted and many others have watered.

There is a certain rare type of man genuinely content to sow while others reap, caring more for the hunt than the capture,

seeking achievement for its own sake rather than for material gain. Men of this type do not trouble about patents or priority and too often their greatness and their works remain unrecognised until after their death. The way of the world! Nevertheless, there is some virtue, too, in those who have taken

the great books and inventions and turned them into things of commerce. How else should the world derive benefit from them?

§ IV.

Senatore Marconi was born on April 25th, 1874, at Bologna, Italy. That his father was Italian and his mother Irish, tempts one to speculate as to what extent the blend of the Latin and Celtic strains accounts for his rare qualities of mind. The spirit of genius, however, "bloweth where it listeth" and knows neither race nor ethnological distinction. Ancestry, parentage,

training and general environment mould the mental man, but genius cannot be accounted for. It springs from uncharted deeps.

Marconi is not a dreamer. He has been described by journalists of the impressionistic school as a man who lives in a world apart, meditating upon unrevealed mysteries, plumbing the profundities of space; as a wizard, working his works under some uncanny



Guglielmo Marconi as a child (left); the late Mrs. A. F. Jameson-Marconi (centre); Mr. Alfonso Marconi.

influence ; as a miracle-worker and conjurer with phenomena. If he has caused these gentlemen to think after that fashion, then it is patent that he has the crowning gift of a sense of humour.

On one occasion an interviewer for the daily press must have secured a "scoop," for in his article he announced, in that language which seems to be necessary for evening editions, that Marconi had divulged to him a brand-new thought. *Wireless waves are eternal.* I leave my readers to imagine how this tit-bit was served up—in half-a-dozen different styles, each one more solemn than its predecessor. However, if Marconi really did say what was alleged, he knew very well that he was merely expressing, in language somewhat more poetic than precise, a fact that is demonstrable by simple mathematics. Perhaps the interviewer disturbed him at work !

The real Marconi is your all-round man. Possessed of a mastery of his subject, he is the cool, precise electrical scientist. He does not suffer from the illusions of the mere dreamer, misreading his results or seeing in them more than they really mean. He is intensely practical. He faced the inhospitable climate of Newfoundland in mid-winter in order to fly his kites and balloons for the great Transatlantic experiment. He evolved his wireless system in a single year's work. A strange dreamer, he ; tireless and of infinite resource in experiment, seeing in his mind the fact already accomplished, and seeking the means of the doing by a path as unwavering as the sleuth-hound's.

He is the man of affairs, senator, peace delegate, naval officer, patriot. The Turco-Italian War and the last great war found him at once in the service of his fatherland. His patriotism is of a different quality to that of his countryman, D'Annunzio, who, no less sincere, seeks the "limelight" as a moth the candle-flame. The poet fights like a protagonist of an epic poem ; Marconi fights as himself, master of himself and of his science.

Honours fall about him freely. He is a freeman of Rome, a Nobel prize winner and the recipient of many decorations. Yet withal he seems to stand aloof from us, a solitary figure, making contact with the heyday of things with one hand, and with the other feeling for the intangible. He is now in the prime of life and still working. Will he "dream" for the world another reality like wireless telegraphy ?

§ v.

Even if the imagination be given wings it is quite impossible fully to estimate the importance of the coming Aether Age or to gauge with any degree of certainty the rôle it is destined to play in the evolution of our race. The aeroplane has made of us unhandy birds, the submarine is the clumsiest, most unseaworthy vertebrate which makes the sea its *habitat*, and the coal-burning locomotive is an anachronism. Yet they serve ; they are triumphs of mind over our natural disabilities.

But our invasion of the aether is an achievement of a different order. We have freed ourselves from the shackles of ordinary matter, its baffling complexities, its unaccountable variations and its limitations. There is no limit to the aether. There might be, but our ignorance of its nature is so profound that, after the manner of the Athenians, we endow the unknown with the attributes of a deity, saying that it is infinite and omnipresent.

This, then, is the field for triumphs to come, as mankind plods its appointed path to wisdom—or, shall I say, knowledge.

The communication of intelligence with the speed of light is only the beginning. It is easy to speculate on the possibility of wireless transmission of power, of wireless-operated printing machinery or the extension of the range of human vision, but it is better to remember that although suchlike crumbs will be thrown to us by the great seekers in their time, the end these men subserve is mental dominion and the enthronement of Ideas above Things.

A WET COTTON GRID LEAK AND INTER-VALVE RESISTANCE

BY E. W. KITCHIN, A.M.I.C.E.

AMATEURS are generally recommended to construct their grid condenser leak by lining with graphite a small groove cut in a piece of ebonite; but no doubt many of us have our own pet substance which we use in preference. The writer has experimented with a number of different materials, and finds a piece of ordinary cotton thread wetted with water as satisfactory as any yet tested. An easy and practical way to make this up into permanent form is described here; the arrangement consisting essentially in a rubber tube filled with water, each end being plugged by a short length of wire, and a piece of cotton passing from wire to wire through the water (Fig. 1).

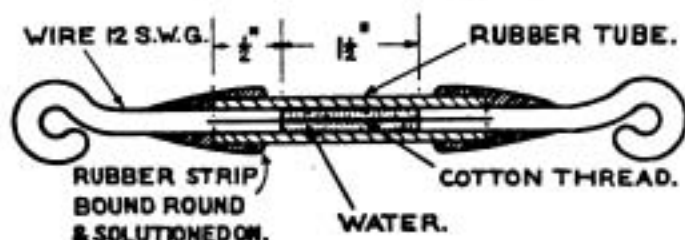

Fig. 1.

The dimensions given below work very well indeed on a particular hook up; but can of course be varied if found desirable; and the length and size of the cotton to suit any other circuit may be determined by experiment. Too much resistance in the leak seems to make the valve "howl" very readily, which of course is undesirable. On the other hand if too little resistance is used the "howling" is certainly eliminated, but at the expense of signal strength. It is not a matter of difficulty to find a suitable value in between these two extremes where the valve will not howl unless the circuit is carelessly adjusted.

Procure a piece of rubber tubing $2\frac{1}{2}$ inches long with a bore large enough to allow a piece of No. 12 S.W.G. wire to be inserted without unduly expanding the rubber. Cut

off two pieces of wire of the gauge mentioned, the length of these being decided by circumstances, the only essential being that just half an inch of each shall enter the tube. These ends should be tinned with solder; the other ends may be formed into hooks suitable for attachment to bolts or terminals.

Pass a piece of Coats' No. 90 cotton through the rubber tube, and allow an inch or two to project at each end. Immerse the tube and cotton in distilled water; or, if that is not available, in boiled and filtered rain water. Carefully squeeze all air out of the tube; and then, with all still under the water and with the cotton held taut, insert the two pieces of wire so that each enters half an inch into the tube; after which cut off the cotton flush with the ends of the rubber tube. It only remains to seal up the ends to prevent the escape of water by evaporation or otherwise; and this can be done with rubber solution and a strip of very thin rubber wound on tightly.

The grid leak as described functions well with a condenser made from a piece of mica with tin foil shellaced on each side, the overlapping or opposed areas being $7\frac{1}{2}$ square centimetres, and the thickness of the mica such as is sold for the windows of oil stoves.

This simple apparatus has quite held its own against any other tested, including both amateur and professionally made articles.

The writer has recently extended the application of the wet cotton to inter-valve resistances, with a large measure of success. The resistance in this case is best not made up with tubing as in the grid leak, because it is not desirable for the metal terminal pieces to touch the free water. With the grid leak this does not seem to matter, and the tube form is very compact and convenient where it can be used.

The containers for the water used in

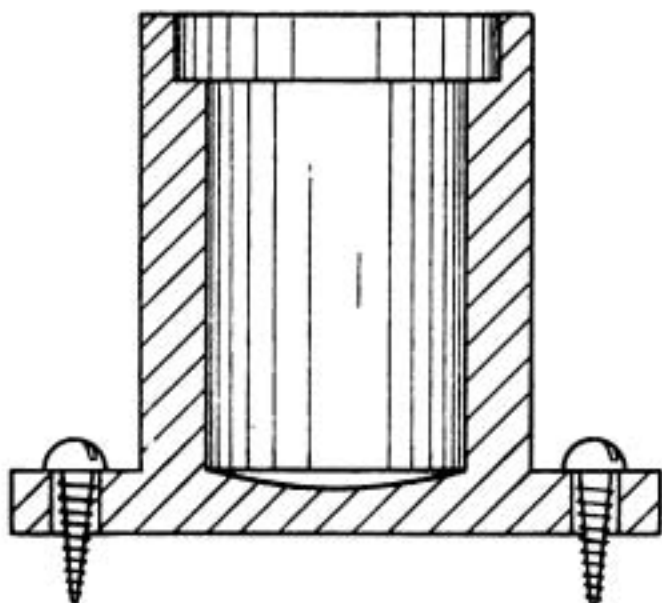

Fig. 2.

inter-valve resistances may be turned out of ebonite rod to the form shown in section in (Fig. 2), the height being about $1\frac{1}{2}$ inches and the inside diameter about $\frac{3}{4}$ inch.

An ebonite plug should be made for each container, of the form shown in Fig. 3.

The top portion should be circular, and a good fit in the upper part of the container. The central rod, which may of course be made separately from the other part, should be of such length that it does not quite touch the bottom of the container.

Drill two holes in the plug top, tap them, and screw in two small binding posts or terminals (Fig. 4), allowing the screwed shanks to project about $\frac{1}{4}$ inch as shown. The shanks should previously be tinned with solder.

A piece of Coats' No. 16 cotton is now tied tightly to one of these projections, passed round the foot of the plug *via* a groove filed to retain it, and taken back to the other projection where it is again tied.

Distilled water, or boiled and filtered rain water, is next placed in the container so that it will reach about half way up the cotton; the plug bearing the cotton and terminals is inserted, and the top sealed externally with a thick coating of sealing wax or Prout's elastic glue.

In regard to the lengths of cotton required,

the best results will be obtained by actual experiment on the amplifying circuit before making up the apparatus just described; but as a guide it will probably be found that if the first valve has a grid leak as described in the first part of these notes, then the resistance for the third and subsequent valves will require a piece of No. 16 cotton from 2 to $2\frac{1}{2}$ inches in length. The second valve will not need so much and its resistance should be about right if additional cotton be added which passes twice direct from one terminal shank to the other. In other words this particular resistance will require a length of double No. 16 cotton about 10 millimetres in length, which must be arranged so as to touch the cotton dipping into the water, in order that all may be kept wet by capillary action.

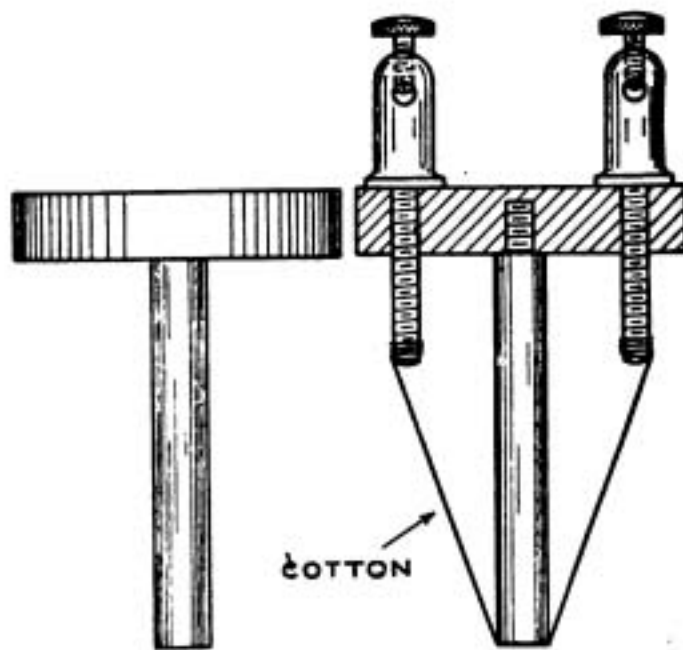

Fig. 3.

Fig. 4.

Suitable dimensions for opposing areas of the grid condensers, on mica as previously referred to, are 22 square centimetres for the second, 16 for the third, and 5 for the fourth valve.

With four of the usual type valves, and grid leak and inter-valve resistances as described, the signals from FL in a head telephone may be heard all over the house on the very limited aerial which we amateurs are at present allowed.

NOTES AND NEWS

A Wireless Demonstration Lorry.—In order to further familiarise the general public with the rapid advances made in Wireless Telegraphy and Telephony in recent years, a motor lorry has recently made a tour throughout the country. Hired by Marconi's Wireless Telegraph Company from the Battersea Motor Express and Engineering Co., Ltd., the lorry left Chelmsford on April 21st, and visited Glasgow, Newcastle, Liverpool and Cardiff. The load carried consisted of apparatus made up as follows:—Automatic calling-up device (transmitter and receiver); $1\frac{1}{2}$ K.W. Wireless telegraph and telephone cabinet set with mast and aerial; wireless telephone set YC3 (installed for working in the lorry); 100 watt wireless telegraph and telephone set type YB1 with mast and aerial; $1\frac{1}{2}$ K.W. quenched spark ship set; Marine Direction-finder No. 11 with mast and aerial. In order to operate the calling-up device, a $\frac{1}{2}$ K.W. set, with mast and aerial, was also carried.

The first of the towns visited was Glasgow, and at the Royal Technical College demonstrations were held, with marked success. On arrival at Glasgow the lorry unloaded the majority of the apparatus at the college, and then proceeded to a temporary site which had been selected at Kilmarnock. The demonstration comprised communi-

cation between the YB1 set and the $\frac{1}{2}$ K.W. cabinet set at the Technical College, and the YC 3 set at Kilmarnock. The calling-up device spark, operated by means of the $\frac{1}{2}$ K.W. spark set, was also set up at Kilmarnock.

Demonstrations were also given with the No. 11 direction finder, which was likewise set up at the "out station," with a 70-foot mast and D.F. aerial.

Leaving Glasgow on May 1st, the lorry reached Newcastle on May 2nd, and unloaded the greater part of the apparatus at the Rutherford Technical College. The out station in this case was at Blythe, the calling-up device transmitter being set up at the Cullercoats station by special arrangement with the Post Office.

The lorry left Newcastle on the 8th inst. for Liverpool, where the Liverpool University placed a room at the demonstrators' disposal, the out station being fitted up at Freshfield, Southport.

The demonstration at Cardiff is touched upon by the Cardiff and South Wales Wireless Society in its last report, published in the *Wireless World* of June 12th, but a photograph of the demonstrators and some of the Club members is shown in this issue.

The demonstrations at every town were well



A motor lorry used for demonstrations of wireless in a tour round the country. Note the 70-ft. portable mast, the earth-mats, and the engine generator on the right.

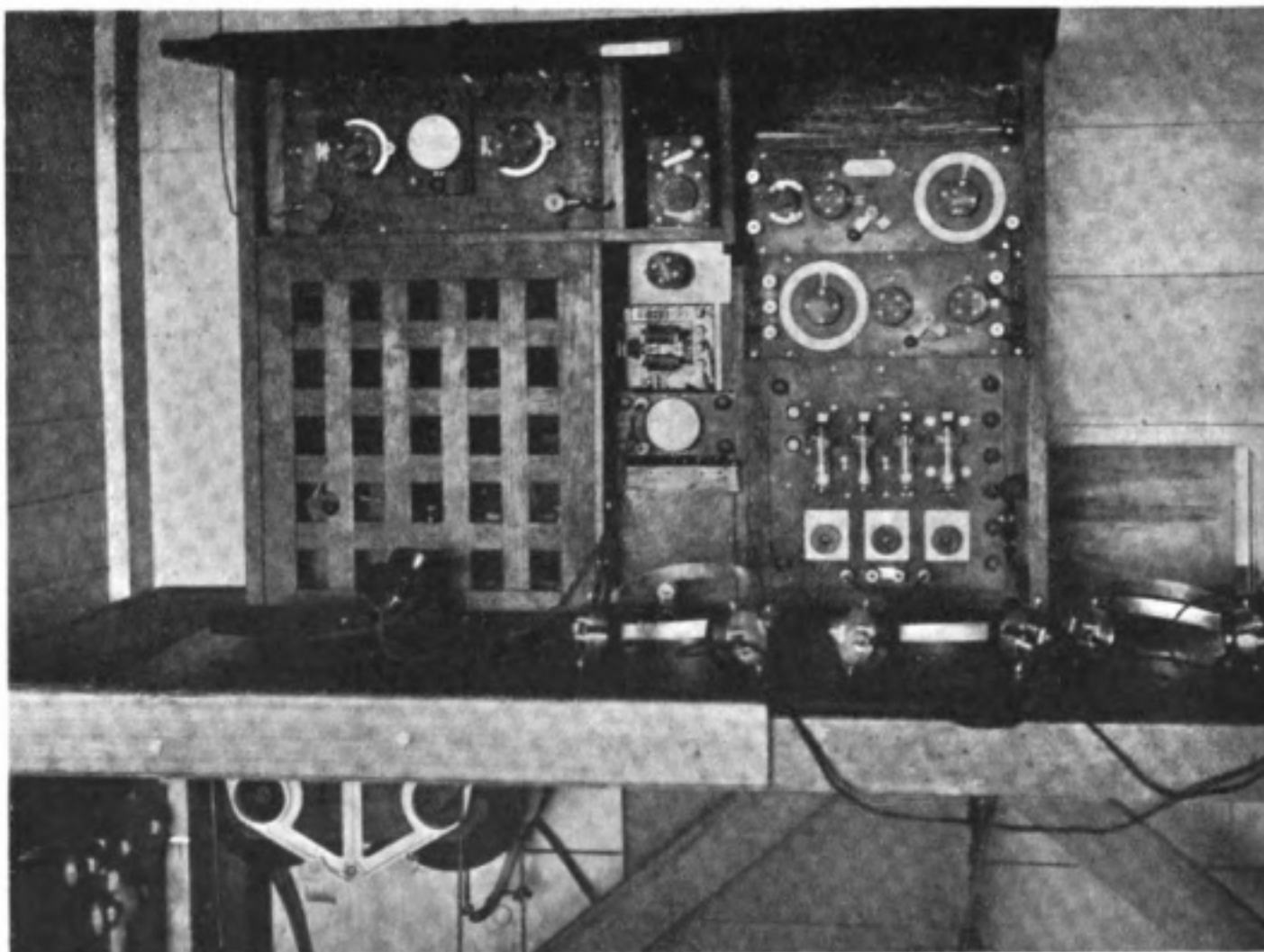

The combined wireless telegraph and telephone set installed in the lorry.

attended by shipping and educational people of high rank, and it would seem that the success of the tour is indicated by the hospitality with which the colleges named received the tourists. The lorry left Cardiff on May 22nd, reaching Chelmsford on Whit Monday, May 23rd, after conducting its tour free from adventure or mishap.

R.N.V.R. Wireless School, Crystal Palace.—The second annual reunion and dinner was held at the Holborn Restaurant, London, on the 19th of June. The O.C., Lieut.-Col. C. G. Crawley, R.M.A. (ret.), M.I.E.E., Deputy Inspector of Wireless Telegraphy, G.P.O., took the chair, and a most enjoyable evening was spent.

Next year's reunion and dinner will be held in London about the end of April, on the day of the Football Cup Final, and all "old boys" are asked to send their present addresses to Mr. N. J. Babbage, Rosieres, Hendon Lane, Finchley, London, N3., so that arrangements may be communicated to them later.

The Imperial Wireless Scheme.—The report of the Committee formed last November to consider a scheme of Imperial Wireless Communication is long, covering the whole field of long-distance wireless telegraphy. The Committee has considered what high-power stations it is considered de-

sirable, upon commercial and strategic grounds, that the Empire should ultimately possess. It has prepared estimates of the capital and annual costs of each station and the life of the plant and buildings, the probable amount of traffic and the revenue which may be expected from each station, as required by the International and Imperial Council.

Obituary Notice.—The death is recorded of Professor Auguste Righi, Professor of Physics at Bologna University. Born in 1850 and educated at Bologna University, he was Assistant in the Department of Physics during the years 1872-3. From 1873 to 1880 he was Professor of Physics at Bologna Technical Institute. Subsequently he was Professor at Palermo and Padua Universities, but in 1890 he returned to his native town. He was an Hon. Fellow of the Physical Society of London, of the Royal Institution and of the Royal Society of Edinburgh. In 1905 he was awarded the Hughes Medal of the Royal Society, of which he was a correspondent. His most famous pupil was Mr. (now Senatore) Marconi.

A Melba Recital by Wireless Telephony.—Not so very long ago speech by wireless was a thing which men were striving after in the laboratory. Now we have a famous *prima donna* singing

NOTES AND NEWS

into the microphone—not into the receiver, as a contemporary put it—of a high-power wireless telephone installation by means of which her voice is flung on the aether to hundreds of listeners scattered over Europe and the seas. No mere experiment this, but a performance undertaken confidently, with the assurance of satisfactory results. We had the privilege of attending the *Daily Mail's* wireless station on the evening of June 15th, where Lady Northcliffe, Lady Malcolm, Sir Robert Hudson and others were gathered to hear Dame Nellie Melba sing at Chelmsford.

The first we heard of Melba was a wonderful

Bernberg's "Chant Venétien," repeated "Nymphes et Sylvains," and concluded with the first verse of the National Anthem.

Transmission was effected on a wavelength of 2,800 metres, the power employed being 15 kilowatts, the rating of the generator at the Marconi station at Chelmsford. We are able to publish a photograph showing Dame Melba singing on this occasion.

New Wireless Magazines.—The *Radio Electricite* is about to make its appearance in France. This magazine will be of interest to both technical men and the general public, in that it will be devoted to the various applications of wireless telegraphy.



Dame Nellie Melba giving her famous Concert by Wireless Telephone at Chelmsford.

trill which she gave as a preliminary. Telephones were clamped tighter, and the condensers swung round for tuning. Then came the old favourite, "Home, Sweet Home," followed by "Nymphes et Sylvains" in French, and the "Addio" from "La Bohème" in Italian.

The "signals" were excellent, notwithstanding a certain unkindness of the atmospheric conditions, and the songs could be heard with the telephones on the table. As encores, Dame Melba rendered

This new magazine has been constituted by eminent persons in the scientific and industrial world, and should make interesting as well as instructive reading for amateurs.

We have seen the first number of another new French radio magazine, *La T.S.F. Moderne*, which is edited by a group of Radio engineers. It is the official organ of the Société Française de Radiotélégraphie et de Préparation Militaire, and the Cercle belge d'Etudes radiotélégraphiques.

THE SIZE AND SHAPE OF THE ELECTRON*

THE magnitude of the electric charge carried by an electron has been determined to a great degree of accuracy, but few investigators have attempted to determine the shape and size of an electron. The customary assumption has been to regard its shape as spherical and the charge uniformly distributed over the surface. If such a charged sphere is set in motion the tubes of electric force which end on it are carried along as well. These moving tubes of force will possess kinetic energy, and if we assume that the kinetic energy of the moving electron is really the kinetic energy of its tubes of force the radius of the electronic sphere can be shown to be 1×10^{-13} cm. (*i.e.* of the order of one hundred-thousandth of the diameter of an atom).

This small value fits in with many facts; for example, electrons possess the power of moving bodily through solid conductors in cases where atoms or molecules would be stopped. But there are other cases where the hypothesis of an electron of such small dimensions is not in accordance with the facts. This discrepancy is particularly evident in the results of many experiments made with X-rays in recent years.

X-rays are now known to be electromagnetic waves of extremely short wavelength (*e.g.* 10^{-10} of a cm.). When these rays impinge on matter they are both scattered and absorbed. The phenomenon of the scattering of X-rays by the electrons in the matter may be regarded as being analogous to the scattering of light by the minute suspended particles in a fog, while the phenomenon of X-ray absorption may be regarded as analogous to the ordinary non-selective absorption of light in semi-transparent media. The magnitudes of these X-rays effects appear to be inexplicable in terms of ordinary electro-dynamical theory if the dimensions of the electron are taken to

be as small as mentioned above. This paper is intended to show that these difficulties disappear when we contemplate an electron of much larger size, for example with a radius two thousand times as large.

Sir J. J. Thomson was the first investigator to calculate the amount of scattering to be expected when X-rays impinge on an isolated small spherical electron. But in the case of X-rays falling on a metal sheet we have to consider the scattering due to a large number of electrons and the question arises as to whether the electrons scatter independently. In most of the experimental results which have been obtained so far the scattering is much less than the amount calculated on Thomson's theory and it is difficult to explain on the basis of the theory of the spherical electron of small dimensions why this should be. This theory, however, has up to the present yielded us important results in giving us information regarding the number of electrons inside an atom. According to the prevailing conception an atom consists of a nucleus of positive electricity with the negative electrons situated outside it. Observations have been made on the relative scattering of different substances with the result that the number of electrons in each atom is found to be approximately equal to half the atomic weight (*e.g.* the number of electrons in an atom of nitrogen of atomic weight 14 is 7). This relation holds extremely well for elements of low atomic weight but not so rigorously in the case of elements of higher atomic weight. In the latter case it has been assumed, however, that the electrons are so tightly packed in the atom that they cannot act independently as is assumed in the theoretical calculation.

As has been pointed out it is impossible to account for the low scattering by the simple theory of the small spherical electron. If on the other hand the electron is considered to have a radius comparable with the wavelength of the incident radiation an explanation

*See Paper by A. H. Compton. *Physical Review*, July, 1919, and September, 1919.

THE SIZE AND SHAPE OF THE ELECTRON

for the small amount actually observed is possible.

The effect of the large electronic radius is to make an appreciable phase difference between the rays scattered by different parts of the electron.

Let $A B$ represent the electron in Fig. 1, and $S A$ and $S B$ two rays of electromagnetic radiation.

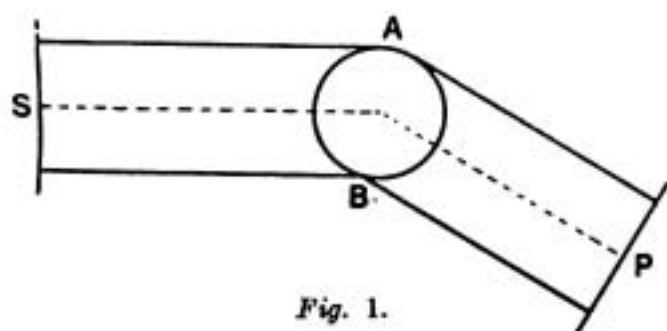

Fig. 1.

Thus the radiation scattered from A traverses a longer path between S and P than does the ray scattered from the part of the electron at B . If the wavelength of the radiation is many times the diameter of the electron the phase difference between these two rays will be negligible and no interference will take place. Consequently the reduction in the intensity of the scattered beam will be inappreciable.

If, however, the electronic diameter is comparable with the wavelength of the incident radiation the phase difference and consequent interference will be such that the intensity of the ray scattered to P will be much reduced. Thus the observed reduction of scattering can be explained if we assume an electron of comparatively large dimensions (*e.g.* radius 2×10^{-10} cms.).

The form of electron is now a matter for speculation. Three feasible theories may be advanced in which an electron may be considered as

- (a) a rigid spherical shell of electricity incapable of rotation. Or
- (b) a flexible spherical shell electron capable of rotation. Or
- (c) a ring of rotating electricity.

These hypotheses have been developed mathematically, but unfortunately the experimental data on the scattering of X-rays

are insufficient to enable us to decide finally between the three. What evidence there is however, agrees best with hypothesis (b).

A second difficulty which is found in Sir J. J. Thomson's simple theory is that it predicts that if a beam of X-rays is passed through a thin plate of matter the intensity of the scattered rays on the two sides of the plate should be the same. The experiments carried out with X-radiation of short wavelength and substances of low atomic weight as scatterers agree well with this theory, but with long and extremely short X-rays the scattered radiation on the emergent side of the plate is more intense than that on the incident side. The qualitative explanation of this phenomenon on the basis of the large electron hypothesis can be obtained.

A spherical flexible shell electron or a ring of rotating electricity [hypotheses (b) and (c) mentioned above] should give this asymmetrical scattering.

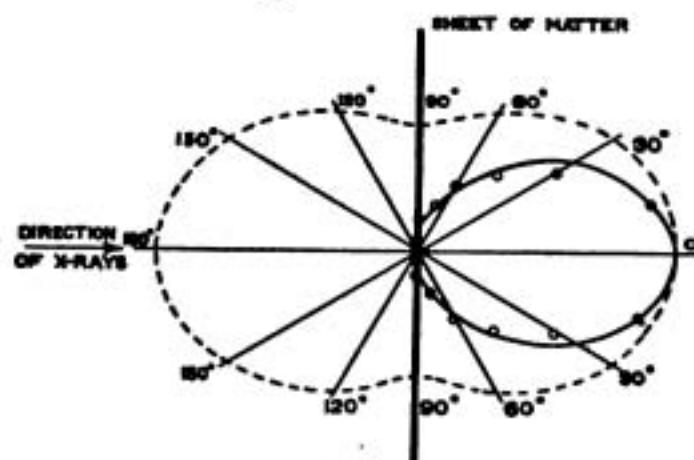

Fig. 2.

Fig. 2 shows a polar diagram representing the calculated and experimental intensities of scattered radiation for various directions. The dotted line shows the calculated values for the old theory of the small electron, the continuous line represents the intensity of scattering demanded by the large flexible spherical shell electron theory, and the rings represent some experimental values. The marked improvement of the new over the old theory is at once apparent.

The absorption which takes place when X-rays pass through matter has usually been explained in terms of the small electron

theory. But the absorption postulated by this theory does not give results agreeing with experiments in the case of short X-rays. Much better results can be obtained by assuming that the electron is a flexible ring of electricity with a radius of 2×10^{-10} cms.

It may be mentioned, however, that there is a good deal of other evidence in favour of a ring electron. Parson, in 1915, was the first to suggest that the electron might be a circular anchor ring of negative electricity which rotates about its axis with a velocity comparable with that of light. He was led to this in his attempts to explain the ordinary facts of magnetism in terms of the electron theory. As the ring of rotating electricity would resemble a circle of conducting wire carrying an electric current and thus produce a magnetic field we may regard the electron

itself as the ultimate magnetic element. Some X-ray reflection experiments on both magnetised and unmagnetised crystals have shown that magnetisation produces no change in either the atomic or molecular groupings. This result shows that the elementary magnet is most probably the electron, which would mean, of course, that Ewing's molecular theory of magnetism is no longer tenable.

It will be seen from the above that in the present state of the theory it is not possible to decide finally between the ring electron and the flexible spherical shell electron, but at all events the theory of the spherical electron of exceedingly small dimensions seems no longer tenable. We must now regard the electron, whether as ring or flexible sphere, as having a radius of 2×10^{10} cms., and not of 1×10^{-13} cms. as stated in most text books.

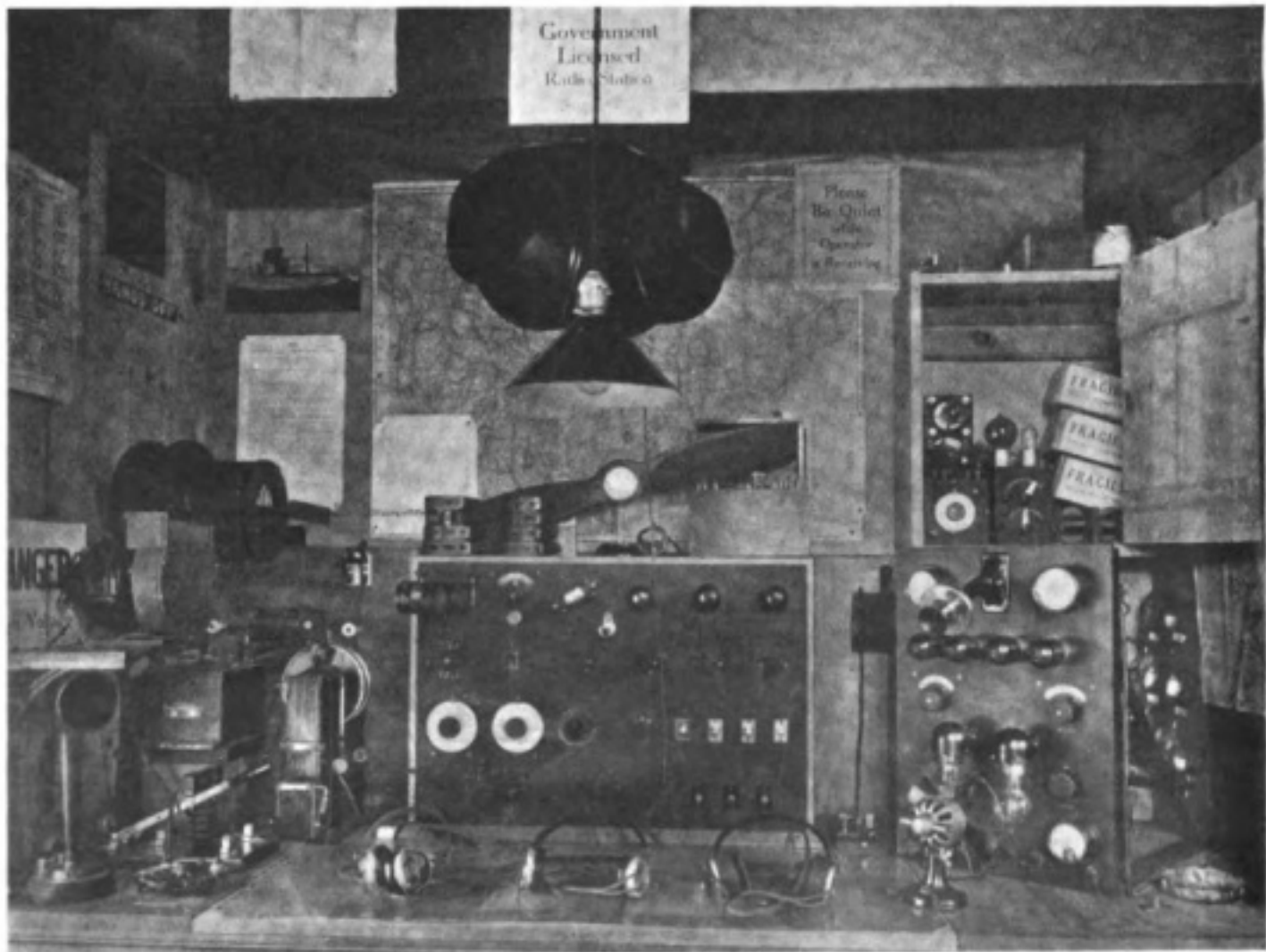

A fine amateur station owned by Messrs. H. and E. Robinson, of New Jersey. Call, 2 QR.

TIME SIGNALLING STATIONS

(From Admiralty Notices to Mariners.)

NOTE I.—Times are given in four-figure notation. The day commences at midnight (00) and the hours are numbered successively up to 23 (11.0 p.m.). Thus 1.0 p.m. is 13.00, 4.0 p.m. is 16.00, 7.28 p.m. is 19.28, and so on. All times are G.M.T.

NOTE II.—Where two times are joined by a hyphen, the times denote respectively the beginning and the end of the signal.

NOTE III.—Except where otherwise stated signals are transmitted by spark.

Station.	Call letters.	λ (metres)	Time. (G.M.T.)	Remarks.
ARGENTINA :—				
Buenos Aires - - -	LIA	800	01.56-02.00	
New Year Islands -	LIG	1,800	01.50-01.52	
AUSTRALIA :—				
Adelaide Radio - - -	VIA	2,600	02.27-02.30 14.27-14.30	} Eiffel Tower System (New)
Melbourne Radio - -	VIM	600	01.57-02.00 13.57-14.00	
Perth Radio - - - -	VIP	600	02.57-03.00 14.57-15.00	
BRAZIL :—				
Ilha do Governador - -	SOH	1,800	03.57-14.00 23.57-00.00	Eiffel Tower System (New)
CANADA :—				
Camperdown - - - -	VCS	600	14.00	
CHILE :—				
Valparaiso - - - - -	CCV	1,800	00.55-01.00	
CHINA :—				
Cape d'Aguilar - - - -	VPS	1,000	03.56-04.00 12.56-13.00	
Shanghai (Zikawei) - -	FFZ	600	02.53-02.59 08.53-08.59	
FRANCE :—				
Eiffel Tower - - - - -	FL	2,500	09.55-10.00 10.44-10.49 23.44-23.49	New System. Old System.
Lyons - - - - - - -	YN	15,000	08.59-09.04	" " Eiffel Tower System (Old) Continuous Wave
GERMANY :—				
Nauen - - - - - - -	POZ	3,600	11.57-12.00 23.57-00.00	} Eiffel Tower System (New)
HAWAIIAN ISLANDS :—				
Pearl Harbour - - - -	NPM	11,200 600	23.55-24.00 23.55-24.00	Continuous Wave.

TIME SIGNALLING STATIONS—*continued.*

Station.	Call. letters.	λ (metres)	Time. (G.M.T.)	Remarks.
INDIA :—				
Calcutta - - - - -		2,000	07.27-07 30 19.27-19.30	} Eiffel Tower System (New)
JAPAN :—				
Choshi Ko - - - - -	JCS	600	12.00-12.04	
Funabashi - - - - -	JJC	4,000	12.00-12.04	
NEW ZEALAND :—				
Awanui - - - - -	VLA	2,000	10.00-10.05	Only sent on application to Wellington Observatory.
PANAMA (Canal Zone) :—				
Balboa - - - - -	NBA	7,000	17.55-18.00 09.55-10.00	} Continuous Wave.
Colon - - - - -	NAX	1,500	17.55-18.00 09.55-10.00	
PHILIPPINES :—				
Kavite - - - - -	NPO	952 5,000	02.55-03.00 13.55-14.00	Continuous Wave.
PORTUGUESE EAST AFRICA :				
Lourenco Marques - -	CRZ	600	07.57-08.00 18.57-19.00	} Eiffel Tower System (New)
SOUTH AFRICA :—				
Cape Town - - - - -	MNC	600	20.59½-21.00	
UNITED STATES :—				
Annapolis - - - - -	NSS	17,000	02.55-03.00 16.55-17 00	} Continuous Wave.
Washington - - - - -	NAA	2,500	02 55-03.00 16.55-17.00	
Key West - - - - -	NAR	1 500	16.55-17.00	
New Orleans - - - - -	NAT	1,000	16.55-17 00	
Great Lakes - - - - -	NAJ	1,512	16.55-17.00	
North Head - - - - -	NPE	2,800	19.55-20.00	
Eureka - - - - -	NPW	2,000	19.55-20.00	
(Table Bluff)				
Arguello Point - - - -	NPK	1,512	19.55-20.00	
San Diego - - - - -	NPL	9,800 2,400	19.55-20.00	Continuous Wave.
San Francisco - - - - -	NPH	2,400 2,800	05.55-06.00 19.55-20.00	Continuous Wave.

WIRELESS CLUB REPORTS

The Wireless Society of London.

Members of this Society to the number of about fifty paid a visit to the Chelmsford Works of Marconi's Wireless Telegraph Company on Wednesday, June 30th. The various shops devoted to the manufacture and testing of all kinds of apparatus were inspected, and at the sight of the stores of delightful "gadgets," so dear to the wireless amateur, the mouths of some of the visitors were very near to that state known as watering.

The meeting of the Society which took place on June 29th, is the last of the session, the meetings recommencing in September next. It is hoped that we shall begin the new session with a greatly increased membership, applications for which should be addressed to the Hon. Secretary, Mr. H. L. McMichael, 32, Quex Road, West Hampstead, N.W.6.

Wireless and Experimental Association.

(Affiliated with the Wireless Society of London.)

At a meeting of this Club on June 16th Mr. Sutton exhibited four D-shaped basket-wound coils connected to form a loose-coupled inductance and variometer, upon which good signals were obtained. Mr. Weeks showed several honeycomb coils wound by hand on a metal former, which he described, and Mr. Kirkby showed a pancake coil. Mr. Kloots, Sen., described his recent visit to the Eiffel Tower, and startled us by stating that the current circulating in the aerial there was 165 amperes. (Think of that, ye 10-watters!) He listened in on a 7-valve amplifier stationed three miles away from the tower, and the signals were like the backfiring of a motor lorry!

At a meeting on June 30th the adjourned discussion on the matter of replies to enquiries made by correspondents to the Secretary, as a result of his letter to the *Daily Mail* anent the Melba Concert, Mr. Kloots, Senior, proposed, and Mr. Howard seconded "that the Secretary shall refer enquiries regarding trade houses to the technical press" was carried. It is hoped to arrange a field experimental day for the members on July 31st. The date for the annual general meeting was fixed for August 4th. Mr. Kloots, Senior, then gave a brief but interesting and instructive lecture on "Valves and Resistance Amplifiers," and Mr. Wright, lately returned from France, discussed crystals, especially "French Galena."—Hon. Secretary, Mr. G. Sutton, 18, Melford Road, East Dulwich.

Edinburgh Wireless Club.

(Affiliated with the Wireless Society of London.)

Membership of this Club is steadily increasing, and its receiving licence has now been obtained. The Secretary very successfully received the Madame Melba signals. Applications for membership and particulars of the Club will be welcomed by the Hon. Secretary, Mr. W. Winkler, 9, Ettrick Road, Edinburgh.

Halifax Wireless Club.

(Affiliated with the Wireless Society of London.)

A meeting of the Halifax Wireless Club was held at the Headquarters, Clare Hall, Halifax, on

Monday, June 21st, twenty-eight persons being present. Mr. Edward Watson, one of the members, gave an instructive discourse on "The Elementary Principles of Magnetism and Electricity," which proved very interesting. A "Buzzer Section" has been formed. The membership is now forty-seven, and many of the members have now installed private receiving sets.—Hon. Secretary, Mr. L. Pemberton, The Y.M.C.A., Clare Hall, Halifax.

Liverpool Wireless Association.

(Affiliated with the Wireless Society of London.)

A meeting of the above was held at 56, White-chapel, on June 23rd, when there was a crowded attendance. It was decided that, owing to the enthusiastic gatherings, meetings would be continued throughout the summer on the usual days, i.e., the second and fourth Wednesdays in the month. There were various discussions, and numerous pieces of apparatus on view; also the usual elementary chats with beginners. Next meeting, Wednesday, July 14th: new members welcomed.—Hon. Secretary, S. Frith, 6, Cambridge Road, Crosby.

The Woolwich Radio Society.

(Affiliated with the Wireless Society of London.)

A most interesting evening was spent by the members of this Society on May 28th, 1920, at the Woolwich Polytechnic, William Street, Woolwich, when Mr. J. Scott Taggart, M.C., delivered an interesting lecture on "Valve Transmission and Reception." The lecturer exhibited several examples of valves for transmission and reception purposes, and explained the method of using these valves in detail. He also dealt with valves for transmission purposes, showing, by means of diagrams, past and present methods for dealing with C.W. transmission, both for small and large currents, especially demonstrating the efficiency of a newly-patented valve containing two plates but only one filament. The lecturer then proceeded to the use of valves for the reception of both spark and C.W. signals. Mr. Scott Taggart kindly offered to reply to any questions raised, and several members responded to the invitation. The meeting was brought to a close by a hearty vote of thanks to the lecturer for his interesting and instructive lecture. The Committee has much pleasure in announcing that the Society has now received permission to use valves for reception purposes, and would be pleased to welcome any new members who may be interested in wireless work.—Hon. Secretary (*pro tem.*), Mr. G. E. H. Denny, 22, Lee Street, Plumstead, S.E.

Stockport Wireless Society.

A most interesting meeting was held on June 18th at the Foresters' Hall, Stockport, several new members being present. Mr. H. Woodyer gave a paper on the construction and use of the Honeycomb Coils patented by Lee de Forest. The simplicity of construction greatly appealed to members: it was explained how the method of winding reduces self-capacity to a minimum, and how, by using a number of interchangeable honeycomb coils for different wavelengths, the use of sliders and switches was obviated and "dead-end" effects eliminated.

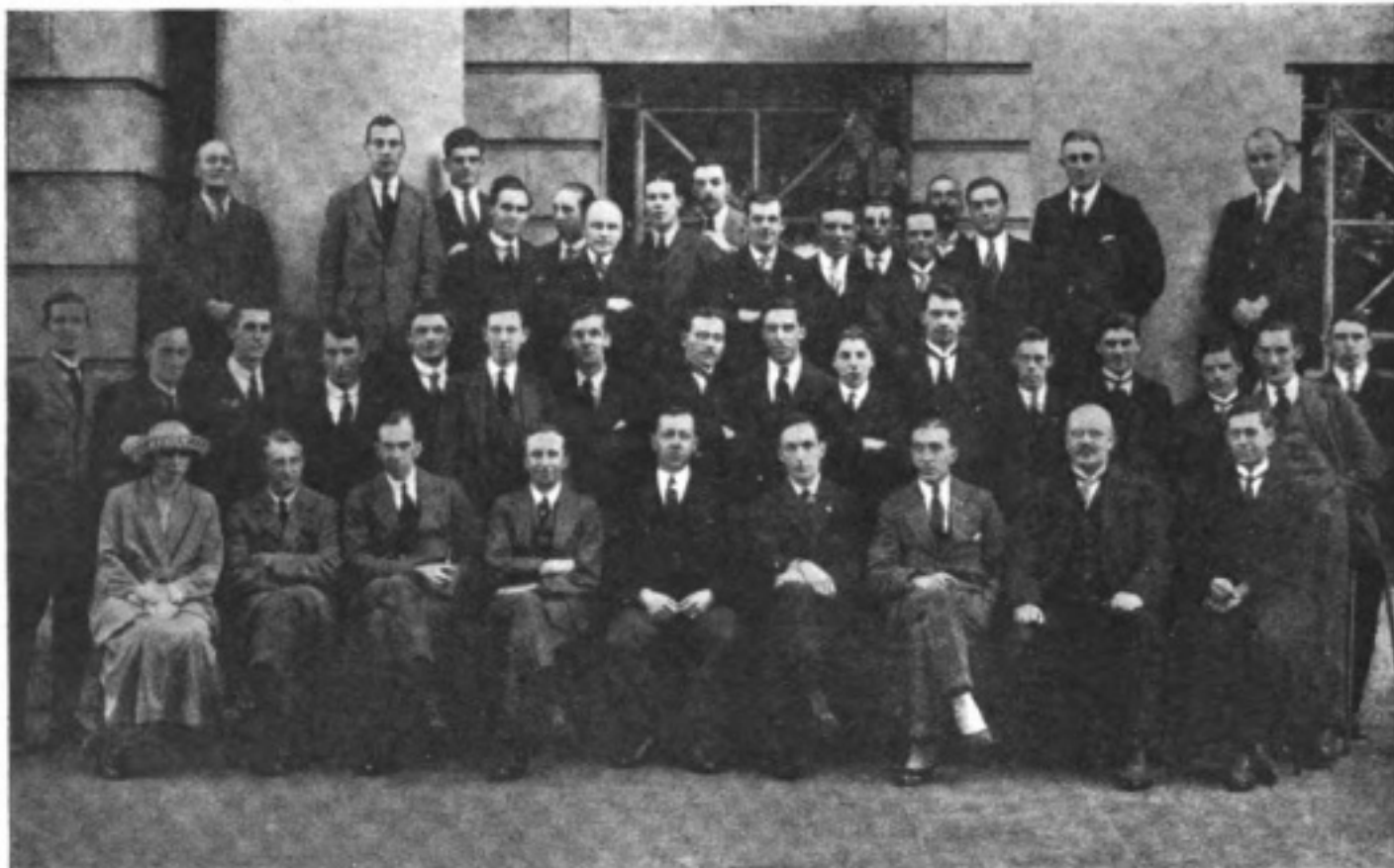

Some members and officers of the Cardiff Wireless Society, with the Marconi engineers who recently gave a demonstration of wireless in the district.

Following this, one of our ex-Marconi members, Mr. H. M. Driver, gave us a very vivid narrative of his various voyages during the war. His recounting of his various troubles and detecting of faults in the apparatus under his charge were of equal interest with his description of U-boat encounters.

It was decided to commence, with next week's meeting, a series of papers on the elementary principles of wireless, and various members have promised to contribute a 15-minutes paper. It is hoped that these papers will be instructive to all members, including both beginners as well as graduates, in the study of wireless.

Intending members are invited to communicate with Mr. W. Hervey Banks, 110, Bramhall Lane, Stockport, or to attend at the Foresters' Hall, Stockport, any Friday evening at 7.45.

The Birmingham Experimental Wireless Club.

This newly-formed Club held a meeting on June 15th for the purpose of hearing Madame Melba's songs, as transmitted from Chelmsford.

On the official Club night, June 16th, Mr. L. Dore gave a most enjoyable lecture on "The Principles of Wireless Telegraphy," after which Clifden was tuned for and his signals received.

The Club is happy in the possession of a room, rent free, kindly lent by Mr. A. Woodcock (Treasurer). Any who may be interested, with a view to membership, should write to the Hon. Secretary, Mr. A. T. Headley, 255, Galton Road, Warley, Birmingham.

Hull and District Wireless Society.

An enthusiastic meeting of wireless amateurs was held on June 3rd in the Wellington Scout Headquarters. Mr. G. H. Strong, who is well known in the city as a keen pre-war wireless amateur, was voted to the chair. A good discussion took place, and the outcome was the formation, from July 1st, of a Society, to be called the Hull and District Wireless Society. The following were elected *pro tem.*:—Chairman, Mr. G. H. Strong; Secretary, Mr. H. Nightscales; Committee, Messrs. C. Dyson, J. Pryce Jones, J. Jephcott and W. Dowson.

It was decided to apply for affiliation with the Wireless Society of London. The rules will be drawn up in due course, and a suitable room in the centre of the city obtained, if possible, for the meetings. It was thought one held monthly during the summer months with a fortnightly meeting during the winter months would meet the case.

Mr. C. Dyson, who is also a keen pre-war amateur, was in a humorous mood, and related, among other incidents, one which took place at his own station on the occasion of the recent Wireless Concert by Madame Melba. He was quite under the impression that he had tuned in to Chelmsford, and was hearing that noted singer, only to discover later that he had been listening to a lady singing and playing the piano near by. It is understood he blamed the crystal detector.

All persons resident in Hull and District who are interested in the study of Wireless Telegraphy and

WIRELESS CLUB REPORTS

Telephony are cordially invited to join this new Society. All particulars as regards membership will gladly be given by the Secretary, whose address is 16, Portobello Street, Holderness Road, Hull.

A meeting of the committee will be held on Thursday, July 1st, at 7.30 p.m. at the same address as here given.

Johannesburg Radio Society.

The Joburg Radio Society has been formed at Johannesburg, South Africa, and already numbers twenty members. We hope to publish fuller information of this Club later on. Meantime, any readers who care to get into touch with South African wireless can write to Mr. G. L. R. Lowe, 51, Kitchener Avenue, Bezuidenhoud Valley, Johannesburg.

Radio Society of South Africa.

Purposing to fulfil similar functions to those of the Wireless Society of London, there is at present forming in Cape Town a Radio Society of South Africa.

The main objectives of the Society are to bring together the numerous enthusiasts in South Africa, to study wireless telegraphy and, if possible, aid its advancement; to form a central body capable of showing itself a responsible and solid organisation; to act in an advisory capacity to the Government in connection with the legislation and regulations affecting amateur wireless.

The numerous replies accepting invitations to the Society's first meeting on April 30th are indicative of the enthusiasm shown by the South Africans in point of wireless, and, as a result of this movement to establish a Radio Society of South Africa, the Johannesburg Radio Society has already been formed.

The position is at present that there are something like 46 members in Cape Town, 20 in Johannesburg and about the same number in Durban. There are, however, quite a number of others scattered over various parts of the country.

At a meeting of the Model Engineer's Society, on June 3rd, the question as to whether the Radio Society will interfere with their membership, was raised, and it was pointed out to the Model Engineers' Society that, on the contrary, it is likely to assist them, in so far that members of the Radio Society interested in the making of apparatus will probably become members of both societies. The Model Engineers' Society thereupon expressed their sympathy with the wireless amateur movement.

A copy of the constitution of the Wireless Society of London is being procured, from which will be drafted a constitution to suit the Society. This draft will be presented to members about the middle of June for consideration, amendment where necessary, and adoption; but in the meantime suggestions are invited, in order that they may be considered when the draft is being prepared, thus saving time.

Correspondence with the Postmaster-General concerning the Radio Society elicited a reply to the effect that no objection would be raised within the Union providing that the rules and regulations governing the operation of amateur wireless stations are adhered to.

Intending members and those interested should communicate with Mr. A. T. Stacey, Rosmead, Bishoplea Road, Claremont, Cape Town.

The Barrow and District Wireless Association.

This Association was formed in 1913, and at present consists of a dozen members. The rooms were retained during the war, and the apparatus has now been brought up to date and re-installed. Permits have been obtained for reception (with use of valves) and also for transmission, the latter using both spark and C.W. The call letters allotted are 2DT (Two D.T.), wavelength 180 metres, and time of transmission 8 p.m. to 10 p.m. Three members of the Association have obtained their permits, one of these being for transmission also. It is expected that the membership will increase, and it is hoped that some useful work will be accomplished. Those interested please communicate with the Hon. Secretary, A. R. Pennington, 73, Ramsden Street, Barrow-in-Furness.

Hands Across the Sea.

The Groveland Park Radio Club would like to correspond, exchange ideas, etc., with other Radio Clubs on both sides of the Atlantic. The Hon. Secretary is Mr. M. Bodley, 1992, Lincoln Avenue, St. Paul, Minn.

Mr. Bodley states that he is working on a device which he hopes will make possible the location of submerged submarines.

Co-operation Wanted in South-East London.

For those amateurs who either do not feel disposed, or else have not the means, to erect for themselves experimental wireless stations of the modern type, it is proposed to form a Club. The suggested scheme is that a number of amateurs combine both efforts and money in procuring accommodation and then erecting for themselves a modern station for common use. To many youths and young men, who find their resources somewhat limited, this proposed scheme should present itself in a very favourable light, for in these days, when apparatus is so high in price, there are many who do not care to make the outlay. Another aspect of the scheme is, that certain amateurs, though enthusiastic, may not be sufficiently familiar with the installing of wireless plant to erect their own stations; the proposed scheme, therefore, would give them the opportunity to learn. Interested amateurs and others should communicate with Mr. E. Bates, 149, Brixton Road, S.W.9, who is responsible for the suggestion.

Amateur Clubs.—There are still wanted to form Wireless Clubs at Bournemouth, Spalding, Doncaster, Exeter, Grimsby, Aberdeen, Rugby, and Glasgow. Those interested should communicate with Mr. T. H. Dyke, Hill Garage, Bournemouth; Mr. W. G. A. Daniels, Pinchbeck Road, G.N.R. Crossing, Spalding; Mr. A. H. Wasley, Glenholme, Ravensworth Road, Doncaster; Mr. H. E. Alcock, 1, Prospect Villas, Heavitree, Exeter; Mr. C. Hewins, 42, St. Augustine Avenue, Grimsby; Mr. W. W. Inder, Crown Mansions, 41, Unions Street, Aberdeen; Mr. A. T. Cave, 3, Charlotte Street, Rugby; Mr. W. Mitchell, 237, North Street, Charing Cross, Glasgow.

WEATHER BULLETINS

(From Admiralty Notice to Mariners. No. 703 of 1920.)

NOTE I.—These may be either (1) A report of existing conditions, or (2) A weather forecast.

NOTE II.—*Weather bulletin follows a time signal. †Weather bulletin is followed by time signal.

Station.	Call letters.	Time (G.M.T.)	λ (metres)
AUSTRALASIA :—			
Adelaide Radio - - - - -	VIA	09.00, 10.30	600
Brisbane Radio - - - - -	VIB	12.30, 13.00	600
Hobart Radio - - - - -	VIH	12.00	600
Melbourne Radio - - - - -	VIM	09.30, 11.00	600
BRAZIL :—			
Ilha de Governador - - - - -	SOH	00.00*	1,800
CHINA :—			
Shanghai-Zikawei - - - - -	FFZ	03.00*, 09.00	600
FRANCE :—			
Eiffel Tower - - - - -	FL	09.45†, 23.30*	2,500
FRENCH OCEANIA :—			
Papeete, Ile Tahiti - - - - -	FOP	11.00, 23.00	600
GERMANY :—			
Norddeich - - - - -	KAV	12.00*, 22.00	1,650
GREAT BRITAIN :—			
Poldhu - - - - -	MPD	09.30, 21.30	2,750
Cleethorpes - - - - -	BYB	05.00, 17.00	3,000
HAWAIIAN ISLANDS :—			
Pearl Harbour - - - - -	NPM	02.30, 06.30 18.30, 22.30	? 600
HOLLAND :—			
Scheveningen - - - - -	PCH	11.15, 23.15	1,800
INDIA :—			
Calcutta Radio - - - - -	VWC	07.30*, 19.10	2,000
Karachi Radio - - - - -	VWK	07.30, 19.10	2,000
Rangoon Radio - - - - -	VTR		1,200
Bombay Radio - - - - -	VMB		2,000
Madras Radio - - - - -	VWM	07.40, 19.20	2,000
Port Blair - - - - -	VTP		1,200
JAPAN :—			
Choshi - - - - -	JCS	12.00*	600
Dairenwan - - - - -	JDA	12.00	600
Fukkukaku - - - - -	JKF	11.30	600

WEATHER BULLETINS

Station.	Call letters.	Time (G.M.T.)	λ (metres)
MEDITERRANEAN :—			
Rinella - - - - -	BYZ	21.00	2,700
MEXICO :—			
Campeche - - - - -	XAB	18 37*	600
Guayamas - - - - -	XAH		
Mazatlan de Sinaloa - - - - -	XAE		
Payo Obispo - - - - -	XAC		
Vera Cruz - - - - -	XAA		
PHILIPPINES :—			
Kavite - - - - -	NPO	03.00* 14.00*	952 5,000 (C.W.)
SAMOA :—			
Tutuila - - - - -	NPU	03.30, 07.30 19.30, 23.30	600
SOUTH AFRICA :—			
Capetown Radio - - - - -	MNC	11.15	600
Durban Radio - - - - -	VND	11.15	600
SPAIN :—			
Madrid - - - - -	EGC	13.30	2,000
UNITED STATES :—			
Washington - - - - -	NAA	03.00*, 17.00*	2,500
Annapolis - - - - -	NSS	01.30, 13.30	1,700
Key West - - - - -	NAR	03.00*	1,500
San Francisco - - - - -	NPH	06.00*	600 and 950
North Head - - - - -	NPE	06 00	600 and 950
San Diego - - - - -	NPL	06 00	600 and 950

ALDÉBARAN SIGNALS FROM LYONS AND NANTES

No doubt many of our readers have wondered about the so-called Aldébaran signals appearing in the daily programmes of the Lyons station. We are now able to explain these, with the aid of an article published in *La Nature* for June 12th.

Lyons (YN) transmits the signals, which are for the use of the ship *Aldébaran*, now cruising in the Pacific, from 08.45 to 08.58 on a wavelength of 15,500 metres (C.W.).

Nantes (UA) repeats these signals four times a day on C.W.,

from 08.23 to 08.31 on 9,000 metres wavelength
 " 10.23 " 10.31 " 11,000 " "
 " 20.23 " 20.31 " 9,000 " "
 " 20.53 " 21.01 " 11,000 " "

The signals are as given in the accompanying diagram :—

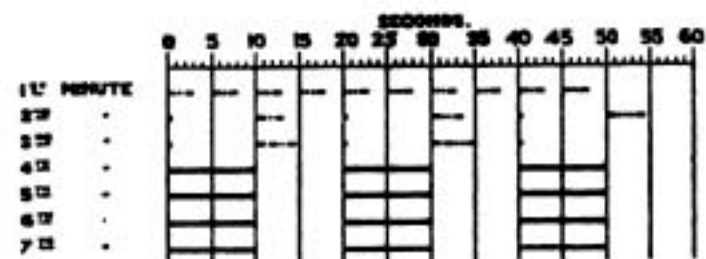

PAGES FOR BEGINNERS

Under this heading we publish COMPLETE instructional articles, forming a series specially designed and written for beginners in wireless work. Hardly any mathematics will be introduced, and we hope to present the fundamental facts of wireless in such a manner as will prove attractive to a much wider range of students than that for which this series is primarily intended.

COUPLING AND RECEIVERS

THE effect exerted by a coil carrying a current on another coil has already been noted, in the case of the Induction Coil, and later, in the simple transmitting circuit.

Before passing on to the reception of wireless waves, it is important to devote some time to the consideration of this interaction between coils, as we shall meet it in all forms of receiving and transmitting circuits.

A glance at Fig. 1 will recall the action which takes place on switching on the current in a coil. The lines of magnetic force in expanding outwards move past, or cut, the

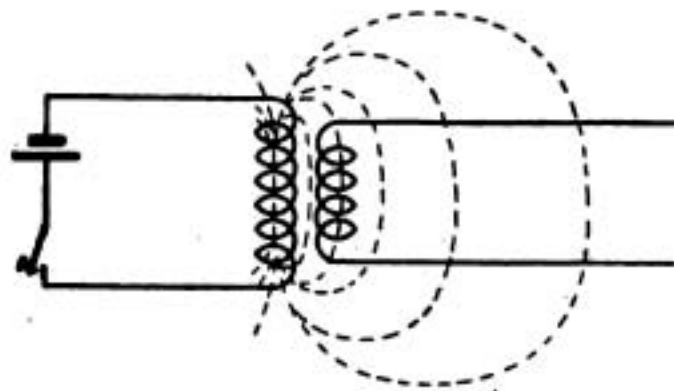

Fig. 1.

turns of the adjacent coil, and induce in it an e.m.f., and hence, a current, which will flow in the opposite direction to that of the current in the coil inducing it.

Now, the number of lines of force is a maximum immediately round the coil inducing the e.m.f. (this coil will be referred to as the "primary," and the coil in which the e.m.f. is induced as the "secondary").

Therefore, to get the maximum induced

effect, it will be necessary to place the secondary as near the primary as possible. In the case of the induction coil, and ordinary transformers, this is obtained by winding the secondary coil concentric with and over the primary coil.

Very much the same effect would be produced if we wound the secondary on a separate tube and slipped it in or over the primary winding.

Suppose the secondary coil to be gradually moved farther away from the primary. The induced e.m.f. at the instant of switching on the current would be less and less, as the number of lines of force which cut the secondary coil would be reduced.

Practically, the coil could be placed at such a distance that no effect would be observed on making or breaking the primary circuit. The lines of force cutting the coil would be so few, that no measurable e.m.f. would be produced. Theoretically, of course, we must remember that the lines of force created extend outwards to an infinite distance in all directions, and therefore to have no effect at all, the secondary coil must be placed an infinite distance away!

Within practical limits, however, the induced effect can be varied from a maximum to a minimum by increasing the distance between the coils.

It will also be understood that there are a great number of these lines of force which do not cut the secondary coil at all. If the two coils are placed side by side, only those lines which extend in the direction of the secondary will have any effect. Fig. 2,

which shows the end view of the two coils, will illustrate this point. The lines of force which do not do useful work are spoken of as "leakage" lines.

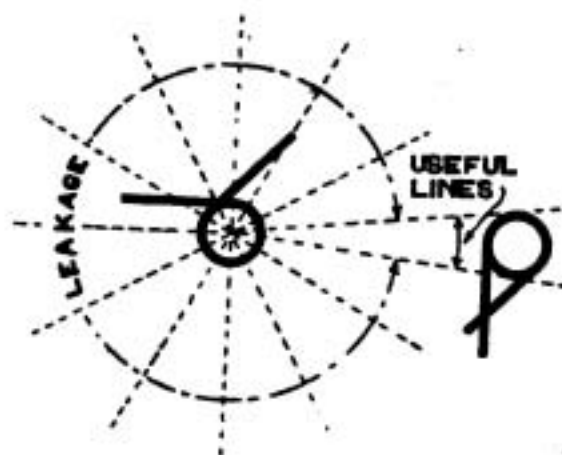

Fig. 2.

We may compare the effects produced on two secondary coils by comparing the lines of force which cut them. Suppose two coils A and B were so placed with regard to a primary coil, that the induced effect in one was twice that in the other. We should then say that the "coupling" between the primary and A was twice as great as that between B and the primary.

The coupling between two coils, therefore, is a measure of the useful lines of force which act between them.

If the secondary is so placed that the induced effect is small, it is said to be "loosely coupled." If the inductive effect is a maximum the coupling is said to be "tight."

One other point must be considered with regard to the action between the primary and secondary coils.

Since the growth of a current in a coil is in all cases accompanied by a radiation of lines of force, it follows that the secondary coil itself will create a magnetic field around it, and these lines of force will in turn cut the primary coil, and tend to weaken the current flowing in it.

This effect will be of importance when we come to consider the inductance of oscillatory currents in coils and wires.

RECEIVING CIRCUITS.

Fundamentally, there are three ways by

which thought can be transmitted between two persons. We can write to each other; we can make signs that can be seen by the person receiving the message, or we can communicate by sounds. In wireless telegraphy, the first method is clearly out of the question. The energy transmitted must therefore be rendered either visible or audible by means of suitable apparatus, before the message can be understood.

The recognised method of transmitting words telegraphically is by means of a code invented by Morse, each letter being represented to the person receiving by one or more sounds of short or long duration. The full Morse code can be found in any textbook on Telegraphy, or the Wireless Year Book.

As in the case of transmitting circuits, the essential requirements for a receiver can be summarised as follows:—

- (1) A conductor by which the energy received can be led to the circuit.
- (2) Apparatus which will convert the energy received into visual or, as is most common, audible signals.

Remembering the fact that oscillations induced in a circuit are a maximum when they are in tune, we must also provide a means of varying the wavelength of our receiving circuit to suit the length of wave transmitted.

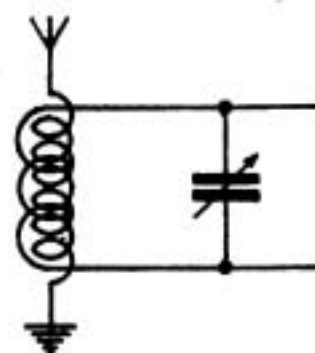

Fig. 3.

The first part of the circuit can therefore be drawn as in Fig. 3.

The action between the transmitting and receiving circuits is exactly the same as that observed between two coils placed near one another. The waves of energy radiated from the transmitting aerial will travel outwards

and cut across the receiving aerial, thus inducing in it an oscillatory current.

If the receiver is in tune with the transmitting circuit these trains of waves or impulses will occur at the correct moment to augment the growth of the induced oscillatory current, and the effect produced will be a maximum.

So, in the receiving circuit, an oscillatory current will be flowing, having the same frequency as that in the transmitting circuit.

We now have to control this oscillatory current in order that it may produce sounds which can be interpreted by the operator.

First let us examine the apparatus in which the sound is produced, or the *telephone*. The simplest form of telephone consists of a case containing one or two electromagnets—soft iron poles wound with many turns of fine copper wire. Over this is placed a thin

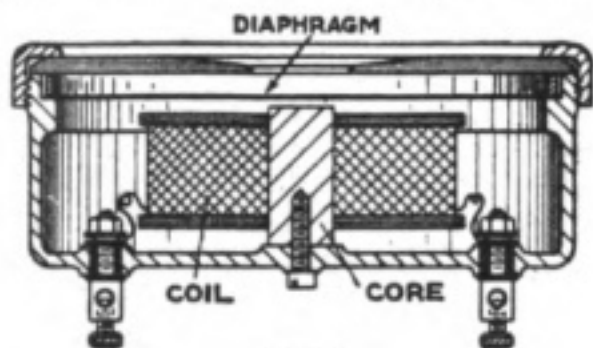

Fig. 4.

disc or diaphragm of iron, clamped, yet allowed a slight movement in a lateral direction. The case usually covers the greater part of this diaphragm, leaving a small part at the centre in communication with the outside air (Fig. 4).

The action of the telephone is this: On passing a slight current through the coil the iron core is magnetised and attracts the thin iron disc. This bulges inwards sharply, and thus disturbs the air, above and below the diaphragm. This, to a person standing near, gives the effect of a sharp sound or click.

If we interrupted the circuit of the magnet at regular intervals we should get a corresponding series of clicks, which would merge into a buzzing sound as the interruption became faster.

Now, we could not hear any sounds if we were to connect the telephone in the aerial of the receiving circuit. There are two principal reasons for this:

The magnet coil of the telephone has considerable inductance, and thus will not respond readily to quick and sudden changes of current. When we realise that the frequency of the induced oscillations is of the order of hundreds of thousands per second it

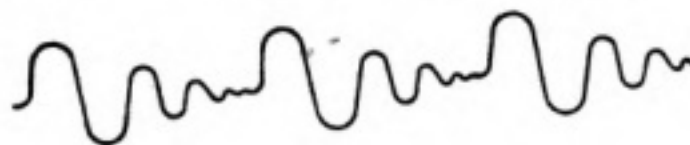

Fig. 5.

is seen that the coil would have to be very sensitive to be affected by each oscillation. Further, the diaphragm of the telephone has such an inertia that it would hardly be affected by changes occurring at this rate.

The range of sound which can be heard by the human ear is very limited. The vibrations of the lowest note audible is about 15 per second, and that of the very highest about 20,000. To emit an audible buzzing sound the diaphragm must vibrate at a frequency somewhere between these ranges. It is clear, therefore, that assuming the diaphragm could vibrate with the frequency of the oscillations, no audible sound would be produced.

Now consider the train of waves transmitted by an aerial (Fig. 5). If we had an apparatus by which these waves could be converted from an alternating current to a unidirectional one, it would then be possible to hear a sound in the telephone which would correspond to the number of waves sent out.

Let us assume that Fig. 5 represents the group of waves which form a certain signal. If they were passed through an instrument which only allowed the current to flow in



Fig. 6.

PAGES FOR BEGINNERS

one direction, the top portions only of the waves would reach the telephone receiver. We should therefore get a continuous current in the receiver as in Fig. 6.

Thus at the commencement of each wave train, the diaphragm of the telephone would be attracted, and then released at the end of each train. Thus there would be a series of clicks, each corresponding to one train of waves, which would merge into a buzz, the duration of which would depend upon the number of wave trains received.

Several pieces of apparatus have been

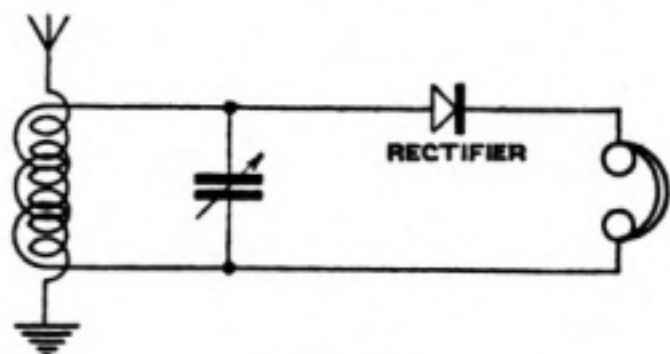

Fig. 7.

designed for the purpose of *rectifying* or converting oscillatory current into unidirectional current. The simplest form of rectifier makes use of the peculiar property possessed by crystals of carborundum.

Carborundum is an extremely hard crystal-

line substance, formed by fusing together carbon and silicon. It usually takes the form of a mass of greenish needle-shaped crystals. These crystals if connected in an alternating

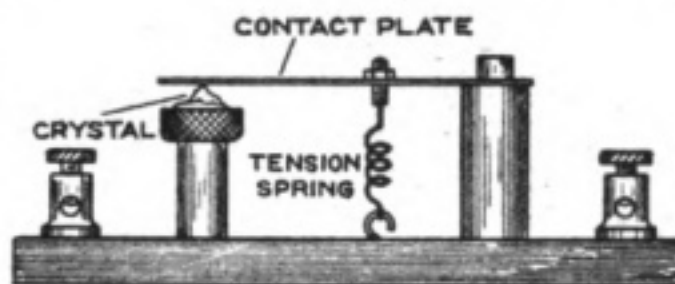

Fig. 8.

current circuit will only permit the current to pass in one direction and offer considerable resistance to any flow of current in the opposite way.

Other minerals have been found to possess this property, a detailed description of which will be given later. It is sufficient to quote a few as examples:—

Iron Pyrites, Copper Pyrites, Galena, Plumbago, Molybdenite, Zincite, Bornite.

We may now complete our diagram of the receiving circuit as in Fig. 7. Fig. 8 shows a simple form of carborundum detector.

In the next article we shall consider the effect of the amplitude of the waves upon the receiving and transmitting circuits.

SYSTEM OF TIME-KEEPING AT SEA BY MEANS OF TIME ZONES*

The following uniform system of time-keeping at sea has been adopted in the Navies of Great Britain, France, Italy, Spain and the United States. This system has been adopted to ensure vessels at sea, within certain defined limits of longitude, keeping the same time in a similar manner to that now used on land, where, for example, London, Plymouth and Dover all keep the same time and not the local time of each place. The ship's clock will therefore now be set to show the time of a definite hourly meridian, instead of being set to an indefinite time selected by the ship.

The world is considered as being longitudinally divided into 24 zones of 15° each, the centre of the system being the meridian of Greenwich; theoretically the centre division, therefore, lies between the meridian of $7\frac{1}{2}^\circ$ east, and that of $7\frac{1}{2}^\circ$ west, and is described as zone 0; the zones lying to the eastward being numbered in sequence up to 12, with a minus (-) prefix, those lying to the westward being similarly numbered with a plus (+) prefix. The twelfth zone is divided

centrally by the 180th meridian, and both prefixes (+) and (-) appear in this zone.

In actual practice the boundaries of time zones on land are determined by the frontiers of countries, etc., and agree generally with those at sea, which will now be defined by the meridians of $7\frac{1}{2}^\circ$, $22\frac{1}{2}^\circ$, etc., except when modified as necessary by the territorial limits of the countries concerned.

By this system the same time will therefore be kept, whether on land or sea, throughout each zone (except during the periods of summer-time) and in different zones the times will differ from one another by an integral number of hours, the minutes and seconds in all zones remaining the same.

Examples.—Greenwich Mean Time will be kept in zone 0. In zone - 8 the time kept will be 8 hours in advance of Greenwich Mean Time, while in zone + 8 it will be 8 hours behind that of Greenwich.

It will thus be seen that in order to obtain Greenwich Mean Time in any zone, the number of hours given by the zone number + or - must be added to or subtracted from the ship's zone time.

* Admiralty Notice to Mariners, No. 918 of 1920.

DETAILED DESCRIPTION OF EIFFEL TOWER TRANSMISSIONS

(Extracted from "T.S.F.", No. 9, p. cxviii.)

NOTE I.—In the event of the arc transmission failing, the service will be carried on with the 2,600 m. spark.

NOTE II.—Time signals, weather reports and press are transmitted by a 150 K.W. set, with a musical note. The rhythmical dots are sent by a 70 K.W. set, and the C.W. set is a 150 K.W. Poulsen arc.

EIFFEL TOWER (F L) PROGRAMMES.

Time (G.M.T.)	λ (metres).	System.	Nature of Programme.
0.15 to 1.00	8,000	Arc	To New Sarajevo (SAR), who works on 4,000 m. (Arc.)
1.00 to 2.00	8,000	Arc	To Nicolaieff (SEW), who works on 3,500 m. (Marconi Spark).
2.00 to 3.30	8,000	Arc	To Budapest (HB), who works on 3,700 m. (Telefunken).
3.30 to 4.30	8,000	Arc	To Warsaw (WAR) " " 2,000 m. (Telefunken).
4.30 to 5.30	8,000	Arc	To Moscow (MSK) " " 5,000 m. (Marconi Spark).
5.30 to 6.30	6,000	Arc	To Prague (PRG) " " 3,000 m. (Telefunken).
6.30 to 8.00	8,000	Arc	To Posen (PSO) " " 1,750 m. (Telefunken).
8.00 to 9.45	8,000	Arc	To Salonika (FWD) " " 7,000 m. (C.W.).
8.30 to 8 35	8,000	Arc	To Nauen (POZ) " " 12,600 m. (C.W.).
9.45	2,600	Musical Spark.	Weather report.
9.55 to 10.00	2,600	Musical Spark.	International time signals. (New system).
10.30 and 10.32	2,600	Musical Spark.	Rythmic dots. About 300 sent, with $\frac{4}{8}$ ths of a second interval between them. Every 60th dot is omitted.
10.44 to 10.49	2,600	Musical Spark.	Time signals. (Old system). Followed by the <i>exact</i> times at which the 1st and last dots of the 10.30 programme were sent.
11.00 to 12.00	6,500	Arc	To SAR. (<i>See above</i>).
12.00 to 12.30	3,200	Arc	Réseau de sécurité.
12.30 to 15.00	8,000	Arc	To HB. (<i>See above</i>).
15.00 to 15.30	3,200	Musical Spark.	Press About 400 words.
16.00 to 16.15	2,600	Musical Spark.	Weather report.
16.30 to 17.00	8,000	Arc	To PRG (<i>See above</i>).
17.00 to 18.00	8,000	Arc	To Rome (<i>Sao'Paolo</i>) (IDO), who works on 11,000 m. (Arc.)
18.00 to 19.00	8,000	Arc	To PSO. (<i>See above</i>).
19.00 to 20.00	8,000	Arc	To WAR. (<i>See above</i>).
20.00 to 21.00	8,000	Arc	To SEW. (<i>See above</i>).
21.00 to 22.00	8,000	Arc	To HB. (<i>See above</i>).

EIFFEL TOWER TRANSMISSIONS

Time (G.M.T.)	λ (metres).	System.	Nature of Programme.
22.00 to 23.30	8,000	Arc	To PSO. (<i>See above</i>).
23.00	2,600	Musical Spark.	Rhythmic dots. About 300 sent, with $\frac{1}{80}$ ths of a second between them. Every 60th dot is omitted.
23.35	2,500	Musical Spark.	Weather report.
23.44 to 23.49	2,500	Musical Spark.	Time signals (Old system). Also the <i>exact times</i> at which the first and last rhythmic dots (sent as per the 23.00 and 23.30 programmes above) were sent. The two references are distinguished by the letters ML (<i>musicale</i>) and RF (<i>ronflée</i>).

THE R.A.F. WIRELESS SCHOOL

A DIGEST OF THE OFFICIAL SYLLABUS

WE think that it may be of interest to many of our readers to have in their possession fuller details of the various courses of training which are provided for Electricians and Mechanic-Operators at the R.A.F. Wireless School at Flowerdown Camp.

After a few months at Halton Camp comes a two-and-a-half years' course which is designed to fit men for all Aviation Wireless duties required in the Air Service, and to provide them with sufficient electrical knowledge to enable them to enter an approved Electrical trade after the completion of eight years' service. The first twelve months is devoted to the study of electrical principles and practice, with electrical workshop experience. During this course it is proposed that men should take the Grade I. and Grade II. City and Guilds Electrical Engineering Examinations, after this the men will be divided into two sections, one of which will receive practical workshop training for a period of

eighteen months, arranged to qualify them to enter some such trade as Instrument making, General Electrician, etc. The other section will receive an advanced wireless training in Corps Squadron Work, Ground C.W., Visual, Aircraft W/T including Wireless Telephony, and D.F. with Aerodrome Practice.

At the end of the course these men will take the P.M.G.'s First Class Examination as Sea and Air Operators. All boys will have a three months' course in Drill, Discipline, General Training, etc., at Halton Camp before they commence training at No. 1 (T) Wireless School.

BASIC ELECTRICIANS' COURSE.

(24 weeks.)

(All boys sent to No. 1 (T) Wireless School will take this course.)

- (1) Electricity and Magnetism with Elementary Electrical Engineering;
- (2) Electrical Workshops with Fitting and Turning;
- (3) General Education;
- (4) Morse: Sending and Receiving, Buzzer and Visual;
- (5) Physical Training and Drill.

Of these subjects (1) comprises a comprehensive course of Lectures in Elementary Magnetism and Electricity; (2) covers ordinary Workshop Practice including Tool and Jig Making; (3) consists of a course of Practical Mathematics, English, Mechanical Drawings, and Elementary Physics and Mechanics.

BASIC ELECTRICIANS' COURSE.

(20 weeks.)

This is an advanced continuation of the previous course. All boys will take the ordinary grade C.C. and A.C. Electrical Engineering Examinations of the City and Guilds of London Institute at the end of this course. The boys will now be divided into two sections: (a) Electricians and Instrument Makers, and (b) Mechanic-Operators.

ELECTRICIANS & INSTRUMENT MAKERS.

(24 weeks.)

This will consist almost entirely of Practical Workshop courses, including the overhauling and repair of dynamos and motors and the permanent installation of motors and generators, the construction and design of switchboards, lighting installation, erection of standards and running of mains for high voltage overhead power lines, the installation of underground mains, practical work on aircraft electrical apparatus including magnetos, compasses and aircraft lighting installations.

A further syllabus covers Workshop Courses in Tool and Jig Making, Advanced Machine Drawing, the Manufacture of Metal Fittings, Casting and Stamping and the Manufacture of Instrument parts.

Yet another syllabus of this course includes Electrical Instrument Making, Test Instrument Making and General Workshop Practice, such as Coppersmith's Work, Foundry Work, the Installation of Shafting and Machinery, and Petrol Engines.

At the completion of the Electricians' Course a special examination in Installation and Instrument Making will be conducted by the City and Guilds of London Institute. The men will be allowed to keep the test instrument they have made, which will be stamped by the Instructor as the work of the man himself. Every man will be presented with a copy of his full syllabus which will, together with the Certificates obtained by the man, be submitted to an employer when the man ultimately leaves the service, and will indicate the lines along which he has been trained.

MECHANIC-OPERATORS COURSE.

(24 weeks.)

(1) **The Principles and Practice of Radiotelegraphy up to and including Ground C.W.**—This, according to the detailed syllabus in our possession, consists of a splendid course of lectures, of which we shall be pleased to give fuller details to any interested reader. Full practical work is provided for.

(2) **Corps Squadron Works, including Artillery, Observation and Co-operation.**—This covers such subjects as the Clock Code, Lamp, Ground Strip and Morse Code Signals, the Squadron Call System, the Zone Call System, Shoots, Organisation of Artillery, the Workshop Lorry, etc.

(3) **Morse, Sending and Receiving, Buzzer and Visual.**—This is designed to enable students to attain a receiving rate of twenty words per minute by the end of a course and an equal transmitting rate.

(4) **Physical Training and Drill.**—One hour per day is devoted to these exercises.

(5) **General Education.**—Special attention is given to practical mathematics, the idea being to apply their principles to the solution of problems arising out of wireless work. Enough chemistry may be taught to enable the students to understand the interactions going on in cells, accumulators, electrolytic devices, etc.

A further course of twenty weeks takes the students further in their knowledge of wireless, including telephony and direction finding. Fuller details of this syllabus will be readily supplied to any applicant.

P.M.G. COURSE: SEA AND AIR.

(24 weeks.)

This comprises Lectures and practical work necessary for the preparation of students for the P.M.G. Examination. The Lectures include the treatment of Oscillatory Circuits, Lag, Lead, and Phase, Detectors, Aerials, the Marconi $1\frac{1}{2}$ K.W. Set, the Marconi Type 16 Balanced Crystal Set and the Marconi Valve Amplifying Receiving Set, the Fleming Valve, the use of Grid Leaks, Grid Condensers and Reactance Circuits, the Principles of Heterodyne Reception, the use of the Valve as a Transmitter, the application of C.W. Work to Wireless Telephony, the principles underlying Direction Finding and the construction and action of Service Sets.

WON'T IT WORK?

Well, send us a sketch and description of the circuit and instruments for criticism and advice. Our experience is at the service of all amateurs, on any "wireless" subject, from the earth plate to Mars. In doubt or difficulty call in the aid of the WIRELESS WORLD "Questions and Answers" Columns.

The CONSTRUCTION of AMATEUR WIRELESS APPARATUS

How to make a Direction Finder (Part II).

Construction of Direction Finder Unit.

THIS unit consists of two field coils mounted at right angles to each other, having a cylindrical search coil which is free to rotate inside the field coils. Mounted at one end of the search coil is an indicator or pointer fixed to a handle, to enable the operator to tell at a glance the exact position of the search coil in the field coils. To enable accurate readings to be taken the pointer must circle round a scale divided into 360 degrees.

To simplify construction and also to make it easy to examine connections at any time I propose to mount the coils, pointer, scale, and terminals on a common board, which in future references we shall term the instrument top.

If possible make the top of ebonite or fibre; if neither of these materials are procurable a hard wood may be used, great care being taken that it is perfectly dry. The insulation resistance must be very high, otherwise poor results will follow. Fig. 1

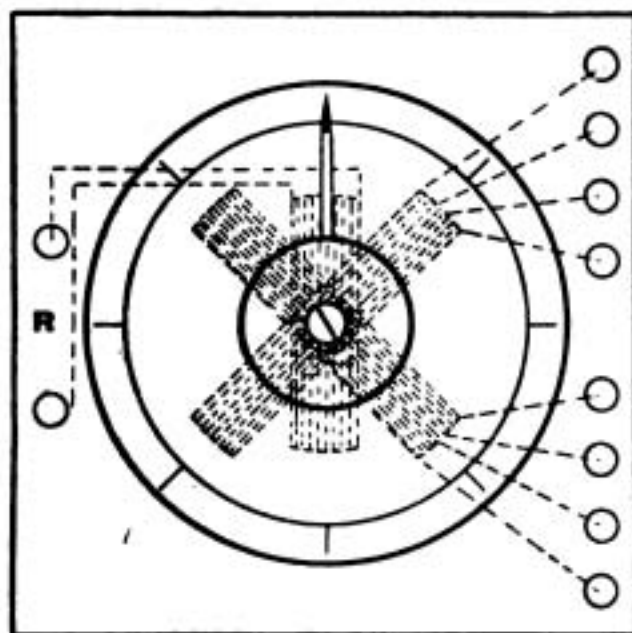

Fig. 1.

will give the reader an idea of the arrangement of mounting the top, the dimensions of which are $6" \times 6" \times \frac{1}{2}"$.

Ten terminals will be required, four for each field coil and two for the search coil. Provision must be made to allow the spindle of the search coil to come through the piece upon which the handle and pointer are fixed. A circular 360 degree celluloid protractor, obtainable at any stationers', makes an excellent scale, to the final fixing of which we shall refer later.

The Search Coil.

The former for the search coil must be cylindrical in shape and may be made of cardboard impregnated and fixed down with shellac varnish. Two wooden discs must be fitted into both ends of the cylinder in order to secure two short pieces of brass rod. Fig. 2 shows clearly the shape of the former and the brass rods in position. These rods serve the double purpose of making connections from the search coil winding, and acting as spindles upon which the coil rotates. The dimensions are given in the sketch.

Letter C in the diagram refers to two extra strips fixed into opposite sides of the cylinder to prevent the winding from slipping off during process of winding or subsequent handling.

The winding will consist of 60 turns of No. 26 D.S.C. having an equal number of turns on each side of the former, *i.e.*, 30 turns.

Connect the ends of the winding to the spindles A and B. When finally mounting up the unit provision must be made to connect the spindles to the two terminals marked R (Fig. 1). In order that the coil may rotate freely these connections will have to be friction contacts. The contact on spindle B can be made by means of a spring fixed to the bearing in which the spindle rotates. In the case of the spindle A the rod can also be

made to rub against a spring mounted on the instrument top.

Friction contacts are not usually advocated, on account of possible faulty contact; in this case, however, it is impossible to provide for the coil to rotate freely without adopting this method.

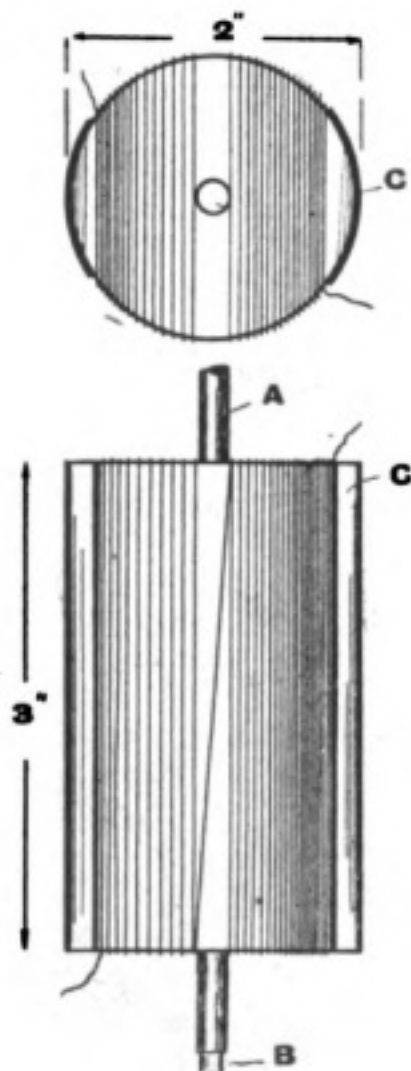

Fig. 2.

The spindle A will be approximately $1\frac{1}{2}$ " in length, measuring from the wooden end of the former; this length will allow for the fixing of the handles and pointer. Spindle B need only project about $\frac{1}{2}$ " as it is only used as a bearing.

Field Coil Windings.

The field coils will be wound on a skeleton former. The top sketch in Fig. 3 shows the shape of the top and bottom flanges of the former. Four pillars of hard wood are used as supports, shown at B in the diagram.

These pillars can either be fixed to the flanges by means of long bolts, which can also be used as a method of fixing the windings to the top of the instrument, or else by merely using wood screws. If long bolts are used these will have to be threaded for a considerable length so that the former can be screwed down tightly with a nut and then a distance piece of $\frac{1}{2}$ " length inserted between the top flange of windings and instrument top.

Before winding, the search coil must be placed in position and mounted so that it is quite free to rotate in the skeleton former; the latter will then be ready for winding. Referring to Fig. 3 it will be noticed that there are four sections of windings, two to each field coil. Each of these sections

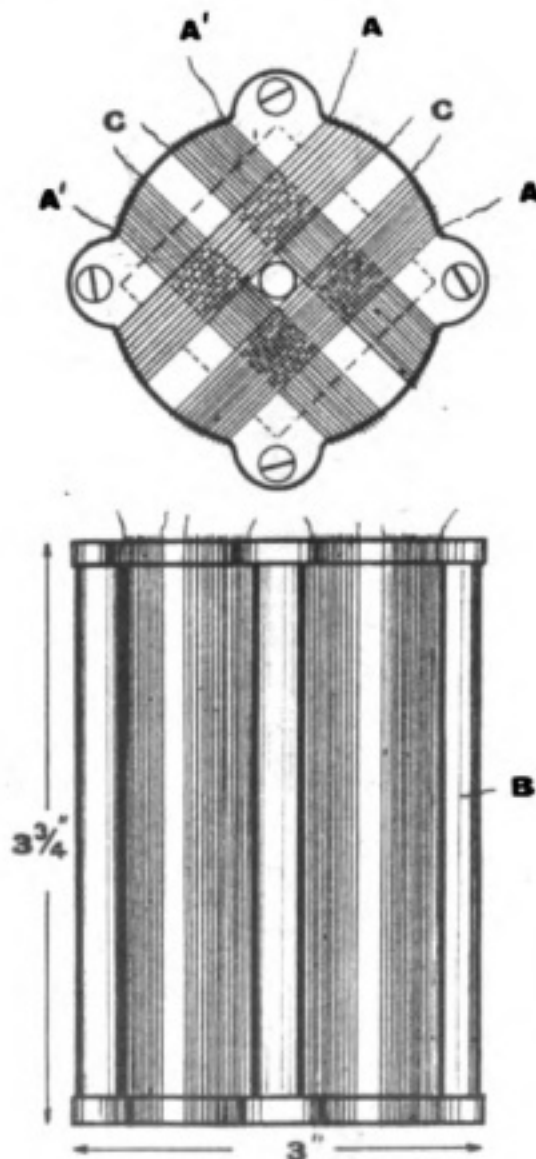

Fig. 3.

CONSTRUCTION OF AMATEUR WIRELESS APPARATUS

consists of 25 turns of No. 26 D.S.C. copper wire.

The reason that both field coils are made in two sections is that in order to take correct bearings on the direction finder both aërials must be electrically balanced; this is accomplished by inserting a variable condenser in the field coil.

The inside ends of the coils are connected to the terminals BC, FG, as shown in Fig. 1, to which a small variable condenser is connected. The outside ends of the coils, *i.e.*, the beginning of the first section and finish of the second section, are connected to terminals AD, EH.

Great care must be taken that the field coil windings are wound exactly alike; it is very necessary to have the wire equally spaced and to have the exact number of turns on each section.

The flanges must be carefully marked so that the coils are exactly 90 degrees apart.

When complete and connected up as shown in Fig. 1, the unit can be boxed up, using a box with interior measurements of $5\frac{1}{2}'' \times 5\frac{1}{2}'' \times 4\frac{1}{2}''$.

The next instalment will deal with the fixing up and testing of the apparatus.

(To be continued.)

BOOK REVIEWS

NAVAL OPERATIONS.

By SIR JULIAN S. CORBETT.

London: Longmans, Green & Co. Vol. 1.

Pp. 470, with illustrations. 17/6 net.

The need of an Official History of the War has long made its presence known, and this book, being one of five volumes dealing with the war in all its various aspects, ably provides that which hitherto has been so conspicuously absent. Free from technicalities, yet giving an intelligible view, not only of naval operations themselves, but of "their mutual connection and meaning, the policy which dictated them, their relation to military and diplomatic action, and the difficulties which in some cases delayed their success" and robbed them of the anticipated results, the book does credit to its author.

One of the outstanding features in the volume is the description of how Wireless Telegraphy made easier both strategic and direct operations. Chapter IX., dealing exclusively with the subject, interestingly states the part played by the German wireless stations of Windhuk, Kamina, and others; tells of their importance to the Central Powers, of how the British Forces caused their destruction, and the subsequent result of Germany's ruptured communications. This chapter speaks also of how, by the supplying

of information which the Mercantile Marine was enabled to transmit to H.M. ships, wireless was the means of capturing so many enemy raiders lurking on our trade routes.

A further account of Wireless Warfare is contained in Chapter X., making as it does a narrative so interesting that even those unacquainted and unfamiliar with things appertaining to wireless telegraphy, must necessarily be all attention, anticipation and anxiety to read on.

Authentic in its statement, brisk in its writing, this First Volume of a series of five is a true presentation of the various "naval operations, actions and individual exploits in their just relations to the course of the war as a whole."

As a reference book it is excellent. Dates, maps and charts, illustrating the various evolutions, leave nothing to be desired. The authorities upon which the author bases his narrative are mainly gleaned from the Committee of Imperial Defence, Admiralty telegrams, letters, reports and despatches from Admirals and Senior Naval Officers, Admiralty correspondence with other departments of State, prisoners, captured documents and other intelligence, and from War Office records relating to combined operation and action of the Fleet.

QUESTIONS AND ANSWERS

NOTE.—This section of the magazine is placed at the disposal of all readers who wish to receive advice and information on matters pertaining to both the technical and non-technical sides of wireless work. Readers should comply with the following rules.—(1) Questions should be numbered and written on one side of the paper only, and should not exceed four in number. (2) Queries should be clear and concise. (3) Before sending in their questions readers are advised to search recent numbers to see whether the same queries have not been dealt with before. (4) The Editor cannot undertake to reply to queries by post. (5) All queries must be accompanied by the full name and address of the sender, which is for reference, not for publication. Queries will be answered under the initials and town of the correspondent, or, if so desired, under a "nom de plume." (6) Readers desirous of knowing the conditions of service, etc., for wireless operators will save time by writing direct to the various firms employing operators.

H.M.H. (Hartford) sends a diagram of a resistance amplifier. He proposes to use three V24 valves for H.F. amplification, followed by one Q valve for rectification. He asks the following questions: (1) Whether 30 volts will be suitable for the H.T. battery under these conditions. (2) Whether 80,000 ohms will do for the plate resistances. (3) Whether 3 megohms will do for the grid leaks. (4) If the Q valve arranged as shown in Fig. 1 will act as a good rectifier.

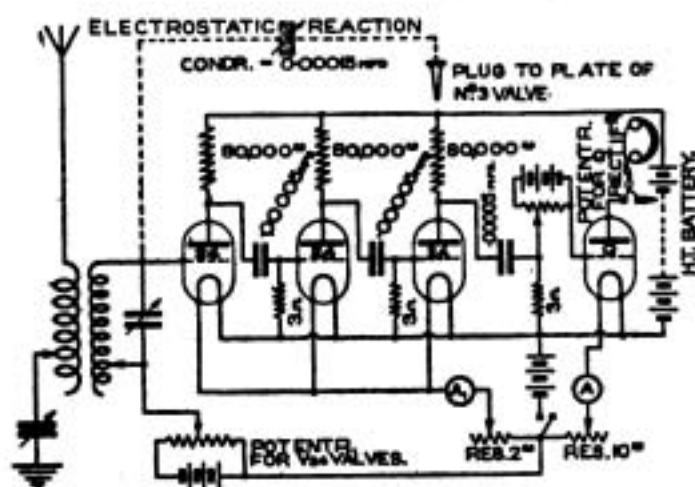

Fig. 1.

(1), (2) and (3) Yes.

(4) Probably. A more usual and simpler arrangement with this type of amplifier would be to use a fourth V24 valve in this position, arranged as with the other three, without a potentiometer. If you use a Q valve with only 30 volts on the plate it will probably be as well to use a suitable potentiometer to get the best rectifying point.

ADAMS (Birmingham).—(1) We know of no private company employing operators; the Marconi, Radio Communication and Siemen's Companies being the chief employers of operators. (2) The maximum age for joining the Marconi Company as an operator is 25.

T.M.W. (Leith).—The Marconi Wireless Telegraph Company, of Canada, Ltd., 11, Sacramento Street, Montreal.

ANXIOUS (Ayrshire).—You will save time and eliminate doubt by applying to the Marconi Company.

L.B.B. (Epsom).—(1) The service is now discontinued. (2) The information given in the *Wireless World* of May 29th still stands correct. We are unable to give the meaning of the figures received by you.

T.F.E. (Ipswich).—We regret to say that to answer the question put to us would necessitate the use of too much space; nothing short of an article would give the required information.

H.M. (Leicester).—Probably BGN (Newbigging) owned by J. Mitchell & Sons.

G.E.W. (Wakefield).—(1) Bangay's book, Part 1 and 2. This book, though giving many details in diagram of thermionic valve circuits, does not describe the actual setting up of apparatus. For this it would be better to follow the Constructional Articles in the *Wireless World*.

S.H.S. (Worcester).—Different countries, different companies, but in the United Kingdom the G.P.O. and Marconi's Wireless Telegraph Company.

R.H. (Dursley).—Either Horsea, Pembroke, or Cleethorpes.

H.J.S. (Eltham).—(1) Station unknown; verify time and wavelength. (2) Very probably Rinella. (3) For particulars of this code see pages 847 and 866 of 1920 edition of Year Book of Wireless Telegraphy. (4) Yes; we are always pleased to publish correspondence on topics of interest.

H.J.B. (Leamington) sends two sketches of aeriels, and asks (1) Which would be the more efficient. He also sends a sketch of his receiver, which he says will only receive on 600 ms. He asks (2) What additions he should make to the circuits, without rewinding the coils, to increase the wavelength.

(1) You do not say where the lead-ins are to be. However, (a) is certainly bad in any case. (b) is not good, but is probably better than (a), but you will get very little advantage by using three wires in parallel if your spreaders are only 2' 6" long.

(2) The obvious way to increase the wavelength of a receiver is to rewind the coils with more wire. However, we do not think it is necessary with your set. You should get considerably more than 600 ms. with the dimensions you show, but if you find that you need nearly all your A.T.I. to tune this figure, you should add another coil in series with the one you have. You will probably get better results by interchanging the two condensers, although this will lower the wavelength of the closed circuit. However, this will not matter, unless you want very long wavelengths, which will never give good results on an aerial such as yours.

C.S. (Windermere) has been experimenting with two similar loops of wire, buzzing one and connecting the other in series with a crystal and 'phones. He finds a variation of signal strength with distance apart of the loops, but no variation with alteration of the orientation of the loops. He asks for an explanation of this.

QUESTIONS AND ANSWERS

We should certainly expect some effect due to rotation of the coils, at any rate if one coil is rotated and the other kept fixed. It appears possible that for certain distances apart in comparison with their sizes, that the effect when the planes of the coils are at right angles to the line joining their centres should be equivalent to the effect when they are both in the same plane. Other causes tending to mask the effect of rotation are direct capacity coupling between the coils, and reflection from objects—chiefly metal—in the room.

A.H. (Thornton Heath) asks (1) For a formula for the inductance of a coil, given number of turns, diameter of the former, gauge of wire and distance between the turns. (2) For criticism of a valve circuit, a sketch of which is sent (Fig. 2). (3) What capacities to use in this circuit. (4) What is a cheap book for beginners, giving such information as wavelengths and call letters of commercial stations.

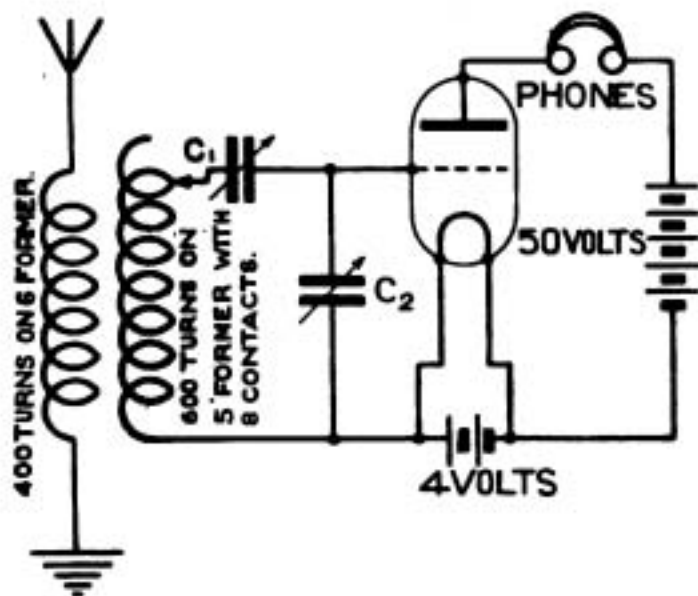

Fig. 2.

(1) The most useful is Nagaoka's, given recently in this column. This formula uses the diameter of the wire, and not the gauge number, of course. It also supposes the turns wound close, but a correction can be made for the case in which the wires are spaced apart. The correction depends on two tables, which we have not space to print here, but which you will find, if you desire them, in Nottage's book on "The Measurement of Capacity and Inductance."

(2) The circuit is fairly suitable, except that (a) the condenser C1 is not required, (b) the telephones would be better on the other side of the H.T. battery, (c) the set would be improved with a potentiometer in the grid circuit, (d) if you wish to receive anything but fairly short wavelengths you will probably need rather more wire on the loose coupler coils.

(3) About 0.0005 mfd.

(4) There is no very cheap book. "The Wireless Yearbook" is the most complete.

A.R. (Brighton) asks (1) What wavelength a coil of 650 turns of No. 26, on a former 13" x 4½" will tune to. (2) What is the capacity of a tubular

condenser, 2½" long by 2" in diameter, with a waxed paper dielectric, and if it will be suitable for the closed circuit condenser in a crystal receiver. (3) He sends a diagram of a simple circuit, and asks why he can get no signals.

(1) If you have a suitable capacity in the closed circuit, say 0.0005 mfd., the coil will tune this circuit to about 3,000 ms. In the aerial circuit it will probably only tune to a good deal less than this figure.

(2) It is impossible to say without knowing what thickness of paper you propose to use. If the thickness is about 10 mils the capacity will probably be about what you require.

(3) We can see no reason why you should not get signals. Your earth would be better if of larger area, and buried a good deal deeper than 3". Also, with 15,000 ohm 'phones you will probably get best results without using a telephone transformer.

J.S.R. (Spalding) has trouble with induction from a Lister automatic lighting plant situated near to the room in which he works, and asks for an explanation and advice. He also notices a momentary scratching sound on connecting the aerial to earth through his 'phones, and asks if this is right.

(1) Presuming this type of set to be run by a dynamo driven by a petrol or similar engine, the trouble may arise from either or both of two causes, bad commutation or faulty design of the dynamo, or high frequency oscillations set up by the magneto discharge. Such noises are generally difficult to eliminate. Make sure the commutation is good. You could then try earthing both poles of the dynamo through a large condenser, which is often very useful, and sheathing the magneto and its high tension lead to the engine in metal casing, which generally minimises magneto induction.

(2) This is natural, and is due to a flow to earth of the charge accumulated on the aerial.

MORSE MAN (Manchester) has a former 11" x 4½", wound with No. 30, which he wishes to use as primary of a loose coupler, the secondary being 11" x 3½", wound with No. 36. The closed circuit condenser is 0.0002 mfd. The aerial is of normal twin wire type. He asks (1) Whether the coil described above will be suitable. (2) What will be the approximate maximum wavelength. (3) If 10-stranded flex, of which he sends a sample strand, will be suitable for connecting up a receiver, including the H.T. leads to the valve.

(1) & (2) The coil would be quite suitable, except that by itself it will probably not tune your aerial circuit up to the maximum wavelength attainable by your closed circuit, which will be about 4,500 ms. If you use this coil for the coupler and wish to tune as high as this you will probably need additional A.T.I.

(3) The gauge of the strand you send is No. 36. The flex can be used for wiring up a receiver. Its suitability for the H.T. leads depends chiefly on the quality of the insulation, about which you do not say anything.

W.McL. (Ashington) asks (1) What size to make the reaction coil in the set shown in Fig. 4, page 483, of the November issue. He suggests a former 4" x 3"

wound full with No. 36. (2) He also asks what would be the best size of tuning coil to use. His loose coupler is as follows:—primary 8" × 6", wound with No. 20; secondary, 7" × 5½", of No. 34. (3) He asks further what is the maximum wavelength he should be able to receive.

(1) To suit the rest of the set we should not use so much wire as you suggest. We think you will get better results by filling the former with No. 26 or 28, instead of 36. You will probably get better results by making this coil capable of sliding into the closed circuit coil, rather than by mounting it on a spindle for rotation as you suggest.

(2) As a rough estimate, without knowing the constants of your aerial we should make an A.T.I. (we presume this is the tuning coil you mean) about as big as your coupler primary, winding it with about No. 28.

(3) About 5,000 ms., if the maximum value of your closed circuit condenser is about 0.0003 mfd.

"COMPLEXED" (Clydebank) asks, re the diagram of the Marconi calling device on page 698, of the March issue (1) What is the purpose of the manipulating key, as it does not appear to be in any battery circuit. (2) If there is not a connection missing, as the bell circuit does not appear completed. (3) How in two coupled oscillatory circuits "the mutual inductance at one time adds itself to the effective L, and at the next time subtracts itself from it," seeing that in two coupled circuits the currents must always be in opposite directions.

(1) This is the main manipulating key of the power set and the calling device transmitter being in parallel with it.

(2) Yes, there should be a connection from the upper middle contact of the lower double pole switch to the lead shown very close to it, i.e., to the negative pole of the 24-volt battery.

(3) This is not very clear, but we do not quite see the force of your objection, as the currents in the two circuits are not always in opposition.

G.T. (York) asks (1) If a former 24" × 6½" will be suitable for a triple slide inductance for a circuit sketched. (2) What is the gauge of a sample of wire sent. (3) If it would be suitable for the above inductance. (4) If tinned iron (e.g., the material of biscuit tins) would be suitable for the vanes of a variable condenser.

(1) It would, but a double slide inductance will be all that you require.

(2) No. 26.

(3) Yes.

(4) It could be used, but is not very suitable as the losses would be rather high. The material is not stout enough for a satisfactory air condenser.

R.G.T.M. (Kingston) sends a description, with sketches, of his receiver, and asks why he gets no results.

Both the description and the sketches are very carelessly drafted, and give us little useful information to help in setting you right. The circuit marked "one I have tried" might possibly work; but the other—undescribed—is quite useless. We can only recommend you to articles for beginners, and at the same time to cultivate a more painstaking and methodical manner of dealing with the subject, if you wish to obtain satisfactory results. Why

not start afresh and build a set from the designs given in our Constructional Series. Try the circuit shown in our December issue.

"GEE" (Sutton) sends a sketch (Fig. 3) of a proposed intervalve transformer wound on an iron wire core which is finally bent round to close the circuit, and asks (1) If this will be satisfactory. (2) What amount of No. 44 D.C.S. will be required for (a) a primary of 2,500 ohms, and (b) a secondary of 12,000 ohms and (3) What is the effect of the cast-iron screening case fitted round some intervalve transformers.

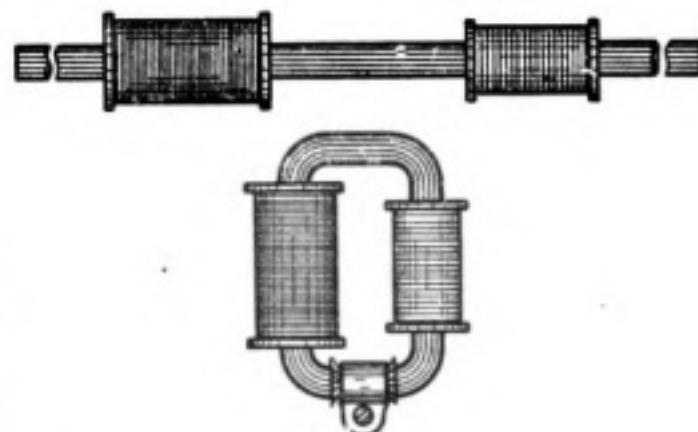

Fig. 3.

(1) Quite, for low frequency, of course.

(2) (a) 1¼ ozs. (b) 6 ozs.

(3) To minimise undesirable interaction between the circuits, due to the stray magnetic fields of the transformers.

"W" (Glasgow) sends a sketch of a receiver, and asks (1) What size of former and wire he should use to tune to 6,000 ms, with a condenser of 0.0015 mfd, the former to be as small as possible. (2) What size of condenser he should use across the H.T. battery, and in the grid circuit. (3) What resistance to make the leak. (4) If he will get ships on 600 ms. strongly. (5) If the set will receive with a frame aerial.

(1) You might use a former 10 cms. by 6 cms., wound with No. 36, if it is necessary to keep it small.

(2) For the H.T. battery, the size is not very important,—say 0.001 mfd. and for the grid 0.0002 mfd.

(3) About 3 megohms,—made most conveniently with pencil lead, as described in a recent reply.

(4) Fairly.

(5) Yes, use as large a frame as possible, with a good number of turns on it.

RAFEX (Epsom) asks (1) If the two portions of a reactance coil are wound unidirectional, or in clockwise and anti-clockwise manner: (2) For a suitable winding for telephones for use with the telephone transformer described in the March number.

(1) The portions should be so wound that they combine to form a single complete coil wound in one direction all along when viewed from one end.

(2) It is usual to design the transformer to suit the telephones and not vice versa. Any winding of about 100 ohms total resistance will do. Choose the gauge to just fill the available space on the bobbins. A usual value is about No. 32.

QUESTIONS AND ANSWERS.

O.S.P. (Ealing) asks:—With a given circuit containing both inductance and capacity, and a P.D. applied at a frequency which will produce complete resonance, will the resulting oscillations be of the same frequency as the supply, or will it be of a value depending on the spark frequency (in the event of there being a spark gap) or the periodic time of the condenser (assuming localised capacity).

We are not quite clear as to your exact meaning. We presume the circuit you have in mind is as in Fig. 4 (a) or (b).

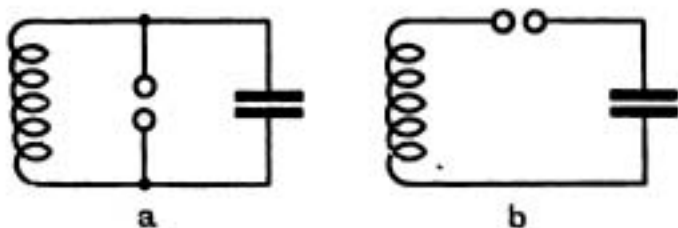

Fig. 4.

In either case, when steady conditions are reached, the frequency will be that of the supply which you assume to be the same as the natural frequency of the circuit, and which will also be the same as the spark frequency.

B.C. (Purley) has a crystal receiver which gives good results, but he wishes to improve it by adding a valve, in order to get C.W. stations. He asks (1) For a diagram of a suitable circuit. (2) For the approximate cost. (3) For a practical book on telephony.

(1) The circuit in Fig. 2, page 675, February issue, should meet your requirements, as it will need little alteration of your existing gear. The telephone transformer can be dispensed with if your 'phones are of high resistance.

(2) About 30s., including valve, if you make the apparatus yourself, and do not require a transformer. It will cost more if you buy such items as the valve holder.

(3) We assume you mean wireless telephony. About the only book likely to suit you is *Telephony Without Wires*, by P. R. Coursey, 15/- net. (The Wireless Press, Ltd.)

C.H.E.R. (London) wishes to try a coherer, and asks (1) Whether he should get results from neighbouring fairly high power stations. He sends a diagram of a proposed circuit for use with the coherer and asks (2) Whether condenser C should be between A and B. (3) Which position (1 or 2) is best for the coherer. (4) If the buzzer could be used to tap the coherer. (5) If a relay made with ordinary bell coils would be delicate enough. (6) If better results are obtained the bigger the battery B is.

(1) Very possibly, except for the usual troubles with coherers from X's, etc.

(2) Preferably.

(3) Either would be all right but in either case a condenser must be introduced at a suitable point to prevent a permanent current through the relay.

(4) It would probably not be strong enough.

(5) No.

(6) No more volts should be used than are necessary to work the relay. You will need high frequency chokes in the battery relay circuit.

Only four questions, please, C.H.E.R.

B.L.S. (Withington) asks (1) Whether the formula

$$L = \frac{l(n^2 \pi^2 d^2)}{1000}$$

where l = length, n = turns per cm.

d = dia., (all in cms), is correct for single layer coils.

(2) He sends sketch of an aerial and asks if it will be efficient.

(3) In the circuit shown for "Carborundum," page 35, April 3rd issue, what would be the size of the A.T.I. to tune 5,800 metres. (4) Which is better to use (a) a loading coil and relatively small loose coupler or (b) a large loose coupler and no A.T.I.

(1) The formula is correct except for the variable factor K including the ratio l/d . For approximate values of this factor see recent answer.

(2) We should prefer to cut the top 9 feet of wire, replacing it by cord.

(3) Try a former about 10" long by 6" diameter, wound with about No. 28 wire.

(4) It is immaterial, provided that the coupling can be made sufficiently tight in the first case, and sufficiently loose in the second.

E.T. (Seaham Harbour) asks (1) What size wire to use for winding a potentiometer for a crystal.

(2) If a 12' earth lead is too long. (3) If it is an advantage to have an aerial on high ground but only 30' high. (4) If No. 1/19 aerial wire would be suitable for an L aerial.

(1) About No. 34 of Eureka or similar material.

(2) No.

(3) The height of the aerial above the ground is more important than the height of the ground at the receiving point. The latter question generally has less effect than the nature of the ground.

(4) Thicker wire would be considerably better. 1/19 would be mechanically weak and not very good electrically.

H.R. (Highgate) asks (1) Would an aerial of 140' long and 40' high be enough for receiving, with a tuning inductance of $11'' \times 2\frac{1}{2}''$ diameter, a blocking condenser, and crystal detector. (2) If he would be able to receive 300 miles with it.

(1) It would, but unfortunately the P.M.G. will not allow you to use it.

(2) This will obviously depend on the power of the transmitting station. You would get high power stations much further than this, but would not be likely to get ship sets at this range.

N.J.W. (Oakham) sends dimensions of a receiver and asks (1) What is approximate range of set. (2) What is the greatest wavelength it will receive. (3) Would circuit sketched act, and if not how should it be connected. (4) If an indoor 3-wire aerial 32' long under the roof could be used when work with outdoor aerial is stopped, e.g., by snow.

(1) Even assuming it is correctly connected up we cannot answer this question; the results obtained depend chiefly on indeterminate factors such as the skill of the user, the situation of the aerial, and so on.

(2) The intermediate circuit would tune to about 10,000 ms., but you would need much more inductance in the aerial circuit to tune this circuit up to such a value.

(3) No; the arrangement of crystal, condenser, and telephones is fundamentally wrong. Consult any crystal receiver diagram.

(4) Results obtained (if any) would be very poor indeed.

W.A.H. (Liverpool) asks (1) *How we reconcile the remarks on page 530 of Vol. 7 with our reply to P.H.B. (item 5) on page 143 of this vol.* (2) *If we recommend a variometer as an A.T.I. for a large range of wavelengths, and will it work with a reaction circuit.* (3) *How much wire wound on a former 6" diameter will be required to tune a P.M.G. aerial to 15,000 ms.*

(1) The circuit in question is of quite unusual type, and we have not had an opportunity of actually working with it. Our comments on page 143 were determined by purely theoretical considerations and we see no reason for modifying them. Moreover, it is quite evident that the circuit cannot work satisfactorily, as shown on page 530, as there is no path shown for leakage of electrons from the grid. With a circuit modified to eliminate this defect interesting experimental results might be obtained by a fairly skilled worker, but we think an average amateur would be well advised to choose a more normal type if he wishes consistent results with freedom from trouble in controlling the set.

(2) In general a variometer is chiefly useful for comparatively small variations of inductance. You would probably find it difficult to get a large wave range by this means. A variometer could be used in a reaction coil circuit.

(3) It is difficult to give more than rough figures for such an extreme loading up, which is not likely to give very good results. A former 12" x 6" wound full with No. 36 wire will probably be about right.

F.M.L. (Highgate) sends particulars of a receiving circuit, with double slide coil 44 x 17 cms. wound with No. 21, variable condenser of 19 plates, 11.5 cms. diameter, 3.5 mms. between plates. Set appears O.K. to buzzer tests, but does not give signals. He asks (1) *If we can point out any faults.* (2) *For capacity of condenser.* (3) *Where on the inductance he should get Eiffel Tower.*

(1) Set as sketched appears quite O.K. Earth lead is undesirably long (40') and should be soldered, not clamped to water-pipe. Tests point to fault lying in connections of aerial, or possibly in its insulation.

(2) Assuming plates semi-circular, about 0.0002 mfd.

(3) Nearly all in, with condenser nearly at maximum. You may possibly want a little extra A.T.I. for perfect tuning, but we hardly think so.

J.T. (South Shields) asks (1) *How and where to apply for a receiving license.* (2) *What is the gauge of a sample of wire.* (3) *What will the resistance of this wire be.* (4) *What will the inductance of a coil of No. 26 wire on a former 6½" diameter and 12" long be.*

(1) The Secretary, G.P.O., London.

(2) No. 40 S.W.G.

(3) About 7 ohms per yard.

(4) About 14,000 microhenries.

R.S. (Streatham) asks the following questions re his receiver. (1) *What wavelength will he be able to tune to with a double slide coil 16" x 9" wound with No. 22.* (2) *Using this with a small variable C (capacity not stated), silicon detector, 2 wire 70'*

aerial, 8,000 ohm 'phones, what range he will be able to get. (3) *How much this would be improved by a valve.*

(1) From the rough information you give, we can only say approximately. You should get about 5,000 ms.

(2) We cannot state ranges, so much depending on conditions which cannot be accurately determined, such as skill of user, etc.

(3) Here again the improvement will depend on the type of set used with the valve. You might get anything from 1½ to 10 times the crystal range.

F.P. (Oxford) sends sketch of a proposed receiver and asks (1) *If he should be able to receive Paris, Madrid, etc., with it.* (2) *What sort of crystal detector would be required.* (3) *Capacity of blocking condenser.* (4) *Price of tuning inductance and where obtainable.*

(1) The circuit, though somewhat primitive, should give fair results with a suitable coupler. You should certainly get FL and possibly Madrid.

(2) Carborundum is as good as any for general purposes.

(3) This will depend on your telephones, which should be of high resistance. The exact value is not important, say 0.0001 mfd.

(4) Consult the price lists of advertisers in the *Wireless World*.

D.E.T. (Sydenham) sends sketch of aerial and asks (1) *Whether arrangement of down lead is efficient.* He also asks (2) *What is the function of a grid leak and condenser in a valve circuit.* (3) *May they be dispensed with to get good results.* (4) *If essential, of what does a grid leak consist.* (5) *In long wave reception why can one not use a large condenser in parallel with a small inductance for tuning.*

(1) You do not state exact position of down lead. It should be exactly in the middle of horizontal part, or at one end, preferably the latter for a small aerial.

(2) This has been treated recently in this column.

(3) Certainly. A grid leak is only needed for the type of circuit known as a grid condenser detector, which you will find described, with explanations, in Bangay's book.

(4) This has also been described recently in these columns.

(5) Any crystal or valve detector works on potential effects, and in order to get these effects large, the ratio of inductance to capacity in the circuits must be large.

H.T.S. (Nice) asks, referring to the unknown signals much discussed lately, (1) *If they could be heard on an aerial 800 ft. long, at a mean height of about 80 ft.* (2) *If a detector valve and one L.F. amplifier would be a sufficiently sensitive combination for the purpose.* (3) *What size inductance would be required to get to 100,000 ms.* (4) *Would a heterodyne be necessary.*

(1) & (2) We do not think the combination you suggest would be any use with your aerial. For satisfactory results you would probably need a much larger and higher aerial; if you try with your present aerial we should recommend higher magnification.

(3) For A.T.I. you would require a coil about 3 ft. by 9 ins. wound with No. 34.

(4) No.

QUESTIONS AND ANSWERS

H.M.W. (Gillingham) asks for a description of a phase meter or power factor meter as used on high frequency circuits.

Presuming that by high frequency you are thinking of radio frequency, we do not know of any such instrument having been developed.

F.A.W. (Catford) sends a diagram (Fig. 5) of a crystal receiver for comment, giving following details of the coupler. Primary, 10 cms. diameter \times 32 cms. long wound with No. 14 S.W.G. Secondary, 12 cm. diameter \times 32 cm. long wound with No. 22 S.W.G. He asks (1) If set should work to 5,000 ms. (2) If the dimensions of the coupler are about right.

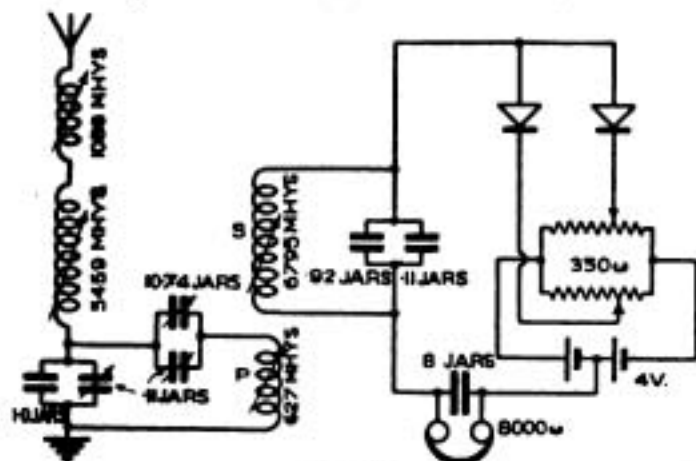

Fig. 5.

(1) General design of the receiver is satisfactory, but the multiplication of variable inductances and condensers does not tend to easy manipulation and is hardly good practice. The secondary tuned circuit will give 5,000 ms. It is probable that you will need more inductance in the aerial for this wavelength if your aerial conforms to P.M.G. rules. The intermediate circuit wavelength is much too low. You could rewind the coupler primary to about 10 times its present value, or preferably substitute a coil of 6,000 mhy. for the two condensers marked 10.74 and 0.11 jars. If you do this the coupler will do very well as at present made.

W.J.T. (Norbiton) sends a diagram of a valve receiver and asks (1) If set is connected up efficiently. (2) Approximately what wavelength it would receive. (3) How to use a wavemeter with this set. (4) If a loose coupler would greatly improve set.

(1) Set is quite well connected up. You do not need a grid leak with this type of set. You will probably want 6 volts for your filament battery. Phones should be on earth side of H.T. battery.

(2) As you do not give the diameter of your formers we cannot calculate the inductance of the coils and therefore cannot answer this question.

(3) Connect a buzzer and cell across the condenser B, and hold the wavemeter near the circuit. The value of wavemeter at which you hear the buzzer best in the wavemeter will be the wavelength of the closed circuit. Alternatively you can buzz the wavemeter and listen in on the set.

(4) A loose coupler should improve the set, but you ought to get quite good results without one.

AMATEUR (Dundee) asks (1) For name of an up-to-date directory giving names and call letters of

stations, times of working, etc. (2) Refers to a recent answer in which it was said that L.R. telephones are less likely to get damaged than H.R., and asks if H.R. phones would be as efficient in a valve circuit as L.R. telephones and a transformer; and if the chance of damaging H.R. phones is big.

(1) The Year Book is the best we know of. However, we believe there is also an American list.

(2) As we have said before, there is little to choose between H.R. 'phones and L.R. 'phones and a transformer, as regards efficiency. H.R. 'phones are however somewhat more likely to break down than L.R., owing to the fineness of the wire employed, and when they break down they are more difficult and expensive to repair. However, the risk of breakdown in either case is quite small. One of the most useful advantages of the transformer and L.R. 'phone method with valves is that it insulates the 'phones from the H.T. battery.

C.T.A. (Leicester) asks (1) Whether it is possible to construct an H.F. amplifier efficient over as large a range of wavelengths as 300-15,000 ms. (2) If so, what type of transformer, etc., would be best for the construction.

(1) The range you suggest is very large for a single instrument; you would probably get better results from one using one H.F. amplification at most, followed by L.F. amplification.

(2) We are afraid we cannot refer you to data for any satisfactory instrument for such a range. There are various types suitable for smaller ranges which you might find possible to develop, such as the resistance-coupled and the Marconi semi-aperiodic types, both of which you will find described in back numbers of the *Wireless World*. The constructional details will depend on which type you prefer.

W.F.C. (Ealing) sends a sketch of a proposed receiver, and asks (1) For general criticism, and (2) Whether it would be better to connect to water pipes near the set or to the same system lower down and close to the ground.

(1) The type of set you describe should give you fairly good results, but you will only get comparatively short wavelengths unless you wind the inductance with more turns of finer wire (dimensions given are $11\frac{1}{2}'' \times 5\frac{1}{2}''$ of No. 20 S.W.G.).

(2) You will probably get best results by connecting to the water system at the nearest point.

SHARE MARKET REPORT.

During the past few weeks considerable liquidation has been noticeable in all speculative sections of the Industrial Market. The investment securities section was generally inactive and rather inclined to weakness. This weakness was reflected in most of the shares of the wireless group; all the issues during the past fortnight show slight declines on balance.

Prices as we go to press, July 2nd, are:—

Ordinary	-	3 $\frac{1}{8}$	cum. dividend and bonus.
Preference	-	3 $\frac{1}{2}$	" " "
Canada	-	10s.	" " "
Marine	-	1 $\frac{1}{8}$	" " "
Marconi new issue,		2 $\frac{1}{8}$	

COMPANY REPORTS

Marconi's Wireless Telegraph Company, Ltd.

REPORT OF DIRECTORS.

The Directors submit herewith the Accounts for the year ended 31st December, 1919.

The Credit Balance of Profit and Loss Account for the year amounted to £1,220,739 12s. 5d. which, added to the Balance brought forward from the last Account, leaves to the credit of Profit and Loss Account a sum of £1,684,526 7 1

From this have to be deducted the following Dividends:—

On Preference Shares 7 per cent. paid on 2nd February, 1920 ..	£17,500 0 0	
On the old Ordinary Shares an Interim Dividend of 10 per cent. paid on 2nd February, 1920	122,364 16 0	
		139,864 16 0

Leaving available for distribution a Balance of £1,544,661 11 1

The Directors recommend payment of further Dividends and a Bonus for the Year ended 31st December, 1919:—

On the old Ordinary Shares 15 per cent. (making 25 per cent. for the year)	£183,547 4 0	
On Preference Shares 15 per cent. (making 22 per cent. for the year)	37,500 0 0	
On the old Ordinary Shares and on the Preference Shares a Bonus of 5s. per Share, without deduction of Income Tax	368,412 0 0	
		589,459 4 0

Leaving a Balance to carry forward to next Account £955,202 7 1

There having been no settlement with any of the Government Departments in respect of any of the Company's claims arising out of the war or for services rendered during the war, no sum in respect of any of these claims figures in the year's Accounts.

In consequence of unfavourable rates of exchange which obtained at the end of the year, considerable sums of money have been allowed to remain abroad on deposit or invested in Foreign Government securities. A sum approximating £58,000 has been debited to Profit and Loss Account, calculating the rate of exchange on the 31st December, as though the money had been brought home at that date, and the loss incurred. The loss, however, has not been actually incurred, and when in the course of time exchanges improve, as no doubt they will do, the sums written off will figure in a future Balance Sheet as a profit.

Further, a sum of £56,000 has been written off, representing depreciation in investments in British and Foreign Government securities.

Since the last Ordinary General Meeting, The Right Hon. Lord Herschell, G.C.V.O., has been appointed a Director of the Company. In accordance with Article 74 he retires, and, being eligible, offers himself for re-election.

The Directors retiring by rotation are Senatore Guglielmo Marconi, Mr. Henry William Allen, and Mr. Alfonso Marconi, who, being eligible, offer themselves for re-election.

The Auditors, Messrs. Cooper Brothers & Co., also retire, and offer themselves for re-appointment.

By Order of the Board,

H. W. CORBY, *Secretary.*

MARCONI HOUSE, STRAND, LONDON, W.C.2.

10th June, 1920.

MARCONI'S WIRELESS TELEGRAPH COMPANY LIMITED.

Dr.

BALANCE SHEET, 31st December, 1919.

	£	s.	d.	£	s.	d.	Cr.
To Capital— Authorized. 2,750,000 Ordinary Shares of £1 each £2,750,000 250,000 7 per cent. Cumula- tive Participating Prefer- ence Shares of £1 each .. 250,000 £3,000,000							
1,223,648 Ordinary Shares, fully paid ..	1,223,648	0	0				
250,000 Preference Shares, fully paid..	250,000	0	0				
Ordinary Shares ranking only for Divi- dends declared in respect of the period commencing 1st January, 1920 :— 90,889 Fully paid 90,889 0 0 1,152,742 Partly paid 115,301 4 0							
To Share Premium Account				206,190	4	0	
To Amount received in respect of Ordinary Shares not allotted, and Premium ..				349,219	15	5	
To Bills Payable				22,139	0	0	
To Sundry Creditors				5,613	3	6	
To Reserve for Expenses Unpaid and Receipts in Advance and other Credit Balances				270,152	8	4	
To General Reserve Account				119,616	3	4	
To Profit and Loss Account— Balance brought forward 463,786 14 8 Balance for the year as per Account .. 1,220,739 12 5 (Subject to Directors' additional remuneration) 1,684,526 7 1				1,250,000	0	0	
To Liability for amounts not called, or not due, on Shares in Associated Companies and Investments £95,362 10s. od. and Liabilities under Agreements.							
							£5,381,105 1 8

Shares held in Associated Companies are of
a par value of £2,351,882 4s. 5d.

GODFREY C. ISAACS, Director.

SIDNEY St. J. STEADMAN, Director.

REPORT OF THE AUDITORS TO THE SHAREHOLDERS.

We have audited the above Balance Sheet with the books in London and accounts from Rome. A large part of the Investments and Shares in Associated Companies are held abroad. Except as to a part held in Russia, we have seen letters or certificates stating that they are held on behalf of this Company. We have obtained all the information and explanations we have required. In our opinion such Balance Sheet is properly drawn up so as to exhibit a true and correct view of the state of the Company's affairs according to the best of our information and the explanations given to us and as shown by the books of the Company.

LONDON, 10th June, 1920.

COOPER BROTHERS & CO., } Auditors.
Chartered Accountants.

MARCONI'S WIRELESS TELEGRAPH COMPANY LIMITED.

Dr.	PROFIT AND LOSS ACCOUNT for year ending 31st December, 1919.	Cr.
	£ s. d.	£ s. d.
To Rents, Rates, Taxes, Travelling, Publicity and General Expenses	42,304 13 4	By Balance of Contracts, Sales, Traffic and Trading Accounts 946,997 6 4
To Salaries, Contribution to Staff Superannuation Fund and Directors' Remuneration	140,773 12 8	By Damages for Breach of Contract 590,000 0 0
To Law Charges, Professional Fees and Patent Expenses	21,539 18 1	By Transfer, Share Warrant and other Fees 1,042 16 6
To Depreciation of Plant, Machinery, Building and Furniture	19,947 15 7	
To Station Expenses	92,734 10 9	
To Balance carried to Balance Sheet	1,220,739 12 5	
	<u>£1,538,040 2 10</u>	<u>£1,538,040 2 10</u>

Dr.	APPROPRIATION ACCOUNT.	Cr.
	£ s. d.	£ s. d.
To Dividend of 7 per cent. on Preference Shares for the Year ending 31st December, 1919, paid 2nd February, 1920	17,500 0 0	By Profit and Loss Account—
To Interim Dividend of 10 per cent. on Ordinary Shares for the Year ending 31st December, 1919, paid 2nd February, 1920	122,364 16 0	Balance Brought Forward 463,786 14 8
To Proposed Final Dividend for the Year ending 31st December, 1919, on the Ordinary Shares at the rate of 15 per cent. per annum	183,547 4 0	Balance for the Year as per Account 1,220,739 12 5
To Proposed Final Dividend for the Year ending 31st December, 1919, on the Preference Shares at the rate of 15 per cent. per annum	37,500 0 0	
To Proposed Bonus for the year ending 31st December, 1919, on the Preference Shares and Ordinary Shares of 5s. per Share, without deduction of Income Tax	368,412 0 0	
To Balance carried to next Account	955,202 7 1	
	<u>£1,684,526 7 1</u>	<u>£1,684,526 7 1</u>

Marconi's Wireless Telegraph Company, Ltd.

REPORT OF THE TWENTY-THIRD ORDINARY GENERAL MEETING.

The Twenty-third Ordinary General Meeting of Marconi's Wireless Telegraph Company, Limited, was held on June 29th at the Connaught Rooms, Great Queen Street, Kingsway, W.C. Senatore G. Marconi, G.C.V.O., LL.D., D.Sc. (the Chairman of the Company), presided, and the other Directors present were Mr. Godfrey C. Isaacs (Deputy Chairman and Managing Director), Mr. William W. Bradfield, C.B.E. (Joint General Manager), Mr. Maurice A. Bramaton, the Right Hon. Lord Herschell, G.C.V.O., Mr. Alfonso Marconi, Captain H. Riall Sankey, C.B., C.B.E., R.E. (retired), Mr. Sidney St. J. Steadman, and Sir Charles J. Stewart, K.B.E.

The Secretary (Mr. H. W. Corby, F.C.I.S.) read the notice convening the meeting and the Auditors' Report.

The Chairman, who was received with cheers, said: Ladies and gentlemen, it is with great pleasure that I take the chair at this meeting for the first time since the general meeting of 1915, my absence having been due to circumstances caused by the war. That great upheaval, which absorbed so many activities, made it my duty to place my services unreservedly at the disposal of my country. I hope, now that I am relieved from rather important responsibilities at the Peace Conference, to be able to take up once more my active co-operation with the Company, especially in regard to my technical work. (Hear, hear.)

The Balance Sheet.

I assume you will approve of my waiving the formality of reading the Report and Accounts. I propose to turn at once to the balance sheet and profit and loss account, which you have before you, and will deal with the figures in so far as they may require comment or explanation. On the debit side the authorised capital has become £3,000,000 by the increase in Ordinary Shares of 1,500,000. The issued capital at the end of the year ranking for dividends in respect of the period under review remains the same as in the preceding year. At the end of the year there had, however, been issued 90,888 shares, fully paid up, and 1,152,742 shares partly paid, in respect of which £206,190 4s. had been received in part payment of the nominal value of the shares, and £349,219 15s. 5d. in respect of premium. There had been received, further, a sum of £22,139 in respect of new shares and premium, which at the end of the year had not been allotted. As you will, of course, remember, the capital of the Company was increased in November last by the creation of 1,500,000 new Ordinary Shares of £1 each, and in December the new shares were offered, share for share, to the existing shareholders at the price of £3 per share. The issue was well applied for by shareholders, and of the 1,473,000 odd shares offered nearly 1,400,000 have been allotted. I am not able to give you the exact figure, as there are still a few questions pending in respect of applica-

tions received from distant places abroad, communications in regard to which take a very long time. The whole of this new share capital ranks for dividend for the period commencing January 1st of this year. The next items in the balance sheet, "Bills payable, sundry creditors, and reserve for expenses unpaid, and receipts in advance, and other credit balances," call for no special comment. The reserve account shows the increase of £150,000, which you authorised to be placed to the credit of that account at the last Ordinary General Meeting. This item will be very largely increased by the transfer in due course of the premium received in respect of the new issue.

Turning to the credit side, the cash at bankers and in hand, largely in consequence of the moneys which were being received on account of the new issue, is a substantial sum. I do not think any of the other items, except the last one, require any explanation. There are, of course, variations in figures which necessarily arise in the ordinary conduct of business. The final item, "Shares in associated companies and patents," is treated in the same way as usual, that is to say, both shares and patents figure in our account at cost, and in the note is given their par value, except in cases where there is no capital denomination; in such cases no sum is added to the figure given in the note. The cost of shares is increased by reason of our having taken our proportion representing a considerable amount in the increase of the capital of companies abroad in which we have considerable interests and our acquiring shares in other companies to which I shall refer later. In addition, we purchased very valuable patents, to which we referred at our last meeting.

Profit and Dividends.

Turning to the Profit and Loss Account, the balance of contracts, sales, traffic and trading accounts amounts to £948,997 6s. 4d., which is approximately £180,000 over and above the preceding year's figures. There is, of course, added to this the sum of £590,000, which was received as damages for breach of contract. There remains a balance to be carried forward to Balance Sheet of £1,220,739 12s. 5d. This sum, added to the balance brought forward from the previous year, results in the very substantial sum of £1,684,526 7s. 1d.

On the debit side of the appropriation account there appears £17,500, representing the 7 per cent. dividend paid on the Preference Shares on February 2nd, and £122,364 16s., the interim dividend of 10 per cent. paid on the Ordinary Shares on the same date, and, subject to your approving the resolution which we shall submit to you, we propose to pay a final dividend of 15 per cent. on the Ordinary Shares, which will absorb £183,547 4s., a final dividend on the Preference Shares at the rate

of 15 per cent., which will absorb £37,500, and a bonus on both Preference and Ordinary Shares of 5s. per share, in this case without deduction of income tax, requiring £368,412. There would thus remain a balance to be carried forward to next account of £955,202 7s. 1d.

I have no doubt these figures will be regarded by you as highly satisfactory—(hear, hear)—and indicative of the continuous extension of our business.

Affiliated Undertakings.

Our affiliated companies and companies in which we hold interests are also making progress. The Marconi International Marine Communication Company, Limited, has declared a dividend of 15 per cent. for the year ending December 31st, 1919. In other companies situated abroad, in which we are largely interested, good progress is being made, and satisfactory dividends have been declared. The Amalgamated Wireless (Australasia), Limited, paid a dividend for the year ending June 30th, 1919, at the rate of 5 per cent., being the same as for the preceding year. The capital of the Wireless Press, Limited, has been increased to £50,000, and a dividend of 6 per cent. paid for last year. We are, of course, still in a position of uncertainty as regards our interests in Russia. We have heard nothing, however, to affect the information which we had previously received, and of which we informed you last year. The reconstruction of the Canadian Company has been completed, and it is now in a financially sound position. The new Managing Director is showing, as we expected, considerable ability and energy. I hope when we meet this time next year it may be possible to include that company with the many others which have entered the list of dividend-paying companies.

It is not expedient for me to speak in much detail of the many interests which we hold abroad, and the negotiations which are pending. You will perhaps be satisfied if I tell you that progress is being made each year, our interests enlarged and our organisation extended. The same remark applies to a considerable extent to many of our interests in the British Empire, and accounts in substantial part for the increase in cost to which I have previously referred, to the item in our balance sheet under the heading, "shares in associated companies and patents." There is included in the cost of these shares a sum of £248,057, which at the end of the year had a par value of approximately £55,000, but we regard the value of this to be considerably more than the £248,000 which figures in the books as its cost.

Unsettled Claims against Government Departments.

You will have learned from the Report that there having been no settlement with any of the Government Departments in respect of any of the Company's claims arising out of the war or for services rendered during the war, no sum in respect of any of these claims, therefore, figures in the year's accounts.

The arbitration to which we referred at our meeting last year, which had been agreed with the Admiralty in respect of the Lodge Patent, is

practically concluded: but Lord Moulton, who has acted as Arbitrator, has not yet delivered his judgment. We may, however, confidently expect to have this very shortly, and we think there should then be no reason for any further delay in coming to an amicable settlement of our claims against the Admiralty, the War Office and the Air Ministry.

With regard to the services rendered in respect of which we have a claim pending against the Post Office, we are still hoping that this also may be settled ere long in an amicable way. In this hope we have stayed our proceedings under our petition of right. We offered, in December last, failing an agreement with the Postmaster-General, that we would be satisfied to submit to any member of the Cabinet an agreed statement of the services which we have rendered and the costs incurred in connection with them, and accept the sum which he would award. We were advised by the Postmaster-General on May 14th last, that the matter was still under the consideration of the Government, but that he hoped a decision would be arrived at shortly. Perhaps we are not too sanguine in thinking that all these matters may be satisfactorily disposed of by the end of this year.

Transmission of Messages.

Our wireless telegraph service has been extended in many parts of the world, and messages can now be received by us for transmission to the United States of America, Italy, Canada, Newfoundland, Honolulu, Antigua, Jamaica, Trinidad, Barbadoes, Montserrat, Turks Island, Bermuda, St. Kitts, Porto Rico, British Guiana, St. Lucia, St. Croix, Dominica, St. Vincent, St. Thomas, Grenada, Tobago, Cuba, British Honduras, Bahamas, Admiralty Island, Australia, Tasmania, British New Guinea, Cook or Hervey Island, Fanning Island, Fiji Islands, Marshall Islands, New Hebrides, New Ireland, New Zealand, Norfolk Island, Ocean Island, Samoa, Tonga Island, Flinders Island, King Island, Woodlark Island, Solomon Islands, Tahiti, Panama, Colombia, Venezuela, Peru, Ecuador, Chile, Bolivia, Argentine, Paraguay, Uruguay, Mexico, Spain, Balearic Islands and Canary Islands. It must not be supposed, however, that these messages are handled entirely by wireless; it is only so in part, but our service arrangements enable us to receive and transmit messages to any of these parts of the world.

We hope that the day is not far distant when the whole service will be conducted by means of wireless telegraphy. We trust also soon to be able to announce many other countries to which wireless messages can be sent through our system. In this respect also, however, there are matters upon which we depend upon Government decisions. We are consequently not able to make the rapid progress we would wish, but it may be, and we are very much hoping, that so soon as we are able to proceed to a settlement with the many Government Departments, to which I have already referred, the facilities for which we are waiting will also be forthcoming. You may then look to very rapid development in a practical commercial way of both wireless telegraphy and wireless telephony.

COMPANY REPORTS

The Imperial Wireless Committee.

As you are aware, no decision has been taken in respect of the Imperial chain of wireless stations. In November last, however, the Secretary of State for the Colonies, as Chairman of the Imperial Communications Committee, appointed a Committee to prepare a complete scheme of Imperial wireless communications in the light of modern wireless science and Imperial needs; to consider what high-power wireless stations it is desirable on commercial or strategic grounds that the Empire should ultimately possess; to prepare estimates of the capital and annual cost of each station; the life of the plant and buildings as taken for the calculation of depreciation, to include an adequate allowance for obsolescence; to examine the probable amount of traffic and revenue which may be expected from each station, and to place the stations recommended in their order of urgency. The Committee was composed of a number of technical gentlemen, with Sir Henry Norman as Chairman.

I may safely claim that no company in the world, or Government, possesses as much knowledge or experience of matters such as the Committee were asked to consider as does this Company. We were the first to conduct a long-distance wireless telegraph service; we are the only ones to have conducted such a service from this country, and the knowledge, experience and information which we possess as a result of our many years' work is very valuable to us, and would be of the highest value to many others.

Why the Company Declined to Give Evidence.

We were therefore most regretfully obliged to decline to give evidence before this Committee so long as Sir Henry Norman was Chairman of it. We could, I think, have taken no other course having regard to the correspondence which you will no doubt remember, some of which has been published, which Sir Henry Norman conducted right up to the outbreak of war. This correspondence could leave no possible doubt that Sir Henry Norman was biased against the Marconi Company.

Our Managing Director felt obliged to address a letter to the Prime Minister in which Sir Henry Norman's evidence in our Courts, and his letters to Germany, were quoted side by side, and he protested against Sir Henry Norman continuing to sit as Chairman upon any National Wireless Committee. I think you will all agree that he was fully justified in this protest, and we may reasonably assume that the Prime Minister and other members of the Government did not differ from his view; at least that is what one must infer from the letter which our Managing Director received, dated March 3rd last, which you will remember was also published, but of which I will remind you. It was written by the Prime Minister's private secretary, and said:—"The Prime Minister desires me to say that he has again been considering the matter which you brought to his notice in a recent letter and that he has also discussed the matter with Mr. Bonar Law. I am to say that Sir Henry Norman will not consent to resign his Chairmanship of the Wireless Committee. In these circumstances

the Prime Minister has no objection to your publishing the correspondence if you wish to do so."

There can be little doubt that this letter means that Sir Henry Norman had been advised to resign his chairmanship of the Wireless Committee, and one must assume that he had refused to do so, and that there was no power to enforce his resignation. Sir Henry Norman is a Privy Councillor, a baronet, and a member of Parliament. His evidence in Court and his letters to Germany have been published; they cannot be reconciled with each other, and he has not attempted to do so. We shall probably hear more of these matters ere long, for the report of this Committee has now been published. We have not had the advantage of seeing a copy of it, and knowing nothing more than can be gleaned from the extracts which appear in this morning's papers. It is no doubt no more than a coincidence that the report, although dated May 28th, should be published on the day of our General Meeting. I have in the circumstances no opportunity of considering it with the necessary thoroughness which would allow of my speaking to you upon it. We may, however, find another occasion to do so shortly. (Hear, hear.) The question will soon be before Parliament, and meantime no doubt it is receiving the consideration of the Cabinet, together with the proposal which this Company has submitted.

The Marconi Scheme.

We have put forward a scheme under which we are prepared to erect for our own account and at our own cost a very complete chain of wireless stations throughout the whole Empire, which will not cost the country a single penny. Not only that, but we have offered that 25 per cent. of the profits derived from the service, after making proper provision for interest on capital and amortization, shall belong to the State. In the hands of private enterprise this 25 per cent. should represent a very considerable sum indeed. (Cheers.)

With reference to technical progress, I can say that very considerable advances have been made by Captain H. J. Round (one of the technical assistants of the Company) in the practical application of what are termed ionic valves, especially in regard to long distance transmission, and also in the efficiency of the general arrangements employed at our high-power stations. The new valves have not only proved their usefulness for long-distance work, but have also considerably increased the range and practicability of what are termed medium and short-distance stations. Many new patents, which I consider of value, have been taken out or applied for, and a new device, with which I first carried out tests on ships of the Italian Navy, has been considerably developed by Mr. C. S. Franklin. By means of this arrangement the electric waves are propagated in a beam in any desired direction only, instead of being allowed to spread out in all directions. The advantages of this system are obvious, as it absolutely prevents stations outside of a certain angle being able to receive messages or signals which are not intended for them, besides greatly reducing mutual interference. In addition, it is likely to be of inestimable value to ships and shipping as an aid to navigation during fogs, and in minimising

all risks of collision. In order thoroughly to test this and other similar devices under the actual conditions prevailing at sea, I have lately equipped an ocean-going yacht with all the necessary apparatus, and, during a recent voyage to the Mediterranean, the great value of direction-finding appliances was most clearly demonstrated. We were able to navigate safely the vessel in very thick weather round Cape Finisterre, and other dangerous coasts, entirely by means of a wireless compass, and in a manner which would have been utterly impossible with the old arrangements. These tests are being continued and developed, and I foresee very considerable advances in the practical application of these new aids to navigation. Other successful tests with a new apparatus applicable to lighthouses and lightships have also been carried out for the authorities at Trinity House.

Wireless Telephony.

Great progress has also been made not only in wireless telegraphy, but in wireless telephony, which must soon be turned to very considerable commercial account, both in respect of telephoning without wires and in the application of our recently-acquired knowledge to telephones with wires. Practical application of these new principles has already been made in America and in Germany. The German Post Office authorities are applying the latest knowledge acquired with regard to wireless inventions, so as to increase tenfold, or more, the capacity of all their telegraph and telephone lines throughout the country. There is no doubt that this lead will probably be followed one day in this and in other countries.

It will interest shareholders to know that by our arrangements we benefit by the principal wireless organisations of America, France, and Germany. We are in close touch with their research work, and have the right of use of their patents in most parts of the world, and a sole licence for the whole of the British Empire.

Ladies and gentlemen, before concluding, I wish to express the appreciation not only of myself, but of the Board of Directors, to Mr. Godfrey Isaacs, our Managing Director (cheers), whose hard and untiring work, and whose zeal for the interests of the Marconi Companies, which he has so ably managed for a number of years, have been unsurpassable. The great ability with which Mr. Isaacs is gifted has not only enabled him to solve all kinds of intricate problems connected with the development and management of our world-wide enterprise, but, in many instances, it has made it possible for him to foresee some of these problems before they have arisen. (Cheers.)

I now beg to move, "That the Report of the Directors submitted, together with the annexed statement of the Company's Accounts at December 31st, 1919, duly audited, be received, approved, and adopted," and I will call on Mr. Godfrey Isaacs to second the motion.

Mr. Godfrey Isaacs on the Norman Committee's Proposals.

Mr. Godfrey C. Isaacs (Deputy Chairman and Managing Director), who was received with cheers, said:—Ladies and gentlemen, before seconding this

motion I would like, in the first instance, to thank our Chairman for the words which he has used so complimentary to me, and you also for the way in which you have received his observations. I had not contemplated saying very much to you to-day, as I think the ground has been very well covered by our illustrious Chairman. The publication, however, of extracts from the Committee's report seems to necessitate my saying something to you on that subject. Mr. Marconi told you that we have only so far seen extracts from that report as they have appeared in the morning papers. Just as I was coming to the meeting I had a copy of the Committee's Report placed in my hands. It is, as you see, a very long report, and I have not even had time to read it all through yet, but I have seen some few things in it which are interesting, and about which, perhaps, I may even, at this short notice, say something to you which, I hope, will be of some interest to you, and perhaps give you a little consolation. I am sure you must feel that you want that consolation after reading this morning's papers. ("Hear, hear," and laughter.) Well, now, first of all, I want to remind you that this Committee is composed of a number of gentlemen, all of whom are purely technical, except the Chairman, Sir Henry Norman, and one other member, who is an assistant secretary of the Post Office.

Basis of the Report.

The Report, in my view, apart from the technical information which it gives—which is very interesting, and which is highly satisfactory to the Marconi Company—is one which is obviously guided by the very clever hand of an experienced Chairman of Parliamentary Committees, and I do not think we want a very great stretch of imagination to know how easy it would be to obtain the unanimous support of a number of technical gentlemen to the views so cleverly put forward in this Report, and which would appear to technical gentlemen to be so natural, particularly when you bear in mind that all the substance which this report contains, and upon which I might say, it is founded, so far as the commercial side of the question is concerned, is based upon figures and information which were supplied by the Assistant Secretary of the Post Office. The Assistant Secretary of the Post Office in this case was Mr. F. J. Brown, and I think you will agree with me that the evidence and the immense information which Mr. Brown put before the Court in July, 1919, necessarily committed him to the evidence and information which he would give to this Committee. There were reams of paper containing figures which were put forward to endeavour to belittle the Marconi claim, which was before Mr. Justice Lawrence last year, and these figures showed, according to Mr. Brown, that the possible services of the Imperial stations, had they been constructed, would have resulted in such a small number of words transmitted and received, such small gross receipts, that the total value of the whole contract, had it been carried out, would not have exceeded £47,500. (Laughter.) Well, that was a matter which, as you know, was then very fully threshed out in Court, and the Judge did not accept Mr. Brown's views: in fact, instead

COMPANY REPORTS

of estimating the value of the contract at £47,500, he, if I remember rightly, put it approximately at £1,200,000, which reduced to present-day value brought it down to some £500,000. I mention those figures only to indicate upon what sort of material this Report is based. The Report deals with very much the same figures as were placed before the Court, and I am inclined to think that, when the matter is considered a little later by Parliament, the figures which will be looked into will be, perhaps, very different from the figures which have formed the basis of this Report, and which were put before the Court in 1919.

Technical Side of the Report.

The technical side of the Report is very interesting. I cannot find the reference in the Report which I have received, but I will quote from a morning newspaper. "The three chief factors of a satisfactory commercial service are reliability, speed, and cheapness. For this reason the system of the thermionic valve, which has revolutionised wireless practice in the last five years, is recommended." Well, ladies and gentlemen, if any of you followed what took place a year ago, you will remember that the Post Office declared in Court, before Mr. Justice Lawrence, that the Poulsen arcs which they were then erecting were a most efficient and up-to-date service, and that they would do all that was required, and they required no patent. No Marconi patents were required for the purpose. Our evidence was to the effect that the Poulsen arcs belonged to the Marconi Company, but that they were obsolete, that wireless telegraphy had made great strides, and that the thermionic or ionic valve had superseded the Poulsen arc. Ladies and gentlemen, I think that was ridiculed by the Post Office a year ago. It is, therefore, some satisfaction to know to-day that the Committee of experts who have inquired into this matter declared that great strides had been made during the past five years by reason of this thermionic valve. I agree that great strides have been made, and I think that greater strides are being made daily. I have seen from the Report sufficient to know that they had very little information of an up-to-date character before them, and it is perfectly natural that they should have very little up-to-date information, for the only people who had that knowledge are ourselves. (Hear, hear.)

Question of State Ownership.

There is one thing more I want to say upon that point. It is recommended here, quite cleverly, outside the terms of reference, but just what one would have expected, that these stations should be State-owned. It is true that it is put a little bit cautiously. On page 16 they say: "The question of State ownership *versus* private ownership of Imperial wireless communication not coming within the terms of our reference, we are restricted in our examination." Not coming within the terms of our reference. I agree. It did not come within the terms of their reference, but notwithstanding the fact that it does not come within the terms of their reference, they make quite a strong point of placing before the Government the great advantages that would accrue if they were State-owned and controlled

by the Post Office. I think we all know—if this Imperial chain of stations were controlled by the Post Office—we all know what a great chance for utility it promises in the near future.

At all events we do know this, that Mr. Brown, on behalf of the Post Office, in 1919, told the Court that the service of the Imperial chain of wireless stations would necessarily be limited, even though his calculations were wrong, and ours were right, because he said, "If we found that the Imperial chain of stations did more than what we say, then we should have to raise the prices of wireless telegrams in order to protect the cable companies." (Laughter.) That is the sort of thing we have in front of us if we are going to have an Imperial chain of stations controlled and worked by the State or by the Post Office. I do not believe we are. I am very confident that we are not, notwithstanding this very able Report. (Hear, hear.)

Ownership of Patents.

Let me assume for a moment, however, that I am wrong, and that the stations are going to be built by the State, and they are going to be worked and owned by the State. What is our position? They must have the thermionic valve, the technical committee says so. Right. They must have it, besides a good many other things, but they must have that. The thermionic valve is controlled by a number of very important master patents. Some of them—most of them—are taken out by gentlemen in the Marconi Company; some of them—very important ones—are taken out by very able people in America, and there are others equally important which belonged to the Germans. All of us, in Germany, in America, and here, have devoted ourselves very much to this great development in wireless telegraphy, and it is only natural that each should have discovered something that is of value in connection with this thermionic valve. Well, ladies and gentlemen, the thermionic valve is covered by master patents taken out in America, Germany, and England. I do not care which form of thermionic valve is used. I do not care whether it is American, whether it is German; or whether it is English, because every one of these patents—every one of these master patents—is the property for the whole of the British Empire of the Marconi Wireless Telegraph Company. That being so, ladies and gentlemen, where in this Report and in the estimate of costs does the Committee deal with the 10 per cent. of the gross receipts to which the Marconi Company would be entitled, how do they show that they are going to avoid paying to our Company 10 per cent. of the gross receipts, if they carry out their own recommendations? If we do not build these stations we shall be entitled to a very substantial royalty, and I do not see how that royalty can be anything different from what the Government itself found fair a few years ago. What was fair and proper then, I think they would be obliged to pay us in future, assuming that they have recourse to the recommendation of this Committee. I fear nothing at all from this Report, and when I have had more time to study it, and have had the assistance which I shall receive from others in connection with the Report, I hope that we shall be able to dispose of many of the

things which, appearing as they do as extracts in the morning Press, must be very alarming to many of you, but, I assure you, were not alarming to us. (Hear, hear.) I think I have said all I need say upon this subject at the moment. You may be perfectly certain that we shall not sit still. I will now conclude by seconding the resolution which has been submitted to you, and I and the Chairman will reserve to ourselves the possibility of answering any questions which touch on the commercial side of the Company which you may wish to put.

Shareholders' Views on the Committee's Report.

The Hon. D. O'Brien.—It occurs to me that the Shareholders might care to follow the suggestion that I propose to make, assuming it is one which meets with the approval of the Board. It is this: that the Report and Account should be adopted, but that the meeting should be adjourned to receive at a later date a considered comment by the Board on the Report of the Wireless Committee, which has just been handed out. If that is a proposal that meets with the views of the Board, I shall be glad to propose it. It might be desirable, and give an opportunity to the Board of commenting on this document.

Mr. Godfrey Isaacs.—I quite appreciate the suggestion made by Mr. O'Brien, but I think that it would be a matter best left to the discretion of the Board. (Hear, hear.) We do not know what is going to happen in the immediate future. We might fix a meeting when it might be very inconvenient to us to come here and discuss the matter at all. When the time is ripe, then, I think, you may rely upon it, if there is any utility in it, that the Board will convene a meeting. (Cheers.)

The Hon. D. O'Brien.—Am I out of order in making any remarks in connection with the importance of these contracts? We, as Shareholders, should not lay too much emphasis on the importance of the contract this Committee proposes. The total amount of the contract is £1,250,000. We may well be disappointed that a much larger scheme is not proposed which would have involved a very large contract, possibly to the Marconi Company or other commercial undertaking, but the value of the business which it is proposed that the Government should transact is a contract to the value of £1,250,000. Now, gentlemen, let me put it to you in this way, assuming that that contract had been placed with the Marconi Wireless Company, and assuming there had been a net profit of 10 per cent. on that contract, the profit to the Wireless Company would be £120,000 for two years, or £60,000 a year for two years. Gentlemen, if you look at the total amount of the sales in respect of contracts and other business in the profit and loss account, you will see that it amounts this year to just under a million pounds. This single contract would show a profit to this Company of only one-ninth of its present sales and contracts. Consequently the contracts in itself amounts to a very small part of our yearly earnings. It will possibly offer the Government a good opportunity of seeing that if the money is expended they will have to come back at a later date to the Marconi Company for a more satisfactory service. At any

rate, we need not throw our shares away owing to the prospective loss of such a small profit which bears such a small relationship to the total turnover of the Company. (Cheers.)

Criticism of Government Control.

Mr. Godfrey Isaacs.—Upon the question of the size of the contract, I might tell you that the estimates made here are perhaps just as erroneous as the figures upon which the whole estimated receipts under this scheme should be received are based, and I think that when this matter is inquired into further that will be so self-evident that the figures of costs here will at once be put aside by Parliament, and probably members of Parliament will be able to appreciate why they were put at so low a figure. I do not think there is much disposition in the country to-day to approve of any expenditure by the country which can be avoided. (Hear, hear.) I think we have had enough of that for a very long time. I think the only chance that there would be of Parliament acceding to any expenditure might be in the case of the figures put before it being very small and insignificant, and, therefore, perhaps, worth while. The item of £1,200,000 which it is estimated this work would cost is, I should say unhesitatingly, absolutely absurd, and I say that, speaking with all the knowledge which we, as the Marconi Wireless Company, possess as to what this sort of thing means. I will remind you that we started building two stations under the old Imperial contract, one of them in Oxford and the other in Egypt, and after the expenditure of a few hundred thousand pounds the work was stopped. It was then taken up by the Post Office, and the first thing they did, for those two stations alone, was to go to Parliament and ask for supplementary estimates of, I think, £280,000 to carry on these two stations. Well, they are not built yet; they were going to be opened a long time ago, but they have not been completed yet, and it will surprise me very much indeed if that £280,000 completes the construction of those two stations. I very much doubt it, and if it does complete them, they will, I think, have to go to Parliament for a further supplementary estimate to pull them down again, for they built with the old arcs which this Committee says won't do, they must have the thermionic valve. (Laughter and cheers.)

Attitude of Sir Henry Norman.

Mr. A. Lyle Samuel.—I venture to think, in this large and representative body of Shareholders, that one of the most pleasant things that the Chairman has said in his speech was the tribute which he paid to our Managing Director, Mr. Godfrey Isaacs. (Hear, hear.) Not merely has Mr. Godfrey Isaacs been confronted with the ordinary kind of difficulties in managing a large commercial concern, but he has had to fight principalities and powers of darkness which he ought not to have to do. In other words, he has not been given a square deal, and I should like to inform him, for his own consolation, that he has the entire confidence of the Shareholders of the Marconi Company, who feel that they are under a debt of great gratitude to him for the splendid way in which he has managed the affairs of the Company. (Cheers.) I should like

COMPANY REPORTS

to say one word about the Report which, as Mr. Isaacs has said, most casually appeared this morning, on the day of our meeting. There was one thing in that Report very clear to me—namely, that the decision of the Chairman of the Committee was that, in no circumstances, should the Marconi Company have the contract. I believe that was the underlying conviction and intention of the Chairman from the very beginning. The Committee have published a Report which, I hope, will interest taxpayers, because you will notice there is to be a sustained loss of about £40,000 odd a year for working, but they hope and believe that, after 10 years of State management, that loss may disappear. (Laughter.) Here is an alternative offer to them by which, without raising any fresh capital on behalf of the State—and heaven knows the State has raised enough capital, for whatever purposes, good or bad—here is our offer, by which there will be no charge to the Exchequer whatever, but there will be a net annual revenue in relief of taxes. I have no great opinion of Government Departments either for capacity, or even, I will go so far as to say, for commercial integrity. I am sorry to say it, but I have had considerable experience with reference to certain large contracts, and if this was an appropriate occasion, I could tell you how difficult I have found it to contend with Government Departments for the past twelve years. The satisfaction we have at this moment is that they have decided to adopt the scheme which originally was put before them 12 years ago, but it was put before them in order to meet a certain state of circumstances, and they have now decided to adopt it *en bloc*. Having regard to the new conditions, however, the whole thing would be perfectly ridiculous and a source of great expenditure to the taxpayer. That is how these things are done, and I only rose to say that I did not think any Shareholder ought to take seriously this Report, or to fear it. As one gentleman says, he is not going to throw his shares away; but I can assure you that, if anybody is going to throw these shares away, I venture to think that there will be a great many people very happy to receive them. As I said in my opening remarks, I merely rose to express the great confidence we have in Mr. Godfrey Isaacs, and I trust that this confidence will be shared by the meeting.

Mr. Barnes.—I should like to know if there is any information you can give us about the American Company. Some of us have not received certificates with regard to those we sent away, and I did not catch what you said with regard to what the American Company is doing. We were led to understand there would be something coming from the American Government—from the original Company—and they would get some shares in the new Company. Last year it was mentioned that the Preference Shares would be dealt with, and placed in the same position as the Ordinary Shares. I take it that the new shares will reap the benefit of any bonuses that are declared.

Mr. Godfrey Isaacs.—With regard to the American Company all the information was given at the last meeting we held, and circulars have been issued by the American Company which should have

provided the Shareholders with all information they require. If there is anything more that you want to know, if you will apply to the office of the Company I am sure that the Secretary will be very glad to give you the information. With regard to the Preference Shares we told you at the last General Meeting that we hoped to put forward a proposal under which the Preference Shares might be converted into Ordinary Shares. We have given that matter a great deal of consideration, but we find that there are too many technical difficulties in the way. I do not think that it is an easy thing to do, and I cannot recommend doing it. With regard to the new shares, you have quite correctly understood that in any further bonus declared the new shares will participate. In fact they participate in everything from now onwards, after the payment of this dividend and bonus.

The resolution was then put to the meeting, and carried unanimously.

The Dividend Resolutions.

Mr. Godfrey Isaacs.—Ladies and gentlemen,—I have to move:—

“That a final dividend of 15 per cent., equal to 3s. per share, less income tax, upon the 1,223,648 Ordinary Shares numbered 1 to 500,000 and 750,001 to 1,473,648, inclusive, be and the same is hereby declared for the year ended 31st December, 1919;

“That a final dividend of 15 per cent., equal to 3s. per share, less income-tax, upon the Cumulative Participating Preference Shares be and the same is hereby declared for the year ended 31st December, 1919;

“That a bonus of 5s. per share, without deduction of income-tax, upon the above mentioned Ordinary and Preference Shares be and the same is hereby declared for the year ended 31st December, 1919;

“That the said dividends and bonus be payable on the 31st July, 1920, to Shareholders registered on the books of the Company at the 21st June, 1920, and to holders of Share Warrants to bearer.”

The Right Hon. Lord Herschell, G.C.V.O.—I beg to second the motion.

The resolution was carried unanimously.

Captain H. Riall Sankey, C.B., C.B.E., R.E.—I beg to move:—

“That the Right Hon. Lord Herschell, G.C.V.O., the Director retiring in accordance with Article 74, be re-elected a Director of the Company.”

“That Senatore Guglielmo Marconi, Mr. Henry William Allen, and Mr. Alfonso Marconi, the Directors retiring in accordance with Article 81, be re-elected Directors of the Company.”

Sir Charles Stewart, K.B.E.—I have great pleasure in seconding that motion.

The resolution was carried unanimously.

Mr. W. H. Christian.—I have much pleasure in moving “That Messrs. Cooper Brothers and Co. be re-elected auditors for the ensuing year, and that their remuneration for auditing the accounts to December 31st, 1919, be 800 guineas.”

Mr. Arthur Hudson, K.C.—I have much pleasure in seconding that resolution. For once I am a barrister who does not stick to his text; I want to say how much I thank the Chairman and Mr. Godfrey Isaacs for the full and frank reports they

have given us as to the outlook of the Directors in relation to this Report which has just been issued. I expect that when we read the papers this morning we did feel perhaps a little depressed, but for myself, after a moment's reflection, I determined that I was not going to lose faith in this Company, whose fortunes I have followed for many years. I began to take an interest in the Marconi shares when they could be purchased at a price of something over £7. I followed them through their various vicissitudes when sometimes the outlook was rather depressing. I think I purchased a good many of the shares when they were as low as 1½, and I still went on buying until I bought some, just before the last issue, at nearly 6. I do hope that not only the Shareholders here present, but the great body of Shareholders who will read this report, will not for a moment allow themselves to get hold of any pannicky sort of feeling, and so bring down the monetary value of the shares. As a personal matter, I am bound to say that I think it would have been wise if Sir Henry Norman had retired

from the Chairmanship of this Committee in view of the previous history of his relationship to the Company. It is, of course, very difficult for one person to lay down a moral line of conduct for another. Still, however, my personal opinion is that it would have been wise for Sir Henry Norman to have retired, and I think the Report which has just been issued would have been of much greater value if he had done so. (Cheers.) I very gladly second the resolution.

The resolution was carried unanimously.

The Chairman.—I think that completes our business, and I thank you very much for your attendance.

Mr. Arthur Hudson, K.C.—Before the meeting separates, I am sure everyone would like to pass a vote of thanks to the Chairman for presiding and for giving us so much information. If everyone agrees, I hope they will show it in the usual way. (Cheers.)

The Chairman.—Thank you very much.

The proceedings then terminated.

THE IMPERIAL WIRELESS COMMITTEE (1919-1920).

The Report of this Committee, published just as we go to press, and which can be obtained from H.M. Stationery Office, price 6d. net, contains the following recommendations :

1. That a scheme of Imperial wireless communications be established connecting the communities of the Empire by geographical steps of about 2,000 miles each, as indicated on the accompanying map.

2. That the wireless system employed be that involving the generation of radio-telegraphic energy by thermionic valves.

3. That the service of communication between Leafield and Cairo by Poulsen arcs, shortly to be in operation by the Post Office, be the first link in the chain of communication with the British communities in Africa, and that this communication be continued by a valve station near Nairobi, in East Africa, and by the alteration of the ex-German station at Windhuk to a valve station, to complete the connection with the Union of South Africa.

4. That for communication with India, the Far East and Australia, valve stations be erected in England, near Cairo, at Poona (or other Indian station), at Singapore, at Hong Kong, and in Australia at Port Darwin or Perth.

5. That similar communications be established by valve stations between England and Canada, subject to decision in conference between the Imperial and Canadian Governments.

6. That the stations be planned by a Wireless Commission of about four members, as herein described, whose functions would probably cease

with the completion of the stations, and that the construction of the stations be entrusted to the Engineering Department of the General Post Office and the corresponding Dominion and Indian authorities, according to the plans furnished by the Wireless Commission.

We find :—

1. That an Imperial wireless scheme established in this manner would afford reliable, expeditious and economical communication for commercial, social and press purposes throughout the Empire, and that it would meet essential Imperial strategic requirements.

2. That estimates of revenue and expenditure indicate an initial annual loss, after paying interest at 6½ per cent. on capital, and allowing for complete amortization of buildings and plant within a proper period, of about £100,000, divided as shown between the Imperial Government and the other Governments concerned, but that (a) this loss, which was to be expected, may reasonably be regarded as likely to decrease annually, until after ten years the service will show a profit; (b) the system recommended is probably the most economical that will produce the results required, and at the same time be in accord with present wireless science and future wireless developments; and (c) the small temporary loss is negligible in comparison with the Imperial benefits to be conferred.

Engineering
Library

UNIVERSITY OF
NORWICH
JUL 9 1920
GENERAL LIBRARY

The WIRELESS WORLD



VOL. VIII No. 9, NEW SERIES]

24th JULY, 1920

[FORTNIGHTLY

CONTENTS

THE ELECTRIC SPARK.

THE STORY OF THE TELEPHONE.

A SIMPLE WIRELESS TELEPHONE SET.

THE USE OF REACTION WITH A FRAME
AERIAL.

DAMPED AND UNDAMPED WAVES.

PRICE 6^D NET

BE A WIRELESS
MAN. WE TRAIN
YOU QUICKLY !!

Write for free Book
"THE WIRELESS
CALLING."

Provincial Wireless Colleges Ltd.

Digitized by Google

Original from
UNIVERSITY OF WICHITA

:: Principal
HENRY A. FLICE

RADIO HOUSE
39, ST. GILES
NORWICH

McGRUER SPARS

The ACME of STRENGTH and
LIGHTNESS.

This Hollow Wooden Structure is ideal for **WIRELESS MASTS** (telescopic or in one length), **AERIAL SPREADERS**, **INDUCTANCE FORMERS**, etc.

MASTS of any length can be constructed by this unique method, where high insulation is required the advantages gained are infinite.

McGRUER HOLLOW SPARS do not hold the damp like solid poles.

HOLLOW AERIAL SPREADERS are an enormous advantage. We specialise in these and have a range of sizes from 2 ft. 6 in., weighing 8 ozs., to 12 ft., weighing 7 lbs. The smaller sizes have a double grooved block at each end for bridle and aerial wires; and the larger a two-eye crane is fitted. These Spars are double tapered and are very strong and light.

WRITE FOR BOOKLET.



COMMERCIAL ROAD,
LAMBETH, LONDON, S.E.1

Telephone: Hop 718.

Teleg.: "Ollosparrsh, Watloo, London."



THE BRITISH SCHOOL of TELEGRAPHY *Ltd.*

179, CLAPHAM RD.
LONDON, S.W.

EXPERT TRAINING FOR YOUNG GENTLEMEN (15-25) IN INLAND, CABLE & WIRELESS TELEGRAPHY. Good appointments are open to our students as soon as qualified, the demand for Skilled Operators in all Services being greater than the supply. Special Short Course suitable for men wishing to obtain Government Certificate and enter the service of the Marconi Co. At several recent Government Exams, all candidates obtained 1st Class Government Certificate. No Branches or Postal Tuition. Fees moderate. Recognised by the War Office, Admiralty, Wireless Telegraph and Cable Companies.

WRITE FOR PROSPECTUS. A. W. WARD (Manager). 'Phone: BRIXTON 215

THE WIRELESS WORLD

THE OFFICIAL ORGAN OF THE WIRELESS SOCIETY OF LONDON

VOL. VIII. No. 9.

JULY 24TH, 1920

FORTNIGHTLY

THE ELECTRIC SPARK

By PHILIP R. COURSEY, B.Sc., A.M.I.E.E.

EVERYONE is familiar with the electric spark in one form or another. The lightning flash is but a huge spark, often some miles in length, but nevertheless of exactly similar nature to those we can produce in the laboratory by ordinary electrical apparatus. The theory of thunderstorms, and of the precise mode of formation of the lightning discharge, need not be discussed here, but it will be sufficient for our purpose to consider what causes give rise to the production of electric sparks, what is their nature and the properties of such discharges.

If we take two metal spheres, mount them upon insulating supports some inches apart and then connect them to some convenient source of electric voltage of which we can vary the magnitude, we may observe a definite series of phenomena as the applied voltage is gradually raised. At first there is no apparent change, but later a point will be reached at which first one and then both of the balls will become surrounded by a bluish luminosity. This is particularly noticeable when the size of the balls is fairly small compared with their distance apart. A further small increase

of voltage and the luminosity spreads out into the space between the balls, in the form of irregular streamers. This is known as the "Brush" discharge—so called from its appearance (Fig. 1). Finally, with any further voltage applied to the spheres a disruptive discharge or spark flashes over between the electrodes.

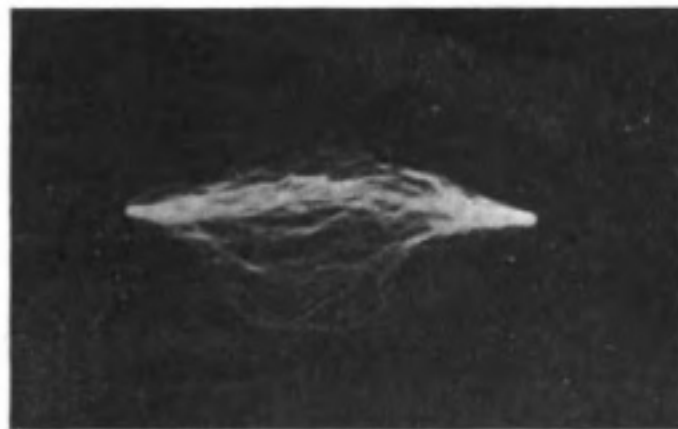

*An electric spark, showing the irregular paths followed by the discharge.**

To form a visual conception of the processes taking place which lead up to this breakdown we may picture to ourselves the gradual piling up of the electrons on one of the metal spheres forming the electrodes of the spark gap we have been considering. When we increase the voltage between the two spheres, what we are

really doing is adding electrons to one sphere and taking them away from the other. We do not maintain a steady flow of electrons into one sphere and out of the other, since before the visible discharge is set up there is no appreciable current flow across the gap, but for each increase of voltage we add a few electrons to one sphere and remove the corresponding number from the other.

* This photograph, and also Fig. 1, were taken in the Testing Dept. of the Dubilier Condenser Co., Ltd.

The increase of the number of free electrons on one sphere is equivalent to an increase of its negative potential, while the removal of electrons from the other leaves the atoms of the metal constituting that sphere in the form of positively charged ions.

The electrons on the one sphere are attracted to the positively charged ions on the other across the intervening space, but the dielectric strength of the air between resists their passage across the gap. When finally the electric stress in the air becomes so great that breakdown commences, the electrons leave the surface of the negatively charged sphere with considerable velocity,

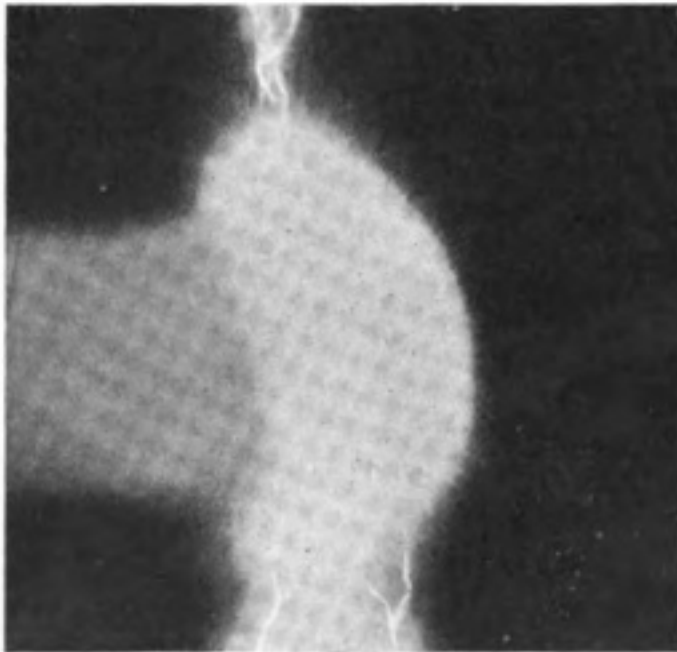

Fig. 1. Brush Discharge.

and, in doing so, strike against and break up the molecules of the air, thus ionising them and in consequence making the air conductive. It is this bombardment of the gas molecules by the rapidly-moving electrons that gives rise to the luminosity round the spark ball. When the balls are separated by a distance of several times their diameters, the electric stress is most concentrated near the surface of the electrodes and, consequently, breakdown commences at these points. The ionised layer—and the glow—spreads out round the ball (or wire) until the diameter of the outside of this gaseous conductor becomes sufficiently great for the electric

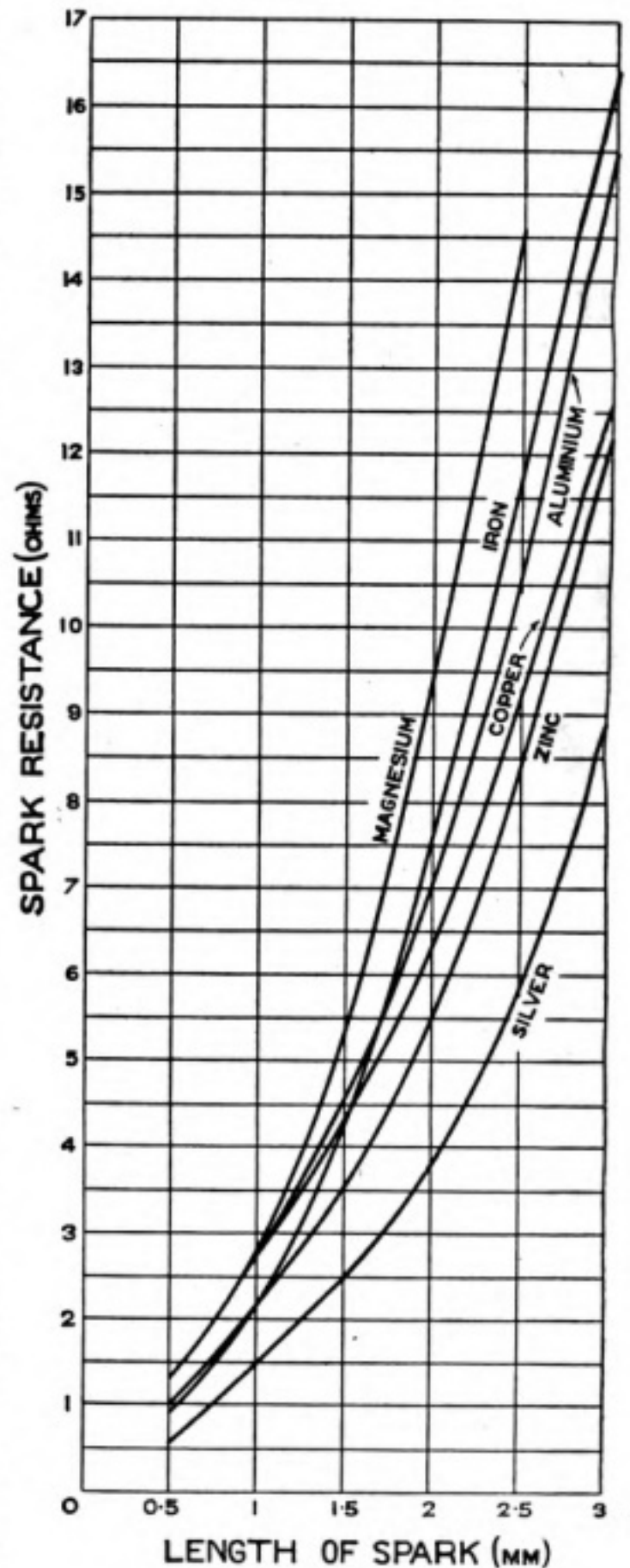

Fig. 2. Resistances of sparks between 1 cm. diameter spheres.

THE ELECTRIC SPARK

stress at its periphery to fall to a value below the breakdown strength of the air. The remainder of the space between the electrodes therefore remains dark and no discharge passes right across.

This explains why no glow discharges are usually observed with short spark gaps, when the length is less than the diameter of the spark balls, as in those cases the electric stress is almost uniform right across the space, so that when breakdown once commences it extends right across and a spark passes.

The luminosity, then, of the spark is due mainly to ionisation and heating by electronic bombardment of the gas molecules, and is not due to any great extent to the electrodes themselves, or to the material of which they are constructed. This forms one of the distinguishing features between sparks and arcs.

From a wireless point of view the great feature of a spark is its suddenness—particularly in the case of short sparks in which, as we have seen, the breakdown when it starts is complete and not gradual—and the facility that it gives us of suddenly closing a previously open circuit by a path of comparatively low resistance, thus enabling us easily to set up oscillations in the circuit connected across the gap. Curves showing the resistance of spark gaps of varying lengths are shown in Fig. 2.

It was discovered in 1842 by Professor Henry that when a charged Leyden jar was suddenly discharged through a path of low resistance, the discharge current was no longer in one direction only, but oscillated backwards and forwards first in one direction and then in the other. An oscillatory current of such a type is capable of setting up electromagnetic waves in the aether as was shown by Hertz* using very simple apparatus.

In many modern wireless transmitters spark gaps are still used to discharge a charged condenser through a coil possessing inductance so that powerful oscillations are set up. The great feature of the spark gap for this purpose is that, until breakdown occurs, the gap is an

almost perfect insulator, and therefore does not hinder the charging up of the condenser to a high voltage from the supply transformer or other source; but as soon as the voltage reaches the critical value, breakdown occurs and the spark forms a momentary low resistance path for the oscillations.

The oscillatory nature of such a spark—which, to the eye, is a perfectly steady phenomenon while it lasts—may be shown up by examining the spark in a rotating mirror driven round at a sufficiently high rate of speed. Were the spark perfectly continuous we should see a uniform band of light in the mirror; but, instead, we see a number of bright dots spaced at regular intervals from

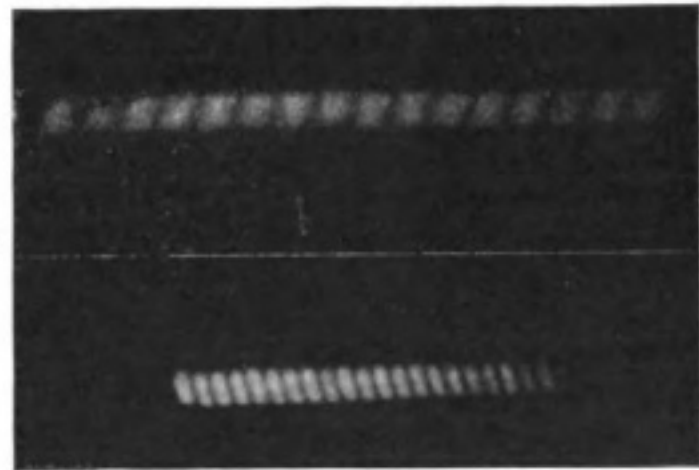

Fig. 3. Photographs of oscillatory sparks.*

one another, these being the successive breakdowns of the gap corresponding to each successive half-wave of the oscillation. Two typical photographs showing this feature are given in Fig. 3, and in them the successive discharges may be clearly seen.

The number of such discharges that occur before the spark dies out and the condenser is recharged depends upon the decrement of the oscillation circuit—that is, upon the rate at which the successive amplitudes of the oscillatory alternations decrease. This quantity is influenced greatly by the resistance in the circuit (the frequency and inductance being other determining factors), but is also dependent to some extent upon the material of the electrodes (*see* curves in Fig. 2) and upon the form given to the spark gap.

* Photographs kindly supplied from Marconi's Wireless Telegraph Co's Works.

* See earlier article "The Discovery of Electromagnetic Waves," *Wireless World*, 8, pp. 73-75, May 1st, 1920.

THE STORY OF THE TELEPHONE.

PAST, PRESENT AND FUTURE.

By WILLIAM D. OWEN, A.M.I.E.E.

ALEXANDER GRAHAM BELL, the inventor of the telephone, was a Scotsman. From his earliest days he was influenced by his environment to study the problems of speech and hearing. His father, Alexander Melville Bell, was the inventor of a system of "visible speech" designed to assist deaf-and-dumb mutes. His grandfather taught the laws of speech in London University.

It is said that the conception of the idea that led up to the invention of the telephone took place during a triangular conversation with Sir Charles Wheatstone and Alexander J. Ellis at the Philological Society of London in 1869, but owing to Bell's lack of electrical knowledge, the early experiments were not very encouraging.

Some time afterwards Bell was appointed Professor of Vocal Physiology at Boston University, U.S.A., where he met Professor Joseph Henry, the great American physicist, whose name is associated with the unit of inductance.

When Henry saw the crude models he realised that Bell was on the verge of an epoch-making discovery and encouraged him to go ahead with his experiments, even if it meant taking up the study of electricity from the beginning. In 1876 success crowned Bell's efforts and the telephone was born.

Bell's first telephone in no way resembles that which still bears his name, in fact it is precisely because of its differences that it is worthy of our attention.

A telephone has two distinct functions ; it has to respond mechanically to minute variations in the strength of the electric current passing through it, and it has to produce sound-waves corresponding to such variations. At first these two operations were separate and distinct as will be seen from the following brief description of an early

model. Some time elapsed before Bell took the next logical step in constructing the vibrating member of suitable proportions to produce the sound-wave direct.

The first articulating telephone consisted of a stout wooden frame carrying an electromagnet which acted upon a flat steel reed. One end of this reed was fixed to the centre of a crude diaphragm of goldbeater's skin stretched like a drumhead attached to the base as shown in Fig. 1.

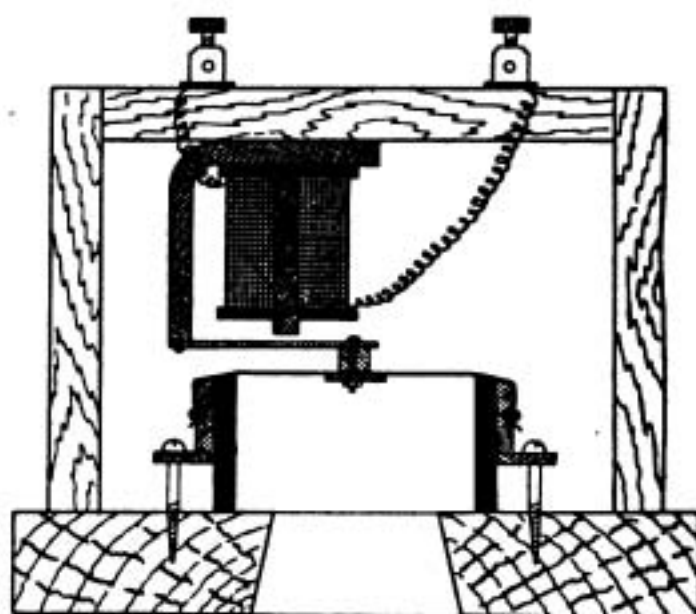

Fig. 1. Bell's First Telephone, 1876.

A hole cut in the base served as an orifice to allow the sound-waves to pass to or from the diaphragm.

This model was exhibited at the Centennial Exposition in Philadelphia in 1876, where it attracted the attention of Sir William Thompson (Lord Kelvin) who was one of the judges of the electrical exhibits. Kelvin was so enthusiastic over the invention that he brought the model to England and exhibited it before the British Association, introducing Bell as the inventor.

According to the *Times* :—

" Queen Victoria expressed a desire to talk by telephone. A wire was therefore put

THE STORY OF THE TELEPHONE

up from a Downing Street office to the City house of Sir Thomas Biddulph. For an hour or longer Her Majesty talked and listened by telephone to Miss Kate Field. Miss Field sang 'Kathleen Mavourneen,' and the Queen thanked her by telephone, saying she was 'immensely pleased.' She congratulated Bell himself, who was present, and asked if she might be permitted to buy the two telephones, whereupon Bell presented her with a pair done in ivory."

It must be admitted that Bell did not have the field entirely to himself. As far back as 1861 Philip Reis exhibited at Frankfurt a simple electro-magnetic device with which he was able to reproduce musical notes. Although he came surprisingly near to inventing the telephone nothing came of his investigations.

Elisha Gray was also working on the problem contemporaneously with Bell, in fact Gray filed particulars of his telephone on the very day that Bell deposited his specifications and drawing.

Thomas A. Edison was also interested in the problem of the reproduction of sound by electrical means. Figs. 2 and 3 show Edison's first telephone, now in the possession of the writer. This was on somewhat different lines from Bell's inasmuch as the transmitter and the receiver were separate units. These were described in the *English Mechanic* as far back as 1877 in the following terms :—

" the transmitting instrument consists of an electro-magnet, or magneto-electric inductor, supported by or attached to a short pillar. In front of this electro-magnet is fixed a vertical brass ring, or what would perhaps be better understood as a short tube with a strong fixed collar at one end,

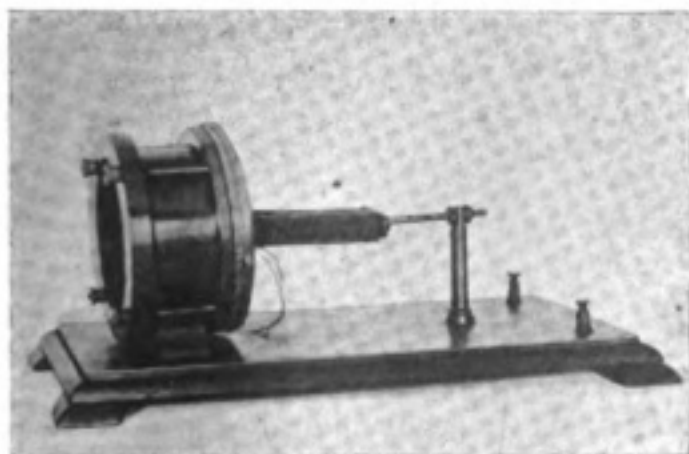

Fig. 2. Edison's Telephone Transmitter, 1877.

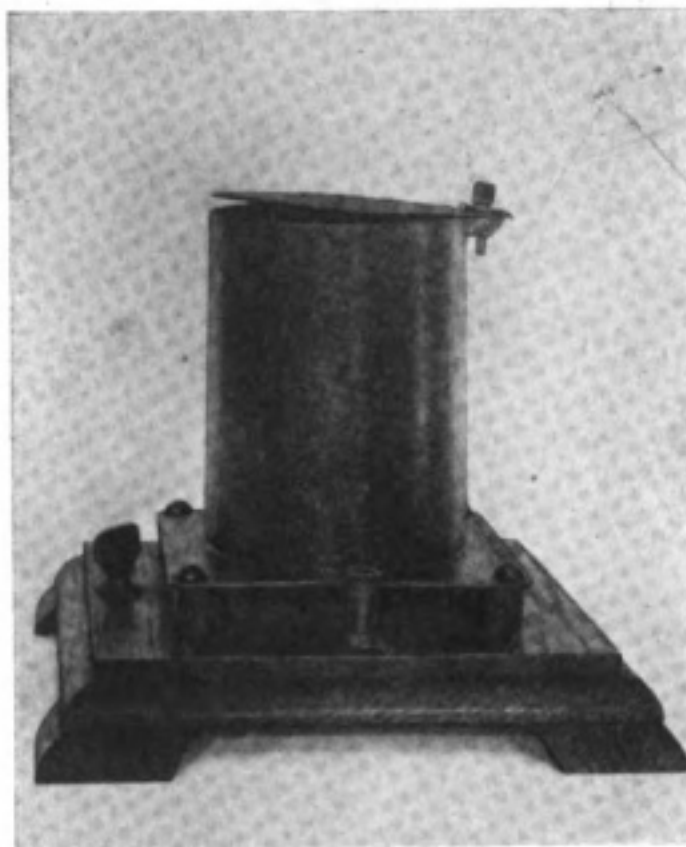

Fig. 3. Edison's Telephone Receiver, 1877.

and a movable collar connected by screws to the fixed collar, as shown. To the movable collar is attached a diaphragm of goldbeater's skin or other suitable material, which is drawn to the required tension by the three screws. In the centre of the membrane or diaphragm is a piece of soft iron, oblong in shape, and so placed as to play close to but not actually to touch, the poles of the electro-magnet whenever the membrane is put into a state of movement. The ends of the wire forming the coils are passed to two binding screws in the usual way, and the transmitting instrument is thus connected to the line wire and thence to the receiver.

"In its simplest form the latter consists of a piece of soft iron tube with a thin and flexible sheet-iron armature held in position by a screw. The interior contains a vertical bar electro-magnet which, under the influence of the current, attracts the thin armature which is thus set in vibration, and as the iron tube surrounding the magnet forms a resonating box, the vibrations become sufficiently sonorous to enable articulate sounds to be distinguished."

The concluding sentence of the article in question is worthy of note :—

" Wonderful as the invention has shown itself to be, it may be fairly assumed that it has scarcely reached its full development."

The writer of this assumption probably lived to see the amazing development of the telephone which for many years has been a

vital necessity of our daily lives. In America there is scarcely a home without its telephone, but Great Britain is yet a long way from that stage, in fact our telephone system is probably the worst in the civilised world. Anyone who has travelled on the Continent or in America will appreciate the force of this statement. This is due almost entirely to the extraordinary decision of the Postal Authorities at that time, that the telephone was "a species of telegraph," and as such, infringed the Government monopoly under the Telegraph Act of 1869.

When studying the question of the telephone from the point of view of its application to Wireless Telegraphy, it is well to bear in mind that a receiver designed for articulate speech is not necessarily suitable for the reception of wireless signals.

The first essential of a wireless receiver is a very strong magnetic field. This is because the pull on the diaphragm varies as the square of the intensity of the magnetic field acting upon it, and the strength of audible signals may be regarded for all practical purposes as being proportional to the movement of the diaphragm; therefore it follows that the pull must vary as much as possible.

Let x represent the strength of the field due to the permanent magnet, and y the strength of the field due to the signals. Then the pull on the diaphragm will be $(x+y)^2$ when the signals produce a magnetic field of the same polarity as the permanent magnets, and $(x-y)^2$ when the magnetic field of the received signals opposes that of the permanent magnets. The difference between these two values is $4xy$ which may be taken to represent the *difference in the pull on the diaphragm*.

If the electro-magnet has a soft iron core with no residual magnetism the difference will be between zero and y^2 , and as y is an exceedingly small quantity, on account of the small magnitude of the received signals, y^2 will be small also. On the other hand $4xy$ is a comparatively large value owing to the inclusion of x , the strength of the permanent magnet. Thus it is seen that the efficiency of a receiver is proportional—within certain

limits—to the strength of its permanent magnet. Unfortunately the type of diaphragm best suited to the production of sound waves has such a small mass in the magnetic circuit that it becomes saturated by but a small proportion of the available flux, thus discounting to some extent the benefit of the strong permanent magnet.

Apparently this was the trouble that S. G. Brown had in mind when he designed the "reed" telephone receiver (Fig. 4). In principle this 'phone is the same as Bell's first model (Fig. 1), but in detail it presents a striking contrast.

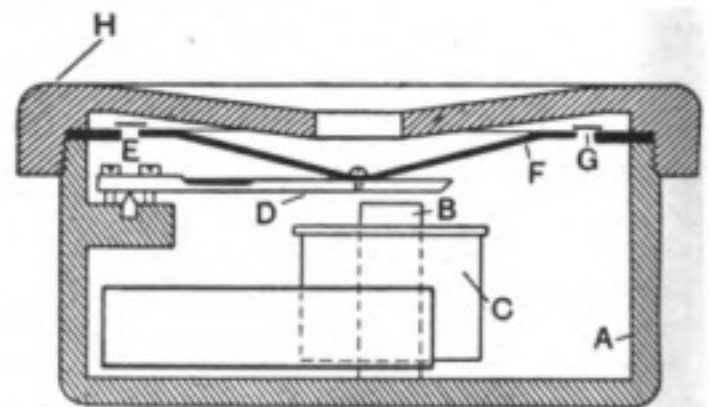

Fig. 4. S. G. Brown's Telephone Receiver. (a) External Case. (b) Magnet Core. (c) Magnet Coils. (d) Steel Reed. (e) Adjusting Screws. (f) Diaphragm. (g) Parchment Ring. (h) Earpiece.

It would appear that the design of the wireless receiver has not received the attention that so important a matter deserves, or perhaps it is that investigators have tackled the problem with lack of imagination. There seems to be a great reluctance to break away from precedent, to "improve" existing types instead of designing new ones. Frequently one sees wireless receivers on the market with glaring errors in design, for example, the high-resistance 'phone very popular in the States a few years ago, with pole pieces quite $\frac{3}{4}$ " long. Evidently the idea was to wind as much wire as possible, quite oblivious of the fact that it is not the length of wire but the *number of turns* that determines the efficiency of the receiver, all other factors being the same. By reducing the width of the magnet the same length of wire could be made to produce at least 50 per cent. more turns with a corresponding increase in efficiency.

THE STORY OF THE TELEPHONE.

At present the aim apparently is to obtain resonance between the natural frequency of the diaphragm and the frequency of the spark which produces the signals. When one considers the variety of "notes" heard in the 'phones it would appear obvious that this is impracticable. Even if it were obtainable it can scarcely be considered desirable, for it involves a diaphragm as little damped as possible and this has a tendency to make fast signals run together. At twenty words per minute the letter "H" takes about half a second to send, during which time the diaphragm has to give *four distinct sets of vibrations* with a period of inactivity between each. With an undamped diaphragm the vibrations would probably continue right through the space intervals with the result that the sender would probably be blamed for careless formation. This seems to be perfectly obvious, yet the writer has seen a suggestion put forward in all seriousness for a wireless receiver on the lines of a frequency-meter with vibrators of different frequencies arranged as in Fig. 5, the idea being to provide resonant systems for a wide range of spark frequencies.

The only modern receiver that can make any claim to originality in design is the Grant Receiver introduced a short time ago by a firm in Cleveland, Ohio. Instead of mounting the mechanism on the headband in the

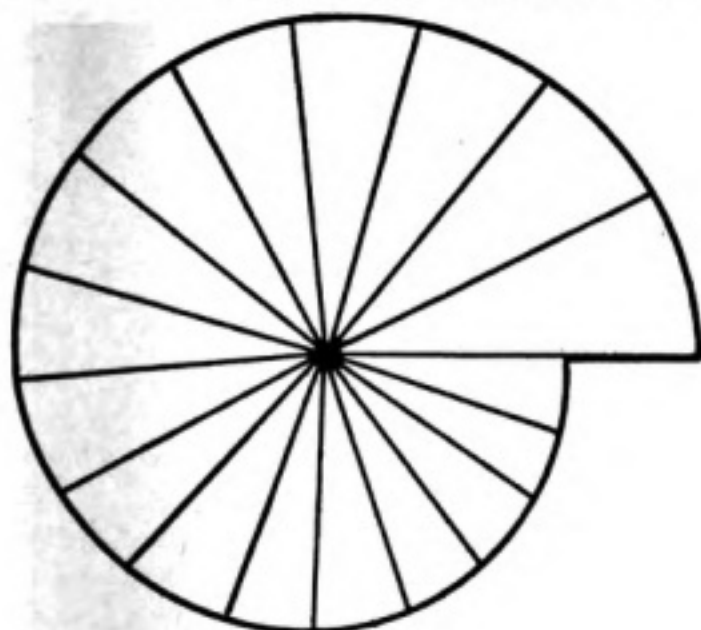

Fig. 5.

usual way, the designer has placed all working parts in a substantial dome-shaped case which rests on the operating bench. A flexible tubing terminating in an extremely light headband conducts the sound waves to the operator's ears (Fig. 6). The limitations of

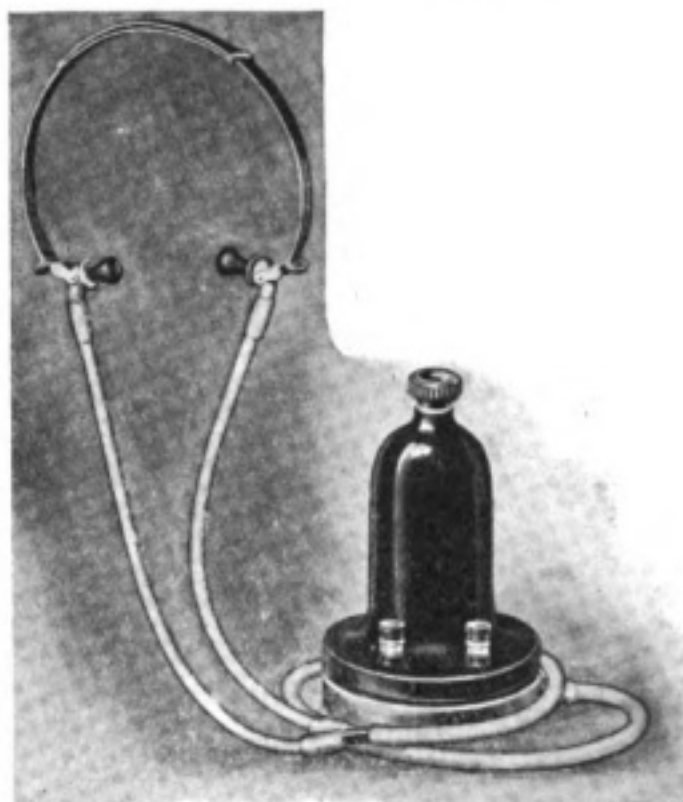

Fig. 6. *The Grant Receiver.*

size and weight of magnets no longer obtain, consequently they are of generous proportions, and may be moved in relation to the diaphragm by means of a milled knob on the top of the instrument. Incidentally, the flexible tube, being a non-conductor, safeguards the operator against shock by accidental contact with transmitters. The writer has not had an opportunity of verifying the maker's claims and would suggest that the subject is one suitable for correspondence in these columns.

It may be that the Grant Receiver is the forerunner of a new type of 'phone for wireless use, indeed it must be admitted that it possesses many attractive features. One advantage that should appeal very much to the wireless worker is the delicacy with which the air-gap can be adjusted without the possibility of alteration during use.

NOTES AND NEWS

Information for Amateurs.—In order that the amateur may pursue his work with interest and advantage it is almost essential that he should possess reliable information regarding the high-power stations of the world, the system used, the wavelengths and the times of working, together with keys to any special codes transmitted, as in the case of weather reports and time signals. Since the commencement of the present volume the *Wireless World* has made a special effort to gather together as much of this sort of data as possible, and we believe that the various tables we have published have been found very welcome. Nevertheless, we have discovered that in some instances our figures have become obsolete almost as soon as they were published on account of the fact that changes, particularly of transmission times in the case of commercial stations, are always occurring. Now, whilst we are only too glad to assist our readers in every possible way, we feel that they can help themselves and others by noting any important changes in the routine of well-known stations and making them known as widely as possible.

The International Bureau at Berne gives, as is well known, the kind of information of which we write, but some time elapses before it is available to our readers. We shall continue to publish useful lists from time to time, but shall have something to say on this matter at the next Conference of Wireless Societies.

Summer Lectures in Wireless Telegraphy.—At the Central Technical School, Byrom Street, Liverpool, on Thursday, July 1st, the last of a series of lectures on "Wireless Telegraphy" was given by Dr. Richardson. These addresses have proved very interesting and instructive, and after the last lecture the students were invited to inspect the school wireless outfit and were much interested in the various apparatus on view. The party had also the pleasure of hearing a musical wireless concert. At the close of the proceedings a hearty vote of thanks was accorded to Dr. Richardson for the very able manner in which he had delivered the various lectures and conducted the numerous experiments. This was proposed by Mr. S. Frith, the Hon. Secretary of the Liverpool Wireless Association, and seconded by Mr. A. P. Whittle, and suitably responded to.

Flying Officer E. A. Turnbull, Royal Air Force, was married to Miss Florence Guy, of Forest Hill, London, at the British Consulate, Cairo, on June 5th. This officer has served with wireless telegraphy sections in the Royal Engineers and R.A.F. since the commencement of the war, and was for a short period acting as Assistant Secretary to the Wireless Society of London shortly after its formation.

Stationary Waves on Wires.—With respect to the article by Mr. Philip R. Coursey on this subject, published in our issue of June 26th, Dr. J. A. Fleming, F.R.S., asks us to state that the discovery of the uses of Neon as a detector of oscillatory fields was made and patented by him in 1904 (Pat. No 13730A, 1904), and "that a careful experimental study of stationary waves on

spiral wires was given by him in the *Philosophical Magazine* for October, 1904, and reproduced in his several books on wireless telegraphy." Readers who wish to study the subject may be glad to have these references.

New Radio-Telegraph Scheme of French Government.—The Posts and Telegraphs Department of the French Government is now engaged upon the development of a great wireless system to release the pressure on the British cable system. In addition, a comprehensive programme has been drawn up in agreement with the Colonial Ministry for the establishment of wireless services between the French Colonies and the Mother Country. The proposed scheme will be divided into four sections. The first, aiming at providing communication between ships at sea and coastal stations, is already working satisfactorily, but further extensions will be made. The second section will be used to maintain regular communication with the mountainous regions, which, owing to the weight of snow invariably bringing down the wires, are out of communication during the winter. The coastal system will ensure communication between France and islands round the coast; it is hoped to also link up Algeria with Paris. The third, or Franco-European system, is already started, wireless communication having been established since May with Hungary, and it is hoped to shortly open up communication with Belgrade also.

The station at La Doua, near Lyons, which is using the Poulsen system, and has for some time past been maintaining communication with the United States, will shortly be available for the transmission of commercial messages, and the new station at Croix d'Hins, near Bordeaux, is likewise intended for commercial communication with Tuckerton, New Jersey. The fourth section covers the linking up of the French Colonies, including Saigon, Noumea and Tahiti, with France. Stations with a transmitting range of 7,500 miles will be erected at Paris, Saigon and Tahiti. Less powerful stations of about 4,300 miles range will be constructed at Jiboutio, Antananarivo, Noumea and Martinique. Smaller stations will link up the French Possessions in Africa, connecting Martinique with French Guinea and Saigon with Pondicherry. The Ministry of War has already begun the construction of stations in the French Congo, Antananarivo and Saigon.

Commercial Application of Wireless Telegraphy.—The Public Service Company of North Illinois is installing wireless telegraphy at its Blue Island and Joliet stations. As the crow flies the intervening distance is about 25 miles. The wireless system will have a radius of about 100 miles, and will be used chiefly during those times that the metallic telephone lines are out of service, due to weather or other causes.

Luxemburg Wireless.—A receiving wireless telegraph station will shortly be erected by the State at Luxemburg, with the object of receiving daily French official time and meteorological information. No law, fixing conditions under which wireless apparatus may be installed is yet in existence

NOTES AND NEWS

although a fair number of amateurs are in possession of receiving apparatus.

The Grand Duché of Luxemburg has not yet adhered to the London Radiotelegraphic Convention, but it has, however, made a declaration to the International Bureau in accordance with Article 48 of the Radiotelegraphic Rules.

Norwegian Wireless Amateurs.—To gain permission for the erection of amateur or experimental wireless stations within the borders of Norway would seem to be no easy matter. Correspondence we have recently received from amateurs in Norway points out in deprecation the Government's refusal to sanction the installing of experimental wireless stations, and, though through not knowing the true facts of the circumstances, we are naturally reluctant to voice an opinion, it would seem to us that some restricted arrangement similar to that existing in England could possibly be arrived at. The difficulty may be due to the necessity of revision of the whole amateur position, a necessity which has been brought home to almost every Government in the world, and if there should be sufficient enthusiasts in Norway, we would suggest that they combine together in an endeavour to induce the authorities to grant more freedom. Though we do not consider that we have by any means the maximum of concessions in this country, we must certainly consider our lot far happier than that of the Norwegian amateur.

A Wireless Hound.—In applying the principles of wireless to control a land vehicle, Mr. E. F. Glavin, of New York, has invented a machine he calls a "Wireless Hound." This strange craft is driven by an electric motor: it has four wheels, one in front, which does the steering, two wheels which turn freely on a fixed axle, and a centre driving wheel. The motor is mounted on a pivoted frame so that its weight is brought to bear on a rubber-faced pulley pressing down on the driving wheel. Storage batteries furnish the current for the motor as well as for other purposes.

Wireless Telephony and Congress.—Wireless telephony was used as a means to gather information for Congress at Washington at the hearings of the Army Appropriation Bill before the House of Military Affairs Committee. This records the first use of the wireless telephone for such a purpose.

Wireless in China.—A reinforced concrete mast, 164 feet in height, has been erected on the Great Wall of China for the use of the American Navy. The erection of the mast is associated with the deaths of an American engineer and four coolies, an accident with the derricks having unfortunately occurred.

Wireless Telephony in Ireland.—As a result of the unhappy state of affairs in Ireland and the consequent interruption of the telephone and telegraph systems, the Government has decided on an extensive use of wireless telephony.

Navy Yards and Wireless Telephony.—In order to expedite conversation between incoming and outgoing vessels, a wireless telephone has been installed at the Charlestown navy yard (U.S.A.). In this way commanding officers of vessels desiring to speak to the officials of the yard will eliminate

the time lost in wireless telegraphy—as little as that loss may be—by the more convenient use of the wireless telephone.

Trans-Atlantic Wireless.—The Radio Corporation of America has inaugurated a high-speed duplex wireless service between the stations at Marion and Chatham, Mass., and the stations at Stavanger and Naerobe, Norway.

The American Academy of Arts and Sciences has awarded the Rumford premium to Dr. Irving Langmuir for his research in thermionic and allied phenomena.

Royal Observatory Wireless Station.—About 400 people accepted the official invitation to visit the Royal Observatory on June 5th. A special attraction was the wireless room, where a few were enabled to hear signals from distant parts of the world. Signals were readily received from Paris, Nauen, Annapolis, Lyons and Darien. The principal use of the observatory's installation appears to be a comparison of the exact time as computed at Greenwich with that determined at Paris and elsewhere.

Wireless and the Stage.—A further illustration of how wireless telegraphy has imposed itself on our daily lives was demonstrated in the production of "The Ruined Lady," by Miss Rosa Lynd, at the Comedy Theatre. The producer, Mr. John Cromwell, was obliged to sail for New York on the morning of the day arranged for the opening performance, and was therefore unable to be present at the play's first night. A full account of the performance was, however, wirelessed to him immediately after the curtain fell, the message reaching him early the next morning, when the ship was well at sea. Certain modifications in the play, suggested by the newspapers, were also wirelessed to Mr. Cromwell, who, on the ocean as he was, called for a rehearsal, when his criticisms on the first night's performance were read to the Company.

Wireless Pictures.—Some years ago a German scientist, Professor Korn, invented a device for the telegraphic transmission of pictures, which required costly, complicated and very fine apparatus. It is now said that Mr. T. H. Anderson, a Danish watchmaker, has invented a method by which he is able to transmit pictures by the ordinary telegraph wire or by wireless to any distance. Upon obtaining from the Danish Telegraph Department permission to demonstrate his invention by using two of the State's wireless stations, Mr. Anderson was able to transmit a picture of a young woman from the wireless station at Bloavandshuk to the wireless station at Lyngby, near Copenhagen. The young inventor declares that the transmission of pictures requires the same time as the transmission of an ordinary message of 100 words; the transmission, we presume, being by hand manipulation. Experts add that, with further development, it will be possible with great accuracy and without great expense to transmit even very complicated pictures, producing the various colours which they contain.

THE PROCEEDINGS OF THE WIRELESS SOCIETY OF LONDON

A SIMPLE WIRELESS TELEPHONE SET.

By G. G. BLAKE, A.M.I.E.E.

AN Ordinary General Meeting was held on Tuesday, June 29th, at 8 p.m., in the Lecture Hall of the Royal Society of Arts, John Street, Adelphi, W.C., the President, Mr. A. A. Campbell Swinton, F.R.S., occupying the chair.

The Minutes of the previous meeting were read and confirmed.

The Chairman: I have to announce that the Committee have elected Brigadier-General Sir Capel Holden, K.C.B., F.R.S., a Vice-President of the Society. General Holden is a very old worker in electrical matters; he is now reverting to work of that kind and I am sure he will be a great acquisition to the Society. There are seven new members for ballot; the papers have been distributed and will be collected at the close of the meeting. I will now call upon Mr. G. G. Blake to read his paper upon Wireless Telephony.

In bringing this paper before you this evening I feel, metaphorically speaking, very much like the proverbial little boy "teaching his grandmother to suck eggs." If the experts present, who in this case represent the grandmother, will kindly use a grandmother's forbearance and allow me to describe the simple apparatus you see upon the lecture table, I hope that I may be able, at any rate, to supply the amateur portion of my audience with some useful constructional details of a small portable wireless telephone set.

We have made up two transmitters, and in the case of the one before you, which I will call Set A (*see* Fig. 1), the inductance I is wound with 140 turns of No. 26 c.c. wire on a cylinder 2½ inches in diameter. The middle of this inductance is connected to the negative side of the filament battery B (6 volts). One end is connected to earth and the other to aerial, and I have connected the microphone between the aerial end of the inductance and the 37th turn.

Here I may be able to give a useful word to anyone who wishes to make up one of these sets. The exact position on the inductance will depend upon the resistance of the particular microphone used and the simplest method of arriving at this is to connect up the set temporarily, placing a watch in front of the microphone. Next tune up a receiving set or wavemeter, and "listen in" for the ticking of the watch, trying various positions on the inductance I until the loudest ticks are obtained in the receiver.

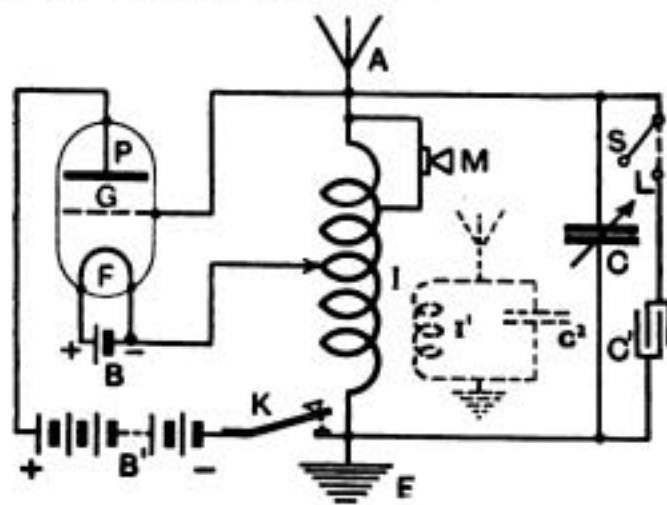

Fig. 1.

The key K in Fig. 1 is used for C.W. transmission. When the set is used for telephony it is removed and replaced by a plug which permanently closes the plate circuit. C is a variable condenser about 0.0005 mfd.; it consists of seven fixed zinc plates, 2 inches in diameter, and six movable plates, 1½ inches in diameter; these plates are arranged so as to be as near as possible, having an air-space of less than 1/16-in.

This condenser and inductance, when used in conjunction with a 12-foot aerial, similar to those we are using this evening, gives us a

THE WIRELESS SOCIETY OF LONDON

range of wavelengths varying from 300 to 700 metres. By the addition of a small fixed capacity about 0.00025 mfd., which can be placed in parallel with C by means of a small switch SL, the wavelengths can be increased, if desired, up to about 1,100 metres. This condenser C consists of two sheets of tinfoil, $1\frac{1}{4}$ -in. wide, one on each side of a sheet of mica, 2 mils thick, and overlapping to a distance of 2 inches. This I think completes the description of Set A.

A word or two are now required with regard to the construction of the Set B, with which we are proposing to transmit music to this room from a gramophone in another part of the building. The connections and dimensions are similar to those already described; but in this case the aerial and earth are connected to an inductively-coupled circuit, consisting of an inductance I^1 (105 turns of No. 26 c.c. wire on a cylinder $1\frac{3}{4}$ inches in diameter) and a variable condenser C^2 , as shown in dotted lines in Fig. 1, instead of being connected to inductance I.

Fig. 2 is a photograph of transmitting Set A, which is contained in a small wooden case 6-in. by 3-in. by 5-in. No other apparatus is needed, except the high and low tension batteries (60 and 6 volts respectively).

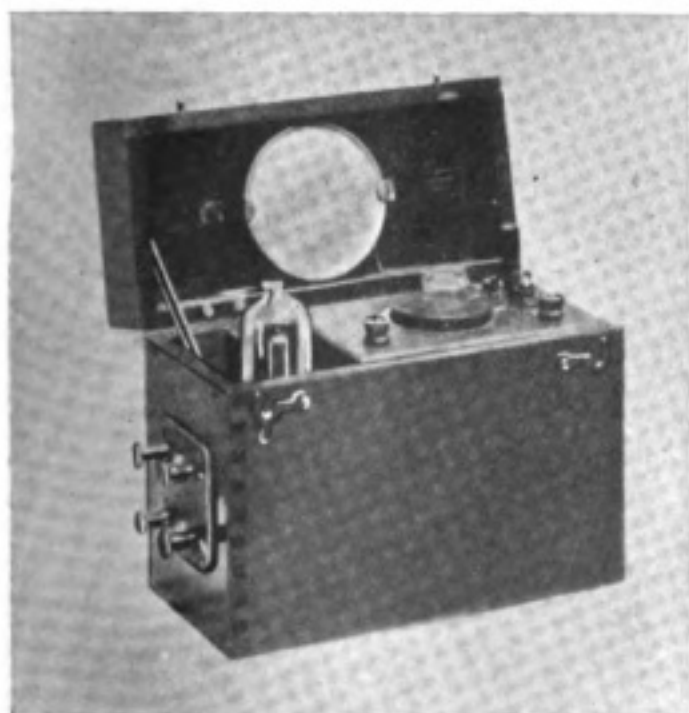

Fig 2

Fig. 3 is a radiograph of the Set A, which gives some idea of the sizes of the various parts and how they are arranged in the case. The lettering corresponds exactly with that in Fig. 1.

Fig. 3A is a photograph of transmitting Set B: after the lecture I will have it brought into this room for inspection.

I will now describe the little set which I am using for reception. Fig. 4 is a diagram of connections. The tuning inductance is wound in the form of a small hank, having a mean diameter of $2\frac{1}{4}$ inches, with 110 turns of No. 28 c.c. wire, with tapings for units and tens, a small condenser C^1 (made up of two sheets of foil $\frac{1}{2}$ -in. wide, one on each side of a sheet of mica 2 mils thick and overlapping 1 inch) is connected across the ends of the inductance. The units end of the inductance is earthed and the other end is connected to the aerial.

The aerial is connected to the grid of the valve through a small condenser C (one sheet of foil $\frac{1}{2}$ -in. wide each side of a sheet of mica 2 mils thick, overlapping 1 inch). Across this condenser is shunted a grid leak resistance of about 80,000 ohms. This consists of a strip of ordinary notepaper $\frac{1}{8}$ -in. wide, soaked in Indian ink; after being placed in position it is adjusted to the best resistance by making a pencil line on one or both sides of the paper. For protection this is placed in a glass tube.

The plate P of the valve is connected to one end of a reactance coil R (300 turns of No. 40 d.c.c. wire) wound in the form of a hank, having a mean diameter of 2 inches. It is arranged on the end of an ebonite arm, so that the coupling between it and the tuning coil can be varied. Its other end is connected in series with a telephone (high resistance type) and a high tension battery of 60 volts, of which the negative terminal is earthed.

The filament is heated by a 6-volt accumulator, the positive terminal of which is earthed. R^2 is a variable resistance made of 5 feet of No. 28 nickel-chrome wire, wound on a slate pencil. C^2 and C^3 are two small condensers, either of which can be placed across

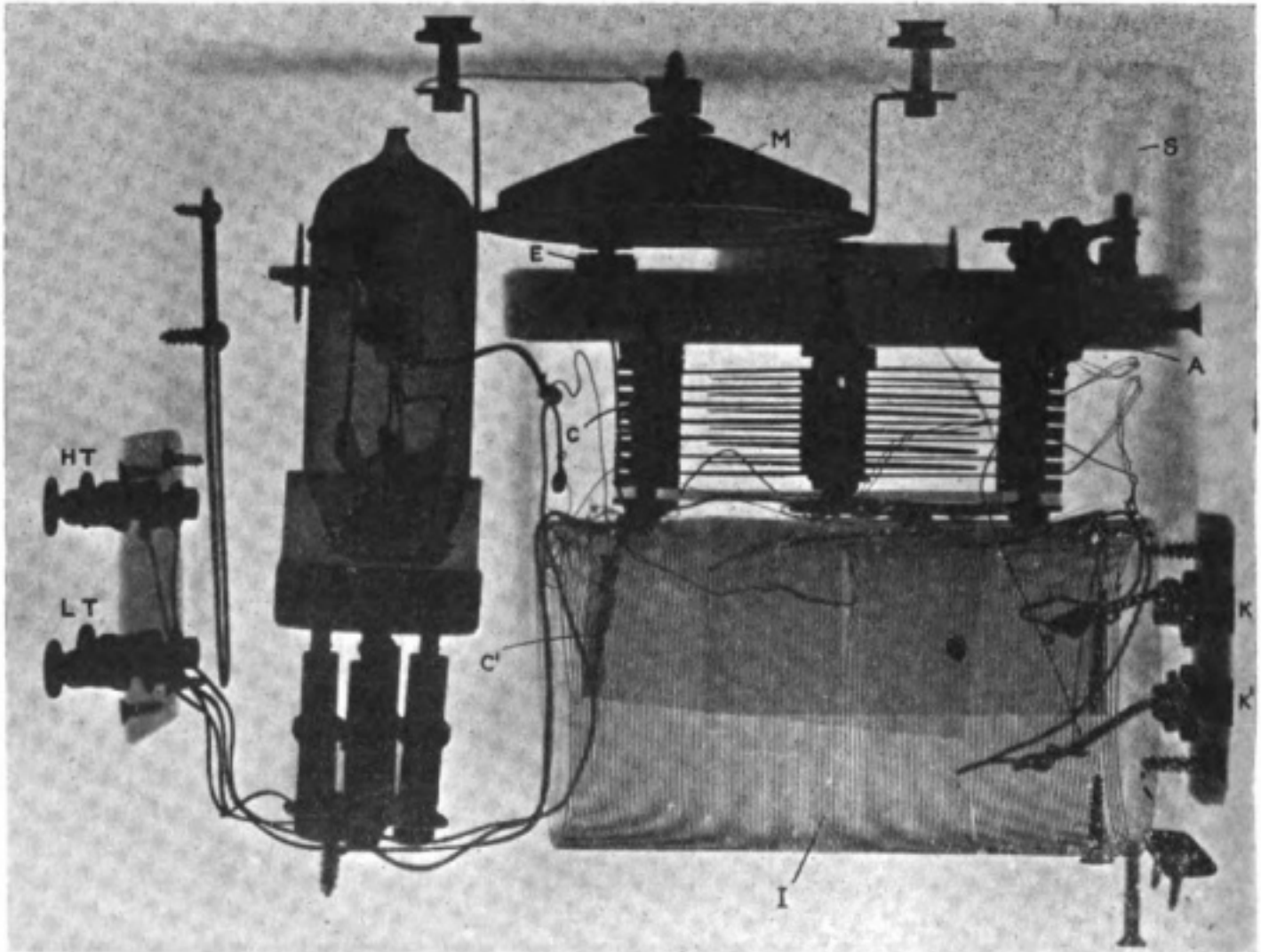

Fig. 3.

the telephones and high tension battery when required. C^2 has seventeen sheets each way, $\frac{3}{8}$ -in. by 1-in., separated by mica sheets 2 mils thick. C^3 has ten sheets each way.

This little set will give signals on a 12-foot indoor aerial up to wavelengths of about 1,100 metres. Wireless telephony from Croydon and Hounslow come in quite audibly at Richmond on such an indoor aerial.

Fig. 5 is an X-ray photograph of the receiving set; the lettering corresponds exactly to Fig. 4, and it gives an idea of the relative sizes and grouping of the coils, etc., with relation to the valve. Note that the reactance coil R is now swung to its position of loosest coupling. When the coupling is tight it (the reactance coil) lies immediately behind the tuning coil and almost touching it.

Fig. 6 is a photograph of the receiving set in its case, 9-in. by 6-in. by $2\frac{1}{2}$ -in., when the

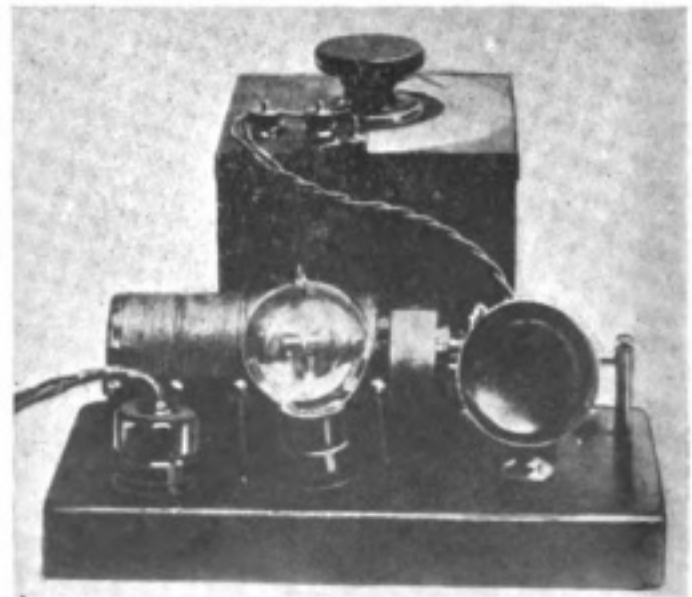

Fig 3a

THE WIRELESS SOCIETY OF LONDON

lid is closed. The whole of the apparatus is mounted upon the underside of the ebonite sheet upon which the studs, switches, etc., are fitted, so that, should it get out of order, the whole of the working parts, including the valve socket, come away from the case bodily, and thus it becomes a very simple matter to carry out repairs.

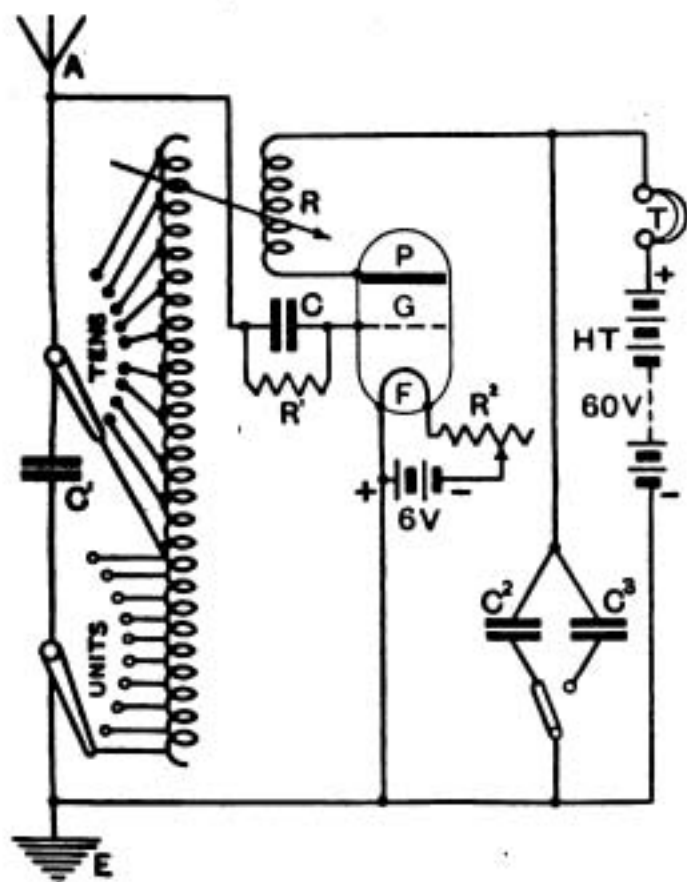

Fig. 4.

In order to make the telephone audible to everyone in the room I have connected the receiving set to a 4-valve (transformer-coupled) amplifier and a loud speaking telephone. In another room in this building we have, as already stated, a transmitting set similar to that upon the table before you, and I will now ask Mr Bonella by its aid to transmit a little music to us from a gramophone, and if all goes well I think you should also be able to hear the ticking of a watch placed against the microphone.

While we are waiting I may just mention a simple way we have found for eliminating the noises which are heard so often when amplifying. We find that if a small leaky condenser is placed in series between the

receiving set and the amplifier, the noises are very much reduced, without appreciably reducing the signals or speech strength. We are using such a condenser in series with the amplifier this evening.

Fig. 7 illustrates a simple method I have used with success as a potentiometer for obtaining H.T. from the direct current mains, instead of using batteries. It is based upon an instrument for supplying direct current at any voltage for medical purposes, which has recently been put on the market by the Medical Supply Association.

A and B are two carbon electrodes bedded in plaster of Paris in the bottom of a glass jar, each having a terminal at its upper end. Two other carbon rods C and D, also fitted with terminals, hang downwards from fixings in a movable lid L. The jar is three parts filled with tap water. The electric light mains are connected to terminals A and B, the leads passing through a hole in the lid L, and a 16-candle-power carbon filament lamp is placed in the circuit, as shown in diagram.

When C and D are at right angles to A and B the voltage at C and D is zero; by rotating the lid, thereby bringing C nearer to A, and D to B, the voltage gradually rises, and can be fixed at any desired value.

We find that this arrangement efficiently chokes out the noises from the generating station and works as well as batteries. If bigger currents are needed, a larger lamp can be substituted. Of course, when this method is used with the transmitting set A, it is necessary to place a condenser of fairly large capacity between the earth and the lower end of the inductance. A 1-microfarad condenser answers the purpose.

If with so simple an apparatus results such as I have shown are attained, may we not confidently look forward in the near future to a much wider use of wireless telephony? I foresee a time when it may be the general custom for us to receive our daily news in the mornings, while breakfasting, by wireless telephone. With a small frame aerial, an amplifier and loud-speaking telephone, we may hear our news from powerful telephone

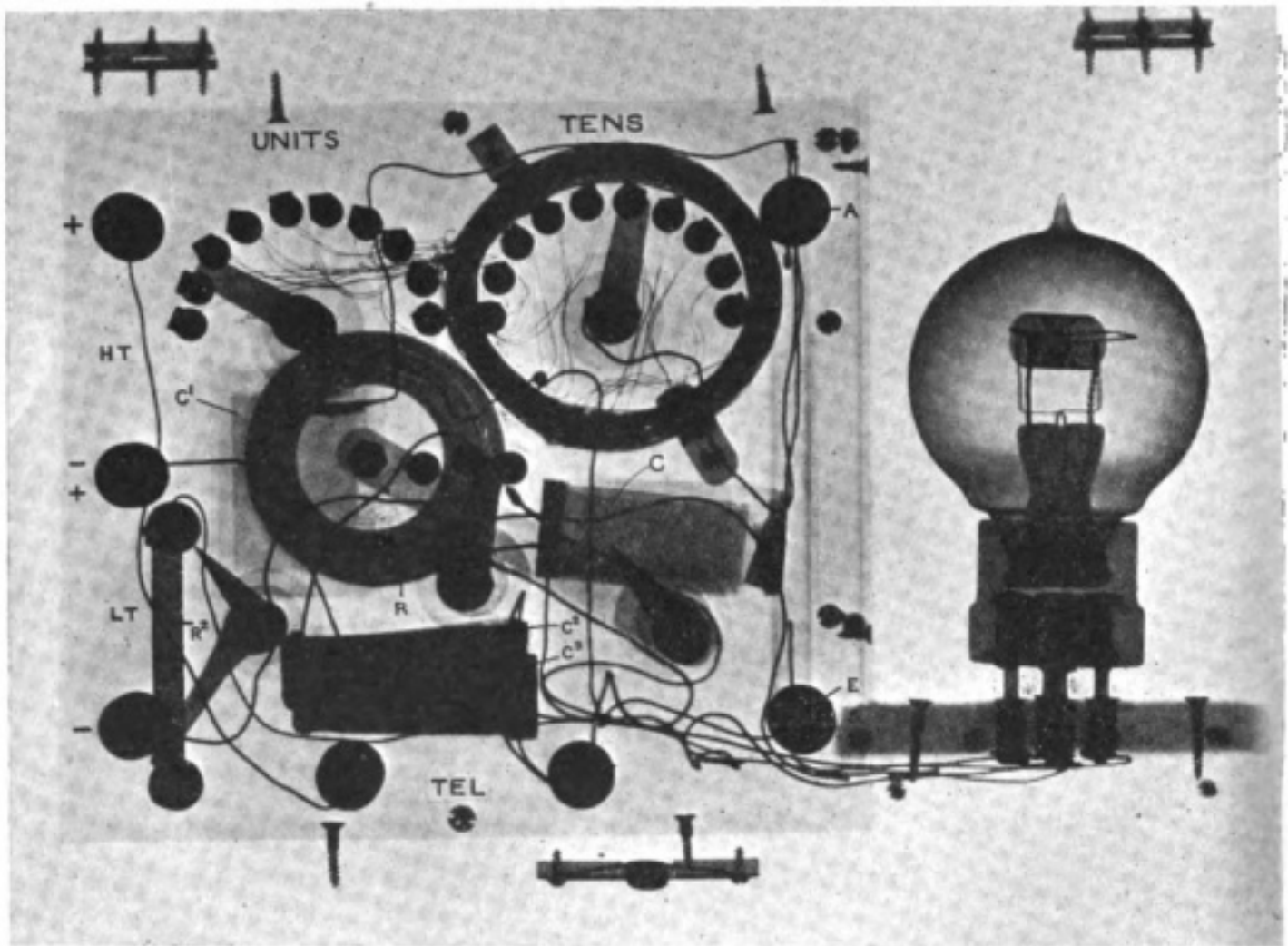

Fig. 5

stations. I see no reason why photographonic records could not be taken of public speeches, important lectures, etc., by making use of a Ruhmer Photographophone (Fig. 8), invented in 1900, so well described in Dr. Erskine Murray's book on wireless telephony, and with which I am at present carrying out experiments with a view to future developments. In this connection I should not omit to mention the name of Dr. Rankine, who has been and I believe still is, carrying out similar experiments in this country.

All public platforms could be fitted with a number of microphones, much as they are now for the electrophone. These microphones would be used to control a speaking arc A, or manometric flame, the light from which is focussed upon a moving strip of photographic film F. When developed this film would be of uneven density, corresponding accurately to the variations in the intensity of the light

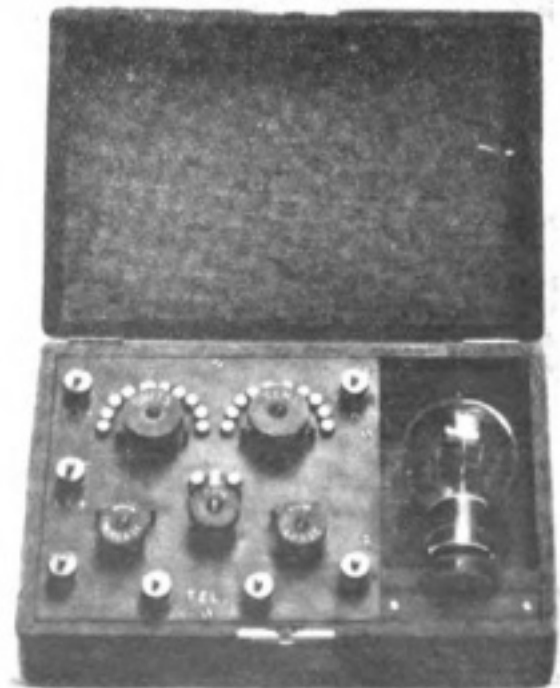

Fig. 6.

THE WIRELESS SOCIETY OF LONDON

from the arc as controlled by the voice. The film could then be sent to the wireless transmitting station, where it would be passed in front of a steady source of light (as shown in the diagram for Ruhmer's reproducer), and the variations of light intensity produced by it would be focussed upon a selenium cell. The corresponding current variations passing through this cell could then be amplified by a series of thermionic valves, and used to modulate the radiations from the aerial of a transmitting station. So that not only would people hear the news but they would hear the actual speeches delivered word for word in the voices of the original speakers. Such photophononic records should be far more reliable than shorthand notes.

To carry this dream one step further, we could imagine all the speeches from, say, the Houses of Parliament, transmitted on one fixed wavelength, and other fixed wavelengths allotted to other important institutions, so that, as one sits at breakfast, one could turn a switch on to a stud marked "Houses of Parliament," "Albert Hall," etc., and select that portion of yesterday's news one wished to hear. Should such a system become universal (which one may be permitted to doubt) I foresee a time when a room is set apart in such an institution as this, where photophononic records of important lectures which have been delivered during the week in all

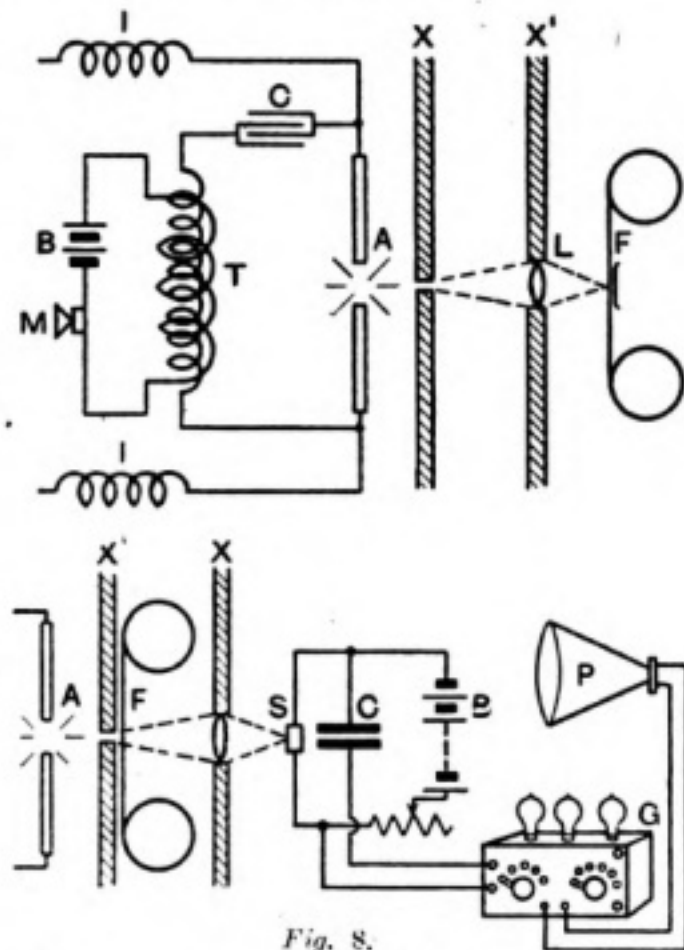

Fig. 8.

(Top.) *Ruhmer's Photographophone Recorder.*
 (Bottom.) *Ruhmer's Photographophone Reproducer.*

parts of the world, are re-delivered, either by wireless from transmitting stations, or by reproduction directly from the film by using a selenium cell, amplifier and loud-speaking telephone, etc., in the lecture room. This, together with a cinematographic reproduction of experiments given at the lecture, synchronized with the speech film, should give a most lifelike representation.

It also occurs to me that Ruhmer's photophononic recorder could be employed at a receiving station to take down telephonic messages or Morse signals in place of a Morse inker or siphon recorder. It might even be used in line telephony to record telephonic messages on ordinary telephone circuits.

The synchronization of the photophononic film with the cinematographic film opens up great possibilities to film producers. It would enable plays to be reproduced, not only in dumb show, as at present, but with words also. The nearest approach to this at present is, I believe, the synchronization of the

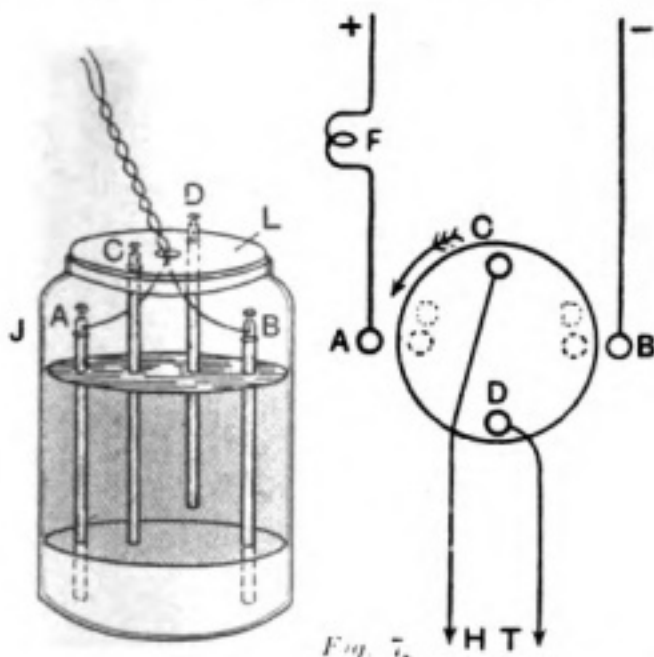

Fig. 7.

cinematographic film with the gramophone. One objection to this arrangement is the small size of the records; a photographic film could, of course, be of any desired length.

Quite recently the Case Research Laboratory, of New York, has placed upon the market the "Thalofide" cell. It is claimed that the electrical resistance of this new cell is reduced by 50 per cent. on exposure to a light of 0.06 of a foot-candle, from a tungsten filament source, and that its response and recovery is more rapid than is the case with a selenium cell.

If what they claim for it is true, the use of this cell in place of selenium should bring my dreams a good deal nearer to realization. I fear that so many ideas have crept into this paper that an apology is needed for having so far departed from my original subject. Before I sit down I would like to thank Mr. Bonella for his very valuable help in making up the greater part of the apparatus which we have used this evening.

DISCUSSION.

The Chairman: I should think, gentlemen, we had better have the discussion on this paper first, because that which we are going to have from Admiral Jackson in a few minutes is on a different subject; so I will ask if anybody would like to say anything upon this very interesting paper. I would like to say myself that I think the experiments have been extraordinarily successful: the speech was really very good indeed, and the smallness of the apparatus does not detract from its being apparently exceedingly effective. I would like myself to ask the reader of the paper if he would explain a little further his device for preventing amplifiers from crackling. I think that is a valuable invention. The amplifiers I have all make the most dreadful noises. I did not quite follow his explanation; if he could put it down on the blackboard, I think perhaps it would be more easily understood. I would ask if anybody would like to say anything?

Mr. Philip R. Coursey, B.Sc.: I think the Society is very fortunate in having this excellent description of the simple apparatus that has been explained to us this evening; I am sure we are all very much indebted to the author for giving it to us. I note that he uses what is practically a resistance-modulation of the transmitted current in the aerial; I should like to ask if he has tried any other methods, such as a microphone in the grid circuit, or coupled to it, and whether he finds this method better. It is usually reckoned that for small powers, resistance-modulation of the aerial is really the most efficient, and that grid modulation may often lead to some distortion of the speech.

It is certainly very interesting to have an apparatus of this kind using such a small open aerial, as distinct from the frame aeriels which are more familiar to one for indoor working. I do not know if the author has tried it, but perhaps this sort of aerial is better than a frame aerial for short distance work. The use of a capacity in parallel with the transmitting and receiving inductances when the aerial is small, is not so efficient as when the aerial is tuned in the usual manner with inductance only, or when a frame is used; but probably the author can give us the results of his experiments on that point. I do not know whether it has been noticed, but General Squier has recently described some experiments carried out at the Signal Corps Laboratories in the United States, using practically open helices -- "resonance coils" he called them -- for reception. It is stated that they can be used indoors. The arrangement is practically a long solenoid wound with fine wire; it is tuned by sliding a metal band along it and connecting it with the first grid of the receiving amplifier. The description was in the *Journal of the Franklin Institute* a short time ago,* and it was stated that very good results were obtained, not only for ordinary reception, but also for directional reception. The arrangement gives not merely the plane of the incoming signal but also the absolute direction, which is an advantage over the frame aerial. That sort of receiver, if practical for indoor working, may be of great value for experimental work.

Has the author tried any comparisons between the use of the type of inductance described as hank-wound compared with ordinary plain winding? Of course, as far as the effective resistance goes, the lumped winding generally has higher resistance, and in that respect is not so efficient. When you have only a small power to deal with efficiency is rather an important point. I did not notice in the paper any mention as to the range of the sets: perhaps no test has been made how far they would carry, but it would be rather interesting if we could be told something about that. A short time ago Dr. A. O. Rankine showed his selenium cell arrangement at one of the Physical Society's meetings. He had a short film there with just a word or so on it that gave quite a good reproduction in the telephone, but it was generally thought that such a photographic method would be too expensive for extensive use, and in all probability, if the author's dreams ever come true, it may be more economical to employ some form of dictaphone recorder instead of the photographic one.

The Chairman: Would anyone else like to make some remarks?

Mr. C. B. Kersting: I should like to ask the author whether the small set here could be applied to medical use, so as to enable us to hear the beating of the heart or the working of the lungs? I have tried an apparatus which was not successful. I do not know whether in view of the fact that the apparatus shown gives such good results with the beating of a watch it might be successful in the direction I have suggested?

**Journal of the Franklin Institute*, 189, pp. 693-714, June, 1920.

THE WIRELESS SOCIETY OF LONDON

Mr. J. Scott-Taggart, A.M.I.E.E. : With regard to the last speaker's remarks : I have been working on somewhat similar lines, not in connection with wireless telephony, but in connection with the use of a microphone in conjunction with a three-valve amplifier for indicating the beating of the heart and similar organic motions. I have found it of considerable value, and in consultation with medical men I have found that the use of an amplifier and microphone in this connection is capable of giving very good results and indicating various weaknesses and faults in the organic character of such functions.

There are one or two points that I would like to raise in connection with the wireless telephony set which we have seen to-night. The method of modulation apparently depends both on the variation of the amount of current radiated, and also on the variation of wavelength; and it is capable of being used on powers up to I should say about 100 watts with considerable efficiency. On higher powers than this I think we should have to look for a more suitable method of modulation.

I was very interested indeed in the photographs taken by X-rays. I think the author is to be congratulated on using this very interesting method of finding the interior of wireless sets, and I can imagine Mr. Blake occupying a great deal of his time by studying commercial sets by X-rays at night in his private room. (Laughter.) In the future it will obviously be useless trying to seal up the commercial sets placed on the market.

In connection with the receiver there are one or two points in which he might improve it. For example he states his grid leak is 80,000 ohms; personally I do not think a resistance of this value would be any better than simply eliminating it. It is usual in the case of modern valves to use a resistance somewhere in the neighbourhood of $1\frac{1}{2}$ megohms to 3 megohms, and it is suggested if that were so probably better results would be obtained. In his circuit he shows a couple of condensers across the telephone receivers and plate battery. There does not seem to be any particular need for a couple of condensers; one would be quite sufficient, with capacity about 0.008 microfarads. No doubt, as this paper is intended for amateurs, the less condensers the better. The same remark might almost apply to the condenser which he places across the aerial tuning inductance, though possibly as this is to gain extra wavelength it undoubtedly would lessen the efficiency of the receiver, particularly when an ordinary aerial was used for reception.

The form of potentiometer which we saw to-night is extremely interesting, and will no doubt appeal to amateurs in general, not only for the specific purpose which he pointed out, but for general work where a potentiometer is required. I would suggest that instead of using plain water a dilute solution of copper sulphate would probably be more serviceable, particularly as there would not be the bubbling that he speaks of.

Mr. L. F. Fogarty, A.M.I.E.E. : I should like to say a few words in connection with the last remarks of Mr. Scott-Taggart relative to the use of copper sulphate. I did some experiments with similar things years ago, and I think he would find

many disadvantages from using anything else but plain water. In the first place you get a deposition of copper on one of the carbon electrodes and if at any time you should reverse the thing you get a back E.M.F. If it is to be used for such delicate work as amplifiers you had far better stick to plain water, if necessary adding a little acid. In the majority of cases the use of plain water would be far better than to introduce anything in the nature of copper sulphate or other metallic solutions.

Mr. J. Scott-Taggart : In suggesting the use of copper sulphate I also suggest using copper wires, not carbon rods, and in that case I do not think the remarks of the last speaker would apply. Moreover, anything in the nature of polarisation in a receiver is obviously most undesirable, particularly if amplifiers are being used, so, if we use copper sulphate with copper electrodes, any noise due to polarisation would be immediately eliminated, and I think my suggestion might be worthy of consideration on this ground.

The Chairman : Before calling upon the author to reply I might point out that another way of recording sounds, and one that has not been mentioned to-night, is by means of Poulsen's telegraphone. The method is extremely effective and consists of magnetising a steel wire. The wire runs between the poles of a very small magnet, through which the microphone current passes. It is a wonderful machine, and gives a most beautiful and clear articulation. I remember hearing one in Copenhagen fifteen years ago, and it was the best articulation I have ever heard on any kind of instrument—clearer than any telephone, even a microphone telephone. On an ordinary Bell telephone, talking into the receiver, it gives a clearer articulation than the microphone transmitter. The only difficulty of the telegraphone was that it was rather faint. If it could be combined with an amplifier so as to increase the volume of sound it might work better. You could record an enormous amount of speech in a very small space, because it is only very fine wire that is used—about No. 28 or something of that order. I have never seen one of these instruments in this country, and I do not think that many of them have been made. I will now call upon the author to reply.

Mr. G. G. Blake : I think the first thing I was asked was by Mr. Campbell Swinton about the small condenser that we had for stopping the amplifier from oscillating. It is a small condenser with one sheet of mica about twice the size of a postage stamp and a piece of foil on each side. It is connected in series with the lead to the grid of the amplifier, an extra pair of telephones being connected across the telephone terminals of the receiver in the usual manner, as if no amplifier were in use.

The Chairman : In some makes of amplifiers they put condensers across the transformers.

Mr. G. G. Blake : This is not across. Then you spoke about the other method of recording, the Poulsen method. I have heard of it but never seen it. I had no idea the thing was really so practical. It seems to me that it is a better way than with the selenium cell, and well worth experimenting with.

The Chairman : It is vastly simpler.

Mr. Blake : It is vastly simpler, yes. Mr. Coursey asked a few questions about the microphone in the grid circuit—had I tried it in the grid circuit as well as in the plate circuit? I have tried it in many different positions; but I have found the best position for this particular little set, using such a small power, is where I put it after experimenting with a great many different positions.

With regard to the aerial, we found working with one of these little transmitters that we got quite as good results with a wire twelve feet long or even only six feet long as from a more elaborate frame aerial. We can pick up Hounslow comfortably with that set with a twelve foot indoor aerial. I have not tried to get any outside stations with a frame aerial, though I have tried it with this little set. I have not tried the helix method of tuning, it sounds very interesting; if there was time and Mr. Coursey could give us a diagram of that it would be perhaps helpful.

With regard to this hank method of winding, we have tried it for transmission, and it was pretty hopeless, but for reception it seems good. The loss is so small that you do not notice it if you wind out the same amount of wire in the two ways. As to the range, the Post Office have stopped me; I have not a transmitting license and cannot try. (Laughter.) I might say I have applied for one; perhaps I shall get one some day.

Now I will deal with Mr. Scott-Taggart's questions. I know that this way of modulating the current in the aerial is only suitable for small powers, but we have found it perfectly suitable for these little sets: I am well aware it would not be any use in a large power station. I do not see why it should not take a good deal of energy, because so very little energy goes through the microphone. Most of the energy seems to be in the inductance; it is only a sort of sidewash that goes through the microphone. I do not know if it has ever been tried in a big station; I know they are using quite different arrangements.

I was glad to hear about the grid leak; I was rather jumping at it in saying 80,000 ohms; that

is what we see stated in the textbooks. I had not a Wheatstone bridge. I adjusted it by scratching a pencil lead up and down the paper until I got the thing to work at its best. Perhaps it was not 80,000 ohms. (Laughter.) We found it necessary to put that small condenser across the tuning inductance in order to bridge over the gap between the different stops on the little tuner.

With regard to copper sulphate, in point of fact that does not work. I have tried various things; water itself is hardly a sufficiently good insulator. The point is not to let a lot of current through the carbons when they are almost touching. I think it is very much better to have an outside resistance to cut the current down, merely using the device for adjusting the potential. Mr. Fogarty was quite right there. He mentioned also the effect one would get with the carbon becoming coated with copper from the sulphate of copper in the solution. We have noticed a very big effect on the carbons when using water which, I may say, does not seem to be detrimental. After you have been running for some time you find, if you stop the whole apparatus and disconnect it, that you get a certain amount of hydrogen round one of the electrodes and a current in the opposite direction to the value of one or two milliamperes.

The Chairman : Ladies and Gentlemen, I am sure you wish to accord Mr. Blake a hearty vote of thanks for his interesting paper and experiments.

Mr. G. G. Blake : One point I did not answer with regard to the medical uses of this apparatus. It would be very useful to amplify the beatings of the heart from a microphone circuit, but it seems totally unnecessary to do it wirelessly—unless the doctor had one wireless apparatus at his house and the patient another at his. Otherwise you could do it direct with an amplifier from the microphone.

The Chairman : Shall we accord a hearty vote of thanks to Mr. Blake?

The vote of thanks was carried by acclamation.

The Chairman : I will now call upon Admiral Jackson to give us his paper.

THE USE OF REACTION WITH A FRAME AERIAL.

By ADMIRAL OF THE FLEET SIR HENRY B. JACKSON, G.C.B., K.C.V.O., F.R.S.

I think some of those who use frame aerials for direction finding may be interested in some practical experiments I have recently made with one of them, as they have resulted in greatly increasing its sensitiveness by means of reaction.

There is, of course, nothing new in the principle involved in the use of reaction in direction finding, but I have not heard of it

being deliberately applied in the manner I am about to describe, though others may have done so, and, if so, I hope they will compare their results with mine.

I had better first describe briefly my receiving apparatus before the experiments, as it was due to the arrangements of my receiving circuits that the desirability of systematic experiments with my frame came to my notice

THE WIRELESS SOCIETY OF LONDON

I have a good note amplifier of three valves with iron core transformers and the usual telephone reception. The incoming signals are rectified in the ordinary manner by direct coupling of the aerial or frame coil to the grid of an extra valve and to the negative leg of the filament, with an adjustable condenser across the terminals. In the plate circuit of this valve I can, at will, plug in or out a tuned reaction circuit and adjustable con-

denser. The one used in the aerial circuit is a variometer, with adjustable coupling to the aerial coil. I do not use loading coils to either circuit. My aerial is only 30 feet long, with a 30-foot T, and has only 15 feet vertical height between the T and the instruments. It is not, therefore, a very efficient one, but I am much cramped for space and height in the part of the house in which I do my W/T work.

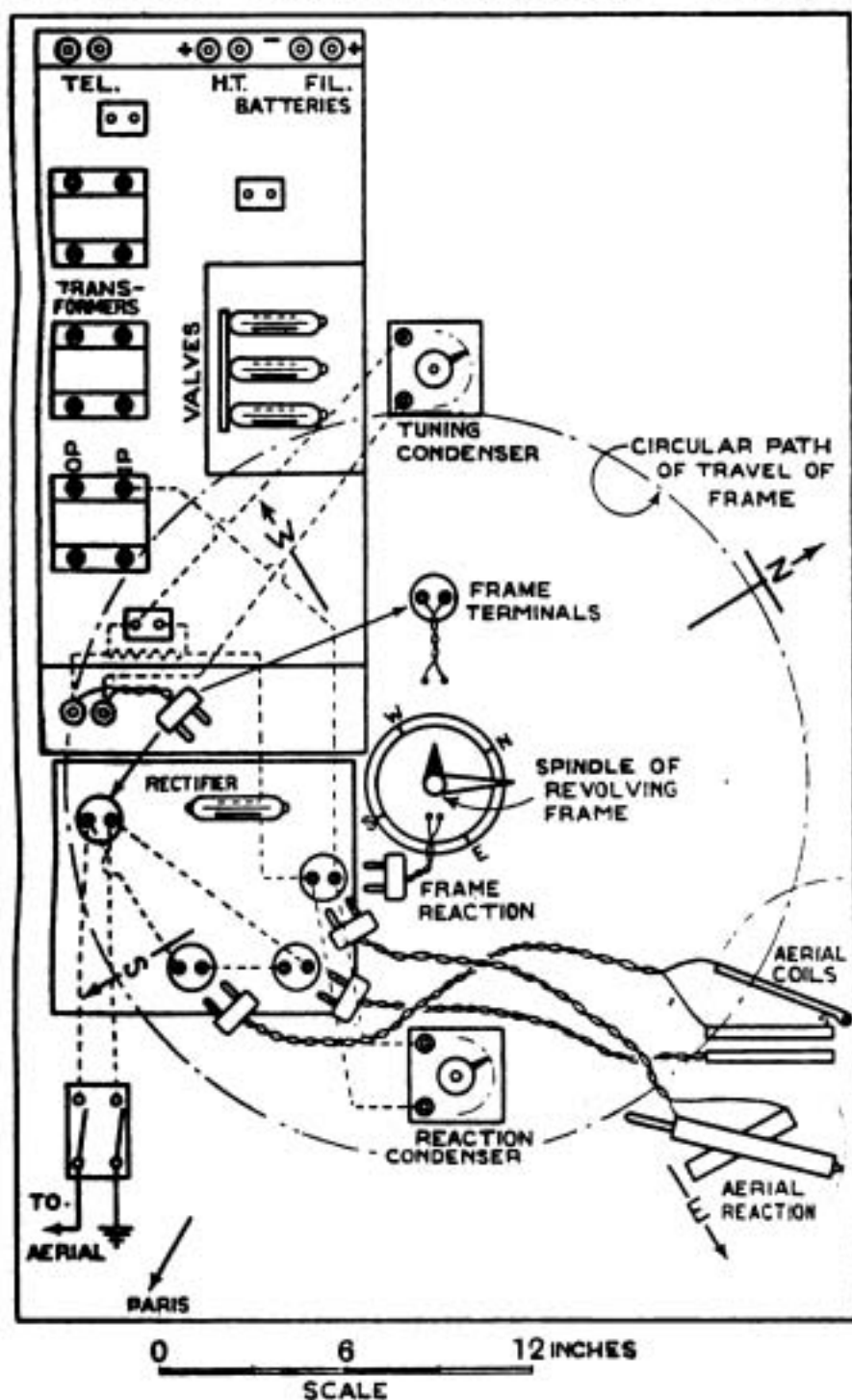

Fig. 1.
Plan of Table. Frame Aerial below table, hung by spindle

The amplifier, rectifier, aerial coil and its reaction, with their condensers, etc., are all mounted on a small table, as shown in Fig. 1. All connections between various parts not actually fixed are made by means of "two pin" plugs and sockets, and these have never given any trouble from bad connections. It can be observed that the aerial coils and reaction are on the N.E. side and the aerial and earth are S.E. side of the table.

My revolving frame is mounted under the table, and its supporting spindle projects through its centre, with a graduated circle on which is marked accurately the great circle bearings of some of the W/T stations. The white pointer shows the plane of the windings, and the black one its axis, and should therefore point to the station when its signals are at a minimum strength.

It can be seen that the frame is very close to the aerial coils in some positions, noticeably when its plane is near S.W. and N.E.

The frame is of the drum type, 25 inches in diameter and 10 inches wide. It is wound with 70 turns of No. 22 S.W.G. with I.R. insulation, in two layers $\frac{1}{2}$ -in. apart and the turns in each layer are openly spaced. Its inductance is 3.8×10^8 cms. and its resistance 5 ohms. The

ends of the wires are soldered to flexible leads and brought up through the table to a plug socket. A pin plug from the rectifier terminals can be plugged into this socket or into one connected to the aerial coils, as desired.

With no reaction fitted to either of these circuits the results with the frame were very poor, signals from such powerful stations as Paris being very faint and irregular in direction.

I left it alone for some time whilst I tried various arrangements of circuits with my aerial. The one I adopted being direct coupling, with or without reaction. With reaction it is very efficient. I then turned my attention again to the frame, first picking up a station on the aerial and then shifting to the frame. I got very inconsistent results in strength of signals, and, for some stations, also in direction. For instance, on one occasion I found the maximum strength of Paris' press signals to be nearly at right angle to the proper line, but very strong, whereas the direction of some other stations, under the same conditions, were nearly correctly indicated. The aerial, earth and coils, with their reaction, were joined up (reaction active), but A and E not connected to the rectifier. By switching these non-active coils off and on I found their proximity to the frame greatly affected the direction, particularly in the case of Paris, less so in some other lines of direction. I found that leaving the aerial, earth and all coils near the frame on open circuit was sufficient to eliminate errors in direction due to them, and, when this is done, the direction of all known stations is consistently correct to less than 1° and uniform, but with no reaction the signals are very weak.

The "active" reaction coil of the aerial circuit increased the strength of the signals in all cases, and so at times accentuated the errors due to the other coils. A study of the relative positions of the frame and aerial reaction coil show that its effect should be at its greatest when the frame is pointing about S.W. and N.E., not far off the perpendicular

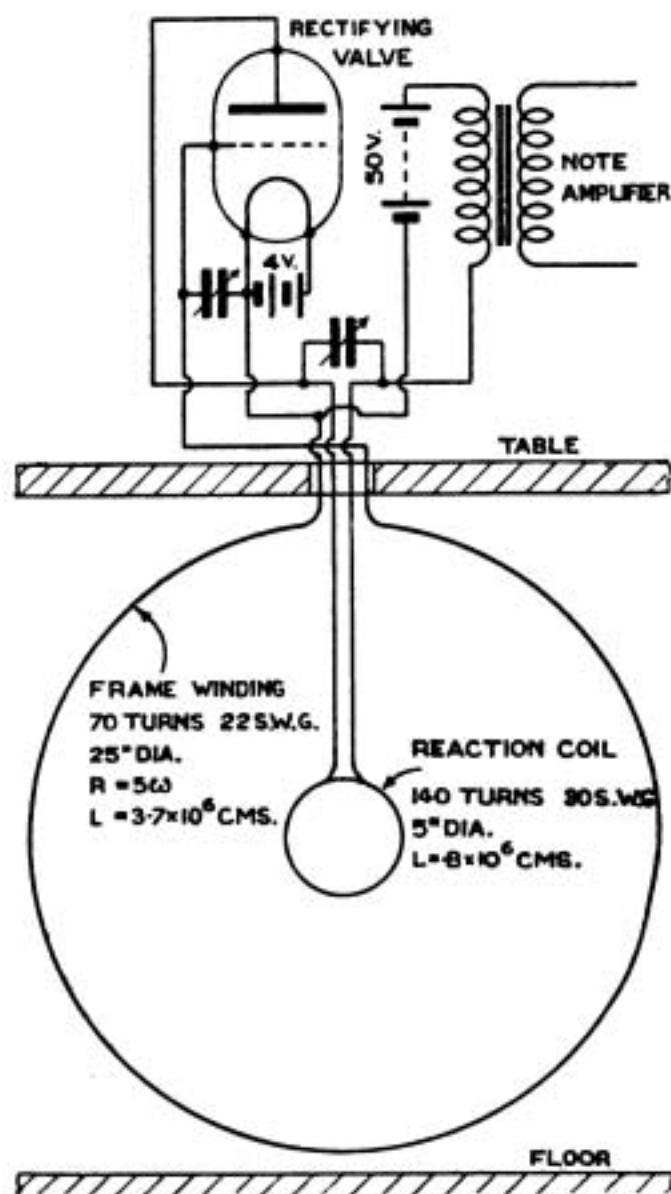

Fig. 2.

to the Paris line, and not far off the direct line of Poldhu and Chelmsford. This, I think, fully accounts for its great effect in the case of Paris and its smaller effect in the case of these other stations.

I have tried this aerial reaction tightly coupled to a loading coil in the frame circuit, so that its effect should be greater than it is on the frame circuit. This has reduced the errors in direction very considerably, but not to less than 7 degrees. Some other coils have also been tried with the loading coil in various positions on the table, and I have reduced the error by these to less than 5 degrees. The errors in direction with the frame are evidently due, partly to the inductive effect of the aerial and its coils on the frame winding,

THE WIRELESS SOCIETY OF LONDON

but mostly to the reaction (if used) of a coil which varies its effect as the frame is rotated. I therefore tried a coil fixed to the frame with its plane parallel to the plane of the frame windings. This has answered very well, and an extensive series of tests has shown it to be a useful and efficient fitting, which greatly increases the strength of the signals and has no detrimental effect on their line of direction. The circuit is shown in the Fig. 2.

I tried many coils of different sizes and inductances, from 1 inch to 12 inches in diameter, and also a variometer, and adjustable coupling, which was the principal difficulty. The one I have finally adopted is fixed 4 inches from the centre of the frame, but in its axis; it is 5 inches in diameter, with 140 turns, and has about 0.8×10^6 cms. inductance. Another one almost as good was a solenoid, 7 inches long, 2.2 inches diameter, with 340 turns, and about the same inductance as the other; this was symmetrically fixed in the axis of the frame.

These reaction coils seem efficient for all wavelengths that the frame will receive with the adjustable condenser of 0.0012 mfd., that is about 800 to 4,500 metres. This fitting brings in many stations which are not audible without it, and is very efficient for telephonic and any C.W. reception. The spark and arc are rough when their intensity is increased, but they are more easily readable. The reaction coil as fitted requires about the same condenser adjustment as the frame, which is a great convenience, as the two knobs can be turned at the same angular velocity when searching for signals.

If the frame or coil is plugged in the reverse manner a different condenser adjustment of the reaction is required, as the phase angle will be altered, and, as a rule, the signals will be weaker. With some of the coils used the frame and reaction circuits can be transposed with little or no loss of strength or directive effect, *i.e.*, the reaction may be in the grid and the frame in the plate circuit.

I cannot trace any detrimental effect from the proximity of the valves, iron core trans-

formers and short leads on the directional effect of the frame. The reaction may cause some howling if it is not in phase with the frame. I have not tried it with H.F. amplification; I think it really takes the place of H.F., enabling L.F. to approach the results which previously I could only obtain with both, necessitating a large number of valves in the amplifier. I could easily dispense with one of my L.F. valves with but little loss of intensity.

NOTE.—I have recently tried this with H.F. amplification and found it equally efficient.

DISCUSSION.

Mr. J. Scott-Taggart: Just one point I would like to ask Admiral Jackson, that is, whether he has carried out any experiments, having the grid coil exactly the same size as the other coil and rotating the two together, one inside the other? Also what effect the rotation of one of the coils inside the other has on the bearings? Obviously varying the coupling between the two coils—varying the mutual direction—will affect not only the strength of the signals received, and probably, although the coils receiving some part of the incoming waves are in different directions, there will be some interference between the two sets of reception. To compensate for any variation in that direction it should be possible to include a condenser across the grid and plate, and so bring the reaction up to the desired point again. It would be interesting to hear if Admiral Jackson has carried out any experiments on these lines. Instead of having the coils connected up outside the set, apparently there would be no objection to using other methods of retro-action than that described. In a resistance-coupled amplifier one could obtain retro-action by means of a condenser between one of the valves and the plate of the valve. In this way there would be no complication with extra inductances liable to pick up waves.

With reference to his remarks about the leads, I think for very accurate work it would be found that the leads to the amplifier would certainly affect the bearings obtained, and to avoid this it would be possible—and it is frequently done—to include the amplifier and connections absolutely inside the rotating coil.

The Chairman: In connection with what the last speaker has just said I am afraid I do not feel very competent to discuss the subject, but I tried some experiments some time ago with two frames both in series and in parallel. They are practically identical frames, and I found when receiving continuous waves I got the most extraordinary results. I do not know that they were very useful, but they were certainly very interesting. No doubt it was due to reaction of the one upon the other, also to the difference of phase, between them. But with

spark stations it did not seem to have the same effect at all. Spark stations either diminished the effect or increased the effect only, without making any other change; but of course with the continuous wave stations they altered the note altogether. You could tune for the note by rotating one of the frames just in the same way as you could by varying your condenser. I may say that I have seen this apparatus of Sir Henry Jackson's at work, so I can testify to its operation; it is a very compact thing. It is not a very large room and it is a very compact arrangement. Putting the frame under the table is a rather unusual method, and I have never seen anybody else do it. Usually frames are hung in the air.

Admiral Sir H. B. Jackson: Mr. Scott-Taggart asked if I had tried, I think, two equal coils, one a reaction and one turning on the other. I have not tried two equal coils with a variable coupling, but I have tried two unequal ones both with vertical and horizontal coupling. It is hopeless to think you will get direction with that, but with a horizontal one I used it a great deal, but managed to do away with it. Of course that would not do away with any vertical component of the wave, but for a horizontal wave it is very useful indeed for tuning. It is simply a variometer. It had no effect on the direction, as long as you left it perfectly fixed, and did not change it after you once started finding the direction. Is that the point you wanted to know?

Mr. J. Scott-Taggart: Yes.

Admiral Sir H. B. Jackson: As regards the two equal coils, I think I have those experiments in my mind's eye to carry out on some future date. As to the reaction of the coil in the amplifier, I have not a resistance amplifier but a transformer amplifier. I have tried a good many experiments with a reaction of these low frequency transformers, and I find you can get very increased sound in the telephones, but generally, a great deal of more careful adjustment is required. I gave it up; so long as you get signals of a certain strength you don't want them heard all over the room. Simplicity is a great thing. I have tried a good many experiments to bring reaction into play in

the low frequency part, and I have had a certain amount of success. You can get louder signals but with a loss of clearness. I think those are all the points to be dealt with.

The Chairman: I will ask you to pass a very hearty vote of thanks to Admiral Sir Henry Jackson. The vote of thanks was heartily accorded.

The Chairman: This is the last meeting of this session, and I have one or two announcements to make. I am asked to draw your attention to the International Aero Exhibition at Olympia which is going to be held from July 9th to 21st, at which a large quantity of R.A.F. wireless apparatus will be on show, including working wireless telephones and various receivers. Lieutenant Duncan Sinclair suggests that this might be of interest to members, who would no doubt like to see what is to be seen.

I have also to announce that all the new members to the number of seven, have been duly elected, also that the Committee have elected Mr. A. Hambling as a full member; he was previously an Associate.

I have to announce that the following wireless Clubs have been affiliated to this Society—the Cardiff and South Wales Wireless Society, the Gloucester Wireless Society and the Newcastle and District Wireless Society. I think we are to be congratulated: before very long practically all the wireless societies of Great Britain will be affiliated to the Wireless Society of London.

As you know, the Marconi Company have kindly invited members to visit their works to-morrow. The train leaves Liverpool Street at 2.15 for Chelmsford, and arrangements have been made with the railway company to reserve, as far as possible, a certain number of places both first class and also third class for those who prefer it; and I understand these carriages will be labelled with the word "Marconi," so that the members should look out for them. There will be no further meetings of this Society till September: before that date the Committee will meet, and notice of such meetings as can be arranged will be sent to all members. The meeting is now closed.

The proceedings terminated at 9.45 p.m.

SOME OF THE CONTENTS OF FUTURE ISSUES

THE WIRELESS LOG OF THE R.34

SPARKS AND SPARK-GAPS

THE EARTH, AETHER AND WIRELESS

STRAYS AND THEIR ORIGIN

WIRELESS TELEGRAPHY IN SAVAGE AFRICA

HIGH VOLTAGE SUPPLY FOR VALVES

WIRELESS CLUB REPORTS

North Middlesex Wireless Club.

(Affiliated with the Wireless Society of London.)

The usual fortnightly meeting was held at Shaftesbury Hall, Bowes Park, on June 30th, and was well attended. After the business of the evening, at which three new members were elected, members turned their attention to the valve receiving set, kindly lent by one of the clubmen. This was connected to the Club's aërial, and signals were successfully received. Intending members should apply to the Hon. Secretary, Mr. E. M. Savage, Nithsdale, Everaley Park Road, Winchmore Hill, N.21.

Glasgow and District Radio Club.

(Affiliated with the Wireless Society of London.)

At a meeting held on May 26th, 1920, it was decided that the usual weekly meetings of the Club would not be held during June, July or August, on account of the absence of so many members on holiday. In the interval the Committee are to meet and draw up a syllabus for the ensuing session, for submission at a preliminary business meeting, to be held some time in September.

A new subscription of 10s. per annum was agreed to, this figure to come into operation at the beginning of the session. The matter of a permit for a valve receiving set is well in hand with the P.M.G., and formal permission is expected in the course of a few days. Through the kindness of Mr. W. K. Dewar, Manager of the North British Wireless Schools, the school's aërial will be available every Wednesday evening for reception purposes, and it has been arranged that a member of the Committee will be in charge each evening. A library has been formed, and the following books will be available for the use of members:—*Wireless World*, *Wireless Age*, *Year Book of WIT*, *Post Office Official List of Stations*, *Berne International List of Call Signs*, *Postmaster-General's Handbook*.

At a Committee meeting, held on June 30th, 1920, it was decided that a smoking concert will be held on the Club's opening night in October. Full particulars and date will be notified later. Members who can contribute items to the programme for this event are invited to communicate with the Secretary, Mr. R. Carlisle, 40, Walton Street, Shawlands, Glasgow.

The Cardiff and South Wales Wireless Society.

(Affiliated with the Wireless Society of London.)

A special meeting of this Society was held at Headquarters, the Wireless Department of the City of Cardiff Technical College, on Thursday, July 1st, 1920, when, in spite of inclement weather, there was a good attendance. The chair was taken by the President, Mr. W. A. Andrews, B.Sc., A.I.C., etc. The Hon. Secretary read the minutes of the last ordinary meeting, which were confirmed. A code of rules drawn up by the Committee two meetings ago was read and unanimously approved, it being resolved to place them in the printer's hands immediately. A telegram was read from Captain C. H. Bailey, of the Royal Automobile Club (Vice-President of the Society), advising us that Mr. McMichael, of the Wireless Society of London, desired him to state our affiliation with the Wireless

Society of London had been effected, and also notifying us of the telephony tests from Chelmsford that evening. A letter was read from the Halifax Wireless Club, requesting a copy of our rules for their guidance. It was decided that the Secretary be authorised to forward the Halifax Club a copy of the rules as soon as they are ready. The Secretary having opened a current account with the Mountain Ash Branch of Lloyd's Bank, Ltd., it was resolved that the bank be authorized to honour all cheques signed by any two persons of the following—the President, the Hon. Secretary and the Treasurer.

The Hon. Secretary had been previously advised by M. le Général Ferrié (Inspecteur Général des Services de la Télégraphie Militaire, Paris), a Vice-President and Honorary Member of the Society, that he would send the Society a special and exclusive message via the high-power wireless station at Eiffel Tower, Paris, on July 1st, when the members were assembled. Having previously connected up 18 valves in cascade to a Brown's Loud-speaker, when F.L.'s preliminary call came through, the terrific strength of signals surprised even those who had expected very loud signals. For the benefit of Press representatives present the Secretary transcribed the signals on to a blackboard—"General Ferrié and F.L. send their best regards to the Cardiff and South Wales Wireless Society for its general meeting, and heartily wishes the continuance of the cordial British-French collaboration in Wireless—F.L."

The Hon. Secretary was afterwards instructed to write to the General, expressing the hearty appreciation of every individual present, and the thanks of the Society as a whole, for this most signal honour. The meeting then dissolved, some remaining in the lecture hall to listen to a most instructive and interesting lecture given by the President on "Early Wireless Apparatus, the Hertz Oscillator, the Coherer, etc.", while others adjourned to the telegraphy room for Morse practice. The remainder were most interested operators of the 18-valve amplifier, which never fails to provide us with new freak signals. At 9.30 p.m. the majority of the members had left to catch their respective trains, but a few remained to listen in for the telephony from Chelmsford Station, which always comes in remarkably strong.

The Hon. Secretary desires to announce that the list of members is almost ready for the printer, and anyone desirous of being included in the said list would do well to enrol immediately. The subscriptions are fixed as follows:—a minimum of 5s. per annum for Full Members and Corresponding Members, and a minimum of 2s. 6d. per annum for Associate Members. Members are at liberty to subscribe any other amounts they wish. Further particulars can be had from the Hon. Secretary, Mr. A. E. Hay, 6, Oxford Street, Mountain Ash.

Bristol Wireless Association.

(Affiliated with the Wireless Society of London.)

A meeting of this Association was held in the Physics Lecture Theatre on July 2nd, at 8 p.m., Mr. E. C. Atkinson being elected to the chair owing to the absence of the Chairman, Dr. Hodgson (who is well known in the scientific world, especially

in the wireless branch) delivered a lecture on the principles of wireless telephony. At the conclusion of the lecture a number of questions were asked. The chairman then moved a hearty vote of thanks to Dr. Hodgson for the trouble he had taken, which vote was seconded by Mr. A. C. Davis. The next meeting will be held on Friday, July 30th.—Hon. Secretary, Mr. A. W. Fawcett, 11, Leigh Road, Clifton, Bristol

Wireless and Experimental Association.

(Affiliated with the Wireless Society of London.)

At a meeting on July 7th Mr. C. Saunders in the chair, the speech and musical trials of the Marconi Chelmsford installations formed a principal topic of discussion. Many of the members who had made their own receiving apparatus were searching for broken wires, when the failure occurred in the early part of the trial of the 6th, but were put at ease by the subsequent perfection of signals and the explanation that the failure was due to causes local to Chelmsford.

The proposed field day and the annual general meeting fixed for August 4th were discussed. Mr. Bates had a proposal for using the mercury arc for a wireless telephone transmitter. Messrs. Weeks and Kloots, Junior, established wireless connection between the gas and water pipes of the building and intercepted F.L. in the act of calling up Constantinople. Hanover, Elvise and Horsea were also heard. Mr. Sutton followed with some data on frame aeriels.—Hon. Secretary, Mr. G. Sutton, 18, Melford Road, East Dulwich, S.E.

Manchester Wireless Society.

(Affiliated with the Wireless Society of London.)

Wednesday, June 30th.—At a special General Meeting, held at the Club Room, a special Advisory Committee was elected to deal with technical questions in wireless telegraphy and telephony and such allied subjects as may occur from time to time. Members, Mr. A. Couyoumjdian, Mr. Y. Evans, Mr. D. J. Davies. Mr. J. McKernan was elected Chairman of the Society, and assured the members of his heartiest support. A vote of £20 for the purpose of obtaining necessary equipment for the Club Room was unanimously carried.

Arrangements were made for members to visit a large generating station in the Manchester district, under the guidance of Mr. D. J. Davies. Three new members were introduced. After other business of the Society had been dealt with the Chairman, Mr. J. C. A. Reid, declared the meeting closed.

As a result of information received from the *Wireless World*, several members tuned for the Chelmsford demonstration on July 6th; both voice and gramophone were heard clearly and distinctly on a frame aerial coupled to a one-valve circuit.

Communications re membership should be addressed to the Hon. Secretary, Mr. J. H. Evans, 7, Clitheroe Road, Longsight, Manchester.

The Birmingham Experimental Wireless Club.

The usual weekly meeting was held on Wednesday, June 30th. Mr. L. Dore was again our lecturer. The subject, "Duplex Telegraphy," was very

ably dealt with, many questions being asked on interesting points, and all who were present gained some very valuable instruction. Mr. Dore was able to illustrate his subject with two complete sets of instruments which he was fortunately able to get the loan of.

The subject for next Wednesday is "Continuous Wave Transmission," by Mr. Woodcock.

The Club is open to receive a few more members, and any who may be interested in wireless are invited to communicate with the Hon. Secretary, Mr. A. T. Headley, 255, Galton Road, Warley, Birmingham.

Gloucester Wireless and Scientific Society.

A very successful meeting was held on the 2nd inst., when, in addition to various discussion, part of the evening was devoted to buzzer practice. The Hon. Secretary has been experimenting with honeycomb inductances, and is securing very successful results. Membership is steadily increasing and the Club is looking forward with eagerness to the time when the aerial and apparatus are finally installed.—Hon. Secretary, Mr. J. Mayall, Burfield Lodge, St. Paul's Road, Gloucester.

Amateur Clubs.—It may interest our readers to know that there are in the United Kingdom forty-one Clubs, formed for the purpose of studying and practising Wireless Telegraphy and Telephony. Of these Clubs, twenty are affiliated with the Wireless Society of London. As far as we are able to gather from our records, the total number of Amateur Club members in the United Kingdom is approximately 1,500; but since the honorary secretaries of many Clubs have not apprised us of further membership, our figures must necessarily be short of the actual total.

We take this opportunity of pointing out that a number of Clubs have become lax in the matter of sending in reports of their meetings, and, in so doing, are helping to defeat the amateur cause. There are, as shown above, forty-one Clubs for whom we could publish reports each month, yet, as enthusiastic as the members of those Clubs profess to be, never have we been called upon to publish a number of reports so high as forty-one.

The publicity of these columns is open to all Clubs, formed and forming, and, speaking from the book of experience, nothing succeeds *without* publicity; no Club can grow without support. Let each Club send in its report; let each Club make known its movements to other Clubs; let all Clubs make their existence known, and so advance the amateur cause. There are still wanted to form Wireless Clubs at Bournemouth, Spalding, Doncaster, Exeter, Grimsby, Aberdeen, Rugby and Glasgow. Those interested should communicate with Mr. T. H. Dyke, Hill Garage, Bournemouth; Mr. W. G. A. Daniels, Pinchbeck Road, G.N.R. Crossing, Spalding; Mr. A. H. Wasley, Glenholme, Ravensworth Road, Doncaster; Mr. H. E. Alcock, 1, Prospect Villas, Heavitree, Exeter; Mr. C. Hewins, 42, St. Augustine Avenue, Grimsby; Mr. W. W. Inder, Crown Mansions, 41, Unions Street, Aberdeen; Mr. A. T. Cave, 3, Charlotte Street, Rugby; Mr. W. Mitchell, 237, North Street, Charing Cross, Glasgow.

PAGES FOR BEGINNERS

Under this heading we publish COMPLETE instructional articles, forming a series specially designed and written for beginners in wireless work. Hardly any mathematics will be introduced, and we hope to present the fundamental facts of wireless in such a manner as will prove attractive to a much wider range of students than that for which this series is primarily intended.

DAMPED AND UNDAMPED WAVES.

AETHER waves sent out from a transmitting station radiate in all directions, and will thus affect every receiver within range. Scientists cannot prevent this to any great extent, but they can make it a difficult matter for "stranger" receiving stations to intercept messages not intended for them. To explain how this is accomplished, let us revert to the tuning-fork analogy, which was of importance in explaining "tuning."

Suppose we had a number of tuning-forks of different frequencies, mounted on a board. If the board were struck a heavy blow with a hammer, all the forks would be set vibrating to a greater or less extent, and it would be impossible for us to single out one that would vibrate while the others were silent.

But if, instead of the hammer, we were to place on the board a tuning-fork of the same frequency as the one required to sound, then, on setting this one vibrating, the fork of corresponding frequency would vibrate, and the others would not be affected.

So, whereas in the first case it was impossible to single out one fork which should be affected, in the second any desired fork can be made to vibrate, irrespective of the others, by simply exciting it by one of the same frequency.

The essential difference between the two methods is this. The hammer transmits a single powerful impulse which, so to speak, forces vibrations on the tuning-forks. The exciting tuning-fork emits a number of small correctly timed vibrations, which will only affect the fork of the same frequency, *i.e.*, the one in tune.

Comparing this with the electrical case, we

see that if we wish to single out one particular circuit for the reception of the message, we must transmit the latter by means of a series of small regularly-occurring impulses, or, technically speaking, we must employ feebly-damped waves of low amplitude. (Fig. 1 will recall the difference between highly damped and undamped waves).

If the receiver is exactly in tune with the transmitting station these small waves will

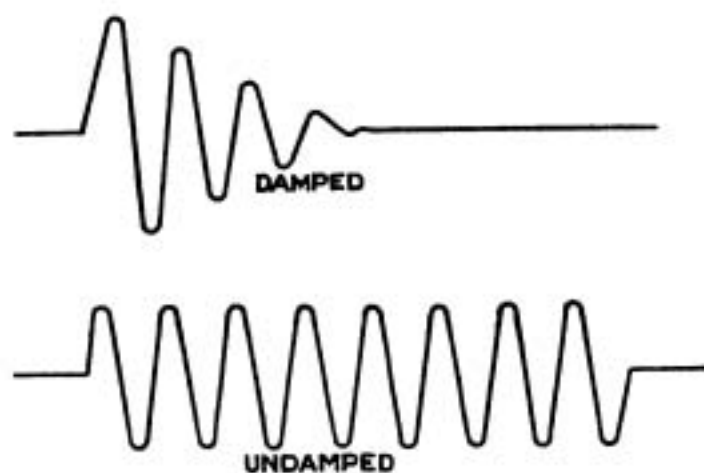

Fig. 1.

occur at the correct intervals to augment the induced oscillatory current, and produce a maximum effect in the circuit. Other receivers, unless they are also exactly tuned, will not be affected, because the frequency of vibration of the waves will not be the same as the frequency of the receiving aerial.

On the other hand, strongly-damped wave trains of a high amplitude will *force* the neighbouring receiving aerials into oscillation, and it thus becomes difficult to prevent the broadcast transmission of any message.

Now, let us see how it is possible to transmit trains of damped waves from a coupled oscillatory circuit. We saw how an oscillatory

current can be induced in a coil placed near the coil forming the oscillatory circuit. Essentially this induction of currents consists in a transference of energy from one coil to the other. The potential energy of the charged condenser becomes kinetic energy

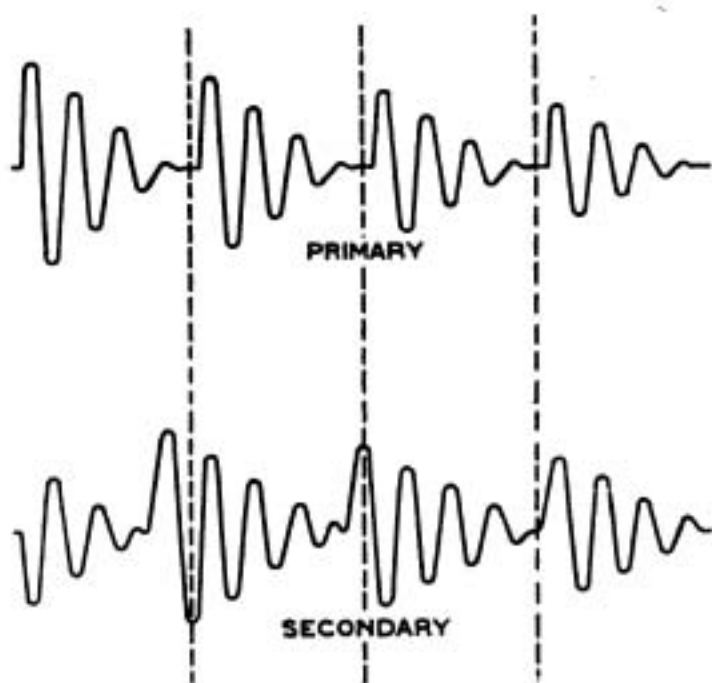

Fig. 2.

when the current is oscillatory, and this kinetic energy is transferred to the secondary circuit. Now, since energy cannot be created or destroyed, it follows that the oscillations in the primary will decrease as those in the secondary increase, until finally the primary oscillations have died down, when the secondary oscillations are a maximum. Now what happens? During the time the spark is passing in the primary circuit the secondary circuit is oscillating, and radiating lines of force which cut the primary, and start it oscillating again. These oscillations increase at the expense of the secondary, until finally all the energy is transferred back to the primary circuit. The cycle of operations then goes on as before, until the oscillatory current dies away altogether as a result of energy lost by radiation and in the resistance of the circuit. This transference of energy can be diagrammatically represented by Fig. 2. In this we see that the primary oscillatory current

is zero when the secondary current is a maximum, and *vice versa*.

The resultant waves emitted by the aerial will be of irregular amplitude, and will consist in reality of two wave trains having different frequencies corresponding to the primary and secondary circuits.

For selective receiving, however, it is essential that the waves transmitted be of low amplitude and constant frequency. Obviously, then, we must prevent interference between the primary and secondary circuits.

This is done by causing the primary to start a train of oscillations in the secondary coil, and immediately opening the primary circuit. Oscillatory currents cannot be induced in a coil on open circuit, and thus the secondary will not transfer its energy back to the primary. The primary circuit can be opened almost immediately by causing the spark to die away as soon as it is formed, or in other words, by *quenching* the spark.

It was discovered that a spark which took place between metal plates or discs was far more rapidly quenched than one which passed between metal spheres. This is probably due to the fact that the metal plates offer a large cooling area to the hot gases, and prevent their continuance.

A number of these metal plates may be put in series, separated by a small air gap. (See Fig 3).

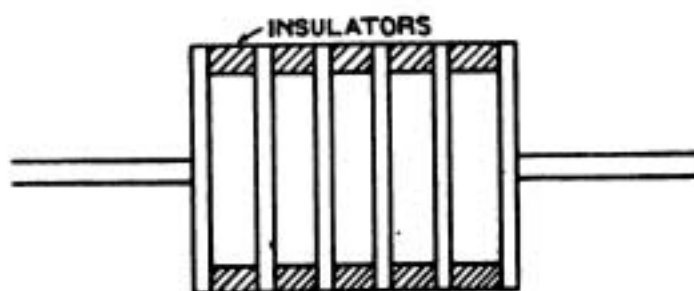

Fig. 3.

The high-speed disc discharger, invented by Marconi, was an improvement on the stationary plates. In the disc discharger a number of contact studs were fixed round the circumference of an insulated disc, which was driven by a high-speed electric

PAGES FOR BEGINNERS

motor. Each of these contacts in turn came opposite a pair of fixed spark knobs and allowed

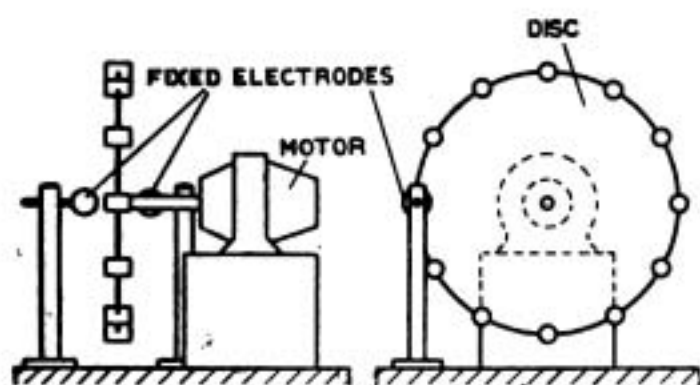

Fig. 4.

a spark to pass. It was instantly quenched by the movement of the rotating stud, and also by the rush of air through the gap. (Fig. 4.)

The oscillations in the primary coil are abruptly stopped by this means, and the timing of the discharge also can be kept under control. The number of discharges of the condenser in a given time obviously depends on the number of studs which pass the spark electrodes, and the rate at which the wave trains are produced can be varied by varying the rate of discharge. It is only necessary therefore to alter the speed of rotation of the disc to be able to vary the wave trains from isolated groups to practically a continuous series waves.

Let us return to a consideration of the secondary circuit, and see how the quenching of the spark affects the waves transmitted.

As noted before, the primary circuit is only closed for a sufficient length of time to start the oscillations in the secondary circuit. The primary circuit is then open, so the secondary will oscillate until the current dies away from the effects of radiation and resistance in the circuit.

The current in each circuit will be as in Fig. 5, and the aerial will therefore radiate

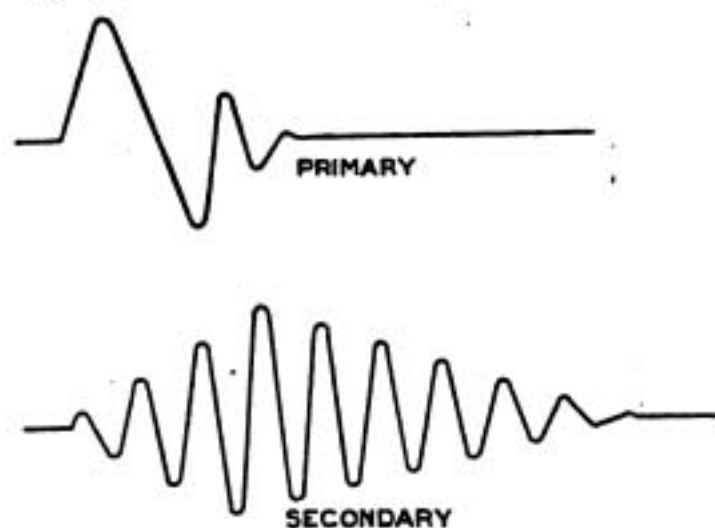

Fig. 5.

a wave train of uniform frequency, and *feebly damped*. Because of the fact that these small wave trains only affect receivers which are in tune, they are easily prevented from affecting other receiving stations within range.

ADVICE TO AMATEURS

We have recently received a very interesting letter from Mr. F. W. Emerson, dealing with the elimination of noises due to the proximity of electrical generating stations. For the information of amateurs similarly troubled we have pleasure in publishing Mr. Emerson's experiences:—

"My station is situated about 100 yards away from an electrical transformer sub-station, the latter supplying the house with 200 volts direct current. On first obtaining my receiving licence I used a crystal detector, and was much disturbed by strong noises from the said electrical station, especially in the region of 1,000 metre wavelength.

I found, however, that if I broke the house-lighting circuit by means of the usual double-pole switch adjacent to the meter, no interfering sounds could then be heard.

"Recently I have installed a single-valve receiving set, after the pattern of Reed's receiver, mentioned in the 'Proceedings of the Wireless Society of London' some time ago, and find that noises from the house wiring are now very slight, even without breaking the house supply. This has obviated the necessity of plunging the house into darkness in order to pick up weak signals, and thereby incurring the wrath of the other members of the household."

The CONSTRUCTION of AMATEUR WIRELESS APPARATUS

How to make a Direction Finder (Part III).

IN winding the coils of the Direction Finder or Radiogoniometer care should be taken that the two windings are evenly wound and at right angles to each other. They should also both be wound in the same direction, *i.e.*, from start to finish both should be clockwise or anti-clockwise.

As soon as the winding is completed a test should be made to determine the electromagnetic accuracy of the "Radio." To do this it is necessary that the windings should be mounted on the base and connections made to the proper terminals. The base should have the 360 degree circular scale fitted so that accurate readings of the search coil may be taken. The 0-180 line of the scale should lie at right angles to the line of terminals—the "nought" point on the scale being nearest the 8 terminals. The pointer should be temporarily fixed to the top spindle of the search coil and should point along the plane of the coil, *i.e.*, along the winding.

Each winding is in two sections so that a condenser may be connected in the middle of the coil. Connect the start of section one of winding one to terminal A and the end of the first section to B. Connect the start of section two to C and the finish to D. Join up winding two to terminals E A G H in the same way. Join the ends of the search coil to the terminals R.

Procure a buzzer or some form of current interrupter and a dry cell. Connect the buzzer and cell in series with terminals A and D. Join B and C with a short lead and connect a pair of low or high resistance telephones across the search coil at R. If the buzzer is buzzing an interrupted current will be set up in the search coil giving signals in the telephones. The strength of these signals will vary according to the relative positions of the field coil and search coil. It will be found that maximum signals are ob-

tained with the two coils in the same plane, *i.e.*, at 135° and 315° and zero points found with coils at right angles, *i.e.*, 45° and 225°. Carefully note the actual zero points obtained.

Now connect the buzzer and cell to E and H and join F and G together. This winding, being at right angles to the other winding, will give maximum and zero points at right angles to previous positions. Maximum signals will be obtained at 45° and 225° and zero points at 135° and 315°. Carefully note these two zero points.

Next compare the positions of the zero points; they should be exactly 90° apart. If they are within 1° of 90° apart accurate results may be expected. If the error is much greater than 1° or 2° one of the windings should be rewound and the test carried out again.

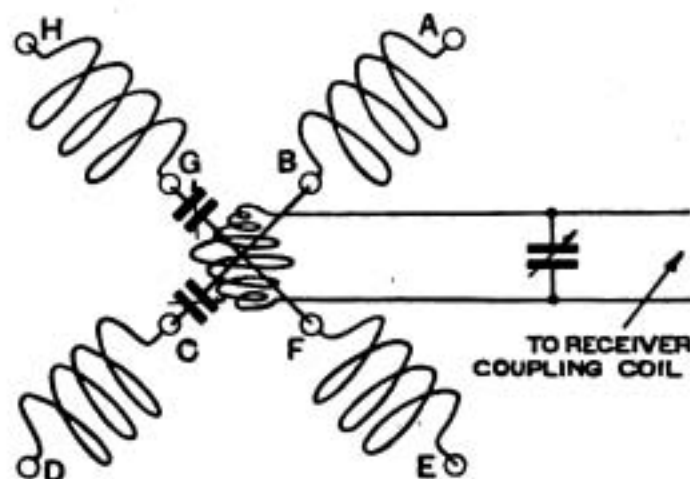

Fig. 1.

If now the two windings are connected in series by joining D and E (the condenser terminals being short circuited) zero signals will be obtained at 90° and 270°.

If the windings are connected in series by joining D and H and connecting the buzzer across A and E zero signals will be obtained at 0° and 180°.

From this it will be seen how it is possible

CONSTRUCTION OF AMATEUR WIRELESS APPARATUS

to get the bearings 90° out if the aerials are inaccurately connected to the D.F. terminals. When the Direction Finder is complete it may be connected up to the aerial and an existing receiver for a test. When using only a crystal receiver with note magnification the aerial circuits should be tuned by means of variable condensers connected up as shown in Fig. 1. These condensers should be of equal capacity—the actual value being determined by the wavelength range desired and the size of the aerials. For 600 metres a 0.0005 mfd. variable condenser will be sufficient. Longer wavelengths may be obtained by means of block condensers connected

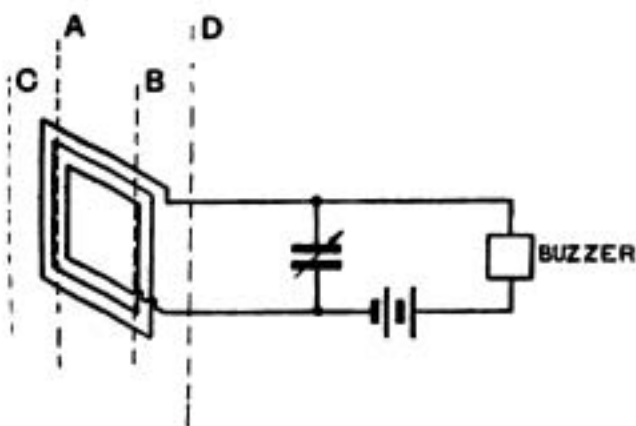

Fig. 2.

in parallel, the variable condensers being used for balancing. When adapting an existing tuning circuit the condenser in the search coil circuit (which may be the receiver aerial

condenser) may be connected either in series with the search coil and tuning inductance or across the two inductances in parallel according to whether the amount of inductance in circuit is too small or too great for tuning to the desired wavelength.

Fig. 2 shows the method used to tune the D.F. aerials, each aerial being tuned separately. The four aerial leads are brought close to the wavemeter inductance when being led to the D.F. terminals. With the buzzer going one aerial circuit is opened and the other tuned. Then the tuned aerial is opened and the other one connected up and tuned. After the aerials are tuned the only adjustment to be made is to rotate the search coil.

A good method of adjusting the D.F. for bearings is to get a known station—whose actual geographical position is known, *i.e.*, so many degrees east of north, and to adjust the search coil pointer until that station's signals vanish, and then adjust the scale to the degree position corresponding to the position of the station.

For direction finding maps, the ordinary maps based on Mercator's Projection are not accurate, and it is necessary to use a map based on Gnomonic projection. At a later date an article will be written in which the construction of such a map will be described.

“SOLD OUT”!

IF that is what you hear when you try to get your copy of the *Wireless World*, place a standing order with your newsagent or bookseller. It is not advisable to miss a copy, intending to obtain it later for binding, because you may be again disappointed; many people are still trying to find back numbers of this magazine.

Please notify all cases of difficulty in obtaining the *Wireless World* to the Circulation Manager, The Wireless Press, Ltd., 12 & 13, Henrietta Street, W.C.2.

BOOK REVIEWS

MANUAL OF RADIO TELEGRAPHY AND TELEPHONY. (*Fifth Edition.*)

By CAPT. S. S. ROBISON, U.S.A.

Reviewed by Captain D. W. Todd, U.S.N.,
and Comdr. S. C. Hooper, U.S.N.

Baltimore: The Lord Baltimore Press,
\$1.50, postpaid. London: S. Rennell & Co., 10s. Pp. 307.

THIS manual is intended for the use of students of wireless telegraphy and telephony, descriptions of apparatus most commonly used being given in detail.

This volume is the fifth revision of that which was originally written by S. S. Robison, when Lieutenant, in 1907, and though the book is highly instructive, the first few chapters, which in themselves form the major portion of the book, are not written in such a way as to hold the reader's interest. Containing long descriptions of elementary principles, these chapters, in their endeavours to make the subject clear, would seem to be overdone, and a little more credit given to the student's intelligence and general knowledge would in no way obscure the meaning the author would wish to convey.

Chapters I to V deal with static charges of electricity, magnetism, the utilising of magnetic fields for the production of electric currents in dynamos, the means of increasing the potential of the currents produced; how by means of these high potential currents large charges may be forced into condensers, and how by discharging these condensers we may produce electric or ether waves.

Chapter VI embraces transmitters of various types in a clear and interesting manner. On page 116 may be found many interesting facts concerning condensers and their dielectrics, and here the author is less laborious in his writing.

Chapters VII and VIII explain the Poulsen arc, giving theories, diagrams and methods of wiring. The valve, which is ever becoming more prominent in wireless, is

given worthy attention in these same chapters; its uses as a transmitter as well as a receiver, its advantages, characteristics and theory, together with diagrams of circuits, being given full description. On page 138 the reader will find a history of the valve and its advance in wireless telegraphy; the names of companies who have experimented, the dates of such experiments and their results.

Chapters IX and X deal exclusively with receiving apparatus and aerials of various systems and types, both chapters abounding with illustrations. Chapter X is especially interesting, in that it gives a pleasing account of the "grounded loop aerial," which is so extensively used on submarines, and tells also of the "underground antennæ," which first came into prominence in 1916. The advantages of this latter aerial over the overhead system are embodied in its directional characteristics, its cheapness and its partial elimination of atmospherics. The chapter concludes with a full description and explanation of the Alexanderson "Barrage Receiver."

The much-used wireless service between Europe and America makes Chapter XII particularly interesting, in that it deals with the high-power stations engaged in the maintenance of such service. The various systems used, the many difficulties which had to be overcome, make both instructive and interesting matter.

Now that wireless is accepted as a part of aircraft equipment, the student would do well to study the methods adopted for the generation of power, the arrangement of aerial and the difficulties of "earth." Chapter XIII deals with the subject in a very capable manner, and is illustrated with photographs of actual machines. The remainder of the book mainly concerns installation, adjustment and measurement, together with the care and operation of apparatus; much useful data is given in tabular form, with extracts from laws and regulations concerning wireless.

QUESTIONS AND ANSWERS

NOTE.—This section of the magazine is placed at the disposal of all readers who wish to receive advice and information on matters pertaining to both the technical and non-technical sides of wireless work. Readers should comply with the following rules—(1) Questions should be numbered and written on one side of the paper only, and should not exceed four in number. (2) Queries should be clear and concise. (3) Before sending in their questions readers are advised to search recent numbers to see whether the same queries have not been dealt with before. (4) The Editor cannot undertake to reply to queries by post. (5) All queries must be accompanied by the full name and address of the sender, which is for reference, not for publication. Queries will be answered under the initials and town of the correspondent, or, if so desired, under a "nom de plume." (6) Readers desirous of knowing the conditions of service, etc., for wireless operators will save time by writing direct to the various firms employing operators.

H.A.H. (Liverpool) sends a sketch of a receiver (Fig. 1) which he wishes to make with a range of 300–30,000 ms. He asks (1) The number of turns on A, R, and SH for 30,000 ms. (2) Proper maximum capacity for K_1 and K_2 . (3) Criticism of the circuit and the use of No. 32 wire on $4\frac{1}{2}$ " formers for the inductances. (4) Is it necessary for R and SH to be wound on separate formers, or if they could be wound on one former and then coupled as one coil to A.

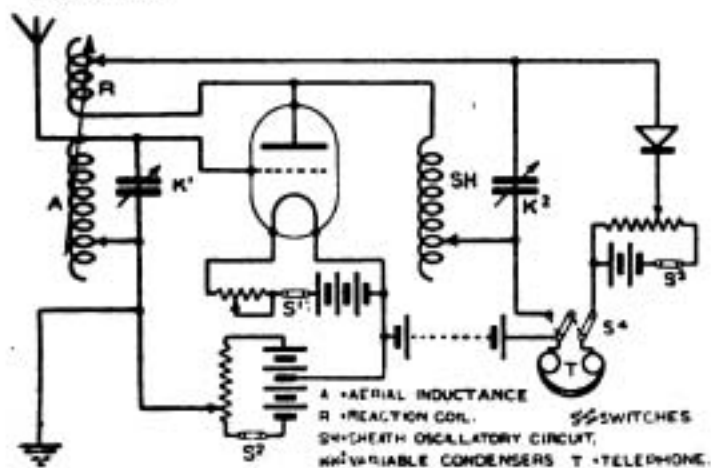

Fig. 1.

It is very difficult to make a receiver for such an extreme range of wavelengths, and such a receiver would be almost useless on a standard P.M.G. aerial. We strongly advise you to adopt a less ambitious maximum.

(1) If you insist on the 30,000 ms., with $4\frac{1}{2}$ " formers and No. 32 wire you might try making coil A (single layer) about 2 yards long, SH about 1 yard, and R, say, about 9".

(2) K_1 and K_2 should each be about 0.0005 mfd.

(3) The set is quite good, but would be improved by connecting the aerial circuit up as in Fig. 2.

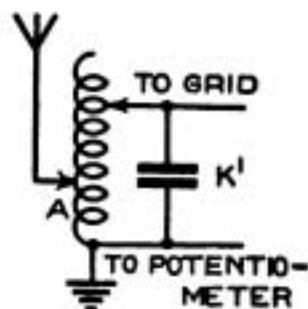

Fig. 2.

(4) R and SH might be combined as you suggest. In practice however, it is often more convenient to keep them separate.

J.W. (Leith) asks (1) For definitions of the "versine" and "coversine." (2) The approximate resistance suitable for measuring signal strength with a Marconi Type 31 receiver. (3) Whether tilting a single coil frame aerial out of the vertical would alter its capacity. (4) Which of two books of wireless formulae goes most fully into details of subjects like the following:—Frame aeriels, gnomonic and similar maps, aerial factors and actual transmission formulae.

(1) Versine = $1 - \cos \theta$.

Coversine = $1 - \sin \theta$.

(2) We presume you mean by the shunted telephone method, which gives results which are only fairly satisfactory. If this is so you could use No. 32 Eureka, of which you will require not less than $\frac{1}{4}$ lb.

(3) The effect would be inconsiderable.

(4) A difficult question. One might cover some of the subjects and not the others. See *Wireless World* (last vol.), and the 1919 Year Book for maps; article on Frame Aeriels just published in the *Wireless World*. For transmission formulae see handbooks of Eccles or Fleming.

C.E.W. (New Cross) sends a sketch of a receiving jigger and asks (1) If it will be satisfactory. (2) He also proposes to get a wave range of 1,700 to 18,500 ms. by changes of capacity only in his circuits, and wishes to have the possibility confirmed.

(1) The jigger shown is of variometer type, the outer coil being wound with 1,000 turns of wire in 7 layers and the inner spherical also wound with 1,000 turns in many layers in a deep groove. This type is quite unsuitable. No multilayer coils should ever be used for a receiver inductance.

(2) No doubt this method is possible, but in determining the sizes of condenser you have neglected various points, such as (a) your aerial has inductance as well as capacity. (b) The aerial capacity is not located in the A.T.I. and therefore putting the A.T.C. across the A.T.I. does not put it in parallel with the capacity of the aerial. These considerations make your results quite incorrect.

(The sample of aerial wire you send does not appear very satisfactory. There is too little wire in the cross section, and the mechanical strength will probably be poor. Also, insulation of the exposed part of the aerial is quite unnecessary.)

J.S. (Bournemouth) sends a diagram (Fig. 3) of a receiving set and asks (1) Best values for jigger primary and secondary for a maximum wavelength of 10,000 ms. (2) Particulars of jigger primary and secondary using pancake coils. (3) Values for grid leak and condenser. (4) Criticism of circuit.

(1) P should be at least 30,000 mhs., S might be about 25,000 mhs.

(2) Dimensions will vary with type of pancake chosen. Say 600 turns of No. 32 on a former 20 cms. outside diameter by 4 cms. internal diameter for primary and 500 turns on a similar former for secondary.

(3) 0.0002 mfd. for condenser; 3 megohms for leak.

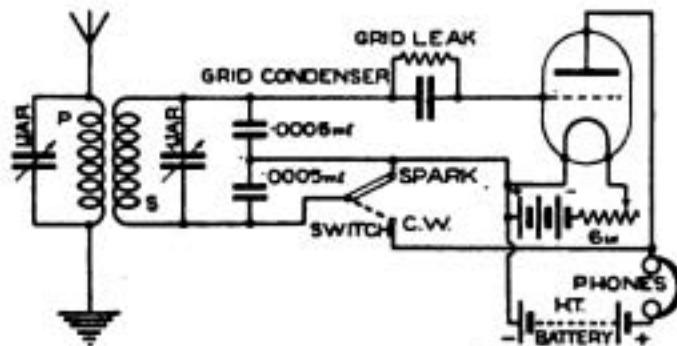

Fig. 3.

(4) Circuit is somewhat unusual but may work satisfactorily. You may find it necessary to try other values of the condensers marked 0.0005 mfd. for successful C.W. working; telephones should be on other side of H.T. battery.

G.P. (Crouch End) sends dimensions of proposed receiver, Aerial—70' long, single wire. 10' lead in; 60.45 ft. high. Inductance—4½" diameter wound with 26 enamel wire for 530 turns. Condenser—Air, with 12 fixed zinc plates, 3½" x 1½", and 11 moveable plates 3" x 1½". (Capacity works out to 0.0004 mfd.) 1/16" between plates. Detector—"Permanite" and copper wire. And asks (1) What wavelength he might hope to tune to (2) If the following dimensions of loose coupler will be correct. Primary—10.5 cms. diameter wound for 16 cms. with No. 24 enamel wire. Secondary—8 cms. diameter wound for 16 cms. with No. 28 silk wire, with tapings. (3) What wavelength he will get by introducing this. (4) If a circuit shown is the correct way to do so.

- (1) It is difficult to say exactly—possibly about 1,000 ms.
- (2) Yes.
- (3) About 3,500 ms.
- (4) Certainly.

E.H.D. (Weymouth).—(1) The Aldebaran Signals sent out by Lyons and Nantes are fully explained in our issue of July 10th. (2) The information required is contained in the 1920 edition of the Year Book of Wireless Telegraphy and Telephony; you may be able to obtain the International Berne List by applying direct to the Bureau of the International Radio-Telegraphic Convention, Berne, Switzerland. Failing this, we suggest you apply to the Secretary of the G.P.O., London.

EBOR (York).—There are no degrees given for Wireless. In the third year of the course prescribed at University College for an Electrical Engineering Degree students may specialise in Radio work.

R.M. (Leicester).—(1) We know of no periodical devoted solely to electro-plating. Articles on this subject appear from time to time in the various electrical magazines and in publications such as *Work, Hobbies* and the *English Mechanic*. (2) We

do not know the best book about electro-plating, but you might try "Electro-plating and Metal Refining," by Watt & Phillips, 14s. net: publishers, Lockwood & Son

W.C.Y. (Colchester).—(1) "The Elementary Principles of Wireless Telegraphy" (in two parts) and "The Oscillation Valve." (2) Yes; it is necessary to have a licence for any wireless set.

D.B. (Greenwich).—We are not sure about Greenwich being a barred area, although we believe that Woolwich is. Apply to the Secretary, G.P.O., London.

"RADIO" (Kensington) (1) Sends a valve circuit (Fig. 4) for criticism and (2) Sends a diagram of a proposed telegraph and telephone transmitter, (Fig. 5) with a frame aerial of 100 turns on a former 2½' square: a tuning inductance, L, of 3" diameter, 8" long and wound with 30 S.W.G. enamelled wire: a reactance, R, 2½" diameter, 3" long wound with

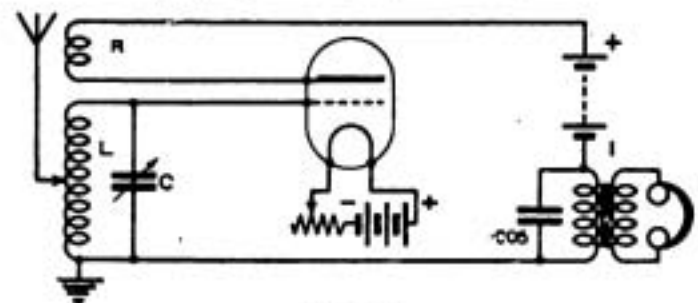

Fig. 4.

30 S.W.G. enamelled wire, asking if it would transmit from one room to another. (3) How far it might transmit to a single valve receiver.

(1) The circuit shown is quite a good one. It would probably work better however with an A.T.I. in the aerial. Dimensions of reaction coil should be about right for tuning coil as shown.

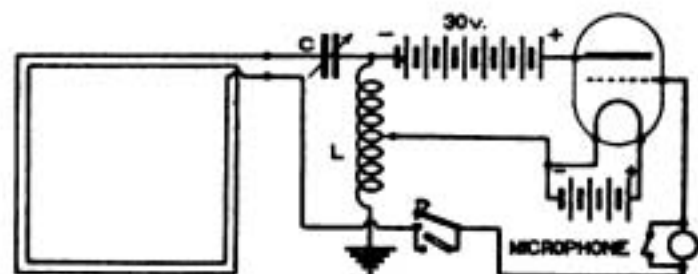

Fig. 5.

(2) Presuming, as you say, that inductance and capacity are about right this set might do the work you suggest, with a high resistance microphone. It would be improved by a condenser across the H.T. battery, and also by coupling the microphone inductively to the grid circuit, putting a dry battery in series with the microphone. A simpler method which should be effective with a fairly low resistance microphone would be to put it in series with the frame aerial.

(3) Difficult to say; possibly a mile with good sets.

P.R.C. (near Leeds).—(1) Apply to the Secretary, G.P.O., London. (2) You might try "The Wireless Experimenter's Manual," by E. E. Bucher

QUESTIONS AND ANSWERS

(The Wireless Press, Ltd.), and follow the constructional articles which began early in the present volume of the *Wireless World*. (3) We strongly recommend you to join a wireless club.

J.H. (Manchester).—The Radio Communication Co., 34, Norfolk Street, W.C.2., The Alfred Holt S.S. Co., 8, Billiter Square, E.C.3., Siemens Bros., Woolwich, S.E.18, the L. S. W. R., and the S.E. & C.R.

W.C.H. (Brighton).—(1) The Army, Navy, Nautical and Aeronautical professions generally, and, of course, in the profession of Telegraphy. (2) Apply direct to the Railway Companies, say, the L.S.W.R. or the S.E. & C.R. (3) Apply to the G.P.O., the various cable companies, or Marconi's Wireless Telegraph Company.

S.R. (Macclesfield).—The Marconi International Marine Communication Co., Ltd., Siemens Bros., Woolwich, and the Radio Communication Co., 34, Norfolk Street, W.C.

E.H. (near Bath).—Mr. F. W. Bridges, 20, High Holborn, W.C.1.

SENEX (Brighton).—(1) General Physics, Magnetism and Electricity and direct reading in wireless literature. If you will write again, stating what knowledge of these subjects you already have, we will outline a course of reading. (2) Ability to use the Calculus is an undoubted advantage, especially for advanced reading: but we cannot say definitely "what knowledge" of this process is required, because you do not tell us how far you wish to go. You can become efficient in practical wireless without a knowledge of Calculus, and it is possible to learn a very useful quantity of theory without it. (3) Yes; excellent correspondence courses in practical mathematics are available. See our advertisement pages. (4) We do not care to recommend any particular course or college. Please refer to advertisements.

G.V. (Greenwich) asks (1) *If amateurs are allowed to receive wireless messages.* (2) *For simple instructions for making a Tesla transformer.* (3) *How he can calculate the primary current required for a certain length of spark with such a coil.* (4) *How far he could transmit with $\frac{1}{4}$ -in. of spark.*

(1) Yes, with official permission. Apply to Secretary, G.P.O., London.

(2) This is not really a wireless question at all. However, you could wind it roughly as sketched in Fig. 6

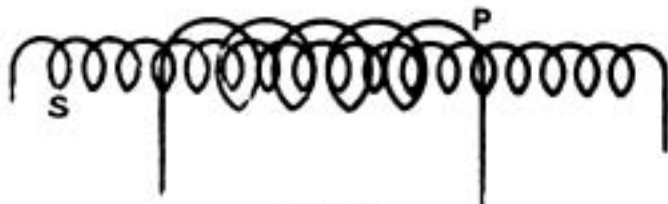

Fig. 6.

P (primary), about a dozen turns of bare copper wire, say No. 10, spaced 1 cm. apart, diameter of turns 9-in.

S (secondary), on former 4-in. by 24-in., wound full in single layer with No. 36; insulation to be the best possible.

(3) This is practically incalculable. Length of

spark depends chiefly on degree of resonance between the circuits. Put various capacities, of the order of 1 jar, across the primary until you get best results.

(4) We cannot say; it would depend on the power in the spark. For instance, the spark length on a $1\frac{1}{2}$ K.W. set on 600 ms. would not be so long as $\frac{1}{4}$ -in., while a tiny induction coil could easily be built to give a longer spark than this on quite a few watts. The $1\frac{1}{2}$ K.W. set would have many times the range of the coil.

R.K.L. (Handsworth) sends description of a receiver with rough sketches. He asks (1) *If his aerial is too small.* (2) *Which is better for long-range stations—a 2-slide A.T.I. or a single-slide coupled coil (from sketch sent we gather that by this he really means a 2-coil coupler).* (3) *If there is any way of tuning out induction from trams, etc.* (4) *For a circuit by which he is bound to receive long-range stations, if properly tuned.*

(1) No, this is about the standard P.M.G. length.

(2) The description of the set is so "scrappy" that we can give you little suggestion as to what is actually wrong. Circuit A could not possibly work. Circuit B should work, but would be better as in Fig. 7

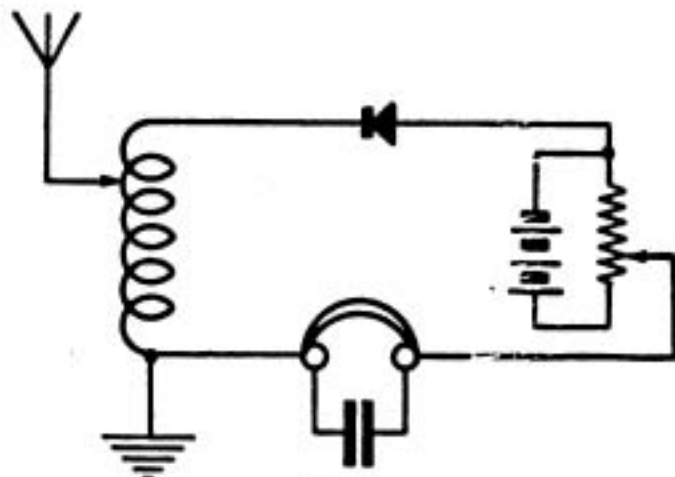

Fig. 7.

Circuit C will not work; circuit D should work.

(3) It is difficult to do this satisfactorily. See recent advice to other querists.

(4) Your circuit B should be all right. You will find others in Bangay's "Elementary Principles" or in the more elementary articles in this magazine.

J.L.D. (Jarrow) sends sketches of his aerial and receiver, which give unsatisfactory results. He asks for advice.

The aerial is badly designed. We have pointed out in several recent answers that an aerial should never be arranged with a small acute angle between the down-lead and horizontal parts. The receiver is not a good one. The chief objection is that, with the small number of turns you have arranged to put across your crystal, you will get very small voltages across it. To remedy this, tap more turns across the crystal on the auto-coupled side, and use a bigger inductance for the secondary of the loose coupler.

E.A.P. (Cheam) notices that Paris C.W. time signals are sent by altering the wavelength on depressing the key, and asks (1) If any other big stations adopt this method, and (2) If it is not undesirable from the point of view of jamming. (3) On listening to special signals "A's" and "C's" on May 15th, he heard "N's" and "V's" on a slightly lower wave. He suspects this to have some connection with the above questions, and asks for an explanation. (4) In arranging a P.M.G. aerial, where should measurement of length be taken to.

(1) This method is usual with almost all C.W. transmitters except the Marconi trigger disc sets.

(2) The method is undoubtedly undesirable from a jamming point of view, but it is almost the only practical way of operating the sets, particularly in the case of arcs.

(3) As you suggest, the lower wave signals were due to the wave sent out when the key is not depressed. It was only by accident that they formed Morse characters, and they do not in general do so. If you write down a series of "A's" and "C's" in Morse you will see that the spaces form the letters "N" and "V," which you heard. These spacing wave or "backlash" signals from a C.W. station are evidently unintelligible as a rule, but are rather liable to confuse inexperienced operators who attempt to take them instead of the true Morse marking signals.

(4) Presumably to the point of lead-in to the wireless room.

G.A.J. (Bromley) sends a long list of questions and criticisms of Shore's "Alternating Current Work," which we have not space to quote, particularly as in most cases the criticisms are not valid. Below are replies to some of the more interesting points:—

(1) *Re* page 5, Fig. 6.—"Should not rate of cutting of lines be in proportion to motion of A along the base?" The magnitude of the rate of cutting is quite correctly given as $X A'$.

(2) *Re* pages 29 and 30, the author uses alternation and period synonymously. Our correspondent thinks a period should be \equiv to two alternations. An alternation is a term rather loosely used for either a complete cycle or a reversal, i.e., a half cycle. As a rule it is taken to be a complete cycle.

(3) Page 37.—A 4-pole commutator is understood, connected in the usual way for a D.C. machine.

(4), (5) and (6), three questions *re* page 41.—The questions are outside our range. Consult a larger treatise on the subject.

(7) Pages 39 and 41.—The statement that "virtual value = $\sqrt{2} \times$ max. value," is queried. In this case our correspondent is right. This is evidently a slip for "virtual value = $\frac{1}{\sqrt{2}} \times$ max. value."

(8) Page 42; $\omega = \sqrt{3} V_3 I_3$ is queried, it being suggested that it leaves it doubtful whether the root is to be taken of V_3 and I_3 , or only of the factor "3." The expression is quite right as it stands. Consult any elementary textbook of algebra for the rule on this point.

J.G. (Murtle-by-Aberdeen) asks (1) What size inductance would be needed for the coils in Fig. 5,

Constructional Articles, in November number, for a wavelength range of from 600-3,000 ms. (2) He also asks for any details available of the circuit shown in Fig. 12 of the Wireless Society of London Report in December issue.

(1) Tuned circuit coil former might be 6-in. long by 4-in. diameter, wound with No. 30 wire. Reaction coil might be about 4-in. by 3-in., wound with No. 26. The best size for this coil depends on various uncertain factors, and you may therefore find it necessary to alter this a little.

(2) We have no special information with regard to this circuit, which we have referred to in other recent replies. We should suggest the following values for trials:—

L1	about 8-in. by 6-in.,	wound with No. 28.
L2	6-in. by 4-in.,	" 30.
C1	"	0.0005 mfds. max.
C2	"	0.00001 mfds.
C3	"	0.001 mfds.

The best value for this condenser should be found by experiment. A grid leak (not shown in the diagram) will also be necessary if your condensers are at all good.

J.O. (Strasburg) sends some speculations as to the possibility of obtaining interference phenomena at long distances between waves from high power stations which have travelled along the shortest possible path between the transmitting and receiving stations, and other waves which arrive at the receiver after passing through the antipodes of the sending station. He bases his arguments on similar optical phenomena, and suggests that interesting experiments might be carried out.

Such effects would be expected from general considerations, but we doubt if they could be observed in practice, and we do not think the results, if obtained, would be worth the trouble taken, either from the point of view of interest or practical value. The earth differs from most experimental optical media in being non-homogeneous—probably to an extent which would quite mask the desired effects. Moreover, there appears no reason why signals should not travel from the transmitter to the receiver by many other paths of different lengths from either of the two postulated. If this were so, the probability of the existence of regular interference effects would be almost nil.

SHARE MARKET REPORT.

Business in all the Wireless Stocks has been quiet. General liquidation has now ceased and prices are all inclined to harden. The ordinary and preference shares are now ex div. and bonus.

Prices as we go to press, July 16th, are:—

Marconi Ordinary	3
" Preference	2½
" Canadian	10s
" Marine	1½
" New Issue	3