

# ELECTRONICS WORLD

VOLUME 114, ISSUE 1871



9 770959 833110 11

NOVEMBER 2008 £4.60  
www.electronicworld.co.uk

THE ESSENTIAL ELECTRONICS ENGINEERING MAGAZINE

## Special Issue – Microcontrollers:

- BUILD YOUR OWN DATA LOGGER
- BUILD YOUR OWN MCU-BASED PLC
- CHOOSING BETWEEN ARM7 AND CORTEX-M3

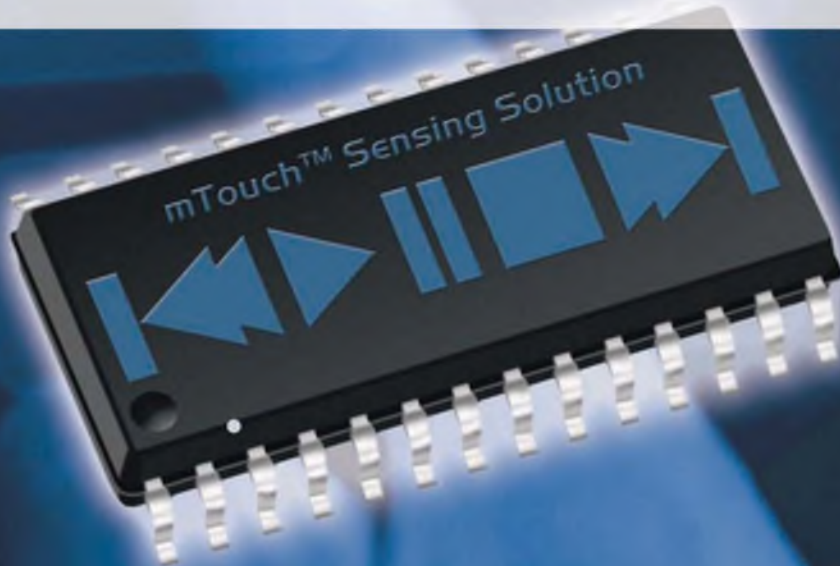

**PURCHASING  
NEW OSCILLOSCOPES?  
CONSIDER THE UPDATE  
RATES!**



**TECHNOLOGY**  
LEARNING  
FROM  
NATURE

**UKDL**  
RIGHT LASER  
FOR THE  
RIGHT JOB



**PRODUCTS**  
COMMS TEST SYSTEMS,  
POSTERS AND  
ANALYSERS



ALSO IN THIS ISSUE: THE TROUBLE WITH RF: SO MANY TRANSMITTERS, SO SMALL A BAND

## Handheld Test Gear - Cool, Smart.



**Atlas DCA - Model DCA55  
Semiconductor Analyser**

Identifies type and pinout! Connect any way round.  
Measures gain, junction characteristics and more.



**New Low Price!**

**Atlas ESR - Model ESR60  
ESR and Capacitance Meter**  
Measures capacitance, ESR (in-circuit too!).  
Automatic controlled capacitor discharge feature!



**Atlas LCR - Model LCR40  
Inductor, Capacitor, Resistor Analyser**  
Automatic part identification, automatic frequency  
selection and auto ranging!



**New Low Price!**

**Atlas SCR - Model SCR100  
Triac and Thyristor Analyser**  
Connect any way round, auto lead identification.  
Auto gate test current from 100uA to 100mA.

**05 EDITOR'S COMMENT**

CALL FOR ARTICLES AND ARTICLE GUIDELINES

**06 TECHNOLOGY****09 NEW READER OFFER****11 FOCUS**

CRACKING THE CRACKERS

by **Steve Rogerson****13 ROHS****Gary Nevison** answers readers' questions relating to the RoHS, REACH, WEEE and EuP directives**14 INSIGHT**

TAIWANESE ICT INDUSTRY FORECAST IN 2008

by **Katie Chen****15 THE TROUBLE WITH RF...**

SO MANY TRANSMITTERS, SO SMALL A BAND

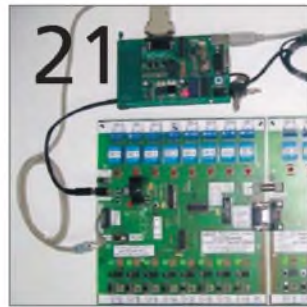
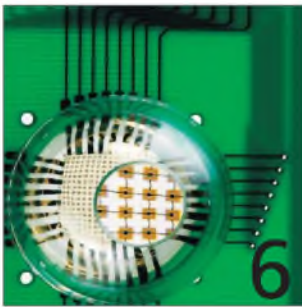
by **Myk Dormer****REGULARS****35 CIRCUIT IDEAS****39 UKDL****Dr Ric Allott** reviews some of the fundamental properties of lasers and how these properties influence the choice of laser for a particular manufacturing operation**42 TIPS 'N' TRICKS****45 PRODUCTS****Page 17** - the place to find more about Microchip's mTouch Sensing Solutions**FEATURES****18 CHOOSING ARM PROCESSOR ARM7 VS CORTEX-M3****Anders Lundgren** considers the criteria when making the choice of microcontrollers based on the ARM Cortex-M3 core**21 PLC WITH PIC16F648A MICROCONTROLLER PART 1****Dr Murat Uzam** kick-starts a series of articles on a project that focuses on microcontroller-based PLCs**26 MICROCONTROLLER AND SD-CARD BASED MULTICHANNEL DATA LOGGER****Dogan Ibrahim** describes the design of a microcontroller-based multichannel data logger device with SD card and real-time clock interface**32 OSCILLOSCOPE UPDATE RATE AND ITS IMPACT ON CAPTURING INFREQUENT AND RANDOM EVENTS****Johnnie Hancock** and **Joel Woodward** look at update rates as one of the primary considerations when purchasing a new oscilloscope



**QUASAR**  
electronics

The Electronic Kit Specialist Since 1993

**Quasar Electronics Limited**  
PO Box 6935, Bishops Cleeve  
CM23 4WP, United Kingdom  
Tel: 0870 246 1826  
Fax: 0870 460 1045  
E-mail: sales@quasarelectronics.com  
Web: www.QuasarElectronics.com

Postage & Packing Options (Up to 0.5Kg gross weight): UK Standard 3-7 Day Delivery - £3.95; UK Mainland Next Day Delivery - £8.95; Europe (EU) - £6.95; Rest of World - £9.95 (up to 0.5Kg)  
!Order online for reduced price UK Postage!  
We accept all major credit/debit cards. Make cheques/PO's payable to Quasar Electronics. Prices include 17.5% VAT.  
Please visit our online shop now for details of over 500 kits, projects, modules and publications. Discounts for bulk quantities.



**08717**

Credit Card  
Sales

**177 168**

## Motor Drivers/Controllers

Here are just a few of our controller and driver modules for AC, DC, Unipolar/Bipolar stepper motors and servo motors. See website for full range and details.

### Computer Controlled / Standalone Unipolar Stepper Motor Driver

Drives any 5-35Vdc 5, 6 or 8-lead unipolar stepper motor rated up to 6 Amps. Provides speed and direction control. Operates in stand-alone or PC-controlled mode for CNC use. Connect up to six 3179 driver boards to a single parallel port. Board supply: 9Vdc. PCB: 80x50mm. Kit Order Code: 3179KT - **£12.95**  
Assembled Order Code: AS3179 - **£19.95**



### Computer Controlled Bi-Polar Stepper Motor Driver

Drive any 5-50Vdc, 5 Amp bi-polar stepper motor using externally supplied 5V levels for STEP and DIRECTION control. Opto-isolated inputs make it ideal for CNC applications using a PC running suitable software. Board supply: 8-30Vdc. PCB: 75x85mm. Kit Order Code: 3158KT - **£17.95**  
Assembled Order Code: AS3158 - **£27.95**



### Bi-Directional DC Motor Controller (v2)

Controls the speed of most common DC motors (rated up to 32Vdc, 10A) in both the forward and reverse direction. The range of control is from fully OFF to fully ON in both directions. The direction and speed are controlled using a single potentiometer. Screw terminal block for connections. Kit Order Code: 3166v2KT - **£17.95**  
Assembled Order Code: AS3166v2 - **£27.95**



### DC Motor Speed Controller (100V/7.5A)

Control the speed of almost any common DC motor rated up to 100V/7.5A. Pulse width modulation output for maximum motor torque at all speeds. Supply: 5-15Vdc. Box supplied. Dimensions (mm): 60Wx100Lx60H. Kit Order Code: 3067KT - **£13.95**  
Assembled Order Code: AS3067 - **£21.95**



Most items are available in kit form (KT suffix) or assembled and ready for use (AS prefix).

## Controllers & Loggers

Here are just a few of the controller and data acquisition and control units we have. See website for full details. Suitable PSU for all units. Order Code PSU445 £8.95

### 8-Ch Serial Isolated I/O Relay Module

Computer controlled 8-channel relay board. 5A mains rated relay outputs. 4 isolated digital inputs. Useful in a variety of control and sensing applications. Controlled via serial port for programming (using our new Windows interface, terminal emulator or batch files). Includes plastic case 130x100x30mm. Power Supply: 12Vdc/500mA. Kit Order Code: 3108KT - **£54.95**  
Assembled Order Code: AS3108 - **£64.95**



### Computer Temperature Data Logger

4-channel temperature logger for serial port. °C or °F. Continuously logs up to 4 separate sensors located 200m+ from board. Wide range of free software applications for storing/using data. PCB just 45x45mm. Powered by PC. Includes one DS1820 sensor. Kit Order Code: 3145KT - **£17.95**  
Assembled Order Code: AS3145 - **£24.95**  
Additional DS1820 Sensors - **£3.95 each**



### Rolling Code 4-Channel UHF Remote

State-of-the-Art. High security, 4 channels. Momentary or latching relay output. Range up to 40m. Up to 15 Tx's can be learnt by one Rx (kit includes one Tx but more available separately). 4 indicator LEDs. Rx: PCB 77x85mm, 12Vdc/6mA (standby). Two and Ten channel versions also available. Kit Order Code: 3180KT - **£44.95**  
Assembled Order Code: AS3180 - **£54.95**



### DTMF Telephone Relay Switcher

Call your phone number using a DTMF phone from anywhere in the world and remotely turn on/off any of the 4 relays as desired. User settable Security Password. Anti-Tamper, Rings to Answer, Auto Hang-up and Lockout. Includes plastic case. Not BT approved. 130x110x30mm. Power: 12Vdc. Kit Order Code: 3140KT - **£54.95**  
Assembled Order Code: AS3140 - **£69.95**



### Infrared RC Relay Board

Individually control 12 on-board relays with included infrared remote control unit. Toggle or momentary. 15m+ range. 112x122mm. Supply: 12Vdc/0.5A. Kit Order Code: 3142KT - **£47.95**  
Assembled Order Code: AS3142 - **£59.95**



## PIC & ATMEL Programmers

We have a wide range of low cost PIC and ATMEL Programmers. Complete range and documentation available from our website.

### Programmer Accessories:

40-pin Wide ZIF socket (ZIF40W) £14.95  
18Vdc Power supply (PSU010) £18.95  
Leads: Parallel (LDC136) £3.95 / Serial (LDC441) £3.95 / USB (LDC644) £2.95

### NEW! USB & Serial Port PIC Programmer

USB/Serial connection. Header cable for ICSP. Free Windows XP software. Wide range of supported PICs - see website for complete listing. ZIF Socket/USB lead not included. Supply: 16-18Vdc. Kit Order Code: 3149EKT - **£39.95**  
Assembled Order Code: AS3149E - **£49.95**



### NEW! USB 'All-Flash' PIC Programmer

USB PIC programmer for all 'Flash' devices. No external power supply making it truly portable. Supplied with box and Windows Software. ZIF Socket and USB lead not included. Assembled Order Code: AS3128 - **£44.95**



### "PICALL" PIC Programmer

"PICALL" will program virtually all 8 to 40 pin serial-mode AND parallel-mode (PIC16C5x family) programmed PIC micro controllers. Free fully functional software. Blank chip auto detect for super fast bulk programming. Parallel port connection. Supply: 16-18Vdc. Assembled Order Code: AS3117 - **£24.95**



### ATMEL 89xxx Programmer

Uses serial port and any standard terminal comms program. Program/ Read/ Verify Code Data. Write Fuse/Lock Bits, Erase and Blank Check. 4 LED's display the status. ZIF sockets not included. Supply: 16-18Vdc. Kit Order Code: 3123KT - **£24.95**  
Assembled Order Code: AS3123 - **£34.95**



**No.1**  
KITS



[www.QuasarElectronics.com](http://www.QuasarElectronics.com)

Secure Online Ordering Facilities • Full Product Listing, Descriptions & Photos • Kit Documentation & Software Downloads

# ELECTRONICS WORLD

## EDITOR:

**Svetlana Josifovska**

Email: svetlana.josifovska@stjohnpatrick.com

## PRODUCTION EDITOR/DESIGNER:

**Tim Wesson**

## DISPLAY SALES EXECUTIVE:

**Matthew Dawe**

TEL: +44 (0) 20 7933 8999

Email: matthew.dawe@stjohnpatrick.com

## SALES DIRECTOR:

**Chris Cooke**

## PUBLISHER:

**John Owen**

## SUBSCRIPTIONS:

**Dovetail Services**

800 Guillat Avenue,

Kent Science Park,

Sittingbourne,

Kent, ME9 8GU

TEL: +44 (0) 844 844 0230

Email: saintjohnpatrick@servicehelpline.co.uk

## SUBSCRIPTION RATES:

1 year: £46 (UK); €120 (Europe);

\$145 (US & worldwide)

## MISSING ISSUES:

Email: GoldeneyeTeam@servicehelpline.co.uk

## NEWSTRADE:

Distributed by Seymour Distribution Ltd,

2 East Poultry Avenue, London, EC1A 9PT

+44 (0) 20 7429 4000

## PRINTER:

**William Gibbons Ltd**

 **St John Patrick Publishers**

## CALL FOR ARTICLES AND ARTICLE GUIDELINES

It's that time of year again when we create the new 'Features List', also known as the 'Special Reports', and invite you to contribute with your researched, knowledgeable, technical articles. You will find the list below, and the next few lines should give you some guidelines as to how you can best prepare your material to adhere to our production requirements.

Contributed articles can vary in length, anything from 1800 to 2500 words is welcome, but equally we will consider a series of articles on a particular subject. Each article should be supported with some sort of imagery: circuit or block diagrams, charts, photos, tables, a mix of all these – anything that will add weight to the content of the article and aid understanding. As a guide, a 2,500-word article, for example, should be supported by at least five images, each with its own caption.

Pictures need to be of high resolution, at least 300dpi, preferably 600. Please send us JPEG, TIFF, GIF or BMP files.

Aim to present the material in a way that appeals to the complete audience, not just a small segment. Consider carefully the basic point of the article that you wish to convey and then support it with the necessary explanatory structure.

You can use equations but please keep this for those instances only where describing something cannot do without mathematics. Use MS Word's 'equation editor' and do explain and quantify the terms.

As for the format of the article itself, the text should be filed in MS Word, using the 'Times' or 'Times New Roman' font. Symbols should be in the 'Symbol' font. Do not use any formatting such as coloured headings, indexes, footers and headers etc, and ideally, you should not add a gap between the number and the unit, for example: 50kW not 50 kW.

You should also note that if you are targeting a specific special report, then you'll need to send us your material at least three months in advance. For example, if you want to place a feature in the May issue, then you'll need to send us the material in February at the latest.

In the end, if you feel there's an interesting article you'd like to share with the greater engineering and scientific community, then start writing and let us know by email [Svetlana.josifovska@stjohnpatrick.com](mailto:Svetlana.josifovska@stjohnpatrick.com).



Check out Electronics World's new website by clicking on [www.electronicsworld.co.uk](http://www.electronicsworld.co.uk)

### ELECTRONICS WORLD FEATURES LIST 2009:

JANUARY:	Robotics	JULY:	Addressing Power
FEBRUARY:	Data Acquisition	AUGUST:	Microcontrollers
MARCH:	Amplifiers	SEPTEMBER:	Components
APRIL:	Test & Measurement	OCTOBER:	Designing Portable Devices
MAY:	RF and Microwave Design	NOVEMBER:	Communications Technologies
JUNE:	Display Technologies	DECEMBER:	Signal Processing

Electronics World is published monthly by **Saint John Patrick Publishers Ltd**, 6 Laurence Pountney Hill, London, EC4R 0BL.

Disclaimer: We work hard to ensure that the information presented in Electronics World is accurate. However, the publisher will not take responsibility for any injury or loss of earnings that may result from applying information presented in the magazine. It is your responsibility to familiarise yourself with the laws relating to dealing with your customers and suppliers, and with safety practices relating to working with electrical/electronic circuitry – particularly as regards electric shock, fire hazards and explosions.

# Silicon camera sees like a human eye

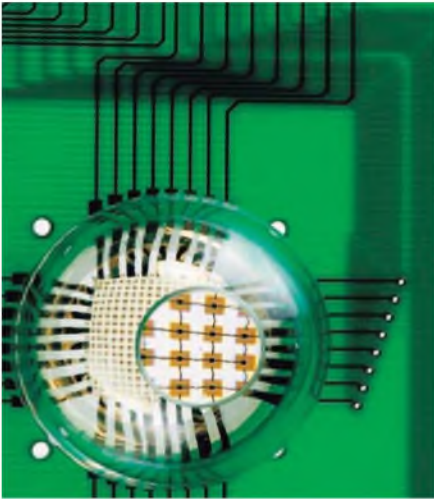

*Photograph of the electronic eye camera after integration with a transparent hemispherical cap and a simple, single component imaging lens*

Two teams of researchers at the University of Illinois at Urbana-Champaign and the Northwestern University in the US have created a camera by using an array of single-crystalline silicon detectors and electronics configured in a stretchable, interconnected mesh.

"Conformally wrapping surfaces

with stretchable sheets of optoelectronics provides a practical route for integrating well-developed planar device technologies onto complex curvilinear objects," said John Rogers, the Flory-Founder Chair Professor of Materials Science and Engineering at Illinois and project leader.

The design has been influenced by the shape of the human eye, which has a single-element lens and a hemispherical detector. The camera integrates such a detector with a hemispherical cap and imaging lens, to recreate a system with the overall size, shape and layout of the human eye.

To make the camera, the researchers molded a thin rubber membrane in the shape of a hemisphere. The rubber membrane is then stretched to form a flat drumhead, which is then tensed further. On top of it, the team "dropped" the prefabricated focal plane array and associated electronics (created by conventional planar processing). Once the tension on the membrane is released it returns to its original shape, which compresses the focal plane array, causing specially

designed electrical interconnects to delaminate from the rubber surface and form arcs, pinned on the ends by detector pixels. These deformations accommodate strains associated with the planar-to-hemispherical transformation, without stressing the silicon, as confirmed by mechanics modelling performed by researchers at Northwestern.

The array package is then transfer-printed to a matching hemispherical glass substrate. The assembly is completed by attaching a lens and connecting the camera to external electronics.

"Hemispherical detector arrays are also much better suited for use as retinal implants than flat detectors," Rogers said. "The ability to wrap high quality silicon devices onto complex surfaces and biological tissues adds very interesting and powerful capabilities to electronic and optoelectronic device design, with many new application possibilities."

Expectations are that the work could lead to systems that can be "wrapped" around living organs to monitor their condition.

# Biology Ideas May Lie At the Crux of Future Networks



*Networks will soon have life-like abilities*

BT is borrowing ideas from the biological world in its effort to create autonomous communications networks.

"These artificial life ideas [inspired by

the biological world] are a very useful source of inspiration as the products and services we provide become increasingly complex and demanding in terms of resources," said Dr Paul Marrow from the BT's Broadband Applications Research Centre.

Part of this research is the Cascadas project where BT collaborates with Telecom Italia, universities and research organisations to establish the best ways of dividing tasks around a network into modules and giving each autonomy and self-awareness. By self-organisation, these modules are expected to be more efficient, allowing them to perform jointly on a bigger task and as such be

less cumbersome on the overall network.

For example, servers can independently balance its load and will communicate only with the other servers they are directly connected to, rather than with a central unit or the network as a whole. Each server can ask for "help" the adjoining servers to which it can re-allocate a task and, hence, balance its load easier.

Dr Marrow said that such an approach is more robust to failures. "If you were to have a rigid control system that depended on a fixed set of rules that could fall apart if any part of the network is lost."

# electronics growth the way forward for electronics

**intellect**  
REPRESENTING THE UK TECHNOLOGY INDUSTRY

Intellect is the UK trade association for the IT, telecoms and electronics industries. Together these sectors make up 10% of UK GDP and 15% of UK exports. Our 800 members, from SMEs to large international corporations, account for over 80% of their markets.

We are here to help the UK electronics sector and supply chain to be as successful as they can be. We provide a powerful, unified voice for the sector to government. Our members are able to benchmark themselves against, and network with, major competitors and gain access to a wide range of markets. Provision of market key performance indicators is major focus for our programme.

As part of our efforts to promote and develop the UK electronics sector, we will be leading a delegation of British companies to electronica, the leading trade fair for the electronics industry, which takes place in Munich, between 11-14 November 2008. Visit Intellect on stand A5.175/2.

For more information on the delegation or about Intellect in general, please contact Henry Parker, programme manager - technology markets, at Intellect on 020 7331 2000, E [henry.parker@intellectuk.org](mailto:henry.parker@intellectuk.org) or visit our website, [www.intellectuk.org/electronicsgrowth](http://www.intellectuk.org/electronicsgrowth)

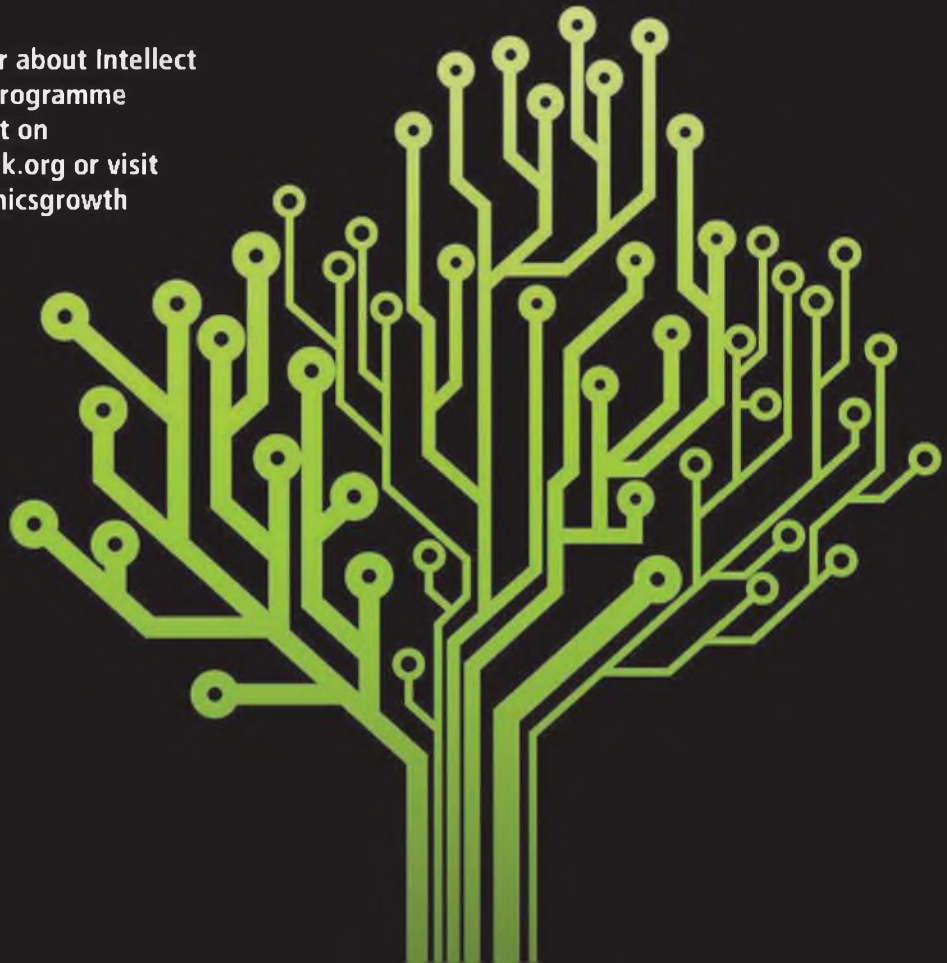

● Siemens PLM Software and Warwick Manufacturing Group (WMG) announced that access to more than £22m-worth of PLM Software technology will be made available to researchers, students and businesses using the new Warwick Digital Laboratory.

The £50m WMG initiative involved the construction of a £13m high specification building on the Warwick University campus; the laboratory opened in September. It now offers state-of-the-art facilities for innovative problem solving through collaborative research, demonstrators, knowledge sharing, education and training.

Siemens PLM Software's NX, Teamcenter and Tecnomatix products will be used in 40 seat bundles to facilitate collaborative research opportunities, create effective transfer of knowledge between academic and industrial disciplines and generate new knowledge and skills in digital manufacturing.

● US scientists have developed robots using the same principles of electro-magnetics that make balloons stick to ceilings after being rubbed.

The robots, developed by a team in SRI's Mobile Robotics and Transducers Programme, are the size of a toy car with caterpillar tracks.

The technology could be used to enable robots to work in areas that are difficult for humans, such as tunnels or outside large buildings.

● Philips has demonstrated 3D on Blu-ray, enabling a 3D movie viewing experience on a variety of displays. The 3D content discs can be enjoyed with both stereoscopic (special glasses needed) as well as auto-stereoscopic 3D displays, which do not require glasses. Philips said that the technology rests on its 2D-plus-Depth content format. 3D displays offer a completely different viewer experience than when seen in 2D format.

3D content on Blu-ray can be used in professional applications such as digital signage for retail and point-of-sale advertising; gaming applications in casinos; home games and 3D visualisation.

## Bionic AquaJelly Created to Help Industrial Autonomous Intelligent Systems



*Bionic AquaJelly in action*

Festo, the German-headquartered supplier of automation technology, has joined forces with German specialist display technology firm Effekt-Technik to create a bionic jellyfish – dubbed AquaJelly – as part of an ongoing research programme into advanced automation.

Festo believes by extending the principles of swarming behaviour to automation, many small autonomous or partly autonomous intelligent systems could work together to solve large-scale problems through strategic cooperation.

At the heart of AquaJelly is a microprocessor-driven control board, sensors and LEDs. With its electronics on board, each AquaJelly is able to sense various aspects of its environment and to function completely autonomously, but also to communicate with the others, which then leads to them forming a group and even cooperating. The bionic jellyfish communicate to distances of around 80cm.

Each jellyfish decides its actions autonomously on the basis of the

prevailing conditions – which for example can depend on the charge condition, the propulsion system's orientation or the proximity of another AquaJelly. Although the overall behaviour of a swarm of AquaJellies is emergent, i.e. arises without predetermined control, it results solely from a suitable choice of simple rules of behaviour for individual AquaJelly and represents a collective behaviour pattern that maximises the number of living jellyfish.

Each AquaJelly has a charging control unit, two lithium-ion polymer accumulator batteries and actuators for the swash plate. When an AquaJelly approaches a charging station located above the water surface, it is drawn towards it and supplied with electricity. An internal sensor system monitors its energy condition and a solenoid switch enables it to register the orientation of the propulsion system.

For further details on the AquaJelly visit [www.electricalreview.co.uk](http://www.electricalreview.co.uk).



## WIN A UMR-X10 DEVELOPMENT KIT

**AND CHOOSE YOUR PREFERRED DISPLAY SIZE**



ANDERS ELECTRONICS, THE SPECIALIST DESIGNER AND SUPPLIER OF DISPLAY SOLUTIONS, HAS TEAMED UP WITH ELECTRONICS WORLD MAGAZINE AND IS OFFERING READERS THE CHANCE TO WIN A UMR-X10 DEVELOPMENT KIT – THE INTELLIGENT DISPLAY PLATFORM WHICH ENABLES THE ULTIMATE END-USER EXPERIENCE FOR YOUR PRODUCT – *AND YOU CAN CHOOSE YOUR PREFERRED DISPLAY SIZE!*



Competitively priced and designed to help developers accelerate colour TFT-LCD integration, shorten time to market and significantly reduce development costs, the development kits offer numerous benefits including:

- Seamless migration to a colour 3.5-inch or 7-inch TFT LCD with touchscreen
- Additional functionality for products, e.g. wireless, audio amplifier
- Pre-integrated, ready-to-run WinCE software (SDK available)
- Easy implementation of a modern GUI using standard Microsoft tools

**Each kit comprises:**

- Chosen colour TFT with touch
- UMR-X10 – a TFT LCD platform with PXA270 processor

- Dual USB cable
- Quick start guide
- ID access to the developers' Web site

**Ready to meet the challenges of almost any application, key features of the kits include:**

- 3.5-inch VGA LTPS TFT or 7-inch WVGA TFT display with resistive touchscreen and LED backlight
- Options of 312 MHz/520MHz clock speeds
- 64MB/128MB SDRAM
- I<sup>2</sup>C, SPI, GPIO, 2TTL serial ports, 1 RS232 serial port
- 10/100-Base-T Ethernet
- 1 USB host port and 1 USB slave port (for ActiveSync)
- SD-card
- 5V DC operation
- GUI design and development service available

**To enter, simply go to:**

**[www.anders.co.uk/electronicsworld](http://www.anders.co.uk/electronicsworld)**

# Fanless Systems

- Panel PC
- Systems
- Chassis
- Mini-ITX
- EBC
- SBC

1.2GHz VIA Esther



## EPC-4853

- VIA Esther 1.2GHz
- Up to 1GB DRAM
- MPEG4/WMV9
- Dual LAN
- Compact Flash Socket
- Mini-PCI
- Internal HDD option
- PXE Discless Boot

## 500MHz ULV



### EPC-500

- 500MHz VIA Eden ULV CPU
- VESA mounting option
- Low Power < 15Watts
- CompactFlash
- 10/100MBS LAN
- 3xUSB
- 2xRS232
- HDD option

## 1GHz VIA Eden



### CMB-365

- 1GHz VIA Eden
- Wall or Desk mounting
- Internal HDD option IDE or SATA
- Up to 1GB DDR2 memory
- DVI or LVDS options
- Two Mini-PCI Slots
- GigaBit Ethernet

## 1.6GHz Core 2



### EPC-6200

- 1.6GHz Low Voltage Core 2 Duo
- GME965 & ICH8M
- Up to 3Ghz SDRAM
- Dual GigaBit LAN
- Dual IEEE1394
- Dual DVI Ports

## Core 2 Bare Bones



### CMB-371

- Core 2 ULV CPU
- Intel 945GM chipset
- Up to 2 GB DDR2
- GigaBit Ethernet
- LVDS, TV and DVI outputs
- Intel Graphics Media Accelerator 950
- 4xUSB2.0
- Mini-PCI slot

For more details of LCDs, touch panels and embedded boards and systems visit [www.bvm-store.com](http://www.bvm-store.com) or call 01489 780144.



BVM Limited, Hobb Lane, Hedge End, Southampton, Hants, SO30 0GH  
Tel: 01489 780144 Web: [www.bvm-store.com](http://www.bvm-store.com) Email: [info@bvm-store.com](mailto:info@bvm-store.com)



ISO9001:2000

PMC

VMEbus

Embedded

Systems

# CRACKING THE CRACKERS

BY STEVE ROGERSON

If someone has made something then someone else – given enough time and resources – will be able to copy it. That is the harsh fact that faces manufacturers of electronics equipment and they know that the laws designed to safeguard intellectual property (IP) and patents do not stretch effectively into some countries giving them very little protection against unscrupulous traders.

The key phrase though is “given enough time and resources”, which is why serious effort goes into protecting the IP on the crucial chips with the goal of making the task of cracking those chips so expensive and time-consuming that the gains from the endeavour fall short of what has been put in.

This task is helped by the trend to sell at below cost – or even give away – hardware such as some medical devices, printers and mobile phones, because the profits from consumables and contracts make it worthwhile. Here, hardware copiers have little to gain from cloning operations.

Where there is money to be made from illegal operations are fast sellers such as MP3 players as well as relatively high priced networking equipment. Video game players and set-top boxes have also been regular targets for the copiers.

“It makes sense for these people to copy networking equipment,” said Ben Jun, VP of technology for Cryptography Research. “They are basic standard PCs with a couple of specialist ASICs and software. It is easy to copy the software and they reverse engineer the ASICs. There have been cases where the copies were so good it was difficult even for the original manufacturer to tell them from the real thing.”

**“GIVEN MODERN DESIGN TOOLS, IT IS OFTEN EASIER TO COPY THE FUNCTIONALITY OF THE CHIP RATHER THAN THE CHIP ITSELF”**

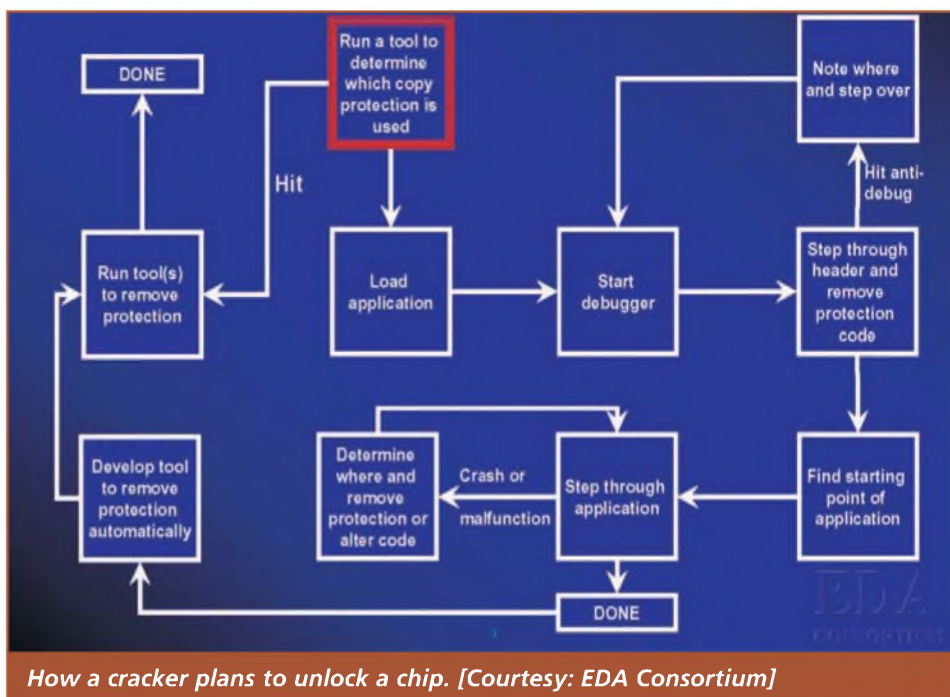

## NOT EASY BUT DONE

There are various ways of copying what is on a chip. The hacker can literally take the top off and read the 0s and 1s in the memory. A more expensive method is to attach probes to the die to find what is happening.

“It is quite an issue in discrete semiconductors,” said Alfred Hesen, European marketing director for semiconductor firm Fairchild. “Some will even cross-section the chip to look at the doping levels and make copies. It is not easy. You need equipment to measure the doping levels accurately, but there are laboratories that are being used for failure analysis that can do it.”

A more passive, non-invasive method involves looking at the chip’s power consumption, in what is known as differential power analysis. This can be interpreted to infer a lot of what is happening inside the chip and can be used to recover the keys to the chip.

Another method that is difficult to protect against is fault induction. The attacker forces the chip to run at conditions that are out of its specification. For example, it can be run at a lower voltage or there will be a quick clock glitch

that causes a hiccup on the chip. If done properly, this can cause the chip to expose what is stored on it.

However, given modern design tools, it is often easier to copy the functionality of the chip rather than the chip itself. Measuring how the chip responds to various stimuli can produce a map of the functionality. Feeding this into modern design tools can produce a different chip but one that does exactly the same. This is why a lot of effort now is into protecting the functionality through patents rather than the actual chip layout.

“It is hard to stop this kind of reverse engineering technically, because people are allowed to buy the chips and test them,” said Bob Yoches, a partner at Finnegan Henderson’s electronics and computer technology patents group. “So you need solid patent protection to stop people copying the functionality. What you have to do to stop them in China is to have a Chinese patent and sue in China. There have been lawsuits where infringements have been stopped.”

But Craig Rawlings, director of marketing at Kilopass, said: “In China, it is hard to follow legal channels. They are starting to look at it because some of the

Chinese companies themselves are having problems. But because of the time it takes you to get through all the channels, by the time you are finished it is too late. The damage has been done.”

He said that even in the US this was a problem because of lengthy legal processes. “There are even companies who look to using IP protection to protect the IP they have already ripped off,” he said. “They keep the IP in an FPGA to protect it because if they put it on an ASIC there are places in Korea that can reverse engineer it in eight weeks flat.”

But Jack Browne, VP of marketing at MPU IP provider Mips Technologies, believes the problem is shrinking as the industry in those countries matures. “In countries where silicon design is just starting, there may not be a lot of respect for the ownership of IP; but by the time they are on their second design, they have their own IP they want to protect and so the culture changes.”

## OVERPROTECTION?

Using Far Eastern manufacturers can also create an extra protection problem, that of

over-production. Here, some manufacturers will make many more chips than have been ordered, with the extra ones finding their way on to the black market. One way to protect against over production is to use a chip-enable mechanism that stops the chip being activated until it has been turned on at a different facility. Basically, different parts of the chip-enable code are implemented at different times in the manufacturing process.



This can be taken a step further by using what is known as anti-fuse technology. With standard fuses that are blown within the chip to write them, it is fairly easy to see what has happened under a microscope. Anti-fuse technology breaks down the gate oxide of the CMOS creating a permanent link between the gate and the drain. All start without the link and are thus 0s. Those with the link broken become 1s. This is buried deep in the semiconductor, making it difficult to detect and it uses a thousandth of the energy of a fuse type so it doesn't leave a residue when blown.

What does cause some problems is allowing potential customers easy access

for testing and evaluation purposes while still keeping the chip secure. “Customers want to use it right away to do emulation for evaluation,” said Dan Weed, VP of customer engineering at IP provider Tensilica. “They want to quickly take the IP and put it into FPGAs to do more system level design.”

The way round this is to use an FPGA synthesis tool that lets the netlist be sent in an encrypted form that the tools can then decipher at the other end. “If someone gets hold of the netlist flow, it is worthless,” said Weed. “It is a meaningless bitstream that you couldn't do anything with. And when you want to integrate the product into silicon, there are tools that can encrypt all the different tools in the EDA flow.”

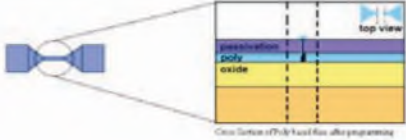
What all the companies spoken to agreed on was that the threat was small, but had to be taken seriously. The difficulty is coming up with a method that does not over-burden legitimate users but is too hard for hackers to copy and still make a profit. The tendency, therefore, is to make some IP freely available but put extra protection on the more sensitive information. ■

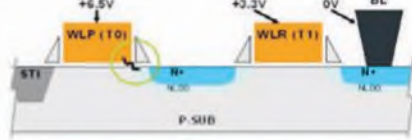
Not Process Scalable	Not Process Scalable	Process Scalable
<b>Poly / Metal Fuse</b> 	<b>Floating Gate (E2PROM/Flash)</b> 	<b>CMOS Antifuse Memory XPM (X-tra Permanent Memory)</b> 
<b>Characteristics:</b> <ul style="list-style-type: none"> <li>• Large bit cell size (50um<sup>2</sup>) ; &lt; 4K-bits @ 65nm</li> <li>• Supported on the most advanced process nodes</li> <li>• Reliability - Poly grow-back challenges to longer life span</li> <li>• Extra mask steps</li> <li>• Non secure data storage</li> </ul>	<b>Characteristics:</b> <ul style="list-style-type: none"> <li>• Large bit cell size (1.2um<sup>2</sup>) ; &lt; 16K-bits @ 65nm</li> <li>• Limited to legacy process technologies; reverse scalable</li> <li>• Reliability – sensitive to tunnel (gate) oxide leakage for data retention</li> <li>• Design rule violations</li> <li>• Non secure data storage</li> </ul>	<b>Characteristics:</b> <ul style="list-style-type: none"> <li>• Small bit cell size (.174um<sup>2</sup>) ; &lt; 1M-bits @ 65nm</li> <li>• Supported and scalable on most advanced process nodes</li> <li>• Reliability – no soft errors and high reliability</li> <li>• No extra mask/process steps</li> <li>• Physical layer security</li> </ul>

Embedded non-volatile memory technologies. [Courtesy: Kilopass]



Gary Nevison is chairman of the AFDEC RoHS team, and Customer Support Manager, Legislation and Environmental Affairs at Premier Farnell. As such he is our industry expert who will try and answer any questions that you might have relating to the issues of RoHS, WEEE and REACH. Your questions will be published together with Gary's answers in the following issues of Electronics World.

## REACH VERSUS ROHS FOR SUBSTANCE RESTRICTION

The principles on which RoHS and REACH substance restrictions are based are markedly different. RoHS restrictions are based on hazards, meaning that if a substance is hazardous and there are alternatives, then it could be banned. REACH restrictions are only introduced if a risk to human health or the environment can be proven, it cannot be controlled and substitutes exist.

RoHS restrictions can be imposed without a full assessment of the impact of the possible alternatives taking place. A ban can be put in place if it can be shown that there is a potential risk without evidence of an actual risk. A good example of this is lead which is banned by RoHS but there is no evidence that its presence in electronics has, or is harming, human health or the environment. Furthermore, the possible substitutes had not been identified when this restriction was imposed in 2002 and, although less hazardous substitute solder alloys have since been found, their impact was not known until some years after the RoHS lead ban.

The impact of lead solder substitutes is now more clearly understood because the US Environmental Protection Agency (EPA) carried out a life cycle assessment, which shows that neither lead based solders nor lead-free solders are clear overall "winners" as they each have different properties and impact.

REACH restrictions are based on lengthy risk assessments that consider research into the impact of the substance in its entire life cycle and, also, the possible alternatives. This also encompasses the control measures used by industry to minimise risk and social and economic issues.

REACH restrictions are likely to be application-specific, where a risk is identified although the implementation of total bans is also possible.

The other key difference is that RoHS legislation bans substances present in electrical and electronic equipment that is within the scope of this directive. REACH affects all chemicals including those used to make the equipment (alloys, solvents, paints, etc.) and chemicals present in finished products of all types. There are very few exclusions and exemptions.

The Oko Institut, working on behalf of the European Commission, has carried out a stakeholder consultation on a short list of 46 possible additional RoHS substances (plus all brominated flame retardants) and this has now been reduced to a final shortlist of eight.

Many responses have been received from industry and there was some opposition to the proposed new restrictions, with respondents preferring regulation by REACH rather than the RoHS mechanism as recommended by Oko.

The following substances remain under the spotlight:

- Tetrabromobisphenol A (TBBPA)

**MOST OF THESE SUBSTANCES ARE NOT HAZARDOUS AND THE ONLY REASON FOR THE PROPOSED BAN IS TO PREVENT UNCONTROLLED AND UNSAFE, SO-CALLED 'BACKYARD', RECYCLING PRACTICES THAT ARE CARRIED OUT IN PARTS OF ASIA AND AFRICA**

- Hexabromocyclododecane (HBCDD)
  - Diethylhexyl phthalate (DEHP) Butylbenzyl phthalate (BBP) and Dibutyl phthalate (DBP)
  - Medium chain chlorinated paraffins (MCCP)
  - Short chain chlorinated paraffins (SCCP)
  - Nonylphenol ethoxylates
  - All organohalogen compounds
  - Others such as arsenic and nickel oxide and dimethyl formamide.
- Uses of these substances include in flame retardants, plasticisers, inks and adhesives.

The subject of organohalogen compounds is a contentious one. This category includes TBBPA, HBCDD, MCCP, SCCP. Most of these substances are not hazardous and the only reason for the proposed ban is to prevent uncontrolled and unsafe, so-called 'backyard', recycling practices that are carried out in parts of Asia and Africa. People may be harmed by the toxic chemicals that are emitted when some of these substances are burnt to recover metals such as silver and copper from electronic waste.

Unfortunately, there are currently insufficient levels of production of the alternative phosphorous-based flame retardants and this will take many years to ramp up. Also, these alternatives have not been thoroughly tested so may themselves present as yet unidentified risks.

Any ban on organohalogen compounds is unlikely to come in effect until 2012, therefore, 'backyard' recycling practices and the associated dangers will continue to be an issue for the foreseeable future.

Please email your questions to:

**[svetlana.josifovska@stjohnpatrick.com](mailto:svetlana.josifovska@stjohnpatrick.com)**

marking them as RoHS or WEEE.

# TAIWANESE ICT INDUSTRY FORECAST IN 2008

**KATIE CHEN**, PROJECT MANAGER AT THE TAIWAN EXTERNAL TRADE DEVELOPMENT COUNCIL LOOKS OVER THE STRENGTHS OF TAIWAN, POSITIONING IT AS ONE OF THE LEADING PRODUCERS OF ICT HARDWARE IN THE WORLD

**N**otebook PCs, motherboards, desktop PCs, servers, LCD (Liquid Crystal Display) monitors, CDT (Color Display Tube) monitors, ODDs (Optical Disk Drive) and digital cameras are the eight leading products in the Taiwanese IT hardware industry, some of which occupy a significant strategic position in the worldwide market. For example, Taiwanese motherboard and notebook PC shares of worldwide production have exceeded 90%, and Taiwanese LCD monitors now account for over 80% of the worldwide market. This signifies the important status of the Taiwanese IT hardware industry in the worldwide market.

Some 11 types of Taiwanese ICT products hold the largest worldwide market share. In 2007, 11 Taiwan-made ICT products accounted for the largest share in their respective worldwide markets, including motherboards, notebook PCs, LCD monitors, CDT monitors, DSCs (Digital Signal Controller), cable CPE (Customer Premises Equipment), DSL (Digital Subscriber Line) CPE, WLAN NIC (Wireless Local Area Network Interface Card), VoIP (Voice over Internet Protocol) routers, IP phones and IP STBs (Set-Top Box). WLAN APs (Access Point), servers, cable STBs, desktop PCs, and ODDs ranked second in worldwide market share.

According to MIC (Market Intelligence Center), the Taiwanese notebook PC, desktop PC and LCD monitor industries are estimated to have reached double-digit shipment value growth in 2007. Notebook PCs had the most brisk performance, with production value increasing by an estimated 27.6% and shipment volume rising approximately 38.4%.

Production value of the Taiwanese IT hardware industry as a whole is estimated to have broken the \$100bn mark in 2007. Looking ahead to 2008, Taiwanese IT hardware industry production value is expected to see 14.7% growth and is likely to reach \$167.5bn in 2012.

MIC expects 11.7% growth for the worldwide PC market in 2008 and the growth will be driven mainly by demand from the consumer market and emerging markets. The greatest share of growth will be contributed by notebook PCs, which will grow steadily at a rate of 25% and will have a shipment share of 45% in the worldwide PC market.

Taiwanese PC makers have accumulated strong production technology and R&D capabilities; this enables them to secure production outsourcing orders from leading international vendors. In 2008, Taiwanese ODM (Original Design Manufacturing) makers' share of worldwide notebook PC shipment is anticipated to exceed 90%.

While the ODM industry is developing prosperously, Taiwan's notebook PC brands also enjoy brisk sales in the worldwide market. Acer is one of world's top-three notebook PC brands and is expected to move up to second place in 2008.

**With rapid growth in the worldwide GPS market, a comprehensive industry value chain has begun to take shape in Taiwan and Taiwanese makers are playing an increasingly important role in the global market**

Established as a motherboard maker, Asus started its notebook PC business five years ago. Adopting a diversification strategy, Asus has become one of top-ten notebook PC vendors worldwide. Other companies such as MSI and Gigabyte have focused on external product design and multimedia functions, along with enhancing users' multimedia gaming experience. Both companies have achieved outstanding results both in Taiwan and the global marketplace.

The Taiwanese makers' share of the worldwide PND (Portable Navigation Device) production is estimated at 70%. With rapid growth in the worldwide GPS (Global Positioning System) market, a comprehensive industry value chain has begun to take shape in Taiwan and Taiwanese makers are playing an increasingly important role in the global market. Among GPS products, handheld navigation devices have the highest growth potential. MIC forecasted that worldwide production volume of PNDs is estimated at nearly 26 million units in 2007, signifying an annual growth rate of 43.3%.

The GPS industry in Taiwan has been developing vigorously. Many leading handheld navigation device vendors such as Mio are achieving high growth performance in both contract manufacturing and own-brand operations. Garmin, which has set up production bases in Taiwan, is making inroads into the consumer electronics market with its strong brand reputation, and has become the world's third largest GPS equipment brand. The development of Taiwanese GPS module and component makers has made Taiwan's GPS application and equipment industry more comprehensive, giving an important boost to Taiwanese makers for the development of the worldwide market. ■

# SO MANY TRANSMITTERS, SO SMALL A BAND

In an ideal world there would be only one transmitter (mine!) and I would use any frequency I desired, whenever I wished. Unfortunately, the real world of low power radio is far from ideal. There is only a relatively limited amount of spectrum allocated to ISM users and there are increasingly large numbers of those users.

It is no longer enough to just buy a link on 433.92MHz and hope that the 'next' user would be out of range of you, or not using their system when yours was operating.

Accommodating multiple users in a limited band is a subject that much work has gone into and the European low power telemetry bands permit a range of possible approaches.

• **Multiple channels:** Each transmitter uses a different frequency, separated by at least the occupied bandwidth (plus a margin) from the 'next' channel. This method tends to be used by narrowband links, where it is possible to fit a useful number of channels into the available spectrum.

**Pro:** All links can operate entirely independent from each other, as each is operating on a unique channel. There are no 'channel available' limitations and the full bandwidth of the channel is always available. Channels can be re-used on the basis of the maximum range for any given link (in turn related to the maximum permitted band power output). Frequencies affected by external interference can be avoided.

**Con:** This mode infers either the inconvenience of ordering and stocking different frequency single channel radios, or complex, expensive multichannel circuitry.

THERE IS ONLY A RELATIVELY LIMITED AMOUNT OF SPECTRUM ALLOCATED TO ISM USERS AND THERE ARE INCREASINGLY LARGE NUMBERS OF THOSE USERS

Setting up the band usage plan requires either user-effort, installation staff or complex (semi) automatic firmware. With higher transmitter powers (up to 500mW in the UK 458MHz band) intermodulation limits the number of usable channels (and makes frequency planning a skilled job).

• **Limited duty cycle:** No transmitter is permitted to be 'on' for longer than a given (and small) proportion of the time. This is specified as a duty cycle, typically 10% or less (on some bands it is as little as 0.1%). The absolute maximum duration of any transmission is often also limited. This makes it statistically unlikely that any two links will be sending at one time.

**Pro:** Very simple hardware can implement simple, low data throughput links. Many bands specifically require this operating mode (the 433MHz 10mW wideband allocation does in many countries. The 169MHz and large parts of the 868-869MHz bands do).

**Con:** Only a small fraction of the available channel bandwidth is available and there is a finite chance that any given transmission will be lost through collision, requiring some manner of acknowledge/re-transmit system, although by using multiple (short) transmissions (separated by a randomly variable time delay to avoid the re-transmission cycles getting into step) the effect of collisions in a crowded bands can be minimised.

• **Listen before talk:** All transmitters are required to also include a receiver and before any transmission a check is made of the strength of any signal on channel. The transmitter is only key'ed on if the channel is 'empty'. Duty cycle or maximum transmission duration limits are usually also imposed to prevent a single device 'hogging' the channel.

**Pro:** A greater amount of the channel bandwidth is available to the users, as the usage is 'politely' shared. Lesser requirement for multiple transmissions. This is the specified operating mode for much of the 868-869MHz band.

**Con:** Requires much more complex (transceiver) radio hardware and more processing power/programming effort. In



by Myk Dormer

presence of other users, the time to send a given data packet can be indeterminate, as multiple links compete for the channel. Weak interferers can spoof the receiver into inhibiting transmission.

Generally speaking, high end (narrowband) industrial control units, where reliable, rapid response matters, and high-performance radio modems, where data throughput is vital, tend to use multiple channel operation. Very low data throughput tasks, such as alarms and environmental monitors, and simple operator observation feedback ('key-fob' level) remote switches can use limited duty cycle, while LBT operation finds use with the higher data throughput telemetry tasks in-between.

**Footnote:** I haven't mentioned the class of "spread spectrum" radios, either direct sequence of frequency hopping, sometimes encountered in GHz band links or in US market (part 15 approval) 915MHz products.

These can be considered a sub-class of the multiple channel radios, where the operating frequency is varied during operation (at a rate much greater than the data throughput in the case of 'direct sequence', or in between data-packets for the 'frequency hopping' radios).

These interesting, and complicated, operating modes deserve separate consideration.

Myk Dormer is Senior RF Design Engineer at Radiometrix Ltd [www.radiometrix.com](http://www.radiometrix.com)

# Capacitive Touch Sensing In a Flexible, Single-chip Solution

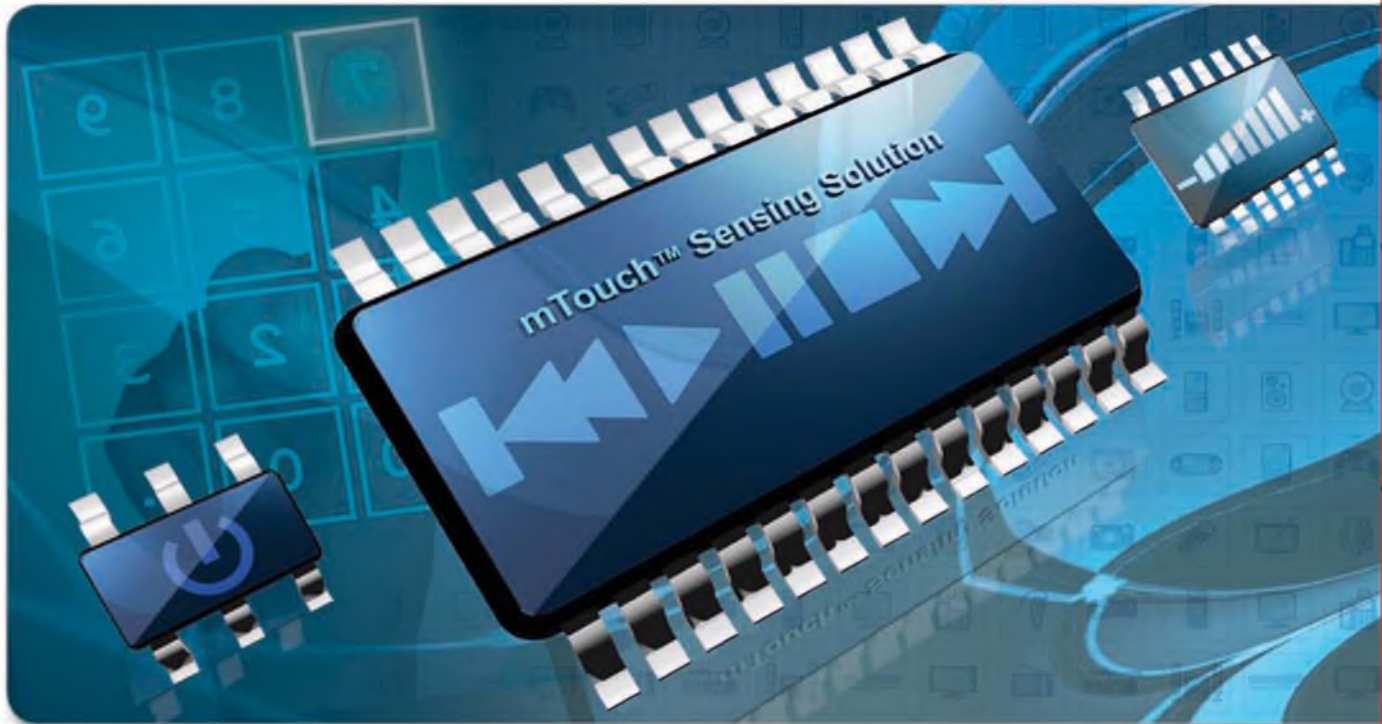

Microcontrollers

Digital Signal  
Controllers

Analog

Serial  
EEPROMs

Capacitive touch interfaces provide an excellent way to add low-cost, reliable and stylish buttons into your design. Microchip Technology's mTouch™ Sensing Solution includes comprehensive development kits and a free diagnostic tool to make implementation easy and fast. Our free source code can be seamlessly integrated with your existing firmware on a single PIC® microcontroller – eliminating the need for additional controllers.

## THE mTouch SENSING SOLUTION FEATURES:

- FREE license libraries and source code
- A FREE diagnostic tool
- Integration with 8- and 16-bit PIC microcontrollers
- Easy expansion, with support from 6 to 100 pins
- Low-power operation

## GET STARTED IN 3 EASY STEPS

1. Visit the mTouch Sensing Solutions design center at [www.microchip.com/mTouch](http://www.microchip.com/mTouch)
2. Download free libraries and source code
3. For a limited time, save 20% off a variety of touch sensing development tools when you purchase from [www.microchipDIRECT.com](http://www.microchipDIRECT.com) and use voucher code **EUMTOUCH**.



Intelligent Electronics start with Microchip

microchip  
**DIRECT**  
www.microchipdirect.com

[www.microchip.com/mtouch](http://www.microchip.com/mtouch)

 **MICROCHIP**



# HUMAN INTERFACE SOLUTIONS FROM MICROCHIP

IF YOU ARE LOOKING TO ADD NEW AND STYLISH INTERFACES TO DIFFERENTIATE YOUR PRODUCT, MICROCHIP'S HUMAN INTERFACE SOLUTIONS INCLUDE I/O PRODUCTS ENCOMPASSING TOUCH SENSING, DISPLAY/QVGA GRAPHICS, AUDIO AND SPEECH. THESE ARE COMPLETE, TURNKEY SOLUTIONS, AND MANY HAVE LICENSE-FREE AND ROYALTY-FREE OPTIONS TO GET YOUR DESIGN TO MARKET FASTER AT A LOWER TOTAL SYSTEM COST.

## CAPACITIVE TOUCH SENSING SOLUTIONS

Capacitive Touch sensing requires no mechanical movement, and enables a completely sealed and modern-looking design for consumer goods and in medical, industrial and automotive applications. Microchip's mTouch™ Sensing Solution uses PIC® microcontrollers that feature on-chip peripherals like high drive I/Os to drive LEDs, wake-up on change and internal pull down/up resistors for push buttons, A/D converters and comparators for variable resistors, and A/D converters for keyboard matrix implementations.

Microchip's Capacitive mTouch Solution offers a number of hardware solutions to suit the demands of any application from the most basic single button design using the incredibly small and cost-effective 8-bit PIC10F to the peripheral-rich 8-bit mid-range and 16-bit PIC24FJ microcontroller families.

Microchip's mTouch employs two main methods: relaxation oscillator or direct capacitance measurement.

The relaxation oscillator measures frequency based on a capacitance value. The frequency of the oscillator is then measured, and any shift due to a user's touch is detected and validated in software.

Direct capacitance measurement charges a capacitance with a fixed current for a fixed time, and then measures the voltage with the A/D converter. This is used by the Charge Time Measurement Unit (CTMU) peripheral allowing a measurement time as low as 4  $\mu$ S.

As part of the PICDEM™ Touch Sense Demonstration Board, the royalty-free mTouch software development kit features the Windows-based mTouch Diagnostic tool provides a graphical user interface to analyse information in "real-time". For more details go to [www.microchip.com/mtouch](http://www.microchip.com/mtouch).

## DISPLAY SOLUTIONS

The use of displays – whether segmented LCD or Graphics – continues to gain popularity and QVGA graphics displays in particular provide detailed information with sharper images. The larger the screen, the more the processing power required to service it. Microchip offers a broad range of 8-, 16- and 32-bit microcontrollers and 16-bit digital signal controllers that enable display applications, many of which feature on-chip LCD peripherals and peripherals such as parallel master support and direct memory access (DMA).

Microchip's free QVGA Graphics Library includes source code and related development tools, schematics, drivers,



documentation and utilities. For more details go to [www.microchip.com/graphics](http://www.microchip.com/graphics).

## VOICE AND AUDIO SOLUTIONS

Voice and audio continues to be a popular and natural medium of communication. Many 8-bit PIC microcontrollers can generate tones, alarms and musical notes in various applications.

Microchip's 16-bit microcontrollers and digital signal controllers and 32-bit microcontrollers provide up to 512 Kbytes of Flash program memory and up to 32 Kbytes of RAM. On-chip direct memory access peripherals allow data to be streamed to and from memory with minimal CPU interaction. Software libraries are available to interface with a variety of external Flash storage devices if extra storage capacity is required.

Microchip has a variety of software libraries that can be used for these audio functions. In particular there are multiple options for audio encoding and decoding, allowing the designer to select the best tradeoff between audio quality, storage space and CPU processing requirements. For more details go to [www.microchip.com/audio](http://www.microchip.com/audio).

## DEVELOPMENT KITS

All these solutions are supported by a comprehensive range of low-cost development systems. To start designing today go to [www.microchipdirect.com](http://www.microchipdirect.com)! ■

# CHOOSING ARM PROCESSOR ARM7 VS CORTEX-M3

WITH THE INTRODUCTION OF MICROCONTROLLERS BASED ON THE ARM CORTEX-M3 CORE, A DEVELOPER WANTING A LOW-COST 32-BIT DEVICE CAN CHOOSE EITHER A CORTEX-M3 BASE OR AN ARM7TDMI. WHAT ARE THE CRITERIA TO CONSIDER WHEN MAKING THAT CHOICE, ASKS **ANDERS LUNDGREN** FROM IAR SYSTEMS

**T**he ARM Cortex-M3 is an implementation of the ARM7v architecture – the latest evolution of ARM's embedded cores. It is a Harvard architecture, using separate buses for instructions and data, rather than a von Neumann architecture where data and instructions share a bus. The Harvard architecture is intrinsically significantly faster

but physically more complex. With Moore's Law, the complexity is not such a significant issue and the increase in throughput is valuable.

The Cortex-M3 is aimed by ARM at the deeply embedded market. It is designed to be very low cost, low power and to provide good performance. ARM sees it as particularly suited to automotive and

wireless communications applications.

As with all ARM designs, the company licenses the design to manufacturers who produce their own implementation, and already a number of manufacturers have committed to producing microcontrollers based on the Cortex-M3. The first of these was Luminary Micro, shown in **Figure 1**, which is shipping devices with volume pricing at less than \$1.



**Figure 1:** Luminary Micro introduced the first Cortex-M3 based microcontroller for less than \$1, shown here on an evaluation board as part of an IAR KickStart Kit

## WORKHORSE OF THE EMBEDDED WORLD

There is a developing ecosystem of development tools and system software, evolving from the ARM7TDMI ecosystem and anticipating further manufacturers entering the area. The other ARM core aimed at the same market is the ARM7TDMI (and ARM7TDMIS). This has been around for more than ten years and is one of the drivers pushing ARM to world dominance in processor cores.

Many manufacturers (ARM claim more than sixteen) are selling families of microcontrollers based on ARM7 cores and the ecosystem of software, development and debugging tools is growing all the time. The ARM7TDMI is, in many ways, the workhorse of the embedded world.

As well as using the Harvard architecture, the Cortex-M3 has other significant differences. It is a smaller basic core, reducing price and increasing speed. Integrated with the core are system peripherals, such as the interrupt controller, bus matrix and debug functionality, which would normally be added by the microcontroller implementer. It has an integrated sleep mode and the

option of an integral eight-region Memory Protection Unit. It is designed for the Thumb-2 instruction set and reduces assembler usage to a minimum.

While the ARM7 implements both the ARM and Thumb instruction sets, the Cortex-M3 is designed for the new Thumb-2 and supports only this instruction set, which has several advantages including:

- There is no need to switch state between Thumb and ARM code, which reduces performance with earlier processors.
- Thumb-2 is designed specifically to implement C and includes an If/Then construct (predicating conditional execution of the next four instructions), hardware division and native bitfield manipulation.
- Thumb-2 allows applications to be maintained and modified at the level of the C code and portions of C can be easily reused.
- Thumb-2 is designed to include functionality that would normally require calling assembler level code: Luminary claims that there is no need ever to drop into assembly language.
- These advantages add up to easier implementation and possibly faster time-to-market for new products.

### NOVEL FEATURES

Another innovation on the Cortex-M3 is the Nested Vector Interrupt Controller (NVIC). Unlike external interrupt controllers, as are used in ARM7TDMI implementations, this is integrated into the Cortex M3 core and can be configured by the silicon implementer to provide from a basic 32 physical interrupts with 8 levels of pre-emption priority up to 240 physical interrupts and 256 levels of priority. The design is deterministic with low latency, making it particularly applicable to automotive applications.

The NVIC uses a stack-based exception model. Program counter, program status register, link register and general purpose registers are all pushed on to the stack to handle the interrupt, and once it is completed, the registers are restored. Stack handling is in hardware, so there is no longer a need to create assembler wrappers for stack manipulation for interrupt service routines.

Interrupts can be nested. An interrupt can exert a higher priority for earlier



**Figure 2:** Embedded Trace Macrocell makes it possible to carry out a wide range of debug and monitoring functions within the core

servicing and priority levels can be changed during run-time. Using a technique of tail-chaining successive interrupts takes only three cycles, compared to 32 needed for a successive stack pop and push, reducing latency and increasing performance.

If the NVIC is stacking (pushing) when an interrupt of higher priority arrives, merely fetching a new vector address is all that is needed to service the higher priority one. Similarly, the NVIC will abandon a pop to service a new interrupt. This also achieves lower latency and is completely deterministic.

The Cortex-M3 power management scheme supports Sleep Now, Sleep on Exit (from exiting the lowest priority ISR) and SLEEPDEEP modes, through the NVIC.

To generate regular time intervals for interrupts, the NVIC has an integrated System Tick timer, which can also be used as a heartbeat for scheduled tasks or for an RTOS. This means that there is no need for an external clock, unlike previous ARM architectures.

### MEMORY PROTECTION UNIT

The memory protection unit is an implementation option. When implemented it allows areas of memory to be associated with specific processes in the application with rules governing access by other

processes. For example, some memory can be totally blocked for all other processes, while other areas can be read only for specific other processes. Another rule could halt execution if a process attempts to enter a memory area. This provides a significant improvement in reliability, particularly in real-time.

The integrated debug and trace Debug Access Port can be implemented as either a two pin Serial Wire Debug Port or a Serial Wire JTAG Debug Port. In association with the Flash Patch and Breakpoint unit, the Data Watchpoint and Trace unit, the implementation option of the Embedded Trace Macrocell and the Instrumentation Trace Macrocell, it is possible to carry out a wide range of debug and monitoring functions within the core. It is, for example, possible to set breakpoints, watchpoints, define fault conditions or carry out debug requests and either halt operations or continue while monitoring. All of these facilities have been available in ARM architectures but the Cortex-M3 pulls them together in a neat package for the developer.

### MCUS GALLORE

While the ARM7 cores do not have such deeply integrated peripherals as the Cortex family, there is vast range of ARM7 based

devices with an even larger range of peripherals, shading from general purpose MCUs, through to application-oriented MCUs, SoCs and even an ARM7 core in an FPGA from Actel. There are around 150 different MCUs based on the ARM7 (and that number can be even higher, depending on how the versions are counted).

For almost every application in the embedded space it is possible to find an ARM7 implementation that has been customised, to some degree or other, to meet the requirements. To the standard core the implementer adds different memory types and sizes and other peripherals, such as serial interfaces, bus controllers, memory controllers and graphics units. They use a range of packaging types and for industrial, automotive and other demanding applications, provide extended temperature range versions. They may also bundle software, such as TCP/IP stacks or even application specific software.

For example, the STR7 product line (from STMicroelectronics) has three major families, with a total of 45 members with variants in packaging and memory. Each family has a different peripheral set aimed at specific applications. For example, the STR730 family is designed for industrial and automotive applications, so is available in an extended temperature range and includes multiple I/O and 3 CAN interfaces, while the STR710 is aimed at consumer, point of sales and high-end industrial applications and has multiple communication interfaces including USB, CAN, ISO7816 and four UART, large memory and an external memory interface.

Implementers also choose to add help for developers, for example, by implementing ARM's Embedded Trace Macrocells (ETM) and by supplying development and debug tools.

By contrast, the number of companies shipping Cortex-M3 based products is limited, although other companies have announced their intention to produce products.

## TOOLS AROUND

The ubiquity of the ARM7 has led to an explosion in third party products for developing and debugging applications. The ARM web site lists over 130 companies and other companies are also serving this market.

Most manufacturers provide a basic development board, housing the device and providing interfaces to load programs,



Figure 3: Schematic of design process for ARM project, from idea to target application

attach debugging tools and drive peripherals. It will include a status display of LEDs or a single line screen. Normally the board is packaged as part of a kit with a compiler and some debugging software. More advanced kits, including those from third parties, will include a full integrated development environment (IDE) with a compiler, linker, debugger, editor and other tools. They may also include hardware, such as JTAG probes to connect the JTAG port on the device to the PC.

In-Circuit Emulators (ICEs), one of the earliest and most useful forms of debugging tools, are available with ARM7 interfacing from a range of manufacturers.

Software development tools abound: they range from modelling and visual design front-ends through to compilers. Application modules and middleware sit on top of real-time operating systems (RTOS) for rapid development, and more of these are coming to the market. And, perhaps very importantly, there is a huge base of experienced ARM7 developers.

There is already an emerging tools base for the Cortex-M3, but obviously this has still some distance to go. However, the integrated debug in the CortexM3 will make system bring-up and debug much easier and more efficient and removes the need for In-Circuit Emulators (ICEs).

## DECISION TIME

So, which do you choose today? If cost is an absolute driver – probably Cortex-M3. If

looking for better performance and improved power at low cost – you might again consider the Cortex-M3, particularly if the application is in the areas that ARM sees as primary targets – automotive and wireless.

The integrated elements within the core and the Thumb-2 instruction set should make developing and debugging on the Cortex-M3 easier and faster than the ARM7TDMI.

The drawback at the moment is that there are a limited number of suppliers. However, many of the companies with ARM7 based devices are working on Cortex-M3 designs and it would be worthwhile talking to suppliers to get a feeling for timescales and implementation details.

But as retargeting an application from the ARM7TDMI is not difficult, particularly when using an RTOS, the conservative route may be to use a device with an ARM7TDMI core for now but ensure that design and implementation do not use features that will make retargeting more complex. ■

## Further Reading

Two ARM white papers that provide further reading are 'Introduction to the ARM Cortex-M3 Processor' and 'Running ARM7TDMI Processor Software on the Cortex-M3 Processor'. Both can be downloaded from [www.arm.com/documentation/](http://www.arm.com/documentation/).

# PLC WITH PIC16F648A MICROCONTROLLER (PART 1)

ASSOCIATE PROFESSOR **DR MURAT UZAM**  
FROM NIGDE UNIVERSITY IN TURKEY  
KICK-STARTS A SERIES OF ARTICLES ON A  
PROJECT THAT FOCUSES ON A  
MICROCONTROLLER-PLC

## The Series

The articles to be published are as follows:

- 1. The Hardware:** Run in this issue.
- 2. The Basic Software:** This article explains the basic software structure of the UZAM\_PLC. A PLC scan cycle includes the following: 1. obtain the inputs, 2. run the user program, 3. update the outputs. In addition, it is also necessary to define and initialise all variables used within a PLC. Necessary functions are all described as PIC Assembly macros to be used in UZAM\_PLC. The macros described in this article could be summarised as follows: "HC165" (for handling the inputs), "HC595" (for sending the outputs), "dbncr" (for debouncing the inputs), "initialise", "get\_inputs", "send\_outputs".
- 3. Contact and Relay Based Macros:** The following contact and relay based macros are described in this article: ld (load), ld\_not (load\_not), not, or, or\_not, nor, and, and\_not, nand, xor, xor\_not, xnor, out, out\_not, in\_out, inv\_out, set, reset. These macros are defined to operate on one bit variables.
- 4. Flip-Flop Based Macros:** The following flip-flop based macros are described in this article: r\_edge (rising\_edge), f\_edge (falling\_edge), latch0, latch1, dff\_r (rising edge triggered D flip-flop), dff\_f (falling edge triggered D flip-flop), tff\_r (rising edge triggered T flip-flop), tff\_f (falling edge triggered T flip-flop), jkff\_r (rising edge triggered JK flip-flop), jkff\_f (falling edge triggered JK flip-flop).
- 5. Timer Macros:** The following timer macros are described in this article: TON\_8 (ON delay timer), TOF\_8 (OFF delay timer), TEP\_8 (Extended Puls timer), TOS\_8 (Oscillator timer).
- 6. Counter Macros:** The following counter macros are described in this article: CTU\_8 (Up Counter), CTD\_8 (Down Counter), CTUD\_8 (Up/Down Counter).
- 7. Comparison Macros:** The following comparison macros are described in this article: The contents of two registers (R1 and R2) are compared according to the following: GT (Greater Than – ">"), GE (Greater than or Equal to – ">="), EQ (Equal to – "="), LT (Less Than – "<"), LE (Less than or Equal to – "<="), NE (Not Equal to – "≠"). Similar comparison macros are also described for comparing the contents of an 8 bit register (R) with an 8 bit constant (K).
- 8. Arithmetical Macros:** The following arithmetical macros are described in this article: The following operators are applied to the contents of two registers (R1 and R2): ADD, SUB (subtract), INC (increment), DEC (decrement). Similar arithmetical macros are also described to be used with the contents of an 8 bit register (R) and an 8 bit constant (K).
- 9. Logical Macros:** The following logical macros are described in this article: inv\_r, AND, NAND, OR, NOR, XOR, XNOR. These macros are applied to an 8 bit register (R1) with another register (R2) or an 8 bit constant (K).
- 10. Shift&Rotate Macros:** The following Shift&Rotate macros are described in this article: SHIFT\_R (shift right the contents of register R), SHIFT\_L (shift left the contents of register R), ROTATE\_R (rotate right the contents of register R), ROTATE\_L (rotate left the contents of register R), SWAP (swap the nibbles of the register).
- 11. Multiplexer Macros:** The following multiplexer macros are described in this article: mux\_2\_1 (2x1 MUX), mux\_2\_1\_E (2x1 MUX with Enable input), mux\_4\_1 (4x1 MUX), mux\_4\_1\_E (4x1 MUX with Enable input), mux\_8\_1 (8x1 MUX), mux\_8\_1\_E (8x1 MUX with Enable input).
- 12. DeMultiplexer Macros:** The following demultiplexer macros are described in this article: Dmux\_1\_2 (1x2 DMUX), Dmux\_1\_2\_E (1x2 DMUX with Enable input), Dmux\_1\_4 (1x4 DMUX), Dmux\_1\_4\_E (1x4 DMUX with Enable input), Dmux\_1\_8 (1x8 DMUX), Dmux\_1\_8\_E (1x8 DMUX with Enable input).
- 13. Decoder Macros:** The following decoder macros are described in this article: decod\_1\_2 (1x2 decoder), decod\_1\_2\_E (1x2 decoder with Enable input), decod\_2\_4 (2x4 decoder), decod\_2\_4\_E (2x4 decoder with Enable input), decod\_3\_8 (3x8 decoder), decod\_3\_8\_E (3x8 decoder with Enable input).
- 14. Priority Encoder Macros:** The following priority encoder macros are described in this article: encod\_4\_2\_p (4x2 priority encoder), encod\_4\_2\_p\_E (4x2 priority encoder with Enable input), encod\_8\_3\_p (8x3 priority encoder), encod\_8\_3\_p\_E (8x3 priority encoder with Enable input), encod\_dec\_bcd\_p {decimal to BCD (Binary Coded Decimal) priority encoder}, encod\_dec\_bcd\_p\_E (decimal to BCD priority encoder with Enable input).
- 15. An Example:** This article describes an example of a remotely-controlled model gate system and makes use of UZAM\_PLC to control it for different control scenarios.

The reader is expected to be familiar with PLCs, PIC microcontrollers and PIC Assembly language. UZAM\_PLC macros are developed by using PIC Assembly language. The program development environment used is that of MPLAB IDE ([www.microchip.com](http://www.microchip.com)).

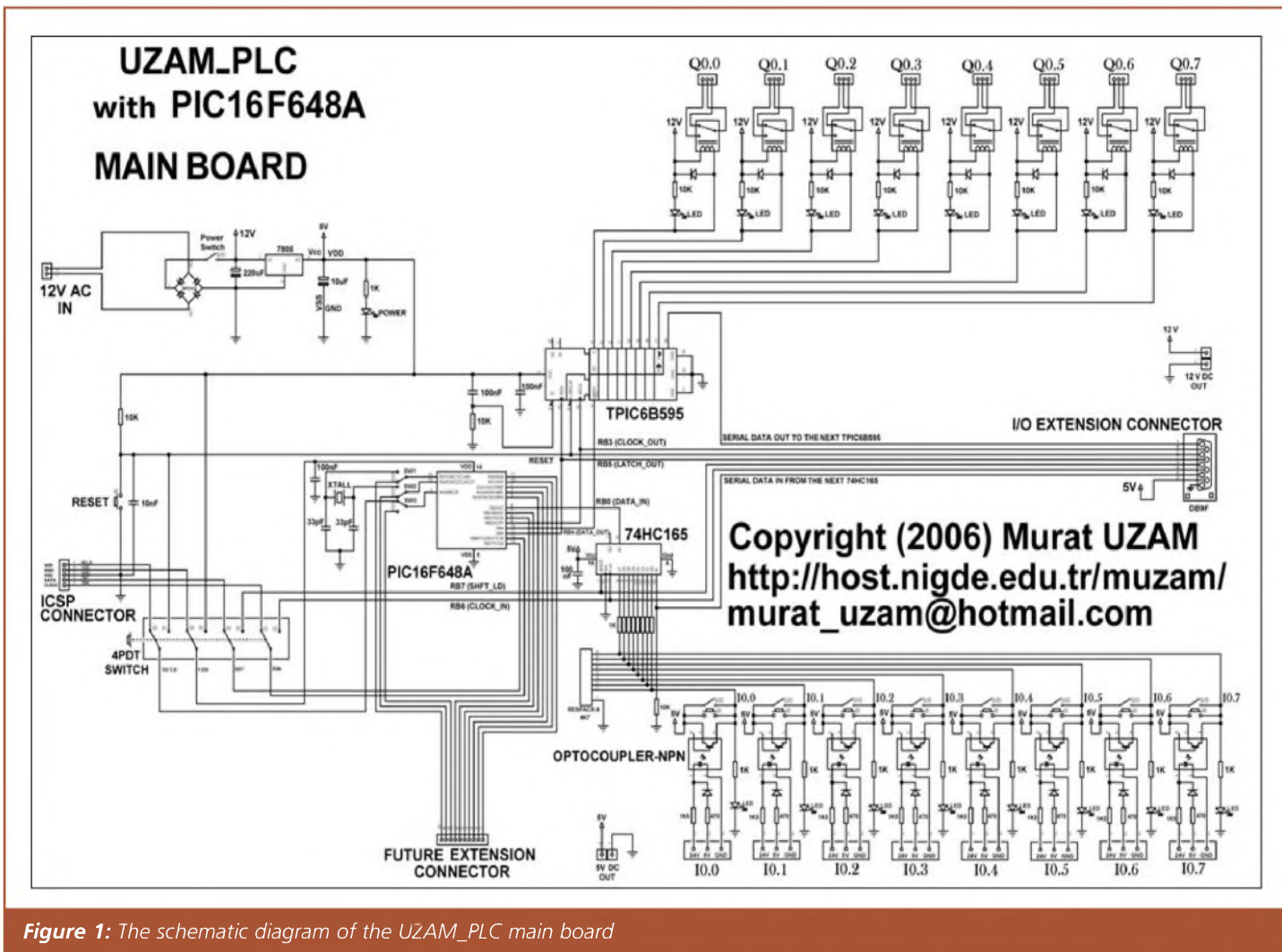

Figure 1: The schematic diagram of the UZAM\_PLC main board

Programmable Logic Controllers (PLCs) have been extensively used in industry for the past five or six decades. PLC manufacturers offer different devices in terms of functions, program memories and the number of inputs/outputs (I/O), ranging from a few to thousands of I/Os.

The design and implementation of PLCs have long been a secret of the PLC manufacturers. As a microprocessor-based technology, the functionality of a PLC is well known from the end-user/programmer point of view, but by now no serious work has been reported to describe a microprocessor/microcontroller based implementation of a PLC.

With a series of articles I aim to describe a PIC microcontroller based design and implementation of a PLC, called

UZAM\_PLC with PIC16F648A. First in the series is this article, which describes the hardware of UZAM\_PLC with PIC16F648A.

### DESIGN AND IMPLEMENTATION

This project has been completed in search for how to design and implement a PLC. Some ideas can be found in the freely available PLC project called "PICBIT" from around 10 years ago. An Internet search for the keyword "PICBIT" leads to this project.

PICBIT describes a PIC16F84 microcontroller based PLC with five discrete inputs and eight discrete outputs. The file called "picbit.inc" of the PICBIT contains the basic PLC macro definitions.

The UZAM\_PLC project has been completed by the inspiration of these

macros. In addition, many new features have been included within UZAM\_PLC project to make it more of an engulfing PLC. However, this project does not include graphical interface PC software as in PICBIT or in other PLCs for developing PLC programs. Rather, PLC programs are developed by using macros as done in the Instruction List (IL) PLC programming language. An interested and skilled reader could well – and encouraged to – develop graphical interface PC software for easy use of UZAM\_PLC.

### THE HARDWARE WITH PIC16F648A

The hardware of UZAM\_PLC with PIC16F648A consists of two parts: "main board" and "I/O extension board". The schematic diagram of UZAM\_PLC main

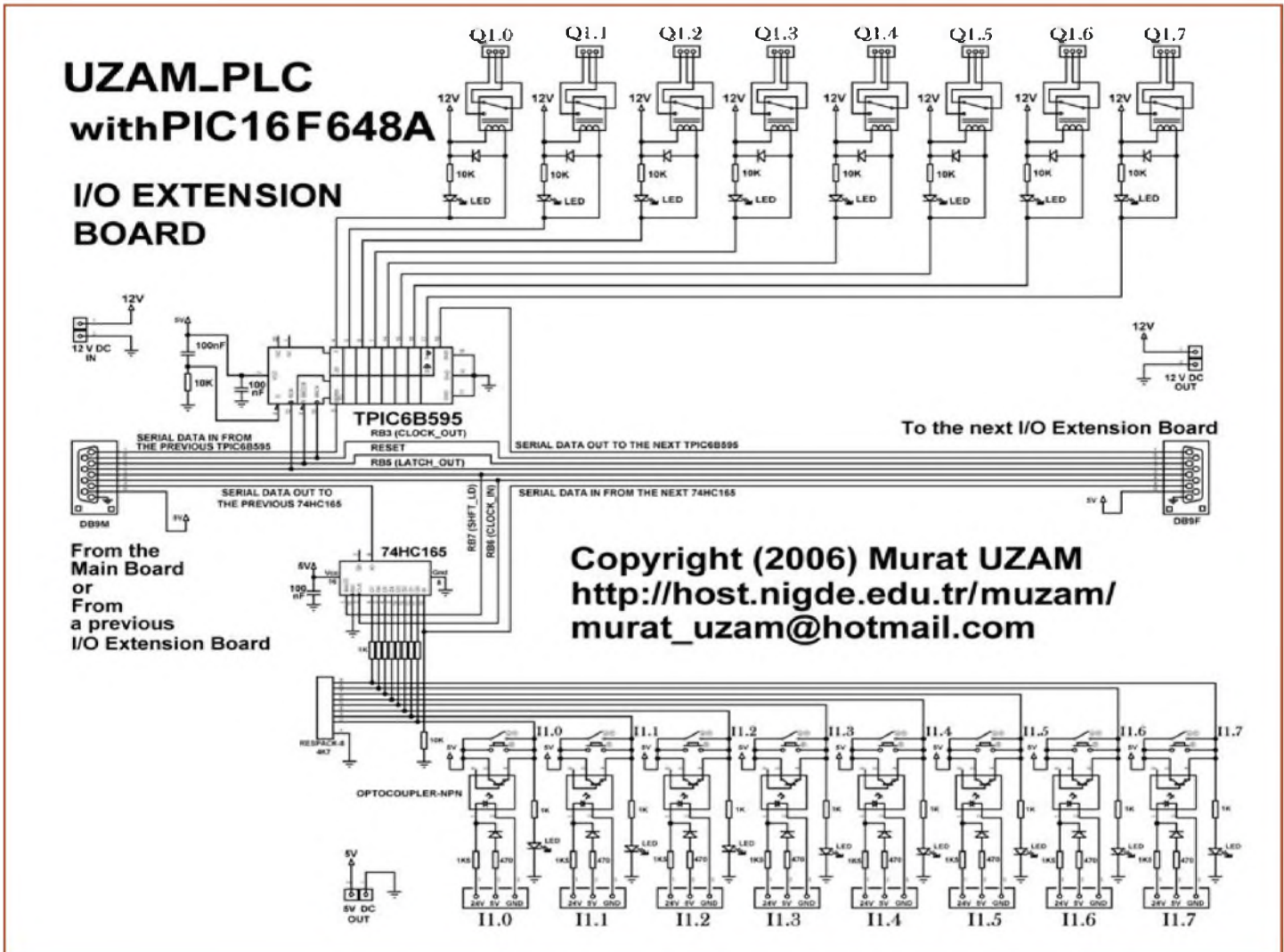

**Figure 2:** The schematic diagram of the UZAM\_PLC I/O extension board

board is shown in **Figure 1**. The main board contains mainly five sections: power, programming, CPU (Central Processor Unit), inputs and outputs.

The power section accepts 12V AC input and produces as outputs 12V DC to be used as the operating voltage of relays, and 5 V DC to be used for ICs, inputs, etc. The programming section deals with the programming of PIC16F648A microcontroller. For programming the PIC16F648A in circuit, it is necessary to use a PIC programmer hardware and software with ICSP (In Circuit Serial Programming) capability. For those who have a PC with serial port, PCB files for a PIC programmer hardware, called JDM programmer, and related software can be downloaded (please contact the editorial office of

*Electronics World* for details).

For other types of USB or parallel port PIC programmers the reader is expected to make necessary arrangements. ICSP connector takes the lines VPP(MCLR), VDD, VSS(GND), DATA (RB7), CLOCK (RB6) from the PIC programmer hardware through a properly prepared cable and it serves them to a 4PDT (four pole double throw) switch.

There are two positions of the 4PDT switch. As seen in Figure 1, in one position of 4PDT switch, PIC16F648A is ready to be programmed and in the other position the loaded program is run. For properly programming the PIC16F648A by means of a PIC programmer and the 4PDT switch, it is also a necessity to *switch off* the power switch.

The CPU section consists of the

PIC16F648A microcontroller. Although it can run up to 20MHz, in UZAM\_PLC it is fixed to run at 4MHz with its internal oscillator. This frequency is fixed because time-delays are calculated based on this speed. However, by means of two switches, namely SW1 and SW2, it is also possible to use an external oscillator with different crystal frequencies. When doing so, time-delay functions must be calculated accordingly. SW3 directs the RA5 pin either to one pole of 4PDT switch or to the future extension connector.

**PROGRAMMING PICS**

When programming PIC16F648A, RA5 should be connected to 4PDT switch. RB0, RB6 and RB7 pins are all reserved to be used for an 8-bit parallel to serial converter

register 74HC/LS165. Through these three pins and with added 74HC/LS165 registers we can describe as many inputs as we wish. RB0, RB6, and RB7 are the "data in", the "clock in" and the "shift/load" pins, respectively.

Similarly, RB3, RB4 and RB5 pins are all reserved to be used for 8-bit serial to parallel converter register/driver TPIC6B595. Through these three pins and with added TPIC6B595 registers we can describe as many outputs as we wish. RB3, RB4 and RB5 are the "clock out", the "data out" and the "latch out" pins, respectively. The remaining unused pins of the PIC16F648A are connected to the "future extension connector".

PIC16F648A provides the following: 4096 words of Flash program memory; 256 bytes of RAM data memory and 256 bytes of EEPROM data memory. The UZAM\_PLC macros make use of registers defined in RAM data memory. Note that it may be possible to use PIC16F628A as the CPU, but one has to bear in mind that PIC16F628A provides the following: 2048 words of Flash program memory; 224 bytes of RAM data memory and 128 bytes of EEPROM data memory.

In this case it is necessary to take care of the usage of RAM data memory. The inputs section introduces 8 discrete inputs for the UZAM\_PLC, called I0.0, I0.1, ..., I0.7. Each input can accept 5V DC or 24V

DC signals. These external input signals are isolated from the other parts of the hardware by using NPN type opto-couplers (e.g. 4N25). For simulating input signals, one can use on board push-buttons as temporary inputs and slide switches as permanent inputs.

In the beginning of each PLC scan cycle (get\_inputs) 74HC/LS165 is loaded (RB7 (shift/load) = 0) with the level of 8 inputs and then this data is serially clocked in (when RB7 = 1; through RB0 "data in" and RB6 "clock in" pins). If there is no I/O extension board used, then 8 clock\_in signals are enough to get the 8 input signals. For each I/O extension board, 8 more clock\_in signals are necessary.

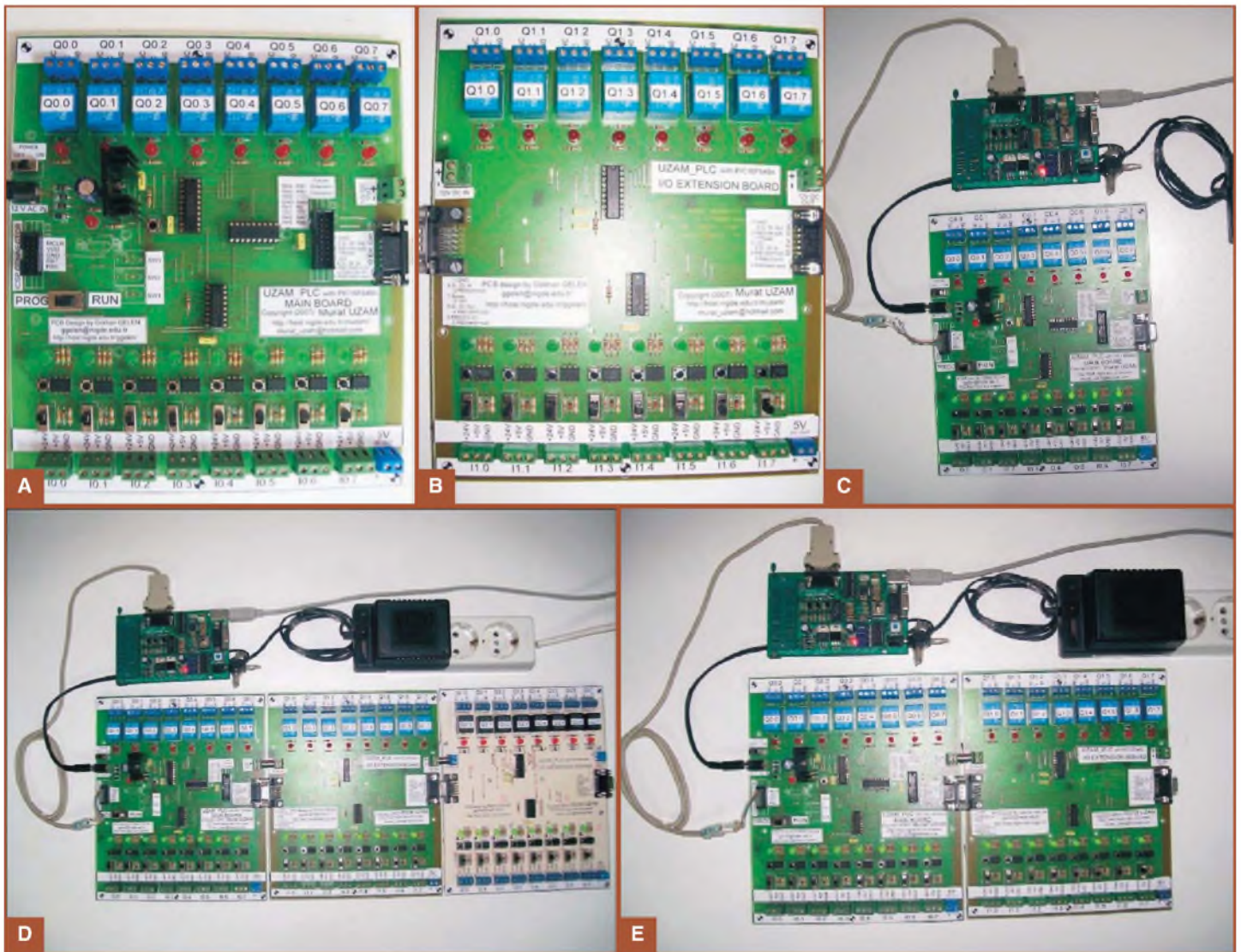

**Figure 3:** Photographs of (a) the UZAM\_PLC main board, (b) UZAM\_PLC I/O extension board, (c) UZAM\_PLC main board with a PIC programmer, (d) UZAM\_PLC main board plus an I/O extension board and a USB PIC programmer, (e) UZAM\_PLC main board plus two I/O extension boards and a USB PIC programmer



## DATA INPUT

The serial data coming from the I/O extension board is taken from the "SI" input of 74HC/LS165. The outputs section introduces 8 discrete relay outputs for the UZAM\_PLC, called Q0.0, Q0.1, ..., Q0.7. Each relay operates with 12V DC and is driven by an 8-bit serial to parallel converter register/driver TPIC6B595.

Relays have SPDT (single pole double throw) contacts with C (common), NC (normally closed) and NO (normally open) terminals. At the end of each PLC scan cycle (send\_outputs) the output data is serially clocked out (through RB3 "clock out" and RB4 "data out" pins) and finally latched within TPIC6B595. If there is no I/O extension board used, then 8 clock\_out signals are enough to send the 8 output signals. For each I/O extension board, 8 more clock\_out signals are necessary.

The serial data going to the I/O extension board is sent out from the "SER OUT" (pin 18) of TPIC6B595. In addition, there is also an I/O extension connector "DB9F" for conveying the I/O data to and from all the connected extension I/O boards. The PCB design files of the main board can be received from the editorial offices of *Electronics World*. Note that in the PCB design of the main board, some lines of I/O extension connector are different from the ones shown in Figure 1.

As shown in **Figure 2**, the "I/O extension board" contains mainly two sections: discrete inputs (8 of them) and discrete outputs (also 8 of them). They are similar to the ones as described for the main board.

The I/O extension connector "DB9M" seen on the left connects the I/O extension board to the main board or to a previous I/O extension board. Similarly, the I/O extension connector "DB9F" seen on the right connects the I/O extension board to an adjacent I/O extension board. In this way we can connect as many I/O extension boards as necessary. The 12V DC power is taken from the main board or from a previous I/O extension board and it is passed to the next I/O extension boards.

The 5V DC voltage is taken from the main board or from a previous I/O extension board through the "DB9M" connector and it is passed on to the next I/O extension boards through the "DB9F" connector. The PCB design files of the I/O extension board can be had from the editorial offices of the magazine. Note that in the PCB design of the I/O extension board, some lines of I/O extension connectors "DB9M" and "DB9F" are different from the ones shown in Figure 2. **Figure 3** is a selection of photos of the UZAM\_PLC main board and I/O extension board with and without a PIC programmer. ■

# No Compromise Oscilloscope

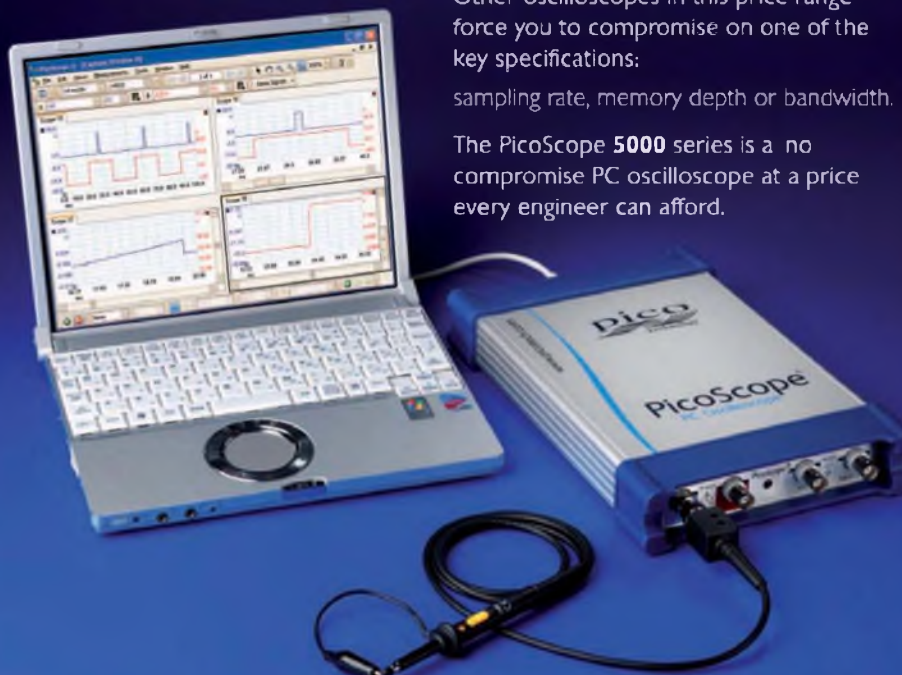

Other oscilloscopes in this price range force you to compromise on one of the key specifications:

sampling rate, memory depth or bandwidth.

The PicoScope 5000 series is a no compromise PC oscilloscope at a price every engineer can afford.

[www.picotech.com/scope493](http://www.picotech.com/scope493)

01480 396395

**pico**<sup>®</sup>  
Technology



**1GS/s sampling rate**

**250MHz bandwidth**

**128M sample buffer memory**

**125MS/s 12 bit AWG built in**

**PicoScope 5203**  
32M buffer £1195

**PicoScope 5204**  
128M buffer £1795

# MICROCONTROLLER AND SD-CARD BASED MULTICHANNEL DATA LOGGER

**DOGAN IBRAHIM,**  
LECTURER AT THE NEAR  
EAST UNIVERSITY IN  
CYPRUS, DESCRIBES THE  
DESIGN OF A  
MICROCONTROLLER-  
BASED MULTICHANNEL  
DATA LOGGER DEVICE  
WITH SD CARD AND  
REAL-TIME CLOCK  
INTERFACE

The term 'data logging' can be defined as the capture and storage of data for use at a later time. Basically, a data logger is an electronic device that captures and records data over time.

Data loggers are nowadays based on the microcontroller technology. They are usually portable, battery-operated devices with internal storage and some incorporating sensors to measure physical quantities such as temperature, pressure, humidity, flow, displacement and so on.

Data loggers can be divided into two basic groups: standalone data loggers and data capturing data loggers.

## STANDALONE DATA LOGGERS

This type of data loggers can be used on their own, without requiring other devices for data collection and storage. Standalone data loggers have large amounts of internal non-volatile memories. They may also have real time clock chips. The collected data can be saved in the memory with time stamping.

The data collected in a standalone data logger is usually analysed offline. A standalone data logger is usually configured and then left at the required

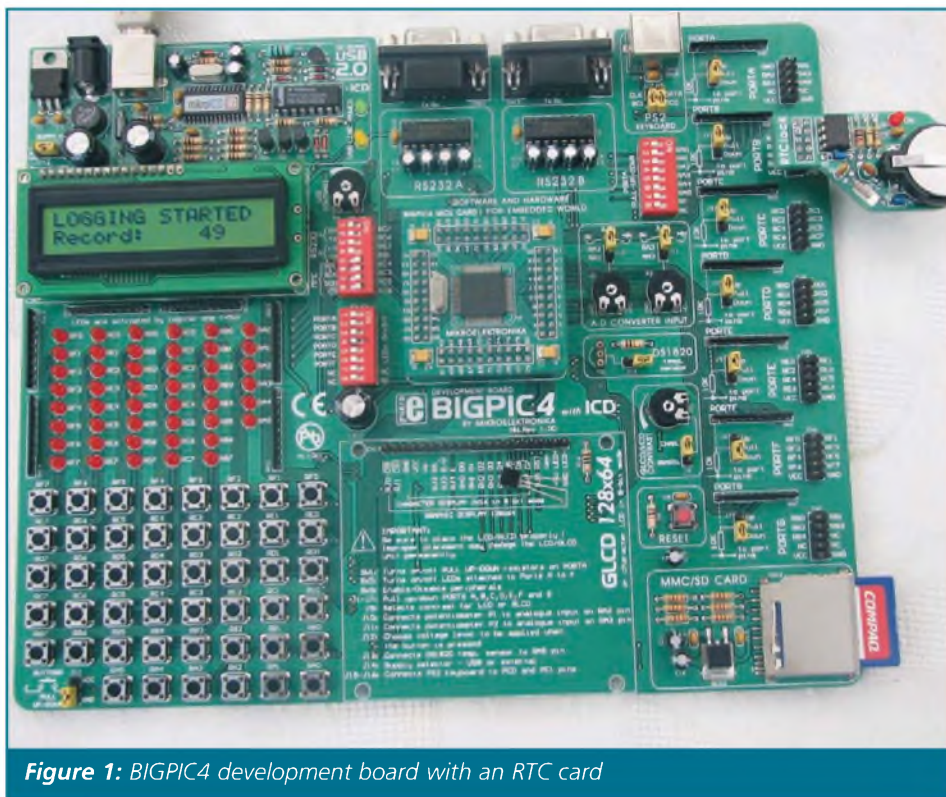

Figure 1: BIGPIC4 development board with an RTC card

site to collect data. At the end of the data collection period the device is connected to a PC and the collected data is read and analysed offline by the PC. Some standalone data loggers are dedicated for specific measurements, for example temperature data loggers.

The Thermo Recorder TR-5 Series ([www.tandd.com](http://www.tandd.com)) is a typical standalone temperature data logger. This data logger has LCD output, it can record up to 16,000 readings with time intervals from one second to one hour and the battery life is quoted as four years.

One of the disadvantages of standalone data loggers is that the devices should be checked at regular intervals to make sure that the memory is not full, or the battery is not flat. This may sometimes cause problems since the device may be located at a remote location or at a place not easily reachable.

## DATA CAPTURING DATA LOGGERS

Data capturing data loggers are used only to capture the data. These devices do not have large internal memories and are normally connected to a PC. The captured data is sent to the PC for storage or for analysis. The data can either be analysed offline or online.

One of the disadvantages of data capturing data loggers is that the devices cannot be used on their own as another device (e.g. a PC) is required to store the captured data. The Pico Technology DrDAQ ([www.drdaq.com](http://www.drdaq.com)) is a typical data capturing data logger that is connected to a PC to transfer the captured data. The device has built in sensors for light, sound and temperature measurements.

Some data capturing data loggers have wireless capabilities. Usually a transmitter-

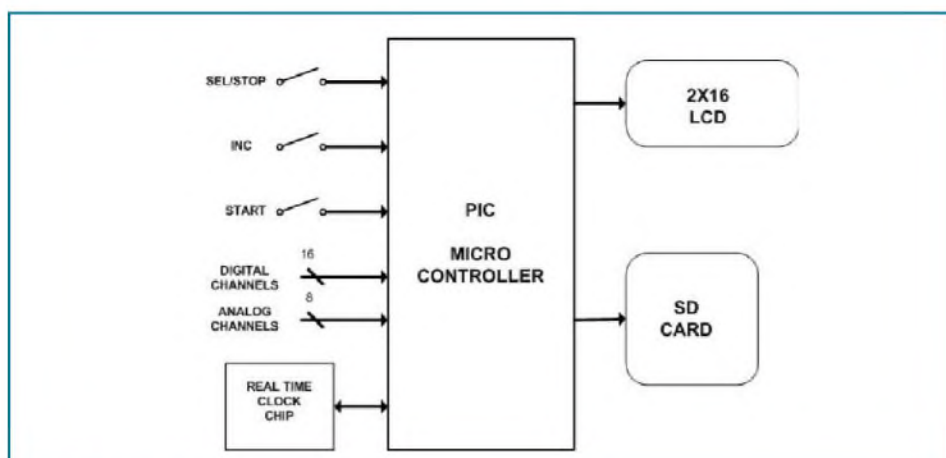

Figure 2: Block diagram of the data logger

receiver pair is used: the transmitter captures the data and sends it to the receiving device using wireless communication. The receiving device usually has large internal memory and stores the received data.

## SPECIFICATION OF THE DESIGNED DATA LOGGER

The designed data logger has the following basic specifications:

- analogue channels and 16 digital channels
- LCD output
- Real time clock (RTC) chip
- Setting the RTC chip using buttons
- SD card to store the collected data
- Data stored in a file on the SD card
- Data is saved with time stamping
- Data is Excel-compatible
- Selectable logging interval
- Portable

## THE CIRCUIT

The data logger was built on the BIGPIC4 development board, manufactured by MikroElektronika ([www.mikroe.com](http://www.mikroe.com)). The BIGPIC4 is a full-featured development board for PIC 18 series of microcontrollers. The board allows PIC microcontrollers to be interfaced with external circuits and a broad range of peripheral devices, allowing the user to concentrate on software development.

The BIGPIC4 development board has the following specifications:

- External or USB power supply
- PIC 18F8520 microcontroller (changeable)
- 36 buttons
- 36 LEDs

- Text-based LCD
- Graphics LCD
- 2 RS232 ports
- PS/2 port
- SD card holder and interface
- In-circuit debugger
- All port pins available on the board

In addition to the basic development board, a number of small external interface cards can be attached to the board, such as real-time clock card, keyboard card, sensor cards and so on. **Figure 1** shows the BIGPIC4 development board with the RTC card attached to PORT B (on the top right-hand side). The SD card holder is placed at the bottom right hand side of the board.

Although the data logger circuit was built and tested using a development board, it is possible to build the circuit on a breadboard or on a PCB using other types of PIC microcontrollers that have the required minimum number of I/O ports, data memory and program memory.

**Figure 2** shows the block diagram of the data logger. The device has 24 channels. The captured data is stored on the SD card with time stamping, in a format suitable to be imported into Excel for offline analysis.

**Figure 3a** shows the circuit diagram of the data logger. This circuit is based on the PIC18F8520 microcontroller, but other PIC18 family members can also be used instead if required.

- **Digital Channels:** PORT D and PORT E pins are used as the 16 digital input channels.

- **Analogue Channels:** 5 pins of PORT A (RA0-RA3, and RA5) and 3 pins of PORT F (RF0-RF2) are used as the 8 analogue input channels.

- **LCD:** A 2x16 column LCD is used in the circuit. The LCD is connected to PORT H pins (RH2-RH7) of the microcontroller.

- **RTC:** A PCF8583 type RTC chip is used in the circuit. This chip has the I<sup>2</sup>C bus type interface. The clock (SCL) and data (SDA) pins are connected to PORT B pins RB3 and RB4 respectively via 10K pull-up resistors. These resistors are required for the proper operation of the I<sup>2</sup>C bus. The RTC chip is connected to a battery so that the date and time information are not lost when power is removed from the circuit. A 32768Hz crystal is used to provide timing pulses to the RTC chip.

- **SD Card:** The BIGPIC4 development board is equipped with an SD card holder. The SD card is used in the SPI mode and the interface between the microcontroller and the SD card is as follows: RC3 is connected to CLK input, RC4 is connected to DO output, RC5 is connected to DI input and RJ6 is connected to the CS input of the SD card.

The SD card requires 3.3V supply for its operation and this is obtained by using a MC33269DT-3.3 type 3.3V regulator. The input voltages on the inputs of the SD card must not be greater than 3.6V and this is not compatible with the outputs of the microcontroller. Potential divider resistors (2.2K and 3.3K) are used at the outputs of the microcontroller to reduce the SD card input voltages to less than 3.6V.

- **Buttons:** Three buttons are used to configure and setup the data logger: SEL/STOP is connected to pin RB0, INC is connected to pin RB1 and STOP is connected to pin RB6 of the microcontroller. The buttons are active LOW i.e. a button output is normally at logic HIGH and goes to logic LOW when the button is pressed.

- **Power supply:** As shown in **Figure 3b**, a 7805 type 5V regulator is used to provide power to the circuit. The circuit can be operated from a 9V battery in portable applications.

- **Reset:** A reset button is provided so that the microcontroller can be reset externally.

- **Clock:** A 10MHz crystal and two 22pF capacitors are used to provide timing pulses to the circuit.

## OPERATION

Three buttons are used to control operation of the data logger: SEL/STOP,

INC and START. The data logger operates in two modes: SETUP mode and LOG mode. Both modes are described below in some detail (see **Figure 4** on how the modes are selected).

- **SETUP Mode:** The SETUP mode is used to set the logging interval and the date and time. This mode is entered by resetting the microcontroller (or applying power) while holding down the SEL/STOP button. Releasing this button will display the logging INTERVAL and expect the user to select the required interval by pressing the INC button.

After selecting the interval, the user has

the choice of either setting the date/time or exiting the SETUP mode. Pressing SEL/STOP twice exits the SETUP mode. Pressing INC enters the date/time setup mode, where the date and time are initially shown as: 01/01/08 12:00:00. The cursor is initially on the 'day' field and pressing the INC button increments this field. Pressing the SEL/STOP button moves the function between the date and time fields.

After setting the seconds field, press SEL/STOP button to exit the SETUP mode. The selected date and time will be updated every second and displayed on

the LCD. Now it's all ready to start the data logging (LOG mode) process.

- **LOG Mode:** The LOG mode is entered by simply resetting the microcontroller, or by applying power to the circuit. This mode is also automatically entered at the end of the SETUP mode. When this mode is selected the current date and time are displayed on the LCD and are updated every second. Pressing the START button starts the data logger to collect data and store on the SD card.

The program checks and data collection does not start if the SD card is not inserted into its holder. During the data collection the current record number is displayed on the LCD as shows in the top left corner of Figure 1.

The data logger is stopped by pressing the SEL/STOP button while in the LOG mode. At this point the SD card can be removed safely from its holder.

## DATA FORMAT

The collected data is stored in hexadecimal ASCII format with the time stamp, where each record occupies one line. The format of a record is as follows: `dd/mm/yy hh:mm:ss PORTD PORTE A1 A2 A3 A4 A5 A6 A7 A8 <cr><lf>` where PORTD and PORTE are the digital input data, A1 to A8 are the analogue input data and `cr` and `lf` are the carriage-return and line-feed characters respectively. The digital data is 8-bits wide and is represented by two hexadecimal digits. The analogue data is 10-bits wide and is represented by three hexadecimal characters.

An example record is given below:  
`12/07/08 10:00:20 FF FE 1FE 1FF 000 000 000 000 000 000 <cr><lf>`

In this example, the data was collected on the 12<sup>th</sup> of July, 2008 at 20 seconds past 10 o'clock. PORT D data was FF (binary: "11111111"), PORT E data was FE (binary: "11111110"). Analogue channel 1 data was 1FE (binary: "011111110"), analogue channel 2 data was 1FF (binary: "011111111"), and so on.

The data fields are separated by spaces and are compatible with the Excel spreadsheet. Thus, the collected data can easily be imported into Excel and then analysed statistically. Post-processing can be done on the data and for example graphs can be drawn to show the variation of the data with time.

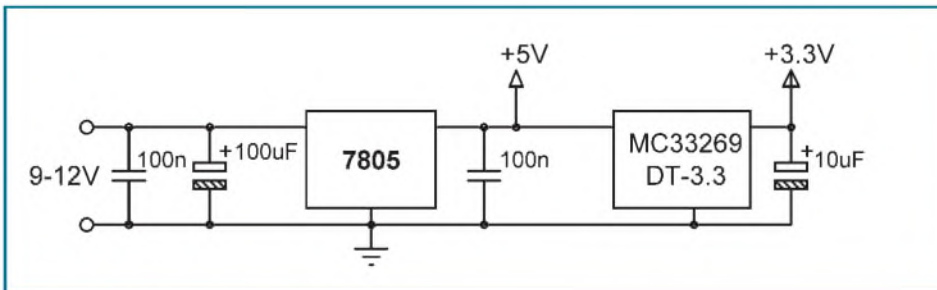

Figure 3b: Power supply of the circuit

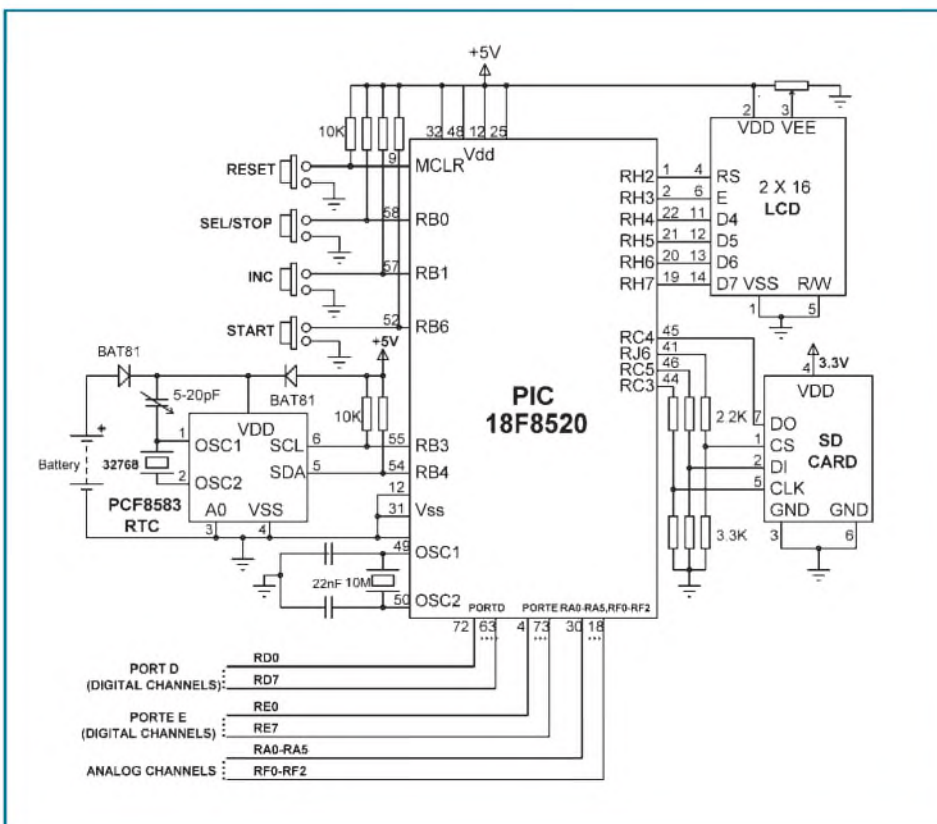

Figure 3a: Circuit diagram of the data logger

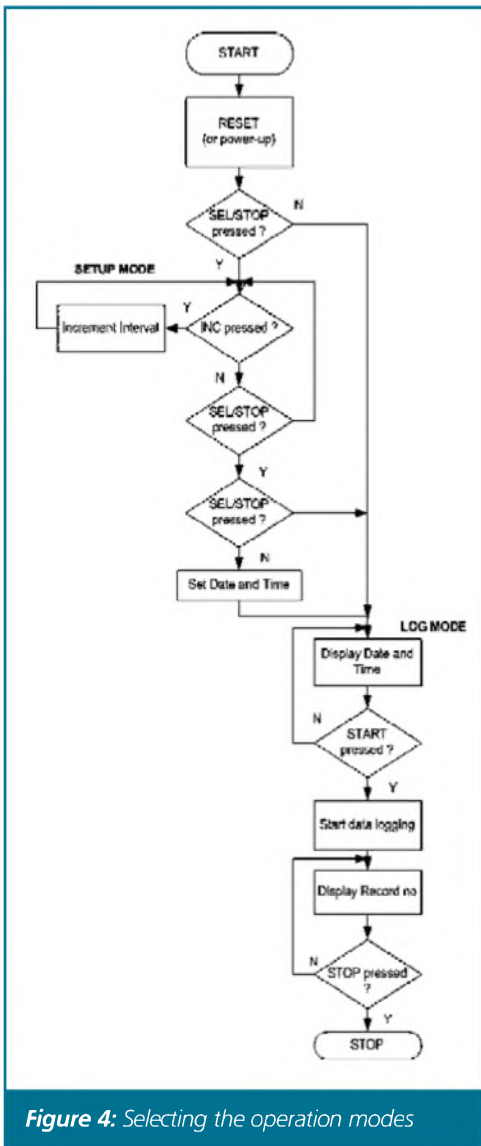

Figure 4: Selecting the operation modes

## THE SOFTWARE

The software of the data logger is based on the mikroC language, developed by mikroElektronika for PIC18 series of microcontrollers. A 2K limited version of the compiler is available free of charge from the developing company. The main reasons for choosing this compiler are that:

- mikroC is a very sophisticated C language compiler;
- It is compatible with the BIGPIC4 development board;
- mikroC supports SD card functions which makes the development of SD card based projects relatively easy;
- mikroC supports software, as well as hardware based I<sup>2</sup>C bus functions. The SD card operates in SPI mode and uses PORT

## BEGIN

RESET (or power-up)

**IF** SEL/STOP pressed **THEN**

Enter SETUP mode

**WHILE** SEL/STOP not pressed

Display Interval

**IF** INC is pressed **THEN** Increment Interval

**WEND**

**WAIT UNTIL** SEL/STOP OR INC pressed

**IF** INC pressed **THEN**

Move to DAY field

**WHILE** SEL/STOP not pressed

**IF** INC pressed **THEN** increment DAY

**WEND**

Move to MONTH field

**WHILE** SEL/STOP not pressed

**IF** INC pressed **THEN** increment MONTH

**WEND**

Move to YEAR field

**WHILE** SEL/STOP not pressed

**IF** INC pressed **THEN** increment YEAR

**WEND**

Move to HOUR field

**WHILE** SEL/STOP not pressed

**IF** INC pressed **THEN** increment HOUR

**WEND**

Move to MINUTE field

**WHILE** SEL/STOP not pressed

**IF** INC pressed **THEN** increment MINUTE

**WEND**

Move to SECOND field

**WHILE** SEL/STOP not pressed

**IF** INC pressed **THEN** increment SECOND

**WEND**

**ELSE**

**ELSE**

Enter LOG Mode

**WHILE** START not pressed

Display Date and Time

**WEND**

**DO FOREVER**

Read and store analogue and digital data on SD card

Display record number

**IF** STOP pressed **THEN**

**STOP**

**ENDIF**

**ENDDO**

**ENDIF**

**END**

Figure 5: Operation of the software

C of the microcontroller. RTC chip is based on I<sup>2</sup>C bus, which also uses PORT C by default. It was necessary to connect the RTC chip to another port of the microcontroller and use the I<sup>2</sup>C bus software functions.

The program has been developed to be modular where procedures and functions are used wherever possible to carry out the required tasks. **Figure 5** shows operation of the software using simple PDL. At the beginning of the program

various peripheral devices such as the LCD, SD card, the RTC chip and the I/O ports are initialised. The program then checks whether to enter the SETUP mode or the LOG mode; mikroC function *Button* is used to check the state of the buttons. In SETUP mode the logging interval is set and date/time can be set to the correct values. Function *Set\_RTC* is used to implement the SETUP mode. The RTC chip is controlled using the mikroC *Soft\_I2C* functions.

Initially, the *Soft\_I2C\_Start* function is called to start communication on the I<sup>2</sup>C bus. Then functions *Soft\_I2C\_Read* and *Soft\_I2C\_Write* are used to read and write to the RTC chip respectively. The LCD is operated in 4-bit mode where only the high 4-bits of the data bus are used. Data is written to the LCD using mikroC functions *Lcd\_Out* and *Lcd\_Out\_Cp*.

## WRITING AND READING

Writing to and reading from the SD card are very easy with the mikroC, as the compiler supports a large number of functions for direct sector based, or FAT-16 based read and write operations.

After initialising the SD card library, function *Mmc\_Fat\_Assign* is used to specify the filename to be used on the SD card. If a new file is to be opened, then function *Mmc\_Rewrite* is called to clear the file and position the file pointer to the beginning of the file. If data is to be appended to the end of the existing file, then *Mmc\_Fat\_Append* function is called. Data is then written to the specified file on the SD card using function *Mmc\_Fat\_Write*. The SEL/STOP button is checked continually and when this button is pressed the program stops, displaying a message on the LCD. The SD card then can be taken out safely for offline analysis on a PC.

Function *Read\_RTC* reads the date and time from the RTC chip using the soft I<sup>2</sup>C bus functions and stores the data in global variables *RTCDate* and *RTCTime* respectively. It is important to realise that the RTC chip expects the data to be in BCD format and the data should be converted into this format before writing to the chip. Similarly, the data is read in BCD format and should be converted to the required format before being used.

The function *Display\_RTC* displays the RTC data on the LCD with row 1 displaying the date and row 2 displaying

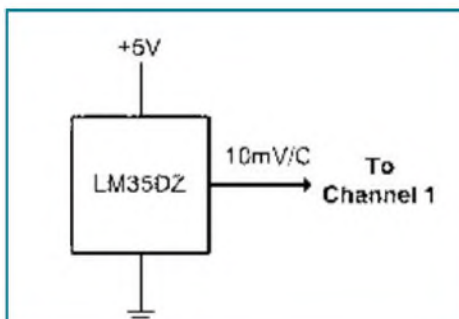

**Figure 6:** Connecting the LM35DZ sensor to analogue channel 1

the time. The function *convert\_to\_hex* converts a given byte into two hexadecimal digits. This function is used to convert the channel data into hexadecimal format before storing on the SD card.

## EXAMPLE DATA LOGGING

An example is given here to illustrate the operation and output file of the data logger. In this example, an LM35DZ type analogue temperature sensor is connected to analogue channel 1 of the data logger (see **Figure 6**). Data is collected every two seconds (Interval = 2) for about 30 seconds.

The data is saved on the SD card in a file called DTLOGGER.TXT. **Figure 7** shows the created file, opened with the WORD program on Windows.

Note that the first two columns show the date and the temperature respectively. Column 5 shows the Channel 1 data (i.e. the temperature) in hexadecimal format. The data is 10-bits wide, having 1024

quantisation levels. Thus, with a reference voltage of +5V, each level corresponds to 5000/1024mV. The LM35DZ sensor output is 10<sup>o</sup>V/mV. Therefore, the temperature in <sup>o</sup>C can be calculated as:

$$\text{Temperature} = T * 500 / 1024$$

where, *T* is the value read from Channel 1. For example, the first value read is hexadecimal 03A which has the decimal equivalent of 58. This corresponds to a temperature of 28.3<sup>o</sup>C.

## IMPORTING TO EXCEL

The steps to import the data into Excel and display the change of temperature with time are given below:

- Start the Excel spreadsheet application
- Add Analysis Toolpak: *Tools -> Add-Ins -> Analysis ToolPak -> Ok*
- Import collected data: *File -> Open -> DTLOGGER.TXT -> Text Import Wizard -> Finish*
- You should now have the collected data in Excel. Select all the fields and click the *Text Center* tool to centre the fields in the worksheet.
- Click on Cell E13 and enter the following formula to convert the hexadecimal data in column 5, row 1, into absolute temperature in <sup>o</sup>C:

$$= 500*(\text{HEX2DEC}(E1))/1024$$

- Now convert all the entries in column 5 into absolute temperature. Copy cell at E13, then Paste it to cells E14 to E22.
- Format the data so that there are 2

```
06/01/08 09:50:13 FF FF 03A 02F 034 038 064 000 000 000
06/01/08 09:50:15 FF FF 03A 01E 016 01D 04A 000 000 000
06/01/08 09:50:17 FF FF 03A 02E 031 039 06A 000 000 000
06/01/08 09:50:19 FF FF 03B 02A 023 030 061 000 000 000
06/01/08 09:50:21 FF FF 03C 02C 026 032 063 000 000 000
06/01/08 09:50:23 FF FF 03E 030 02E 038 068 000 000 000
06/01/08 09:50:25 FF FF 040 026 020 026 057 000 000 000
06/01/08 09:50:27 FF FF 041 02D 02A 030 060 000 000 000
06/01/08 09:50:29 FF FF 043 02C 029 02D 05D 000 000 000
06/01/08 09:50:31 FF FF 048 02E 02B 032 064 000 000 000
```

**Figure 7:** File DTLOGGER.TXT with the collected data

	A	B	C	D	E	F	G	H	I	J	K	L
1	06.01.2008	09:50:13	FF	FF	03A	02F	34	38	64	0	0	0
2	06.01.2008	09:50:15	FF	FF	03A	01E	16	01D	04A	0	0	0
3	06.01.2008	09:50:17	FF	FF	03A	02E	31	39	06A	0	0	0
4	06.01.2008	09:50:19	FF	FF	03A	02A	23	30	61	0	0	0
5	06.01.2008	09:50:21	FF	FF	03C	02C	26	32	63	0	0	0
6	06.01.2008	09:50:23	FF	FF	03E	30	02E	38	68	0	0	0
7	06.01.2008	09:50:25	FF	FF	40	26	20	26	57	0	0	0
8	06.01.2008	09:50:27	FF	FF	41	02D	02A	30	60	0	0	0
9	06.01.2008	09:50:29	FF	FF	43	02C	29	02D	05D	0	0	0
10	06.01.2008	09:50:31	FF	FF	48	02E	02B	32	64	0	0	0
11												
12												
13					28.32							
14					28.32							
15					28.32							
16					28.32							
17					29.30							
18					30.27							
19					31.25							
20					31.74							
21					32.71							

Figure 8: Column 5 stores the temperature in °C

	A	B	C	D	E	F	G	H	I	J
1	06.01.2008	09:50:13	FF	FF	03A	02F	34	38	64	0
2	06.01.2008	09:50:15	FF	FF	03A	01E	16	01D	04A	0
3	06.01.2008	09:50:17	FF	FF	03A	02E	31	39	06A	0
4	06.01.2008	09:50:19	FF	FF	03A	02A	23	30	61	0
5	06.01.2008	09:50:21	FF	FF	03C	02C	26	32	63	0
6	06.01.2008	09:50:23	FF	FF	03E	30	02E	38	68	0
7	06.01.2008	09:50:25	FF	FF	40	26	20	26	57	0
8	06.01.2008	09:50:27	FF	FF	41	02D	02A	30	60	0
9	06.01.2008	09:50:29	FF	FF	43	02C	29	02D	05D	0
10	06.01.2008	09:50:31	FF	FF	48	02E	02B	32	64	0
11										
12										
13		09:50:13			28.32					
14		09:50:15			28.32					
15		09:50:17			28.32					
16		09:50:19			28.32					
17		09:50:21			29.30					
18		09:50:23			30.27					
19		09:50:25			31.25					
20		09:50:27			31.74					
21		09:50:29			32.71					
22		09:50:31			35.16					
23										
24										
25										
26										
27										
28										
29										
30										
31										
32										
33										
34										
35										
36										
37										
38										
39										
40										
41										
42										
43										

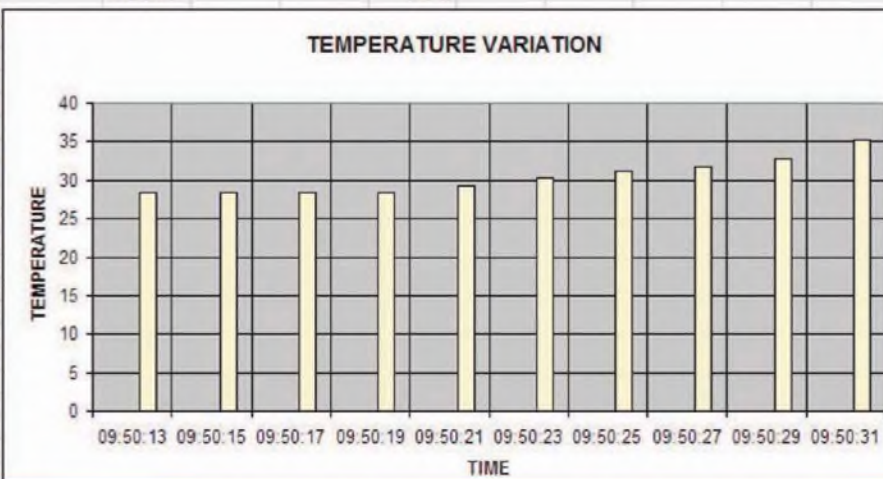

Figure 9: Graph of temperature variation

digits after the decimal point, and select dot for the decimal point. *Format -> Cells -> Number -> Decimal Places = 2 -> Ok. Click Use 1000 Separator.*

- Your Excel worksheet should now look as in **Figure 8**.

### DRAWING A GRAPH

We can now draw a graph in Excel to show the change of temperature with absolute time:

- Copy and paste the time fields from B1:B10 to B13:B22.
- Select and highlight the time and temperature fields (B13 to E22).
- Click on *Chart Wizard* icon. The default graph type is vertical bar-chart. Click on *Finish* to draw the graph.
- Enter graph title, x-axis, y-axis and gridlines: *Chart -> Chart Options -> Chart title = TEMPERATURE VARIATION. Category (X) axis = TIME. Value (Y) axis = TEMPERATURE. Click Gridlines -> Major gridlines -> Ok*

The graph shown in **Figure 9** will be drawn to show the variation of temperature with time.

### FURTHER ENHANCEMENTS

The data logger described here can have many educational, commercial and industrial applications. The design can be improved further by incorporating the following modifications to the hardware and software:

- A communications interface (e.g USB port or RS232 interface) can be added to the hardware so that the collected data can be sent directly to a PC.
- Input signal conditioning circuits can be added to the analogue channels.
- The software can be modified by introducing more than one logging interval so that, for example, one channel of the A/D can be sampled every second, while another channel can be samples every 10 seconds.
- The hardware and software can be modified by introducing triggering so that a channel data is only read after it is triggered by an external or an internal event.
- A graphics LCD display can be added to the data logger so that a selected channel data can be displayed dynamically on the LCD in real time.
- More digital or analogue channels can easily be added to the data logger. ■

# OSCILLOSCOPE UPDATE RATE AND ITS IMPACT ON **CAPTURING INFREQUENT AND RANDOM EVENTS**

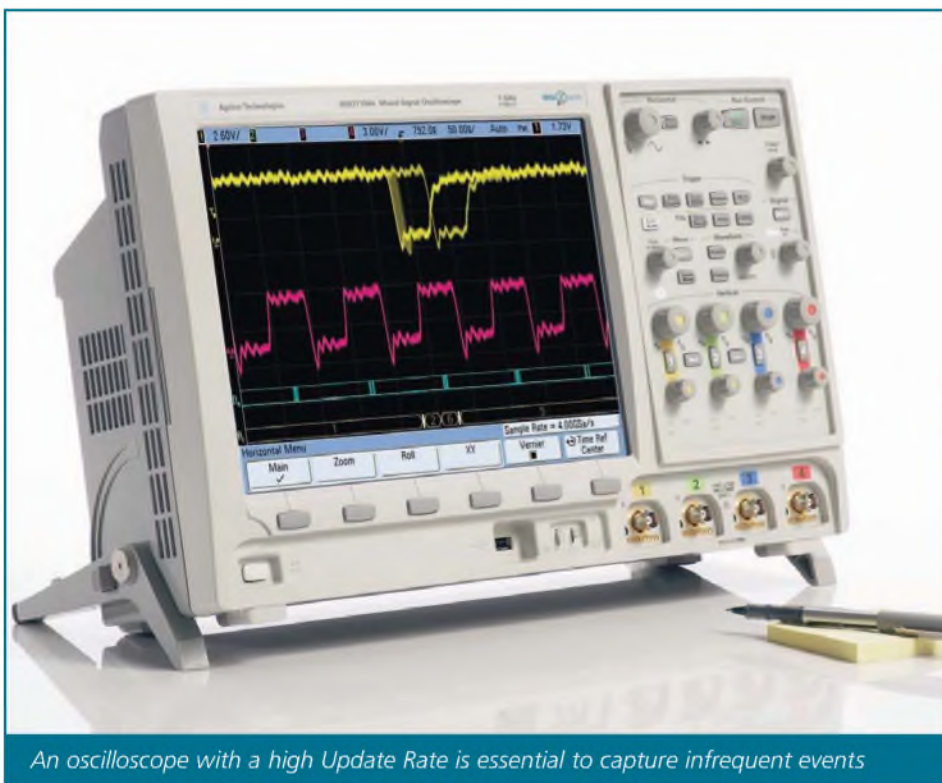

*An oscilloscope with a high Update Rate is essential to capture infrequent events*

**W**hen evaluating the purchase of a new digital storage oscilloscope (DSO), the most obvious criteria that evaluators consider include bandwidth, sample rate, memory depth and number of channels. Often overlooked characteristics of an oscilloscope are the waveform and serial decode update rates.

Update rate should be an important consideration for two primary reasons. First, the waveform update rate of an oscilloscope can greatly affect the usability of the instrument. Second, the oscilloscope's acquisition/waveform update rate can affect the statistical probability of capturing infrequent anomalies and glitches.

When DSOs first came on the market back in the 1980s, one of their major drawbacks as compared to analogue

oscilloscopes was their lack of responsiveness. It wasn't uncommon for digitising oscilloscopes to have acquisition update rates in the range of one or two waveforms per second, even with a shallow memory depth of just 1000 points. This lack of responsiveness made DSOs difficult to use.

When engineers and technicians use their oscilloscope to debug an electronic system, they often used the scope as a "browsing" tool, rapidly changing setup conditions such as V/div and timebase controls while viewing the waveforms on the oscilloscope's display. If the display update changed slowly while making these setup changes, it could become very frustrating and slow down the debugging process.

With advances in digital scope

**JOHNNIE HANCOCK AND JOEL WOODWARD** FROM AGILENT TECHNOLOGIES CONSIDER UPDATE RATES AS ONE OF THE PRIMARY CONSIDERATIONS WHEN PURCHASING A NEW OSCILLOSCOPE

technology, most oscilloscope vendors have solved the problem of responsiveness in scopes with memory depths less than 100K points. A good rule-of-thumb is if the oscilloscope can update the display with a new acquisition at least twenty times per second, the oscilloscope will feel responsive. Granted, this is still much slower than a typical analogue oscilloscope's sweep rate, which can produce hundreds of thousands of sweeps per second, but to the human eye twenty digitised updates per second is usually sufficient to give a DSO a "live" feel.

As the demand for DSOs with much deeper memory (> 1 MB) increases, responsiveness in many oscilloscopes still suffers due to the time for processing digitised waveform records. For this reason, the default operation for many oscilloscopes with deep memory is a shallow memory mode (less than 50K points, typically). With shallow memory, the scope is responsive. If users require deeper memory for special applications, they can select one of the deeper memory modes, but then they must deal with the scope's unresponsive operation. Some scopes with very deep memory can take as long as 8 to 10 seconds for each screen update. To many users, this is unacceptable.



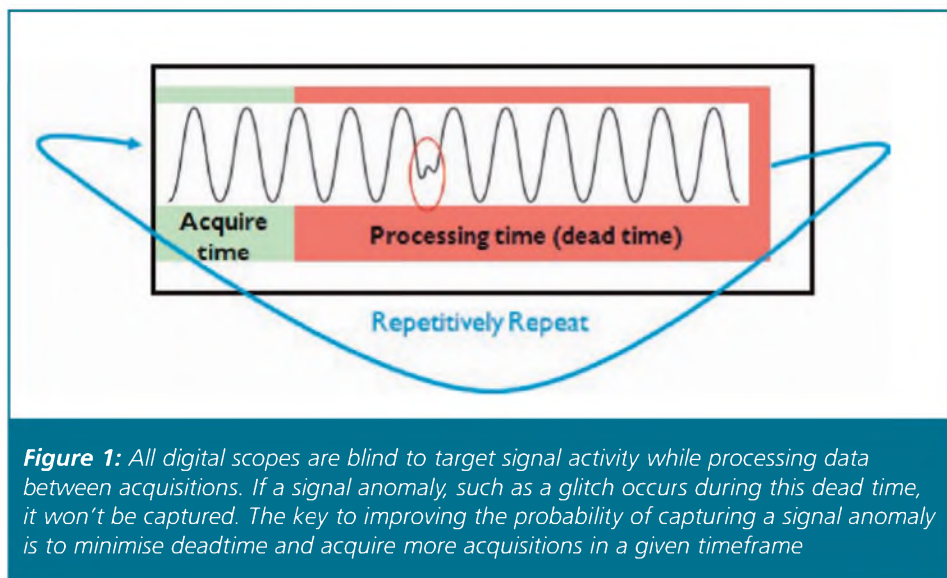

**Figure 1:** All digital scopes are blind to target signal activity while processing data between acquisitions. If a signal anomaly, such as a glitch occurs during this dead time, it won't be captured. The key to improving the probability of capturing a signal anomaly is to minimise deadtime and acquire more acquisitions in a given timeframe

### WHAT IS UPDATE RATE?

Update rate is defined as the number of waveforms per second the scope can acquire, process and display. Scope vendors will specify their fastest update rate in waveforms (acquisitions) per second. Digital scopes repetitively fill their memory buffers with signal detail. After every acquisition the oscilloscope must process the previous acquisition's data before acquiring new information.

The time it takes for a scope to process an acquisition before re-arming its trigger for the next acquisition is called the dead time. During dead time, the scope is blind to any changes in target signal activity.

When running repetitively, multiple scope acquisitions are aggregated and written to the scope display at the display refresh rate of 60Hz. For example, an oscilloscope that is capturing 6,000 waveforms per second would aggregate each 100 acquisitions and place the resulting composite image on the scopes display each time the LCD refreshed.

### HOW DO YOU MEASURE UPDATE RATE?

All scope vendors characterise and publish their best update rate specification, which may or may not be typical. Often this value will only be achievable in a special mode that limits other scope functionality. For this reason purchasers should not take at face value the oscilloscope vendor's banner waveform update rate specifications. The better approach is to measure it in practice. For a timebase setting of 100ns and below, good update rate values will be above

50,000 acquisitions per second and poor values will be below 5,000 acquisitions per second.

It's relatively straightforward to characterise objectively and quickly a scope's update rate. Firstly, connect a moderately fast signal into a scope channel. The signal should exceed the scope's specified update rate by a couple orders of magnitude (e.g. 50MHz). Then connect a BNC cable from the scope's trigger output to a counter or second oscilloscope. Finally, measure the first scope's average trigger output signal frequency. This is the scope's update rate for the specified settings.

The update rate of the oscilloscope should be tested under various set-up conditions by varying timebase range, memory depth and number of channels. Include analogue and digital (for MSOs) channels, as well as channels assigned for serial decoding.

Update rate is relative and the best approach is to undertake a side-by-side comparison of oscilloscopes from different vendors. This can be done using the

objective test described above, or using a subjective test. A subjective test is to connect to a target with a modulated signal, video, jitter, or an event that happens infrequently.

Signals that are regular in nature such as sine waves do not provide good samples for subjectively evaluating update rate. Turn on deep memory, analogue and digital channels. Now look at how fast the waveforms are updated. Do the analogue waveforms look identical to how they look with only analogue channels turned on? Change the timebase setting. How quickly does the scope update with the new setting?

### WHAT IMPACTS UPDATE RATE?

Update rate is not static, but changes with the oscilloscope settings. The primary factors that impact update rate are adjustments of timebase setting, number of channels turned on, and turning on additional memory depth. For digital scopes total dead time will be much greater than acquisition time on fast timebase settings.

The scope architecture also dramatically impacts update rate. While one vendor's update rate may stay fast across a number of different settings, a second vendor's oscilloscope may drop by a factor a 100 or 1000 with a simple setting change such as turning on deep memory or serial decode.

As an example here are the results of a few setting changes and the measured impact on update rate. Remember, as update rate goes down, the analogue measurement will be compromised and more prone to missing critical signal detail.

### STATISTICAL PROBABILITY OF CAPTURING INFREQUENT AND RANDOM EVENTS

Capturing infrequent events on a scope with a given update rate adheres to the laws of probability.

Analogue Channels	Digital Channels	Serial Decode	Time base	Scope 1 update rate	Scope 2 Update Rate
ON			20ns/div	35,000	95,000
ON			10ns/div	2,700	95,000
ON	ON		20ns/div	125	95,000
ON	ON	ON	20ns/div	0.2	95,000

**Table 1:** Update rates

	Scope 1	Scope 2
Update Rate	100 waveforms per second	100,000 waveforms per second
Probability of seeing glitch in 5 seconds	0.25%	99%

**Table 2:** Comparison between two scopes with different update rates for an event that occurs 100 times per second

To understand how, consider the rolling of a die. The probability of getting a 6 in one roll of a die is 1/6. Given multiple rolls, the probability of getting a 6 on any one of the rolls increases with each new roll. The probability of obtaining a 6 on any one of N rolls is defined by the following equation.

$$P_N = 100 \times (1 - [(S-1)/S]^N)$$

where:

S = number of sides on the die

N = number of rolls

After one roll the probability is just 1/6 or 17%, while after 10 rolls the probability increases to 84%.

Instead of rolling a fixed number of times, consider a situation where you are given five seconds and rewarded each time you roll a 6. The motivation would naturally be to try and roll the die as many times as possible in the five seconds to increase the probability of getting a 6.

Statistical probability theory can also be applied to oscilloscopes with update rates being a primary factor. The number of rolls of the die is analogous to the number of acquisitions processed and displayed per time

period (i.e. the update rate). The time period is dependent on how long the user is willing to leave the scope probe on for a measurement. The longer the probe is connected, the higher the probability of capturing an infrequent event during a given time.

In practice, five seconds is a good estimate for the time a user will connect a probe to a target signal to see if there are unanticipated anomalies.

The chances of capturing anomalies can be computed using statistical probabilities based on:

- update rates for various setup conditions and measurement
- parameters associated with the scope architecture
- infrequency of the anomaly
- observation time.

For digital scopes the probability of capturing an event is governed by the same formula as before:

$$P_N = 100 \times (1 - [(S-1)/S]^N)$$

In this case:

S = 1/(time window of scope display \*

number of anomalous events per second)

N = amount of total acquisitions captured by scope (update rate \* number of seconds probe is connected)

Using this equation, we can determine the probability of capturing an infrequent event.

**Table 2** shows a comparison between two scopes with different update rates for an event that occurs 100 times per second. The probability of finding anomalies varies dramatically.

### PRIMARY CONSIDERATION

When choosing an oscilloscope for use or purchase, update rate should be a primary consideration. The update rate of an oscilloscope will directly impact the probability that the user will find infrequent events, see subtle signal detail, and experience responsiveness when changing scope settings.

Fast update rates enable a superior view of the signal being measured making debug faster and more effective. ■

### Additional Reading

"Capturing Infrequent and Random Events Using Deep Memory Oscilloscopes," Agilent Application Note 1431 Ref 5988-8240EN

"Evaluating Oscilloscopes for Best Signal Visibility", Agilent Application Note 1604 Ref 5989-7885EN.

## RADIO MODULES FOR WIRELESS DATALINKS

Radiometrix continues to be recognised as the leading manufacturer of wireless datalinks for a wide variety of applications: it brings to market high-quality yet cost effective VHF & UHF low power radio modules that cater for the needs of OEMs manufacturing for international wireless data transmission industries.

### Products available include:

- Narrow Band and Wide Band FM Transmitters, Receivers and Transceivers
- Single Channel and Multi-channel operation
- UHF and VHF ISM bands
- Custom design service
- Encoders and Decoders for RF remote control
- Radio Packet Modems
- Radio Packet Controllers
- Evaluation Kits

### Applications include:

- Security & Alarm
- Telecommand or Remote Control
- Telemetry
- Industrial and Commercial
- Data Logging
- Automatic Meter Reading (AMR)
- Tracking



Radiometrix Ltd  
Hartcran House  
231 Kenton Lane  
Harrow, Middlesex  
HA3 8RP UK

Tel: +44 20 8909 9595  
Fax: +44 20 8909 2233  
sales@radiometrix.com

# FLEXIBLE ARCHITECTURE FOR ANALOGUE DELAY LINE

Early analogue delay lines (ADL) were used as effect devices in audio systems, so that it was possible to alter the musical perception of listeners.

Quite recently, ADLs using charge-coupled devices were employed in secure communication systems – in so-called chaotic transmitters and receivers – where the complexity of the encryption is a function of the time-delayed feedback. Although various electronic ADL implementations are currently available, most are constrained to applications that do not require a wide bandwidth. In this regard, the present circuit affords a flexible ADL architecture which is practicable both for low and high frequencies.

As shown in **Figure 1**, this design consists of four basic blocks, namely:

- an analogue-to-digital converter (ADC);
- a static memory device (SRAM);
- a digital-to-analogue converter (DAC); and
- an address counter (AC).

Analogue input is converted by the ADC to an 8-bit sample which is stored (written) in a particular memory location of SRAM1. At the same time, the DAC reads a stored sample from a memory location of SRAM2. By design, a common address code is used to access both SRAMs and this code is provided by the AC, which increments with every sample taken by the ADC.

The AC also provides an extra output bit used to toggle the switches. In effect, after all address bits have gone high, the SRAMs switch roles: SRAM2 stores (writes) the samples and SRAM1 reads (outputs) data to the DAC.

Based on the foregoing, there are two variables that determine the amount of time delay ( $T_d$ ) between the analogue input and output. First is the system clock which controls the timing of all blocks and switches shown in Figure 1. The other is the number of active address lines used by the SRAMs. In this case, the delay doubles with every additional address bit utilised. Hence, by jointly adjusting these two variables, one can attain a continuum of delays.

**Figure 2** shows the circuit which implements the scheme of Figure 1. U7 is an 8-bit modified flash ADC which executes a conversion after every rising edge of the WR/RDY or CLK signal. The WR/RDY signal is provided by a clock-triggered monostable circuit (not shown) with a high time of 1.5 $\mu$ s.

Samples from the ADC are stored in the memory block (U5 and U6), which consists of a pair of 15-bit CMOS static RAMs. The addresses of the SRAMs are generated by a cascade of four 4-bit synchronous binary counters (U1-U4). After a certain delay ( $T_d$ ), stored samples are read by a current-mode R-2R ladder DAC (U10) that reconstructs a time-delayed version of the analogue input.

Since the SRAMs alternate in reading and writing, the flow of bytes is controlled by four octal buffers/line drivers (U8, U9, U12, U13). When the pair of U8 and U13 are enabled, samples from the ADC are written in SRAM1 (U5), while data from SRAM2 are

read by the DAC (U10).

At the same time, U9 and U12 are tri-stated to prevent collision of data. After  $T_d$  seconds, U9 and U12 are enabled while U8 and U13 are inhibited. This allows data from the ADC to enter SRAM2 while previously stored bytes from SRAM1 are accessed by the DAC.

Recall in Figure 1 that AC uses an extra bit to toggle the roles of the SRAMs. For this purpose, output Q3 of U3 furnishes the (n+1)th bit which, likewise, controls the four octal buffers.

It must be pointed out that timing is controlled by the INT signal from the ADC. With the same frequency as the WR/RDY signal, the INT provides the CP pulses for the counters as well as the triggers that prompt the DAC to begin conversion. Hence, the INT's period ( $T_{int}$ ) also determines the delay ( $T_d$ ) which can be computed using the equation:

$$T_d = 2^n \times T_{int}$$

where  $n$  = number of active SRAM address lines. For example, in the circuit shown, the A11-A14 address lines of both SRAMs are switched to ground, hence there remain  $n = 11$  active address bits.

Now, assuming that the CLK pulses are running at 460kHz, this gives  $T_{int} = 2.17\mu$ s and the delay is 4.45ms. These computations are confirmed in the experimental results shown in **Figure 3**. Through cursor measurement, it was ascertained that the displacement between the two 30Hz signals amount to 4.43ms. However, it should be noted that the output contains a dc component due to the 2.5V offset introduced by a difference amp (U11). This amp shifts the input signals before passing them on to the ADC since the converter only accepts uni-polar voltages from 0 to 5V.

As mentioned, delay can be controlled by modifying the INT's period. For example, the authors lowered the frequency of the WR/RDY signal down to 321kHz and got the results shown in **Figure 4**. It was found that the falling edges of the two pulses are displaced by 6.30ms, which is fairly close to the theoretically predicted value of 6.38ms.

Finally, it could be said that the architecture of this circuit is not frequency-constrained aside from that which can be attributed to Nyquist limits. With the ubiquity of high-speed components, the architecture can be tailor-fitted for a wide variety of applications.

**Arthur E. Edang and Hadrian D. Dela Cruz**  
**Don Bosco Technical College and**  
**De La Salle University**  
**Philippines**

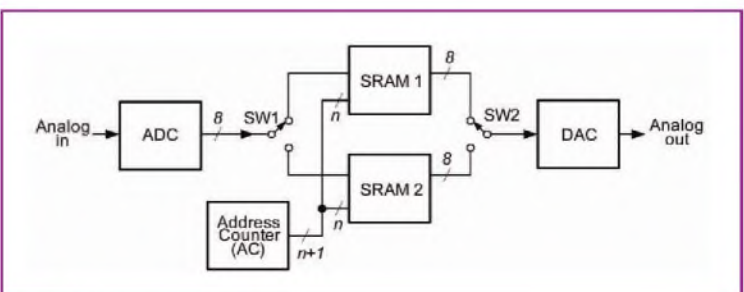

**Figure 1:** System diagram

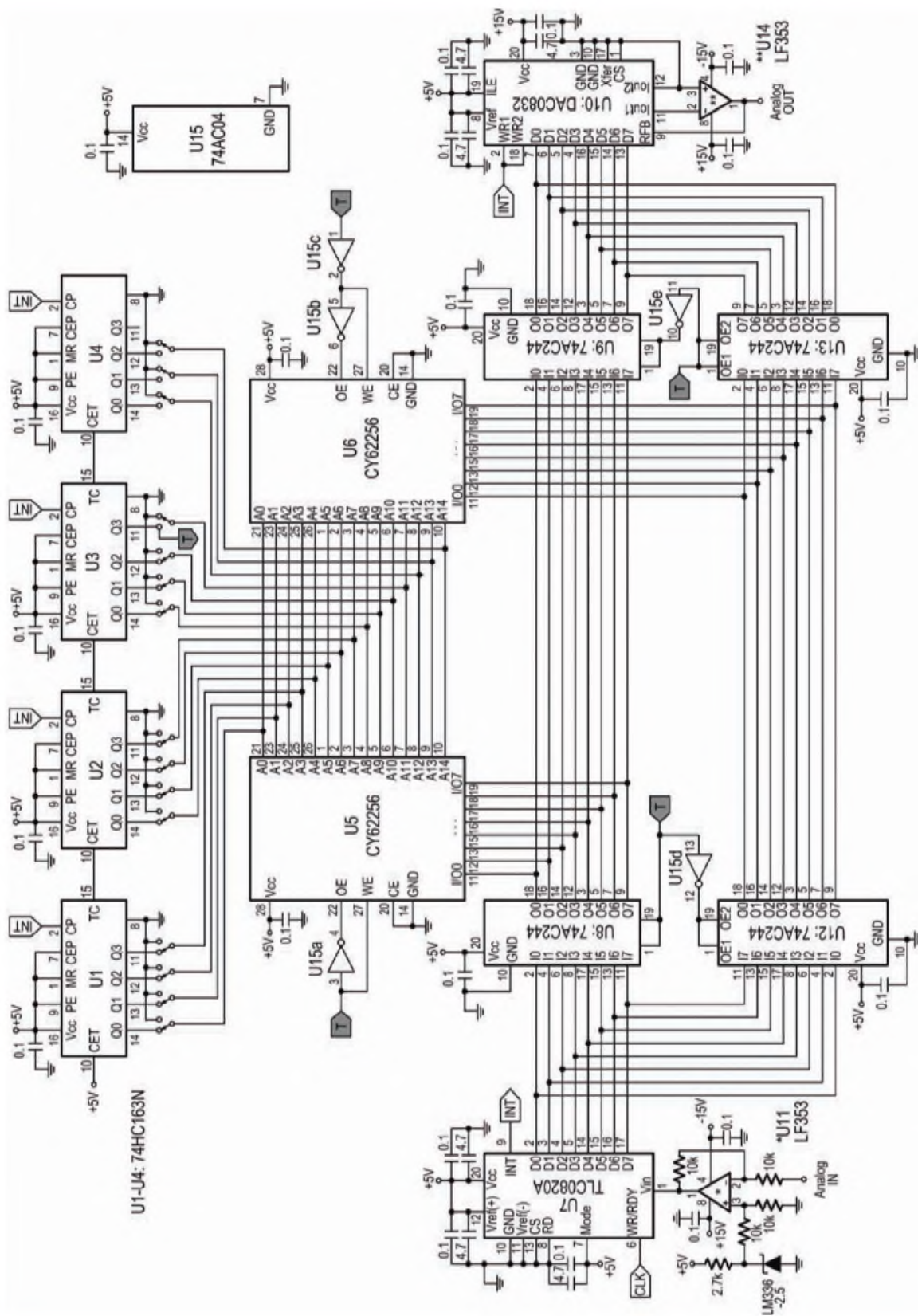

Figure 2: The circuit which implements the scheme of Figure 1

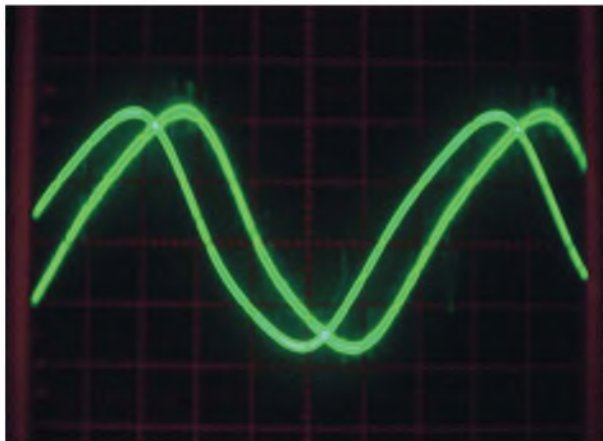

Figure 3: Input and delayed output. Settings: 0.5V/div, 5ms/div

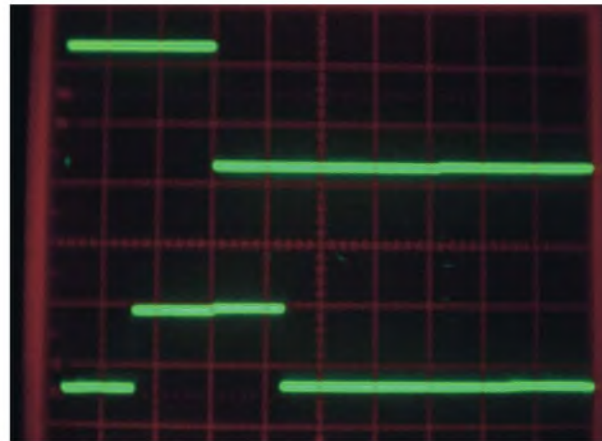

Figure 4: Input (upper) 0.5V/div; output (lower) 1V/div, 5ms/div

**PCB-POOL®**  
SERVICING YOUR COMPLETE PROTOTYPE NEEDS

**1 EUROCARD**  
(140 x 100 mm)  
+ Tooling  
+ Photoplots  
+ VAT

**€49**  
Price example  
Any size and contour possible!

**Optional:**

- Soldermask
- Fast-turnaround
- Silkscreen
- 4-Layer Multilayer
- 6-Layer Multilayer

**DOWNLOAD OUR FREE LAYOUT SOFTWARE!**

**Freephone**   
**0800-3898560**

Over 15,000 Customers

LEAD FREE

PCB-POOL.COM

Simply send your files and order ONLINE: **PCB-POOL.COM**

**VIBRATION MONITORING YOU CAN RELY ON**

**MONITRAN ACCELEROMETERS TRUSTED TO PROTECT PLANT AND MACHINERY THE WORLD OVER**

Monitran has been making rugged, reliable and versatile accelerometers for over 21 years. No wonder the company is acknowledged as one of the leading authorities on vibration monitoring worldwide.

To see our recently expanded range of products and learn how Monitran accelerometers can benefit your business, visit [www.monitran.com](http://www.monitran.com) or call us on +44 (0)1494 816569.



**MONITRAN**  
SENSING THE FUTURE

T. +44 (0)1494 816569  
F. +44 (0)1494 812256  
E. [info@monitran.com](mailto:info@monitran.com)  
[www.monitran.com](http://www.monitran.com)

# RIGHT LASER FOR THE RIGHT JOB

By Dr Ric Allott, UKDL

Using lasers to patterning and process display devices on glass or flexible substrates is not new, but there are a few “technical tricks” that must be applied in order to achieve the increasingly high quality results that the flat panel display (FPD) industry demands.

The first question to ask is why use lasers. There are many occasions where the use of a laser is inappropriate. The applied principle is that if you can do a process in some other way with equivalent benefits in speed, cost and quality then don't use a laser. However, there are occasions when only a laser will do the job and it is these that are discussed here.

## AS POWERFUL AS A LASER

Lasers deliver their energy with a unique directional precision. The exact spot to be machined is easily targeted with little or no “spill over” to the surrounding material. A big advantage of this directed energy is in the processing of materials within a vacuum environment. Here the processing can proceed without breaking vacuum, simply by inserting a window into the vacuum chamber, through which the laser is pointed.

Laser micromachining is non-contact, so the tip of the tool does not wear out or become blunt or indeed touch the material at all. Because laser light can be focused or used to form images of very small dimensions (typically down to 1-2 microns) high-resolution patterning is possible. By choosing the correct combination of wavelength and pulse width, it is possible to machine or pattern a very wide range of materials and (critical to the displays industry) *selectively* remove one material over another, without adversely interacting with the underlying sensitive thin film layers that may be critical to the function of the device.

The lasers described below are “pulsed”, i.e. their energy is delivered in discrete packets. Typically for display applications the



Lasers are used to pattern many different materials such as the colour filters for this LCD display

width of these pulses is from a 20-30ns pulse down to 10ps with repetition rates varying from a few Hz to tens of kHz.

## LASER CHOICES

Why use pulse lasers? As the interaction time with the material is extremely short the peak power delivered to the material is very high, so material literally “explodes” from the surface, the ejected material carrying away excess energy from the processing site. This, combined with the short interaction time leads to small heat affected zones and allows for very fine depth control.

For example, for an Excimer laser operating at 100Hz with a pulse width of 20ns, the on/off ratio of the laser energy is  $5 \times 10^5$ . In other words, the material has ample time to recover and cool down before the next pulse hits. This is important when selectively removing one thin film layer from another without damaging the secondary layer.

Imagine using a continuous wave laser where the energy is constantly applied to the

material, here the material and everything surrounding it would simply melt or burn - great for welding but not so good for fine and controlled material removal.

The range of pulsed lasers used for patterning and processing display materials and devices varies, as wavelengths range from the near IR at 1064nm down to the deep UV at 157nm.

Apart from wavelength and pulse-width, a further fundamental property of the laser to be considered is the  $M^2$  or beam quality factor. This is critical when deciding which type of laser to do which job.

The family of lasers known as DPSS (Diode Pumped Solid State) typically have very low  $M^2$  values ( $< 1.4$ ) and, hence, have very high beam quality. This means that they can be focused to very tight spots and are excellent for drilling tiny holes and vias, or scribing very fine lines in a direct write mode of operation. The Nd:YAG laser and its harmonics fall into this category. The spatial profile of these lasers tends to be Gaussian. The problem

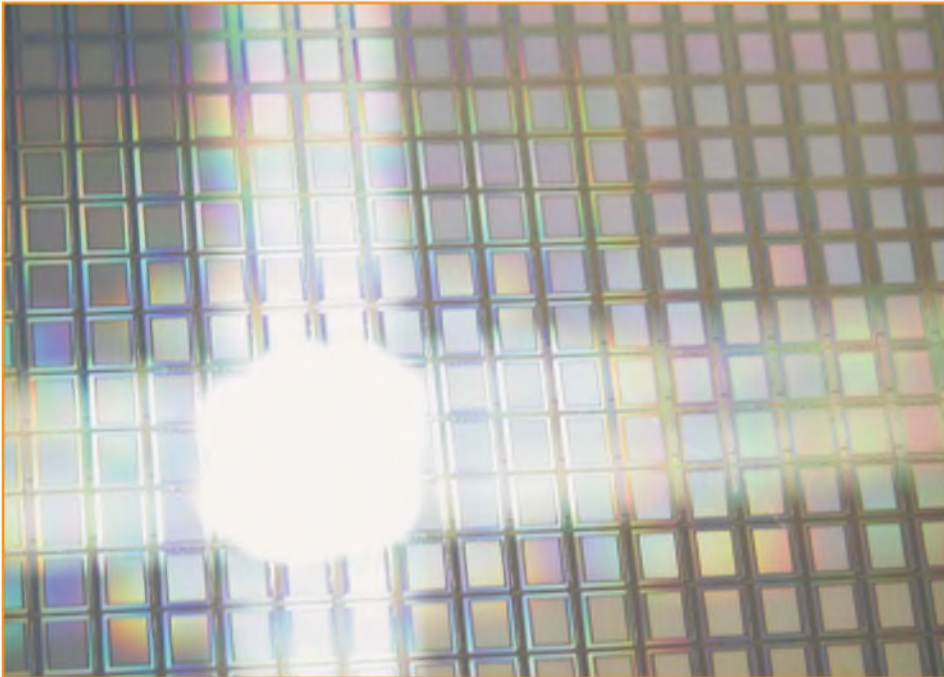

High resolution patterning of display components

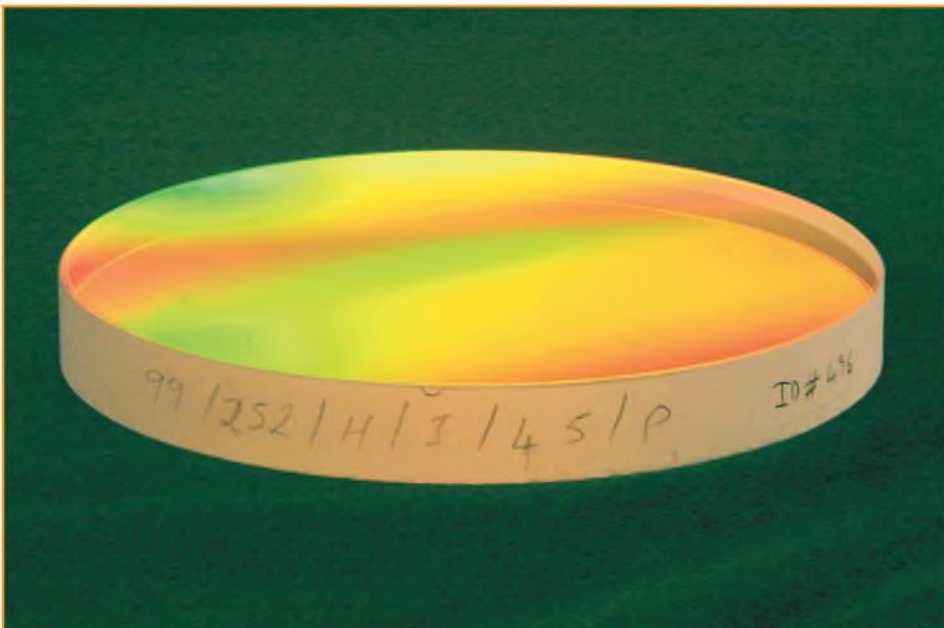

Laser Optics: Special coatings increase the efficiency of the laser process and reduce operating costs

with this profile is that the very high energy within the peak of the profile can cause damage to underlying layers and structures.

In many processing applications it is necessary to spread the energy distribution so that the profile is more "top hat" in shape, such that there is an even distribution of energy across the entire beam profile. Being able to tightly focus implies that the

light emitted is highly coherent (think of the speckle pattern you see from a laser pointer). This is a direct consequence of the highly coherent light interfering to produce speckle and, worse still, fringes. This is not a problem if one is drilling a hole but a serious issue if trying to homogenise the laser beam to illuminate a mask and form an image across the mask pattern.

This is where the Excimer laser steps up to the plate. Behaving more like a giant torch, the light from the Excimer is much less coherent with  $M^2 > 100$ . This lack of spatial coherence means the Excimer laser beam can be smoothed and shaped without the risk of fringes and speckle. Although these lasers cannot be focused to such tight spots, the very short wavelengths mean that you can form an image of a pattern with very high resolution (1-2 microns), given suitable high quality optical components.

### FOCUSING AND DIVERGENCE

For a diffraction limited Gaussian beam ( $M^2 = 1$ ) the product of the divergence and the diameter is invariant.

$$\Delta\theta \times D = 1.27 \lambda \text{ (mm.mrad)}$$

So for a Nd:YAG laser with a diameter  $D = 1\text{mm}$  and wavelength  $\lambda = 1.06\mu\text{m}$  the  $\Delta\theta \times D = 1.35 \text{ mm.mrad}$ . For laser beams with  $M^2 > 1$  simply multiply by the  $M^2$  factor.

For any laser beam the spot diameter  $d = f \times \Delta\theta$  (where  $f$  = focal length of lens). So to focus to smaller spots one must reduce the beam divergence and/or the focal length of the lens. From our fundamental statement above in order to reduce divergence one must expand the beam. The divergence is also a function of wavelength, so shorter wavelengths give smaller spots and higher resolution.

The diffraction limited resolution is given by  $R = 0.8\lambda/\text{NA}$  where NA is the numerical aperture of the optical system. Typical values of  $\lambda = 248\text{nm}$  (KrF laser) and  $\text{NA} = 0.1\text{rad}$  implies a resolution limit of 2 microns. Using a 157nm F2 laser reduces the resolution limit to 0.13 microns.

However, it is all very well achieving high resolution but – there is a cost. The Depth of Field (DoF) scales inversely with the square of the NA. So the higher the resolution the smaller the depth of field and the more difficult it becomes to maintain the image plane. For our example above a resolution of 2 microns means a DoF of just  $\pm 12$  microns. Not a problem when working on a compact 2" semiconductor wafer, but scale this to a Gen 8 glass sheet for the LCD industry (1.5 metres x 1.2 metres) and you begin to see the enormous engineering challenges that are to be faced and overcome in order to launch a laser process into mass production.

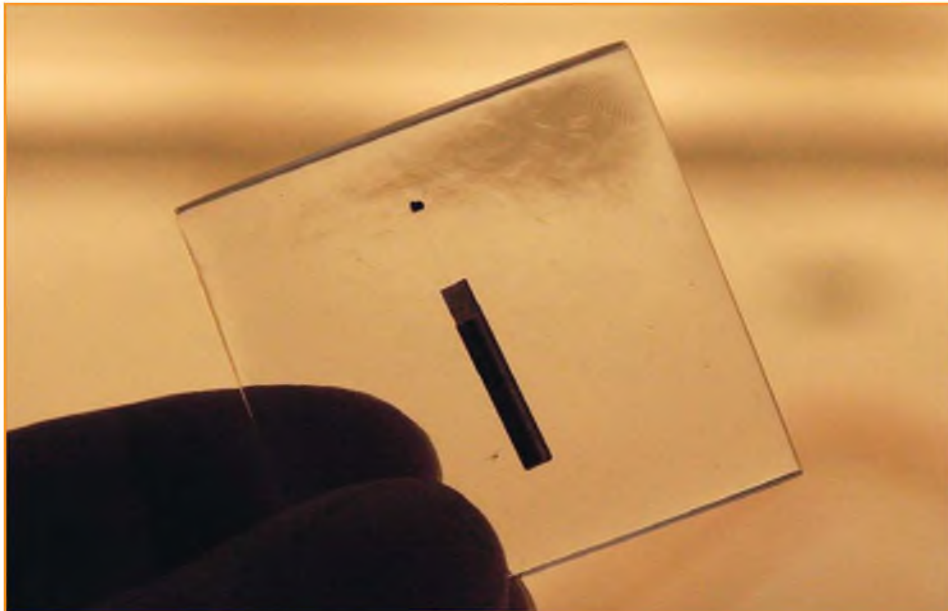

Lasers can be used to pattern materials on flexible substrates

Patterning Process	IR DPSS	UV Excimer
TCO on Glass/Flexible	👉	
TCO on Overcoat Layer for Colour Filters	👉	👉
Black Matrix on Glass	👉	
Metal Layers on Glass/Flexible	👉	👉
Resist Exposure		👉
Mastering of Diffusers/Lens Arrays		👉

Table 1: IR DPSS vs UV Excimer application comparisons

**THE RIGHT LASER FOR THE JOB**

In the world of flat panel displays, flexible displays and indeed plastic electronics, the key activity for the laser is the Selective Removal and Patterning of Thin Films, such as:

- Transparent conducting layers (ITO, SnO2, etc)
- Metal layers (Al, Au, Ag..)
- Polymer layers
- PLED materials
- Resists

So what laser for which job? **Table 1** summarises some of the applications together with the appropriate laser choice.

By way of example let us look at two applications to see how the choice of laser is influenced: the patterning of ITO on glass for Plasma Display Panels and the patterning of ITO on Colour Filters for LCD panels.

In the first case the pattern resolution required is around 5-10 microns and the selectivity required is between the ITO and the glass substrate. (Manufacturing process

times are often referred to as TACT times, which simply means the time it takes to complete one unit before the start of the next)

A process TACT time of 60 seconds dictates the use of a high average power laser (capable of delivering lots of energy in a short period of time). The short TACT time, lower resolution requirement and less sensitive layer structure steers one to look to the DPSS lasers. However using a typical high average power Infra Red, low M<sup>2</sup> laser with a Gaussian profile would not be appropriate as this would result in damage to the glass substrate and uneven removal of the ITO film. Here a special class of DPSS laser with high M<sup>2</sup> operating at 1064nm is most appropriate.

One can make use of the high average power, the resolution requirement is easily met and the DoF is large enough to be controllable over large areas. Because this laser has a high M<sup>2</sup> it is possible to shape and homogenise the beam in a similar way to the

Excimer laser. The result is a smooth, shaped profile that illuminates a mask of the required pattern that is then imaged onto the panel surface to create the required pattern. In order to meet the TACT time this imaged pattern is scanned across the panel in a process known as Bow-tie Scanning (BTS).

In the second example, the underlying colour filter material is highly sensitive and would be simply “blown away” by using an IR DPSS laser. Here, use is made of the selectivity offered by UV wavelengths, ensuring that the laser light is full absorbed by the upper layer and that there is no heat conduction down to the underlying layers.

This LCD application requires a process resolution of around 1-2 microns, again dictating the use of UV wavelengths. A KrF Excimer laser operating at 248nm would be used, in an imaging mode. Control of the DoF is vital and special methods are required to achieve this. The entire panel is patterned via a technique known as Synchronised Image Scanning (SIS) that optimises the use of the available laser power.

As mentioned before, transferring these processes to a fully automated production over large areas requires the integration of sophisticated and, in many cases, heavy engineering as shown by the photograph below. This shows a Gen 6 laser processing machine for LCD processing designed and built in the UK weighing in at 20 tonnes! Vibration control, translation stage reproducibility, optical stability and the all important debris removal mechanisms all have to be considered.

**A CONSIDERED CHOICE**

This short review shows how a display manufacturer wanting to use lasers in an automated production line may well have to use completely different types of laser technologies for different steps in the process, depending on the resolution required and types of material being processed. There is no “one size fits all” solution in the complicated world of display manufacture, but even though we do not (yet) manufacture LCD or Plasma displays on glass here in the UK, it is great to know that we do design and manufacture some of the equipment they are made on.■

*Dr Ric Allott is the Deputy Director of the UK Display & Lighting Knowledge Transfer Network (UKDL)*



## TIP: SPECTRAL-MASK SHAPING FOR A CLASS 1 GEN 2 PR-ASK RFID I/Q MODULATOR

By Doug Stuetzle, RF Design Engineer, Linear Technology

An integrated I/Q modulator such as the LT5568-2 can easily generate the 900MHz transmit signal for a Class 1 Gen 2 UHF RFID reader. While there are less expensive alternatives, for example directly modulating a VCO, an I/Q modulator offers considerably more flexibility to generate multi-protocol signals to meet various RFID standards. For example, a Class 1 Gen 2 reader can send information to one or more tags by means of several different modulation formats. The RF carrier may be modulated by double-sideband amplitude shift keying (DSB-ASK), single-sideband amplitude shift keying (SSB-ASK), or phase-reversal amplitude shift keying (PR-ASK) using a pulse-interval encoding format.

To implement SSB-ASK modulation, the I and Q inputs of a balanced modulator are driven with in-phase and quadrature signals; the quadrature signal is the Hilbert transform of the in-phase signal. The resulting modulator output is a LO-suppressed, single-sideband RF signal.

Alternatively, to generate a double-sideband RFID signal, the circuit required to drive such a modulator is simple. Only the I (or Q) port of the modulator need be driven with the baseband signal. The unused port is left unconnected or not driven. Thus a single DAC can be used to drive its DC output current of 10.4mA into the modulator's  $50\Omega$  internal input resistance. This implementation is shown in **Figure 1**.

A 0.5V DC bias current output DAC should be chosen, which matches the common-mode DC voltage at the baseband pins of the LT5568-2. The waveforms generated by the DAC should be equal and opposite such that their average value

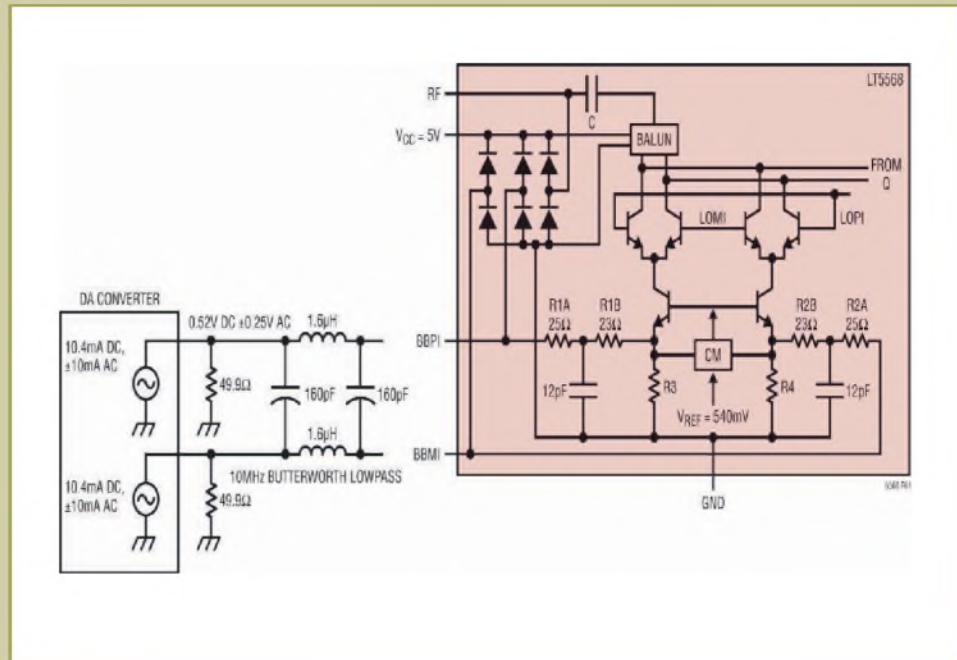

Figure 1: LT5568 baseband interface circuit

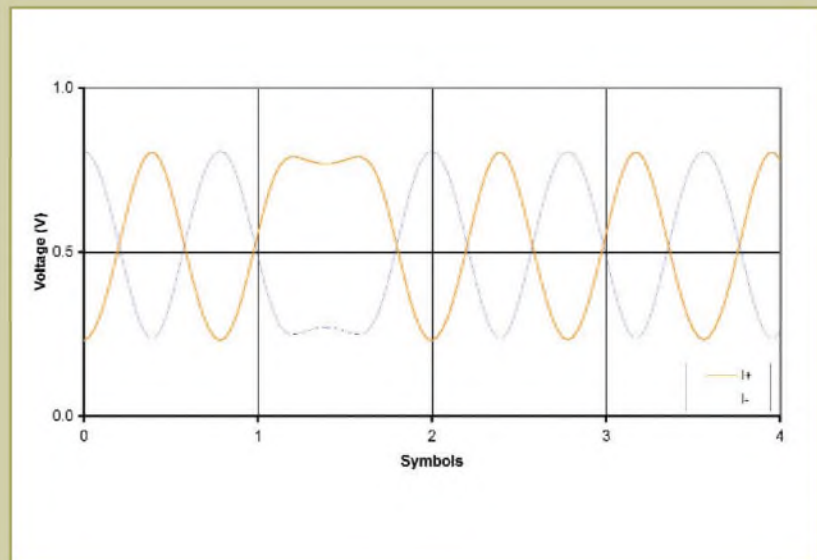

Figure 2: Baseband PR-ASK pulses at 64kbps

satisfies the 0.52V DC bias requirement of the LT5568-2.

The interface circuit includes a 10MHz Butterworth low-pass filter to attenuate the sampling images from the DAC. This is a reconstruction filter, so its corner frequency will depend upon the sampling frequency of DAC.

Besides this filter, some amount of pulse shaping is necessary in order to control the filter side-lobes such that the shaped waveform will meet the RF spectral mask requirements of this class of RFID reader equipment.

The EPC Global specification does not include spectral mask requirements, except for dense-reader mode operation. The reader emissions are instead constrained by the requirements set forth in either FCC part 15.247 (for US applications), or ETSI EN302208 section 8.4.3 (for Europe applications).

The ETSI mask is much more demanding than the FCC requirements, so we will use it in our design example here. This mask includes a channel that is 200kHz wide. The ETSI mask requires the adjacent carrier power at  $\pm 300\text{kHz}$  from the main carrier shall not exceed  $-36\text{dBm}$ .

In the Class 1 Gen 2 RFID specification the '0' symbol duration is denoted 'TARI', or Type A Reference Interval. The symbol is a simple pulse, with a 'low' time of  $1/2 \cdot \text{TARI}$ , and a 'high' time of only  $2 \cdot \text{TARI}$ . The '1' symbol duration can be between  $1.5 \cdot \text{TARI}$  and  $2 \cdot \text{TARI}$ , with a 'low' time of  $1/2 \cdot \text{TARI}$ . To meet this mask with a PR-ASK (Phase-Reversed-Amplitude Shift Key) signal, choose TARI equal to  $12.5\mu\text{s}$ . The average symbol duration is then  $15.625\mu\text{s}$ , yielding a data rate of 64kbps. The central lobe of the signal will then be  $\sim 200\text{kHz}$  wide, just enough to fit within the mask.

To meet the requirements of the mask outside the channel, we add some pulse shaping to the symbols. This can be done digitally with an FIR filter. In this case, a 118kHz raised cosine filter with 39 taps and an alpha of 0.8 was used. This can be implemented easily in the baseband DSP that drives the DAC. The resulting shaped pulses appear in **Figure 2**.

The effect of this pulse shaping is to reduce the sidelobes of the PR-ASK signal. **Figure 3** shows both the unshaped and

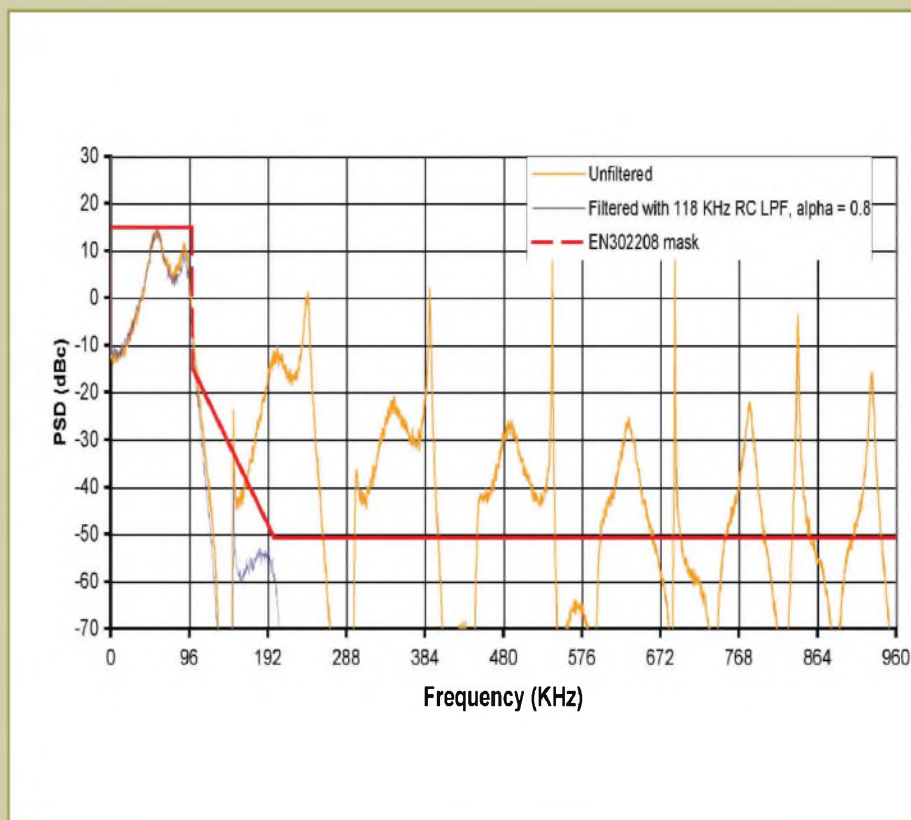

**Figure 3:** Baseband PR-ASK pulse spectra

shaped pulse spectra and their relation to the ETSI spectral mask. This mask assumes the RFID transmit power is  $+33\text{dBm}$ . The FIR filter is designed to reduce the spectral width of the signal without slowing the symbol transitions excessively. This is critical because there is also a time domain mask the shaped pulses must meet, per section 6.3.1.2.5 of the EPC Global Specification.

A key advantage of this LT5568-2 modulator in an RFID transmitter application is its high output dynamic range. Its output noise floor is exceptionally low and it adds negligible distortion to the RF output signal. Its Output Third Order Intercept Point (OIP3) of  $+22.9\text{dBm}$  easily preserves the baseband pulse shaping as well as minimising spectral regrowth. Note that the LT5568-2 works equally well at the ETSI 865MHz to 868MHz band. The result is excellent transmit spectra purity.

Additionally, its low output noise floor of  $-159\text{dBm/Hz}$  helps to minimise the noise leakage from the RFID transmitter output to its receiver input. This is especially critical in single antenna designs having limited isolation in the circulator between the transmitter output and the receiver input. Thus, a reduced RF noise leakage has the beneficial effect of improving the receiver sensitivity and consequently boosting the RFID reader's useful range.

## TIP: RS-485: SIMPLE LOSS-OF-SIGNAL INDICATOR DISTINGUISHES BETWEEN FAILSAFE-HIGH AND DATA-HIGH

By Thomas Kugelstadt, Senior Applications Engineer, Texas Instruments

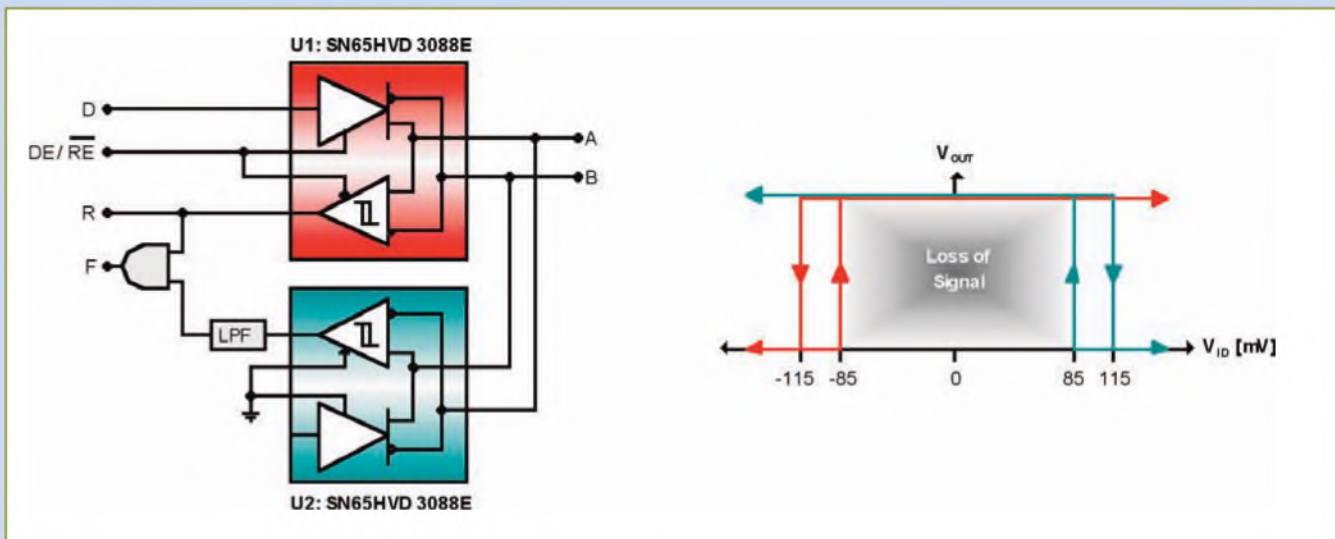

Figure 1: LOS indicator with transfer function

Formerly RS-485, EIA/TIA 485 specifies its receiver input thresholds with  $\pm 200\text{mV}$ . For signals above  $200\text{mV}$ , the receiver output becomes logic high. Signals below  $-200\text{mV}$  become logic low. For signals in between, the output state is undefined.

Modern transceivers featuring integrated failsafe biasing have their input threshold voltages offset into the negative voltage range, thus driving the receiver output high when the input signal exceeds an upper negative threshold. See U1 thresholds in **Figure 1**.

A slight drawback is that the processing logic following the receiver cannot easily differentiate between a high caused by the loss of an input signal and a high representing valid data. A simple do-it-yourself loss-of-signal (LOS) indicator, however, overcomes this lack of differentiation by providing a separate LOS-flag in addition to the receiver output state.

Figure 1 shows the LOS indicator circuit with its associated transfer functions on the right. The design requires two transceivers. The first is a primary transceiver taking care of the standard data traffic and indicating signal voltages higher than  $-85\text{mV}$ . The second is a transceiver with reversed input polarity, indicating voltages below  $+85\text{mV}$ . AND-gating both receiver outputs causes output fault (F) to assume logic high for voltages between  $-85\text{mV}$  and  $+85\text{mV}$ . Thus, indicating the loss of an input signal.

To avoid F becoming high during normal signal transitions, low-pass filtering (LPF) of the second receiver output is required, thus only indicating low-voltage conditions of sufficient duration.

In addition to the simple R-C low-pass creating the necessary delay, the resistor-diode path parallel to  $R_C$  provides fast and complete discharge of  $C_C$  before the next signal transition. See

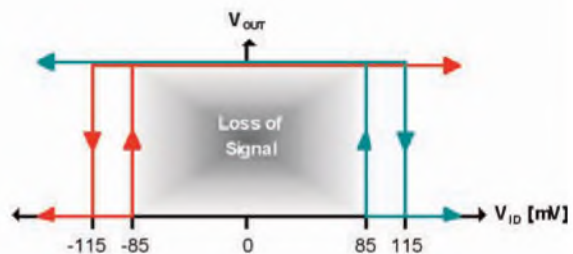

Figure 2: Low-pass filter with accelerated discharge

### Figure 2.

Note that the combination of the one-eighth unit load transceivers above increases the unit loading per node to one-fourth UL. Thus, allowing for a total number of 128 nodes featuring LOS indication while complying to EIA/TIA 485.

### References:

"Failsafe in RS-485 Data Busses (slyt080)" by Kevin Gingerich, Texas Instruments, 3Q04: [www.ti.com/aaaj](http://www.ti.com/aaaj). For more information about RS-485 or interface solutions from Texas Instruments, visit: [www.ti.com/interface](http://www.ti.com/interface)

## Six Terminals LEDs Available Through CML-IT

Now available through CML Innovative Technologies (CML-IT) is a medium-power



LED from Samsung featuring six terminals. The 5252 series LED benefits from three chips which can be connected in series or parallel, making the LED useable in a multitude of different applications. Instead of assembling three LEDs now only one LED is needed, saving costs and assembly time.

The 5252 series LED is available in three different shades, including cool white, warm white and an RGB version. The LED offers a viewing angle of 120 degrees and measures only 5.2mm x 5.2mm x 1.3mm. Maximum current is 3 x 20mA.

Samsung's 5252 series LED will be distributed from CML-IT's ISO 9001:2000 certified logistics facility in Bad Dürkheim (Germany). From there CML-IT is serving the whole of Europe with a 48-hour delivery from stock service.

[www.cml-it.com](http://www.cml-it.com)

## High-Reliability, Secure-Locking, FFC/FFP Automotive Connector

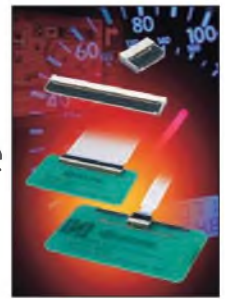

A range of FFC/FPC connectors with secure locking facility, aimed primarily at the transportation market, 6288 Series Secure Lock ZIF connectors from AVX Corporation address reliability concerns by virtually eliminating production process failure, preventing accidental removal of the cable in the field and by delivering more robustness against vibration.

Mouldings in the connector accept shaped FPC/FFC cable and lock to guarantee that accidental removal of the cable and incorrect insertion is virtually impossible. Further, the shaped cable ensures correct alignment in the production process, eliminating failures due to misalignment. To facilitate ease-of-assembly, a one-touch flip lock provides audible and tactile "click" feedback.

Available in six to 60 positions with a standard 0.5mm pitch, the connectors are tested to automotive specifications and rated for the extended -40 to 105degC temperature range. The standard 0.5mm pitch contacts feature a gold flash finish for higher reliability soldering.

[www.avx.com](http://www.avx.com)

## Surface Mount RFI Clips Reduce Assembly Time



High-reliability interconnect company Harwin has introduced a new range of surface mount EMI/RFI shield clips which reduce assembly time and simplify rework by eliminating secondary soldering operations.

Supplied in industry-standard tape and reel packaging, Harwin's RFI shield clips are positioned on the board and soldered using standard SMT placement equipment. The shielding can is then simply pushed into place during final assembly. Because it is possible to remove and refit the can a number of times, adjustment and rework operations are simplified. Therefore both initial production and rework costs are significantly reduced.

RFI clips are available in two sizes. The larger Midi clip can handle cans with a wall thickness of 0.3mm and is available in beryllium copper and beryllium-free copper. The smaller Mini version is only available in beryllium copper and suits cans with 0.13-0.23mm thick walls.

[www.harwin.co.uk](http://www.harwin.co.uk)

## New Miniature HCE Pressure Sensors Offer



Sensortronics's new HCE series offers precision pressure measurement from 10 mbar up to 10 bar. The HCE sensors perform digital signal conditioning to provide highly accurate digital and analogue output signals. They comply with the SPI bus protocol and can directly communicate with microcontrollers and microprocessors. I2C bus, switching or custom-specific outputs are available on request.

The HCE series utilises the latest ASIC technologies to achieve high total accuracies, with an excellent Total Error Band (TEB) better than  $\pm 0.5\%$  FSS, including all temperature effects. Miniature SMT housings (DIP and SIL versions on request) with straight or barbed pressure ports allow for highly flexible OEM designs and space-saving PCB-mounting.

For all HCE pressure sensors Sensortronics can provide fast and flexible modifications based on custom-specific requirements.

[www.sensortronics.com](http://www.sensortronics.com)

## First 8 x 8 MIMO Test System

Keithley Instruments is extending its RF MIMO (multiple-input, multiple-output) test portfolio with the industry's first measurement-grade 8 x 8 MIMO system. The system is used for primary research of next-generation RF MIMO devices and technologies.



Keithley introduced the industry's first 4 x 4 MIMO test equipment for R&D product development in late 2007.

The new 8 x 8 MIMO system features support for MIMO research applications ranging from two channels now up to eight; flexible system configurations with individual system component instruments; phase and amplitude control of the RF carrier; less than  $\pm 1$ ns signal sampler synchronisation; less than 1ns peak-to-peak signal sampler jitter and less than 1 degree of peak-to-peak RF-carrier phase jitter, among others.

By allowing for precise and stable multi-unit synchronisation with these high performance measurement specifications, the new Keithley system extends support of 4 x 4 MIMO measurements currently being used for commercial test applications on demanding signals, such as 802.11n WiFi, 802.16e Mobile WiMAX Wave 2 and future standards such as 4G LTE (Long Term Evolution) and UMB (Ultra Mobile Broadband).

The system uses a measurement platform based on DSP-based Software-Defined Radio architecture, a versatile software architecture to adapt to the quickly changing test requirements of the dynamic wireless market.

[www.keithley.com/rf](http://www.keithley.com/rf)

## Solid-State, High-Power Amplifier for Mobile Jamming Applications

Link Microtek has announced the availability of a new solid-state high-power amplifier module that has been designed for use in military mobile jamming systems to counter the threat of IEDs.



Manufactured by Empower RF Systems, the 1119 module covers the frequency range 500MHz to 2.5GHz and features a rugged construction that ensures excellent long-term reliability.

The module utilises high-power advanced GaN transistors to achieve an output of 50W with high efficiency, low distortion and wide dynamic range. It has a maximum noise figure of 10dB and a minimum IP3 of +48dBm.

Operating from a 28VDC supply, the 1119 includes built-in control and monitoring circuits to protect it against input overdrive, any load VSWR and thermal overload.

This compact module measures only 188 x 91 x 27mm, weighs just 454g and has an operating temperature range of -40 to +80degC.

A datasheet for the 1119 module can be found at [www.linkmicrotek.com](http://www.linkmicrotek.com) under the product category 'Amplifiers – Power Modules'.

[www.linkmicrotek.com](http://www.linkmicrotek.com)

## New Ripcord2 Single-Chip, Ultra-Wideband IC Family

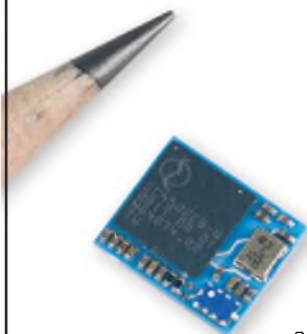

Staccato Communications announced the availability of the Ripcord2 family of single-chip, all-CMOS solutions targeted for WiMedia UWB and Wireless USB applications. This second-generation

family is the industry's first implementation utilising 65nm CMOS process technology and offers a quantum leap in power consumption, size and integration over existing solutions.

Leveraging software development on the fully certified Ripcord1 family, Staccato's Ripcord2 supports multiple protocols, including Wireless USB, High-Speed Bluetooth, Wireless IP and Wireless Audio/Video. In addition, there are several new features in the

Ripcord2 family including support for WiMedia Band Groups 1, 3 and 6, as well as the capability for detection and avoidance (DAA), providing a worldwide compatible solution in a single device.

Ripcord2 is ideally suited for high volume consumer applications including handsets, DSC/DVC, printers, PMP, wireless audio/video and mass storage.

The Ripcord2 DVK provides an integrated development environment that accelerates native Wireless USB device and high-speed Bluetooth designs, as well as generic WiMedia UWB applications. The Ripcord Control Library (RCL) included with the DVK provides a fully abstracted embedded software library with portable services to simplify the interface to the Ripcord2 IC enabling easy integration on a wide variety of platforms.

[www.ripcord2.com](http://www.ripcord2.com)

## World's First USB 3.0 Protocol Analyser Exerciser System

The new Voyager verification system from LeCroy, claimed to be the world's first protocol analyser for USB 3.0 (also known as SuperSpeed USB) has been launched in the UK and Ireland by LeCroy's sole agent Nohau.



The new development joins a wide range of USB related hardware and software products now available from Nohau, including protocol and bus analysers supporting USB 1.1, USB 2.0 and USB-OTG from LeCroy, USB host and device software from HCC, integrated USB host and device stacks from Quadros Systems, as well as compilers assemblers, debuggers and other USB device software from IAR and Keil.

Voyager uses custom front-end circuitry developed in conjunction with LeCroy's 5Gbps PCI-Express platform, to provide simultaneous protocol capture of both USB 2.0 and USB 3.0 signalling. Available with an integrated exerciser option, this sixth generation verification platform is LeCroy's complete solution for testing USB devices, systems and software.

The USB 3.0 specification development was announced in September 2007 offering ten times the speed of USB 2.0 and backward compatibility with legacy devices. It features physical layer characteristics similar to PCI Express 2.0, including 5GHz signalling, that relies on link training to synchronise communication between devices.

[www.nohau.co.uk](http://www.nohau.co.uk)

## Tutorial Poster for WiMAX Measurement Available Free

Keithley Instruments has published a new poster that illustrates the key measurement tools and software analysis techniques required for measuring complex WiMAX signals. The poster is available at no charge at [www.keithley.info/wimaxposter](http://www.keithley.info/wimaxposter).



The poster provides a clear illustration for making easy signal creation and analysis of WiMAX signals, arguably the most complex modulation scheme around. WiMAX signals encompass multiple technologies into one very versatile system, including bandwidths in excess of 20MHz, configurations with more than 2000 subcarriers, high peak-to-average power ratios and both SISO and MIMO radio configurations.

The poster builds on the capabilities of a variety of new Keithley signal creation and analysis tools that extend its RF test capabilities to include WiMAX signal testing. Keithley's RF test solutions are based on the company's award-winning Model 2820 RF Vector Signal Analysers and Model 2920 RF Vector Signal Generators.

The poster highlights the powerful RF signal analysis capabilities included in Version 2.0 of Keithley's SignalMeister Waveform Creation Software. Version 2.0 supports creation of the entire range of signals in accordance with WiMAX and WLAN wireless connectivity standards and 3GPP and 3GPP2 cellular standards.

[www.keithley.info/wimaxposter](http://www.keithley.info/wimaxposter)

## Fanless, Ultra-Low Voltage, Celeron M PC/104-Plus Single Board Computer



VersaLogic Corp announced the release of a fanless version of its Cheetah PC/104-Plus embedded single board computer (SBC). The new Cheetah version (EPM-32v) boasts the processing power of Intel's Ultra-Low Voltage Celeron M CPU, but operates without a fan and uses only 8W of power.

The new ULV Cheetah is targeted at applications such as medical, avionics, navigation/tracking, system monitoring and security/homeland defense that require substantial processing power and low power draw, as well as extensive features in a rugged, compact design. The Cheetah is especially well suited for

embedded control applications requiring a very small footprint, which the 3.6" x 3.8" (90mm x 96mm) size provides.

Standard on-board features of this RoHS-compliant SBC include 2 COM ports, 2 USB 2.0 ports, Ethernet, IDE, LPT, audio and PS/2 keyboard/mouse support. The board also features integrated high-performance video with support for both analogue monitors and LVDS flat panels.

The Extreme Graphics 2 video processor includes high speed 3-D rendering, full-motion video and MPEG-2 decoding. The PC/104-Plus interface supports both ISA and PCI add-on modules. Standard pass-through connectors allow the board to be used above other PC/104 modules.

[www.VersaLogic.com](http://www.VersaLogic.com)

## Clansman Military Audio Connectors with 48-Hour Assembly Service



Franchised assembling distributor PEI-Genesis has extended its ITT Interconnect Solutions stock profile to include the VEAM PT (Pattern 105) range of military audio connectors and is now offering them

with the standard PEI-Genesis 48-hour assembly service.

The VEAM PT connectors are widely used in fighting vehicles and ground-based military communications equipment such as the MoD's Clansman and Bowman radio systems.

These multiple-contact connectors offer a high-quality, miniature bayonet-coupling connection that is particularly suitable for applications where high reliability is a prime requirement.

Providing a lightweight yet rugged construction, the VEAM PT connectors feature aluminium shells with a choice of cadmium olive drab or green zinc cobalt plating for excellent corrosion resistance.

The connectors are available in a variety of styles with numerous contact arrangements from 2 to 61 contacts. To prevent cross plugging of adjacent connectors, they can be specified with up to five different keyway polarisations or insert orientations.

As well as fully conforming to the rigorous requirements of BS9522 F0017, the PT connectors are also compatible and fully interchangeable with connectors meeting the requirements of MIL-C-26482.

[www.peigenesis.com](http://www.peigenesis.com)

## High Temperature Ultra-Miniature Photocoupler

Toshiba Electronics Europe (TEE) has expanded its family of miniature photocouplers with a new extended temperature device suitable for applications, including switching power supplies, programmable controllers and AC/DC input modules.



The TLP285 offers an isolation voltage of 3.75kV and is rated for operation at temperatures from -55°C to 110°C. The creepage distance and clearance increased to minimum 5mm.

Supplied in an ultra-miniature SOP4 package, the photocoupler has dimensions of just 4.4mm x 2.6mm x 2.1mm.

Toshiba's new coupler consists of a GaAs infrared LED that is optically coupled to a phototransistor. Minimum current transfer ratio is 50%, while collector-emitter voltage (VCE) is rated at 80V. Maximum operating insulation voltage is 707Vpk, while highest permissible overvoltage is 6000Vpk.

The new device is fully approved to all relevant UL, BS, EN and VDE safety standards including UL1577, BS EN 60065: 2002, BS EN 60950-1: 2006 and EN60747-5-2.

Toshiba Electronics Europe offers one of the industry's broadest IC and discrete product lines including high-end memory, microcontrollers, ASICs, ASSPs and display products for automotive, multimedia, consumer, telecoms and networking applications. The company also has a wide range of power semiconductor solutions.

[www.toshiba-components.com](http://www.toshiba-components.com)

## High Speed Contact Image Sensor Head



Rohm has introduced its new image sensor head IA2002-CE10A for card scanning. The image sensor head with a reading width of 54mm delivers lower power consumption than CCD systems and offers a greater versatility, especially in design options.

Ideal for security authentication and reading of rewritable cards, the IA2002-CE10A utilises a special ceramic substrate featuring superior dimensional precision and thermal dissipation characteristics, resulting in stable reading, even under fluctuating ambient temperature conditions and during continuous use. A prism based on the latest optical technologies ensures

simultaneous uniform light output and low light radiation to the media, reducing optical power loss.

RGB LEDs used in the light source enable colour reading while a 3.3V supply voltage operation minimises power consumption. A monochrome reading speed of 25 inches/second (635mm/s) is possible.

In addition, the external structure of the IA2002-CE10A was specifically developed to support bidirectional scanning, allowing for greater design flexibility in carrier orientation.

Among the target applications are image scanners, card readers, detection sets and ATMs or betting kiosks.

[www.rohmeurope.com](http://www.rohmeurope.com)

## IQD Enhances Real-Time Clock Performance for Process Control

A new range of 'watch crystal' oscillators offering a four-fold improvement in stability over previous-generation devices is introduced by IQD Frequency Products. Providing output at the standard watch crystal frequency of 32.768kHz – divisible to precisely the 1Hz requirement of a real-time clock – the CFPS-107/108/109 oscillator series offers stability down to 20ppm over its operating temperature range in a miniature 2.6 x 2.1mm ceramic SMD package.



IQD has improved on the 80ppm stability typically offered by watch crystal oscillators by using an AT-cut rather than a GT-cut quartz crystal resonator. AT-cut crystals provide an inherently more stable frequency output, but at a higher frequency. The CFPS-107/108/109 uses a divider to bring the high internal signal frequency down to the required 32.768kHz.

The CFPS-107/108/109 is particularly well suited to process control applications, being available with a -40° to +85°C industrial operating temperature range, as well as the standard 0° to +70°C. It also offers a high level of shock and vibration resistance, with qualification to Mil-Std-883F.

[www.iqdfrequencyproducts.com](http://www.iqdfrequencyproducts.com)

## Compact Benchtop Power Analyser for Phase Measurements

The new Yokogawa WT500 is a compact benchtop power analyser which can carry out DC or single and three-phase AC measurements at voltages of up to 1000V and currents up to 40A.



With a basic voltage, current and power accuracy of  $\pm 0.2\%$  and a frequency range of DC and 0.5Hz to 100kHz, the new instrument features a 5.7-inch colour LCD display for showing numerical, waveform and harmonic data. Extensive harmonic measurement capabilities are also available as an option.

The compact size, high speed and accuracy of the WT500 will make it attractive for quality-assurance purposes to manufacturers of power conversion equipment, including alternative energy sources such as photovoltaic generators, fuel cells and wind generators. It is also ideally suited to the measurement of bought and sold power in photovoltaic and other independent generation systems.

The WT500 will measure voltage, current, power and total harmonic distortion with a high update rate.

[www.yokogawa.com](http://www.yokogawa.com)

## Zypos and Zybrid Projected Capacitive Technology Based Touch Sensors

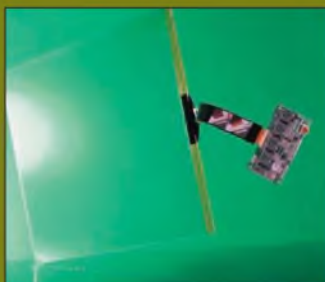

Zypos and Zybrid are just two of the touch sensor products that Zytronic will be featuring during the Electronica show this year. Based on the company's internationally award-winning Projected Capacitive Technology (PCT), these products are highly accurate and offer better

reliability and life expectancy than conventional 'front-face-active' surface alternatives.

PCT is achieved by embedding an array of near-invisible capacitors on the second surface of the front substrate within a laminated construction. The capacitors may be up to 20mm

below the screen surface, allowing them to be extremely well-protected from accidental or deliberate damage. It can also detect touch through a gloved hand, has unlimited touch life and is drift-free, thus eliminating the need for costly and inconvenient recalibration.

Zypos and Zybrid offer a fast and accurate response time (<10ms) and the way in which both products are constructed protects the sensing elements from damage that can be caused by moisture, heat, common cleaning agents, grease and debris. OEMs can create sealed designs with both products that comply with NEMA 4, 12 and IP 65 standards and driver software is fully compatible with Windows 2000, XP, XP-E, Vista, CE and Linux.

[www.zytronic.co.uk](http://www.zytronic.co.uk)



## OSCILLOSCOPES ON EXTRA SPECIAL OFFER

(For Limited Period Only)

### TEKTRONIX

465	Dual Trace 100MHz Delay Sweep	£75
465B	Dual Trace 100MHz Delay Sweep	£95
466	Dual Trace 100MHz Analogue Storage	£75
468	Dual Trace 100MHz Delay Sweep Digital Storage	£125
475	Dual Trace 200MHz Delay Sweep	£110
2214	4 Ch 20MHz Analogue 1 MS/S	£95
2215A	Dual Trace 60MHz Delay Sweep Dual TB	£95
2220	Dual Trace 60MHz Digital Storage Cursors	£125
2225	Dual Trace 50MHz	£95
2230	Dual Trace 100MHz Digital Storage Cursors	£195
2235	Dual Trace 100MHz Dual TB	£150
2235A	Dual Trace 100MHz Dual TB	£175
2236	Dual Trace 100MHz Dual TB with Counter Timer & DMM	£175
2236A	Dual Trace 100MHz Dual TB with Counter Timer & DMM	£195
2245A	4 Ch 100MHz Dual TB Delay Sweep. Cursors	£195
2430	Dual Trace 150MHz 100 MS/S	£250
2445	4 Ch 150MHz Delay Sweep. Cursors etc	£195
2445A	4 Ch 150MHz Delay Sweep. Cursors etc	£225
2445B	4 Ch 150MHz Delay Sweep. Cursors	£250
2445B	With DMM 4 Ch, 150MHz Delay Sweep. Cursors	£250
2465	4 Ch 300MHz Delay Sweep. Cursors etc	£300



2465A	4 Ch. 350MHz Delay Sweep. Cursors etc	£400
2465B	4 Ch. 400MHz Delay Sweep. Cursors etc	£500
2465B	Rack Mount 4 Ch 400MHz Delay Sweep. Cursors etc	£400
2467	4 Ch. 350MHz Delay Sweep. Cursors etc	£400
TAS 465	Dual Trace 100MHz Delay. Cursors	£195
TAS 485	4 Ch. 200MHz Delay Cursors	£275

### HP

54501A	Digitising 2+2 Ch 100MHz 10 MS/S	£150
54502A	Digitising 2 Ch 400MHz 400 MS/S	£250
54600A	Dual Trace 100MHz 20 MS/S	£195
54600B	Dual Trace 100MHz 20 MS/S	£225

### PHILLIPS

PM3052	Rack Mount Dual Trace 60MHz	£75
PM3055	2+1 Ch. 60MHz dual TB/Delay Autoset	£95
PM3065	2+1 Ch. 100MHz dual TB/Delay Autoset	£125
PM3084	4 Ch 100MHz Delay TB	£140
PM3335	Digital Storage Dual Trace 60MHz 20 MS/S	£125
PM3337	Rack Mount Digital Storage Dual Trace 60MHz 20 MS/S	£125
PM3365A	Digital Storage Dual Trace 100MHz 100 MS/S	£150

### HITACHI

V222	Dual Trace 20MHz DC Offset, Alt. Mag	£50
V522	Dual Trace 50MHz DC Offset, Alt. Mag	£65
V665	Dual Trace 60MHz Delay Sweep. Cursors etc	£75
V1065	Dual Trace 100MHz Delay Sweep. Cursors etc	£85
V1065A	Dual Trace 100MHz Delay Sweep. Cursors etc	£95
V1150	4 Ch 150MHz Delay Sweep. Cursors. DVM etc	£125

### HAMAG

203.4	Dual Trace 20MHz Component Tester	£75
203.6	Dual Trace 20MHz Component Tester	£85
305	Dual Trace 03MHz Analogue/Digital 40 MS/S per Channel Component Tester	£140
604.2	Dual Trace 60MHz Component Tester	£125

**STEWART of READING**  
17A King Street, Mortimer, Near Reading RG7 3RS  
Telephone: (0118) 933 1111  
Fax: (0118) 933 2375  
www.stewart-of-reading.co.uk  
9am-5.00pm Monday to Friday

See our website for 1,000's of items currently in stock

**Used Equipment - GUARANTEED.**  
Most Manuals supplied  
Please check availability before ordering or calling.  
Prices plus carriage and VAT

## WEBSITE DIRECTORY

### Beta Layout Ltd

[www.pcb-pool.com](http://www.pcb-pool.com)

The Best Value Online PCB Prototyping Service Available:  
Instant on line quotations & ordering (no pre registration).  
We offer the following:  
• No minimum quantity. • No tooling charges. • No drill Limitations. • 1 to 6 layers (prototype quantities) • 2 layers (small production batches) • Fr4, 1.6mm, 35 um, HASL (Pb free/RoHS/Weee) • Soldermask / Silkscreen (optional) • Leadtimes from 2 -8 working days • Full DRC on all orders (we manually check every file !!!). • PCB-POOL®



accepts direct outputs from 15 major layout softwares (see our website for details)  
Download our fully functional PCB LAYOUT software FREE of charge.  
Free Phone : 0800 3898560

### Sky systems ltd

[www.sky-pcb.com](http://www.sky-pcb.com)

Sky Systems Ltd. was established with the vision and promise of providing manufacturing high quality, cost effective solution and one-stop service to meet the most demanding of our customers' requirements.  
We offer the followings:  
• 1-12 Layers • Fr-4 / Cem-3 • HAL(Lead Free), Flash Gold, Electroless Gold Plating, OSP, Immersion Silver, Immersion Tin • Gold Finger • Soldermask • Silkscreen • Routing / Punching / V-Cut • Online quotation • FREE PCB Prototype with quantity orders • Short



lead time • Fast worldwide delivery • Flexible quantity • CHINA Factory  
For more information or request a quote today from our web site.

### Designer Systems

<http://www.designersystems.co.uk>  
Professional product development services.

- Marine (Security, Tracking, Monitoring & control)
  - Automotive (AV, Tracking, Gadget, Monitoring & control)
  - Industrial (Safety systems, Monitoring over Ethernet)
  - Telecoms (PSTN handsets, GSM/GPRS)
  - AudioVisual ((HD)DVD accessories & controllers)
- Tel: +44 (0)1872 223306



### Microchip Technologies

<http://www.microchip.com/>

Microchip Technology Inc. is a leading provider of microcontroller and analogue semiconductors, providing low-risk product development, lower total system cost and faster time to market for thousands of diverse customer applications worldwide. Microchip designs, manufactures, and markets a variety of high performance components for high volume, cost-effective embedded control solutions, including 8- and 16-bit PIC® microcontrollers; dsPIC® digital signal



controllers; development kits; serial EEPROMs, more than 350 mixed-signal analogue and interface products; KEELOQ secure data transmission products; and the PowerSmart® family of smart battery management products. Microchip's product solutions feature compact size, integrated functionality, and ease of development.

ADVERTISING ENQUIRIES CONTACT MATTHEW ON: 020 7933 8980

## ADVERTISING

**EMC ADVERTISING GIFTS**  
1064 High Road, London, N20 0YY  
Huge range - All prices - Quick delivery

**20 cm 8 Inch RULER CALCULATOR**  
print 1 colour 100 @ £2.75 each.  
500 @ £2.25 each.



**FLIP OPEN CALCULATOR**  
print 1 colour  
100 @ £2.75 each.  
500 @ £2.45 each.

**EMC ADVERTISING GIFTS**  
Phone • email for catalogues  
tel: 0845 345 1064  
sales@emcadgifts.co.uk  
FULL CATALOGUE ONLINE  
www.emcadgifts.co.uk

## PCB DESIGN

**SKY SYSTEMS LTD.**

**China Factory**

- \* 1 - 12 Layers
- \* High Quality
- \* Cost Competitive
- \* Flexible Qty
- \* World Wide Delivery

GS-9000

UL

ISO 9001

RoHS

Tel: (852) 2111 9428  
<http://www.sky-pcb.com>



## PRODUCT DEVELOPMENT

**Creative Product Design**  
AV Accessories, Robotics & manufacturing

Automotive AudioVisual Telecoms

Marine Industrial Robotics

**Product Design and Manufacturing Services**

T. +44 (0) 1872 223306  
F. +44 (0) 845 8687573  
sales@designersystems.co.uk

**Designer Systems** co.uk

**MICROCHIP**  
Consultant Program Member

for more information see our web site @ <http://www.designersystems.co.uk>



## TRANSFORMER MANUFACTURE

**AUTOMATIC Windings Ltd.**

**NEW**

Our new East European production plant for medium to high volume production is now fully operational.

We are pleased to offer an end to end solution for wire wound components Via a UK based company

D2, 4 Nimrod Way, East Dorset Trade Park, Wimborne Dorset. BH21 7SH.  
Tel: 01 202 87 21 01 Fax: 01 202 87 20 87  
E-Mail: sales@automatic-windings.co.uk  
Web: www.automatic-windings.co.uk





## Increased Focus on Power Supplies and DC/DC Converters



Arrow Electronics has expanded its power technology portfolio by signing a distribution agreement with Recom, a leading global supplier of DC/DC and AC/DC converters. Arrow will sell and support Recom's complete power converter product range throughout Europe.

The new agreement is in line with Arrow's strategy to provide the widest possible range of power supply and converter technologies to designers across Europe. For

Recom, the agreement will expand the penetration of its product ranges into European markets and ensure that customers have access to products and support at a local level.

Available in single, dual, and triple rail outputs and a wide variety of input and output voltage configurations, power ratings, and isolation voltages, Recom converters are used in most industries requiring low- to medium-power voltage conversion in the 0.25W to 60W range. The company also offers the largest range of safety agency-approved converters from any manufacturer.

[www.arrowne.com](http://www.arrowne.com)

## PCB DESIGN

**DACS**

**Digital Audio and Computer Systems Ltd**

**High performance stereo pro-interface PCB £58.75**

For information on these and other custom products:  
Website - [www.dacs-audio.com](http://www.dacs-audio.com), click "DACS Custom"  
Phone - 00 44 (0)191 438 2500

## IR Introduces GaN-based Power Device Technology Platform



International Rectifier (IR) announced the successful development of a revolutionary gallium nitride (GaN)-based power device technology platform that can provide customers with improvements in key application-specific figures of merit (FOM) of up to a factor of ten compared to state-of-the-art silicon-based technology platforms. It promises to dramatically increase performance and cut energy consumption in and applications in a variety of market segments such as computing and communications, automotive and appliances.

The GaN-based power device technology platform is the result of five years of research and development by IR based on the company's proprietary GaN-on-silicon epitaxial technology. "This GaN-based technology platform and IP portfolio extends IR's leadership in power semiconductor devices and heralds a new era for power conversion,

in line with our core mission to help our customers save energy," said IR's President and Chief Executive Officer, Oleg Khaykin (left).

IR's GaN-based power device technology platform enables revolutionary advancements in power conversion solutions. The high throughput, 150mm GaN-on-Si epitaxy, together with subsequent device fabrication processes which are fully compatible with IR's cost-effective silicon manufacturing facilities, offers customers a world-class, commercially viable manufacturing platform for GaN-based power devices.

Prototypes of several new GaN-based product platforms will be available to leading OEM customers at the Electronica tradeshow which takes place in Munich, November 11-14, 2008.

[www.irf.com](http://www.irf.com)

# Our new autorouter will turn this... into this...

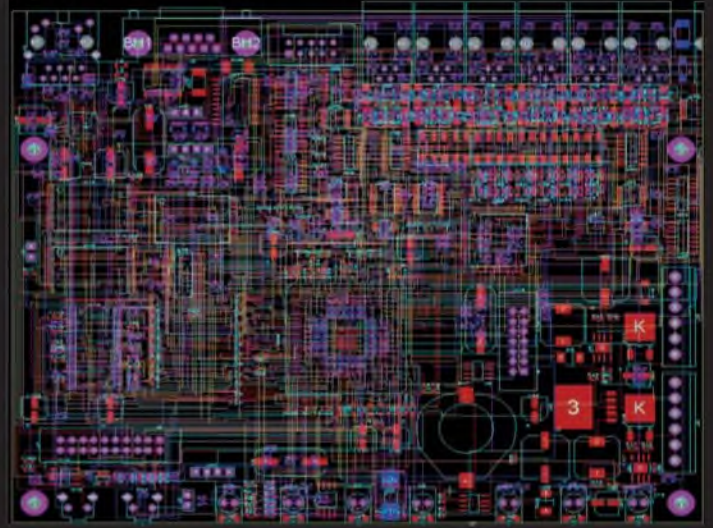
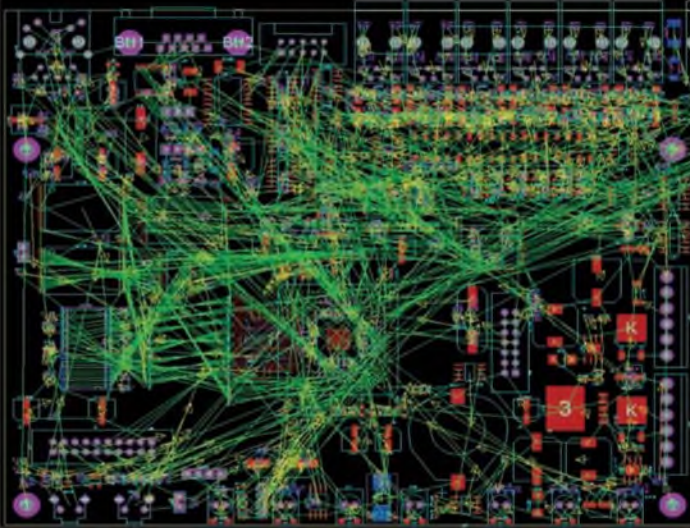

## in less than 5 minutes!

All levels of the **Proteus Design Suite** now include a world class fully integrated shape based autorouter at no additional cost.

The **Proteus Design Suite** also incorporates:

- Professional schematic capture
- Publication quality schematics
- Fully configurable bill of materials
- Large component libraries for both simulation and PCB layout
- Mixed mode SPICE circuit simulation
- Co-simulation of PIC, AVR, 8051 and ARM7 microcontroller firmware
- Automatic component placement and gateswap optimization
- Highly configurable design rules
- Interactive design rule checking
- Polygonal and split power planes
- RS274X, Excellon and ODB++ database export
- 3D Viewer with 3DS and DXF export

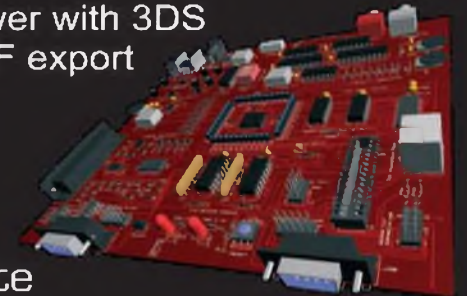

Prices start from **just £150\*** - visit our website for full details or to download a free demo.

**labcenter**  [www.labcenter.com](http://www.labcenter.com)  
**Electronics**

Labcenter Electronics Ltd. 53-55 Main Street, Grassington, North Yorks. BD23 5AA.  
Registered in England 4692454 Tel: +44 (0)1756 753440, Email: [info@labcenter.com](mailto:info@labcenter.com)



\*exc. VAT & delivery

# The New Oscilloscope Experience Is Here



Quick Insight. Deep Insight.  
Experience the New LeCroy Oscilloscopes.

[www.insightwithconfidence.com](http://www.insightwithconfidence.com)

**LeCroy**

Phone 01235-533114 | [www.lecroy.com/europe](http://www.lecroy.com/europe)