

ELECTRONICS WORLD

VOLUME 113, ISSUE 1861



JANUARY 2008 £4.60
www.electronicsworld.co.uk

WHY IS STANDARDISING
LINUX GOOD FOR
DEVELOPERS

HOW TO IMPROVE VOIP
QUALITY IN BROADBAND
CPE SYSTEMS

LEARN OF THE
TECHNICAL
REQUIREMENTS AS
QUAD-PLAY BEGINS

EMC GUIDELINES

SAVE
16%
TODAY
& RECEIVE OUR
2004 LIBRARY
ON CD



What do Marvell Technology and Intel have in common?

Enjoy 2 issues FREE when you subscribe today
– call +44 (0)1795 414608 or visit www.electronicsworld.co.uk



TECHNOLOGY
FIDO – POLICE
DOG
WIRELESS SYSTEM

SPECIAL REPORT
ADDRESSING THE
GLOBAL
COMMUNICATIONS
CHALLENGE

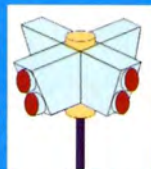

PRODUCTS
MICROOHMMETERS,
MULTIMETERS AND
ELECTRICAL TESTERS



ALSO IN THIS ISSUE: THE TROUBLE WITH RF... @ THE BEST OF IPTV @ BOOK REVIEW

featured products



£81.50

£61.00

CAN-USB & CAN-232

affordable CAN Bus to USB and RS232 interface solutions

Affordable CAN Bus Solutions

CANUSB is a very small dongle that plugs into any PC USB Port and gives an instant CAN connectivity. This means it can be treated by software as a standard COM Port (serial RS232 port) which eliminates the need for any extra drivers or by installing a direct driver DLL for faster communications and higher CAN bus loads. CAN232 is a very small dongle that plugs into any PC COM Port, or any other RS232 port in an embedded system and gives an instant CAN connectivity. This means it can be treated by software as a standard COM Port (serial RS232 port) which eliminates the need for any extra drivers. Sending and receiving can be done in standard ASCII format.

priced from £61.00 (CAN-232)

=== Bronze Prize Winner ===
NASA Tech Briefs 2004
Products of the Year



£125.00

DS1M12 USB Scope / Logger

2 x 1MS/s Input Channels + waveform generator output. EasyScope & EasyLogger s/w included.

USB Instruments - PC Oscilloscopes & Logic Analyzers

Our range of PC Instruments may be budget priced but have a wealth of features normally only found in more expensive instrumentation. Our DS1M12 and PS40M10 oscilloscopes have sophisticated digital triggering including delayed timebase and come with our EasyScope oscilloscope / spectrum analyzer / voltage and frequency display application software and our EasyLogger data logging software. We also provide Windows DLLs and code examples for 3rd party software interfacing to our scopes. Our ANT8 and ANT16 Logic Analyzers feature 8/16 capture channels of data at a blazing 500MS/S sample rate in a compact enclosure.

priced from £125.00 (DS1M12 & ANT8)



£36.00

USB-2COM-M

2 Port Industrial USB RS232 Serial with wall mount bracket and DC auxiliary output

1 to 16 port USB to Serial Adapters

With over 16 different models available, we probably stock the widest range of USB Serial Adapters available anywhere. We offer converter cables, multi-port enclosure style models in metal and plastic, also rack mount units with integral PSU such as the USB-16COM-RM. Serial interfaces supported include RS232, RS422 and RS485. We also supply opto-isolated RS422 and RS485 versions for reliable long distance communications. All our USB Serial products are based on the premium chipsets and drivers from FTDI Chip for superior compatibility, performance and technical support across Windows, MAC-OS, CE and Linux platforms.

priced from £20.00 (US232B/LC)



£65.00

£10.00

UPCI-400HS

4 Port UPCI RS232 Serial Card with Spider Cable or COMBOX IO (extra)

UPCI Serial Cards

Discover our great value for money range of multi-port UPCI serial cards. Supporting from two to eight ports, the range includes RS232, RS422, RS485 and opto-isolated versions. Our 4 port and 8 port models can connect through external cables or the innovative wall mounting COMBOX.

priced from £21.00 (UPCI - 200L)

EasySync Ltd

373 Scotland Street
Glasgow G5 8QB U.K.

Tel: +44 (141) 418-0181 Fax: +44 (141) 418-0110

Web : <http://www.easysync.co.uk>

E-Mail: sales@easysync.co.uk

* Prices shown exclude carriage and VAT where applicable

05 **EDITOR'S COMMENT**
ENGINEER: OVER-USED AND ABUSED

06 **TECHNOLOGY**

11 **TOP TEN TIPS – EMC**

12 **INSIGHT**
THE BEST OF IPTV by
Danny Wilson

17 **ROHS**
Gary Nevison answers readers' questions
relating to the RoHS and WEEE directives

18 **COMPANY PROFILE**
MARVELLISE THIS by **Juan Pablo Conti**

21 **THE TROUBLE WITH RF...**
INDUSTRIAL RADIO, AMATEUR BAND
by **Myk Dormer**



FEATURES

23 **CGL 4.0 – RAISING THE BAR**
The history and latest developments of Carrier
Grade Linux are delved into by **Glenn Seiler**

26 **BUILDING BLOCKS OF BROADBAND**
Craig Iwata and **Sinclair Vass** analyse the technical
requirements of telecom and cable operators as the broadband
traffic and the demand for triple and quad-play begins to soar

29 **RESCUING VoIP QUALITY IN HIGH-SPEED BROADBAND CPE**
Sun Ren and **Stephan Pruecklmayer** explain why VoIP quality
seems to deteriorate fast in certain conditions imposed on
broadband CPE systems and how to best address the issue

33 **ADDRESSING THE GLOBAL SPECTRUM CHALLENGE**
Tim Crocker explains how to go about re-engineering the
network for the broadband 'goldrush'

36 **BISTABLE AND PROUD OF IT**
I. Dozov, S. Joly, L. Faget, D. Stoenescu, S. Lamarque-Forget
and **Ph. Martinot-Lagarde** discuss the bistable nematic displays'
switching mechanisms



REGULARS

40 **UKDL**
TAKING A PEEK AT THE
FUTURE by
Chris Williams

43 **CIRCUIT IDEAS**

46 **TIPS 'N' TRICKS**
Power supply building,
digital level and
analogue translation
blocks * Dual input
boost converter shares
power from two inputs

50 **BOOK REVIEW**

52 **PRODUCTS**

ELECTRONICS WORLD

has now gone online
www.electronicsworld.co.uk

You are clicks away from your own copy of
the magazine – *faster than ever!*

Here, you can register for:

- key-word searches
- article searches
- customised newsletters
- buy any edition of the magazine – including the latest one, before it hits the newsstands
- buy CDs of past articles from different years
- chat on our exclusive forum with like-minded professionals
- comment on articles
- buy techy items
- get software code, references and additional material on certain articles run in the magazine
- win prizes

So, don't waste any time and go to
Electronics World's website now!

www.electronicsworld.co.uk

ELECTRONICS WORLD

EDITOR:

Svetlana Josifovska

Email: svetlana.josifovska@stjohnpatrick.com

PRODUCTION EDITOR/DESIGNER:

Tim Wesson

DISPLAY SALES EXECUTIVE:

Matthew Dawe

TEL: +44 (0) 20 7933 8999

Email: matthew.dawe@stjohnpatrick.com

EDITORIAL DIRECTOR:

Melony Rocque

SALES DIRECTOR:

Chris Cooke

PUBLISHER:

John Owen

SUBSCRIPTIONS:

Davetail Services

800 Guillat Avenue,

Kent Science Park,

Sittingbourne,

Kent, ME9 8GU

TEL: +44 (0) 870 428 1426

Email: saintjohnpatrick@servicehelpline.co.uk

SUBSCRIPTION RATES:

1 year: £46 (UK); €120 (Europe);

\$145 (US & worldwide)

NEWSTRADE:

Distributed by Seymour Distribution Ltd,

2 East Poultry Avenue, London, EC1A 9PT

+44 (0) 20 7429 4000

PRINTER:

William Gibbons Ltd

St John Patrick Publishers

ENGINEER: OVER-USED AND ABUSED

It's been an on-going problem and it's been an on-going debate; a problematic issue which has only intensified with time: the UK suffers from a lack of electronics engineering graduates. Various reports and studies confirm that there aren't many students choosing electronic engineering courses each year, and even less pupils are interested in finding out of what this subject is about.

UK engineering firms like to talk about it and complain. We hear that there are

"IF PAY IS TWICE AS HIGH IN THE FINANCIAL SECTOR THEN IT'S DIFFICULT TO SEE WHY ANYBODY WOULD WANT TO STAY IN ENGINEERING"

"not enough engineers" and yet they've all more or less stopped any kind of sponsorship. We hear "We pick the best from the pool", so why not give all a chance then, as they are only likely to go elsewhere.

Even before they get to apply for jobs in engineering, anything up to 50% of the 'cream of the crop' graduates leave engineering altogether to earn a lot more money in the City. If pay is twice as high in the financial sector then it's difficult to see why anybody would want to stay in engineering.

So, in more ways than one, talent is slipping away.

Turning to another perennial problem: the UK has traditionally had a perception issue with the word 'engineer'. In the UK everybody can call themselves an engineer: a person installing phone lines is

an engineer; a person collecting rubbish bins is a "refuse engineer", we might as well call a housewife a "domestic engineer" (I suspect somebody might have done that already) – we could all be called engineers in the UK!

So, is it surprising when not many children aspire to become one? The first thing a youngster might know of "an engineer" is that he "fixes things" and drives around in a white van. No wonder most of them want to be footballers.

Joking aside, the perception of 'engineering' in this country is dramatically flawed. The simplest thing might be to create a new name for the 'real', professional engineer instead of re-educating the country.

The next thing might be to link the modern word with the modern world, associating it with new and exciting things and away from the glowering looks of Faraday statues and the likes.

And lastly, engineering firms should start to dig deep into their pockets: Pay for sponsorships and, for crying out loud, just pay a decent salary if this business is it to survive here!

Svetlana Josifovska
Editor



Check out Electronics World's new website by clicking on www.electronicworld.co.uk

Electronics World is published monthly by **Saint John Patrick Publishers Ltd**, 6 Laurence Pountney Hill, London, EC4R 0BL.

Disclaimer: We work hard to ensure that the information presented in Electronics World is accurate. However, the publisher will not take responsibility for any injury or loss of earnings that may result from applying information presented in the magazine. It is your responsibility to familiarise yourself with the laws relating to dealing with your customers and suppliers, and with safety practices relating to working with electrical/electronic circuitry – particularly as regards electric shock, fire hazards and explosions.

Optical microphone eliminates distracting noises

Researchers at the Technion Institute of Technology in Haifa have developed an optical microphone that eliminates background noises by monitoring acoustic signals from the human head.

The Optical Noise-Free Microphone (ONFM) for suppression of background noise can reach suppression levels exceeding 50dB as opposed to the current levels of suppression of, essentially, monotonous sound of around 20dB. While the commercial device suppresses to some extent the monotonous 'beep', it fails to suppress the same sound when it is

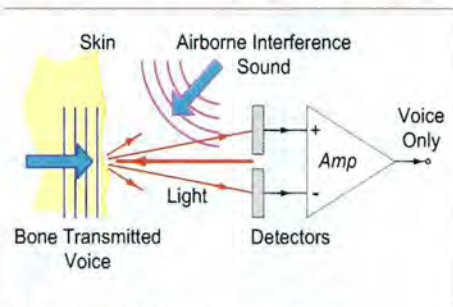

The optical microphone concept

intermittent, and it completely fails to suppress the abrupt noise of hand clapping (upper waveform). The ONFM successfully suppresses both sounds (lower waveform). Another advantage is that it is broadband and requires no delay or build-up times, which are the drawbacks of most of the current devices.

The ONFM suppression relies on a physical process rather than signal processing. The concept was invented by Professor Moti Segev and Zvi Katz and it relies on optical detection of the voice-induced, acoustic vibrations of the head during speech. The ability to detect these minute perturbations permits the differentiation between voice, the signal of interest and background noise, which can thereby be filtered out.

"When we speak, we hear ourselves from the transfer of sound waves in the bones of the head. The ability to identify these tiny acoustical changes in the skull makes possible the differentiation between the voice of the caller –

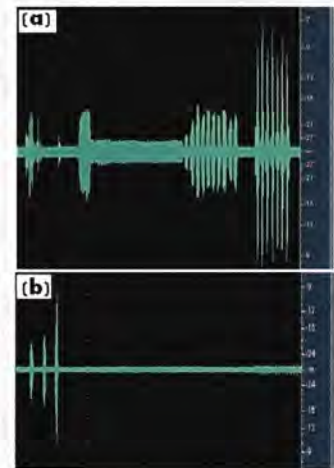

Comparison of sound recorded with a leading-edge commercial noise-suppression device to a recording with an ONFMt

the signal that interests us – and the background noises that come from outside the body," said Segev.

On the basis of this differentiation, the background noises can be filtered out much more successfully than with existing noise filters.

The OFNM drastically reduces the interference from background noise for improved reception and comprehensibility in noisy environments: operating on busy streets, in a car or on a factory floor.

MEMORY MAKERS BACK FLASH STANDARD

Seven electronics companies announced their support for an industry specification for next-generation removable flash memory cards.

The new specification, Universal Flash Storage (UFS), is being developed by the Jedec standards group. The proposal would create an industry spec for removable memory cards and embedded memory products. The UFS standard is expected to be completed in 2009.

Endorsing the proposed standard are Micron Technology, Nokia,

Samsung Electronics, Sony Ericsson, Spansion, STMicroelectronics and Texas Instruments. The companies said UFS would speed access times for flash memories, ease high-speed access to large media files and reduce power consumption in consumer devices. Users currently have a three-minute access time for a 4GB, high-definition movie. The backers said the new standard would reduce that wait to a few seconds.

"Standardisation of flash-based technologies will be crucial in

determining how fast storage devices will be able to fully support industry demand for higher densities and faster transmission speeds," said Frankie Roothparvar, vice president of NAND development for Micron Technology.

George Minassian, Spansion vice president, added that the proposed spec "not only provides significantly higher bandwidth, but also supports low latency accesses and is positioned to provide essential infrastructure in future mobile devices".

FIDO – police dog wireless camera system



Blade, a Belgian Shepherd, with the head-mounted camera

A new solution has started to sweep across the police force: a dog-mounted camera system. Industrial Television Ltd (ITV's) FIDO (Firearms Incident and Dangerous Operations) is now in use by almost all police authorities in the UK and is on the increase overseas.

The idea is not new, but the special features of the FIDO system make it the first fully practical scheme. Earlier efforts failed because their power

consumption needed lead-acid batteries, carried in a fabric waistcoat worn by the dog. The waistcoat and connecting cable tended to snag and trap the dog, and the weight of the pack unbalanced it in movement down stairs and steep slopes, resulting in injuries.

ITV Ltd was commissioned by South Yorkshire Police to design the FIDO system but without the associated problems. Now, the equipment carried by the dog weighs only 440g including batteries and is very well balanced, eliminating the need for a waistcoat. The clip-on camera can be attached at the last moment, and infra-red LEDs in the camera housing provide pictures in dark conditions of objects up to 5m from the dog.

The transmitter operates at 2.4GHz, with excellent transmission through three floors and 100m of building, while outdoor range is up to 500m. Circular polarisation is used, with 8dB of gain and a 50° by 70° aperture. Seven AA-size NMH batteries in the collar give 2½ hrs of operation, with the controlling officer recording to solid-state memory with a colour monitor and audio to listen to whatever the dog is hearing.

NEW FIBRE CAN OPERATE EVEN WHEN SHARPLY BENT

If conventional optical fibre is bent into an arc of small radius at any point along its length, signal transmission can be severely attenuated. This makes it very difficult to use such fibres for connections around buildings in which there are many offices and, also, raises the cost of installations. This has delayed the implementation of fibre broadband systems in some large buildings.

Corning has now developed a new type of nano-structured optical fibre that can be cabled and bent around very tight corners with barely any loss of the optical signal. The nano-structures in this fibre accurately control its internal refractive index

profile without any need for the composition of the glass to be modified. The transmission of the radiation is better controlled than in normal fibre and sharp bends cease to be any problem.

Corning claims that the use of its nano-structured fibre raises the performance on sharp bends by a factor of about one hundred times over that of ordinary, single-mode fibres. The company claims that the nano-structured fibre is as rugged as copper cable, but has all of the bandwidth advantages of ordinary fibre. It expects to make the new material commercially available in the very near future.

IN BRIEF

- Some 90% of 14 and 15-year olds know little or nothing about careers in engineering and technology, revealed a study by the Institution of Engineering and Technology (IET). Engineering also features outside the top ten career choices among the same age group, even ranking behind hotel management. The top three are: lawyer, teacher and professional sportsperson.

Jan Stapleton, head of Education 5-19, at the IET said: "I really expected the results to show young people had an increasingly positive view towards science, technology, engineering and maths subjects and the careers they can lead to. However, the first wave of results has shown that this is simply not the case despite the many activities and initiatives in this area in recent years."

- A newly-refurbished laboratory was opened today at the University of Reading, with a £40,000 investment from Microchip Technology.

The School of Systems Engineering already uses Microchip Technology's devices in its teaching and project work and when an opportunity arose to refurbish an existing teaching laboratory, an approach was made to see if further support would be forthcoming.

"Students on Electronic Engineering and Cybernetics courses will benefit greatly from this exciting new development. It will enhance the learning of all existing students whilst acting as a major recruitment tool for potential undergraduates," said Chris Guy, Head of the School of Systems Engineering.

- The MontaVista software has opened embedded Linux training classes to the public. Previously available only to MontaVista clients, multi-day courses are expected to accelerate product development for all companies considering embedded Linux Vision 2007.

Classes open to the public include interactive courses with topics of "Embedded Linux System Development Jumpstart", "Embedded Linux Foundation for Managers", and "Device Drivers with MontaVista Linux".

Further course descriptions, prices, registration and schedules are available at <http://www.mvista.com/learn>.

IN BRIEF

● **G24 Innovations (G24i) and BASF** have signed a development agreement to jointly develop ionic liquids and formulations that further improve the performance and efficiency of photovoltaic solar cells using a proprietary dye-sensitised, thin-film technology.

G24i produces the photovoltaic cells, which are sensitive to far more of the visible spectrum of light than conventional solar cells, so that all sorts of light sources can be used to generate power, even at relatively low levels of light intensity. BASF is manufacturing the ionic liquids – salts which are liquid below 100°C – that are suitable for use across a broad range of different applications.

● **Altera and TRS-STAR of Germany** announced the PARIS development platform, claimed to be the industry's first fully scalable infotainment platform for the automotive market. The PARIS platform supports CAN, MOST, USB, Ethernet and SDHC interfaces and features a scalable automotive graphics system with multiple video-in and video-out functionalities, an audio processing module and an application processor.

The PARIS platform features a scalable framework which offers up to 50% less development time and system cost. The two firms worked with more than 12 hardware and software intellectual property (IP) providers to help develop this system.

● **Infineon and Jungo** have partnered to deliver a carrier-grade residential gateway platform.

The partnership will enable customers to offer complete solutions for operator-specific products based on a pre-integrated, carrier-ready software platform from Jungo and Infineon's communications chips.

Furthermore, it is claimed that will help significantly reduce the customer's time-to-market by shortening in-house design by up to 50%. The new design is available for ADSL2/ 2+ and VDSL solutions. Service providers deploying gateways based on the new platform can dramatically increase revenue streams by offering new services for home subscribers, say the partners.

Epitaxy trends presented at Cardiff

The market drivers for silicon epitaxy fabrication are mobile phone chips, power ICs (a growing sector) and automotive applications; we will soon see the 45nm technology node, transistors that can switch at 3×10^{11} times per second, the use of 7-9 metal layers and an estimated length of copper wiring of over 1000 miles on each 300mm wafer. This was the view of Robert Harper, technical sales manager of IQE Silicon Ltd in Cardiff, UK, speaking at the S2K conference organised by JEMI UK.

Harper said there are lots of new opportunities for the application of silicon epitaxy including next generation strain technologies (following the demonstration of tensile embedded strain

using silicon carbide); engineered substrates such as SOI products; large bandgap materials like GaN on silicon; and monolithic integration of III-V materials on silicon.

Silicon epitaxy can be used on other substrates for improved thermal transfer, such as on diamond or silicon carbide, and for isolation characteristics (silicon on sapphire on silicon, as an alternative to an SOI substrate).

SiGe buffers can be used to engineer the lattice constant of Ge, which is suitable for use in solar cells and III-V materials on Si or Ge. It is also suitable for layer transfers, while etch stops can be introduced to enable the re-use of donors.

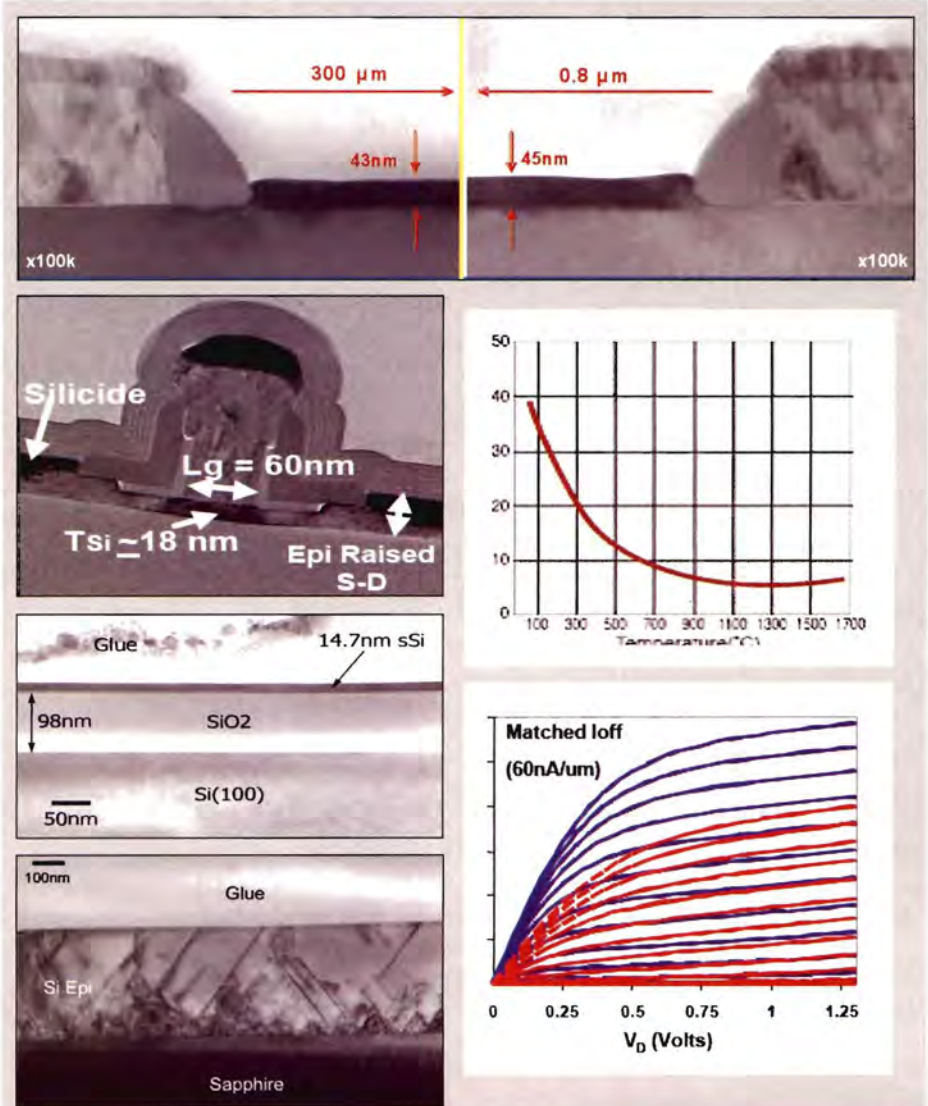

Epitaxy thickness variation with pattern density must be avoided

Look at the Peripherals You Can Map to I/O Pins

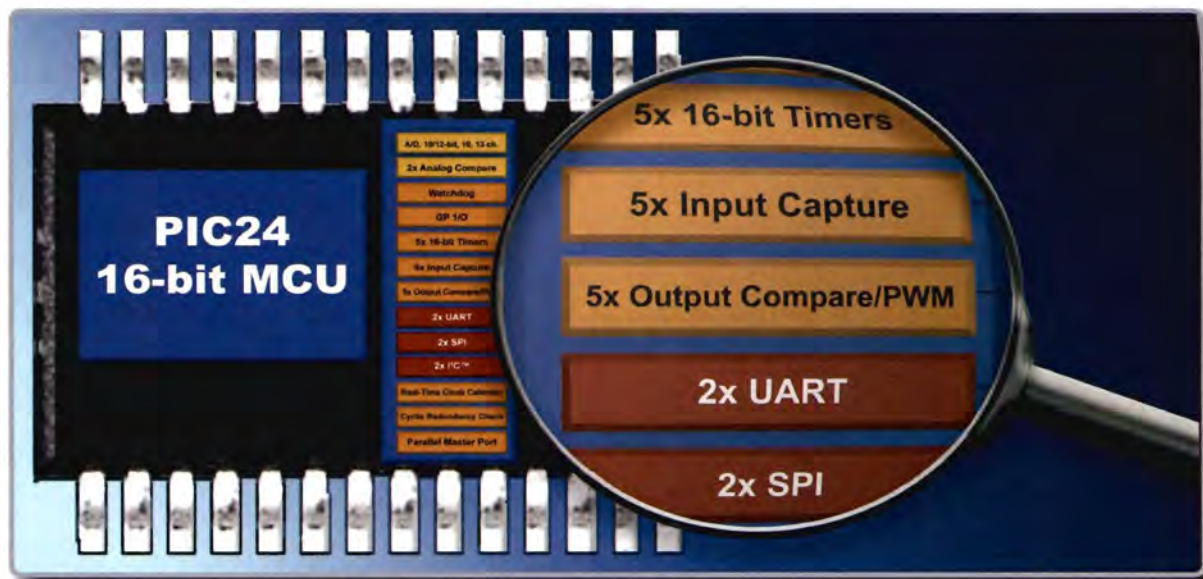

Now you have the flexibility to customize your microcontroller with Microchip's Peripheral Pin Select feature

Microchip's 16-bit PIC24 microcontroller family includes tiny 28-pin devices that offer up to 64 KB of Flash and 8 KB of RAM, with a peripheral set that can be dynamically customized for your application.

3 EASY STEPS TO GET STARTED...

1. **FREE** 16-bit web seminars
2. **FREE** product samples
3. **Exclusive development tool discounts available at www.microchip.com/LPC**



Check out our web site for special pricing on the 16-bit 28-pin Development Kit and MPLAB® ICD 2 In-Circuit Debugger!

Visit www.microchip.com/LPC today!

microchip
DIRECT
www.microchipdirect.com

Now
Pb-free!
RoHS Compliant

MICROCHIP
www.microchip.com/LPC

Low Pincount 16-Bit Microcontrollers				
Device	Pins	RAM (KB)	Flash (KB)	Features Include
PIC24FJ16GA002	28	4	16	5x 16-bit Timers
PIC24FJ16GA004	44	4	16	5x Output Compare/PWM
PIC24FJ32GA002	28	8	32	5x Input Capture
PIC24FJ32GA004	44	8	32	Real Time Clock Calendar
PIC24FJ48GA002	28	8	48	2x UART
PIC24FJ48GA004	44	8	48	2x SPI
PIC24FJ64GA002	28	8	64	2x I ² C™
PIC24FJ64GA004	44	8	64	Parallel Master Port
PIC24HJ12GP201	18	1	12	2x Analog Comparators
PIC24HJ12GP202	28	1	12	10/12-bit ADC

Purchase and program your 16-bit PIC24 devices and related development tools at www.microchipdirect.com

MEMS in strong growth

The Micro-Electronic Mechanical Systems (MEMS) market is on the up, expected to reach \$10.8m in 2011 with a 13% compounded annual growth. Among the new MEMS products to be introduced this year alone are the silicon microphone, whose volumes are anticipated to exceed 270 million units; the micro-fuel cell and the first RF MEMS switch integrated into a mobile phone.

According to a presentation given by Jean-Christophe Eloy of Yole Développement in Lyons, France, at the S2K conference in Cardiff, there are three key trends in MEMS work. These include the use of MEMS for "More than Moore" integration of RF front-end modules in transceivers and 3D ICs integration, and the use of MEMS to replace non-silicon devices, including replacements for quartz devices, electret condenser microphones, antenna switches, optical autofocus and zoom, among others. MEMS will also facilitate a step-by-step move from sensors to integrated modules.

Eloy explained that putting MEMS devices into consumer applications is a great challenge. The cost structure must be adapted, especially for packaging, while a complete function or module approach is needed to help integrators use MEMS devices as well as make adjustment for the shorter product life-cycle.

Manufacturing of MEMS on 8-inch wafers is becoming more popular. Bosch has announced a new

2006 ranking	Company	2005	2006	Annual Growth
1	STMicro electronics	\$198.00	\$200.00	1%
2	IMT	\$14.00	\$21.00	50%
3	Sony	\$15.00	\$20.00	33%
4	APM	\$15.00	\$17.00	13%
5	Micra Lyne	\$14.00	\$17.00	21%
6	Dalsa semiconductor	\$15.20	\$16.20	7%
7	ELM OSMI	\$10.50	\$14.00	33%
8	Mems Tech	\$13.00	\$13.50	4%
9	Colibrys	\$12.00	\$13.50	8%
10	Silex	\$6.70	\$13.10	96%
11	Mems Cap	\$6.00	\$10.30	72%
12	Tronic Micro Systems	\$7.40	\$8.70	18%

Ranking of the MEMS foundries, 2006

investment after moves by STMicroelectronics, DNP, Jazz Semiconductor and Texas Instruments, with more announcements expected soon.

Three manufacturers employ thin film wafer level packaging for MEMS devices now in production, among them Freescale for low g accelerometers, Bosch for gyroscopes and SiTime for resonators (under a Bosch licence).

The MEMS industry is still very fragmented when it comes to

companies and products, but the production infrastructure is established, with automotive and consumer applications driving the business. New companies are fabless, using existing MEMS and independent device manufacturing fabs. In 2016 MEMS markets could be \$18bn worldwide, with 70% of the total market in the hands of the semiconductor manufacturers, mainly for consumer business. This would leave \$6bn for non-consumer applications.

Top Ten Tips

Guidelines for EMC

01. Electromagnetic Compatibility (EMC) is as amenable to analysis as any other aspect of system design.

Development of hardware and software over the past half-century has made it possible for the engineer at the bench to deal with the EMC requirements of equipment as a matter of course. Computing power of personal computers, development of SPICE software and the low cost of general-purpose test equipment have all contributed to the present situation. Tests can be carried out on the system under development and the results can be immediately analysed. The key to this approach is the use of circuit modelling to simulate the coupling of interference into the system and out of the system.

There are several advantages to the use of circuits:

- * An experienced designer can deduce the function of an item of equipment, just by looking at the circuit diagrams;
 - * Circuits can be used to create a set of equations which define the performance of the equipment;
 - * Either frequency analysis or transient analysis can be invoked. This avoids complex transformations between the frequency and time domains;
 - * A definitive circuit model can be created to simulate the interference coupling characteristics of any particular wiring configuration.
 - * Circuit designers work with currents and voltages, not with E and H fields.
- Characteristics which would seem to rule out the use of circuit modelling are:
- * Current in any branch of a circuit is solely dependant on the voltage appearing across that branch. Electromagnetic theory indicates that current in any branch will affect the voltage across every other branch.
 - * Current entering a branch at one end is exactly the same as the current leaving the branch at the other end. No antenna could function if this were true.

However, once these problems are identified, ways can be found to overcome them. When this is done, the many analytical tools available in circuit theory can be invoked to assess the EMC of the system-under-review.

It cannot be claimed that designing a system to meet the EMC requirements is at all simple. But it can be suggested that the task is well within the capability of any subscriber to *Electronics World*.

02. There is no such thing as the equipotential ground plane.

Ground planes are an extremely useful design feature of printed circuit boards and integrated circuits. But this does not mean that they are equipotential surfaces. Nor does it mean that a conductor designated as 'ground' or 'earth' is automatically a zero reference point for all signals in the system.

Figure 1 illustrates a cross-sectional view of two conductors routed over a flat conducting surface. It is assumed that current is flowing down conductor 1 and back via the length of the ground plane, whilst conductor 2 is shorted to ground at both ends. Since all points along the width of the plane are at the same potential, it is possible to simulate its effect by replacing it with two image conductors.

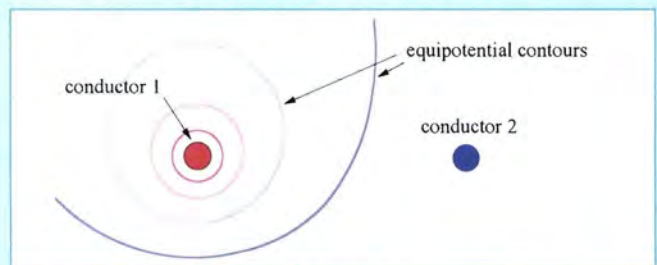

Figure 1: Two conductors above a ground plane

Using data on the physical dimensions, formulae can be derived which define the inductive properties of the assembly. This results in **Figure 2**. In this circuit, it is assumed that conductors 1 and 2 are shorted to the ground plane at the far end; that a sinusoidal signal is applied at the near end; and that the short circuit at the near end of conductor 2 is replaced by a voltmeter. Since inductors $L1$ and $L3$ are acting as a potentiometer, a voltage $V2$ will appear between the monitor points. This means that the voltage at the far end of the ground plane is different from the voltage at the near end. If a voltage exists along the surface, it cannot be equipotential.

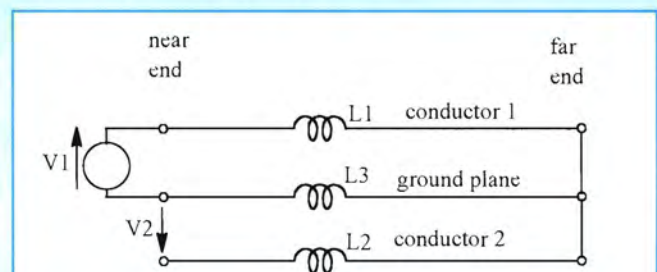

Figure 2: Inductive properties of assembly of fig. 1

The fact that a set of equipotential points exist along any width of the plane does not mean that all voltages along the length are the same. The action of the ground plane is extremely useful in the design of printed circuit boards. It provides a return path for signal current precisely where it is needed.

If the ground plane is assumed to be equipotential, then all sorts of problems arise when an attempt is made to understand the coupling mechanisms. It is not surprising that EMC has often been declared to be a black art.

Assumption of the existence of an equipotential surface is evident in every circuit diagram which includes the ground symbol, or any of its variants. This may be reasonable if the purpose is to describe the function of the circuit, but totally counter-productive if the objective is to analyse EMC. The existence of this symbol means that the return path for every signal current is undefined.

If half the circuitry is unknown, then the EMC of the system is out of control. Its function can be affected by all manner of extraneous sources. Hence the familiar announcement: "Will all passengers please switch off their mobile phones".

03. Route the return conductor as close to the signal conductor as possible.

If a current starts to flow in a wire, it immediately sets up an electromagnetic field which spreads out at the speed of light. This field causes a current to flow in any adjacent conductor in the opposite direction. The less the spacing between the conductors, the less time it takes for the return current to be created, the greater the coupling and the better the balance between signal and return currents.

If the return conductor is routed some distance away from the signal conductor, then more of the electromagnetic field will couple with other conductors of the system – a clear recipe for high levels of interference. If dedicated conductors are added to a cable bundle to carry return currents, then there is no need to construct conduits and trays for that purpose.

04. As far as it's practicable, balance the signal and return currents.

If the signal and return conductors are close together, natural forces will act to balance the two currents. This balance can be enhanced or destroyed by the design of the interface circuitry at the conductor terminals.

Figure 3 illustrates one way of enhancing the current balance. All the resistors (R1 to R4) at the receiver have equal value. So the operational amplifier is non-inverting, and has a gain of unity. Feedback to the inverting input acts as a source for the current *I*return. Over the operating range of the amplifier, *I*return is equal in magnitude and opposite in direction to *I*signal. This is just one way of enhancing balance. There are others.

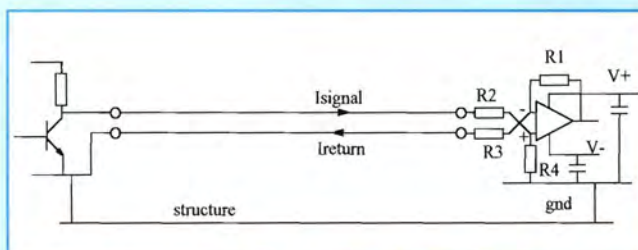

Figure 3: Balancing the signal and return currents

In **Figure 4**, the bypass capacitor C1 acts as a short circuit to send transient current back into the earth conductor. A closure of the switch results in a brief burst of high frequency oscillation that couples energy into the mains supply cable. The cable then acts as an antenna to radiate interference far and wide. When the switch is opened, the unwanted energy in the filter departs via the same route.

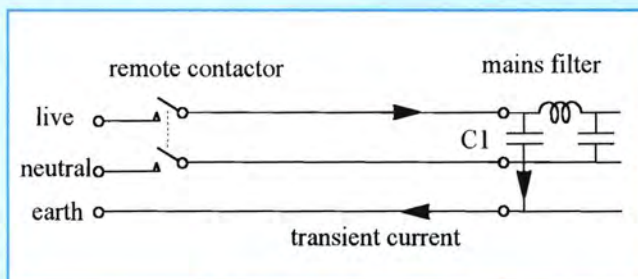

Figure 4: Bad practice

This configuration destroys the balance between live and neutral currents and creates high levels of emission by the system.

05. Ground loops are good

In any electronics system, there is a multitude of individual functions, each with its own discrete circuit module. Each module needs to be supplied with power, usually from the mains supply via a switched mode converter. Safety considerations dictate that the earth conductor of the mains be connected to the structure of the assembly.

Consequently, the return conductors in each module are connected to the structure of the module, and the structures of the modules are connected to the framework of the assembly.

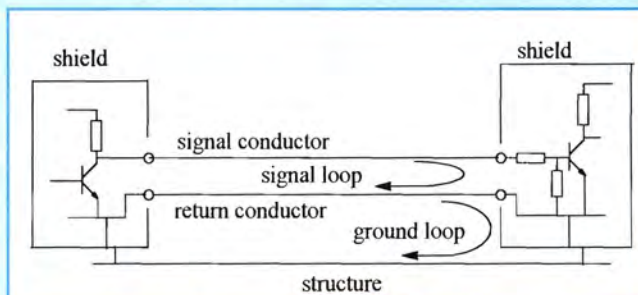

Figure 5: Large ground loop, small signal loop

The net result is that a ground loop is formed between the return conductor and the structure connections, as illustrated in **Figure 5**. Any external field which links with this loop will also link with the loop formed by signal conductor and structure. Each conductor will experience the same induced voltage along its length. Since the induced voltages are equal, they will cancel each other out. The configuration is effectively a common-mode transformer. Although there will be some common-mode to differential-mode coupling, the resultant interference is dramatically less than would be the case if the return conductor did not exist. Hence, susceptibility is much reduced.

Unwanted emissions are also reduced, since the electromagnetic signal is effectively contained by the signal and return conductors. In a multilayer circuit board, the ground plane carries the return current for every signal carried by a copper trace on the adjacent surface. This gives rise to a large number of circulating currents. Effectively, the flat conducting surface contains a multitude of ground loops. This is good.

06. Treat each conductor pair as a transmission line.

Although transmission line equations are not often used in the design of low-frequency circuits, they still apply. There is no cut-off point in the spectrum where they cease to be valid. Transmission line theory introduces the concept of the characteristic impedance. Optimum transmission is obtained when the input impedance of the receiver is equal to the characteristic impedance of the line. There is no reflection of energy. If the source resistance is also equal to the characteristic impedance, then there are no reflections at either end.

If the line is operating at maximum efficiency, then it must also be experiencing minimum loss. Since much of the loss is due to radiation, it follows that by terminating the line correctly, minimum radiation will occur. This configuration also experiences minimum susceptibility, since no spurious signal will be reflected or amplified.

As far as a step pulse is concerned, a capacitor looks like a short circuit and an inductor looks like an open circuit. Hence, a filter capacitor between live and neutral of the mains power supply will reflect all the energy of the pulse back into the line. This means that when an item of equipment is switched on, all the transient energy is reflected back into the mains supply.

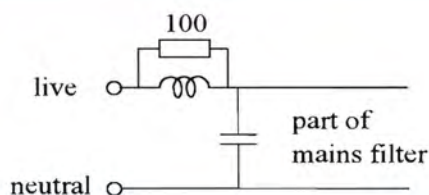

Figure 6: Parallel resistor

One way of avoiding this situation would be to include a resistor in parallel with the series inductor, as shown in **Figure 6**. Another would be to insert a resistor in series with the bypass capacitor. **Figure 7** illustrates this option. As far as transient signals are concerned, each of these filters look like a 100-ohm resistance. This is a fair approximation to the characteristic impedance of a two-conductor mains cable.

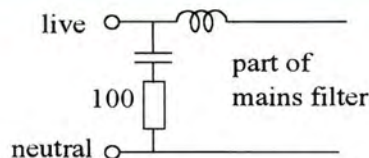

Figure 7: Series resistor

07. Absorb unwanted energy.

Two loop currents are identified in **Figure 5**, the signal loop and the ground loop. These could equally well be named differential-mode loop and common-mode loop. Hence the previous guideline is a recommendation that the differential-mode current be treated as a transmission line signal.

The same reasoning applies to the interference signal carried by the common-mode loop. If it is short circuited at both ends, then reflections will occur and the unwanted signal will reverberate backwards and forwards along the line. If the interference is occurring at a frequency equivalent to a half-wavelength, then the ground loop will act like a tuned circuit to amplify the signal dramatically. If one end of the common-mode loop is open circuit – that is, if the load is floating – then the reverberations will peak at the quarter-wave frequency. This means that there is little point in trying to ‘float’ every load. Breaking the ground loop only moves the problem to another part of the spectrum.

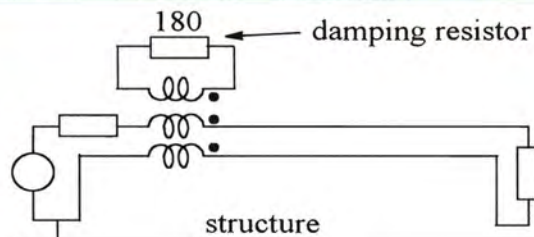

Figure 8: Transformer-coupled damping

The only way of preventing the amplification of interference signals is to absorb the unwanted energy in a resistance.

Figure 8 shows one way of achieving this objective. Add a third winding to a common-mode transformer and connect a damping resistor between the terminals of the new winding. Then clamp the transformer round the cable, near to the grounded termination. The

resistor will act as a load to any interference current in the cable. Since this resistor is effectively in series with the common-mode current, it prevents the high peaks that would occur at resonance. The common-mode resistor works equally well whether the cable is grounded or floating. In the example shown, the far end of the cable is floating.

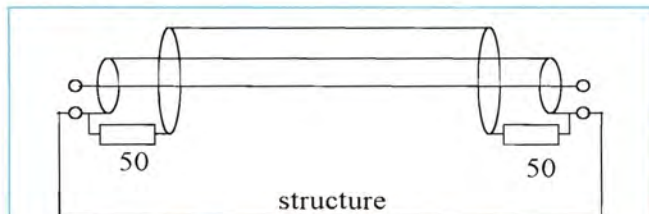

Figure 9: Tri-axial termination

Another way would be to insert a co-axial cable in a braided sheath and connect each end of the sheath to the cable screen via a resistor, as shown in **Figure 9**. Skin effect ensures that common-mode current from an external source will flow in the outer sheath. The resistors will attenuate any spurious current.

08. Analyse critical signal links.

A minimum of three conductors are involved in the coupling of electromagnetic energy into and out of any particular circuit. In the examples shown, these are signal, return and structure. Three conductors are necessary.

If all the other conductors in the system are treated as part of the ground path, then the analysis can be limited to three conductors. From an engineering point of view, three conductors are sufficient. This means that the analysis of three-conductor interconnections will enable EMC to be assessed. Basic textbooks on electrical engineering derive equations relating the physical dimensions of three conductors to the electrical parameters of inductance, capacitance, and resistance. A fundamental circuit model can be constructed, as shown by **Figure 10**. Adding details of the interface circuitry at the terminations enables a definitive circuit model to be created of the configuration-under-review. SPICE software can then be used to simulate the response of the model. To present-day personal computers, the number crunching is a piece of cake.

Conducted emission can be defined as the ratio of common-mode current I_2 to the source voltage V_1 when V_2 is equal to zero. Conducted susceptibility can be defined as the ratio of the differential-mode current I_1 to the voltage V_2 applied to the common-mode loop when V_1 is equal to zero. Both parameters are defined in terms of the ratio of current in one loop to the voltage in another loop. That is, as a transfer admittance. Components in **Figure 10** can be described as lumped parameters, since the current entering each branch is assumed to be the same as the current leaving. Analyses are reasonably

accurate up to about half the frequency of first resonance. They also give a fair indication of the response up to the second resonance. More accurate analyses at higher frequencies involve the use of distributed parameters, where the current in each branch is assumed to vary. Fortunately, this assumption has only a marginal effect on the complexity of the mathematics. Algorithms in the form of Mathcad worksheets are available to carry out this more accurate simulation. All the software is low-cost. Any circuit designer can understand it and use it.

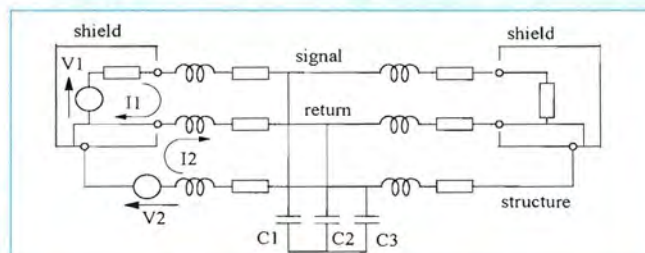

Figure 10: Circuit model of set-up

The technique can be developed to simulate radiated emission and radiated susceptibility, by treating the environment as a virtual conductor.

For the analysis of radiated emission, the common-mode current I_2 can be regarded as a radiation source. This can be related to the power density of the radiated signal at a particular distance. Power delivered to a receiving antenna can be related to the power density. Hence, the results of a radiated emission test can be predicted. For susceptibility analyses, it is entirely possible to define the threat environment in terms of the intensity of the electric field versus frequency. The voltage V_2 induced in the cable-under-review is proportional to the electric field strength and to the wavelength.

09. Test at all stages of development.

It is a wise move to confirm the results of analytical simulation by carrying out tests at the earliest possible stage in the project. **Figure 11** is a block diagram of the test equipment used for interference susceptibility measurements. The voltage transformer is a split-core ferrite with a monitor winding. Using this approach, the equipment-under-test (EUT) can be checked at the prototype stage, during field trials, or at any time between. All the test equipment is low-cost. Measurement of the transfer admittance for conducted emissions can be achieved by applying a known voltage between the signal and return terminals of the line and noting the amplitude of the common-mode current. Current measurement is achieved simply by a split-core ferrite, configured as a current transformer and clamped round the cable.

The test results can then be correlated with the analytical results obtained from physical measurements and circuit theory. If close correlation is achieved, a high level of confidence can be achieved on

the quality of the design. Precise correlation can be obtained by modifying the circuit model.

A definitive circuit model derived from emission tests can be used to predict the susceptibility characteristics, and vice versa. This model can be

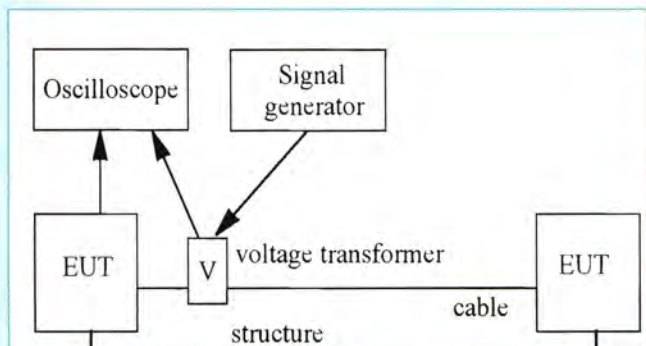

Figure 11: Block diagram of a susceptibility test

developed to predict the EMC of a wide range of similar configurations. In particular, the circuit model derived from tests on a long cable can be used to define the coupling characteristics of a short length.

10. Plan effectively.

The first step is to identify the transmission links which are likely to cause problems. The second step is to construct circuit models to simulate the interference coupling parameters of each of the links so identified. The simulated performance of each model can be compared with the formal EMC test requirements. This should allow the details of each problem to be identified.

It is possible to establish an iterative process during the development of a system. Analyses indicate the type of testing needed; testing identifies the flaws in any analysis; assessment of the results leads to an understanding of the coupling mechanisms and this understanding leads to design decisions. These decisions could be to proceed to the next stage of development, or to modify the system. The earlier such decisions are made, the more cost-effective the design process. Using this approach, the EMC requirements can be dealt with in exactly the same way as any other system requirement. That is, in the same way as system function, frequency response, power consumption, size, mass, reliability and cost. Analytical reports so gathered could form the basis of the Technical Construction File. The work could be carried out in-house, without the need to involve an EMC test facility. Cost saving could be significant. ■

This month's top ten tips were supplied by Ian Darney. You can find out more by going on www.designemc.info.

If you want to send us your top tips on any engineering and design subject, please write to the Editor: svetlana.josifovska@stjohnpatrick.com

www.stewart-of-reading.co.uk

Check out our website, 1,000s of items in stock.



PM3082 - £195



HP 34401A - £500 to £550



HP33120A - £575 to £700



HP 8563A - £6,000

DIGITISING/STORAGE OSCILLOSCOPES

HP 54816B Digitising 500MHz 2GS/S 2 Channel	£1,100
TEKTRONIX TDS520 Digitising 500MHz 500MS/S 2 Channel	£800
TEKTRONIX TDS360 Digitising 200MHz 1GS/S 2 Channel	£650
TEKTRONIX 2232 Dual Trace 100MHz 100MS/S	£325
HP 54600B Dual Trace 100MHz 20MS/S with RS232: 2HP Probes, Ops Manual, Pouch & Front Cover	£325
TEKTRONIX TDS224 Digitising 100MHz 4 Channel 1GS/S	£750

SCOPEMETERS

FLUKE 97 Dual Trace 50MHz 25 MS/S	£295
-----------------------------------	------

OSCILLOSCOPES

TEKTRONIX 2465B 4 Channel 400MHz Delay Cursors etc incl. Tek Probes	£750
PHILIPS PM3082 2+2 Channels 100MHz Delay TB etc. Autoset	£195
TEKTRONIX 2445A 4 Channel 150MHz Delay Sweep Cursor etc	£375
GOULD OS300 Dual Trace 20MHz	£75
PHILIPS PM3217 Dual Trace 50MHz Delay Sweep	£125
FARNELL DTV12-14 Dual Trace 12MHz	£40
TEKTRONIX PB139A 100MHz Probes - Unused	£140

STEWART of READING
17A King Street, Mortimer, Near Reading RG7 3RS
Telephone: (0118) 933 1111
Fax: (0118) 933 2375
www.stewart-of-reading.co.uk
9am-5.00pm Monday to Friday



MARCONI 2024 - £1,250 to £1,500

SPECTRUM ANALYSERS

HP 8563A 9KHZ-22GHZ Synthesised	£6,000
HP 8580A 50HZ-2.9GHZ Synthesised Various opts	£1,900-£3,250
HP 8590A 10KHZ-1.5GHZ	£1,400
HP 3580A 5HZ-50KHZ	£295
ADVANTEST TR4132 100KHZ-1000MHZ	£750

SIGNAL GENERATORS

HP 83731A Synthesised 1-20GHZ	£5,000
Marconi 2032 Sig Gen, 10KHZ-5.4GHZ Opt 01/02/06	£3,250
Avonics	£750
HP 8F48A Sig Gen 0 1-1000MHZ	£750
Cigitalonic 7100 Synth 10MHz-20GHz (internal sweep/mod 130 to +15dBm)	£3,000
Marconi 2024 9KHZ-2.4GHZ - HP1B used/unused	£1,250-£1,500
Marconi 2022E Synthesised AM/FM 10KHZ-1.01GHZ	£500
Marconi 2019A Synthesised AM/FM 80KHZ-1040MHZ	£150-£195
HP 33120A Function Gen. 100 microHz-15MHz used/unused	£575-£700
T.T.I TG210 Function Gen 0 002Hz-2MHz TTL etc.	£70
R&S APN62 Synth Function Gen 1Hz-260KHz Bal/Unbal Output LCD	£195
Metrix GX5000 Pulse Gen 50MHz Programmable	£150
HP 3325A Synthesised Function Gen 21MHz	£295

HP 3312A Function Gen 0 1Hz-13MHz AM/FM Sweep/Tri/Burst etc	£175
HP 8112A Pulse Gen 50MHz	£350
HP 8116 Pulse/Function Gen 50MHz	£750
Gould J3B Sine/Sq Osc 10Hz-100KHz Low Distortion	£50-£75

FREQUENCY COUNTER/TIMERS

HP 5350B Counter 20 GHz	£750
Marconi 2440 Counter 20 GHz	£500
Racal 1998 Counter 10Hz-1.3GHz	£225
Racal 1991 Counter/Timer 160MHz 9 Digit	£150
HP 53131A Universal Counter 3GHz Opt 001 oven	£995/£750
HP 53131A Universal Counter 225MHz Oven-in original boxes - unused/used	£700/£600

DIGITAL MULTIMETERS

HP/Agilent 34401A 8 1/2 Digit	£500/£550
Solartron 7150Plus 8 1/2 Digit True RMS IEEE w/h tem measurement	£75
Fluke 77 series 2 3 1/2 Digit Handheld	£45
AVO 8 Mk6 in Ever Ready Case with Leads etc	£75
AVO 9 Mk5 with Leads etc	£50
Goodwill GWT427 Dual Ch AC Millivoltmeter 10mV in 12 ranges 10Hz-1MHz. Unused	£80

MISCELLANEOUS

MARCONI 2955A Radio Communications Test Set	£1,000
MARCONI 2955 Radio Communications Test Set	£625
MARCONI 6950B RF Power Meter with head	£500
MARCONI 893C AF Power Meter Sinead Measurement Unused	£50
HP 4192A Impedance Analyser with 16047A Text Fixture etc	£3,500
HP 8902A Measuring Receiver 150KHz-1300MHz	£4,500
HP 85032A Calibration Kits	£400
SEAWARD Nova Pat Tester	£195
BIRD 43 Wattmeter - Many Elements Available	£75
HUNTRON 1000 Tracker	£75
RACAL DANA 8343M LCR Databridge Digital Auto Measurements of RCL QD	£95
RACAL 9008 Automatic Modulation Meter 1.5MHz-2GHz	£60
MEGGER PAT2 Tester	£95

POWER SUPPLIES

FARNELL AP60/50 0-60V 0-50A 1KW Switch Mode	£400
FARNELL H60250-80V 0-25A	£400
THURLBY PL320QMD 0-30V 0-2A Twice Digital	£180
H.P. 6826A Precision High Resolution 4 Outputs 0-7V 0-15mA or 0-50V 0-0.5A Twice 0-16V 0-0.2A or 0-50V 0-2A Twice	£500
FARNELL XA35 2T 0-35V 0-2A Twice Digital	£85
FARNELL B301030V 10A Variable No Meters	£55
FARNELL LT30-1 0-30 0-1A Twice	£60
FARNELL L30-2 0-30V 0-2A	£50
THURLBY PL330 0-32V 0-3A Digital (Kenwood badged)	£75
THURLBY PL320 0-30V 0-2A Digital	£65
TAKASAGO GM305-2 0-35V 0-2A 2 Meters	£35

Used Equipment - GUARANTEED. Most Manuals supplied
Please check availability before ordering or calling.
Prices plus carriage and VAT

THE BEST OF IPTV

DANNY WILSON, PRESIDENT AND CEO OF PIXELMETRIX CORPORATION ARGUES THAT TOO MANY IPTV OPERATORS FORGET THAT, TO A GREAT EXTENT, THE PROCESS IN ANY RESELLER BUSINESS IS THE SAME, INCLUDING THAT OF TELEVISION PROGRAMMES



There are few things generating more hype in the technology and entertainment world than IPTV (and, I guess, aside from the iPhone). Promising a tidy response to years of declining fixed-line voice revenues at the telcos, providing television over their broadband networks is supposed to be the final bullet against the cable operators – the triple play. If only that could be true.

Fuelling the optimism of a global, unified information, communication and entertainment infrastructure is the multitude of conferences and exhibitions focused on IPTV. The IPTV World Forum last year showed off the 'IPTV Ecosystem' in its full glory.

The presentations ran the full spectrum of technology primers, case studies by emerging operators, as well as handy and clever money-making ideas for new operators. I was privileged to take part in the session on strategies for launching and growing the business of IPTV for operators. Following presentations from five telecom operators on their service offerings and future plans for television delivery, the panel discussion centred on the "revenue generators and killer applications".

The usual euphoria of the next new thing was evident in the papers presented by all the main speakers: that the operators have a long history of success with DSL and broadband services, and their television services are built on a solid technology base.

However, questions from the audience revealed a few cracks in the armour. For example, after aggressive questioning from one audience member, a spokesman from a major European telecom operator would neither confirm nor deny how many actual customers they had, or exactly why they consistently refused to sign up that same audience member for their IPTV service despite numerous applications.

The ensuing panel discussion, consisting of only network equipment providers, naturally focused on 'other' key success factors for IPTV: "You'll need more routers," said the router company, "and good DSLAMs" said the DSLAM company, "and don't forget the audio", said the audio processor company, and so on.

But like the child in 'The Emperor's New Clothes', we do really need to step back and consider what IPTV is really all about. Fully half of IPTV is, well... TV! It is a simple fact, yet one that is so often overlooked. People want to watch television.

And you know what? Television has already been around for a long, long time. It is hardly a new thing. Within that context, the standard of performance and expectations of the viewing public have also been set

long ago. My aunt, your mother or your friend's father could hardly be concerned with whether their TV is 'IP' or not - only that the quality of the picture and sound are acceptable, the user experience is acceptable and they can watch their favourite shows.

To effectively compete against cable, satellite and terrestrial, IPTV operators have to realise that the 'TV' is the important part of IPTV. Whatever standards for quality, price and program availability exist from the established players, these must be exceeded by the new players.

Too many IPTV operators are preoccupied with the mechanics of the IP network. Why? Because, since the beginning, telcos have existed as 'service' providers. They enable two people to 'talk' with each other and they take a cut for providing that service.

Television, on the other hand, is a reseller business model. An operator must buy content (TV programs), mark them up and sell them at a profit. It seems obvious when you read it here, but it is surprising how many IPTV operators have yet to realise this.

To a great extent, the process in any reseller business is the same: buy some product, make sure you get what you pay for (incoming QA), package it attractively and deliver it undamaged to the end consumer. All of these process steps apply equally well to IPTV as they do to the shoes or tires business. And it is this attitude and process which must be adapted for IPTV to be successful; to first ensure the direction is right: we are going to provide television; to make sure the inventory we buy (content) is something we can profitably resell; and finally, effectively manage the supply chain (content delivery). This last part then, of course, confirms that 'we get what we pay for' and that 'we meet our delivery obligations to the end consumer'.

With a happy customer – glued to his TV – comes good fortune and profitability. ■

With a happy customer – glued to his TV – comes good fortune and profitability



Gary Nevison is chairman of the AFDEC RoHS team, and Customer Support Manager, Legislation and Environmental Affairs at Premier Farnell. As such he is our industry expert who will try and answer any questions that you might have relating to the issues of RoHS, WEEE and REACH. Your questions will be published together with Gary's answers in the following issues of Electronics World.

IMPACT ON DESIGN

Of all the recently adopted EU legislation, the Ecodesign of Energy using Products (EuP) Directive (2005/32/EC) is likely to have the most significant impact on the design engineer. This is a framework directive which means that it does not impose requirements on manufacturers, or their designers, but sets up a mechanism for introducing "implementing measures" that will impose specified design requirements. EuP has a very broad scope including any product that consumes, generates or controls energy (excluding transport).

The main aim of the directive is to reduce the energy consumption of electrical equipment, especially while in use. However, any environmental impact such as the use of hazardous substances and ease of recycling could also be legislated.

The directive itself sets a list of criteria that need to be met if an implementing measure is to be permitted. In order for the directive to apply, there have to be at least 200,000 units sold per year of a given product, although the directive does not specify whether this is of individual product types or broad categories.

There must be significant potential for environmental improvement but without serious cost to industry or consumers. It is the responsibility of the European Commission to carry out studies to determine if implementing measures are required and to then recommend targets, such as energy consumption reductions, that must be reached. So far there have been over 20 studies into different product types and many more will be carried out in the future.

Studies underway include:

1. External power supplies and battery chargers (now completed);
2. Stand-by and off-mode power losses;
3. Personal computers;
4. Consumer electronics – televisions;
5. Office lighting;
6. Street lighting (now completed);
7. Set top boxes;
8. Electric motors 1 – 150kW.

The first two of these are generic and cover a wide variety of product types whereas the others target specific products or components. The recommendations from the two studies that are complete are useful to illustrate the type of requirements that will be required for all products, although it should be noted that the aim of the studies is to provide options, not to make specific recommendations.

This study identified the best available technology that is in current use as well as developments that will be available in the near future. It is likely that implementing measures will force designers to utilise new low energy technologies. These include:

- Switch-mode power conversion;
- Integrated ICs;
- Efficient transistors such as MOSFETs;
- Resonant switching;
- Synchronous power rectification.

Designs will also need to have low power consumption when not

under load. Nokia for example, plans to develop a battery charger that tells the user to unplug it when not in use.

The approach that the European Commission and Parliament will use is to legislate if voluntary eco-design improvements are not already in place and seen to be effective. It is, therefore, in the interest of manufacturers and their design engineers to plan ahead by designing all new products with the environment in mind. This will help provide products that comply with future voluntary or compulsory requirements. It will be well worthwhile businesses considering eco-design and in particular energy efficiency, as a high priority in their future product designs. There are many things that designers can do to reduce energy consumption of products and equipment while in use, as well as developing innovative approaches such as the Nokia battery charger.

Some ideas include:

- Design equipment with good ventilation and low power dissipation components to avoid the need for fans, as fans consume significant amounts of power.
- The power consumption of ICs and other components (motors, motor controllers, transformers, etc) varies considerably although the information is often hidden in lengthy datasheets. Choose low power consumption components.
- Use lower voltages. Power consumption is directly proportional to voltage and so halving voltage halves power consumption.
- Use active power management to switch off systems and functions that are not in use. Battery life of mobile phones and laptop computers has been greatly increased by taking this approach.
- Minimise the number of supply rails in a product as well as using low voltages.
- Use LCD instead of CRT displays. LCDs also use less power than LED indicators or filament lamps.
- Use switched mode power supplies instead of linear power supplies.

Low power designs can have other benefits, for example, reliability tends to be better and the life of components such as electrolytic capacitors will be longer if the operating temperature of a piece of equipment is lower.

Eco-design is not only about energy consumption. Although this is the current priority, all aspects of design should be addressed. For example avoiding hazardous substances whenever possible and not using difficult to recycle materials (also encouraged by the WEEE directive) are very important considerations. Also avoiding rare metals such as gold that use huge amounts of energy in their extraction and very toxic substances (such as cyanide) in refinement processes is always advisable.

So, in summary, the key impacts of the EuP directive on the design engineer are:

- May need to comply with implementing measures;
- Should pre-empt future measures in new designs;
- Forces consideration of energy consumption in new designs as higher priority than previously;
- Encourages avoidance of use of hazardous substances where possible;
- Compliance documentation may be required for some products. ■

MARVELL TECHNOLOGY RAISED A FEW EYEBROWS WHEN IT DECIDED TO BUY A KEY INTEL DIVISION IN 2006. BUT WHERE WAS IT COMING FROM AND – MORE IMPORTANTLY – WHERE IS IT HOPING TO GO? **JUAN PABLO CONTI** FINDS OUT

MARVELLISE THIS

Being the world's largest semiconductor maker, very few of the decisions Intel regularly makes have the capacity to surprise those following the fortunes of the electronics industry. When the company announced in June 2006 that it was selling its communications and application processor business unit, industry watchers were already expecting something along these lines.

After all, CEO Paul Otellini's assertion a couple of months earlier that he was ready to "restructure, repurpose and resize" Intel was a very good indication that either non-core or unprofitable businesses were candidates to go under the hammer. And Intel's cellular and handheld chip division was both these things.

What did surprise quite a few was the name of the company buying the Intel business. Marvell Technology wasn't exactly an outsider after having spent over a decade establishing a reputation as a force to be reckoned with in the hard disk drive and LAN controller markets. And even though the Californian fabless semiconductor firm had already gained experience in the wireless sector by virtue of its involvement in Wi-Fi technology, it wasn't until the move for Intel's XScale cellular division that Marvell's actions started to catch the eye of the wider electronics community.

"They started out making new, more powerful hard disk drive controllers, which sounds pretty way at the bottom of the barrel... until you consider that disk drive controllers are the second largest market for processor silicon in the world after cellphones," notes Will Strauss, principal analyst with electronics market research firm Forward Concepts.

From its 1995 establishment, Marvell quickly grew to become the number one vendor of disk drive controllers, a position they held until April 2007, when LSI Corporation (formerly, LSI Logic) bought Agere Systems complete with its disk drive controller business, which automatically made it the new market leader – at least in terms of units shipped.

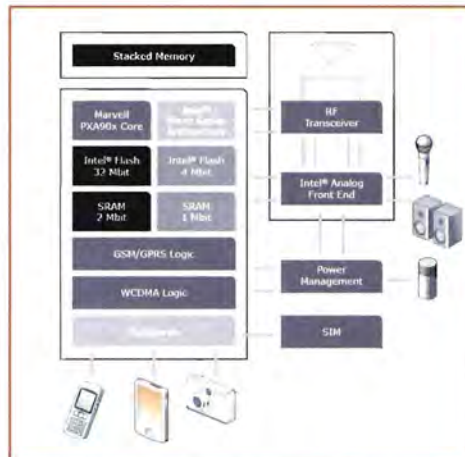

Marvell's PXA90x cellular processor architecture

NIC Chips

The best indication of how well Marvell was doing in its original market came in October 2000, when it was happy to pay a whopping \$2.7bn for Israel-based Galileo Technology,

then the world's largest fabless LAN switching company. "That acquisition proved to be a good one," Strauss recalls, "and it meant Marvell is now very strong in that area of the market, too."

"Then, they also expanded into wireless LANs and they are, actually, very strong there. They are probably number three in total units [shipped], but they're possibly number one in wireless LANs for cellphones."

Marvell has played an active role in the development of the Draft 802.11n standard; so much so that its Wi-Fi silicon (marketed under the 'TopDog' brand) was the first to be based on the draft specification. Major OEMs such as Netgear, D-Link and Gateway have been using the TopDog family of chipsets in their access points and data cards.

Compared to the price Marvell paid for Galileo at the height of the telecoms bubble, the \$600m price tag of Intel's communications and application processor business might have seemed like a bargain. But the big challenge for the company will be to turn the business into profitability as soon as possible.



Marvell hopes one day all large HD screens will feature the Qdeo



LG's next generation of dual-format HD disc players will incorporate Qdeo technology

As part of the agreement, Intel will continue to use its fab facilities to produce the chipsets now sold by Marvell until the end of 2008. This will have given the new owners enough time to find alternative foundry partners – and upgrade to 65nm geometries in the process.

Of the two XScale subdivisions that were transferred from Intel, the application processor side is clearly in a much better shape than its 3G baseband counterpart. Known in handheld design circles as the 'XScale PXA' family of application processors, they are currently only outsold in this category by Texas Instruments's OMAP series.

As soon as the Intel deal was officially closed, Marvell re-launched the XScale Monahans family (the successor to Intel's successful Bulverde application processors) with three available versions: the Marvell PXA320 (featuring an 806MHz core), PXA310 (624MHz) and PXA300 (also running at 624MHz). Last August, LG Electronics confirmed that its new LG-KC1 smartphone designed for Korea Telecom's high-speed WiBro network was based on the Marvell PXA320.

But things won't be so easy on the RF side of the XScale equation. After years of frustratingly trying, Intel wasn't able to ship its 3G, UMTS baseband chip in volume. However, Strauss is confident Marvell has what it takes to turn things around: "They are selling Intel's earlier baseband [codenamed 'Hermon'], not yet in high volume – but they are in volume at RIM, the makers of the BlackBerry. So they are already shipping in the hundreds of thousands if not the millions yet, but certainly they are moving

into that area."

"They do have a new UMTS solution [codenamed 'Tavor'] and – although I haven't seen it in a volume circuit yet – there's no doubt in my mind that this will eventually happen. This is a much better performing chipset for UMTS, so I suspect it will start doing quite well," predicts Strauss.

The Technical Factor

If there is one thing that can be expected from Marvell is that it will be turning to technology in order to catch up with the rest of the 3G baseband field. The company has consistently characterised itself for applying sheer technical innovation to existing solutions as a way of gaining market share.

Indeed, the reason the firm was able to take the disk drive controller market by storm in the mid-1990 was because, while competitors were then busy working on primarily analogue controllers, Marvell was the first company to adopt an all-digital approach.

"It really is a technology-driven company," says Strauss. "You won't see a lot of full-page ads in the Wall Street Journal; they just simply concentrate on what they do and make very good products. And they tend to be either number one or number two in any of the markets they're in. Now, of course they've got a ways to go in UMTS. WCDMA (as some people would call it) is right now the fastest-growing cellular market, but admittedly on a low base. So there's room for competition there."

Strauss believes that Sehat Sutardja, the current head and co-founder of the company, is "probably one of the most

technically savvy CEOs in the semiconductor industry". The man himself, who was born and raised in Indonesia, has been reported as claiming that he was the world's best analogue chip designer.

Whether or not he is the best designer, it might be difficult to prove. What can be unquestionably affirmed is that he's become one of the richest ones around. Forbes magazine recently included him in the elite club of the world's billionaires, with his personal fortune passing the \$1bn mark in early 2007.

Quite Video, Quietly

Meanwhile, his company is expanding into new areas. During the 2007 Consumer Electronics Show (CES) in Las Vegas, it announced a video processing solution that has the potential to extend the footprint of Marvell's silicon into a much broader set of consumer electronics products. Initially called 88DE2710, the company has recently come up with the catchier name of Qdeo (from 'quiet video'), for what is effectively an advanced digital video format converter.

Qdeo technology, which went into mass production in July, is based around a suite of proprietary algorithms that allow a multitude of video sources (be them in low, standard or high-definition resolution) to be enhanced and "upconverted" so that – regardless of their native resolution – they can be enjoyed with drastic quality improvement in the latest generation of HD screens.

Some of the key techniques used to



Marvell's line of application processors is based on ARM architecture



Prototype of a Marvell PXA320 SODIMM module for handheld devices

achieve this include per-pixel noise and compression artefact reduction, per-pixel motion-adaptive 3D de-interlacing, adaptive contrast enhancement and intelligent colour remapping. In September 2007, high-end AV equipment manufacturer Meridian announced the first implementation of a Qdeo chipset. Taking full advantage of the

flexibility offered by this piece of silicon, the British firm has designed an innovative iPod HD video dock. Called iRIS, the dock lets users play back in a large HD screen the typically low-resolution files stored in their Apple devices, supporting up to full 1080p resolution.

Apart from the use of the chipset in similar standalone products, its logical evolution will be to see it embedded directly in HD screens, HD DVD players, AV receiver, set-top boxes and even handheld devices. LG Electronics – again – has taken the first step in that direction by including the Qdeo chip in its second generation of dual-format HD disc players.

Handling the Obstacles

As Marvell looks to consolidate its presence in each of the new markets it is targeting, there will be inevitable obstacles to overcome. Chief among them will be completing a smooth integration of the Intel business. Forward Concepts's Strauss is somewhat pessimistic: "I had predicted



This wireless router from Netgear is powered by Marvell's TopDog 11n chip



Using Qdeo, the iRIS dock upconverts iPod video to full HD resolution

earlier that, out of the 1400 buddies that moved from Intel to Marvell, a number of those would be leaving after the first year. Now, how many that might be, and who, and where I don't know."

"Those employees have suddenly found themselves thrust into a new cultural environment that doesn't allow them the corporate bickering and things like that. It's just accepting that they're moving into a more pure-engineering environment than they were used to. Because Intel is so big and politics are so much a part of it, I think there's going to be a cultural problem there with some of the employees – not all, but certainly some are going to chafe at the idea that they actually have to produce now."

Marvell was unavailable to comment.

MARVELL TECHNOLOGY IN BRIEF

Founded: 1995 by Sehat Sutardja, wife Weili Dai and brother Pantas Sutardja

Headquarters: Santa Clara, California (US)

President & CEO: Sehat Sutardja

Employees: over 5000

Annual sales: \$2.24bn (Fiscal 2007)

Net loss: (\$12m) (Fiscal 2007)

Listed: NASDAQ

INDUSTRIAL RADIO, AMATEUR BAND

The availability of modular, component-level radios for the commonly used European ISM data telemetry bands is no secret, and the common applications for such devices in industrial control and telemonitoring are well known. But, with current developments in RF component technology, these inexpensive modules are beginning to offer features that make them suitable for another, often ignored, area of radio application: amateur radio communications.

“THESE INEXPENSIVE
MODULES ARE
BEGINNING TO
OFFER FEATURES THAT
MAKE THEM SUITABLE
FOR ANOTHER,
OFTEN IGNORED,
AREA OF RADIO
APPLICATION:
AMATEUR RADIO
COMMUNICATIONS”

Conventional, single-channel, short-range wideband radio modules are, it must be admitted, worlds apart from even the most elementary amateur band system, where long range performance in often hostile radio environments is essential, but the introduction by several manufacturers of lower cost narrowband, programmable multiple-channel telemetry

modules intended for long range industrial control has changed the situation somewhat. While these units will be limited to FM operation by their 'fsk data link' ancestry (unfortunately much amateur traffic uses narrower bandwidth SSB and CW modes), such modules provide performance adequate for use in those segments of the VHF and UHF bands, where channelised FM operation is the norm.

The available power output levels of 100-500mW are suitable for the now popular low power (QRP) operating discipline (or an external third-party power amplifier could be used, within the legal limits for the licence and band).

An examination of the current amateur band allocations reveals several frequency segments close enough to existing ISM allocations that equipment designed for the one band ought to be usable with little or no modification in the other (see http://hfllink.com/bandplans/UK_bandplan.pdf for full details):

70cm band:

433.000-433.400MHz	FM repeater outputs
433.400-434.600MHz	Simplex FM
434.600-435.000MHz	FM repeater inputs

The 70cm band actually co-exists with the commonly used 433MHz ISM band. Modules designed for this band will only require new channel frequency programming for amateur use.

2m band:

144.5000-144.7940MHz	fax, RTTY and SSTV (25kHz)
144.7940-144.9900MHz	Packet radio (12.5 and 25kHz)
144.9900-145.1935MHz	FM repeater inputs (12.5kHz)
145.2000-145.5935MHz	Simplex FM voice (etc)
145.5935-145.7935MHz	FM repeater outputs
145.200 and 145.800MHz	FM space communications



by Myk Dormer

The VHF 2m band does not have an ISM equivalent, but most manufacturers of modules can provide their multiple channel VHF designs tuned to any band segment. Some already offer 144MHz versions for the popular APRS systems.

From the point of view of the Radio Amateur, a wireless telemetry module constitutes a very useful off-the-shelf constructional building-block. It provides much of the flexibility and feel of completely scratch-built equipment, while

bridging the ever widening gap between what is possible with simple home-built circuits and the functionality offered by a commercially produced set.

This is not to say that the module provides a complete solution. Compared to an off-the-shelf transceiver the constructor needs to provide quite a bit of hardware to make a usable radio: casings, power supplies, user connectors, controls (which could be as little as a volume control and a channel change thumb wheel switch, or as much as a microprocessor-controlled keypad and display) and all of the analogue interface from the microphone amplifier to the speaker will be needed, but this allows the final result to be exactly customised to the user's requirement.

For the more experienced constructor, a module can provide a useful shortcut, as a frequency source,

an exciter or local oscillator, or as an IF section in a larger and more complex project. They also have many uses as "limited function" radios (where it would be wasteful commit a 'full' commercial transceiver) such as packet radio nodes, specific channel monitors, beacon transmitters or direction finding receivers.

Finally, if considering a wireless module for an amateur radio application, it is well worth contacting the manufacturer's technical department. You would be surprised just how many professional RF designers either are, or were, radio amateurs and will be more than happy to offer advice and support.

Good luck!

Myk Dormer is Senior RF Design Engineer at Radiometrix Ltd
www.radiometrix.com

RADIO MODULES FOR WIRELESS DATA-LINKS

LMT2 / LMR2

25kHz Narrow Band FM 32-channel transmitter and receiver for industrial remote control, telemetry, security and alarm applications in 433MHz (EU) or 458MHz (UK).

- Standard frequencies: 32 channels: 433.875 - 434.65MHz
- Data rates up to 5kpbs
- Usable range over 500m
- User re-configurable via an RS232 interface

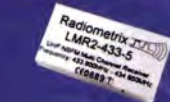

LMT2

- Dimensions: 33 x 23 x 9mm
- Transmit power: +10dBm (10mW)
- Supply: 3.1 - 15V @ 34mA

LMR2

- Dimensions: 46 x 23 x 9mm
- Sensitivity: -120dBm (for 12dB SINAD)
- Supply: 3.1 - 15V @ 20mA

NTX2 / NRX2

Genuine 25kHz Narrow Band FM UHF transmitter and receiver for ISM/SSD applications where existing single frequency wideband or quasi-narrowband UHF modules provide insufficient range.

- Standard frequencies: 434.075MHz, 434.650MHz and 458.700MHz
- Data rates up to 10kpbs
- Custom frequencies available in 433MHz (EU) and 458MHz (UK) bands
- Usable range over 500m



NTX2

- Dimensions: 43 x 15 x 8mm
- Transmit power: +10dBm (10mW)
- Supply: 2.9 - 15V @ 18mA

NRX2

- Dimensions: 47 x 17 x 8mm
- Sensitivity: -118dBm (for 12dB SINAD)
- Supply: 2.9 - 15V @ 14mA

CE Certified by Independent Notified Body



Full technical details are available online at: www.radiometrix.com

RADIOMETRIX

20 YEARS OF INNOVATION FROM THE PIONEERS IN WIRELESS

For sales information please contact sales at sales@radiometrix.co.uk or Tel: 020 8909 9595

ELECTRONICS WORLD

IF YOU ARE INTERESTED IN STAYING AT THE CUTTING-EDGE OF ELECTRONIC DESIGN, ELECTRONICS WORLD IS THE MAGAZINE FOR YOU. SIGN UP AND BE INSPIRED EVERY MONTH.

A subscription guarantees your magazine arrives every month promptly and without fail.

SUBSCRIBE NOW! SUBSCRIBE NOW!

Electronics World Subscription
 Dovetail Services
 800 Guillat Avenue,
 Kent Science Park,
 Sittingbourne,
 Kent, ME9 8GU
 Tel: +44 (0) 870 428 1426

Email: saintjohnpatrick@servicehelpline.co.uk

CGL 4.0 – RAISING THE BAR

Standards-based technologies are rapidly being adopted by the telecommunications industry, and for good reason. Leveraging standards-based solutions allows telecom equipment manufacturers (TEMs) and network equipment providers (NEPs) to use commercial off-the-shelf (COTS) hardware and software systems across multiple network elements – speeding time-to-market, saving money and freeing up key resources to focus on competitive differentiation.

Equally important is the adoption of standards-based elements, which enables new and emerging hardware to plug into an existing network infrastructure without

maturity for wide use in real-world implementations.

Cooperation for Standards

Getting standards-based technologies to deliver on their intended promise requires heavy lifting and cooperation. For many industries, such as mobile phones, the proliferation of special interest groups (SIGs) has led to overlap and competing standards, resulting in a splintered, confused industry and delays in standards adoption.

In the communications industry, however, there is significant cooperation between different SIGs. In telecommunications, nearly a dozen SIGs have worked to define

THE HISTORY AND LATEST DEVELOPMENTS OF CARRIER GRADE LINUX ARE DELVED INTO HERE BY **GLENN SEILER**, A DIRECTOR AT WIND RIVER WHO WAS ALSO THE STEERING COMMITTEE CHAIRPERSON FOR THE CGL WORKING GROUP OF THE OSDL AND AN ACTIVE MEMBER OF THE NEW CARRIER GRADE WORKING GROUP OF THE LINUX FOUNDATION

SCOPE Alliance Carrier Grade Platform Reference Architecture

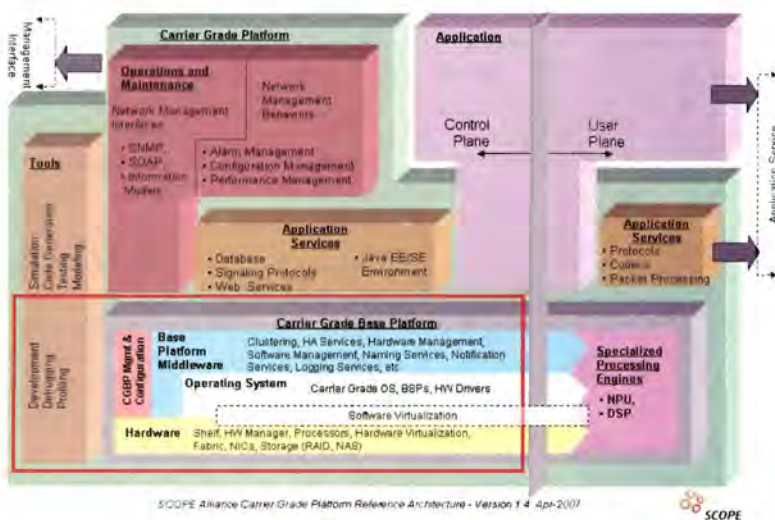

specifications for the Linux OS; PICMG focuses on standards for ATCA hardware; the SAF focuses on middleware above the OS; and the CP-TA focuses on interoperability between different vendor implementations of hardware and software. The SCOPE Alliance doesn't define any particular standard, but creates desired technology profiles based on Linux Foundation, PICMG and SAF specifications.

Unlike in many other industries, communications SIGs work closely together. The CGL specification developed by The Linux Foundation includes some standards defined by the SAF and specifies support for ATCA. A loose consortium, the Mountain View Alliance, provides a liaison, marketing and awareness function for all communications SIGs.

extensive retooling and associated costs. It also encourages use of best-of-breed technologies without imposing vendor lock-in. For much of the new hardware being deployed in next generation networking (NGN) infrastructures, the de facto standard is the Advanced Telecommunications Computing Architecture (ATCA). ATCA is a perfect example of a standard that not only promises all the benefits of a COTS solution, but has also reached a point of

the technology components that fit into an overall solution. Some of the most notable SIGs include the Communications Platform-Trade Association (CP-TA), PICMG, the SCOPE Alliance, the Service Availability Forum (SAF) and The Linux Foundation.

Each communication SIG has a specific function and focus: The Linux Foundation, created by a merger between the Open Source Development Labs (OSDL) and the Free Standards Group, focuses on

CGL 4.0: Tighter Alignment, Tighter Compliance

In late 2006, the CGL Working Group and members of the SCOPE Alliance joined forces to develop a new version of the CGL specification, 4.0. One of the major goals of CGL 4.0 was to align with the SCOPE Alliance Linux Profile. This profile prioritised CGL 3.2 requirements into three categories: mandatory, desired and roadmap. This was

considered a huge contribution toward moving the CGL spec forward. The users of CGL – TEMs and NEPs – provided critical input on what was absolutely required in a Linux distribution to develop ATCA-based applications.

The CGL Working Group also worked to address criticism that the specification was inconsistently implemented across distributions. In earlier spec releases, any Linux distribution that met even a few CGL requirements could claim compliance – and because The Linux Foundation (formerly OSDL) did not endorse or validate the veracity of the registration disclosure data, there was no guarantee of complete feature support. In an effort to solve this problem, the CGL Working Group created

a more formal process for registering Linux software as CGL-compliant. Linux distribution providers could follow this process to ensure they delivered consistent functionality.

In February 2007, The Linux Foundation released the CGL 4.0 specification. This version does not represent a host of new technical requirements, but it highlights the unprecedented level of cooperation that led to CGL 4.0, especially between The Linux Foundation and the SCOPE Alliance. A key focus of the revised specification is to meet the needs of its primary users: equipment providers.

With CGL 4.0, when an equipment provider specifies the need for a CGL distribution, there is a consistent standard

for what that means and for verifying the claim. CGL 4.0 specifies that a software distribution must meet all 135 mandatory requirements before claiming CGL compliance, guaranteeing a higher level of functionality in CGL-compliant distributions.

This major step will help accelerate growth and adoption of CGL, and further integration with ATCA-based COTS hardware, ultimately resulting in accelerated time-to-market for NEPs, TEMs, and service providers.

The New in CGL 4.0

In CGL 4.0, all the specifications defined in version 3.2 have been regrouped and reprioritised to reflect the SCOPE Alliance profile. A few other requirements have also been added.

Tremendous effort was required to update the specification from 3.2 to 4.0. The CGL Working Group reviewed the entire spec item by item, adding new requirements, removing old requirements, acting on change requests, correcting errata and clarifying definitions. In some cases, an existing requirement was broken into multiple better-defined requirements. This resulted in a much clearer set of requirements that more accurately reflects the current state of Linux functionality available for carrier-grade-class systems (visit www.linux-foundation.org for a complete list of CGL requirements).

CGL 4.0 comprises more than 250 individual requirements covering seven categories, or “books”: performance, hardware, standards, serviceability, availability, security and clustering. Each core member of the CGL Working Group (Hewlett-Packard, IBM, Intel, MontaVista, Motorola, NTT and Wind River) was responsible for updating each book.

Feedback from the SCOPE Alliance was taken into account by the CGL Working Group during their edits. “SCOPE and The Linux Foundation are both committed to accelerating the deployment of carrier-grade-base platforms based on open industry specifications,” says Leslie Guth, SCOPE Alliance Marketing Co-Chair and Board Member. “With the cooperation of OSDL prior to the merger and The Linux Foundation since, we’ve worked to align the CGL specification with our released

A BRIEF HISTORY OF CARRIER GRADE LINUX

Carrier Grade Linux (CGL) is the operating system of choice for ATCA-based network equipment and is considered the architectural “hub” that defines many telecom solutions. CGL is designed to support all the hardware capabilities (such as booting from flash or support for ATCA hot-plug, along with high-availability middleware interfaces) to create the foundation for a complete carrier-grade solution and ensure high performance.

CGL was started by OSDL in January 2002. Equipment providers such as Nokia, Ericsson and Alcatel, were initial members and contributors.

The first two releases of the CGL spec resulted in approximately 200 requirements across five different categories: hardware, performance, standards, availability and serviceability. At least seven different Linux distributions claimed compliance.

In 2005, the third CGL specification, version 3.2, was created. It added two more requirements categories, clustering and security, growing the number of overall requirements to more than 280. However, by the time the 3.2 spec was released, the CGL Working Group realised there was no way to consistently measure how each distribution supported the CGL specification. One distribution

might support the majority of requirements, while another supported only a handful. Ultimately, while significant in scope, CGL 3.2 didn’t hit the mark in establishing a complete requirements list that met the needs of TEMs and NEPs. Many TEMs discontinued active participation in the CGL Working Group, and some in the industry wondered if the CGL specification had run its course.

Around the same time, many top-tier TEMs formed their own association, the SCOPE Alliance, to focus on hardware and software profiles they believed were most important in implementing COTS building blocks for carrier-grade-base platforms. The SCOPE Alliance quickly became an important force in the ecosystem, taking an active interest in CGL and making a conscious effort to focus on the operating system first. This action by the SCOPE Alliance changed everything for CGL. It clearly indicated time the CGL specification was important and relevant to equipment providers – the primary consumers of CGL. It also initiated a tight working relationship between the CGL Working Group and equipment providers, a relationship that had been missing. Suddenly, the CGL specification was on a path to renewed relevance.

THE LINUX FOUNDATION

The Linux Foundation (www.linux-foundation.org) is a nonprofit consortium dedicated to fostering the growth of Linux. Founded in 2007 by the merger of the OSDL and the Free Standards Group, the foundation sponsors the work of Linux creator Linus Torvalds and is supported by leading Linux and open-source companies and developers around the world.

The SCOPE Alliance (www.scope-alliance.org) is an association of NEPs aimed at accelerating the deployment of carrier-grade-base platforms for service provider applications. SCOPE was founded by Alcatel, Ericsson, Lucent, Motorola, NEC, Nokia and Siemens.

Carrier Grade Profile and we look forward to the benefits, such as faster time-to-market, that interoperable commercial off-the-shelf building blocks bring."

The new CGL 4.0 specification also includes useful information and resources for developers. The specific tools and APIs needed for CGL distributions are specified and proofs of concepts (PoCs) are provided, along with reference code. The PoCs play a critical role, because they refer to existing open-source projects that can be used to implement the CGL requirement. All requirements in the specification must have an associated PoC. In some cases, there may be multiple PoCs or other open-source projects available to

meet a requirement.

This has a dual impact: First, all distributions registering for CGL 4.0 will have a consistent set of features, with at least one active open-source project supporting it. Second, because there are often many ways to implement a feature, there is room for different distributions to compete and differentiate. This improves the overall quality and choice available to providers implementing CGL.

Carrier Grade Linux: Now a Linux Standard Base Workgroup

With publication of CGL 4.0 complete, The Linux Foundation is in the process of rechartering the CGL Working Group to fit the foundation's organisational structure. The foundation plans to integrate the CGL specification into the Linux Standard Base (LSB). The LSB delivers interoperability between applications and the Linux OS. Currently, all major distributions comply with the LSB, and many leading application vendors, such as MySQL, RealNetworks and SAP, are certifying. The LSB provides a cost-effective way for vendors to target multiple Linux distributions while building only one software package.

For end users, the LSB and its mark of interoperability preserves choice by allowing them to select the applications and distributions they want, while avoiding technology and vendor lock-in. LSB certification of distributions results in more applications being ported to Linux, and ensures that distribution vendors are compatible with those applications. The LSB ensures that Linux does not fragment.

By adding the CGL specification as a LSB

certification or sub-profile, The Linux Foundation will raise the bar even further for the CGL spec, improving its already high level of credibility and value for equipment providers.

The Impact of CGL 4.0

The CGL 4.0 specification has immediate, ongoing benefits for everyone who develops, deploys and uses Linux-based software for communications-based applications.

For TEMs and NEPs, a unified, stable specification means faster time-to-market, investment protection, a longer life-cycle for network equipment, improved interoperability, a real multi-vendor ecosystem and streamlined compliance with environmental standards.

For hardware and software COTS vendors, reduced fragmentation of the ecosystem will motivate application vendors to produce off-the-shelf building-block components consistent with the needs of TEMs and NEPs.

For service providers, CGL 4.0 means the ability to accelerate service deployment with confidence, knowing the platform is stable and delivers a high level of functionality, performance and reliability.

For developers, specifying the right tools and practices for carrier-grade development, along with PoCs and reference code, simplifies and expedites the development process.

For end customers and end users, the net result is equipment and services that deliver exceptional performance and availability, increased freedom of choice and quality of services and a seamless user experience. ■

LSB 3.x (2006-2008)	LSB 4.x (2008-2010)
Asianux 2.0 Debian 4.0 ("etch") Mandriva Corporate 4.0 Red Hat Enterprise Linux 4 and 5 SUSE Linux Enterprise 9 and 10 Ubuntu 6.06 LTS ("dapper") [...]	Asianux 3.0 Debian "etch" + 1 Mandriva Corporate 5.0 Red Hat Enterprise Linux 6 SUSE Linux Enterprise 11 Ubuntu LTS "dapper" + 1 [...]

Table 1: The Linux Standard Base (LSB) roadmap

BUILDING BLOCKS OF BROADBAND

Back in the 1990s, consumers and businesses began to embrace the Internet for a variety of uses and telecom providers built network infrastructures that supported and eventually exceeded that demand.

At that time, network traffic was very predictable and providers planned for and accommodated traffic patterns manually by sending out technicians to repair and upgrade the networks as necessary. These efforts taxed both the end users waiting for new services and the overall operating expenses of service providers. The market was segmented, with providers offering separate, "fixed", point-to-point networks for voice, video and data needs.

Today, an entirely different evolution is taking place. Use of the Internet is now an integral part of how businesses and consumers function every day. New uses for the Internet are being driven by Internet service providers and media companies, as consumer appetite for on-demand services continues to grow.

When you consider that YouTube, the leading Internet US video download site,

recently announced that its users are watching more than 100 million videos per day, and that a typical video uses 1,000 times as much bandwidth as a sound file, it is clear that the demand for bandwidth-hungry applications has taken off. The popularity of video-on-demand (VoD), voice over IP (VoIP), IPTV and other emerging applications are driving urgency for flexible, fast and high-quality network services.

As the telecom revival has blurred the boundaries between information technology, media and the Internet, it has also changed the service provider model. Now both telecommunications companies and cable operators are fighting for supremacy to provide triple-play (voice, video, data) and quad-play (voice, video, data and mobile) services to consumers within a single package.

One of the key strategies that service providers are employing to add and retain new customers is scaling their network infrastructures to support emerging types of content. Part of this approach includes replacing slow, manual operations with

BY CRAIG IWATA, DIRECTOR OF PRODUCT MARKETING AT JDSU AND SINCLAIR VASS, DIRECTOR OF EMEA FOR COMMUNICATIONS SALES ANALYSE THE TECHNICAL REQUIREMENTS OF TELECOM AND CABLE OPERATORS AS THE BROADBAND TRAFFIC AND THE DEMAND FOR TRIPLE AND, EVEN, QUAD-PLAY BEGINS TO SOAR

simplified and dynamic network solutions that can respond disruptive and explosive traffic travelling over fibre optic networks. To retain control in an ever-changing market, deliver the level of programming and service that end users expect, as well as keep control of operating costs, service providers are turning to Agile Optical Networks (AON).

The Importance of the AON

AONs are based on a key element called "dynamic reconfigurability". This approach allows service providers to simplify network management and optimise network activity by using flexible optical equipment that can be monitored and adjusted remotely.

Key benefits of an AON, as cited by Infonetics Research Inc, include:

- * Allows wavelengths to be remotely configured;
- * Reduces time for wavelength

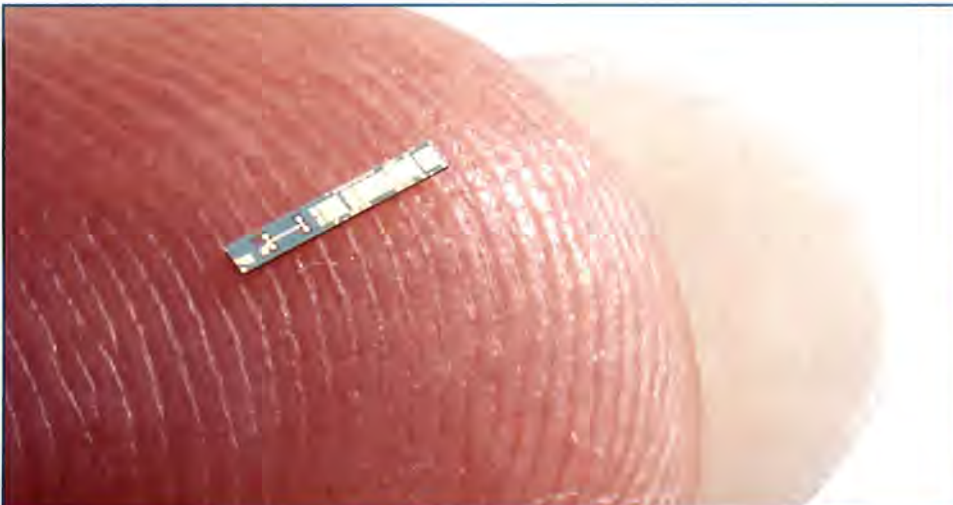

The JDSU Integrated Laser Mach Sehnder

provisioning, typically from weeks or months to a few hours or days;

- * Reduces opex, as human labour is reduced and truck rolls are minimised;
- * Enables efficiencies required for triple play, especially IPTV services;
- * Provides capabilities required for dynamic wavelength services;
- * Shortens time-to-service revenue;
- * Supplies automation and/or automatic functions through "points of agility";
- * Provides resilience to respond to spontaneous bandwidth demands; compensates for errors in the planning process.

The global AON component market is expected to expand rapidly, growing 43% from less than \$100m in 2004 to nearly \$700m in 2010, according to research from Ovum-RHK.

The Building Blocks of AONs

There are several aspects that go into creating an AON. However, three technologies provide the basic building blocks: reconfigurable add/drop multiplexers (ROADMs) and tunable transponders and erbium-doped fibre amplifiers (EDFAs). Each of these elements sits within network nodes in a carrier's network, ensuring that electrical signals are converted into optical signals and are then routed on specific network paths to reach their destination.

In early attempts to meet growing network capacity needs, providers began a migration from SONET/SDH networks to DWDM (dense wavelength division multiplexing) architecture. DWDM brought more channels to carry the data-rich payloads; however, the optical-to-electrical-to-optical (OEO) conversions continued to hinder network flexibility. While data was transmitted over lightwaves, it was repeatedly converted to electrical signals, or multiplexed, so that traffic could be managed electronically.

Inherent limitations of this process were the manual intervention and traffic disturbance at the time of each network modification. Bringing more capacity online, adding new services, or reallocating existing bandwidth required labour-intensive point-to-point hardwiring. For each modification, an engineer would travel to a central office or customer premises, change a line card,

update configurations, install filters and then tune amplifiers at other drops. This process could interrupt other services and take months to plan and weeks to eventually complete.

The ROADM entered the scene in 2003. It is essentially a wavelength switch that enables a network engineer to switch traffic with wavelength-level granularity, or add or drop any wavelength at any time. Functionally, a ROADM revolutionises optical networking because it can 'future-proof' DWDM architectures with intelligence and modularity, replacing 'passive' uncontrollable optical hardware.

With a ROADM the entire circuit and service provisioning process is reduced to a simplistic point-and-click process. Essentially, a remote operator can open a workstation window and quickly configure connection of any wavelength to any node on the network. ROADMs can increase the speed at which service providers respond to the demands of their end-user customers, including offering new services. And they grant service providers the flexibility to quickly and cost-effectively adapt to the increasingly unpredictable changes in network demands.

With such a flexible provisioning potential, service providers can trim both their cost per Mbit and per wavelength – and their customers benefit, too. By removing the exorbitant costs of setting up and tearing down connections, providers can easily charge only for the bandwidth their customers need, when they need it.

One Size Does Not Fit All

Like any component of the communications infrastructure, one size does not fit all. ROADM solutions that are perfect for ultra long haul or long haul transmissions may not be as economical for metro core or metro access applications. Leading optical components and subsystems vendors recognise this and have responded with an array of ROADM configurations that bring agility to the very edge of the network. They also address the new needs to support network architectures with mesh topologies and interconnecting rings.

Operators must choose from an entire

range of ROADM technologies to meet the various market needs, which include:

* **Wave blockers** – Ultra long haul and long haul service providers are benefiting from innovations in wavelength blocker ROADM technology. These devices are based on a free space optics platform, typically employing a liquid crystal switching engine.

* **PLC ROADMs** – Metro service providers are benefiting from innovations in planar lightwave circuit (PLC) ROADMs. These devices are built on proven waveguide technology with the main ROADM functions synthesised through a wafer scale manufacturing platform that relies on lithographic techniques to automatically and repeatedly print integrated optical components. These PLC ROADMs are optimised for two-dimensional metro applications.

The industry has long used AWGs (arrayed waveguide gratings) that are manufactured in this way. Through increasing levels of integration, leading component manufacturers are delivering a cutting edge product on a qualified platform without the typical leading edge risk factors.

* **WSS ROADMs** – Also in deployment in ultra long haul, long haul and metro networks, is a newer generation Wavelength Selective Switch (WSS) ROADM. WSS devices provide colourless routing and switching – in other words, any channel or channels can be routed to any port or ports – with full flexibility eliminating the need for pre-planning port usage as carriers move towards mesh networks. These devices are based on the highly successful free space optics platform, typically employing a micro-electromechanical systems (MEMS) switching engine. WSS ROADMs have the flexibility to support ROADM applications requiring greater than two dimensions, such as interconnecting multiple rings and/or supporting meshed topologies.

* **Edge-ROADMs** – On-demand applications are driving increased needs for network capacity closer to the edge of the network, or closer to the end user. JDSU is currently working on future edge-ROADM solutions that will provide a much more compact, cost-effective solution designed to meet the reconfigurability and tunability

requirements in the metro and metro access space.

Simplified Wavelength Management

Recent growth in network demand has also stimulated healthy demand for tunable transponders, a key technology for the successful deployment of AONs. Research firm CIR predicts that the market for tunable lasers will flourish over the next five years, with compound annual growth of 37% and a total market value of nearly \$1bn by 2012.

Before the advent of tunable lasers, service providers had no choice for high capacity DWDM systems other than using fixed wavelength lasers. This meant that providers had to hold expensive inventory to support each wavelength or compromise the time taken to activate a service and generate revenue.

The overhead associated with managing this entire inventory was painful at all levels in the supply chain, all the way from source lasers through a lighted wavelength. Since wavelength activity could not be predicted, providers would often run into supply shortages for specific wavelengths.

Today's tunable transponders ease the planning, forecasting and inventory management of wavelength support because each tunable transponder can support up to more than 80 channels. They can either be used as a universal source to support a particular wavelength for a long time period, or for dynamically provisioned applications such as those incorporating ROADMs, which provide the ability for network operators to change wavelengths on the fly.

JDSU is also working on a future solution called the Integrated Laser Mach Sehnder (ILMS). This approach leverages the advantages of photonic integration: a monolithically integrated laser and modulator on a single chip that is smaller than the tip of a finger (see image on page 26). This enables the tunable technology to be provided in smaller packages, such as 300-pin small form factor (SFF) and XFP form factors.

EDFAs Provide Optical Boost

EDFAs, or optical amplifiers, allow the transmission of optical signals over long distances. As ROADMs dynamically add

and drop wavelengths within the network and tunable transponders change the wavelengths, EDFAs must dynamically adjust their ability to boost optical signals based on the unpredictable and ever-changing number of wavelengths that are present. As with other AON components, EDFAs eliminate the need for time-consuming and costly truck rolls required to upgrade and fine-tune fixed amplifiers within the network.

Today, vendors offer network equipment manufacturers a fully vertically integrated EDFA portfolio made up of related components, modules and subsystems.

Response to AON

Across the globe, market demand for the delivery of broadband and packet-based services is driving the need for agile, high-capacity optical networks. Here's how providers around the world are responding.

In the United States, in response to the unpredictable traffic patterns, every major service provider is deploying some amount of AON technology in their networks. Analysts predict that several imminent mergers and consolidations in the US market will propel the move toward simpler and fewer all-IP networks, with next-generation voice, IP/Ethernet and various other services and technologies travelling over all-optical networks.

In Europe, several major PTTs are making significant strides in upgrading their networks and shifting to an IP infrastructure. BT is moving ahead with its 21st Century Network program to convert its systems to an entirely packet-based infrastructure with VoIP as a key service offering.

Several key value-added services are gaining widespread adoption, with IP virtual private networks (VPNs) and VoIP leading the list. Additional headway is being made for optical Ethernet, virtual LANs, bandwidth-on-demand, storage and managed security.

Increased adoption of broadband and an increasing broadband traffic are driving spending in edge, core and optical networks.

In the Asia Pacific, most carriers have plans for data, voice and video convergence within the next two to five

years, with carriers in Japan and Korea taking a particularly aggressive approach to rolling out triple-play services. The Japanese government began working on plans in 2006 to bring 30 million consumers online at 10Mbps/sec and 10 million consumers online at 100Mbps/sec, whilst in the Chinese government announced a goal of 75 million broadband users by 2008 – a goal that will drive growth in VPN, security, VoIP and other emerging segments.

What's in Store for the Future

The widespread availability of affordable broadband and the continued migration to IP networks have tremendously affected the way we communicate both personally and professionally.

As media-rich applications generated from our personal computers turn us into bandwidth-on-demand addicts, there will continue to be a healthy urgency for innovation on the optics level. Service providers will need to increase the automation of their networks in the long-haul, metro and access spaces. There will continue to be both evolutionary and revolutionary developments around the key building blocks of the AON.

Each component of the AON will evolve through technology breakthroughs and continue to provide the flexibility that networks require. As more flexibility is built into a network, service providers can consider their "fear of the next YouTube" a thing of the past - like that old dial-up noise our children will wonder about. ■

NEW APPLICATIONS FUEL DEMAND FOR AON

- Broadband users will grow from 32 million lines in 2004 to nearly 57 million lines in 2008, according to the Telecommunications Industry Association (TIA) study of February 2005.

- VoD streams worldwide will explode from 1.67 million in 2005 to 163 million in 2011, says the same report.

- VoIP lines in the US will grow from 6.5 million in 2004 to 26 million in 2008, according to ABI Research, 2005.

RESCUING VoIP QUALITY IN HIGH-SPEED BROADBAND

It's unbelievably bad! In fact, I sometimes can't even make a call at all," Smith shouts over the customer hotline of his broadband service provider soon after upgrading his Internet service to a 'triple play' bundle of video, voice over IP and data, based on high-speed ADSL2+. "My previous gateway was perfect with 1Mbit/s service. Now I get 16Mbit/s but can hardly make any phone calls," he complains. "I thought that with the extra download speed and bandwidth I would also get extra quality so that I could finally use your bundled service. I'm not going to pay more money just to add problems. Please cancel my contract now."

Such customer service nightmare is not as imaginary as one might think. In fact, several service providers have had to deal with angry customers demanding their money back because they were unable to get adequate voice quality – and at times could not get any service at all – despite upgrading their Customer Premises Equipment (CPE) and service plan. Indeed, the assumption that simply adding bandwidth will solve all Quality of Service (QoS) issues, especially for the real-time, sound quality sensitive VoIP applications, has been proven wrong.

Strange though it may seem, often times VoIP service quality actually goes down with the added bandwidth. But it doesn't have to be that way; chip and system architectures are working hard on improving VoIP quality, ensuring customer satisfaction.

Over the past few years the broadband access market has experienced explosive growth. Meanwhile, VoIP became one of the most important and profitable value-added services as the new form of voice service over broadband networks. It was widely accepted that the key to successful VoIP service, from a technical perspective,

is to offer subscribers good voice quality – comparable to that of traditional analogue services. Due to the improved Internet access speeds, VoIP services overcame the old image in people's mind and the notion that VoIP is synonymous with poor quality is giving way to a more positive approach. VoIP's market success also drives several other technical and business trends. For example, higher integrated silicon solutions now offer support for high speed data access, voice over IP and even video on a single chip. Service providers, new comers as well as established incumbents, have begun to treat VoIP as a "must have" service and are currently trying to increase their ARPU (average revenue per user) through offering additional value-added services, such as high-speed music download, IPTV and more. With VoIP gaining commodity status and line speeds reaching 16, 25

SUN REN, PRODUCT MARKETING MANAGER FOR VOIP AT INFINEON TECHNOLOGIES AND STEPHAN PRUECKLMAYER, SENIOR MARKETING MANAGER, EXPLAIN WHY VOIP QUALITY SEEMS TO DETERIORATE FAST IN CERTAIN CONDITIONS IMPOSED ON BROADBAND CPE SYSTEMS AND HOW TO BEST ADDRESS THE MATTER

and even 50Mbit/s, no one estimated that the quality problems would come up again. But they have.

The Demise of the "Fat Pipe" Theory
Yes, no one saw it coming. With the deployment of ADSL2/2+, VDSL/2 and

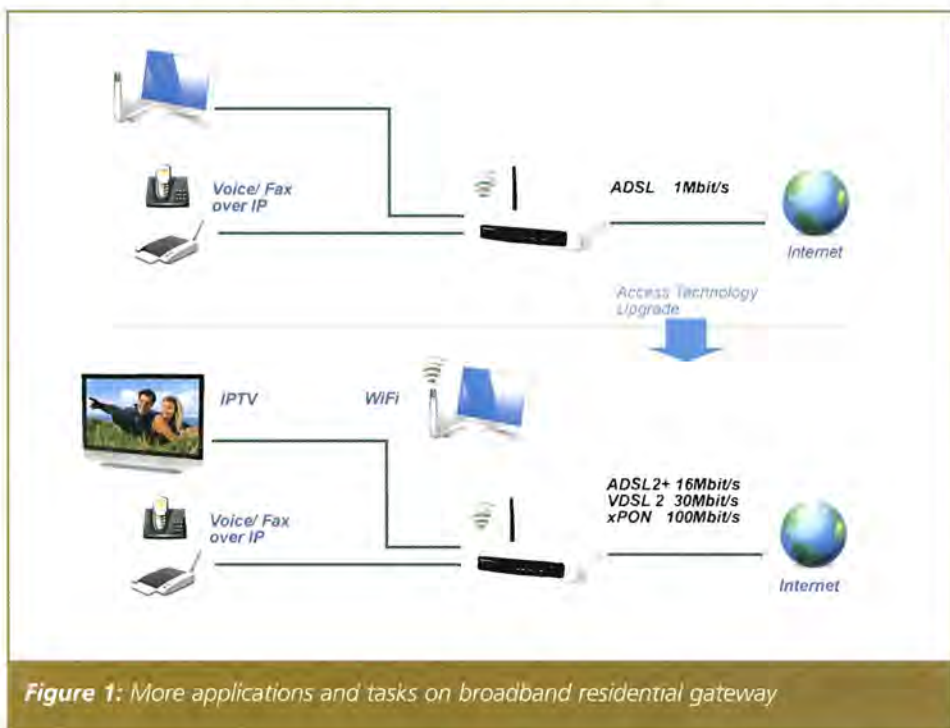

Figure 1: More applications and tasks on broadband residential gateway

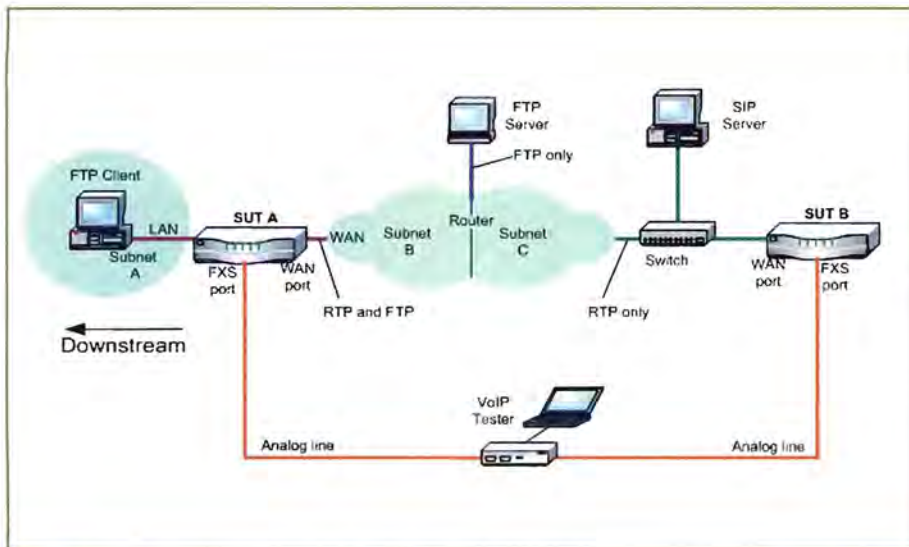

Figure 2: Voice quality test setup (as per ITU and ETSI recommendation)

xPON, the “big pipe” theory that bandwidth solves everything took hold. In truth, the belief that there is surplus bandwidth, over and above what is required for voice traffic, is justified. Certainly a 16Mbit/s ADSL2+ connection would be able to support at least one IPTV stream and fast Internet access leaving ample headroom for VoIP services. Reality however tells a different story. While the early generations of broadband CPEs had to deal with almost pure data applications, today’s systems must cope with a host of real-time services all competing for the same, sometimes limited, CPU processing capacity. As a result, VoIP quality in high speed broadband access environment can become severely impaired.

Certainly, adopting a more powerful processor for VoIP CPE relieves this problem. Yet, this technically feasible solution may not always be efficient from a business perspective, as higher processing power also means higher costs for equipment manufacturers. Higher costs should always be avoided and this is especially true in the highly competitive, low-margin CPE market. So, is there an alternative to rescue VoIP quality in high speed broadband CPEs in a smarter, more efficient way? The quality test described below suggests that there is.

VoIP Quality Parameters

Before we dive into details, let us first understand the root cause of different voice quality behaviours by elaborating on some important measurement parameters:

* **Jitter** refers to the non-regularity method in which voice packets arrive. Typically, the voice packets are generated at a constant rate. However, in an IP network packets do not always arrive at the destination in the same order they have been sent.

* **Echo**. This is the audible leak-through of one’s own voice into the return path. Line echo is the most prevalent echo in voice networks caused by impedance mismatches within the 4-wire/2-wire hybrid and it is not avoidable due to the uncertainty of AC impedance of analogue telephones and the telephone lines.

* **Delay or latency** is the period of time it takes for the voice signal to cross the network from origin to destination. The human ear is highly sensitive to delays that are longer than 50ms. The voice packets in packet networks often encounter longer delays than the transmission over TDM network.

* **Silent phases and VAD (Voice Activation Detection)** – the silent phase refers to the periods in which one party in the conversation is listening to the other. In this case it is unnecessary to transmit packets carrying silence in order to reduce the packet traffic. VAD (also called “silence suppression”) can be enabled to monitor signals for voice activity so that when silence is detected for a specified amount of time, the application informs the packet voice protocol and prevents the encoder output from being transported across the network.

* **Packet loss** (including late/early packets) – such packets cannot convey their information to the voice stream in time and therefore the content is discarded; the higher the rate of such packets, the lower the speech quality.

The VoIP Quality Test

So how do you measure voice quality? One voice quality comparison test, based on the ITU-T and ETSI setup recommendation, was executed to find out the root for worse VoIP quality in broadband CPEs. The results, surprisingly enough, show that higher access speeds do not necessarily ensure stable and better voice quality. In fact, as will be described below, in some cases the voice

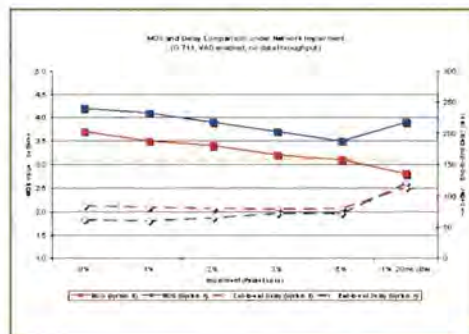

Figure 3a: Result of voice quality comparison test



Figure 3b: Result of voice quality comparison test

quality falls dramatically when data traffic is high, despite the added bandwidth.

Figure 2 shows the setup used for this test. This is a back-to-back connection of two of the same CPEs in order to avoid the influence of interoperability on voice quality. In data traffic is generated by an FTP server in the network while a client is attached to the CPE, in order to simulate downstream data traffic including Internet surfing, file downloading and IPTV. The Mean Opinion Score (MOS) was mapped following the ITU-T P.862 specification to objectively measure the voice quality.

The test was performed on two similar VoIP ADSL2+ home gateways deployed by one of the biggest telecommunication operators in Europe. System A is based on the chip solution from Infineon

Technologies and system B as service provider's series product is designed in similar plastic housing but comes from another vendor. During the test different data traffic and network environments were applied to simulate various popular broadband access services. **Figures 3a** and **3b** show the results. As it can be seen, they indicate that the two ADSL2+ VoIP gateways have similar appearance, but perform very differently under the same network scenarios. When using G.711 voice coder and enabling VAD with no parallel data traffic, both systems' MOS goes down following the increase of jitter in the networks. However, system B was unable to handle the voice properly when data traffic was increased. For example, when the downlink data traffic was higher than 6Mbit/s system B's MOS value was lower than 3.0, which is considered a non-acceptable quality. System B received even lower MOS marks as along with higher delay compared to system A, especially when the VAD or Wireless LAN routing was switched on resulting in significant quality deterioration. On the other hand, system A achieved very stable and good MOS values as along with shorter delay in different network environments despite increased download data traffic and regardless of whether Wireless LAN and VAD were switched on or off. System A's MOS value was close to 4.5 which is the

highest MOS value under G.711 coding in real-life systems.

The test results prove that simply increasing broadband access bandwidth does not always bring the benefit of improved voice quality. As shown above, system B was unable to provide sufficient voice quality as data download traffic, running in parallel to VoIP telephony. In other words, if the CPE is not capable of handling increased multi-tasking, VoIP quality will drop down. The test also proves that, when designed right, a VoIP system (in this case system A) should and can handle increased data traffic without it having any affect on voice quality.

VoIP Quality Behaviours in Broadband CPE and Gateways

So what caused the deterioration of the voice quality in the test described above? The problem can be traced to the time critical signal processing, or network processing features inside the CPE itself. Jitter buffer, voice packetisation, echo cancellation and Bad Frame Masking (BFM) – also called BFI (Bad Frame Interpolation) or PLC (Packet Loss Concealment), all have to be implemented successfully within the CPE's processor in order to maintain voice quality. Due to the natural characteristics of the human ear, voice communication is always a real-time critical function and, therefore, voice should be processed based on the seamless collaboration of all function blocks. This requires stable and powerful processing as the central processing unit (CPU) must deal with each and every packet – whether voice, video or data in a

broadband CPE. But as packet traffic increases, the load on the CPU becomes heavier and, if the necessary measures are not taken, the quality of time critical applications deteriorates.

The growing popularity of bandwidth-hungry applications such as IPTV are the main contributor to the increased the burden on the CPE's processor, making real-time VoIP processing even more critical. Some methods such as traffic shaping and QoS control may help to achieve better quality for specific applications by guaranteeing enough traffic bandwidth within the crowded networks but, since voice quality problems are generally caused by the lack of processing power inside CPE processor, they provide little relief.

Rescue VoIP Quality in CPE and Gateways

One can, of course, suggest to simply add more processing power to the CPE. But as already mentioned, bigger and more powerful processors come with a high price tag. The answer should then be sought elsewhere.

And the answer is simple enough to grasp: process the voice separately from the other traffic by completely encapsulating voice processing together with optimised VoIP algorithms like echo cancellation, jitter buffer, silence phase detection, voice compression etc, inside the CPE. When voice processing is handled independently from other network traffic, all important functions can be correctly implemented and work together seamlessly and in real-time. VoIP

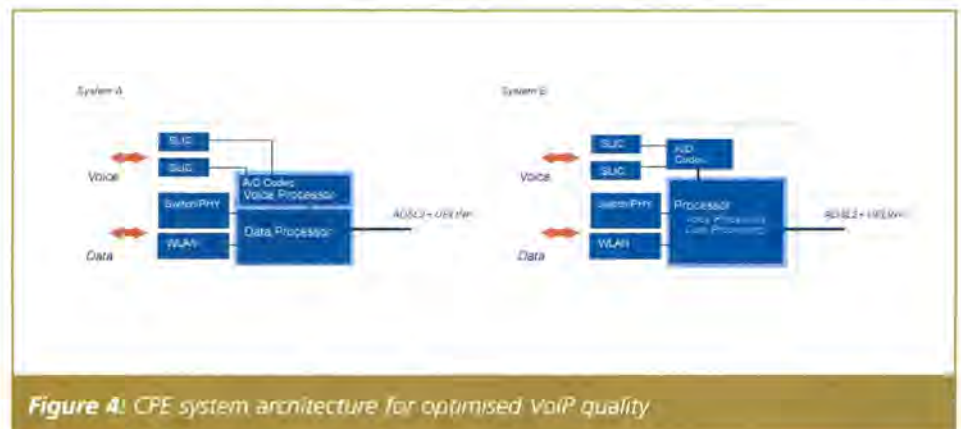

Figure 4: CPE system architecture for optimised VoIP quality

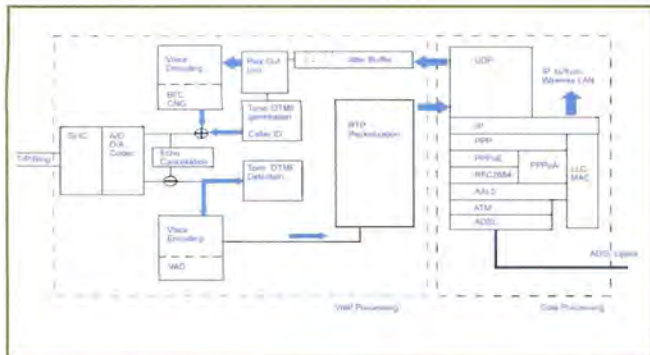

Figure 5: VoIP packet flow (System A)



Figure 6: Separated voice and data engine in Infineon broadband CPE solutions

functions are then dealt with efficiently and deliver high voice quality performance even in a heavy data traffic environment.

“compete” with other data, music or video packets for the processor capacity. The way this is handled within the CPE itself is shown in **Figure 5**.

Figure 4 shows the architecture of system A and system B used in the test described above. With system B, all the processing functionalities are handled on the main processor using an external analogue/digital codec and SLIC (subscriber line interface circuit) to access the telephones. System A, on the other hand, has a dedicated VoIP processor with integrated codecs. A voice packet going into system A is immediately routed to the VoIP processor with all real-time functionalities handled separately from the main processor. This way, voice quality is ensured regardless of how heavy the data traffic is. In system, on the other hand, voice packets have to

Removing VoIP Service Suffering

The abundance of services offered over today’s high-speed broadband access networks has reached a point in which time critical services, and VoIP in particular, suffer due to inadequate processing capacity of broadband CPEs. Simply increasing the bandwidth offers no relief since voice quality problems depend on the CPE architecture and implementation rather than on the network speed. Adding processing power to the CPE is economically inefficient. The solution is to separate VoIP traffic from the other data and video packets. When voice processing is handled independently from other network traffic, all important quality of service functions can be correctly implemented and work together seamlessly and in real-time.

And what about Smith? Now that his high-speed ADSL2+ gateway runs VoIP separately from other data applications, he can finally enjoy not just IP video, online gaming and fast Internet surfing, but also high quality phone conversations over packet networks, using VoIP. This is one customer who will not be calling the service provider’s hotline any time soon. Well, maybe just to ask for another service upgrade. ■

ORDER FORM – PLEASE HAND THIS TO YOUR NEWSAGENT

Please reserve one copy of Electronics World for me each month. I do/do not want the magazine delivering to my home address (delete as appropriate)

Name _____

Address _____

Post code _____

Telephone _____

Date _____

Signature _____

ELECTRONICS WORLD



TIM CROCKER, CHIEF SCIENCE OFFICER OF LASTMILE COMMUNICATIONS, EXPLAINS HOW TO GO ABOUT RE-ENGINEERING THE NETWORK FOR THE BROADBAND 'GOLDRUSH'

ADDRESSING THE GLOBAL SPECTRUM CHALLENGE

Demand for bandwidth across business and consumer audiences has been growing exponentially as more information, media and applications are accessible over the Internet. Today, gigabit capacity and high data rate availability are expected all the way to the last mile – over fixed and wireless connectivity alike, and regardless of city centre or remote countryside location. Centralised networks with data centres at the core have become taxed and overused, heralding a need for change in the design and cost-model of the communications infrastructure.

Prior to the 1970s, consumer electronics consisted almost exclusively of white goods TV, radio, audio and POTS (plain old telephone systems). An analogue electronics world prevailed and semiconductor technology was only just beginning to debut into consumer electronic products. The 80s and 90s saw the world shift to digital technology, with the advent of the PC, CD, DVD and mobile phones, and in the last decade wireless network infrastructure has also migrated to digital technology. Today the winds of change are in the air again, as use of the Internet drives the movement of greater quantities of rich data across networks that struggle to provide sufficient bandwidth.

The primary factor causing bandwidth overload relates back to Moore's Law and its continuing application and relevance in modern technology. Commodity pricing

has enabled increasingly capable personal digital products to sell in hundreds of millions of units, as new generations of products launch every six months.

Alongside an increasingly networked or 'connected' way of life, all this results in increased demand for wireless networks.

To capitalise on this growing demand, operators need to be able to accommodate it with high quality broadband and rich media distribution to urban and rural areas alike. Central to accommodating the traffic is lightening the load on the fixed backhaul to the core network. Operators need to look to the last mile and short distance communications and caching technologies as the future of efficient and cost-effective content delivery.

The Spectrum Squeeze

On a typical urban street where WiFi is prevalent, there could be ten or more

users competing for wireless access, assuming the 57Mbps 802.11g link will satisfy their need for speed. The contention for service actually strangles the performance down, in the direction, and perhaps to a fraction of the 2Mbps or so specified by the ADSL service providers. As time and Moore's Law march on, the emergence of higher bandwidth applications such as HDTV and other IP Multimedia Subsystems (IMS)-based applications, will only accelerate these

capacity problems further. The result is invariably degradation in the quality of service to the end user.

With machine-to-machine (M2M) communication in industrial environments, and soon to be seen in vehicles, wireless connectivity remains on a growth path for years to come. On the roads, markets for public transport applications, highway management, road safety and transport information services are emerging, whilst on the pavement pedestrians will see WiFi infotainment zones replacing public 'hot spots' around cities and towns.

WiFi, WiMax and 3G service providers are all challenged by the same problem: volume of data increasing the cost of supporting network ubiquity. Within the radio spectrum, the majority of wireless consumer applications sit within the 5GHz and below band, competing for just a few hundred MHz of spectrum. With the forecast growth in applications and devices, the competition in this range is set to intensify dramatically.

The implications of overloading this spectrum band, for users and network operators, should not be underestimated. With so many critical, as well as luxury, applications depending on bandwidth availability, a network jam would result in lost workforce productivity, service downtime across industries and failure of business and personal applications. The impact potentially reaches across the state of the nation, with implications for the complexity of large-scale networks and the cost of service delivery, not simply individual inconvenience.

Spectrum availability and the cost of backhaul, created by an overload of devices and applications on the networks, are generating the 'perfect storm'. It is crucial that telecoms and network industries look higher than 5GHz – much higher – to resolve the last mile communication challenges.



Figure 1: Millimetre microwave transceiver using fibre-optic system



Figure 2: Millimetre microwave coverage

Other Spectral Options

This 5GHz watershed is not entirely arbitrary, but it pushes the capabilities of pure silicon semiconductors that tend not to handle higher frequencies. Advances in semiconductor technology powers have allowed for greater integration of functionality for wireless devices and services, along with a smaller footprint on the network and a broader scope for deployment. In combination, this supports broader reach and utilisation of the millimetre wave wireless radio spectrum.

The millimetre wave spectrum meets the needs of both short (up to 600 metres, 60GHz range) and mid range (up to 1-5km, 70-80GHz range). This increases the available bandwidth to allow for a more effective content delivery system, particularly when network operators utilise caching to reduce backhaul over the fixed infrastructure.

In the last few years this burgeoning bandwidth problem has been the focus of innovative technology companies, with investigation reaching into solutions in the 60GHz spectrum, including LastMile Communications.

Wavelength in the 60GHz spectrum is about 5mm, and quarter wave stub antenna is 1.25mm. The maximum theoretical range of millimetre wave wireless broadband is 600m, however, the radiation is weakened in this part of the band by the oxygen molecule's absorption characteristics therefore by the air it travels through, limiting communication ranges to up to 250 metres of the transceiver. These are the upper limits of

the current radio 'Everest' and spectrum where only the military and a very few research-based industries currently have any applications. For domestic and business use, this part of the spectrum offers many advantages.

Millimetre Wave Wireless Broadband

Millimetre wave radio spectrum has attracted a great deal of attention from academia, industry and global standardisation bodies. The 60GHz spectrum offers reliable short-range connectivity at high throughput. Potentially providing a multi gigabit transmission rate, millimetre wave technology enables many new applications such as rich video and audio

communications, extra large file sharing and transfer and a high quality user experience.

It can be leveraged as an asset for new wireless infrastructural techniques to create re-use of bandwidth on a geographically dense basis. Millimetre short wave subsystems enable point-to-point high-speed communication across a distribution grid of mounted wireless transceiver nodes, removing the need for underground fibre optic cabling and similar expensive options.

Most current millimetre transceiver products available today offer up to offer up to 1.5 Gigabits per second of a potential 7GHz of bandwidth available at 60GHz range of frequencies. This millimetre wavelength spectrum could provide the answer for growing bandwidth needs, with increasing rich media demand over communications networks, with a focus on driving maximum throughput within an economical price range.

For millimetre wave products to be deployed as part of a larger geographical roll-out requires commodity pricing through mass market adoption where volume will drive down unit prices for equipment. This in turn encourages development of industry standards for millimetre wave communications components.

Quarter-wave stub antennas do not pull much energy out of the air (and power-for-power this is a critical consideration for omni-directional systems and a key differentiator to 2-



Figure 3: Millimetre microwave local coverage

5GHz systems), but a 20-wavelength aperture dish is only 100mm across and can achieve antenna gain of 33dB. As an alternative to installing countryside antennas (the type preferred by wireless GSM, UMTS or WiMAX operators utilising longer range radio spectrum and transmitters), which cannot reach all areas equally, a series of these short distance, high quality, nodes can provide seamless wireless connectivity in highly contended or sparsely provided areas.

Given the size and power efficiency, this compact hardware can be mounted on roadside lampposts, rather than on rooftops, to enable wider installation and use throughout urban and rural areas. Individual nodes can even be made self-sufficient through solar power generation, further increasing the possible locations for installation. The short range is not a disadvantage: the antenna 'spot size' is smaller and interference is controlled, whilst each node provides a 'data-breakout', which is

where the cost is incurred in competing fibre-based systems.

Millimetre wave wireless broadband could also be used for backhaul or cross-link between nearby sites, such as enterprise solutions between buildings or as a back-haul to be used in short distances (300-600m for 60GHz band). This would allow service providers to link back to the longer distance back-haul, a key point of aggregation for a higher bandwidth backhaul pipe.

It is important to note that the 57GHz to 66GHz range is not part of the ISM bands in the UK, with current designations being finalised. As it stands 57GHz to 63GHz is essentially unlicensed, 63GHz to 64GHz is being reserved for Intelligent Traffic Systems (ITS), and the 64GHz to 66GHz range is 'lightly licensed' for point-to-point links. Refining and managing the millimetre wave allocation is a vital step towards solving the wireless bandwidth congestion problems forecast over the

next decade, driven by the fast-growing demand for high quality broadband and rich media.

Competing technologies in this price band include infrared systems and fibre networks. For infrared, the size of the antenna required and need for a constant power source constrain the equipment to be sited on rooftops, and fibre systems carry a high cost of deployment.

As millimetre wave technology, currently in comparative infancy, develops, these differentials – particularly price/performance – are only set to increase. To operators, this opens up a wealth of revenue from high bandwidth delivery to consumers and businesses. Whilst costs are reduced with the second generation of millimetre wave communication, a further generation should make it feasible for M2M technology in cars and other consumer electronics applications to become an every-day reality. ■

Telnet

Quality second-user test & measurement equipment

Tel: 02476 650 702 Fax: 02476 650 773

Web: www.telnet.uk.com Email: sales@telnet.uk.com

All equipment is used – with 30 days guarantee and 90 days in some cases. Add carriage and VAT to all goods.
1 Stone Court, Hotchkiss Way, Binley Industrial Estate Coventry CV3 2RL ENGLAND



Agilent (HP) 3314A Function Generator 20 MHz	£650	Agilent (HP) 53181A Frequency Counter	£750
Agilent (HP) 3325A and B function gen. from	£550	Agilent (HP) 4284A Precision LCR Meter	£5750
Agilent (HP) 435A/B, 436A, 4637B, 438A Power Meters from	£100	Agilent (HP) 6031A Power Supply (20V – 120A)	£1250
Agilent (HP) 3561A Dynamic Signal Analyser	£2950	Agilent (HP) 6032A Power Supply (60V – 50A)	£2000
Agilent (HP) 3562A Dual Ch. Dynamic Sig. Analyser	£2750	Agilent (HP) 6671A Power Supply (8V – 200A)	£1350
Agilent (HP) 3582A Spectrum Analyser Dual Channel	£995	Agilent (HP) E4411A Spectrum Analyser (9kHz – 1.5GHz)	£2995
Agilent (HP) 3585A and B Spec. An. (40MHz) from	£2500	Agilent (HP) 8924C CDMA Mobile Station Test Set	£3000
Agilent (HP) 35660A Dynamic Sig. An	£2950	Agilent (HP) E8285C CDMA Mobile Station Test Set	£3000
Agilent (HP) 4191A R/F Impedance analyzer (1 GHz)	£2995	Agilent (HP) 54520A 500MHz 2 Channel Oscilloscope	£1000
Agilent (HP) 4192A L/F Impedance Analyser (13MHz)	£3500	Agilent (HP) 54645D 100MHz Mixed Signal Oscilloscope	£3000
Agilent (HP) 4193A Vector Impedance Meter	£2750	Agilent (HP) 8713B 300kHz – 3GHz Network Analyser	£4500
Agilent (HP) 4274A LCR Meter	£1750	Agilent (HP) 8566B 100Hz – 22GHz High Performance Spec. An.	£7000
Agilent (HP) 4275A LCR Meter	£2750	Agilent (HP) 8592B 9kHz – 22GHz Spectrum Analyser	£6250
Agilent (HP) 4276A LCR Meter	£1400	Amplifier Research 10W1000B Power Amplifier (1 GHz)	£4700
Agilent (HP) 4278A Capacitance Meter (1kHz / 1MHz)	£2500	Anritsu ML 2438A Power Meter	£1400
Agilent (HP) 5342A Frequency Counter (18GHz)	£850	Rohde & Schwarz SMY01 9kHz – 1040 MHz Signal Generator	£1750
Agilent (HP) 5351B Frequency Counter (26.5GHz)	£2250	Rohde & Schwarz CMD 57 Digital Radio Comms Test Set	£4250
Agilent (HP) 5352B Frequency Counter (40GHz)	£3950	Rohde & Schwarz XSRM Rubidium Frequency Standard	£3750
Agilent (HP) 53310A Mod. Domain An (opt 1/31)	£2750	Rohde & Schwarz CMD 80 Digital Radio Comms Test Set	£3500
Agilent (HP) 54600A / B 100 MHz Scopes from	£700	R&S SMIQ-03B Vector Sig. Gen. (3 GHz)	£7000
Agilent (HP) 54810A Infinium Scope 500MHz	£2995	R&S SMG (0.1 – 1 GHz) Sig. Gen.	£1750
Agilent (HP) 8116A Function Gen. (50MHz)	£1500	Tektronix THS 720A 100MHz 2 Channel Hand-held Oscilloscope	£1250
Agilent (HP) 8349B (2- 20GHz) Amplifier	£1750	W&G PFJ 8 Error & Jitter Test Set	£4500
Agilent (HP) 8350B Mainframe sweeper (plug-ins avail)	£250	IFR (Marconi) 2051 10kHz-2.7GHz) Sig. Gen.	£5000
Agilent (HP) 85024A High Frequency Probe	£1000	Wayne Kerr AP 6050A Power Supply (60V – 50A)	£1850
Agilent (HP) 8594E Spec. An. (2.9GHz) opt 41,101,105,130)	£3995	Wayne Kerr AP 400-5 Power Supply (400V – 5A)	£1300
Agilent (HP) 8596E Spec. An. (12.8 GHz) opt various	£6500	Wayne Kerr 3260A+3265A Precision Mag. An. with Bias Unit	£5500
Agilent (HP) 89410A Vector Sig. An. Dc to 10MHz	£7500	Wayne Kerr 3245 Precision Ind. Analyser	£1750
Agilent (HP) 89440A Vector Signal Analyser 2MHz – 1.8GHz	£7750	Wayne Kerr 6425 Precision Component Analyser	£2000
Agilent (HP) 33120A Function/Arbitrary Waveform Generator 15MHz	£850	Wavetek 9100 Universal Calibrator (Opts 100 / 250)	£9000
Agilent (HP) 53131A Frequency Counter	£750	Various other calibrators in stock. Call for stock / prices	

I. DOZOV, S. JOLY, L. FAGET, D. STOENESCU, S. LAMARQUE-FORGET AND PH. MARTINOT-LAGARDE OF NEMOPTIC IN FRANCE DISCUSS THE BISTABLE NEMATIC DISPLAYS' SWITCHING MECHANISMS AND SPECIFIC MATERIALS REQUIREMENTS

BISTABLE AND PROUD OF IT

Most liquid crystal displays (LCD) are monostable, with unique off-field state. They require continuous image refreshment, increasing the energy consumption and limiting the multiplexing ratio in passive matrix configuration.

Bistable displays have two (or more) stable states and intrinsic memory of the pixel. They need power only for the image update. For some applications, such as e-book for example, the energy saving can increase the battery lifetime by orders of magnitude. Passive bistable devices can be driven line-by-line, memorising the displayed information and achieving infinite multiplexing ratio.

Several bistable technologies, like the 360° BTN and the bistable cholesteric, depend mainly on the bulk properties of the liquid crystal (LC) and use standard strong anchoring, with alignment films and LC mixtures similar to the traditional monostable materials. Other bistable technologies are based mainly on the surface properties and need specific weak anchoring materials.

The bistable textures of our BiNem display are realised with monostable anchorings and the surface state is the same for the two textures. However, the surface plays a crucial role in the switching between the two states under field. Here we analyse the physical mechanisms of the bistable switching and the specific requirements to the surface and bulk properties of the materials. We study analytically the influence of the anchoring (azimuthal and zenithal anchoring energy, pre-tilt angle on the two plates, etc) and of the bulk properties (elastic constants and viscosities) on the switching and we define the target values for optimal performances of the bistable display. The analytical results are

compared with numerical simulations of the bulk and surface re-orientational dynamics.

Bistable Textures

The BiNem display uses a thin sandwich type cell (gap $d < 2\mu\text{m}$) with monostable alignments of the nematic on both plates, with easy axes lying in the same vertical plane, see **Figure 1**. The surface anchoring energy can be approximated as

$$W(\theta_s, \varphi_s) = \frac{1}{2}W_z \sin^2(\theta_s - \theta_e) + \frac{1}{2}W_{az} \sin^2(\varphi_s - \varphi_e) \quad (1)$$

where W_z and W_{az} are the zenithal and the azimuthal anchoring energies, and θ and φ are the polar angles of the surface director (s) and the easy axis (e) imposed by the alignment layer.

Without field, two different textures minimise the anchoring energy: one is quasi-uniform (U), the other is twisted at 180° (T). These textures are topologically bistable: in absence of external fields and defects they cannot transform one into another by bulk deformation. Additional texture stabilisation is obtained by suitable chiral doping, equalising the bulk twist energies of U and T. The azimuthal anchoring on the two plates also helps the

textures stability: stronger is W_{az} , higher is the surface energy barrier separating the T and U states. In practice, to insure infinite bistability one needs $W_{az} > 3.10^{-5} \text{ J/m}^2$, a moderately strong azimuthal anchoring.

Switching by Anchoring Breaking

The switching between U and T is obtained under field $E = U/d$ by breaking of the anchoring on one of the surfaces. Let us suppose different anchorings on the two plates. On the upper ("master") plate the anchoring is tilted ($\psi_1 = \pi/2 - \theta_{e1} \sim 5^\circ$) and strong ($W_{z1} \approx 10^{-3} \text{ J/m}^2$).

On the bottom ("slave") plate the pre-tilt is very small ($\psi_2 \ll 1^\circ$) and the anchoring is weaker ($W_{z2} \approx 3.10^{-4} \text{ J/m}^2$). Under field (and $\Delta\epsilon > 0$) the bulk director is oriented along E ($\theta \approx 0$), except in the two surface layers of thickness $\xi \approx \sqrt{K/\epsilon_0 \Delta\epsilon} \cdot d$. On the surfaces, the director orientation satisfies the torque equilibrium equation:

$$E\sqrt{K\Delta\epsilon_0} \sin(\theta_s) + \frac{1}{2}W_z \sin 2(\theta_s - \theta_e) = 0 \quad (2)$$

where the two terms are respectively the bulk and the anchoring torques and K is an average elastic constant.

The strong anchoring on the master plate keeps $\theta_{s1} \approx \theta_{e1}$. On the weaker slave plate

θ_{s2} decreases rapidly with increasing field. In **Figure 2** we plot $\theta_{s2}(E)$ for strictly planar anchoring ($\psi_2 = 0$). The two symmetric branches on the figure correspond to initial U or T texture (after transient 180° bent state). At a threshold

$E_c = W_z / \sqrt{K\epsilon_0 \Delta\epsilon}$ (typically $E_c = 10\text{-}30\text{V}/\mu\text{m}$) the anchoring is broken – the anchoring torque vanishes and the surface

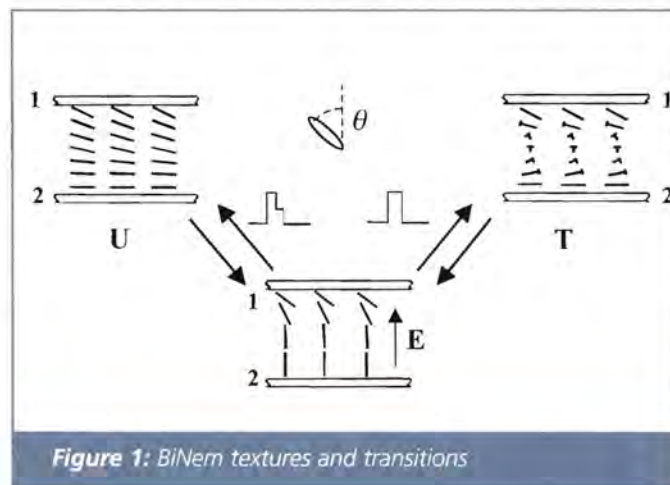

Figure 1: BiNem textures and transitions

director is parallel to E.

After removing the field, the surface is in unstable equilibrium (both torques in Equation 2 vanish at $\theta_{s2}=0$) and can relax to either one of the bistable states. This continuous (second-order) anchoring breaking transition is possible only in the $\psi_2=0$ case.

Selecting the Texture

To control the switching, we use the static and dynamic couplings of the two surface directors. The strongly anchored “master” plate emits a “command” signal, the broken anchoring “slave” plate receives it and switches.

Let us first consider slow decrease of the field from $E_0 > E_c$ down to 0, to avoid any dynamical effects (Figure 3b). The director distortion close to the “unbroken” master surface relaxes down elastically in the bulk, giving on the slave plate a small tilt $\approx \theta_0 \exp(-d/\xi)$. For thin cells this elastic coupling is sufficient to lift the degeneracy: for $E < E_c$, the tilt increases, keeping the same sign and the sample relaxes always toward the U state.

Dynamic couplings will be favoured if we turn off the field instantaneously. The master plate director rotates rapidly back toward its equilibrium orientation θ_0 . This creates a surface flow V , diffusing rapidly in the bulk down to the broken slave plate. The shear velocity gradient V/d applies on the slave plate a hydrodynamic torque $\Gamma \sim \kappa L_2 / d$, with a sign opposite to the elastic tilt. The cell relaxes rapidly to the transient π -bent state B and then to the π -twisted texture T (Figures 3c and d). The

hydrodynamic effect, proportional to ξ/d , dominates the elastic coupling $\sim \exp(-\xi/d)$; with fast field decrease the final T state is always obtained.

In practice, to select the final state we vary the electric pulse back to front. Turning off the field sharply, we always obtain the T texture, i.e. we “write” the pixel. To “erase”, which means to produce the U texture, we decrease the field slowly (~ 1 ms). To make the erasing pulses shorter, a two-step decrease of the field can be used, with an intermediate value adjusted to the breaking threshold. It is important to note that in the $\psi_2=0$ case the strength of the two couplings is quite unbalanced. To obtain the “erased” state U one needs to damp completely the backflow hydrodynamics, very efficient in thin cells.

The anchoring breaking described above is impossible in the $\psi_2 \neq 0$ case. Even in a very strong field, when $\theta_{s2}=0$, the anchoring torque does not vanish (see Equation 2), the surface director being repulsed away from the anchoring energy maximum (called “difficult” axis) at $\theta_{2d} = \theta_{2e} - \pi/2$. Here we assume $\theta_{2d} = -\psi_2$, although this relation is not general, but due to the Rapini-Papoular approximation in Equation 1 ($\theta_{2d} = -\psi_2$ has been reported for the higher symmetry conical anchoring).

First-Order Anchoring Breaking

Under suitable topological constraint a discontinuous (first-order) anchoring breaking could be obtained. In this case the breaking is a transient process, with the surface director jumping across the anchoring energy maximum and relaxing to

a new $\theta_{s2} = 0$ state. In Figure 4 we plot $\theta_{s2}(E)$ for a tilted anchoring ($\psi_2 \neq 0$) and parallel pre-tilts on the two plates (the anti-parallel pre-tilts geometry is less interesting – there is no T-to-U switching in this case).

Starting from the U texture, the director explores only the positive branch, even at very high fields. Starting from the T texture (transformed under field to the bend texture B) the director is on the negative branch, approaching the difficult axis. At a threshold field E_U the director reaches the critical angle $\theta_{c-} = -\sqrt{3}\psi_2$, the last stable point on this branch (the dashed curve is the solution maximising the energy instead of minimising it).

Above E_U the anchoring torque is too weak to equilibrate the still strong electric torque and the first-order breaking takes place, with a jump of the system to the positive branch: the initial T-texture is erased (transformed to U). Because of the finite torques during the transition, the first-order breaking is fast and highly efficient. The erasing threshold $E_U = E_c / \sqrt{1+3\theta_{c-}^2}$, is close to the anchoring breaking threshold E_c and decreases slowly with increasing ψ_2 .

Hydrodynamic Flow in the Tilted Case

The positive branch in Figure 4 is stable: the system cannot go back to the T state by anchoring breaking. However, strong enough flow can bring it back across the anchoring energy barrier to the negative branch. At $E = E_U$, after the jump to the positive branch, $\theta_{s2} = \theta_{c+} = -2\theta_{c-}$, and the anchoring torque is strong ($\approx 2W_2 \sqrt{3}\psi_2$). To overcome it, much stronger hydro-dynamic flow is needed than in the $\psi_2 = 0$ case. Up

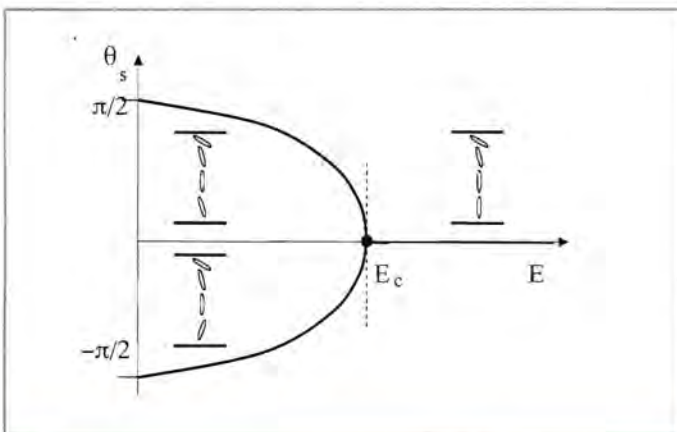

Figure 2: Second-order anchoring breaking

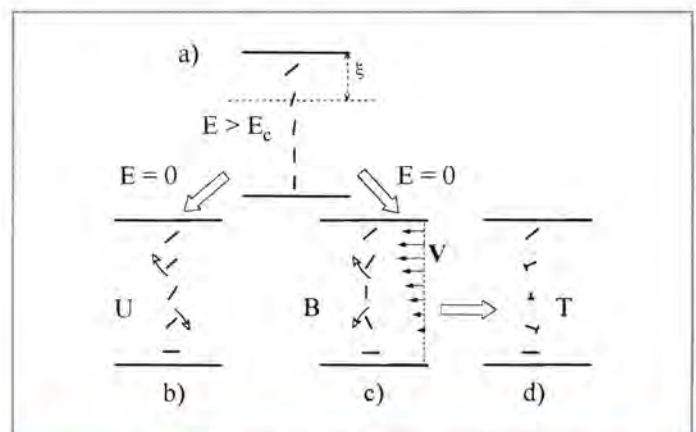

Figure 3: Texture selection by static/dynamic competition

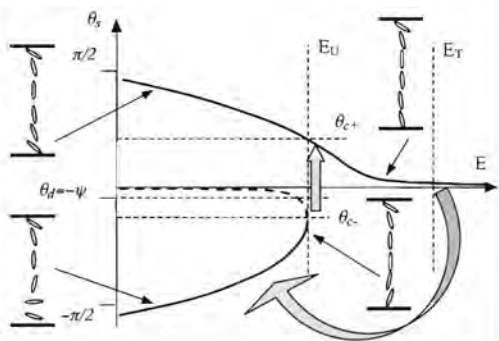

Figure 4: First-order anchoring breaking. The gray arrows show the transitions: T to U by anchoring breaking and U to T by hydrodynamic flow

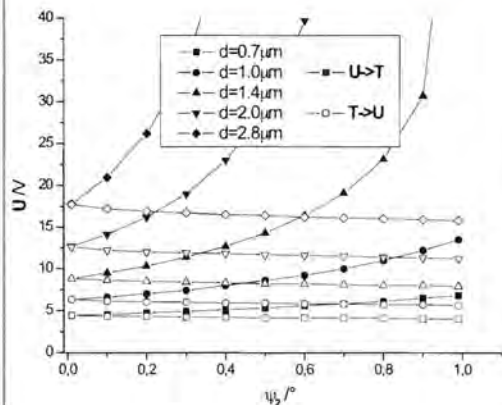

Figure 5: Switching voltages as a function of the pre-tilt

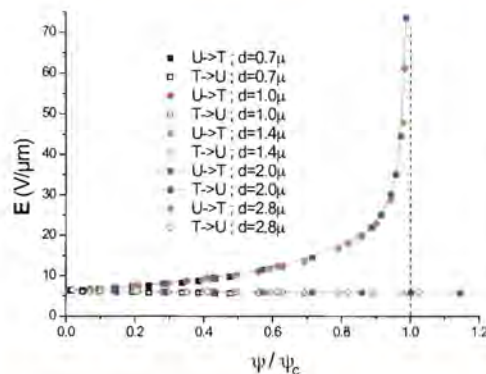

Figure 6: Field thresholds as a function of the relative pre-tilt

to a new threshold, the “writing” (or U to T) threshold E_T , the flow is too weak and the cell remains in the U state, independently from the driving pulse form. Above E_T , at fast field removal, the flow is strong enough to drive the surface director back over the anchoring energy maximum toward the T texture.

The existence of two distinct thresholds in the $\psi_2 = 0$ case brings an important advantage to the BiNem display: a static texture selection is now possible, dependent only on the pulse amplitude and not on its waveform. The multiplexing of the device is improved, with simpler driving pulses and shorter line-writing times.

The two competing torques, elastic and hydrodynamic, are strong and with similar amplitude, less sensitive to perturbations.

The writing threshold field depends strongly on the anchoring strength and the pre-tilt, but also on the details of the switching dynamics: anchoring strength and pre-tilt on the master plate (source of the shear flow), bulk nematic visco-elastic properties (flow diffusion to the slave plate), cell gap (flow attenuation), surface director relaxation on the slave plate (efficiency of the hydrodynamic flow) etc. The analytical treatment of the dynamic phenomena is prohibitively difficult and numerical simulations are necessary for the quantitative description of the switching.

Numerical Simulation

The numerical simulation program for the study of the statics and dynamics of the physical phenomena in weak anchoring nematic cells was developed at Nemoptics. It is based on the solution of the torques and forces equilibrium equations in the bulk and on the two surfaces. A relaxation algorithm enables the exact description of the bulk and surface dynamics during the anchoring breaking transitions. All the anisotropies are taken into account: elastic, dielectric, viscous and surface anchoring. The program will be described in details elsewhere, here we focus on the results related to the

BiNemptic switching.

We choose a basic set of values corresponding to the nematic 5CB at room temperature and to the Nemoptics’s proprietary BP101 weak anchoring layer on the slave plate: $K_{11}=6.4\text{pN}$, $K_{22}=3\text{pN}$, $K_{33}=10\text{pN}$, $\epsilon_{//} = 19.7$, $\epsilon_{\perp}=6.7$; $W_{22}=0.21\text{ mJ/m}^2$, $W_{21}=0.5\text{ mJ/m}^2$, $\psi_2=0.4^\circ$, $\psi_1=9^\circ$; $d=1.4\mu\text{m}$, $d/P=0.25$. Starting from the U or T texture we “apply” square electric pulses with variable amplitude (0-50 V/ μm) and duration 1ms and we “measure” the switching thresholds varying some of the parameters.

Switching Thresholds

At low fields, there is no surface switching, but only a transient distortion. Above a first threshold, identified as E_U , the cell relaxes to the U texture, independently of the initial state. Under field we observe rapid ($\sim 10\ \mu\text{s}$) bulk and surface distortions, and a first-order anchoring breaking. The static features (E_U , θ_{c+} , θ_{c-}) are in good agreement with the analytical model.

Above a second threshold, identified as E_T , the cell relaxes to the T texture after the field removal. Independently of the initial state, under field the slave surface is on the positive branch of Figure 4, ready to relax back to the U-texture. Above E_T the shear flow launched by the master plate is strong enough to bring it back on the negative branch and to the final T-state.

In Figure 5 we plot the threshold voltages as a function of ψ_2 and the cell gap. The erasing threshold (open symbols) decreases with the increasing pre-tilt. The writing voltage increases rapidly with the pre-tilt, from $U_T = U_U$ for $\psi_2 = 0$, up to infinity for high ψ_2 : above some critical value ψ_c of the pre-tilt, the anchoring energy barrier is too high and for any field strength the shear flow is too weak to write the T texture.

The critical pre-tilt depends on the anchoring and bulk LC properties. However, when plotted as a function of the relative pre-tilt ψ_2/ψ_c , the switching thresholds show a quasi-universal behaviour, as shown in Figure 6 for the

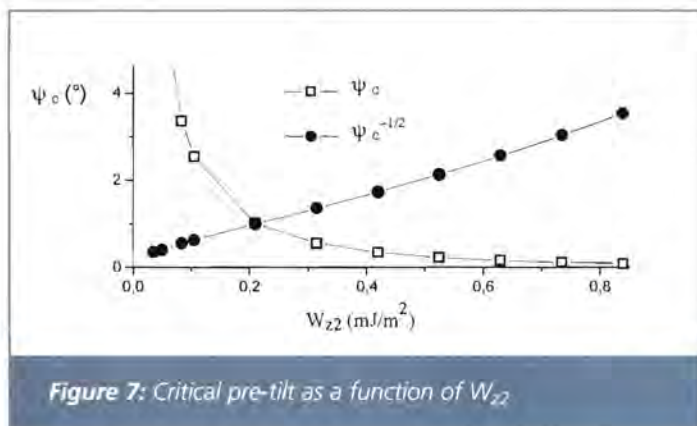

Figure 7: Critical pre-tilt as a function of W_{22}

case of a varying gap. This enables us to focus the numerical simulation on the calculation of the ψ_c values as a function of the LC properties and, then, to find the optimal ψ_2 value from the “universal” curve.

Critical Pre-tilt Variation

The critical pre-tilt ψ_c is defined on the field removal by the competition between the anchoring and the hydrodynamic torques. Due to the variation of the anchoring torque, $\psi_c(W_{22})$ vary as W_{22}^{-2} (Figure 7). For other anchoring properties (W_{21} , ψ_1 , W_{az1} , W_{az1}) the resulting ψ_c variation is quite weak (for reasonable parameters values) and we don't present it here.

In a similar way, the ψ_c variation with some bulk properties (like K_{11} and K_{22}) can be neglected. Other bulk properties influence strongly the ψ_c value.

From the analytical formulae we expect flow torque linear in K_{33}/d . The numerical simulation confirms the variation of ψ_c as K_{33} and $1/d$.

The viscosity dependence of the critical pre-tilt is much more complicated. The nematic viscosities influence the flow strength at several stages: at its “emission” close to the master plate, at its “transmission” through the bulk and at its “reception” at the slave plate. The numerical simulations show that the critical pre-tilt depends only on the anisotropy $\chi = \alpha_2/(\alpha_4 + \alpha_5)$ of the viscosities and not on their absolute values. The $\psi_c(\chi)$ dependence (Figure 8) shows a maximum at $\chi = -0.8$, where the hydrodynamic coupling is the most efficient.

Discussion and Conclusion

The numerical results are in good agreement with the analytical formulae, but give more detailed description of the dynamics of the switching. The agreement with the experiment is semi-quantitative, but the comparison is complicated due to the limited choice of weak anchoring materials, the lack of data about their physical properties and the impossibility to vary continuously and independently the parameters.

For optimal performance, the BiNem device needs specific anchoring and bulk properties of the materials. At least moderate azimuthal anchoring strength W_{az1} is needed to obtain infinite bistability, but the zenithal energy W_{z1} should be as weak as possible, to achieve low switching thresholds. In practice, weak anchoring materials are rare and not well studied, imposing strong restrictions on the choice of the nematic compounds and the anchoring polymer. Moreover, W_{az1} and W_{z1} are correlated, and to satisfy the bistability/low threshold requirements, drastic restrictions are imposed on other properties of the materials: very high $\Delta\epsilon$, typically > 20 , implying also high viscosities; low cell gap $d < 2\mu\text{m}$; etc.

The passive matrix multiplexing imposes an additional requirement: the ratio of the switching thresholds $R = E_T/E_U$ should be > 1 , ideally $R \sim 1.5$, to avoid crosstalk and to enable line-by-line refreshment of the device without dynamical perturbations. As seen from Figure 5, the control of the slave plate pre-tilt ψ_2 is an efficient tool to vary R . For any combination of bulk and

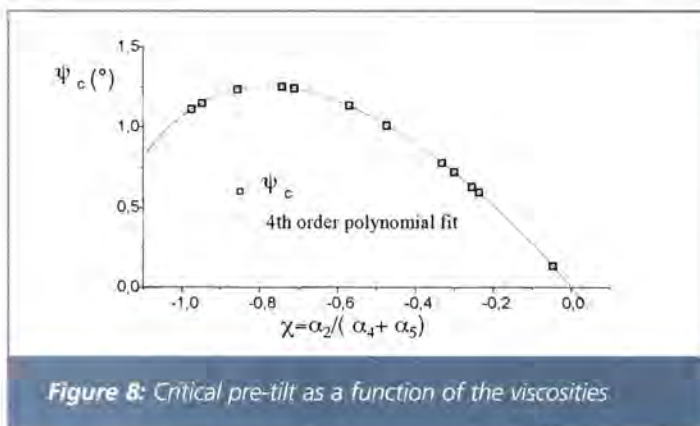

Figure 8: Critical pre-tilt as a function of the viscosities

anchoring properties, there exists a critical pre-tilt ψ_c , and the optimal pre-tilt value is defined from the quasi-universal dependence shown on Figure 6, with $R \sim 1.5$ obtained for ψ_2/ψ_c in the range 0.4-0.6. With reasonable values of the parameters, the numerical simulations give $\psi_c \sim 1^\circ$ and, hence, a target value for ψ_2 of the order of 0.5° .

Our experience with weak anchoring materials shows that ψ_2 is a convenient parameter for the thresholds ratio control – it is only weakly correlated to the anchoring strength and can be varied almost independently by fine tuning of the alignment layer process (film thickness, baking temperature, rubbing strength, etc).

For the specific BiNem materials developed at Nemoptic, the critical pre-tilt value is about 0.8° and the process tuning insures optimal pre-tilt on the slave plate in the range $0.3\text{-}0.4^\circ$, with satisfying reproducibility.

To conclude, we show here the importance of the anchoring breaking geometry for the bistable switching of weak anchoring devices. The first order anchoring breaking brings important advantages to the BiNem display, improving the refreshment speed and decreasing the crosstalk and other dynamical perturbations.

By numerical simulations we show the existence of a critical pre-tilt value and a quasi-universal dependence of the switching thresholds as a function of the relative pre-tilt ψ_2/ψ_c . We find a small but finite optimal value of the weak anchoring plate pre-tilt in the 10mrad range. ■

TAKING A PEEK AT THE FUTURE

By Chris Williams, UKDL

The UKDL column usually focuses on just one item, so for a change I thought I'd introduce you to a couple of the developments taking place around the UK that are helping to revolutionise the displays industry in different ways.

First up, we have Pelikon Ltd, a small private company that is already in volume production of electroluminescent (EL) displays. Pelikon manufactures these EL displays by screen-printing conductors, dielectric layers and phosphors onto transparent plastic that is itself coated with a transparent Indium Tin Oxide (ITO) electrically-conductive layer. This is a fairly conventional structure and manufacturing, but Pelikon have cleverly maximised the efficiency of their system to be able to make printed, segmented displays on a roll to roll (R2R) production basis at their factory in Caerphilly, South Wales. You may well be using one of these displays yourself – one of the main applications has been the display in handheld controllers for AV equipment allowing a clever "secret till lit" facility to be implemented.

This is all very well, but we know that EL displays – even well made ones – aren't particularly bright, and you certainly can't read one if you took it outside into direct sunlight. Enter the clever guys at Pelikon's research labs in Cambridge and their collaborators at Cambridge University. Working together on a project that was financially supported under the government's Technology Programme, they have developed and are now putting into mass production a new hybrid display. This display combines a phosphor-based electroluminescent display and a dye-doped liquid crystal shutter in the same package.

This may seem familiar to some of you and, indeed, various companies have tried similar combinations of display technologies to achieve the Holy Grail of a display that reads perfectly in all conditions. The basic idea is simple: you have a dye doped liquid crystal display that can operate in reflective mode during the day, so regardless of however bright the

ambient light is, the contrast between the "on" segments and the "off" segments will be sufficient to read the display correctly. As the ambient light goes down, the electroluminescent backlight shines sufficiently brightly and the display remains perfectly viewable.

Where the Pelikon display is totally unique is that they have developed a system whereby you drive the EL display *through* the Liquid Crystal display – there is just one cell, with one backplane and one frontplane. They have created what is probably the world's first low-power, low-

cost display that is viewable in all lighting conditions. As you read this, the process of moving the design into production is taking place and the hybrid display will be appearing very soon on a whole range of consumer electronic handheld equipments. Pelikon are taking advantage of the tremendous reductions in materials cost that have taken place in the last few years, with high voltage drivers now being readily available following the explosive growth of the plasma TV market. Similarly, liquid crystal materials are also in very high volume production, and the combination of

Figure 1: Pelikon lamp with a few segments lit, illuminated by bright halogen lamp



Figure 2: Pelikon lamp



low materials cost with relatively simple manufacturing processes is allowing this displays company based in the UK to enter the global market and compete directly with the production giants based in the Far East.

Figure 1 shows a sample of the Pelikon hybrid display, printed on thin plastic, being flexed whilst being driven and whilst being illuminated by an extremely bright halogen lamp.

Figure 2 shows the same display working with many more of the segments lit, again illuminated by an extremely bright halogen lamp.

As we move into 2008, keep an eye open for consumer products using this new "view any time of day" display offering ultra-thin, low-power operation on fully flexible substrates.

Next up is Plastic Logic, also based in Cambridge. Plastic Logic prints organic semiconductor materials to manufacture active matrix backplanes that are in turn

THEY HAVE CREATED WHAT IS PROBABLY THE WORLD'S FIRST LOW-POWER, LOW- COST DISPLAY THAT IS VIEWABLE IN ALL LIGHTING CONDITIONS

used to drive frontplanes made from E-Ink's electrophoretic display material. The Plastic Logic materials are printed onto a low-cost plastic material (PET, a material similar to that used in food and drinks packaging).

The principles of the display operation are similar in many ways to the LCD active matrix display in a laptop computer, mobile phone and LCD TV, for example. The active matrix backplane is an array of hundreds of thousands (and will be millions) of tiny FET transistors that switch each pixel of the display individually. Where it fundamentally differs from active matrix LCDs is that it uses organic semiconductor material that is printed rather than an inorganic silicon material which is deposited at high temperature, to form the individual transistors.

By printing the materials, the resulting backplane uses simpler, lower temperature manufacturing processes than glass-based displays, and by printing onto a plastic substrate and not glass, the backplane itself remains flexible. When laminated to a frontplane (the electrophoretic display, made by E-Ink), the resulting combination creates a flexible, electronic display, which is most

No1 Number One Systems

Easy-PC for Windows

The World Beating PCB design software

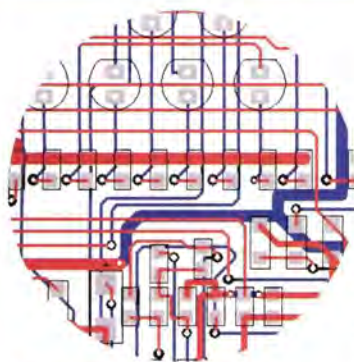

Version 11 features

- Design revision analysis
 - Star/Delta points
 - Apply layout pattern & groups
 - Design calculators
 - Electrical rules check (ERC)
 - Shape editing panel
 - Merge/subtract shape editing
 - Track analysis
- Plus many more exciting features...

The new Easy-PC reaches even higher!

The breathtaking new Easy-PC for Windows Version 11 is released. Winning accolades the world over, V11 of the market leading Easy-PC delivers even more remarkable value for money and sets the new benchmark for performance in PCB CAD.

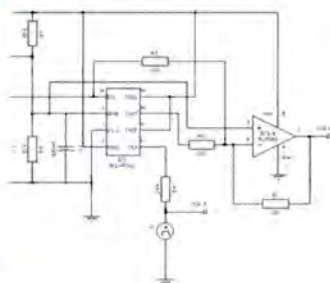

Just try a demonstration copy of Easy-PC and prepare to be amazed...

Easy-PC delivers a simple to understand, fully integrated Schematics & PCB layout in a single application. Design and rules checks at all stages ensure integrity at all times. Professional manufacturing outputs allow you to finish the design process with ease.

Stop press... Stop press... Stop press...
Easy-PC is supported running under Windows Vista

Call for a brochure, prices & CD on +44 (0)1684 773662
or e-mail sales@numberone.com
you can also download a demo from

www.NumberOne.com

Oak Lane, Bredon, Tewkesbury, Glos. GL20 7LR. United Kingdom

STILL FROM ONLY
£247
PLUS VAT



Figure 3: Plastic Logic COO John Mills holds a sample of their electronic paper modelled as an electronic book or newspaper module



often referred to as e-paper (short for electronic paper).

Figure 3 shows the COO of Plastic Logic, Dr John Mills, holding one of the demonstration units of his company's e-paper units. The firm is now building its first production factory at Dresden in Germany, and production units will roll off the line towards the autumn of 2008.

Again, 2008 will be the year when the first examples of these and other UK-based flexible display activities will begin to emerge into the consumer marketplace. The revolution of Plastic Electronics really is just around the corner.

Finally, I can write about a little piece of history in the making. Again, as part of a government-funded collaborative research project, several UK companies are working with Cambridge University to develop a way of manufacturing high brightness LEDs at a cost that will knock 90% off the current manufacturing cost in the Far East. Ambitious target or what?!

The way that the consortium is addressing this objective is to develop a way of building the (relatively high cost)

Gallium Nitride high brightness LED on a (very low cost) silicon substrate. All existing manufacturers of GaN LEDs build them on Gallium Arsenide, Gallium Nitride, Sapphire, or Silicon Carbide substrates. These are chosen because the atomic spacing of the individual atoms of the substrate material are similar to the atomic spacing of the Gallium Nitride that forms the epitaxial layer grown on top. With a good match between substrate and epitaxial layer, there is little stress between the two during production, and yield and reliability can be very high.

By choosing to use silicon as a substrate, because it is so much cheaper than any of the other material types, the project team are faced with huge problems. The atomic spacing of silicon is very different to Gallium Nitride, and this can lead to very high stresses as the epitaxial layer is grown. The research team in Cambridge are applying their inventive magic to solve this conundrum, and are developing interfacial layers that

lie between the substrate and the epitaxial layer to absorb and reduce, or eliminate, this stress factor.

The project is in its early days, but I am delighted to be able to show the picture in **Figure 4**, which shows an individual Gallium Nitride LED grown on a large silicon wafer being probed, and emitting its characteristic blue light.

It is a long step to go from this point in the laboratory to mass production of high brightness, commercial quality LED devices, but the results are very encouraging so far.

In next month's column I will give you examples of some of the novel production methods and equipments that UK companies have invented to be able to manufacture displays and lighting components on low-temperature plastic substrates.

Chris Williams is Network Director at the UK Display & Lighting Knowledge Transfer Network (UKDL KTN)

Figure 4: Prototype GaN LED grown on a silicon wafer being probe tested at the laboratory in Cambridge University



ELECTRONIC TELE-SECURITY SYSTEM

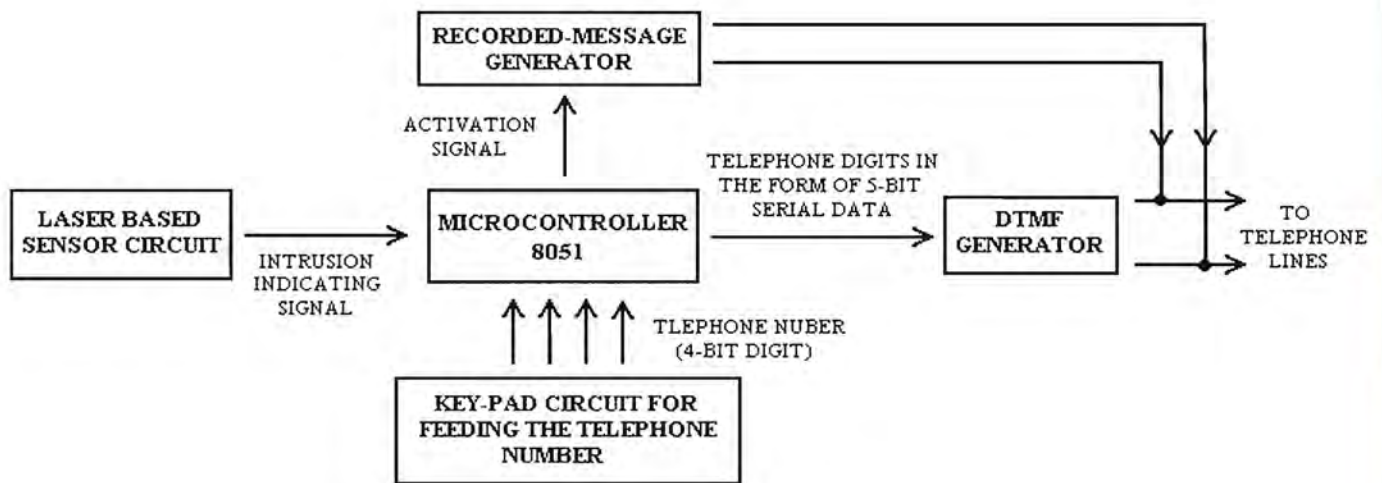

Schematic diagram

The circuit here deals with the security of a home or office, while the user is away. It essentially alarms the user of any intrusion or illegal entry into their premises via a telephone line when the user is away from the place, no matter how far away. If some intrusion occurs at the user's home or office, the user receives a call on his mobile phone, warning of the intrusion. The user, before leaving the home or office, needs to enter the telephone number to which the call should be made in such a case. All this is taken care of by an assembly of various parts of the circuit listed below.

1. A keypad-interfacing unit for telephone number entry;
2. An LCD to display the entered number;
3. A laser-based sensor circuit to detect the intrusion;
4. A telephone line status detection circuit;
5. A telephone line connecting/disconnecting circuit;
6. A DTMF generator to dial the telephone number;
7. Recorded message generator;
8. A microcontroller.

THE KEYPAD-INTERFACING UNIT

This unit serves the purpose of storing the user's number in the microcontroller. This has a keypad and a keypad encoder (IC 74C922) that generates the binary code for the entered digit so that it can be given to the microcontroller as input. The keypad encoder IC contains a data

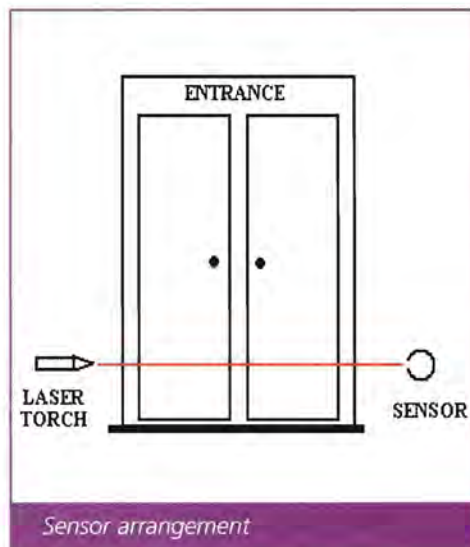

available pin (DA), which goes high while a key is pressed on the keypad, so whenever the DA pin goes high, the microcontroller reads the data. The pin numbers 16 to 19 of the IC transmit the binary equivalent of each digit entered through the keypad to the microcontroller's Port 1.

The LCD is used to display the number that is being entered into the microcontroller through the keypad. This is connected to Port 2 of the microcontroller.

THE SENSOR CIRCUIT

This is the part of the circuit, which actually signals the intrusion to the microcontroller. Whenever some intruder enters the home or office and crosses a laser beam, the output of this part goes high, and thus the microcontroller senses the intrusion. This part is based on a laser detection circuit consisting of an LDR and a 555-based monostable circuit that is triggered by the laser detection circuit.

The output of this circuit is connected to Port 0.6 of the microcontroller.

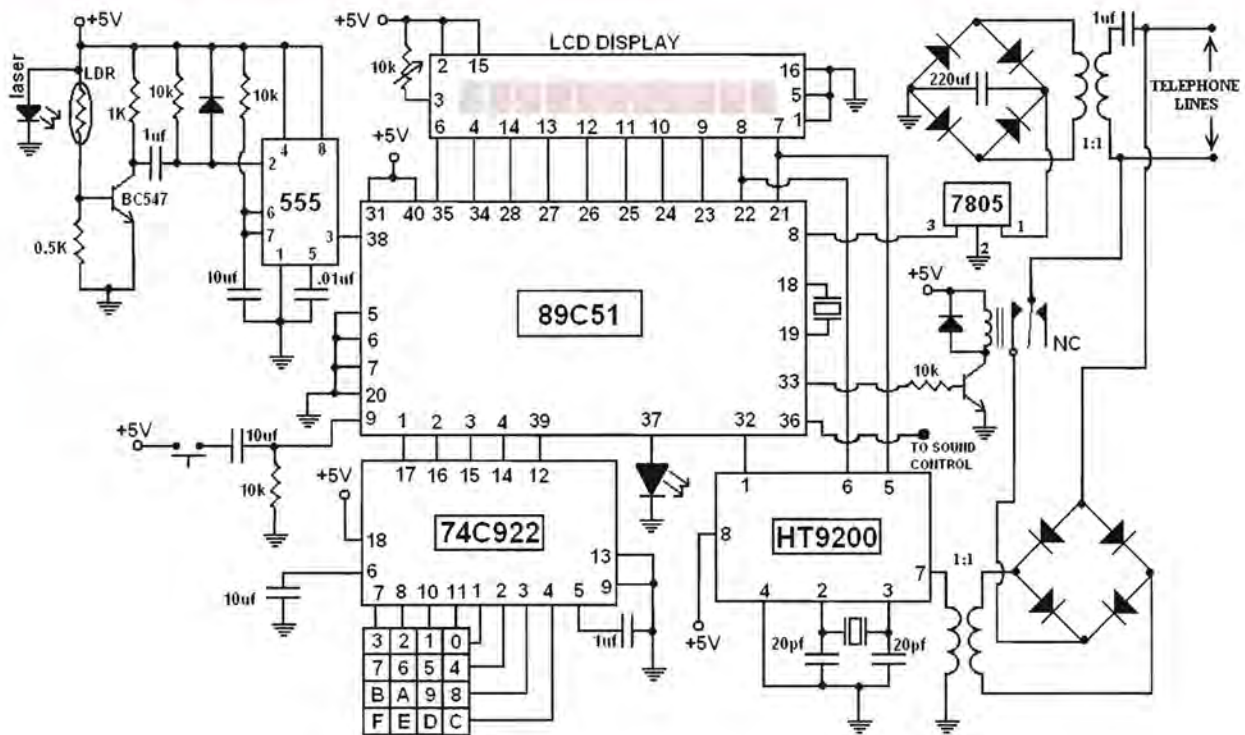

Circuit diagram

TELEPHONE-LINE STATUS DETECTION CIRCUIT

This part of the circuit is basically used to inform the microcontroller whether the telephone line is free for making calls or not. Its output is high, whenever the telephone line is in use and it goes low when the line is free. Its output is sent to Port 1.7 of the microcontroller.

The telephone line connecting/ disconnecting circuit part consists of a single relay, which is operated by the microcontroller, which activates the relay while making the call and deactivates it after the call has been made. This part is connected to Port 0.1 of the microcontroller.

THE GENERATORS

The DTMF generator generates a dual tone multiple frequency output by taking serial five bits for each digit along with a clock pulse, as input from Port 2.0 and Port 2.1 of the microcontroller. The IC used for this is HT 9200.

The recorded message generator circuit generates the recorded message, which is to be sent to the user after the telephone number is dialled. The microcontroller

activates this circuit after dialling the telephone number.

THE MICROCONTROLLER

The microcontroller is the central part of the whole circuit, to which all the abovementioned parts are interfaced to various ports.

It has six functions:

1. It stores the user's telephone number that is entered through the keypad;
2. It senses any intrusion in the house or office through the sensor circuit;
3. It checks if the telephone line is free or busy before the number is dialled;
4. It connects and disconnects the telephone line according to the need;
5. Dials the entered number through the DTMF generator upon any intrusion;
6. Sends the recorded message to the user.

A program stored in it drives all the needed functions. The sequence of steps followed by it is shown in the flowchart. The flow chart also explains the overall working of the circuit.

Mahesh C Siddartha Kumar and A. Anusha,
India

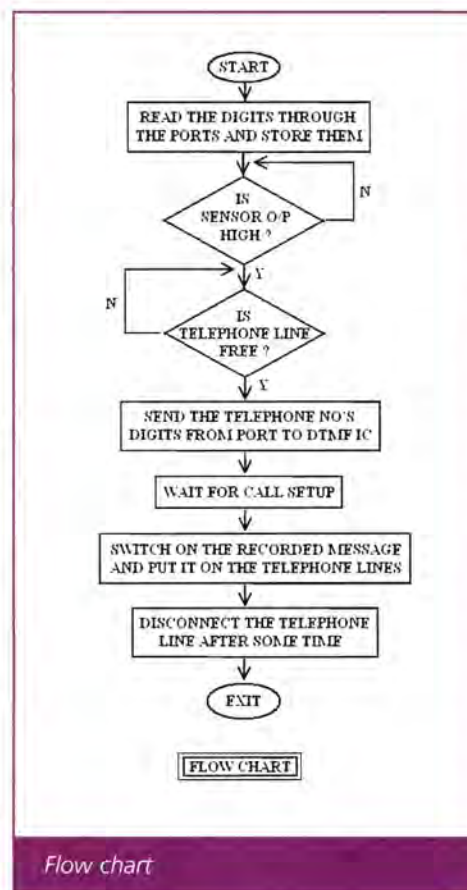

Flow chart

ASSEMBLY LANGUAGE PROGRAM FOR 8051

```

MOV A, #0FFh      MOV A, 08h
MOV P1, A         ACALL CMDW
MOV A, #03h      ACALL DELAY
MOV P0, A        SETB P0.6
MOV R0, #30h     CLR B P0.7
MOV R1, R0       CLR B P0.3

CLR B P0.2
CLR B P0.6
SETB P0.7
CLR B P0.3

MOV A, #0Eh
ACALL CMDW
ACALL DELAY
MOV A, #01h
ACALL CMDW
ACALL DELAY
MOV A, #06h
ACALL CMDW
ACALL DELAY
MOV A, #80h
ACALL CMDW
ACALL DELAY

DATA_AC: SETB P0.2

DA_CHECK: JNB P0.0, DA_CHECK
MOV A, P1
ANL A, #01h
ACALL DATAW
ACALL DELAY
CLR B P0.2
CJNE A, #00h, STORE
MOV A, #0Ah

STORE: MOV @R0, A
INC R0
CJNE A, #0Fh, DATA_AC

SENSR_CHK: JNB P0.1, SENSR_CHK

RING_CHK: JB P1.7, RING_CHK

CMDW: MOV P2, A
CLR B P0.5
SETB P0.4
CLR B P0.4
RET

DATAW: MOV P2, A
SETB P0.5
SETB P0.4
CLR B P0.4
RET

DELAY: MOV R4, #01Eh

AGAIN3: DJNZ R4, AGAIN3
RET

MOV A, 08h
ACALL CMDW
ACALL DELAY
SETB P0.6
CLR B P0.7

DATA_TRANS: MOV A, @R1
MOV R3, #05H
CJNE A, #0Fh,

BIT_SEND
SETB P0.7
SIMP SOUND_ACT

BIT_SEND: SETB P2.0
ACALL DELAY
RRC A
MOV P2.1, C
ACALL DELAY
CLR B P2.0
ACALL DELAY
DJNZ R3, BIT_SEND
INC R1
ACALL DELAY
ACALL DELAY
SIMP DATA_TRANS

SOUND_ACT: MOV A, #0FFh

AGAIN1: ACALL DELAY
DJNZ A, AGAIN1

SETB P0.3
MOV R2, #0FFh

SND_D: MOV R3, #0FFh

AGAIN2: ACALL DELAY
DJNZ R3, AGAIN2
DJNZ R2, SND_D

CLR B P0.3
CLR B P0.6

EXIT

```

SAVE 16%

on the in-store price
subscribe today



Subscribe today

to enjoy 2 issues free

CALL TODAY OR SUBSCRIBE ONLINE

UK: 0870 428 1426

International: +44 1795 414608

Web: www.electronicsworld.co.uk

PCB-POOL®

SERVICING YOUR COMPLETE PROTOTYPE NEEDS

1 EUROCARD
(160 x 100 mm)
+ Tooling
+ Photoplots
+ VAT

€49

Price example
Any size and contour possible!

Optional:

- Soldermask
- Fast-turnaround
- Silkscreen
- 4-Layer Multilayer
- 6-Layer Multilayer

**DOWNLOAD OUR
FREE LAYOUT SOFTWARE!**

Over 15,000 Customers

LEAD FREE

Freephone 0800-3898560

Tel: +353 (0)61 701170
Fax: +353 (0)61 701165
pcb-pool@bang-layout.com

This series of Tips 'n' Tricks addresses the challenges with a collection of power supply building blocks, digital level translation blocks and even analogue translation blocks. Throughout the series, multiple options are presented for each of the transitions, spanning the range from all-in-one interface devices, to low-cost discrete solutions. In short, all the blocks a designer is likely to need

for handling the 3.3V challenge, whether the driving force is complexity, cost or size.

NOTE: The tips 'n' tricks presented here assume a 3.3V supply. However, the techniques work equally well for other supply voltages with the appropriate modifications.

TIP 1: DRIVING BIPOLAR TRANSISTORS

When driving bipolar transistors, the amount of base current "drive" and forward current gain (μ/h_{FE}) will determine how much current the transistor can sink. When driven by a microcontroller I/O port, the base drive current is calculated using the port voltage and the port current limit (typically 20mA). When using 3.3V technology, smaller value base current limiting resistors should be used to ensure sufficient base drive to saturate the transistor.

The value of R_{BASE} will depend on the microcontroller supply voltage. **Equation 1** describes how to calculate R_{BASE} .

When using bipolar transistors as switches to turn on and off loads controlled by the microcontroller I/O port pin, use the minimum h_{FE} specification and margin to ensure complete device saturation.

$$R_{BASE} = \frac{(V_{DD} - V_{BE}) \times h_{FE} \times R_{LOAD}}{V_{LOAD}}$$

3V technology example:

$V_{DD} = +3V$, $V_{LOAD} = +40V$, $R_{LOAD} = 400\Omega$, $h_{FE} \text{ min.} = 180$, $V_{BE} = 0.7V$ $R_{BASE} = 4.14k\Omega$, I/O port current = $556\mu A$

5V technology example:

$V_{DD} = +5V$, $V_{LOAD} = +40V$, $R_{LOAD} = 400\Omega$, $h_{FE} \text{ min.} = 180$, $V_{BE} = 0.7V$ $R_{BASE} = 7.74k\Omega$, I/O port current = $556\mu A$

For both examples, it is good practice to increase base current for margin. Driving the base with 1mA to 2mA would ensure saturation at the expense of increasing the input power consumption.

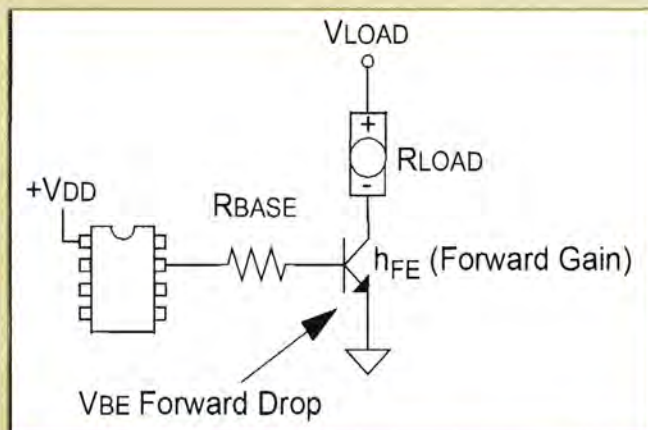

Figure 1: DRIVING BIPOLAR TRANSISTORS USING MICROCONTROLLER I/O PORT

Characteristic	Sym	Min	Max	Unit	Test Condition
OFF CHARACTERISTICS					
Collector-Base Breakdown voltage	$V_{(BR)CBO}$	60	—	V	$I_C = 50 \mu A$, $I_E = 0$
Collector-Emitter Breakdown Voltage	$V_{(BR)CEO}$	50	—	V	$I_C = 1.0 \text{ mA}$, $I_B = 0$
Emitter-Base Breakdown Voltage	$V_{(BR)EBO}$	7.0	—	V	$I_E = 50 \mu A$, $I_C = 0$
Collector Cutoff Current	I_{CBO}	—	100	nA	$V_{CB} = 60V$
Emitter Cutoff Current	I_{EBO}	—	100	nA	$V_{EB} = 7.0V$
ON CHARACTERISTICS					
DC Current Gain	h_{FE}	120 180 270	270 390 560	—	$V_{CE} = 6.0V$, $I_C = 1.0 \text{ mA}$
Collector-Emitter Saturation Voltage	$V_{CE(SAT)}$	—	0.4	V	$I_C = 50 \text{ mA}$, $I_B = 5.0 \text{ mA}$

TABLE 1: BIPOLAR TRANSISTOR DC SPECIFICATIONS

TIP 2: DRIVING N-CHANNEL MOSFET TRANSISTORS

Care must be taken when selecting an external N-channel MOSFET for use with a 3.3V microcontroller. The MOSFET gate threshold voltage is an indication of the device's capability to completely saturate. For 3.3V applications, select MOSFETs that have an ON resistance rating for gate drive of 3V or less. For example, a FET that is rated for 250uA of drain current with 1V applied from gate-to-source is not necessarily going to deliver satisfactory results for 100mA load with a 3.3V drive. Review the gate-to-source threshold and ON resistance characteristics very carefully when switching from 5V to 3V technology, as shown in **Figure 2**. A small decrease in gate drive voltage can significantly reduce drain current.

Low threshold devices commonly exist for MOSFETs with drain-to-source voltages rated below 30V. MOSFETs with drain-to-source voltages above 30V typically have higher gate thresholds (VT).

As shown in **Table 2**, the threshold voltage for this 30V, N-channel MOSFET switch is 0.6V. The resistance rating for this MOSFET is 35mΩ with 2.8V applied gate, as a result, this device is well suited for 3.3V applications.

For the IRF7201 data sheet specifications, the gate threshold voltage is specified as a 1.0V minimum. This does not mean the device can be used to switch current with a 1.0V gate-to-source voltage as there is no RDS(ON) specification for VGS(th) values below 4.5V. This device is not recommended for 3.3V drive applications that require low switch resistance but can be used for 5V drive applications.

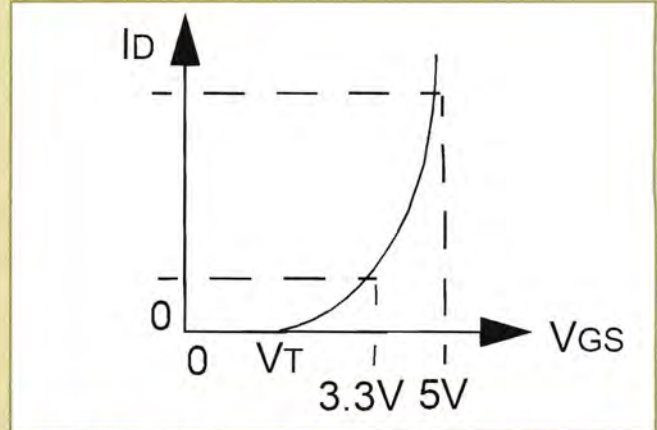

FIGURE 2: DRAIN CURRENT CAPABILITY VERSUS GATE TO SOURCE VOLTAGE

Rbs(on)	Static Drain-to-Source On-Resistance	—	9.4	12	mΩ	VGS = 10V, ID = 11A
		—	10.6	13.5		VGS = 4.5V, ID = 9.0A
		—	17	35		VGS = 2.8V, ID = 5.5A
Vgs(th)	Gate Threshold Voltage	0.6	—	2.0	V	VDS = VGS, ID = 250 μA

TABLE 2: RDS(ON) AND VGS(TH) SPECIFICATIONS FOR IRF7467

Rbs(on)	Static Drain-to-Source On-Resistance	—	—	0.030	Ω	VGS = 10V, ID = 7.3A
		—	—	0.050		VGS = 4.5V, ID = 3.7A
Vgs(th)	Gate Threshold Voltage	1.0	—	—	V	VDS = VGS, ID = 250 μA

TABLE 3: RDS(ON) AND VGS(TH) SPECIFICATIONS FOR IRF7201

WINNER OF THE ELECTRONICS WORLD PICDEM 4 COMPETITION IS:

Mr Greg McNelly
 GAEA
 114, Staplegraove Rd
 TAUNTON
 Somerset
 TA1 1DP

TIP: DUAL INPUT BOOST CONVERTER SHARES POWER FROM TWO INPUTS

by Goran Perica, Applications Engineer at Linear Technology

Multiple power sources are often used by high power applications for load sharing (for high power) or redundancy (for high availability). A diode-OR circuit, as shown in **Figure 3**, is often the accepted solution to combining the inputs to a single output. If the two power sources are identical, a diode-OR circuit is not a bad solution, but it may not be the best option if the two power sources have different voltages (e.g. 12V and 24V).

If increased power capability is the goal via power sharing of two different sources, a diode-OR circuit will have hard time balancing the currents of the two sources. Slightly different voltage drops in diode-OR circuit can produce large current imbalance between the two power sources, which may overload one power source while preventing the second source from providing any power to the load. To remedy the imbalance, current-balancing resistors may be required, which results in additional power loss and decreased system efficiency.

This simple load sharing diode-OR circuit requires current sharing resistors in order to balance the currents of two sources. The added resistors present a heat dissipation problem and related efficiency hit in high power circuits.

An efficient and space-conscious solution is to use an active current sharing circuit in the form of a power converter. A

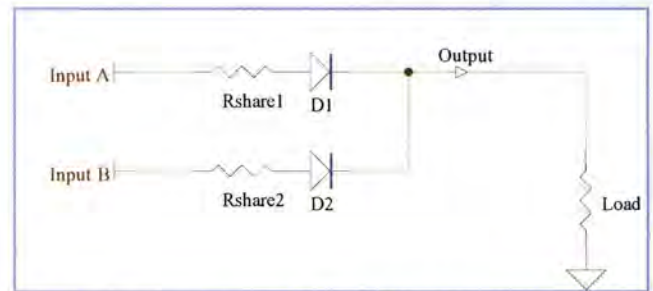

Figure 3: This simple load sharing diode-OR circuit requires current sharing resistors in order to balance the currents of two sources. The added resistors present a heat dissipation problem and related efficiency hit in high power circuits

power converter can provide both load current balancing and regulation, precluding the need for another regulator.

The circuit discussed here is a boost converter, but the underlying design principle can be applied to other topologies – such as buck, boost, flyback and SEPIC – to satisfy various input and output specifications.

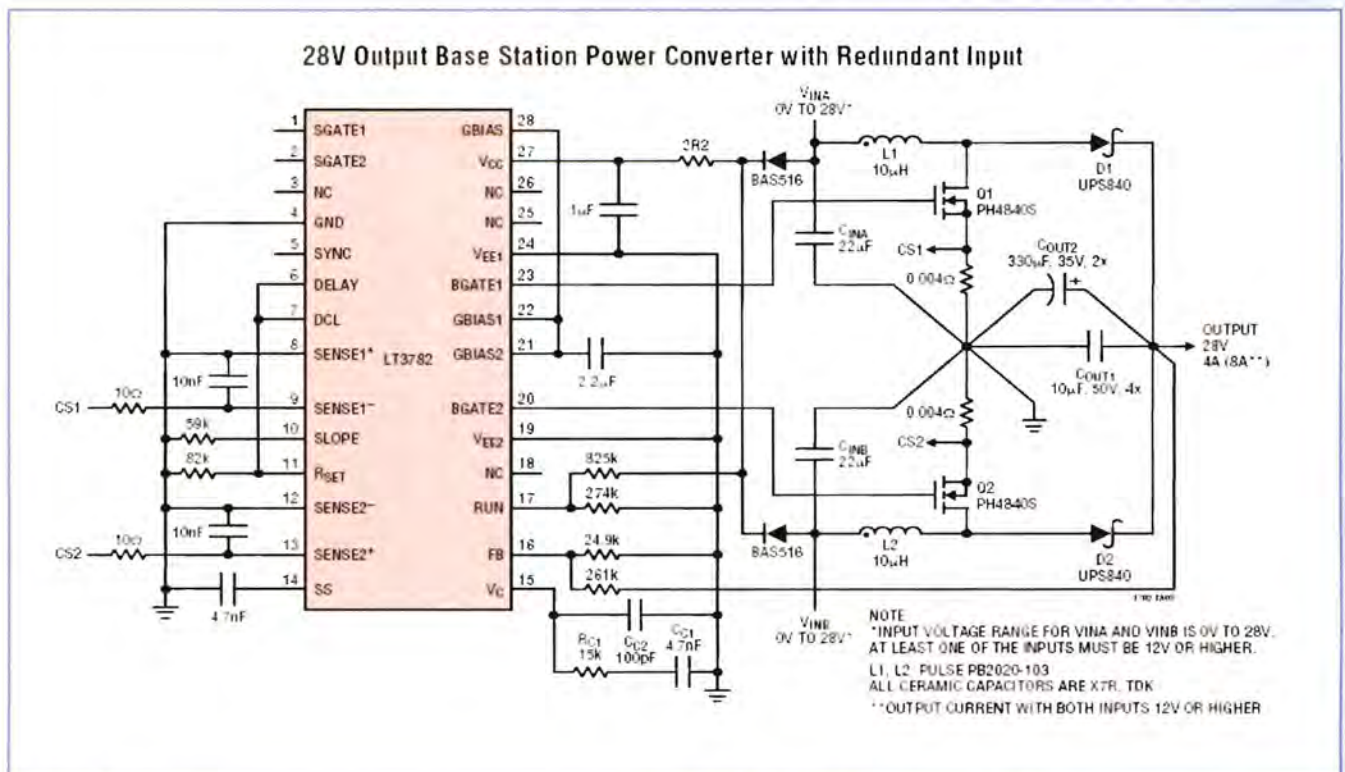

Figure 4: This 95% efficient, 28V basestation power converter can operate from redundant power sources

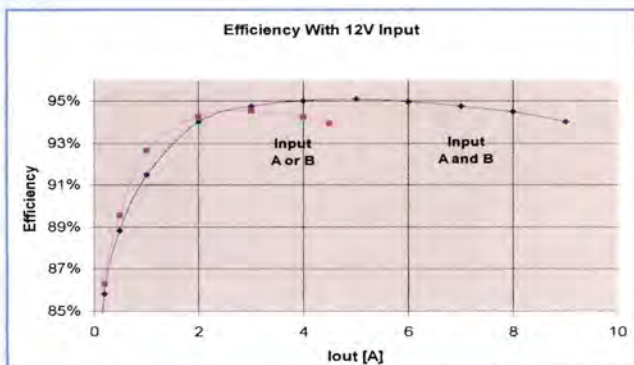

Figure 5: The converter in Figure 2 peaks at 95% efficiency when operating from two inputs

130W to 260W Base Station Boost Converter with Dual Power Source

Figure 4 illustrates an active current sharing boost converter that can deliver 130W of output power from either of two redundant 12V power sources, or 260W by load sharing the two 12V power sources. The circuit can also generate 260W from single 12V power source if inputs A and B are tied together.

The centerpiece of the design is the LT3782 current mode PWM controller. Current mode operation ensures balanced current sharing between the two power sources, even if the sources have different voltages. Current balancing improves efficiency of the entire system by allowing each power source to operate at lower power level where the efficiency is typically higher. The current balance is achieved by choosing appropriate values of the two current sense resistors, R_{CS1} and R_{CS2} in Figure 4, to provide relatively more power from the supply with

higher output power rating. For example, the currents can be programmed to provide 25% of output power from a 5V source and 75% from a 12V source.

This 95% efficient, 28V basestation power converter can operate from redundant power sources.

The circuit in Figure 4 can be powered from either input A or input B. The only condition is that at least one of the inputs is greater than 10V, which is required for biasing of PWM controller circuit U1. Diodes D3 and D4 provide the diode-OR function for biasing of controller U1. The bias power for controller U1 can also be provided by a separate power source. In that case, theoretically, the circuit could regulate with inputs down to 0V. In practice, the lowest required input voltage depends on the control circuit's maximum duty cycle and output voltage. The circuit in Figure 4 can produce 28V of output voltage from 2V input. However, the higher input current at 2V input will result in lower available output power.

The converter in Figure 4 peaks at 95% efficiency when operating from two inputs. The efficiency of this converter (**Figure 5**) is high enough that it can be built entirely with surface mount components, without the need for heat sinks. In a 130W, redundant supply application, the power dissipation of 8.4W should be relatively easy to manage; but for 260W application, the circuit's power dissipation of 17W needs more attention. A well laid out large multilayer PCB with some forced airflow should be sufficient to keep the components cool.

So, the simple switching power converter shown here can be used to boost one of two redundant supplies, or it can be used to combine the supplies for high power output. Either way, the result is an efficient and compact circuit, better than a diode-OR circuit, which would dissipate additional power.

Win a Microchip PICDEM 2 Plus Demo Board

Electronics World is offering its readers the chance to win a Microchip PICDEM 2 Demonstration Board. This board now has an ICD port, LCD read-out, sounder and a temperature sensor. The enhanced PICDEM 2 Plus Demonstration Board provides designers with a tool for immediate programming and debugging Flash-based microcontrollers. The board is supplied with software loaded on a PIC18F452 microcontroller to demonstrate the device's features and peripherals. The program also sets up the microcontroller as a real-time clock and measures the local temperature, both of which are displayed on an LCD display. A PWM signal is sent directly to the Piezo sounder. There is an active RS-232 port and on-board Serial EEPROM and there is ample room in the generous prototyping area for project development work. A second Flash-based microcontroller with its own demonstration program, the PIC16F877, is also included.

Source code is provided allowing users to understand and dissect the programming algorithm. Additionally, users with an MPLAB® In-Circuit Debugger 2 can take advantage of the Flash-based microcontroller's in-circuit debugger capability by cutting, pasting, rewriting or adding to the program.

The PICDEM 2 Plus Demonstration Board is available separately or as part of the MPLAB ICD 2 Evaluation Kit, which also includes a power supply, serial cable and USB cable.

If you would like to be in with a chance of winning Microchip's PICDEM 2 Plus Demo Board, log onto www.microchip-comp.com/ew-picdem2 and enter your details into the online entry form.



INTUITIVE ANALOG CIRCUIT DESIGN

MARC T. THOMPSON
NEWNES

For many years I have felt there is a need for a book aimed at demystifying the, sometimes complex, process of designing analogue circuits using mainly descriptive text augmented by a sprinkling of equations and rules-of-thumb. I envisaged that the title of such a book would include the words analogue and intuitive but, despite the promising-sounding title and rear-cover synopsis, this is not that book. However, if pages filled with equations interspersed with a few lines of explanatory text are your preferred method of getting to grips with the operation of a circuit then this book offers an interesting approach.

The general format is one of presenting the material to be covered in each chapter using numerous worked examples, described using a mixture of maths and, largely

THE SYNOPSIS INDICATES THAT THE INTENDED READERSHIP IS PEOPLE, PERHAPS WORKING IN THE FIELD OF DIGITAL ELECTRONICS, WHO ARE LOOKING FOR STRAIGHTFORWARD METHODS TO HELP IN THEIR UNDERSTANDING OF ANALOGUE CIRCUITS

informal, text. This is followed by a 'Problems' section where the reader is offered the opportunity to exercise his newly-found knowledge on a few exam-like questions and each chapter concludes with a page containing an extensive list of references. A CD is included that contains a PowerPoint presentation of each chapter and copies of the MATLAB files.

Chapter 1 presents an introduction while

Chapter 2 provides a review of the basics of signal processing and immediately introduces the Laplace transform, transfer functions and the concept of poles and zeros – all tools that are used extensively throughout the book.

Chapters 3 and 4 look at the physics of semiconductors and present both low and high frequency hybrid- π models for bipolar

transistors, indicating how to derive the various parameter values from the device datasheet. Chapter 5 examines the issue of biasing the three basic amplifier configurations and presents methods for estimating various circuit characteristics including low-frequency gain and high-frequency bandwidth.

In Chapter 6 the concept of Open Circuit Time Constants is introduced. This is an interesting method of calculating the approximate high frequency bandwidth of a circuit using 'lumped' model parameter values and without resorting to an extensive mathematical analysis. Chapter 7 builds on the work presented in Chapter 6 to include the effects of emitter degeneration and, from there, moves logically on to the emitter follower, a potentially troublesome circuit configuration which is covered in some depth. This chapter concludes by introducing Short Circuit Time Constants – a companion method to OCTC and used for finding a circuit's low-frequency limit – and touching on Pole Splitting, a technique commonly used to increase the useful bandwidth of an amplifier.

Chapter 8 augments the transistor model used so far to include the effects of base-width modulation (the Early effect) and examines its impact on high-gain amplifiers, emitter followers and current sources and mirrors.

MOSFET devices are introduced in Chapter 9 and, although covered in somewhat less detail than their bipolar counterparts, the same approach is taken to provide both low and high frequency models, examine the characteristics of the three basic circuit configurations and estimate high-frequency bandwidth.

Chapter 10 departs from the small-signal analysis of circuits presented so far and explores large-signal switching in bipolar transistors using the Charge Control model in which the effects on switching speed of saturation and junction capacitance are considered. Worked examples separately deriving charge-storage time and collector current decay are given for both current and voltage-driven single stage saturating switches. The chapter concludes with a very brief look at non-saturating current switches using emitter switching and the differential amplifier.

Negative feedback is the subject of Chapter 11 and is, as might be expected, not for the faint-hearted. A short but interesting history of NFB is followed by a review of control system basics, stability and a section on the Routh stability criterion. The usual suspects – gain and phase margins, damping ratio, loop compensation – are briefly covered followed by a few simple worked examples for gain and bandwidth using

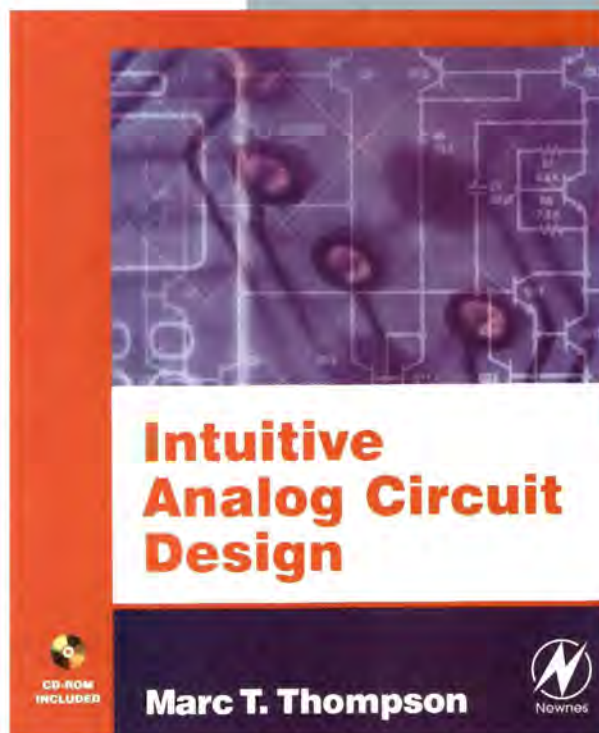

idealised op-amp gain blocks. A MATLAB script for each of the examples presented is given in an appendix enabling a suitably equipped reader to run his own visualisations.

Chapter 12 presents the topology of a very basic three-stage operational amplifier and proceeds to 'design' a working circuit using discrete components which, although instructive, perhaps, in a theoretical sense, is of no practical value. The chapter concludes by looking at the some of the limitations of real-world op-amps and examines the effects of these on circuit performance. Chapter 13 does for current feedback op-amps what Chapter 12 did for the conventional type.

The subject of the final chapter covering circuit design and performance, Chapter 14, is the analogue low-pass filter and, by the author's own admission, it is a far from comprehensive treatise. The standard

configurations of Butterworth, Chebyshev and Bessel are covered, followed by a brief comparison of the three circuit's performance characteristics. A section on implementing passive (LC) filters by scaling, for frequency and impedance, the values obtained from a limited set of normalised tables is followed by a very brief look at an adjustable-Q active filter.

Chapter 15 examines real-world passive components and printed circuit board layout issues with particular emphasis on the parasitic elements and their effects on circuit performance and the author rounds-off the book with an 'oddments' chapter, which he describes as "a potpourri of (hopefully) useful design techniques". These range from heat-flow/current flow analogies through comparisons between vibrating mechanical and electrical systems to calculation of the input impedance of finite and infinite length

transmission lines – to name but a few.

As an analogue engineer of some years' experience with a reasonable collection of relevant texts I feel that there is little in this book to persuade me to part with its cover price. The back-cover synopsis indicates that the intended readership is people, perhaps working in the field of digital electronics, who are looking for straightforward methods to help in their understanding of analogue circuits and, as such, I consider that it fails in its purpose. However, for someone with a mathematical bent and starting a career designing analogue circuits this book contains much useful material – indeed the preface indicates that its original source material was lecture notes presented to students at a US technical institute.

Martin Barratt

No Compromise Oscilloscope



Other oscilloscopes in this price range force you to compromise on one of the key specifications:

sampling rate, memory depth or bandwidth.

The PicoScope 5000 series is a no compromise PC oscilloscope at a price every engineer can afford.

www.picotech.com/scope446

01480 396395

pico[®]
Technology



1GS/s sampling rate

250MHz bandwidth

128M sample buffer memory

125MS/s 12 bit AWG built in

PicoScope 5203
32M buffer **£1195**

PicoScope 5204
128M buffer **£1795**

High Accuracy Microohmmeter

The Cropico DO5000 series of microohm-meters offers increased flexibility for the highly accurate measurement of resistance values in a variety of



electrical manufacturing, electronic component testing and equipment calibration applications.

The versatile DO5000 has programmable current settings in 100 steps from 10 μ A to 10A and measures from 3m Ω to 30k Ω with a resolution of 0.1 $\mu\Omega$ and \pm 0.03% accuracy.

Variable measurement speed settings of 50, 25 or 2.5 per second allow the selection of high-speed testing for production line applications, a medium mode where the device under test needs more time to settle or a slow speed for manual operation where display clarity is a priority.

True four-wire resistance measurement eliminates lead resistance errors, while auto averaging and automatic temperature compensation with 20 $^{\circ}$ C referencing or other user-defined settings increases true measurement accuracy.

All these options are included in the basic DO5000 unit, as well as a data logging function which stores up to 4000 readings with date and time stamp. Statistical analysis of these values allows the display of Max / Min /Average values as well as peak to peak and standard deviation.

www.cropico.co.uk

Condition Monitoring with Multimeter

Fluke is now offering a money-saving 289/FVF Combo Kit that bundles FlukeView Forms software with the latest Fluke 289 true-rms Industrial Logging Multimeter for diagnosing problems in electronics, plant automation, power distribution and electromechanical equipment.



The Fluke 289 features an extra-large, quarter-VGA, dot matrix display showing results graphically, backed by an enhanced user interface with on-board help and soft-key interface. The Fluke 289 can log multiple sessions unattended in the field and incorporates advanced data logging and TrendCapture to help track down elusive, intermittent problems faster than before. An interface ensures easy data transfer to a PC, on which FlukeView Forms software enables users to document, store and analyse readings which are then converted into graphs and tables for professional reports. Logged data from up to six time periods or six meters can be overlaid to find cause and effect relationships or for condition monitoring.

The multimeter quickly records electrical performance and shows trend information, storing up to 10,000 readings. It features a Lo-Pass filter, for accurate voltage and frequency measurements on adjustable speed motor drives and other electrically noisy equipment, as well as Lo-ohms and Lo-impedance measurement ranges.

www.fluke.co.uk

Three-Phase Brushless DC Motor Pre-Driver IC



The new A4931 from Allegro MicroSystems Europe is a 3-phase brushless DC motor pre-driver integrated circuit with outputs for the direct high-current gate drive of an all N-channel power MOSFET 3-phase bridge with a maximum supply voltage of 38V.

The device includes three Hall-element inputs, a sequencer for commutation control, fixed off-time pulse width modulation (PWM) current control and locked rotor protection. Output current is scalable with the choice of external MOSFETs.

The Hall element inputs used in the A4931 have internal noise filtering to prevent false commutation signals. A 7.5 V regulated

supply output is provided to power the three Hall elements.

'Enable', 'direction' and 'brake' inputs can be used to control the motor, speed, position and torque. Output speed can be regulated using the two speed-control outputs, using either one Hall-element or all three Hall transition outputs to provide flexibility for a variety of speed control applications.

The external MOSFETs can be PWM-controlled via the 'enable' input or with the internal PWM current regulator. In both cases, Allegro's A4931 synchronous rectification feature will turn on the appropriate MOSFET(s) during current decay to reduce power dissipation.

www.allegromicro.com

High Performance Scanning in Miniature



New from Metrologic, the IS4910 is a powerful and versatile image scanner built to capture 1D, 2D, OCR and images of barcodes and documents. Its compact size and crisp high-resolution image capture capability make the IS4910 the ideal choice for kiosk applications such as payment terminals, price check kiosks and lottery terminals, as well as read application specific OCR

requirements including passport reading.

With a set of features specifically engineered for the kiosk market, the IS4910 comes with a 1.2-megapixel CMOS sensor, allowing a large field of view for easy scanning and a handy power saving mode which lowers power consumption when the scanner is not in use. Offering aggressive scanning performance, the IS4910 features Metrologic's patented FirstFlash technology, capable of capturing images regardless of lighting conditions and so offers increased battery life.

Designed to provide unmatched barcode scanning, the IS4910 is also capable of capturing images for archiving and analysis purposes. The image size is scalable to fit specific application requirements.

With its low power consumption and reduced size, the Metrologic IS4910 is easy to integrate into both new and existing kiosk applications.

www.ded.co.uk

New USB Option for the HV Rack System



As official distributor of UltraVolt in the UK, Ireland and Scandinavia (except Denmark) AMS Technologies announces the availability of the new USB interface option for the HV Rack system. This will allow users to control and monitor the system via a PC.

With the USB interface option, the HV Rack system's voltage and current settings can be controlled remotely, giving the user greater ease of operation. The settings for voltage and current can be more precise because the user is able to type the exact set points into the programme. After the voltage and current are set, these settings can be saved to a file to be restored whenever needed.

The USB-HV-RACK interface uses 16-bit resolution for set points and monitors. This allows a 6kV UltraVolt power supply to be controlled and monitored with 0.1V resolution.

The HV Rack system is a one-to-four-channel, fully featured configurable chassis that enables end users to select and specify the UltraVolt high-voltage power supply operating in each channel from UltraVolt's catalogue of over 450 models. Voltages range from 0 to 62VDC through 40kV at 4W to 250W per channel.

www.ams.de

New Precision Line of HV Power Supplies

As official distributor of UltraVolt in the UK, Ireland and Scandinavia (except Denmark) AMS Technologies announces the availability of a line of precision, enhanced power supplies – the E Series.

The E Series operates from 0 to 1kV through 0 to 15kV at 4W, 15/20W or 30W.

The modules are based on UltraVolt's popular E Series high-voltage power supplies and offer a high-resolution, programmable, high-voltage DC output optimised for bias or power applications.

This new line of power supplies provides ppm (parts per million) level performance.

Target specifications include a tight temperature coefficient of $\leq 10\text{ppm}$ for the +10VDC reference, output voltage monitor and



HV output. Each model features 0 to +10V remote programming, and 0 to +10V monitors for output voltage and output current calibrated to $< \pm 0.01\%$. The E Series also offers ppm-level line regulation and ppm-level load regulation.

Output ripple will be available as low as 1mV @ 2kV (0.5ppm), 10mV @ 6kV (1.6ppm), 20mV @ 10kV (2ppm) and 35mV @ 15kV (2.3ppm). All specifications for output ripple, output regulation,

stability and control exceed the A Series specifications by at least an order of magnitude.

www.ams.de

ricos TP – Designed for Harsh Environments



Wieland Electric's *ricos TP*, a decentralised I/O system that allows communication

over a standard fieldbus protocol between a controller and sensor level, has been specifically designed for use in harsh environments. *ricos TP* can be used in rough environmental conditions ranging from the transportation industry to oil production, construction machinery, cranes and traffic control systems.

Wieland's *ricos TP* provides an extended temperature range in all applications and is rated for use from -40°C up to +70°C. This is vastly superior to serviceability only from 0°C to +55°C. It also provides high EMC immunity.

The multi-functionality of *ricos TP* enables it to be compatible with various interfaces. Depending on the application requirements, it can be used as a powerful control or automation system with a power PC CPU, or as an intelligent fieldbus node. Suitable bus interfaces include Ethernet, LON, Profibus, CANopen and MVB.

www.wielandinc.com

High Speed, Hard Metric, B19 connector



3M has launched the new Metpak brand HSHM Press-Fit B19 connector. It is tailored to give system designers working with VME and CompactPCI backplane systems a cost-effective

path to higher speed serial input/output (I/O) protocols, such as PCI Express and RapidIO, without disruptive backplane redesign or needing a 'forklift' upgrade.

Multi-gigabit per second interconnection solutions compatible with the existing VME infrastructure were once considered impossible without an expensive disruptive upgrade or system re-design. Furthermore, some mission-critical systems cannot be taken offline to increase speeds. The new 3M B19 connector solution enables the extension of the life and investment of existing VME and CPCI systems.

Highly flexible and modular, the connector will meet the industry standard 2mm hard metric format in accordance with the IEC-61076-4 101 connector standard. The 3M HSHM connectors use virtual coaxial shielding technology to provide maximum performance with minimal crosstalk and skew, allowing them to plug into existing 2mm hard metric connectors and support PCI Express and RapidIO protocols.

www.3m.com

ITT 'Rack and Panel' Connector Catalogue

Now available from ITT Electronic Components is the company's latest Rack and Panel (R&P) connector catalogue. This 'engineered for reading' catalogue has been produced in a format that will allow the end user to obtain information readily on whatever aspect of the wide R&P range is needed to hand.

In 120 pages, the Rack and Panel catalogue details: part number breakdown; polarising positions; cross reference part number to customer drawing; dimensions; MIL spec to ITT Cannon part number detail; contact type details; performance and material specifications, as well as ordering information.

MIL-C-81659 (DPXNE/DPXNA) and MIL-C-83733 (DPK) have dedicated sections with all the relevant information requirements, as do devices for ARINC 600 and ARINC 404. General aerospace market products, shielded, co-axial and modified co-axial products are also shown with all information required to hand.

The new Rack and Panel connector catalogue can be ordered on-line at:

www.ittcannon.com

World's Smallest 400W Medical Grade Power Supply

SynQor has introduced its first AC/DC product designed specifically for medical applications. The ACuQor range of power supplies pack 400W of useable power into just 76mm x 127mm x 36.7mm, which is thought to be the world's smallest footprint for the power level.

The ACuQor family operates over a universal input range of 85-264Vrms and 47-63Hz, and single outputs of 48V, 36V or 24V are available to facilitate the use of distributed power architectures and battery backup, and to directly drive components such as fans, motors, pumps, lamps and actuators.

Full output power is available up to 50degC with natural convection (derates linearly to 300W at 70degC). A transient power rating of 500W is possible for up to 5s in the open frame version, and even longer in a proprietary encased version. Active

Power Factor Correction is incorporated to a level > 0.98 enabling compliance with IEC/EN61000-3-2. Both AC lines are internally fused.

The ACuQor models include versions designed for both BF (direct patient contact) and CF (direct cardiac contact) applications in accordance with UL/EN60601-1. Input Earth Leakage Current and type CF Patient Leakage Current are well below the requirements of the standard at < 110uA and < 4uA respectively.

www.synqor.com



Low Profile Miniature Slide Switches



New from C&K Components are the low profile miniature slide switches which are also highly cost-effective. An ideal solution where space is at a premium,

for example in mobile telecommunications, computers and remote control equipment, one pole JSM series miniature slide switches benefit from only 2.5mm (.098") high actuators, making them very easy to operate.

Available in single, double or triple throw styles, the new devices come in surface mount format and momentary either both sides or one side maintained and the other momentary.

Highly reliable JSM series miniature slide switches are lead-free and process compatible. The devices feature IR re-flows to 260degC solder profile, an electrical rating of 0.3A at 4VDC and an electrical life of a minimum of 10,000 cycles. Actuator travel is 2mm.

Designed for an operating temperature range from -10 up to +60 degrees Celsius, JSM series slide switches can withstand a shock/vibration of 10-55Hz 1min sweep. The devices are available in tape and reel packaging.

www.ck-components.com

Electrical Instrumentation Tester



Designed so electricians can carry out recommended tests for all 17th edition type testers and instruments, is the new EETI from Link Instruments.

The EETI is ideal for testing multi-

functional testers, loop testers, insulation testers, and all 17th edition type instruments. The EETI has both, LEDs to indicate test results and an LCD readout to indicate results and what test has been selected. This makes the unit versatile and easy to use.

The EETI features include continuity test (resistance measured in ohms), voltage test (line AC voltage check), insulation test (resistance in MΩ applied voltage 100V to 1kV), loop test (the LCD indicates phase to earth and P-E +1 Ω selection) and RCD test (LCD indicates overcurrent and mA trip value, with RCD tests being 15mA/30mS, 100mA/45mS, 30mA/100mS and 10mA/150mA).

The unit is supplied complete with carry case instructions and a calibration certificate. The EETI costs £245 plus Vat.

Contact Link Instruments Ltd: 01730 897100

www.linkinst.com

New OLP Liquid Level Switches

Sensortech has introduced a new OLP series of miniature optical liquid level switches. These very cost-effective point level sensors measure the presence or absence of liquid in a wide range of OEM applications.

The optical OLP switches use solid state technology with no moving parts for highly accurate and reliable measurements. The product range offers basic devices with analogue signals, switches with microprocessor compatible digital outputs, or high power transistor output versions capable of switching currents up to 500mA. The sensors provide excellent media compatibility with their miniature plastic polysulphone housings. Additionally, Sensortech can easily modify or customise these products to fit special customers' requirements.

Among the new important features of the OLP series are the optical point liquid level detection; solid state technology with no moving parts; analogue, digital or transistor outputs for up to 500mA; and excellent media compatibility.

The new OLP point level sensors are suitable for a wide range of OEM applications such as medical equipment, HVAC, compressors, hydraulic reservoirs, machine tools and leak detection as well as food, beverage and pharmaceutical processing.



www.sensortech.com/olp

To reserve your website space phone Matthew Dawe 020 7933 8980
or email matthew.dawe@stjohnpatrick.com

Beta Layout Ltd

www.pcb-pool.com

The Best Value Online PCB Prototyping Service Available:
Instant on line quotations & ordering (no pre registration).
We offer the following:
• No minimum quantity. • No tooling charges. • No drill Limitations. • 1 to 6 layers (prototype quantities) • 2 layers (small production batches) • Fr4,1.6mm,35 um,HASL (Pb free/Rohs/Weee) • Soldermask / Silkscreen (optional) • Leadtimes from 2-8 working days • Full DRC on all orders (we manually check every file !!!). • PCB-POOL®



accepts direct outputs from 15 major layout softwares (see our website for details)
Download our fully functional PCB LAYOUT software FREE of charge.
Free Phone : 0800 3898560

Sky systems ltd

www.sky-pcb.com

Sky Systems Ltd. was established with the vision and promise of providing manufacturing high quality, cost effective solution and one-stop service to meet the most demanding of our customers' requirements.
We offer the followings:
• 1-12 Layers • Fr-4 / Cem-3 • HAL(Lead Free),Flash Gold, Electroless Gold Plating, OSP ,Immersion Silver, Immersion Tin • Gold Finger • Soldermask • Silkscreen • Routing / Punching / V-Cut • Online quotation • FREE PCB Prototype with quantity orders • Short



lead time • Fast worldwide delivery • Flexible quantity • CHINA Factory
For more information or request a quote today from our web site.

DataQuest Solutions Ltd

www.dqsolutions.co.uk

As specialists in the supply of ultra high-speed instrumentation cards for the PC and industrial chassis, we provide an advanced product range with the following features:
• PCI, PCI-X, PCI-express & PXI formats.
• Signal capture (A/D) with sampling rates up to 500M samples/sec.
• Simultaneous sample and hold with up to 16 bits resolution.
• Waveform generation (D/A) to 125 million samples per second.



- Digital I/O and pattern generation for a wide range of logic levels.
- Storage of data to deep on-board RAM or PC memory.
- Fully portable systems for many types of card.

Surplelectronics

www.surplelectronics.com

Surplelectronics is a brand new electronics components e-Store with a difference. We specialise in popular electronic components from leading manufacturers at rock bottom prices that you won't find elsewhere.
New lines are arriving every day and many of our products are one-off specials that may not be repeated.
Our products are all new, unused and are fully guaranteed. Ordering is simple, with UK shipment free for orders over £50 and



payment is completed credit card. Goods are shipped that day for prompt delivery.
Surplelectronics - serious about surplus. Tel: 0870 850 5258

DB Technology

www.dbtechnology.co.uk/

Anechoic chamber and open area test site.
• Compliance Tests
• Fixes included. FCC Listed.
• Flexible hourly booking available.
• Rapid, accurate pre-compliance tests.



Telnet Ltd

www.telnet.uk.com

Suppliers of quality second-user test and measurement equipment at prices you can afford. Manuals and accessories supplied. If you would like a quote, please call. We also purchase your surplus test equipment. Please call us for the best offers.



Mobile: 07860 400683
Email: dales@telnet.uk.com

TELNET
1 Stoney Court, Hotchkiss Way, Binley
Industrial Estate, CV3 2RL
Tel: 024 76650702 Fax: 024 76650773

FTT

www.ftt.co.uk/PICProTrng.html

FTT (a Microchip Consultant Partner & Training Partner) has developed a range of courses – both distance learning and instructor led – covering Assembly and C Programming of PIC16, PIC18, PIC24 and dsPIC microcontrollers. For each processor family there are both C and Assembly programming courses at: • FOUNDATION LEVEL & • INTERMEDIATE LEVEL. For information about these courses, advanced courses and workshops such as: • Advanced C Embedded & Real Time Programming • TCP/IP & Ethernet • USB •



CAN • DSP • Motor Control • programming using Real Time Operating Systems such as uCOSII, CMX & Salvo and • other micro-controllers, please inquire.
Tel: 020 8669 0769 Email: pictrng@ftt.co.uk

Microchip Technologies

<http://www.microchip.com/>

Microchip Technology Inc. is a leading provider of microcontroller and analogue semiconductors, providing low-risk product development, lower total system cost and faster time to market for thousands of diverse customer applications worldwide. Microchip designs, manufactures, and markets a variety of high performance components for high volume, cost-effective embedded control solutions, including 8- and 16-bit PIC® microcontrollers; dsPIC® digital signal



controllers; development kits; serial EEPROMs, more than 350 mixed-signal analogue and interface products; KEELOQ secure data transmission products; and the PowerSmart® family of smart battery management products. Microchip's product solutions feature compact size, integrated functionality, and ease of development.

ADVERTISING ENQUIRIES CONTACT MATTHEW ON: 020 7933 8980

ADVERTISING

EMC ADVERTISING GIFTS
1064 High Road, London, N20 0YY
Huge range • All prices • Quick delivery

20 cm 8 Inch RULER CALCULATOR
print 1 colour 100 @ £2.75 each.
500 @ £2.25 each.



FLIP OPEN CALCULATOR
print 1 colour
100 @ £2.75 each.
500 @ £2.45 each.

EMC ADVERTISING GIFTS
Phone • email for catalogues
tel: 0845 345 1064
sales@emcadgifts.co.uk
FULL CATALOGUE ONLINE
www.emcadgifts.co.uk

PCB DESIGN

SKY SYSTEMS LTD.
China Factory

- * 1 - 12 Layers
- * High Quality
- * Cost Competitive
- * Flexible Qty
- * World Wide Delivery

GS-9000 UPL ISO RoHS

Tel: (852) 2111 9428
<http://www.sky-pcb.com>

PCB MANUFACTURE

RAK Printed Circuit Boards
www.rak.co.uk - data@rak.co.uk
24 Hour Service
Quality Prototype and Small Quantity
Printed Circuits Fast

Single Sided • Double Sided
Multi Layer • PTFE • RoHS Compliant
Silver & Gold • SMD Assembly

Unit 12, Shirehill Industrial Estate, Saffron Walden,
Essex CB11 3AQ
Tel: 01799 526227 Fax: 01799 525107

ARTICLED WANTED

TOP PRICES PAID

For all your valves,
tubes, semi conductors
and ICs.

Langrex Supplies Limited

1 Mayo Road, Croydon, Surrey CR0 2QP
TEL: 020 8684 1166 FAX: 020 8684 3056

BATTERIES/CHARGERS

ANSMANN energy

ANSMANN ENERGY (UK) LIMITED
Units 19/20, Maple Park, Essex Road,
Hoddesdon, Herts, EN11 0EX, UK
Tel: +44 (0) 870 609 2233
Fax: +44 (0) 870 609 2234
Email: info@ansmann.co.uk
Web: www.ansmann.co.uk

FOR SALE

agar Circuits

PCB DESIGN & MANUFACTURE
for both the Hobbyist and Professional

PCBs designed and produced from :

- Notes
- Schematics
- Specifications
- Descriptions
- Print - outs
- Gerbers

Available With or without component assembly

* FREE * PCB PROTOTYPE With Quantity Orders

Email: adinfo@agarcircuits.com
Tel: 028 (90) 738 897

COMPONENTS WANTED

Components wanted
Excess/Surplus
www.mushroom.co.uk
01234 363611
will collect anywhere in Europe
Instant Cash Settlement

PCB MANUFACTURE

PCB MANUFACTURE
VISIT **PCB-VALUE.CO.UK** FOR

- REAL-TIME QUOTES CALCULATOR
- LOW COST, EVEN FOR SMALL QUANTITIES
- A QUALITY SERVICE YOU CAN TRUST
- ON-LINE PURCHASING OPTION
- PCB LAYOUT DESIGN



UNIT 39, LANSDOWN IND. EST.
CHELTENHAM, GLOS, GL51 8PL
TEL: 01242 587700

POWER

TOROIDAL TRANSFORMERS

- Product Range 10va - 6kva
- Short Lead Times
- Large or Short Production Runs
- Very Fast Prototype Service
- All products manufactured in UK

TIGER TOROIDS LTD

Unit 5 Pulham Market Hall,
Station Road, Pulham Market
Diss, Norfolk, IP21 4XF

Tel: 01379 608 868
Fax: 01379 608 871

DEVICE PROGRAMMING SERVICES

action circuits
(UK) LIMITED

device programming & reeling specialists



SMD TAPING & REELING SERVICES

Tel: 00 44 (0)1582 412323
Email: sales@actioncircuits.com
www.actioncircuits.com

ADVERTISING ENQUIRIES CONTACT MATTHEW ON: 020 7933 8980

SERVICES

PCB-POOL® 

- Prototypes at a fraction of the cost
- Tooling and setup included
- Industry standard quality
- Any contour

FREE LAYOUT SOFTWARE!

with first order (while stocks last)

Freephone 0800-3898560

WWW.PCB-POOL.COM

Follow up Services Runs •
CAM/CAD Consulting •
ONLINE Quotations •
ISO-Approved •

Beta LAYOUT

Tel: +353 (0)61 701170
Fax: +353 (0)61 701164
sales@beta-layout.com

TRANSFORMER MANUFACTURE

AUTOMATIC windings Ltd.

NEW

Our new East European production plant for medium to high volume production is now fully operational.

We are pleased to offer an end to end solution for wire wound components Via a UK based company

D2, 4 Nimrod Way, East Dorset Trade Park, Wimborne Dorset, BH21 7SH.
Tel: 01 202 87 21 01 Fax: 01 202 87 20 87
E-Mail: sales@automatic-windings.co.uk
Web: www.automatic-windings.co.uk





FOR SALE

Agilent/HP3561A

Dynamic Signal Analyser

£1600.00 Inc. VAT

Excellent working Order

Good Cosmetic Condition

Operator & Service Manual

90 Day Warranty

Tel: +44(0)1454 315432

Email: sales@jelavender.fsnet.co.uk



SURPLUS COMPONENTS FOR SALE

new parts @ surplus prices

www.surplectronics.com

REMOTE MANAGEMENT

TTI named Kemet 'Charged' Distributor of 2007

TTI has been awarded the Kemet 'Charged' European Distributor of the year award for financial year 2007. This completes a 'Triple Crown' of Distributor awards in North America, Europe and Asia. This recognition has never before been achieved by a Kemet distributor. Kemet places a great deal of value on its distributor business, and its annual awards are based on a number of key factors - sales growth, market share, new product development, ease of doing business, and field and corporate relationships. Andrew Kerr, European Director of Passive Supplier Marketing at TTI said: "Kemet offers one the world's

most complete line of surface-mount and through-hole capacitor technologies across tantalum, ceramic, aluminum, film and paper dielectrics. We are delighted to have been named as Kemet's European Distributor of the Year for a second consecutive year, and believe it reflects the value that our two companies place on building excellent partner relationships." Graeme Dorkings, Director Distribution Sales of EMEA added: "TTI continues to operate a business model which delivers strong performance on all key criteria and this award truly demonstrates that their model works."



08717 Credit Card **177 168**
Sales



Ho! Ho! Ho! Christmas 2007 is on it's way

BUT DON'T PANIC!!

We have some fantastic gift ideas for young (and old) enquiring minds



Electronic Project Labs

An electronics course in a box! All assume no previous knowledge and require NO solder. See website for full details



Robot Sensor - £19.95
Order Code EPLR20KT



Electronic Bell - £8.95
Order Code EAKEBKT



30 in ONE - £16.95
Order Code EPL030KT



Digital Recording Laboratory - £29.95
Order Code EPLDRKT



Electronic Motor - £8.95
Order Code EAKEMKT



130 in ONE - £39.95
Order Code EPL130KT



AM-FM Radio Kit - £6.95
Order Code ERKAFKT



Generator - £8.95
Order Code EAKEGKT



300 in ONE - £59.95
Order Code EPL300KT



Short Wave Kit - £6.95
Order Code ERKSWKT



Room Alarm - £4.95
Order Code EAKRAKT



500 in ONE - £149.95
Order Code EPL500KT

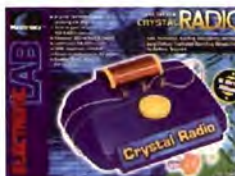

Crystal Radio Kit - £6.95
Order Code ERKCKT



Hand Held Metal Detector - £9.95
Order Code ELMDX7KT



Metal Detector - £9.95
Order Code ELMDKT

Mechanical Motorised Wooden Kits

Future engineers can learn about the operation of transmissions steered through gears or pulleys. Easy to build, no glue or soldering required.



Stegomech - £12.95
Order Code C21-602KT



Tyrannomech - £12.95
Order Code C21-601KT

Automech - £12.95
Order Code C21-605KT



Coptermech - £12.95
Order Code C21-604KT



Trainmech - £12.95
Order Code C21-606KT



Robomech - £12.95
Order Code C21-603KT

Festive Electronic Project Kits



Musical LED Jingle Bells - £17.95
Order Code 1176KT



Flashing LED Christmas Tree - £6.95
Order Code 4080KT

See our website for even more great gift ideas!

PROTEUS DESIGN SUITE

TIME FOR A CHANGE ?



NEW IN DESIGN SUITE 7:

NEW: Redesigned User Interface includes modeless selection, modeless wiring and intuitive operation to maximise speed and ease of use.

NEW: Design Explorer provides easy navigation, design inspection tools and cross-probing support to improve quality assurance and assist with fault finding.

NEW: 3D Visualisation Engine provides the means to preview boards in the context of a mechanical design prior to physical prototyping.

NEW: Simulation Advisor includes reporting on simulation problems with links to detailed troubleshooting information where appropriate.

NEW: Trace capability within both MCU and peripheral models provides detailed information on system operation which allows for faster debugging of both hardware and software problems.

NEW: Hundreds of new device models including PIC24, LPC2000, network controllers and general purpose electronic components.

Electronic Design From Concept To Completion

labcenter  www.labcenter.com

Electronics

E-mail: info@labcenter.com

Tel: +44 (0) 1756 753440

Fax: +44 (0) 1756 752857

Labcenter Electronics Limited
Registered in England 4692454

Registered Address: 53-55 Main Street, Grassington, North Yorks, UK, BD23 5AA