

EVERYMAN HIS OWN SET DOCTOR

Wireless Magazine

1/-

MAY
1934



In This Issue

*The Most
Complete and
Simplest
Fault-finding
Guide Ever
Presented
to the Radio
Public*

*How to Trace
All Faults
by a Process
of Elimination
and How to
Put Them
Right When
They Have
Been Found*

TELLS ALL THAT YOU WANT TO KNOW

THE TRUTH
THE WHOLE
TRUTH
GIVES
ACCURATE
Evidence
of Everything

10
TESTING
INSTRUMENTS
IN
ONE

Complete in hand-
some case with pair
of leads, interchange-
able testing prods
and crocodile clips.

BRITISH
MADE

IS YOUR SET giving you all that it could—its performance absolutely up to scratch? Is every connection and component efficient, or is there some baffling defect difficult to detect? You can tell at once with the AvoMinor. It tests everything *accurately*. It gives you an expert's mastery of radio faults. It is TEN testing instruments in one, with the outstanding advantage of being accurate. It gives you *precision* testing facilities obtainable hitherto only with high-priced instruments.

The AVOMINOR

TRADE MARK



CURRENT MILLIAMPS

0-6 milliamps
0-30 ..
0-120 ..

VOLTAGE VOLTS

0-6 volts
0-120 ..
0-300 ..

RESISTANCE OHMS

0-10,000 ohms
0-60,000 ..
0-1,200,000 ..
0-3 megohms

SUPPOSE, to-night, you are troubled with loss of volume, or a noisy crackle, or, worse than that, complete silence. You can find the trouble at once with the AvoMinor. This instrument is invaluable to anyone whose interests are perfect set-performance.

With the AvoMinor every fault can be traced, every source of trouble detected. It tests circuits, valves, components, batteries, and power units.

There is nothing like it at anywhere near its price. It is the younger Avometer, which, because of its accuracy and efficiency, is used by the foremost radio manufacturers and their service engineers.

The AvoMinor is a moving-coil combination instrument with a total resistance of 100,000 ohms. Full scale deflection is obtained with only 3 milliamps.

Ask your dealer, or write for fully descriptive folder.

THE AUTOMATIC COIL WINDER
& ELECTRICAL EQUIPMENT CO. LTD.
Winder House, Douglas St., London, S.W.1

DEFERRED TERMS
if desired. Write
for particulars

Phone: Victoria 3404-7

Editor-in-Chief:
BERNARD E. JONES

Technical Editor:
J. H. REYNER
B.Sc. (Hons.), A.M.I.E.E.

Radiovision Editor:
H. CORBISHLEY

Wireless Magazine

The Best Shillingworth in Radio

Vol. XIX : MAY 1934 : No. 112

Editor:
D. SISSON RELPH

Research Consultants:
W. JAMES and
PERCY W. HARRIS

Assistant Editor:
T. F. HENN

Published by BERNARD JONES PUBLICATIONS, LTD., 58/61 Fetter Lane, London, E.C.4. Telephone: Central 4341 (four lines). Telegrams: "Beejapee. Fleet, London." Subscription: Great Britain and abroad, 15s. 6d. a year, post paid (Canada only, 13s. 6d.). Next issue published on Wednesday, May 30.

A Satisfaction You Will Share

YEARS ago I said to myself "One of these days I will prepare a comprehensive chart showing the wireless amateur exactly what to do when his set goes wrong. I know exactly how I shall do it. I shall start off with 'When the set is dead' and then I shall deal one by one with the many causes for such a state of affairs and give my reader advice under every sub-heading."

This month I have the satisfaction of realising the promise made to myself. Not that I have done the work; two members of my staff have done it for me and put in a lot of thought and time to the producing of a chart which, I think, will meet very nearly every need.

I publish this chart this month under the title of "Everyman His Own Set Doctor" and I invite you to turn to page 299, where this feature starts, and test for yourself how useful this really is. You will see from the introduction that our Staff has proceeded on the assumption that your set has been giving satisfaction up to a well defined occasion when something—one of many dozens of things—went wrong.

This special feature is not addressed to experienced readers but is offered for the help, and perhaps the salvation, of those readers who have but little technical knowledge but want to be independent of outside experts. I feel sure that the feature will be very generally appreciated and I trust to hear about it from many readers, especially from those who feel that they can improve it in any respect.

The increasing interest in television is remarkable. I daresay that the publication of the new series of "Television" (the shilling monthly publication now owned and published by the proprietors of "Wireless Magazine") has had much to do with this as far as the public is concerned; but there is great activity behind the scenes and I hope the time is not far off when the B.B.C. will see its way to give a regular television service.

There are two special articles in this issue on television, one explaining the new Baird high-definition system by

means of which there has recently been given one of the most successful semi-public demonstrations I have yet seen, and the other giving information on how to use an ordinary broadcast set in connection with a television receiver.

General articles this month cover a wide range and include Whitaker-Wilson's "Where the B.B.C. Wastes Money"—largely an argument that the B.B.C. has spent too much money on unsuitable productions; our American correspondent's visit to the Bell Laboratories, showing how this huge experimental organisation with its four thousand employees is continually working on new ideas; Dr. Gradenwitz's "Healing by Short-wave Radio," which deals with some startling developments of the healing properties of ultra-short waves.

A set which we believe to be the first all-electric three-valve super-het ever offered to the home-constructor is the "Heptode Super Three," for operation on A.C. mains and fully described in the present issue.

This set has been made possible by the use of two new valves—a heptode and a double-diode pentode. The set has been put through stringent tests in South London and has come through with flying colours. During an ordinary evening no fewer than fifty-five stations were received at full loud-speaker strength, all free from interference.

An inherent fault of most four-valve super-hets is poor daylight range, but our new three-valver gives a good performance both day and night. We have no hesitation in claiming that it is the best A.C. three-valver yet offered to the home constructor.

A novelty set is the "Companionette," a midget mains receiver—no larger than an ordinary shoebox—which will work on both A.C. and D.C. supplies without alteration. With a small piece of wire slung across the room and a good earth, the Companionette will bring in the local stations at adequate strength.

B. E. J.

FOR THE CONSTRUCTOR

THE HEPTODE SUPER THREE. Designed by The "W.M." Technical Staff ..	315
FIFTY-FIVE STATIONS ON THE HEPTODE SUPER THREE!	320
THE COMPANIONETTE. Designed by J. B. Crofts and the "W.M." Technical Staff ..	324
AN EVENING'S PLEASURE WITH THE COMPANIONETTE ..	329
WIRELESS JOBS MADE EASY FOR MR. EVERYMAN. By R. W. Hallows ..	333
MORE ABOUT THE SPECTRUM PORTABLE EXPERIMENTER'S ALL-WAVE SEVEN ..	368
THE 1934 A.C. QUADRADYNE ..	380

TECHNICAL FEATURES

EVERYMAN-HIS OWN SET DOCTOR. Compiled by the "W.M." Technical Staff ..	299
TUNING BY EYE—INSTEAD OF BY EAR! OUR TEST OF NEW SETS. By the "W.M." Set Selection Bureau ..	339
H.M.V. GREENWICH SUPER-HET ..	340
COSSOR MODEL 435 THREE-VALVER ..	341
EKCO MODEL AC64 ..	342
DRUMMER MODEL MS6 ..	343

Contents

OSTAR-GANZ UNIVERSAL SUPER-HET ..	344
HEALING BY SHORT-WAVE RADIO. By Dr. Alfred Gradenwitz ..	346
HIGH-FREQUENCY COUPLING AND THE DETECTOR STAGE. By Percy W. Harris, M.Inst.Rad. E. ..	358
AUTOMATIC TONE CONTROL FOR YOUR SET. By S. Rutherford Wilkins ..	364
TESTS OF NEW APPARATUS ..	371

GENERAL ARTICLES

GUIDE TO THE WORLD'S BROADCASTERS. By Jay Coote ..	290
WORLD'S BROADCAST WAVELENGTHS ..	292
IN TUNE WITH THE TRADE. By Fetter Lane ..	296
RADIOS—AND RIOT GUNS—HELP AMERICAN POLICE ..	311
WHEN BROADCASTING BEGAN—By Derek England ..	312
MY VISIT TO THE BELL LABORATORIES. By Lionel Merdler ..	321
COPENHAGEN AND KALUNDBORG ..	330
WHERE THE B.B.C. WASTES MONEY. By Whitaker-Wilson ..	331

RADIO MEDLEY. By BM/PRESS ..	336
AIRCRAFT RADIO 1914-1918. By W. T. Lowe ..	345
ON THE CREST OF THE WAVES. By Jay Coote ..	349
RECORDING THE SOUND ON FILM. By Baynham Honri ..	350
HOME RECORDING ON FILM. By G. S. Scott ..	353
LISTEN TO THE VOICE OF THE WORLD—AND SEE IT AS WELL! ..	354
BROADCAST MUSIC OF THE MONTH. By T. F. Henn ..	361
NEWS OF THE SHORT WAVES. By Kenneth Jowers ..	369
NOTES AND JOTTINGS ..	380
COUPONS; INDEX TO ADVERTISERS ..	384

TELEVISION SECTION

WORKING A SIMPLE TELEVISION RECEIVER FROM YOUR BROADCAST SET ..	373
ANOTHER GREAT ADVANCE IN TELEVISION ..	374
HOLDING THE IMAGE STEADY ..	376
HOW NEON TUBES ARE MADE ..	378

GRAMOPHONE FEATURES

CHOOSING YOUR RECORDS. By Whitaker-Wilson ..	366
ADDITIONAL RECORDS REVIEWED By Chopstick ..	367

A FINE THREE-VALVE A.C. SUPER-HET FOR YOU TO BUILD—See page 315

Registered at the General Post Office for transmission by Canadian Magazine Post

Postage on this issue 3d. (inland and abroad)

Guide to the World's Broadcasters

Specially Compiled for "Wireless Magazine" by JAY COOTE

Metres: (Revised) **Kilocycles: 15,200**
 19.73 (DJB) 11,760
 25.51 (DJD) **ZEESEN** 9,560
 31.38 (DJA) 6,020
 49.83 (DJC) (Germany)

Power: 8 kw.

Distance from London: Approximately 588 miles.

Standard Time: Central European (coincides with British Summer Time).

Announcer: Man.

Call: "Achtung! Achtung! Hier der Deutsche Weltrundfunksender," followed by name of studio or city from which relay is taken.

Interval Signal: Short carillon.

Times of Transmission (B.S.T.):

Programme for Asia: 06.35-08.00 (DJB), 12.45-16.00 (DJA).

Programme for Africa: 18.50-22.30 (DJD and DJC).

Programme for South America: 23.00-01.30 (DJA).

Programme for North America: 02.00-04.00 (DJC and DJD).

News bulletins given in English at 14.45, 20.10, 22.10, and 03.00.

Closes down with usual German good-night greetings, followed by *Horst Wessel lied* (Nazi March) and National Anthem, *Deutschland Ueber Alles*.

Metres: (Revised) **Kilocycles: 11,730**
 25.57 **EINDHOVEN (PHI)**
 Power: 40 kw. (Holland)

Distance from London: Approximately 235 miles.

Standard Time: When Amsterdam Summer Time, 20 minutes ahead of British Summer Time.

Announcer: Man.

Languages: Dutch, German, French, English and Spanish.

Call: "Hier Philips Omroep, Holland-India, PHI."

Interval Signal: Metronome: 80 beats per minute.

Times of Transmission (B.S.T.): Daily, 13.00-16.00 (except Tuesdays and Wednesdays).

Closes down with Dutch National Anthem, *Wilhelmus van Nassau*.

Metres: **CARACAS (YV3BC)** **Kilocycles: 9,510**
 31.55 6,209
 48.34 (Venezuela)

Distance from London: Approximately 3,900 miles.

Standard Time: British Summer Times less 3 hours.

Announcer: Man.

Language: Spanish, but on the 11th of each month a special programme is given for the U.S.A., when announcements are also made in English.

Call: "Radiodifusoria Venezolana en Caracas."

Interval Signal: Gong.

Times of Transmission (B.S.T.): 11.45 and 02.10, native songs, etc. (48.34 metres); 04.00-04.30 (Sundays, 04.00-05.00) (31.55 metres). Relays programmes from medium-wave station, YV3BC, Caracas, on 250 metres (1,200 kilocycles).

Metres: (Revised) **Kilo-cycles: 6,100**
 49.18 **DOWNERS GROVE (W9XF)**
 Power: 9 kw. Illinois (U.S.A.)

Distance from London: Approximately 3,650 miles.

Standard Time: British Summer Time less 5 hours.

Announcer: Man.

Call: "This is WENR, the National Broadcasting Company's station at Chicago City, calling." (When experimenting uses the call: "W9XQ.")

Times of Transmission (B.S.T.): Sundays, 19.00-20.30, 22.30-01.00, 03.30-08.00 (Mondays).

Weekdays, 22.30-02.00, 03.30-08.00.

No transmission on Saturdays.

Relays WENR, Chicago, 344.6 metres (870 kilocycles), also other stations belonging to the N.B.C. Blue and Red network.

Metres: (Revised) **Kilocycles: 658**
 455.9 **LANGENBERG**
 Power: 60 kw. (Germany)

Distance from London: Approximately 314 miles.

Standard Time: Central European (coincides with British Summer Time).

Announcer: Man.

Opening and Interval Signal: Short musical phrase from German folk song.

Call: "Achtung! Westdeutscher Rundfunk."

Main Daily Programme (B.S.T.): 06.35 (Sundays), concert; 06.40 and 08.20 (except Sundays), physical exercises; 07.15 (09.45 Sundays), concert; 13.10 (Sundays), gramophone records; 16.00, concert; 18.00, talks; 18.25 (Mondays), Italian lesson (Friday, English); 20.00, main evening programme; 22.00, time signal, weather, news, etc., followed by concert or dance music; 24.00-02.00 (Sundays), late concert; (Saturdays until 01.00).

Closes down at 24.30 approximately with usual good-night greeting in German, followed by National Anthem, *Deutschland Ueber Alles*.

Metres: (Revised) **Kilocycles: 638**
 470.2 **PRAGUE**
 Power: 120 kw. (Czechoslovakia)

Distance from London: Approximately 635 miles.

Announcers: Man and woman.

Call: "Allo! Praha." When with relays: "Allo! Praha, Brno, Bratislava, Moravska-Ostrava, Kosice."

Languages: Czech, also occasionally French, German, and English.

Interval Signal: First bars of Smetana's *Wyschehrad* (harp theme).

Opening Signal: For early-morning transmissions, a cock crow.

Main Daily Transmissions (B.S.T.): 06.15 (06.45 Sundays), physical exercises, concert; 07.30 and 09.05 (Sundays), concert; 10.05 (except Sundays), German news; 17.35 (Thursdays), French lesson; 18.25 (17.50 Sundays), German programme; 21.00, time signal, followed by main evening programme; 22.00, weather, news, etc.; 22.15 (Tuesdays), news in English; 22.30-23.00 (approximately), concert or gramophone records.

Closes down at approximately 23.00 (23.30 Saturdays) with good-night greetings in Czech ("*Dobrou noc*"), German, French, and English.

Metres: (Revised) **Kilocycles: 592**
 506.8 **VIENNA**
 Power: 120 kw. (Austria)

Distance from London: Approximately 760 miles.

Standard Time: Central European (coincides with British Summer Time).

Announcers: Man and woman.

Language: German.

Opening and Interval Signal: Metronome, 270 beats per minute.

Call: "Allo! Hier Radio Wien."

Main Daily Programme (B.S.T.): 06.55 (Sundays), weather; 07.00 (Sundays), concert (Mondays 07.35); 09.00, weather, news, etc.; 12.00, gramophone records; continuous transmission until 18.00, talks; 18.30 (Mondays), English lesson (Tuesdays, French); 19.50, time signal, weather, news, etc., followed by main evening programme. Closes down at approximately 23.30 or 00.00 with good-night greeting, followed by National Anthem, *Oesterreichische Bundes-hymne*.

Relays Graz, 338.6 metres (886 kilocycles), 7 kilowatts; Innsbruck Dornbirn, 578 metres (519 kilocycles), 0.5 kilowatts; Klagenfurt, Linz, 231.8 metres, 0.5 kilowatts; Salzburg, 222.6 metres.

Metres: (Revised) **Kilocycles: 583**
 514.6 **RIGA**
 Power: 15 kw. (Latvia)

Distance from London: Approximately 1,050 miles.

Standard Time: Eastern European (British Summer Time plus 1 hour).

Announcers: Man and woman.

Languages: Lettish and frequently German.

Opening Signal: Cock crow.

Interval Signal: Short musical melody.

Call: "Hallo! Latvia, Riga, Madona."

Main Daily Programme (B.S.T.): 06.00 (except Sundays), physical exercises; 08.30 (Sundays), gramophone records; 10.00 (Sundays), church service; 18.00 (Saturdays), French lesson; 18.10 (Sundays), concert; (Tuesdays, French lesson); 18.30 (Mondays), English lesson (18.40 Thursdays); 19.00, weather, followed by main evening programme; 21.00, news, etc., usually followed by dance music until 23.00 approximately.

Closes down with words, "Ar Labu Nakti."

Relays Madona, Brno, Bratislava, Kosice, Moravska Ostrava, Prague(2).

TELSEN COMPONENTS

Specified for "Wireless Magazine" Circuits

HEPTODE SUPER THREE

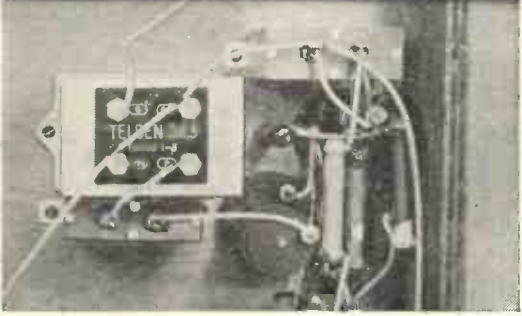

TELSEN D.R.3 TRANSFORMER



By specifying this amazing transformer, the designer of the Heptode Super Three has ensured absolutely uniform amplification over the entire range of audio-frequencies. For it is the L.F. transformer with a completely straight-line characteristic, being both theoretically and practically perfect. Spaced layer windings with special non-hygroscopic impregnation eliminate the possibility of shorted turns and breakdowns due to large magnetic surges, while the inductance is increased to 150 henries by the use of a nickel iron alloy core of very high permeability. D.R.3 (Ratio 3-1).

8/6

TELSEN IRON-CORED SCREENED COIL

The designer of the COMPANIONETTE has acknowledged the superiority of this famous dual-range coil by exclusively specifying it for use in his set. The result of extensive research, it embodies an iron-dust core which has enabled its size to be greatly reduced, while its efficiency—its magnification and selectivity—have been considerably increased.

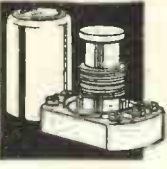

8/6



SPECTRUM PORTABLE

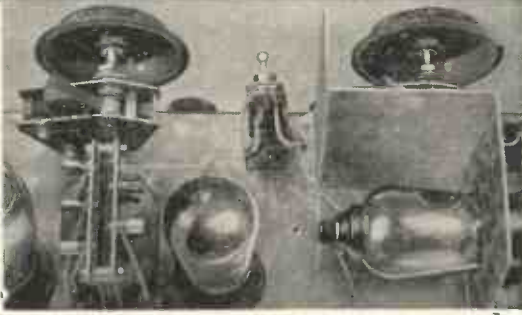

2 TELSEN BAKELITE DIELECTRIC VARIABLE CONDENSERS



These condensers have been specified and used by the designer of the Spectrum Portable, not only because their compact design makes them ideal where space is limited but also because of their great rigidity of construction and exceptionally high efficiency. A high-grade dielectric is employed, ensuring accuracy of tuning with minimum losses. Cap. mfd. .0005

2/6
each

Also Telsens Iron-Cored Screened Coil **8/6**

Follow the designers' lead—Insist on TELSEN

Announcement of THE TELSEN ELECTRIC COMPANY LIMITED, ASTON, BIRMINGHAM.



BROADCAST WAVELENGTHS

Stations best received in the British Isles are indicated in bold type

Note: Names in brackets are those of stations relayed

Wave-length	Name of Station	Dial Readings	Country	Wave-length	Name of Station	Dial Readings	Country
13.52	W8XK, Saxonburg (KDKA)		United States	31.297	Davenport (Empire) GSC		Great Britain
13.97	Davenport GSF		Great Britain	31.32	Radio Nations HBL		Switzerland
14.47	Buenos Aires LSY		Argentina	31.33	Millis W1XAZ (WBZ)		United States
14.58	Bandoeng PMB		Java	31.38	Zeesen DJA		Germany
15.5	Bandoeng PMA		Java	31.46	Schenectady W2XAF (WGY)		United States
15.82	Buenos Aires LSR		Argentina	31.545	Davenport (Empire) GSB		Great Britain
15.92	Bandoeng PLE		Java	31.55	Melbourne VK3ME		Victoria
16.36	Lawrenceville (N.J.) WLA		United States	31.55	Caracas YV3BC		Venezuela
16.38	Rugby GAS		Great Britain	31.58	Rio de Janeiro PSA		Brazil
16.39	Maracay YVR		Venezuela	31.6	Poznan SRI		Poland
16.56	Bandoeng PMC		Java	31.71	Rocky Point WKJ		United States
16.66	Rocky Point WAI		United States	31.83	Maracay YVR		Venezuela
16.7	Buenos Aires LSY		Argentina	32.0	Heredia T14NRH		Costa Rica
16.81	Bandoeng PLF		Java	32.71	Lawrenceville WND		United States
16.85	Kootwijk PCV		Holland	33.26	Rugby GBS		Great Britain
16.86	Davenport Empire GSG		Great Britain	33.59	Rocky Point (N.J.) WEC		United States
16.878	Boundbrook W3XAL (WJZ)		United States	35.0	Khaharovsk (RV15)		U.S.S.R.
16.88	Eindhoven PHI		Holland	36.65	Rio de Janeiro PSK (PRA3)		Brazil
16.89	Königswusterhausen DJE		Germany	37.04	Quito HCJB		Ecuador
17.05	Transatlantic Liners			37.33	Rabat (CNR)		Morocco
19.55	Schenectady W2XAD (WGY)		United States	38.47	Radio Nations HBP		Switzerland
19.61	La Paz CP4		Bolivia	39.7	Maracay HFK		Colombia
19.62	New York W2XE (WABC)		United States	40.3	Radio Nations HBQ		Switzerland
19.67	Coytesville N.J. W1XAL (WEEI)		United States	40.5	Bogota HJ3ABB		Colombia
19.68	Radio Colonial FYA		France	49.54	Rocky Point WEM		United States
19.71	Saxonburg W8XK (KDKA)		United States	41.1	Amateur band		
19.737	Zeesen DJB		Germany	41.55	Bogota HKE		Colombia
19.815	Davenport (Empire) GSF		Great Britain	41.6	Las Palmas EAR58		Canary Isles
19.84	Rome (Vatican) HVJ		Italy	41.67	Singapore VSIAB		Sis. Sett'l'mts.
19.85	Tashkent (RAU)		U.S.S.R.	42.0	Maracay YV2AM		Venezuela
19.88	Moscow (RKI)		U.S.S.R.	42.92	Jeloy LCL (relay Oslo)		Norway
19.99	Central Tuinucu CM6XJ		Cuba	43.0	Madrid EAR110		Spain
20.27	Rocky Point WQV		United States	43.86	Budapest HAT2		Hungary
20.31	Rocky Point N.Y. (WEAF)		United States	44.61	Rocky Point WQO		United States
20.49	Deal (N.J.) WND (W2XBJ)		United States	44.96	Maracay YVQ		Venezuela
20.5	Chapultepec XDA		Mexico	45.0	Constantine FM8KR		Tunis
20.7	Rocky Point WEB		United States	45.02	Guayaquil HC2RL		Ecuador
20.97	Amateur band			45.31	Rio Bamba PRADO		Ecuador
21.43	Cairo SUV		Egypt	45.38	Moscow		U.S.S.R.
21.45	Rocky Point WQB		United States	45.38	Moscow RW72		U.S.S.R.
21.58	Rocky Point WQP		United States	45.5	Bucharest		Romania
21.83	Drummondville CGA		Canada	46.53	Barranquilla (HJ1ABB)		Colombia
22.26	Rocky Point WAJ		United States	46.66	Boundbrook W3XL (WJZ)		United States
22.48	Maracay YVQ		Venezuela	46.67	London (Ont.) VE9BY		Canada
22.68	Liners			46.7	Boston W1XAL		United States
22.684	Zeesen (DHB)		Germany	46.73	Minsk RCAD		U.S.S.R.
23.39	Radio Maroc (Rabat) CNR		Morocco	47.0	Cali HJ5ABB		Colombia
24.41	Rugby GBU		Great Britain	48.05	Barranquilla (HKD)		Colombia
24.9	Kootwijk PDV		Holland	48.34	Caracas YV3BC		Venezuela
25.0	Moscow RNE		U.S.S.R.	48.58	Winnipeg VE9CL (CJRM)		Canada
25.16	Moscow RW50		U.S.S.R.	48.83	Saxonburg (Pa.) W8XK (KDKA)		United States
25.25	Radio Colonial, Paris (FYA)		France	48.86	Moscow (RKI)		U.S.S.R.
25.25	Saxonburg (Pa.) W8XK (KDKA)		United States	48.94	Mexico XETE		Mexico
25.274	Calcutta VUC		India	48.95	Maracay YVHBM0		Venezuela
25.284	Davenport (Empire) GSE		Great Britain	48.99	Wayne W2XE (WABC)		United States
25.32	Wayne W2XE (WABC)		United States	49.0	Johannesburg ZTJ		Sth. Africa
25.36	New York W2XE (WABC)		United States	49.08	Caracas YVIBC		Venezuela
25.4	Rome 2RO		Italy	49.07	Halifax VE9HX (CHNS)		Nova Scotia
25.45	Boston W1XAL (WEEI)		United States	49.1	Halifax VE9HX (CHNS)		Canada
25.51	Zeesen DJD		Germany	49.1	Calcutta VUC		Brit. India
25.532	Davenport (Empire) GSD		Great Britain	49.15	Boundbrook W3XAL (WJZ)		United States
25.57	Eindhoven (PHI)		Holland	49.15	Chicago W9XF (WENR)		United States
25.58	Winnipeg VE9JR (CJRC)		Canada	49.19	Bowmanville VE9GW (CRCT)		Canada
25.63	Radio Coloniale FYA		France	49.3	La Paz CP5		N. Brunswick
25.68	Marapicu PSA		Brazil	49.3	St. John VE9BJ (CFBL)		Bolivia
26.83	Funchal CT3AQ		Madeira	49.31	Chicago W9XAA (WCFL)		United States
27.65	Nauen DFL		Germany	49.39	Maracaibo YV2AM		Venezuela
27.88	Marapicu PSA		Brazil	49.39	Vancouver VE9CS (CKFC)		Brit. Columbia
28.28	Rocky Point (N.J.) WEA		United States	49.4	Skamlebaek OXY		Denmark
28.98	Buenos Aires LSX		Brazil	49.43	Vancouver VE9CS (CKFC)		Brit. Columbia
29.04	Ruysselede (ORK)		Belgium	49.47	Nairobi VQ7LO		Kenya Colony
29.16	Zeesen (DIQ)		Germany	49.48	Philadelphia W4XAU (WCAU)		United States
29.35	Marapicu PSH		Brazil		Cincinnati W8XAL (WLW)		United States
29.58	Leopoldville OPM		BelgianCongo	49.586	Davenport (Empire) GSA		Great Britain
29.64	Marapicu PSD		Brazil	49.6	Bogota HJ3ABI		Colombia
30.0	Radio Excelsior LR5		Argentina	49.67	Miami W4XB		United States
30.0	Madrid EAQ		Spain	49.87	Mexico (XEW)		Mexico
30.4	Tokio JIAA		Japan	49.83	Zeesen DIC		Germany
30.77	Lawrenceville WOF		United States	49.92	Havana YCOC		Cuba
30.89	Rugby GCA		Great Britain	49.93	Drummondville VE9DR (CFCF)		Canada
31.0	Heredia (T14NRH)		Costa Rica	49.96	Tegucigalpa (HRB)		Honduras
31.20	Nauen DGU		Germany	49.97	Caracas YV2BC		Venezuela
31.23	Mexico City XETE		Mexico	50.0	Barcelona EAR25		Spain
31.25	Lisbon CT1AA		Portugal	50.0	Moscow RNE		U.S.S.R.
31.26	Philadelphia W3XAU (WCAU)		United States	50.26	Rome (Vatican) HVJ		Italy
	Sydney VK2ME		N.S. Wales	50.4	Tunja HJ2BA		Colombia

(Continued on page 294)

**We offer to
CONVERT
any type of receiver to
the most up-to-date
UNIVERSAL A.C./D.C.
ALL-MAINS RECEIVER**

using the famous Ostar-Ganz Universal High Voltage Valves. Charges most reasonable. Estimates free if old set is sent us carriage paid.

**UNIVERSAL
AMPLIFIERS**

fitted with the latest Ostar-Ganz 5-watt "K" Triode Valve.
ONE output stage 6 Gns.
TWO output stages 8 Gns.
Excellent for use in large halls and for public address work.

**5 VALVE SUPER
UNIVERSAL RECEIVER**

In this issue of the "Wireless Magazine" a complete "test" report appears. We commend your attention to it (see page 344).
A most selective set with quality of reproduction as near perfect as it is possible to obtain. Can be used on either A.C. or D.C. mains supply, because the famous Ostar-Ganz Universal Valves are fitted.
15
Gns. Complete
Also supplied with ultra-short wave unit.
Hire purchase terms arranged. State mains voltage when ordering.

**UNIVERSAL HIGH VOLTAGE
RADIO, LTD., 28-29 Southampton
Street, Strand, London, W.C.2.**

Telephone: Temple Bar 4985.

THE LATEST ARRIVALS

OSTAR-GANZ

**H.F. PENTODE and PENTAGRID
Universal High Voltage Mains Valves**

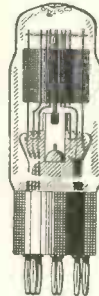

The Ostar-Ganz range are the **only** Universal Valves that can be wired in PARALLEL. There's no wider, finer or more up-to-date range available.

The characteristics of these valves assure a higher performance than is possible with any other Universal or D.C. valves.

Remember that Ostar-Ganz Valves work equally as well on either D.C. or A.C. supply without alteration and, they do not require TRANSFORMERS, BARRETER LAMPS or Break-down RESISTANCES. They work off the FULL Mains Voltage.

Builders or Converters of Receivers and Amplifiers should write at once for details of the full range.

KITS for Universal A.C./D.C. Receivers and Amplifiers also supplied. Full details on request. Blueprints available.

OSTAR-GANZ VALVES EXCLUSIVELY SPECIFIED

Only Ostar-Ganz Universal High Voltage Valves as Specified can be used for the "COMPANIONETTE" described in this issue. (See article on page 324)

EUGEN J. FORBAT,

28-29 Southampton Street, Strand, London, W.C.2.
Telephone: Temple Bar 8608.

SOUND SALES TRANSFORMERS

make a sound foundation for every new advance in radio technique hence their

EXCLUSIVE SPECIFICATION

for the
"THREE-VALVE SUPER-HET"

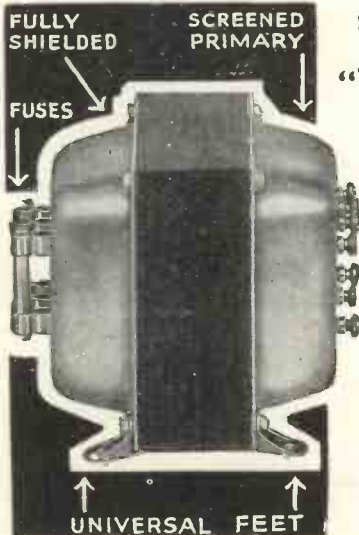

Specified because this is the latest design of mains transformer—Totally Enclosed Static Shielded, and it has several distinct advantages over other types.
Tappings instantly variable; no tools required—merely change position of special fuse which complies with the I.E.E. regulations and those of various supply companies.

1933-34 IMPROVED SPECIFICATION

Type 250 Shielded Super
Primary 0, 210, 230, 250 v. at 50 cycles.
Sec. 250-0-250 v. at 60 m.a.
Rec. 2-0-2 v. at 1 amp.
I.T. 2-0-2 v. at 3 amp.
L.T. 2-0-2 v. at 1 amp.
Size 3 1/2 in. by 4 1/2 in. by 3 3/4 in.
Weight 4 1/2 lb.

Price 25/- Cuts out all modulation hum. Cuts down running costs to a minimum.

The only transformer incorporating a fuse and combined tapping selector. Absolutely safe.

Phone: Archway 1861.

SOUND SALES

Tremlett Grove Works LTD.
JUNCTION ROAD, HAMPSTEAD, LONDON, N.19

They all call
for **ERIES**



Here are three different sets—and for the resistors the "Wireless Magazine" says ERIES every time—specified because of their greater safety, their lower noise level, and their guaranteed life-time's stability.

The "Wireless Magazine" says—ERIES!

SPECTRUM PORTABLE 3 Eries Resistors Specified

COMPANIONETTE 4 Eries Resistors Specified

HEPTODE SUPER 3 13 Eries Resistors Specified



Your nearest dealer has all these Eries in stock. Ask definitely for Eries Impregnated resistors.

1/- PER WATT IN ALL VALUES All hand-tested, colour-coded and labelled.

Write for free colour code chart and technical data.

THE RADIO RESISTOR Co., Ltd.,
1 GOLDEN SQUARE, PICCADILLY CIRCUS, LONDON, W.1

When replying to advertisements, please mention "Wireless Magazine"

WORLD'S BROADCAST WAVELENGTHS Continued from page 292

Metres	Name of Station	Dial Readings	Country	Metres	Name of Station	Dial Readings	Country
50.82	Medellin HJ4ABE		Colombia	304.3	Genoa		Italy
56.9	Koenigswestern'sen (DTG)		Germany	307.1	Cracow		Poland
57.03	Rocky Point WQN		United States	307.1	West Regional		Great Britain
58.03	Bandoeng PMY		Java	309.9	Grenoble PTT		France
58.31	Prague		Czechoslovakia	312.8	Odessa		U.S.S.R.
62.5	Long Island (N.J.) W2X		United States	312.8	Poste Parisien, Paris		France
62.56	London (Ont.) VE9BY		Canada	315.8	Breslau		Germany
65.93	Rocky Point WAD		United States	318.8	Algiers		North Africa
68.18	Moscow (RFCK)		U.S.S.R.	321.9	Göteborg		Sweden
69.44	Rugby G6RX		Great Britain	321.9	Brussels (2)		Belgium
70.2	Khabarovsk RV15		U.S.S.R.	325.4	Brno		Czechoslovakia
73.0	Quito (HCJB)		Ecuador	328.6	Limoges PTT		France
76.0	Maracay (YV11AM)		Venezuela	331.9	Dniepropetrovsk		U.S.S.R.
80.0	Lisbon DTICT		Portugal	331.9	Hamburg		Germany
84.5	Berlin D4AGE		Germany	335.2	Radio Toulouse		France
84.67	Mozambique CR7AA		East Africa	338.6	Helsinki		Finland
85.9	Boston WIXAL		United States	342.1	Graz		Austria
200	Agen		France	342.1	London Regional		Great Britain
201.1	Bordeaux-Sud-Ouest		France	345.6	Poznan		Poland
203.5	Plymouth		Great Britain	349.2	Strasbourg		France
203.5	Bournemouth		Great Britain	350.7	Porsgrund		Norway
204.2	Pecs		Hungary	352.9	Bergen		Norway
206	Fécamp		France	352.9	Valencia		Spain
208.8	Miskolcz		Hungary	356.7	Berlin		Germany
209.5	Newcastle		Great Britain	360.6	Moscow (4)		U.S.S.R.
209.5	Beziere		France	362.2	Radio LL Paris		France
211.3	Tampore		Finland	364.5	Bucharest		Roumania
212.6	Bucharest		Roumania	368.6	Milan		Italy
215	Radio Lyon		France	373.1	Scottish Regional		Great Britain
216.8	Warsaw No. 2		Poland	373.1	Salonika		Greece
218.2	Basle, Berne		Switzerland	377.4	Lwow		Poland
219.6	Cracow		Poland	377.4	Barcelona (EAJ1)		Spain
221.1	Turin (2)		Italy	382.2	Leipzig		Germany
221.3	Vitus, Paris		France	386.6	Toulouse PTT		France
222	Dublin		Irish Free State	391.1	Midland Regional		Great Britain
222.6	Nice-Juan-les-Pins		France	395.8	Katowice		Poland
222.6	Koenigsberg		Germany	400.5	Marseilles PTT		France
224	Milan Vigentino (2)		Italy	405.4	Munich		Germany
224.1	Montpellier		France	405.4	Seville		Spain
224.1	Lodz		Poland	410.4	Madrid (Espania)		Spain
225.6	Hanover		Germany	410.4	Tallinn		Estonia
225.6	Bremen		Germany	415.5	Dorpat		Estonia
225.6	Flensburg		Germany	415.5	Kiev		U.S.S.R.
227.1	Stettin		Germany	420.8	Rome		Italy
227.1	Madgeberg		Germany	420.8	Stockholm		Sweden
227.1	Budapest (2)		Hungary	426.1	Paris PTT		France
230.2	Danzig		Germany	431.7	Belgrade		Yugoslavia
230.2	Linz		Austria	437.3	Fredr. ksstad		Norway
231.8	Salzburg		Austria	443.1	Sottens		Switzerland
231.8	Klagenfurt		Austria	449.1	North Regional		Great Britain
231.8	Dornbirn		Austria	455.9	Langenberg		Germany
233.5	Aberdeen		Great Britain	463	Lyons PTT		France
235.1	Stravenger		Norway	470.2	Prague (1)		Czechoslovakia
236.8	Nurnberg		Germany	476.9	Trondheim		Norway
236.8	Dresden		Germany	476.9	Lisbon		Portugal
238.5	San Sebastian		Spain	483.9	Brussels (1)		Belgium
241.9	Rome (3)		Italy	491.8	Florence		Italy
241.9	Cork		Irish Free State	499.2	Sundsvall		Sweden
243.7	Gleiwitz		Germany	506.8	Rabat		Morocco
245.5	Trieste		Italy	514.3	Vienna		Austria
247.3	Lille PTT		France	514.3	Riga		Latvia
249.2	Prague Strasnice (2)		Czechoslovakia	522.6	Mühlacker		Germany
249.2	Frankfurt-am-Main		Germany	531	Athlone		Irish Free State
251	Trier		Germany	531	Beromünster		Switzerland
251	Freiburg im Breslau		Germany	539.6	Budapest		Hungary
251	Cassel		Germany	549.5	Wilno		Poland
253.2	Kaiserlautern		Germany	559.7	Bolzano		Italy
255.1	Kharkov (2)		U.S.S.R.	559.7	Vilpuri		Finland
257.1	Copenhagen		Denmark	569.3	Ljubljana		Yugoslavia
257.1	Monte Ceneri		Switzerland	578	Innsbruck		Austria
259.1	Moravska-Ostrava		Czechoslovakia	696	Hamar		Norway
261.1	London National		Great Britain	726	Oulu		Finland
261.1	West Regional		Great Britain	726	Boden		Sweden
263.2	Turin (1)		Italy	748	Moscow		U.S.S.R.
265.3	Hoe-by		Sweden	748	Geneva		Switzerland
267.4	Belfast		N. Ireland	765	Ostersund		Sweden
267.4	Nyiregyhaza		Hungary	840	Budapest (2)		Hungary
269.5	Kosice		Czechoslovakia	1,107	Moscow (RCZ)		U.S.S.R.
271.7	Naples		Italy	1,175	Oslo		Norway
271.7	Madona		Latvia	1,224	Leningrad		U.S.S.R.
274	Madrid EAJ7		Spain	1,250	Vienna (Exp.)		Austria
276.2	Falun		Sweden	1,261	Kalundborg		Denmark
276.2	Magyarovar		Hungary	1,304	Luxembourg		Luxembourg
276.2	Zagreb		Yugoslavia	1,357	Motala		Sweden
278.6	Bordeaux PTT		France	1,389	Eiffel Tower		France
280.9	Tiraspol		U.S.S.R.	1,415	Warsaw		Poland
283.3	Bari		Italy	1,500	Daventry National		Great Britain
285.7	Scottish National		Great Britain	1,500	Deutschlandsender		Germany
285.7	Leningrad (2)		U.S.S.R.	1,570.7	Istanbul		Turkey
288.5	Rennes PTT		France	1,613	Reykjavik		Iceland
288.5	Heilsberg		Germany	1,639	Moscow No. 1		U.S.S.R.
291	Parede		Portugal	1,714	Radio Paris		France
293.5	Barcelona (EAJ15)		Spain	1,796	Lahti		Finland
296.2	North National		Great Britain	1,797	Kootwijk		Holland
298.8	Bratislava		Czechoslovakia	1,875	Brasov		Roumania
301.5	Hu'uzen		Holland	1,935	Kaunas		Lithuania

THE HEPTODE



The Ferranti VHT4 combines in one valve the function of both Oscillator and Modulator, and, in addition, is a Variable Mu type, enabling full A.V.C. to be obtained in sets with only one I.F. stage.

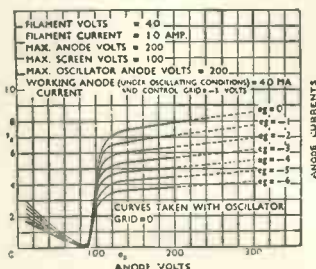

2 Volt Battery Heptode VHT2 also available price 17/6.

Specify Ferranti Valves. They have been proved and used exclusively in tens of thousands of Ferranti Superhets.

Price
20/-

FERRANTI LTD.
HOLLINWOOD LANCASHIRE



HAVE YOU HAD?
particulars of the famous "Magnum" Short Wave Adaptor, which is now available for every type of receiver? Full particulars, with a list of short-wave stations and free trial offer, on request.

BURNE-JONES & CO. LTD. (Dept. M),
296 Borough High St, London, S.E. 1

Micromesh
THE MODERN VALVE
Literature and prices on request
Standard Telephones and Cables, Ltd.,
Et. Chad's Place, 384 Gray's Inn
Road, London, W.C.1. Terminus 6253.

YOUR OLD COMPONENTS

are worth money. Sort out the spare radio parts you no longer require and advertise them in the "Miscellaneous Columns" of **AMATEUR WIRELESS**. You will be surprised how quickly they will be snapped up. Your announcement will cost you 3d. a word. Send your list of parts, together with your name, address and remittance to:

"Small Advertisement" Department,
AMATEUR WIRELESS
58-61 Fetter Lane, London, E.C.

PILOT AUTHOR KITS

Exact to Specification
HOME-CINÉ

KIT "A" Author's Kit of First Specified Parts, including wood for chassis and cabinet in knock-down form, ready drilled and vignetted, but less valves and speaker. Cash or C.O.D. **£4:5:0** Or 12 monthly Carriage Paid payments of 7/9.

KIT "B" As for Kit "A," but with set of specified valves only. Cash or C.O.D. **£7:6:3** Or 12 monthly Carriage Paid payments of 13/6.

SPECTRUM PORTABLE

KIT "A" Author's Kit of First Specified Parts, including wood for Cabinet and Chassis "knock-down" form, and wire for Frame Aerial, but less Valves and Speaker. Cash or C.O.D. **£4:15:0** Or 12 monthly Carriage Paid payments of 8/9.

PETO-SCOTT PERMANENT MAGNET MOVING COIL 1934 EXTENSION SPEAKER
SUITABLE FOR ANY SET

With inclined baffles, supported on felt cushions. Free from all resonance and boom-enhancing the already perfect tonal balance. In beautiful walnut cabinet. Suitable for any type of set. Direct only from PETO-SCOTT.

30 RATIOS



Balance in 7 monthly payments of 5/8. Cash or C.O.D. Carriage Paid, 39/6.

IMPORTANT Miscellaneous Components, Parts, Kits, Finished Receivers or Accessories for Cash, C.O.D. or H.P. on our own system of Easy Payments. Send us a list of your wants. We will quote you by return. C.O.D. orders value over 10/- sent carriage and post charges paid (GREAT BRITAIN ONLY). OVERSEAS CUSTOMERS CAN SEND TO US WITH CONFIDENCE. We carry a special export staff and save all delay. We pay half carriage—packed free. Send full value plus sufficient for half carriage. Any surplus refunded immediately. Hire Purchase Terms are NOT available to Irish or Overseas customers.

PETO-SCOTT CO. LTD.
77 CITY ROAD, LONDON, E.C.1
Telephone: Clerkenwell 9406/7
West End Showrooms: 62 High Holborn, London, W.C.1
EST. 1919

Advertisers like to know you "saw it in the 'Wireless Magazine'"

In Tune with the Trade

FETTER LANE'S Review of the Latest Catalogues

FOR HIGH-QUALITY DETECTION

A LEAFLET describing the new WX6 Westector has just arrived on my desk. This new rectifier is designed to give high-quality detection at radio frequencies of about 1,000 cycles. It has a very low capacity and can be employed on the lower wavelengths without excessive damping and loss of selectivity.

Numerous suggested circuits are given for half-wave rectification and automatic volume control as well as information on the correct use of these new Westectors.

You must keep up to date with these advancements, so send for this catalogue and have it on hand for future reference. **385**

NEW EKCO RADIOGRAM

THE new Ekco radiogram model RG84 for A.C. or D.C. mains has as its basis a four-valve (five with rectifier) super-het receiver. It has many outstanding points of interest, such as full automatic volume control, light-beam and shadow tuning, a local-distance switch and an interchangeable tuning scale.

The gramophone motor is a Collaro model incorporating an automatic stop. There is only one volume control and this operates on both radio and gramophone. All controls are mounted on the gramophone

motor board—a point of design that makes for neatness. The modern inlaid cabinet is of two-tone walnut with a semi-matt finish. A really fine looking job!

A catalogue giving full details of this new receiver is available through this free service. **386**

CLAUDE LYONS RESISTANCES

THE resistance problem ties quite a number of constructors "up in knots." Any constructor with the aid of this Claude Lyons catalogue will be able to select, at a glance, any resistance he may want to do a certain job.

Fixed resistances, variable resistances and hum adjustors are listed as well as switches, ganged potentiometers, mains condensers and transformers, sparking plug suppressors, valve holders, microphones and pick-ups.

A very good helping hand to constructors! **387**

FERRANTI'S POPULAR AF4

THE Ferranti AF4 inter-valve transformer was first introduced in 1925 and is still a very popular model. It is quite suitable for receivers used in tropical conditions. Freedom from breakdown under tropical conditions is, by the way, a feature of all Ferranti transformers.

The leaflet recently produced gives full details about it. Here are one or two of the most important details. The ratio is 1 to 3.5, the primary inductance at zero current is 45 henries, the weight 1.5 lbs. and the price 17s. 6d. And Ferranti transformers are reliable, you know! **388**

K.B.'s NEW RECEIVERS

SEVEN new receivers for the 1934 season are included in the new Kolster-Brandes catalogue. The most outstanding set listed is the model 888 de-luxe, an eight-valve

super-heterodyne receiver in a modern design cabinet of Queensland walnut with edges of chromium-plated metal strips and control knobs to match.

The K.B. Rejectostat system of static suppression is incorporated as well as automatic-tone compensation and volume control.

Two other new models, 365 and 378, are radiograms, four- and six-valve super-heterodynes respectively, housed in cabinets of the same style as the 888.

The 363 is a four-valve class-B receiver, and the models 333A, 364 and 393 are three-valve battery-operated receivers.

Truly a very fine range with a wide margin for choice. Now ask for this catalogue; I'm sure you will like this range of receivers. **389**

NEW MCMICHAEL SUPER-HET

THE new McMichael super-heterodyne receiver is a four-valve receiver for A.C. mains employing a Westinghouse rectifier. Tone correction and automatic volume control are two of the main features. The tone control is variable to the listener's requirements and the A.V.C. is supplemented with a manual control which limits the controlling action to suit the listener.

The scale is marked in wavelengths, so that any further changes in station wavelengths will not put the scale out of date.

Provision is made for an external loud-speaker and a switch provided to cut out the internal loud-speaker, which, by the way, is of the mains energised type.

Sockets are provided for a gramophone pick-up and the main volume control operates on gramophone reproduction. The cabinet is of modern design in figured walnut.

To obtain an illustrated leaflet of this receiver just fill in the coupon on this page and send it to us. We will see that you get all the literature you need. **390**

RELIABILITY



Battleships and T.M.C. HYDRA Condensers have this in common—both are built to give reliable service—both have to pass the strictest tests—and both are made only with the finest materials.

When you build a T.M.C. HYDRA Condenser into your set you can rest assured that it is the best your money can buy—it is a product of the most up-to-date condenser plant in the world—and tests, repeated at intervals throughout its making, have proved its quality and capacity to give you a long life of unequalled reliability. Equip your set, then, with T.M.C. HYDRA Condensers—you will get better results.

T.M.C. HYDRA Condensers are made in all standard capacities, with soldering tags or screw terminals at the same price.

They are specified for the "Heptode Super 3" described in this issue.

Write to the Sole Sales Distributors if you have any difficulty in obtaining supplies.



T.M.C. BRITISH MADE HYDRA CONDENSERS

Price List from
SOLE SALES DISTRIBUTORS FOR GREAT BRITAIN:

HARWELL LTD

The Sessions House, Clerkenwell Green, London, E.C.1
Telephone: Clerkenwell 6905

Made by TELEPHONE MANUFACTURING Co. Ltd.

IF your set crackles and bangs like a friendly argument in Chicago

*don't be puzzled
find out why*

The easiest way to solve that problem—or any other radio problem—is to use a PIFCO Trouble Tracker. Just get one of these wonder instruments on the trail and even the most complex radio fault will hold up its hands and surrender. The PIFCO Trouble Trackers show the shortest way to 100% radio reception. Ask your dealer or electrician for a demonstration of a PIFCO.



● PIFCO "ALL-IN-ONE" RADIOMETER (above). For battery sets. Makes any test in a few seconds. Mottled bakelite case. Complete with leads. Price 12/6.

● PIFCO DE LUXE "ALL-IN-ONE" RADIOMETER, Moving Coil model, 125,000 ohms resistance. Tests everything. For electric radio, mains units, or battery sets. Finished mottled bakelite, complete with leads and case. Price £2 2s.

● PIFCO ROTAMETER (right). A radio testing instrument on entirely new principles. One needle operates on 8 separate dials. For electric or battery sets. Amazingly handy and accurate. No other instrument in the world like it. In black bakelite, complete with leads. Price 29/6.

Issued by PIFCO, LTD.
High St., MANCHESTER
or 150 Charing Cross Road
London, W.C.2.

INSIST ON A PIFCO AND
SAVE TROUBLE.



PIFCO Trouble Trackers

THE RADIO
YOU'VE
WANTED



INDOORS OR
OUTDOORS
TRUE-TO-LIFE TONE
NO WIRES

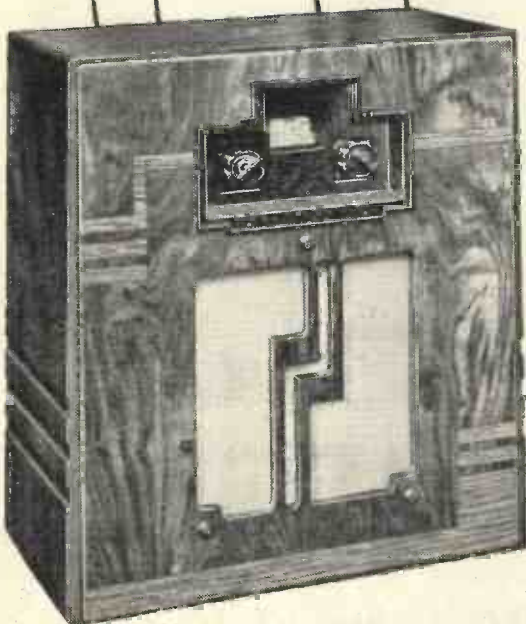

Once considered impossible, now within your reach: a battery portable with the pure tone of an expensive "mains" set—the new "His Master's Voice" A.V.C. Portable Grand! Hear it, and realise how delightfully different it is! The finest radio for those without electric supply, for flats where good aerials are impossible, for the garden, the car, the boat.

No earth, no aerial, no external wires of any description. Six-valve Superhet Battery-operated Portable with Automatic Volume Control, frame aerial, ample power for extra speaker, switch for gramophone pick-up.

15 GNS. OR BY HIRE PURCHASE
"His Master's Voice"
SUPERHET A.V.C. PORTABLE GRAND

EVERYMAN HIS OWN SET DOCTOR



Here we present what we believe to be the simplest and most complete fault-finding guide ever presented to the radio public. It has been specially prepared by the WIRELESS MAGAZINE Technical Staff for all set owners

IN compiling the tabulated list of faults, their diagnosis and remedies, we have acted on a very simple, yet we think entirely reasonable, assumption. We have imagined that your set has been giving satisfaction up to a well-defined occasion, when something—one of many dozens of things—has gone wrong.

That is the main condition for which we have worked to remedy. Of course there are other conditions, such as when you buy a new set, put in a new valve or new battery; but these are *initial* conditions, not really coming within the scope of a fault-finding analysis. Some of our points do actually cover set installations but that is incidental to the main idea.

Now assuming that your set has unfortunately gone wrong overnight—or over a holiday period, for example—what is the first thing to do? We ask that question on the assumption that you have very little technical knowledge, and that your chief equipment for the job of putting the set right is a grain of common sense and the possession of your five senses—especially the senses of sight and hearing.

Well, the first thing to do is to *classify* the fault. We have been thinking a great deal about the many and varied faults that sets are heir to, and we have come to

the conclusion that all normal or common faults can be classified under one of *five* distinct heads.

So your first job ought to be to find out which of these divisions your set's fault comes under. In our tabulated information you will find that the five classifications are as follows:—

When the Set is Dead.—This means that you switch on the set and no sound of any sort can be heard in the loud-speaker. It means that not even the usual rushing noise can be heard, nor can any clicks be detected when the set is switched on or off, or when controls are varied.

Set Alive But No Signals.—Here you are not much better off than before. You still cannot hear any signals, no matter how you rotate the controls, yet there is evidence that some part of the set is working—clicks and rushing noises in the loud-speaker are heard.

Signals Heard But Only Faintly.—Here your set is not in such a parlous state as under the first two conditions, but the remedy may be more difficult to find because the cause may be more subtle. Faint signals means volume below normal on any station received—that is, a general lowering of the output level.

Distorted Signals.—Here the volume may be quite up to standard and the set may be working well in all

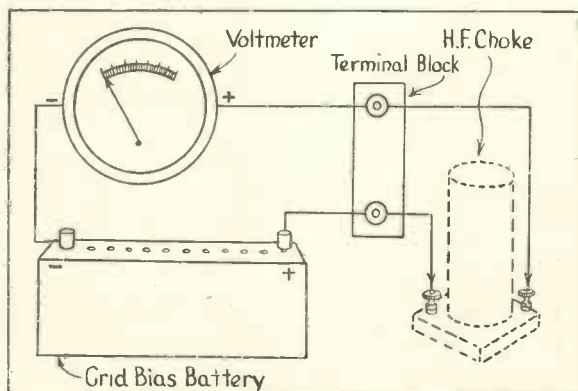

Fig. 1.—Simple test for continuity. A voltmeter has one side connected to a battery, leaving the remaining battery and voltmeter connections for the test component

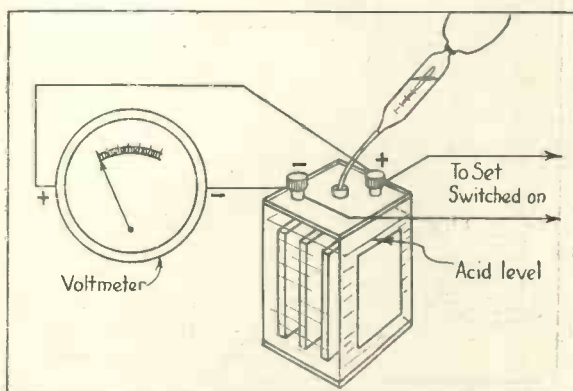

Fig. 2.—Hydrometer test for a suspected accumulator, which, if properly charged, should give a reading of about 1.250. Or use the voltmeter test as shown by our diagram

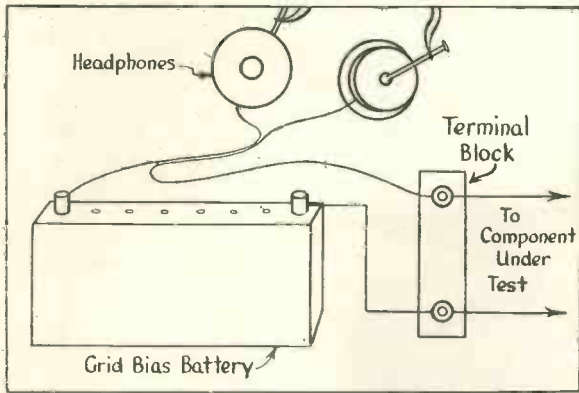

Fig. 3.—Another simple continuity test. A battery in series with a pair of headphones, connected through the test component. A click in the headphones denotes continuity

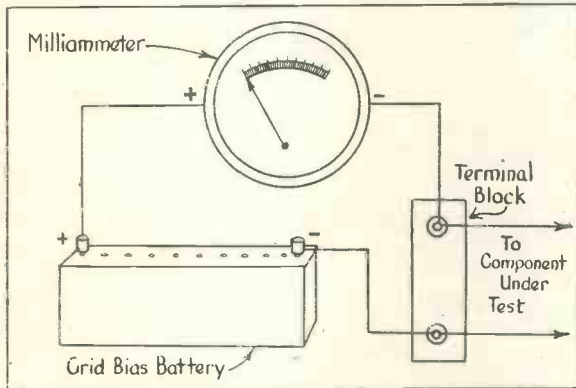

Fig. 4.—For high-resistance components, such as a grid leak, use this test. A milliammeter connected in series with a battery and the component. A flick denotes continuity

respects except quality of reproduction. Distortion may take the form of choking, loss of high notes, boominess, wheezy noises, grunts, choppy speech and sibilant s's.

Noises that Mar Reception.—Everything may be working quite well, volume and quality being well up to standard, and foreigners coming in at their accustomed strength, but behind the signals may develop all kinds of noises—frying, sizzling, crackles and so on.

Well, there you have the five main classifications of faults in wireless sets. We quite agree that there are many other queer faults that do not come under these headings; indeed we give one or two in a special classification at the end of the tabular matter.

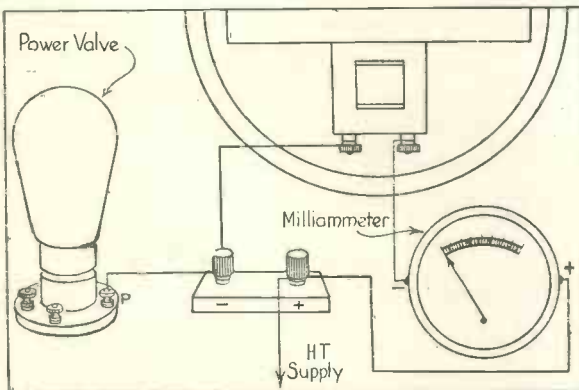

Fig. 5a.—Testing anode current of a power valve with a milliammeter. The meter is in series with the maximum high-tension lead or one side of the loud-speaker

But it must be borne in mind that rare faults cannot be expected to yield to such treatment as the average amateur is capable of applying. Faults other than those mentioned in these pages are usually so individualistic that no general instructions are of any use.

All we hope to do with this guide is to put you on to the more obvious and the most commonly experienced faults, in order that you may save time and money in restoring your set to its usual condition of operation

May we stress the point that our guide is only intended to remedy *developed* faults, and not to put right *inherent limitations* of any given circuit such as weakness on foreigners, absence of high notes, poor selectivity and so on.

Again, this guide is mostly directed to the home builder, but many of the points can be just as well applied to the factory-built set. Always assuming, of course, that you do not interfere with the chassis while the set is still under its makers' guarantee. Certain simple adjustments, such as replacing fuses, valves and batteries, and the checking up of poor connections, can equally be applied to either home-made or commercial sets.

To return to the five main fault headings: when your set goes wrong your first job is, as we say, to see which heading its fault comes under. We will assume for a start that it is dead—utterly dead and lifeless. There are thirteen different causes that we have mentioned. Of course there must be lots of others, but most of the common ones are included.

Don't for a moment imagine that you have to carry out *all* these tests. Probably the first one or two will yield a positive result, in which case all the rest are unnecessary.

For example, if your set has a dial lamp and it lights you know that the set is switched on, the accumulator is working, the leads to the accumulator are making connection, and there is no corrosion worth worrying about at the terminals.

So you must go on to the next test. Is there a battery disconnection? Look at the high-tension leads at the set end. Put a voltmeter across the negative high-tension terminal and the maximum positive high-tension terminal, such as we show by Fig. 6B, and if you get a reading you will know that the connections are correct,

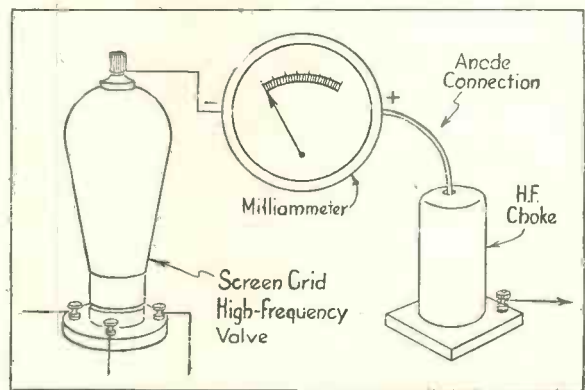

Fig. 5b.—Here a milliammeter registers the anode current of a screen-grid valve. Note that with a screen-grid valve the anode connection is at the top of the bulb, not to a pin

the plugs are making contact, the battery is working, and, if you have a mains unit, there is no fault there.

Assuming now that this test proves the power supply is in order you know that the fault must be either in the set or the loud-speaker.

On the other hand, if you don't get that voltage across the meter, you will have to make more tests—in this order : test for the continuity of the leads between the batteries and their terminals on the set ; if no break is revealed test the wander plugs and sockets ; if there is still no fault discovered put your voltmeter right across the battery or mains unit, as we show at Fig. 6A.

That will show whether the trouble is in the power supply. If the set is battery operated, and all preceding tests have failed to reveal any fault, the battery itself must either have run right down or have developed an internal fault.

Not quite so simple if you are using a mains unit. If there is no voltage across the negative and maximum positive tappings the next test is to see whether the mains are on, the house fuses are intact, and that the mains supply has not failed—all done by one simple test, by putting an electric-light bulb in the socket that takes the mains unit.

If the electric-light bulb lights the trouble *must* be in the mains unit. It may be a serious fault, or simply a blown fuse. Check the fuse by the Fig. 1 continuity circuit, and if that is in order there is nothing to do but have the mains unit tested.

Many other little points relating to causes of deadness are dealt with in the table and need no further comment.

♦ ♦ ♦

Much the same procedure should be adopted if you find the set is live but giving no signals. Such simple causes as the aerial coming adrift or the valves being in wrong holders can be tackled in a moment, while it is common to find that the only reason a set will not tune in signals is that the combination switch is over to gramophone instead of radio.

The mere fact that the set seems alive tends to show that the power supply is not at fault and that the output stage at least is in good order. Therefore you will naturally start to look for the fault in the preceding stages of the set.

Firstly, try testing for the voltage on the high-tension terminals of the set as at Fig. 6B, making sure with a voltmeter that the right voltages are actually reaching the set. Then you should test each valve except the

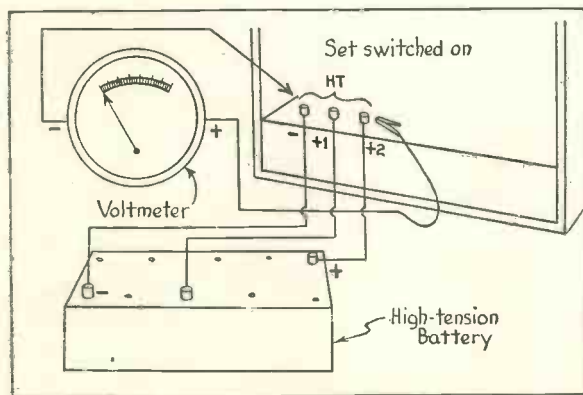

Fig. 6b.—To make a simple but effective simultaneous test of high-tension battery and leads connect the meter across the set's terminals. Normal readings O.K. both battery and leads

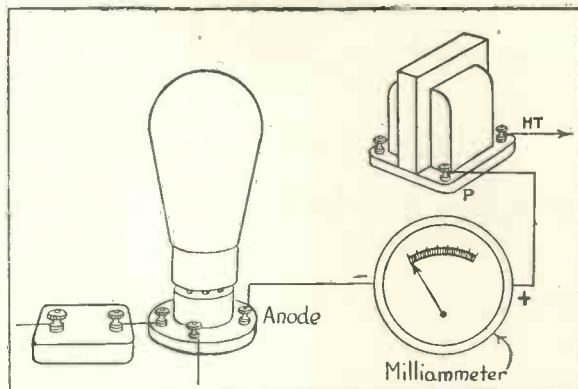

Fig. 5c.—Showing how to obtain the anode current of a three-electrode valve, such as a detector, with a milliammeter in series with the anode components

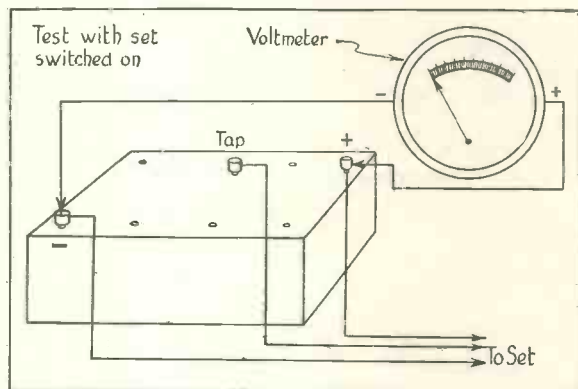

Fig. 6a.—Very simple test for a high-tension battery. The positive and negative of a high-reading voltmeter are connected to their respective battery terminals—when the set is on

power valve for anode current, by the circuits shown at Figs. 5B, 5c. Test the screen current of the screen-grid valve as at Fig. 6c.

This test, if positive, proves that the valves are working as they should and that the high-tension voltage is actually reaching the set. But should there prove to be no current flow for any stage either the valve is faulty or the voltage is not getting to the valve, due to a break in an anode-circuit component.

You then apply the tests applicable to faulty anode components and valves, as indicated by our circuits Figs. 9 and 1 respectively.

Assuming you find out that there must be a faulty component in the anode circuit you simply try each in turn

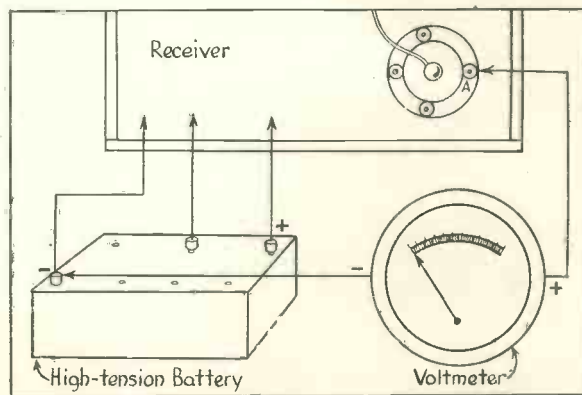

Fig. 6c.—Showing how to test the voltage on the screen of a screen-grid valve. Connect the negative side of the voltmeter to the negative side of the battery and the positive side to the A

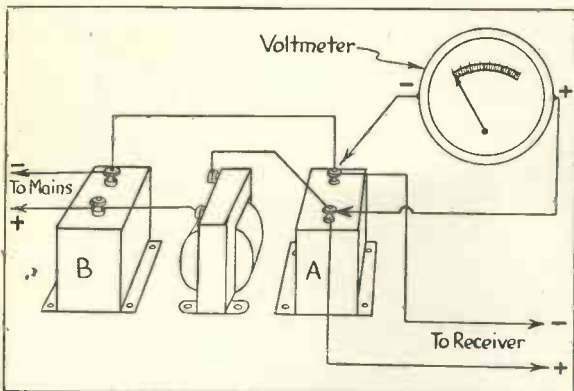

Fig. 7a.—For a home-constructed mains unit test the voltage across the second smoothing condenser by connecting a voltmeter as shown by our diagram

for continuity by the Fig. 1 test. A faulty valve will have to be replaced and so, of course, will a faulty component.

Then take a look at the variable condenser, testing them for insulation as shown you by Fig. 8. If you find that one or more plates are touching you may be able to separate them by a penknife.

Now supposing that your fault comes under the heading of signals heard but only faintly. How are you going to set about locating the cause? For a start you should certainly go over all the more obvious causes.

Examine the aerial and earth, set's control knobs, wrong switching, and wrong adjustments of controls. All these tests can be done without any meters or apparatus—just using your eyes.

Assuming that these simple things are not to blame, you must look for a slightly more subtle cause. Check the voltage of the high tension under load, as shown by Fig. 6A, and the accumulator, as at Fig. 2.

If the signals are faint for only a period, and come up to full strength every now and then, a nearby aerial may be absorbing energy

Try the loud-speaker unit. It may have gone out of adjustment. This often happens when the current is fairly high.

Suspect the high-frequency stage. A simple way of

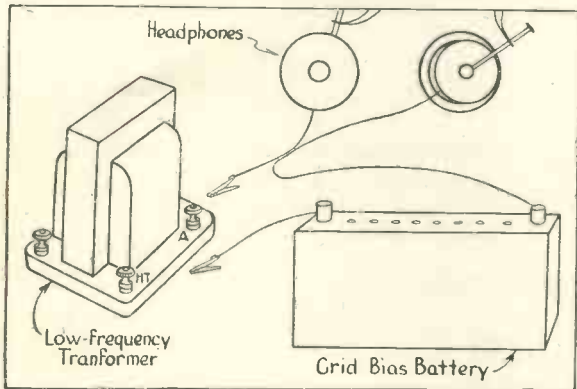

Fig. 7c.—To test the primary winding of a low-frequency transformer connect up headphones and grid-bias battery as shown. Click denotes a continuous and therefore sound primary

checking whether this valve is working is to remove the connecting wire from the terminal on the top of the bulb and join to this terminal the aerial lead-in wire.

This alteration will cause an increase in volume if the screen-grid valve is not working and tuning will be flattened.

If there are two screen-grid stages first try the one nearest the detector, connecting the aerial wire to it as explained. Then, if this proves to be working, repeat the test for the valve next to the aerial.

Don't confuse screen-grid high-frequency stages with intermediate-frequency stages in a super-het. The only way to test the efficiency of intermediate valves is to test them along the lines of Figs. 5B. and 6c.

For checking up distorted signals there is no special sequence of tests, but you should certainly test at once for such things as incorrect grid bias, high-tension

dropping, accumulator running down, worn-out power valve, wrong adjustment of loud-speaker, too much reaction and so on.

An infallible test to find out at which stage the distortion is produced is to put a milliammeter in the anode circuit of the power valve, as at Fig. 5A. Then if you note a flicker in the meter, upwards or downwards, it shows that wrong bias is applied.

If these simple tests do not give you any positive result you will then have to seek out the fault in the grid circuits of the valves. You can test the transformer secondary winding as at Fig 9, and the grid

leak as at Fig. 10.

The leads for the grid-bias battery can also be checked for continuity as at Fig. 1, while the grid-bias battery can be tested for voltage in a similar way to the test for a high-tension battery as at Fig. 6A.

Now we come to what is probably the most worrying of all receiver faults, and that is noise in the background. There are so many possible causes that it is a little difficult to give a definite sequence of tests to apply. But always the first thing to do is to take off the aerial and then the earth, just to make sure that the noise is really coming from the set and not from the aerial-earth system.

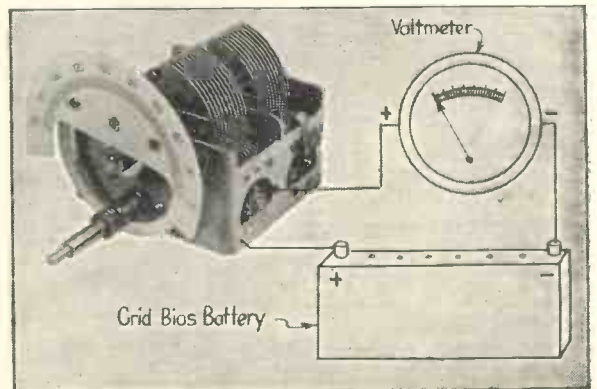

Fig. 8.—This is a test for insulation of the variable condenser. A meter and battery are used as shown, and if the plates touch the meter will register a voltage

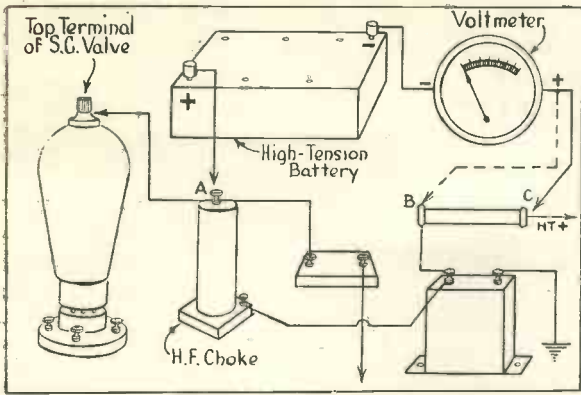

Fig. 9.—High- and low-frequency chokes can be tested with a battery and a voltmeter across the suspected component. Needle flick denotes continuity and therefore sound component

Assuming you prove that the noise continues when the aerial system is disconnected you know that something is causing the noise inside the set, the mains supply, the batteries or the loud speaker.

Always suspect the high tension if it has been in use for any length of time. If you suspect this source, and the battery is not very old, try the effect of a large fixed condenser, say 2-microfarad, across the positive and negative terminals.

If by substitution you find the battery is not at fault, you must try other simple tests. For example, take a look at the accumulator, noting that the terminals are clean and bright. Examine all battery contacts for dirty or partial connections. Turn up the volume control and tap each valve in turn. If one is at fault it will vibrate or increase the noise when you touch it.



One of the frequent causes of small noises are faulty anode components, such as high-frequency chokes or anode resistances. The quickest way is to test by substitution, otherwise apply test as at Fig. 9, making quite sure that the anode current flowing through the meter is perfectly steady.

As this test is best done with a small reading meter, which you may not have available, perhaps you might prefer to apply the test as at Fig. 3, with a battery and headphones.

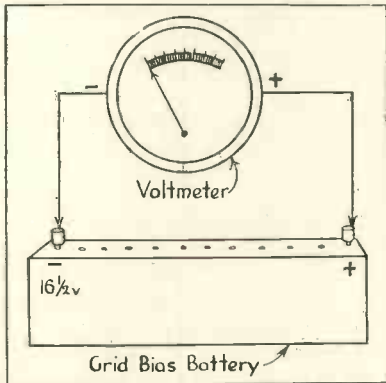

Fig. 12.—Simple way to test a suspected grid-bias battery. Connect a low reading voltmeter across the positive and negative terminals of the battery. Set need not be on

If you are using a mains set, and none of the above tests yield any results, suspect the mains themselves. Clicks and intermittent buzzes are often picked up by the mains conduit, and here the only solution is to fit a filter. Try the Fig. 13 circuit.

Don't forget that if the power socket is not making good contact an arcing effect may be produced, and

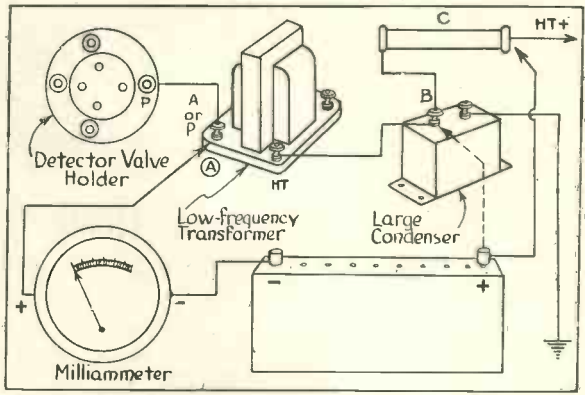

Fig. 10.—For high-resistance components continuity can be tested with a battery and milliammeter. A current reading denotes continuity and that the component is not faulty

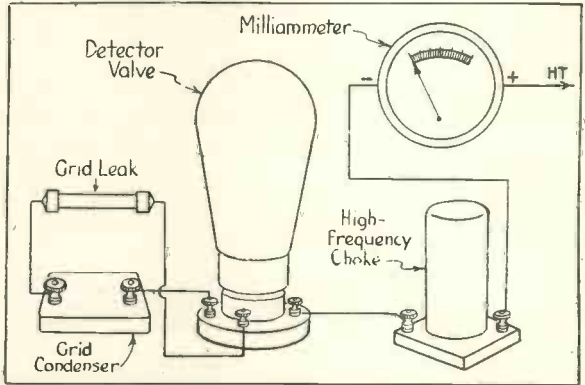

Fig. 11.—Quickest way to test a grid condenser is to watch the anode current with a milliammeter in the detector circuit. Upward deflection means faulty condenser and downward deflection sound condenser

that will cause a very bad crackle in your set, and in your neighbours' sets.

Now assuming that when in the first place you remove the aerial and earth the noise stops then you can be fairly sure the trouble is due to some external source.

The most satisfactory way out is to go to the local Post Office, obtain the new interference form, fill it in and let the engineers do the rest. We might mention that some of the most frequent causes of outside noise are vacuum cleaners, small electrical motors, hair dryers, neon signs, winking signs and violet-ray apparatus.

Even the Post Office may not be able to remedy such noise, and your best plan then is to erect either a screened download or a complete noise-suppression equipment.

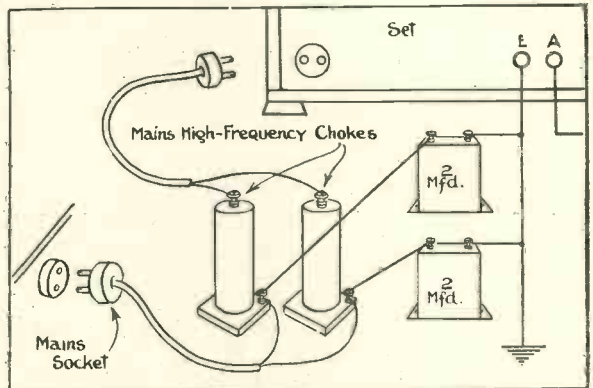

Fig. 13.—Connections for a simple mains filter to eliminate or reduce interference coming into the set from the mains. Consists of two condensers and two high-frequency chokes

Fault Finding Step by Step

If this step-by-step fault finder is carefully followed you will have no trouble about finding what is wrong—and how to put the fault right

WHEN THE SET IS DEAD

Is it switched on?

Examine battery on-off switch or mains switch. See it is at the "on" position. Contacts must be clean. See that control knob is not slipping. Is the electric-light switch on?

Are the batteries disconnected?

Are the plugs and sockets of the high-tension, low-tension and grid-bias batteries making good contact? Open up the plugs with a penknife and scrape clean any dirty terminals points.

Inspect flexible connecting wires for break in the wire under the rubber covering.

Test all connecting leads for continuity as explained by Fig. 1.

See that on the high-tension and grid-bias batteries the metal cups have not become loose or disconnected.

Are the battery connections faulty?

Spade terminals on the low-tension accumulator must be clean. Both positive and negative get corroded unless periodically cleaned and sprayed with vaseline.

Are any of the battery leads frayed? If so, are any of the loose strands touching any part of the set? Bind all loose ends with insulation tape or make sure that the rubber covering extends right up to the head of the terminal or plug.

Is the accumulator run down?

Has it by accident been on all night? Try spare charged accumulator, or test doubtful one with voltmeter and hydrometer, as explained by Fig. 2.

Is the fuse burnt out?

If of the bulb type, see that it is screwed down, or that the spring in the bottom of the holder is pushed well up. Test the bulb for continuity as shown by Fig. 1. If the bulb is O.K., screw it well down in the holder and test for continuity from one fuse holder terminal to the other.

Is the loud-speaker connected?

Is it an old loud-speaker? If so, the winding may be broken down. Apply continuity test with battery and headphones, as at Fig. 3. Test connections of loud-speaker to set, as with battery test. Test for continuity as at Fig. 1.

Is the power valve faulty?

Has the power valve failed? Try another valve of the same type. Or test for filament continuity as at Fig. 1. If you have a milliammeter test as at Fig. 5A. If you have no spare valve of the same type try a low-frequency type valve with less grid bias than you use for the power valve.

Is the power valve holder faulty?

Sometimes the sockets in the valve holder work loose. Tighten them up, and make sure the valve pins are clean and making good connection. If pins are of the banana type open them carefully with a penknife.

Are the battery connections reversed?

Are the positive and negative battery tappings on the high-tension the right way round? And on the accumulator? Check up carefully—a common fault when a new battery is put in.

Has a battery broken down?

Test battery for voltage with set switched on. Use voltmeter as shown by Fig. 6A. If the meter is only a cheap one do not worry if voltage is a little low. If no reading is obtained, the battery has broken down. Return to dealer.

Is the loud-speaker in circuit?

Have you an extension loud-speaker? If so, see that it is not switched so that the internal loud-speaker is out of circuit.

Is the mains unit faulty?

Test rectifier valve with a spare. Or measure the voltage across the smoothing condenser as at Fig. 7A. If condenser is inaccessible test the output of the mains unit across negative and the maximum positive, as at Fig. 7B. Look for glow in the bulb of rectifier. Wait a few minutes and then feel if bulb is warm, if not it may be dud.

Test mains fuse or fuses as for battery fuse test at Fig. 1.

Cont.—Is the mains-unit faulty?

See that the mains-unit plug is firmly fitting the wall socket or lampholder.

If mains are D.C., check polarity, by trying mains plug both ways in power point.

Check house mains fuses, by plugging in a bulb into the suspected point.

Has the power station broken down? Switch on any house light, or see if electric clock has stopped.

Is the trickle-charger switch over to the high-tension side? Assuming, of course, that you are using a combination unit with common switch.

Is the mains transformer voltage tapping making good contact? When contact is made by a screwed-down plug constant vibration in the house sometimes works it loose. See that it is screwed well home.

SET ALIVE BUT NO SIGNALS

Is the aerial connected?

Has aerial lead come adrift from the lead-in tube outside the house? Note: when living very near a regional you may still hear faint signals.

Has the lead-in wire corroded? Where it is clamped to the terminal of the lead-in tube it may need cleaning with sandpaper.

Is the aerial accidentally shorting to earth? One or more strands may have worked loose and be shorting on to the earth side of the aerial-earth switch. Same inside—one or more strands may be touching metal chassis of set. If using flexible lead-in wire check for continuity as at Fig. 1.

Has the inside aerial wire been renewed? If so, perhaps the rubber covering has not been removed and the wire is therefore insulated from the set terminal. Or if the wire is enamelled perhaps you have not scraped the enamel off with sandpaper where it is clamped under aerial terminal.

Is the aerial switched to earth on the aerial-earth switch? Look out and see.

Cont.—Is the aerial connected?

Is the local-distance switch in the local position? If so, that accounts for no signals if you live a long way from your nearest station.

Is the volume control properly adjusted?

Master volume control may be turned back to minimum position. Turn up. See that knob on volume control has not slipped or worked loose.

Is the variable condenser short-circuited?

As the tuning knob is rotated note the movement of the plates of the variable condenser or condensers. If condenser is screened, remove wires from it and test for insulation as at Fig. 8. See that moving plates do not touch the fixed plates. If this is the reason for the lack of signals, some adjustments will give signals while others will not.

Are the valves faulty?

One or other of the valves, except power, may be faulty. Easiest way to test this is substitution. Try valves of similiar type in each socket. Or test valves as at Fig. 5A, 5B and 5c.

Are the valve contacts faulty?

See that all pins are making good contact in their holders. If the sockets of the holders are rather worn, open the valve-pin legs a little with a penknife. Make sure legs or pins of valves are clean, and that contacts with holders are tight.

Are the high-tension leads disconnected?

Either the screen-grid valve or detector valve tappings, that is the leads from the set's terminals to the battery, may have come adrift. On sets with visual tuning there is usually a detector meter. If this does not function it proves that either there is no high-tension on the detector or that the valve is faulty.

Is the combination switch adjusted properly?

Make sure that the master or combination switch is either at medium- or long-wave position, otherwise set will be live, but there will be no signals. Sometimes this switch is left at gramophone. If there is no switch for the gramophone, see that pick-up has been removed from set when not in use.

Are the valves in the right holders?

In a newly installed set make sure that the valves have been inserted in their right sockets. Wrong types of valves may by accident be supplied. Check this up with maker's instructions booklet.

Is the high-tension on the early stages?

The battery sockets of the high-tension may be loose or disconnected internally. If a simple examination does not show up any such fault, test with voltmeter as at Fig. 6A.

Are the anode components faulty?

Test for continuity the following components: high- and low-frequency chokes, and low-value resistances, as shown at Fig. 9. Test high-value resistances and transformers for continuity as explained in the alternative method at Fig. 10.

Are the grid-circuit components faulty?

Test grid leaks and transformer secondaries as at Fig. 10. Test low-frequency chokes for continuity by the Fig. 9 method.

For testing small grid condensers that are suspected, try a spare of similar capacity.

SIGNALS HEARD—BUT ONLY FAINTLY

Is the aerial faulty?

Has it fallen down? Has the lead-in wire broken? Has it come off the lead-in tube? Is it shorting to earth across the outside switch? Is the inside lead-in wire sound? Any fault in the aerial will reduce signal strength.

If the set works from A.C. mains, are you trying to use the mains aerial for reception from stations too far away for satisfactory mains-aerial working?

Is the earth faulty?

See if the earth wire has become disconnected. If so, signals will be reduced in strength and the ganging of multiple tuning condensers will be upset.

If the earth is old, the lead may have rusted off the original plate or tube. Try effect of temporary connection to water pipe.

Is the set ganged correctly?

If signals are faint, and you hear local at two points on the dial, the variable condenser ganging is out of adjustment.

Is there absorption by a nearby aerial?

Intermittent faint signals and fading can often be traced to oscillation by a neighbour working his set on the "silent point" of oscillation. Try your aerial at right angles. This trouble is specially noticeable when both sets—yours and neighbour's—are using indoor aeriels.

Is the dial slipping?

See that the tuning control knob is actuating the variable condenser. If the dial slips, you may think you are tuned-in to the local when actually you are off tune, and therefore only weakly receiving the wanted station.

Is the set tuning on a second channel?

If the set is a super-het, be careful that you are tuned to the proper setting for the wanted station. If you accidentally tune to second reading, which is usually much higher than the normal, the signal strength may be greatly reduced.

Are you tuning-in the right station?

With big sets it is easy to tune in to a distant Regional or National in mistake for the locals when the programmes are the same. Check up readings.

Is the high-tension run down?

When in a semi run-down condition the signals will be weak, particularly on distant stations. Test with voltmeter while the set is working, as at Fig. 6B.

Is the accumulator run down?

If you have borrowed an accumulator it may be too small and have run down in a very short time. Temporary leads to accumulator may be of too thin a gauge of wire, causing voltage drop and reduction of valve sensitivity.

Are the high-tension voltages correct?

Have you without thinking interchanged the positive high-tension tappings on the battery? The screen-grid, detector and power valves would then get the wrong voltages, and weak signals would result. Check up voltages on all valves with voltmeter, particularly the screen of the screen-grid valve, as at Fig. 6C.

Are the valves deteriorating?

Power and low-frequency valves may be going soft—that is the vacuum may be deteriorating, causing loss of volume and excessive anode current. Symptom of old age.

Is the screen-grid valve operating?

Try a new screen-grid valve in place of suspected one. To prove if this valve is faulty connect the aerial lead to the top of the screen-grid valve. If volume increases a lot the valve is dud. Does not apply, though, to intermediate-frequency valves of a super-het.

Is the moving-iron loud-speaker adjusted?

If the reed or armature adjustment is pushed too far, faint or distorted signals will be heard.

Cont.—Is the moving-iron loud-speaker adjusted?

Is the pick-up accidentally in circuit?

Is the reaction correctly adjusted?

Is the grid condenser faulty?

Is the grid bias correct?

Is the accumulator ageing?

Is the sensitivity control adjusted properly?

Is the volume control turned down?

Turn back unit knob until a click is heard and signals regain normal strength.

Certain types of pick-up damp out signals if left in circuit when the radio side is switched on. Especially where there is no gramophone pick-up switch.

If pushed too far the set may be in silent oscillation, and therefore reducing signal strength. Or reaction may be at minimum, and not giving enough amplification even for good local reception, check reaction control.

A fixed condenser in the grid circuit of the detector that has broken down reduces signal strength. If suspected try a new one, or apply test as at Fig. 11.

Check up bias voltage for the screen-grid valve. This should rarely be above 1.5 volts. Possibly this may have been mistakenly changed with low-frequency valve bias tappings.

Volume will be decreased if low-frequency detector—if anode-bend type—has too much bias applied—as it may have when renewing the grid-bias battery.

If the paste in a mass-type accumulator is falling away there may be sufficient accumulating at the bottom of the cell to short circuit the two plates and decrease the life of the cell. This may happen overnight if the process has been going on for some time. A local dealer can easily clean out the plates.

Often in multi-valve sets today there is a sensitivity control at the back of the chassis. This may be turned accidentally to minimum, and no adjustment of the front controls will then give good signals.

Perhaps the knob of the high- or low-frequency volume control may be loose, and control may then be at minimum when the knob is set at maximum. Check up movement.

DISTORTED SIGNALS

Is the grid bias correct?

This is the most common cause of distortion. Even though bias plugs are not touched, an old grid battery will give too low a voltage for a new high-tension battery.

Cont.—Is the grid-bias correct?

Are the high-tension voltages down?

Is the accumulator running down?

Is the power valve worn out?

Is there absence of high notes and presence of boom?

Is the loud-speaker unit wrongly adjusted?

Is there too much reaction?

Is the power or other valve overloading?

If the grid-bias battery is renewed, the bias voltages will probably be too high for the existing high-tension battery.

Test voltage of bias battery with voltmeter, as shown at Fig. 6A.

If the high-tension battery is in a semi-run-down condition, quality will be bad. Partly because there is not enough high-tension and partly because grid bias will be too high. Reduce bias as a temporary measure or renew high-tension battery.

Although the accumulator may still give enough voltage to work the set, the load of several filaments will bring down the voltage of a running-down accumulator, and quality will suffer. Test with voltmeter and hydrometer as at Fig. 2.

A new high-tension battery will show up an old power valve. Try reducing input and grid-bias. Confirm suspicions as to old valve causing distortion by trying a new one of same type.

Test the anode current with milliammeter, as shown by Fig. 5A.

If reception is woofy or boomy, the tone-control knob may be too far pushed over to low-note position. Or an inside or back of cabinet switch may be on low-note setting.

If removal of the back of the cabinet reduces boominess, the cabinet is resonating at low frequencies. A remedy is to mount the loud-speaker unit on some absorbent material.

If the reed or armature is out of adjustment, quality will suffer. Turn adjusting knob in anti-clockwise direction until click is heard.

If the detector stage is oscillating, or is very near the oscillation point, signals will be chopped up and distorted. To remedy, reduce reaction and increase manual volume control to make up for any loss of volume.

If you advance volume control farther than you have been in the habit of doing, distortion may be set up in the low-frequency stage.

Cont.—Is the power or other valve overloading?

Power valve will then be asked to handle more input than it has been designed to take. Distortion of this kind can easily be cured—reduce volume control, or use a larger power valve.

Is there partial disconnection of the loud-speaker?

In sets with choke-filter output, signals of a weak and distorted type can be obtained when only one side of the loud-speaker is connected. The actual connecting leads should be checked.

Is the high-tension battery big enough for the set?

On a large set a change to a new and smaller-capacity high-tension battery may give satisfactory results for a night or two and then cause bad distortion through serious voltage dropping caused by overload. Always use the biggest capacity you can afford.

Are the valves in the right holders?

If the low-frequency and power valves, or the low-frequency and detector valves, have been reversed signals will not be stopped but quality will be bad. Check over each stage to see that correct type is inserted.

Is the loud-speaker wrongly matched?

When installing an extension loud-speaker distorted signals may be produced in it through incorrect matching. At the same time, the quality of the original speaker will be impaired. Consult dealer before buying a new model, giving details of set—especially the output valve.

Is a neighbour oscillating?

Persistent "silent-point" oscillation by a neighbouring set will affect quality of your own set. If you suspect this alter your aerial or go over to a mains aerial or indoor aerial. If neighbour is obdurate consult the Post Office.

Is the high-frequency stage unstable?

Instability in a high-frequency stage will cut high notes and so cause distortion. Adjust the screening volts or change to lower efficiency valve—assuming you don't want to alter the set.

NOISES THAT MAR RECEPTION

Are there atmospherics, X's, etc.?

Certain noises are developed in the ether, especially in the summer months, that cannot be cut out. Test is to remove the aerial lead from set terminal. If the noises cease or are very greatly reduced, the set itself is exonerated. But the noises may be either atmospherics, or machine-made interference, or a

Is the aerial system faulty?

partial shorting of the aerial on to the guttering.

The aerial wire may be intermittently earthing by touching guttering, water pipes or branches of trees. Remedy is to keep the lead-in wire taut, and clear of all possible earthed parts.

If the aerial wire is fractured it will cause crackles when swaying in the wind.

There may be a semi-break in the earth lead, also causing a crackle.

Are the accumulator terminals corroded?

Old accumulators not very well looked after may have corroded terminals, which will make poor contacts of high-resistance, thus causing sizzling noises. Remedy is to clean all terminals with sand paper and wipe with vaseline.

Is the high-tension running down?

This will cause crackling very similar to atmospherics. Remedy is a new battery. As a temporary measure connect a large condenser between the negative and maximum positive sockets of the battery. Not less than 2-microfarads capacity should be used.

Are the battery socket contacts poor?

If plugs are loose in their sockets, sharp intermittent crackles will be produced. Remedy is to clean the sockets of the battery and the terminal plugs. Open up slack ones with a penknife.

Are the valves noisy?

Loose electrodes in a valve will set up frying and sizzling noises. Turn up volume and tap each valve in turn. The dud valve will at once be obvious. Remedy is a new valve but as temporary measure pack bulb with cotton wool.

Are the valve-holder contacts worn?

Constant use tends to loosen the spring contacts in valve-holders, making bad connections with the valve pins. The symptom is a frying noise, to which is added a crackle, often caused by a loose nut and bolt allowing the filament wiring to vibrate.

Is the loud-speaker vibrating?

If you hear a mechanical vibration when volume is turned up, examine carefully every part of the loud-speaker as well as the fret in front of it. If this is loose tighten up. See that the centering device, if it is held in position with a screw, has not come loose.

Cont.—Is the loud-speaker vibrating?

Ashtrays and ornaments on top of the loud-speaker often cause rattles at certain frequencies. Remedy is obvious.

Are the earth-switch contacts dirty?

As the aerial-earthing switch is outside the house it becomes corroded, which sets up a frying or background noise. The shorting busbar and the contact springs should be periodically examined and kept clean with sand paper.

Are the tuning-condenser plates touching?

Note whether the noises vary when you rotate the variable tuning condenser. If at certain points you hear scratchings examine the condenser plates, and see that the moving plates are not touching the fixed ones at any point. Make this test with the aerial off, in case it is an external source from which the noise is coming.

Are any of the resistances faulty?

High background noise can often be traced to breaking down or just noisy grid leaks and anode resistances. If you have no spares to test by substitution apply the milliammeter test as at Fig. 4. This trouble is caused sometimes by passing too much anode current through resistances. Have you recently installed a new valve?

Is a neighbour oscillating?

Continuous high-pitched whistles can sometimes be traced to a near-by oscillating set. Check by removing the aerial, or by tuning in another station, or using another aerial.

Are there heterodyne whistles?

If accompanying the station tuned-in there is a high-pitched whistle of constant pitch it is probably due to heterodyning by an adjacent station. No real remedy, but tone control can often be set to diminish the noise by cutting out the higher notes.

Don't forget that when one station has a heterodyne whistle on it there is often an alternative channel free from this trouble.

Are there high- and low-pitched whistles?

If the whistle is high-pitched and does not vary in pitch or intensity when the tuning is altered, the high-frequency stage may have become unstable.

Examine the high-tension battery, test voltages on screen-grid valve with voltmeter.

Cont.—Are there high- and low-pitched whistles?

Is there motor-boating?

Is reaction "grunty"?

Is there a hissing background?

Is there mains hum or mains noise?

Low-pitched whistles are often caused by running-down high-tension battery. Try if possible a new battery—as a voltmeter test is not conclusive at this stage.

Try reversing the transformer connections on the secondary.

If a pop-popping noise develops, the battery is most certainly running down. Unless the set is altered to include decoupling the only remedy is a new battery.

When you change over from battery to mains supply, a hitherto stable set may motor-boat—and more decoupling is needed to stop the noise.

This develops if the characteristics of the detector valve change, as they do after long use of the valve. Try a .0003-microfarad by-pass condenser from anode to earth. Or a new grid condenser. Or if convenient a new or alternative detector valve.

If the earth becomes disconnected the efficiency of the set will be decreased, and amplification will have to be increased. This may cause the hiss.

In a super-het the oscillator valve may have become soft, causing a rise in anode current—resulting in hiss. Check anode current with milliammeter as at Fig. 5c.

With a new high-tension battery, too high a voltage may be applied to the first detector. This may cause the valve to oscillate and so set up hissing noises.

If you have changed over to a mains aerial there will be an increased hiss due to extra amplification needed to make up volume.

If you are using a mains aerial, is the earth good? Background hiss will go up if not.

Unwonted mains hum can be caused by deteriorating valves. Get the makers to test all types.

Has the aerial lead-in come near to telephone or other electric conduit? This will cause hum.

Has a lamp standard been left casually near the set? If so, remove and note if hum decreases.

Cont.—Is there hum or mains noise?

A moving-coil loud-speaker may have recently been installed. If so, this may cause hum. It may be responding to low frequencies that were not noticed before with a less efficient reproducer.

Hum on a battery set is almost invariable due to the lead-in wire coming too near to such a wire as the telephone. A new set might be earthed to the same wire as a telephone—this will cause hum.

Clicks are set up by noisy light switches. Note if this is so in your house by listening to set while someone tries each switch in turn. Remedy is to tighten and clean light switches, and if possible to put a large-capacity condenser across each of the light contacts giving offence.

If your set is not dead in tune, or is unselective, you may hear a sort of whispering sound in the background. Note whether slight re-adjustment of tuning clears the trouble.

Often mains noises coming in to the set via the mains leads can be stopped by using a filter, consisting of two chokes and two condensers. See circuit arrangement at Fig. 13.

Have you recently installed any electrical apparatus, such as refrigerators, vacuum cleaners or hair driers? These will emit high-frequency radiations heard in a set as crackles, buzzes, phizzes and other distressing noises. The remedy is to filter out the radiations—a job for the local dealer.

If you have been using a vacuum cleaner without interference for some time, and it has just developed noises, have the commutator brushes examined by the dealer.

If you have an electric fire that spits or arcs, it may easily set up crackles in the set.

Interference may be caused by quite remote neighbours' machinery. Here the best thing is to fit a screened down lead or modern noise-suppression system for the aerial.

Apply to the Post Office in all cases of persistent noise that cannot be cured.

Is there a whispering background?

Are there crackles, buzzes or similar intermittent noises in the background?

GENERAL UNCLASSIFIED FAULTS

Do signals wax and wane in strength?

Is the aerial swaying in the wind? If so it will alter the tuning and cause signals to vary in strength.

Are you on the edge of your local-station's service area? 20 miles or more? If so you cannot prevent signal-strength variation unless the set is fitted with some form of self-adjusting volume control.

Does the fading occur only on foreigners? Here again, if so it is due to natural causes and not to any fault in the set or aerial.

Bad contacts can cause periodic fading, but this will apply to all stations. Tighten up all suspected points.

Is tuning flat?

If your earth has not been looked at for some time, the tuning may be flattened on that account.

Has one of the little trimmers on the gang condenser slipped? If so this will cause flat tuning.

Possibly the screen-grid valve has gone off. Test by substitution.

Is sensitivity uneven?

If you find that stations are much louder at one end of the tuning scale than the other, it shows that the tuning condenser has not been properly trimmed or has come out of adjustment. Gang up the whole condenser by adjusting each trimmer in turn with the main knob.

Is there a blue glow in a valve bulb?

If you notice a blue glow inside the bulb that fluctuates when the set is working, the valve is suffering from partial loss of vacuum. A new valve will soon be needed.

Do not mistake this type of blue glow with the fluorescent glow between the electrodes—which indicates a good hard valve, especially noticed in pentodes.

Is there an intermittent scratching noise?

When the anode connection to a metallised screen-grid valve is screened by a metal covering, it often happens that this covering makes intermittent contact with the valve. This sets up an intermittent background noise, somewhat similar to atmospherics.

The same effect can be obtained if the earth connection to the braiding becomes defective, particularly if it has passed through a metal chassis.

A group of American "cops" outside the police station with their assortment of weapons for hunting down criminals. Their huge car is fitted with a special radio receiver housed underneath the floorboards. The set is operated from the steering column of the car.



Radios—and Riot Guns— Help American Police!

WITH the repeal of prohibition and the arrival of police radio cars, the criminal in the United States stands little chance, nowadays, and is being forced to find fresh outlets for his activities. "Chicago officials call use of radio best crime weapon," reads one newspaper, which states also that radio alarms led to the arrest of forty-three slayers in the last ten months, 168 hold-up men; 107 larceny cases and 443 ordinary burglaries. There is little doubt that such a list must have impressed even Mayor Cermack of Chicago, to whom it was shown.

With their 40 h.p. radio-equipped cars, the American police are getting their man more consistently than ever before.

The top illustration shows a typical installation, complete with "cops" outside their station. There is,

of course, the siren of talkie fame, bullet-proof tyres and bullet-proof radiator. On the right-hand front mudguard can be seen the "Stop—Police" warning sign. Bearing in mind that American cars are left-hand drive, its use can obviously be seen. As the police car draws level with the unhappy victim a button is pressed and a high-powered lamp shows the warning, "Stop—Police."

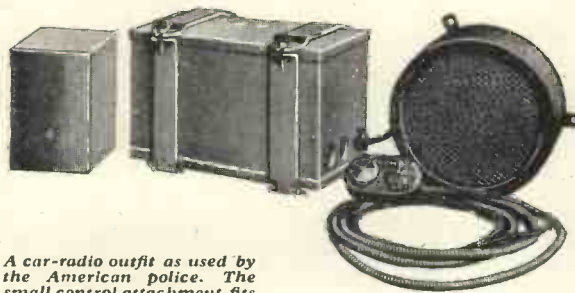

A car-radio outfit as used by the American police. The small control attachment fits on to the steering column of the car

Other parts of this fearsome equipment include shatter-proof glass, a siren, Winchester sawed-off shot gun, 30.06 Remington rifle, Federal riot gun, special tear-gas gun and bombs, grenades, danger flares, Bullard first-aid kit, smoke bombs, bullet-proof screen and other pleasant delicacies.

Taking a look at a typical American police radio receiver, it can be seen at once that robustness has been the one idea of the designers. The tuning range is from 100-200 metres and it is a five-valve tuned radio-frequency outfit, battery operated.

The controls are mounted on the steering column. The aerial is a sheet of copper gauze under the car roof and the whole receiver unit, including batteries, is arranged for mounting under the floorboards.

The transmitters are of only moderate power so that various police departments will not interfere with one another and cause confusion. The power, although, however, of only 1 or 2 kilowatts, does not prevent radio listeners from picking up calls.

It is felt in official circles that this may prove dangerous to the efficiency of the system as a whole and efforts are being made to open up channels on ultra-short wavelengths.

Another way out of the difficulty is to use code and there is little doubt that the code system will soon be adopted, thus avoiding the opening up of new channels in ultra-short wavebands. Whatever system is ultimately used it can be safely assumed that there will be no falling off in efficiency.

Lionel Merdler.

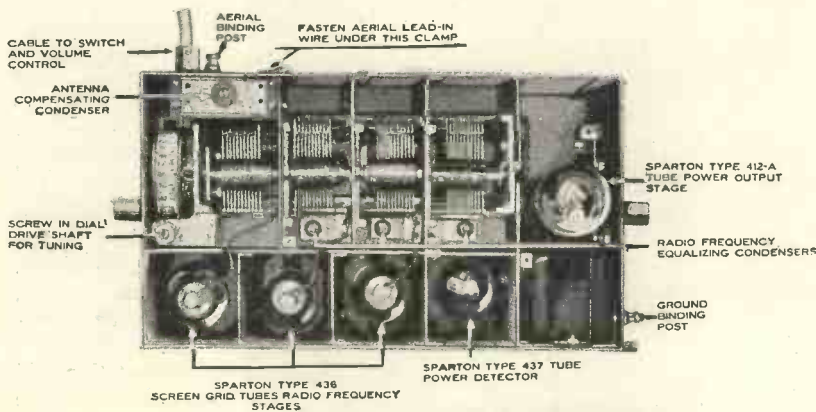

The interior of the Sparton automobile police radio outfit. The set employs five valves and is driven from batteries. Its tuning range is from 100 to 200 metres

By DEREK ENGLAND



The above photograph is of Arthur Burrows, the first announcer, in the days when broadcasting was done from Marconi House. Broadcasting's modern home is on the right; while below is George Robey at the Marconi House microphone. The heading photograph is of Miss Olive Sturgess and Mr. John Huntingdon singing a duet in the Marconi House studio as far back as 1922



WHEN

1921 to 1934 is not a progress. Millions of when a few enthusiastic the ether when In this article Derek England the first

TURN back the clock to 1921.

No B.B.C.

No radio programmes.

Practically no speech at all on the ether . . . only dots and dashes.

Two or three hundred enthusiastic wireless amateurs and technical tinkerers grouped together and brought pressure to bear on the Post Office.

Result . . . a small official station known as 2MT was allowed to broadcast for just under an hour once a week. That was the first station officially permitted to broadcast programmes.

Even this station, which was at Writtle, near Chelmsford, was not officially regarded as a centre of entertainment. It was supposed to be a test station by means of which keen amateurs could improve the quality of their reception.

At first the organisers had to guarantee to broadcast only a certain amount of music before giving an equal period of morse code.

Then they had to shut down for two minutes between items in order to listen for SOS calls—in spite of the fact that the station did not work on any recognised shipping or aircraft wavelength.



Every Tuesday night, from February, 1921, to the beginning of 1923, the station gave ten minutes morse code and twenty minutes speech and music. The organisers were enterprising enough, despite the extreme technical difficulties then existing, to give a scene from a play, *Cyrano de Bergerac*.

The station did not definitely close down its operations until the old 2LO



BROADCASTING BEGAN

long time, but broadcasting has made amazing listeners today forget the birth of broadcasting wireless amateurs listened for faint sounds on their enthusiasm brought broadcasting into being. recalls the early days of "2 Emma Toc" and programmes from 2LO

station, which most people know by name, if not by its programmes, had definitely come into being in May, 1922.

How many listeners today remember with what joy the then huge volume from 2LO was received? 2LO came in strong enough to rattle the headphones, and a number of Londoners realised that it would even be possible to work a loud-speaker on this sort of thing. So loud-speakers were invented!

Within a few months the Governmental red-tape business of S O S listening and morse broadcasting, which corresponds with the red flag days of the motor-car, was abolished. Continuous programmes were given for the first time, and broadcasting may truly be said to have started.

It started with an important event.

On November 14, 1922, there was a General Election, and 2LO christened itself by broadcasting the results in the evening. It was, at the same time, an auspicious and unfortunate start for broadcasting. The keen

listeners of those days welcomed it, because by broadcasting election results, the organisers of 2LO showed how useful broadcasting could be to the public. On the other hand the huge newspaper interests realised its potentialities and were afraid.

At the start, Arthur Burrows ("Uncle Arthur") was working almost single-handed on the organising side. Later Stanton Jefferies—still on the staff of the B.B.C.—took over the job of Musical Director and helped with the concert arrangements.

The General Electric Company Ltd. provided room for the newly formed B.B.C. in their Kingsway premises.

There was great confusion, but out of this chaos came broadcasting.

In the centre of the room was a large table on which ten girls dealt with the mail: an exceptional mail. Mr. Burrows and C. A. Lewis (later to be Programme Organiser of the B.B.C.) shared a desk and approximately half a dozen telephones!

Behind the scenes were Lord Gainford, Sir William Noble, and others, including Mr. (now Sir John) Reith.

In the ensuing months other stations were opened. Manchester and Birmingham were brought into going order, and just before Christmas, 1922, a small transmitter was opened at Newcastle. Cardiff and Glasgow

were fitted up with transmitters at the beginning of 1923, and the remaining two stations at Aberdeen and

Bournemouth were inaugurated in October of that year.

So, you see, within four months six stations were started up, and a daily programme of about four or five hours' duration was regularly given.

Then the London headquarters moved to Marconi House, it being advisable that the offices should be nearer to the London transmitter.

Here lack of accommodation was even more acute and much of the office work had to be done in the studio itself. This studio was previously an experimental cinematograph theatre. There may be some hidden significance in that British broadcasting was pioneered in a cinema, but I fail to find it!

As time went on matters got worse, and it was quite obvious that several studios were needed. No. 2 Savoy Hill was suggested, and at the end of February the whole gear was transferred. Later the transmitter was moved to the top of a West End store, and remained there until the London National and Regional transmitter buildings at Brookmans Park were open.

The romance of the start of broadcasting is really the romance of the product of hard work. Listeners today have need to be thankful for pioneer labours of Sir John Reith, Capt. Eckersley, Messrs. Burrows, Stanton Jefferies, Lewis, and the rest who pioneered British broadcasting.

Stanton Jefferies now plays an important part behind British broadcasting. He is in charge of programme-balance control—a very responsible position.

Tuning by Eye— Instead of by Ear!

THE time is now definitely in sight when wireless receivers will no longer be tuned by ear. Even the cheapest sets are now provided with calibrated dials permitting tuning with little trouble.

Highly ingenious tuning-in mechanisms have been created, making such optical control both simple and exact. But despite the greatest precision, it is still necessary to rely on the human ear, for even with the most carefully calibrated scales, optical adjustment merely has the effect of bringing the desired station within hearing range.

Coarse Mechanical Adjustment

We have only to consider the closely calibrated dials of modern sets, necessary to embrace the large number of existing wireless stations, to comprehend why any mechanical adjustment is too coarse for accurate tuning.

The greatest volume is an hypothesis for the best quality of sound, which only people possessing a particularly good ear for music are qualified to do, whereas differences in volume can be easily detected by the average person.

Therefore if a receiving set does not lose in volume when inaccurately tuned, the average person is denied the possibility of close tuning, as this is then entirely governed by musical talent.

Uniform Volume

Most receivers are, however, fitted with an automatic fading compensating arrangement which keeps the volume uniform within certain limits, irrespective of whether the station is weaker or stronger, or is tuned in accurately or otherwise.

In other words, a weaker reception also signifies a weakening of the rectified current passing the audio circuit, and when this current flows through a resistance provided for this purpose it experiences a slight voltage drop.

Since the grid of the input valve is connected to this resistance, its grid bias is consequently reduced. This valve is, however, not like the usual valves as it has the characteristic of greater amplification the smaller the grid bias imparted to it. This valve therefore automatically ensures reception at uniform volume, but at the same time obviates fine adjustment by ear.

If the station has not been accurately tuned in, the hexode will, for instance, be subjected to greater load than if this were not the case. But greater loading means that a heavier current will flow through it, and vice

versa. The intensity of the current passing the hexode consequently provides an accurate measure as to whether the optimum of the fine adjustment has been attained.

Hence, if a modern receiver of this kind is furnished with an additional device allowing it to be known when the intensity of the current passing through the hexode is at its lowest value and the operating knob is actuated until this value is attained to a nicety, the optimum of fine adjustment will have been ascertained in a much more reliable way than is possible by ear.

The intensity of an electric current can, for instance, be determined by a measuring instrument by passing through it the current to be measured. In this case, the fine-adjustment knob would be operated until the merest pointer deflection is obtained.

Shadow-indicator Method

This method of fine adjustment has been adopted for the latest sets of the leading wireless firms. Other large firms in the radio trade allow the hexode current to flow through a small glow lamp of the resonance type.

Another possibility of fine adjustment is the shadow indicator illustrated. Here, the indicating current traverses a magnetic coil and by the co-operation of its magnetic field and the field of the permanent magnet surrounding it, an armature moving inside the coil is more or less deflected. A small lamp illuminates the armature in such a way that it throws a band of shadow in the small window.

Adjustment is such that this band appears smallest at lowest current intensity and therefore at best fine adjustment. With these modern sets, fine adjustment is effected optically.

Perfect Tuning

The volume regulator is set to zero so that no sound can be heard from the loud-speaker. This is followed by coarse adjustment to the desired station, then fine adjustment by one of the three methods described, finally followed by volume control. Hence perfect reception can

be obtained from any of the stations without producing irritating noises when tuning in.

Moreover, optical control also provides a means of realising greater selectivity between stations. With the shadow indicator it will, for instance, be found that stations whose shadow bands cannot be brought within a certain breadth, do not come into consideration for the best reception qualities.

Rene Leonhardt

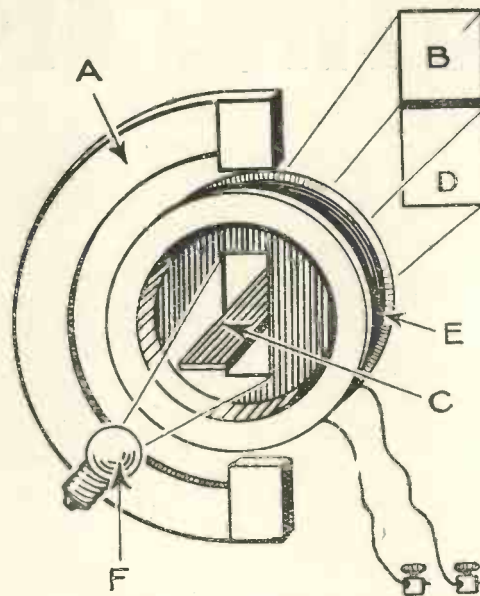

FINE TUNING ADJUSTMENT BY SHADOW INDICATOR

The indicating current flows through the coil E, the resulting field deflects the armature C thus increasing or decreasing the shadow B thrown by the lamp F on to the window D. A is the permanent magnet



SIMPLE YET OUTSTANDING DESIGN
A back view of the Heptode Super Three showing the set chassis ready for fitting in the cabinet. It is built up on a metallised wood chassis

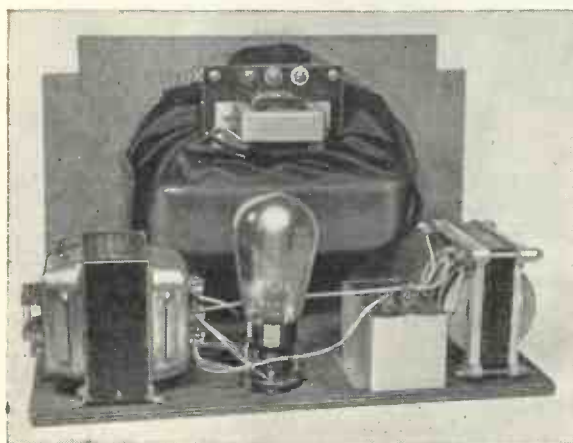

MOUNTING THE MAINS SECTION
The mains section and the moving-coil loud-speaker are mounted together and fit in the top half of the table cabinet. Note the fuse fixed to the mains transformer

are used in the average super-het so if we are going to use only one stage it must be of the utmost efficiency. Here, then, we have used a high-frequency pentode, which gives a high degree of amplification.

Now we are faced with the greatest problem of all. How can we combine the second detector and output stages, for that is what we must do if we are to produce a complete three-valve super-het receiver. This

interesting problem is solved for us by the recent introduction of a new type of multiple-electrode valve—the double-diode-pentode.

As its name implies, this valve comprises two separate diodes (which can, of course, be used as rectifiers) and a pentode. This, then, is how we can

combine the functions of second detector and output stage.

But we need only one of the diodes for second detection, so what shall we do with the second? The answer is to use it for obtaining self-adjusting volume control, which is what is actually done in the Heptode Super Three.

Just pause a minute and see what this all means. By the use of only three valves we have produced a receiver that only a short time ago would have needed five separate valves. There are some who think that the tendency of cutting down the number of valves by using multiple-electrode types is being overdone, but while our valve manufacturers continue to provide us with these fancy types the most sensible course is to make good use of them.

Reasonable Price of the Valves

The price of these multiple mains types is reasonable in comparison with what separate valves for each function would cost and there is a great deal to be said for the saving in space that they make possible.

Then the constructor is further interested in the simplified form of assembly that such valves make possible. Here, for instance, you have a set, run entirely from the mains, that can be housed comfortably in a table-console cabinet of quite usual dimensions.

Then there is the question of results. What are they like? Well, we are not overstating the case when we say that they are surprising. It is no secret that the use of one valve for two functions that are normally carried out by separate "tubes" does result in a slight loss of efficiency; but we would stress the point that the loss of efficiency in this case is very slight indeed.

When we had finished our preliminary work with this receiver—which has occupied a number of months, for we had experimental valves for some time before the final models were generally released—we were really gratified at the reception we did get on final test.

A Freak Kind of Set!

Although we admit that a three-valve super is to some extent a freak kind of set, this receiver does not handle like a freak. If any impartial observer were to take a turn at the controls without knowing what the set was or how many valves it employed we are certain that in nine cases out of ten it would be taken for a standard type of five-valve super.

There is a band-pass aerial tuner to give that initial degree of selectivity that is so essential to cut out second-

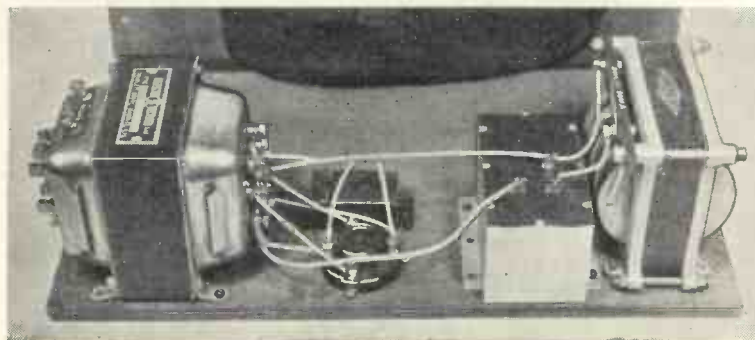

LAYOUT OF THE FEW MAINS COMPONENTS
How the five components which constitute the mains section are mounted can be easily followed from this photograph. Constructors will find this design especially simple and efficient

channel interference; the oscillator is ganged up with the band-pass circuit to give one-knob control; the intermediate-frequency stage with its high-frequency pentode pulls its full weight; the double-diode-pentode gives good second detection and automatic volume control; and the pentode

portion of the valve gives an output of nearly 2.5 watts—which is as much as most people want!

On top of all this you have a set that is compact, neat in appearance, and simple to build. In fact, this Heptode Super Three does represent a definite advance in super-het practice and is not just a flash in the pan that will be forgotten in six months time.

Mains Rectifier

One thing we have not so far mentioned is the mains rectifier. That, of course, does make a fourth stage; but it has never been our practice to class the mains rectifier in an A.C. set as one of the "valves." If this set were turned into a battery version (with battery valves, of course) then no mains rectifier would be needed and it would be a three from every point of view: similarly, if the circuit were built up with valves for operation from D.C. mains no question of a fourth valve would arise.

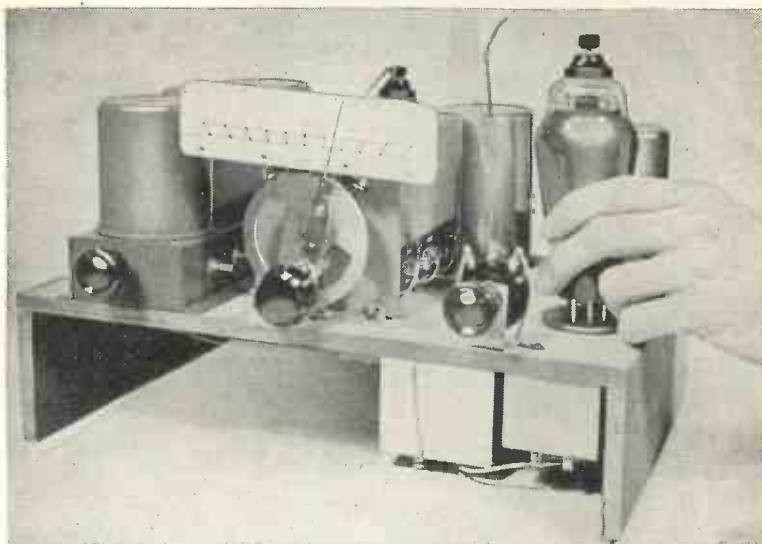

CONTROLS OF THE HEPTODE SUPER THREE

There are only three controls to the Heptode Super Three. On the extreme left is the wave-change switch; in the centre the tuning; and on the right the combined manual volume control and on-off switch. Tuning could not be simpler!

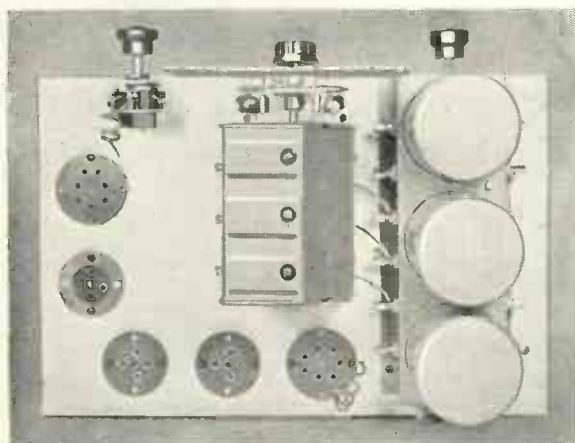

PHOTOGRAPHIC PLAN VIEW

There are very few parts mounted on the upper side of the wooden chassis. Make a special note of the position of the holders for the valves and the intermediate-frequency transformers

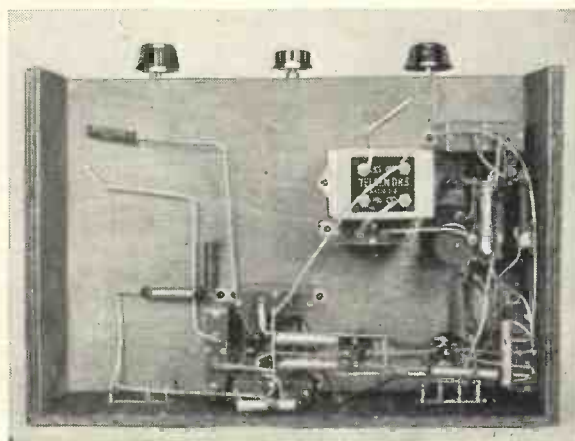

UNDERNEATH THE WOODEN CHASSIS

A glance at this photograph of the underside, and the other plan view above, will show that very few components are used in this design. There are no snags about the construction

So we think that it is quite logical and not at all misleading to call this an A.C. mains three-valver although in fact a fourth valve is needed for mains rectification.

Further, although we have used a thermionic valve for this purpose, it *would* be possible to use a metal rectifier, and no body of technicians has agreed yet whether a metal rectifier (for mains or high-frequency rectification) should be classed as a "valve" or not; although, of course, logically it is just as much a valve as the ordinary thermionic device in a glass bulb.

Features of the Circuit

This set being such a departure from standard practice—and one of the first of its kind to be presented to the home constructor—most readers will want to have a good look at the circuit, which is reproduced on page 315. There are several features worth looking into.

The band-pass input circuit is arranged in the usual way and is tuned by two sections of a three-gang .0005-microfarad variable condenser. Part of the heptode (or pentagrid) is used as a screen-grid first detector, a .0003-microfarad grid condenser and a 2-megohm grid-leak being used.

Then the triode portion of the same valve is used as the local oscillator, electronic coupling taking place inside the valve itself to give the intermediate-frequency signal of 126 kilocycles.

Self-adjusting Volume Control

There is no fixed bias for the high-frequency pentode (coupled to the heptode by the usual 126-kilocycle intermediate-frequency transformer, of course); varying voltages are fed back from the second diode of the third valve and thus self-adjusting volume control is obtained. And, for this reason also, it should be noted, there is no high-frequency manual volume control.

The first diode portion of the double-diode-pentode is coupled to the pentode portion by means of a low-frequency transformer so that the maximum amplification is obtained. In order to minimise inter-electrode

Third-scale Wiring Plan

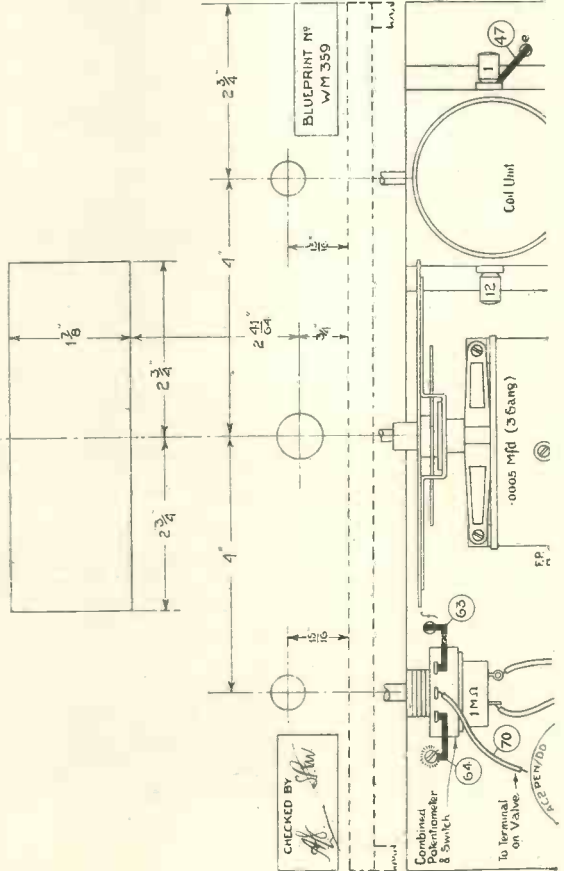
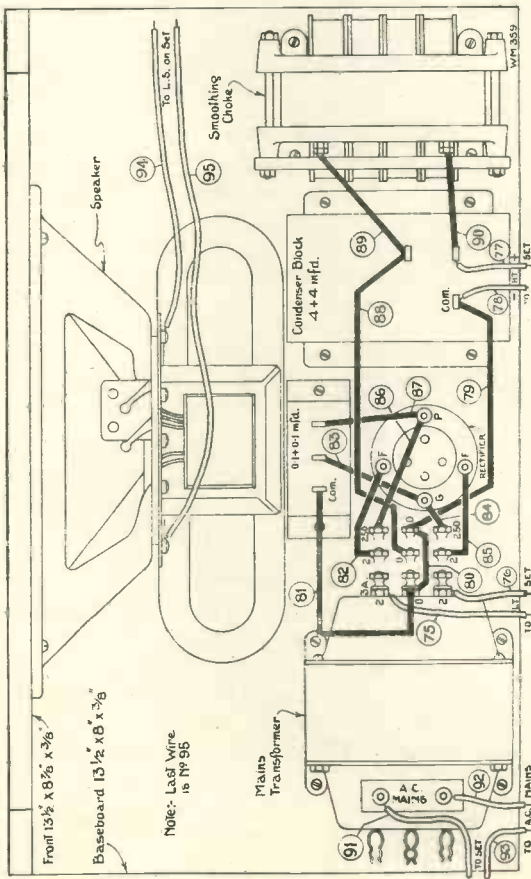

capacity, by the way, the operating grid terminal of the double-diode-pentode is mounted at the top of the bulb.

All three valves, of course, need seven-pin holders.

In order to by-pass high-frequency energy and to prevent it from getting into the output circuit the double-diode-pentode is provided with a high-frequency choke and a by-pass condenser. There is also a 100-ohm resistance in the anode circuit to prevent low-frequency oscillation.

Provision has not been made for the use of a pick-up, as is usual with "Wireless Magazine" designs, because there is no intermediate low-frequency amplifier between the diode and the pentode portions of the third valve and results are not worth while when only the single stage is used.

Apart from the trimmers on the three-gang condenser, which are operated in the usual way, there is an extra *long-wave* only trimmer on the



COMPACT CABINET ARRANGEMENT
The set chassis and the mains section and loud-speaker fit comfortably into the special table cabinet designed for the Heptode Super Three

shown in our drawings. The whole of the mains unit is built up on the loud-speaker chassis so that the complete assembly can be housed without difficulty in a small size of cabinet.

By the way, what do you think of the cabinet we have chosen for this set? Pretty neat, isn't it? And, as you cannot tell from the photograph, we will tell you that it is particularly well made, even as cabinets go now-a-days.

You will be proud to have the Heptode Super Three in this

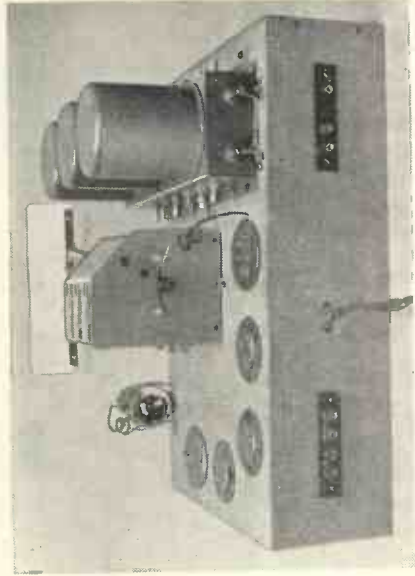

NEAT ARRANGEMENT FOR EXTERNAL CONNECTIONS
Two small bakelite strips are fitted to the back of the chassis for the aerial and earth leads, and the wires to the loud-speaker. Although pick-up terminals are provided on the strip, the design does not include provision for electrical reproduction of records

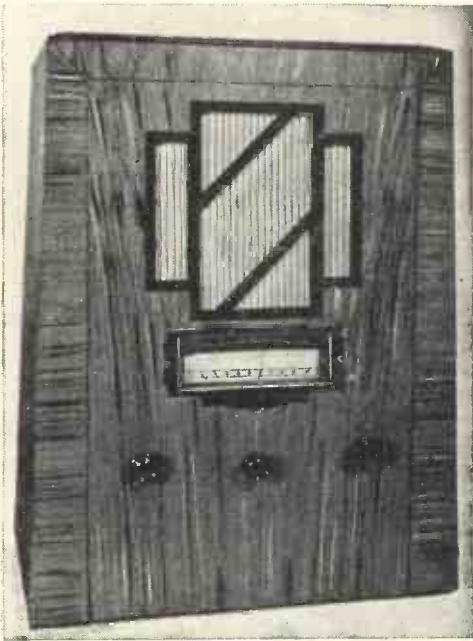

A REALLY NEAT OUTFIT!
Here is the Heptode Super Three in its cabinet. It looks a fine job and, as this test report confirms, it gives a really remarkable performance

Fifty-five Stations on the Heptode Super Three!

Results of an Independent Test

this point very conclusively. A station was tuned in at about 300 metres, and the other two trimmers were adjusted to get maximum volume. No snags about this at all: meters were not necessary for the job.

Then the preliminary run round the dial, and my amazement at the set's wonderful performance grew by leaps and bounds. The manual volume control on the extreme right was turned to maximum, and there was no trace of overloading. The most noticeable point in the first run round was the fine action of the automatic volume control. As an example, let me just say that I had difficulty in finding out which was London, Scottish, and North Nationals, so even was the strength of received signals.

The actual job of compiling the

log was a tedious one. From one end of the scale to the other, stations came in, one after the other, all at about the same strength. Not only that, but selectivity was so good that each station was clear cut from its next-door neighbour. One other point: background noise was the least I have ever heard from a super-het.

Efficient Long-wave Results

Long waves were equally good. From Daventry National upwards and from Luxembourg downwards all was well. I defy any set to produce efficient results on the remaining portion of this band.

Daylight results on the medium band brought in many of the more powerful foreigners better than I have heard on the average straight A.C. three-valver.

Quality was notable for more top and bottom notes than usual, and the almost complete absence of background. *D. St. J.*

THERE have been no frills about the conditions of the test of the Heptode Super Three. The set was taken from the "W.M." laboratories to my residence in South London and connected up in the ordinary way to an outdoor aerial about 40 ft. long, and a good earth.

Stations—Not Whispers!

The first tests were made one evening between 8 and 10 p.m.; what I am going to tell you about this test can be imagined by a glance at the list of stations on this page. Fifty-five stations on a three-valver during a two-hour test takes some believing, but it is a solid fact. And these stations were not whispers; full loud-speaker strength signals that could be heard all over my house.

Simple Ganging

My first job after having connected the set up to aerial, earth, and mains and switched on, was to make sure that the three-gang condenser was trimmed up properly.

Purposely I made no use of meters for this job. According to instructions I unscrewed the trimmer nearest the dial. This is the trimmer for the oscillator circuit, and it was unscrewed to ensure the set going down to 200 metres. Fécamp, coming in at 5 on the scale, proved

The Log of the Heptode Super Three

LONG WAVES		Dial Reading	Station	Dial Reading
Station			Scottish Regional ...	53
Kootwijk ...	90	Milan ...	52	
Radio Paris ...	74	Radio LL (Paris) ...	50	
Königswusterhausen ...	68	Berlin Funkstunde ...	49	
Daventry National ...	62	Strasbourg ...	47	
Luxembourg ...	46	London Regional ...	45	
Kalundborg ...	41	Radio Toulouse ...	43	
Oslo ...	36	Hamburg ...	42	
		Göteborg ...	40	
		Breslau ...	38	
MEDIUM WAVES			Poste Parisien ...	37
Budapest ...	98	West Regional ...	35	
Beromunster ...	96	Genoa ...	34 ¹ / ₂	
Athlone ...	94	Hilversum ...	33 ¹ / ₂	
Mühlacker ...	90	North National ...	32	
Vienna ...	87	Heilsberg ...	31	
Brussels No. 1 ...	81	Scottish National ...	29	
Prague ...	79	Bari ...	27	
Lyons PTT ...	77	Bordeaux ...	26	
Langenberg ...	75	Belfast ...	24	
North Regional ...	73	Hörby ...	23	
Sottens ...	72	Turin ...	22	
Belgrade ...	70	London National ...	21	
Paris PTT ...	69	Moravska Ostrava ...	20	
Stockholm ...	68	Copenhagen ...	19	
Rome ...	66	Frankfurt ...	18	
Munich ...	62	Trieste ...	16	
Katowice ...	60	Juan-les-Pins ...	15	
Midland Regional ...	58	Fécamp ...	5	
Leipsig ...	56			

My Visit to the Bell Laboratories

In this article our American correspondent takes us behind the scenes of the famous Bell Laboratories in New York and explains how this huge experimental organisation with its 4,000 employees is continually working to improve the standard of the electrical and radio industry

THE great power behind American radio, television, talkies, telephone, and the Western Electric Corporation is the famous Bell Telephone Laboratories. These laboratories are the silent source of many of the latest electrical devices now taken for granted in the entertainment world.

Situated in the Down Town area of New York and housing over 4,000 of the world's greatest experts in telephonic engineering, the Bell Laboratory Building quietly and methodically plods on in the inventive field, making the almost impossible feats commercially possible.

The American Telephone and Telegraph system operates, the Western Electric Corporation manufactures, but the Bell Telephone Laboratories invents and does



By Our Special American Correspondent
LIONEL MERDLER

research work in the truest meaning of the word. Although its main interest is in the telephonic field, anything appertaining to communication, visual or aural, is carefully investigated and the results filed away so that in the event of any new developments in other fields, such schemes may be immediately applied.

Television, wired wireless and optical waves are just a few of the subjects that have all been looked into and the pros and cons carefully weighed. The hard and unbroken ground is carefully tilled so that at the right moment the manufacturing engineers may take up the ripened seeds and apply them to the benefits of civilisation

That is the policy of the organisation:

to break new ground irrespective of the immediate monetary gains. No problem is too great for the engineers concerned; the greater the odds against them the keener is their interest in the experiments.

The Atlantic had to be bridged by a telephone system linking up Europe with the American continent. Two years of intensive research work by the laboratories, concluding in 1924, justified the operation of short-wave transmitters on a larger scale, and in 1929 we saw the first station in operation. So successful have these short-wave telephonic links become that now millions of radio listeners in America are enabled to hear events of topical interest taking place at the very moment of enacting in England.

There are now a dozen or more short-wave links in operation joining up the continents and enabling any telephone subscriber to talk to another in different continents. Transoceanic telephony becomes a



RESEARCH LABORATORY IN THE AIR
The Bell people maintain a fully equipped laboratory for its studies of aircraft radio transmission in a three-engined Ford monoplane

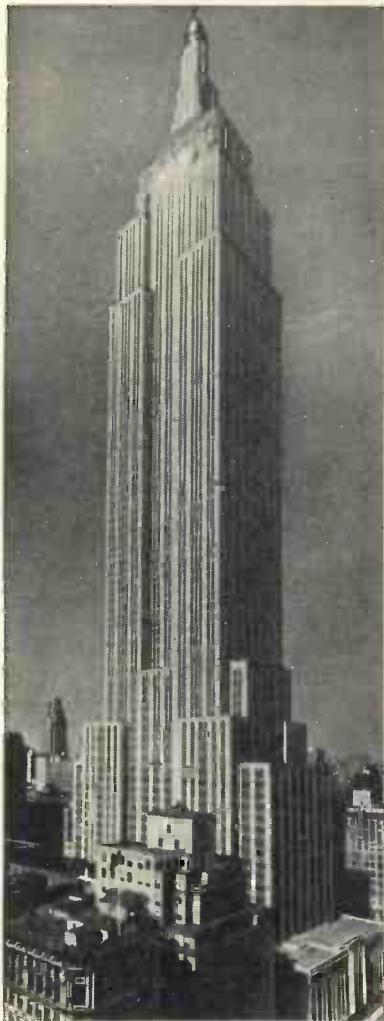

SCENE OF TELEVISION TESTS

Television tests are made from the Empire State Building in New York. The transmitter is at the top of this building, which is 1,028 ft. high

commercial proposition from a mere train of ideas.

The sound picture industry was an offshoot from these laboratories where sound recording was first brought up to its present high level of reproduction. In 1924 gramophone records were still being made by the old process of playing right into a metallic horn. With the introduction of delicate and carefully devised electrical recording apparatus, microphones could be used and the flexibility and range of recording so increased that gramophones boomed into a popularity never before encountered in the industry.

Recording apparatus was, of course, marketed under the Western Electric name. With this system came the condenser microphone which replaced the carbon

type for the majority of broadcasting purposes. Not content with their conquests in the gramophone industry, however, the engineers set about developing and perfecting a combination of sound and film, giving to the motion picture industry a new tool to work with, so sharp indeed that those concerned were badly cut in the initial stages.

Still the responsibilities of the Laboratories were to produce the most perfect practical system possible. What use to be made of it and what monetary gains to be obtained was not their immediate concern.

Television was required, and the engineers set about investigating the various systems in order to find one which would be most suitable for use with telephonic communication. Some practical system had to be found regardless of first cost, and it was in June, 1927, that television was placed on the map by the Bell Laboratories.

Systems were developed for broadcasting and wired television, and also for the transmission of motion pictures. Photocell development

perfected a system which is largely used on the American continent and elsewhere.

Radio listeners were complaining that their programmes were fading; advertisers stated that they wanted to reach a greater public, so intensive research produced giant tubes capable of satisfying immediate and future needs. No request placed on the Laboratories is neglected. Apparatus has been devised so that even those rendered dumb by surgical operations may speak with a specially devised artificial throat; one of the most ingenious devices yet produced from this centre.

With the development of recognised airways across the States, the attention of the engineers was turned to aircraft radio and the guidance of aeroplanes during foggy weather. Complete laboratories were built up into aeroplanes and a very extensive research programme carried out.

As the result of their investigations it is now possible for 'planes to land during the foggiest weather



BIG OPTICAL RANGE

An idea of the large optical range of the ultra short-wave transmissions from the Empire building (seen in the background) can be gauged from this photograph

pushes on continually, and fresh developments in this direction are being constantly recorded.

One of the first to market the cathode-ray tube were the Western Electric people, and with more recent improvements these tubes are now playing an important part in television progress. Picture transmission is already a commercial proposition, and the Laboratories have



WHERE THE WORK IS DONE

Our correspondent's photograph of a corner of the Bell Laboratory buildings in New York. Many famous electrical developments have originated here

by means of radio beacons and radio guide ways and for the pilot to keep in constant touch with the landing posts and meteorological stations.

Such are the developments that reach the public through the manufacturing houses, but behind these complete engineering systems we have the physicists and chemists continually working on the production

of new materials and the purifying of those already in use.

In the metallurgical laboratory the nature and properties of alloys are studied; special attention being given to alloys which promise improved magnetic qualities. It is here that the new magnetic alloys for the transatlantic telephone cables are being developed.

In the humidity rooms products and materials can be subjected to tropical heat or frosty polar conditions. With the gradual lessening of major and fundamental discoveries, the development of more perfect materials and the production of substitutes

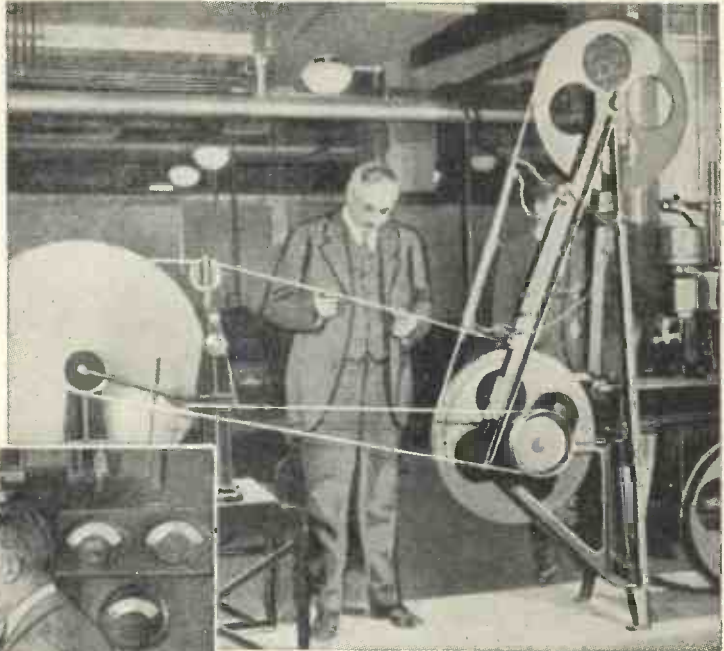

AT WORK IN THE LABORATORIES
 (Above) G. W. Elmen at work in the Bell Magnetic Laboratory where he has developed remarkable new magnetic alloys. (Left) Two of the Bell experts with a high-power water-cooled valve developed under their supervision for the Atlantic telephony service



mysteries, and I could only gather a comprehensive idea of the whole organisation. There are some very interesting experiments being carried on in the acoustic field.

To enable the engineers to carry on their work efficiently the administrative offices occupy a large section of the building, and drafting, too, plays an important part in the day's work. It must not be thought that the personnel is composed of hoary old professors. On the contrary, they are young, if not in age, in spirit, and they have progressive ideas.

for expensive and rare substances is playing a greater part in all laboratories, and more reliance is being placed on the physicists and chemists by engineering staffs.

During a recent visit I was enabled to see the work being carried on in the Bell building. With the time at my disposal it was impossible to delve into all the

One gets the impression that it is here that the very fundamentals of the subject are delved into. The apparatus I saw helped to confirm this impression. Much of it on the surface seemed simple, yet it involved many hours of careful calculation.



WESTERN ELECTRIC PUBLIC ADDRESS INSTALLATION

A compact public address station manufactured by the Western Electric Corporation that was used in a recent Ford exhibition in America

will do everything that a normal two-valver can be expected to do and, as has already been pointed out, it has many advantages over the usual run of receivers.

The circuit of the set, as will be seen from the diagram reproduced on page 324, is quite straightforward. The combination is, of course, a detector and a power valve, with a rectifier for use on A.C. mains.

Let us look into the circuit and see what are the outstanding features.

Outstanding Features of the Circuit

In the first place two aerial tapplings are provided, one direct to the tuning coil and the other through a .0002-microfarad fixed series condenser. In this way the set is easily adapted to the aerial system with which it may be used.

It has, of course, been necessary to design the set round the smallest possible components and for that reason, as well as for its efficiency, an iron-core coil has been used. This is at the same time both compact and of good efficiency so that the maximum strength and selectivity are obtained from the single tuned circuit.

The grid leak and condenser arrangement for the detector follow the usual lines and no comment is needed on that score. It will be noted, though, that the power valve is coupled to the detector stage by means of a resistance-fed transformer. That is because the small transformer used will not stand a large current through the primary.

Detector Decoupling

The anode resistance has a value of 50,000 ohms and a 20,000-ohm resistance and 2-microfarad condenser are provided for decoupling this stage to prevent any possibility of instability.

When we come to the power valve it will be seen that the low-frequency transformer is connected on the auto-transformer principle to give the maximum step-up.

The power valve is actually a pentode and in order to keep the high-note response down a little, a .01-microfarad condenser is provided across the loud-speaker input transformer. It will also be seen that this valve is provided with automatic grid bias, a 850-ohm resistance by-passed by a 2-microfarad condenser being used for this purpose. Now for the smoothing circuit.

Smoothing is carried out by two 4-microfarad and an 8-microfarad condenser. There is also a low-frequency

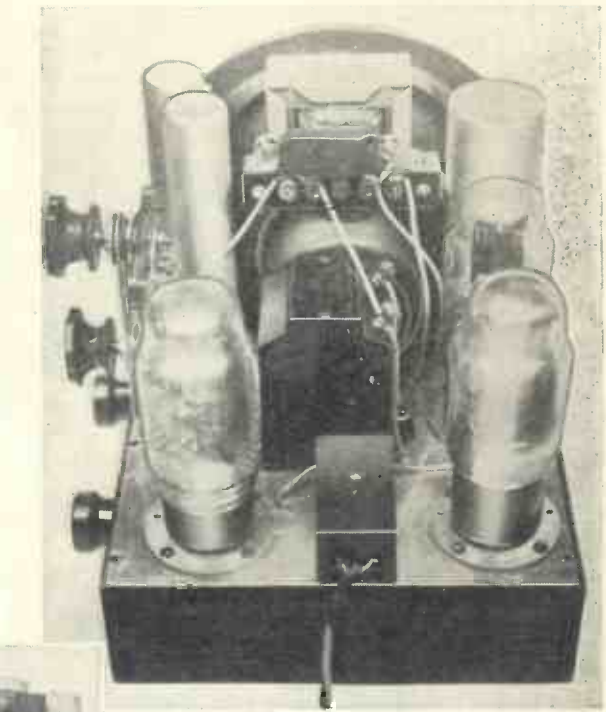

COMPACT AND NEAT ARRANGEMENT
How the three valves and the loud-speaker are arranged on the upper side of the chassis can be seen here. Note the fusebox in the front

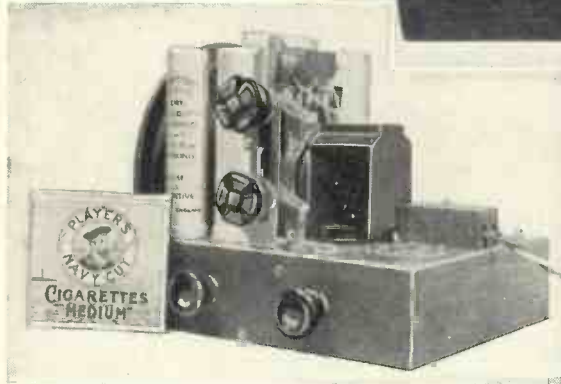

SMALL BUT EFFICIENT RECEIVER
The smallness of the Companionette is shown by its size alongside a cigarette packet. It is an ideal set to take to bed for listening to late evening programmes



ALTERNATIVE AERIAL TAPPINGS
The aerial and earth sockets are fixed on one side of the wooden baseboard assembly. The set will give good results from an indoor aerial if used in a Regional area

smoothing choke. It should be noted in this connection that all the large-capacity condensers employed in this receiver are of the electrolytic type and must be connected up with due regard to their polarity or they will be damaged. Electrolytic condensers have the advantage of giving the greatest possible capacity for a given size.

Heater Wiring

The heaters of all three valves are run in parallel and are fed with the full voltage of the mains; that is they can be run on anything from 200 to 250 volts, either A.C. or D.C.

The moving-coil loud-speaker used in this set is of the energised type, as these are smaller than any permanent-magnet models. In this case the energising winding is wired directly across the mains, but on the set side of the on-off switch.

Fuses are provided so that even if an accidental short-circuit should occur there is no risk of any damage being done to the set.

The set having been designed the next problem was the cabinet, for it is no use making a compact set and then putting it in a large cabinet when the object is to produce a real midget receiver. We can claim that the cabinet for this receiver could not possibly be made any smaller, and it will be interesting to see just how everything is arranged.

The box is solid at the front, but is open at both sides and at the back. The opening at the left-hand side is for the moving-



A HANDY LITTLE OUTFIT

You will find a multitude of uses for the Companionette. The quality and volume from the moving-coil loud-speaker are sufficient for all normal purposes.

No volume control is provided other than the usual reaction control as the latter will be found adequate for most conditions.

Having analysed the technical features of the Companionette, let us now turn our attention to more practical points.

Layout of the Components

In the first place we must point out that the compactness of the design is very largely due to the fact that it is built up on the chassis principle, which automatically helps towards a neat assembly. Mounted on the top of the chassis are the



SIMPLE AND EASY TO BUILD

The two plan photographs on this page show clearly how easy the set is to build. Note that the two tuning condensers are mounted on a metal strip

coil loud-speaker, while the other openings are to ventilate the set. Mains valves get hot in operation and it is essential in a small cabinet of this kind that adequate ventilation should be provided. During tests the set has been kept in use for several hours at

Half-scale Wiring Plan

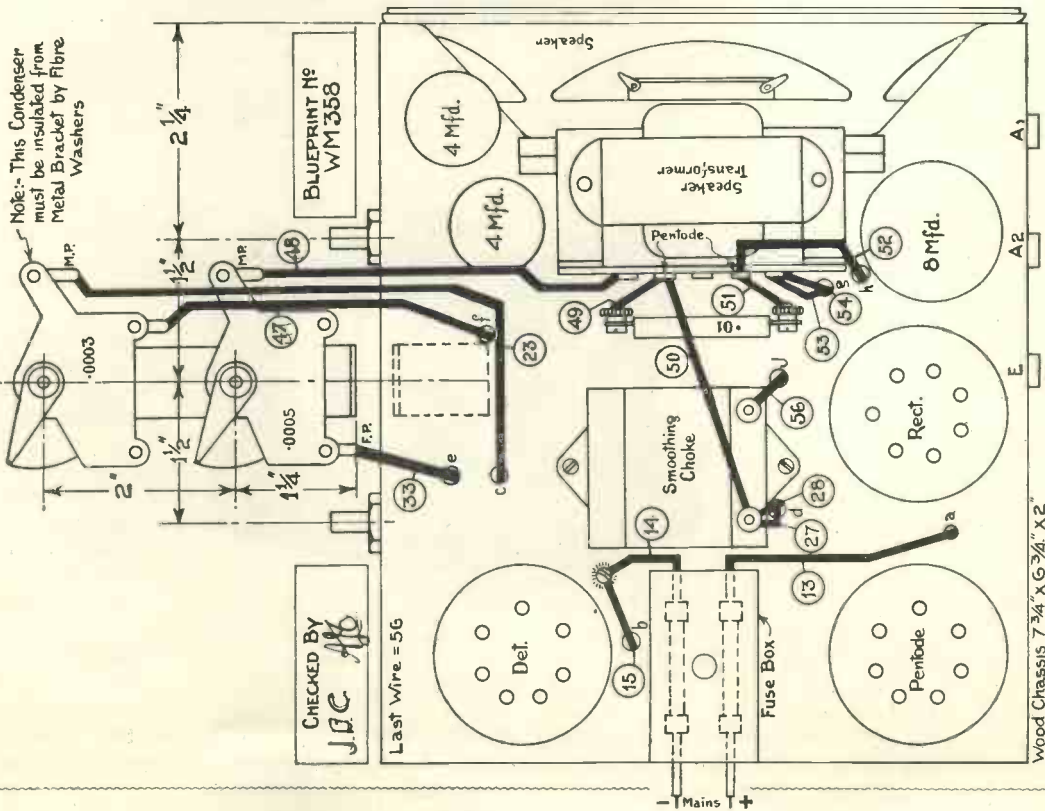



A SET THAT ANYONE CAN OPERATE

There are no snags about the operation of the Companionette. The control at the top is reaction and underneath is the tuner. At the bottom are the on-off and wave-change switches

cabinet maker or carpenter will make it to order for a few shillings.

In many cases constructors will prefer to paint the box a bright colour to match a modern furnishing scheme as suggested in these pages for the Spectrum Portable described last month.

Trouble-free Construction

There will be no trouble at all about the assembly or wiring if the half-scale layout guide (or a full-size blueprint) is followed. This shows very clearly the positions of all the parts and the wiring connections. Note particularly that where leads are taken from the parts on the top of the chassis to those on the underside (there are very few such leads, though) the holes needed for this purpose are marked with a small letter on both parts of the blueprint. There will therefore be no difficulty about following a lead through from the top to the underneath.

Further than this all the connections are numbered in the best and most convenient order of assembly, the numbers appearing in circles alongside each

wire. A good deal of thought has been put into this numbering, so constructors should follow the sequence right through.

There will be no possibility of a mistake if each number on the blueprint is crossed through with a pencil as the corresponding connection on the set is completed.

There may be some criticism when it comes to operating the set on the grounds that no scale is provided for the tuning condenser. As the set is intended mainly for local-station reception we have thought it better to keep the appearance clean rather than put on a scale that is really unnecessary when only one or two stations are

to be received.

It will be found that there is no difficulty about picking up the required programme by the sense of touch alone after the set has been in commission for a few minutes.

Those who want to get a more extended log of stations, though, may find it advisable to fit some kind of calibrated scale, but this is a matter that will present no difficulty to those who want it.

Although we have described the box as being open on three sides we do not imagine that many constructors

will want to leave it in that state. It is a simple matter to cover the three openings with some kind of silk, which is at once decorative and allows of a free flow of air to keep the "works" cool. In order that the silk may be quite taut when it is fixed in position it is advisable to steam it first. It will then shrink



CLOSE-UP OF THE LOUD-SPEAKER
The loud-speaker is mounted immediately behind the low-frequency choke. The necessary connections can be followed easily from this photograph

very slightly when dry and will present a perfectly flat surface without wrinkles.

Care must be taken when fitting the valves into their holders, for they have seven pins each and are not easy to insert unless they are held in just the right position.

There are no alternatives to the valves used in the original receiver, by the way.

The chassis slides right into the cabinet after the valves have been inserted into their holders and after the preliminary tests the whole thing should be screwed up. In this way there is no chance of some uninitiated member of the family poking about inside, with a possibility of shocks. With the back firmly screwed on the set is quite safe in the hands of the youngest child and for that reason will find favour in many homes where there are youngsters about.

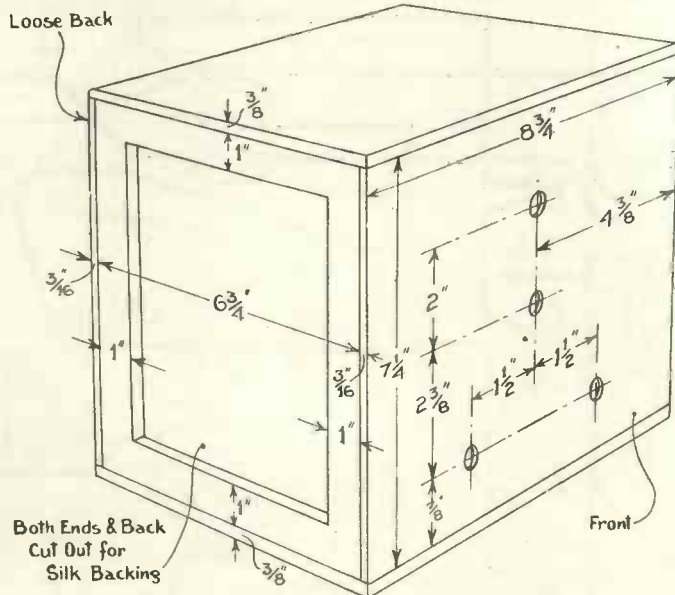

A NEAT CABINET YOU CAN MAKE AT HOME

All the dimensions for making the neat cabinet shown in the photographs on these pages will be found in this drawing. Ordinary three-ply wood and a little varnish or paint will make a good-looking outfit

An Evening's Pleasure with the Companionette

I HAVE just tried out the Companionette, which can be operated from alternating—or direct—current mains. The voltage must not be lower than 200, as that is the lowest rating of the valve filaments. They are heated without dropping resistances or series wiring.

Compact Little Outfit

Well, I was curious about this set, but when it was handed over to me, I was amazed to find such a compact little outfit. The total size of the cabinet was not much more than an 8-in. cube, and when I tell you it enclosed two mains valves, a rectifying valve, an energised moving-coil loud-speaker and all decoupling and smoothing circuits you also will be amazed.

I glanced at the controls and found four knobs—two switches and two variable condensers. The left-hand lower knob was the mains on-off, the right-hand lower, the wave-change switch; the knob immediately above these was for station finding, and the top one for reaction or volume.

The whole outfit was remarkably light, and could be carried by a child.

A "Little Wonder"

On arriving at my home in south-east London, I straightway got down to finding out the capabilities of this so-called "little wonder." My supply is 200 volts alternating current. The aerial is about 25 ft. high, 40 ft. long and hardly ideal owing to the presence of large overhanging trees.

My earth lead is at least 20 ft. long connected to a copper earth tube in the garden.

However, I switched on and waited a moment or two for the filaments to warm up. By turning the reaction

knob, I found that the set was lively by the "plop." I turned the tuning knob and found two very strong signals—my local stations at Brookman's Park (about 15 miles away).

First I tuned in the lower of the two wavelengths—the National—and was frankly surprised at the volume obtained. I was quite prepared to make allowances for quality at such output, but no, the tone was there, and good enough to satisfy the most critical musician.

For comfortable listening strength I had to reduce the volume by means of the reaction control.

On London Regional a talk was in progress, so I looked for a background of hum—it was practically nil, and not to be heard a yard or so away from the loud-speaker. Moving round the tuning knob, Poste Parisien and one or two Germans were picked up with the greatest of ease.

marked "A1,"—it is with the .0002-microfarad fixed condenser in the aerial circuit—the selectivity was of such an order as to enable me to tune in many of the good power stations clear of their neighbours.

This set seems ideal for people who want good quality radio entertainment from a few stations—but not for the restless "knob twiddler."

Results on D.C. Mains

Having satisfied myself as to its efficiency on A.C., I was more than a little curious to know how it would show up on direct-current mains. I tried it out at the "W.M." Fetter Lane laboratory, where the supply is 200 volts D.C. Well, I met with the same results as on my A.C. supply at home and was certainly convinced that this was the ideal universal electric set—good quality, simple to operate, compact and cheap.

Remember that this set can be used on any mains with a voltage of between 200 and 250 without any alteration whatsoever and whether they are A.C. or D.C. It is completely self-contained and can be used in any circumstances where there is electric light of the right voltage and some kind of aerial system.

The moving-coil loud-speaker gives quite good volume in spite of its small size and the quality, although not in the "real quality" class, is nevertheless satisfactory and will suit most listeners.—A. C. H.

Readers are reminded that half a guinea is paid for every photograph of a home-constructed "W.M." set reproduced in these pages. So when you have built your Companionette, do not fail to send us a photograph and a few words about the results you obtain.

Long waves produced the best stations, such as Luxembourg, Radio Paris and of course—Daventry National.

A set of this type with only one tuned circuit was not expected to produce knife-edge selectivity but with the aerial plugged in socket

COMPONENTS YOU WILL NEED FOR THE COMPANIONETTE

CHOKE, LOW-FREQUENCY		HOLDERS, VALVE		Wood for cabinet and chassis as £ s. d.		
1—Varley Nichoke II, type DP23	10 6	3—Clix seven-pin, type screened continental	5 0	specification, say	2 0	
COIL		RESISTANCES, FIXED		Silk for covering loud-speaker	1 0	
1—Telsen dual-range screened, type W349	8 6	4—Erie 1-watt type, values: 850, 20,000, 50,000-ohm, 2-megohm	4 0	fret, say	1 0	
CONDENSERS, FIXED		SUNDRIES		SWITCHES		
3—Dubilier, .0002-microfarad type 665	1 6	1—British Radiogram 3½-in. metal mounting bracket	6	2—Bulgin rotary on-off, type S91	3 6	
1—Dubilier, type 670, value .01-microfarad	2 0	3—Clix insulated sockets marked A1, A2, E	4½	TRANSFORMER, LOW-FREQUENCY		
2—Dubilier, type tubular, values: .1, .5-microfarad	3 4	2—Clix plugs, marked A, E	4	1—R.I. Parafeed, type DY28	8 6	
2—T.C.C. 2-microfarad electrolytic type 561	6 0	Aluminium foil 7¼-in by 6¼-in. say	4	ACCESSORIES		
3—Dubilier, type electrolytic values: 4 (2), 8-microfarad	7 6	Round tinned copper wire No. 20 gauge for connecting, say	6	LOUD-SPEAKER		
CONDENSERS, VARIABLE		Oiled sleeving, say	9	1—Rola, type F5/P/6500	1 7 6	
2—Polar, type Compax, values .0008, .0005-microfarad	5 0	2—Bulgin knobs, type K34	9	VALVES		
HOLDERS, FUSE		1—yd. thin flex	1	1—Ostar-Ganz D130 (detector)	17 6	
1—Fuses twin, complete with fuses, type F14	2 3	1—Ostar-Ganz PT3 (output pentode)				19 9
1—Ostar-Ganz NG100 (rectifier) 1 4 0						

The prices mentioned are those for the parts used in the original set; the prices of alternatives as indicated in the brackets may be either higher or lower

2137

1272

5.4.30
12
2137
8.10.54

COPENHAGEN *and* KALUNDBORG



1



4

3



2

Denmark has two transmitters which can be heard well in the British Isles—Copenhagen on 255.1 metres and Kalundborg, 1,261 metres. Both stations are situated in very picturesque localities as can be seen from these photographs

(1) The lady announcer at Kalundborg. (2) Broadcasting House at Copenhagen is an annex to the Royal Opera House—a curious shape structure. (3) The station engineers of Kalundborg enjoy this beautiful view (4) The famous tower of Copenhagen Town Hall

(5) Kalundborg stands on a small peninsula outside the town of the same name. (6) A group of fishermen taking a midday nap at Kalundborg. (7) The machine that is responsible for the musical-box signals you hear from these stations



6



5



7

The recent first performance of the German opera, "Wozzeck," in this country was the climax to a deal of anti-B.B.C. propaganda that has appeared lately. In this article WHITAKER-WILSON, the "W.M." Music Critic, constructively criticises the programme compilers at Broadcasting House, quoting "Wozzeck" as an example of how money is wasted



A popular broadcasting combination, the Theatre Orchestra, seen busy at work under its conductor, Stanford Robinson

Where the B.B.C. Wastes Money

HAVING recently had an opportunity of discussing the methods behind the general programme make-up with a high official in the B.B.C., I have concluded that a great deal of commonsense is expended over them. There is a genuine attempt to please all types of listener. No intelligent person can conclude otherwise.

Contrast and variety are the chief watchwords. That can be said sincerely.

Contrast and variety, in a concern so huge as the B.B.C., can only be arrived at by means of centralising at one point and absorbing material from various departments. Suggestions come in daily for a group of talks, light entertainment, serious music, light plays, serious plays, a spot of Shakespeare, a modicum of chamber music, more vaudevilles and still more dance music. The people responsible for these bits and pieces send in their programmes which are dealt with at a central point, approved or vetoed, and finally arranged for presentation. Thus you have your programmes before you.

Now, can you think of any other method by which programmes lasting twelve hours a day for 365 days in the year can be arranged? If you can, you had better send it to the B.B.C. You will probably be recommended for knighthood next year.

That is how they arrive at their conclusions at Broadcasting House:

Huge sums of money are spent each year in providing the result of their deliberations. In the main it is true to say that money is spent and not wasted. When waste occurs it is only when someone makes the mistake of bringing into prominence productions that can only appeal to a minority.

The B.B.C. says: "We must experiment; we must try everything." I wonder whether that is really as sound as it sounds? If modified to "we must try everything suitable for the microphone," by which I mean suitable for performance to a blindfolded audience, the slogan might stand. Not otherwise.

Val Gielgud is more fortunate than Dr. Adrian Boult. As Drama Director, he can fly fairly high in the matter of his productions, because they are more easily appreciated by the average listener than music flying at a corresponding altitude. The reason is, that if Mr. Gielgud produces a play taxing the intellect of the listener he has a better chance of success than Dr. Boult when he does the same thing with serious music.

Appreciation of plays is simply a matter of using your intellect in the ordinary way. A play is a story, or should be, and most of us like stories.

Appreciation of serious music is not quite the same thing. It requires more than the ordinary intellect. It

needs a certain predisposition towards music as an art and to be absorbed successfully, needs a certain amount of musical knowledge and training.

Therefore, it can be argued that Mr. Gielgud gets away with his plays further and more quickly than Dr. Boult with his music.

If that argument is to stand it penalises Dr. Boult. In other words, he must be content to make haste more slowly than his colleague.

It is sad. No one regrets it more than I, but there it is and something ought to be done about it. I have no doubt the Music Department of Broadcasting House will say "that's all very well, but unless we go on and perform every class of serious music how can you expect appreciation of art to be fostered in the country?"

It is obviously silly of me to say that it doesn't matter whether appreciation be fostered or not, because they would have me on the questions of idealism and breadth of outlook.

My only reply is to point out the vast difference (once again) between performances in Queen's Hall and reception in our front parlours.

To bring the argument down to realities is to emphasise a fact that, seemingly, has been missed at Portland Place. Strong dissonances by wireless are acoustically at fault in the first place, and psychologically at fault in the second. Chords containing more than a certain number of distinct sounds—I am trying to put this down non-technically—chords too full of sounds—with too many notes in them, if you prefer it

—confuse the listener's ear. You can have the chord of C (just C, E, G, C) thundered out by an unlimited number of instruments with complete success, because it can be dealt with by your volume control. But you cannot deal with chords containing a dozen notes—all different and without reasonable relation to one another.

Therefore, putting it very bluntly, you are safe with the classics and with the moderns up to Strauss, Debussy, and Ravel. Yet their music is modern. Indeed, in their day it was considered hyper-modern. For that matter, so was Wagner's.

Say what you like, these composers are still modern because they represent the furthest limit—the furthest wise limit—of dissonance. Moreover, their work is a logical outcome of all that preceded it.

With composers like Scriabin, Hindemith and Alban Berg, the rules of music have been discarded. In plain words, there are no restrictions.

Once you lift all restriction you lift all decency of thought. Anything will do for a chord, and melody does not count. It is old-fashioned. That is, really and truly, the state of hyper-modern music. I defy any advocate of it to argue against the statement.

These are my conclusions about hyper-modern music.

When I first heard and liked Wagner in the days of my youth all my friends told me I was a hyper-modern highbrow, or words to that effect. I said I could not see it. The man's harmonies were modern, but sensible. They were founded on musical principles.

I said the same thing over Debussy, whom I knew and admired intensely. I said it over Strauss and Ravel. But I can never say it over Scriabin and Hindemith. Hyper-modern music in these days is not founded on musical principles. Therefore it is not to be encouraged.

If I had the programmes in my hands, hyper-modern music would be stamped out in this country within a year. It is not progressive.

It is vulgar high-browism, just as scatsinging is pronounced low-browism.

Looking back over the programmes I have been amazed at the number of performances of hyper-modern music. The expense of these productions is great. Nobody at the B.B.C. will go so far as to deny that.

I maintain the B.B.C. has wasted a great deal of money in the production of something totally unsuitable for broadcasting. That is a very serious charge, but it is one that cannot be refuted.

There is only one way of arguing this question in the broadcasting sense. Wireless exists for all. Nobody but a complete imbecile would suggest the division between serious-music listeners and light-music listeners to be anything like equal. I prefer serious music, and I know I am very much in the minority. Therefore I do not expect to be catered for to the extent of my neighbour who may prefer the other.

Further, it is impossible to deny that, out of serious-music listeners, the hyper-modernists are definitely in the minority. Serious-music lovers are divided more unequally between classic and hyper-modern than the whole range of listeners between serious and light.

The B.B.C. should not have spent £800 on the production of the German opera, "Wozzeck," last March.

It was totally unsuited to broadcasting, whichever way one looked at it. First, it was hyper-modern, devoid of musical form, and dissonant to a point of extreme offensiveness. Second, it was not seen—as an opera should be—in fact, it was admitted only to be a concert version. Third, it was far too elaborate for any wireless set to receive and reproduce intelligently. Fourth, it was not even sung in English.

I went to Broadcasting House and met the German musician who had been engaged to see the production through.

I asked him to tell me the plot. He did. After hearing its lurid details I came to the conclusion the B.B.C. had acted wisely in *not* translating it.

The cast was English, with the exception of Richard Bitterauf, brought over from abroad to play the name part. People like May Blyth, Parry Jones, Mary Jarred, Percy Heming, Walter Widdop, and others, did wonderfully well in it. They learnt their German and pronounced it perfectly; they mastered the absurd and unnecessary difficulties of the score; they sang the unmusical and hideously ugly sentences as though they had known them for years.

In other words, it was a first-rate experience for them. They are, I doubt not, better musicians for it. I examined the score of the work and noted passages I should have been sorry to sing. Probably they were sorry to sing them, but the fact remains that one and all distinguished themselves in the process.

And, when it was all sung and done, what good was it to broadcasting. To spend £800 in the production of an opera merely because it was said to be the world's most difficult (a point against it, really) was a gross waste of money.

Hyper-modern music should be confined to small halls in London and the provinces where such few of us who see in it any artistic value can gather to hear it.



VAL GIELGUD'S PLAY STORE

This is where all the hundreds of plays, which have been broadcast and might be broadcast, are carefully filed. Whitaker-Wilson says that plays are appreciated by the average listener

Wireless Jobs Made Easy for Mr. Everyman

By **R. W. HALLOWS**

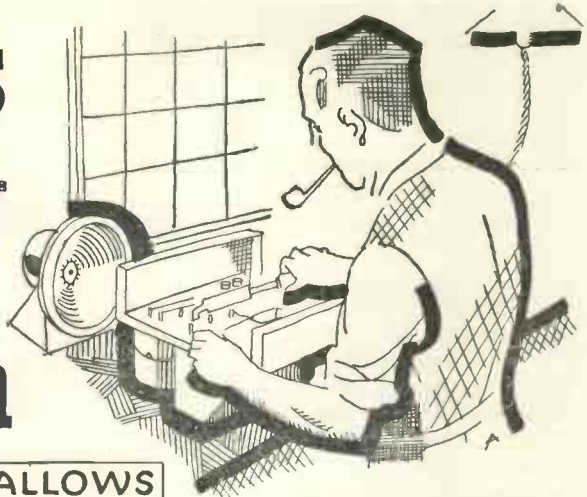

A READER sends me a problem which has been puzzling him and may have presented difficulties to others. He has a multi-valve battery-operated set, and inside its cabinet there is no room for anything larger than a standard - capacity high - tension battery.

Having found by bitter experience that this requires all too frequent renewals, he wants to use a triple-capacity battery, but cannot think of any way of fitting it in. What is to be done about it?

Housing the Battery

Clearly it cannot go inside the cabinet, for it would be folly to try to alter the layout of the set to make room for it. We must therefore see if we can find some neat way of housing it externally. Some people who have changed over from standard - to large-capacity batteries simply place them on the table behind the set, but this is not a method that will recommend it to many, since it brings us back to the old untidy days of external batteries and of trailing wires. Also it is not

particularly good for the health of the battery.

The layer of dust which is apt to collect on top of the battery may lead to leakages of current, which, small though they may be, are nevertheless important, since owing to their presence the battery has never any complete rest.

Fig. 1 shows a method which I use myself and find very satisfactory. The battery lives in a box specially made to fit it, and this box acts as a stand for the set itself. The material used is plywood with a veneer to match the cabinet of the receiver. If the job is neatly carried out the box is completely inconspicuous. Few people, in fact, would suspect that it was not part of the set itself.

Making the Box at Home

The battery box is very easily constructed by anyone who can use tools no more complicated than the bradawl and the screwdriver. Those who are used to woodworking will cut out for themselves the pieces required; but others will have the work done by the joiner or cabinet maker from whom the plywood is obtained.

The most suitable wood for the job is 7-ply $\frac{3}{8}$ in. thick. This can be obtained in a large variety of beautiful veneers—walnut, oak, maple, teak, and so on—and the constructor may choose either a veneer which matches the cabinet of the set exactly or one which forms a pleasing colour contrast.

Triple-capacity batteries vary somewhat in size and shape. The design shown in Fig. 2 is for a very commonly seen type, which measures $13\frac{3}{4}$ in. from end to end by 10 in. in width and 3 in. in depth. It will be seen that the *inside* dimen-

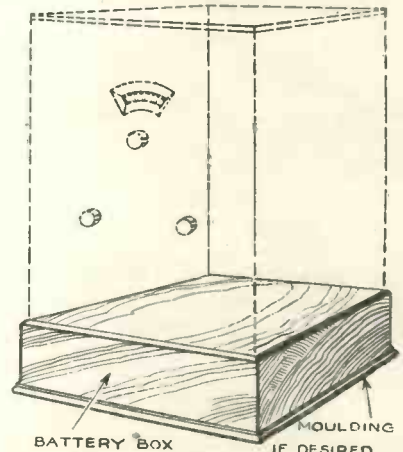
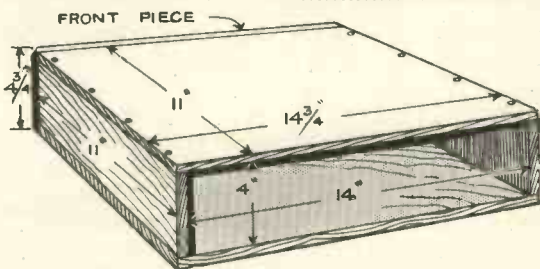

Fig. 1.—It is much neater to house the batteries of a set in a box underneath the cabinet. The box, incidentally, forms a neat stand for the set

sions of the box are $\frac{1}{2}$ in. greater from end to end, $\frac{1}{2}$ in. greater in width, and 1 in. greater again in depth. Bearing this in mind, it is easy to plan a box for a battery of any shape or size.

Materials and Make-up

The pieces required are top and bottom, each measuring 11 in. by $14\frac{3}{4}$ in.; two sides, each 11 in. by 4 in.; and a front piece $14\frac{3}{4}$ in. by $4\frac{3}{4}$ in. If desired the box can be provided with a flush hinged-on back. This will be found to measure 14 in. by 4 in.



DIMENSIONS FOR A BATTERY BOX

Fig. 2.—All the dimensions for a battery box to take most types of triple-capacity batteries are given here

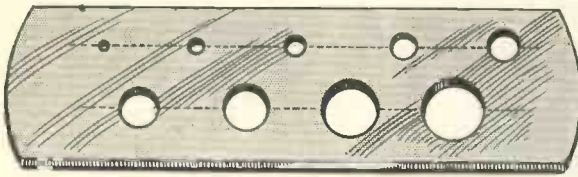

HOME-MADE DRILL GAUGE

Fig. 3.—Any piece of flat scrap metal can be used to make this gauge, which will be invaluable to practical set builders

The pieces having been cut square and true, the actual construction of the box presents no difficulties. Attach the sidepieces to the bottom first of all by means of $\frac{3}{4}$ -in. counter-sunk wood-screws; then deal with the top in the same way. Next put on the front, using either counter-sunk or round-headed screws $\frac{3}{4}$ in. in length. No. 5 is a useful size for all screws.

Some readers may like to provide the box with a moulding at the bottom as shown in Fig. 1. Mouldings in great variety can be obtained from any carpenter who, for a very small charge, will cut out the three pieces required for those who do not possess a mitre block.

All that remains is to give the box a pleasing finish. Begin by rubbing it down with the finest of glass-paper, remembering that the more careful the rubbing down is done the better will be the final appearance of the box. Then use one of the simple French polishes such as that obtainable from Hobbies. Full instructions for use come with the polish, and if these are followed carefully success is certain.

Fitting the Leads

In most instances it will be found that the set's high-tension leads are too short to reach the battery in its new home. New ones must be fitted or the old ones lengthened by soldering additional pieces of flexible wire to them. If you lengthen, by the way, do not omit to insulate the joints thoroughly by covering them with electrician's tape or sticking plaster.

The leads should be so long that the plugs can be inserted into their sockets when the high-tension battery is standing just outside its box. Twist or plait them into a cable, and if you have a back to your box cut a recess in it through which this cable can pass. Make a similar recess in the back of the set, if there is one.

Having put the plugs into their

sockets slide the battery into its box. Then tuck the surplus length of cable neatly away inside the set cabinet. In this way all trailing wires are avoided. Even from behind nothing is to be seen but an inch or two of cable.

For Portable Sets

The idea is applicable equally to the suitcase type of portable set, and here it may be used with great advantage. These sets have no turntables so that they have to be shifted bodily round to make their built-in frame aërials point in the desired direction. A turntable is easily fitted to the bottom of the battery box, both set and box being then rotatable together with a minimum of trouble.

Query About Drills

Another reader sends me a question about drill sizes. He has, he tells me, an outfit of nine drills ranging from No. 30 Morse to $\frac{3}{8}$ in. His trouble is that he is not good at judging sizes by eye, so that when he has to select a drill to make a hole for a screw or a pin he usually finds that at his first shot he chooses one that is either too large or too small.

The best of all methods of selecting drills for jobs is to make use of a drill-plate. This consists of a flat piece of steel containing holes made exact to size either for all Morse drills from No. 1 to No. 60 or for inch-fraction drills, say $\frac{1}{16}$ in. to $\frac{3}{8}$ in. by steps of $\frac{1}{60}$ in.

Such drill-plates, however, are rather expensive, and though the skilled workshop man would not be without them, it is hardly to be expected that they will be found in the tool kit of the wireless man who undertakes only simple jobs.

It is, however, possible to make a gauge for one's own set of drills at a cost of exactly nothing!

Home-made Gauge

Fig. 3 shows how this is done. Any flat piece of scrap metal will do so long as it is fairly hard and not less than about $\frac{1}{16}$ in. thick. The size will depend upon the number of drills that are to be dealt with.

Mark off two or three horizontal lines on the metal and then make on these as many centre punch marks as you have drills. Now run each drill in turn through the plate, beginning with the smallest and continuing in ascending order of magnitude, as Euclid might have put it.

To use the gauge, take the screw for which you wish to make a clearance hole, and try it in the plate until you find the hole that is the best fit. Pick out the drill that has made the hole, and that is the one to use for the job. This gauge plate does not take more than half an hour or so to make, and its usefulness in the future will well repay your time and trouble.

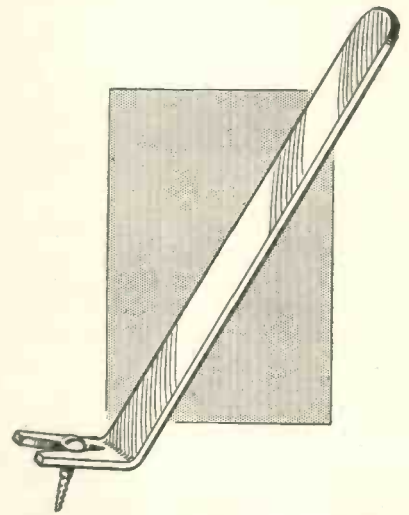

GETTING INTO AWKWARD CORNERS
Fig. 4.—This useful home-made tool, which can be made out of brass or other stiff metal, will be found a great help in getting screws into awkward corners

For Awkward Screws

Whilst I am on the subject of easily made gadgets, let me draw your attention to the little screw-holder illustrated in Fig. 4. You all know those exasperating screws which have to be driven into odd corners which your fingers cannot possibly reach. You make rather a large hole and insert the point of the screw into it with the pliers.

Then you take the screwdriver, carefully place it in the nick, and endeavour to make the threads bite. The moment you apply pressure with the screwdriver the screw falls over to one side and you begin again.

All of this trouble is easily avoided. The only material required for making the tool is a stiffish strip of

brass or of other metal some 6 in. long by $\frac{3}{4}$ in. wide. In one end of this file a slot into which the screws you generally use fit comfortably. Then bend at an angle as shown in the drawing.

To use the tool, place the screw in the slot and insert the end of the screwdriver blade into its nick. You will now have no difficulty in putting the point of the screw where you want it, and in holding it, by a slight upward pressure under the head, until the screwdriver has made its threads bite. The tool is now withdrawn and the screw turned right home. Simple, but it *does* save trouble.

Trimming Made Easy

In all modern sets which use ganged variable condensers the process of trimming has to be undertaken before sharp tuning can be obtained. Many super-hets also have intermediate-frequency transformers which must be trimmed by means of small built-in condensers of the pre-set type.

All of the trimmers, of whatever kind they may be, are operated by means of screws. Try to use an ordinary metal-bladed screwdriver for the job and you may find it one of the most exasperating that you have ever tackled.

Owing to the presence of the metal blade, capacity effects manifest themselves, and though you may trim

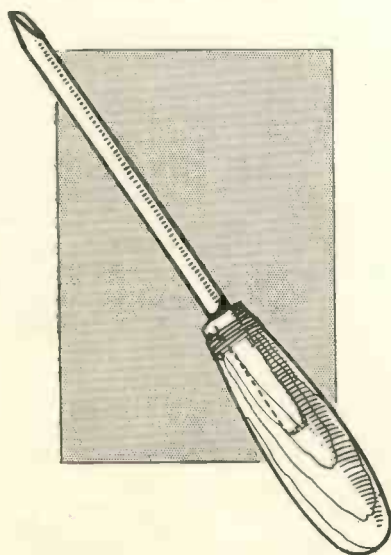

SCREWDRIVER FOR TRIMMING

Fig. 5.—A screwdriver made from bone, ebonite rod, or any insulating material, is the ideal tool for accurate trimming of ganged condensers

one circuit to perfect resonance with the screwdriver in position it is apt to go right off tune the moment you remove the tool.

The solution is to make a special trimming screwdriver of non-conducting material. Fig. 5 shows how this can be done. All that is required is a 6-in. length of ebonite rod or a piece of one of those bone or erinoid knitting needles, which keep the gentler sex so busy nowadays. With a file one end of this is readily shaped to form a screwdriver blade.

Don't make the point of your blade too fine. There is no need to do so, since the slots in trimmer screws are usually cut fairly generously. The non-conducting screwdriver will stand up well to the work, for only the lightest pressure is usually required to turn the screws. You can finish it off if you like by slipping the unshaped end into a file handle as shown in the drawing.

File Handles

Talking of file handles, did you know that these are to be obtained at ridiculously small prices from any tool shop? One of the most useful kinds is split around the hole as shown in Fig. 5. It thus expands to take file tangs of various sizes and grips them firmly when they are pushed well home into it.

The wise man never tries to use a file, particularly a small one, without a handle. If you do so you may be lucky for a long time, but the day will come when something slips and the sharp tang of the file gives you a nasty jab in the palm of your right hand. A file handle gives complete protection against this kind of thing.

Really Good Earth

A good many readers have asked me to describe a first-rate earth connection. There are many ways of making an earth, but probably the best of all is that illustrated in Fig. 6. It consists of a sheet of copper about 12 in. wide by 3 ft. long, and buried vertically in the ground, right under the aerial wires if possible.

Don't jump to the conclusion that because you want 3 sq. ft. of sheet copper this sort of earth is going to be an expensive one. There is not the least need to buy the

burnished kind of copper that is used for a chassis and so on. Go round to your local metal dealer and purchase your sheet copper in the rough. You will then find that it won't run to very much. It is very cheap.

No Soldering

Many earth connections become

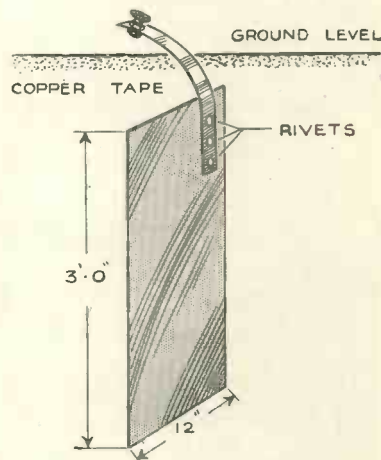

EFFICIENT EARTH CONNECTION

Fig. 6.—A strip of sheet copper with a rivetted strip of copper tape makes an ideal form of earth. It can be depended upon to last for years

faulty in time because the earth wire is soldered to them. If you think for a moment you will see that in somewhat acid soil this is simply asking for trouble. You have a copper earth plate to which is fixed an earth wire, probably of phosphor bronze, by means of solder, which is itself an alloy of several metals.

Place dissimilar metals in contact in an acid medium and everything is ready for electrolytic action. I well remember digging up some years ago a biscuit tin earth-contact of which nothing remained but the wire forming the beading round the rim!

The earth lead for this ideal contact consists of a piece of copper tape fixed to the plate by means of rivets.

Rivets of suitable size can be purchased from any tool-shop and rivetting is a very simple business. Space forbids me describing it this month, but I will do so in the next series of these hints. Meantime, if you are burning to get the ideal earth connection into use, either try your prentice hand at rivetting or ask the man from whom you purchased the copper to do it for you.



H.M.V. photo

PLEASURE BY RADIO
An attractive listener finds pleasure in an attractive set! Such a cabinet harmonises with almost any furnishing scheme

Stripped Component Opinions

THIS stripped-component idea certainly seems to be popular among "Wireless Magazine" readers. Since I last wrote these notes I have had many more letters from constructors backing up my suggestion. Next I shall have to make serious inquiries to find out what manufacturers intend to do about it.

Mr. W. Richardson, of Middlesborough, says that absolute standard design is necessary and should be the rule. This reader also suggests that components should be fitted with larger lugs drilled with a hole big enough to accommodate a nut and bolt. In this way the connection could be screwed or soldered, as desired.

This method of construction is sometimes used with small tag-type fixed condensers now.

When Soldering is Not Desirable

Whilst most constructors seem to be prepared to solder if that course would save money, there are others who object to this method of wiring. One of the best reasons against soldering is advanced by Mr. S. Darnell, of Stoke Newington. I cannot do better than quote his remarks :

RADIO MEDLEY

"I do not think a return to soldering lugs would be popular. I, for one, would not be in agreement, and for this reason.

"I am a keen wireless amateur. Suppose I buy a fixed condenser. I am continually building up various circuits for experimental purposes and dismantling them again. Consequently my condenser would be jostled about from place to place in various positions. Upside down, the right way up, inside out—in fact after a time it would become quite giddy and break down altogether!

"Now if soldering lugs only were provided, my condenser would look a sorry sight after so many removals. In spite of the fact that I am an old hand at soldering, after a time the condenser might appear 'messy' and the insulating wax on the top might melt in several places and perhaps become very dirty.

Longer to Make Connections

"Not only that; think of the time it would take in comparison with terminals. Should the condenser be connected up only for a moment, one would have to use crocodile clips, which are far from satisfactory, especially if they have to carry any amount of current."

Thank you, Mr. Darnell, but does it really take so much longer to solder a connection than to screw it down under a decent-sized terminal head?

The Question of Cost

On the question of cost, Mr. Darnell also makes an illuminating comment. Thus :

"I heartily agree with you that the prices of good components are not comparable with completed receivers. It would almost seem to be cheaper to buy a commercial set and dismantle it, as probably the resultant number of parts obtained in this way, price for price, would come to more than the receiver's original cost!"

Belgrade's Rapid Move

IT must be very infrequent that a complete broadcasting station is dismantled and moved to a new site, but that is what happened to Radio Belgrade at the end of February—and in something like record time, too.

This station, which uses a Marconi type 9-kilowatt transmitter, was situated in the centre of the city and it was decided for technical reasons—particularly to obtain

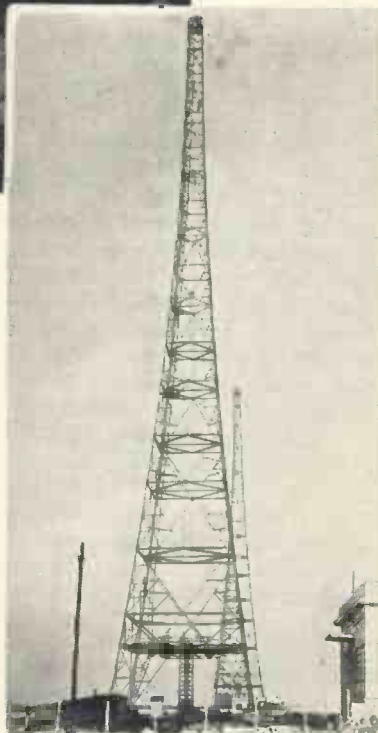

Marconi photo

HAVE YOU HEARD IT?
Radio Belgrade was recently moved and is now at Makis, some six miles from the capital

A Radio Fan's Causerie

Conducted by BM/PRESS

a more efficient aerial system—to move it out into the country. The new site is at Makis, some six miles from Belgrade.

On the evening of Friday, February 23, the old



H.M.V. photo

RADIO TOFFEE

Frances Day, the broadcasting, recording, and stage star, finds radio a fitting accompaniment to the making of toffee. So does her dog—Bill

dislike straight sets until last week. For the past six months I have been using for most of my listening, a five-valve super-het and last week I changed it for a three-valve straight set.

Both are commercial models of the latest types, although neither is fitted with self-adjusting volume control.

It seems to me that there are two snags about the straight set when compared with the super-het. In the first place it is nothing like so selective, and, secondly, the reaction control is very fiddling.

Fiddling with a Straight Set

With the super-het stations come in sharp and clear cut within an arc of about one degree on the dial; with the straight set the locals spread considerably and a careful balance has to be made between the reaction and volume controls to cut them out when it is desired to pick up a foreigner working on an adjacent wavelength channel.

There is a lot of talk about background noises from



H.M.V. photo

RADIO ABROAD
Starting off for a motor tour of the Continent—the expedition would not be complete without a radio set of some kind

station gave a concert that lasted until midnight. Dismantling was started as soon as the transmission came to an end and the gear was shifted piecemeal to the new site. The actual moving occupied all Saturday and Sunday, but the first transmission from the new site was made at 9 p.m. on the following Wednesday.

Telegrams and letters from listeners in all parts of Yugo-Slavia and abroad show that reception of Radio Belgrade is now clearer and better than it has ever been since the original station was opened five years ago. Have you heard it recently?

Super-hets versus Straight Sets

For a number of years now I have been an enthusiastic super-het fan, but I did not realise how much I



SPORTS RESULTS
The boys at Leys School, Cambridge, rigged up their own public-address system to announce recent sports results. Three loud-speakers were used, one of the box-baffle type

Sport as a General photo



L.N.A. photo.

THEY'RE BUSY AT THE B.B.C.!

An animated scene in the control room at the top of Broadcasting House on the occasion of an important relay

super-hets, but I cannot say that I have ever experienced any trouble on this score. There is very much more background with the straight set and the ether seems to be full of strange noises—it is like going back to the pre-Lucerne Plan days.

Of course, the screen-grid high-frequency stage in the straight set does give a better daylight range, even though it has only three valves and the super-het has five. This leads me to the conclusion that the next super-het I have must definitely incorporate a high-frequency stage before the first detector—not that I do much daylight listening, but one likes to feel that one has a set that will put up the best possible performance under all conditions.

Question of Mains Hum

Then there is the question of mains hum. Both the sets I am discussing are made by the same people and one would therefore expect that they would be on a par so far as smoothing is concerned. I find, however, that the hum from the straight three-valver is much more pronounced than that from the five-valve super-het (both sets are worked on A.C. mains).

With the super-het the hum is so subdued that it does not interfere with reception at any volume, but with the straight set it is loud enough to be annoying. This is largely a question of direct comparison, of course. No doubt if I used the straight set exclusively for a few weeks I should get used to the hum and not notice half as much.

Midget Battery Valves

In the middle of writing these notes I have just been shown one of the new midget battery valves—it is really a midget and will attract

considerable attention on that score alone. That is not its only point of interest, however, for the filament takes only .1 ampere at 1 volt. The idea is that they should be wired in series and run from a 2-volt accumulator in the usual way.

When you see one of these valves you will be surprised at its very small size, but I suppose there is no reason for surprise really. After all, the "vacuum" round the electrodes in the standard size of bulb does

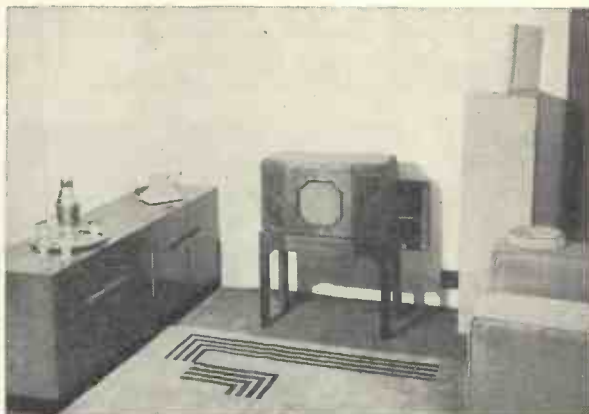

Pye photo

A MODERN SET IN A MODERN SETTING

Note how well this new type of receiver cabinet harmonises with a modern furnishing scheme. It is equally at home with a period setting, though

not perform any useful function and the electrodes themselves do not occupy very much space.

I understand that these valves are in great demand for police radio sets and that it will probably be some weeks before they are in full production for the retail market.

The only thing I do not like about these valves is their high price—they are to be 15s. each.

Strange Switch Fault

Some months ago there was much talk because the sets put out by a well-known firm suffered from switch faults—at least, that is the story I heard from several quarters. So recently when I ran into a member of the staff of this particular firm I tackled him.

He admitted that a batch of receivers did suffer from switch trouble, investigation proving it to be due to unusual circumstances.

In this particular batch of sets (the switches of which, by the way, are of a gold-and-silver alloy) a rubber-covered wire was used in place of oiled-silk covering. The heat generated by the mains valves inside the set affected the rubber, which gave off sulphur fumes. That corroded the switch contacts and caused all the trouble.

London, W.C.2. BM/PRESS



WHY THERE WAS NO BROADCAST THAT NIGHT!

"We regret to announce that Professor Must is unable to come to the studio to-night; the car in which he was travelling became involved in a serious accident"

An up-to-date baker using the new H.M.V. Greenwich Super-het to provide entertainment at his work. Incidentally he makes use of the clock to check his baking time

By the "W.M." Set Selection Bureau

THIS month we have endeavoured to cater for the tastes of all readers by reviewing five distinct types of set. One that will create an unusual amount of interest is the Ostar-Ganz Universal super-het, suitable for either A.C. or D.C. mains at will.

Then there is the double-purpose set, the H.M.V. Greenwich Super-het with a built-in clock. You have to use an electric clock before you can fully appreciate its good points.

Ekco's latest product has been put through its paces, and our test report tells you in no uncertain way what we think of this new eleven-guinea super-het. The reason for Cossor introducing a four-valve (with rectifier) straight set is also explained, and finally, there is the report on the Drummer MS6, one of the most efficient super-hets we have ever tried. This set has two loud-speakers, so we draw it to the attention of the music lover.

FREE ADVICE TO PROSPECTIVE SET BUYERS

To make the most of this free advice service, we ask you to answer the following questions:—

(1) The maximum price you wish to pay, and whether you are prepared to exceed this if there is no suitable set at your desired price.

(2) The locality in which the set will be installed.

(3) The stations required, that is, locals only or a selection of foreigners.

(4) Whether you want an entirely self-contained set or one with external aerial and earth.

(5) Whether battery or mains driven. If the latter, whether A.C. or D.C.

A stamped-addressed envelope for our reply is your only expense. Address your inquiry to Set Selection Bureau, "Wireless Magazine," 58-61 Fetter Lane, E.C.4. Tell your friends about this useful service, exclusive to "W.M."

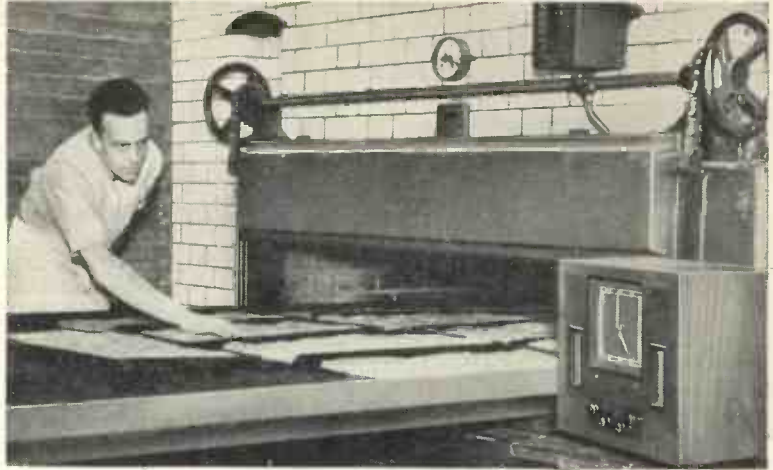

Our Tests of New Sets

So far this year we have not had the opportunity of testing any two-valve A.C. or D.C. mains-driven sets for which there is quite a steady demand.

Far too many readers ask for receivers of all kinds without a built-in loud-speaker for us to accept the manufacturers' views that only self-contained sets are in demand. A large section of the community are of the opinion, rightly or wrongly, that the reproduction of self-contained sets is not so good when the loud-speaker is fitted in the same cabinet as the set.

There is the problem of the extension loud-speaker. Although the majority of sets incorporate terminals or sockets for this purpose, the percentage of listeners who can obtain satisfactory results is very small. Far too few details are given as to the best impedance for the extra loud-speaker, what output transformer should be used, or any suggestions as to what type of extension loud-speaker should be bought.

Another problem that worries listeners is how to increase the volume from the pick-up. Many commercial sets only give sufficient volume when a pick-up with a high voltage output is used. Others give bad quality if a high output pick-up is used, due to the detector valve overloading.

Very few details are ever given as to what type of volume control should be used and the effect of different values. These points, if they were explained in detail, would make many readers more satisfied with their sets.

It seems that some manufacturers feel that a set buyer is like a child with a new toy: so pleased to get it that he overlooks the minor faults. That view is in a measure correct, but there comes a time when the novelty of the new set wears off, and the user begins to notice points and compare results with his friends. That is how reputations are either made or destroyed.

Although the Lucerne Plan has reasonably settled down, we still advise listeners buying new receivers to pay particular attention to the tuning-dial calibration. If the dial is marked in station wavelengths, make sure that it can easily be removed. A good example of forethought in this direction is the Ekco model 64 reviewed in this issue. The tuning scale is calibrated in station names and wavelengths, and can be removed in a few minutes.

This is a distinct contrast to those sets which have to be returned to the manufacturer for alteration, with consequent delay and expense.

Next month we are reviewing a selection of the best portable sets on the market. The selection will include four-, five- and six-valvers.

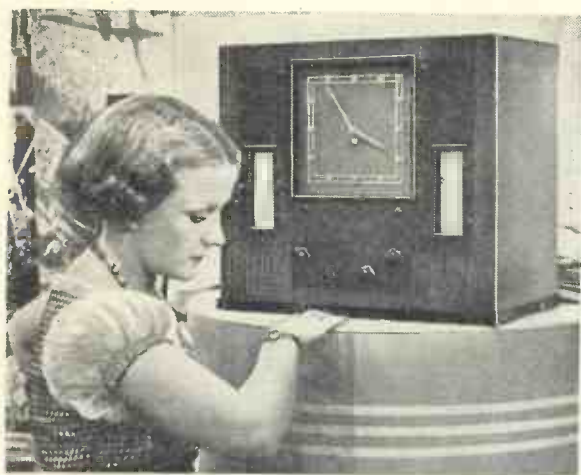

"The H.M.V. model 439 is a useful addition to the household . . . the user has all the advantages of the electric clock"

BESIDES being a handsome piece of furniture the H.M.V. model 439 is a useful addition to the household. As well as an excellent radio set, the user has all the advantages of the electric clock, which is fitted in the centre of the loud-speaker opening.

With this clock it is no longer necessary to check up the time, for providing your mains supply is synchronised—and most mains are—this electric clock keeps perfect time.

This new receiver is housed in an attractive walnut cabinet of typical H.M.V. design; a dignified cabinet giving an appearance of stability and general value for money.

Compactness is another important asset, for even with the clock the dimensions are very reasonable. The overall height is 16 in. by 18 in. wide and 11 in. deep.

The circuit is novel in many ways, as you will see. As a combined detector-oscillator the Marconi screen-grid valve type MS4B is used. Owing to an ingenious method of cathode coupling the circuit is absolutely non-radiating: a good feature, for when the receiver is used in flats or crowded areas, no interference is caused to neighbouring receivers.

The single intermediate-frequency valve is a Marconi VMS4. This is in turn coupled to a power-grid type of detector. The power-grid method of detection has been used to preserve quality. The detector valve is of the triode type, and is auto-transformer coupled to the output power pentode.

An output of over 2 watts is obtained from this valve, enough to fill a large room and quite enough for average households. Another important feature is that second channel or image interference has been completely overcome. An impressive point is the very fine interior finish, a point often overlooked by many manufacturers in their eagerness to reduce prices.

Four controls and a separately illuminated tuning scale are arranged on the front of the cabinet. These controls are quite conventional—a master tuner, a tone and volume control, wave-change and on-off and

H.M.V. Greenwich Super-het

gramophone switches. The tuning dials are calibrated in wavelengths from 200 to 550 metres on the medium waves and from 1,000 to 2,000 on the long. This range covers all the stations you are likely to need.

There is a remarkable absence of hum, and even when used with the mains aerial and no earth connection, there is hardly any difference except greater susceptibility to pick up the clicks from noisy light switches.

If you are interested in parties or small dances, the gramophone attachment should not be forgotten. When used with the H.M.V. type of pick-up the volume is sufficient to fill a small hall or enough for twenty or thirty couples for dancing.

On the radio side we have no adverse criticism to make. Quality and selectivity, are beyond reproach. On an aerial having a total length of 50 ft., and at a distance of 20 miles from London, the separation was of the order of 9 kilocycles, while on the long waves stations only 7 kilocycles apart could be separated.

With the exception of a few tests after midnight, our work on this set was carried out during daylight, which makes the results all the more noteworthy.

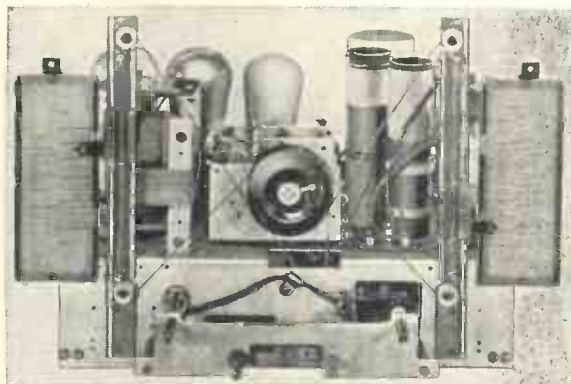

"Four controls and a separately illuminated tuning scale are arranged on the front of the cabinet . . ."

The H.M.V. Greenwich Super has been so designed that with a moderate aerial, sensitivity is sufficient to enable the average listener to log up to twenty Continental programmes during daylight. Towards the end of the afternoon we found that the sensitivity was equivalent to the night-time log of an ordinary super-het.

Such stations as Fécamp, Hilversum, Poste Parisien, Berlin, Kalundborg, Oslo, Langenberg, etc., were as easy to tune in as the local station. One can realise from this that under good conditions in the evening almost every worth-while European station can be heard.

During one of our after-midnight tests, we had little difficulty in tuning in a number of American stations with only a moderate aerial.

BRIEF SPECIFICATION

MAKERS: The Gramophone Co., Ltd.
MODEL: Greenwich Super-het Five.
PRICE: £16 10s.
VALVE COMBINATION: Combined detector-oscillator (Marconi MS4B), single intermediate-frequency stage (Marconi VMS4), triode detector (Marconi MHD4), power pentode output (Marconi MPT4), and full-wave valve rectifier (Marconi U12).
POWER SUPPLY: A.C. mains from 200 to 250 volts, 40 to 100 cycles.
TYPE: Upright table model with walnut cabinet and totally self-contained.
REMARKS: An excellent super for family use.

Cossor Model 435 Three-valver

WITH the majority of set manufacturers concentrating on the design of small three-valve super-hets it is surprising—on the surface—that Cossor should bring out a three-valve *straight* receiver.

If a little thought is given to finding the reasons underlying the production of this new set, there are points which immediately make themselves noticed. The straight type of set embodies ideas that can never be had in a super-het.

Absence of background noise, better daylight range, no image interference, and good quality are all excellent reasons for the retention of the straight set.



"Provision has been made for external loud-speakers, a gramophone pick-up, a power point to feed a gramophone motor or external reproducer"

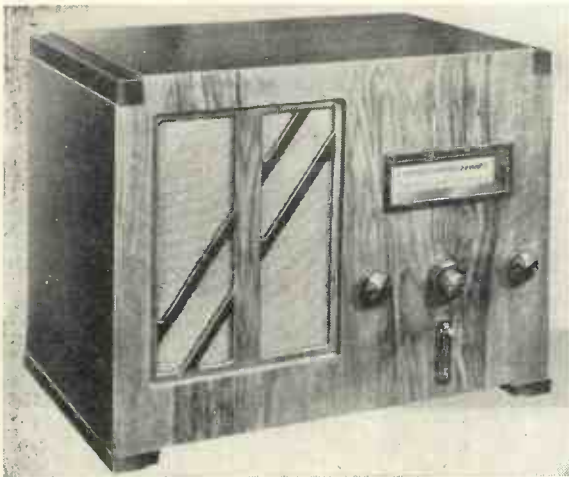

"A rather feminine touch is noticeable in the cabinet design. . . . It is of dark oak of severe design, but very neat and compact"

This new Cossor set will appeal to a very high percentage of listeners who only want a small number of stations, say twenty or thirty, but these to be of high entertainment value.

A rather feminine touch is noticeable in the cabinet design. It is of very dark oak of severe design, but very neat and compact. The loud-speaker, receiver, and mains pack are all housed inside the one cabinet.

Simplicity of control is at once very evident, so it should appeal to the family man who has a family all wanting "to work the wireless."

There are only four major controls. In the centre is the main tuning knob and with it a smaller knob—a trimmer on the two-gang condenser. On the left-hand side is the combined volume control and on-off switch. When the volume is reduced to the minimum, a further turn of the volume control cuts off the mains supply. The other knob on the right-hand side is a simple reaction or signal-boosting control. Wave-change is by a lever type of switch. Fitted in the centre of the panel.

Take a look at the chassis of pressed steel—a really workmanlike job. There are three receiving valves, the first a variable-mu screen-grid, which is tuned-anode coupled to a high-frequency pentode detector. To maintain quality at the highest possible level the detector valve is resistance-capacity coupled to the output pentode.

Provision has been made for using external loud-speakers, a gramophone pick-up, and there is a power point to feed a gramophone motor or external loud-speaker should either of these require energising. This point is very useful, for it means that you do not need a separate power point for the gramophone motor, and should you convert the receiver into a radio-gramophone you will still only need one mains lead.

The loud-speaker of this Cossor 435 is of the energised type, which accounts for the exceptional quality and sensitivity.

Over 2,000 milliwatts are given by the output valve and this is handled by the loud-speaker with the greatest of ease. When tested some thirty miles north of London on a 50-ft. aerial, we had no difficulty in obtaining a very large number of stations. Selectivity was reasonably good. With judicious use of volume and reaction controls no more than three channels need be lost on either side of the local station.

During a daylight test a considerable number of stations were heard. The minimum wavelength is a trifle under 200 metres, so that Fécamp, Newcastle and Aberdeen can be covered quite easily. Features of our daylight tests were that at 10 a.m. Fécamp was loud enough to be heard all over the building, and that no less than twenty stations were tuned in at varying strengths within fifteen minutes.

Of course, as you would expect, the log increased tremendously after dark. It was more a matter of losing stations than getting them. By careful tuning to eliminate the unwanted stations we found that a good average log each evening was forty stations clear of interference. Under better conditions there should be no limit to the number heard.

BRIEF SPECIFICATION

MAKERS: A. C. Cossor, Ltd.
 TYPE: 435.
 PRICE: £9 15s.
 VALVE COMBINATION: High-frequency stage (Cossor MVSG), High-frequency pentode detector (Cossor MS/Pen), power pentode output (Cossor MP/Pen), and full-wave valve rectifier (Cossor 442BU).
 POWER SUPPLY: A.C. mains 200 to 250 volts, 40 to 100 cycles.
 TYPE: Self-contained table model.
 REMARKS: An excellent straight set that gives a fair number of stations at especially good quality.

Ekco Model AC64



"It is supplied in the now famous Ekco moulded bakelite cabinet, in walnut, or black and chromium finish"

EK. COLE, Ltd. will have a difficult job in front of them if they intend to bring out a more efficient set than the model AC64 for next season.

This set—the first of this year's productions—is an example of what can be done by clever design and good mass production. Not only is the efficiency of an unparalleled order for a four-valve super-het, but the price, coupled with good workmanship, sets a new standard in value for money.

It is supplied in the now famous Ekco moulded bakelite cabinet in

BRIEF SPECIFICATION

MAKERS: E. K. Cole, Ltd.
 MODEL: AC64.
 PRICE: £11 11s.
 VALVE COMBINATION: Combined detector-oscillator (Mazda AC/SPen), single intermediate-frequency stage (Mullard VP4), diode second detector (Mazda V914), power pentode output (Mazda AC/2Pen), full-wave valve rectifier (Mullard IW2).
 POWER SUPPLY: A.C. mains, 200 to 250 volts, 40 to 100 cycles.
 TYPE: Self-contained upright table model.
 REMARKS: This is a value-for-money set, giving quality well above the average.

walnut, or in black and chromium finish. These cabinets are of the upright type with a self-contained energised moving-coil loud-speaker mounted behind the grille.

There are only three controls. First the tuning knob in the centre, then the wave-change switch on the bottom left-hand side, with the combined on-off and volume control on the right-hand side.

A point of interest is that there is no actual tuning pointer; a special light beam method of tuning is used. As the tuning dial is rotated a fine light beam travels behind the tuning dial. The tuning scale is calibrated

in station names, according to the Lucerne Plan arrangement, as well as in wavelengths.

In case of another station shuffle this dial can be taken off and a new one put in its place in less than three seconds.

A local-distance switch is provided with this new Ekco set. It is brought into operation by pulling out the wave-change switch. This local-distance switch prevents the first valve from overloading and eliminates any possibility of distortion with local-station reception.

A three-point tone control is provided at the back of the chassis. It takes the form of three sockets marked H, L, and M, corresponding to high, low and medium. When the low pitch is in circuit, heterodyne whistles and background noises are reduced to almost nothing. The real value of this tone control is that the user can satisfy his particular whims about quality.

Delayed automatic volume control is another of the high lights. When tuning in, all of the more important stations seem to come in at about the same strength. There is no blasting when you go past the local station. This automatic volume control is a feature which does not get the full amount of credit. It is only after trying a set without it that you realise what a boon it is to have almost all stations rock-steady without any fading.

Provision has been made for an external loud-speaker and for a gramophone pick-up. By the way, the volume control also works on gramophone, so that there is no need to go to the added expense of buying a pick-up with a built-in volume control.

Now take a look at the back of the set. On the extreme left is the detector-oscillator, a high-frequency pentode, then comes the intermediate-frequency amplifier, followed by the double-diode second detector. Behind the second detector

is the rectifying valve, and on the right of it the output pentode. This is the valve that gives 3,400-milliwatts with an input of only 2.6 volts. This means that even the very weak foreign stations will be of good strength, or, on the other hand, should your aerial be rather poor you will still get very good volume.

Amains aerial attachment is not provided, as Ekco—in common with many important manufacturers—contend that a short indoor aerial, or even a yard or two of wire round the picture rail, will give better and quieter results.

It was not necessary for us to use an external aerial during our tests. All the stations marked on the



"A three-point tone control is fitted at the back of the chassis . . . delayed automatic volume control is another of the high lights"

tuning scale, and more besides, were tuned in quite comfortably at good volume on our 25-ft. indoor wire. We found that the selectivity on the medium waveband was between 8 and 9 kilocycles. This means that the set is sufficiently selective to cope with the Lucerne Plan and still have a margin to spare.

On the long waves the selectivity was good enough to enable us to separate Kootwijk from Radio Paris.

How's this for proof of sensitivity? On the 25-ft. indoor aerial four American medium-wave stations were logged between midnight and 12.15 a.m. One of them, WCAU, was loud enough to be heard all over the house, while the others were at comfortable room strength.

Drummer Model MS6

IT is not very often that we have the opportunity of testing a receiver that is in a class of its own. When we do get such a set it is usually the product of an old-established firm and not of a newcomer to radio.

The Drummer people, who first showed at the Exhibition last year, have brought out a new five-valve super-het with twin moving-coil loud-speakers. This type of set appears to have been overlooked by the majority of designers, who have concentrated mainly on four- and six-valve supers this season. The twin loud-speakers have made the cabinet larger than usual, but it is still of the upright table type. It is of figured walnut of neat design and really good finish.

Four controls are all you have to worry about, although there is a fifth which governs the set's sensitivity at the back of the chassis.

On the front of the cabinet are the usual tuner, wave-change and gramophone switch, volume and tone controls. Wavelengths are marked on the tuning dial and range between 200 and 550 metres on the medium waveband and 900 and 2,000 metres on the long. This covers the listening needs of most listeners including those relying on low-wave relays.

This MS6 makes use of five receiving valves and a high-voltage full-

wave rectifying valve giving 350 volts high tension.

A high-frequency pentode is in the first position followed by an AC/S2Pen as the combined first detector-oscillator, while in the single intermediate-frequency stage is another Mullard VP4.

For second detection, low-frequency amplification and automatic volume control a three-in-one valve—a Mullard TDD4—is used. This is resistance-capacity coupled to the power pentode output valve—a Mazda AC/2Pen.

The AC/2Pen valve gives an output of 3,400 milliwatts with only 2.6 volts on the grid. This output of nearly 3.5 watts is sufficient to provide dancing for twenty or thirty couples. Provision has been made for a mains aerial, gramophone pick-up, and extra loud-speakers.

We are in favour of the twin loud-speaker idea. The reproduction from this Drummer will suffice the most fastidious listener. Broadcasts such as the symphony concerts from Queen's Hall sound like the real thing, and you would have to be there to better reproduction.

Drummer's make thorough factory tests to prevent any faulty sets being sold. Being a new firm they realise that the most important thing to remember is that the receivers must be trouble-free if they are to become universally popular, so in addition to the usual routine tests the receivers are checked in the following ways.

Every chassis is subjected to severe mechanical tests in addition to the normal electrical tests. All joints, switches and movable parts are carefully examined. After this all components are tested for values and efficiency before the coils are aligned by means of cathode-ray equipment. Then the ganged condenser is checked and the overall sensitivity of



"Four controls are all you have to worry about, although there is a fifth which governs the set's sensitivity at the back of the chassis"

the receiver measured to see whether it comes up to the standard of the laboratory receiver.

The Drummer people have found that sets often go wrong after they have been in use for only an hour or so and that the faults causing this breakdown cannot always be traced in the factory.

To overcome this fault every

BRIEF SPECIFICATION

MAKERS: Edge Radio, Ltd.
 TYPE: Drummer MS6.
 PRICE: £19 19s.
 VALVE COMBINATION: High-frequency stage (Mullard VP4), combined detector-oscillator (Mazda AC/S2Pen), single intermediate-frequency stage (Mullard VP4), double-diode triode second detector (Mullard TDD4), power pentode output (Mazda AC/2Pen), and full-wave indirectly-heated rectifying valve (Mullard IW3).
 POWER SUPPLY: A.C. mains 200 to 250 volts, 40 to 100 cycles.
 TYPE: Self-contained upright table model.
 REMARKS: One of the most powerful five-valve supers we have tried. Quality from the twin moving-coil loud-speakers is especially well balanced. Volume is more than sufficient for average use.



"The twin loud-speakers have made the cabinet larger than usual, but it is still of the upright table type"

Drummer set, before it is dispatched, is left running for a period of four hours, after which it is very unlikely that there will be any trouble. You will no doubt realise that we expected a lot from this set, after knowing all about these tests, and we gave it an unusually thorough examination.

Almost every European station was received at good loud-speaker strength, and owing to the extra high-frequency stage the daylight range was exceptionally good.



"It is suitable for A.C. or D.C. mains of any voltage with any A.C. frequency . . . simplicity of control is the salient feature"

Ostar-Ganz Universal Super-het

is the wave-change and gramophone switch. In the centre beneath the tuning dial is a toggle switch for switching the set on and off.

The tuning dial is calibrated in wavelengths from 200 to 550 metres on the medium waves and 700 to 1,950 metres on the long waves. A thin pointer travels along the tuning scale in a horizontal manner, so that it is quite easy to see to what wavelength the receiver is tuned.

This is the first super-het we have tried that uses

were received free from mutual interference, although the separation between them is only 7 kilocycles.

During a test extending over a month almost every worthwhile European station was picked up as well as some medium-wave Americans. Ninety per cent. of the stations logged could have been picked up almost any evening, but our reason for making the extended test was to find out how the new type of valve used would behave.

It is sufficient to say that during the test period there were no valve troubles of any kind, and microphony was conspicuous by its absence.

One evening after testing on the medium waveband we decided to try the set on a good aerial to see what American stations could be logged. We were rewarded by a bag of sixteen, all on the loud-speaker. Such stations as WTIC, WBZ, WIOD—over 6,000 miles away—and KDKA were all giving entertaining programmes that could be followed with ease. There were

WHAT with A.C. mains in one town and D.C. in the next, and sometimes both in the same town, it is surprising that there are not more universal mains sets available, particularly as they have now reached such a high stage of efficiency.

The new Ostar-Ganz five-valve (with rectifier) is one of the best examples of this type of set. It is suitable for A.C. or D.C. mains of any voltage, with any A.C. frequency. It is a great advantage to be able to take your set anywhere and plug it in without having to worry about the type of mains supply. It is also a boon to those on D.C. mains where the supply is likely to be changed over to A.C. in the very near future.

Until recently universal mains sets have been rather on the small side, and not like the new Ostar-Ganz super-hets.

This set uses four receiving valves and a mains rectifier when on A.C. mains; the rectifier, of course, does not function on D.C. mains. The cabinet work is rather Continental in design. A light walnut is used throughout, and has an attractive grain. The cabinet is of the upright type, the moving-coil loud-speaker being mounted above the receiver.

Simplicity of control is a salient feature, there being only three control knobs and a master switch. On the left-hand side is the volume control, which is very smooth and gradual in operation. On the opposite side

the new high-potential heater valves. The most astonishing point about this type of set is the complete absence of hum, and excellent quality. It is almost impossible to detect any trace of hum with one's ear close to the loud-speaker with the set switched on with no signal being received.

The maximum output is in the region of 2,500 milliwatts: enough for a large room. The quality is well above the average, and a moving-coil loud-speaker handles the output without any trace of rattle.

A word about the circuit used. The first stage is a screen-grid combined oscillator-detector followed by a variable- μ intermediate-frequency stage bandpass coupled to a screen-grid detector.

The second-detector valve is then resistance-capacity coupled to a double-grid output valve, and owing to the very careful design of the low-frequency side the stage-gain is exceptionally high.

Fuses are not always easy to get at, but in this set they are right on top of the chassis and are of the bulb type, which are easier to obtain than those of the tubular type.

We found on test that a long aerial was unnecessary, and that 20 ft. of wire round the picture rail gave quite good volume on about forty stations. The selectivity was of the 9-kilocycle order, but tended to be a little better than this on the medium waveband. On the long waves Kootwijk and Radio Paris

BRIEF SPECIFICATION

MAKERS: Ostar Ganz, Ltd.
 MODEL: Universal Super het Five.
 PRICE: £15 15s.; £11 11s. in kit form.
 VALVE COMBINATION: Screen-grid combined oscillator-detector (Ostar-Ganz S25), single variable- μ intermediate-frequency stage (Ostar-Ganz MS18), screen-grid detector (Ostar-Ganz S100), multi-grid output valve (Ostar-Ganz PP3), and full-wave valve rectifier (Ostar-Ganz EG100).
 POWER SUPPLY: 110 to 250 volts A.C. or D.C. at will.
 TYPE: Upright table model with exceptionally good cabinet finish.
 REMARKS: A universal receiver that solves the problem for the D.C. mains user whose supply is liable to change to A.C.

quite a number of other faint stations that we did not bother to identify, otherwise the log may have been much bigger.

For a receiver to tune in so many stations, all over 3,000 miles away, speaks very highly of the design of the detector-oscillator and intermediate-frequency stages. It must also be borne in mind that this efficiency and volume has *not* been gained at the expense of selectivity.

We feel that this type of set will become very popular, particularly for D.C. mains users.

Aircraft RADIO 1914-1918

The vast strides that have been made in radio during the past few years is strongly emphasised in this article by W. T. LOWE, who recalls the conditions and gear used in the days of the Great War for signalling between 'planes and bombing artillery

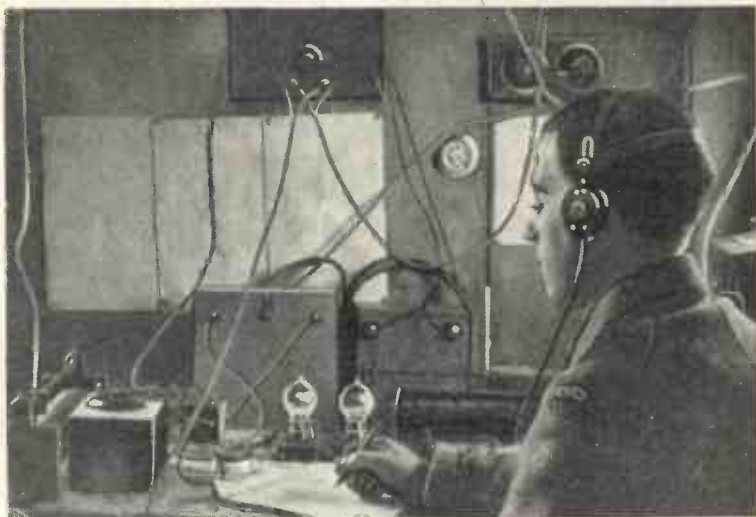

Air Ministry photo
A radio operator with his gear in the cabin of an aer plane in early War days. The long tuning coils will remind many keen experimenters of their early radio days

WHAT a difference there is between the radio equipment of the Air Force to-day compared with that of the early days of the War! In these days aircraft radio communication was confined mostly to a form of co-operation between 'planes and ground artillery. Towards the end of the War, however, telephony passed between R.A.F. bombers and ground stations, and telegraphy was used as a go-between by observers and men stationed at the batteries.

Many difficulties prevented the use of receiving apparatus on "spotting" machines in early War days. The operators—attached to ground artillery—signalled to the observer above by making code letters with strips of white American cloth. These were placed in a conspicuous position so that they could easily be seen by the men in the 'planes.

The early type of 'plane transmitter—very clumsy and heavy—occupied the observer's compartment and overflowed into the pilot's cockpit. Its total weight was about 75 lb.

In the autumn of 1915 a Sterling set weighing about 20 lb., and much smaller than the existing outfit, was introduced.

One of the first difficulties experienced was jamming of signals. This trouble was partly overcome by

tightening up the radio organisation and reducing signals transmitted to a minimum. Another cure was effected through the aid of a device called the Clapper Break, by means of which it was possible to vary the tonal pitch of a transmitter.

A ground operator could, therefore, distinguish one 'plane from another when both were working on the same wavelength. The transmitters were capable of sending signals up to a distance of ten miles and could work on only three short wavelengths. In the Ypres Salient the transmitters on the French 'planes caused a deal of annoyance. They were flatly tuned and it was impossible to get rid of their piano-like signals.

Sometimes the ether was choked and tense watch had to be kept for an expected signal. The 'planes were used as scouts and advised the

artillery below when and where to fire. Through a bombardment of extraneous signals the ground operator had to strain his ears for those which were being sent from his battery's 'plane.

Incidentally, the first type of receiving instrument was also clumsy and heavy. It measured about 3 ft. long by 1 ft. wide. Later instruments were smaller and much more efficient. They had a coupled inductance, two variable condensers, a perikon and carborundum system of crystal detectors, a buzzer for adjusting them and terminals for a valve amplifier extension.

The aerial consisted of 125 ft. of seven-stranded copper wire. A hollow steel pole in six sections, which was 40 ft. high when erected, supported one end.

If the weather prevented aerial observations, the ground operators would amuse themselves by listening to press notices from Paris, Nauen, Posen, or Poldhu. Pieces of wood, bottles, and even tin cans were commandeered for the purpose of winding telephone wire for making an extra inductance to enable the set to tune to the long wavelengths of these stations.

The wave-range of the receivers was increased by connecting this "coil" between aerial and earth.

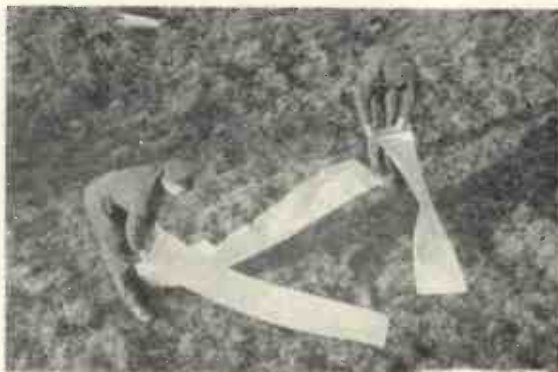

Air Ministry photo
WARTIME SIGNALLING TO AEROPLANES
Strips of white American cloth were spread on the ground to convey messages from artillery to the scouting 'planes above



(Left) Two patients undergoing the new short-wave treatment. The woman in the chair is being treated for rheumatism of the elbow joint and the other for internal trouble. (Right) A doctor applying the two electrodes to a patient who has shoulder trouble

Healing by Short-wave Radio

How the medical world is making use of the recently discovered healing properties of ultra-short waves in its war against disease is explained in this exclusive article by DR. ALFRED GRADENWITZ

IT is seldom that a month goes by nowadays without some news of broadcasting developments on ultra-short wavelengths. But more startling is the news that short wavelengths between 20 and 2 metres are being used as a healing agent in modern medical science.

those who operated short-wave gear. As far back as 1927, Dr. E. Schliephake, private lecturer at Jena University, made an interesting discovery. He was affected with a rebellious furuncle on the face, and it occurred to him that the application of ultra-short waves, with which he was experimenting, might offer some chance of a cure.

A test was made and, very much to his surprise, it proved a perfect success, for the abscess entirely disappeared within thirty-six hours. This was the first step to new

methods of medical therapy from which the most gratifying results have been obtained.

The waves used for this new branch of science, like those of wireless, are produced by oscillating electrical charges in appropriate circuits. Such a circuit is constituted by two discs facing each other, charged positively and negatively respectively and connected together by a loop of wire.

As the connection is made the opposite charges, instead of compensating one another, will start oscillating in a pendulum fashion between the two discs.

When two discs are intermittently recharged and discharged across a spark gap, continuous oscillations are set up. If electronic valves similar to those employed in radio are used in place of the spark gap, these oscillations will continue with constant amplitude. If this arrangement is coupled to an aerial, which in this case may be a simple metal rod, the waves thus generated may be sent

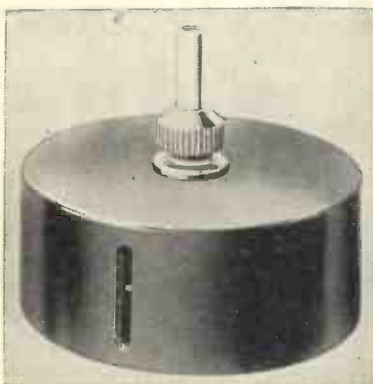

HARD RUBBER ELECTRODE
A hard rubber condenser electrode designed by Dr. Schliephake. It can be adjusted for different treatments

It was believed years ago that short-wave transmitters were the direct cause of fever and other illnesses which frequently affected



ADJUSTABLE GLASS ELECTRODE
Another of the electrodes used by the inventor. It is made of glass and can be adjusted by the movable condenser disc

out into space and used for the transmission of speech. However, for curative purposes wireless energy should not be broadcast but, on the contrary, held together and concentrated upon the part of the body under treatment. This is done by causing most of the available energy

rise of temperature. The heat produced is fundamentally different in production and distribution from heat effects due to either direct current or diathermy; the high-frequency resistance, which controls the ultra-short wave heating effect, decreases with rising frequency, that is, as the wavelength is shortened.

The maximum heat effect in a given tissue of the human body is produced when this capacitative resistance just equals the D.C. resistance.

In fact, the wavelength should, in order to result in a maximum heating effect, bear a certain ratio to the conductivity and dielectric constant of the tissue. In human tissues this ratio is such that wavelengths between 2 and 20 metres will result in maximum heat effects, which accounts for the action of ultra-short waves upon human and animal tissues.

As there are small differences of ionisation and dielectric constant in different parts of the body, the ultra short-wave field can be made to act upon certain particles differently from adjacent particles. This selectivity becomes more marked as shorter wavelengths are used.

Because of existing differences in structure, the skin, fat, muscles, bones, etc., can be submitted to special effects, limited if desired to the cells under treatment. In fact,



LARGE POWER VALVE
A water-cooled high-power valve used in the output stage of ultra-short-wave therapy apparatus

each layer will most readily respond to a given wavelength. The special shape of the electrodes used enables their effects not only to be dosed, but at the same time to be extended to the deeper organs of the body.

However, the heating of tissues is not by any means the only effect of ultra-short waves. Most bacteria, under the action of these waves, will be killed, the species varying according to the temperature. A temperature of 37 degrees Centigrade—approximately the normal blood temperature—is in most cases sufficient to kill bacteria. However, these effects vary in efficiency according to the wavelength used.

As the temperature rises the

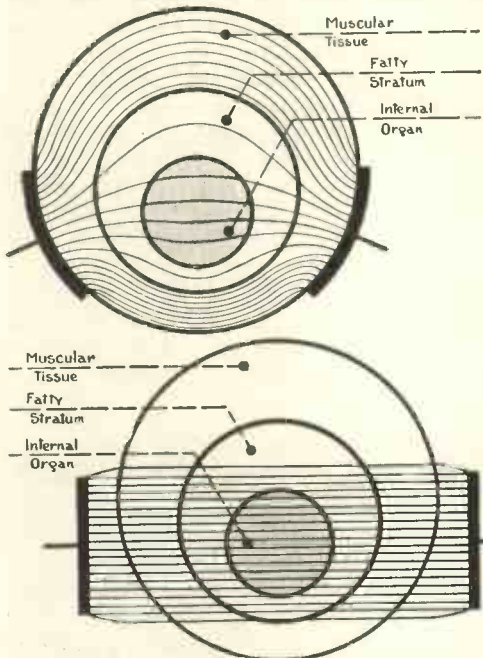

FLOW OF ENERGY THROUGH BODY
In the top drawing you will see that when the electrodes are placed against the body the flow of energy follows more or less around the various layers. In the bottom drawing you see the effect when the electrodes are not in immediate contact with the body

to pass between two discs, with the organ or part of the body to be treated in the intervening space.

The most striking effect induced in the patient's body is a considerable

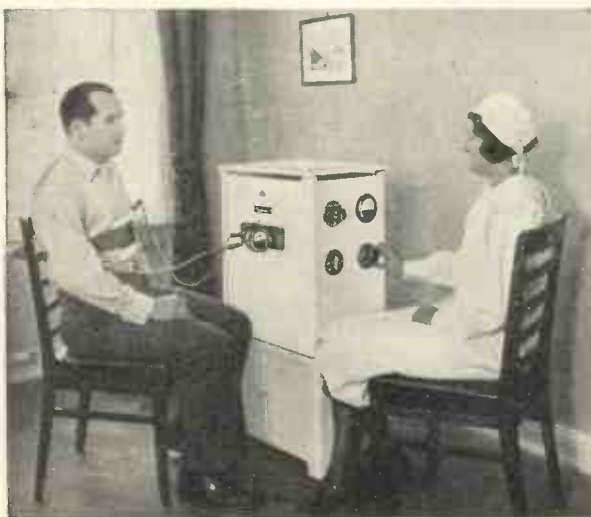

TREATMENT FOR INTERNAL DISORDERS
A patient receiving ultra short-wave treatment for a stomach complaint. The instrument used is called the Universal Radiotherm



ARRANGEMENT FOR SHOULDER TREATMENT
Two sets of electrodes are used in connection with treatment for the shoulders. As you can see, there is little discomfort attached to the sitting



TREATMENT FOR THE THORAX
A patient receiving treatment for the thorax with ultra short-wave energy

destruction of bacteria occurs more and more rapidly. Now, as most disease centres under the action of very short waves are heated more strongly than surrounding regions of the body, the healing process becomes accelerated.

The treatment also gives rise to a lively migration of white globules (leucocytes) towards the affected regions, so accelerating the cure even further. The results obtained by Dr. Schliephake's method of the treatment of furuncles are surprising; perfect cures having been obtained within four or five days in all of the 150 cases under treatment recently.

The dissolving of considerable masses of pus is noted in connection with the treatment of pulmonary abscesses and empyemes of the pleura. Twenty-five cases recently treated by Schliephake have resulted in rapid and complete cures. These affections usually show a particularly high death rate.

Chronic rheumatism can likewise be cured rapidly by an application of ultra-short waves, which enable not only the seat, but the original centre of the illness to be treated. Patients often find that the first application of the treatment relieves pain, though the definite cure may entail a treatment lasting a week or two.

Since ultra-short wave treatment raises the blood temperature considerably, and so inducing some sort

of artificial fever, it was thought that diseases such as general paralysis might be cured. The results of recent tests fully bear out this assumption.

Many cases of tuberculosis have been treated with remarkable success, and tests seem to point to the possibility of developing ultra-short wave therapy to a powerful agent in the fight against cancer.

An additional advantage of the new treatment is the fact that ultra-short waves are not hampered in their action by the patient's clothes, nor by the dressing of any wound. In fact, the electrodes, so far from touching the skin, are usually kept some distance away, thus avoiding any risk of burning the skin.

The condenser electrodes designed by Dr. Schliephake are of hollow glass or hard rubber cylinders. In the interior of these is a metal disc, which can be shifted to any desired point and so graduating the heating effect in the lower layers and making it more uniform.

The output of the ultra-short wave generators made by the Siemens-Reiniger Works, of Berlin, vary up to 10,000 watts.

Since the experiments of Dr. Edwin Schliephake in Berlin last year, Dr. Horder in England has already expressed considerable interest in this form of treatment, which will shortly be introduced to a number of the London hospitals.

Dr. Schliephake has been successful in removing lung abscesses and internal growths. The case of lung abscesses is particularly interesting, for the normal death rate in such

cases is about 40 per cent. With the short-wave treatment, however, the death rate has dropped to 1 or 2 per cent. and by means of X-ray photographs the actual effect of short-wave radiation upon internal abscesses can be followed from week to week and the most effective wavelength noted.

The actual wavelength used is of vital importance. For example, Dr. Schliephake states that sinuses of the lung are best reached by wavelengths between 4 and 6 metres,

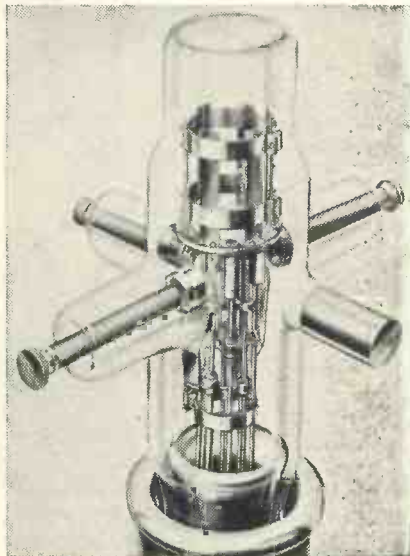

UPPER PORTION OF SIEMENS VALVE
The upper portion of a Siemens water-cooled valve as used for the new ultra-short-wave treatment

while asthma and even chronic headaches can be cured or relieved by a higher wavelength of between 10 and 15 metres.

It must not be taken for granted that these are the definite wavelengths which will effect a cure. They are only given to illustrate the point that different wavelengths are required for different complaints.

Another example of the importance of this new treatment is in connection with brain operations, or tumours of the brain. There has been definite proof that without this treatment the patient would have died.

Internal abscesses can be dispersed by the use of ultra short-wave radiation. If short-wave radiation is concentrated on an abscess, this abscess would be heated more quickly than would be a healthy tissue, because it would not be subjected to cooling by means of the blood stream.



HEAD TREATMENT BY ULTRA SHORT-WAVE THERAPY
The arrangement of the electrodes for ultra short-wave treatment of the Maxillar-Cavity

On the Crest of the Waves

Radio News from All the World : : By JAY COOTE

ALGERIA

THE local authorities are considering a plan for the replacement of the present station (Radio Alger) by a 120-kilowatt transmitter which can, if necessary, be increased in power to 200 kilowatts. With new aerial masts 660 ft. high it is expected that the broadcasts would be heard clearly by most listeners in Western Europe.

BELGIUM

Notwithstanding the desire of the Government to close down a number of private broadcasting stations, public feeling has been responsible for new licences being granted to many transmitters. These transmitters have been combined into three groups and given permission to work on 267.4, 201.1, and 200 metres, according to the areas in which they are situated.

The stations include: Radio Conference (Brussels) and Radio Schaerbeek; Binche, Châtelineau, Courtrai, Bonne Esperance; Cointe, Seraing, Wallonie—in the Liège suburbs and one in the city itself—and two small broadcasters at Verviers.

GERMANY

This summer will mark the tercentenary of the Oberammergau Passion Play, and to commemorate this event the German Reichsfunk on some date in May intends to relay an excerpt to all their stations. It is also possible that some European and American transmitters may take the relay.

I understand it was very difficult to induce the inhabitants of the village who take part in this sacred play to agree to its broadcast. Some few years ago a very substantial sum was offered by an American concern to secure the filming rights, but the permission to do so was flatly refused.

The German Government, however, has been able to bring the needful pressure upon the organisers to give the world an opportunity of hearing this unique performance.

HOLLAND

The little transmitter at Bloemendaal, one of the oldest broadcasting stations in Europe, has now increased its power to nearly 10 kilowatts. It may be heard every Sunday morning and Holy days at 9.40 a.m. taking a relay of a local sacred service, and again in the afternoon at 4.40 p.m. on 245.9 metres (1,220 kilocycles). It does not work on other days of the week.

ITALY

As in previous years the Italian stations will broadcast during April and May a series of special concerts every Monday between G.M.T. 21.00 and 22.00. They appear in the programmes under the title "Standard Hour," and constitute a pleasant form of publicity inasmuch as the expenses are defrayed by an American petroleum concern.

PORTUGAL

The 20-kilowatt transmitter under construction by British engineers at Barcarena, near Lisbon, the buildings of which have been so delayed owing to antagonism between the Portuguese Office of Works and the Ministry of Public Monuments, is not yet on the air although the local authorities had promised that it would be officially opened on October 5 last.

In the meantime Radio Parede, a station which has been installed by private means, is merrily working on 396.7 metres, a channel to which Portugal is not entitled. The 291-metre wavelength which was allotted for the purpose is still being used, it is understood, by CT1AA, Lisbon, with concerts between G.M.T. 21.30 and 00.00.

Although mention is seldom made of any other stations in that country, we find three more transmitters working respectively on 212.6, 216.6, and 245.9 metres, namely, CT1DH and CT1DR, both at Lisbon, and CT1RP at Oporto; they are of low power, but their broadcasts have been picked up in the British Isles.

SPAIN

Present political troubles so far have prevented the carrying out of the scheme for the reorganisation of the entire Spanish broadcasting system. In the meantime the authorities have granted licences to some fifty-two privately owned transmitters, most of which do not exceed 100 watts in power, permitting them to work on wavelengths of 200 and 201.1 metres.

In addition to the better known Madrid and Barcelona transmitters, Oviedo (EAJ19) and Barcelona (EAJ15) have been resurrected on 293.5 metres. The broadcasts from the smaller transmitters are mostly limited to programmes of gramophone records, short news bulletins and local talent, but it is thought that their installation over the entire country will give an impetus to radio when eventually the Government scheme is carried out.

SWITZERLAND

The Swiss authorities have decided to start immediately on increasing the power of the Beromünster and Sötens transmitters to bring them on a par with stations in neighbouring countries. As the work is to be undertaken at once it is expected that these two regional transmitters will be rated at 100 and 50 kilowatts respectively by the end of the summer.

UNITED STATES OF AMERICA

The Federal Radio Commission has been greatly worried about the transmissions made by Mexican stations on the United States border the studios of which are actually in Texas territory. This scheme was adopted to evade American laws which prohibit the broadcast of advertisements relating to quack medicines, fortune telling, and so on. It is reported that a Bill will now be passed to give powers to the Federal Commission to prevent broadcasts made in this manner.

Recording the

Some New Angles on Talking



Wide World photo

NOISES FOR MICKEY MOUSE

Most of the strange voices you hear in Walt Disney's Mickey Mouse pictures are made by Pinto Colvig, who was formerly a circus "barker"

IN the days of the late-lamented silent picture, a young man would often seek to flatter his sweetheart by telling her she had a "picture face."

"Maud, you ought to be on the pictures," he would say. "Wiv your lovely fice, you'd beat Mary Pickford to a frazzle!"

If he cared to pay the same compliment in these enlightened days of broadcasting and talkies, not to say television, he would have to assure her that she also had a beautiful voice.

Hollywood Crowds

It is largely owing to such complimentary remarks from thousands of well-meaning young men, parents and friends that the streets, soda fountains and five-and-ten cent. stores of Hollywood are crowded with would-be film stars who are (temporarily, they hope) occupied in serving behind counters or making fruitless journeys around the studios for work.

The qualifications do not end with the possession of a beautiful face and/or voice; personality is all-important, brains are advantageous, and a knowledge of the elements of dramatic art, deportment and languages is a distinct help.

And with the sum of these gifts,

plus the advantage of at least a little stage experience, the microphone may still prove to be the stumbling-block on the road to fame. Friend "mike" is no respecter of persons, and is mighty particular about the kind of sound he is permitted to pick up.

Microphone technique in broadcasting, gramophone recording, and talking-picture work has progressed very considerably in the last year

or two. In broadcasting, progress has been most noticeable in the radio-play department, which seems to have mastered very thoroughly the intricacies of the dramatic control panel—a multi-studio fading device which was at one time my own particular pet.

In gramophone work we have had our "whispering baritones" and magnificent symphony - orchestra recordings.

And in talking pictures we have lost the slow, clear, "elocutionary" method of speaking that seemed to

be so essential in the early days. Microphones, recording and projection apparatus have improved so much that actors are now permitted to use their natural conversational tone of voice, and the speed of talking has become normal or even faster than normal.

Nevertheless, the microphone still has limitations: the limitations of an instrument that is virtually trying to do the work of two ears with the equivalent of one. You and I listen with two ears, which enable us to hear the sounds of this busy world with a stereoscopic or, rather, stereophonic effect.

Put one ear out of action, and we are hearing what a common or garden microphone picks up. The sound loses a great deal of its

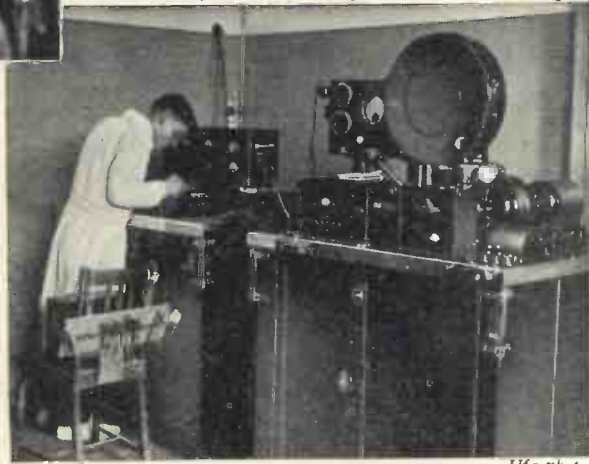

Ufa photo

THE "HEART" OF TALKIE PRODUCTION

A scene in the recording studio of a famous German film producing concern. Typical of German thoroughness, all the gear is very finely finished



G. B. Equipment photo

WHERE THE SOUND COMES FROM

When you next go to the cinema remember that the sound comes from a big power amplifier. This photograph shows a 60-watt Gaumont-British amplifier

Sound on Film

Picture Technique by BAYNHAM HONRI

perspective and the echoes and reverberation of a room are doubled, and certain characteristics of the human voice are unduly emphasised.

"S" sounds and consonants become magnified so much that in some cases voices that are apparently crisp and clear record with a hissy, spluttery sound.

This is particularly noticeable in the broadcasting field during talks, when we sometimes have to listen to "visiting" speakers with untested voices—and with special reference to political and philan-

a complex wave-form, the most prominent frequency being in the neighbourhood of 8,000 cycles per second. On the other hand, old gentlemen with whistling sibilants show a distinct preference for the 4,000- or 5,000-cycle mark.

These "highs" have always been dangerous to sound engineers, and now, with the frequency range of reproduction extending upwards, day by day, the danger is not lessened. If the recording, whether it be on gramophone record or film, is well-nigh perfect, it can still be ruined in "processing," particularly in regard to the higher frequencies.

In gramophone work, bad processing in the electroplating works, bad pressing, and poor disc composition can all ruin the highs (and consequently, on good reproducers, the quality) without appreciably affecting the rest of the musical scale.

And in film work, poor laboratory work, especially printing, kills off all the highs and introduces a peculiar form of distur-

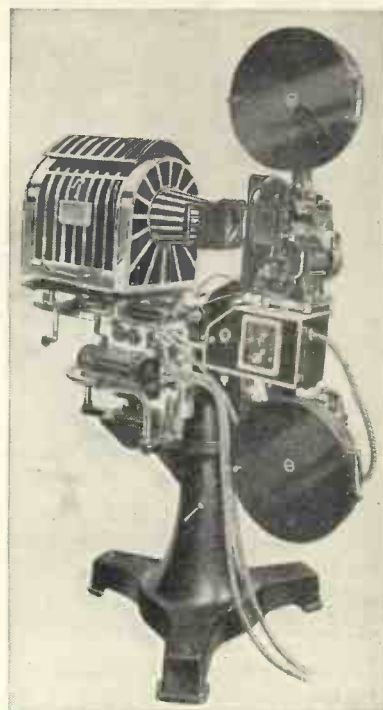

G.B. Equipment photo

PROJECTOR AND SOUND HEAD
A Gaumont-British rear-shutter projector fitted for the British Acoustic sound-on-film system. There is a lag of fourteen frames between the picture and the sound

tion similar to that created by rectification in a valve amplifying stage.

Of course, poor reproduction of the higher frequencies, by gramophone or talkie apparatus, can still ruin a good recording and a perfect print; but it is a curious fact that a *bad* recording and a *bad* print often give the best results on a *bad* reproducer!

Who, then, can say that this recording is good, or that bad?

There are so many factors to be considered that even the expert is frequently deceived. Indeed, these extreme high audible frequencies are a (necessary) nuisance.

I add the word "necessary" because it must be admitted at once that future improvement in quality of sound reproduction is largely based on the all-round improvement of the treatment the highs receive from every link in the chain.

In real life, the possession of false



G. B. Equipment photo

SUITCASE TALKIES
A Gaumont-British 16-millimetre sound-on-film portable talkie reproducer

thropic speakers.

Technically, the difficulties these sounds give the engineers are due to the strength and complexity of the "highs" in the "s" sounds and the explosiveness of the "t's" and other hard consonants. Sibilant sounds result in the transmission of high frequencies of the order of 5,000 cycles and upwards, and the peak frequency varies from person to person.

The maidenly lisp has

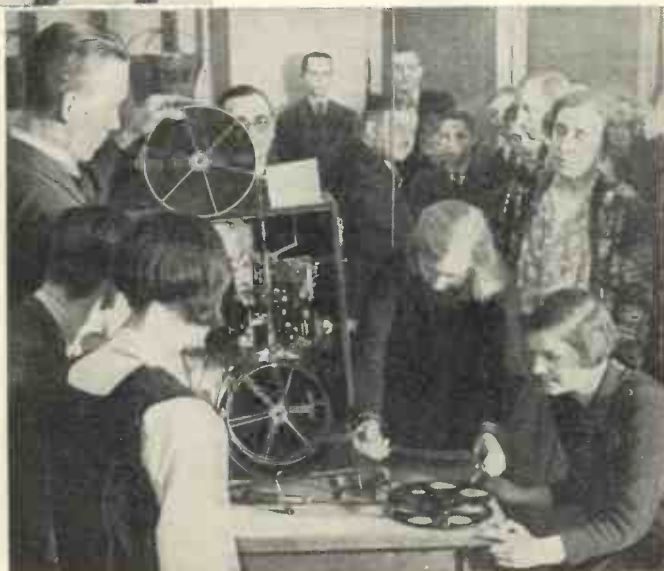

Photopress photo

"NOW WE HAVE THE 'TEACHIES'"
School children inspect a portable talkie apparatus used for special lessons. Such lessons are known as the "teachies"! There is no doubt that "teachies" will improve the standard of general knowledge



Keystone Photo

FAMOUS ACTOR AT WORK

George Arliss, the famous actor, in an unusual scene in a talkie studio. Note the compact recording amplifier

teeth by the person talking to you is not usually noticeable—audibly, at any rate. But the microphone, like the starry nights, finds them out. The click of a badly fitting plate and the very slightly unnatural “s s” register with terrific force.

Sibilants are sometimes unduly cut down in intensity by these precious aids to nature, resulting in a peculiar kind of lisp; and sometimes, more annoying still, the treacherous “s” comes out followed by a Harry Weldon-like whistle.

False-teeth Safeguards

False teeth by no means render an actor or broadcast speaker useless for the microphone; but the possessor should safeguard himself (or, may it be whispered, herself) by visiting regularly the dentist for adjustments and by practising a few vocal exercises.

The strength of “s’s” and all sibilant sounds is regulated by the distance of the tongue from the teeth. Try for yourself the effect of saying “Sister Susie’s sewing shirts for soldiers,” firstly with the tongue close up to the teeth, and secondly with the tongue drawn back away from them. You will notice at once a marked difference in the intensity and quality of the sibilants.

This is the kind of exercise all good film actors do with their daily dozen each morning before break-

fast; and what many broadcast speakers certainly don’t do, judging by what we hear occasionally during the Sunday night charity appeal and at other odd times.

The earnest and serious film actor repeats this and other vocal exercises with the tongue in the correct position, so that the sibilants are, if anything, on the weak side. Inability to master “w’s” (as in the word “wrong”) can be cured by making a special noise with the mouth that can be only written down as a “Br-r-r-r-r-r-r-r-r.”

In general, stage actors

Film actors of the silent picture days go to the other extreme: they mumble their words of dialogue in just the same way as they did the “sub-titles,” the words of which would be flashed upon the screen in letterpress just after the mouthings commenced.

Difficulties of Recording

When the extremes—stage actor and silent film actor—meet in a talkie dialogue scene, the recording engineer has an anxious time trying to prevent the first one “blasting” at the same time as he makes the second one audible.

Recently I had to record a scene in which a slightly deaf stage actor held conversation with a charming young lady, the lady being accustomed only to working in silent pictures. The bel- lowing of the stage actor (being deaf, he failed to realise how loud he was) completely submerged the twit- terings of the girl.

The acoustics of studios and rooms affect the highs, too. That is possibly why, gener- ally speaking, sibilants do not give quite so much

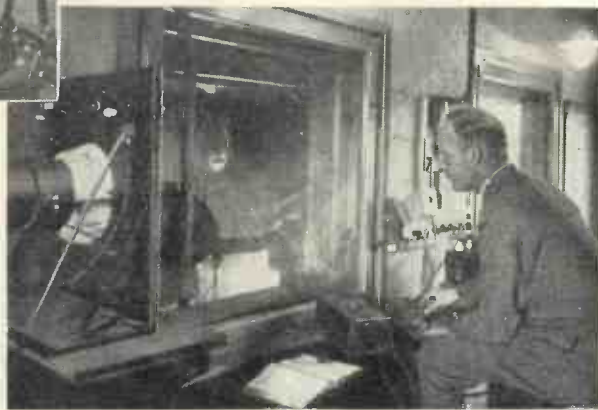

Ufa photo

BEHIND THE SCENES OF A TALKIE

A recording engineer behind the scenes regulates the volume of sound while the film is being “shot.” It is most important to avoid “blasting”

and actresses are inclined to speak too loudly and to enunciate *too clearly*, as though they intended the people in the back of the pit and gallery to hear every word.

trouble on broadcasting as they do in other microphone fields. Unlike the film studio, where settings are changed from day to day with correspondingly changing acoustics,

the broadcasting studio has fixed acoustics, known to producer and engineer.

They have found from experience the best distance to place actors from the microphone in their radio plays or revues. The rooms set aside for the broadcast- ing of dialogue are usually fairly highly damped, so that there is little reverberation or echo to contend with.



Wide World photo

MORE NOISES FOR MICKEY MOUSE

Sound-effect men in action for one of Walt Disney’s Mickey Mouse films. More than a thousand different drums and other gadgets are used for this purpose

Home Recording on Film

Will the Cathode-ray Tube Solve the Problem?

By G. S. SCOTT

"W.M." is now devoting some space to the matter of home talkies. There is no doubt that this form of entertainment is bound to come, and it is interesting to speculate how the home talkie is going to develop. Some might even say that it had now come, but its present scale of operation is hardly yet that of complete arrival.

Films Now Available

As was indicated in the April issue, there is as yet no apparatus available on the market for the home-recording of sound on film.

Meantime, however, ready-made films are on the market for home reproduction with the sound track already prepared on the film, while other systems available for home use involve synchronised discs.

The latter method is actually available for home recording, but just as the sound-on-film method has completely won the day in the world of professional or commercial films, so does it appear probable that this method will ultimately be supreme in the realm of the home talkie.

Development Difficulties

Undoubtedly, however, there are difficulties in the way of developing apparatus for the home recording of sound on film.

In the recording of commercial films the sound and picture parts are done quite separately. The picture part is, of course, directly photographed in the film-camera taking the "shot." The sound currents from the microphone are passed to amplifiers, and thence on to quite another camera on which the sound record is first made. Their

combination into one final negative (from which the ultimate positives for projection and reproduction are made) involves considerable filming and photographic processing. These call for apparatus and facilities which are distinctly beyond the scope of home operation.

As regards cost, also, such processing is quite economic on a commercial scale when many positives for circulation and hire can be made from one negative. But it remains distinctly costly for the making of the one copy which is more typical of the amateur's requirement.

The real criterion of the home talkie must undoubtedly remain the entertainment value—using the term perhaps rather widely. The sound on film now available for home projection uses the 16-millimetre film already in use for one system of amateur cinematography, with a miniature sound-track down one side just as in the standard 35-millimetre film of commercial practice.

The 16-millimetre film is prepared by the makers, and the material is normally derived by ordinary photographic reduction from a standard 35-millimetre film. The technical

difficulties of producing this film are now pretty well solved, and it is quite possible to produce a 16-millimetre film which projects a picture to the typical home talkie size with a sound-track giving quite a good quality of reproduction.

The writer had a demonstration of this kind so far back as two years ago, featuring a then current talkie of a well-known English comedian—and very good it was, too!

Economic Difficulties

Perhaps the greater difficulty is in the reproduction rights rather than in technical details. In the first place it is obvious that film producers are not going to allow their standard film to be copied for home reproduction while their "box-office value" is at all high. At least if they do the price is going to be one which the amateur is not likely to be able or willing to afford.

It is revealing no particular secret to say that these difficulties are already being experienced by firms concerned with the marketing of sound-track film for home reproduction. This is purely an economic matter.

Big Market Needed

No doubt a big enough home-talkie market would make it worth some one's while to pay the big price that producers would reasonably enough demand for the rights of a film while it is still new and of high entertainment value.

But it would need to be a fairly big market, and that certainly is not yet to hand.

Against this, however, the economic cost of processing film for educational and like purposes
Cont. at foot of
next page



Fox Photos

IMPORTANCE OF THE CATHODE RAY TUBE
Nowadays the cathode-ray tube is becoming of increasing importance. Here are some cathode-ray tubes at a television demonstration. The cathode-ray tube is likely to play a big part in home talkies

Listen to the Voice of the Records and Ciné Gear Revolutionise

WE have already explained in these pages the possibilities of synchronising a home-talkie projector with some kind of sound record—which at present must be on disc if the recording is to be carried out at home.

Recent Progress

Several firms are catering for this need, and it is interesting to see how far they have progressed. In the first place let us say at once that recording has gone ahead by leaps and bounds during the past few months, and now some really fine recording gear is available.

One of the most interesting of these systems is that developed by Partridge & Mee, Ltd., who have developed a special amplifier and turntable assembly for this purpose.

This gear is intended for serious recording and is not by any means the usual "home" arrangement with a cutting pick-up connected to a standard broadcast receiver. It is, indeed, suitable for professional use, and it is likely that in a few months many centres at which the public will be able to make their own records will be opened all over the country.

Although the blanks used have the appearance of aluminium, actually no metal cutting takes place at all when the

record is being made. Each side of the disc is covered with a special material that has a cellulose base, and it is this that is cut away; the metal is not touched at all. It will at once be thought that the records will have a soft surface, and that they must be played back with fibre



FOR DIRECT RECORDING ON DISC
This new Parmeko direct-recording outfit is provided with a heavy turntable driven by a synchronous motor. It cuts perfect records that can be played many times with a steel needle

25 watts distortionless!

PARMEKO

Power Amplifier

If we say that the quality of reproduction obtainable from this amplifier is quite up to our usual standard, readers will know that this means something more than the usual superlatives and sounding phrases. It is a four-stage unit capable of working off a Photo-Electric Cell, for which a variable supply of H.T. is arranged. Choke filter and milliammeter for overload indication. Also supplied for direct Microphone Input for P.A. work. Price complete **£36**
Write for price list B.

PARTRIDGE & MEE, LTD.

AYLESTONE PARK, LEICESTER (Aylestone 487) and
74 NEW OXFORD ST., LONDON, W.C.1 (Museum 5070)

Home Recording

Continued from

does not appear prohibitive, and this "institutional" use is possibly one of the first developments in the way of the small-scale talkie.

It has already been said that the recording of a complete film with sound and sight on the same strip is still a matter beyond amateur scope. As in all things, however, the demand creates the supply, and the home-recorded talkie is certainly something for which the technicians must strive.

"Running Commentary"

Apart from mere technical difficulties (for example, pure electrical development) another difficulty in the way of the home talkie is the conditions under which it is often taken—conditions imposed by the very nature of the subject matter.

For example, that seaside romp, which was so easily taken on the small ciné camera, would not have been quite so easy, and possibly not so natural, if it had involved the setting up of sound-recording gear. But it would nevertheless be quite attractive to be able, later, to add a "running commentary" timed to

World—and See it as Well!

Entertainment in the Home

needles, but this is by no means the case. The surface, without any baking or other treatment of any kind, will stand a steel needle and will give as many as thirty or forty playings before the quality of reproduction depreciates to an extent that can be noticed by the ear.

Immediate Playing Back

The advantage of this system is, of course, that the records can be played back immediately the recording is completed. You can run your film through on the screen and make a running commentary on the disc to keep in synchronism. The latest Parmeko recording outfit is run from a synchronous motor, so that the speed is quite constant.

There is some difficulty about providing synchronisation between the projector and the film, but this

will not matter if the recording is only a running commentary.

The amplifier made for recording by Parmeko is an ambitious job for the average listener, but it will interest a number of readers who can afford the very best gear for their experimental radio and talkie work. It has an output of 25 watts.

The complete amplifier, for mains operation, of course, costs £36; the recording gear about £25; and a microphone can be obtained for a



THE QUALITY DEPENDS ON THE AMPLIFIER
You cannot expect to make good records with a poor amplifier. This is a Parmeko 25-watt job specially developed for the purpose and will interest all talkie enthusiasts

further £7 7s. The equipment is not cheap, but it is really well made.

Eric J. Lever (Trix), Ltd., make a 3.5-watt amplifier that will be found useful for playing records, whether professionally made or made at home.

On Film

page 353

the movement, and this could be done at home!

The greatest need in the way of home recording on film is a simple method of getting light variations to photograph. Some of the methods in professional use are likely always to be beyond the possibility of amateur use.

A method which appears to offer possibilities in the amateur field is the use of the cathode-ray tube, an instrument which is already well known in many other applications. The cathode-ray tube can now easily be made to give sufficiently bright fluorescence to be photographed and many applications to photographic recording of other phenomena have already been described.

Cathode-ray Advantage

Some of these, indeed, appear to be much more difficult than the photographing of a sound track. Another distinct advantage of the cathode-ray tube is the relative simplicity of the photographic methods that are possible with it, for example, great simplicity of the camera.

QUALITY Amplification and Sound Reproduction

To obtain speech or music amplification at its best, it is essential to use first grade apparatus.

Let us know your particular problems and we will willingly give you helpful and understanding advice, and the benefit of our extensive experience in all branches of sound amplification.



ALL BRITISH SOUND EQUIPMENT

for all Reproduction and Recording purposes.

MICROPHONES, AMPLIFIERS LOUDSPEAKERS, ALL-MAINS AND BATTERY-DRIVEN EQUIPMENTS

THE TRIX ELECTRICAL COMPANY LTD.
8/9 Clerkenwell Green, London, E.C.1
Phone: Clerk. 3014-5. Telegrams: Trixradio Smith
Contractors to H.M. Government London

ELECTRADIX MICROPHONES



No. 11, 5/6

GENUINE EISEL MICROPHONES

at Bargain Prices.
A 25 Microphone of incomparable quality and wide frequency response range at sacrifice price of 55/-. Special cushion mounting in this make only. Limited number at 55/-. Handsome Stand for table P.A., 15/-. Matched Transformer, 7/6.

PROJECTOR LAMPS
Philips' 22-volt, 600-watt, S.C., 2 at 17/6 each; Siemens, 100-volt, 400-watt, S.C., 2 at 15/- each; G.E.C. 10-volt, 500-watt, S.C., 15/-; 100-volt, 1,000 watt, S.C., 17/6; 18-volt, 600-watt, S.C., 15/-; 6-volt, 300-watt, S.C., 2 at 12/6 each; 9-volt, 1,000-watt, S.C., 21/-; 9-volt, 400-watt, S.C., 12/6; 12-volt, 48-watt, C.C., 3/6.



EISEL only 55/-

70/- With Stand



No. "W.M." 11/6

No. "W.M." 11 TABLE MIKE. This is a splendid little pedestal Microphone for speech and music. The bakelite case, containing a 2-in. mike and transformer, is on a bronze pedestal. Switch and plug sockets are fitted on the case. It stands unrivalled for quality and price ... 10/6

CROONERS. Lapel Mikes for dance bands. American type model 12/6

LENSES. Concave lenses, 1 1/2 in. diameter, in brass housing, 2 1/2 in. long; fitted 'map' shutter in centre of housing, 7/6. Concave lenses, 3 in. diameter, fitted in brass housing, 1 1/2 in. long, 12/6. Write for Complete List "W.M."

Ask for May Bargain List, W.M.

ELECTRADIX RADIOS
218, UPPER THAMES STREET, LONDON, E.C.4
Telephone: Central 4011



More About the Spectrum Portable

Designed by the "W.M." Technical Staff

makes for good balanced reproduction.

Only three valves are used, a variable-mu screen-grid high-frequency amplifier, and a triode detector which feeds into the QP21 output stage.

The description published in the April issue included drawings of the cabinet and the frame-aerial windings—showing all the dimensions—and a half-scale reproduction of the blueprint. There is hardly any need to remind readers that they can obtain a full-size blueprint of any "W.M." design. The Spectrum blueprint is No. 357 and can be obtained for 1s. post paid from the "Wireless Magazine" Blueprint

WE make no apologies for repeating brief details of the Spectrum Portable which was described fully in our last issue. Most wireless fans are portable-minded at this time of the year, and we know that the Spectrum is an outstanding proposition; it is reasonably cheap to build, and it gives satisfactory results.

Design in Brief

First let us run briefly over the high-spots of the design. We had in mind, when we designed this set, the love of the average Englishman for "messing about" at home. So we decided that the cabinet of the Spectrum should be of the home-made variety that could be coloured to suit the builder's own home-furnishing schemes, or perhaps the inside of his car, if he is lucky enough to have one.

Several leading paint concerns have introduced new quick-drying paints—Robbilac, Nu-old, and Woolworth's new Chinese lacquer, for example—which give a good polished finish. These new paints are available in all colours of the rainbow, and are so easy to work that anyone can make a good-looking job of colouring the box.

Large-power Output Stage

There are several reasons why we know that the design of the Spectrum is first rate. We have used the new Marconi-Osram QP21 output valve, which, as you probably know, gives an output of nearly a watt with little drain on the high-tension battery. Another advantage of this Q.P.P. valve is that it does not need a driver stage, and we immediately save money and, what is more important, we save valuable space.

Quality is of a high order, the large power fed into an efficient moving-coil loud-speaker

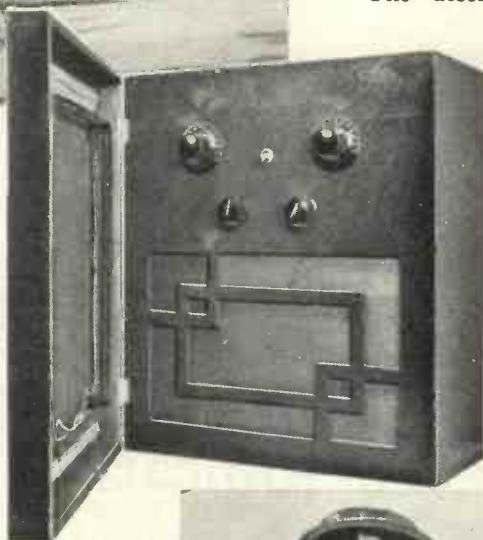

AN IDEAL SET FOR OUTDOORS
(Left) the finished set in its home-made cabinet. The frame-aerial windings can be seen inside the lid

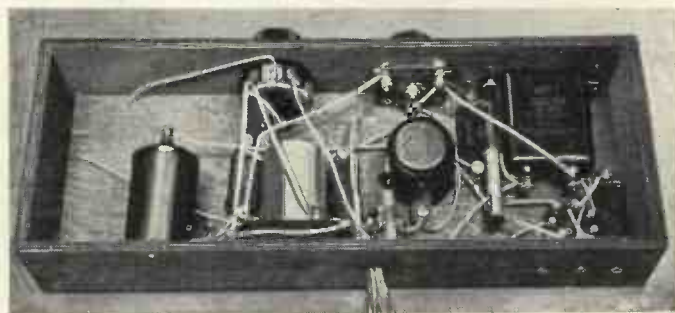
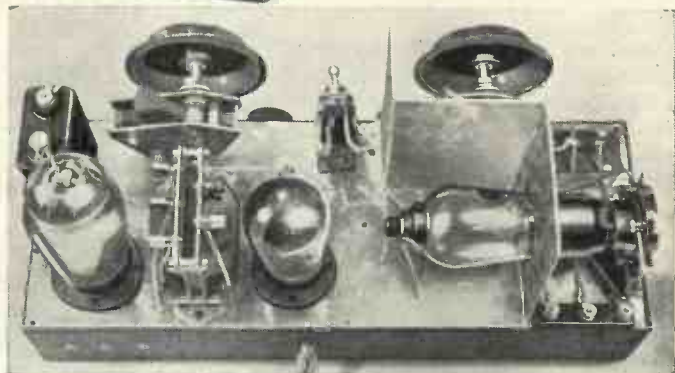

CONSTRUCTION IS VERY SIMPLE

As you can see from these two photographs the construction of the set chassis of the Spectrum is straightforward. Note the position of the tuning coil in the bottom illustration



High-frequency Coupling and the Detector Stage

By

Percy W. Harris

M. Inst. Rad. E.

SO far, we have considered the design of a wireless receiver up to the point where we have effected a suitable aerial coupling, tuned the first circuit, and applied the signals so received to the grid and filament of a screen-grid valve. We are now in the position where, if we connect a high-tension battery of suitable voltage to the screen-grid valve, variations of plate current will occur in the anode circuit corresponding with the variations of voltage applied to the grid.

Principles of High-frequency Coupling

If, now, we are to apply our signals to the next valve, which we will assume is the detector, we must supply to the grid and filament of the detector, voltages corresponding in form to those applied to the grid and filament of the high-frequency valve, but, of course, amplified. The problem of high-frequency coupling is, therefore, how to change the variations of anode current in the high-frequency valve into variations of voltage to apply to the grid of the detector.

Essentials of the Circuit

In Fig. 1 we find the real essentials of the circuits we are talking about. You will notice that the tuned circuit L_1, C_1 applies voltages to the grid, and the plate circuit is connected through X to B.

Now X must include the high-tension battery, which we will assume has a resistance of only a hundred or two ohms at the most. If now

we connect the grid and filament of the detector valve via the grid condenser to the points A and B, what happens?

Obviously no direct current can pass through any path other than X and the only effect on the detector valve will be that of any high-frequency voltage set up across the points A and B. The only voltages available here are those set up across the high-tension battery and the slight changes through this (the plate current, of course, is in the nature of milliamperes only) will be so small as to be negligible.

In Fig. 2 we have included a resistance R in series with the high-tension supply. The position now alters and if the impedance of this resistance R is equal to that of the valve itself, the voltage change occurring in the plate circuit will be divided equally between the valve and the resistance, and really useful voltages can be applied to the detector.

The internal resistance of a valve of this kind is many thousands of ohms and, as previously mentioned, the internal resistance of a good high-tension battery should only be a comparatively few ohms, therefore in Fig. 1 practically the whole voltage drop occurs in the valve itself whereas in Fig. 2 a good deal of it takes place in the "load" R, the voltage changes across which are easily applied to the detector valve.

Resistance coupling is not very practical on ordinary broadcast wavelengths for reasons I have not space to discuss in any detail here,

except to say that the numerous small capacity effects by-pass for high-frequency voltages a good deal of the voltage which we should like to use.

Impedance Coupling

If a simple impedance form of coupling is desired it is preferable to use the scheme shown in Fig. 3, where we substitute a choke for the resistance. Such a choke has both

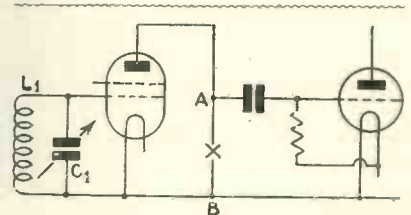

Fig. 1.—Essentials of a high-frequency coupling circuit shown in diagrammatic form

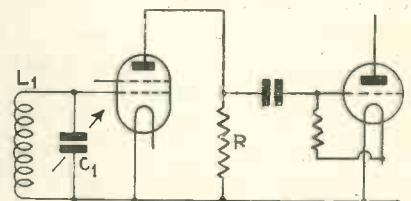

Fig. 2.—This is similar to Fig. 1 except that a resistance has been included in series with the high-tension supply

advantages and disadvantages. It is impossible to wind a choke of this kind without some self-capacity between windings and this capacity works with the inductance to form a tuned circuit, which may or may not be useful according to what its frequency happens to be.

If the stray capacity together with the inductance of the choke bring about resonance at the frequency we desire to receive, all will be well, for when this circuit is tuned and is in the position shown (between the

plate and the high-tension battery) then it will offer a maximum impedance to the frequency we desire to receive and therefore a maximum voltage across itself for application to the detector valve.

It is, however, possible to design a choke which will offer a reasonably high impedance to all the frequencies we desire to receive without giving any awkward resonance effects, but the scheme has a number of disadvantages.

More Efficient Method

Fig. 4 is a further step forward because we can design the tuned circuit $L_2 C_2$ to have the same frequency as $L_1 C_1$ when it will have a maximum impedance to the voltage we want to receive and a very low impedance to others. Thus not only do we get a higher efficiency here, but we add to the sharpness of tuning; any unwanted frequencies getting through the first tuning system $L_1 C_1$ being still further attenuated by not being of the actual tuned frequency of $L_2 C_2$.

Fig. 2 is known as resistance coupling, Fig. 3 as choke or impedance coupling and Fig. 4 as tuned-anode coupling.

Tuned-transformer Advantages

In Fig. 5 the primary of a transformer is substituted for the inductance L_2 on Fig. 4, the secondary of this transformer being tuned in the usual way. This is known as a tuned-transformer coupling and has a number of advantages in the way of sharpness of tuning; it is also easier to gang.

So far I have made no reference to questions of stability, which are very important in high-frequency coupling. Take for example, Fig. 4, where there are two tuned circuits $L_1 C_1$ and $L_2 C_2$ both resonating at the same frequency. A very small coupling between the two circuits is sufficient to bring about reaction effects and self-oscillation and the same applies to Fig. 5.

Fig. 3 is more stable because the tuned circuit $L_1 C_1$ is practically always out of tune with the natural frequency of the choke CH plus its distributed capacity. If, however, we happen to tune $L_1 C_1$ to the natural frequency of the choke, then, unless we have taken particular

precautions to prevent coupling, the whole set may burst into self-oscillation.

When radio-frequency chokes are included in the plate circuit of high-frequency valves or detector valves, they are usually designed to have a frequency well out of the broadcast band, either medium or long wave, but badly designed chokes frequently have their natural frequency somewhere in the long-wave band. Many readers may have noticed how some sets have suddenly become unstable when tuned just above Radio Paris or perhaps below the long-wave National.

The reason is that the radio-frequency choke and the signal circuit have both been brought into resonance with one another.

A form of coupling which has been used a good deal, and which is a combination of the scheme of Fig. 3 with Fig. 4, is shown in Fig. 6. The simplification of a circuit by omitting batteries, etc., makes it appear different from the conventional way of drawing it, but it is thereby easier to understand.

In the scheme it will be seen that the voltages set up across the choke are applied through the condenser C_3 to the tuned circuit $L_2 C_2$. The condenser C_3 is merely a blocking condenser to prevent the short circuiting of the battery through the inductance L_2 . By tapping down on this coil, tuning can be still further sharpened and the circuit, while not of extreme efficiency from the magnification point of view, has many advantages in the way of stability, etc. Its theory is not simple for choke and tuned circuit work in parallel.

The diagrams Fig. 1 to Fig. 6 do not, of course, complete all possible forms of high-frequency coupling, but they are sufficient to indicate the general principles, for modifications are really combinations of one or more of the methods.

Screen-grid Valve Advantage

The real advantage of the screen-grid valve in such circuits as Fig. 4, Fig. 5 and Fig. 6 is that the small capacity between the plate and grid

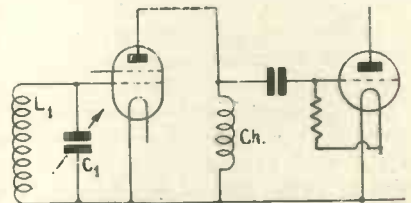

Fig. 3.—A simple form of impedance coupling; a choke is used in place of the resistance shown in Fig. 2

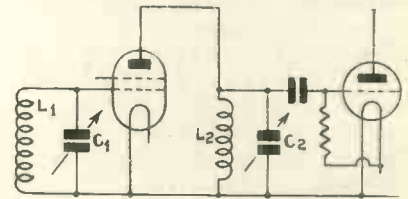

Fig. 4.—Another method of high-frequency coupling. This diagram shows the principle of tuned-anode coupling

of the ordinary triode—quite sufficient to couple two tuned circuits and thus give self oscillation even with the most careful exterior screening—has been removed by means of the screening grid.

At the same time the elimination of capacity between the plate and control grid of the screen-grid valve is not perfect and we still have to be careful in our circuit design.

Selectivity at present is largely a question of the number of tuned circuits so that the inclusion of a tuned circuit in a high-frequency coupling may be highly desirable from the selectivity point of view, even if it is unnecessary from the amplification aspect.

The importance of eliminating all stray capacity couplings will be evident from the examination of these diagrams, particularly when the valves used are of high gain. When laying out the parts of a set, therefore, place them in such a relation to one another that vital leads, such as that between

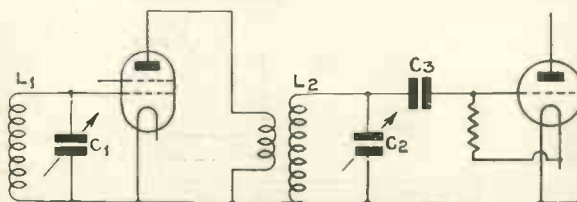

Fig. 5.—Showing the principle of tuned-transformer coupling. This has a number of advantages over other methods

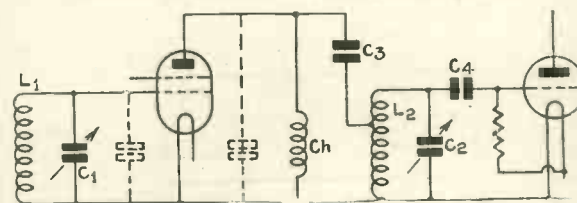

Fig. 6.—A form of coupling which is a combination of choke, or impedance, coupling and the tuned-anode method

the tuned circuit of a valve and the grid of the valve and similar leads of the next valve, are not likely to influence one another.

You will now see, too, why the grid lead in the Ethergram receiver, to which I referred last month, is so important.

Advantages of Screening

Screening of important leads is a great help, but in view of the fact that the screen must be earthed and forms one plate of a condenser, the other plate of which is the wire being screened, you must take great care not to introduce inefficiency thereby.

If you look at Fig. 6 you will find two dotted condensers, one connected to the grid of the high-frequency valve and the other to the plate. If the lead from the condenser C_1 to the grid is shielded and the shielding earthed, the only effect will be to add a certain amount of capacity in parallel with C_1 . The trimmer of C_1 can be altered to compensate for this so as not to upset the ganging.

If, however, the plate lead is shielded, unwanted capacity may be introduced across the choke CH , and by reason of this shunt capacity the voltages set up across CH may be reduced to some extent. No amount of compensation of trimmers anywhere in the set can restore what you have lost in this way.

Keeping Leads Short

Keep all your vital leads short and by careful layout obtain your stability as far as possible without the use of long screened leads. In circumstances such as Fig. 6 if there is interaction between grid and plate leads then obviously it is better to screen the grid lead rather than the plate.

Remember, too, in all of these discussions that the by-passing effect of a condenser shunted across an impedance increases very rapidly with frequency. An amount of capacity shunt, which may have practically no effect on the long-waveband, may occasion a very serious loss on the lower part of the medium band.

I have been much amused by the changes in fashion in the detector circuits of high-frequency sets. A few years ago certain writers suddenly showed a tremendous liking for anode-bend detection and endeavoured to persuade us that grid leak and condenser detection

would inevitably give distortion.

Some time later all kinds of theoretical reasons against anode-bend detection were discovered and then, not so long ago, so-called "power" detection using grid leak and condenser again came into being. This is not the place to discuss the various theories of detection, which have already been discussed at length in these pages. I want to confine myself to practical aspects of detector-circuit design.

Let us therefore consider first of all Fig. 7 and Fig. 8 respectively. In both of these cases we are using a grid condenser and a grid leak, the values of which we will not for a moment discuss. We will assume, in this case that, the same values are used for both examples. In Fig. 7 the grid leak is shown shunted across the condenser and in Fig. 8 the grid leak is taken from the grid down to the filament direct. What are the practical points and differences here?

If you have studied leaky-grid detection you will know that, due to the fact that the grid is positive, a grid current flows—that is to say electrons pass from the filament to the controlled grid and must naturally complete their path through the grid leak back to the filament.

It does not matter for detection

whether in passing from the grid to the filament they go through the inductance L_1 which has a negligible resistance compared with that of the leak, or if they go straight back to filament as in Fig. 7. Of course in Fig. 8 the resistance is shunted across the tuned circuit $L_1 C_1$ (strictly speaking the condenser C_2 and the resistance R in series with one another are shunted across this tuned circuit) whereas in Fig. 7 the resistance is in series with the tuned circuit.

Several Advantages

In practice these matters are not important. From a practical design point of view, however, the scheme of Fig. 8 has several advantages, for in Fig. 7 the grid leak must be connected to the same polarity as that to which the condenser C_1 and inductance L_1 are joined, whereas in Fig. 8 the leak can be connected to either negative or positive filament without regard to where the condenser C_1 and the inductance L_1 are joined.

It is universal practice nowadays to join negative to earth in battery sets whereas the grid leak is always connected to positive, and so Fig. 8 is naturally that most generally used.

One of the important things to consider in set design is the damping effect of the detector on the tuned circuit. The effect of the grid current in the detector circuit is to give very considerable damping to any tuned circuit connected with it for which reason the circuit shown in Fig. 4, for example, gives much flatter tuning than one might first imagine. Fig. 5 gives much sharper tuning and in Fig. 6 tapping down improves matters, for the damping effect in one circuit is very easily reflected back into the previous circuit.

Reducing Damping Effect

In Fig. 9 is shown a method of tapping down the inductance L_1 in order to reduce the damping effect of the detector on the circuit C_1 , but, of course, as we are dependent upon voltages set up across $L_1 C_1$ any tapping down reduces the voltage applied to the detector.

Most amateurs are in the habit of using a grid condenser of .0003 microfarad and a leak of 2 megohms, particularly as these values are obtainable everywhere, but it can easily be shown that these values are by no means ideal.

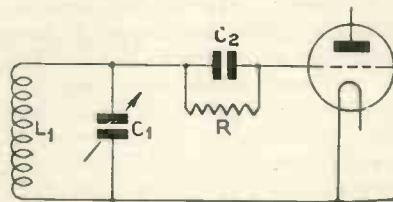

Fig. 7.—The grid leak is shown shunted across the grid condenser

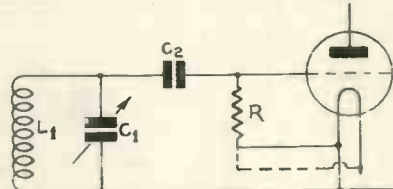

Fig. 8.—Another method showing the grid leak connected between the grid condenser and the filament circuit

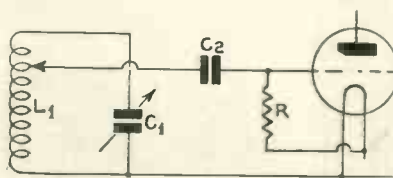

Fig. 9.—Here the inductance L_1 is tapped down to reduce the damping effect of the detector circuit

SUMMER is almost here again, and with it, I suppose, comes a change in our listening habits. No longer shall we huddle round a great fire listening to big orchestras thundering out forty-five minute symphonies. Our tastes will turn to lighter material, and it is to be hoped that the B.B.C. will do its best with the light-entertainment productions.

I paid my monthly visit to Broadcasting House just after Easter and was told that the time was rather early to give any definite news, but I could rest assured that every effort was to be made to



Columbia photo

Two popular artists who frequently entertain you, Malcolm McEachern and B. C. Hilliam. You know them better as Floisam and Jetsam

Broadcast Music of the Month

By T. F. HENN.

improve the summer entertainment. Probably many of you will do the same as I do when the weather is good—take a loud-speaker out into the garden and enjoy the programmes there. Please don't accuse me of giving publicity to a practice which has caused many domestic troubles.

There is nothing wrong in having a loud-speaker in your garden providing you remember that your next-door neighbour may not be a wireless enthusiast and probably hates the noise.

I have a very small moving-coil instrument that I fix up in my garden. I put it on the ground quite near to my chair. The volume is kept down and you can't hear the sound if you are more than a few feet away.

The idea is worth trying, but don't blame me if you get into trouble because you have disregarded my advice about a small loud-speaker and low volume.

I heard a funny story the last time I was visiting a press official at Broadcasting House. This does show how rumours get about. While we were talking, the radio correspondent of a London newspaper 'phoned up and asked if it was true that Eric Maschwitz—the light

entertainment director—gave lessons in hairdressing at the Regent Street Polytechnic. The "Polly"—as the place is nicknamed—is only a stone's throw from Broadcasting House.

After muzzling the telephone



An Irish singer and actor who makes frequent appearances in light entertainment, Denis O'Neil



Maurice Elwin has made a serious study of correct singing for the microphone. This famous artist has been heard several times recently

mouthpiece, the official got through to Maschwitz and asked him to confirm or deny the story. The truth of the matter originated from a remark by Maschwitz, in which he said that in preparation for the world revolution that everyone was talking about, he thought it would be a good idea to learn a trade and hairdressing was not a bad one.



Columbia photo

Henry Hall is in the news this month. His band has been chosen to play at the Command Variety show at the Palladium on May 8. There has been a lot of talk as to whether Henry Hall would or would not make music-hall appearances. I have it from a very reliable authority that he will make occasional appearances. Henry is very bucked at the honour of being chosen for the Command show.

Two other interesting tidbits are that Eddie Carroll, the band's new pianist, has decided to leave the band in April, and that the band would continue to give the late dance music on Saturday nights until the end of May.

This "guest-night" business has

(Above) Two famous duet-tists, Layton and Johnstone recently celebrated the tenth anniversary of their partnership. They have appeared many times before the "mike."
(Right) A violinist who is a great favourite with listeners, Alfredo Campoli



rather taken my fancy. I think it is a good idea, but at the moment it needs brightening. The way it is done is much too stiff; more turns of a general nature with not so much talk is what is wanted.

Personally I am very sorry that Bert Ambrose is off the air for the time being. I want to hear this band back in the programmes; any night

will do. It is still one of the finest British dance bands.

As a final to the season's highbrow music, the B.B.C. has again organised a London Music Festival to take place in Queen's Hall during the first fortnight in May. The big orchestra of 119 players will be conducted by Adrian Boult for the first three concerts on May 4, 7, and 9, and by Bruno Walter, the celebrated German conductor, on May 11, 14, and 16.

The music is particularly well chosen. Music of all types will be

heard from Bach, Beethoven, and Brahms to Hindemith, Bax, and Richard Strauss.

The concert on May 7 will consist of a performance of Hindemith's oratorio, *Das Unäufhorliche*, which, you will remember, was given its first British performance at a B.B.C. Symphony Concert in March, 1933. It was considered the



Harry Bentley, one of the vocalists heard with Charlie Kunz's band from the Casani Club, London



Another of the Casani Club vocalists, Dawn Davis. Miss Davis is often heard in the role of the band's announcer



Heard in the Sadler Wells relays, Joan Cross, soprano, started her musical career as a violinist at the age of six

most outstanding work given that season.

In addition to the orchestra and the B.B.C. Chorus, Adelheid Armhold, Parry Jones, Arthur Cranmer, and Harold Williams will be taking part.

From my own point of view the most interesting concert will be that heard on May 9. We were to have been given the pleasure of hearing Sir Edward Elgar's third symphony, but, as I mentioned last month, the work was not sufficiently advanced at the time of Elgar's death to enable even an unfinished version to be given. In its place the orchestra are playing the famous *Enigma Variations*.

Other high-spots of this concert are Tchaikovsky's *Concerto No. 1 for Piano and Orchestra* with Vladimir Horowitz as soloist, the first performance of Arnold Bax's *Fifth Symphony* and the first performance of the winning overture in the *Daily Telegraph* competition for 1934.

Of the concerts conducted by Bruno Walter, the most outstanding is that on May 14. Bruno Walter is himself playing the solo part in a



A famous pianist who makes frequent appearances on the air, Clifford Curzon. He was heard in the Sunday evening orchestral concert at Easter

Mozart piano concerto. This concert also includes two little heard Bruckner compositions, the *Ninth Symphony* and the *Te Deum*. The soloists for the latter work will be Isobel Baillie, Enid Cruickshank, Heddle Nash, Arthur Fear and a part of the Philharmonic Choir.

Quite a good series of concerts to satisfy all tastes!

May 3 will see the broadcast of a show that is called the Imperial Airways Programme. This pro-



Norman Stone is a member of that famous sextet, the English singers. He served through the war, and afterwards became tenor soloist of the London Bach Choir



Formerly leading dramatic soprano at the Imperial Opera, Petrograd, Oda Slobodskaya has been heard several times over the air in this country

gramme, which will be arranged and produced by Lance Sieveking, covers in a dramatic form with dialogue, the development of commercial aviation.

The first Wright flight and also the way in which the Great War fostered the development of flying will be portrayed.

The programme is intended more or less to commemorate the fifteenth anniversary of Imperial Airways. At the time of writing the programme has not been officially announced but it is entered for presentation to listeners on May 3.

Now I know that this is hardly a musical topic, but it sounds very interesting. Interesting because it leads me to ask; "What is a sponsored programme?"

Great strides are being made with the new studios that the B.B.C. are building at Maida Vale. You will remember that they recently acquired a disused skating rink at Delaware Road in North West London to take the place of the river studio known as No. 10, which may be wanted if a new Waterloo Bridge is built.

The new orchestral studio will be ready for use sometime this summer. It will be much larger than No. 10 and besides having ample room for the big orchestra and the National Chorus, it will hold an audience of 200 people.

Meanwhile the B.B.C. say that they intend to keep No. 10 as long as they possibly can. The new studios will be a permanent home for the big orchestra.



A new photograph of Lew Stone and his band. Recently he has been broadcasting from the B.B.C. studios. This is one of the few British dance bands that is really improving in style and performance. Lew Stone is going back to the Marseigneur Restaurant from which he will broadcast. Al Bowlly is at the "mike"



Young students receiving instruction in radio at the Music Trades School, Holloway, the only school of its kind in the country

characteristic of the apparatus appears to have been seriously curtailed both at the higher and the lower end, and the resultant reproduction seems to consist entirely of the middle register and is consequently lacking both in body and definition. This is actually no fault of the receiver or amplifier, but is due to that very unruly piece of apparatus—the human ear.

Response of the Ear

When listening to low-volume sounds the ear responds much more readily to the middle register than it does to the upper and lower ends of the musical scale. Therefore what seems to be necessary is, first, a receiver which has a reasonably straight-line characteristic when delivering its full output of one or two watts; secondly, a form of

THE idea of tone compensation is by no means new. Various devices have been used for the past few years to make up for deficiencies in loud-speakers and other parts of the reproducing apparatus in order to obtain an output which sounds something like the original.

Recording Deficiencies

It is well known that, when a gramophone record is reproduced, there is a serious lack of the lower frequencies from 250 cycles downwards, owing to deficiencies in the recording mechanism. A simple tone corrector circuit placed either directly across the pick-up, or in the first stages of the amplifier, can be easily made to correct this defect and give an output either from the pick-up circuit or from the amplifier, corresponding to that which would be obtained if the recording level were constant from 50 cycles upwards.

Simple Method

In a similar manner an amplifier or other piece of reproducing apparatus can be corrected for deficiencies in amplification of any part of the frequency band. The well-known device consisting of a resistance and condenser in series across the loud-speaker, when a pentode output valve is used, is merely a simple

Automatic Tone Control for Your Set

By S. RUTHERFORD WILKINS

method of tone compensation to cut down the amplification of the valve at the higher frequencies.

Without this simple compensating circuit the high impedance of the pentode would cause severe peaking in the neighbourhood of 4,000 cycles and upwards, and would render the output distinctly strident and unpleasant to the ear.

All these devices referred to relate to fixed methods of tone compensation to make up for inherent deficiencies in the reproducing apparatus, and have the same effect on the frequency characteristic whether a large or small sound output is obtained from the loud-speaker. Not one of these devices, however, counteract the unpleasant effect that is obtained when a reproducer with a fairly constant frequency characteristic at a normal output of about 1 or 2 watts has its sound output reduced to 100 or 200 milliwatts.

At low-sound output the frequency

automatic tone compensation for increasing the response of the receiver at the upper and lower ends of the frequency scale as the volume of output is lowered.

At any given output level, the amount of tone compensation should be just sufficient to compensate deficiencies in the audible frequency range. The amount of apparent attenuation is greater with the lower frequencies and it is the loss of these frequencies which makes music reproduced at a low level sound so unpleasant.

Pleasant Quality

The loss of the higher frequencies merely causes loss in brilliance, but is not really so serious. A simple way, therefore, to make the output from your receiver sound reasonably pleasant at low levels is to arrange for the amplifier to have a rising characteristic at the low-frequency end, the slope of which gets steeper as the output is decreased.

This can be simply accomplished by the use of the circuit shown in Fig. 1a. A straightforward resistance-coupled amplifier is shown; the volume control taking the form of the grid-leak potentiometer A. Across the anode resistance is shown a tone-compensating circuit consisting of a variable resistance B in series with a fairly large fixed capacity of about .1-microfarad.

If B and A are now ganged so that B decreases as the volume control A approaches its minimum, the amount of bass compensation provided will thus increase as the volume of output decreases.

Loud-speaker Control

Provided that B is chosen to have a fairly large maximum value, the compensation will not become really noticeable until the volume control is nearing the end of its travel. Fig. 1b shows a similar arrangement when transformer coupling is used.

There is a growing tendency nowadays towards the use of extension loud-speakers to enable programmes to be heard in various rooms without disturbing the set.

It is a good idea to have with this

winding of the extension loud-speaker transformer is connected a resistance-capacity tone-compensating circuit, the amount of compensation being varied by means of a variable resistance as in the cases already mentioned.

Volume control to the loud-speaker is accomplished by means of a potentiometer across the secondary winding, which is ganged with the tone-compensating resistance.

If the variable tone-compensating resistance has a value of about twice the load resistance of the output valve and the condenser has a value of about .05-microfarad, the amplification of the lower frequencies will be increased relative to the upper end of the musical scale when the output is lowered. This arrangement, although not by any means giving true automatic tone compensation, will make music at low level outputs sound pleasant.

Fig. 3 shows a more involved circuit for giving true automatic tone compensation. Briefly, the arrangement is to take a tap on the volume control potentiometer and connect from it to earth a series-absorption circuit resonant at roughly 1,000 cycles.

The effect of this is obvious. As the slider of the potentiometer nears the lower end, the middle register is attenuated in relation to the lower and upper frequencies, maximum attenuation taking place at the resonance frequency of the absorption circuit.

The amount of attenuation will increase as the

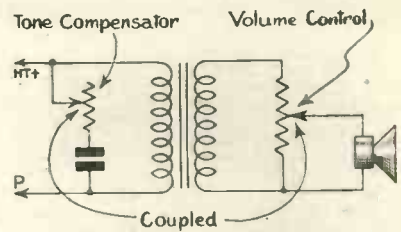

Fig. 2.—Automatic tone compensation can be added to an external loud-speaker in the manner shown in this diagram

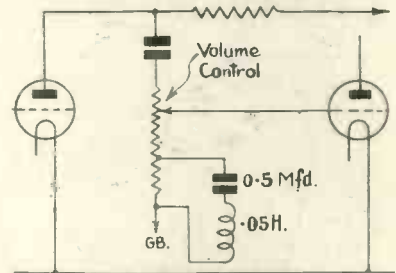

Fig. 3.—True automatic tone compensation can be obtained if the arrangement shown in this circuit is followed

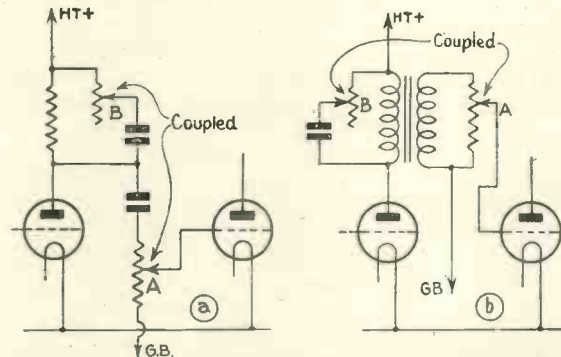
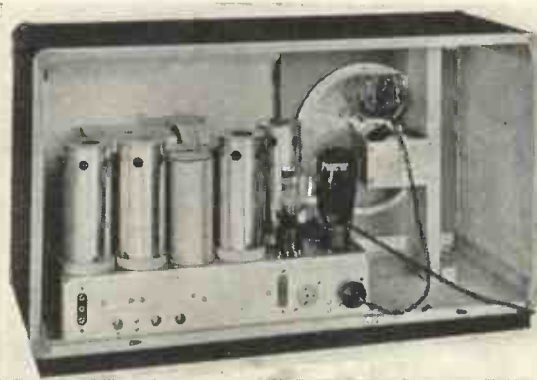

Fig. 1 (a).—Showing a simple method of compensating the tone of a set with a resistance-coupled amplifier. Fig. 1 (b) is for sets with transformer-coupled amplifiers

loud-speaker a remote volume control so that the volume of the programme can be varied without going to the set.

It is necessary, however, for this volume control to be tone compensated in a similar manner to that already described, so that although the listener may have his volume turned down almost to zero, the tone level is still good.

A circuit for accomplishing this in a rough and ready manner is shown in Fig. 2. In parallel with the primary



The Kolster-Brandes model 666 super-het incorporates a system of tone compensation similar to that shown in Fig. 3 on this page.

potentiometer slider nears the lower end of the resistance. That is to say as the volume output is decreased, the effective amplification of the reproducing apparatus will be greater at the lower and upper ends of the frequency scale.

Moreover, with the values chosen the compensation will be more marked at the lower frequencies than the upper. The position on the potentiometer from which the absorption circuit is tapped depends on the amount of compensation necessary at a given low volume output.

Potentiometer Tapping

As a rule satisfactory results are obtained with a tapping point about a third of the way up from the zero-volume end of the potentiometer. The circuit shown is suitable for a resistance-coupled low-frequency stage, but it can be easily adapted for transformer-coupled circuits or for a volume control used directly across a pick-up.

This arrangement is beginning to find favour among u.r.e. manufacturers. A circuit similar to that shown in Fig. 3 is used by Kolster Brandes, Ltd., on their model 666 super-heterodyne receiver.

This set, which is typical of present-day design, was reviewed in the January, 1934, issue of "Wireless Magazine." It is a six-valver and operates from A.C. mains.



A record by Carroll Gibbons, the pianist and composer, is reviewed by Chopstick

THERE is a small consignment of H.M.V. records for you this month. I am quite attracted to Evelyn Laye singing *Near and Yet so Far* and *Brave Hearts* from the film, *Princess Charming* (B8136, 2s. 6d.). Another excerpt from a production is *I'll Follow my Secret Heart*, sung by Yvonne Printemps and Noel Coward with the orchestra at His Majesty's Theatre. Quite attractive and in some ways a pretentious production (DA1363, 4s.). These two are from the show, *Conversation Piece*.

I find there is another record from *Princess Charming* with Evelyn Laye as singer. The songs are *Love is a Song* and *The Princess is Awakening*. If you like the music to this film I think you ought to hear both these. You will probably end by choosing both.

An *Hour ago This Minute*, from "Big Business" and *What Now?* from the same source (B8137, 2s. 6d.) is another of those production records to which I draw your attention. This is particularly good.

You know *Ar Hyd Y Nos*, generally translated as *All Through the Night*, of course? Well, Richard Crooks sings it on one side of a red-label record, with *Beautiful Isle of Somewhere* on the reverse. Red-label price is high, but so is the standard of singing. You can't expect these things for twopence (DA1265, 4s.).

Now for a few Regal with

which to regale you. The Singing Mountaineers (why not the Mountaineering Singers?) give you, on MR1253 (1s. 6d.), *Wagon Wheels* and *The Old River Road*. The Hill Billies (presumably not the same firm) on MR1251, give you *The Night Herding Song* with *West Bound Freight* on the reverse. I like this the better of the two.

Another Regal heard is Fred Hartley's Quintet playing *Brown Bird Singing* and *A Little Love, a Little Kiss* for Webster Booth who sings both delightfully (MR1244). Sinding's *Rustle of Spring* is played astonishingly well by

Choosing

A Critical Review of the—

the Commodore Grand Orchestra on MR1240—but all Commodore records are safe.

All the same, I was surprised to find the Commodore in a *Monastery Garden*. Quite effective though! (MR1239). Lastly, MR1238 is a massed band production of two marches.

Decca does well on PO5091 (2s. 6d.), where the soprano of the Berlin State Opera (Erna Berger) sings Schubert's *Ave Maria* and *Serenade*, accompanied by the Lasovoski String Quartet. This is extraordinarily good.

Stanelli and his "Hornchestra" does a good stunt on F3922. Very like his wireless turns. He is very clever.

Now, then! If you want *Knightsbridge*—the tune they play every Saturday evening in the *In Town Tonight* broadcasts—Decca does it for you with the Grenadiers on F3917 (1s. 6d.). You had better get your copy of it before they are all snapped up.

Elgar's *Adieu* and *Serenade* is played by Szigeti, one of the best violinists of our time, on Columbia LB14 (4s.). A fine record! Columbia also sends me a good Layton and Johnstone record—*Ol' Pappy* and the charming *Dixie Lee* (DB1351, 2s. 6d.). Also, Albert Sandler, with his orchestra, playing *Love's Last Word* and *Le Chaband qui passe*. Good of course! (DB1332).

Two Wagnerian excerpts by the Wireless Military Band (DB1341, 2s. 6d.); an arrangement of Faust waltzes and the *Barcarolle* from *Tales of Hoffmann* for a grand piano orchestra (DB1343), are more releases; all are safe as houses. Also—and I am delighted with it—Layton and Johnstone doing *By a Waterfall*. It really is charming (Col. DB1345). Columbia have done us well this month!

The rest are twelve inches—H.M.V. first. The No. 1



H.M.V. Photo

A new portrait of the famous American tenor, Richard Crooks. He has recorded two fine songs which are reviewed by Whitaker-Wilson

F Major Brandenburg Concerto (Bach) by the École Normale Chamber Orchestra. A remarkable performance occupying two records (H.M.V. DB2033-4, 6s. each). Another red-label twelve-incher is DB2124 (6s.) with Toti Dal Monte (soprano) singing *Verdi* accompanied by the Milan Scala Orchestra. This is a luxury record!

Columbia's twelve-inchers are four in number and all 4s. First (DX569) is John Tilley on the *London Transport Board*, with *Maudie the Race Horse* on the reverse. Splendid, of course!

Your Records

—Month's Releases by WHITAKER-WILSON

Then (DX573), overtures to *The Mousme* and *The Arcadians*, by Arthur Wood and his orchestra, is worth your consideration. Rather an interesting record by Marie Burke called *My Songs from the Shows* is presented on DX572. Quite a good selection! The fourth is *March Militaire* (Schubert) and *Valse Triste* (Sibelius) on DX571 by Sir Hamilton Harty and the London Philharmonic. This ought to be very popular.

Two Deccas: Heinrich Schlusnus, baritone, of the Berlin State Opera, sings the famous *Largo al Factotum* and an aria of Rossini—I enjoyed both solos immensely (CCA8172, 4s.). The other is a Berlin Philharmonic



Yvonne Printemps, who is appearing in Noel Coward's "Conversation Piece," has recorded for H.M.V.

H.V.M. Photo

record (CA8173) playing the *Funeral March* from Wagner's opera, *The Twilight of the Gods*. Very impressive, too! These Deccas are especially good.

Additional Records Reviewed

By CHOPSTICK

VOCAL RECORDS

- (a) *How Was I to Know?* (b) *Everything I Have is Yours*, The Street Singer with Ray Sinatra and his Orchestra, 1s. 6d.

REGAL-ZONO MR1249

(a) only; I am rather tired of (b). Arthur Tracy, the Street Singer, gives a good account of himself here, though it is difficult to follow his words at times. Besides being a good vocal record, Sinatra's band is an added attraction. Tracy is, by the way, a popular American radio star.

- ★(a) *I Got Rhythm*, (b) *Rhythm*, Five Spirits of Rhythm, BRUNS 1715

These five negro artists show you real rhythm. They are five hot vocalists who accompany themselves with a ukelele, guitar and string bass. Their hot work leaves one almost breathless. These people are in a class by themselves.

ORGAN SELECTIONS

- ★The Mikado—Selection, organ solo by Quentin Maclean, 2s. 6d. COL DB1305

Wholesome entertainment for everybody this. Maclean knows how to treat this popular type of music on his cinema organ. Nothing frivolous is attempted in this medley; all the effect is got by making full use of solo stops of a quiet character. You know these Mikado tunes quite well. Here are some from this medley: *Behold the Lord High Executioner*, *Tit Willow*, *Flowers that Bloom in the*

Spring, and *Three Little Maids from School*. Recording splendid, with some good bass.

PIANO SOLOS

- ★Piano Pie No. 2, George Scott Wood, 1s. 6d.

REGAL-ZONO MR1246

This is No. 2 of a series of pies that Scott Wood is making for Regal-Zonophone. The ingredients of this one include: *Whispering*, *Last Round Up*, *Wagon Wheels*, *Bon Bijou*, *Tell Me To-night*, *Dinah*. Quite a good mixture! There is nothing objectionably ultra-modern about this pie; it is just a neatly arranged selection of tunes played in an ordinary sort of way that you or I could imitate. Nice entertainment!

Tunes of the Times, piano solo by Bert Read, 1s. 6d.

DECCA F3924

Another piano medley, this time by Bert Read, who is now with Henry Hall's band. No comments are therefore necessary. Here are some of the best tunes in his selection: *Did You Ever See a Dream Walking*, *Experiment*, *Without That Certain Thing*, and *After You've Gone*. Worth having!

- ★Two Friends in Harmony, John W. Green and Carroll Gibbons, 2s. 6d.

COL DB1333

The best record so far by this pair of pianists and composers. Actually, it is a discussion with musical illustrations. Briefly, the story is this: on the first side Carroll Gibbons plays his own composition *On the Air*—and the band's signature tune—and

Johnny Green literally pulls it to pieces and shows how he would alter it to suit his ideas. On the second side Green tries his hand at crooning and so provides more fun. On this side the subject is Green's composition, *Living in Dreams*.

- (a) *It's Time to Say Goodnight* (f.), (b) *In Town Tonight* (f.), B.B.C. Dance Orchestra, 2s. 6d. COL CB716

(a) is a Henry Hall composition; his band broadcasts the tune at the end of almost every programme. As one would naturally expect, this band gives the tune a good show; Les Allen's rendering of the vocal is, however, rather strained. I liked better their version of Eric Coates' *Knightsbridge* on (b). If you want a good version of the *In Town Tonight* theme song, try this. It is as good as any you will get.

- (a) *Mama Don't Allow It* (f.), (b) *Fifteen Cents* (f.), Frankie "Half-pint" Jaxon and his Half Shots, 2s. 6d. BRUNS 1719

A queer name for a dance band, but not so queer as its performance. Jaxon's band is a small town's dance band composed entirely of negroes. If you want a hot dance record that is like nothing you have heard before, get a copy of this. It is real entertainment. Negro rhythm in the raw!

- ★(a) *Liebstraum* (f.), (b) *La Veeda* (Rumba), Howard Jacobs and his Orchestra, 2s. 6d. COL CB718

I am definitely against the practice of jazzing classics but, in fairness to Howard Jacobs, I must

give credit to his (a), derived from the Liszt composition. His arrangement is particularly noteworthy—heavy string rhythmic bass with the melody picked out by his Neo-Bechstein piano. This piano electrically amplifies the sound after the notes have been struck by ordinary mechanical means. By turning up the amplifier it is possible to sustain or even get a crescendo after a chord has been struck. The record is worth getting for (a) alone.

- ★(a) *Nevermore* (w.), (b) *I'll Follow my Secret Heart* (w.), Ray Noble and his Orchestra, 2s. 6d. H.M.V. B6464

This is the first of a series of records that H.M.V. are producing of excerpts from the new Coward-Cochran success, *Conversation Piece*. These two tunes are waltzes of the very best kind. (b) has all that melodious charm that is an essential part of a good waltz.

- ★(a) *Repeat the Blues* (f.), (b) *Not Bad* (f.), Ray Noble and his Orchestra, 2s. 6d. H.M.V. B6471

These two numbers are from the recent radio broadcast, *Big Business*, the music of which was written by Johnny Green. I think (a) has the honour of being the best dance record of the month. It is full of hot fiddle and brass work. (b) is one of those catchy melodies. Both tunes are of a high standard—composition and performance.

- (a) *Over on the Sunny Side* (f) (b) *In Town To-night* (one-step), Ray Noble and his Orch., 2s. 6d. H.M.V. B6463

This record is worth getting for (b), which you have heard dozens of times in the *In Town Tonight* broadcast on Saturday nights.

Experimenter's All-wave Seven

Here we reproduce a letter from a reader, who travels all over the world, in which he gives details of an all-wave seven-valve super-het. No doubt many constructors who have many spare parts on their shelves may like to try their hand at building this receiver. Judging from this reader's letter, the results obtained are quite satisfactory

YOUR readers may possibly be interested in the description of the receiver illustrated in the accompanying photograph and theoretical diagram. I have built this set up after a series of experiments and alterations to meet my particular requirements—all-wave reception in any part of the world.

Four-volt Valves

The receiver is used at sea and uses ordinary 4-volt battery valves, with high tension from the ship's mains of 100 volts.

It may be thought that one cannot get good reproduction with this low voltage on the power valve; all I can say is that I personally get it, and I have never heard any listener to my set comment otherwise than favourably on the tone.

Solely for Short Waves

It will be seen that the sequence is a seven-valve super-het, consisting of oscillator, first detector, two intermediate-frequency amplifiers, second detector, first low-frequency amplifier, and power output. This combination is used solely for short-wave reception, and gives me the Empire

programmes wherever I may be, at excellent strength and purity.

For long- and medium-wave reception I cut out the two first valves and use the set as a straight five-valver, namely, two screen-grids, detector, and the low-frequency amplifiers.

For local-station listening I can cut out the high-frequency valves and use the set as a detector and two low-frequency amplifiers.

Finally, for experimental searching I can cut out the last valve or last two valves and use it as a one or two valver for headphones only. In fact by the arrangement of switches, rheostats, and jacks, it is anything from a one- to a seven-valver at will.

For efficiency in long-distance reception I do not believe in dual-wave coils or ganged condensers; my medium- and long-wave coils are wound on old-fashioned barrel-type formers (originally used as high-frequency transformers in the days of neutrodyne sets) plugged into valve holders and separately screened; all tuning condensers are separately screened also, and as the second screen-grid valve is aperiodic, this limits the tuning coils for medium and long waves to two; short-wave working has two condensers only, for oscillator and detector, and when these are in use the long-wave coils are plugged into the intermediate-frequency end and tuned to their

maximum wave-length, 1,875 metres.

It will be noted that I have reaction on the first screen-grid valve which, together with a series condenser in the aerial lead, gives me excellent selectivity even in the Mediterranean where one has all the stations of Europe at hand.

For real long-distance reception on the medium waves I do not use the series-aerial condenser, of course. As an example of what I can do in this connection I may remark that I have many times had excellent loud-speaker reception of a number

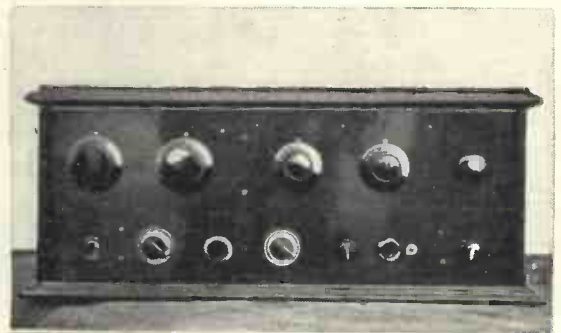

TWELVE CONTROLS AND THREE JACKS!
This photograph of the all-wave seven-valver was taken on board ship. There is some difference between the controls of this set and one-knob control!

of European stations when in South Africa and in Bombay.

Your readers may be amused at the number of controls on the panel; these number twelve in all, together with three plugs for jacks (two for headphones, and one for pick-up). Certainly it does not conform to the modern one-knob control, but I can assure you that I find every one useful at times to get the utmost limit from the receiver for long-distance reception. *J. H. Wilson.*

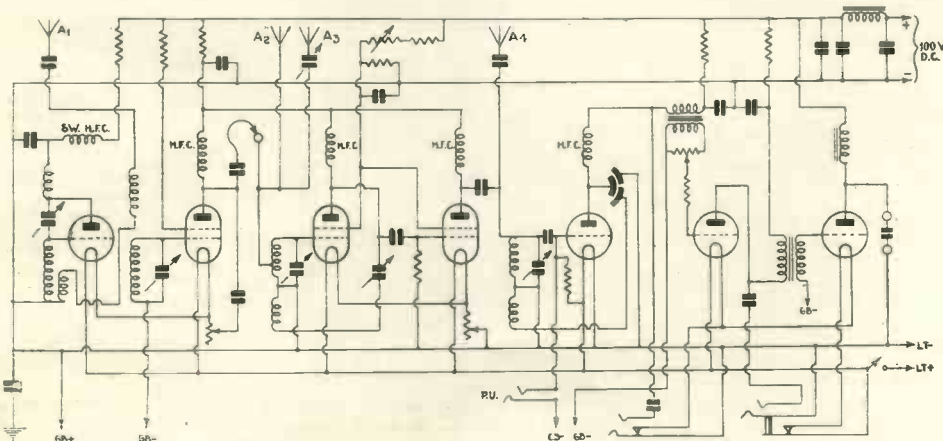

THE CIRCUIT
Seven valves are used in super-het sequence. The combination is an oscillator, first detector, two intermediate-frequency amplifiers, second detector and two low-frequency amplifiers

WHY is the majority of the listening public agreed that short-wave sets are a waste of time, and the short-wave enthusiast something akin to a fisherman, when it comes to recounting experiences? Why do they consider that the short-wave man is one who sits up burning the midnight oil and, after hearing faint noises on a pair of super-sensitive headphones, tells of entertaining programmes on the loud-speaker?

That is the position to-day as I see it. I may be right or wrong, but I cannot help feeling that this view



One of the oldest short-wave pioneers is J. E. Nickless who works with a power of 10 watts. Mr. Nickless (G2KT), who first started transmitting in 1910, is here seen with his transmitter

News of the Short Waves

By KENNETH JOWERS

represents the general idea. The wonderful achievements of some of the amateur and commercial transmitters, as well as amateur listeners, does not carry very much weight while some of the good reports that I receive are put down to imagination or, should they be proved, to exceptional receiving conditions.

During the past week-end I had an experience that made me realise just what I am up against in trying to prove the worth of short-waves.

Short-wave Opinions

I spent an afternoon with a friend of mine and, after a while, naturally the conversation came round to radio, the best type of set, picking-up America and so, to short-waves.

My friend remarked that a short-wave set was a waste of time and money and the one that he had was buried in the cupboard somewhere or other. To complete his remarks he went on to say that he had only made his short-wave set after reading my notes on how to hear stations from the four corners of the earth. His log to date consisted of a whole heap of Morse, an odd American or two, and, of course, the local Empire stations.

The set was produced for inspection and a good set, or rather unit, it was. It consisted of a screen-grid stage followed by a leaky-grid detector, all ready to be plugged into the detector stage of a broadcast set. As the broadcast set had two low-frequency stages, this was equivalent to a four-valve short-waver.

All of the components were of the best quality, the coils were home constructed, but very well made, and the circuit was a well-trying one of my own.

A five-minute test soon showed up a few faults. The inductance of the coils were out of match. The aerial coil was about 60 degrees out on a 100-degree dial, and neither covered any of the interesting commercial bands. A frantic rattle appeared to come from the tuning condenser, so that faint signals were completely lost.

The reaction control varied the wavelength by about 5 or 6 metres and the grid coil made bad contact in the holder, so that the receiver only oscillated at rare intervals.

It was a moment's job to take off or put on a few turns from the coils and match them all up. The noisy condenser turned out to be a metal

dial touching the panel; a new dial stopped this trouble. The pins on the coil were opened with a pen-knife, the coils then made good contact in the holders.

By spacing the reaction winding in a similar way to the grid coil, this wavelength variation caused by the reaction condenser was decreased to a negligible quantity, so that I was able to get down to real short-wave work.

First Results

I first logged two Empire stations, one on the 16- and one on the 19-metre bands, Rome on 24 metres and Copenhagen on 49 metres. This gave me some idea as to where the other stations would be. As it was early in the afternoon I concentrated on the 16- and 19-metre bands and with a little care was able to tune in W3XAL and W8XK on 'phones.

The signal strength was well down and the high-frequency stage was inclined to be unstable, so I replaced the plain screen-grid valve with a new one having a metallised bulb and so increased the efficiency. I could do nothing more to the set to bring in any further Yanks at better strength, so I looked at his aerial.

I found about 20 ft. of wire trailing round the picture rail making a bad contact to a corroded lead-in tube. I moved the set bodily to the window, put in a short lead-in of about 1 yd., cleaned up the connections and immediately those

Americans, which I had been hearing on headphones, came in on the loud-speaker.

During the next two or three hours all of the more familiar American stations were tuned in. Buenos Aires and others four or five thousand miles away came in well. That was on a set supposed to be dud.

I thought then it was about time that I left well alone, but I have

and components were improved out of all recognition, this power has been slowly reduced until now the station is operating under the call sign of 2KT with a power of 10 watts.

This station operates on 20, 40, 80 or 160 metres; has worked stations in every country of the world and is familiar to all short-wave fans. The station is owned by J. E. Nickless.

The other early bird is F. C. Stimpson of Leytonstone, who was operating his station CXX on 150 metres in 1911.

From the photograph you can see the large inductance with the large variable condenser and crystal detectors for tuning in Cliften and the Eiffel Tower.

The spark transmitter consists of an electrolytic interruptor, step-up transformer, rotary and quenched sparks gaps with copper-strip inductances wound to 150 metres.

The photograph was taken by the operator himself on a slow plate.



SHORT WAVES IN PRE-WAR DAYS

Here is F. C. Stimpson with his transmitter which started work in 1911. This photograph was taken by the owner himself on a very slow plate in 1911

since made enquiries and that listener is now a confirmed short-wave enthusiast. I have reproduced in these pages the final circuit which is really worth making up. It is so much better than the average single-valve plug-in adaptor, which suffers from dead spots, bad reaction and so on.

As you can see, it consists of a straightforward screen-grid stage and a tuned-grid detector. The tuning condensers are the standard Stratton .00017-microfarad.

The reaction condenser is a standard .00025-microfarad slow-motion Polar. Tuning coils are the Eddystone plug-in type which cover all wavebands, or on the other hand you can make them yourself.

I have received some details of two very early pioneers. The first started in 1910 with the call sign NXC with a power of 1-kilo-watt. As the efficiency of the station increased

THE HEPTODE SUPER THREE

(Continued from page 319)

There is no need to go into details of the construction for everything will be clear from our photographs and drawings. Remember that all the wires on the full-size blueprint (and on the half-scale black-and-white reproduced on pages 318 and 319) are numbered in the best and most convenient order of assembly. You will save yourself a lot of time and trouble by following the wiring through in the numerical order indicated and crossing through each number on the blueprint as the corresponding wire is put into position on the set.

Aid to Identification

The small letters are for indentifying the holes in the chassis needed for taking leads from the top to the underside.

There is little that need be said about the operation of the set. The secret of good results is, of course, to get the ganging right in the first place. It will be found that the first trimmer (looking from the front of the set) is the most critical, but the other two will need careful adjustment. The long-wave oscillator trimmer on the coil unit must also be carefully set for the best results.

Pretty Good Going

During a short test the Heptode Super Three brought in no fewer than fifty-five stations, which is pretty good going, for the general experience since the coming of the Plan de Lucerne is that it is not so easy to get the bag of stations now as it was six months ago. While the new Plan has cleaned up the ether in

a welcome manner, many of the smaller stations that could previously be picked up have now been absorbed into international common wavelengths and cannot be separated out.

Still if you have A.C. mains you will find that this set will bring you all the stations you really need at comfortable—and sometimes uncomfortable, if you do not use the volume control!—strength on the loud-speaker. We shall be glad to hear from you!

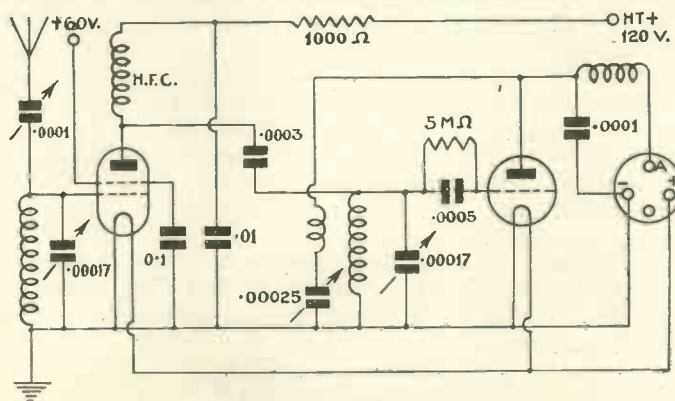

SIMPLE CIRCUIT FOR A SHORT-WAVE ADAPTOR

Here is a circuit for an ordinary plug-in adaptor that can be relied upon to give satisfactory results. It consists of a screen-grid stage and a tuned-grid detector



Westinghouse Metal Rectifier :: Erie Potentiometer :: Eelex Short-wave Coil :: Benjamin Autocontrolla Ferranti Electrolytic Condenser :: Goltone Lightning Arrester.

WESTINGHOUSE METAL RECTIFIER

APPARATUS : Metal rectifier, type WX.
MAKERS : Westinghouse Brake & Saxby Signal Co., Ltd.
PRICE : 7s. 6d.

THE Westector introduced a little over a year ago suffered from the disadvantage that it was inefficient at frequencies above 200 kilocycles, so that although it was satisfactory as a detector in the intermediate-frequency stages of a super-het, it was not suitable for use at ordinary radio frequencies.

This limitation was mainly due to the self-capacity of the component, and the Westinghouse engineers concentrated on still further reducing this undesirable effect. They have now introduced a series of WX rectifiers which mark a distinct step forward.

In appearance they are similar to



The new WX Westector is quite small as can be seen by comparison with a penny

the normal Westector, but they maintain their efficiency at frequencies as high as 1,500 kilocycles. We found on test that there was still a falling off in efficiency at the higher frequencies, but this new Westector can be used quite well on straight sets, whereas the older form was not successful under such conditions.

Automatic volume control circuits

for straight receivers are simplified by this new component and, in fact, there are numerous applications, several of which are detailed in the leaflet supplied.

It is pointed out that for low-frequency work or super-het circuits this new type presents no advantage, the older W type being quite satisfactory, but in those instances where radio frequencies have to be handled the new type will come into its own.

An interesting point brought out by our tests was that the damping is quite small, being, in fact, no worse than that of a diode, even at 1,500 kilocycles. This new Westector should have a wide appeal.

ERIE POTENTIOMETER

APPARATUS : High-resistance potentiometer.
MAKERS : Erie Resistor, Ltd.
PRICE : 3s. 6d.

IT is not surprising that following the success of the Erie resistor a series of volume controls has been introduced by this firm. The volume control is a very small and compact unit which will prove very useful in confined spaces. It measures $1\frac{7}{8}$ in. in diameter and $\frac{1}{2}$ in. deep.

The resistance element is a washer of carbon-impregnated material with a small graphite contact carried in a spring for making connection. This gives a smooth and noise-free action. Altogether the job is a satisfactory one.

The components are available in sizes from 25,000 to 250,000 ohms. The sample tested was 50,000 ohms



The Erie potentiometer is a well-made component, is made in several useful sizes

and actually had a maximum resistance slightly in excess of its value. The element is graded so that the increase in resistance is slow at first and increases rapidly towards the end of the travel.

EELEX SHORT-WAVE COIL

APPARATUS : Short-wave coil.
MAKERS : J. J. Eastick & Sons, Ltd.
PRICE : 7s. 6d.

THIS short-wave coil is an ingenious attempt to retain the advantages of inter-changeable plug-in coils without the necessity for carrying a range. The makers claim that any short-wave coil using a switching scheme to vary the wave-range is inefficient owing to the damping introduced by the short-circuited turns.

They have therefore arranged that the coil under test is capable of insertion in its base in two possible positions, the act of turning the coil round and re-inserting it altering the connections so that the wave-

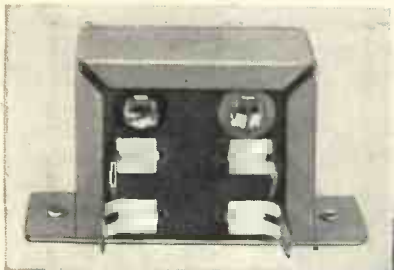

(Above) the new battery economiser recently released by Benjamin. (Right) satisfactory results were given by the new Ealex short-wave coil on test

range covered is quite different.

The coil is wound on a bakelite former provided with 8 pins and a special base is used in which the coil may be inserted in either one of two positions. In the first position the wave-range is from 15 to 30 metres, and on turning the coil through 180 degrees, the wave-range covered is from 28 to 60 metres. These are the maker's figures.

The wave-range covered was slightly different from that claimed, being 16.5 to 39 metres on the shorter range and 25 to 61.5 metres on the longer range.

BENJAMIN AUTOCONTROLLA

APPARATUS : Battery economy unit.
MAKERS : Benjamin Electric, Ltd.
PRICE : 7s. 6d.

THIS is a new addition to the ranks of battery economisers

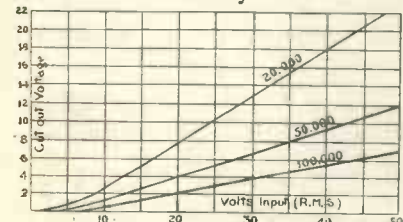

Three curves showing the voltage feedback of the Benjamin unit with different resistances.

characterised by an improved flexibility and adaptability to different sets. The main part of the unit is housed internally being contained on two paxolin boards held together in a light pressed-metal framework.

The Westector, however, which provides the rectification and the series-feed resistance, which controls the extent of the bias voltage developed, are mounted externally, and the user is thus able to adjust the opera-

tion of the unit to suit his valves.

Thus, for a super-power valve, having a large grid base, a large measure of control is required and the series-feed resistance is only some 20,000 ohms, whereas with a pentode

the value should be in the neighbourhood of 100,000 ohms.

As an indication of the variation we obtained three curves plotting the audio-frequency volts in the anode of the last valve and the D.C. feed-back voltage produced.

It will be seen that a large voltage is available, if required, and the unit is one which will commend

itself to battery users.

FERRANTI ELECTROLYTIC CONDENSER

APPARATUS : Dry electrolytic condensers, type CE100.

MAKERS : Ferranti, Ltd.
PRICE : 7s. 9d.

FERRANTI have recently introduced a range of dry electrolytic condensers. We have received for test an 8+8-microfarad sample rated at 500 volts peak.

This sample is slightly above the usual size of electrolytic condensers measuring 2½ in. by 1½ in. by 4 in. high, which is approximately .9 cubic in. per microfarad.

The condenser is housed in a waxed cardboard container with flexible leads for the connections. The two sections of the condenser are entirely separate and are provided with individual leads, which is often convenient.

The capacity of the condenser was measured and was found to be

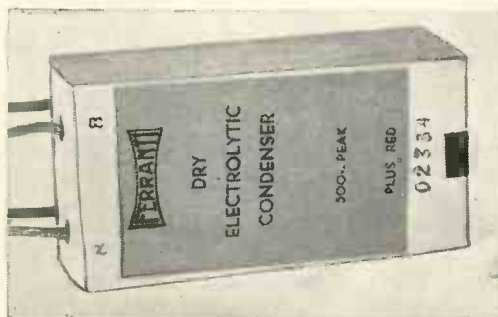

One of the new range of electrolytic condensers made by Ferranti. Flexible leads are provided

7.6- and 7-microfarad respectively on the two sections. The leakage current, taken at the end of a 30-minute run, was found to be slightly above .5 milliampere per section.

The condensers were tested with 550 volts D.C. and showed no signs of breakdown, so that the rating of 500 volts peak is satisfactory.

The condenser, of course, may be mounted in any position, therefore forming a convenient unit for set construction.

GOLTONE LIGHTNING ARRESTER

APPARATUS : Lightning arrester.
MAKERS : Ward & Goldstone, Ltd.
PRICE : 2s. 6d.

ALTHOUGH the cases of damage by lightning are few, one always feels safer if some form of lightning arrester is fitted to the aerial. Actually, with a proper arrangement, an aerial acts as a



The Goltone lightning arrester provides adequate protection against lightning discharges

lightning conductor and the house is safer than without it. The Goltone lightning arrester takes the form of a terminal mounted on a brass stem carried on a simple right-angle bracket.

The terminal and the stem are separated by a small mica washer at a distance which is insufficient to have any undue effect on the operation of the wireless set, but is sufficiently small to break down quite easily under the influence of a powerful lightning stroke.

The stem is surrounded by a bakelite cowl providing an effective insulation, even in wet weather, so that there is no danger of leakage even under the worst conditions.

We tested the apparatus and found that it had no undue effect on the reception. It certainly provides a simple and adequate protection against lightning.

HOME TELEVISION SECTION

Working a Simple Television Receiver from Your Broadcast Set

By H. CORBISHLEY

MOST readers will have realised that it is now easily possible to operate a simple television receiver of the

neon lamp, and provided that the output voltage is sufficiently high and that there is enough current, then you can receive the programmes. A reasonably powerful set will usually do all that is required, but if it will not quite "deliver the goods" then the high tension can be added to in a variety of ways, depending upon individual circumstances; in any case these are all very simple, which it is the purpose of this article to describe.

First of all, we can connect the neon lamp directly to the set in place of the loud-speaker as shown by Fig. 1. If with the set switched on, irrespective of whether any signals are being received, the lamp lights up then nothing more need be done; the varying output from the receiver when receiving the transmissions will cause the light of the lamp to vary and this is all that is required. The voltage necessary for this is roughly 180 as a minimum and a current of from 20 to 25 milliamps is required.

It will be understood that the first objective is to cause the lamp to light, so that the output from the receiver will vary the amount of the light. Now assume that the lamp does not light and we must provide the extra voltage necessary. A simple way of doing this is to add to the high-tension voltage ordinarily available by using

an additional battery of which the voltage need only be that required to bring the existing voltage up to a little over 180 volts. How this

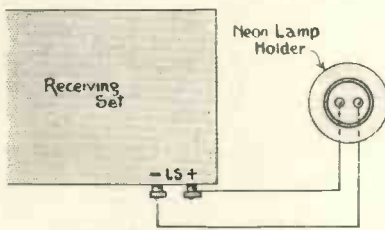

Fig. 1.—The simplest arrangement of all, which can be used when there is ample H.T. voltage

disc or mirror-screw types from an average broadcast receiver. This fact has resulted in many thousands of listeners taking up television who previously were under the impression that the B.B.C. transmissions

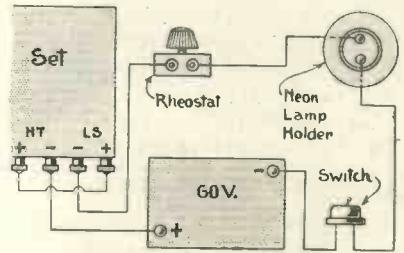

Fig. 2.—A simple way of adding to the high tension by means of an extra battery

can be done is shown by Fig. 2. The diagram is self-explanatory but it should be noticed that in this case it will be necessary to adjust the bias on the valves to compensate for the increased high tension.

If it is not wished to disturb the

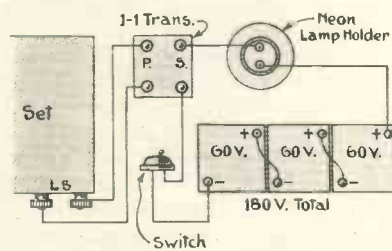

Fig. 3.—This diagram shows an entirely separate source of H.T. being used for the neon lamp

could only be received with comparatively costly apparatus.

In this type of visor a neon lamp is used to provide the illumination, and the sum and substance of the whole business is that the output from the wireless set must be sufficient to cause the lamp to light—in other words the output from the receiver, instead of being fed to the loud-speaker, is fed to the

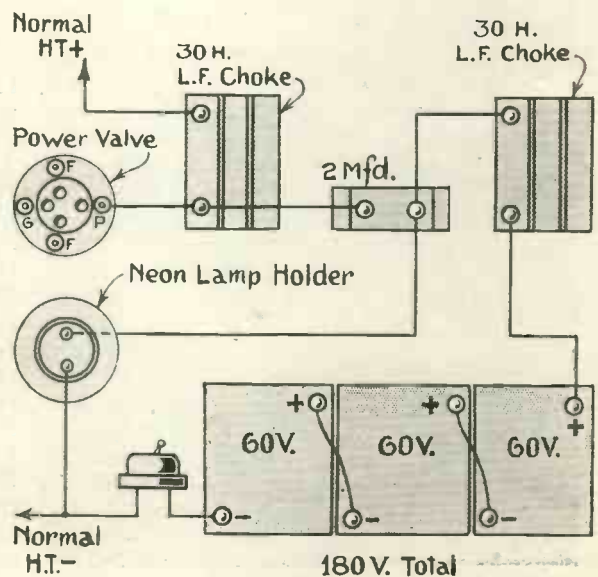

Fig. 4.—When the set has choke output the arrangement shown here is necessary

bias arrangements, so that the set by the mere disconnection of the neon lamp will be suitable for ordinary broadcasting use, then an entirely separate source of high tension can be used for lighting the lamp. This method entails the use of additional batteries, of a total voltage to enable the lamp to be lighted, and a 1-1 transformer. This assembly can be made as a separate unit for attachment to the receiver when it is desired to receive the television transmissions or the units can be placed in the base of the visor. The scheme is shown by Fig. 3. It will be noticed that a switch is included to disconnect the lamp from the batteries when not in use.

If the set has choke output a somewhat different arrangement must be used, though in effect it is the same as that just described. The scheme is shown by Fig. 4. In this the use of an additional

choke is necessary of a similar type to the one already installed in the set. So far we have only considered

adding to the high tension by using batteries, but when mains are available the extra voltage can be obtained from these by the use of an exciter unit constructed as shown by Fig. 5. The scheme is substantially the same as that given by Fig. 3 and consists of a 1-1 transformer, an L.F. choke, a rectifier and a couple of 2-microfarad condensers. In this case also these

components can be made up as a separate unit for quick attachment to the receiver.

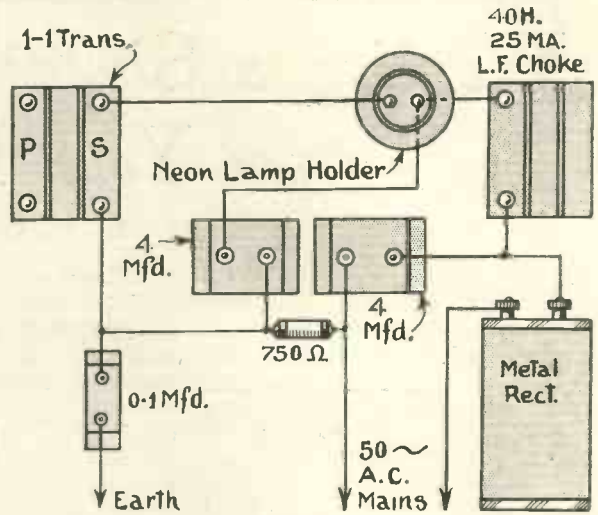

Fig. 5.—This is a method of lighting the neon lamp with a separate high-tension supply when mains are available

Another Great Advance in Television

High-definition Pictures on the Ultra-short Waves

A COUPLE of months ago even the best informed of those who are aware of the progress that is being made in the development of television would not have been sufficiently optimis-

tic to have held the opinion that the broadcasting of high-definition pictures on the ultra-short waves was an immediate possibility. As a laboratory experiment with a short line between the transmitter and receiver such pictures have been produced by various workers, but the broadcasting of them presented an entirely different problem. Those who have had experience with ultra-short wave receivers will appreciate how tricky they can be and with the more exacting demands of television the difficulties are increased many times.

And now the Baird Company have shown that all the difficulties have been surmounted and that the broadcasting of high-definition

television is quite practicable on wavelengths as low as 6 metres. This in itself is a remarkable achievement, but coupled with the facts that the pictures are perfectly steady and show all desired detail, proves what wonderful progress has been made.

On the occasion of the recent Baird demonstration of their new system the transmitter was situated in one of the towers of the Crystal Palace and the receiver was at Film House, Wardour Street, a position where it can be assumed interference from machine static would be as bad as anywhere. But the received pictures were entirely free from any trouble of this kind and remained perfectly clear during the whole of the programme which lasted about an hour.

The Baird Company have made a departure from their ordinary practice in that with this latest apparatus the cathode-ray tube is being used at the receiving end instead of a mechanical device. The diameter of the end of the tube is twelve inches and this, of course, is the size of the picture



An actual photograph of the image as received in London and broadcast from the Crystal Palace on the ultra-short waves

RADIO POWER PLANT MACHINES FOR EVERY NEED

ROTARY TRANSFORMERS

Models for All Purposes! D.C. to D.C. Models for supplying H.T. Current to Large Public Address Amplifiers, etc. D.C. to A.C. Models for operating A.C. Receivers and Radiogramophones from D.C. Mains.

ANODE CONVERTORS

Give H.T. from L.T. Battery! Models to suit all Receivers. Special Models exclusively adopted and recommended by makers of Eddystone, McMichael, Gecophone, Philips, Peto-Scott, Scott Sessions, Mavox and other Short-Wave Receivers. Specially designed models also for Car Radio.

SYNCHRONOUS GRAMOPHONE MOTORS, MOTOR GENERATORS AND MAINS TRANSFORMERS.

Write for full details, stating your requirements.

ROTAX LTD., Radio Dept., 7, Willesden Junction, London, N.W.10.

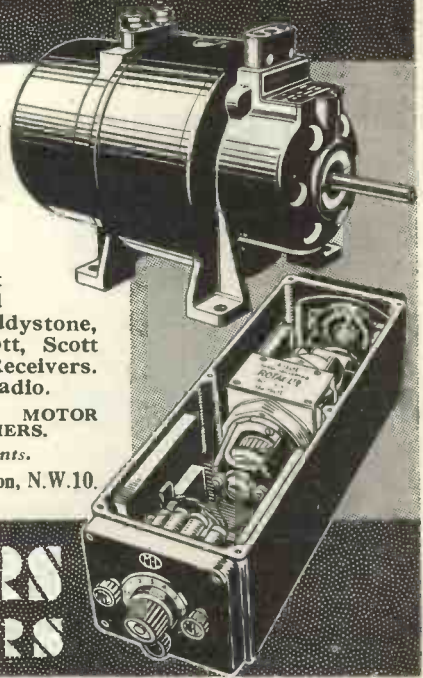

ROTARY TRANSFORMERS & ANODE CONVERTERS

EASY CIRCUIT TESTING with the MEGGER CIRCUIT TESTER



The instrument is battery operated and the readings are independent of voltage variations. The scale reproduced above shows one range of the instrument.

For full particulars write for List No. W 314 to
EVERSHED & VIGNOLES LTD.

Registered MEGGER Trade Mark

ACTON LANE WORKS, CHISWICK, LONDON, W.4.
Telegrams: "Dorothea, Chisk, London." Telephone: Chiswick 1370 (3 lines).

4-133

IF YOU WANT THE BEST,
(you're right, it is the only way to avoid regret)

THERE'S

PARMEKO

**TRANSFORMERS, CHOKES,
SPEAKERS, AMPLIFIERS**

PARTRIDGE & MEE, Ltd.
AYLESTONE PARK,
LEICESTER (AYLESTONE 487),
& 74, NEW OXFORD STREET,
LONDON, W.C.1. (MUS. 5070).

Better service results from mentioning "Wireless Magazine" when writing to advertisers

ordinarily produced, though in this case the image was magnified by means of a lens which brought the picture up to approximately 18 inches square. The photograph on page 374 shows the relative size in comparison with the heads

The number of scanning lines employed is 180 and the picture frequency is twenty-five per second, which is the same as is used in the cinema, so that there is no suggestion of flicker. The detail obtained using 180 lines is six

times that of the present B.B.C. transmissions. It will be seen that disc scanning is employed and provision is made for either subject or film transmission. Wonderful detail was observable in the case of the latter.

Although the Baird Company have demonstrated that high-definition television using the ultra-short waves is now quite practicable, it should not be assumed that apparatus of this kind will be immediately available for general use. One thing, at first at all events, it will be costly and then again no arrangements have been made for broadcasting upon the ultra-short wavelengths and there is also the question whether this prerogative lies with the B.B.C. or whether its monopoly is only in the broadcasting band. Matters such as these and the provision of programmes will take a considerable

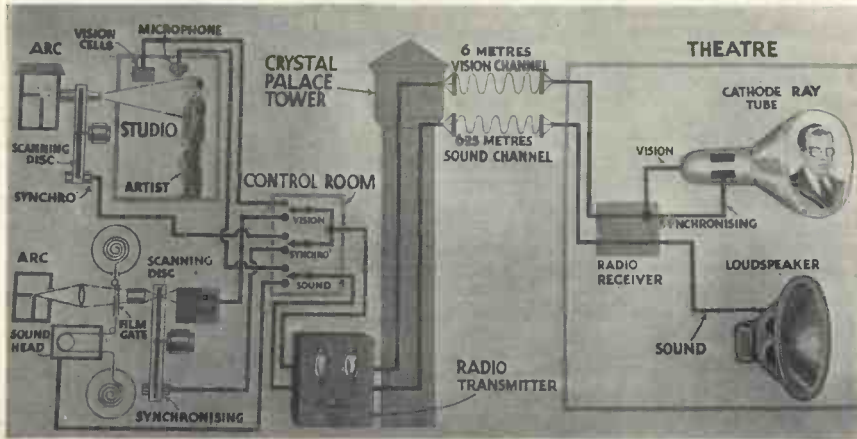

The schematic arrangement of the Baird high-definition television system on the ultra-short waves

of the audience. This, it may be remarked, is an actual photograph and owing to the nature of the subject does not do the received picture justice.

times that of the present B.B.C. transmissions.

The diagram on this page shows a schematic arrangement of the Baird system in a simple manner.

time to settle, so it can be assumed that for a somewhat lengthy time the most will have to be made of the 30-line transmissions now being put out.

Holding the Image Steady

ONE of the greatest problems in using a television receiver of a simple type is that of maintaining a correct speed. Most of those at present in use are not fitted with synchronising gear, but even when this is fitted the difficulties are not entirely over-

running which will have their effect whether the control is manual or automatic.

There are several small motors on the market now which have been specially designed for driving television receivers of the disc or mirror-drum types and, provided that these are used properly, they give very reliable service and run at reasonably steady speeds. A number of people, however, press into service motors which have been intended for other purposes, often with a fair measure of success. Hair-drier, dental, vacuum-cleaner, and even toy motors can be used.

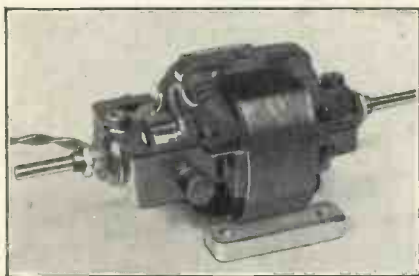

A small motor specially designed for television purposes. The makers are Peto-Scott, Ltd.

come, though naturally the gear is a great help and relieves the operator of constant control. However, it is not this side of the question which it is proposed briefly to discuss, but a few prime causes of irregular

The load on the motor is practically steady and yet it should be capable of quick speed variation when a load is applied, as, for instance, by means of a friction brake. This means that the motor must be series wound. The use of a shunt-wound motor is bound to occasion difficulties. In order that

it may be able to maintain a constant speed it must be well designed and the armature must be well balanced both mechanically and electrically. Whether this is the case can be determined by running it at a high speed and noting whether there is excessive vibration or sparking at the brushes.

This latter fault is fatal to good results for television purposes, though apart from electrical design, it may be caused by a defective commutator. This must be above reproach, for in addition to causing irregular running the sparking will make itself manifest by flashes in the picture. A worn or untrue commutator is thus out of the question if satisfactory results are to be obtained. Attention should be given to the brushes so that these bed firmly, yet lightly, on the commutator. Too much pressure will have a considerable braking effect and make the motor liable to run hot.

Then there is the question of

BRINGING THE RADIO STARS to LIFE! for the SPECTRUM PORTABLE

Every Friday RADIO PICTORIAL will reveal in pictures and in words the home life of popular broadcasters. Scores of lifelike photographs of the favourites you listen to, thrilling fiction, clever humour, a corner for the children, a splendid feature for the wife, etc., etc. In other words RADIO PICTORIAL puts you in intimate touch with the human side of broadcasting and adds greatly to your listening-in.

A great twopennyworth!

Take a copy home on Friday—not only will you enjoy it, but the rest of the family, too!

THEN GET YOUR NEWS-AGENT TO DELIVER "RADIO PICTORIAL" EVERY FRIDAY

RADIO PICTORIAL

EVERY FRIDAY

*these



BATTERIES

are exclusively recommended

★ 2 Ever Ready 63 volt high tension type Ever Ready Popular Portable No. 1 (price 7/6) Ever Ready 9 volt Grid Bias (price 1/-)

Always use Ever Ready batteries for greater power, finer selectivity and true tone.

Satisfactory Service guaranteed—by the makers of Britain's finest batteries for over 30 years.

The EVER READY CO., (Gt. Britain) Ltd.
HERCULES PLACE, HOLLOWAY, LONDON, N.7.

Advertisers like to know you "saw it in the 'Wireless Magazine'"

power. A motor of which the power is greatly in excess of requirements will be found difficult to control so that it runs steadily at the speed necessary—viz., 750 revolutions per minute. It will be found impossible to brake it mechanically and if a large amount of resistance is inserted to bring the speed down, wide variations of speed will occur. The ideal is a motor with power just in excess of that required when it is driving the scanner at the correct speed.

Disc Mounted on Shaft

As a rule, the disc of the disc type of receiver is mounted directly on the motor shaft, but this by no means implies that this is the best or only method, though it is certainly the

simplest. By arranging for a step-up ratio between the motor and the disc, it is possible to run the motor nearer to its normal speed at which it will work the most efficiently. Furthermore a flexible drive can be arranged such as, for instance, a rubber belt and this will act as a simple type of mechanical filter which will cut out any irregularities. In the case of a mirror-drum receiver some sort of filter device should always be fitted and the usual practice is to have the drum loose on its spindle on which there is a collar with a light spring attached which at its other end is secured to a pin projecting from the drum. Stop pins are fitted to restrict the movement of the drum beyond the point at which the spring can control it.

Some scanning devices are easier to maintain at a constant speed than others; the disc for instance does not present much difficulty for there is a considerable flywheel effect and almost perfect balance can be easily secured.

Success Needs Care

The mirror drum also has a flywheel effect, but in this case exact balance is not so easily attained. The most difficult scanning device of all to run at a constant speed is the mirror screw, because of its weight and small diameter, and success with this can only be obtained by the most careful attention to mechanical details, such as the proper alignment of the bearings and rigid mounting.

How Neon Tubes are Made

THE electrodes of neon tubes as used for television are usually made from nickel or iron. Before assembly they are placed in a vacuum furnace which is pumped out to a low pressure, then the electrodes are raised to red heat so that gases occluded in the metal may be liberated and pumped away. If this were not done, these gases would be freed during the operation of the tube, and so contaminate the gas in which the glow takes place, altering the colour and characteristics of the discharge. The electrodes, after this treatment, are mounted on a "pinch" and sealed into a glass bulb in the usual way, the process resembling that employed in making lamps and valves.

Electrodes Sealed Individually

In some tubes, where it is not possible to adopt an electrode system on one support (*e.g.*, where very high voltages are to be applied), the electrodes are sealed individually into the glass envelope by hand, as in the case of the positive column tube where the electrodes are usually placed one at each end of the tube.

A glass tube is sealed into the bulb, so that the discharge tube may be connected to the pumping system. This latter consists of a high-speed mercury vapour pump, capable of exhausting to a pressure of 10^{-6} mms. mercury or less, together with an oven in which the tubes are

baked to free the glass of the water vapour and other gases held on and beneath its surface.

Cylinders of the various gases to be used such as neon, argon, helium, hydrogen, etc., together with purifying devices and pressure gauges, are connected to the pump system, so that the discharge tube may be filled with any gas at any given pressure. Direct and alternating current supplies up to 1,000 volts or more are available for glowing the tubes.

white by traces of carbon monoxide gas liberated in this way. The contaminated gas is then pumped away and the tube refilled to the desired pressure, and sealed off ready for capping.

There are three types of tube used for television purposes—the plate type, the crater type and the positive column. The plate type is most common and the voltage required to operate it is lower than for any of the others.

The Crater Tube

In the crater type, the glow, although small in area, is intense and takes place in a small metal tube, the other electrode being arranged as a metal ring around it. The crater type of neon lamp is only suitable for use in television systems employing an optical system in which a point of light is projected on to a screen.

In the positive column type the whole of the tube glows with a bright red light. A fairly high voltage is required to operate it.

The ability of the neon tube to respond fairly accurately to rapid current fluctuations allows it to be used to detect very minute quantities of current, providing the voltage is high enough—most wireless amateurs are fully conversant with it as an indicator in a wave-meter. It can also be used as a rectifier of current and as a generator of oscillations.

"Recognising and Remediating Picture Faults"

Read

"TELEVISION"

for MAY

Monthly - - 1/-

When the tube has been pumped and baked it is filled with gas at about 10 mms. or so pressure, and a heavy discharge is passed through it, so that the electrodes are brought to a bright red heat in order to free them of the last traces of occluded gases. The rich red colour of the neon discharge is changed to an intense blue

SPECIFIED for the
**HEPTODE
SUPER-THREE**

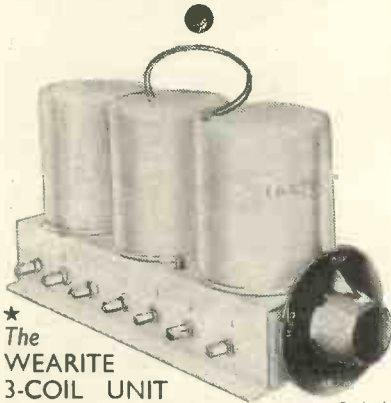

★ The WEARITE 3-COIL UNIT Type G.N.3 . . . PRICE 30/-



★ and . . . ONE WEARITE I.F. TRANSFORMER Type OT1 . . . 7/6

ONE WEARITE I.F. TRANSFORMER Type OT2 . . . 7/6

★ and . . . The WEARITE H.F.S H.F. CHOKE . . . 4/6

Here is THE UNIVERSAL COIL . . .

Tunes 180 - 550 and 850 - 1950 metres

Specially designed to cover the Lucerne Plan. One Type of Coil suitable for H.F. Aerial and Band Pass Tuning.

PRICE PER COIL 5/-



**WEARITE
COMPONENTS**

COUPON

To MESSRS. WRIGHT & WEAIRE, LTD., 740 High Road, Tottenham, London, N.17.

Please send me a copy of your booklet No. M.12, together with details of your Universal Coils and "L.P." (Lucerne Plan) Circuits, particulars of your Class "B" Components (and Circuits) & also H.T. Power Packs with circuits

NAME.....
ADDRESS.....
W.M. 5/34.....

The Designer says

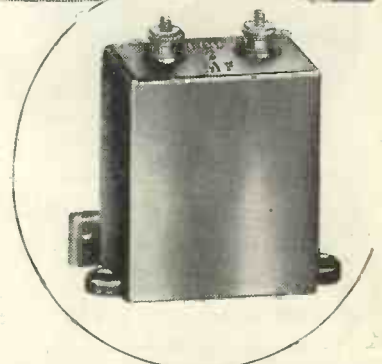

A popular T.C.C. Condenser—the type 50—2 mfd. for 200v. D.C. working. Price 3/6. Other capacities from .005 to 10 mfd.

for the
**UNIVERSAL
MERRYMAKER**

Here is a formidable list of SPECIFIED condensers, the designer says "use T.C.C. Condensers" so that you can be sure of downright dependability . . . and that, too, is a formidable reason why, when you order your components you say "T.C.C. Condensers." You know then, that they are backed by specialised research of over 27 years standing.

- One T.C.C. .0003 mfd. Type S, Price 1/3
- One T.C.C. .0002 mfd. Type S, Price 1/3
- Two T.C.C. .0003 mfd. Type S, Price 2/6
- One T.C.C. .01 mfd. Type S, Price 2/6
- One T.C.C. .05 mfd. Type 40, Price 1/9
- Six T.C.C. .1 mfd. Type 50, Price 11/-
- Three T.C.C. 1 mfd. Type 50, Price 7/6
- Three T.C.C. 2 mfd. Type 50, Price 10/6

T.C.C.
ALL-BRITISH
CONDENSERS

THE TELEGRAPH CONDENSER Co. Ltd.
WALES FARM ROAD, N. ACTON, W.2.



NEW FOUR-VALVE MCMICHAEL SUPER
 Many modern refinements, including variable tone control, delayed automatic volume control, and a wavelength-calibrated tuning scale, are incorporated in the new McMichael A.C. super-het

READERS should note that the Westinghouse Brake and Saxby Signal Co., Ltd., are supplying blueprints showing the method of using a metal rectifier in the Universal Merrymaker, a four-valve A.C./D.C. super-het described in our last issue.

Applications for a blueprint should be addressed to Westinghouse at 82 York Road, King's Cross, London, N.1, and 6d. in stamps should be enclosed.

In the list of parts for the Universal Merrymaker, the type number of the Bulgin mains resistance was given as MR5. This should have read type MR25.

McMichael Radio, Ltd., of Slough, Bucks., have recently introduced a new four-valve A.C. super-het priced at £14 14s. From the photograph on this page it will be seen that the set is a handsome outfit; the loud-speaker fret is of typical McMichael design. The set uses four of the latest multi-electrode valves and a Westinghouse metal rectifier.

Its main features include automatic volume control, variable tone control, a built-in mains-energised moving-coil loud-speaker, and a full-vision illuminated tuning scale calibrated in wavelengths only. A good proposition for set buyers!

Notes and Jottings

Max Kester, who has been on the artists staff of His Master's Voice for the last four years, has just left to accept a position on the light entertainment staff of the B.B.C., the department with Eric Maschwitz at its head. Max Kester, who is a well-known lyric writer, has recently devised and made a record for H.M.V. called *In Town All Night*, which is a humorous skit on the B.B.C.'s Saturday night feature, *In Town Tonight*. The number of the record is B8145 and costs 2s. 6d.

Ekco have just introduced a new five-stage four-valve battery super-het priced at £10 10s. The new set is housed in an attractive bakelite cabinet and, with its many modern refinements, represents excellent value for money. Like all Ekco sets, the model B54 incorporates light-beam and shadow tuning and a scale calibrated in wavelengths and stations.

This new battery set has a class-B output stage, a moving-coil

loud-speaker of large dimensions.

At this time of the year, when people are getting their cars in trim for the summer season, it was with interest that we noted that the Philco Radio and Television Corp. of Gt. Britain, Ltd., has introduced a Transitone car radio outfit for the low price of £16 16s.

The new instrument incorporates a six-valve super-het receiver with a four-point tone control. High tension is obtained from a vibrator unit, the whole set being run off a 12-volt car battery.

The set is controlled by a unit fitted to the steering column of the car, and the tuning scale is illuminated. This new outfit is type 10T.

A long patent battle has been going on in Europe, Philips and Tungsram being involved over some very interesting technical points. Of certain claims put forward by Philips, one of the most important of those disallowed by the Courts concerned the "cascade" patent (re-tuned circuits), on which this company would have been entitled to royalties from Czechoslovakian set-makers, but which has been declared as not valid.

Continued on page 384

The 1934 A.C. Quadradyne

Kenton (Middlesex).—Just a few lines in praise of your 1934 A.C. Quadradyne. I have built this set exactly to specification, and have mounted the W.B.PM4A loud-speaker on a 3-ft. baffle separate from the set.

Quality is exceptional; reproduction being crisp with a good natural base response. Selectivity is remarkable for a straight set. Using a big outdoor aerial the London stations have a spread of only two degrees.

To test the sensitivity of the set I rigged up a 20-ft. indoor aerial and found that such stations as Fécamp, Poste Parisien, and Hamburg could be received in broad daylight at good loud-speaker strength.

With the outdoor aerial, all the worth-while Continental transmitters can be received and, what is more, they are free of the background of mush which so many multi-valve sets introduce. Long-wave results are equally as good as medium.

I am sure this set will meet the demands of those who, like myself, want a good selection of stations but, at the same time, require really tip-top quality both on radio and when using a pick-up. Thanking you for a good circuit.

[The 1934 A.C. Quadradyne was described in the January, 1934, issue of "Wireless Magazine." The circuit consists of two variable- μ screen-grid amplifiers, detector, and a pentode output valve.—Ed.]

ANOTHER EXCLUSIVE SPECIFICATION

British Radiophone Condensers have been specified exclusively for the
WIRELESS MAGAZINE

Heptode Super Three

Again and again Radiophone Products are specified for important sets—a fact which shows with how much confidence prominent designers regard these quality components. Make no mistake about this. If you want your set to give the best results, the most accurate tuning and the most reliable service, buy British Radiophone components and accept nothing else.

BRITISH RADIOPHONE LIMITED
ALDWYCH HOUSE, ALDWYCH, LONDON, W.C.2

RADIOPHONE
MATE D PERFECTION

Radiophone 3 gang variable condenser
.0005 microfarad Type 604 with slow
motion drive Type 743c - complete **26/6**

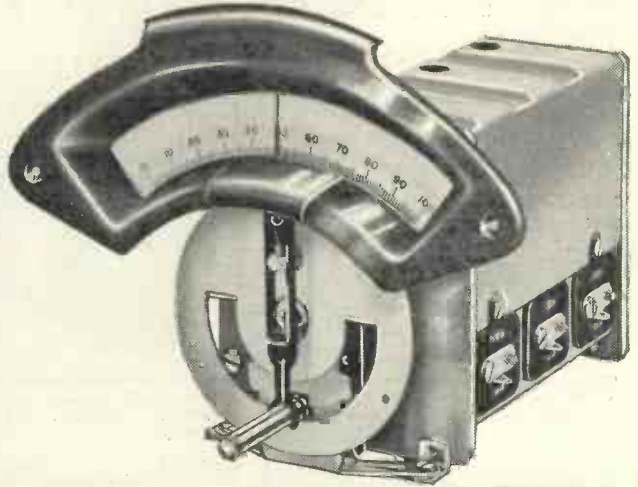

Blueprints are the key to the building of a successful receiver

The issue of blueprints for every set produced by the WIRELESS MAGAZINE removes the usual difficulty which confronts the home-set builder who has little or no technical wireless knowledge.

These blueprints illustrate, in the most simple manner, the complete construction of receivers in such a way that a two-valver or a complicated seven-valve superhet can be assembled in the short space of an hour or two.

Turn to page 382
of this issue for de-
tails of W.M. "star" sets

THE NEW PRINCIPLE IN RADIO

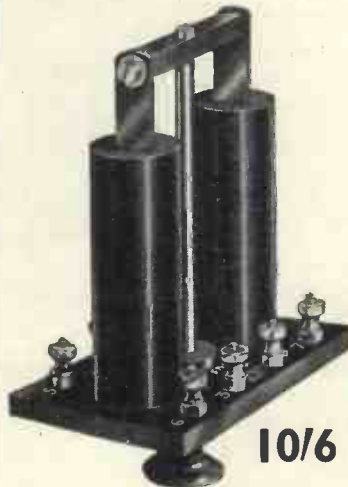

10/6

B I F O C A L
F O C U S S I N G C O I L S

Countless simple sets that were satisfactory when first designed cannot now get the increased number of stations in operation today. The Varley Bifocal Focussing coil with its revolutionary design, means entirely new life to these sets. Installing these new coils is so simple—the operation being no more difficult than any existing arrangement with a fixed aerial coupling. Write for full information, together with FREE CIRCUIT DIAGRAMS.

Varley
(Proprietors: Oliver Pell Control Ltd)

FOREMOST AS PIONEERS

Advt. of Oliver Pell Control Ltd., Kingsway House, 103 Kingsway, W.C.2. Phone: Holborn 5303

It helps us if you mention "Wireless Magazine"

YOU CANNOT GO WRONG IF YOU USE A

FULL-SIZE BLUEPRINT

Each blueprint shows the position of each component and every wire and makes construction a simple matter. Copies of "Wireless Magazine" and of "Amateur Wireless" containing descriptions of most of these sets can be obtained at 1s. 3d. and 4d., respectively, post paid. Index letters "A.W." refer to "Amateur Wireless" sets and "W.M." to "Wireless Magazine" sets. Send, preferably, a postal order (stamps over sixpence unacceptable) to "Wireless Magazine," Blueprint Dept., 58-61 Fetter Lane, London, E.C.4.

The TABLE QUAD

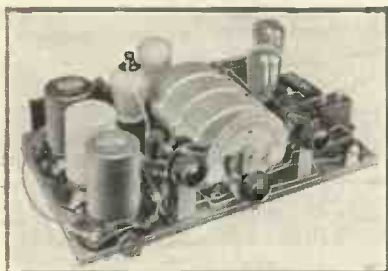

Circuit: SG., Detector, L.F., and power output (4 valves). Price of set: £5, less valves.

Clapham (London, S.W.).—I am pleased with the results I am getting from the Table Quad. It is undoubtedly the best battery four-valver I have handled. Up to the time of writing, I have identified over forty stations—your log only differs by one or two degrees at the most. Thank you!

The W.M. SHORT-WAVE SUPER

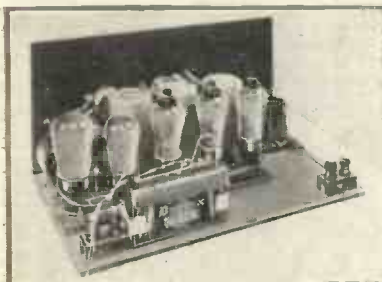

Designed by W. G. Hill. Circuit: 5-valve short-wave super-het. Price of set: £6 10s. without valves.

Walthamstow (Essex).—I wish to commend the "W.M." Short-wave Super. This set is the ninth short-waver I have built, and I am convinced that it is the real "easytune" short-wave set. I did not realise that there were so many languages in the world until I tuned on the "W.M." Short-wave Super. The log to date is twenty-three stations, all at good strength. WBXK provides a real good programme from 9 p.m. onwards. It is truly the last word in short-wave sets.

The CALIBRATOR

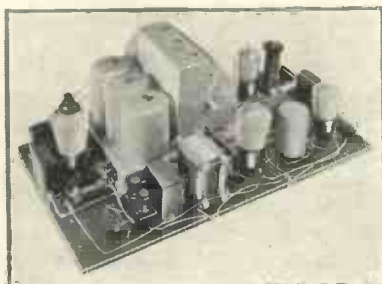

Circuit: SG., Detector, L.F., and Power output (4 valves). Price of set: £6, less valves.

Blackpool (Lancs).—I thought you might be interested to know how pleased I am with the Calibrator. I have adapted the set for all-mains working and am extremely satisfied with the results obtained. I can log over forty-five stations at good loud-speaker strength.

The WIZARD 3

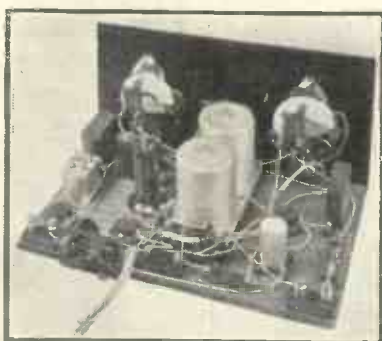

Circuit: SG., D., Trans. Designed by Percy W. Harris. A simple battery three-valver, a fine station-getter, and an ideal family set. Approximate cost, less valves, £4.

Swansea.—Have built up the Wizard from a kit of parts, and have pleasure in giving the results I have had with this truly magical three-valver. Have already logged thirty-seven stations at good loud-speaker strength and an American station, also at loud-speaker volume. I must say that, for a three-valver, this one takes top score.—D. R.

SPECIAL HALF-PRICE OFFER

Blueprints of the following "Wireless Magazine" sets described in this issue are obtainable at the special price, given below, if the coupon on last page is used before May 31, 1934.

- Heptode Super Three (3-valve A.C. Super-het) No. WM359 ... 6d.
- Companionette (A.C./D.C. two valver) No. WM358 ... 9d.

And here are over 50 more to choose from—

CRYSTAL SET (6d.)

- 1931 Crystal Set ... AW308
- ONE-VALVE SETS (1s. each)**
- Easy to Build One ... AW304
- Portable Short-wave One ... AW354
- B.B.C. One-valver ... AW387

TWO-VALVE SETS (1s. each)

- A.C. Quality Gem (D, Trans) ... WM312
- Home Station A.C. 2 (D, Pen) ... AW374
- B.B.C. National Two (D, Trans) ... AW377
- Melody Ranger Two (D, Trans) ... AW389
- Consolectric Two (D, Pen) A.C. ... AW403

THREE-VALVE SETS (1s. each)

- Economy-pentode Three (SG, D, Pen) ... WM1337
- D.C. Calibrator (SG, D, Push-pull Pen) ... WM1328
- Tyers Iron-core Three (SG, SGD, Pen) ... WM1330
- A.C.-D.C. Three (SG, D, Pen) ... WM1332
- C.B. Three (D, LF, Class-B) ... WM1333
- Duo-tuned Three (SG, D, Pen) ... WM1341
- A.C. Transportable (SG, D, Pen) ... WM1347
- All-wave Three (D, 2LF) ... WM1348
- "W.M." 1934 Standard Three (S.G., Det Pen) ... WM1351

- Emigrator (A.C. set : 14-500.m.) (S.G., D., Pen) ... WM1352
- £3 3s. Three (SG, D, Trans) ... WM1354
- Spectrum Portable (SG, D, Q.P.P.) ... WM1357
- James Push-push Three (SG, D, Q.P.P.) (1/6) ... AW378
- Everybody's Home Radiogram (SG, D, Trans) ... AW381
- Home-lover's New All-electric 3 for A.C. mains (SG, D, Trans) ... AW383
- Our Up-to-the-Minute Three (SG, West-rector, LF, Trans) ... AW384
- Class-B Three (D, Trans, class B) ... AW386
- A.C. Trilodyne (SG, D, Pen) ... AW399
- Home-built Coil Three (SG, D, Trans) ... AW404
- Fan and Family Three (D, 2LF) ... AW410
- £5. 5s. S.G.3 (SG, D, Trans) ... AW412
- 39/- Lucerne Ranger (SG, D, Trans) ... AW422

FOUR-VALVE SETS (1s. 6d. each)

- Gold Coaster (A.C. Short-waver) ... WM1292
- Triple-tune Four (2 SG, D, Trans) ... WM1293
- Calibrator (SG, D, RC, Trans) ... WM1300
- Table Quad (SG, D, RC, Trans) ... WM1303
- "Words and Music" Radiogram (2 SG, D, Trans) ... WM1307
- "Words and Music" Radiogram de Luxe (SG, D, RC, Q.P.P.) ... WM1307a
- Home Short-waver (SG, D, RC, Trans) ... WM1311
- Home Short-waver (SG, D, RC, Trans) ... WM1313
- Calibrator de Luxe (SG, D, RC, Trans) ... WM1316
- All-metal Four (2 SG, D, Pen-A. C. Mains) ... WM1329
- Self-contained Four (SG, D, LF, Class B) ... WM1331
- All-progress Four (Battery Super-het) ... WM1335
- Merrymaker Super (A.C. Super-het) ... WM1345
- 1934 A.C. Quadradyne (2SG, D, Pen) ... WM1349
- Lucerne Straight Four (SG, D, LF, Trans) ... WM1350
- Universal Merrymaker (A.C./D.C. Super-het) ... WM1356
- "A.C. Melody Ranger" (SG, D, RC, Trans) ... AW380
- "A.W." Ideal Four (2SG, D, Pen) ... AW402
- 2 H.F. Four (2 SG, D, Trans) ... AW421

FIVE-VALVE SETS (1s. 6d. each)

- New Class-B Five (SG, D, LF, Class-B) ... WM1340
- Class-B Quadradyne (2 SG, D, LF, Class-B) ... WM1344
- James Short-wave Super (Super-het) ... AW328
- Simple Super (Super-het) ... AW340
- The Etherdyne (Super-het) ... AW406
- 1934 Century Super (Battery super-het) ... AW413

SIX-VALVE SETS (1s. 6d. each)

- 1932 Super 60 (Super-het) ... WM1269
- 1932 A.C. Super 60 (A.C. Super-het) ... WM1272
- "W.M." D.C. (Super-het) ... WM1321
- James Class-B Super (Super-het with iron-cored coils) ... WM1326
- Welcome Portable with class-B output stage ... WM1325
- Connoisseurs' Super (A.C. Super-het) ... WM1334
- James Super Straight Six (2 SG, D, LF, Push-pull) ... WM1339
- Lucerne Super (battery super-het) ... WM1355

SEVEN-VALVE SETS (1s. 6d. each)

- Super Senior (Super-het) ... WM1256
- Seventy-seven Super (A.C. Super-het) ... WM1305
- Q.P.P. Super 60 (Super-het) ... WM1319

PORTABLES (1s. 6d. each)

- Town and Country Four (SG, D, RC, Trans) ... WM282
- Everybody's Portable (five-valve Super-het) ... WM1291
- Welcome Portable (six-valve Super-het) ... WM1322
- General-purpose Portable (SG, D, RC, Trans) ... AW351

MISCELLANEOUS (1s. each)

- Voltage Regulator ... WM1287
- Class-B Mains Unit ... WM1324
- A.C. Short-wave Converter ... WM1353
- "A.W." Trickle Charger ... AW352
- Add-on Band-pass Unit ... AW359
- Plug-in Short-wave Adaptor ... AW382

Renowned for Reliability and long Service . . .



Dubilier High Voltage Dry Electrolytic Condensers are far ahead of any others on the market. You are assured of a real value-for-money condenser upon which you can rely for outstanding performance.

DUBILIER ELECTROLYTIC CONDENSERS



They are used in thousands by keen experimenters and constructors, and specified by the leading set designers for all their latest circuits such as The Companionette. Six quality points are:

1. Entirely sealed.
2. No liquid.
3. No leakage of electrolyte.
4. Constant capacity.
5. Rapid reforming.
6. Low power factor.

4 mfd. 4/6.
6 mfd. 5/-.
8 mfd. 5/6.

500 D.C. Max peak volts

DUBILIER CONDENSER CO. (1925), LTD., DUCON WORKS, VICTORIA RD., N. ACTON, W.3

"We're Fluxite and Solder. The reliable pair; Famous for Soldering, Known everywhere!"

When fixing your aerial Be sure not to shirk—"SOLDER" your connections—A good spot of work!

See that Fluxite and Solder are always by you—in the house—garage—workshop—anywhere where simple, speedy soldering is needed.

ALL MECHANICS WILL HAVE
FLUXITE
IT SIMPLIFIES ALL SOLDERING

All Ironmongers sell Fluxite in tins: 4d., 8d., 1s. 4d., and 2s. 8d. Ask to see the **FLUXITE POCKET SOLDERING SET**—complete with full instructions—7s. 6d. Ask also for our leaflet on **HARDENING STEEL** with Fluxite.

FLUXITE LTD., Dept. 332
Dragar Works, Bermondsey St., S.E.1

FOR ALL REPAIRS!

CLIX

CHASSIS MOUNTING VALVEHOLDERS

★ Specified for the "HEPTODE" SUPER THREE

Because they are of the super low-loss type, give full surface contact with any type of pin and are the only chassis mounting valveholders with terminals.

★ 4-Pin, 8d. 5-Pin, 9d. 7-Pin, 1/-

For the "COMPANIONETTE" 7-Pin Screened Continental Type 1/8 ea.

INSULATED SOCKETS 2d. each ★

CLIX Chassis Mounting STRIPS

No. 23: -L.S.+ Pick-up ... 8d.
No. 24: -A1, A2, E. ... 7d.

CLIX SOLID PLUGS for use with above 2d. each

LECTRO LINX LTD.
79a Rochester Row, London, S.W.1

YOUR OLD COMPONENTS

are worth money. Sort out the spare radio parts you no longer require and advertise them in the "Miscellaneous Columns" of AMATEUR WIRELESS. You will be surprised how quickly they will be snapped up.

Your announcement will cost you 3d. a word. Send your list of parts, together with your name, address and remittance, to:

"Small Advertisement" Dept.,
AMATEUR WIRELESS, 58-61 FETTER LANE, LONDON, E.C.

There is news in the "Wireless Magazine" advertisements

BLUEPRINT COUPON

Valid only until May 31, 1934 (or until June 30, 1934, for overseas readers)

FOR ONE BLUEPRINT ONLY

If you want a full-size blueprint of any ONE of the sets constructionally described in this issue for half price, cut out the above coupon and send it, together with a postal order, to Blueprint Department, WIRELESS MAGAZINE, 58-61 Fetter Lane, London, E.C.4.

This coupon is valid for a blueprint of any ONE only of the following sets at the prices indicated :—

THE HEPTODE SUPER THREE (page 315), No. WM359, price 6d., post paid.

THE COMPANIONETTE (page 324), No. WM358, price 6d., post paid.

INFORMATION COUPON

Valid only until May 31, 1934 (or until June 30, 1934, for overseas readers)

If you want to ask any questions, cut out the above coupon and send it, together with a postal order for 1s. and stamped addressed envelope, to the Information Bureau, WIRELESS MAGAZINE, 58-61 Fetter Lane, London, E.C.4.

Note that not more than two questions may be asked at a time and that queries should be written on one side of the paper only.

Under no circumstances can questions be answered personally or by telephone. All inquiries must be made by letter so that every reader gets exactly the same treatment.

Alterations to blueprints or special designs cannot be undertaken: nor can readers' sets or components be tested.

If you want advice on buying a set, a stamped addressed envelope only (without coupon or fee) should be sent to the Set Selection Bureau, WIRELESS MAGAZINE, 58-61 Fetter Lane, London, E.C.4.

NOTES AND JOTTINGS

Continued from page 380

Similarly, Tungram succeeded in a case against the centre-tapped patent.

But a third patent of this group, the grid-detection patent, has simply been restricted in Czechoslovakia in such a way that it no longer covers all variations.

In Hungary important issues centred round a Philips patent for horizontal-electrode structure and one on cathode manufacture by vapour process. The Supreme Court has finally found both these to be invalid.

A new patent application on slanting electrodes, put forward in Germany by the Valvo Company of Hamburg (a sister concern, by the way, of Philips) has been refused in the Supreme Court.

The B.B.C.'s programme policy was paid a great tribute by Louis Sterling, the managing director of Electric and Musical Industries, Ltd., when he returned from his recent visit to the U.S. He said that the recent attacks on the B.B.C. were unduly severe, and that "the radio industry in America is in a state of absolute chaos, due entirely to the poor quality of the sponsored programme."

A permanent-magnet moving-coil loud-speaker with an entirely new magnet system has just been introduced by the British Blue Spot Co., Ltd., of 94/96 Rosoman Street, London, E.C.1. The feature is that the magnetic material is enclosed in four special chromium-plated tubes bolted in the usual place behind the loud-speaker cone. The makers claim that this new system is infinitely more efficient than the present general practice. A test report on this instrument will appear next month.

Readers on D.C. mains will be interested to hear that Pye Radio, Ltd., of Africa House, Kingsway, London, W.C.2, has recently introduced a D.C. version of the Cambridge seven-valve super-het. This set is housed in the new architect-designed cabinet, and its most outstanding feature is that it delivers an undistorted output of 3 watts; a large output for a D.C. receiver.

The new model is known as type CR/DC and costs £21 in table form and £23 2s. with the pedestal.

INDEX TO ADVERTISERS

A	Page
Automatic Coil Winder Co.	Cover ij
B	
British Radiophone Ltd.	381
Burne-Jones & Co., Ltd.	295
D	
Dubilier Condenser Co., Ltd.	383
E	
Electradix	355
Ever Ready (G.B.), Ltd.	377
Evershed & Vignoles, Ltd.	375
F	
Ferranti, Ltd.	295
Fluxite, Ltd.	383
Forbat, Eugene, Ltd.	293
G	
Gramophone Co., Ltd.	298
L	
Lectro-Linx, Ltd.	383
P	
Partridge & Mee, Ltd.	354, 375
Peto-Scott Co., Ltd.	295
Pifco, Ltd.	297
R	
Radio Pictorial	377
Radio Resistor Co., Ltd.	293
Rotax, Ltd.	375
S	
Smith (M/A), Ltd.	Cover iv
Standard Telephones, Ltd.	295
Sound Sales, Ltd.	293
T	
Telegraph Condenser Co., Ltd.	379
Telephone Manufacturing Co., Ltd.	297
Telsen Electric Co.	291
Trix Electrical Co., Ltd.	355
V	
Varley, Ltd.	381
W	
Westinghouse Brake & Saxby Signal Co., Ltd.	Cover iv
Wright & Weaire	379

HOW TO BUILD A SIMPLE SET

which can be used in conjunction with

Daily Express TELEVISION KIT

The construction of this new Television receiver is explained in full in the May issue of *Television*.

Not only can it be used in conjunction with the recently issued "Daily Express" kit, but it enables amateurs to receive transmissions in **ANY** part of the country.

Included in the many other features of the May issue is much useful information that will enable constructors who have already assembled the "Daily Express" kit, to obtain really first-class results.

Get a copy to-day from your newsagent, price 1s.

PRICE
1/-
ORDER YOUR
COPY TO-DAY

Published
by
Bernard Jones
Publications
Ltd., 58/61
Fetter Lane,
London,
E.C. 4

SUBSCRIPTION RATES

Post paid to
any part of the
world— 3
months 3/6,
6 months 6/9,
12 months
13/6.

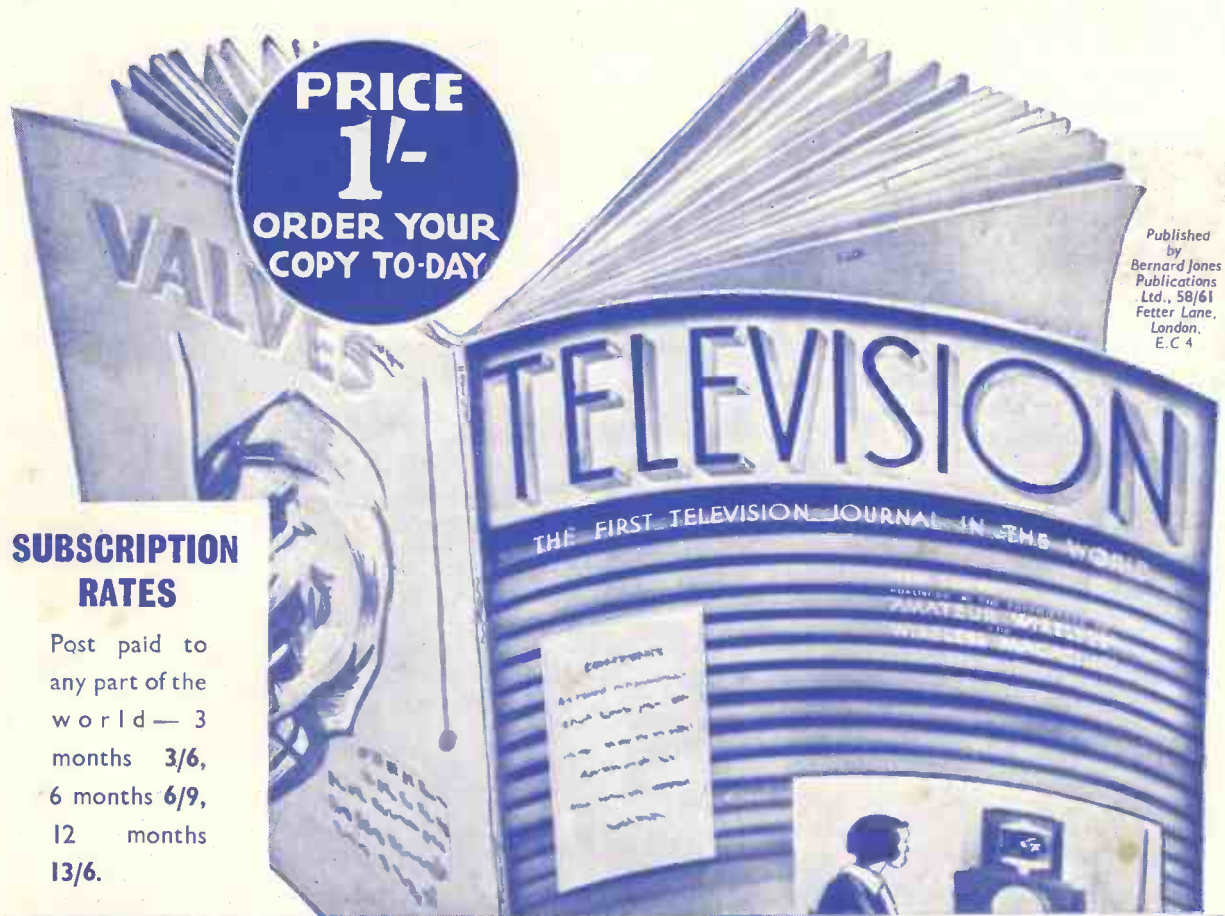

The ONLY Publication entirely devoted to TELEVISION



Exceptional Power and Long Life

The elephant, the longest lived of all animals, is noted for its phenomenal strength and staying power. The Smith Accumulator, the most dependable of all accumulators, is noted for its extra long life. Buy one yourself and prove the aptness of this comparison.

For H.T. and Grid Bias use 'Anodex' Dry Batteries.

The Smith Accumulator Type 2PJD9, price 12/6, is exclusively specified for the SPECTRUM PORTABLE described in this issue.



SMITH'S ACCUMULATORS

S. SMITH & SONS
CRICKLEWOOD



(Motor Accessories) Ltd.
LONDON N.W.2

METAL★ RECTIFICATION

FOR THE
UNIVERSAL MERRYMAKER

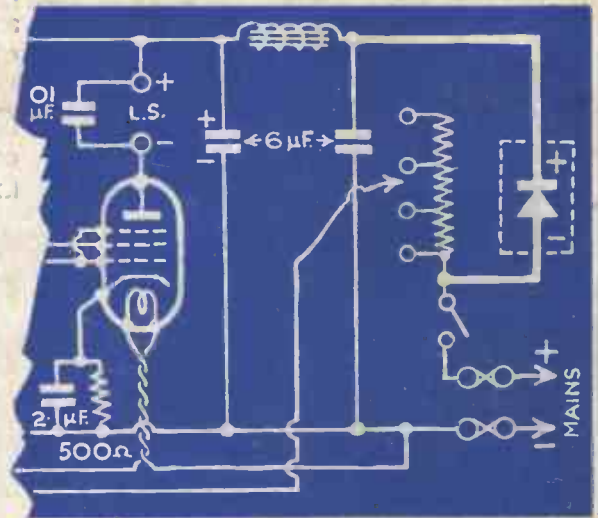

- ★ SIMPLER
- MORE RELIABLE
- PERMANENT rectification at
- NO EXTRA COST
- SAFER

See how much more simple the circuit is. Only two connections! Far less trouble to instal. And it's much safer, too! There can be no high voltages between anode and cathode; no danger of breakdown. And, although it costs no more than the alternative valve and valve-holder, the metal rectifier style H.T.10 will last for ever.

For those who prefer a safe A.C./D.C. receiver with permanent rectification, we have prepared a blueprint showing how the few necessary alterations may be carried out. The attached coupon and 6d. in stamps will bring you a copy.

Get YOUR Blueprint Now!

-----COUPON-----

Please send me blueprint and building particulars of "The Universal Merry-maker" using Westinghouse Metal Rectification. I enclose 6d. in stamps.

NAME.....

ADDRESS.....

W.M.534

THE WESTINGHOUSE BRAKE & SAXBY SIGNAL CO., LTD.,
82 York Road, King's Cross, London, N.I.