

BUILDING A BATTERY RADIOGRAM FOR £10

# Wireless Magazine

THE BEST SHILLINGSWORTH IN RADIO

MARCH, 1932

1/-

## Your Practical Guide to GRAMO-RADIO

SPECIAL 20-PAGE SECTION



P. K. TURNER'S "A"-QUALITY AMPLIFIER  
GETTING THE BEST FROM A PICK-UP  
H. J. ROUND ON MICROPHONES  
DOUBLE BAND-PASS FOUR  
MORE ABOUT THE  
QUADRADYNE  
132 PAGES

# LEWCOS

(Regd.)

## Components

*The Criterion of  
Craftsmanship*



*The Lewcos components illustrated above*

1. TWIN OSCILLATOR COIL, REFERENCE T.O.S. PRICE 8/6
  2. I.F. TRANSFORMER, WITHOUT PIGTAIL, REFERENCE I.F.T. PRICE 10/6
  3. TWO I.F. TRANSFORMERS, WITH PIGTAILS, REFERENCE I.F.T.P. PRICE 10/6
- and*
4. THE LEWCOS BAND-PASS FILTER. PRICE 12/-

*are specified for the*

**1932 A.C. SUPER 60**

*and for the*

**1932 SUPER 60 RECEIVERS**

E.T.

Perfect symmetry and elegance of design, and maximum efficiency on every technical point have made LEWCOS components the standard by which all others are judged. This pre-eminence has been achieved by skilled workmen using only the very finest of materials, and by a staff of experts who constantly experiment to ensure that LEWCOS components live up to their manufacturer's reputation for being in the forefront of radio design.

*Write for fully descriptive leaflets :*

No. 1. Twin Oscillator Coil, Ref. R75  
Nos. 2, 3 & 5. I.F. Transformer, Ref. R71

No. 4. Band-pass Filter, Ref. R73



**LEWCOS RADIO PRODUCTS—BETTER RECEPTION**

THE LONDON ELECTRIC WIRE COMPANY AND SMITHS LIMITED CHURCH ROAD, LEYTON, LONDON E.14



Editor:

BERNARD E. JONES

Technical Editor:

J. H. REYNER,  
B.Sc. (Hons.), A.M.I.E.E.

# Wireless Magazine

The Best Shillingsworth in Radio

Vol. XV :: MARCH, 1932 :: No. 86

Research Consultant:

W. JAMES

Assistant Editor:

D. SISSON RELPH

Published by BERNARD JONES PUBLICATIONS, LTD., publishers of "Wireless Magazine" and "Amateur Wireless." Editorial and Advertisement Offices: 58-61 Fetter Lane, London, E.C.4. Telephone: City 3733, 3744. Telegrams: "Beesjapee, Fleet, London." Subscription: Great Britain and abroad, 15s. 6d. a year, post free (Canada only, 13s. 6d.). Contributions are invited and will be promptly considered. Next issue published on Wednesday, March 29.

## The Editor's Shop Window

I BRING into this page, my shop window, samples of the goods within, and naturally I give prominent place to what I consider my "best lines." But I have so many "best lines" this month that I have scarcely room in which to place them all before you.

But I will make a start with "Your Practical Gramo-radio Guide," a twenty-page section containing many features, among them being the Economy Radio Gramophone, for which we know there is a keen demand; this is a battery-operated record player, in the design of which we have especially considered quality and economy. For the first we gladly answer; for the second, you can judge for yourself when I say that without batteries the cost is about £10, and absolutely complete and ready for use the cost does not reach £12.

In this Gramo-radio section there are one or two articles which I particularly invite you to read. For example, "Getting the Best from Your Pick-up," by a member of our Technical Staff; "Pick-up Damping," by Noel Bonavia-Hunt; "More About Featherweighting," further correspondence on a controversy which Capt. Barnett started some few months ago.

Back again with us this month, we are glad to say, is Capt. Round, who during the past two years has put a deal of work into the development of microphones, some echoes which of special interest are to be found in his article.

Our sets this month will appeal to every type of reader. We give more information about the Quadradyne, the one-knob screen-grid four described last month, and in a later issue we shall describe an A.C. version of this fine set.

From the circuit standpoint the Double Band-pass Four will interest you; it is a screen-grid set possessing great sensitivity and a high degree of selectivity. The aerial circuit and the intervalve coupling avail themselves of the band-pass system.

P. K. Turner believes in quality. The initials

A-P-A. on other pages this month stand for the A-quality Power Amplifier, embodying the designer's and author's ideas on a much discussed subject. The A-P-A. is not a cheap proposition, but the reader who is looking for an amplifier giving great output with perfect quality, and at the same time able to provide high-tension and low-tension power for the mains receiver, will not lightly pass over the A-P-A.

Whitaker-Wilson describes in this issue a visit he paid to P. K. T.'s laboratory, and says that now he realises what quality means!

P. K. Turner tells me that he has something particularly good up his sleeve for an early issue. By the way, he has another article in this issue, and in that he asks whether we are using the right type of variable condenser, his conclusion being that a revival of the S.L.F. type would be advantageous.

Although short-wave transmissions have not been at their best recently, there has undoubtedly been a very considerable addition to the number of short-wave listeners, and I am glad at this extension of the programmes available to all and sundry. We recognise the position by now including the short-wave stations as a regular part of our list of broadcast wavelengths.

Prominent among our general articles is Frank Rogers' "How a Play is Broadcast," which really does take you behind the scenes and gives an extraordinarily good demonstration from which you will gather that the control engineer has to be alive and quick-witted. Just look at the instructions on the photographic reproduction of a play typescript given on page 167!

While this number of "Wireless Magazine" was being prepared for press, the B.B.C. staff was getting ready to leave Savoy Hill for its new headquarters at Broadcasting House, and our Special Commissioner has taken the opportunity of recalling many incidents that have occurred at the B.B.C.'s old home. Here's luck to the B.B.C. in its new home!

B. E. J.

### FOR THE CONSTRUCTOR

THE DOUBLE BAND-PASS FOUR: SCREEN-GRID SET WITH TWO BAND-PASS TUNING CIRCUITS. By the "W.M." Technical Staff .....	PAGE 174
THE ECONOMY RADIO GRAMOPHONE: COMPLETELY SELF-CONTAINED AND BATTERY-OPERATED. By the "W.M." Technical Staff .....	192
THE A-P-A: AN A-QUALITY POWER AMPLIFIER AND POWER SUPPLY UNIT FOR A.C. MAINS. By P. K. Turner, M.I.E.E. .....	211
ABOUT THE QUADRADYNE. By the "W.M." Technical Staff .....	224

### GRAMO-RADIO SECTION

YOUR GUIDE TO PRACTICAL GRAMO-RADIO: INTRODUCTION .....	PAGE 181
GETTING THE BEST FROM YOUR PICK-UP. By S. Rutherford Wilkins .....	182
ELECTRIC DRIVES FOR TURNTABLES. PICK-UP DAMPING. By Noel Bonavia-Hunt, M.A. ....	184
TO CECILIA: VERSE .....	186
MORE ABOUT FEATHERWEIGHTING .....	187
OVERHAULING YOUR ELECTRIC GRAMOPHONE MOTOR. By E. J. G. Lewis .....	188
YOUR CHOICE OF NEW RECORDS. By Whitaker-Wilson .....	190
.....	197

## Contents

LONG-PLAYING RECORDS. By P. K. Turner, M.I.E.E. ....	PAGE 200
A POWER PICK-UP .....	248

### TECHNICAL FEATURES

VOLUMES TO USE IN YOUR SET .....	PAGE 132
ARE WE USING THE RIGHT TYPE OF CONDENSER? By P. K. Turner, M.I.E.E. ....	153
MICROPHONES: SOME RECENT DEVELOPMENTS. By Capt. H. J. Round, M.I.E.E. ....	161
MIKES AT THE B.B.C. ....	165
WE TEST BEFORE YOU BUY .....	168
BLUE SPOT A.C. FOUR-VALVER .....	169
K.B. KITTEN TWO-VALVER .....	170
MCMICHAEL COLONIAL SHORT-WAVE SET .....	171
R.I. MADRIGAL BAND-PASS THREE .....	172
COLUMBIA RADIO GRAMOPHONE. ....	173
RADIO IN REVIEW. By Morton Barr .....	180
USING A.C. SETS ON D.C. MAINS. ....	205
SECRETS OF SUPER-HET SUCCESS. By W. James .....	234
OUR TESTS OF NEW APPARATUS .....	244
DESIGN DATA SHEETS. By J. H. Reyner, B.Sc., A.M.I.E.E. ....	250

### GENERAL ARTICLES

GUIDE TO THE WORLD'S BROADCASTERS. ....	PAGE 138
WORLD'S BROADCAST STATIONS .....	142
IN TUNE WITH THE TRAD. By Fetter Lane .....	148
RADIO RHYMES .....	156
RADIO MEDLEY. By BM/PRESS .....	157
THE A.B.C. OF RADIO .....	160
ONE OF THE NO-VICE'S BRIGADE: VERSE ..	165
HOW A PLAY IS BROADCAST. By Frank Rogers .....	166
UNDER MY AERIAL. By Halyard .....	201
EXPLORERS' ELECTRICAL RECORDING .....	204
THE VOICE OF ITALY. By J. Godchaux Abrahams .....	206
HUNGARY'S PLANS .....	208
THE WIRELESS ZOO: THE SET-TER: VERSE ..	208
WHAT QUALITY MEANS: By Whitaker-Wilson .....	209
MUSIC OF THE MONTH. By T. F. Henn ..	218
GOOD-BYE TO SAVOY HILL. By Our Special Commissioner .....	228
THE LOG: VERSE .....	232
ON THE CREST OF THE WAVES. By Jay Coote .....	240
STORIES OF THE OPERAS: Parsifal .....	254
NEWS OF THE SHORT WAVES .....	254
ODD NOTES .....	256
BLUEPRINT AND INFORMATION COUPONS ..	256
INDEX TO ADVERTISERS .....	256



# DO YOU REALLY UNDERSTAND HOW YOUR SET WORKS?

You can add 50 per cent. to the enjoyment of radio by having a clear understanding of how your set works. To have a fundamental knowledge of wireless means that should any trouble develop, or improvements or additions be required, you can do them yourself without having to resort to trouble and expense of professional assistance.

AMATEUR WIRELESS will help you to obtain this knowledge for the reason that all technical matters, illustrations and diagrams are explained in simple, everyday language, to be understood by everybody.

Two features at present appearing, which are of tremendous interest to all beginners in radio, are "The A.B.C. of All-electric Radio" and "The How and Why of Tuning."

In addition, details of many new and original receivers are published for you to build, and exclusive features contributed by the best known names in the industry, combine to make AMATEUR WIRELESS Britain's Leading Radio Weekly.

Read "Amateur Wireless" weekly and be up to date in radio.

# AMATEUR WIRELESS

ON SALE EVERY THURSDAY, PRICE 3d.



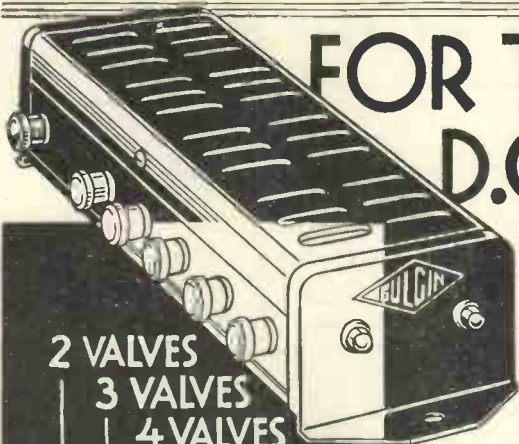

# FOR THE NEW D.C. VALVES

The introduction of indirectly heated D.C. Valves has revolutionised the standards of efficiency of sets operated by D.C. Mains, therefore every constructor should investigate the Bulgin D.C. Mains Resistance, which has UNIVERSAL APPLICATION. The same mains resistance is equally suitable for ANY NUMBER OF VALVES OF THE SAME MAKE, from two to six. In addition, each component is applicable to all D.C. voltages in general use, FROM 200 to 250 VOLTS. By any other method a different resistance unit is necessary if you alter the number of valves or change the voltage.

PATENTS PENDING

Each instrument is heavily constructed and of high carrying capacity and low-temperature operation. The casing ensures adequate protection and safety and provides efficient cooling.

Available in three Types

- A For  $\frac{1}{2}$  amp. "Mazda" D.C. Valves (one 8 volt and any number at 6 volts up to a total of six).
- B For  $\frac{1}{2}$  amp. "Osram" D.C. Valves (any number from two to six at 16 volts each).
- C For .1 amp. "Mazda" D.C. Valves (two to six at 40 and 30 volts each).

Send 2d. postage for 75-page Illustrated Catalogue and Manual.

**A. F. BULGIN & CO., LTD.**

ABBEY ROAD, BARKING, ESSEX

Telephones: Grangewood 3266 and 3267.

London Showrooms: 9, 10, 11 Cursitor Street, Chancery Lane, E.C.4. Telephone: Holborn 2072.

## AGAIN RECOMMENDED



Tunewell Choke S20/25 Inductance 20H up to 50 m/a

12/6

—one required for the

## DOUBLE BAND-PASS 4

This Tunewell 20-henry L.F. Choke, which was specified for the 1932 Super 60, is again recommended this month.

Tunewell Eliminators and Components have rapidly come to the front because of their exceptional efficiency and reliability. They are specially designed and built for the expert; and test reports in the leading technical and trade papers are enthusiastic in their praise.

Hundreds of these Tunewell Chokes have already been used for the Super 60.

Always insist on Tunewell products, for any set to ensure the utmost quality of reproduction at the lowest cost.

## TUNEWELL

- Eliminator, type FV150/30. Output 150 volts at 30 m/a, 4 tappings (2 variable) **£5**
- Pentode Output Choke, 4 tappings, 9 ratios. Inductance, 70 h. at 20 m/a. Low self-capacity. **15/6**
- Choke S50/50. Inductance, 50 h. at 50 m/a. **18/6**
- Transformer T4. Output, 450 v. at 100 m/a., 4 v. at 4 amps., 4 v. at 2 amps., and 4 v. at 2 amps. **£3/15/-**
- Power Unit for A.C. Sets. Output, 250 v. at 60 m/a., 3 tappings (2 variable), 4 v. at 1 amp. and 4 v. at 4 amp., centre tapped for heaters of A.C. valves. **£6/6/-**
- Choke S20/25. Inductance, 20 h. up to 50 m/a. **12/6**
- Transformer MV/50. Output 250 v. at 60 m/a., 4 v. at 4 amp., 4 v. at 2 amp., and 4 v. at 1 amp. **£1/15/-**

★ Write for special lists of Tunewell Eliminators and Components; also for details of the remarkable Tunewell All-mains 3 Receiver, which will be ready soon.

**TURNER & CO.,**

54 Station Rd., London, N.11

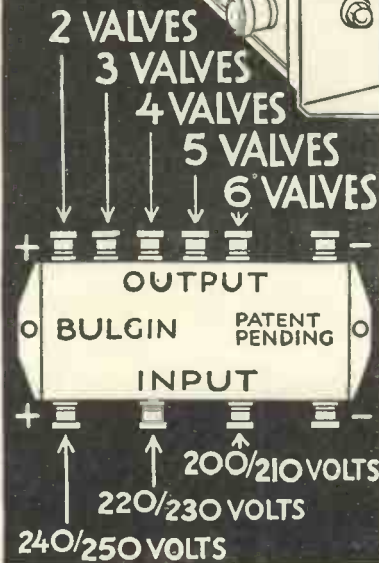

PRICE  
**18'6**  
EACH



### MODERNISE YOUR SET!

House it in the Camco "Master" Cabinet, a most handsome piece of furniture, in beautiful Oak or Mahogany finish—only 90/- Panel sizes 14ins. by 7ins. to 21ins. by 7inches. When ordering state exact size of panel. Write for FREE copy of the Camco Radio Cabinet Catalogue.

CARRINGTON MFG. CO. LTD., Showrooms: 24, Hatton Garden, London, E.C.1 Phone: Holborn 8202 Works: South Croydon



NAME \_\_\_\_\_  
ADDRESS \_\_\_\_\_

WM11

### Individuality

We do not manufacture indiscriminately every component and accessory known to radio: we produce rotary switches and anti-microphonic valveholders which are quite definitely the finest in the world. For your own good you should incorporate Benjamin components in your set.

By the way, have you had our 1932 Catalogue with its three original circuits?

If not write now—right now!

The Benjamin Electric Ltd.  
Tarriff Road, Tottenham, N.17  
Tottenham 1500.



BUY

**Amateur Wireless**

3d. Weekly

You will get prompt replies by mentioning "Wireless Magazine"

# Valves to Use in Your Set

Make	Type	Impedance	Amplification Factor	Filament Current	Mutual Conductance	Anode Current at 120 volts	Grid Bias at 100 volts	Grid Bias at 150 volts
<b>2-volt Three-electrode Valves</b>								
Mazda ..	H210	59,000	47	.1	.8	.5	1.1	1.0
Lissen ..	H210	50,000	35	.1	.7	1.1	1.1	1.5
Lissen ..	H2	50,000	45	.1	.9	2.0	1.0	1.5
Cossor ..	210RC	50,000	40	.1	.8	5	1.5	1.5
Tungram ..	R208	50,000	35	.1	1.0	1.0	1.5	1.5
Six-Sixty ..	210RC	45,400	35	.1	1.1	1.0	1.0	1.5
Mullard ..	PM1A	41,600	50	.1	1.2	.75	1.5	1.5
Marconi ..	H2	35,000	30	.1	1.0	1.0	—	1.5
Osram ..	H2	35,000	35	.1	1.0	1.0	—	1.5
Dario ..	Detector	30,000	30	.1	1.0	1.0	—	1.5
Six-Sixty ..	210HF	25,000	19	.1	.75	1.0	3.0	4.5
Tungram ..	H210	25,000	24	.1	1.0	2.0	1.5	3.0
Mullard ..	PM1HF	22,500	18	.1	.8	1.0	3.0	4.5
Cossor ..	210HL	22,000	20	.1	1.1	.75	1.5	3.0
Lissen ..	HL210	20,000	32	.1	1.0	2.2	1.5	4.5
Lissen ..	HL2	21,000	30	.1	1.5	3.0	1.0	1.5
Mazda ..	HL2	21,000	32	.1	1.5	—	—	1.5
Dario ..	Super H.F.	20,000	32	.1	1.6	2.0	—	1.5
Mazda ..	HL210	18,500	26	.1	1.4	3.0	1.5	3.0
Marconi ..	HL2	18,000	27	.1	1.5	1.0	1.5	3.0
Osram ..	HL2	18,000	27	.1	1.5	1.0	1.5	3.0
Six-Sixty ..	210HL	17,200	26	.1	1.5	1.0	1.5	3.0
Tungram ..	L210	16,000	16	.1	1.0	2.5	3.0	6.0
Cossor ..	210HF	15,800	24	.1	1.5	2.25	1.5	3.0
Mullard ..	PM1HL	14,000	28	.1	2.0	1.2	1.5	3.0
Cossor ..	210Det	13,000	15	.1	1.15	2.5	1.5	3.0
Six-Sixty ..	210LF	12,500	10.6	.1	.85	2.5	4.5	7.5
Mullard ..	PM1LF	12,000	11	.1	.9	2.6	4.5	7.5
Six-Sixty ..	210D	10,600	17	.1	1.6	2.0	3.0	7.5
Cossor ..	210F	10,000	14	.1	1.4	3.0	3.0	4.5
Lissen ..	L210	10,000	12	.1	1.2	3.0	3.0	7.5
Lissen ..	L2	10,000	20	.1	2.0	3.0	1.5	3.0
Marconi ..	L2/b	10,000	15.5	.1	1.55	4.0	1.5	3.0
Mullard ..	PM2DX	10,000	17	.1	1.7	2.0	3.0	6.0
Mazda ..	L210	10,000	17	.1	1.7	5.0	2.5	4.5
Tungram ..	L2	10,000	19	.1	1.9	3.0	—	3.0
Mazda ..	LG210	10,000	10	.1	1.0	4.0	6.0	9.0
Tungram ..	PD220	10,000	17	.2	1.7	4.0	4.5	7.5
Dario ..	Universal	8,000	10	.1	1.25	3.5	—	4.5
Dario ..	Super Det.	7,500	15	.15	2.0	3.5	3.0	4.5
Six-Sixty ..	220P	4,800	7.2	.2	1.5	5.0	7.5	12.0
Lissen ..	P220	4,400	7	.2	1.75	5.0	7.5	15.0
Mullard ..	PM2	4,400	7.5	.2	1.7	5.0	7.5	12.0
Cossor ..	220P	4,000	8	.2	2.0	6.0	4.5	9.0
Cossor ..	215P	4,000	9	.15	2.25	5.0	4.5	7.5
Cossor ..	220Pa	4,000	16	.2	4.0	5.5	3.0	4.5
Marconi ..	LP2	3,900	15	.2	3.85	6.0	3.0	4.5
Osram ..	LP2	3,900	15	.2	3.85	6.0	3.0	4.5
Mazda ..	P220	3,700	12.5	.2	3.4	11.0	3.0	6.0
Six-Sixty ..	22PA	3,700	13	.2	3.5	6.0	3.0	6.0
Mullard ..	PM2A	3,600	12.5	.2	3.5	6.5	3.0	6.0
Lissen ..	LP2	3,500	12.0	.2	3.4	8.0	6.0	7.0
Tungram ..	P215	3,300	5	.2	1.5	12.0	9.0	12.0
Dario ..	Super P'r	3,000	6	.18	2.0	8.5	12.0	15.0
Marconi ..	P240	2,500	4	.4	1.6	12.0	15.0	24.0
Osram ..	P240	2,500	4	.4	1.6	11.0	16.0	24.0
Tungram ..	SP230	2,500	5	.3	2.0	15.0	15.0	23.0
Dario ..	Hyper P'r	2,400	7	.3	3.0	14.0	12.0	18.0
Tungram ..	P2	2,200	6.6	.2	3.0	5.0	9.0	12.0
Marconi ..	P2	2,150	7.5	.2	3.5	12.0	6.0	10.5
Osram ..	P2	2,150	7.5	.2	3.5	10.0	7.5	10.5
Six-Sixty ..	220SP	2,060	7	.2	3.4	13.5	7.5	15.0
Mullard ..	PM202	1,800	7.0	.2	3.5	14.0	7.5	15.0
Lissen ..	PX240	1,800	4	.4	2.5	14.0	12.5	22.5
Mazda ..	P240	1,900	7	.4	3.7	18.0	6.0	13.5
Mullard ..	PM252	1,900	7	.4	3.7	14.0	6.0	12.0
Six-Sixty ..	240SP	1,900	6.6	.4	3.5	14.0	6.0	13.5
Mazda ..	P220A	1,850	6.5	.2	3.5	13.0	9.0	15.0
Marconi ..	P2/b	1,850	6.5	.2	3.5	15.0	—	—
Cossor ..	230XP	1,500	4.5	.3	3.0	15.0	10.5	18.0
Lissen ..	P220A	1,700	6.0	.2	3.5	12.0	9.0	15.0
Lissen ..	P240A	1,000	5.0	.4	5.0	20.0	15.0	20.0

Make	Type	Impedance	Amplification Factor	Filament Current	Mutual Conductance	Anode Current at 120 volts	Grid Bias at 100 volts	Grid Bias at 150 volts
<b>2-volt Pentode Valves</b>								
Lissen ..	PT225	64,000	90	.25	1.4	7.0	3.0	6.0
Six-Sixty ..	230PP	64,000	80	.3	1.25	10.0	6.0	12.0
Mullard ..	PM22	—	—	—	1.3	12.0	6.0	10.0
Marconi ..	PT240	55,000	90	.4	1.65	9.0	6.0	9.0
Tungram ..	PP230	33,000	50	.3	1.5	10.0	9.0	16.0
Lissen ..	PT240	22,500	45	.4	2.25	12.5	7.5	10.5
Lissen ..	PT20A	22,500	45	.2	2.5	15.0	7.5	9.0
Cossor ..	230PT	—	—	—	2.0	13.0	15.0	15.0
Mazda ..	220Pen.	—	—	—	2.5	—	—	—
Mazda ..	20A Pen.	—	—	—	1.8	6.5	7.5	7.5
Osram ..	230HPT	—	—	—	2.5	5.0	3.0	4.5
Cossor ..	PT2	—	—	—	1.5	—	—	—
Mazda ..	Pen.230	—	—	—	1.5	—	—	—
Marconi ..	PT2	—	—	—	2.5	5.0	3.0	4.5

Make	Type	Impedance	Amplification Factor	Filament Current	Mutual Conductance	Anode Current at 120 volts	Grid Bias at 100 volts	Grid Bias at 150 volts
<b>4-volt Three-electrode Valves</b>								
Dario ..	Resistron	60,000	30	.075	.5	.25	—	1.5
Marconi ..	H410	60,000	40	.1	.66	.35	—	1.5
Osram ..	H410	60,000	40	.1	.66	.35	—	1.5
Six-Sixty ..	4075RC	58,000	37	.075	.64	.55	1.0	1.5
Mullard ..	PM3A	55,000	38	.075	.66	.3	1.5	1.5
Cossor ..	410RC	50,000	40	.1	.8	1.6	1.0	1.5
Lissen ..	H410	40,000	36	.1	.83	1.0	2.0	3.0
Marconi ..	HL410	30,000	25	.1	.83	1.0	1.5	1.5
Dario ..	Super H.F.	21,000	25	.075	1.2	2.0	1.5	3.0
Lissen ..	HLD410	21,000	25	.1	1.2	2.5	1.5	3.0
Osram ..	HL410	20,800	25	.1	1.2	1.25	1.5	3.0
Cossor ..	410HF	20,000	22	.1	1.1	1.0	1.5	3.0
Tungram ..	R406	18,000	25	.06	1.4	3.5	2.0	3.5
Tungram ..	HR406	17,000	25	.065	1.5	1.5	1.5	3.0
Tungram ..	HR410	17,000	25	.1	1.05	1.5	3.0	6.0
Mullard ..	PM3	13,000	14	.075	1.05	3.0	3.0	4.5
Six-Sixty ..	4075HF	12,500	13.5	.075	1.1	2.5	1.5	4.5
Cossor ..	410LF	10,000	17	.1	1.7	3.0	—	4.5
Dario ..	Universal	10,000	10	.075	1.0	3.0	3.0	4.5
Tungram ..	LD408	8,500	17	.085	2.0	3.5	1.5	4.5
Lissen ..	L410	8,500	15	.1	1.77	3.0	2.0	4.5
Marconi ..	L410	8,500	15	.1	1.77	3.5	3.0	4.5
Osram ..	L410	8,500	15	.1	1.77	3.0	3.0	4.5
Dario ..	Super Det.	7,500	15	.075	2.0	3.0	3.0	6.0
Mullard ..	PM4DX	7,500	15	.1	2.0	4.0	3.0	6.0
Six-Sixty ..	410D	7,250	14.5	.1	2.3	4.5	4.5	7.5
Tungram ..	LD410	7,000	16.5	.1	2.3	6.0	6.0	10.5
Marconi ..	P410	5,000	7.5	.1	1.5	6.0	6.0	10.5
Osram ..	P410	5,000	7.5	.1	1.5	6.0	6.0	15.0
Dario ..	Super P'r	4,500	9	.1	2.0	7.0	7.5	12.0
Six-Sixty ..	410P	4,100	7.8	.1	1.9	7.5	9.0	9.0
Cossor ..	410P	4,000	8	.1	2.0	8.0	5.0	8.0
Mullard ..	PM4	4,000	8	.1	2.0	7.5	6.0	9.0
Lissen ..	P410	4,000	8	.1	2.0	7.0	6.5	9.0
Tungram ..	L414	3,300	10	.15	3.0	6.0	9.0	16.5
Marconi ..	P425	2,300	4.5	.25	1.95	15.0	12.0	18.0
Dario ..	Hyper P'r	2,200	5	.15	2.3	15.0	9.0	15.0
Mullard ..	PM254	2,150	6.5	.2	3.0	10.0	8.0	15.0
Six-Sixty ..	420SP	2,150	6.5	.2	3.0	10.0	8.0	16.5
Marconi ..	P415	2,080	5.0	.15	2.4	14.0	9.0	16.5
Osram ..	P415	2,080	5.0	.15	2.4	13.0	6.0	12.0
Cossor ..	425XP	2,000	7	.25	3.5	25	10.0	15.0
Tungram ..	P430	2,000	5	.25	3.5	25	14.0	26.0
Mazda ..	P425	1,950	3.5	.25	1.8	26.0	9.0	18.0
Tungram ..	P414	1,700	5	.15	3.0	12.0	12.0	20.0
Lissen ..	P425	1,600	4.5	.25	2.8	18.0	9.0	18.0
Cossor ..	415XP	1,500	4.5	.15	3.0	35	—	25
Tungram ..	P4100	1,400	7</					



# THE NEW TUNGSRAM HIGH POWER OUTPUT VALVES

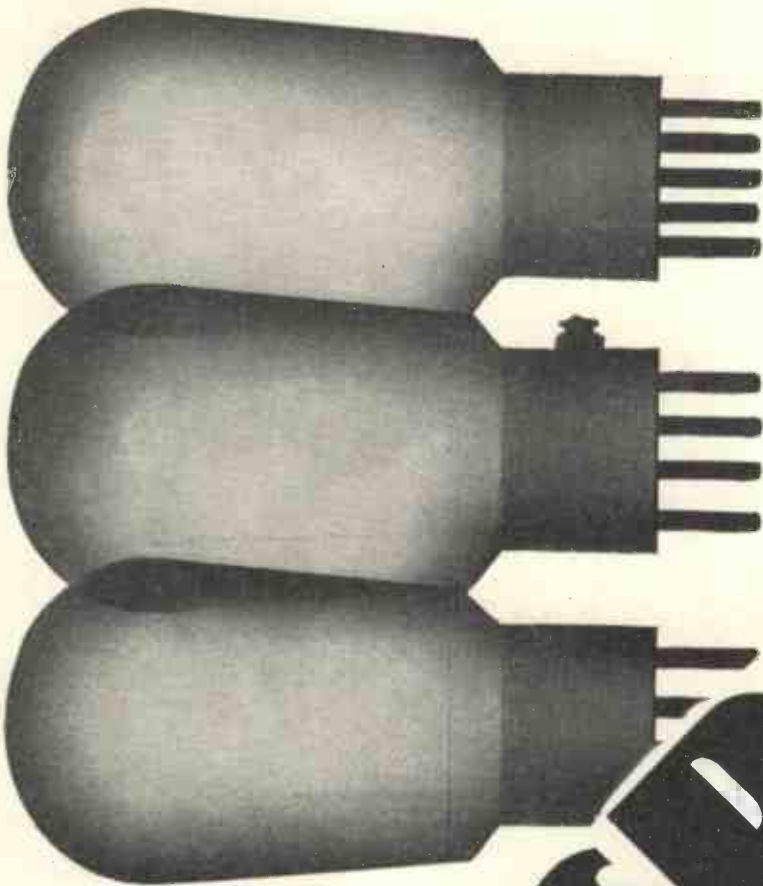

# TUNGSRAM

The four new Tungoram High Power Output Valves, P414, P430, P460 and P4100, are particularly useful to constructors of gramophone amplifiers where immense volume is required.

Using these four types, an undistorted output of the amplifier ranging from 500 to 3,500 milliwatts can be obtained. The filaments can be operated from a 4-volt accumulator, or from the secondary winding of a suitable transformer.

P414, P430, P460 are suitable for operation at an anode voltage of 200, 250, and 220 volts respectively. The anode current consumption is 18, 25, and 50 m/a respectively at Grid Bias voltages 20, 25, and 35 volts. P4100 can be operated at an anode voltage of 400 volts the grid bias at this voltage being 35 volts and it consumes 30 m/a. It has an undistorted output of 3,500 milliwatts. By connecting two or more valves in push-pull or parallel even greater output can be obtained. Write for further particulars to Dept. S.T.1.

**PRICES: P414, 9/6; P430, 12/3; P460, 18/- P4100, 20/-; Other types from 6/3 to 22/6**

Tungoram Barium Valves are manufactured under one or more of the following British patents: 289,762, 289,763, 311,705, and 313,151  
**TUNGSRAM ELECTRIC LAMP WORKS (GT. BRITAIN), LTD.,** Radio Dept., Commerce House, 72 Oxford St., London, W.1.

Makers of the famous Tungoram Electric Lamps.

Bristol. Cardiff, Glasgow, Leeds, Manchester, Newcastle, Nottingham, Southampton.  
Lamp, Valve and Glass Factories in Austria, Czecho-slovakia, Hungary, Italy and Poland.  
I.F.S. Organisation, Tungoram Lamps & Radio, Ltd., 11 Burgh Quay, Dublin.



Advertisers like to know you "saw it in the 'Wireless Magazine'"

# VALVES TO USE IN YOUR SET—Continued from page 132

Make	Type	Impedance	Amplification Factor	Filament Current	Minimal Condensance	Anode Current at 120 volts	Grid Bias at 100 volts	Grid Bias at 150 volts
<b>4-volt Pentode Valves—Continued</b>								
Mazda ..	425Pen.	—	—	.25	2.0	14.0	14.0	—
Mullard..	PM24C	—	—	1.0	3.0	—	—	—

Make	Type	Impedance	Amplification Factor	Filament Current	Minimal Condensance	Anode Current at 120 volts	Grid Bias at 100 volts	Grid Bias at 150 volts
<b>6-volt Three-electrode Valves</b>								
Mazda ..	H607	90,000	40	.07	.45	1.0	—	1.5
Mazda ..	H610	66,000	40	.1	.6	1.0	—	—
Cossor ..	610RC	50,000	40	.1	.8	.75	—	1.5
Marconi ..	H610	60,000	40	.1	.66	.35	1.5	1.5
Osram ..	H610	60,000	40	.1	.7	.35	3.0	3.0
Six-Sixty	6075RC	58,000	42	.075	.7	.5	1.0	1.5
Lissen ..	H610	40,000	36	.1	.9	1.0	1.0	1.5
Mullard..	PM5B	49,000	40	.075	.85	.5	1.5	1.5
Marconi ..	HL610	30,000	30	.1	1.0	1.0	1.5	1.5
Osram ..	HL610	30,000	30	.1	1.0	1.0	1.5	1.5
Osram ..	LS5B	25,000	20	.8	.8	—	—	—
Lissen ..	11LD610	21,000	25	.1	1.2	2.5	1.5	3.0
Cossor ..	610HF	20,000	20	.1	1.0	1.75	1.5	3.0
Mazda ..	HL610	20,000	20	.07	1.0	1.8	1.5	3.0
Mullard..	PM5D	20,000	26	.075	1.3	1.0	1.5	3.0
Six-Sixty	607HF	15,200	17	.075	1.1	2.0	2.0	4.0
Tungoram	HR607	15,000	30	.07	2.0	2.0	1.5	3.0
Tungoram	PM5X	14,700	17.5	.075	1.2	1.6	3.0	4.5
Six-Sixty	610D	9,250	18.5	.1	2.0	2.0	3.0	4.0
Mullard..	PM6D	9,000	18	.1	2.0	2.0	3.0	4.5
Tungoram	LC607	9,000	16.5	.07	1.8	3.5	3.0	4.5
Lissen ..	L610	8,000	16	.1	2.0	2.0	3.0	4.5
Cossor ..	610LF	7,500	15	.1	2.0	3.4	1.5	4.5
Marconi ..	L610	7,500	15	.1	2.0	3.0	2.0	4.0
Osram ..	L610	7,500	15	.1	2.0	3.5	1.5	4.5
Osram ..	LS5	6,000	5	.8	.8	—	—	—
Mullard..	PM6	3,550	8	.1	2.25	7.0	6.0	9.0
Cossor ..	610P	3,500	8	.1	2.28	8.0	3.0	7.5
Marconi ..	P610	3,500	8	.1	2.28	6.0	6.0	9.0
Osram ..	P610	3,500	8	.1	2.28	7.0	6.0	9.0
Six-Sixty	610P	3,400	7.8	.1	2.3	8.0	6.0	9.0
Tungoram	P615	3,300	10	.15	3.0	10.0	4.5	7.5
Lissen ..	P610	3,200	8	.1	2.5	6.0	6.0	9.0
Marconi ..	LSSA	2,750	2.5	.8	.9	—	—	—
Osram ..	LSSA	2,750	2.5	.8	.9	—	—	—
Cossor ..	625P	2,500	7	.25	2.8	13.0	3.0	12.0
Lissen ..	P625	2,500	7.5	.25	3.0	8.0	7.5	12.0
Mazda ..	P625B	2,500	7	.25	2.8	11.0	6.0	12.0
Marconi ..	P625	2,400	6	.25	2.5	11.0	6.0	24.0
Osram ..	P625	2,400	6	.25	2.5	11.0	6.0	12.0
Tungoram	SP614	2,300	6	.15	2.6	17.0	6.0	18.0
Cossor ..	610XP	2,000	5	.1	2.5	15.0	7.5	15.0
Mullard..	PM256	1,850	6	.25	3.25	8.0	9.0	27.0
Six-Sixty	625SP	1,780	5.8	.25	3.25	8.0	10.0	15.0
Marconi ..	P625A	1,600	3.7	.25	2.3	20.0	13.5	36.0
Mazda ..	P625A	1,600	4	.25	2.5	27.0	10.0	20.0
Osram ..	P625A	1,600	3.7	.25	2.3	16.0	13.5	24.0
Lissen ..	P625A	1,500	4.5	.25	3.0	12.0	13.5	24.0
Six-Sixty	625SPA	1,500	3.9	.25	2.6	20.0	12.0	22.5
Cossor ..	620T	1,400	3.2	2.0	2.3	—	—	33.0
Mullard..	PM256A	1,400	3.6	.25	2.6	20.0	12.0	33.0
Marconi ..	LS6A	1,300	3.0	2.0	2.3	—	—	25.0
Mazda ..	P650	1,300	3.5	.5	2.7	30.0	12.0	25.0
Osram ..	LS6A	1,300	3.0	2.0	2.3	—	—	—
Marconi ..	DA60	835	2.5	4.0	3.0	—	—	—
Osram ..	DA60	835	2.5	4.0	3.0	—	—	—

Make	Type	Impedance	Amplification Factor	Filament Current	Minimal Condensance	Anode Current at 120 volts	Grid Bias at 100 volts	Grid Bias at 150 volts
<b>6-volt Screen-grid Valves</b>								
Six-Sixty	SS6075SG	210,000	190	.075	.9	—	—	—
Cossor ..	610SG	200,000	200	.1	1.0	—	1.5	—
Mullard..	PM16	200,000	200	.075	1.0	—	—	—
Osram ..	S610	200,000	210	.1	1.05	4.0	1.5	—
Marconi ..	S610	200,000	210	.1	1.05	4.0	1.5	—

Make	Type	Impedance	Amplification Factor	Filament Current	Minimal Condensance	Anode Current at 120 volts	Grid Bias at 100 volts	Grid Bias at 150 volts
<b>6-volt Pentode Valves</b>								
Marconi ..	PT625	42,000	80	.25	1.85	10.0	6.0	15.0
Osram ..	PT625	42,000	80	.25	1.85	10.0	6.0	10.5
Tungoram	PP610	40,000	60	.1	1.6	10.0	6.0	10.0
Six-Sixty	SS617PP	28,500	54	.17	1.9	15.0	8.0	14.0
Mullard..	PM26	—	—	.17	2.0	15.0	9.0	15.0
Lissen ..	PT625	24,000	60	.25	2.5	14.0	7.5	10.0
Cossor ..	615PT	—	—	.15	2.0	17.0	6.9	7.5

Make	Type	Impedance	Amplification Factor	Filament Current	Minimal Condensance	Anode Current at 120 volts	Grid Bias at 100 volts	Grid Bias at 150 volts
<b>A.C. Three-electrode Mains Valves</b>								
Cossor ..	41MHF	14,500	41	1.0	2.8	2.5	—	2.0
Mullard..	904V	21,000	75	1.0	3.6	3.0	.75	1.0
Dario ..	Sup. H.F.	20,000	40	1.0	2.0	4.5	—	1.5
Cossor ..	41MHC	19,500	50	1.0	2.6	2.0	—	1.5
Six-Sixty	41MH	18,000	72	1.0	4.0	2.0	1.0	1.5
Tungoram	4DX AC	17,700	85	1.0	4.8	3.0	1.0	1.5
Tungoram	AR495	17,000	85	1.0	5	4.0	1.5	1.5
Tungoram	AR4100	16,000	33	1.0	2.0	2.5	1.5	3.0
Mazda ..	AC/HL	13,500	35	1.0	3.0	4.5	1.5	3.0
Tungoram	AR4101	13,300	40	1.0	3	2.5	1.5	3.0
Six-Sixty	4CP AC	12,000	36	1.0	3.0	2.0	2.0	3.0
Lissen ..	AC/HL	11,700	35	1.0	3.0	5.0	1.5	3.0
Cossor ..	41MHL	11,500	52	1.0	4.5	3.0	1.2	2.0

Make	Type	Impedance	Amplification Factor	Filament Current	Minimal Condensance	Anode Current at 120 volts	Grid Bias at 100 volts	Grid Bias at 150 volts
<b>A.C. Three-electrode Mains Valves—Continued</b>								
Mazda ..	AC2HL	11,500	75	1.0	6.5	3.0	—	1.5
Marconi ..	MH4	11,100	40	1.0	3.6	4.0	1.5	3.0
Osram ..	MH4	11,100	40	1.0	3.6	4.0	1.5	3.0
Mullard..	354V	10,000	35	1.0	3.5	2.0	2.0	3.0
Marconi ..	MHL/4	8,000	20	1.0	2.5	5.0	3.0	6.0
Osram ..	MHL4	8,000	20	1.0	2.5	5.0	3.0	6.0
Tungoram	AG4100	8,000	16	1.0	2.0	5.0	4.0	6.0
Cossor ..	41MLF	7,900	15	1.0	1.9	4.5	4.5	6.0
Dario ..	Sup. r.d.	7,500	15	1.0	2.0	6.0	3.0	4.5
Tungoram	AG495	6,250	25	1.0	4.0	4.0	3.0	4.5
Six-Sixty	4L AC	5,000	10	1.0	3.2	5.0	4.5	7.0
Mullard..	164V	4,850	16	1.0	3.3	5.0	4.5	6.5
Six-Sixty	SS4PAC	3,000	10	1.0	3.3	10.0	5.9	8.0
Mazda ..	PP3/425	2,900	2.9	1.25	1.0	—	—	100
Osram ..	ML4	2,860	12	1.0	4.2	12.0	5.0	8.0
Mullard..	104V	2,850	10	1.0	3.5	11.0	5.0	8.5
Marconi ..	ML4	2,800	12	1.0	2.5	13.0	4.0	6.0
Mazda ..	AC/P	2,650	10	1.0	3.75	14.0	6.0	12.0
Cossor ..	41MP	2,500	18.7	1.0	7.5	10.0	3.0	6.0
Tungoram	AP495	2,500	10	1.0	4.0	20.0	9.0	12.5
Dario ..	Mag. P'r	2,200	8.5	3	3.8	15.0	15.0	24.0
Mullard..	AC064	2,000	6	1.0	3.0	15.0	9.0	14.0
Tungoram	P430	2,000	5	3	2.5	20.0	—	—
Cossor ..	41MXP	1,500	11.2	1.0	7.5	23.0	6.0	9.0
Mazda ..	PP3/400	1,500	9	2.0	6.0	—	—	32.0
Mazda ..	AC/P1	1,450	5.4	1.0	3.7	—	—	14.0
Six-Sixty	HV4/1	1,450	6.3	1.0	3.0	15.0	9.0	14.0
Tungoram	P4100	1,400	7	1.0	5.0	35.0	—	35.0
Mullard..	AC044	1,150	4	.7	3.5	17.0	14.0	23.0
Tungoram	P460	1,100	4	.6	3.5	30.0	14.0	22.0

Make	Type	Impedance	Amplification Factor	Filament Current	Minimal Condensance	Anode Current at 120 volts	Grid Bias at 100 volts	Grid Bias at 150 volts
<b>A.C. Double-grid Valves</b>								
Cossor ..	41MDG	40,000	10	1.0	.25	—	—	—
Tungoram	DG4100	5,000	5	1.0	1.0	3.0	—	—

Make	Type	Impedance	Amplification Factor	Filament Current	Minimal Condensance	Anode Current at 120 volts	Grid Bias at 100 volts	Grid Bias at 150 volts
<b>A.C. Screen-grid Mains Valves</b>								
Dario ..	ACSG	1,000,000	1,000	1.0	1.5	—	—	—
Six-Sixty	4SGAC	1,000,000	1,000	1.0	1.0	1.5	—	—
Mullard..	SV4	909,000	1,000	1.0	1.1	—	—	—
Mazda ..	AC/SG	800,000	1,200	1.0	3.0	5.0	.5	.5
Tungoram	AS494	667,000	1,000	1.0	1.5	1.5	.5	.5
Mazda ..	ACS2	600,000	3,000	1.0	5.0	—	—	—
Cossor ..	MSG/HA	500,000	1,000	1.0				



**THE LATEST, PUREST & MOST SELECTIVE**

**3 VALVE KIT**  
**39'6**



Spend a thrilling evening at home building the finest 3-valve Radio Set ever produced—one combining wonderful selectivity and correct tone, easy tuning and low price.

Get a Lotus Landmark 3 Kit now, and within a few hours you will be listening to the broadcast entertainment of Europe, as well as the British programmes.

The sealed carton contains all the necessary LOTUS GUARANTEED COMPONENTS, with wire, screens, etc., at the low price of 39s. 6d. complete with full instructions and diagram.

All the tools that are necessary are a screw-driver and pliers. You will be amazed at the beautiful tone with simple tuning. Examine this "King of Kits" at your nearest dealer, and enjoy real radio within a few hours.

**PURE TONE**  
**WONDERFUL SELECTIVITY**  
**BUILT IN ONE NIGHT**



**LANDMARK**  
**... THREE**

**LOTUS RADIO LIMITED,**  
**MILL LANE, LIVERPOOL**

**POST THIS COUPON NOW!**  
Lotus Radio, Ltd.,  
Mill Lane, Liverpool.  
Please send me full details of the "Landmark 3."

Name .....  
Address .....

**PROVED!**



**TYPE 9200**

**THE FIRST and FINEST CONDENSER for BAND-PASS CIRCUITS!**

These Dubilier condensers are specified in all the best constructors' sets where band-pass tuning is employed. The internal inductance is extremely small, and there is a type to suit exactly all the well-known makes of band-pass coils. The Dubilier type 9200 is available in capacities from .01 mF. to 2 mF.

**TYPES TO SUIT THE POPULAR BAND-PASS COILS**

R.I.	...	...	...	.01 mF.	... 2/- each
Lewcos	...	...	...	.02 mF.	... 2/- ..
Varley	...	...	...	.04 mF.	... 2/- ..
Colvern	...	...	...	.05 mF.	... 2/- ..
Watmel (Capacity coupled)	...	...	...	.05 mF.	... 2/- ..

**DUBILIER**  
**CONDENSER CO. (1925) LTD.**

Ducon Works, Victoria Rd., N. Acton,  
London, W.3.

Advertisers like to know you "saw it in the 'Wireless Magazine'"

# EXPRESSLY WRITTEN FOR THE BEGINNER

**2/6**  
NETT



“The How and Why of Radio” by Alan Hunter, has been expressly written for beginners.

It provides a clear conception of the general theory and practices of wireless reception in simple, non-technical terms, and contains over ninety clearly defined illustrations. It has been mainly compiled from the series of articles in AMATEUR WIRELESS:—“The How and Why of Radio”—which proved so popular during the past twelve months.

Get this indispensable Book NOW. Of all Newsagents and Booksellers, or 2/9 post free,

from

“AMATEUR WIRELESS,”  
58/61 Fetter Lane, London, E.C.4  
Phone: City 3733



# FOR YOUR "DOUBLE BAND PASS A"

Selective tuning with simplicity of operation; good volume, and unsurpassed tone by incorporating Aerial and Anode Band Pass tuning. But be sure to get the *right* models—specified by the designers—**BRITISH GENERAL.**

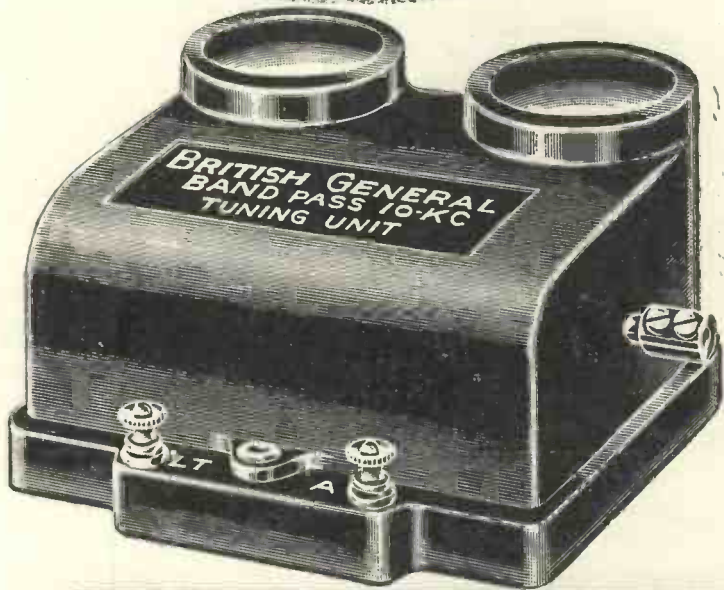

**Aerial and Anode models,** both complete with non-inductive coupling condensers, **14/6 each.**

*From all dealers or direct from the Manufacturers.*

**British General Manufacturing Co., Ltd.,**  
Brockley Works, London, S.E.14.

**14/6**

Including Non-Inductive Coupling Condenser.

## BRITISH GENERAL

### 200 page book on engineering careers

Modern Home Study Courses in all branches of  
**Civil, Mechanical, Motor, Electrical, Wireless, Aeronautical, "Talkie" Eng**  
ETC.

Special Courses to cover  
**B.Sc., A.M.I.C.E., A.M.I.Mech.E., I.E.E., A.M.I.A.E., A.M.I.Struct.E., G.P.O., C. & G., MATRIC., etc., Exams., and for entry into the Public Service.**

**OVER 90% SUCCESSES.**

*We alone Guarantee—  
"No Pass - No Fee."*

Send for it to-day, stating the subject of most interest.  
**BRITISH INSTITUTE OF ENGINEERING TECHNOLOGY,**  
283, SHAKESPEARE HOUSE, OXFORD STREET, LONDON.



*If you are earning less than £10 per week you cannot afford to carry on without reading this book!*

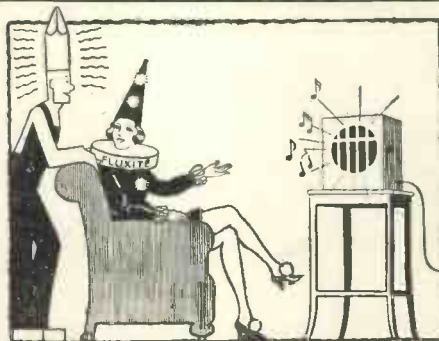

"We're Fluxite and Solder, the reliable pair,  
Famous for Soldering — known everywhere!  
We **SOLDER** all "connections"; it doesn't take long,  
Then sit back and listen to music and song!"

See that Fluxite and Solder are always by you—in the house, garage, workshop—anywhere where simple, speedy, soldering is needed. They cost so little, but will make scores of everyday articles last years longer! For Pots, Pans, Silver, and Brassware; RADIO; odd jobs in the garage—there's always something useful for Fluxite and Solder to do. **All Hardware and Ironmongery** **ANOTHER USE FOR FLUXITE**  
Stores sell Fluxite in tins, 8d., Hardening Tools and Case Hardening.  
1/4 and 2/8. Ask for Leaflet on improved method.

#### NEW "JUNIOR" SIZE, 4d. per tin FLUXITE SOLDERING SET

Simple to use and lasts for years in constant use. Contains special "small-space" soldering iron with non-heating metal handle; pocket blow-lamp, Fluxite, Solder, etc.; and full instructions.

COMPLETE, 7/6, or LAMP only, 2/8.

**FLUXITE, LTD.**

(Dept. 332)  
ROTHERHITHE, S.E.16

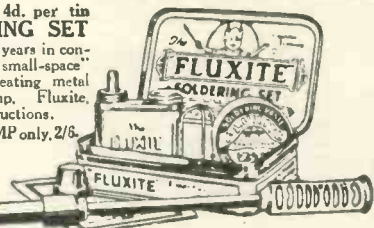

ALL MECHANICS WILL HAVE

# FLUXITE

IT SIMPLIFIES ALL SOLDERING



### MACOM ELECTRIC TURNTABLE

#### A Technical Revolution

A Super-electric Turntable. One Unit only, for A.C. or D.C. Mains of all voltages—little deeper than an ordinary turntable—will transform any wireless set into a radio-gramophone. Complete with sensitive pick-up, volume-control, accurate tracking arm, automatic start and stop, rubber feet and lead. No gears—cannot overheat or burn out—no oiling—constant speed. Complete ready for use.

**MODEL "D" £4 12 6**

**F. PARKER WOOD,** 51 Fenchurch St. London, E.C.1  
Royal 4014

UNIVERSAL • LOW SPEED •  
COMPACT • LIGHT IN WEIGHT •  
FREE FROM INTERFERENCE •  
BRITISH MADE •  
**F. PARKER WOOD,**

# GUIDE TO THE WORLD'S BROADCASTERS

Specially Compiled for "Wireless Magazine" by JAY COOTE

19.84 } Metres **ROME (Vatican-HVJ)** 15,120 }  
50.26 } *(Italy)* 5,970 }  
Power: 15 Kw. *Kilocycles*

Distance from London: Approximately 890 miles.  
Standard Time: Central European (G.M.T. PLUS one hour).  
Announcer: Man.  
Opening Call: "Laudatur Jesu Christus! Radio Citta Vaticana."  
Interval Signal: Metronome; also heard in background whilst speech is broadcast.  
Standard Transmissions: Weekdays, G.M.T. 10.00 (19.84 metres); 19.00 (50.26 metres). Sundays, G.M.T. 10.00 (19.84 metres). The weekday transmissions are broadcast in Latin and Italian; talks are also broadcast in English (Tuesday), Spanish (Wednesday), French (Thursday), and German (Friday).  
Closes down with the opening call, followed on occasions by a Gregorian chant or the Papal March.

31.48 Metres **SCHENECTADY (W2XAF)** 9,530  
Power: *Kilocycles*  
10 Kw. *(New York, U.S.A.)*

Distance from London: Approximately 3,050 miles.  
Standard Time: Eastern Standard Time (G.M.T. LESS five hours).  
Announcer: Man.  
Opening Call: "This is station W2XAF, Schenectady, of the General Electric Company, transmitting on a frequency of 9,530 kilocycles. Good afternoon, ladies and gentlemen."  
Standard Transmissions: Relays WGY, Schenectady (N.Y.), which is linked up with WEA, New York; main station of the National Broadcasting Company of America. G.M.T. 22.30 to 04.00, weekdays (except Saturdays); 21.00 to 04.00 (Saturdays and Sundays).  
Interval Signal: Short melody of eight notes (E, C sharp, A, E, C sharp, E, E, A) on xylophone. (When relaying WEA, New York, the interval signal consists of three notes only on a similar instrument).

49.18 Metres **BOUNDBROOK (W3XAL)** 6,100  
Power: *Kilocycles*  
12 Kw. *(New Jersey, U.S.A.)*

Distance from London: Approximately 3,050 miles.  
Standard Time: Eastern Standard Time (G.M.T. LESS five hours).  
Announcer: Man.  
Interval Signal: Three notes on xylophone.  
Call: "This is W3XAL, Boundbrook, New Jersey, relaying WJZ (Z pronounced Zee) of the National Broadcasting Company of New York."  
Standard Transmissions: Relays WJZ Boundbrook, WEA, New York, and other stations of the N.B.C. network. G.M.T. 18.30 to 23.45; 04.00 to 06.00 (excluding Friday); 13.00 to 19.30 (Sunday).

49.5 Metres **NAIROBI (VQ7LO)** 6,060  
*Kilocycles*  
*(Kenya Colony)*

Distance from London: Approximately 4,300 miles.  
Standard Time: Greenwich Mean Time PLUS three hours.  
Announcer: Man.  
Call: "This is 7LO, the Nairobi station of the East African Broadcasting Company."  
Standard Transmissions: G.M.T. 16.00 to 19.30 daily. Special transmissions are occasionally made at 08.00 (Tuesday) and at 13.00 (Thursday). Sometimes relays G5SW, Chelmsford.  
Closes down with good-night greetings, followed by "God Save the King."  
These transmissions are simultaneously broadcast on 400 metres (750 kilocycles).

\*298.8 Metres **HUIZEN** 1,004  
Power: *Kilocycles*  
8.5 Kw. *(Holland)*

Distance from London: Approximately 236 miles.  
Standard Time: Amsterdam (G.M.T. PLUS twenty minutes).  
Announcer: Man (except for Children's Hour). Dutch language only.  
Call: "Hallo! Hallo! Hier is Huizen," followed by initials or name of the association offering programme, namely, either N.C.R.V. (Nederlandsche Christelijke Radio Vereeniging) or K.R.O. (Katholieke Radio Omroep).  
Interval Signal: Chimes (for K.R.O. only).  
Good Night: "Ik wensch U goede nacht en wel te rusten" (sleep well).  
Main Programme: 07.40, time signal; 07.50, physical exercises (Sunday); 07.55, concert; 10.10, sacred service; 11.00, gramophone records; 11.40, news; 12.10, time signal and concert; 13.25, gramophone records then continues broadcast until close down (23.40).  
\* Every three months the two Dutch transmitting associations exchange wavelengths; Huizen on April 1 will broadcast on 1,875 metres.

370.4 Metres **RADIO LL, PARIS** 810  
Power: *Kilocycles*  
.5 Kw. *(France)*

Distance from London: Approximately 214 miles.  
Standard Time: Greenwich Mean Time (France adopts B.S.T.).  
Announcer: Man.  
Call: "Ici Radio L.L. de la Compagnie Nationale de radiodiffusion à Paris."  
Main Programme: G.M.T. 10.00, talks (Sunday); 11.30, concert (Sunday), 12.30 (weekdays); 14.30, news, talks; 15.00, dance music (Sunday); 18.00, news, talks; 20.15, concert (except Tuesday and Thursday).  
Closes down with usual French good night greetings.  
Programmes are simultaneously broadcast on 61 metres.

389.6 Metres **FRANKFORT** 770  
Power: *Kilocycles*  
1.5 Kw. *(Germany)*

Distance from London: Approximately 395 miles.  
Standard Time: Central European (G.M.T. PLUS one hour).  
Announcers: Man and woman.  
Call: "Achtung! Hier Suedwestfunk." (When relaying Stuttgart call heard will be "Hier Suedfunk und Suedwestfunk").  
Interval Signal: Metronome (190 beats per minute) if from own studio; when relaying Stuttgart, three notes (C, D, G).  
Good Night: "Gute Nacht, meine Damen und Herren," followed by German National Anthem, "Deutschlandslied" (Haydn's hymn, Austria).  
Main Daily Programme: Frequently exchanges broadcasts with Stuttgart (Mühlacker). G.M.T. 05.15 and 05.45, physical exercises; 06.00, "liner" concert from Hamburg (Sunday); 07.15, sacred service (Sunday); 16.00, concert; 18.50, time signal and news; 19.00, main evening entertainment; 21.00, news, night concert, dance music (mainly relayed from Berlin).  
Relay: Cassel, 246 metres (1,220 kcs.), .25 kilowatt.

495.8 metres **WILNO** 605.1  
*(temporary)* *(Poland)* *Kilocycles*

Distance from London: Approximately 1,070 miles.  
Standard Time: Central European (G.M.T. PLUS one hour).  
Announcer: Woman.  
Call: "Uwaga! (phon.: oo-var-gha) Polskie Raadio Wilno."  
Opening Signal: Three blasts on a trumpet.  
Interval Signal: Cuckoo call.  
Main Daily Programme: Mostly relays Warsaw and other Polish stations; if own evening entertainment; at 19.30 G.M.T.  
Closes down with the Polish National Anthem ("Dobrowolna mazurek").



Read "Wireless World" Report:

"The output rises steeply from 1,000 cycles downwards, the bass response from 200 down to 80 cycles being exceptionally high... the response is quite definite up to 7,000 cycles."

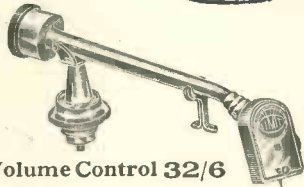

Pick-up, Arm, and Volume Control 32/6  
Pick-up and Arm only ... 30/-

THEN READ Mr. BONAIVIA-HUNT'S ARTICLE On Page 186

Extracts from Testimonials.

"I have never found anything to touch the LIMIT at the price."  
"Please send further... pick-ups, it is the best I have found." S.M.  
"I shall do my best to recommend the LIMIT to my friends—I am delighted." R.W.

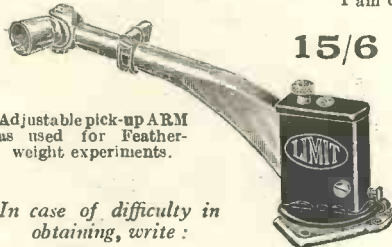

Adjustable pick-up ARM as used for Feather-weight experiments.

In case of difficulty in obtaining, write:

15/6

"The LIMIT is definitely ahead of any other on the market at ANY price." N.B.H.

"I have been using your pick-up for the last 6 months and getting splendid results." R.F.

LIMIT RADIO LTD., 15/29 Windsor St., N.1

For Quality Reproduction

For sheer quality of reproduction the R. & A. Reproducers are without a rival, and at the price are unequalled value. Ask your dealer to demonstrate, and refuse a substitute. If out of stock he can obtain at short notice. Descriptive literature sent post free on application.



Reproducers

BRITISH MADE

R. & A. 'Type 40.' Chosen by Mr. G. P. Kendall for use with the "Meteor III," and described by him as the "best value-for-money reproducer I can find." Will satisfy your most critical demands.

R. & A. '100' P.M.M.C. Reproducer. *Wireless Trader* states: "Tone will appeal to a wide public... really excellent value... plenty of bass and no shrillness... reproduction very good." Let expert opinion guide you, and let your choice be R. & A.

R. & A. '100' 45/-



TYPE '40' 16/6

REPRODUCERS & AMPLIFIERS, LTD., FREDERICK ST., WOLVERHAMPTON.

PILOT AUTHOR'S KITS

Exact to Specification

Peto - Scott, suppliers of everything new in radio since 1919

IMMEDIATE DELIVERY

CASH - C.O.D. - H.P.

ECONOMY RADIO-GRAMOPHONE

(As described in this month's issue)

KIT A Author's Kit, less valves, cabinet, motor Pick-up and speaker

CASH or C.O.D. £3.4.11

Or 12 monthly payments of 5/11

KIT B Author's Kit, with valves

CASH or C.O.D. £5.12.5 or 12 monthly payments of 10/4

KIT C Author's Kit, complete with valves, cabinet, motor, Pick-up and speaker

CASH or C.O.D. £10.11.5 or 12 monthly payments of 19/5

SPECIAL C.O.D. LINES

- Set of Specified Four Valves ... £2 7 6
- Vibrant Radiogram Cabinet ... £2 5 0
- Collaro Single Spring Motor, Type A.30 ... 19 0
- Zonophone Pick-up ... 15 0
- Ormond Loudspeaker Unit and Chassis... £1 0 0

You pay the Postman—we pay all post charges

Special quotations for the "Double Band-pass Four" will be willingly given by return of post

1932 SUPER 60 (Battery Model)

KIT A Author's Kit, less valves and cabinet. CASH or C.O.D. £7.16.10

Or 12 monthly payments of 14/5

KIT B Author's Kit, with valves less cabinet

CASH or C.O.D. £12.4.4 or 12 monthly payments of 22/5

KIT C Author's Kit complete with valves and cabinet

CASH or C.O.D. £14.0.4 or 12 monthly payments of 25/8

SPECIAL C.O.D. LINES

You pay the postman—we pay all charges

- Complete Set of Lewcos Coils, comprising Band-pass Filter Coil, Oscillator Coil, 2 Intermediates with pigtailed, 1 Intermediate without pigtail £2 12 0
- 1 Ormond .0005 2-gang Variable Condenser, type R/429/S2, with disc drive ... 16 6
- 1 Ormond .0005-mfd. Variable Condenser, type R/429/S1 ... 9 6
- 6 Valves, as specified ... £4 7 6

FINISHED INSTRUMENT.

Fully Assembled. Aerial Tested. Royalties paid. Cash or C.O.D. £17.10.0 or 12 monthly payments of 32/-

Special quotations for the "1932 Super 60," A.C. MODEL, will be willingly given by return of post

Any parts for the above and all "Wireless Magazine" sets. If value over 10/-, sent carriage paid. C.O.D. — all post charges paid.

PETO-SCOTT

CO. LTD.

77 CITY ROAD, LONDON, E.C.1.

Telephone: Clerkenwell 9406-7-8

62 HIGH HOLBORN, LONDON, W.C.1.

Telephone: Chancery 8266

It helps us if you mention "Wireless Magazine"

# SPECIFIED FOR THE "QUADRADYNE"

The enormous success of the "Quadradyne"—fully described in the February issue of the "Wireless Magazine"—has depended to no small degree on the British Radiophone Four-gang Condenser incorporated in its circuit. No other ganged condenser can compare with it in accuracy and strength of construction. No other condenser can give such Knife-edge selectivity!

**Accuracy is guaranteed to within half of one per cent!**

- Four-gang Condenser ... .. 38/-
- Dustproof Metal Cover ... .. 4/-
- Oxidised Silver Escutcheon and Drive Assembly complete with pilot lamp attachment ... .. 5/-

Also made in 2 and 3 Gang Sizes.

Write for completely illustrated descriptive brochure.

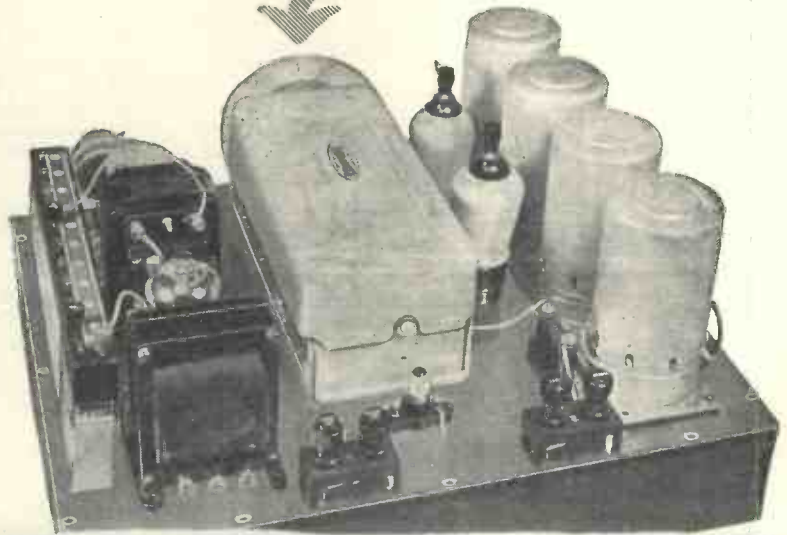

## RADIOPHONE GANGED CONDENSER

THE BRITISH RADIOPHONE LTD., Aldwych House, Aldwych, London, W.C.2

Telephone: HOLBORN 6744



# Specified for the "Economy Radio Gramophone"

### THE ORMOND No. 1 ADJUSTABLE LOUD-SPEAKER UNIT

Designed for use with normal power and pentode valves, this famous Ormond Unit reproduces both music and speech with life and sparkle which gives vivid reality and will handle big volume without the least distortion. All working parts are enclosed in a beautifully polished bakelite cover and the terminals are heavily nickel plated. **12/6**

**The New Ormond No. 1.Z. Loud-speaker Unit**  
Similar in construction, but specially matched to operate with the new high efficiency pentode valves. To distinguish this model the terminals are copper oxidised. **12/6**

**THE ORMOND SMALL CHASSIS AND CONE**  
This Ormond Chassis and Cone has rapidly become the most popular combination of its kind on the market. Constructed of aluminium, 11½ in. in diameter, ribbed to give greater strength, and provided with two brass pillars complete with lock nuts to ensure easy assembly of the unit. The cone, of specially selected material, is firmly secured to the outer ring, in which screw holes are provided for securing to baffle board or cabinet. **5/-**  
The Ormond large Chassis and Cone is of similar construction, but 16½ in. in diameter. **9/-**

**THE ORMOND ENGINEERING CO., LTD.,**  
Ormond House, Rosebery Avenue, LONDON, E.C.1

Telephone: Clerkenwell 5334-5-6 and 9344-5-6  
Telegrams: "Ormondengi, Isling."



**12/6**

Advertisers take more interest when you mention "Wireless Magazine"



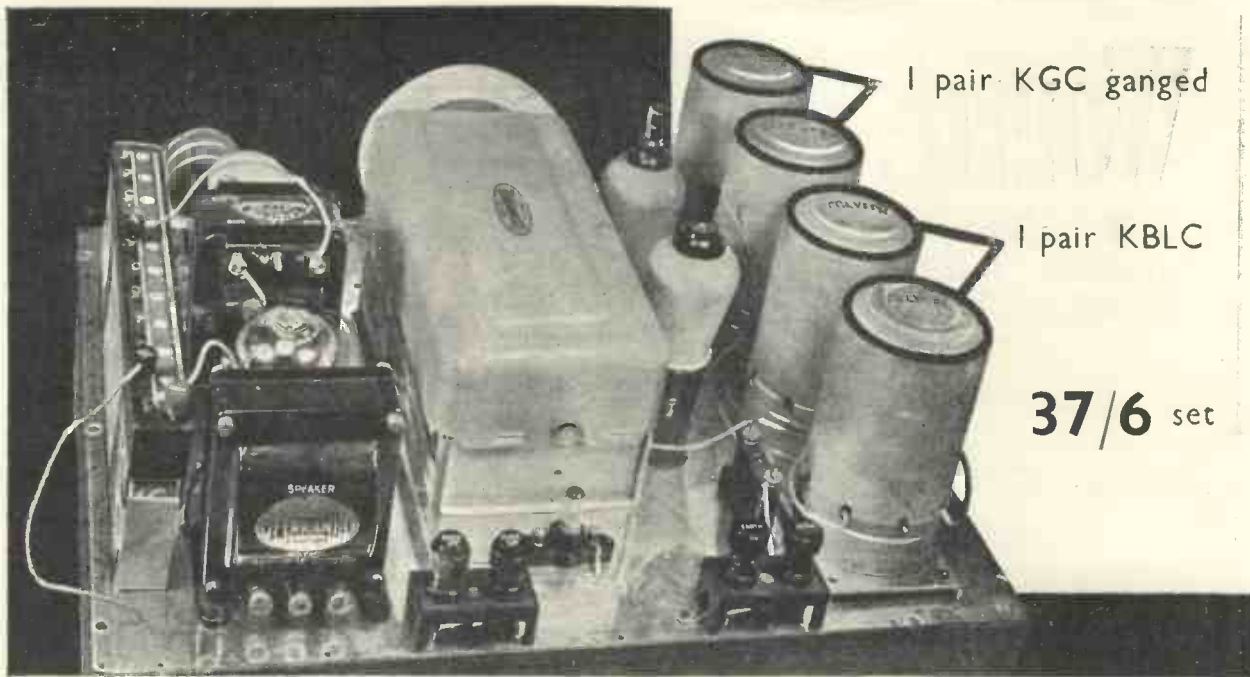

1 pair KGC ganged

1 pair KBLC

37/6 set

# COLVERN COILS ARE SPECIFIED IN THE "QUADRADYNE"

COLVERN LIMITED, MAWNEY'S ROAD, ROMFORD, ESSEX

Preserve your copies of the "WIRELESS MAGAZINE"

THE ideal way of keeping your copies of the "Wireless Magazine" is to have them bound into volumes, each with its appropriate index, in the handsome grey-tinted stiff covers which are obtainable, at 2/6 each (inclusive of the index for each volume of six copies), plus postage, 3d. from the publishers.

**BERNARD JONES PUBLICATIONS LIMITED,**  
58-61 Fetter Lane, London, E.C.4

BECAUSE



IS SPECIFIED

by Mr. James in the 1932 Super 60 with 2 Spaghetti Resistances (20,000 ohms, 10d.) and 5 Terminal Blocks (6d.) you should try using other Sovereign components wherever possible in this set, too. Remember, every Sovereign component functions with utmost efficiency and is of best quality consistent with reasonable price.

*Make it a Sovereign 1932 Super 60. Send for the Sovereign Catalogue and see how many Sovereign Components you can use in this wonderful set.*

**SOVEREIGN PRODUCTS LTD.**  
52/54, Rosebery Avenue, London, E.C.1

**1932 SUPER 60—THE GREATEST YET**

**ORDER NOW**

"1932 SUPER 60"

Oak Cabinet in Dull Wax Finish or French Polished, with Baseboard and Dark Oak Panel ready drilled. **36/-** Carr. Paid in U.K.

These **CLARION** Specified **CABINETS**

THE "QUADRADYNE"

A choice Oak Cabinet. French Polished or Dull Wax finish, with Panel ready drilled. **27/6** Carr. Paid Baseboard 3/6 extra.

Illustrated Catalogue "W.M." free on request

"A.W." 1932 ETHER SEARCHER RADIOGRAMPHONE

Oak, dull finish. Feet black. **£4-17-6** works



**CLARION** Radio Furniture, 28-38 Mansford St., London, E.2

You will get prompt replies by mentioning "Wireless Magazine"

# WORLD'S BROADCAST STATIONS

The following list contains details of more than 300 broadcasting stations all over the world. Spaces are left for recording your dial readings. The list is corrected at the last moment of going to press each month

Wave-length	Name of Station	Dial Readings	Country	Wave-length	Name of Station	Dial Readings	Country
13.95	Boundbrook W3XAL		United States	43.6	Koethen D4AFF		Germany
14.47	Buenos Aires LSY		Argentina	43.75	Paris (Vitus)		France
14.65	Malabar PMB		Java	44.9	Nauen DGK		Germany
14.83	Nauen DGW		Germany	45	Constantine FM8KR		Tunis
15.03	Montegrande LSG		Argentina	45.38	Moscow		U.S.S.R.
15.14	Deal Beach WM1		United States	46.69	Boundbrook W3XL		United States
15.198	Aranjuez EAQ		Spain	46.72	Minsk RW62		U.S.S.R.
15.3	Nauen DFA		Germany	47	Quito HCIDR		Ecuador
15.33	Saigon FZS		Indo-China	48	Casablanca CN8MC		Morocco
15.5	Sydney VK2ME		New South Wales	48.35	Bogota HKC		Colombia
15.5	Nancy		France	48.59	Halifax		Nova Scotia
15.51	Deal Beach WNC		United States	48.85	Winnipeg VE9CL		Canada
15.93	Bandoeng PLE		Java	48.86	East Pittsburgh W8XK		United States
16.3	Kootwijk PCK		Holland	49.02	Richmond Hill W2XE		United States
16.57	Chicago W9XAA		United States	49.05	Saigon F31CD		Indo-China
16.8	Malabar PLF		Java	49.18	Boundbrook W3XAL		United States
16.85	Kootwijk PCV		Holland	49.22	Bowmanville VE9GW		Canada
16.9	Bangkok HSJ		Siam	49.34	Chicago W9XAA		United States
18.41	Kootwijk PCL		Holland	49.4	Johannesburg ZTJ		South Africa
18.5	Saigon FZR		Indo-China	49.43	Vancouver VE9CS		British Columbia
19.0	Barcelona		Spain	49.5	Nairobi 7LO		Kenya Colony
19.56	Schenectady W2XAD		United States	49.5	Philadelphia W3XAU		United States
19.68	Pontoise FYA		France	49.83	Chicago W9XF		United States
19.72	East Pittsburgh W8XK		United States	49.96	Montreal VE9DR		Canada
19.84	Rome (Vatican) HVJ		Italy	49.96	Tegucigalpa HRB		Honduras
20.5	Chapultepec XDA		Mexico	50	Moscow RV59		U.S.S.R.
21.5	Bucharest CV1		Roumania	50	Barcelona EAJ25		Spain
23.8	Rabat		Morocco	50.1	Caracas YV2BC		Venezuela
24	Funchal CT3AQ		Madeira	50.26	Eindhoven		Holland
24.98	Saigon FZR		Indo-China	50.26	Rome (Vatican) HVJ		Italy
25.16	Moscow (Popoff) RW50		U.S.S.R.	51.22	Chapultepec XDA		Mexico
25.2	Pontoise FYA		France	58	Prague OK1MPT		Czechoslovakia
25.25	East Pittsburgh W8XK		United States	62.5	Long Island W2XV		United States
25.27	Calcutta VUC		India	70.2	Khabarovsk RV15		U.S.S.R.
25.4	Rome (Prato Smeraldo) 2RO		Italy	80	Rome (Prato Smeraldo) 3RO		Italy
25.465	Saigon (Chi-Hoa)		Indo-China	92.3	Doerbitz		Germany
25.5	Chapultepec XDA		Mexico	206	Antwerp		Belgium
25.53	Chelmsford 5SW		Great Britain	214.2	Warsaw (No. 2)		Poland
25.6	Caracas		Venezuela	215	Li ge		Belgium
25.63	Pontoise FYA		France	215.3	Chatelineau		Belgium
26.7	S.S. Elettra 1BXX			216	Brussels (Conferéce)		Belgium
27.3	Wellington		New Zealand	217	Konigsberg		Germany
28.2	Bandoeng PLR		Java	217.5	Flensburg		Germany
28.9	Nauen		Germany	217.5	Salzburg		Austria
28.98	Buenos Aires LSX		Argentina	218.7	Beziere		France
29.04	Ruyselede		Belgium	220.3	Fecamp		France
29.5	Bangkok HS2PJ		Siam	222	Cork		Irish Free State
30	Belgrade		Yugoslavia	222.4	Cologne		Germany
30.57	Buenos Aires LSOR		Argentina	227.4	Munster		Germany
31.1	Maracay YVQ		Venezuela	227.4	Aachen		Germany
31.28	Sydney VK2ME		New South Wales	227.4	Malmö		Sweden
31.28	Melbourne VK3ME		Victoria	230	Kiel		Germany
31.3	Philadelphia W3XAU		United States	232.2	Lodz		Poland
31.35	Springfield W1XAZ		United States	234.4	Kristiansand		Norway
31.35	Poznan SR1		Poland	235.91	Bordeaux-Sud-Ouest		Belgium
31.38	Zeesen DJA		Germany	237.6	Binche		Belgium
31.48	Schenectady W2XAF		United States	239	Nurnberg		Germany
31.51	Skamlebaek OXY		Denmark	240.2	Stavanger		Norway
31.55	Melbourne VK3ME		Victoria	242	Belfast		Ireland
31.75	Rio de Janeiro		Brazil	244.7	Basle		Switzerland
31.86	Bandoeng PLE		Java	245.9	Cassel		Germany
32	Dakar		French West Africa	245.9	Linz		Austria
32.26	Rabat		Morocco	246	Berne		Switzerland
34.5	Bogota HKF		Colombia	247	Trieste		Italy
34.68	Long Island W2XV		United States	249.6	Juan-les-Pins		France
35	Dakar		French W. Africa	251	Prague (No. 2)		Czechoslovakia
36.92	Bandoeng PLW		Java	252.9	Barcelona EAJ15		Spain
38.07	Tokio J1AA		Japan	255.1	Gleiwitz		Germany
39.4	Nuevo Laredo X26A		Mexico	257	Toulouse PTT		France
39.7	Botoga HKF		Colombia	259	Hörby		Sweden
39.8	Rio Bamba		Ecuador	259.3	Radio Cointe		Belgium
40	Doerbitz DOA		Germany	261.5	Leipzig		Germany
41.6	Bangkok HSP2		Siam	263.8	London National		Great Britain
41.7	Las Palmas EAR58		Canary Isles	266	Moravska Ostrava		Czechoslovakia
42.3	Singapore US1AB		Singapore	266.5	Lille		France
42.3	Stuttgart D4XAA		Germany	269.8	Valencia		Spain
42.8	Rugles F8BP		France	271.5	Bremen		Germany
42.9	Lisbon CT1AA		Portugal	273.6	Rennes		France
43	Madrid EAR100		Spain	276.5	Turin		Italy
					Heilsberg		Germany

(Continued on page 144)



# Portadyne

## CHALLENGE ALL EXISTING IDEAS OF RADIO VALUE

Money buys more in the new Portadyne CHALLENGER—a Receiver as modern as the minute—giving a performance far ahead of all similarly priced sets.

The All-British Portadyne CHALLENGER is full of exclusive features, among them being concealed and dustproof controls, and Instantaneous Tuning which gets any selected station in 3 SECONDS. The Portadyne CHALLENGER'S range is enormous, its reproduction something new in faithfulness, its volume impressive.

Get to know more about this astounding new Receiver—it is the greatest value in the radio world to-day. Post the coupon now for fully illustrated details.

**CHALLENGER**  
**CASH PRICE £12.17.6**

**YOURS FOR 24/6** & 11 monthly payments of **24/6**



To Portadyne Radio Ltd., Gorst Rd., North Acton, London, N.W.10  
Details of CHALLENGER, please.

NAME.....

ADDRESS.....

## NOW! a SENSITIVE Moving Coil

The New

# MOTOR

Permanent Magnet

## MOVING COIL Loudspeaker

This latest MoToR masterpiece is something more than a high-grade P.M. Moving Coil should be—something more than you can expect. Added to its punch and brilliancy of tone is a degree of extreme sensitivity hitherto unobtainable in loud speakers of the moving-coil type. It is, indeed, a revelation! Write for fully descriptive pamphlet, post free.

Price **70/-** including Transformer



BRITISH MADE



World's supreme Balanced Armature SPEAKERS AND UNITS  
MoToR Unit, type S8, 23/6  
REX Loudspeaker 60/-  
(As illustrated)  
DELTA 75/- CARMEN 85/-  
MASTERSINGER 120/-

TEKADE RADIO & ELECTRIC Ltd,  
147 Farringdon Rd., London, E.C.1

# MOTOR

LOUDSPEAKERS · UNITS · CHASSIS

Northern Wholesale Distributors:

L. KREMNER, LTD.,  
2 Bradshaw Street, Manchester. Agent for Scotland: R. G. J. NISBET, 132 Renfrew Street, Glasgow, C.2. West of England: BRUNWEC, LTD., 28 Cumberland Street, St. Paul's, Bristol. Agent for South Wales: ARTHUR E. HOWARD, 113 Bute Street, Treherbert, Rhondda, Glam.

When you send your order don't forget to say you "saw it in the 'W.M.'"

# WORLD'S BROADCAST STATIONS—Cont. from page 142

Wave-length	Name of Station	Dial Readings	Country	Wave-length	Name of Station	Dial Readings	Country
279.3	Bratislava .. .. .		Czechoslovakia	416	Radio Maroc .. .. .		North Africa
281.2	Copenhagen .. .. .		Denmark	418	Berlin .. .. .		Germany
282.5	Lisbon CTIAA .. .. .		Portugal	424	Madrid EAJ7 (and España)		Spain
283	Berlin .. .. .		Germany	424.3	Moscow (Stalin) .. .. .		U.S.S.R.
283	Magdeburg .. .. .		Germany	431	Belgrade .. .. .		Yugoslavia
283	Stettin .. .. .		Germany	435.4	Stockholm .. .. .		Sweden
283.6	Brussels SBR .. .. .		Belgium	441	Rome .. .. .		Italy
285.2	Innsbruck .. .. .		Austria	447.1	Paris PTT .. .. .		France
286	Montpelier .. .. .		France	453.2	Danzig .. .. .		Danzig
287	Radio Lyons .. .. .		France	453.2	Klagenfurt .. .. .		Austria
	Aberdeen .. .. .		Great Britain	453.2	Porsgrund .. .. .		Norway
	Bournemouth .. .. .		" "	456.6	San Sebastian .. .. .		Spain
	Dundee .. .. .		" "	456.6	Beromuenster .. .. .		Switzerland
288.5	Edinburgh .. .. .		" "	466	Lyons PTT .. .. .		France
	Newcastle .. .. .		" "	468.7	Tartu .. .. .		Estonia
	Plymouth .. .. .		" "	472.4	Langenberg .. .. .		Germany
	Swansea .. .. .		" "	480	North Regional .. .. .		Great Britain
291	Viipuri .. .. .		Finland	488.6	Prague (Leibnitz) .. .. .		Czechoslovakia
293	Limoges PTT .. .. .		France	493.4	Trondheim .. .. .		Norway
294.4	Kosice .. .. .		Czechoslovakia	501.7	Florence .. .. .		Italy
296.1	Tallinn .. .. .		Esthonia	509.3	Brussels No. 1 .. .. .		Belgium
298.2	Huizen .. .. .		Holland	518.2	Vienna .. .. .		Austria
299.5	Radio Iderza .. .. .		Holland	525	Riga .. .. .		Latvia
301.5	North National .. .. .		Great Britain	532.9	Munich .. .. .		Germany
304.9	Bordeaux PTT .. .. .		France	541.5	Palermo .. .. .		Italy
306.8	Falun .. .. .		Sweden	541.5	Sundsvall .. .. .		Sweden
308.3	Zagreb .. .. .		Yugoslavia	550	Budapest .. .. .		Hungary
309.9	Cardiff .. .. .		Great Britain	559.7	Kaiserslautern .. .. .		Germany
312.2	Genoa .. .. .		Italy	559.7	Tampere .. .. .		Finland
312.6	Natan Vitus (Paris) .. .. .		France	559.7	Augsburg .. .. .		Germany
312.8	Cracow .. .. .		Poland	565	Hamar .. .. .		Norway
317.3	Marseilles .. .. .		France	566	Hanover .. .. .		Germany
318.8	Naples .. .. .		Italy	566	Wilno .. .. .		Poland
318.81	Sofia .. .. .		Bulgaria	569.3	Freiburg .. .. .		Germany
319.7	Dresden .. .. .		Germany	574.7	Ljubljana .. .. .		Yugoslavia
321.9	Göteborg .. .. .		Sweden	720	Moscow PTT .. .. .		U.S.S.R.
323.3	Breslau .. .. .		Germany	770	Ostersund .. .. .		Sweden
327.5	Grenoble .. .. .		France	937.5	Kharkov .. .. .		U.S.S.R.
328.9	Poste Parisien .. .. .		France	967.7	Alma-ata .. .. .		U.S.S.R.
331.81	Milan .. .. .		Italy	1,000.	Leningrad .. .. .		U.S.S.R.
334.4	Poznan .. .. .		Poland	1,053	Kootwijk .. .. .		Holland
337.8	Brussels No. 2 .. .. .		Belgium	1,071.4	Scheveningen-Haven .. .. .		Holland
341.7	Brno .. .. .		Czechoslovakia	1,075	Tiflis .. .. .		U.S.S.R.
345.2	Strasbourg .. .. .		France	1,090	Oslo .. .. .		Sweden
348.8	Barcelona EAJ1 .. .. .		Spain	1,117.3	Moscow (Popoff) .. .. .		U.S.S.R.
352.1	Graz .. .. .		Austria	1,153	Kalundborg .. .. .		Denmark
355.8	London Regional .. .. .		Great Britain	1,175	Reykjavik .. .. .		Iceland
360.6	Mühlacker .. .. .		Germany	1,216.2	Istanbul .. .. .		Turkey
363.4	Algiers .. .. .		North Africa	1,218	Vienna .. .. .		Austria
365.4	Bergen .. .. .		Norway	1,241.6	Boden .. .. .		Sweden
367.6	Frederikstaad .. .. .		Norway	1,304	Moscow (Trades Union) .. .. .		U.S.S.R.
368.1	Helsinki .. .. .		Finland	1,348.3	Motala .. .. .		Sweden
368.1	Seville .. .. .		Spain	1,411.8	Warsaw .. .. .		Poland
368.1	Bolzano .. .. .		Italy	1,445.7	Paris (Eiffel Tower) .. .. .		France
368.4	Radio LL, Paris .. .. .		France	1,481	Moscow (Komintern) .. .. .		U.S.S.R.
372	Hamburg .. .. .		Germany	1,538	Ankara .. .. .		Turkey
376.4	Glasgow .. .. .		Great Britain	1,554.4	Davenport National .. .. .		Great Britain
380.7	Lvov .. .. .		Poland	1,600	Irkutsk .. .. .		U.S.S.R.
384.4	Radio Toulouse .. .. .		France	1,634.9	Königswusterhausen .. .. .		Germany
389.6	Frankfurt .. .. .		Germany	1,724.1	Radio Paris .. .. .		France
390	Archangel .. .. .		U.S.S.R.	1,796	Lahti .. .. .		Finland
394	Bucharest .. .. .		Roumania	1,875	Hilversum .. .. .		Holland
398.9	Midland Regional .. .. .		Great Britain	1,935	Kaunas .. .. .		Lithuania
403	Sötters .. .. .		Switzerland	2,525	Königswusterhausen .. .. .		Germany
409.8	Katowice .. .. .		Poland	2,900	Königswusterhausen .. .. .		Germany
413	Dublin .. .. .		Irish Free State				

## For A.C. Sets on D.C. Mains use



D.C. to A.C. Types for operating A.C. Receivers and Radio-Gramophones from D.C. supplies. Electrically and mechanically silent in operation; can be supplied complete with an anti-interference unit and sound-proof cover (as illustrated). Input 12 to 220v. D.C. Output: Up to 200 watts at 230v. 50c. Also D.C. to D.C. Types for supplying H.T. Current to large Public Address Amplifiers, etc. Input: 12 to 220v. D.C. Output: 300v. to 1000v., etc.

Solve your power supply problems with an M-L Machine, there are **MODELS FOR EVERY REQUIREMENT**  
**ROTARY TRANSFORMERS**  
**AND ANODE CONVERTERS**

Get full details immediately, Post Free from **ROTAX LTD., RADIO DEPT. 7, WILLESDEN, LONDON, N.W. 10**

Latest type M-L Rotary Transformer complete with anti-interference unit and sound-proof cover

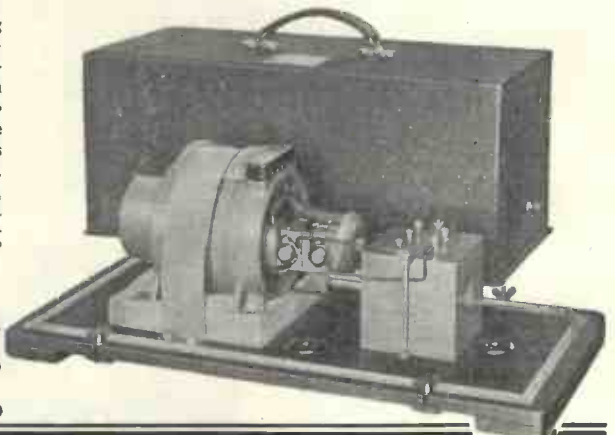



# The DUX

## Audirad CHOKE

### An Outstanding Radio Development for 1932

Once again R.I. proves that there is no finality in Radio Progress—by the introduction of a remarkable new development in Choke design—the “DUX AUDIRAD.”

This component, offered at the low price of 8/9, is not only a high-class L.F. choke, but embodies a unique H.F. stopping device which deals effectively with mains and other annoying H.F. noises so often associated with all mains smoothing.

As with all R.I. Components, full technical printed matter, including diagrams, is provided. Ask your dealer or write to us for a copy of the leaflet.

L.F. Inductance 25 henries. Maximum D.C. Current 50m.a.  
 H.F. Inductance of H.F. Overall dimensions, 2 ins. x 2½ ins. x 2½ ins. Weight 15 ozs.  
 Stopper 10,000 micro-henries.

# 8/9



Advt. of Radio Instruments Ltd., Croydon, England. 'Phone: Thornton Heath 3211 (5 lines.)

T.A.

SPECIFIED  
 AND  
 USED BY THE DESIGNERS  
 FOR THE

### Economy Radio Gram GENTS' (TANGENT) EWEBEC COILS

ENTIRELY { NEW DESIGN  
 NEW EFFICIENCY  
 NEW EASE OF ASSEMBLY

PRICES :

Wound Coils complete per pair 8/10  
 Bare Blank formers only per pair 2/6

**GENT & CO. LTD.**  
 Established 1872

Faraday Works  
 LEICESTER

LONDON—47 VICTORIA STREET, S.W.1

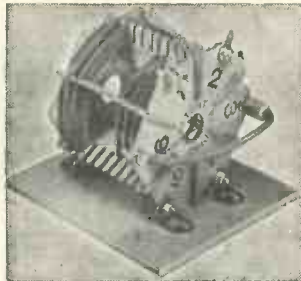

THE BEST receiver is only as good as its speaker. The Best Speaker has the name of Edison Bell behind it. Therefore, the Best Wireless Receiving-set is that equipped with one of

### The new EDISON BELL Permanent Magnet Moving Coil Models

universally admitted by Trade, Press and Public to be EASILY FIRST

the  
 WIRELESS RETAILERS ASSOCN  
 writes:

“At the Radio Exhibition held in Bristol your Permanent Magnet Moving-coil Speaker was placed first by popular vote.”

Two types are available—as illustration, in finely grained walnut cabinet. Model 553 with tapped transformer to which the connections may be adjusted in order to match various power-valves, and Model 553a fitted with Transformer suitable for use with Pentode and small power-valves.

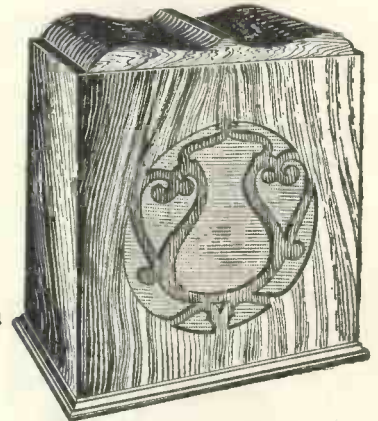

### WHEN ITS BEST BUY BRITISH EDISON BELL IS BOTH

Prices:  
 In Walnut Cabinet  
 £4 : 15 : 0

No. 456 & 456a  
 Chassis only  
 £3 : 7 : 6  
 Write for folder.

We Use DARWIN'S MAGNETS

*Edison Bell*

Manufactured by -  
**EDISON BELL LTD**  
 Glengall Road. S.E.15

It helps us if you mention “Wireless Magazine”

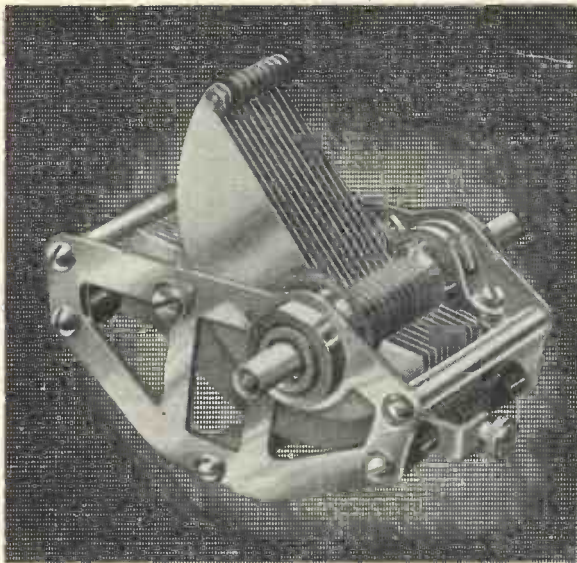

## J.B. UNIVERSAL LOG

Frame and vanes of extra hard brass. One-hole fixing. Takes any panel up to 1/4 in. Pigtail to rotor.

.0005 ...	9/6	.00025 ...	8/9
.0003 ...	9/-	.00015 ...	8/9

4-in. J.B. Bakelite Dial  
 Black - 1/6 extra  
 Mahogany 2/- extra



**PRECISION  
 INSTRUMENTS**

Showing reversible panel bush and spindle withdrawn from condenser.

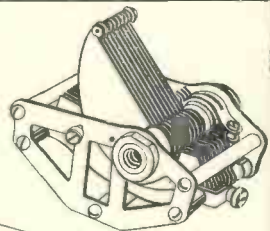

Advertisement of Jackson Brothers, 72 St. Thomas' Street, London, S.E.1.

Telephone: Hop 1837.

## IGRANIC

### Permanent Magnet Moving Coil Speaker



Write for a copy of our leaflet No. D. 160

#### Amazing Tone-Purity

The extraordinary purity of tone, combined with brilliant clear-cut reproduction of voice and music, will satisfy the most critical ear.

Size of Cone 10" dia. Supplied complete with Dual Input Transformer.

May we arrange a demonstration for you?

**PRICE  
 67/6**

**IGRANIC ELECTRIC CO., LTD.,**  
 149 Queen Victoria St., London

## Lanchester MOVING COIL Speakers

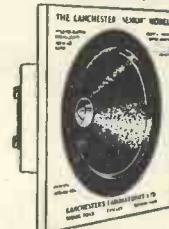

COBALT STEEL PERMANENT MAGNET

### High Sensitivity Full Musical Response Speech Perfect

Designed by F. W. Lanchester (originator of the Lanchester Car) and produced under his personal supervision.

We sell direct to the public and are able to offer our speakers, value for value, 40% below competitors' prices.

**BEAUTIFULLY ILLUSTRATED  
 CATALOGUE  
 Free & Post Free  
 WRITE FOR IT**

WE SELL DIRECT TO PUBLIC ONLY

**14  
 DAYS' FREE  
 TRIAL**

**CHASSIS PRICES :**  
 "Special Senior" £3-3-0  
 "Senior" ... £2-18-0  
 "Monitor" ... £2-8-0  
 "Junior" ... £1-10-0  
 Transformer extra, see catalogue.

**LANCHESTER'S LABORATORIES**  
 TYSELEY ... BIRMINGHAM

Better service results from mentioning "Wireless Magazine" when writing to advertisers



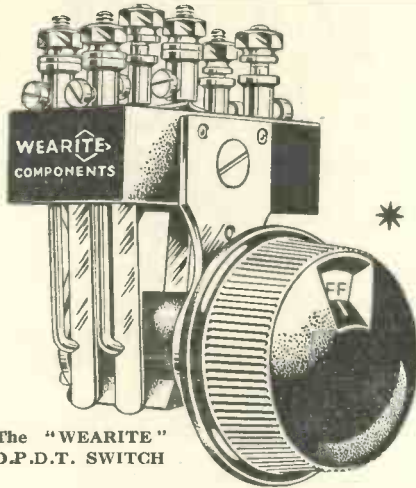

The "WEARITE"  
D.P.D.T. SWITCH

**\* NOTE THE INDICATOR WINDOW ON KNOB**

These switches are now fitted with terminals and are complete with window knob, dial and bracket—and are "one-hole" fixing.

	Price		Price
No. I.21 1-way D.P.D.T.	3/3	No. I.24 4-way D.P.D.T.	4/6
No. I.22 2 " "	3/6	No. I.25 5 " "	5/3
No. I.23 3 " "	4/-	No. I.26 6 " "	6/3

The following indicating discs are available—either black lettering on white, or white lettering on black. "Rad-off-Gran," "L-off-S," "Off-On," and also blank white for own marking.

**AND REMEMBER—A GOOD EARTH ALWAYS**



NO SPANNER  
NO SCREWDRIVER

Price 3/6 complete

# CLICK!

**YOU HEAR—FEEL and KNOW that contact has been made—good and hard**

THERE is nothing half-hearted about these "Wearite" Switches—positive contact every time—clean make and break. That is because each type is a thoroughly scientific job—designed and built by switch specialists of unequalled experience. And that is why leading set designers and makers always specify "Wearite." Whatever the switching problem there is a "Wearite" Switch to do the job—and do it perfectly.

THE FIRST NAME IN  
RADIO COMPONENTS

# WEARITE COMPONENTS

WRIGHT & WEAIRE LTD.

740 High Road, Tottenham, N.17

Telephone: Tottenham, 3847/8

9772

## FOR P. K. TURNER'S "A-QUALITY AMPLIFIER"

Westinghouse Metal Rectifiers have been chosen by P. K. Turner for his "A-Quality Amplifier." He knows that quality is ensured by their use, as they will give a constant and adequate high-tension supply throughout the lifetime of the set, thus enabling the power valve to work always at its maximum efficiency.

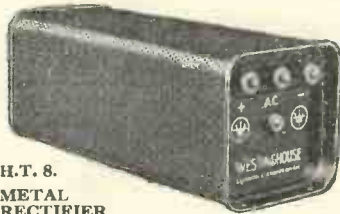
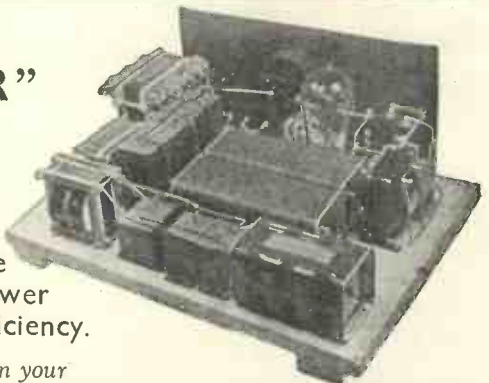

H.T. 8.  
METAL  
RECTIFIER  
OUTPUT:  
250v. 60mA.

PRICE  
**£1 1 0**

You want good and constant quality in your present receiver. Make the first step towards obtaining it by sending in the attached coupon, together with 3d. in stamps, for a copy of our booklet "The All Metal Way," which gives full particulars of

**WESTINGHOUSE**  
METAL RECTIFIERS

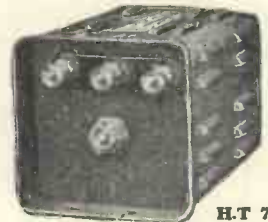

H.T. 7  
METAL  
RECTIFIER

Output:  
PRICE 17s. 6d. 200v. 28mA.

**THE WESTINGHOUSE  
BRAKE & SAXBY  
SIGNAL CO. LTD.**

COUPON

Westinghouse Publicity, 82 York Road, King's Cross, London, N.1. Please send me a copy of your booklet "The All Metal Way," for which I enclose 3d. in stamps.

Name .....

Address .....

W.M. 3. 32

**82 YORK ROAD,  
KING'S CROSS,  
LONDON, N.1.**

# In Tune with the Trade

## SEND TO US FOR THESE CATALOGUES!

Here we review the newest booklets and folders issued by six manufacturers. If you want copies of any or all of them just cut out this coupon and send it to us. We will see that you get all the literature you desire.

Just indicate the numbers (seen at the end of each paragraph) of the catalogues you want below.

My name and address are:—

Send this coupon in an unsealed envelope, bearing ½ d. stamp, to "Catalogue Service," WIRELESS MAGAZINE, 58/61 Fetter Lane, E.C.4. Valid till March 31

## MOTORING EXPERIENCE

**B**ATTERIES which stand up to long service in a car are admirably fitted, as a rule, for more leisurely radio work. The extensive experience of S. Smith & Sons (Motor Accessories), Ltd., in the automobile world means that when they start to bring out a new range of wireless batteries, the motoring experience stands them in good stead.

The new jelly-acid and slow-discharge cells, besides others in the wide range, certainly look good and have all the practical points one expects from batteries made by a firm of this standard—clearly marked polarity for terminals, sensible filler caps, and so on. Handy carriers are supplied with some of these batteries and, taking into consideration the new low prices now operating, the sturdiness is remarkable.

A free sheet can be had giving battery recommendations for all the popular sets. **246**

## YOU SHOULD SEE THIS

**I**HAVE spent quite a time going through the new Loewe Radio components catalogue No. 31-32. There are so many interesting and, in some cases, unusual parts in this that you will find it well worth while having it in your file for reference when building up a new set.

The new high-vacuum resistances and heavy-current resistances with a protective gas filling have their

special jobs in a set, and the tubular paper condensers, not much larger than an ordinary grid leak, are fine for portable and other sets where space is limited. A number of valves are also marketed by Loewe and the rectifier section is particularly complete. **247**

A section of this No. 31-32 catalogue is devoted to pick-ups, volume controls, and loud-speakers. Altogether, a most interesting production. **247**

## SOLILOQUY ON SPECIALISING

**W**HEN a manufacturer specialises in one particular line of components, as J. Dyson & Co., Ltd., do in Godwinex eliminators, one is apt to overlook other parts in the range, although they may equally well be deserving of attention. I have often tried sets excellently supplied with juice by a Godwinex mains job, but it is only with the arrival of a folder describing other Godwinex parts that I have realised that these mains units are not the Alpha and Omega of friend Dyson.

The other parts include a good selectivity unit, some fine six-pin plug-in coils, binocular high-frequency chokes, and four- and five-pin valve holders. **248**

## EASY SOLDERING

**I**KNOW that I often make the confession on this page that I am a duffer at soldering and that when possible I use, in my own sets, bare wire tucked in insulated sleeving. But, of course, you can't do away with soldering altogether, and for some time past I have been on the lookout for a really convenient means of making professional-looking soldered joints.

My problem seems to be half solved by the arrival of a little folder describing the Solon electric soldering iron, which is supplied wholesale by Brown Bros., Ltd., and obtainable through most wireless dealers.

This iron, made by Henley's, the well-known electrical people, is made for two voltage ranges, 200-220 and 230-250 volts. It takes only 65 watts

from the mains and is, I think, moderately priced at 7s. 6d.

Get the folder describing it, and you will feel, as I do, that a Solon will go a long way towards making soldering really easy. **249**

## USING WATMEL COILS

**A**NUMBER of keen friends of mine grab at any new circuit published and make it up in the optimistic hope that it will be better than their existing equipment. If you are that way inclined, then here is new food for thought.

Watmel have sent me a sheet giving eight new circuits for such sets as band-pass threes, A.C. screen-grid threes, super-hets, and quality sets with power-grid detectors and pentode outputs. These receivers are all built round the popular Watmel coils, of course, and values are given for the main components in the rest of the circuit.

Anyone capable of following a theoretical circuit diagram will get a great deal of fun out of this free sheet of circuits, and copies can be obtained through my free catalogue service.

The connections for the coils are clearly shown and, although no layouts are given, you should have no difficulty in making up these circuits in hook-up form. **250**

## MAKING IT LOUD

**I**N these days of cheap pentodes and simple power circuits, there is a rather mistaken impression that anybody can build an amplifier capable of giving an undistorted output of 20 or 30 watts. That is the sort of output one needs to fill a fairly small hall for dancing, and for those several other jobs upon which keen amateurs often get called in to assist.

If you want expert advice on the subject of small power reproduction, then get in touch with F. E. Godfrey (Radio), Ltd., through my free catalogue service. A booklet is published describing two extremely good small power amplifiers, giving undistorted outputs of 10 and 20 watts respectively. **251**



# OTHER PEOPLE'S VIEWS

# PROVE OUR CLAIMS



"... the performance of the receiver is striking. One is struck first of all by the sensitivity and the complete stability . . . . All the time one is using the controls, one has the feeling that a super-heterodyne is being used, so prolific is it as a station getter . . . ."

"We were impressed by the very high quality and finish and soundness of workmanship throughout. The set is of the highest quality . . . ."

"Speech and piano tone are particularly good; the latter is round and full . . . . In all we were able to tune in twenty transmissions at our offices in Soho Square, which is notably a 'blind' spot for reception . . . ."

"The most striking feature of this set on test was the extreme beauty of tone of the moving coil loud-speaker . . . The receiver was sufficiently sensitive for a small picture rail aerial to suffice for a wide range of reception. . . ."



**All - British**



A long distance high power set. One knob tunes three ganged condensers; no reaction. Volume control also acts as the "off" switch. Coil excited speaker. In Walnut cabinet. A.C. or D.C. Mains

# Columbia *Long Distance* RADIO

COLUMBIA  
GRAPHOPHONE  
CO. LTD., 98/108  
CLERKENWELL  
RD, LONDON, E.C.1

# New Watmel 1932 Variable Resistance



TYPE 3

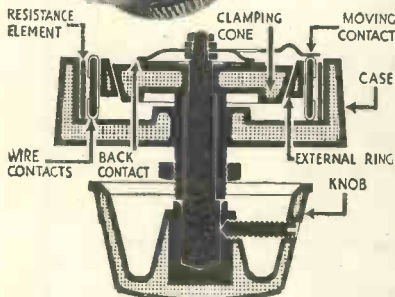

This new all-British resistance embodies many new and novel features which guarantee a higher degree of efficiency and a far steadier performance than resistances constructed on old and obsolete principles.

### ADVANTAGES

1. The extremely firm and even contact with the element. This is obtained by a new patented clamping cone which directly it is screwed down forces the external ring against the wire band. *The pressure is so great that perfect all-round contact is made with the element which will not vary under any circumstances.*
2. Self-cleaning wiping contacts. This ensures perfectly clean contact always.
3. Non-inductive.
4. Silent in operation.
5. Price

4/6

We recommend this resistance (Type 3) only for all values above 50,000 ohms where wire-wound potentiometers are not required.

Patents for this new resistance have been applied for.

Write for free Component Catalogue and also for our free Circuit Diagrams.

If you have any difficulty in obtaining Watmel components write direct to us.

TRADE INQUIRIES INVITED.



**GET THE BEST OUT OF ANY SET**  
WATMEL WIRELESS CO., LTD.,  
Imperial Works, High St., Edgware.  
Telephone: Edgware 0323

M.C.56

## TRUE MOVING-COIL REPRODUCTION

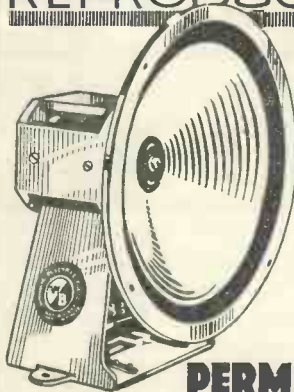

from  
**ANY**  
2, 3 or  
multi-valve  
set

Selling in thousands. The astonishing W.B. Model, P.M.3.

**PERMANENT  
MAGNET  
MOVING-COIL SPEAKER**

**45/-**

Three-ratio output transformer extra - - 7/6  
Handsome Grained Oak Cabinet - 30/-

Write for free booklet

**WHITELEY  
ELECTRICAL  
RADIO CO., LTD.,**

Nottingham Road,  
Mansfield :: Notts.

Irish Free State Distributors:  
**KELLY & SHIEL, LTD.**  
47 Fleet Street, Dublin.



## FUSE PRICES REDUCED



**SAFETY  
TWIN  
FUSEHOLDER**

(Specified in the A.P.A. amplifier)

fuses for mains leads.

With two 1-amp. fuses  
Reduced from 3/6 to **2/6**



**SINGLE  
BASEBOARD  
FUSEHOLDER**

The best method of mounting fuses inside any set. Complete with 1/2 amp. fuse.

Reduced from 1/3 to **1/6**

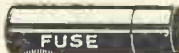

**WANDER-  
FUSE**

Fuse and wander plug combined. Lies flat on battery top—takes no extra space. Use one in the H.T.—lead to protect valves and H.T. supply. Fitted without tools. Complete with 150 m.A. fuse.  
Reduced from 1/6 to **1/6**

Spare fuses, all ratings, 6d. each.

**BELLING-LEE  
FOR EVERY RADIO CONNECTION**

Advt. of Belling & Lee, Ltd., Queensway, Ponders End, Mdx.

## "Ready to Switch on"

Just switch on to the mains for steady, trouble-free power for your receiver. Ready for instant action, the Heayberd Model BD.150 is the acme of eliminator perfection, read why in the specification below. You may, however, BUILD YOUR OWN ELIMINATOR with our components. All units are Guaranteed Three Years.

MODEL BD.150 Output 40 ma. at 200v. or 50 ma. at 150v. Tappings: 60/80v. variable S.G., 150v. and 200v. fixed. Complete in neat steel case, alternative output panel switch, Westinghouse Rectification and flex to switch on. Price **120/-**



(One minute from Moorgate Undergr'd Station)

**16  
FINSBURY  
STREET,  
LONDON,  
E.C.2**

MONARCH OF THE MAINS.

POST NOW

Enclose 3d. stamps for List 962 and useful information with circuit diagrams incorporating Heayberd Transformers.



M.....

Address.....

## PEAK CONDENSERS BRITISH MADE

1,500v. D.C. TEST

Read an independent authorities' report. Reprinted from the "WIRELESS TRADER" :-

TEST RESULTS.—Three sample condensers were tested, the rated capacities being 4, 1 and 0.1 mfd. The actual measured capacities were 3.85, 1.05 and 0.098 mfd. respectively. Thus the errors are only -4, +5 and -2 per cent. respectively, which is a very good degree of accuracy for paper condensers, well within the 10 per cent. allowable according to the B.E.S.A. standard specification. All the samples were given a voltage test at about 1,500 v. D.C., and withstood this satisfactorily. In addition, a leakage test, with 250 v. applied, was made on the 4-mfd. sample, and this revealed the very high insulation resistance of about 19,000 MO per mfd.

Thus the condensers can be recommended as very efficient British-made components, suitable for working voltages of 500 to 700 v. D.C. Incidentally, it might be a good point to have the working voltage marked on the cases. The prices, considering the quality of the components, are extremely reasonable.

### 1,500 VOLTS D.C. TEST

1 mfd.	-	-	-	1/10
1 mfd.	-	-	-	2/8
2 mfd.	-	-	-	3/9
4 mfd.	-	-	-	6/9

### 1,000 VOLTS A.C. TEST

0.1+0.1	-	-	-	2/6
---------	---	---	---	-----

\* With terminals at same prices.

**WILBURN & CO.**  
23 Bride Lane, E.C.4. Phone: Central 6994  
Northern Stockists: W. Andrew Bryce & Co., Bury

Advertisers like to know you "saw it in the 'Wireless Magazine'"



# These are the valves for the "WIRELESS MAGAZINE" DOUBLE BAND-PASS

as specified by the "Wireless Magazine" Technical Staff

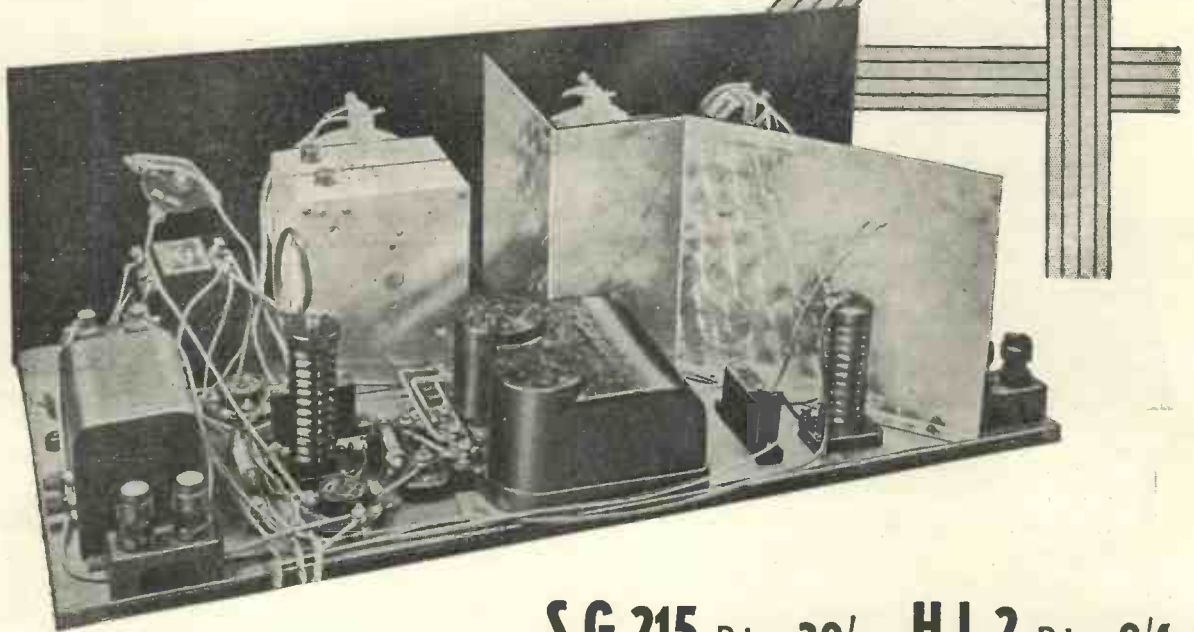

The amazing

# MAZDA THE BRITISH VALVES

**S.G.215** Price 20/-    **H.L.2** Price 8/6

**L.2** Price 8/6    **P.220A** Price 13/6

To make the most of that combination of selectivity and quality which characterises this new "Wireless Magazine" Receiver, Mazda valves should be employed. Mazda valves are 100% British made and designed by British engineers. All good radio dealers sell them.

## EDISWAN RADIO

THE EDISON SWAN ELECTRIC CO. LTD.



155 CHARING CROSS RD., LONDON W.2

V158

There is news in the "Wireless Magazine" advertisements

# 9 VALVE super-heterodyne all-electric record-changing RADIO-GRAMOPHONE

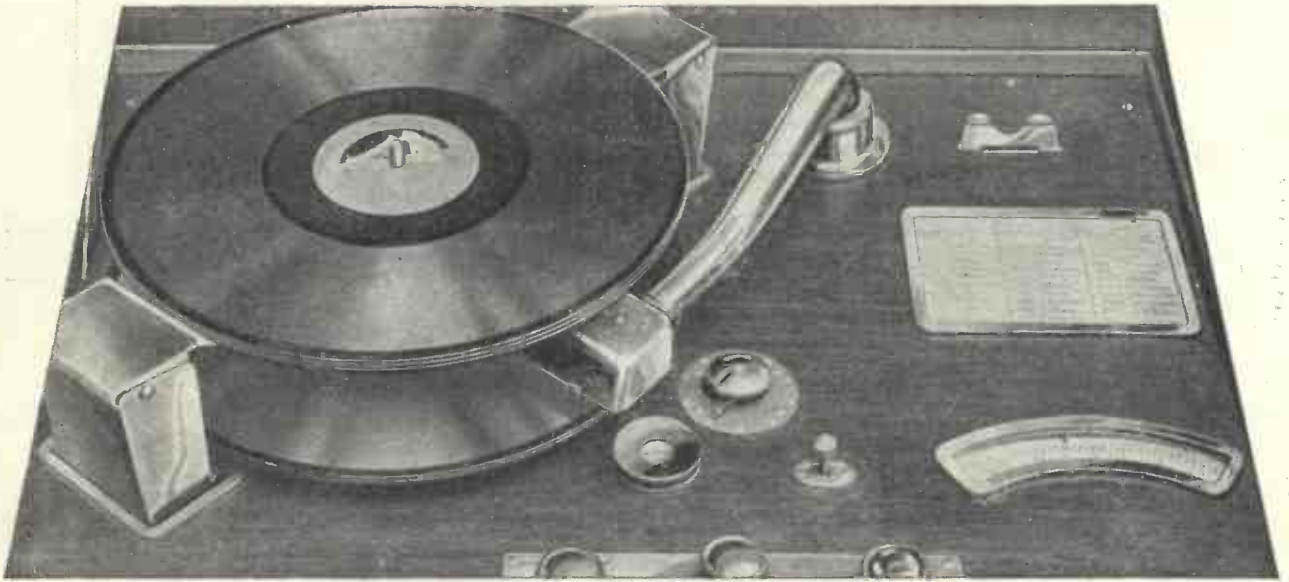

**T**HIS remarkable instrument knows nothing of overcrowded ether. The fact that, for instance, London Regional and Muhlacker jostle wave lengths is no matter. A fractional turn of the tuning knob cuts the one cleanly out, the other coming in with beautiful precision. No station is allowed by this 9 valve "super-het" to encroach upon the programme of another. And its normal range is eighty or so stations at the command of a single control, and with only a few feet of aerial. But, even with nearly a hundred broadcasts at choice, the gramophone will give you that which nothing else can offer: your

own programme. Take any eight records, 10 inch or 12 inch (unmixed) and they will be played through with automatic changing. You can follow a song with a dance, a violin solo with an organ fugue. You can play a four, five or six-record symphony or concerto, turning the whole set of records only once. From radio and record, the quality of reproduction is brilliantly real. Output is sufficient for six extra loudspeakers and volume can be graded from a whisper to a superb outpouring of sound overwhelming in any but the largest of rooms.



The Gramophone Co. Ltd.,  
London, W.1.

**SPECIFICATION** Super-heterodyne for extreme sensitivity and selectivity, with single knob control. Nine valves and rectifier, and ten tuned circuits. Dial calibrated in wave lengths. Band pass tuning. Provision for six extra loudspeakers. "His Master's Voice" electro-magnetic moving-coil loudspeaker. Electric gramophone motor, absolutely true-running. All mains — no batteries required. Cabinet of choicely figured walnut and distinguished design.

**PRICE - - 70 GUINEAS**

(Price does not apply in Irish Free State)

or 7 Gns. down and 12 monthly payments of £5. 18. 6.

Full particulars from any "His Master's Voice" dealer.

# His Master's Voice

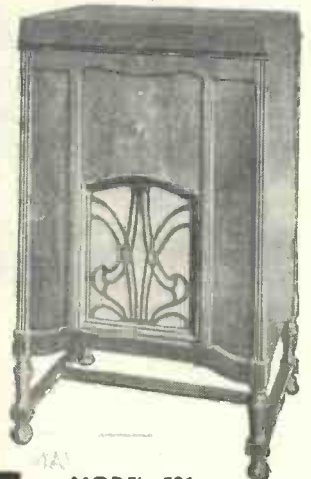

MODEL 531

Advertisers like to know you "saw it in the 'Wireless Magazine'"



# Are We Using the Right Type of Condenser?

Asks  
P. K. TURNER, M.I.E.E.



OF all the variable condensers sold this season, I suppose nine out of ten are "log law." Why is this? What is the virtue of this shape of plate, that it should be so popular, and is it really the best for our purpose?

### Shapes and Properties

Before we can answer this question properly, we must see what other shapes there are, and what are the special properties of each; and let me begin by saying that I refer only to variable condensers used for tuning in the ordinary way—not to reaction or aerial series condensers.

Apart from "freak" condensers for special purposes, there are four well-known shapes of plate which I give in the order in which they became

of the ordinary interleaved-plate type, is scarcely found at all nowadays in receivers, but is widely used in the laboratory for measurement purposes.

First, let us bear in mind the general principle that the capacity for any setting of any type of variable condenser is proportional to the area of the plates engaged. Now with the type having semi-circular plates, whether it is set at 19 degrees, 50, or any other setting, the effect of adding ten degrees, say, is always to add the same area, and hence the same capacity.

So if we draw a diagram of capacity against setting, we get a straight line like Fig. 1: this type of condenser is a "straight-line capacity."

If it is really accurately manufactured, then (except for the extreme ends of the scale) adding, say, 5 degrees to the setting will always add just the same number of micro-microfarads to the capacity. Now in laboratory work, one usually wants to know the exact capacity of a condenser at any setting, but it is not practical to *measure* it at every possible setting.

What we do is to measure it at say twenty settings well spaced over the scale, and plot the results on a diagram like Fig. 1. Then by drawing a straight line through the points found, we can get the capacity for *any* setting.

If the line through the points found by measurements were not a straight line but a curve, then we could still try the same thing by drawing the curve, but it would not be nearly so accurate.

It is well known that the relative positions of different stations on the dial of a variable condenser depend on the shape of the vanes. In this article P. K. TURNER, M.I.E.E., expresses the opinion that the kind of variable condenser in general use is not really the best and that we ought to go back to the straight-line frequency (S.L.F.) type.

So we see the great advantage of this type of condenser for the laboratory: it lends itself well to accurate and easy calibration in capacity. But it is awkward in a receiver for two reasons: one that it does not give a straight-line calibration in wavelengths, and the other that if we used it for broadcast reception we should find, as you will see presently, that most of the stations would be crowded together at the bottom end of the scale, leaving only a few, rather widely spaced, at the top.

### "Square-law Condensers"

It is a property of tuned circuits that if the inductance of the coil is unaltered, the wavelength to which one is tuned is exactly proportional to the square root of the capacity; and presently it occurred to some bright person that if one altered the shape of the plates so that the capacity were proportional to the square of the setting, then it would follow that the wavelength would be proportional to the setting, and one would have a "straight-line wavelength" condenser, with a curve like that of Fig. 2.

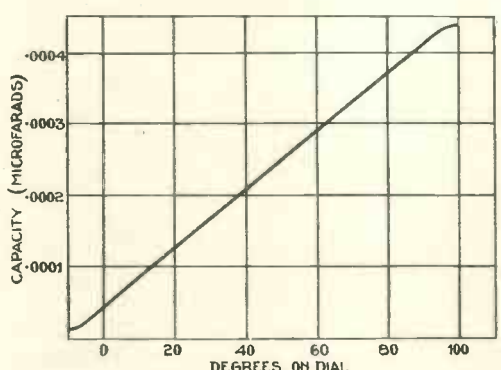

Fig. 1.—When we want a condenser calibrated in capacity, the old semi-circular type, with a scale like this, is the best

well-known and popular: the old semi-circular, the square-law, the S.L.F., and the log-law. We will deal with these one by one.

### The Semi-circular

This, the first variable condenser

# ARE WE USING THE RIGHT CONDENSERS?



**SOMETHING LIKE CONDENSERS!**  
 This photograph shows the apparatus used by an American amateur transmitter. He certainly has a unique collection of variable condensers for tuning

The first ones made didn't give the required law, for it was not realised that the stray capacity of the circuit upset the law. Eventually it was seen that for all condensers except the semi-circular, this must always be the case, and the shape of the blades must be altered to allow for it.

Moreover, the shape can only be got right for one particular value of stray. So what one does is to design the blades to be right for a larger stray capacity than we ever expect to get, and then to fit a "trimmer," a small adjustable condenser by which the stray, if too small, can be brought up to the value that gives the correct law.

### Important Point

This point is rather important—the trimmer is only to compensate for differences in the stray capacity; it can't be used to make up for any inaccuracy in the inductance of the coil without upsetting the "straight-line wavelength" law.

The reason why one should have desired this law will be plain from what I have already said about laboratory condensers, but in an ordinary receiver we are only interested in calibrating it for stations. If we make a diagram with scales of setting and wavelength like Fig. 2, and manage to plot on it the settings we find for a few known stations, we can then draw a straight line through the points and so find the setting for any other station.

### "Log Law"

In the log-law condenser, the distinguishing property is this: that if we properly adjust a trimmer as explained above, then for an equal change of setting we always find an equal percentage change of wave-

length or of frequency. then decrease the setting by 10 degrees. Suppose the coil is such as to give 600 metres with the condenser all in.

With the "straight-line capacity" condenser, changing from full to half setting reduces the wavelength from 600 to 445 metres, or a ratio of 1 to .74. The 10 degrees decrease reduces 600 to 571, and 445 to 407—a drop of 29 metres in the first case and 38 metres in the second, or in percentages 5 per cent. in the first case and 8½ per cent. in the second. Neither the actual change nor the percentage is constant.

### Square-law Readings

With the "square-law" or "straight-line wavelength" type, the change from full to half setting reduces the wavelength from 600 to 395 metres, or 1 to .66. The 10 degrees change reduces 600 to 560 metres, and 395 to 355—a drop of 40 metres in each case. As explained, this is the special property of this type.

Lastly, with the "log-law" condenser, the change from full to half setting changes the wavelength from 600 to 337, or 1 to .56; the 10 degrees change reduces 600 metres to 535, and 337 to 300, a drop of 65 metres in the first case and 37 metres in the second; but in each case a drop of 11 per cent.

Now suppose that we have two or more separate circuits to tune in this way, always to the same wavelength, and suppose that the various coils haven't all exactly the same inductance. For the same wavelength we *must* have in every case the same value of capacity × inductance.

So if, for example, Coil No. 1 is 10 per cent. bigger than coil No. 2, No. 1 condenser must always be set to 10 per cent. more than condenser No. 2. If they are log law, we have only to set No. 2 always some fixed number of degrees ahead of No. 1—9 degrees in the case worked out above—and both coils will be tuned to the

same wave. And since the angle between the two condensers is a fixed one, we can "gang" them, although the coils are not the same.

This idea was thought out at the same time, but independently by

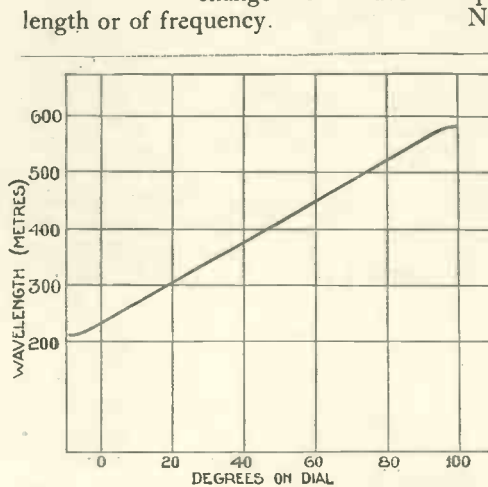

Fig. 2.—The next stage: the square-law condenser gives a scale like this, and a receiver using it is easy to calibrate in wavelengths

Just to get this idea clearly into one's head, let us compare it with the other types. Suppose in each case we imagine the condenser first set at 100 degrees (all in), and then at 50 degrees, and that in each case we



# A SPECIAL ARTICLE FOR CONSTRUCTORS

Mr. F. H. Haynes and myself, in 1926, and the "log-law" condenser has been the most popular ever since.

But I believe it is time for a change. The great virtue of the log-law condenser is that by its use one may "gang" a set of condensers, even though the coils are not all accurately matched. But nowadays coils are as accurately matched as the condensers themselves, and so this property of the log-law condenser is not really needed, and we have a free hand to choose whatever type is the most convenient in other ways.

## The S.L.F. Condenser

One especially convenient condenser for our purpose is the rather neglected S.L.F. This has plates of such a shape that instead of, like the "square-law," giving a constant change of wavelength for a fixed change of setting it gives a constant change of frequency. Such a condenser is "straight-line frequency," which gives the clue to its name. (See Fig. 3).

Now many of us find it hard to

think in terms of frequency. Although we know that frequency can always be found approximately by dividing 300,000 by the wavelength (which gives the frequency in kilocycles), and *vice versa*, we still have vague ideas about a frequency until we do turn it into a wavelength.

It is just the same with centimetres; I know quite well that about 2½ centimetres go to an inch, but if someone says 15 cm., I don't really *feel* how big it is till I have worked it out and find six inches!

But those of us who can't feel 750 kilocycles till we have worked it out and found 400 metres must learn. It is becoming more and more essential to think in frequency and not in wavelength. The whole basis of any settlement of the international interference problem is bound up with the frequency-difference of stations—as we know, under the Prague plan they are set at equal intervals of 9 kilocycles apart. And

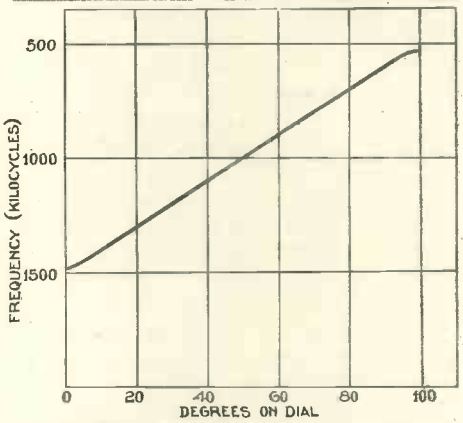

Fig. 3.—Better still, and probably the condenser of the future, is the S.L.F., with a curve like this. The receiver can easily be calibrated in frequencies

with S.L.F. condensers all such stations are spaced apart at even distances all round the scale.

To show what an advantage this is, I have worked out, and show in Fig. 4, the calibration scales of four imaginary receivers, all with the same wave range of 190 to 600 metres, but fitted with the four different types of condenser.

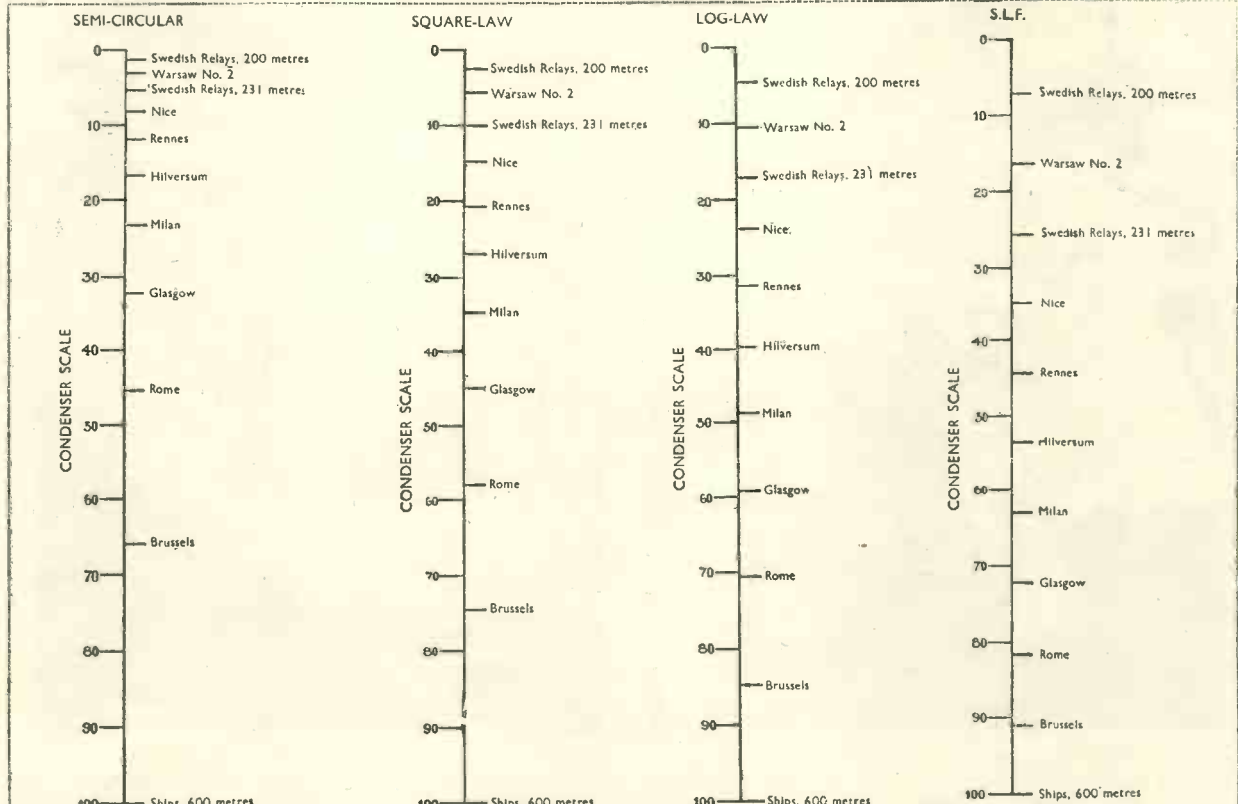

Fig. 4.—Some well-known stations as they would come on the scale of receivers with the four types of condenser. Between each pair of stations shown are ten others on the Prague plan. Note that the S.L.F. is the only scale with stations evenly spaced

# ARE WE USING THE RIGHT CONDENSERS?

## 100-kilocycle Separation

I have not marked all the stations, but only every eleventh one; that is, I have marked stations 100 kilocycles apart. I have marked them with the names of stations which are approximately on these waves, so that the reader may compare them with his own set; and to save a lot of space, I have straightened them out from their usual semi-circular shape.

It is obvious that the old semi-circular condenser would never do. At the bottom end of the scale there are twelve stations in less than 2 degrees on a 100 degree scale, and even if the set can separate them one's fingers are not accurate enough to set the condenser right.

The "square-law" is better, and the "log-law" as fitted to most modern sets better still, but it is by no means perfect. We have ten stations between  $4\frac{1}{2}$  and  $10\frac{1}{2}$  degrees—or about .6 degree to a station, while at the upper end of the scale there are only ten stations between

84 degrees and 100 degrees, or 1.6 degrees to a station.

But the S.L.F. condenser spreads them out evenly. There are just about eleven stations to every 10 degrees all over the scale, so that they are all equally easy to tune accurately. And we have the advantage that the square-law had and the log-law lost: that if we plot a few known stations against the settings we have found for them, on a diagram like Fig. 3, then they all lie on a straight line, and if we draw it we can quite easily find the settings for other stations.

## For Supersonic Sets

One more advantage. In a super-het receiver, the oscillator has always to be tuned to a different frequency from the radio-frequency part of the set; and the frequency difference is a fixed one—that of the intermediate-frequency amplifier. For this reason a "single-control" super-het is not easy to design.

At present a patchy job is made of it by what are known as "padding" condensers in series with the variable and across the coil, combined with the use of a special coil, different from the others, in the oscillator circuit. But this arrangement only gives an approximation to accurate tuning, though not far off if well arranged.

## Making Coils Alike

If, however, we use S.L.F. condensers, all we have to do is to make all the coils alike, including the oscillator, but give the oscillator condenser a "lead" or "lag" compared with the others. Then by the very property of the S.L.F. condenser we shall get constant frequency-difference between oscillator and amplifier as required.

Lastly, the S.L.F. condenser is not new. Most of the well-known manufacturers have made them before, and they will make them again if we ask for them.

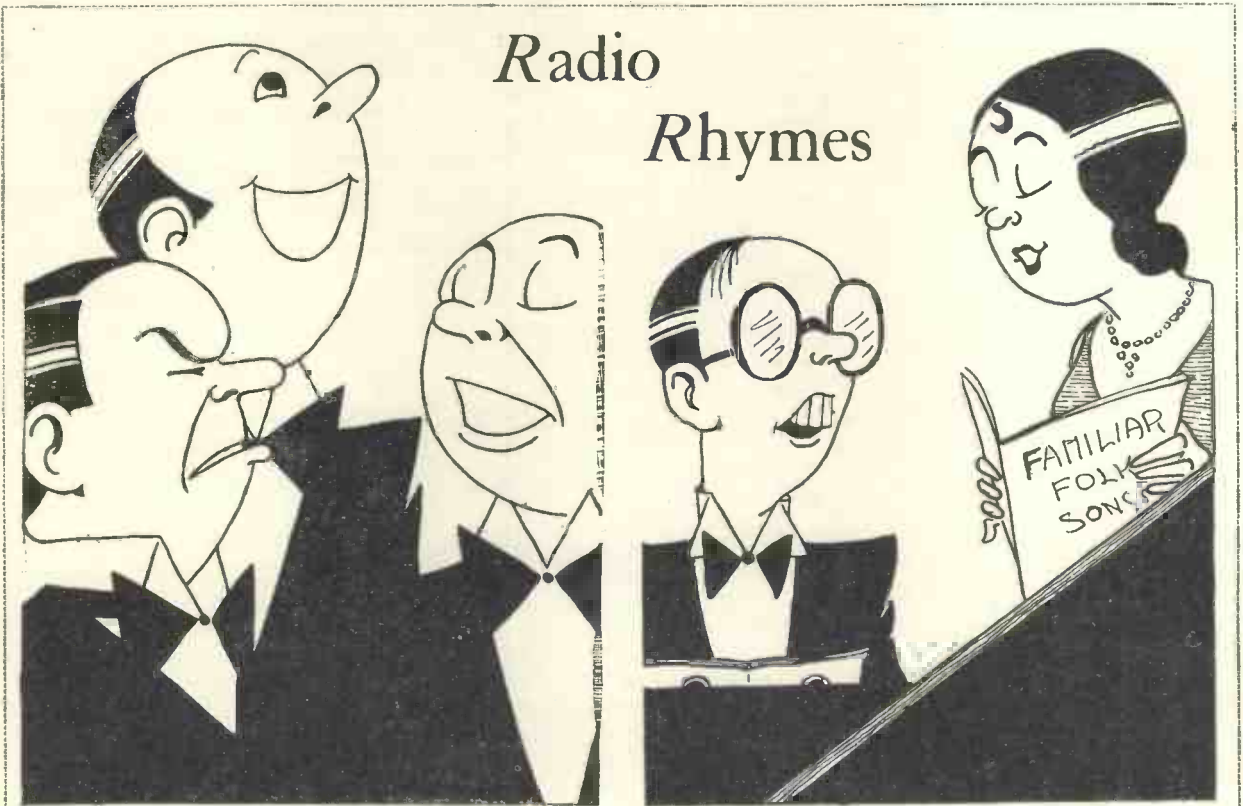

The Trios consist of a tenor, A bass and a bold baritone; So in "Widdicombe Fair," for the sake of the rhyme, Tom Pearce's "grey mare" is a "roan"!

The Duettists sing folk songs, "Hey nonnie nonnie," Or songs about Scotland where braes are so bonnie: One takes the low notes—the other the high. They threaten (only threaten) to "lay" down and die!





## RADIO MEDLEY IN THE FARMYARD

The question to-day is not "Why did the chicken cross the road?" but "Will radio make the hen lay more eggs?" The owner of this farm in Germany evidently means to make sure about it!

## Better Dials Needed

WHEN shall we have a really good slow-motion dial at a reasonable price? It seems to me that too many manufacturers are catering for the cheap market in this respect. There are a number of dials selling at 2s. 6d., but they are not too good mechanically; most of them slip after quite a little use.

I am sure that there would be a good market for something a bit better—to sell at 5s. or so. A nice smooth motion *all round* the scale is wanted.

Another trouble is the difference in the diameters of condenser spindles. There are still some at  $\frac{1}{4}$  in. and others at  $\frac{3}{8}$  in. Consequently when you do get hold of a good dial you find that it will not fit your condenser.

## Is Television Near?

Last month I mentioned that the B.B.C. were to start experimental transmissions of a new system of television. I now learn that the system to be used is one developed by the Marconi Company and I also understand that receivers will be put on the market by the H.M.V.-Marconiphone group.

All the usual sources of official information are silent about this development and at present no details can be obtained as to when and how the transmissions will be

put out. It seems pretty certain that nothing will be done for some months, however.

I was interested to hear from an unofficial, but nevertheless authentic, source the other day that the B.B.C. estimates that about 400 people are equipped to take advantage of the present Baird television programmes.

The number would, no doubt, increase rapidly if cheap and reasonably satisfactory receivers became available—and if the transmissions were put out at a reasonable time of the day when we are at home and not working at our businesses.

## Combination Controls

I was glad to see when details of the Quadradyne were published in "Wireless Magazine" last month that use has been made of two combination controls—a combined radio volume control and on-off switch and a combined gramophone volume control and gramo-radio switch. This is certainly a step in the right direction and one which, as you know, I have consistently advocated in these notes.

One more thing is wanted. The controls should be provided with indicators showing what the knobs do. At present the job is only half done and I hope that the makers will take steps to complete it. Then we shall be able to make sets that are as good from the control point of view as most commercial models.

## Grouses from Scotland

More money ought to be spent on Scottish broadcasting, says Mr. J. B. Mackay, of Edinburgh, in a letter the Editor has passed on to me. "Scottish money is being spent in London instead of in Scotland, to the discouragement of Scottish broadcasters, who fail to get employment, and to the disgust of Scottish listeners," sums up the complaint.

This correspondent also points out that 300 miles of Scotland are north of the northernmost point of the proposed Falkirk station's service area. The people in this area, says Mr. Mackay, need wireless even more than do the town dwellers: they need it for amusement, for news, for education, and for general interest—and they need it for safety, for to them weather reports and gale warnings may be a matter of life and death, both at sea and on the hills.

From all this it does seem that some Scottish listeners are badly off in the way of radio reception. It is a pity, for Scotsmen are particularly keen radio fans. I must ask some of my friends at the B.B.C. for the official explanation of this state of affairs.

## Loud-speaker Cabinets

An interesting loud-speaker problem is raised by Mr. H. F. A. Kinder, of St. Leonards-on-Sea, who asks whether loud-speaker cabinets should be made to resonate. This correspondent's experience is

## RADIO MEDLEY—Continued

that with a largish cabinet resonance is to be sought after.

"One cannot imagine, for instance," he says, "a good church organ cased in ferro-concrete, and all the string instruments depend on

one point; by making a slight alteration to the position of the horn or a sounding board—I forget which—he could produce the effect that the sound was coming from a point about a foot outside the

### More About Text Books

Last month I asked if anybody could tell me of a good radio text book suitable for the advanced amateur. Now comes a letter from Mr. S. R. Money, of Hendon, who tells me that Ferranti's issue such a publication at 5s. It is called "The True Road to Radio."

I do not know whether this publication can be obtained through the ordinary channels, so I am getting into touch with Ferranti's direct.

### Sets for Hikers

In January I mentioned the case of a Glasgow reader who wanted suggestions for a compact and light-weight set to take out on hikes. Now I can pass on some hints from Mr. W. P. Winston, of Kingswood School, Lansdown.

Mr. Winston suggests that a two-valve Hartley circuit is the best—a detector and a transformer-coupled output valve. Headphone reception is, of course, the main requirement, so that even an ordinary low-frequency valve (which, perhaps, could be used without any grid bias) would be suitable.

For the tuner this correspondent suggests a Lewcos plug-in coil and a small roll of wire for the aerial. He himself has used a frame aerial about 18 in. square. An R.I. Parafed transformer might be used in conjunction with an R.C. valve as

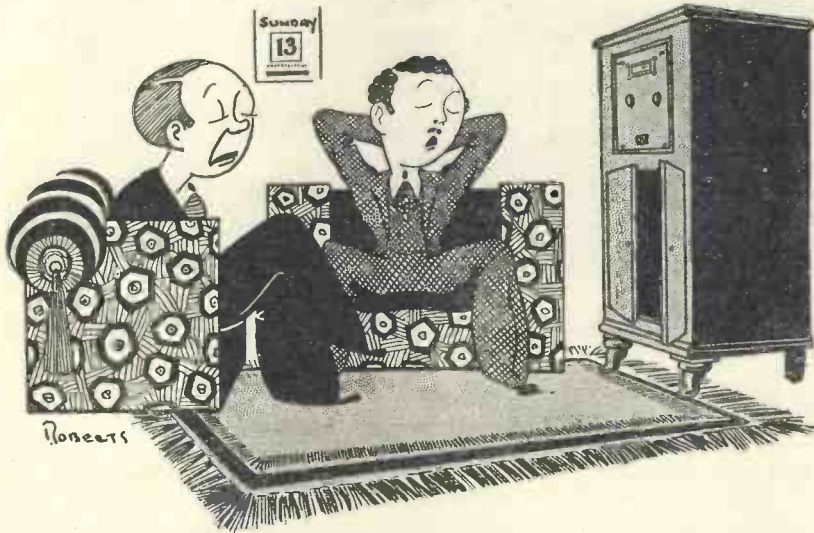

"Programmes are going to the dogs!" (writes "X" of Richmond Park).  
That explains why Sunday concerts very Offenbach!

the wood 'bellies' to bring out the vibrations of the strings and enhance their volume so that they can develop timbre, body, and carrying power."

I know of one person who thoroughly agrees with this view, and that is Capt. H. T. Barnett, who described a resonating loud-speaker cabinet in "Wireless Magazine" some time ago. Experience seems to show that only a large size of cabinet will give resonance that actually improves the tone of a loud-speaker.

As is the case in so many radio problems, the answer to this one is a matter of individual taste. There still seem to be many people who prefer a thin, high-pitched tone to full and mellow reproduction.

### Gramophone Practice

I believe this question of resonance is very little understood, except by one or two gramophone manufacturers. I remember going with Mr. James some time ago to hear one of Mr. H. J. Cullum's Perophone gramophones.

We were both very interested in

opening in the cabinet. This resulted in an astonishing difference in the reproduction, which at once became more brilliant.

I believe that Capt. Barnett's cabinet gives much the same effect with a loud-speaker: instead of the sounds coming from *inside* a box, they seem to be generated right *outside* it.

### Sensible Condensers

I am glad to see at last that one manufacturer is putting out better variable-condenser scales. I refer to the new horizontal and vertical scales made by the Simplicon people. In these models the scale is fixed and the pointer moves across or up and down as the knob is turned.

Samples I have seen leave no doubt in my mind that these fixed-scale condensers are very much easier to read than the old moving-scale type, and I am sure that they will become popular among constructors.

Now that one manufacturer has taken the lead, let us hope that others will follow. It is a step in the right direction.

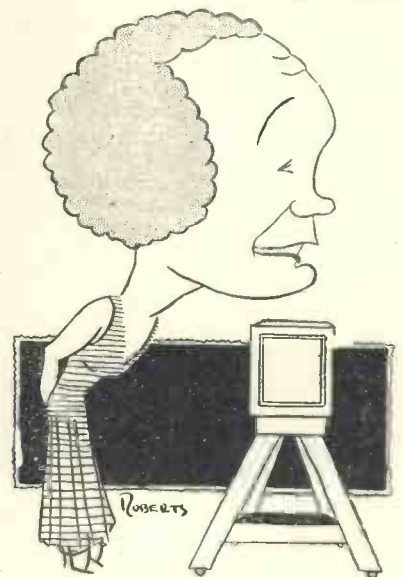

Renee Roberts is a broadcast soubrette you may have heard recently



## CONDUCTED BY BM/PRESS

detector, so that the anode current would be quite small.

A two-valve set on these lines has been made by Mr. Winston and built into a case measuring only 12 in. wide, 12 in. high, and 3 $\frac{3}{4}$  in. thick. There are no projections. This seems to be on the right lines.

### About the Hospitals

I make no apology for taking up this subject again this month. It is far too important to let slide altogether.

I have already explained at some length that many hospital radio



Here is Richard Addinsell, the composer and pianist who often plays throughout the vaudeville programmes

installations are practically useless because there is nobody on the staff to keep them in order and the authorities have no money to spend on the upkeep of such "luxuries."

"Too many installations have been presented gratis without due regard to the upkeep," says Mr. P. Bourne, of Shrewsbury, who seems to have had some experience in this matter, "but since the impractical, charitably minded people who started the various wireless funds can be forgiven their shortsightedness, the responsibility of maintaining such installations would seem to fall upon the equally charitable but practical men of the present."



### HEART BEATS THROUGH THE MICROPHONE

Experiments have been made at a maternity home attached to University College Hospital whereby the doctors can listen to heart beats and still fainter sounds without disturbing the patients. This illustration shows the gear developed for the purpose by the Marconiphone Co., Ltd.

### Repair Squads

Mr. Bourne tells me that Toc H, in a quiet way and without any publicity, is doing what it can in this direction and he supports my suggestion that "repair squads" should be organised all over the country so that any hospital could call on them for maintenance adjustments. It seems to me that a lot of valuable work could be done by squads of about half a dozen skilled amateurs in each district.

The point is whether sufficient volunteers will come forward to make the scheme a success. The time taken up should not be great, for it should not take long to rectify small faults as they occur.

Would you be willing to give an hour or so a month in the service of your local hospital? If so, send me a postcard and I will see if we cannot organise such a series of repair squads all over the country among "Wireless Magazine" readers.

### Information from Hospitals

Perhaps you will also be good enough to bring this suggestion to the notice of your local hospital authorities. It would be necessary to have their co-operation.

Besides the organisation of repair squads it might be possible to form a central stores to which listeners could send such of their unwanted surplus gear as might come in useful for keeping a big installation in order. How far are you prepared to help in this work?

### B.B.C. Questionnaire

I have just been having a look at the B.B.C. questionnaire form, designed to get information as to the changes that are taking place in family life.

You may feel differently about such things, but wild horses would not make me complete the returns asked for.

You are asked where and when you were born; where you went to school; how you got your first job; when you left home; when and how you married; how you first met your wife; and so on, almost *ad infinitum*.

Still, you may be interested.

You can obtain a copy by writing to the B.B.C. Publications Department, Broadcasting House, Portland Place, W.1.

BM/PRESS

London, W.C.1.

# The ABC of Radio

**A** is the Aerial. Its function is quite clear.  
It picks up the signals, some far and some quite near.

**B** is for Bias (you put it on the grid).  
A battery costs a bob or two, and saves you p'raps a quid.

**C** stands for Circuit, with straight and wavy lines.  
It mustn't have a break within its very strict confines.

**D** is for De-coupling; it keeps the H.F. out  
Of batteries and other things and sends it right about.

**E** is for Electron, which parts without a jerk  
From filament, then on to plate, to do its useful work.

**F** might stand for Flat Tuning—not found in modern sets.  
To sharpen it considerably, we now use super-hets.

**G** stands for the Grid Leak. (Most probably 2 megs.)  
Suspect it if your set is trying hard to pull your leg.

**H** stands for the High Tension. It's packed in boxes, dry.  
A voltmeter is its best friend; its little pulse to try.

**I** stands for Interior. Your set's you should keep clean.  
Between condenser vanes, I hope, no specks of dust are seen.

**J** is for the Juice with which you keep your set alive.  
The more you give the anodes, then the better it will thrive.

**K** sometimes stands for Kilo. You've heard of kilowatt?  
Well multiply a thousand times whatever what is what.

**L** is what you mustn't say. (This do I humbly beg.)  
No matter if you've joined your H.T. pos. to H.T. neg.

**M** is the Milliammeter to check your valves' consumption.  
You'll find that certainty is better far than any mere assumption.

**N** stands for Nickel-iron. It often forms the core.  
Of small but good transformers—their inductance then is more.

**O** stands for Oscillation. If people only knew  
What current they are taking when they're oscillating! Phew!

**P** surely stands for Programmes—friend Bach and shrill sopranos.  
And maybe sometimes, as a treat, duets on two pianos.

**Q** stands for "Quiet Background." Not difficult to get . . .  
Unless your soldered joints are "dry." It's noisy then, you bet.

**R**'s obviously Reaction—some say regeneration—  
Which greatly boosts the signal strength of that far foreign station.

**S** maybe stands for S.G. valve—that lovely amplifier.  
If S.G. voltage is O.K. then signal strength is higher.

**T**'s obviously Transformer—two coils, an iron core,  
A primary, a secondary, a case—and nothing more.

**U** stands for Ultra (very) Short—applied to little waves,  
They fade and fade and fade until the operator raves.

**V** stands for Vernier Dial—an aid to easy tuning.  
Instead of fiddling about, the wanted station's soon in.

**W** stands for Wire—it's found in lots of parts.  
If breakages occur in it, that's where the trouble starts.

**X** stands for X's (static)—all right then, atmospheric.  
It causes constant cracklings which drive you in hysterics.

**Y** stands for Your Receiver—you built or bought it, when?  
Don't ever let it reach the age of three score years and ten.

**Z** is that awkward letter that I don't like a bit.  
There isn't a component that I can make it fit.  
Perhaps if you can think of one, you'll let me know, and then  
I'll have another shot at it and try and find you ten.

L.P.





MARCONI CARBON MICROPHONE IN USE IN A TALKIE STUDIO

The Stoll studios at Cricklewood are equipped with Capt. H. J. Round's talking-picture system—the Stoll Visatone sound-on-film method. The new microphone is described in this article

THE whole of the art of sound transformation is now being tidied up, and the little kinks and discrepancies which previously worried us are being removed bit by bit.

The microphone is still the subject of much research and will be for some time to come, but recent developments have given very considerable improvements and have indicated very clearly in what directions further improvement must occur.

#### Carbon Microphones

The oldest of all the high-quality microphones is the granular carbon instrument, but at the time it was invented in its perfect quality form it was of very little use because it was insensitive.

However, as the invention was that of an Englishman, Hunnings, and as it was made at so early a date, I cannot resist giving an illustration of the microphone (Fig. 1) and a

short extract from his patent, taken out in 1878 :

"... Referring to the drawing, *A* is the *vibrating diaphragm* which I make very thin, preferably of platinum foil... it is kept in place by ring *F*. *B* is the fixed disc or diaphragm of brass or suitable material, the intervening space being filled with the loose, finely divided conducting material *C*.

"I find the most advantageous result to proceed from the use of oven-made engine coke, crushed very finely, not ground, so as to pulverise (not to shear or tear) the particles, as I find the best results proceed from this. . . ."

I can guarantee from my own experimental knowledge that this microphone would give what we know as a level curve of response, and although it would be subject to "ground noise" because of the poor quality of the carbon used, it would be satisfactory for reproducing orchestras and other complicated sounds.

With this article we welcome Capt. H. J. Round once again to our pages. For the past two years he has been actively engaged in talkie work so that everything he writes about microphones has real practical experience behind it. These notes indicate how progress has been made and suggest future tendencies in design.

I have recently introduced a microphone (Fig. 2) which, except for minor details, is an exact copy of Hunnings' microphone. Instead of platinum foil I use gold foil on paper and my back electrode is gold plated, but my dimensions, particularly the depth of layer of carbon, remain the same.

#### Anthracite Coke

Of course, the modern hard anthracite coke or carbon now universally used in carbon microphones is employed. This instrument is of exceptionally high

*A Special Article by Capt. H. J. Round, M.I.E.E.*

## MICROPHONES—Continued

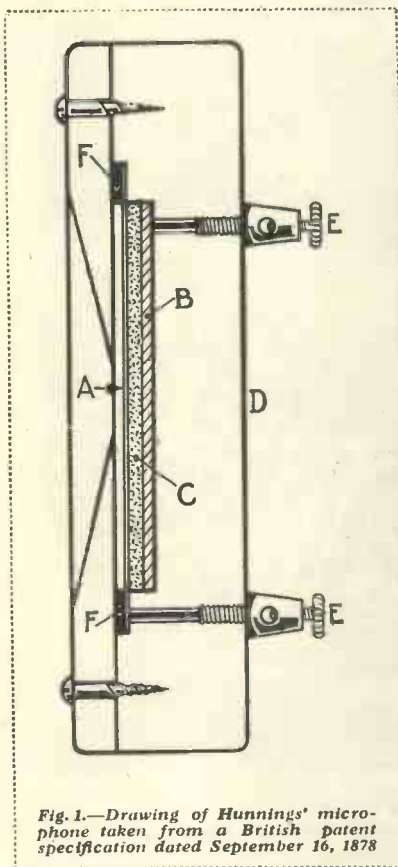

Fig. 1.—Drawing of Hunnings' microphone taken from a British patent specification dated September 16, 1878

quality, exhibiting a level response up to 8,000 cycles.

I am still puzzled to know how Hunnings hit on his carbon depth of  $\frac{1}{16}$  in. because for high quality this depth must not be seriously exceeded, otherwise the higher frequencies are lost.

All carbon microphones exhibit certain defects and the chief of these are as follows:—

- 1.—Variability of sensitivity due to more or less packing of the carbon.
- 2.—Non-linear response above certain strengths of applied sound and a consequent production of harmonics.
- 3.—Ground noise, the cause of which is still unknown.

#### Effect of Light Packing

The sensitivity and ratio of sensitivity ground noise is a maximum with very light packing, but the response tends to be non-linear as soon as the strength of sound reaches a certain value, and unwanted harmonics are produced.

As the packing is increased sensitivity goes down and so does the ratio of sensitivity ground noise, but the microphone now has the ability to stand greater sound strengths without distortion.

An operator who understands these points will use his carbon microphone and always get good results from it, but if he is careless all sorts of distortions may occur.

Thus, if, as in the making of moving pictures, speech has to be picked up from a group of people at,

packed condition is required. Orchestras or crowds, or loud speech near to the microphone, require a medium packing and dance orchestras, crowded round the microphone, as is sometimes done in gramophone recording, require excessive packing.

Although this excessive packing decreases the sensitivity ground noise ratio, it does not matter because the increased strength of sound overpowers the noise.

#### Horrible Ground Noise

Imagine the trouble that may be caused by an operator handling his microphone in an inverse way to this. Suppose he packs his microphone (or it is packed and he does not notice it) and he tries to record speech 10 ft. away! The result will be a horrible roar of ground noise with weak speech in the background.

Again, imagine he has a loosely packed microphone and is trying to record a jazz orchestra located only a few yards from it. The effect will be terrible as every note will blast and the result will be like Toulouse trying to reach Australia.

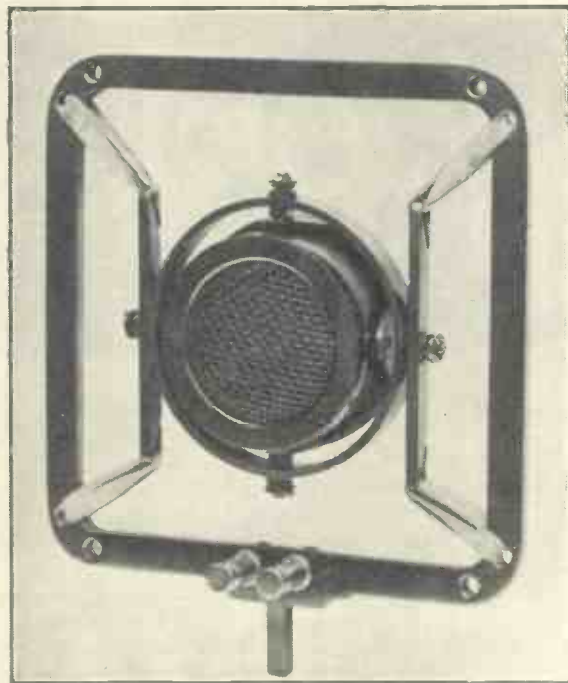

Fig. 2.—The latest form of Marconi carbon microphone developed by Capt. Round. It is fully described in this exclusive "Wireless Magazine" article

say, 10 or 12 ft., or a weak intimate conversation nearer than this, a light packing of the microphone will reduce ground noise, and no distortion will occur.

The adjustment is comparatively easy and rapid. Thus, on my own type, a tap with a metal object on the top of the carbon cell will unpack the microphone, and its degree of unpacking can be at once estimated by the alteration in current flowing through the microphone circuit.

A tap on the bottom of the instrument performs the reverse process of packing the microphone when required.

If sounds are required to be taken of much greater strength than those previously mentioned, a more closely

It is rather a fortunate thing that over a very great range of packing the frequency response characteristic of these carbon microphones remains the same and steady improvement in the quality of the carbon used promises finally to practically remove ground noise; but even in its present state the carbon microphone is so good and so simple to make that it promises to be used for a long time to come.

#### Chief Advantages

Its chief advantages are:—

- 1.—Good frequency-response characteristic.
- 2.—Great sensitivity, thus requiring much less amplification than other high-quality microphones.



# Capt. ROUND DISCUSSES RECENT PROGRESS

3.—Owing to this great sensitivity and its normal terminal resistance there is no necessity to have amplifiers closely combined with it as required for condenser and other types of less sensitive microphones.

## The Condenser Microphone

The condenser microphone is still the standard high-quality instrument, and it is quite free from the great variability and ground noise of the carbon microphone, but in its ordinary form its frequency response is not all that can be desired and its sensitivity is very low.

It has also the serious defect that, owing to the excessively high terminal-resistance condition, a valve has to be attached right close to it, and moisture and heat affect it rather seriously.

Although the condenser microphone itself has no ground noise similar to the carbon microphone, unless its sensitivity is above a certain order the noise usually designated as valve noise enters quite seriously. Valve ponging and valve hiss are well known to all and these steadily increase with the increase of magnification. The more sensitive a microphone is, the less frequently these valve troubles occur.

Some recent forms of the condenser microphone have been pro-

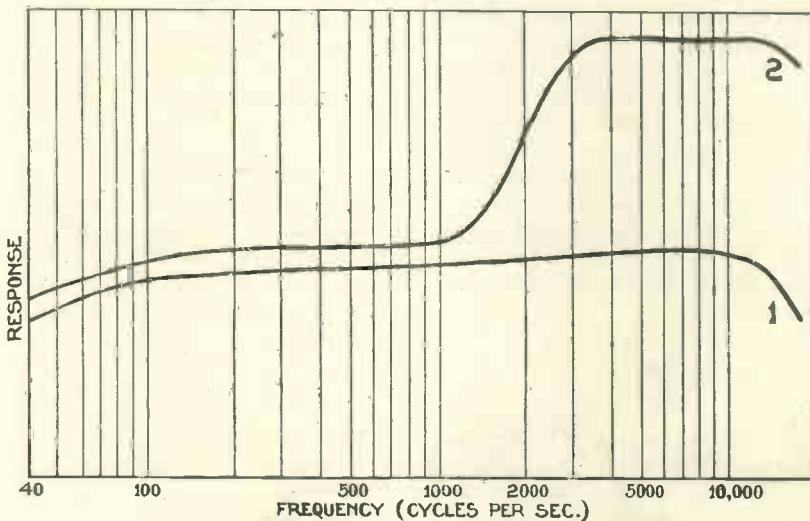

Fig. 4.—Curve 1 shows the static calibration; this becomes as curve 2 through the effects of doubling

duced which are stated to be more sensitive and have a better frequency response than the older ones, but no extensive data has yet been published about these.

## Common Faults in Microphones

While I am on this subject of carbon and condenser microphones, I would like to point out some very serious difficulties in all microphones used at the present day.

The ideal microphone should give an electrical current an exact duplicate of the air wave varying pressure at the point where the microphone is suspended. Unfortunately, microphones are comparatively large and disturb the air pressure quite seriously. It is also found that their reception from different angles differs considerably in tone.

I can explain this best by giving the results in particular cases. Suppose we have a microphone *CD* (Fig. 3) with a diaphragm *AB* fixed in the centre and suppose this microphone has been calibrated and found to give the same current at all frequencies for the same applied pressure where that pressure is not a sound wave—for instance, we calibrate the microphone by applying an electrostatic alternating force to the diaphragm, measuring both the force and the output.

Now suppose sound waves impinge on the microphone perpendicularly to the diaphragm; it is found that on

frequencies below 1,000 cycles the microphone behaves very much as the calibration indicates, but on frequencies above 1,000 the response tends to get nearer and nearer double what it ought to be if the frequency is raised.

This effect is simply explained by stating that an air wave hitting a large flat surface produces double its normal pressure at the surface, due to the wave's complete reflection, but if that surface is small the

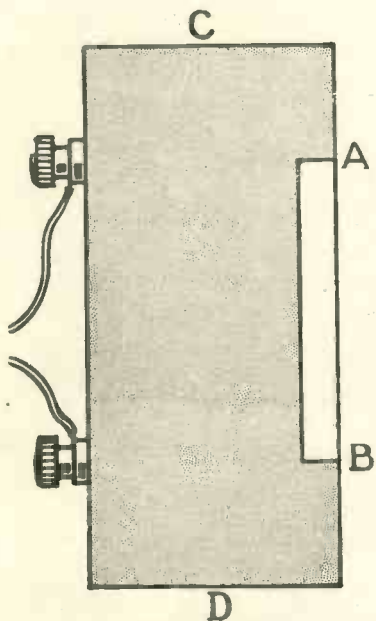

Fig. 3.—Simple form of microphone: *AB* is the diaphragm

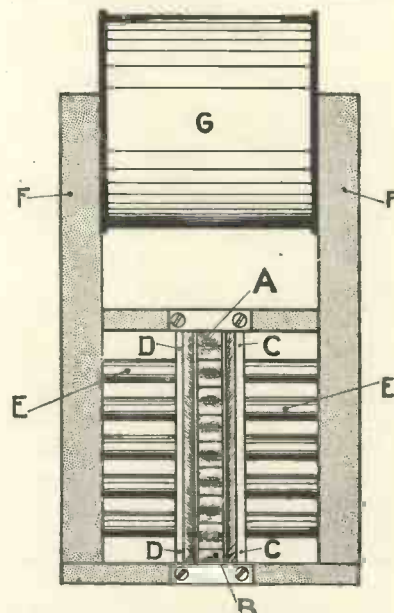

Fig. 5.—R.C.A. magnetophone: *AB*, strip; *CC, DD*, polepieces; *EE*, magnetic connecting bars; *FF*, electromagnet; and *G*, exciting coil

## MICROPHONES—Continued

doubling only takes place when the size of the surface is of the order of half a wavelength or larger.

Thus the microphone illustrated arrives at double its wanted strength at 2,000 cycles. Of course, the change from single pressure to double pressure takes place slowly over the frequency curve, and the two curves (Fig. 4) show how a microphone with a static calibration (1) becomes (2) in its real curve taken with sound waves.

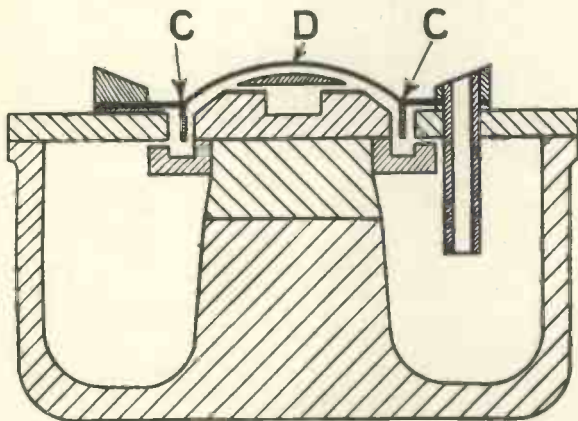

Fig. 6.—Western Electric magnetophone: CC, moving-coil and D, diaphragm

Halving the total size would give the doubling at 4,000 cycles and if the microphone was only 1 in. in diameter it would not disturb the air wave at any frequency that matters.

In addition to this microphone fault, if the sound waves attack the microphone away from the perpendicular to its diaphragm surface, some of the higher frequencies tend to get reduced by the fact that different parts of the wave (possibly opposing parts) act on the diaphragm at the same time, thus reducing the total effect.

#### Future Tendencies

It is probable that the rise of pressure to twice the normal, and the reduction at certain high frequencies when reception takes place at an angle, tend to balance one another and make reception possible over a wider angle than would otherwise be possible, but obviously as a reduction of size would cure both defects simultaneously the correct process in the future is to get smaller microphones.

Both condenser and carbon micro-

phones suffer at present from this defect and as reduction of size in both cases increases the ground noise, it is not very easy to improve these types of microphone in this direction.

#### Magnetophones

Several attempts have been made in the past to construct magnetophones, but until recently they have not compared with the high-quality carbon or the condenser microphone.

The first of these was the Sykes microphone, which was used at the B.B.C. for a long time. This type suffered with an erratic frequency response, particularly at the lower frequencies, and all attempts to overcome this difficulty were without success.

The next one invented was the German strip microphone, which recently, in the hands of the R.C.A., has become quite good.

Sykes depended upon the motion under sound forces of conductive masses of comparatively great weight situated in a magnetic field and an electrical correction of the resulting current to obtain level response. Theoretically quite a simple correction was necessary, but in practice this became very complicated because of resonances and other effects.

The German-American microphones (Fig. 5) consist of a strip of extremely thin aluminium (1/2,000 in. thick) in a magnetic field and partly depend upon the fact that a metal

strip of such a light weight very nearly moves with the air, so that the resulting current represents the air motion.

But we also meet with certain difficulties in this form of instrument. The terminal resistance is such an extremely low one that it is not easy to handle. The presence of the magnetic poles is liable to set up reflections and generally disturb the air path and, of course, these microphones have a peculiar polar diagram all their own, because as the diaphragm is open back and front any air waves hitting them edgewise will produce no effect.

This point is being used to advantage in talking-picture work where a microphone is often wanted *not* to pick up certain sounds, such as camera noises, but as a general property of a microphone I am not sure that it is too desirable.

#### Strip Microphone

All our ordinary microphones, while they do not receive uniformly all the frequencies all the way round, at least make an effort at it. The strip microphone deliberately reverses its phase between back and front and the acoustical result in a room with echo, even when that echo is small, is rather hard to calculate on.

Response curves of these magnetic microphones have to be taken by air-wave action and in consequence their response is not too clearly defined as measurement of response is very difficult by this method.

A more recent form of magnetophone issued by the Bell Telephone Research is that shown in Fig. 6. They publish a response curve (Fig. 7) and also data on the sensitivity, which is apparently superior to the condenser microphone, and

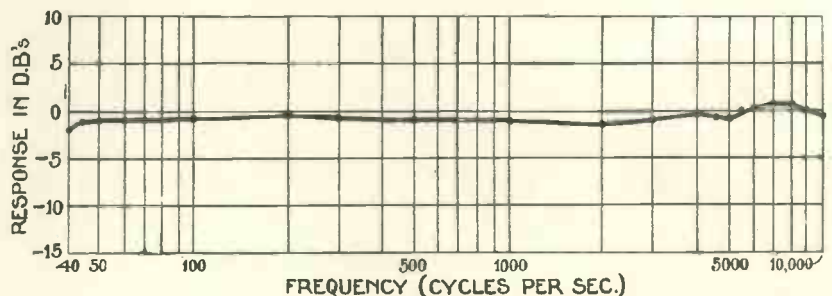

Fig. 7.—Response curve of the magnetophone illustrated in Fig. 6.



## ALL THE NEW TYPES

the measured response curve is better.

### Mechanical Correction

This microphone resembles the Sykes in requiring correction, but the designers have inserted these corrections mechanically in the instrument and not in the electrical circuits, and one is rather doubtful whether the results will be the same from instrument to instrument.

This magnetophone has, of course, similar polar diagrams to the carbon and electrostatic instruments, and is quite different in this respect to the German-American microphones, but as an instrument I would say that it probably has an easier terminal condition to handle, that its sensitivity is better than the electrostatic instrument, and its reliability under conditions of heat and moisture are better than the electrostatic or the carbon, but it is not the solution of

the ideal microphone which will give us, at any instant, the value of an air pressure or air velocity at the particular point being investigated; it is still too big and upsets the air wave too much.

So that notwithstanding the great work already done, there is still room for more before this small but important instrument is written down as perfect.

### Absolute Sensitivity

The absolute sensitivity of those microphones spoken about in this article is approximately as follows:—

*Condenser*—Voltage across first valve, 3 millivolts per bar.

*Western Electric Magnetophone*.—9.5 millivolts per bar.

*R.C.A. Magnetophone*—3.5 millivolts per bar.

*Carbon Microphone*—From 80 to 200 millivolts per bar.

[A bar is the standard of air pressure, being one dyne per sq. cm.]

## Mikes at the B.B.C.

UNTIL quite recently the B.B.C., in its London and provincial studios, has made almost exclusive use of the Reiss type of microphone, which works on the carbon-granule principle. Although this type of microphone has a fairly delicate mechanism, it is probably the most robust of any, and on this account it will continue to be used for outside broadcasting, under conditions that would probably damage certain other types of microphone, such as the condenser microphone.

### Background "Hiss"

In fact, the only objection that can be raised against the Reiss, so far as the B.B.C. is concerned, is a certain background "hissing" which listeners can easily notice when the carrier wave is not being modulated.

The condenser type of microphone, when working properly, is absolutely silent in operation, and for this reason it is coming into favour for talks broadcasts, in which any sort of background noise is apt to cause distraction.

For large orchestral broadcasts, also, the condenser microphone is being more and more utilised, as it is found to provide a better definition than the normal carbon type.

At present the use of the condenser microphone is somewhat restricted because, although it works so well when in good order, it easily goes wrong. Another disadvantage of the condenser microphone is that owing to its lack of sensitivity it requires a special resistance-capacity-coupled amplifier fitted immediately behind it.

The maintenance of a condenser microphone of the present type is much more trouble than the carbon type, which will give long service without much attention.

The B.B.C. research engineers are at the moment experimenting with condensers in an endeavour to produce a more robust type free from the snags of existing models. Even now this type of microphone is gaining ground in the studios, especially for the talks.

### Fifty Microphones

It is understood that at Broadcasting House no less than fifty microphones will be installed in the various studios, and about half this number will be condenser microphones. During the course of a day's broadcasting about twenty microphones will probably be involved.

It is seldom that more than one

## ONE OF THE NO-VICES BRIGADE

(After Tennyson)

*Half a turn, half a turn,  
Half a turn. Splendid!  
Now all my weary toil  
Soon will be ended.*

*I am of that Brigade  
By whom new Sets are  
made.*

*Now we start Listening—  
That's fixed it, splen-  
did!*

*Howls to the right of us,  
Morse to the left of us,  
Squeakings encompass us,  
Lightning and thunder!  
I built this set quite well,  
Nor did I stint the Shell-  
Ac. Did I—one can't tell—  
Make some small blun-  
der?*

*Can't hear much I'm  
afraid.  
Why did those Signals  
fade?  
Heavyside Layer made  
Those Waves reflected.  
Some Wire is lost or  
strayed,  
Programmes won't be re-  
layed;  
I'll seek an expert's aid,  
We're disconnected!*

LESLIE M. OYLER

microphone is used at a time in any given studio. Usually only one microphone is needed, even for the broadcasting of a large orchestra. The players are scientifically placed with respect to the microphone so that it picks up a balanced composite sound from the whole orchestra.

In the large studios at Broadcasting House it is likely that condenser microphones will be installed, and when the B.B.C. engineers have improved existing types of microphones it is likely that talks studios will be similarly fitted.

A. S. H.

# How a Play is Broadcast

This article by FRANK ROGERS will be read with interest by all listeners, for it discloses exactly what the control engineer has to do when a play is broadcast—in this case, "Baghdad on the Subway." As this article explains, the control work is particularly interesting

THIS play belonged to the multiple-studio type, that is to say the performers were scattered about Savoy Hill in different studios, and the impulses of the various microphones were brought to a fade panel, where they were combined and passed on to the control room.

The work of the operator of this panel is particularly interesting, and I think readers will be glad of the opportunity to examine the specimen of his cue-sheet reproduced on the opposite page.

## Production

The typescript is the work of the productions department, while the pencillings are the additional notes made by the operator, "Control," as he is called, during rehearsals. The amount of action covered by this sheet is very small, in spite of its lengthy appearance. Let me catalogue the "parts."

There is, first of all, the opening announcement in studio 8, followed by the elevated-railway noise in *E*, and the strumming banjo in 4. Then comes the Caliph's lines spoken in 8 again, dance music in 4 and cock-crow in *G*. Lastly, we have a preliminary alarm-clock noise in 8 and the Late Riser's lines, a little more elevated railway in *E*, and milk bottles and door-knock in 8. From beginning to end not more than five minutes elapse, probably less.

Now let us see what "Control" has to do. The panel, as shown in the sketch, is surmounted with a number of knobs, the middle one being larger than

the rest. It is always called the centre knob, or *C*, and controls the others by pointing towards them. Thus, when *C* is to the left all those to the right are dead even if they are open themselves.

As there are only four studios mentioned on the sheet reproduced opposite I have just put this number in the diagram, although in actual fact there are several more. It will be seen that each bears the number or letter of the studio it controls.

Before we pass on to manipulation of these knobs one or two technical terms need explanation. A "flick," for instance, refers to a push-switch which operates a warning light in the studios to give the next person his cue.

Strictly speaking, there is no necessity for this as each studio is in charge of a responsible official who, like "Control," follows the whole play through headphones and can, therefore, tell quite easily when his cue arrives. But multiple-studio production is an extremely complicated business and the B.B.C. feels it cannot afford to neglect a single safeguard, even if it means doubling the precautions.

"Flash" means that a sample is being taken of the noise available in a certain studio. The elevated railway is a good example of this. The noise is kept running for several minutes and the microphone is brought to life for a second or so

whenever a little is needed for the background of the play.

This can be accomplished by steadily opening the proper knob, *E* in this case, to the full, and steadily shutting it again. Nine times out of ten, however, the centre knob is used to perform either the first half of this operation or the second, as the reader will see for himself in a moment.

The term "fade" means, of course, that a fresh microphone has to be brought in gradually and a "cross-fade" means that another has to be taken out simultaneously.

## "On the Spot"

"Spot" refers to a noise being created in a studio "on the spot," instead of in the special noise room. The only reason for the term being mentioned here is the necessity for "Control" giving the cue-flick to the right studio.

Now, if the reader wants to have a little personal experience of the art of multiple studio control, I suggest he provides himself with pieces of paper marked to represent the five knobs. The play opens with an announcement from 8, so this studio has to be flicked, and 8 opened with one hand as *C* is turned left with the other. Meanwhile, the noise of elevated railway trains is being created in *E* ready for use when required.

Immediately the announcement is concluded this must be flashed, so one hand turns *C* to the right while the other opens *E*. The next operation is to bring in the strumming banjo in 4, and this calls for some dexterity. As soon as the peak of *E*'s flash is reached the left hand leaves *C*, flicks 4 and shuts 8 or it will come in when *C* is turned left in a moment. This hand then begins to open 4. The right hand simultaneously leaves *E* and starts to turn *C* left.

The result of the action is that 4 is quickly reaching the peak of its flash and that

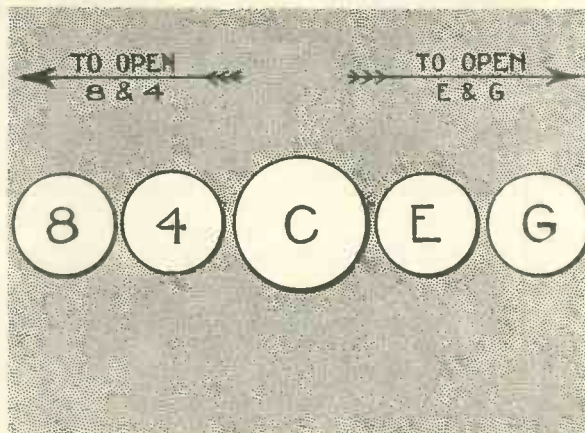

CONTROL ENGINEER'S PANEL

This diagram shows the controls the broadcast engineer has to operate to "fade in" different effects. The uses of the various knobs are explained in the article



E is still open, its flash having been completed by turning C in the opposite direction. When 4's peak is reached the Caliph must be flicked in 8. 4 is then steadily shut to complete the flash, and 8 opened.

Towards the end of Caliph's lines 4 has to be flicked for dance music. Then 8 is shut and 4 opened. The next studio required is E, from which it has been decided at the last moment to take a little more elevated railway.

Now E is already open and can be made live simply by turning C to the right. The next operation is just to turn C in this direction, leaving 4 open but dead. G is flicked for the cock-crow as the peak of E's flash is reached.

The flash is completed by shutting E, whereupon G is opened. 4 is then shut because C is to be turned left and this studio is not wanted. 8 is flicked for alarm clock, C shut and both hands combine to open 8 and turn C to the left.

As Late Riser also speaks in 8 he must be flicked and while he is speaking "Control" has a few seconds respite. He uses his time checking up the position of the knobs, and has made a marginal note in a blue frame for this purpose. He notes that G is shut, because he is shortly going to turn C and does not want it to come in as C is left and he must open E to the full.

Almost before he is really ready Late Riser is finishing and E has to be flicked for elevated railway noise. C is then turned right and left again for the flash from E. When the

"BAGHDAD ON THE SUBWAY"

**CONTROL:** Buzzing in and opening Announcement in 8.

*Flash E*  
4x  
*Flash 4 (spot)*  
Flick 4 end cross-fade.  
(A thrumming banjo is heard) (4)  
(Fade down)

**CONTROL:** Flick 8 for Caliph.

*8x* CALIPH: There was a certain Caliph of Baghdad who used to go down amongst the poor of his city for the solace that he obtained in hearing their tales and histories, and realising that there were others even less happy than himself. What the poor of the city thought of it is not recorded. We modern Caliphs mingle incognito with the lowly ones of "Baghdad on the Subway", and hear the Symphony of New York which roars out its melody day and night.

*4x*  
*Flash 4 (music)*  
**CONTROL:** Flick 4 for dance music.  
(Fade to Jazz) (No.7.)

*8x* *Flash E (clock)*  
*Flash G (cock-crow)*  
Flick 2.  
(Fade to cock-crow) (2G)

*8x* *Flash 8 (alarm clock)*  
Flick 8 for clock.  
(Fade to alarm clock) (8)

*8x* (clock) Flick 8 for speech.

*8x* LATE RISER: Oh, heck! Another day!  
(Alarm again) (in 8)

For crying out loud! If someone don't fling that alarrum in the ash-can there'll be murder round here! X

**CONTROL:** Flick 2E.  
(Fade in roar of Elevated) (2E)  
(Fade)

*Flash E (on bottles)*  
Flick 8 for bottles.  
(Rattle of milk bottles) (8)

*8x* (bottles)  
Flick 8 for knock. Dialogue follows.  
(Knock on door) (8)

*8x* (knock dialogue)

**INSTRUCTIONS FROM THE B.B.C. PRODUCTIONS DEPARTMENT TO THE CONTROL ENGINEER**  
This is the photograph of the typescript actually used by the control engineer for broadcasting the radio play, "Baghdad on the Subway"

flash is at its peak 8 must be flicked studio—and so on for twenty pages. How many readers could do this without a single mistake? I know I couldn't!

# We Test Before You Buy

## FREE ADVICE TO PROSPECTIVE SET BUYERS

To take advantage of this service it is necessary only to mention (1) the maximum price and whether this is for a complete installation or the bare set; (2) where the set will be used; (3) what particular stations are desired; (4) whether a self-contained set with or without aerial, or an ordinary set with external accessories, is preferred; and (5), in the case of mains-driven sets, whether the mains are A.C. or D.C.

A stamped-addressed envelope for reply is the only expense. Address your inquiry to Set Selection Bureau, WIRELESS MAGAZINE, 58-61 Fetter Lane, E.C.4. There is no need to send any coupon, but it is essential to give the information detailed above on one side of the paper only. Tell your friends about this useful service.

**T**HIS month we give brief résumés of nineteen reports published since September. All the sets referred to are still on the market and *all can be thoroughly recommended from actual test experiences.* For convenience they are arranged in order of price:—

**£3, Ealex Short-wave Converter.**—Wavelength range of 16 to 60 metres. Suitable for use with any set that has one or more stages of low-frequency amplification. Run from batteries.

**£4 4s., The Super Two.**—Self-contained table-cabinet set. Detector followed by a transformer-coupled power valve. Cabinet is of dark oak with ornamental loud-speaker fret.

**£4 17s. 6d., Eddystone Short-wave Converter.**—Unit for converting any set with a screen-grid high-frequency stage into a short-wave super-het. Price includes all accessories. Handsome oak cabinet.

**£5, Columbia Model 351 Two-valver.**—Self-contained battery set with valves, batteries and loud-speaker. Cabinet is of oak. Probably the best value for money as far as cheap sets are concerned.

**£6 15s., Regentone A.C. Two-valver.**—Neat and compact two-valve A.C. set for use with an

external loud-speaker. A Westinghouse metal rectifier is incorporated to supply the valves with anode current.

**£11 10s., Marconiphone Model 246 Two.**—A.C. table set for use with an external loud-speaker. Cabinet is of oak. Arranged for use of pick-up.

**£15 15s., Ekco Three-valve Console.**—Mains set (models are available for A.C. and D.C. supplies) with a built-in loud-speaker. Screen-grid stage followed by a detector and a pentode.

**£15 15s., Ferranti Three-valve Console.**—Three-valve A.C. set with built-in inductor loud-speaker. The cabinet is of metal covered with Rexine.

**£15 15s., Lotus Three-valve A.C. Set.**—Completely self-contained console with built-in moving-coil loud-speaker for use on A.C. mains. Screen-grid, detector and super-power output. Very handsome in appearance.



IN AUSTRALIA

Here you see a Portadyne portable set in use on board a ship in Sydney harbour. It was found to give excellent results.

**£18 18s., Gecophone Compact Table Three.**—Console with built-in inductor loud-speaker for use on A.C. mains. Screen-grid high-frequency stage followed by a detector and pentode. Excellent value for money.

**£18 18s., Kolster Brandes Model KB279.**—Three-valve A.C. set with built-in moving-coil loud-speaker. Screen-grid stage, followed by a detector and pentode. The cabinet has a walnut finish.

**£21, Gecophone Table Four.**—Two screen-grid high-frequency stages, detector, and pentode. Operates from A.C. mains and is for use with an external loud-speaker. Cabinet finished in figured walnut.

**£23 2s., H.M.V. Model 435 Three-valver.**—A.C. table console with screen-grid, power-grid detector, and pentode valves. Incorporates a moving-coil loud-speaker. A.C. current is rectified by means of a valve.

**£27 10s., Gecophone Six-valve Super-het.**—Battery super-het covering wavelengths from 13 to 100 metres and from 198 to 720 metres. Enclosed in a metal case.

**£30 19s., H.M.V. Table Radio Gramophone.**—Three-valve A.C. set with built-in loud-speaker and electrically-driven turntable. Cabinet of walnut and loud-speaker of the moving-coil type. One of the only instruments of its kind.

**£30 19s., Varley Square-peak Four.**—Handsome table cabinet set with two screen-grid high-frequency stages. For use with an external loud-speaker.

**£39, Philips D.C. Radioplayer.**—Five-valve set for use on D.C. supplies. Cabinet of the console type, incorporating a moving-coil loud-speaker. Two stages of screen-grid amplification and an output pentode.

**£50 8s., H.M.V. Radio Gramophone Model 521.**—D.C. mains set with four valves. Electrically-driven turntable and moving-coil loud-speaker. Cabinet of handsome walnut finish. Two screen-grid high-frequency stages incorporated.

**£50 8s., McMichael Radio Gramophone.**—Incorporates the McMichael All-mains Three in a walnut cabinet, with Marconiphone pick-up and Garrard induction motor. Models for A.C. and D.C.



## Blue Spot A.C. Four-valver

**T**ABLE-CABINET sets without self-contained loud-speakers are now the exception rather than the rule. This fact has been brought home to us on many occasions during the past few months, when we have searched our records to find sets conforming to readers' requirements.

### Existing Loud-speakers

Many of our set-buying readers still ask for table-cabinet sets for use with existing loud-speakers. Naturally, such readers do not want to go to the expense of a console when they have a perfectly good loud-speaker on hand.

#### THE SET IN BRIEF

**MAKERS:** British Blue Spot Co., Ltd.  
**PRICE:** 18 guineas.

**VALVE COMBINATION:** High-frequency amplifier (Osram MS4), detector (Cosor 41MRC), resistance-capacity-coupled low-frequency amplifier (Osram MS4), output power valve (Osram P425).

**POWER SUPPLY:** A.C. mains, from 100 to 250 volts.

**POWER CONSUMPTION:** 35 watts.

**TYPE:** Table cabinet set—not a console—needing an external loud-speaker and aerial and earth to complete the installation.

**FINISH:** Neat oak cabinet with metal escutcheon control panel.

**REMARKS:** An excellent mains set for those already possessing a good loud-speaker; will get many stations on the mains aerial.

We are glad to be able to add the Blue Spot table four-valver to the very small group of non-consoles. This set can also be obtained with a self-contained Blue Spot loud-speaker, but here we are concerned with the simple and cheaper table model shown by the photographs.

There are many points of interest in this set, both in circuit and layout. The circuit comprises four valves and a mains rectifying valve, for this is an all-electric set for A.C. mains supplies.

The four receiving valves are arranged in an unusual sequence, but tests show that the sequence is more than justified. The first valve is a screen-grid amplifying stage and then comes

the detector, which works on the anode-bend system.

After this comes a resistance-capacity-coupled stage, and this third valve is a screen-grid type like the high-frequency amplifying valve.

Lastly comes the power valve, a 4-volt super-power type with a directly heated filament. This is also a resistance-coupled stage.

There are only two tuning circuits and these are operated by two solid-dielectric variable condensers ganged on the main tuning spindle, with a separate trimmer mounted above the knob. These tuning circuits are totally enclosed in the metal chassis, which is by far the neatest we have yet examined.

Only the valves are exposed on the chassis, and at the extreme left-hand end is a simple and easily adjusted input tapping for the mains transformer.

The makers have embodied several novel points in the control of this set. All the controls, without exception, are carried on a metal escutcheon plate fitted at the bottom centre of the cabinet. The tuning scale is let into the centre of this plate, so that the scale is almost

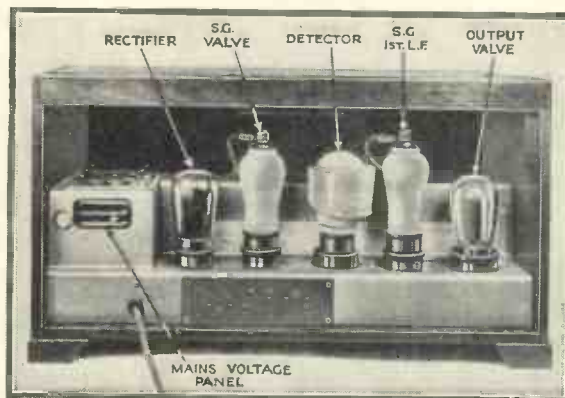

A SET WITH GANGED TUNING

A two-gang solid-dielectric condenser is used for tuning the Blue Spot four-valver

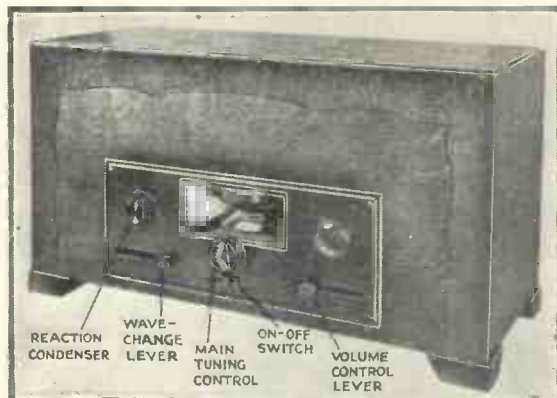

FOR USE WITH EXTERNAL LOUD-SPEAKER

Excellent results were obtained with this Blue Spot four-valver, operated from A.C. mains

horizontal—and very easy to read. This set is unique in having wavelengths marked continuously from 200 to 2,200 metres.

The scale is rotated by a large knob and final tuning is done by means of the neat little trimmer device super-imposed on the main tuning control.

### Levers in Place of Knobs

There is no need to detail all the other controls, but we should like to draw attention to the use of levers instead of knobs for some of the subsidiary controls.

We must say we were specially pleased with the selectivity of this set when it was connected to the standard aerial. The London National was cut out within five degrees and London Regional was sufficiently restricted on the dial to enable us to get Toulouse clear of all interference.

Using the mains aerial connection provided on the back of the chassis we were able to log a dozen stations at full loud speaker strength. There is ample power in hand.

Quality has a rare incisiveness, due, no doubt, to the use of resistance-capacity coupling.

In operating the controls we were pleased with the flexibility of the aerial coupling, with its ability to cut down volume and increase selectivity when separating high-power stations.

## K.B. Kitten Two-valver



**NEAT AND GOOD VALUE FOR THE MONEY**  
A companion set to the Pup, this K.B. Kitten is a battery-operated two-valver that can be recommended

**T**HIS is a little marvel among cheap self-contained sets. We have been more than satisfied with the results obtained on test. There is, we know from readers' letters, quite a definite market for a two-valve battery set with everything inside the cabinet except the aerial and earth.

### Aerial Requirements

The K.B. Kitten has been produced to satisfy this market, and we think it does so admirably. You need an efficient aerial to get the best out of this set, but within twenty miles of a regional centre, such as Brookman's Park or Moor-side Edge, it is easy to reproduce the alternative programmes with quite a modest indoor aerial.

We made our tests on the standard 60-ft. aerial, with a good earth, and in addition to the two London stations we logged, directly on the loud-speaker, no less than eight foreign stations.

### Log Details

Let us give the details of our log; using the aerial terminal marked "A2" we sensed a certain liveliness as soon as the battery switch was moved to the "on" position. In came London National, a full loud-speaker signal, at 52 degrees. At

98 degrees London Regional was equally strong, and quite clear of all trace of the National.

An inexpensive two-valver that does the above reception has really fulfilled its function, but the Kitten does more! In our tests we got Midland Regional at 120 degrees, also clear of in-

wavelengths to be tuned in. We were frankly surprised to get North Regional at fair loud-speaker strength, the dial reading being 142 degrees. On each side of this station we found foreigners, and Langenberg was quite strong.

The undeniable sensitivity of the set was further shown by the strength of Daventry on the long-wave setting, this station being logged at 98 degrees on "A2" and 73 degrees on "A1."

To achieve these excellent results the makers have made sure of smooth reaction. We found this particularly good with the detector anode voltage around 60 volts. No doubt the valves have something to do with the unusually good reception of the foreign stations, as the detector is a Marconi HL210 and the power valve is the new Mullard PM2A.

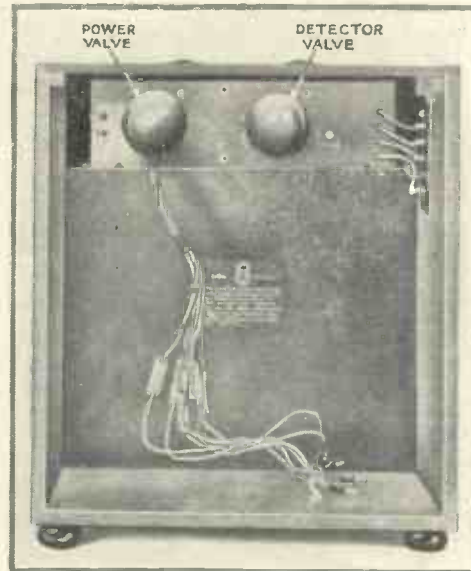

**COMPACTLY ASSEMBLED**  
This back view shows the construction of the K.B. Kitten receiver, which is remarkably good value for money

interference and at enjoyable strength.

Using aerial terminal "A1" we found the dial settings came lower down for the London stations, and this enabled some of the higher

of running is not the least of the good points of the Kitten. On test the anode current of the two valves was found to be only 4.5 milliamperes.

The makers recommend a combined high-tension and grid-bias battery unit and there is ample room for this inside the back of the cabinet, which will also house the 2-volt accumulator.

### Clear Reproduction

We always adopt a tolerant attitude when speaking of the quality of the reproduction from small battery sets, knowing full well the limitations involved. Naturally, this Kitten set has limitations in volume output and frequency response, but we can say without any reservation that the speech is clear and the music very pleasing.

#### POINTS ABOUT THIS SET

**MAKERS:** Kolster Brandes, Ltd.  
**PRICE:** £3 15s. (without batteries).  
**VALVE COMBINATION:** Detector (Marconi HL210) transformer coupled to power-output valve (Mullard PM2A).  
**POWER SUPPLY:** Self-contained batteries. (Mains units can be used).  
**POWER CONSUMPTION:** Total anode current, 4.5 milliamperes.  
**TYPE:** Table cabinet set, needing only aerial and earth to complete the installation.  
**FINISH:** Pleasing walnut finish to the five-ply cabinet.  
**REMARKS:** This is essentially a cheap local-station set, suitable for use within 100 miles of a regional centre and capable, under average conditions, of tuning in several of the more powerful foreign stations at fair loud-speaker strength. Very easy to operate.



# McMichael Colonial Short-wave Set

## BRIEF SPECIFICATION

**MAKER:** L. McMichael, Ltd.  
**PRICE:** £15.  
**VALVE COMBINATION:** Oscillator-detector (Osram HL210), intermediate frequency amplifier (Mazda 215SG), detector (Mazda 215SG), and power output (Mazda Pen220).  
**POWER SUPPLY:** Externally-connected batteries.  
**POWER CONSUMPTION:** 13 milliamperes anode-current consumption.  
**TYPE:** Special short-wave set, with tuning for normal broadcast wavelengths.  
**FINISH:** Wax-polished teak case, specially made for transport under bad conditions.  
**REMARKS:** A well-designed short-wave set, with the most ingenious coil system yet examined. Ideal for overseas listeners.

**T**his is one of the most interesting sets we have tried for a long time. Specially designed for long-distance reception of short-wave signals, the McMichael set under review appeals to us as being ideal for overseas listeners anxious to keep in touch with England through the B.B.C.'s short-wave transmissions.

### Easy Transport

A preliminary examination of the set shows that everything has been done to facilitate easy transport; the case measures 14½ in. long, 9 in. high and 9 in. deep overall. This case is very solidly constructed, being made of ½-in. teak, with all joints rebated and securely pinned.

Holes at each end and a long slit at the back permit easy connection of the external loud-

speaker and batteries, as well as the aerial and earth.

The whole set slides easily out of the case by undoing four bolts. Most of the wiring is done beneath the chassis, leaving a very clean layout above, with the four valves in accessible positions.

The valve combination is ideal for consistent short-wave working, comprising a super-het arrangement of advanced design.

First, we have the combined oscillator and detector valve, followed by a stage of screen-grid intermediate amplification. This is followed by the second detector, which is also a screen-grid valve, and finally there is a transformer-coupled pentode output valve.

This batch of valves has been carefully chosen to give maximum efficiency with moderate running cost; we found the total anode current was 13 milliamperes, which is not excessive in view of the type of set. A double-capacity anode battery would give economical running.

From the operating point of view the most interesting departure is the use of a plug-in coil box.

The McMichael coil box fits snugly into a square receptacle on the left-hand end of the front of the set. There are four possible ways of inserting the coil box, but whichever way it is inserted it makes contact with the tuning circuit of the oscillator valve; the four alternative positions of the box provide a complete range of short and medium wavelengths.

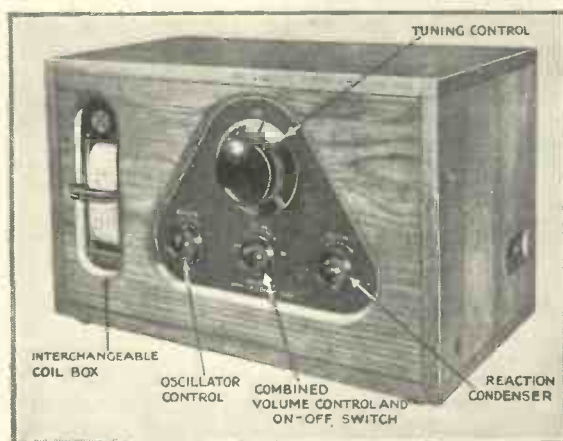

### EVERY CONTROL INDICATED

Every control knob of this set is clearly marked to ensure easy operation. Note the calibrated interchangeable coil box on the left of the receiver

The lowest range of the coil box is from 14 to 30 metres; the next goes from 25 to 55 metres; the next from 50 to 95 metres, and lastly there is a range from 250 to 500 metres.

We were particularly pleased to find that the calibrations correlating wavelengths with condenser dial settings are clearly marked on each of the four sides of the coil box.

### World's Short-wavers

The present time is not very good for short-wave reception, but thanks to the very clear calibrations, we have been able to get America many times at full loud-speaker strength, as well as a host of other short-wavers all over the world.

The reception on the broadcast band is adequate, the locals coming in at great strength, although naturally the phenomenal range of the short waves could not be expected.



### WELL-FINISHED INSTRUMENT

The McMichael Colonial Short-waver has been strongly built to withstand rough transport conditions abroad. Every individual component is easily accessible

## R.I. Madrigal Band-pass Three

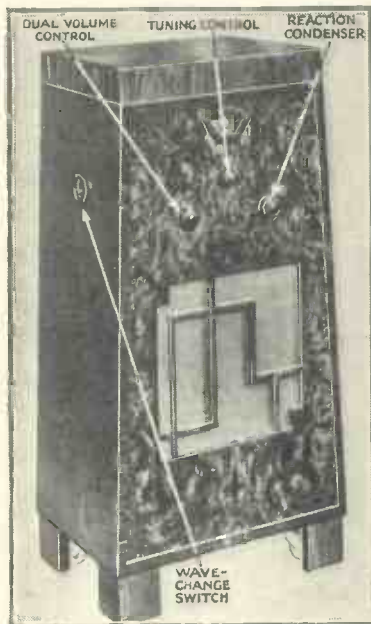

### REALLY HANDSOME

The cabinet work of the R.I. Madrigal is of the best workmanship possible. It certainly looks good, as this photograph shows

HERE is a set designed essentially for music lovers, as opposed to those who think of radio only in terms of the number of foreign stations that can be logged. The R.I. Madrigal set is a quality set, but that does not mean it is deficient in station-getting properties.

### A Weekend Test

Indeed, during a test extending over a weekend, we were able at one time or another to bring in most of the worth-while foreign stations at good loud-speaker strength on both medium and long waves.

Before going into details, let us emphasise the good appearance of the cabinet work. The figuring and cross-band decoration is really beautiful, and the cabinet stands out as an example of what can be done by a maker of taste.

The dimensions of the cabinet will interest some readers; it is 38 in. high, 19 in. wide, and 13 in. deep, the last two dimensions being at the base.

In this cabinet are housed all the essentials of enjoyable reception—a band-pass three-valver, a separate power supply for A.C. mains, and a moving-coil loud-speaker which, due to the excellent baffle effect of the ample-sized cabinet, gives remarkably good results.

Removal of the back, by lifting a projecting knob, shows the accessibility of the mains-voltage adjustment. The set is suitable for all supplies between 100 and 250 volts, of periodicities between 40 and 100 cycles, with a special model for lower frequencies.

Now for a few remarks on the set; all three valves are of the indirectly-heated type and there is a Mullard DW3 valve rectifier for the mains.

The aerial circuit comprises an efficient band-pass with two tuned circuits ganged up with the intervalve tuning.

The sensitivity of the valves and the selectivity of the band-pass combine to produce a compromise that meets present reception needs more than adequately.

The inherent selectivity of the set enables the makers to recommend a full 100-ft. aerial if this is desired, but there is provision for using an internal aerial. The smoothing is so good that, while an earth is desirable, it is not actually essential with this set, there being no hum even when the patent internal aerial is used and the earth lead is left off.

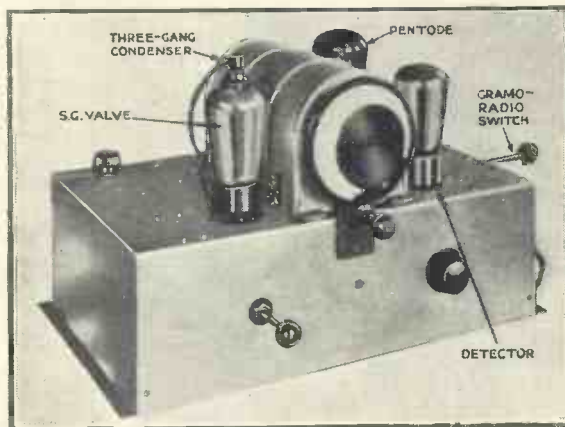

### NEAT ARRANGEMENT

A metal chassis is utilised in the design of this set. Complete screening is thus obtained, and this gives great stability.

We found the operation of the Madrigal a sheer delight, stations coming in with a rare beauty of tone and without any trace of that mushy background so often experienced in these congested days.

The tuning scale is well and

### THE SET IN BRIEF

MAKERS: Radio Instruments, Ltd.

PRICE: £35.

VALVE COMBINATION: Screen-grid high-frequency amplifier (Mullard S4VA), detector (Mullard 904V) output valve (Mullard PM24B), and mains rectifier (Mullard DW3).

POWER SUPPLY: A.C. mains, all voltages and periodicities.

POWER CONSUMPTION: 50 watts. TYPE: Pedestal console, with patent aerial attachment.

FINISH: Beautiful figured walnut cabinet.

REMARKS: One of the best quality sets of the year, specially recommended for really good reproduction.

carefully calibrated in medium and long waves, from 240 to 554 in steps of 20 metres, and from 1,000 to 2,000 metres in steps of 100 metres.

### Dual Volume Control

The dual volume control on the left works well, on radio and for gramophone reproduction when an external pick-up is added. The reaction on the right is very smooth and if used in conjunction with the volume control has a great effect on selectivity, as explained by the makers.

The switch controls on each side of the cabinet are exceptionally smooth in action, giving medium or long waves and radio or gramophone with the minimum of effort.

With the volume control at its midway position most of the stations were logged at full strength, and in this position of the volume the selectivity is really good.

Altogether, a set we should be proud to have in the home; as hand some a set as we could wish to behold—and a good worker.



# Columbia Radio Gramophone

WE think this is one of the best "value-for-money" radio gramophones on the market, for it embodies all the latest technique, including automatic record changing, at a phenomenally low price. Last month, in the Gramo-radio Section, we described the record changer, which is one of the best yet designed, being as near foolproof as human ingenuity can make it.

### Points of Interest

In brief, the record changer has the following points: it plays eight 10-in. or 12-in. records at a loading and any make of record will fit; it will repeat any chosen section of any record; when it stops it automatically shuts off the amplifier; and the magazine may be freshly loaded while the last of the previous set is being played.

This mechanism is situated on the motor board just under the lid of the cabinet, where we find the pick-up and the tuning scale, and also the gramophone volume control.



CONSOLE FOUR-VALVER

This is the Columbia four-valve console model for A.C. mains operation. It gives excellent results

On the front of the cabinet, as can be seen from the illustration, are the master switch and tuning control—the former also combining the functions of radio and gramophone volume control.

### Special Demonstration

We attended a demonstration of the radio gramophone at the makers' London showrooms, and we were impressed very much with the good results obtained on the gramophone side. The automatic changing was effected without any trouble and a lengthy test proved that there is absolutely no snag in it. We congratulate the makers on a fine piece of work.

The tone sounded very satisfactory in the showrooms and

there was evidently plenty of power in hand. Volume control worked smoothly and at moderate outputs there was no sign of high-note suppression, or, indeed, of any tone mutilation.

For our test of the radio side we were loaned the Columbia four-valve console, which employs exactly the same basic cir-



LATEST AUTOMATIC RADIO GRAMOPHONE

This Columbia radio gramophone incorporates the automatic record-changer described in the Gramo-radio Section last month

shown by the illustration and is 23 guineas.

The basic arrangement is two stages of high-frequency ampli-

cuit as the radio gramophone. This console is

tion, a detector and a transformer-coupled pentode output valve. High-frequency transformers couple the aerial to the first valve, the first two valves to each other and the second valve to the detector. This provides a good degree of selectivity, as tests soon proved.

### Results on Test

For example, Toulouse and Strasbourg were received clear of London Regional and the National had only a 20-metre spread.

On the long waves the selectivity is even better, Zeesen being heard at good strength clear of interference from Radio Paris and Daventry—not many sets on the market will do this.

The sensitivity is remarkable, nearly every station in Europe having been logged on the loud-speaker during a week's trial.

#### BRIEF DETAILS OF THE SET

**MAKERS:** Columbia Graphophone Co., Ltd.

**PRICE:** Model 604 radio gramophone, 47 guineas; console set, 23 guineas.

**VALVE COMBINATION:** Two screen-grid high-frequency amplifiers (Mazda MSG/HA), detector (Mazda AC/HL), and pentode output (Osram MPT4), with a mains rectifying valve (Osram U12).

**POWER SUPPLY:** A.C. and D.C. mains.

**TYPE:** Model 604 is a radio gramophone with automatic record-changing mechanism, while the radio set referred to is a table cabinet console.

**FINISH:** Dark walnut cabinet work of distinguished appearance.

**REMARKS:** Both the radio gramophone and the table console are very good value for money.

# The DOUBLE BAND-PASS FOUR



Here are details of a more powerful companion to the "Double Band-pass Three": the set has been designed by the "W.M." Technical Staff

There are two tuning dials. On the left is the volume control and on the right the reaction knob. Along the bottom of the panel are two wave-change switches and the on-off switch

## A Set with Great Sensitivity and Selectivity

FROM experiments with this modified version of the Double Band-pass Three, it appears that it will be particularly suitable for those who live in adverse localities. Under fairly good conditions just outside London the signal strength was too large for comfort, and it was found necessary to reduce the volume control on almost every station.

Reaction had to be used occasionally, but not much, and it happens that the sensitivity of the receiver is very uniform, so that it is possible to tune many stations in without taking one's hands off the tuning controls.

### Two Band-pass Filters

The circuit diagram of the receiver which is reproduced on page 175 will be seen to be similar to that of the previous set. A straightforward high-frequency stage is used, but band-pass filters are employed in both the aerial and the high-frequency tuning stages.

The advantage of this procedure is that with the single high-frequency valve (which is quite capable of giving all the amplification required for normal purposes) we are enabled to obtain four tuned circuits and, therefore, selectivity hitherto not approached with a straight set,

Yet the operation is quite simple, as has already been pointed out, because there are only two main operating knobs and searching for the stations is a matter of the greatest ease.

The selectivity in the present receiver is further improved because of the added low-frequency sensitivity which enables one to reduce the aerial coupling to a large extent or, alternatively, to use a compara-

tively short aerial. Whichever arrangement is adopted results in excellent selectivity, although the tune on each dial is comparatively broad and easy to find. *It is the combination of the two band-pass filters which gives the selectivity.*

The low-frequency stage consists of a resistance-coupled arrangement followed by a transformer, and in the output stage a choke-capacity filter is included. This is found desirable in order to avoid battery coupling, which otherwise may be troublesome. It is manifested itself during the experimental stages as a growl, particularly when approaching the reaction point, indicating an inherent instability, although the set was not actually oscillating or motor-boating.

### Trouble Cured

The introduction of the choke-output circuit completely cured this trouble and its presence, therefore, is essential.

It may be mentioned in passing that in the present circuit a good output transformer will also cure the difficulty. The de-coupling action of a transformer, however, is distinctly less than that of a choke-capacity filter; so that the arrangement actually included in

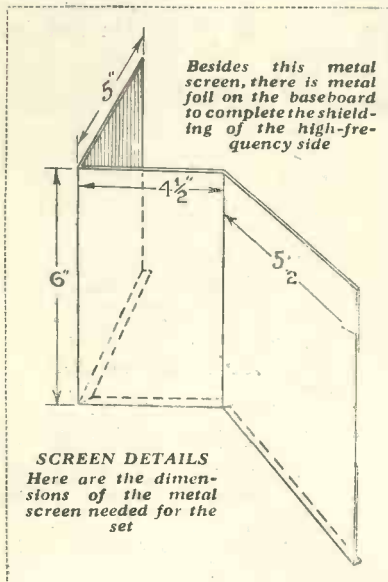



the receiver is to be preferred. The controls on the panel have been somewhat simplified. There are the two tuning knobs with window dials and, in addition, a volume control on the screen grid and a reaction control around the detector valve.

**Phase Change**

This latter control is of a form particularly suitable with band-pass filters. The energy is fed back through a small condenser on to the input side of the filter. Owing to the phase change which takes place across the coupling impedance of the filter, this energy is in the right direction to produce reaction.

This form of reaction is very convenient with a band-pass filter, because it serves to show when the two circuits are properly matched on the trimmer. If the matching is good the circuit slides into oscillation, whereas if the circuits are not accurately tuned it is very often ploppy. It does, however, have a slight effect on the tuning of the set, a point which should be borne in mind.

**Panel Controls**

The panel assembly is completed by the two wave-change switches and the on-off switch. This latter is of the three-point variety, disconnecting the high tension as well as the low tension, and thus preventing the screen-grid potentiometer from running the battery down when the set is not in use.

The components employed call for little comment. The tuning condensers were used on account of their compactness, and are essential

**AN EVENING'S TEST**

The following stations were received on the Double Band-pass Four during an evening's test in South London. The aerial used was 60 ft. long and is not too favourably located:—

**MEDIUM-WAVE STATIONS**

Station	Dial Readings	Station	Dial Readings
Trieste	16 11½	Bucharest	55 51
Fécamp	17 12	Midland Regional	56 52
Gleitwitz	20 15	Söttens	57½ 53
London National	24 19	Katowice	59 55
Heilsberg	28 22½	Berlin	62 57½
Huizen	33 27½	Belgrade	65 60
North National	34 28	Stockholm	66 64
Bordeaux	35 29	Rome	67 64½
Breslau	40 31½	Paris (PTT)	69 66
Milan	41 36	Beromuenster	72 68½
Brussels No. 2	43 37½	Langenberg	75 72
Strasbourg	44 39	North Regional	77 74
Barcelona	45 40	Prague	79 76
London Regional	47 42	Florence	83 79
Mühlacker	48 43	Brussels No. 1	85 81
Lvov	52 47	Vienna	87 83
Toulouse	53½ 49	Budapest	96 93

**LONG-WAVE STATIONS**

Hilversum	86 81	Motala	47 42
Radio Paris	76 69	Moscow	43 37
Königswusterhausen	67 62	Kalundborg	35 27
Daventry National	62 55	Vienna	29 25
Eiffel Tower	56 48	Oslo	24 17
Warsaw	51 45		

because the layout of the high-frequency portion cannot be obtained in the same space with any other make. The actual layout of the high-frequency side of the set should not be altered, as it has been carefully chosen.

It is necessary to avoid any stray coupling between the circuits as far as possible. In the present receiver there is no tendency to instability even when using full voltages, but if the layout is appreciably altered it is quite possible that some difficulty may be encountered in this direction.

The grid circuit is shielded from the anode circuit by a partition screen, and the coils and components themselves are mounted on a copper-foil baseboard screen in contact with the partition screen, giving a simple yet effective arrangement.

**A Special Point**

It is desirable, however, to mount a small piece of paper underneath the coils to prevent any of the connections on the under side of the coil base short-circuiting on to the copper foil. No damage will result if such a short-circuit does take place,

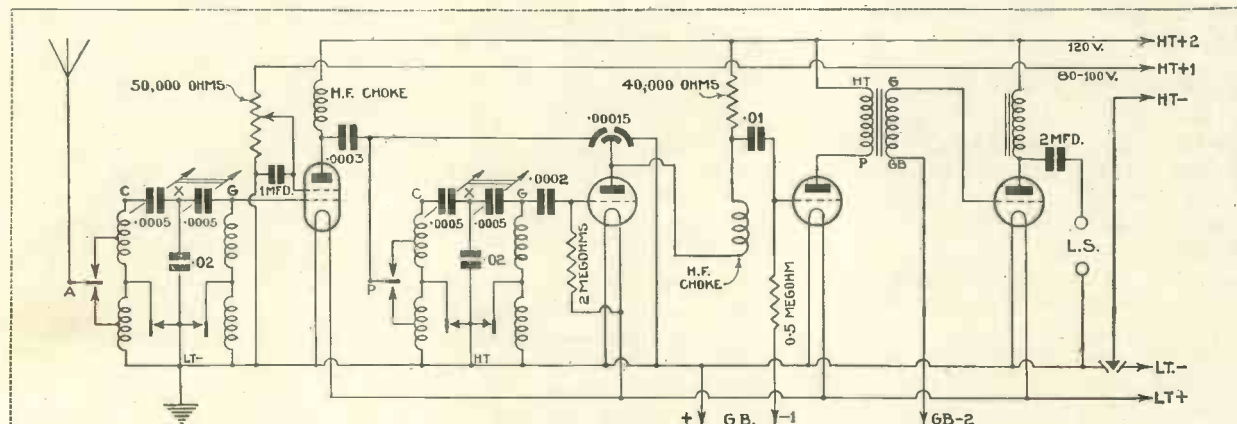

**A CIRCUIT THAT ENSURES ADEQUATE SELECTIVITY AND SENSITIVITY**

The Double Band-pass Four comprises a screen-grid high-frequency stage, leaky-grid detector, a resistance-coupled low-frequency stage and a transformer-coupled power valve. Two band-pass tuning circuits are incorporated

# THE DOUBLE BAND-PASS FOUR—Cont.

## COMPONENTS NEEDED FOR THE DOUBLE BAND-PASS FOUR

### CHOKES, HIGH-FREQUENCY

2—Readi-Rad, standard type, 9s. (or Wearite, Varley).

### CHOKE, LOW-FREQUENCY

1—Bulgin 20-henry, type LF4, 12s. 6d. (or Tunewell).

### COILS

2—British General band-pass tuning coils, types Aerial and Anode, £1 19s.

### CONDENSERS, FIXED

1—Dubilier .0002-microfarad, type 610, 1s. 8d. (or T.C.C., Telsen).

1—Dubilier .0003-microfarad, type 620, 1s. 8d. (or T.C.C., Telsen).

1—Dubilier .01-microfarad, type 620, 3s. (or T.C.C., Telsen).

1—Dubilier 1-microfarad, type BB, 2s. 6d. (or T.C.C., Formo).

1—Dubilier 2-microfarad, type BB, 3s. 6d. (or T.C.C., Formo).

### CONDENSERS, VARIABLE

2—Cydion .0005-microfarad two-gang, with slow-motion disc drive, type SPV2, £2 11s.

1—Readi-Rad .00015-microfarad differential reaction, 2s. 6d.

### EBONITE

1—Redwood 2 1/2 in. by 7 in. panel, 6s. 4d. (or Perm Triangle, Becol).

### HOLDER, GRID-LEAK

1—Readi-Rad, 6d. (or Telsen, Bulgin).

### HOLDERS, VALVE

4—W.B. 4-5 pin, miniature type, 2s. 8d. (or Lotus, Telsen).

### PLUGS AND TERMINALS

6—Belling-Lee wander plugs, marked: H.T.-2, H.T.+1, H.T.-, G.B.+

G.B.-1, G.B.-2, 1s. (or Clix, Eelex).

2—Belling-Lee spade terminals, marked: L.T.-, L.T.-, 4d. (or Clix, Eelex).

4—Belling-Lee terminals, marked: Aerial, Earth, L.S.+ L.S.-, type B, 2s.

### RESISTANCES, FIXED

1—Lewcos 40,000-ohm spaghetti, 1s. 6d. (or Bulgin, Magnum).

1—Telsen 5-megohm grid leak, 9d. (or Watmel, Dubilier).

1—Telsen 2-megohm grid leak, 9d. (or Watmel, Dubilier).

The prices mentioned are those for the parts used in the original set; the prices of alternatives as indicated in the brackets may be either higher or lower

### RESISTANCE, VARIABLE

1—Colvern 50,000-ohm potentiometer, 5s. 6d. (or Wearite, Bulgin).

### SCREEN

1—Peto-Scott to specification, 3s. 6d. (or Readi-Rad, Parex).

### SUNDRIES

Tinned-copper wire for connecting (Lewcos). Lengths of oiled-cotton sleeving (Lewcos).

1—13 1/2 in. by 10 in. sheet of aluminium foil (Peto-Scott).

2—Belling-Lee terminal blocks, 1s. 4d. (or Sov reign).

### SWITCH

1—Bulgin three-point, type S39, 1s. 3d. (or W.B., Lissen).

### TRANSFORMER, LOW-FREQUENCY

1—Varley Ni-core 11, ratio 1:4, 11s. 6d. (or Ferranti AF8, Telsen Ace).

## ACCESSORIES

### BATTERIES

1—Full O'Power 120-volt, type V8, £1 4s. (or Ever-Ready, Pertrix).

1—Full O'Power 9-volt grid-bias, 1s. 3d. (or Ever-Ready, Pertrix).

1—C.A.V. 2-volt accumulator, type 2AG7, 10s. 6d. (or Ever-Ready, Pertrix).

### CABINET

1—Osborn, type 178 in oak, 17s.

### LOUD-SPEAKER

1—Brown Court, £3 3s., in oak (or Amplion, Blue Spot).

### VALVES

1—Mazda 215SG, £1 (or Marconi S22, Lissen SG215).

1—Mazda HL2, 8s. 6d. (or Marconi HL2, Lissen HL210).

1—Mazda HL210, 8s. 6d. (or Marconi L2/b, Lissen L210).

1—Mazda P220A, 13s. 6d. (or Marconi P2, Lissen PX240).

### MAINS UNIT (in place of high-tension battery)

1—Ekco, type K18, with trickle charger, £4 12s. 6d.

All the essential details for the construction of the set are included in these pages, but if desired a full-size blueprint can be obtained for half price (that is, 9d., post free) if the coupon to be found on the last page of this issue is used by March 31. Address your order to "Wireless Magazine" Blueprint Department, 58-61 Fetter Lane, London, E.C.4, and ask for No. WM274.

A glance at the wiring diagram reproduced in these pages (or the full-size blueprint) will show that all the connecting wires are numbered separately. These numbers indicate the simplest and most straightforward sequence for putting the leads in position.

## Cross Checking

It is a good plan to cross the numbers through with a pencil as the leads are put in position; there can then be no possibility of making a mistake.

Having completed the wiring, the set is ready for testing. The valves used should be of the following types: For the high-frequency stage a standard screen-grid valve is used, while for the detector an H.F. valve is preferable, even though it is followed by a resistance-coupled arrangement. This is to ensure adequate signal-handling capacity, and the anode resistance has been kept low to maintain adequate anode voltage.

The first low-frequency valve should be an L.F. type, while the output stage must be a super-power

but the coil will not work at its proper efficiency, and the insertion of a small piece of paper is to prevent this from happening.

The first operation in the construction is the drilling of the panel to take the window dials, the volume and reaction controls, and the three switch knobs. These are marked out as shown on the layout diagram. The window for the operating dial only requires a circular hole to be cut out.

## Holes for Switch Rods

Holes have to be drilled at the left-hand side and in the middle of the panel for the switch rods on the coils. These must either be drilled very accurately or slightly over size to allow for any inequalities in mounting, particularly in the case of the left-hand hole, since the coil is close up against the panel, and there is no play in the switch rod. The hole on the right-hand side, of course, takes the on-off switch, which is of the one-hole fixing pattern.

The various components are then laid out on the baseboard, the copper foil being first fixed on the baseboard

over the required area, and the partition screen screwed down into position. The coils and other components are then mounted in the locations shown in the diagram and photographs, and the set is ready for wiring.

It should be emphasised that the copper foil must not be allowed to

## REASONS WHY YOU SHOULD BUILD THE DOUBLE BAND-PASS FOUR

- 1.—It incorporates two band-pass tuning units which give a very high degree of selectivity.
- 2.—The two low-frequency stages ensure ample volume from dozens of foreign stations.
- 3.—Very complete screening is used, and this results in stable operation under all conditions.
- 4.—There is no difficulty about the gang-ing. Complete instructions are given in this article.
- 5.—A choke-filter output circuit is employed to get the best from the loud-speaker.
- 6.—The condensers are supplied with dial lights, thus making the tuning easy to carry out.
- 7.—A volume control allows the strength of the local station to be reduced to comfortable limits.
- 8.—Construction is straightforward and presents no difficulties even to the beginner.

touch the chassis of the variable condensers, as otherwise the coupling condenser in the band-pass filters will be short-circuited and the signal strength considerably reduced. There is adequate clearance between the coils and the condensers in the layout shown, and this must be adhered to.

class of valve capable of handling a grid swing of 15 to 20 volts. The grid bias on the last valve must be correspondingly great, while that on the first valve need not be more than about 3 volts.

There are two high-tension tap-pings, one of 60 to 80 volts for the screen potential and the other from



## A Set That Pulls In the Stations!

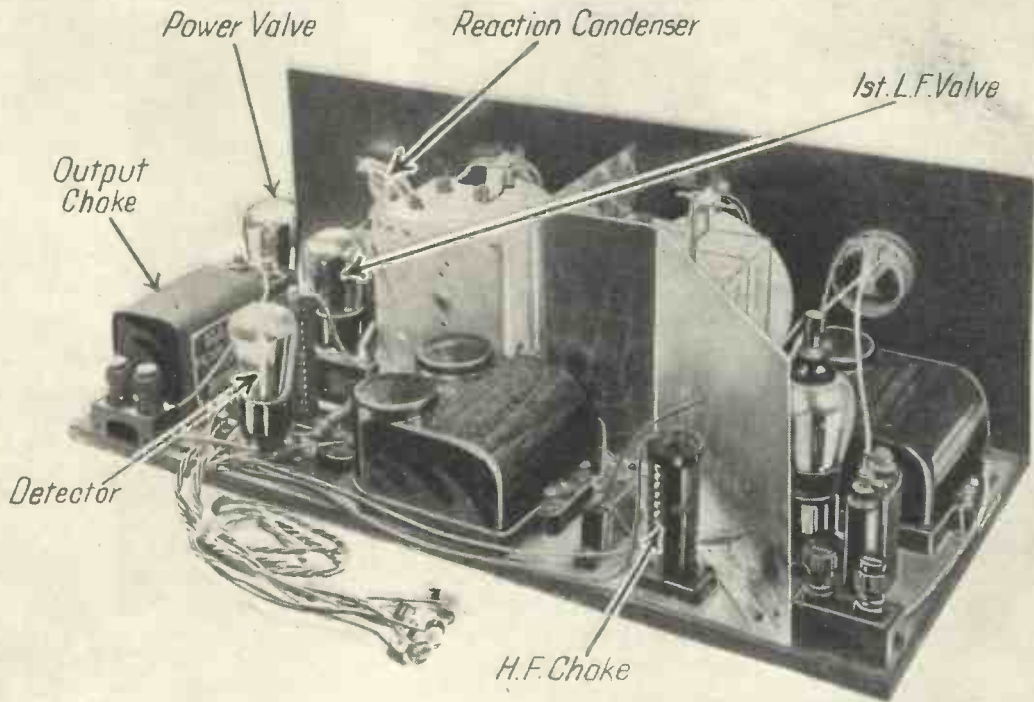

Although compact, the assembly of the Double Band-pass Four is not at all difficult. A full-size blueprint is available

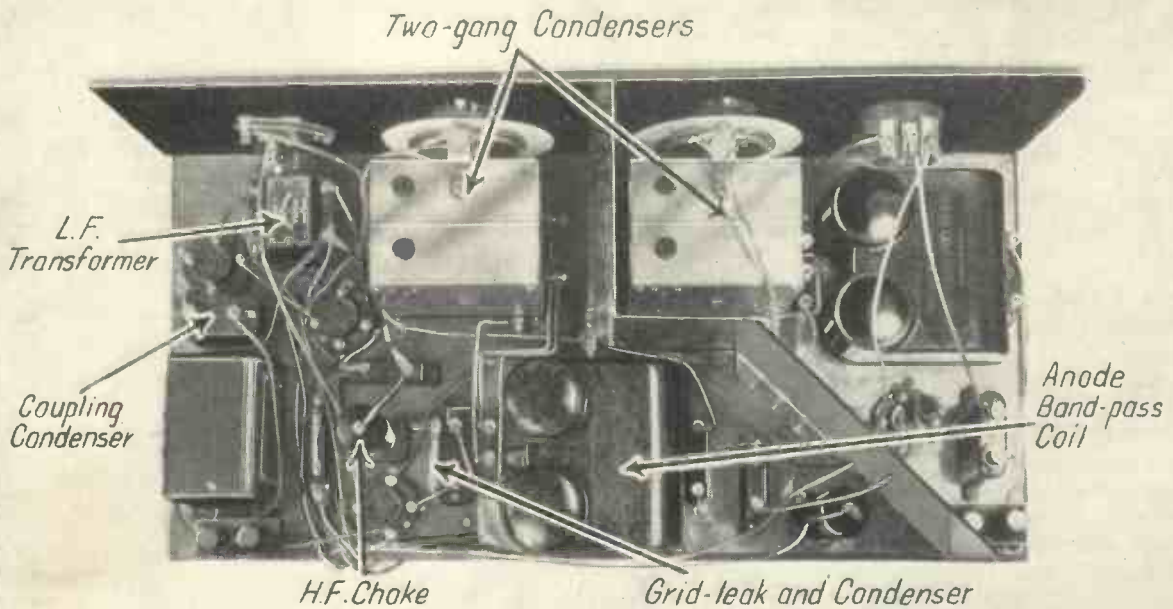

The positions of all the parts in the set will be clear from this special plan photograph. Note the metal foil on the right of the baseboard

# THE DOUBLE BAND-PASS FOUR—Cont.

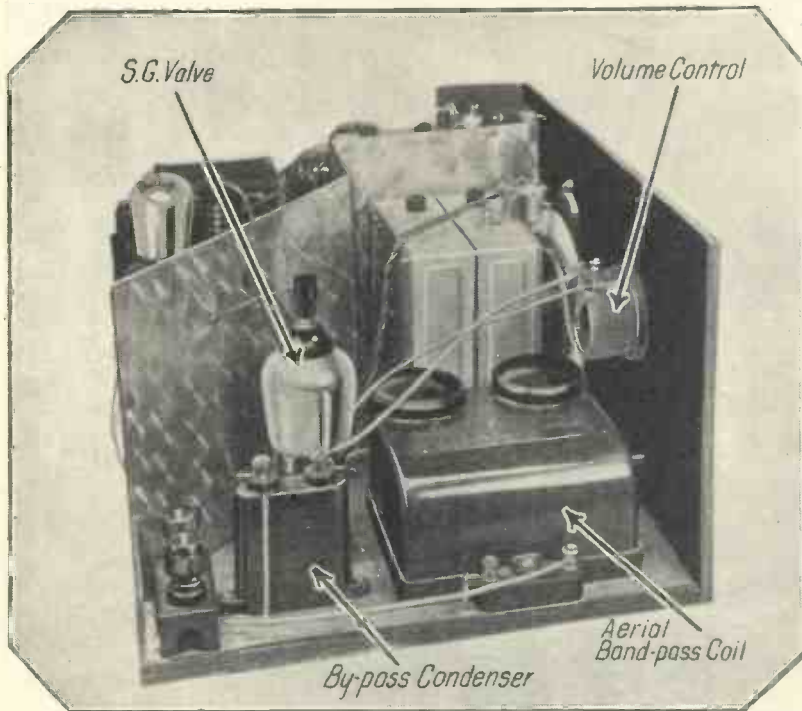

**COMPLETE SCREENING FOR STABILITY IN OPERATION**

This photograph shows the position of the vertical metal screen. There is also metal foil on the baseboard. Notes on this point will be found in the text

120 to 150 volts for the anodes of the various valves. The screen-grid, first low-frequency, and output valves receive practically the full voltage, while the detector receives about one-third of this value, namely, 50-odd volts, owing to the voltage drop on the resistance in the anode circuit.

Under these conditions an H.F. valve will handle about two volts input, which is more than sufficient to load up the last stage fully. Overloading in the last valve will occur before it takes place in the detector stage, and if the volume control is kept adjusted so that the last stage is not overloading the remainder of the set will be working well within its capacity.

### Plenty of High Tension

The limitation is, indeed, the output stage, and the better the valve which one can use here, the better the results likely to be obtained. All tests were carried out with 2-volt valves and 120 volts high tension. The use of 150 volts high tension is strongly to be recommended.

Having selected the valves and connected up the high-tension voltages as described, it is now necessary to adjust the trimmers on the

set. For this purpose the best procedure is as follows:—

Screw down the four trimmers on the condensers until they are just finger tight. Then unscrew them half a turn. The condensers will now be approximately balanced. Rotate the dials with the reaction condenser at the minimum, but with the volume control in the maximum position. Numerous stations will be heard straightaway, and it is necessary to select one suitable station at about 400 metres. (Balancing should

be carried out on the medium waves; that is, with the wave-change switches pulled out).

Having chosen a suitable (foreign) station, adjust the two trimmers on the high-frequency condenser one at a time until the signal tunes in at maximum strength. There should be a definite tuning point on the trimmer and the condenser should be adjusted to this tuning point in each case, after which it may be left set.

The same procedure is now adopted on the aerial condenser, when the whole circuit is properly tuned up.

### Setting Too High

If it is found that unscrewing any one trimmer increases the signal strength, but there is no sudden subsequent decrease (that is, it is not possible to pass through a definite tuning point on the trimmer), this indicates that the setting of the main condenser is a little too high. Therefore, reduce the setting of appropriate main tuning knob by a degree or so (but not too much) and retune on both trimmers.

Similarly, if it is found that the trimmer has to be screwed right down and still does not tune in properly, the setting of the main condenser is a little too low, and the main dial reading should be increased by a degree or so, after which the station is retuned on both trimmers.

With a little juggling of this nature a condition of affairs will quickly be found at which the station tunes quite definitely on both trimmers,

### QUICK WIRING DATA

Following are the lengths of insulating sleeving needed for connecting up the Double Band-pass Four. In each case the wires should be cut an inch longer, to allow ½ in. at each end for screwing under terminal heads:

1	6½ in.	18	2 in.	34	½ in.
2	½ in.	19	8 in.	35	3 in.
3	1 in.	20	1½ in.	35	2½ in.
4	2½ in.	21	1½ in.	37	3 in.
5	2½ in.	22	16 in.	38	3 in.
6	6 in.	23	1 in.	39	8 in.
7	5 in.	24	7 in.	40	19 in.
8	1 in.	25	5 in.	41	7 in.
9	1 in.	26	7 in.	42	2½ in.
10	3½ in.	27	1½ in.	43	1½ in.
11	½ in.	28	1 in.	44	5 in.
12	8 in. flex	29	2 in.	45	2 in.
13	8 in. flex	30	8 in.	46	3 in.
14	12 in.	31	3 in.	47 to 57 (inclusive)	flexible battery leads to suit.
15	4 in.	32	Spaghetti resistance		
16	1 in.	33	1 in.		
17	8 in.				





# RADIO IN REVIEW

**A**T first sight the use of an iron-cored transformer on the high-frequency side of a wireless set seems somewhat out of place. Of course, if the core were solid, the winding would simply act as a high-frequency choke and prevent the passage of any signals.

But by substituting a core of powdered iron the creation of eddy currents is prevented—in other words, the induction is cut down—and such transformers are, in fact, used to some extent, particularly in the intermediate-frequency stages of a super-het set.

## New Tuning System

W. J. Polydoroff, an American inventor, now claims to have developed an entirely new scheme of highly selective tuning, which depends upon the use of transformers fitted with a moveable core of very finely powdered iron.

The whole secret lies in the size of the grains, which are too small to be produced by any mechanical process.

Actually, they are formed by reducing iron sulphate chemically by means of a stream of hydrogen. After formation and before being exposed to the air, the grains must be covered with a thin layer of a special insulating compound; otherwise they would burn spontaneously directly they came into contact with oxygen. The layer of insulation still further reduces the eddy currents, and so prevents any large variation in the inductance value of the windings.

## Moving the Core

The specially prepared cores are ganged together and mounted so that they can be moved along the axis of each of the transformer windings. The extent of this movement determines the tuning of the set. The advantage claimed is that the selectivity of the set is kept constant over the whole tuning range, as distinct from ordinary tuning by means of variable condensers, where, in practice, selectivity tends to fall off as the signal frequency increases.

## MORTON BARR Discusses Recent Progress

A few years ago the light-sensitive cell was little more than a scientific curiosity rarely used outside the research laboratory. Now it is beginning to compete on an equal footing with the thermionic valve as a sensitive relay capable of a wide variety of useful applications.

This rapid development is due in part to the cinema industry, where the light-sensitive cell is used for reproducing the speech or music of a talkie film, and in part to the intensive work which is now being carried out in television and in telegraphic picture-transmission.

In television, particularly, the clearness or definition of the transmitted picture depends upon the rapidity with which the photo-sensitive "eye" can respond to variations of light and shade.

So much progress has been made in this direction that the latest type of photo-sensitive cell may fairly be said to be as much an improvement on the original selenium cell as the modern pentode is, say, in advance of the early Fleming valve. The modern photo-electric tube is, in fact, closely related to the thermionic valve. It consists of an evacuated glass bulb with an alkali-metal plate or coating which emits a stream of electrons when acted on by light.

As the output current is small, this type of tube is always used in combination with a thermionic amplifier.

On the other hand, it has recently been found that a copper/copper-oxide contact, similar to the well-known dry rectifiers used for energising sets from A.C. mains, will also serve as a light-sensitive device. When subjected to the action of light, the copper-oxide combination produces a comparatively large current, sufficient to operate a relay without further amplification.

Here are some recent applications of the new "electric eye": Alarms which automatically indicate the passage of a burglar or other unauthorised person across a door or

other barrier guarded by an invisible ray of light; the automatic switching on and off of street lamps, illuminated signs, etc., at sunset and sunrise; the automatic "sorting" of various kinds of manufactured articles according to their colour; the automatic control of passenger lifts, stopping them at each floor, and also preventing the lift doors from being closed so long as any person is across a beam of light thrown across the threshold.

## Other Practical Uses

Automatically opening the "service" door in a restaurant on the approach of a waiter carrying a loaded tray; phonograph and sound-picture recording and reproduction; and, of course, television and picture telegraphy are other uses.

The introduction of the all-mains set, which relieved listeners from the battery problem, created another difficulty peculiar to itself, namely that of noise or hum due to the frequency of the electric-light supply. A recent suggestion has been made to separate a mains-driven set so completely from the source of supply as to prevent any trouble arising from this cause.

The idea is to use the current taken from the mains first to energise a valve oscillator and then to apply the output from this valve oscillator to supply both the filament and plate current for the receiver proper. The oscillator, of course, produces high-frequency current, which is applied directly to heat the valve filaments.

## Above Audibility

There is no risk of hum, since the frequency used is far above audibility. An eliminator unit is used to rectify the locally produced oscillations for the plate and grid voltages.

The scheme has the advantage that it can be used to convert an ordinary battery-driven receiver into an all-mains set without changing the existing valves, since the filaments are heated directly and not indirectly through a separate heating electrode.





**CONVERTING YOUR SET TO A RADIO GRAMOPHONE**

Any radio set can be converted into a radio gramophone by the addition of the H.M.V. playing desk (model 116), which incorporates an electrically-driven turntable, pick-up and volume control.

## Your Guide to Practical Gramo-Radio

**N**OWADAYS everybody who has a radio set wants to use it also for the electrical reproduction of gramophone records. The articles in this section of "Wireless Magazine" show how the best results can be obtained. There are two articles on electric motors, hints on controlling tone and volume and cutting out needle scratch, a discussion of the latest technique in pick-up damping, reviews of the latest records, and full details for building a battery-operated radio gramophone at low cost.

In short, everything you want to know for the best gramo-radio results.

**GETTING THE BEST FROM YOUR PICK-UP.** By S. Rutherford Wilkins. Explains how to control tone and volume; adjusting frequency response, cutting out needle scratch, etc. Page 182

**ELECTRIC DRIVES FOR TURNTABLES.** Hints on the choice of an electric motor for driving your turntable, illustrated with eight photographs ..... Page 184

**PICK-UP DAMPING.** By Noel Bonavia-Hunt, M.A. An article by a recognised authority which throws further light on the ques-

tion of featherweighting as suggested by Capt. H. T. Barnett in these pages recently. Page 186

**MORE ABOUT FEATHERWEIGHTING.** Correspondence on this interesting development in gramo-radio practice ..... Page 188

**OVERHAULING YOUR ELECTRIC GRAMOPHONE MOTOR.** By E. J. G. Lewis. A practical article explaining faults that are likely to occur and how they can be rectified. Of value to everyone with an electrically-driven turntable, whether in a mechanical or radio gramophone ..... Page 190

**THE ECONOMY RADIO GRAMOPHONE.** A completely self-contained battery-operated radio gramophone that can be built at low cost. The radio set is on the lines of the New Economy Three and excellent results are assured. .... Page 191

**YOUR CHOICE OF NEW RECORDS.** By Whitaker-Wilson. Reviews of the latest record releases that you should read before buying your next batch. Outstanding discs are indicated by an asterisk for quick reference. ... Page 197



WHEN a gramophone record is made, owing to limitations in the pitch of the grooves, the bass notes are not reproduced in anything like their correct proportion compared with the high notes. In consequence, when records are played through the medium of a pick-up, amplifier and loud-speaker, the resulting music sounds high-pitched and lacking in body.

It will be seen from the accompanying curve (Fig. 1) that there is a gradual falling in the strength of recording of frequencies from 250 cycles downwards, and that in the recording of a 50-cycle note less than 20 per cent. of the original sound is present on any record.

**Compensation Needed**

Thus, if we are to achieve an adequate reproduction of the original, we must compensate for the low notes lost in recording, pick-up and amplifier. It is also advisable to introduce a slight high-frequency cut-off in the reproducing system, which should be designed so that there is a slight fall in amplification from about 3,500 to

5,500 cycles, with an almost complete cut-off at the latter frequency.

This will have the effect of lessening slightly the overall brilliance or "attack" of the music, but at the same time most of the needle scratch and surface noise will be eliminated. This is a most desirable

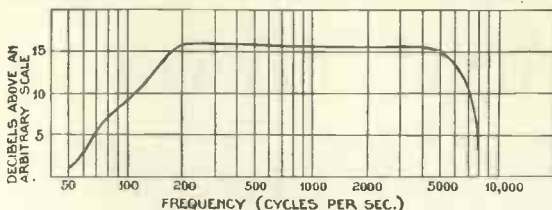

Fig. 1.—Output obtained from good gramophone record at various frequencies

feature of a gramophone amplifier.

On examination of the curve showing the frequency range of an average pick-up (Fig. 2), it will be noticed that the curve rises slightly from 150 cycles downwards until at 50 cycles the output of the pick-up is about doubled. This effect is due to amplitude distortion in the pick-up and is a decided asset.

The curve is then practically level up to about 6,000 cycles, when a cut-off occurs. There is often a minor peak in the higher frequencies due to a resonance of the armature system and sometimes due to resonance of the needle.

By the suitable adjustment of damping and the weight of the moving system this peak can be shifted outside the audible-frequency range. In many of the latest pick-ups this trouble is satisfactorily overcome, but in cases where the peak occurs below 4,000 cycles it must be removed by a suitable absorption filter.

**Value of Potentiometer**

Haphazard choice in the value of the volume-control potentiometer will often cause a serious reduction in the upper register due to the shunt effect at higher frequencies, when the impedance of the pick-up becomes comparable with the resistance of the volume control.

A minimum value of 250,000 ohms is sufficient for the average high-impedance pick-up and will cause no appreciable high-note loss. A good form of volume control is obtained by using a tapped low-frequency choke instead of a variable resistance. The impedance of the former will rise with frequency in a similar manner to the pick-up. This choke should have a value of 12 to 15 henries.

**Avoiding Needle Scratch**

A common method of limiting high-note response for the purpose of avoiding needle scratch is to place a suitable resistance in parallel with the pick-up. This will cause a drop in the upper register, owing to the load imposed on the pick-up. This is an unsatisfactory method since the cut-off is much too gradual and in order to achieve a large enough cut-off in the region

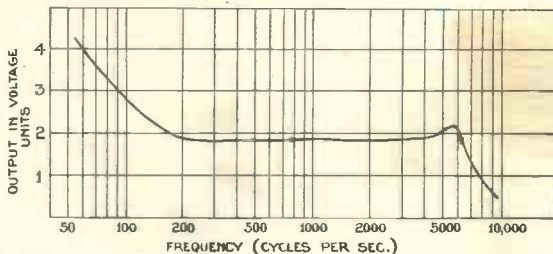

Fig. 2.—Response curve of average pick-up. Note the rise at low frequencies



of 5,000 cycles quite a substantial loss would occur at 2,000 cycles.

Another method of high-note control is to shunt the pick-up with a condenser of suitable size. This is slightly better than the parallel-resistance method, but still does not give the correct type of control. What is needed is a gradual decline in the frequency characteristic from 3,500 cycles to 5,500 cycles with rapid falling off at the latter frequency (where most of the needle scratch occurs).

**Variable Control**

In Fig. 3 is shown a filter circuit which will give this type of control. The inductance L should have a value of about 25 henries and C should be about .005 microfarad. A 50,000-ohm variable resistance will be suitable at R. This circuit has the advantage of giving variable control by means of the resistance R, so that the amount of high-note cut-off can be controlled to suit individual requirements.

The values given here are suitable for the average pick-up, but as they are also dependent on the characteristics of the first amplifying valve, it might be advantageous to experiment a little before the final values are decided upon.

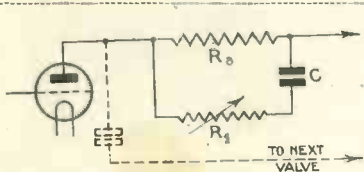

Fig. 5.—Circuit for bass compensation in anode circuit of first low-frequency amplifying valve

A measure of compensation for the loss of the lower frequencies in the recording can be accomplished by the insertion of an inductance-capacity circuit between the pick-up and the amplifier as shown in Fig. 4. With this a rise occurs in the response curve at a frequency determined by the resonance point of L and C.

Below the resonant frequency, however, there is a definite falling-off in response due to the impedance of C. The higher frequencies are not appreciably attenuated, however, if the inductance of L is large compared with that of the pick-up, as the impedance of the

choke L rises in a similar manner to that of the pick-up.

This method of "bass boosting" has several objections in that the boosting occurs over a fairly narrow frequency band, and the amount of compensation is not easily controlled or varied to suit individual requirements.

A much more satisfactory circuit for bass correction is shown in Fig. 5. Here, the compensator is introduced into the anode circuit of the first amplifying valve. It consists of a series circuit in shunt with the anode resistance Ra. The amplification given by the first stage of the amplifier at any frequency is given by

$$\frac{\text{Anode impedance}}{\text{Anode Impedance} + \text{valve impedance}} \times \text{valve amplification.}$$

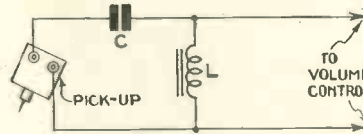

Fig. 4.—Circuit for rough bass compensation.

Thus, if this anode impedance can be made variable with frequency, the stage amplification will vary in sympathy.

Now C is the only component in the anode circuit whose impedance varies with frequency, and by suitable choice of this condenser the stage amplification can be made to vary inversely with frequency for frequencies below 250 cycles, which is the point at which the strength of recording begins to fall off.

Suppose that the values of C and R1 are .2 microfarad and 1,000 ohms respectively and Ra has a value of 75,000 ohms. Now the impedance of the circuit RC at 50 cycles will be approximately 16,000 ohms and at 250 cycles this impedance is reduced to 5,000 ohms. It will be seen that Ra is large compared with these values and the total anode-circuit impedance can therefore be taken as the impedance

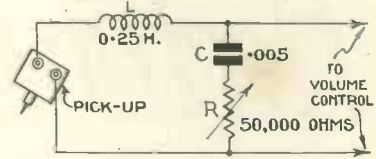

Fig. 3.—Circuit of variable scratch filter; it can very easily be made up

of the circuit R,C.

If the valve used has an impedance of 10,000 ohms, it will be found that the amplification given at 50 cycles is roughly three-fifths of the amplification factor of the valve.

At 250 cycles the amplification of the stage falls to three-thirteenths. This figure does not decrease appreciably for higher frequencies, and for all practical purposes the amplification can be considered constant above 250 cycles.

Below 250 cycles the amplification rises steadily until, at 50 cycles, there is 2.6 times the amplification at and above 250 cycles.

**Pick-up Output**

On examining the curve of the average pick-up it will be seen that it gives about twice as much output at 50 cycles as it does at 150 cycles, and above this figure the output is reasonably constant. Thus the combined output from pick-up and amplifier will be fairly steady down to 250 cycles, and will rise gradually down to 150 cycles.

From 150 cycles downwards there will be a much steeper rise, until at 50 cycles the output is 5.5 times that at 250 cycles. This is equivalent to a rise of approximately 14 decibels, and gives ample compensation for deficiencies in the recording, in which there is a loss of approximately 15 decibels at 50 cycles (see comparison curves in Fig. 6).

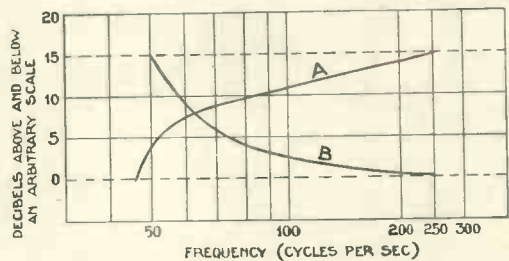
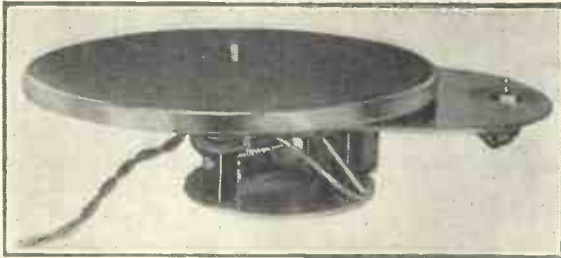

Fig. 6.—Comparison of loss in recording and gain in reproduction of frequencies below 250 cycles

# Electric Drives for Turntables



The B.T.H. Synchro-blue motor costs only £1 19s. 6d. It is suitable only for A.C. supplies

**T**WO bugbears of the gramophone, whether arranged for mechanical or electrical reproduction, are the necessity of changing the needle frequently and winding up the motor.

Some people think that the first problem is solved to a great extent by the adoption of the feather-weighting method discussed elsewhere in this supplement. The second problem has a straightforward solution—the installation of an electric motor in place of the usual clockwork drive.

## A.C. or D.C. Mains ?

Before deciding on what make of electric gramophone motor will best suit your requirements it is essential to know the kind of electric supply that is available. It is essential to find out whether the mains are A.C. or D.C.; the voltage; and the frequency (if A.C.).

As usual, the man with D.C. mains comes off worst. Few manufacturers produce D.C. motors, and it is necessary to use one of the universal type that can be employed on both D.C. and A.C. mains. One of the cheapest examples of this type is the Macom. Garrard's and B.T.H. also make a higher priced model of the same type. If you are on D.C. you cannot do better than use one of these.

When we come

to A.C. models we are much better off. There is a large number of suitable machines on the market, their prices ranging from £1 19s. 6d. upwards.

Most A.C. motors will work on any A.C.

frequency is lower (there are still some supplies at 25 and 33½ cycles).

In general it can be said that a motor that has no brush contacts will be the most satisfactory for use in a radio gramophone. Brush contacts often spark, and the sparks cause noises in the reproduction like bad atmospherics.

To overcome this trouble most makers now produce induction motors; in these there are no brush contacts and usually there is

no appreciable interference with the set. Should any noises be heard, they can usually be got rid of by simple screening with metal or by means of by-pass condensers across the input from the mains.

You may be puzzled by the

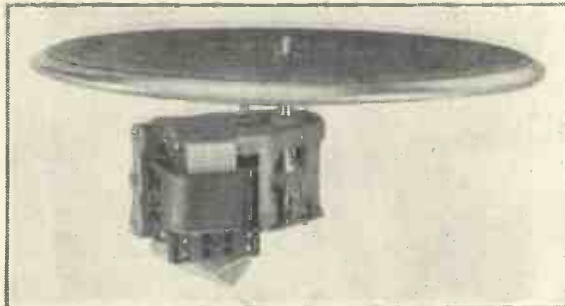

The Paillard Junior induction model is priced at £2 5s. and is good value for the money

supply, for they are usually wound for voltages between 110 and 250 volts and 40 to 60 cycles frequency. You must tell the makers, though, if your supply is of higher or lower voltage than the figures mentioned, and also if the fre-



Another A.C. motor—the Garrard model 202, which costs £2 18s. 6d.



The B.T.H. Golden Disc induction motor sells at £3 15s. and is very well made

fact that some electric motors are larger than others. It is often thought that even a small motor must be powerful if it is run from the mains, but this does not always follow. On very heavy records, especially if a heavily weighted pick-up is used, there is an inclination for the motor to slow up somewhat, and this produces an unpleasant effect in the reproduction.

If you can afford it in the first place, it is much more satisfactory to buy the biggest motor you can



get. You will then (other things being equal) get perfect results from even the heaviest recordings.

If there is any difficulty about the use of an electric gramophone motor, it is the fixing of it. Several makers still fail to supply templates with their machines and consequently it is a troublesome job to mark out and drill the necessary fixing holes.

It is certainly a good plan to buy a motor that is provided with such a template; you will save your time and temper!

A new type of A.C. motor to be put on the market comparatively recently is the synchronous machine. This is wound specially to work on a particular frequency of supply, the rate of rotation being governed by the frequency.

The speeds of these motors therefore cannot be varied. They

when they are rotating.

A point to be watched when an electric gramophone motor is to be installed in a cabinet is that there is sufficient clearance left to get the set into position. Some motors are very deep and a deep



This Collaro induction motor is priced at £3. It is, of course, for A.C. supplies

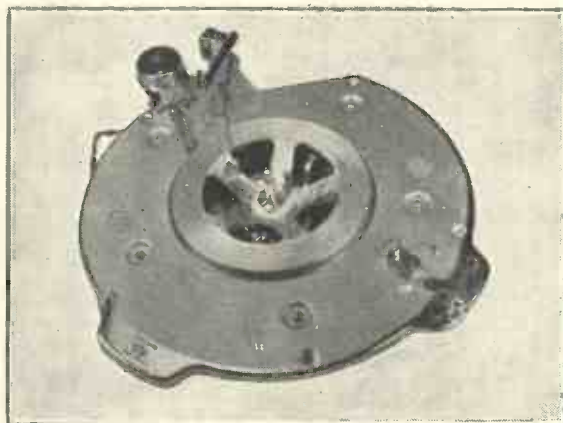

This photograph shows the Garrard induction motor without the turntable. It costs £4 17s. 6d.



Another large induction motor—the Paillard type 1,233, price £4 17s. 6d.

either run at the speed for which they are designed—or they stop completely. When buying one of these motors it is essential to know the exact frequency of the A.C. supply. The turntable is started in motion by giving it a flick with the fingers; it will not start on its own accord when the current is switched on.

An interesting point about these synchronous motors is that they consume more current when they are stationary (provided the current is switched on, of course) than

cabinet is needed to accommodate them.

Some listeners will want to know what it costs to run an electric motor of the types illustrated on these pages. It is impossible to give exact figures, for different models have different consumptions.

It is safe to say, though, that the consumption does not exceed 50 watts in most cases. This means that the motor can be run for 200 hours at the cost of one unit of electricity.

Anybody who has ever used an electric gramophone motor will never want to go back to a clock-work-driven model. Not only is the electric motor so very convenient but, if it is well made, it can be relied on to give good service for many years without much attention.

#### Little Chance of Faults

If it is carefully used there is little chance of any major fault occurring. Small adjustments are sometimes needed; the nature of these will be clear from the notes that appear on page 190.

A refinement that can be attached to most motors is an automatic stop. It is doubtful whether one of these is worth while unless one particular make of record only is to be used, however, as the "running-in" grooves vary in diameter.

Remember, if you are D.C. mains, it is best to get a universal model; it will then be suitable for A.C. if you move or if your mains are brought up to date. If you are already on A.C. then you have a wide choice of satisfactory instruments.

In any case the installation of an electric drive will increase your gramophone entertainment tremendously.

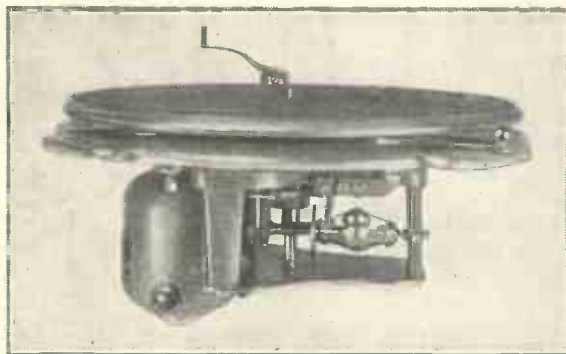

The Garrard Universal motor for A.C. and D.C. mains costs £5 15s.

# PICK-UP



# DAMPING

This special article by NOEL BONA VIA-HUNT, M.A., written at the Editor's invitation, will interest all who use electrical methods of reproducing their records. It is a particularly valuable contribution by a recognised authority in the musical world. It also throws further light on the question of featherweighting

**W**HAT is meant by the term "damping"? It means keeping under control, making a thing do just what we want it to do, no more, no less. The refractory article we have to control in the case of a gramophone pick-up is the armature. This is the iron rocker or lever which is fixed midway between the magnetic poles (north and south).

## Rocking Armature

The needle is attached to this rocker and really forms a continuation of it just as the dog's tail is a continuation of its spine. As the needle tracks the grooves of the record, the armature rocks laterally to and fro between the magnetic poles, and this oscillatory motion sets up fluctuating electric voltages in the pick-up coil.

Thus sound waves are converted into electric pulsations and are ready to be handed on to the valve amplifier and loud-speaker.

Now the armature during its rocking movements must never touch the polepieces, otherwise it will adhere to one or other of the

poles and cease to rock. On the other hand, the distance between the poles should be reasonably small so that the flux density in the gap may be as high as possible.

It will be readily perceived that the armature cannot be left to take care of itself, hence the necessity for some form of damping.

But there are other reasons that make damping imperative. The armature must allow the tracking needle complete freedom to do its work of reproducing the stored sound waves. When the armature moves towards one of the poles the tendency is for it to linger there unless some resisting force sends it back. This "restoring force" is supplied by the damping material.

Furthermore, the efficiency of the armature is at its maximum when it is balanced midway between the polepieces; this position is called the "electrical centre." We have also to take into account the extremely troublesome habit that metal systems have of "resonating" on their own. These resonances are entirely hybrid and seriously detract from the purity

and fidelity of the reproducing process.

It is apparently impossible to eliminate these resonances completely but they can be reduced and their peaks made quite small so that the reproduction shall be reasonably accurate. Damping is introduced as a means of solving these problems.

## Kinds of Damping

There are three kinds of damping which can be employed: rubber, oil, and spring-tensioning. I am only concerned with rubber damping in this article, since it is the simplest, commonest, and cheapest method in present use.

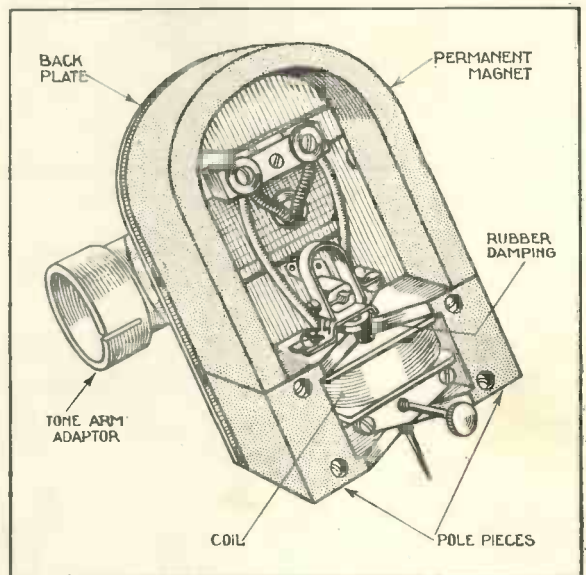

ARRANGEMENT OF PICK-UP DAMPING

This illustration shows the method of armature damping adopted in the Limit pick-up to which reference is made in this article



Now, the art of damping does not consist in merely packing pieces of rubber around or on either side of the armature!

Assuming that all the other parts of the pick-up are correctly made and fitted (an assumption which in these days of mass production is not invariably to be relied upon), the damping in itself exercises a profound influence on three highly important factors on which the ultimate success of the pick-up depends. These are:

1. Sensitivity;
2. Resonance peaks; and
3. Record wear.

#### Pick-up Sensitivity

1.—It used not so long ago to be thought that sensitivity was of small account compared to a good response curve. It is now realised that it is better to increase the sensitivity and use less valve amplification, and also that this increased sensitivity helps to boost up the extreme ends of the musical scale.

But what is *not* realised is that the pick-up should be sufficiently sensitive to respond to those *very minute* movements of the needle which few people are even aware of.

I have tested quite a number of commercial pick-ups and have found that the smallest amplitudes of the needle fail to set up corresponding voltage fluctuations in the coil. Thus, the ends of words and of piano notes are clipped off and left with blunted extremities, and

Capt. H. T. Barnett's articles of featherweighting (together with other contributions on this interesting subject) have appeared in "Wireless Magazine" for August, September, October, December and January.

*certain very little things* are missing from the reproduced version for which the recording is often unjustly blamed.

I am glad to say that there are at least two commercial pick-ups which survive this test.

2.—As regards resonance peaks, it is very desirable that these should be straightened out in the upper portion of the musical scale, especially between 800 and 4,500 cycles, in which band the ear is extremely sensitive to excrescences of any kind.

3.—The wear and tear of records is naturally a subject of tremendous interest to gramophone users, and

the preservation of the grooves depends largely on the method of damping employed. It stands to reason that if the needle is free to track without undue restraint, more than half the problem of record wear is solved.

Further—and this is a point which I would emphasise in connection with Captain Barnett's excellent articles on featherweighting—it is *then* possible to reduce the weight of the pick-up to a considerable extent.

Heavily damped pick-ups require a greater weight to keep the needle in the correct position in the groove, but lighter damping removes this

necessity since the needle is freer to do its work of tracking. The decreased load will also serve to raise the needle so that it rides on the correct part of the groove, and this means that soft and extra-soft needles with sharp extremities can be used with perfectly satisfactory results.

Now this is a real advantage, since light weighting considerably reduces record wear and surface noise.

What is the ideal type of damping? Well, the ideal to aim at is to employ a material that *offers a graduated resistance*, very little indeed when the armature *starts*

moving, and more and more as the amplitude increases. The restraining action should resemble somewhat that offered by a small and weakly tensioned spiral spring.

For this purpose there appears to be nothing so good as a soft, spongy rubber pad, which should be so shaped as to increase in mass as the armature presses more and more against it in its effort to execute larger and larger amplitudes.

#### Experimental Results

I have in my possession an experimental pick-up fitted with this particular type of damping, due to Mr. O. H. Peasgood, the sub-organist of Westminster Abbey. The sensitivity is truly amazing, for not only is it possible to obtain enormous volume with a two-stage triode amplifier with a colossal bass output, but the minutest wave forms are readily picked up from the record with the effect of imparting extraordinary life and realism to the performance.

Indeed, one does realise with such a pick-up the remarkable fidelity of the recording process. That this is no freak result is proved by the fact that the method has been repeated in half a dozen further instances with equal success. Only very light weighting is necessary for perfect tracking.

There is no doubt that the excellent qualities of the Limit pick-up, for example, are due to the use of soft, spongy rubber for damping the armature.

## TO CECILIA

(After Herrick)

*Sweet, be not proud of your good voice  
Which makes your many friends rejoice,  
And be not proud that you can play  
The violin so well to-day:  
Be you not proud that you can thrum  
The banjo, also beat the drum,  
Because the Radiogram you hear,  
Producing music loud and clear,  
Will last continually go on  
When all your dainty skill is gone!*

LESLIE M. OYLER



A "FEATHERWEIGHT" TOUCH IS REQUIRED FOR THIS!

A "rolling-the-record" race among the staff of the Columbia Graphophone Co., Ltd. Make a note of it for next summer if you are a sports-club secretary or if you have any kiddies

### Reducing Record Wear

To the Editor, "Wireless Magazine."

SIR,—I have been interested in the recent articles in "Wireless Magazine" on reducing the weight on the needle of gramophone pick-ups.

I was led to experiment when I read, some months ago, in the "Wireless Magazine" that the weight on the point of a needle was some tons per square inch. My sole object was to reduce this appalling weight as much as possible consistent with retaining quality. I was not concerned with volume of reproduction; I have more than sufficient volume as I use a three-stage amplifier, the last stage being two P650 valves in push-pull. The set is a modified Lodestone Five given in "Wireless Magazine" of July, 1929: it gives great purity of reproduction.

#### Counterbalance Weight

I use a Marconiphone pick-up which weighs 5.25 ounces at the point of the needle. I worked on the same lines as Captain Barnett, using a lead weight on a threaded rod screwed into the end of the pick-up arm.

I found that, with a weight adjusted to give one ounce on the needle, the needle occasionally jumped out of the groove. After experiment I have finally adopted a weight of just under two ounces on the needle point. I use an H.M.V. soft-tone needle in preference to the Columbia which Captain Barnett advises; with neither of these needles do I find any audible reduction of surface noise.

The Gramophone Company write that this reduction of weight gives a reduction of volume measured with a voltmeter. This may be, but by ear I find the volume to be unreduced and the quality of reproduction unchanged. I may say that quality of reproduction is my main object and that my gramophone pick-up gives me slightly better reproduction than the B.B.C. Symphony Orchestra radiated from 5XX, and that is saying a good deal.

I would emphasise this. Records do wear out. A reduction in the weight on the point of the needle must, other things being equal, reduce the wear on the record. I can reduce the weight on the needle of my pick-up to less than half with no loss of quality that I can detect. I therefore advise all owners of electrical pick-ups who are interested in prolonging the life of their records to follow in Captain Barnett's footsteps.

A. C. GEMMELL.

Brighton.

### The Value of Curves

To the Editor, "Wireless Magazine."

SIR,—In the December issue of last year I replied to a number of articles by Capt. Barnett on the "featherweighting" of gramophone pick-ups. This reply was criticised by the Research Consultant, Mr. W. James, in the following number. In his remarks he states that such curves as were given in my article may or may not be of value, and then proceeds to give evidence of a one-sided character, which is rather misleading.

As I consider that my results are somewhat misrepresented and the validity of my research procedure questioned, I shall be glad if you will kindly allow me to reply to the criticism and explain a little more fully the value and meaning of the curves published.

#### Use of Memory

First it is claimed that listening is the only test. This is very misleading, and indeed is not true. When we are listening to gramophone reproduction we wish it to be as natural as possible. Our ears are, then, the final test in deciding whether one reproduction is more like the original than another. In the making of the test we are bound to make use of our memory.

Now one's ears and one's memory are often very deceptive, especially when small differences in quality are being compared. Also the result depends on the mood and bias of the individual listening, though the latter can be eliminated if "blind" tests are adopted. It is quite possible for a person to become so used to a certain quality of reproduction that, when improvements are made, they are rejected. If, then, we rely only on aural tests we cannot make good progress.

#### Poverty of the Old Method

The extraordinary developments made after the introduction of scientific method to the study of the gramophone in 1924 illustrates the poverty of the old method—where listening was the only test—in producing results.

That does not mean that aural tests are of no avail; but that they are insufficient by themselves to indicate the line of progress, for they are not quantitative, but qualitative.



Taking the present question as an example, featherweighting was conceived as a possible technique for gramophone reproduction. It was tried aurally on various types of records, and my results were given in the December article—namely, very poor definition or fuzziness and “tinny” quality.

### Painful Reproduction

Now this test showed that the method of very light loading gave painful reproduction to my ear, and to others who heard it. It was not a case of comparing it with the original, or even other reproductions heard at a previous time, but merely considered by itself as music, it was bad. The whole matter would have been dropped at once if listening had been the only test.

If this was done we should have had little information to judge on as to the extent and nature of the change in the reproduction and, further, very little indication would have been obtained as to its possibilities or otherwise. If the result had been good, we should have been in a similar position—not certain of the exact change that had taken place, and with consequently little indication as to how to make further improvements.

Now if we can measure the change we shall have useful knowledge for consideration. The method of measuring this change in the response of the pick-up was indicated in my previous article. To gain as much information as possible a family of curves was taken, three of which were given for two types of needles.

The curve for any particular loading shows us how the output varies with frequency. The differences in the shapes indicate the effect of the change in the loading on the voltage output at each frequency.

The effect of decreased loading is deleterious to the response characteristic; and, moreover, it cannot be rectified by doping the electrical system that follows the pick-up. If we read the curves we find two effects present.

### Lower Output

First, with the pick-up feather-weighted, the output at all frequencies below 2,000 cycles is lower than when normally weighted, and the lower the frequency, the greater the difference.

This suggests that the needle at these frequencies is not being oscillated

to the full amplitude of the groove on the record. The needle, therefore, is riding up and down in the groove to a very considerable extent. At 1,000 cycles a difference in output of 9 decibels is measured; this means that with  $\frac{1}{8}$  oz. the amplitude of the needle point is only .35 of the amplitude of the record groove!

Such a state of affairs cannot take place without giving rise to parasitic vibrations which will sound distinctly disagreeable. Moreover, since this loss in output occurs as far up in the musical scale as 2,000 cycles (three octaves above middle C on the piano) all records will exhibit an unpleasantness in reproduction.

## A Super-het Automatic Radio Gramophone



A REALLY DE-LUXE INSTALLATION

This radio gramophone is claimed to receive over ninety stations on one tuning dial and it is also fitted with an automatic record-changing mechanism. It is the His Master's Voice model 531 and the price is 70 guineas. Eight records can be played in sequence without the machine being touched by hand. This is probably the most ambitious receiver at present on the market

Since also the loss of quality is due to such a cause—namely, failure of the needle to follow the groove faithfully, there is only one remedy, and that is to increase the weight. The aural test yielded a similar result, but with less information.

Moreover, in the bass the pick-up fails to track the groove. This will give rise to more or less record wear than with normal loading, according to the magnitude of the inertia of the pick-up and its arm.

The second effect is in the treble,

above 2,000 cycles. Here we find that the top resonance, and consequently the top cut-off, have been lowered considerably and the magnitude of the resonance increased. Apart from the first effect, this is very undesirable as it gives a harshness and unnatural quality to the reproduction; and coupled with the first effect, which reduces the bass response so much, it gives a hard, tinny quality that is most unpleasant.

### Future Improvements

One can only conclude that improvement in the reproduction from pick-ups does not lie along the road of featherweighting.

Mr. James, in commenting on the value of the curves, mentions the capacity and shunt resistance losses which, being varying in value, modify the characteristic. That is true enough, but they do not effect the difference that is obtained.

His attitude seems to be that since the final result depends on these losses, on the amplifier and loud-speaker characteristics, it means nothing to determine these characteristics.

Surely he cannot think so. Such an attitude would mean pot-shooting at all the units of the set, with very meagre results. It is far better to work in the light than in the dark.

The factors mentioned in this case would both produce a sloping of the characteristic towards the treble. Such a slope with certain amplifiers may be desirable, if the amplifier has a characteristic of the same slope, but in the opposite direction. Both effects would still be obtained; the lack of bass with the accompanying fuzziness, and the lower cut-off with consequent poorer quality. The curves, then, give us a very good picture of what is happening.

It is hoped that readers will find these remarks helpful in their experiments and will be able to divert their attention to more fruitful lines of attack than featherweighting in the improvement of their gramophone reproduction.

H. E. GAUSS

The Gramophone Co., Ltd.,  
Hayes, Middlesex

[The Editor of “Wireless Magazine” will be glad to hear from readers who have any light to throw on the value or otherwise of featherweighting.]

# Overhauling Your Electric GRAMOPHONE MOTOR

So many people use electric gramophone motors nowadays that a few hints about the best methods of overhauling them will be of value to readers of "Wireless Magazine." In this article E. J. G. LEWIS explains the most common faults and their remedies

**M**ANY readers have probably become acquainted with electric gramophone motors for the first time during the last season or two, and when making a periodical overhaul of a radio gramophone will feel inclined to shirk doing anything to the motor.

There is no need for this if the little motor is treated with respect and handled carefully. Indeed, providing that it is running consistently, that is, at constant speed and quietly, there is very little to do.

## Induction Motors

As regards induction-type motors, the gears should be thoroughly cleaned of old and congealed grease, and a fresh supply applied.

The brake pad—the little piece of leather pressing on the governor flange—should be well lubricated with fine oil, so that it is soft and supple. This pad should be more frequently attended to than any other part of the motor, as the constancy of the speed depends to a large extent upon the condition of the brake pad.

The bearings of the governor assembly, the brass sleeve, the main bearing of the turntable spindle, and its bottom bearing, should be lubricated with very fine oil obtainable at any gramophone dealers. On no account use a thick cheap oil. If you do, you will find the motor running sluggishly in a very short time,

with the bearings gummed up.

D.C. or universal-type motors (those suitable for A.C. or D.C.) have commutators and brushes. These should be examined and cleaned with a very fine glass-paper if dirty. Just a light pressure of a strip of glass-paper on the commutator is sufficient.

Carefully remove any dust with a camel-hair painting brush after the operation. On no account use emery-paper.

If the carbon brushes are worn more than half their length, fit a new set. The new brushes must be properly bedded in, and this is done as follows:—

Cut a long, narrow strip of very fine glass-paper as wide as the commutator and wrap it round the latter with the rough side outward. Then place the new brushes in the holders and rock the commutator so that the faces of the brushes are worn to the curvature of the commutator.

Try the motor running and see that the brushes are not sparking after brushing away all dust from the glass-paper. If there is sparking try the glass-paper again.

See that no oil gets on to the commutator or brushes, otherwise you will get bad sparking and a

black deposit on the commutator, which will cause further sparking, until the motor finally refuses to pull. If any oil has been absorbed by the brushes, new ones must be fitted.

Let us now go into the causes and cures of faults most commonly found with small motors.

*Loss of Power.*—Generally due to lack of lubrication, but can also be caused through stiff bearings, and in the case of commutator motors, dirty commutator and brushes.

The first and third causes have obvious remedies, but the second is harder to get over.

## Turning by Hand

See whether the motor rotates easily when turned by hand, or whether it is stiff and comes quickly to rest.

If everything is easy, the cause must be electrical. Either the motor is not getting its correct voltage (check up mains resistance, if any) or there is a breakdown in the windings and the motor should be put into experienced hands or returned to the makers for overhaul and repair.

Should there be stiffness, remove the governor assembly to ascertain whether it is the main spindle or the assembly bearings that are stiff.

The governor assembly is generally suspended between adjustable bearings and the governor spindle should have just a trace of lateral movement between them.

If, with the governor assembly removed, the main spindle is stiff, unless it is obviously easy of removal, I would not recommend its adjustment. If you can get it out, examine the bearing surfaces, and should there be exceptionally bright polished rings, these are the "high spots" which should



**ADJUSTING THE AUTOMATIC STOP**

To adjust an automatic stop the pick-up should be placed with the needle in the inner concentric groove of the record and the "stop" arm brought up against the tone arm



be removed with a fine grade of carborundum stone.

Thoroughly wipe the spindle and lubricate before replacing it.

**"Crazy" or "Roaring" Governors.**  
—The term "crazy governors" is used when the three governor balls are not working together. They should, of course, all move out the same distance when they rotate, and to ascertain definitely whether they are the following simple test should be applied.

#### Pencil Marks

With the motor running at normal speed, carefully bring the point of a pencil against the revolving balls, until it touches them. Then stop the motor and examine the pencil marks on the balls.

They should all be of the same thickness. If one ball has a heavier marking that ball is evidently throwing out too far. If the mark is lighter than the other two, the ball is not throwing out far enough.

The ball and spring are attached to the governor assembly by screws, and by slackening these the spring can be made to slide a little as the hole in the spring is larger than the screw. Therefore, if the ball throws out too far, push it down a little, tighten the screws, and test again. If the ball is not throwing out enough, pull it up gently while you tighten the screws. Then test your setting.

Examine each spring where the ball is screwed or riveted to it. The spring should have a nice curve at this position. If it has a sharp angle, replace the spring, adjusting the setting as described above. If you do not, the spring will soon break and the flying ball may cause serious damage to any valves beneath it!

#### Twisted Springs

Another cause of crazy governors is a twisted spring. If you examine a governor assembly, you will observe that the flange portion that acts on the brake pad is driven by the springs from the part of the assembly fastened to the spindle.

There is thus a twisting force acting on the springs which in time causes the springs to take on a definite twist. Such springs must be replaced.



A COMPLETE GRAMO-RADIO ASSEMBLY

This Macom outfit consists of a universal motor for A.C. or D.C. mains, a turntable and a Limit pick-up. It can be used as it stands or can be screwed down to the usual motor board in a grammo-radio cabinet

Now for a few more faults in brief:—

*Dragging on heavy passages* is due either to worn records, or needles, or loss of power. Remedy for last as above.

*Varying speed*, not necessarily on loud passages, but on long, sustained notes which are reproduced with a "wobble." May be due to tight bearings, lack of lubrication of governor sleeve or brake pad.

Next month the "Wireless Magazine" Gramo-radio Section will contain a special article by P. K. TURNER, M. I. E. E., describing a battery-operated gramophone amplifier designed on the "economy push-pull" principle outlined last month. Those who want purity with low maintenance costs should not miss this feature

Sparking brushes, crazy governors should also be suspected.

*Hum or noise* may be due to crazy governors; gears hard with old lubricant or loose field windings or laminations: the remedies are obvious.

*Consistently sparking brushes* may be caused by crazy governors; brushes or commutator dirty; brush or brushes loose in holders; not enough spring pressure behind brush to keep it on the commutator; loose terminal connection; or open circuit of one or more armature coils (make a continuity test from

segment to segment of commutator). Oil or grease on the commutator or brushes may also cause this trouble.

*Noise from loud-speaker when motor running* is caused by sparking brushes or lack of earth wire to metal chassis of motor. If bad, try a 1-microfarad condenser between earth and one of the brushes.

#### Failure to Rotate

Finally, if the motor fails to rotate when you switch on, switch off and try to rotate the turntable by hand. If it is stiff, the trouble is mechanical and to be dealt with as outlined under "Loss of Power," unless, of course, you can see an obvious breakdown, such as a broken governor spring entangled in something.

If the motor rotates easily by hand, suspect a broken electrical connection or switch. Perhaps the switch contacts are very dirty or burnt. Clean them up with a small file or glass-paper.

With the motor running, test with a voltmeter across the motor terminals. If a voltage is registered there must be an electrical fault in the motor itself, such as broken connection between terminals and brushes or field coils.

A brush may be stuck in its holder so that it has not fed up to the commutator as it was worn.

With a little care and observance the majority of faults on small electric gramophone motors can be satisfactorily cleared.



# The ECONOMY RADIO GRAMOPHONE

By the "Wireless Magazine"  
Technical Staff



*A Companion to the New Economy Two and Three*

**I**N this article we give full instructional details for making a simple battery-operated radio gramophone for a few pounds. The whole outfit is accommodated in one cabinet, which contains the radio set, loud-speaker, batteries, clockwork-driven turntable, and pick-up.

The radio set is a four-valver, built on the lines of the New Economy Two and the New Economy Three. Regular readers will know how successful these two receivers were, and they will therefore have no doubts about the efficiency of this four-valve edition.

### Ample Loud-speaker Volume

With this set ample loud-speaker volume can be obtained from many Continental stations, and as two of the valves are used for gramophone reproduction there is good volume also for the electrical playing of records.

For the price this radio gramophone cannot be beaten, and it is certain that many thousands will be made up during the course of the next few weeks.

The controls of the set (which, of course, can be used in an ordinary table cabinet if desired) are particularly simple. There is a combined wave-change switch and

on-off switch, and also a combined radio and gramophone volume control. The latter has the further advantage of working as a gramophone-radio switch as well: it is arranged on the "fader" principle and the pick-up is kept

---

Here is a simple radio gramophone that will meet the needs of thousands of constructors. It is operated entirely from batteries and economical running can be obtained from those of the double-capacity type. The whole outfit is self-contained and includes a four-valve set, clockwork-driven turntable, pick-up, loud-speaker, and batteries.

The Economy Radio Gramophone has been designed by the "Wireless Magazine" Technical Staff. Although it is cheap, the results are excellent and nobody who builds it will be disappointed with its performance. Full constructional details are given in these pages and those who desire one can obtain a full-size blueprint for 9d., post free, by using the coupon on the last page of the issue.

---

permanently connected in circuit for instant use.

As this is a battery-operated set, a clockwork motor has been used for driving the turntable. As it stands, the outfit is ideal for those who have no electric-light supply available. Those who have electric light may prefer to use an electrically-driven motor and perhaps obtain the anode-current supply from a mains unit.

### Using Spare Components

The set is so designed that constructors who already have a number of spare components on hand will be able to use many of them in the assembly of the Economy Radio Gramophone. For instance, most constructors will have some fixed condensers and perhaps some variable condensers that will also be suitable. In this case the receiver can be put together at very low cost.

A fair degree of selectivity and great sensitivity are ensured by the valve combination utilised. There is a screen-grid high-frequency stage, followed by a detector, a resistance-coupled low-frequency stage, and a transformer-coupled power valve. All four valves are, of course, used for radio reception, while for the electrical reproduction of records the last two



valves are used. The circuit is quite straight forward and follows standard practice; it will give good results without any trouble.

### Adjusting Selectivity

In the aerial lead is a semi-variable or pre-set condenser to adjust the selectivity for the best results under different aerial conditions. As the knob of this condenser is unscrewed the set is made more selective, but at the expense of some loss of signal strength. This is unavoidable with this type of selectivity control, which, however, has the advantages of simplicity and cheapness.

When the set is in use this condenser should be adjusted so that the required degree of selectivity for the easy separation of the local stations is obtained; once adjusted, it can be left permanently set.

### New Economy Coils

The aerial coil is of the same type as that used in the New Economy Three, and full details for winding it at home will be found in the December "Wireless Magazine." The same applies to the tuned-grid coil (see photo on page 196). If it is not desired to make these coils at home they can be bought ready wound from several of the advertisers.

The circuit incorporates two high-frequency chokes. One is in the anode circuit of the screen-grid valve and the other in the anode circuit of the detector. It is desirable that these two chokes should have different electrical characteristics,

otherwise interaction might occur between them and uncontrollable self-oscillation might arise. For this reason chokes of different makes are used.

There is nothing unusual about the remainder of the circuit. The coupling between the detector and

Between the first low-frequency valve and the power valve there is a transformer coupling. This is arranged in the standard way and needs no comment.

It will be noticed that the circuit includes no decoupling arrangements. For operation with batteries



THE GRAMOPHONE PART OF THE EQUIPMENT

On the left are the needle cups; in the centre the clockwork-driven turntable; and on the right the pick-up. The cabinet is supplied with the motor board screwed in position so the necessary holes must be cut with a keyhole saw

the first low-frequency amplifying valve is of the resistance-capacity type, the resistance being of 50,000 ohms and the condenser of .005 microfarad.

The grid leak associated with this valve has a resistance of .5 megohm, for it is actually one half of the "fader" potentiometer.

these are not found to be necessary, but they might be needed if the set were to be operated from a mains high-tension unit.

Actually, the set has been tested as it stands with the mains unit specified in the list of parts on page 196; good reception, quite free from motor-boating, was obtained. In other cases it might be necessary to add a decoupler to the detector and/or first low-frequency valve.

### Simple Construction

A glance at the photographs and diagrams of the set reproduced in these pages will show clearly the simple nature of the construction. It is no exaggeration to say that even the beginner will have no trouble with the building.

Many constructors will find one of the "Wireless Magazine" blueprints of considerable help. These are available for every set constructionally described in these pages, and a copy for this set can be obtained for half price, that is 9d., post free, if the coupon on the last page is used by March 31.

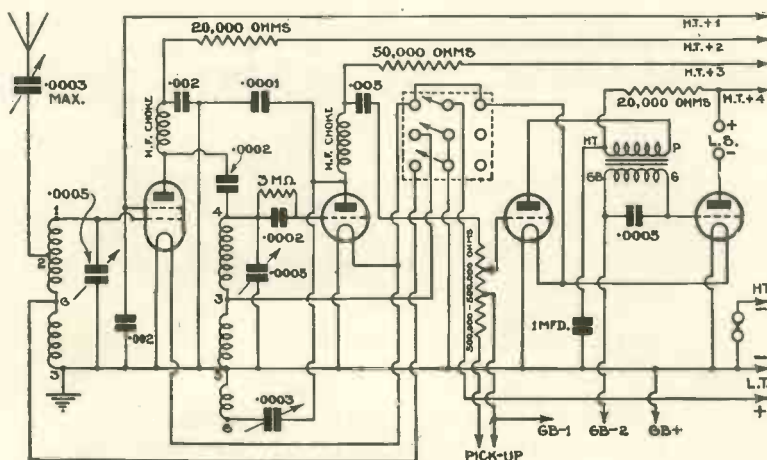

STRAIGHTFORWARD YET POWERFUL CIRCUIT

There are four valves in the set: screen-grid high-frequency stage, detector, resistance-capacity coupled low-frequency amplifier and transformer-coupled power valve. Two tuned circuits give adequate selectivity for most normal conditions

# ECONOMY RADIO GRAMOPHONE—Cont.

Ask for No. WM276 and address your inquiry to "Wireless Magazine" Blueprint Department, 58-61 Fetter Lane, London, E.C.4.

The first part of the construction to be tackled is the mounting of the parts on the front panel. In the original set this was of wood but, if preferred for any reason, an

metal screen, which can be of either aluminium or copper, is provided with a hole through which the screen-grid valve can be inserted into its holder.

The holder for the screen-grid valve is mounted vertically on a small block of wood, but to save confusion the connections to it are

the numbers on the blueprint as the connections are completed; there will then be no possibility of making a mistake. The best way of making the connections is with tinned-copper wire covered with insulating sleeving. The wires are cut to the right lengths to stretch between the terminal points and lengths of sleeving are then slipped over the wire, each end of which is screwed under the appropriate terminal.

### Lengths of Wire

Following is a list of the lengths of insulating sleeving needed for wiring up the set. In each case the wire itself should be cut an inch longer to allow half an inch at each end for screwing under terminal heads, etc.:

- |           |               |
|-----------|---------------|
| 1. 4in.   | 26. Flex res. |
| 2. 2½in.  | 27. 2in.      |
| 3. 4in.   | 28. 4in.      |
| 4. 2½in.  | 29. 3in.      |
| 5. 3½in.  | 30. ½in.      |
| 6. 2in.   | 31. 2in.      |
| 7. 3in.   | 32. 1in.      |
| 8. 3¼in.  | 33. 6in.      |
| 9. 1in.   | 34. 3in.      |
| 10. 3in.  | 35. Flex res. |
| 11. 3in.  | 36. 2in.      |
| 12. 3½in. | 37. 2in.      |
| 13. 4in.  | 38. 4½in.     |
| 14. 5in.  | 39. 4in.      |
| 15. ½in.  | 40. 2in.      |
| 16. 4in.  | 41. 1in.      |
| 17. 7in.  | 42. Flex res. |
| 18. 6in.  | 43. 1in.      |
| 19. 3in.  | 44. ½in.      |
| 20. 5in.  | 45. 1in.      |

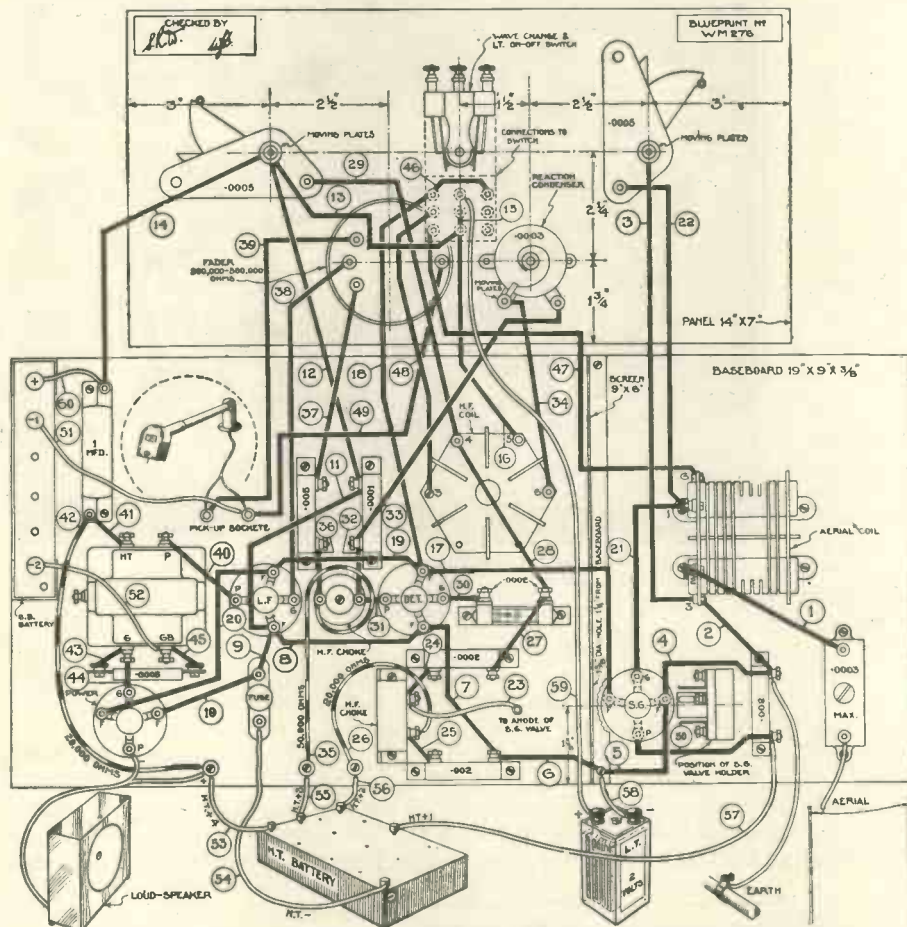

QUARTER-SCALE LAYOUT AND WIRING DIAGRAM

This can be obtained as a full-size blueprint for half price, that is, 9d. post free, if the coupon on the last page is used by March 31. Ask for No. WM276. Wire up in the numerical order indicated

ebonite panel can, of course, be utilised. If the top part of the blueprint is laid squarely over the back of the panel the centres of the necessary fixing holes can be easily marked through with a sharp-pointed instrument; afterwards they can be drilled to the sizes indicated.

The next step is to screw all the other parts firmly to the baseboard in the positions shown by the bottom half of the blueprint (or the quarter-scale reproduction that appears above. Note that the

shown in plan on the blueprint.

When all the parts have been fixed firmly in their respective positions the wiring of the set can be undertaken. This will present no difficulty at all if the blueprint is carefully followed. It will be noted that each lead is numbered separately and these numbers indicate the best sequence of connecting.

Start with wire No. 1 and then work through in numerical order until the wiring is completed. It is a good plan to cross through

- |                |           |
|----------------|-----------|
| 21. 1½in.      | 46. 1½in. |
| 22. 4½in. flex | 47. 7in.  |
| 23. 2in. flex  | 48. 4in.  |
| 24. ¼ in.      | 49. 4in.  |
| 25. ½ in.      |           |

Suitable valves for use in the set are indicated in the list of parts. Alternative valves with similar characteristics will quickly be found from the lists on pages 132 and 134.

Approximate battery voltages for the best results will be clear from the wiring diagram on this page.

The operation of the set for



# Just the Kind of Battery Set You Want!

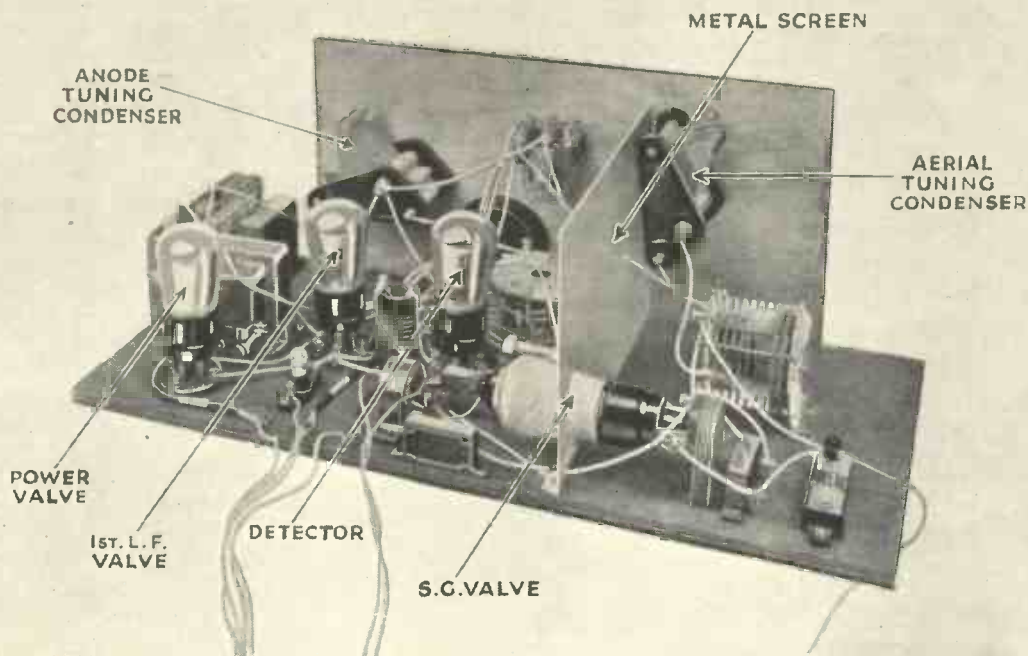

Here is the receiver portion of the Economy Radio Gramophone complete with valves and ready for radio or gramophone reproduction

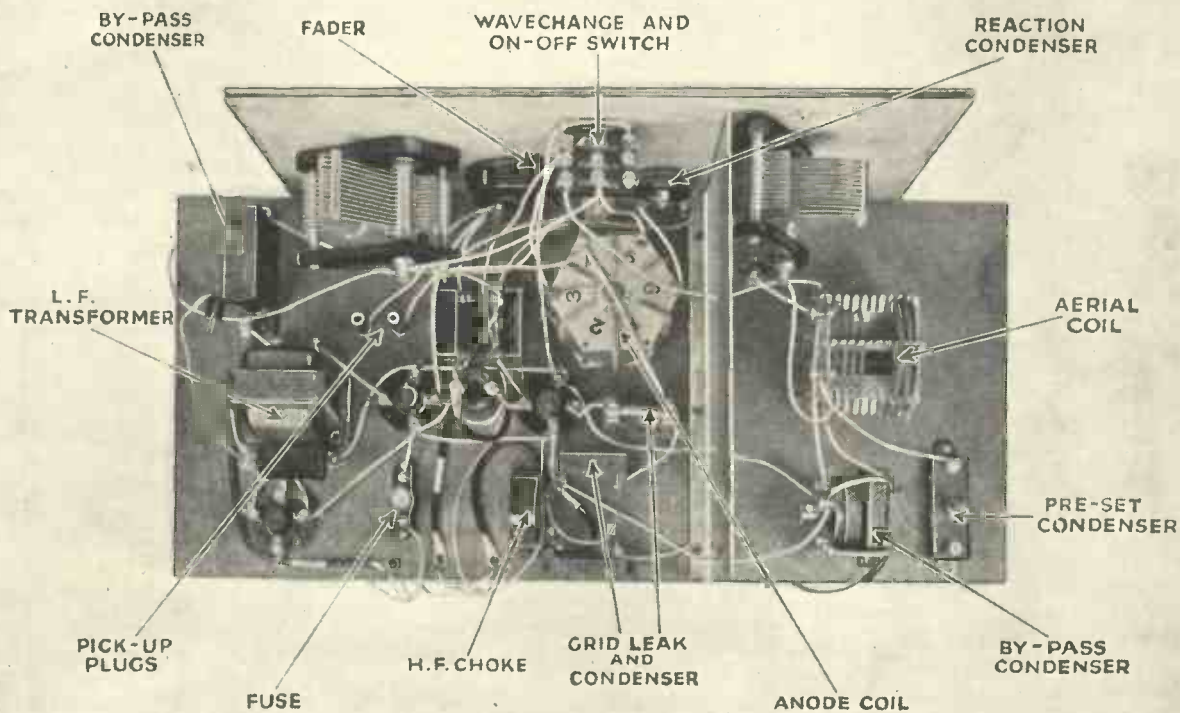

With this plan view and a full-size blueprint nobody will have any difficulty in the construction. All the wires are numbered for easy reference

# ECONOMY RADIO GRAMOPHONE—Cont.

## COMPONENTS NEEDED FOR THE ECONOMY RADIO GRAMOPHONE

### CHOKES, HIGH-FREQUENCY

- 1—Keystone, 3s. 6d. (or Varley, Wearite).
- 1—Telsen, 2s. (or Watmel, R.I.).

### COILS

- 2—Ewebec coil formers, 2s. 6d.
- ¼ lb. Lewcos No. 28 d.s.c., 1s. 10d. (or)
- 2—Economy dual-range coils (Ewebec-Tangent, Peto-Scott, Read-Rad, Wearite).

### CONDENSERS, FIXED

- 1—Telsen .0001-microfarad, 6d. (or Lissen, Dubilier).
- 2—Telsen .0002-microfarad, 6d. (or Lissen, Dubilier).
- 1—Dubilier .0005-microfarad, type 670, 1s. 3d. (or Lissen, Telsen).
- 2—Telsen .002-microfarad, 1s. (or Lissen, Dubilier).
- 1—Dubilier .005-microfarad, 2s. 3d.
- 1—Telsen 1-microfarad, 2s. 3d. (or Lissen, Dubilier).

### CONDENSERS, VARIABLE

- 2—Lotus .0005-microfarad, type KC5, with dials, 7s. (or Utility, Telsen).
- 1—Telsen .0003-microfarad reaction, 2s. (or Peto-Scott, Bulgin).
- 1—Formo pre-set .0003-microfarad maximum, type F, 1s. 6d. (or Sovereign, Igranic).

### FUSE

- 1—Read-Rad fuseholder and bulb, 1s. 3d. (or Bulgin, Belling-Lee).

### HOLDERS, VALVE

- 4—Lissen rigid, 1s. 6d. (or Clix, W.B.).

### PLUGS AND TERMINALS

- 8—Clix wander plugs, marked G.B.+ , G.B.—1, G.B.—2, H.T.+4, H.T.+3, H.T.+2, H.T.—1, H.T.—, 1s. 4d. (or Belling-Lee, Ealex).
- 2—Clix spade terminals, marked L.T.+ , L.T.—, 4d. (or Belling-Lee, Ealex).
- 2—Clix wood-screw sockets and plugs for pick-up, 8d.

### RESISTANCES, FIXED

- 2—Lewcos 20,000-ohm spaghetti, 8s. (or Bulgin, Magnum).
- 1—Lewcos 50,000-ohm spaghetti, 1s. 6d. (or Bulgin, Magnum).

The prices mentioned are those for the parts used in the original set; the prices of alternatives as indicated in the brackets may be either higher or lower

- 1—Telsen 3-megohm grid leak, 9d. (or Watmel, Dubilier).

### RESISTANCE, VARIABLE

- 1—Magnum .5-0-.5 megohm fader, 10s.

### SUNDRIES

- Tinned-copper wire for connecting (Lewcos).
- Length of oiled-cotton sleeving (Lewcos).
- Length of rubber-covered flex (Lewcos).
- Piece of wood for mounting valve holder.
- 1—Bulgin Duplex needle-cup, type AK1, 2s. 6d.
- 1—Read-Rad 9 in. by 6 in. aluminium screen, 2s. (or Peto-Scott, Parex).

### SWITCH

- 1—Wearite three-pole change-over, type 123, with terminals and window knob, 4s. 6d.

### TRANSFORMER, LOW-FREQUENCY

- 1—Telsen Ace, 5s. 6d. (or R.I. Dux, Lotus).

### ACCESSORIES

#### BATTERIES

- 1—Lissen 120-volt high-tension, 11s. (or Siemens, Ever Ready).
- 1—Lissen 9-volt grid-bias, 1s. (or Siemens, Ever Ready).
- 1—Lissen 2-volt accumulator, type 2005, 12s. 6d. (or Siemens, Ever Ready).

#### CABINET

- 1—Vibranti radio gramophone, £2 5s.

#### GRAMOPHONE MOTOR

- 1—Collaro single-spring, type A30, 19s.

#### LOUD-SPEAKER

- 1—Ormond loud-speaker unit and chassis, £1 (or Telsen, Blue Spot).

#### PICK-UP

- 1—Zonophone, 15s.

#### VALVES

- 1—Cossor 220SG, metallised, £1.
- 1—Cossor 210 Det, 8s. 6d.
- 1—Cossor 210LF, 8s. 6d.
- 1—Cossor 220Pa, 10s. 6d.

#### MAINS UNIT (in place of high-tension battery)

- 1—Atlas, type AC244, £2 19s. 6d.

For gramophone-record reproduction a pick-up must be inserted in the grid circuit of the first low-frequency amplifying valve. This is accomplished in practice by connecting the leads to two sockets screwed down on the baseboard and turning the "fader" knob to the right.

### Permanently Connected

The pick-up can be kept permanently connected in circuit, of course, and brought into use when desired by means of the "fader" knob on the panel.

It is advisable to test the set out and make sure that everything is all right before putting it in the cabinet.

When finally assembled in the cabinet with the gramophone gear, the Economy Radio Gramophone is particularly handsome in appearance and the constructor will be proud of his handiwork.

### See It in London

Those who would like to inspect the set before building it will be able to do so if they live near London, for during the currency of this issue of "Wireless Magazine" arrangements have been made for it to be on view in Selfridge's Somerset Street windows.

There is no question that thousands of these sets will be made up during the next few weeks. Readers are again reminded of the value of test reports to the "Wireless Magazine" Technical Staff, so don't forget to let us know how you get on.

ordinary radio reception will present no difficulties. The set is switched on for medium-wave reception by turning the centre knob to the left; when it is turned to the right the set is switched for long-wave working. In its central position the knob switches the set off altogether.

### Operation of "Fader"

Another point to be noted is that the knob of the "fader" potentiometer, to the right of the panel, must be turned to the left for radio reception. When it is turned as far as possible to the left volume will be at its greatest and will be reduced as the knob is turned to the right towards its centre position.

Both the large dials must be turned to pick up stations, but after a few minutes practice there will be no difficulty about this

operation. The reaction condenser should be turned a little to the right to increase the strength of weak signals, but in the ordinary way no reaction will be needed for the reception of the locals.

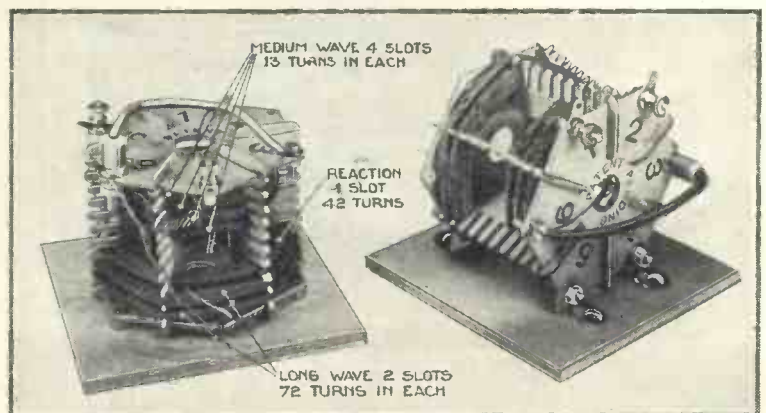

### DETAILS FOR MAKING THE TWO TUNING COILS

On these photographs of the coils for the Economy Radio Gramophone are indicated the numbers of turns required on Ewebec formers. On the left is the tuned-grid coil, while the aerial coil is seen on the right



Derrickson  
and  
Brown,  
Vocalists

# YOUR CHOICE of NEW RECORDS

Here are reviews of the latest record releases by WHITAKER - WILSON. Outstanding discs are indicated by an asterisk (\*) against the title.

## SACRED MUSIC

- ★(a) Easter Processional, O Fili et Filiae, (b) O, Thou the Central Orb, St. George's Chapel Choir, 4s. COL DX316

Very beautiful. Those interested in church music of the very best type should buy this. They will not be disappointed.

- (a) Nearer My God to Thee, (b) Cast Thy Burden, Master Graham Payne, sop., with organ, 2s. 6d. ZONO 6033  
Not too good. Choir boys do not record well. This one should get a shock if he hears this disc!

## GRAND OPERA AND CLASSICAL ARIAS

- ★(a) In Fernem Land, (b) Morgenlich Leuchtend Im Rosigen Schein, Richard Crooks, ten., 6s. H.M.V. DB1598  
(a) is from *Lohengrin*; (b) from



Richard Crooks

the *Meistersingers*. Both are really fine. Richard Crooks is well worth hearing. Something for your operatic collection!

- (a) Isoldes Liebestod, (b) Ich Sah' Das Kind (Herzeleide), Frida Leider, sop., and London Symphony Orch., 6s. H.M.V. DB1545

(a) is from *Tristan*; (b) from *Parsifal*. A good voice, though not the finest I have heard recently by a long way. The playing of the band, however, is superb in places.

- ★(a) When the Stars Were Brightly Shining, (b) Strange

Harmony, Joseph Schmidt, 2s. BRDCST 5263A  
Both from *La Tosca*. Schmidt's voice is very fine. I consider this a cheap grand opera record. You should hear it.

## ORGAN MUSIC

- (a) In a Persian Market, (b) In a Monastery Garden, Wurlitzer organ, 1s. BRDCST 795A

Edward O'Henry is the player on the organ that is at Madame Tussaud's. He makes exactly the effects you expect Mr. O'Henry to make when he plays the organ at Madame Tussaud's.

- ★(a) Vision of Fuji-San, (b) By the Blue Hawaiian Waters, Reginald Foort, 4s. COL DX315

I recommend this as being very cleverly done. I think lovers of cinema organs will really enjoy it.

## CHAMBER MUSIC

- ★(a) Piece, (b) Londonderry Air, Leon Goossens, oboe solo, 2s. 6d. COL DB691

This is very charming. Goossens is always well worth hearing. As a piece of light chamber music this should appeal to a good many people.

## LIGHT ORCHESTRAL MUSIC

- ★(a) Bolero in D Major, (b) Spanish Dance in G Minor, New Light Symphony Orch., 2s. 6d. H.M.V. B4046

This is well worth having. Both dances are by Moskovski and are very attractive. Get it on my recommendation; you will not be disappointed.

- ★"Bow Bells" Selection, (d.s.), New Mayfair Orch. 4s. H.M.V. C2342

Quite a good light music selection. Somehow, though, I think the recording not quite as perfect as H.M.V. generally does. On the other hand, there is not much wrong and I have not time to go back and search for defects. Ask to hear it on a good machine.

- ★(a) "Coppelia Ballet"—Czardas, (b) "Coppelia Bal-

let" (mazurka), London Symphony Orch., 2s. 6d. H.M.V. B3941

The mazurka is very charming. I like the other, but I recommend the disc on this side alone. Ask to hear it played through.

- ★(a) Gipsy Idylle, (b) Hungarian Melodies, Constantine Vladescu and his Gipsy Orch., 2s. 6d. H.M.V. B4022

I am glad to have heard it, so to speak; very atmospheric and truly Hungarian in style. Good recording, also.

- ★Irish Waltz Melody, (d.s.), New Mayfair Dance Orch. 2s. 6d. H.M.V. B6094

Quite interesting. It is an education to listen to these Irish waltzes; I had no idea they were so distinctive. I recommend the record; I enjoyed it.

- ★(a) Liebestraume, (b) Prelude in C Sharp Minor, Berlin Philharmonic Orch., 1s. 6d. BRDCST 3141B

A very good and acceptable light music record; the playing—as one might expect from such an orchestra—is good. Ask to hear it.

- Stealing Thro' the Classics No. 4, Overtures, (d.s.), Debroy Somers Band, 4s. COL DX310

The title puts me off, because I cannot conceive why anyone should steal through them. I heard that the I.S.M. sent a protest to the B.B.C. about this sort of thing. I have been protesting for months. I do so again. *Columbia, don't do it!*

- ★(a) Stephanie Gavotte, (b) In Tulip Time Beside the Water Mill, International Novelty Quartet, 2s. 6d. ZONO 6020

Decidedly a good light music record. I think these discs are quite useful. This is very attractive musically.

- ★Stradella Overture, (d.s.), Berlin Philharmonic Orch. 2s. BRDCST 5264A

By Flotow. This makes a very good light orchestral record. The playing is better than the recording as a matter of fact.

- (a) This is the Day of Days (b) Just a Crazy Song, Eddie Peabody with own vocal chorus, 2s. 6d. COL DB702

The noises are strange, but the technique of the player is



Eddie Peabody

amazingly good. I think a good many people will enjoy the banjo, guitar, mandoline, mando-cello, sackbut, psaltery, and all kinds of music. I think Nebuchadnezzar would have appreciated it.

## LIGHT SONGS AND BALLADS

- ★(a) All on Account of Your Kisses, (b) My Sunshine is You, Three Ginx, 1s. RAD 1583

Well up to their high standard. I enjoy them broadcast so much, that I am always sympathetic towards their records.

- ★(a) Changing of the Guard, (b) Carry On, Radio Melody Boys. RAD 1577

This is, of course, very popular—(a) especially. Ask to hear this edition of it if you have not already bought any other. It is quite good.

- (a) In Old Madrid, (b) That's My Song of Love, Norman Lambert, ten., 1s. rd. PIC 879

The songs are moderately good and he sings them rather in the dance-band-voice style. Perhaps that will recommend them, though!

- (a) I've Got a Lump in My

## YOUR CHOICE OF RECORDS—Cont.

Throat, (b) It's a Cold and Frosty Night, Jenny Howard with orch., rs. 6d.

WIN 5416

I am not in love with her voice, which I do not think nearly good enough for recording. As the songs are only moderate, I can see no sense in the record at all. Sorry.

★(a) La Paloma, (b) O Sole Mio, Richard Bouter, ten., rs. 6d. BRDCST 3139A

A fine voice. These two favourites are well treated; both are worth hearing.

★(a) Life is Just a Bowl of Cherries, (b) Guilty, Layton and Johnstone, 2s. 6d.

COL DB711

They are in top form and, therefore, very pleasurable. I always enjoy their records. This is especially good.

Melodies of the Moment, (d.s.), Middleton and Dawson, rs. BRDCST 796B

You can guess the sort of thing—just your favourites in succession. Quite well produced. The accompanying is the weakest part; it is rather rough in places.

★(a) My Heart is Where the Mohawk Flows, (b) The Folks I Used to Know, Paul Robeson, 2s. 6d.

H.M.V. B4052

This is, I think, the best Paul Robeson record I have heard. Admirers of his art should certainly hear this.

★(a) My Mystery Girl, (b) Many Happy Returns of the Day, Layton and Johnstone. COL DB738



Bob and Alf Pearson (see "Songs of Old England," under "Light Songs and Ballads")

(a) Save the Last Dance for Me, (b) My Mystery Girl, Derickson and Brown, 2s. 6d.

H.M.V. B4066

I do not think much of the songs—or the singer either, for that matter. I think H.M.V. can do much better than this.

★Songs of Old England, (d.s.), Bob and Alf Pearson, rs. 6d. BRDCST 3140B

Quite up to their standard, which, in my opinion, is a high one. I think many people will

As good as he always is. The songs are good and he sings them so well. I always enjoy an Elliott record.

★(a) That's Why Darkles Were Born, (b) Sleepy Time Down South, Paul Robeson, 2s. 6d. H.M.V. B4058

He seems to be in good voice. If you have not heard him in either of these I certainly suggest you ask to hear the record. I cannot endure his singing at any price, but that need not influence you!

(a) To the Ends of the Earth, (b) Hold My Hand, Les. Allen, 2s. 6d. ZONO 6025

Both are sentimental sort of songs. He sings them well and his voice records well. The bass of the accompaniment is noticeably good.

★(a) Tramps at Sea, (b) Cuban Love Song, Lawrence Tibbett, bar., 4s. H.M.V. DA1251

Lawrence Tibbett has the touch of a tenor about him. I think his is a very fine voice and the record, though a trifle expensive, well worth having.

(a) Trees, (b) When It's Sleepy Time Down South, John Macklin, rs. 6d. WIN 5420

Two pleasant, quiet sort of songs. The voice is not too good, but it suits the songs. That is something, after all. Ask to hear it and make your own decision. Some of the humming effects are quite good.

(a) Vienna, City of My Dreams, (b) Song of Songs, Broadway Cinema Orch., rs. BRDCST 797B

A good cinema orchestra record, if you want one. I think they play exceedingly well. You know both works, of course!

★(a) What's Gonna Happen to Me? (b) Looking for You, Jack and Jill, 2s. 6d. ZONO 6029

They are always good. I like him better than her in the vocal sense, but both know the business of singing this sort of thing. I think you will like it.

(a) You Didn't Know the Music, (b) A Faded Summer Love, Sylvia Froos.

H.M.V. B4053

You must judge this for yourself. It passes me, as many of this type of record do. You can hear every word, if that is any inducement for you to buy the record. Sorry, I cannot say more.

## MILITARY BAND

★(a) Elephant March, (b) Middy, March, Black Dyke Mills Band, rs. 6d.

WIN 5424

Worth having from the military band point of view. The first, especially, is good.

★More Melodious Memories, (d.s.), Band of H.M. Royal Horse Guards (The Blues), rs. 1d. PIC 878

Quite a good military band record. Of course it is a very good band. I think the price for the record very reasonable.

## SPOKEN RECORDS

(a) Last Trail, W. P. Lipscombe and Michael Hogan, (b) Verdict, W. P. Lipscombe, Michael Hogan, and Mary Newland, 4s. H.M.V. C2340

These are two prize-winning sketches in John O'London's thriller competition. Very good. I think you will enjoy it and be thrilled at the same time. My pen is shaking so that I can hardly write!

## HUMOROUS RECORDS

(a) Down in the Old Churchyard, (b) Charlie's Saxophone, Charlie Higgins, com. rs. BRDCST 794B

Fairly funny! The saxophone is grotesque enough, but the dialogue is not too good. As I say, fairly funny!

Eleven More Months and Ten More Days (d.s.), (f.), The Masqueraders 2s. 6d. COL CB402

Quite entertaining. I like these people, who sing with a good spirit about them. I think, all the same, it is a record to hear before buying. Don't take it on my recommendation, anyhow!

★Rhythmic Eight (d.s.), 2s. 6d. ZONO 6041

Rather amusing and certainly very well played. The voice is very peculiar in tone, but quite attractive. I enjoyed it.

(a) Foolish Facts, (b) Eleven More Months and Ten More Days, Al Bowlly and the Radio Rhythm Five, rs. 6d. WIN 5440

Quite entertaining. I do not know what to say about recommending it as being humorous. It has a certain amount of originality about it.

(a) I'm One of the Old Froth Blowers, (b) Coster's Sister, Nat Travers, rs. 1d. PIC 880

If you like coster comedians, this will suit you, I imagine. Quite good for the sort of thing it is.

More Rhymes (d.s.), (comedy)



Layton & Johnstone (see "My Mystery Girl," under "Light Songs and Ballads")

Excellent—as they always are. I sincerely recommend this as being worth having. There is a finish about their production totally absent from so many of the same type.

★(a) On a Cold and Frosty Morning (b) Joey the Clown, Walter Miller with Harry Hudson's Melody Men, rs. RAD 1582

Very rhythmical and enjoyable from the musical point of view. The recording is also very good.

like this and I unreservedly recommend it.

★Tales from the Vienna Woods, (d.s.), B.B.C. Wireless Chorus with orch. 2s. 6d. COL DB694

Very well produced. A chorus that is drilled for broadcasting is naturally able to record well. This is an instance of it. I recommend the disc.

★(a) Tell Me, Are You from Georgia? (b) When It's Sleepy Time Down South, G. H. Elliott, rs. RAD 1588



# HELPFUL REVIEWS by WHITAKER-WILSON

fox-trot), Ambrose and his Orch. 2s. 6d.

H.M.V. B6123

These things are certainly increasingly popular. Perhaps it is their veiled vulgarity that is their attraction. It is disappointing when you cannot think of the *real* limerick! However—

- (a) *My Rough and Rowdy Ways*, (b) *Jimmie the Kid*, Jimmy Rodgers, 2s. 6d.

ZONO 6022

You must hear this to judge it. It yodels a bit here and there and does some other queer things. I cannot make much of it and I hate the voice!

- ★ *Parson Pleads for Happiness*,



Vivian Foster

(d.s.), Vivian Foster 2s. 6d.

COL DB696

Very good and really funny in places. The "stage parson" is very well done. I can confidently recommend this.

- Puzzle Record, No. 2*, (d.s.), Zonophone Salon Orch. 2s. 6d.

ZONO 6028

This has more than one track. I do not see much puzzle in it, but it is amusing, as all these things are. If you have not already obtained one of these curiosities, you might as well begin here.

- ★ (a) *Resolutions for 1932* (six-eight one-step), (b) *Carry On* (six-eight one-step), Orpheus Dance Band, 2s. 6d.

ZONO 6037

Here is a very jolly record; decidedly humorous and a good tune well played. It will be excellent for dance purposes.

- Rhymes*, (d.s.), White Star Syncopators, 1s. 1d.

PIC 881

A bit dangerous—as all these things are. I am rather tired of vulgar records. Still they seem to be popular. I wonder why!

- (a) *Settin' by the Fire*, Bud Billings Trio, (b) *Wolf at the Door*, Carson Robison, 2s. 6d.

ZONO 6048

Rather a distinctive type of record. Carson Robison, who is new to me, is very attractive in his patter. Do ask to hear this: I think you will like it.

- Volunteer Organist Up to Date*, sketch (d.s.), with barrel organ, 2s. 6d.

ZONO 6032

Quite amusing in a way, but not too good. It is a trifle out of the ordinary, but is not the sort of record one could hear through twice. I had enough hearing it once.

## DANCE MUSIC

- (a) *Bend Down, Sister* (f.), (b) *There's Nothing Too Good*

for *My Baby* (f.), Gus Arnheim and his Cocoanut Grove Orch., 2s. 6d.

H.M.V. B6126

These are both from films. I cannot *endure* the voice, which I think far too harsh and even coarse for recording. Sorry, but I cannot recommend it.

- ★ (a) *Bow Bells—You're Blase* (slow f.), (b) *Bow Bells—Mona Lisa* (quick step), Savoy Hotel Orpheans.

COL CB400

I like the Bow fox-trot very much. Good recording is a feature of this excellent disc. Ask for it.

- (a) *Casey Jones* (f.), Blanche Galloway and her Joy Boys, (b) *Washboards Get Together*, Washboard Serenaders, 2s. 6d.

H.M.V. B6114

This is a "hot" one! I like them cooler personally, but if you are of another opinion, now's your chance.

- (a) *Close Your Eyes* (f.), (b) *When It's Sleepy Time Down South* (slow f.), Bidgood's Good Boys, 1s.

BRDCST 799A

They are *very* good boys! They play expressively and rhythmically at the same time. I like both sides.

- ★ (a) *Close Your Eyes* (f.), Cunard Dance Band, (b) *I Believe in You* (w.), Jerry Hoey and his Orch., 1s. 1d.

PIC 884

This is rather well sung; I recommend it on that account. The waltz is very attractive musically.

- ★ (a) *Faded Summer Love* (f.), *Let's Drift Away on Dream-*



Paul Whiteman

*er's Bay* (f.), Paul Whiteman and his Orchestra, 2s. 6d.

H.M.V. B6116

This band is new to me. It is very good. I think you will find the record useful for dancing, and certainly pleasant as light music.

- (a) *Gully* (f.), Jerry Hoey and his Orch., (b) *Life is Just a Bowl of Cherries* (f.), Cunard Dance Band, 1s. 1d.

PIC 888

The second of these (from *Scandals*) is rather attractive. You probably know it. Ask to hear it.

- ★ (a) *I Don't Know Why* (slow f.), (b) *A Faded Summer Love* (slow f.), 2s. 6d.

COL CB394

The first of these hardly comes into the category of slow records. Still, the fact does not

detract from the excellence of the disc. Ask for it. It is played by the Savoy Orpheans.

- (a) *I Idolise My Baby's Eyes* (f.), (b) *To-night or Never* (f.), Leo Reisman and his Orch., 2s. 6d.

H.M.V. B6115

Of these two I infinitely prefer the second, though (a) has plenty of go in it. I increasingly think the slow fox-trots are the more attractive of the two kinds.

- ★ (a) *It's the Girl* (f.), (b) *How's Your Uncle?* (f.), Bidgood's Good Boys, 1s.

BRDCST 798A

Good dancing tunes both of them. (b) has rather silly words which, really and truly, spoil a perfectly good melody.

- ★ (a) *Jana* (tango), (b) *She Was Seen with Another* (tango), Juan Llossas' Tango Band, 1s. 6d.

BRDCST 3144B

Very well produced. The soloist is not too good, but from any other point of view the record is a good one. I hate the soloist, now I have heard both sides!

- (a) *Just Once for all Time* (f.), Jerry Hoey and his Orch., (b) *For the Sake of the Days Gone By* (w.), White Star Syncopators, 1s. 1d.

PIC 882

The singing is better than the playing in this instance. I am not too keen on any of it.

- (a) *Live, Laugh, and Love* (w.), (b) *Just Once for all Time* (f.), Rolando and his Blue Salon Orch., 1s. 6d.

WIN 5414

These are both from the sound film, *Congress Dances*. Very attractive; the waltz especially. Ask to hear it.

- ★ (a) *Longer That You Linger* in Virginia (f.), (b) *Cuban Love Song* (w.), Ambrose and his Orch., 2s. 6d.

H.M.V. B6121

A typical Ambrose record. I think the waltz, especially, is very attractive. A cheap record, for the actual recording is first class.

- ★ (a) *Mona Lisa* (f.), (b) *You're Blase* (f.), Ambrose and his Orch., 2s. 6d.

H.M.V. B6125

The playing here is much better than the singing. I do wish



Ambrose

I could persuade the gramophone companies to employ good singers for these things. Honestly, when I have heard a couple of dozen of them I come to the conclusion that the human voice is not an artistic device, but a *deadly disease*!

- ★ (a) *My Song* (f.), (b) *That's Why Darkies Were Born* (slow f.), Jack Payne and his B.B.C. Dance Orch., 2s. 6d.

COL CB390

We shall soon be losing him—more's the pity. He is well up to form in both these. I need say nothing further.

- ★ (a) *Rio de Janeiro* (one-step), Teddy Petersen and his Orch., (b) *Long Ago* (w.), Marek Weber and his Orch., 2s. 6d.

H.M.V. B6120

Very well played—(a) I mean; (b) also—but (a) really attracted me.

- ★ (a) *Rio de Janeiro* (one-step), (b) *Joey the Clown* (f.),



Jerry Hoey

Jerry Hoey and his Orch., 1s. 1d.

PIC 885

Well sung and played. Jerry Hoey is generally worth hearing.

- (a) *Rio de Janeiro*, (b) *Lies* (f.), Deauville Dance Band, 1s.

RAD 1584

Quite worth hearing. The recording is not as good as usual, but the blemishes are not serious.

- ★ (a) *Tales from the Vienna Woods*, (b) *Skaters* (Les Patineurs), Commodore Grand Orch. and organ, 1s. 6d.

WIN 5421

A good band. The music is also quite attractive.

- ★ (a) *That's My Desire* (f.), (b) *Lies* (f.), Jack Harris and his Grosvenor House Band, 1s. 6d.

BRDCST 3143B

Worth having—if you do not already possess records of either dance. Well played and sung.

- ★ (a) *Tom Thumb's Drum* (novelty f.), (b) *Magic Notes*, Deauville Dance Band, 1s. 6d.

WIN 5415

These novelty fox-trots are very entertaining and very jolly to dance to. They have some *life* in them. Ask for this.

- ★ (a) *Under the Spell of the Waltz* (w.), (b) *Carry On* (six-eight one-step), Ambrose and his Orch., 2s. 6d.

H.M.V. B6124

The one-step is good enough to buy this disc for; it is well played, some of the orchestral effects being quite novel.

- ★ (a) *You Call it Madness* (slow f.), (b) *I Apologise* (slow f.), Jack Harris and his Grosvenor House Band, 1s. 6d.

BRDCST 3142B

These slow fox-trots attract me far more than the quicker ones. I think these are splendid. Jack Harris's band is decidedly improving.

# Long-playing Records

THERE have been several recent references in the press to the new "long-playing" records which the Victor Co. have produced in America, and it may be of interest to explain just what are the technical and commercial difficulties that have for so long delayed the marketing of such records, though they have been made in the laboratory for years.

It is obvious that if the outside

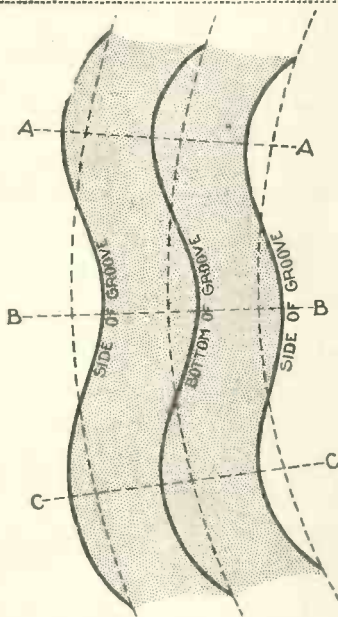

Fig 1.—Track of needle in groove as it would appear if highly magnified

and inside diameters of the track are fixed, there are just two ways of making the record play longer: more grooves per inch width, so making a greater total number of turns in the record, or slower turns per minute, which makes the same number of turns last longer.

## Commercial Limitation

The greatest difficulty up to now in adopting either of these two methods is the commercial one: that all records must be suitable for playing off with the ordinary soundbox. The soundbox is (or, at least, is meant to be) a "constant-velocity" device.

Imagine that Fig. 1 is a highly magnified view of part of one

## Technical and Commercial Prospects

groove in a record. If there were no sound recorded on it, it would be part of a circle, as shown by the dotted lines. Actually, it is wavy, with the result that in one "cycle" of the note the needle is moved sideways from *A* to *B* and back to *C*.

Suppose the note is of 1,000 cycles pitch, and that the sideways distance moved in going from *A* to *B* is one thousandth of an inch, then the needle is moved a thousandth of an inch in half a thousandth of a second, or its velocity is 2 inches per second.

But suppose that the note is only of 100 cycles pitch, with the "wave" the same width as before. Then the needle would move one thousandth of an inch in half a hundredth of a second, or two tenths of an inch per second—only a tenth of what it was before. So to get "constant velocity" the wave of the groove must be made ten times as big (that is, one hundredth of an inch) at 100 cycles as at 1,000.

If, then, the lower the note the wider must be the wave or wobble of the groove to get the same loudness, we see that if we want to cut down the whole width of the groove to get more grooves per inch, we may get into trouble in reproducing the bass notes.

In actual practice, even present-day records are up against this difficulty; the wobble is at the danger point at 150 cycles, and for all notes below that the strength has to be artificially reduced.

Now consider the high notes. If the inside groove of the track is about 5 in. diameter, the movement of the groove past the needle will be 15 in. per turn, or if the record does 80 turns per minute, its speed past the needle will be 20 in. per second.

So if we want to record a 5,000-cycle note, one "cycle" (that is, *A* to *C* in Fig. 1) will be twenty five thousandths or four thousandths of an inch long. If we run the record slower, the "cycle" will have to be

correspondingly shorter. But if we make it too short we are in the difficulty that the needle-point itself will be as big as the wave!

So this sets a limit to the top frequency that can be played at any given speed, and in practice 5,000 cycles is about the limit for ordinary records and needles.

## Bass and Treble "Cut-off"

So we see that our only two methods of getting longer playing have the effect of giving "cut-off"—one in the bass and the other in the treble. I have not myself heard the new Victor records, but accounts at second-hand say that the quality is not up to that of standard present-day records, and I gather that there is loss at both ends of the scale: the records apparently both run slower and have closer grooves.

There is, however, a much better way of attacking the problem, if only we do not insist on having the long records playable on the ordinary soundbox. We can arrange the recording gear to give "constant amplitude," that is to make the width of the "wave" in the groove the same for equal loudness at all frequencies.

When we reproduce electrically it is easy to arrange that the pick-up circuit will put matters right so that the final result is just like that of a "constant-velocity" or ordinary record with an ordinary pick-up circuit. Further, with electrical playing we can arrange the amplifier to give rather more magnification at the very high frequencies to compensate for any cut-off due to slower playing.

I have heard records made and played in this way three years ago, that give over half an hour's playing, with *better* quality than the ordinary present-day record.

Why, then, aren't these on the market? For commercial reasons. Long records *don't pay*. They are naturally only needed for fairly serious music, and the records that pay are dance records and so on.

P. K. Turner.





*More Light :: U.S.A. Wireless :: Pre-recorded Programmes :: A Wireless Party :: Green and Gold :: Home Museums :: Set Descriptions*

**More Light**

WELL, here we are once again with winter nearly over and spring actually in sight! How do you feel about this very welcome change this year? I am more than usually glad because this last winter has seemed to me to have been an abnormally dark winter, and I welcome the change to longer and brighter days.

Wireless has its two distinct sides, listening and constructing. Winter is a great time for listening, but it is not the best time for constructional work. At least, it is not so for me, for I do like a good light when I am building or altering a set.

Daylight in winter is never very good, and artificial light is rather trying for close and careful work. Hence, because I have a lot of interesting constructional work on hand and in view, I am very happy indeed that the dark days of winter are now giving place to the lighter days of spring.

The most difficult piece of con-



*When I am building or altering a set*

structional work I had to do this last winter was to repair the suspensory wire of a moving-coil galvanometer. The instrument was one

I sometimes use in wireless work, and the delicate wire by which the coil was suspended had broken.

It was a hard task indeed to solder together the two sections of this fine wire in the poor light of a gloomy winter afternoon, but I eventually did it, more by good luck than anything else.

I shall remember that piece of repair work, and next time I have a similar task to do I hope it will be in the better light of spring or summer.



**U.S.A. Wireless**

We can sympathise with our wireless friends in the United States of America over the trying and uncertain time through which they are passing, for we have had our period of anxiety as to what the effect of intense trade depression would be on wireless.

With the finances of the nation growing steadily worse, the Government of the United States is looking round for new sources of revenue, and it seems possible that wireless will have to make some contribution to the national need.

The payment of an annual fee of ten shillings for a wireless licence has become such an established thing with us that we should expect any country desiring to raise money from wireless to adopt a similar scheme. Yet a wireless-licence scheme seems to be about the last kind of scheme the United States will adopt.

One scheme proposed for the raising of money from wireless in the United States is a tax to be added to the selling price of a set. Another scheme put forward is an



*The raising of money from wireless*

“internal tariff” of 10 per cent. on all sets and components. It is easy to see why the wireless manufacturers of the United States are opposed to these two schemes.

A third scheme proposed is a tax on the fees received by broadcasting stations for “selling time on the air” for advertisement purposes.

When we read of these, and other such schemes, we cannot help but realise that, in our own country, we have the simplest and least irksome method of raising money from wireless.

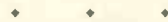

**Pre-recorded Programmes**

What difference would it make to us if the pre-recording of programmes took the place of, and put an end to, simultaneous broadcasting? Would the quality of our reception be improved, or would it not? Since there is a distinct likelihood of such a thing happening, the point is worth consideration.

*Halyard's Chat on the Month's Topics*

## UNDER MY AERIAL—Continued

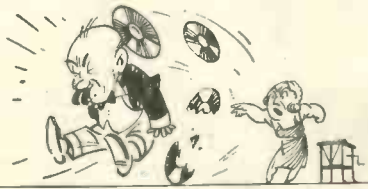

Gramophone records are being broadcast

Under our present system of simultaneous broadcasting, music or speech in one studio is sent over telephone lines to other broadcasting stations and is there transmitted by wireless. Under a system of pre-recorded programmes the different items are recorded electrically beforehand. Copies are made of the records, and these copies are sent to the different stations to be transmitted simultaneously at the time arranged.

The one great advantage of pre-recorded programmes is that it does away with the use of long landlines, which cause so much distortion. Another advantage is that the pre-recording system is cheaper than our present simultaneous-broadcasting system.

From the experience of American listeners, it can be said that we should never know whether a programme was pre-recorded or spontaneous. That may be so, but there is a psychological effect to be considered.

We should not object to pre-recorded programmes if we were always told just beforehand when an item was pre-recorded, but I think we should have a right to object if we were not told beforehand when a pre-recorded item was used. After all, a pre-recorded item would be little more than a gramophone record, and we are always told when gramophone records are being broadcast.

George is in favour of pre-recorded programmes. He says if ever he broadcasts again it will be pre-recorded stuff, so that he can listen to his stuff at home and have the satisfaction of saying at the end:—

“That was me, that was.”

### A Wireless Party

Have you ever had a wireless-reception party? It isn't at all a bad idea. You invite a number of your special wireless friends to your house to listen to your reception of

some particular programme or station, and you note your friends' criticism, not of your set—oh, no!—but of the transmission and programme received.

The last wireless party George and I gave—at my house, naturally—was on the occasion of the big American relay. We had an exceptionally good time, and all the enthusiasts there were unanimous about one thing—the wonderful quality of the relay.

Somebody's ears must have tingled at the B.B.C. that night, judging by the complimentary things said about the way the relay came through to us.

My friends, however, were far from being unanimous about the American star performers. Indeed the comments on most items varied from “very good” to “rotten.” All of us thought our own British programmes far superior to the American programme.

George was fairly quiet for him that night. When a sound of bubbly morse broke in on the second item of the American programme he remarked that somebody would be sweating acid trying to tune that out at the B.B.C. end.

After my wireless friends had dispersed, George said to me:—

“You might have gone one better over the supper, old man.”

“In what way, George?” I asked.

“By giving us an American supper of hot-dogs and sundaes to create the right atmosphere for your American reception.”



A Radio Paris night with white wine

“There's an idea in that for the future, George. Why not a Radio Paris night with white wine and French beans?”

“Or a Trieste night with a supper of spaghetti, not the resistance type, macaroni and vermicelli?”

Think out a wireless supper of this kind for yourself and give it to your wireless friends on your birthday.

Good idea—what?

### Seven Metres

I expect, like me, you are devouring every bit of news that comes through about the 7-metre transmitter of the B.B.C. This new and rather startling departure in transmitters has passed its test and may soon be actually in use.

What intrigues me most about these 7-metre transmissions of the B.B.C. is the type of receiver needed for reception. Can high-frequency amplification be employed on such a low wavelength? Are there coils in a 7-metre receiver, or do a couple of parallel wires take the place of the usual tuning coil?



The human body reflected wireless waves

Reception on 7 metres fairly bristles with problems, known and unknown, doesn't it?

I wonder if waves of 7 metres in length will be absorbed or reflected by such things as hills, trees, and houses. If the railway at the bottom of the garden comes between you and the 7-metre transmitter of the B.B.C. will reception be cut off every time a train passes?

A few years ago I read in an American magazine an article describing experiments carried out to show that the human body reflected wireless waves of very short wavelength. I forget the actual wavelengths, but I hope that 7-metre waves will not play the same tricks with us.

### Green and Gold

“Here's a bit of wireless information which you may have missed, George,” I said to my technical adviser during our usual nightly discussion last night.

“What is it about,” asked George.

“Broadcasting House,” I replied.

“The last thing you told me about Broadcasting House was that they had bunged a barrel organ in the effects studio.”

“George, I never——”

“Just previous to that you told



# HALYARD'S CHAT on the MONTH'S TOPICS

me that somebody or other in the world of science had produced, by Mendelian methods, a silent breed of cats to keep down the mice which had followed the B.B.C. from Savoy Hill."

"Look here, George——"

"You also told me that you had read in the B.B.C. Year Book for 1932 that the staff of Broadcasting House needed a thousand gallons of hot water to wash themselves before they went home at night."

"The little bit of information I am trying to get in edgeways, George, concerns the new offices in Broadcasting House."

"Well, what is it?"

"A number of the new offices in Broadcasting House have been decorated a striking shade of green."

"Sure it isn't pink?"

"Quite sure, George. The paragraph distinctly states a striking shade of green."

"All that I can hope, then, is that there is nobody on the office staff of the B.B.C. with a striking shade of red hair."

## In the Village

Years ago, the way to spend an idle hour in the village was to go to the blacksmith's forge, watch the blacksmith at work on his many and varied tasks, and listen to the music of his anvil. The modern equivalent



Find the Village Wireless Shop

is to go to the village wireless shop, watch the local mechanic at work, and listen to the music of the sets he is repairing and testing.

I know, because I have just returned from spending an idle hour in this way in the village in which I am staying this week-end. It has been a delightful hour, and one I would not have missed for a great deal.

My excuse for entry into the village wireless shop was a need for a 5-megohm grid leak. I thought this was rather a neat excuse, but the village mechanic very nearly



Hot water to wash themselves. (See first column)

sold me a couple of 2-megohm grid leaks and a 1-megohm leak, together with the necessary holders.

I turned the conversation from the danger point by expressing admiration of a manufacturer's five-valve set of handsome appearance.

After this initial sparring I managed to make friends with my village mechanic. I stayed with him while he told customers what was wrong with the sets they had left for repair, and I heard the repaired sets demonstrated. I also watched him attack the problem of a five-valve portable set in for repair, and I admired the quick way in which he found the faulty valve.

If ever you find yourself with time on your hands in a village, don't go round looking for the blacksmith's forge. Find the village wireless shop instead, and you'll be all right.

## Home Museums

Whenever I read of a gift of early and historic wireless apparatus by one of the famous pioneers to a big museum, I wonder how those pioneers can bear to part with their old apparatus.

Have you a collection of old apparatus in your house? Junk is the name generally given to such a collection. If you have, would you willingly give away those early relics of treasured and honoured memory? I daresay somebody else in your house—your wife, for example—would most cheerfully give away the whole lot; but would you yourself?

Like every other old experimenter, I have a noble collection of ancient apparatus. Although these old sets

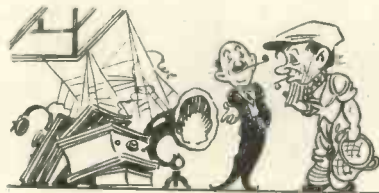

A noble collection of ancient apparatus

and components will never be used again, I should not like to part with them. Why? Oh, sentimental reasons very largely!

Sometimes I spend an hour or two going over my home museum—or junk heap, if you like—and I do enjoy being taken back into the past by those old bits of apparatus. If I were to sort out my old junk in order of date, I think I should have a pretty good record of progress for more than a decade.

Certain of my old exhibits might make others smile, but they make me feel jolly thankful for the progress wireless has made, and for the way our early difficulties have been overcome by the ingenuity of our manufacturers.

## Set Descriptions

When you come across a description of a manufacturer's set in

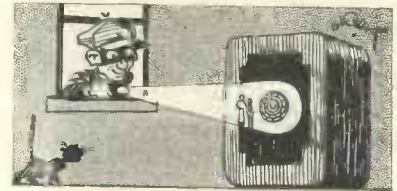

I always wanted to try that combination

"Wireless Magazine," do you glance casually through it or do you read it carefully? I have made a point recently of reading these descriptions most carefully and, in consequence, I have learnt a great deal of modern progress in design and performance.

The first thing that interests me in the description of a manufacturer's set is the circuit used. I like to know how many stages of high-frequency amplification are used, and I like to know the type of high-frequency amplification employed. Then I like to know what sort of an output circuit is used, and whether the loud-speaker is of the moving-coil type or not.

Another little point which interests me is the types of valve used. Sometimes the three, four, or five valves employed in the set are all of one make. At other times the valves selected form a combination of two or more makes of valve. I always wonder why such a combination has been decided upon, and I always want to try it myself. *Halyard.*

# EXPLORERS' ELECTRICAL RECORDING



**A MOVABLE MICROPHONE**

Here you see the recording microphone attached to a belt, so that it can be moved about. Just the thing for running commentaries in the jungle!

**T**HE explorer of to-day undertakes many tasks which his predecessor, even ten years ago, would have been unable to face. Not content with his scientific data and photographic records, he tries to bring back a glimpse of the strange lands he has been visiting in the form of records of their landscapes, animals, and men.

## Records of Animals and Humans

The Schomburgk expedition, which has left recently for Central Africa, has a particularly ambitious programme of this kind. Records of animal and human voices will, for instance, be given a paramount place, both for separate reproduction and as an acoustic accompaniment of moving pictures.

Inasmuch as no simple and easily transportable recording outfit had so far been

available, the Siemens and Halske people were asked to develop one for this purpose.

The entire installation of a gramophone-record works had to be condensed into a limited number of easily transportable boxes, without, however, impairing the quality of reproduction.

Moreover, rough handling and the influences of tropical

**A STAND MICROPHONE**  
This is a stand microphone for making recording announcements

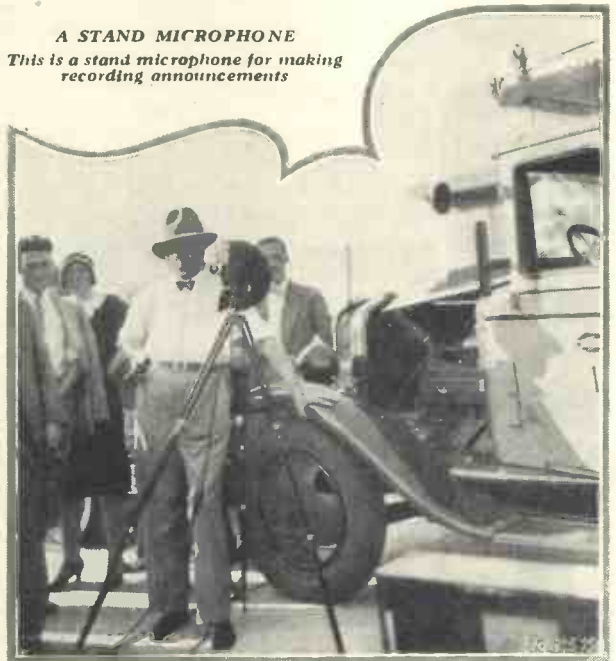

**ONE OF THE EXPEDITION'S CARS AND THE RECORDING EQUIPMENT**  
All the parts of the special recording equipment used by the Schomburgk expedition in Central Africa can be packed into transportable cases

climates, of course, raised particularly exacting requirements as to the substantial construction of the apparatus. A recent demonstration in the outskirts of Berlin showed that the ultimate design is perfectly successful.

The plant comprises a recording microphone (on the Siemens band principle), a



1.5-watt amplifier, a cutting device, and the necessary sources of electric current. To this were added a number of spare parts, records, a portable gramophone, and a cable drum for the microphone conductors. All these parts are accommodated in ten substantial boxes, each of which is readily carried by one or two men.

#### Proof Against Insects

The microphone is encompassed by a special protective device destined to prevent any insects from penetrating into its interior, when left to itself in tropical forests, etc. The microphone cable, being 200 metres long, enables any animals to be listened to, even when outside the camp. Headphones have been provided so that the microphone may be checked from the camp.

Special batteries will supply current, their capacity sufficing for a continued operation of about twenty-five to thirty hours, after which they have to be recharged from a Bosch generator coupled to one of the engines of the motor-car.

A special material, resisting the effects of tropical climates (and pro-



ANOTHER VIEW OF THE RECORDING EQUIPMENT

Note the recording desk and portable gramophone on the right. Records can be played back as soon as they have been made

ected by a special wrapper) had to be chosen. Records are cut direct without the intermediary of any matrices, as used in the wax-disc process. Moreover, records can be played immediately, thus enabling them to be checked and replaced

on the spot in case of failure.

Finally, there is a possibility of manifolding any records, an electric pick-up having been provided in connection with the cutting machine. In fact, up to fifty copies can be prepared of every record. A. G.

## Using A.C. Sets on D.C. Mains

IN spite of the fact that a good proportion of the electricity supplies in this country are still D.C., most of the expensive sets produced this year are for A.C. mains. But there is no need for D.C. mains users to forgo the advantages of these new A.C. sets if some form of converter is installed.

Such a plan will appeal only to the prospective buyer of a luxury set who is not averse to spending an extra £10 or so to get the very best. In general, it may be said that a first-class A.C. mains set with a suitable converter will be capable of better results on a D.C. mains supply than a set specially designed for D.C.

#### Research Work on A.C.

This is because most of the research work on mains sets has been in connection with A.C. models. And it is a fact that D.C. mains working is more difficult than A.C.

A converter of the M-L type, made by Rotax, Ltd., will enable any good A.C. set or radio gramophone to be worked with entire

satisfaction from a D.C. supply.

There are no inherent snags in this plan, but when installing a converter it should, if possible, be as far removed from the set, and the room in which the set is to be used, as possible. Two sources of annoyance may otherwise be set up—the mechanical noise of the converter and the high-frequency radiations from the make-and-break contacts.

The noise caused by the running of a converter such as the M-L is not likely to be heard at more than a few yards distance. And if the converter is installed at a fair distance from the set the high-frequency interference, manifested as a crackling or buzzing background in reception, is not likely to be heard.

#### Use of Filter

A suitable filter between the output of the converter and the set will stop all trace of D.C. from getting into the set. If there is any high-frequency interference it can usually be stopped by totally enclosing the converter in a copper-lined box, and shielding the wires from converter to set.

With these simple precautions, the converter will enable the latest A.C. sets, as, for example, the 1932 A.C. Super 60, to be run from any D.C. mains supply. Many listeners will probably be prepared to go to the expense of a converter rather than put up with the alternatives, either a battery-operated set or a not very satisfactory D.C. mains set.

You will enjoy reading this enlarged number of "Wireless Magazine." Next month's issue will be equally interesting. Make a note of the publishing date — Wednesday, March 23. It is advisable to order from your newsagent in advance to make certain of getting your copy.

HOW TO  
RECOGNISE



TESTING AT THE VATICAN STATION

This photograph shows the Marchese Marconi (with phones) testing out the apparatus at the Vatican broadcasting station.

# The Voice of Italy

Exclusive to WIRELESS MAGAZINE  
by J. GODCHAUX ABRAHAMS

"E.I.A.R." have themselves been abbreviated to two sounds approximating "Eh yah."

The native names of foreign cities are not always those used by foreigners and those of the broadcasting cities of Italy in their own country may be spelt phonetically:

*Roam-ah, Nar-polly* (Naples), *Mee-lar-no* (Milan), *Tor-ee-no* (Turin), *Tree-ess-tay* (Trieste), *Djenn-owe-va* (Genoa), *Fear-en-zay* (Florence), *Pal-air-mo* (Palermo) and *Bol-zah-no* (Bolzano). As you will see from the above, Florence on its native soil bears a totally different name.

Now for the announcement. *Arb-ee-yah-mo trans-mees-see-yo* (We have

transmitted) *atto pree-mo* (the first act) *dell'Opera* (of the opera) *Madama Butterfly di* (of) *Puccini*. Don't forget, however, that the *U* in Italian is our *OU* and, consequently, that "butterfly" suffers a slight alteration. Also the composer (*Pooch-ee-nee*) may be given his title of Maestro (*My-stro*) signifying not only Master, but a great teacher, director or artist.

Italian is one of the Romance languages derived from Latin and in its purest form adheres more closely to its mother tongue than any of the others, such as French, Spanish, Portuguese or Roumanian. For this reason it is more easily understood than its sisters by those of us who still recall their *amos, amas, amat* of their early schooldays.

### Strange Sounds

But our ears must get accustomed to these strange sounds and a course of nightly listening to the Italian stations will considerably assist.

It is, perhaps, fortunate for us that in every instance—without any exception—the Italian studios have selected as announcers officials whose enunciation is almost perfect and, moreover, a further advantage, in my opinion, have chosen women whose voices are peculiarly suited to microphone requirements. Nor are they niggardly in their calls; you will hear them regularly after every item in the programme.

### Typical Broadcast

Now, suppose we follow a typical broadcast. As a rule, between the acts of an operatic transmission or play, the interval is filled up by items of news; we may hear a "giornale radio," namely, an oral newspaper similar to the French "journal parlé"; or perhaps some "Note finanziarie e commerciali" (financial,

CRASHING chords from the orchestra, a burst of cheering from a full-throated audience, followed by an announcement in a feminine voice: "Eh yah! Radio Roma-Napoli. Abbiamo trasmisso atto primo dell'Opera Madama Butterfly di Puccini."

Did that puzzle you? As the daily help might say: "It didn't oughter!" for if the words were clearly heard—and the enunciation of Signorina Maria Luisa Boncompagni is exceptionally good—the sense, at least, of her announcements should be plain to you.

But let us presume it was not as, after all, that is the aim of the present article.

### Semi-official Station

At the outset, bear in mind that the Italian stations are run by a semi-official body or corporation blessed with the extensive title of Ente Italiano Audizione Radiofoniche. It might be literally translated as the Italian entity of "radiophonic auditions," which to us is a somewhat roundabout way of designating radio broadcasts.

The announcer could not be expected to repeat such a mouthful at frequent intervals and therefore for practical purposes the initials

### LISTEN FOR THESE ITALIAN STATIONS

Wave-length	Call	Station
19.84	HVY	Rome (Vatican)
25.4	3RO	Rome
26.7	1BXX	S.Y. "Elettra"
80	3 RO	Rome
247.7	—	Trieste
273.6	—	Turin
312.2	—	Genoa
318.8	—	Naples
331.5	—	Milan
368.1	—	Bolzano
441	—	Rome
501.7	—	Florence
541.5	—	Palermo



stock-exchange and commercial notes).

Possibly between items or, as the announcer may state, "nell' intervallo," the listener will pick up "Rubrica della Moda" or a review of fashions so dear to the ear of all female audiences.

Turin has lately introduced a new feature in its daily broadcasts, the radio physician and in the "consiglio del medico" (or, as we can clearly see, the medico's counsels) a diagnosis is given and a remedy offered for ailments of which the symptoms described by patients have been sent to the studio. Obviously, such a service is destined more to outlying country districts than to the immediate suburbs of a city.

### News Bulletins

Then, in the official news bulletins we find several headings such as "Notizie dal Interno" (home news), "dal Estero" (from foreign sources) or "Notizie sportive" (sporting items), which may also be announced as "avvenimento sportivi." Compare this with the French "événements sportifs" (sporting events).

Again, during intervals in musical transmissions, we may be given a talk, usually referred to as a "conversazione," which might deal with new books ("libri nuovi") or a chat on general topics ("da vicino e da lontano" (from near and afar).

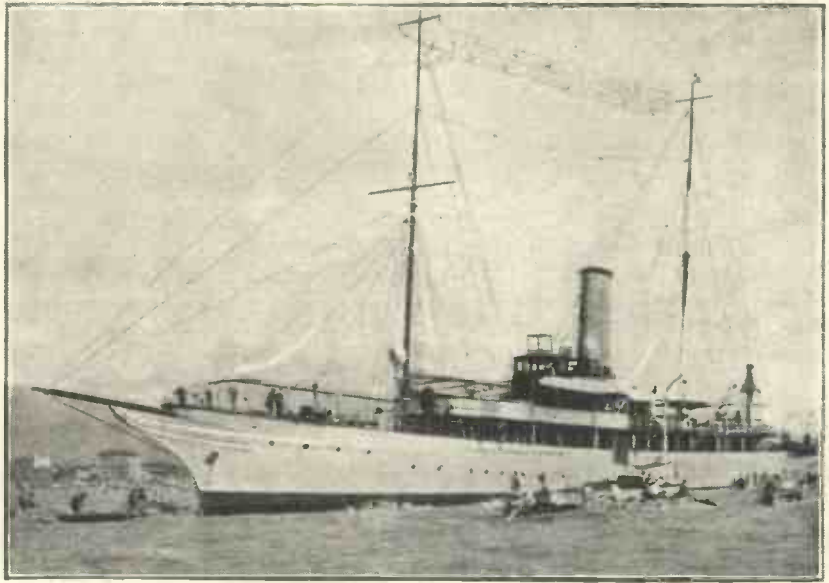

THE "ELETTRA" IN SUNNY WATERS

A happy snapshot of the Marchese Marconi's yacht "Elettra." It is used for a great deal of radio experimental work

A regular feature from most Italian studios is a review of the latest plays under the title "Notiziario Teatrale" or of the more recently produced talkies ("cinematografica") or even a more general discourse on "la vita letteraria ed artistica" (literary and artistic matters).

Recitals of gramophone records figure largely in the day's programme, especially from Trieste, Turin and Palermo, and you will know what to expect if you hear the words "tras-

missione dischi grammo-fonici," which is sometimes camouflaged as "musica varia," needing no translation.

Although familiar to you under another guise, you may be puzzled by the words "La Voce del Padrone" which follow what is obviously the number of a record played; it is only an Italian way of saying "His Master's Voice," but there is a true operatic flavour about it!

### Musical Transmissions

In musical transmissions you will experience little difficulty in translating the announcements. "Concerto strumentale e vocale" does not need an explanation and qualified by, for instance, "diretto dal Maestro Enrico Martucci," indicates that it will be conducted by the signor in question. "Musica religiosa" is equally clear, as also is "musica da camera" (chamber music). "Serata di varietà" coincides with the B.B.C. vaudeville evening.

In the earlier part of the main entertainment a portion of the programme is devoted to "dopo lavoro" signifying "after work;" it consists either of short entertaining talks or light music ("musica leggera"); in fact, anything which may be considered appropriate to while away half an hour or so before the news bulletin is transmitted.

### Time Signals

Special mention must also be made of the distinctive manner in which the daily time signals are broadcast.



RADIO AT THE NEW VATICAN CITY

A view of the magnificent building for the new Vatican City radio station. It is used for world-wide broadcasts

## THE VOICE OF ITALY—Continued

So far the Italian stations have not adopted the conventional six "pips"; but still continue to give out the time verbally.

At 7.29 G.M.T. the speaker will say: "Radio Roma-Napoli. Fra poco il segnale orario" (shortly, the time signal) followed by a longer announcement, namely: "Attenzione al segnale orario delle ore venti e trenta" (pay attention to the time signal at twenty thirty).

### One Hour-Fast

After this preliminary warning the speaker, with her eyes on the studio clock, gives out the passing seconds in this manner: "Meno cinquanta secondi" (less fifty seconds), "meno quaranta secondi, trenta, venti, dieci, cinque, quattro, tre, due, uno," with a final stroke on a gong. "E stato il segnale orario de venti et trenta" (that was the 8.30 time signal). When you hear it, however, remember that standard time in Italy is one hour *fast* on Greenwich Mean Time.

Should an opera or operetta be broadcast, so you will hear the names of the singers or actors in the cast, as for instance: "El dramma lirico in 4 atti" (the lyric drama in four acts) with, as "interpreti" the usual soprano, mezzo-soprano, baritone, tenor and bass. Special mention may be made of the "Maestro del coro" (chorus master) and, of course, of the "Maestro Concertatore" or "Direttore d'Orchestra"; in some instances both titles are given if he is an important person.

In the foreign news bulletins you may pick up frequent references to "Londra" (London) or "Isole Britanniche" (British Isles), "Parigi" (Paris), "Berlino" (Berlin), "Stoccarda" (Stuttgart), "Monaco" (Munich), "Lipsia" (Leipzig), "Stoccolma" (Stockholm), "Colonia" (Cologne) and so on. Under their Italian disguise it is not always easy to recognise familiar names. Perhaps a few words regarding the calls when stations are testing may also prove useful.

### "Pronto"

Sometimes in the late hours of the night when twirling the dials you may hear the word "Pronto" frequently repeated. "Pronto" is equivalent to "Ready, stand by," and is given out to attract the attention of listeners.

Possibly by the time these lines

are in print you may have logged tests carried out by the new Florence (Radio Firenze) station. Similar to those carried out by Trieste when that station took the air, you will have heard "Prove tecniche di trasmissione (technical transmission tests) Stazione di Firenze." "Pronto" as a rule immediately precedes the name of the station.

Finally, all Italian studios close down at night and sign off with the

conventional "Fine della trasmissione" (end of broadcast) and the lady announcer extends her good-night greetings to all: "Buona notte a tutti."

On occasion it may take the form of "Signore e Signori, Buona Notte" (Ladies and gentlemen, good night). A few bars of the "Marcia Reale" (Royal Anthem), the Fascist hymn ("Giovinezza") and the stations go off the air.

## Hungary's Plans

**I**N view of the activity displayed by its immediate neighbours, namely, Austria and Czecho-Slovakia, the Telefono Hirmondo Broadcasting Company has decided to reorganise completely its radio system. The scheme calls for a number of transmitters and the constructional programme is to be completed within two years.

As a first step to an improvement in the service, Budapest is to be endowed with a super-power station to be installed at Lakihegy, within easy reach of the capital.

A contract has already been placed for the supply of the plant with the Hungarian branch of the International Standard Electric Corporation, which has undertaken the construction of a 175-kilowatt transmitter of the most modern type comprising a giant output valve of 130 kilowatts. It is also stated that the aerial masts

will be of a pattern new to Europe.

To act as relays of the capital programmes three 1.8-kilowatt regional stations are to be built at Pecs, Magyarovar, and Miskolcz with, in addition, an 8-kilowatt transmitter at Nyiregyhaza. Although the wavelengths of these stations have not yet been definitely fixed it is expected that at least three of them will use a common channel, the fourth working on 210 metres (1,430 kilocycles) a wavelength already allotted to Hungary.

### On the Short Waves

As the authorities are anxious that the broadcasts should be heard by nationals residing in foreign countries and in particular, in the United States of America a special short-wave station will be simultaneously erected at Szekesfehervar.

*Gridda.*

## THE WIRELESS ZOO

The Set-ter

*The homemade Set-ter is a pup  
Who simply ought to be chained up;  
He strews his "bones," the Parts about,  
Then snaps "you'll tread on them, look  
out!"*

*We find Transformers on the stairs,  
Ebonite Panels in the chairs.*

*He makes his Set, at least he tries,  
Then snarls with anger and surprise  
When it won't work, for at the start  
He left out some important Part!*

LESLIE M. OYLER



Modern Standards of Quality

Whitaker-Wilson Visits P. K. Turner and Learns

## WHAT QUALITY MEANS

NO doubt most of you read the brilliant article by P. K. Turner on "Modern Standards of Quality" in the December "Wireless Magazine." That article interested me profoundly. It also settled one or two points upon which I was doubtful.

You who read these words may safely assume that your knowledge of wireless and mine are incomparable, by which I mean yours is very much the greater.

Perhaps you think that I have been quite long enough associated with "Wireless Magazine" to have assimilated a little knowledge? If so, I respectfully disagree with you.

I have found it a better plan to let my sense of musicianship be my guide and to judge by results in terms of artistry rather than attempt to examine in detail the causes of the various effects.

Finding that Mr. Turner's article was in no way too technical for me; and being deeply interested in acoustics and sound-production generally, I studied it carefully.

The question of notes of low frequency has naturally interested me because I am an organist. I think I have mentioned before that I was one of the very first to broadcast the organ in 1924, in days when the reproduction of either low notes or very loud ones was attended by considerable difficulty.

**Research Work**

I actually made the first organ record in this country and spent several months, on and off, in researching for H.M.V. on this very question of the reproduction of notes of low frequency.

Until I read Mr. Turner's article I admit I have been inclined to trust my own ears and to persist that what I have heard I *have* heard, despite

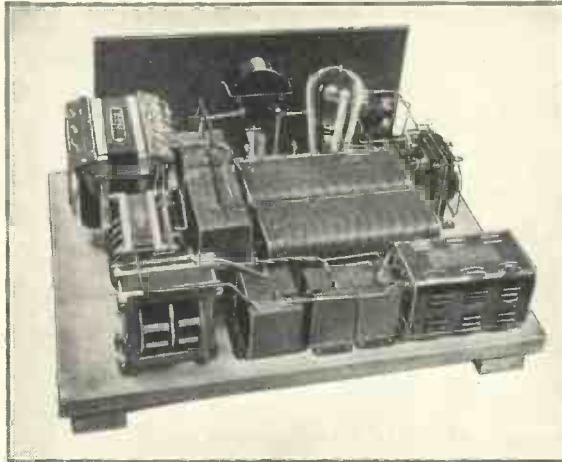

**AN AMPLIFIER FOR REAL QUALITY**  
This is P. K. Turner's A-quality amplifier, which gives an undistorted output of 5 watts. The construction is fully described on page 211 of this issue

the protests of my technical friends who have done their best to persuade me that the fundamentals of notes below a certain frequency *cannot* be heard.

I have always taken this to mean *heard through a loud-speaker*, and in any case I have found myself arguing that my ears have been the final judge and that if I have only heard the note by way of its harmonics *the pitch must have been altered*.

After having visited Mr. Turner and studied his article, I have become more docile in the matter and have been brought to see that even if the fundamental *is* missing the question of pitch is *not* affected.

I have no doubt some of you may have realised this all along, but you must forgive a musician for using his faculties and for refusing to take things for granted.

As a point of stern fact I happen to be one of the earth's unfortunates; I am cursed with Absolute Pitch.

In case you do not know what that is, I will tell you. Providence seems to shower the sense of Absolute Pitch here and there amongst those who are naturally musical and sometimes amongst those who are not.

As far as I can see, the so-called

gift has nothing to do with the faculty of music proper; this must be so because I know many first-rate musicians who do not possess it in any degree.

So that I am not suggesting that you regard me as any sort of genius merely because at three years of age, when somebody struck a note on the piano and named it, I recognised it for ever afterwards. I merely state the fact as a fact; I have not the least idea how it came about.

All I know is that ever since then I have always been able to pitch a note when I want it; to tell without the least effort what

key a work is being played in, and even to carry difference of pitch in my mind for extended periods.

This knowledge of pitch—such as it is—rather makes me inclined to wonder if Mr. Turner is right in saying that a youngster is able to detect notes of higher frequency more easily than older people.

**High Notes**

I have made no test of my own powers in that respect. I understand, from what ornithologists say, that the birds can detect higher notes than we can. I do not know how that conclusion has been arrived at or even if it is true; so far as I am concerned they are welcome to the high notes. I hate very high notes.

On the other hand—and this is where I question Mr. Turner, with all due respect to his powers, of which I have the highest opinion—I *know* that my own ears are keener now than they were only a year ago.

I have pointed all this out because I want to make it clear that when one's sense of pitch is so-called *absolute* one *does* take a bit of persuading that fundamentals cannot be heard.

On the other hand, I feel that if

## WHAT QUALITY MEANS—Continued

Mr. Turner is right in asserting that the pitch is not thereby altered and that nothing in the ear can correspond to a frequency of, say 20 cycles, I am content to concede the point to him, the more so because of an experience which I will here relate.

Not long ago I had the pleasure of playing for some time on the new organ in the Albert Hall. On the pedal organ there is what is termed a 64-ft. stop. For those who are not organists perhaps I should make it perfectly clear what that is.

### A Normal Stop

An 8-ft. stop is what we can call normal. On a stop of that pitch the low C has a frequency of 64 cycles and is a note that can be easily sung by a bass such as Jetsam.

The New Philharmonic Pitch, in use at the B.B.C., is identified by treble C—the C above the middle one on the piano—being of 522 cycles frequency. Middle C is therefore 256 cycles, tenor C 128 cycles, and the bass C 64 cycles. These figures are approximate, but are fairly accurate.

A frequency of 64 cycles therefore produces the lowest note in the organ as represented by the keys on the manuals. It must be pointed out that an organ does not depend on its actual keys for its lowest notes.

If you hold down that bass C with an 8-ft. stop drawn you will get that bass C. If you draw a 4-ft. stop instead, you will get the octave higher and double your frequency.

If, on the other hand, you draw a 16-ft. stop you will get an octave lower, at half the frequency; in other words you will produce a note that is not represented on the keys of the organ, though it may be found on the piano.

### Pedal Stops

Most of the pedal stops are of 16-ft. pitch so that, generally speaking, the pedals are capable of descending an octave lower than the manuals, although 16-ft. stops are to be found on the manuals in most organs.

Anyhow, the fact remains that the lowest C is *not* represented on the keys.

Large organs possess a 32-ft. stop which, of course, goes an octave lower still. So that the lowest C with this stop drawn (it will be on the pedals) produces a note *two octaves*

lower than the C as represented by the key itself, with a frequency of about 16 cycles.

Very few organs boast a 64-ft. stop, but there is one on the Albert Hall organ. That is to say, it descends *three* octaves lower than the C on the manuals, and its frequency is down to about 8 cycles.

Such a note cannot be heard in the ordinary sense, but it can be felt. The effect is mystery and majesty in the hall but, of course, it cannot be reproduced microphonically.

I have had an organ of my own, so to speak, with a 32-footer, and on one occasion when some dust had invaded the low C I had the pleasure of blowing it out, after which I set to work to tune it.

I experienced great difficulty, not being an organ tuner in the correct sense of the term, in getting it to sound at all satisfactory. All the same I can safely assert that I *did* get it right, though how, exactly, I find impossible to explain.

A 64-footer is another matter altogether; I have never tried my hand at tuning one, but I imagine it is a mathematical process rather than a musical one.

Thinking all this over, on top of Mr. Turner's statements, I think I begin to realise that there *is* nothing in the ear that can correspond to such frequencies unless sheer training, as organ tuners must get, makes it possible to appreciate lower notes than ordinary folk do.

The other part of the article seems to me to be very sound-sense. Mr. Turner speaks of power in your set as being an essential to quality.

I know next to nothing about wireless sets, but I think he must be right because I see an analogy in the organ.

Sixteen-foot stops are of two kinds, which we may call open and closed. If you want a real 16-footer you must have your lowest pipe about that number of feet in length and the rest

in proportion. If, however, you cannot afford these things you can get the effect by pegging an 8-footer, which has the advantage of sending it down an octave and therefore producing 16-ft. tone.

Yes, but it is not the same thing. It gets the pitch for you, *but not the same quality*. All organs possess both kinds, if they are any good at all, but the difference between the tone of a real sixteen and a faked one is—well what do you expect it to be?

### Power Essential

I wonder if I am right in suggesting that power in the set, within the meaning of the term as Mr. Turner uses it, *must* be necessary, drawing my conclusions from the organ analogy?

Here, again, I will be quite frank and admit that I have thought the tendency has been recently to build too powerful a set in many instances. I have been inclined to ask why one needed such power.

All that has been changed since I visited Mr. Turner. I was very glad to avail myself of his invitation and, one unpleasantly foggy afternoon, Alan Hunter and I drove down to Windsor to hear the set.

When we were ushered into the room where it lives I saw something in one corner of the room which I thought was an unusually tall side-board, but Alan said he thought it was the set; it proved that he was right.

### Amazing Quality

Unfortunately, it was in the afternoon and there was only an orchestra playing light music. Nevertheless the low notes of the double-bass simply amazed me. They zoomed out and vibrated all over us. I longed to hear some great organ or the full symphony orchestra.

No, as I tell you, I know nothing about wireless technically, but I tell you, speaking as a musician, that *Mr. Turner's set produced the nearest thing to the real thing that I have heard so far.*

As I write these words 1932 is still very young, but before Ol' Man 1932 goes and Baby 1933 arrives, readers of "Wireless Magazine" should have realised that the phrase "sounding like the wireless" is a thing of the past. *The B.B.C. sends out the real thing; it is our business to collect it.*

The A-P-A described in the following pages is substantially the same amplifier as that used by P. K. Turner in his own home and as discussed in this article by Whitaker-Wilson. Many readers have asked for details of an A-quality power amplifier as recommended by P. K. Turner and in spite of the comparatively high cost of the A-P-A there is no doubt that some hundreds will be made up by "W.M." readers





## An A-quality Power Amplifier and High-Tension Unit

**I**N my first article on the subject of quality, I attempted a definition of some "standards of quality," and one of the points I stressed was the absolute necessity, for the very highest standard, of plenty of power in the last stage.

Now, when one comes to design a set with a high-power last stage, one is confronted with the fact that the set becomes heavy and bulky. In fact, it is not sound practice to put it all on one baseboard. If the set is to be complete in one cabinet, this will probably be of the console type, and it is natural to put the earlier part of the set, with its tuning controls, etc., at the top; the loud-speaker in the centre; and the later part of the set, with its supply units, at the bottom, where its weight helps to stabilise the whole thing.

### "Breaking" the Set

Where, then, is the best place to "break" the set? To my mind, the answer is obvious: just before the last stage. There are several reasons for this. For one thing, the last stage (with the mains unit for its power supply) then becomes a self-contained power amplifier. It can be removed complete and put into another set if the set becomes obso-

lete; for although sets become obsolete fairly rapidly these days, a power amplifier does not.

Again, such a power amplifier has high voltages in it, so it is just as well to keep it away on its own, so that there is no risk of getting 500 volts wandering about in the set, which may need internal adjustment from time to time. The P.A. (power amplifier) itself can be covered up and marked "DANGEROUS," and there is not likely to be any need to adjust its inside.

I therefore propose to start my description of an "A-quality" set by describing the P.A. first as a separate unit. Anyone who builds it, and who has a first-class moving-coil loud-speaker, will probably find that even on his present set it offers such a great apparent improvement in quality that he can then be leisurely in setting about the building of an improved set.

The first thing to think of in the design of a P.A. is the valve, and the most obvious choice is between the Osram LS6a and the Mullard DO24. Both take about the same high tension and give the same output, even calling for about the same output resistance for best matching. The Mullard valve has the greater

amplification and hence calls for less input, so I have designed for this.

Referring to the valve curves, we find that the DO24 should be fed with about 500 volts high tension, and it will then take about 50 milliamperes with the correct bias, and we must think out the best way of providing for these voltages.

### Power Supply for the Set

In my view, it is the duty of the P.A. also to provide the power supply for the earlier part of the set. One is immediately tempted simply to take some of the 500 volts high tension, and put in resistances to drop it to what is required, but this is neither safe, nor economical, nor good for quality. On the economy side it would mean that we should waste in the resistances more than we should use in the set and although the actual power from the mains is so cheap that this doesn't much matter, it would mean providing transformers, rectifiers, etc., of double the size really needed, and then throwing away half the D.C. power they give us.

On the score of safety also, this way of doing things is condemned, for it means that if a valve in the set loses its emission and takes no cur-

# THE A-P-A—Continued

rent, there will be less drop in the resistance, and the voltage on the set will rise to a dangerous value. And lastly, the separate source of high tension for the last valve has the advantage of freedom from feedback from the large audio-frequency power in the output circuit.

It is important to ascertain from the manufacturers whether their transformer is suitable for this job, for it may not be.

The transformer must be capable of standing up to a high voltage; for although it is connected below the mains unit, so that it has not the

loud-speaker behaves like about 8,000 to 10,000 ohms in the anode circuit.

The idea used in this amplifier, of connecting the load below the high-tension supply, is quite a useful one, but is only applicable when (as in this case) the high-tension unit supplies no other stage. It is really desirable that the smoothing choke should be split and put half in each side of the smoothing circuit, to avoid any easy path for audio-frequency currents through  $C_1$  and the capacity of the mains transformer to earth, which would short the output transformer. But in practice I do not find this necessary.

The choke  $L_2$  is a standard article, as are the smoothing condensers. On no account try to use ordinary low-voltage condensers in this smoother; they won't stand up to the work.

## Metal Rectifiers

I have designed both high-tension units in this P.A. for Westinghouse rectifiers. They are particularly suitable in this case, where a high-voltage set is designed for home construction. If we used a valve for Rectifier No. 1, the transformer would have to give 1,000 volts, which is an uncomfortably high pressure, but the metal rectifier only calls for 350 volts. The rectifier itself consists of two units of the H.T.8 size, connected in series; this is done quite simply, as will be seen in wiring the amplifier.

The power-valve anode circuit also contains a milliammeter. It may be desirable to put this meter away from the P.A., in some place where

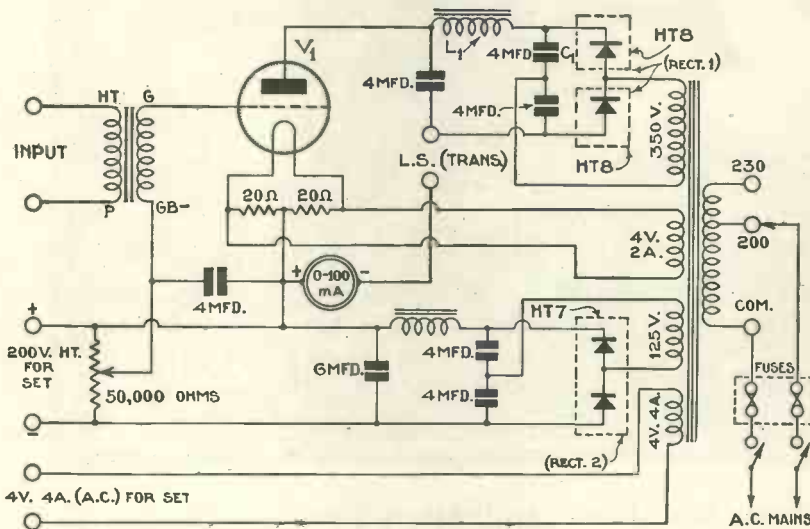

CIRCUIT OF P. K. TURNER'S A-P-A

Fig. 1.—Here is the circuit of the A-P-A, with its two high-tension supply units. Rectifier No. 1 feeds the power valve with 500 volts 50 milliamperes, while No. 2 supplies the set with 200 volts 30 milliamperes and also provides the bias for the power valve. There is also a heater supply for the set.

All these things long ago convinced me that (except where the whole outfit is designed as one unit and special precautions can be taken) the best system is to provide an entirely separate rectifier and smoother for the high-tension supply to the set, and to use this as a source of grid bias for the power valve.

How this is done can be seen from the schematic diagram, Fig. 1. The filament of the power valve is connected to the positive of the smaller high-tension units which supplies the set, and its grid-bias lead is taken to a potentiometer across the output of this unit, so that the grid bias of the power valve can be easily adjusted.

## Circuit Used

We can now consider the schematic diagram in greater detail.  $V_1$  is the valve and holder. The only point to remark here is that the holder must be a good one, for there are 500 volts on it. A pair of terminals is shown in the anode circuit, where the loud-speaker transformer is to be con-

steady 500 volts to earth across it, the audio-frequency voltage itself may be quite large, amounting to 200 or 300 volts at times. Also, the primary must be capable of carrying the 50 milliamperes of D.C. anode current without distress. The transformer ratio should be such that the

## COMPONENTS NEEDED FOR THE A-P-A

### CHOKES, LOW-FREQUENCY

- 1—Parmeko 30-henry at 50 milliamperes, £1 7s. 6d.
- 1—Parmeko 60-henry at 30 milliamperes, £1 7s. 6d.

### CONDENSERS, FIXED

- 3—T.C.C. 4-microfarad (500-volt test), type 64, 18s.
- 2—T.C.C. 4-microfarad (1,000-volt test), type 95, £1 5s.
- 1—T.C.C. 4-microfarad (1,500-volt test), type 105, 16s.
- 1—T.C.C. 8-microfarad (500-volt test), type 64, 8s. 6d.

### EBONITE

- 1—Red Triangle 16 in. by 8 in. panel, 8s. (or Becol, Permcot).

### FUSE

- 1—Belling-Lee twin fuse, 2s. 6d.

### HOLDER, VALVE

- 1—Bulgin four-pin, type VH4, 9d.

### METER

- 1—Ferranti 0 to 100 milliammeter, panel mounting type 29F, £1 15s.

### METAL RECTIFIERS

- 1—Westinghouse type HT7, 17s. 6d.
- 2—Westinghouse type HT8, £2 2s.

### PLUGS AND SOCKETS

- 1—Bulgin baseboard-mounting mains plug and socket, type P12, 3s.
- 1—Bulgin flush-mounting plug and socket, type P20, 2s. 9d.

### RESISTANCE, FIXED

- 1—Varley 40-ohm centre-tapped, type CP75, 1s. 6d.

### RESISTANCE, VARIABLE

- 1—Varley 50,000-ohm power potentiometer, type CP66, 10s. 6d.

### SUNDRIES

- Tinned-copper wire for connecting (Lewcos).
- Lengths of oiled-cotton sleeving (Lewcos).
- 1—Wooden baseboard 19½ in. by 14 in. by ¾ in.

### SWITCH

- 1—Bulgin mains on-off, type S56, 3s. 6d.

### TERMINALS

- 6—Belling-Lee type B, marked; Input (2), L.T.A.C. (2), H.T.+, H.T.—, 3s.

### TRANSFORMER, LOW-FREQUENCY

- 1—Ferranti, type AF3, £1 5s.

### TRANSFORMER, MAINS

- 1—Parmeko to specification, £2 15s.

### VALVE

- 1—Mullard DO24, £1 10s.



### A Power Amplifier for "A" Quality

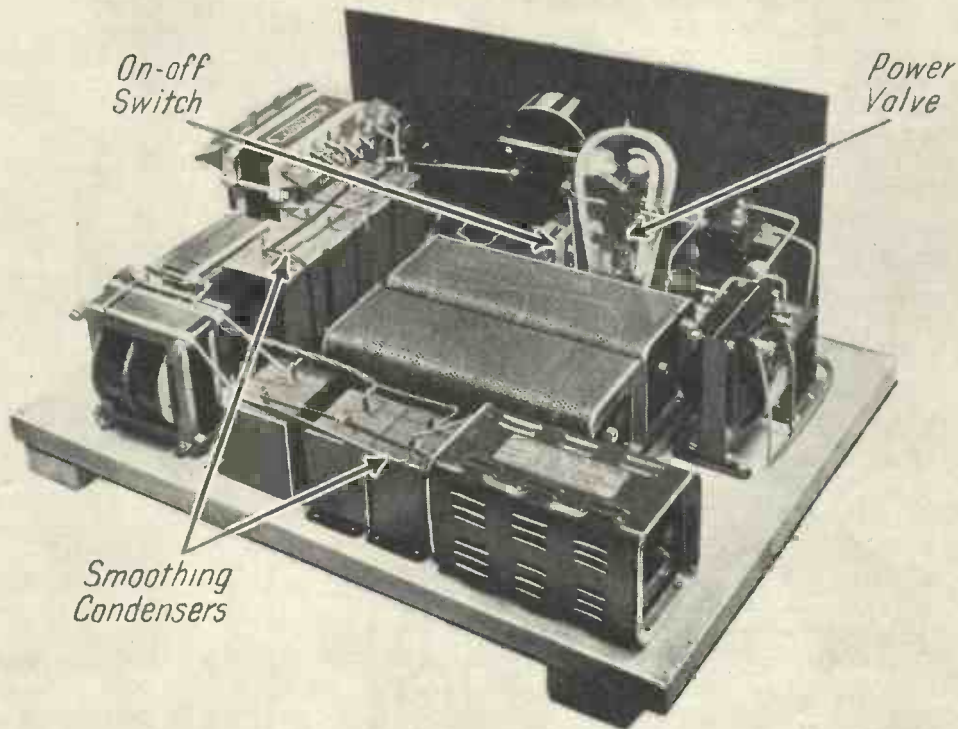

This amplifier gives an undistorted output of about 5 watts and also supplies high tension and heater current to the main receiver

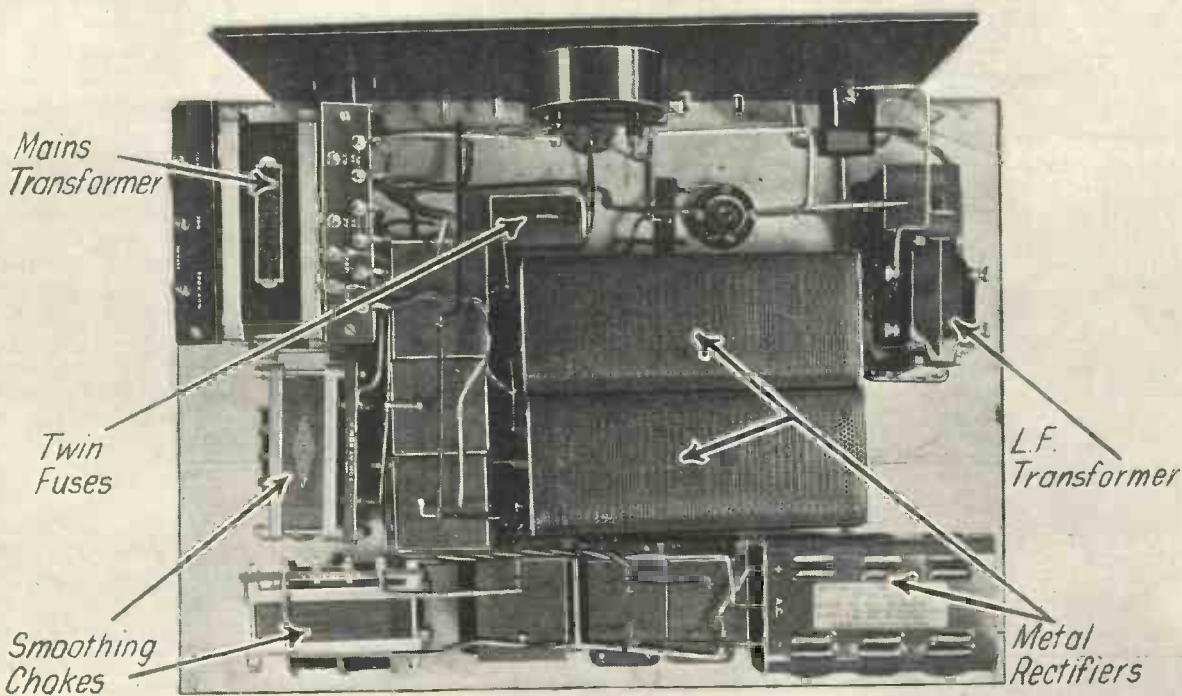

This plan view shows the straightforward nature of the layout and wiring. All joints should be soldered because of the high voltages involved

# THE A-P-A—Continued

it can be more easily seen. In this case two terminals should be substituted for the hole in the panel for the meter. The meter is practically a necessity in any case when first starting up the amplifier, to make sure that the grid bias is correct. Afterwards it is a valuable indicator of distortion, and also enables one to make sure that the valve still keeps its emission.

### Separate Meter

All such tests can, of course, be made with a separate meter connected in circuit only when required, but

it must be used with care and on no account connected with the valve-socket adaptors which are so useful in other cases. The voltage here is too high to do this safely.

The next point for consideration is the small high-tension unit for feeding the set and providing bias for the P.A. Some of my readers may think I have made this unnecessarily powerful. But this is not so. A modern set should be designed for at least 200 volts high-tension supply, and is quite likely to take 30 milliamperes, so I have arranged the small high-tension unit for that.

It is possible—though not recommended except for skilled readers—to modify the P.A. here if the reader already has a mains-driven set or a separate mains unit with which he is quite satisfied. In such a case the whole row of components at the back of the baseboard—H.T. 7 rectifier, three condensers, and choke—can be omitted, and no connection is taken from the 135-volt secondary of the mains transformer; leads Nos. 8 and 10 in the wiring diagram are left out. The terminals H.T. + and — on the panel are to be connected to the high-tension supply on the set, or to the mains unit, whichever there may be.

### Special Point

In this case it is *essential* to take the main A.C. supply for the P.A. from the set or mains unit from the *set* side of its switch, so that the P.A. cannot be switched on unless the set or separate mains unit is already working. This is necessary, for otherwise there would be power on the power valve with no grid bias, and the valve would be destroyed. In any case, do not make the baseboard smaller; leave room to add these components later if desired.

It is necessary to say a word or two about the input and output connections of the P.A. As described and shown in the drawings, the input goes simply to the primary of the intervalve transformer and to get the best results certain conditions should be fulfilled.

First, since the valve calls for a maximum of about 70 volts "swing" of audio-frequency input to its grid, and the transformer is  $3\frac{1}{2}/1$ , the maximum signal strength required at the input is 20 volts swing. Second, to get a good audio-frequency response curve, the resistance in the input circuit should

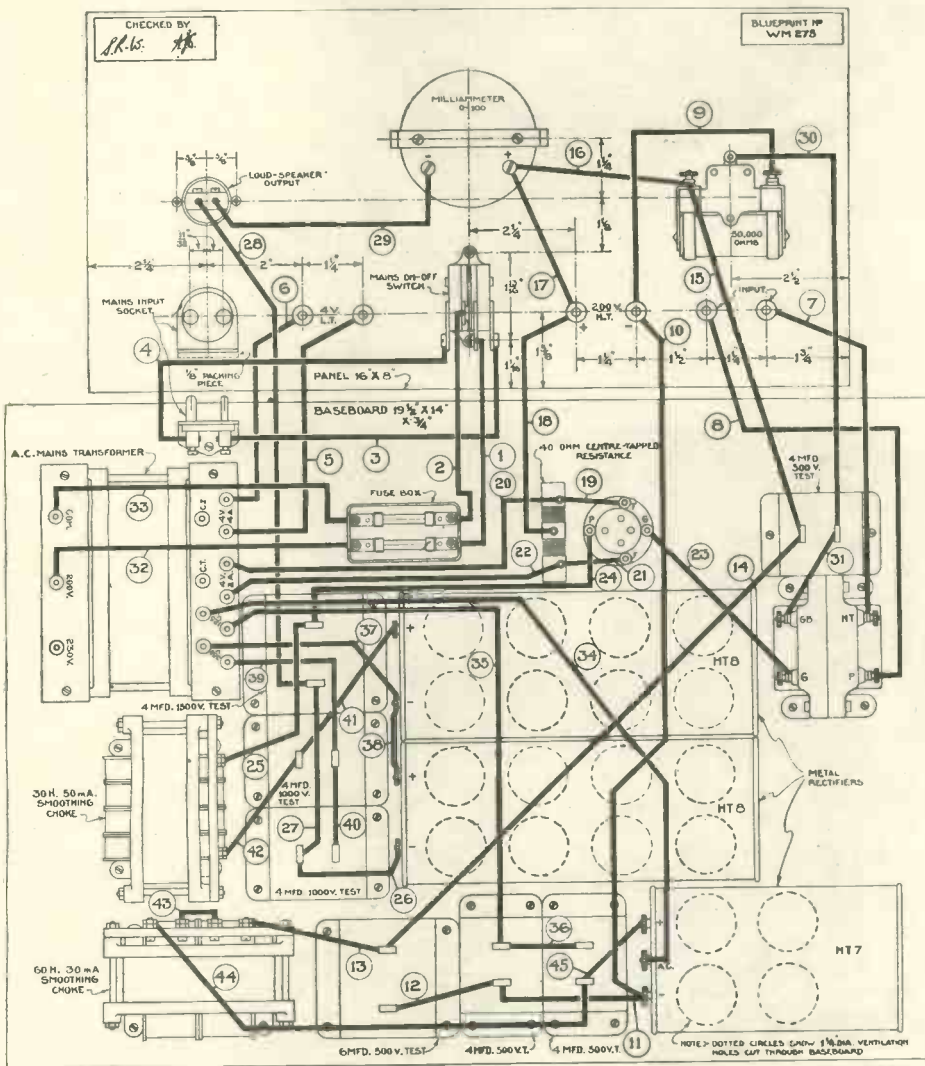

QUARTER-SCALE LAYOUT AND WIRING DIAGRAM OF THE A-P-A

If desired a full-size blueprint can be obtained for half price, that is 6d. post free if the coupon on the last page of this issue is used by March 31. Ask for No. WM275. Address your enquiry to "Wireless Magazine" Blueprint Dept., 53/61 Fetter Lane, London, E.C.4. When wiring up connect the leads in the numerical order indicated. Details of the protective metal cover, without which the A-P-A should not be used, will be found on page 216



# A POWER AMPLIFIER BY P. K. TURNER, M.I.E.E.

not be too far from 10,000 ohms.

If you are going to use the P.A. on a set with plenty of high-frequency amplification, or only on near stations so that there is plenty of power on the detector, then the detector itself ought to put out enough power to work the P.A., and the connections will be simply as in Fig. 2; break the leads to the existing intervalve transformer (where shown dotted), and connect them instead to the input of the amplifier.

### If the Set is Weak

But if the whole set is rather weak, this may not give enough. In this case it may be necessary to work from the output of the set, and care must be taken. The simplest way is to take out the power valve of the set and put in a valve of about 10,000 ohms impedance—such as a PM2DX or L210 (2-volt) or a 354V or MH4 (mains). Of course, the grid bias must be altered to suit.

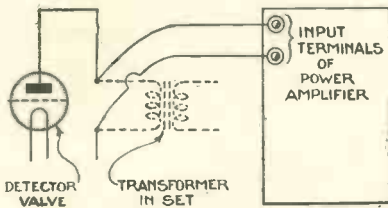
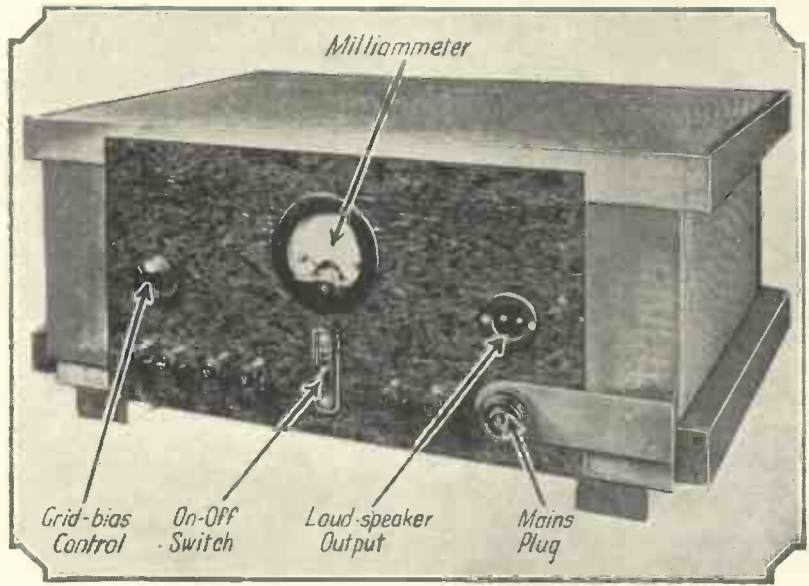

Fig. 2.—If the detector is a good, powerful "linear" one, it will give enough power to work the A-P-A direct, so connect like this

Then connect the loud-speaker terminals of the set to the input of the P.A. But this means buying a new valve, and will very likely give too much input to the amplifier.

If the set has a choke-fed output circuit, there is little difficulty. Use the vacant space behind the input transformer for three resistor holders, and connect them as shown in Fig. 3. Put an 8,000-ohm resistor in the right-hand holder, and do not alter this. Try with a 1,000-ohm and a 3,000-ohm as shown, and if this gives too much input, change over these two, which will reduce it to one-third as much. If still too strong, leave in the 3,000-ohm, but try a 500-ohm instead of the 1,000-ohm in the middle holder.

If, however, the set has direct feed to its output, it will be necessary not only to fit these resistors, but also to connect a choke—10 to 20 henries—across the output terminals of the set.



HOW THE CONTROLS ARE ARRANGED

A view of the A-P-A with its protective metal cover. Note the safety device on the right: the cover cannot be removed until the mains plug is withdrawn from its socket

Now as regards the output circuit. I have already said something about the sort of output transformer required, but just a little thought may be devoted to its position. If the loud-speaker is permanently installed as part of the outfit, the transformer may be attached to the loud-speaker or put in the P.A. as desired; room has been left for it between the power transformer and the valve, the fuse-block being shifted if necessary. If the loud-speaker is a long way off—20 ft. or more—it is not good practice to have these long leads in between transformer and speaker, so the transformer should be put with the loud-speaker.

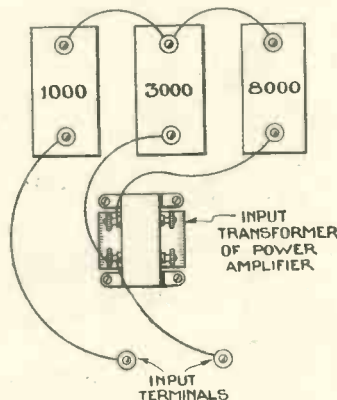

Fig. 3.—In cases where the A-P-A is being fed from output terminals of an ordinary set, it is best to arrange its input circuit like this

But remember that there is enough audio-frequency voltage on the primary to give a nasty shock; so use first-quality electric-light wire for the connecting leads.

It will be found simplest to fix the components in the following order,

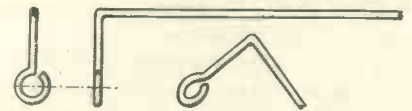

Fig. 4.—As the terminals of the rectifiers are a little awkward to get at, attach short wires to them, bent as in this sketch

and to "prepare" one or two of them before fixing down.

The terminals of the rectifiers are not quite easy to get at when they have been screwed down, as the condensers are very near, so get a piece of the tinned connecting wire about 1½ in. long, make an eye in one end to fit the terminal screw, and then bend up the free end as in Fig. 4. Fit one of these to each terminal of the HT7, and to the two outside terminals of each of the two HT8 rectifiers.

Next, if either of the two Parmeko chokes is of the two-winding type, put a wire in to connect the two windings in series.

Thirdly, if any of the components have nice nickelled soldering-tags, file off some of the nickel-plating and get the tags tinned comfortably before fixing them down—you will usually

## THE A-P-A—Continued

find that solder will not take on these nickelled tags, and some of them may be in awkward positions when you come to do the wiring up. Don't bother about the condenser tags: I pay T.C.C. the compliment that their tags *will* take solder.

Now screw down the HT7 rectifier. Put the two 4-microfarad condensers in place, and so find out just where the 6-microfarad one is to come, *remove* the two 4-microfarads and screw down the 6-microfarad. Then replace the two 4's and screw them down.

### Fitting the HT8's

The screws between the two HT8 rectifiers and their condensers are a little awkward to get at. So put these five components in place, mark all the holes, and remove the components. Make the screwholes, and actually enter the screws halfway so that they will enter the holes again quite easily. Then take them out and put the rectifiers in place, screw them down, and then fix the condensers.

There is little difficulty with the other components. Note that when screwing down the little centre-tapping resistor across the valve filament an oversize nut or one or two washers should be put round each screw below the resistor, to hold it clear of the baseboard.

When all the components are down on the board, fit up the panel with its components and mark off the holes for the screws holding it to the baseboard. Actually screw it in place to make sure everything is all right, and then remove it.

### Wiring the A-P-A

Now as to the wiring. Remember that there are high voltages on some of the wires, so that the job *must* be done with good quality material. To my mind there is nothing as good as No. 18-gauge tinned wire and good sleeving—the latter will stand 2,000 volts comfortably. Several of the connections on the base and on the panel (Nos. 20, 22; 5, 6; 34, 35; 37, 39; 3, 4; 1, 2; and 32, 33) each consist of two wires in separate sleeveings twisted up together.

### Sound Practice

This is simply because they are A.C. wires, to avoid hum. It is not really essential to twist them up in this case as it is for similar leads in an A.C. set of high amplification, but it is always a sound thing to do.

The leads which call for the greatest care are Nos. 37, 39 (350 volts between the two leads) and 41, 42, 25 and 24; these last four, going from the rectifier to the valve anode, are 500 volts above anything else.

Nos. 5, 6; 10, 30 and 28 are left free at one end, to be connected to components on the panel later on.

Now turn to the panel, and wire up the various leads which are marked on it. Nos. 18, 7, 8, 1, 2, 3 and 4 are left free at one end for connections to the baseboard; their correct length can be found by temporarily fitting panel and board together. Finally, screw these two together permanently, and you will then have to connect up 5, 6; 10, 30 and 28 to their proper points on the panel, and 18, 7, 8, 1, 2, 3 and 4 (which are already on the panel) to their proper points on the baseboard.

This completes the job, though it is advisable to make a careful check, wire by wire, and make sure that every connection is (1) correct, and (2) tight.

Assuming that the P.A. has been built complete with the power unit for the set, not modified as described

on page 214, it is best to see that it is in good order before trying it on the set. See that the switch is "off," connect up the loud-speaker transformer, and then plug in to the mains.

Set the grid bias adjustment central, and switch on, keeping one eye on the valve filament and the other on the meter—if your own eyes can't manage both at once, you must borrow one from a helper for a few moments! The filament should glow a very dull red, and the meter should be quite low. Turn the bias adjustment slowly left-handed till the meter reads about 45 milliamperes. If nothing out of the way happens, you can assume that all is well, switch off and connect up to the set, but *watch the meter*.

### Drop in Grid Bias

If the set takes a fair amount of power from its high-tension unit there will be a drop in the voltage from this, and hence a decrease in the total grid bias supply, and it will probably be necessary to readjust the potentiometer. For safety it is best to set the potentiometer to give about 45 milliamperes.

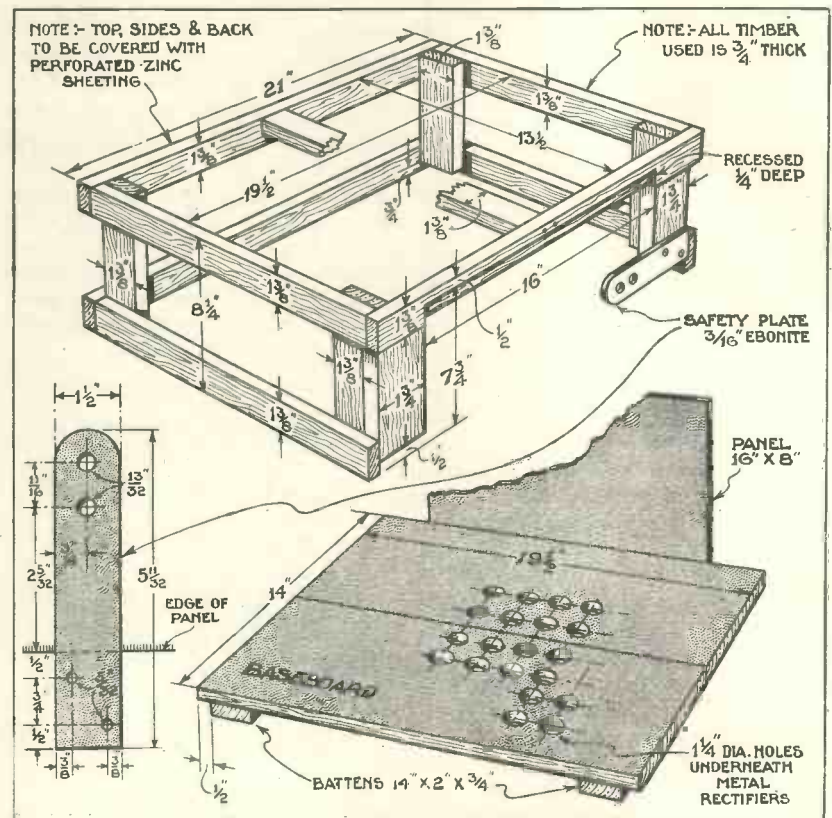

**PROTECTIVE COVER FOR THE A-P-A**  
This metal cover is so designed that once it has been put in position over the amplifier it cannot be removed until the mains plug is withdrawn from its socket



E D I S W A N R A D I O

IF YOU COULD  
SEE YOUR  
RECORDS  
LIKE THIS . . .

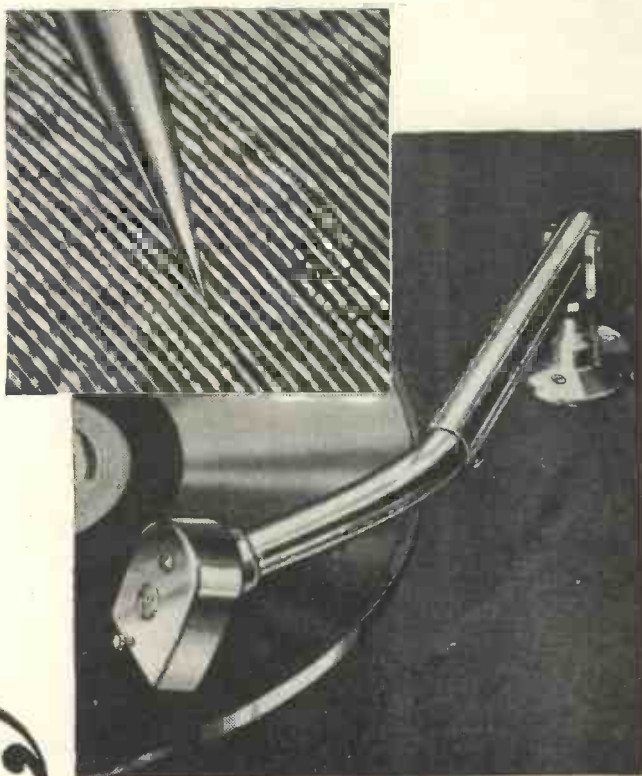

## PICK-UP and TONE ARM



**B.T.H. "Minor" Pick-up and Tone Arm**, moulded as one unit in Fabrolite compound, radio brown finish, free universal action on tone arm pillar. Price **27/6**

**B.T.H. "Senior" Pick-up and Tone Arm**, latest model with ball-bearing, spring balanced, cranked tone arm. Nickel finish, swivelling device on tone arm facilitates needle changing. Price **45/-**

**B.T.H. "Senior" Pick-up with four adaptors**, suitable for H.M.V., Columbia or other standard tone arms. Price **27/6**

If you could see the needle actually tracking in the record grooves—if you could actually watch the vibrations and responses it conveys—you would no longer wonder why a really good pick-up is the first essential of a good radiogram. The pick-up must be capable of responding to and reproducing surface indentations in the sides of the record grooves at the rate of approximately a thousand per second. The needle must not slur or jump these indentations but follow accurately the path designed for it. This is why a B.T.H. Pick-up, with its perfectly balanced damping and 97% perfect tracking, is recognised as the finest pick-up produced. Every inflexion, every graduation of tone and harmony, is unerringly reproduced. That is why they are used by leading radiogram manufacturers and that is why you should use one, if you want the best possible reproduction.

**B.T.H. Pick-ups are sold by all good radio dealers.**

# EDISWAN RADIO



THE EDISON SWAN ELECTRIC CO. LTD. Radio Division 155, Charing Cross Rd. London W.C.2.

W.186

*There is news in the "Wireless Magazine" advertisements*



Two clever stars of light opera, Elsie Griffen and Kingsley Lark are both heard frequently in wireless programmes

# Music of

## Broadcast Programmes

One of Dr. Boult's dearest ambitions is to arrange a series of international orchestral exchanges between this country and Germany, Austria, Belgium, and other European countries.

This would entail the transference of the whole 117 members of the B.B.C. Symphony Orchestra to, say, Vienna for a week, while the

be a miscellaneous programme consisting of works by Bach, Bax, and Berlioz. The soloist on this occasion will be Elizabeth Schumann, the famous Continental prima donna. This concert will be conducted by Sir Henry Wood.

Felix Weingartner, the conductor



An artist who has been heard in recent vaudeville sketches, Laura Smithson. Her character studies are free from exaggeration

THERE has been a revival of rumours that Dr. Boult, the musical director of the B.B.C., is leaving and going to America. It is well known that America wanted Dr. Boult when he relinquished control of the City of Birmingham Orchestra to join the B.B.C.

Vienna Philharmonic Orchestra would visit this country for a similar period. Public concerts

### Perhaps the Continent?

Actually, Dr. Boult has no intention of leaving this country at present and sailing off to America. I have been told that if there is any inducement for him to leave, it would be in the direction of the Continent, the heart of the classics.



Billy Thorburn, a clever syncopated pianist, has been heard in duets with Jean Melville, another favourite

would help defray the expenses.

I learn that such a transfer is not unlikely in the near future. It will give listeners a splendid opportunity of hearing and comparing the great orchestras of the day at first hand. It is to be hoped that this ambition of Dr. Boult will be achieved.

There are only two symphony concerts to be performed and relayed from the Queen's Hall during March. The first, on March 9, will

of a symphony orchestra at Basle, will make one of his rare visits to this country to conduct at the concert on March 16. The concert will be devoted entirely to works of Beethoven and the programme will include the *Pastoral Symphony* and the popular *Leonora Overture, No. 3*.

If you want to hear the B.B.C. Symphony Orchestra at its best, listen to these two concerts. They will both be well worth hearing.

### From No. 10 Studio

I would like to draw your attention to the orchestral concert to be relayed from No. 10 studio on February 28. Conducted by Sir Henry Wood, this concert will include besides other good fare the new *Nursery Suite* by Sir Edward Elgar, and the exciting *Bolero* by the French composer, Ravel. If you have not heard *Bolero* before, take this oppor-



Roy Ellett has broadcast each year since 1926 in pianoforte recitals. He is noted for his fine technique and range of compositions



# the Month

Discussed by T. F. HENN

tunity. It is very modern, but I am certain you will enjoy the fun.

It is no use any reader who fancies he has a suitable voice, or that he can play an instrument sufficiently well to warrant his appearance before the microphone, writing to the B.B.C. and asking for an audition.



Roy Fox is the conductor of the dance band at the Monseigneur Restaurant, London. His broadcasts are very popular

All auditions in this class are suspended for the present.

On the music department's register are upwards of 2,000 names of artists, many of whom are of international repute. One bright member of the music department counted up all the names recorded in this book and by complex arithmetic worked out that if every artist were engaged once and without any increase in the number of solo items, three years would be taken to give every artist the chance of appearing once.

## Overcrowded Profession

The B.B.C. is strenuously opposing the idea of any person entering the musical profession through the medium of broadcasting. Anyone who thinks he has a chance in this already overcrowded profession will have to make his name on the concert platform before he can think

of broadcasting.

I have just been told a remarkable story why the engagements of two foreign artists were recently cancelled by themselves.

These two artists—I will not mention their names—were engaged some little time back to appear jointly at a concert at Savoy Hill. As is usual with artists who have to come from abroad the B.B.C. sent them a letter reminding them of



A well-known bass heard in Sunday programmes, Robert Easton has had experience in every type of vocal music

their engagements. One of them replied direct and stated that it was impossible for him to come, and the other replied to the same effect, only through his agent.

The B.B.C., not to be beaten, sent them both a telegram, pointing out that all the programmes had been published and urged them both to reconsider their decision. Only one replied to this second request and asked to be allowed to appear another time.

The reason for this joint cancella-



Julien Krein, a clever Continental 'cellist, is likely to be heard at a forthcoming concert. He has composed a concerto for cello and small orchestra

tion has now been found out. One of the artists has run away with the other's wife and the infuriated husband is trying to find him!

## Cinema Organists

I have done my best to defend the entertainment value of the cinema organ against many musicians who condemn it as an atrocity. However, when one or more offends I will be one of the first to say so.

Mr. Reginald Dixon, at the organ of the Tower Ballroom, Blackpool, is not pleasing me too much at present. I do not appreciate his choice of music and I do not like  
(Continued on page 222)



A Swedish soprano, Karin Ohman was heard to good advantage in a recent London Regional programme. Her choice of songs was good

# TELSEN

THE SECRET OF PERFECT  
RADIO RECEPTION



NEARER . . .  
CLEARER . . .  
MORE LIVELY  
THAN BEFORE

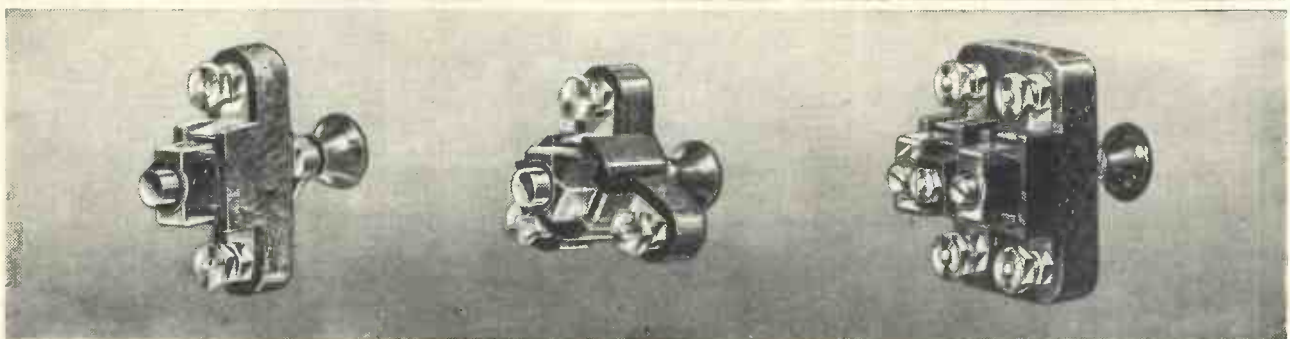



"CHANGING over to Telsen is like taking the wool out of your ears"—that is the verdict of an enthusiastic Telsen constructor which inspired the illustration on the opposite page. Telsen Components in your set give you a realism which is astonishing—they enable you to sit back and hear, without straining forward to listen—they bring every item on the programme "nearer, clearer, more lively than before."

- DUAL-RANGE AERIAL COIL .. .. 7/6
- H.F. TRANSFORMER AND AERIAL COIL 5/6
- LOGARITHMIC VARIABLE CONDENSER  
in capacities .0005, .00035, .00025 .. 4/6
- BAKELITE DIELECTRIC DIFFERENTIAL,  
REACTION AND TUNING CONDENSERS  
in all capacities .. .. From 2/-
- PRE-SET CONDENSERS .. .. Price 1/6
- MANSBRIDGE TYPE CONDENSERS From 1/6
- FIXED CONDENSERS (Prov. Pat. No. 20287/30) 6d.
- PUSH-PULL SWITCHES (Prov. Pat. No. 14125/31).
- Two-point .. .. Price 1/-
- Three-point .. .. Price 1/3
- Four-point (2 pole) .. .. Price 1/6

# TELSEN

100% BRITISH  
RADIO COMPONENTS

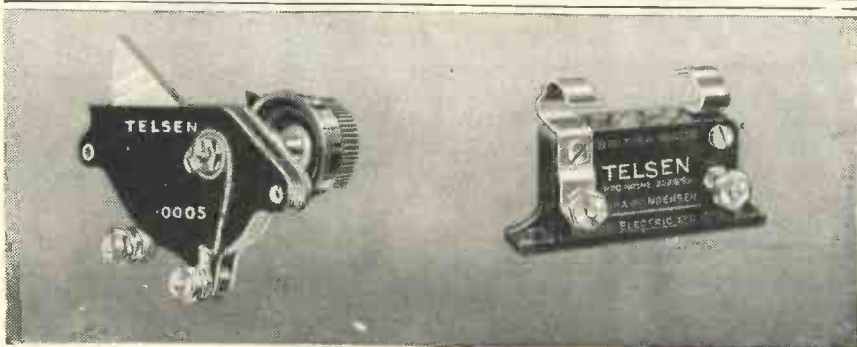
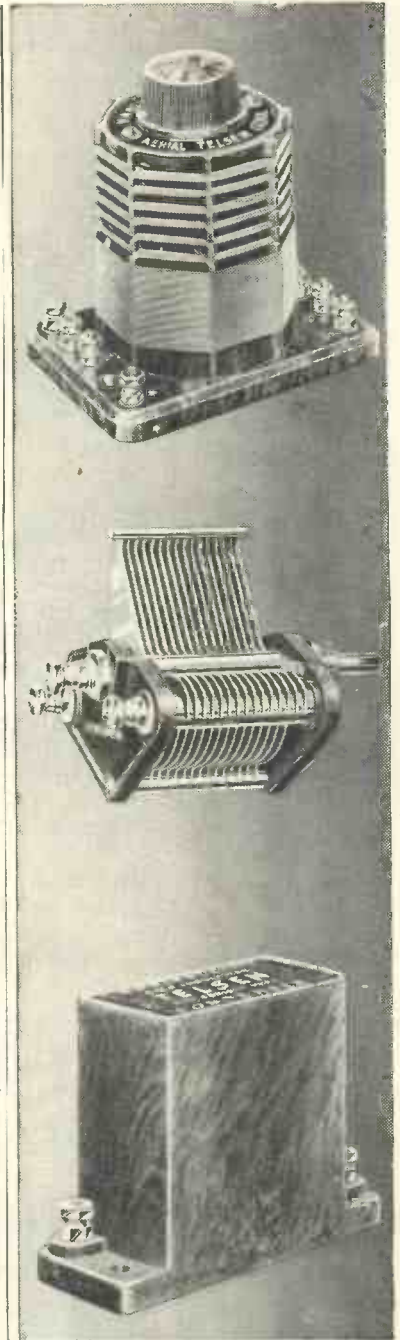

Advt. of The Telsen Electric Co., Ltd., Aston, Birmingham.

# MUSIC OF THE MONTH—Cont. from page 219



Beatrice Galloway, one of the Ridgeway Parade artists, will be heard again when these shows shortly return to the "air"

the excessive use he makes of the tremulant stops on his instrument.

The B.B.C. can find much better talent in London, so why take all the trouble to relay from Blackpool?

One point about a recent programme played by Reginald Foort at the Regal Cinema, Marble Arch. I know he is good, but surely he knows better than to include Schubert's *Unfinished Symphony* (first part, whatever that is) in his programme.

I suggested in these columns quite recently that there are many organs far more suitable for broadcasting than those being used at present.

Quentin Maclean, the organist of the Trocadero Cinema, Elephant and Castle, tells me that there is now one

right outside Broadcasting House. He refers to the organ at All Souls, Langham Place, which has recently been renovated and, according to Mr. Maclean, ideal for broadcasting.

Perhaps the B.B.C. engineers would like to make a test.

So Jack Payne and his boys are leaving the B.B.C. after all that has been said to the contrary. This band has been broadcasting for the last four or five years. I can well remember the time when this now famous band was the most horrid musical combination I had ever listened to. In the past two or three years they have become good.

All this graduation process will have to be repeated till the B.B.C.

## NEXT MONTH

So great is the demand for "Wireless Magazine" that the last issue went out of print within a week of publication.

It is a great help to us and to newsagents if readers will order their copies in advance; steps can then be taken to print a sufficient quantity.

The April issue will be published on Wednesday, March 23. Make a note of the date and ask your newsagent to reserve a copy for you.

By so doing you will avoid disappointment.

can have another dance orchestra comparable with others that are broadcast.

I have been listening to the broadcasts by Henry Hall (Jack Payne's successor) and his Gleneagles Hotel Band, and apparently they fall into a different category to the usual "hotters." Their music is inclined to be melodious rather than "jazzy."

To achieve the same popularity as Jack Payne, Henry Hall will have to alter his whole idea of dance-music production. At least, I think so; but I may be wrong.

He has also to remember that to arrange a broadcast of one hour, and vary it sufficiently to make it interesting, is no difficult job, but to provide over a dozen hours entertainment every week and still make it interesting is not so easy.

Jack Payne's popularity depended



A provincial artist well known on the concert platform, Howell Hatswell will figure in future Midland Regional programmes

on one point only; versatility. Versatility is the keynote of success of a broadcast dance orchestra. Mr. Hall has the experience of another band's success to help him do the same thing. His future entirely rests with himself.

One point in his favour. Jack Payne could not play an arrangement of the waltz from the ballet music to *Sylvia* in the same pleasing style as Henry Hall and the Gleneagles band. The first broadcast by the new band will be on March 14.

A recent hour's broadcast by Ambrose and his Mayfair Hotel Band was an example of an ideal performance for the microphone. Ambrose takes some beating.



One of the few artists who specialise in the xylophone as a solo instrument, Jack Collings has featured in special programmes



Phyllis Evers, an English soprano, is frequently heard in B.B.C. concerts. She has sung in many Old Vic productions



# T.C.C. SPECIFIED BY THE RECOGNISED AUTHORITY ON QUALITY REPRODUCTION

● Here is Mr. P. K. Turner's  
specification for condensers  
in his "QUALITY AMPLIFIER"

One 4mfd. T.C.C. TYPE 105  
Two 4mfd. T.C.C. TYPE 95  
Three 4mfd. T.C.C. TYPE 64  
One 6mfd. T.C.C. TYPE 64

Again it is proved that for "quality" results "quality" components must be used. And when the leading authority on faithful reproduction insisted on T.C.C. it was with the knowledge that his choice would definitely fulfil his requirements. Do not jeopardise the quality of your amplifier by substituting condensers. Follow the designer—in every particular—use T.C.C.

## T.C.C.

ALL-BRITISH  
CONDENSERS

The Telegraph  
Condenser Co., Ltd.,  
Wales Farm Rd.,  
N. Acton, W.3.

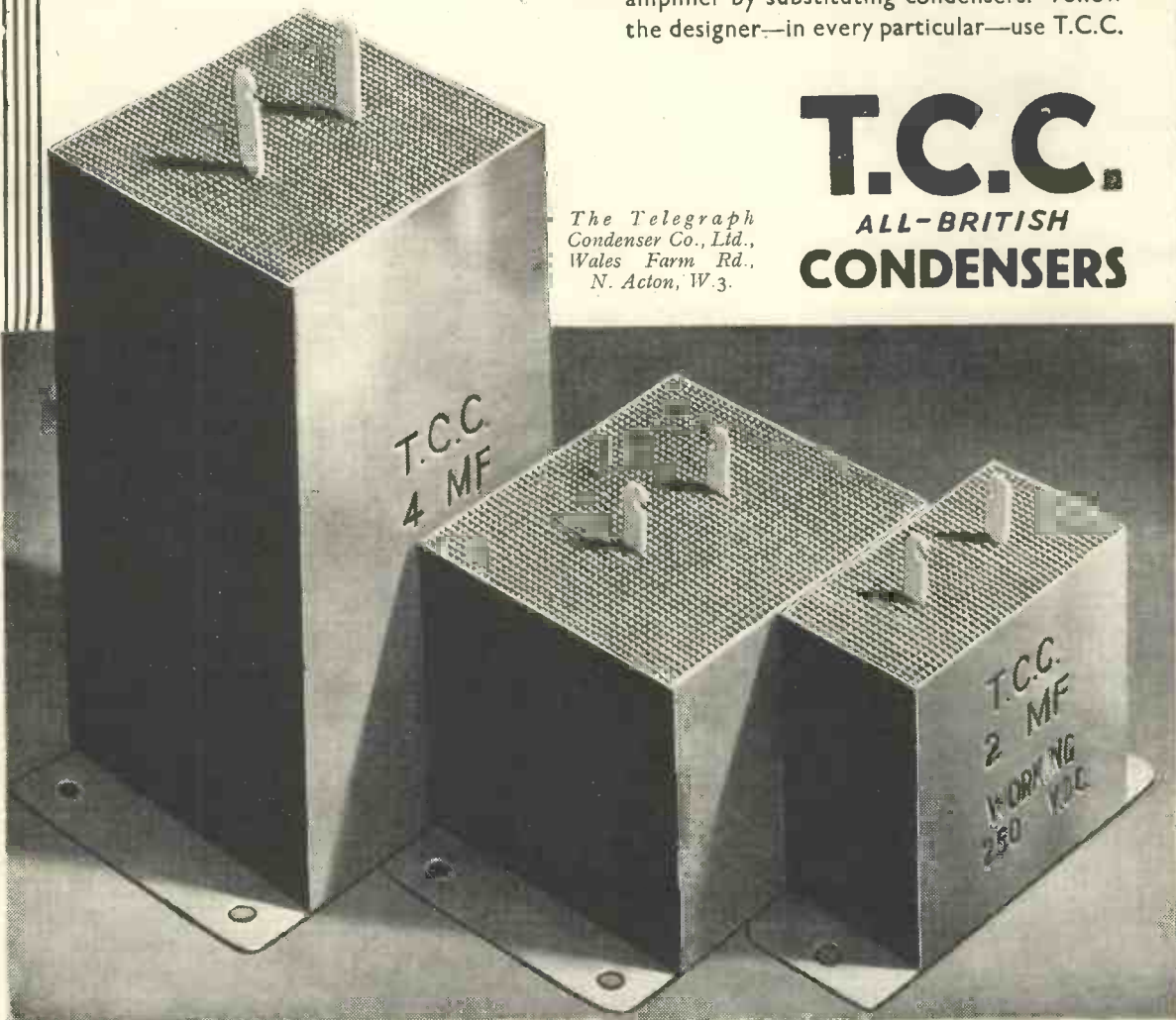

Mention of the "Wireless Magazine" will ensure prompt attention

♡ 9625





# FERRANTI TRANSFORMERS and TRUE REPRODUCTION

When you build a modern Set you rightly expect to secure better performance. Design has improved with the greater knowledge designers now possess. Valves are more efficient, and speakers are capable of materially better reproduction. The transmissions have attained a very high standard.

It is clearly not worth while to negative all these advantages by fitting an inferior transformer which is incapable of amplifying uniformly all the frequencies essential to good reproduction as judged by the standards of to-day.

You must have the audio end right before you can get good reproduction from any set. The first step in that direction is to install the best Transformer you can buy.

Whatever price you decide to pay you will be certain to get the best Transformer and the greatest satisfaction if you fit FERRANTI.

AF3 ratio 1/3½	.....	25/-
AF5 „ 1/3½	.....	30/-
AF6 „ 1/7	.....	30/-
AF7 „ 1/1½	.....	30/-
AF8 „ 1/3½	.....	11/6

# FERRANTI TRANSFORMERS

FERRANTI LTD.

HEAD OFFICE AND WORKS: HOLLINWOOD,  
LANCASHIRE.

LONDON: BUSH HOUSE, ALDWYCH, W.C.2.

*Gives* LUXURY RECEPTION  
*Gives* GREATER SENSITIVITY  
*Gives* PURER REPRODUCTION



The Celestion M.12 at 35/- is unquestionably the finest speaker ever offered. It definitely places Celestion quality within the reach of all. It incorporates the famous Reinforced Diaphragm, a patent exclusive to Celestion, which to a large degree is responsible for the infinite superiority of Celestion speakers.

Ask to hear the M.12 demonstrated. Also ask to hear J.12 cabinet—38/6. Easy payments available for all models. Write for full descriptive literature.

**8/-**  
DOWN  
4 monthly  
payments  
of 8/-

# CELESTION

*The Very Soul of Music*

CELESTION LTD., LONDON ROAD, KINGSTON-ON-THAMES.  
London Showrooms: 106 Victoria Street, S.W.1

Speedy replies result from mentioning "Wireless Magazine"

# ABOUT THE QUADRADYNE—Continued from page 224

## COMPONENTS NEEDED FOR THE QUADRADYNE

### CHOKES, HIGH-FREQUENCY

- 2—Watmel, type DX3, 8s.
- 1—Wearite, type HFS, 6s. 6d.

### COILS

- 1—Colvern coil assembly (1 pair KBLC ganged with 2 KCG's), £1 17s. 6d.

### CONDENSERS, FIXED

- 1—T.C.C. .00005-microfarad, type 34, 1s. 6d.
- 1—T.C.C. .0001-microfarad, type SP, 2s. 4d.
- 1—T.C.C. .0001-microfarad, type 34, 1s. 6d.
- 1—T.C.C. .0002-microfarad, type 34, 1s. 6d.
- 1—T.C.C. .0003-microfarad, type 34, 1s. 6d.
- 1—T.C.C. .01-microfarad, type 40, 1s. 9d.
- 1—T.C.C. .05-microfarad, non-inductive type, 1s. 9d.
- 1—T.C.C. 1-microfarad, type 50, 2s. 10d.
- 4—T.C.C. 2-microfarad, type 60, 15s. 4d.

### CONDENSERS, VARIABLE

- 1—British Radiophone .0005-microfarad four-gang, with metal cover and disc drive, £2 7s.

### HOLDERS, VALVE

- 4—W.B., sub-baseboard type, 5s.

### METER

- 1—Bulgin 0-5 panel-mounting milliammeter, £1 10s.

### PLUGS AND TERMINALS

- 4—Belling-Lee terminals, marked: Aerial, Earth, Pick-up (2), 2s.
- 2—Belling-Lee spade terminals, marked: L.T., L.T., 4d.
- 5—Belling-Lee wander plugs, marked: H.T., H.T., G.B., G.B.—1, G.B.—2, 1s. 3d.

### RESISTANCES, FIXED

- 1—Varley 1,000-ohm spaghetti, 9d.
- 1—Varley 5,000-ohm spaghetti, 9d.
- 2—Varley 10,000-ohm spaghetti, 1s. 6d.
- 1—Varley 30,000-ohm spaghetti, 1s.
- 1—Varley 40,000-ohm spaghetti, 1s.
- 1—Dubilier 50,000-ohm grid leak 1s.
- 1—Dubilier 1-megohm grid leak, 1s. 9d.

### RESISTANCES, VARIABLE

- 1—Wearite 25,000-ohm potentiometer, type Q34 IS, with insulated spindle and bracket, 4s. 3d.
- 1—Wearite 50,000-ohm potentiometer and on-off switch, types Q35 and G22, 5s. 6d.
- 1—Wearite .25-megohm potentiometer and single-pole change-over switch, types Q21 and G24, 0s. 9d.

### SUNDRIES

- Tinned-copper wire for connecting (Lewcos). Lengths of oiled-cotton sleeving (Lewcos). Length of rubber-covered flex (Lewcos).
- 2—Belling-Lee terminal blocks, 1s. 4d.
- 1—Sheet of No. 32 or 34 gauge aluminium foil 16 in. by 13 in.
- 1—Pair Bulgin grid-bias battery clips, No. 1, 6d.
- 1—Readi-Rad fuseholder and bulb, 1s. 3d.

### TRANSFORMER, LOW-FREQUENCY

- 1—Lewcos, type LFT5, 10s.

### TRANSFORMER, OUTPUT

- 1—Ferranti, type OPML, £1 2s. 6d.

### ACCESSORIES

#### BATTERIES

- 1—Drydex 120-volt, orange series, £1 4s.
- 1—Drydex 16½-volt, green series, 2s. 6d.
- 1—Exide 2-volt accumulator, type ICZ5, 15s. (or Smith's).

#### CABINET

- 1—Clarion, £1 7s. 6d.
- 1—Clarion baseboard assembly, 3s. 6d.

#### LOUD-SPEAKER

- 1—Amplion MC9, cabinet model, £9 9s.

#### VALVES

- 2—Six-Sixty 215SG, £2 (or Mullard PM12, Cossor 220SG).
- 1—Six-Sixty 210D, 3s. 6d. (or Mullard PM210X, Cossor 210 Det.).
- 1—Six-Sixty 230PP, £1 (or Mullard PM22, Cossor 230PT).

(If it is desired to run this set with an A.C. high-tension unit, a Regentone W4A, price £5 5s., is recommended.)

switch and radio volume control, which actually adjusts the voltage applied to the screening grids of the two high-frequency valves.

When the knob is pulled out the switch is operated in the usual way and the set is switched on. Then as the knob is turned the volume is controlled; the more the control is turned to the right the greater is the volume, to be exact. Whatever the position of this knob for controlling volume, the set is immediately switched off by pushing it in again.

### Gramo Control

The right-hand knob works in a similar way; it is a combination of gramoradio switch and gramophone volume control. The knob is kept in for radio reception and is pulled out for record reproduction through the medium of a pick-up, which can be kept permanently connected to the set ready for instant use.

When this knob has been pulled out it is turned to control volume in the

usual way and, again, whatever its position, the set is switched back for radio reproduction by pushing the knob in.

Another refinement of the Quadradyne is the tone control, which enables the quality of reproduction to be adjusted to give the utmost satisfaction in individual cases. Some people prefer high-pitched reproduction; if so, just turn the tone-control knob to the right. On the other hand, if more mellow repro-

duction is preferred turn the knob to the left.

It will usually be found best to turn the knob to the right for speech and keep it to the left for orchestral items.

From these remarks it will be realised that the Quadradyne is something a little better than usual and for that reason it will attract the attention of a large number of constructors who want a first-grade instrument.

### Constructional Feature

There is an interesting constructional feature about the Quadradyne—it uses a special form of baseboard-chassis assembly. In other words, the baseboard is raised and many of the components are mounted underneath it. The top of the board is covered with a sheet of aluminium foil which helps to complete the screening of the four coils and the four-gang condenser.

It might be thought that this assembly leads to difficulties in construction, but this will not be found to be the case if a full-size blueprint is used. This is provided in three parts. There is a drilling guide (full size, of course) for marking out the holes that have to be drilled in the baseboard to pass wires through from the top to the underneath. Then there is a plan view of the top of the board and, lastly, a plan view of the underside of the board.

### Half-price Offer

Copies of this blueprint are available at 1s. 6d., post free, from the "Wireless Magazine" Blueprint Department. By using the special coupon on the last page of the February issue a copy of the blueprint can be obtained for half price up till February 29.

Many requests have already been received for an all-A.C. version of the Quadradyne. The "W.M." Technical Staff is at work on this and full details will be published in an early issue.

The design is particularly well adapted for conversion to mains operation. Variable-Mu Valves will be used.



AN EFFICIENT DESIGN THAT LOOKS GOOD

The Quadradyne in its special Clarion cabinet. Note the milliammeter mounted on the top of the cabinet to facilitate ganging



# MAMMOTH PLATES

## save recharging fees



Actual photograph of plates from a Fuller L.D.G.H. Accumulator.

LOOK at the thickness of these Mammoth Plates. They are specially constructed by Fuller's to give maximum service in modern wireless sets. Mammoth Plates have advantages in every possible direction—long life, exceptional capacity, steady current emission, powers of rapid recuperation, need less frequent recharging, hold charge better when not in use, are dry charged ready for service. In addition to these remarkable plates Fuller Accumulators incorporate other unique features—specially strong moulded glass containers, improved covers and vents—patented double grease cup terminals—Life Preserver—and free safety carriers. Fit a 'Fuller' and your wireless will take on a new lease of life.

Visit the Fuller Stand No. 22, N. 3 at the British Industries Fair, Birmingham.

# FULLER

## SUPER BATTERIES

L.D.G.H.—2 v. 60 a.h. Price 9/6. Dry charged. (Other sizes for low intermittent current service.)

Contractors to British and Overseas Government Depts., Railways, etc.

Full list of H.T. Dry Batteries and L.T. and H.T. Accumulators on request.

FULLER ACCUMULATOR CO. (1926), LTD., CHADWELL HEATH, ESSEX. 'Phone: Seven Kings 1200. 'Grams: "Fuller, Chadwell Heath"

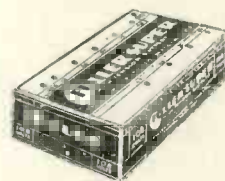

### SUPER H.T. DRY BATTERIES

Machine made and tested throughout... long life... emission up to 20 M/amps. From 60 to 120 volts. Prices, 5/3 to 15/3. Also complete ranges of Standard, Triple, Portable, and Grid Bias Dry Batteries, etc. Write for List D.3.

### CAR AND MOTOR CYCLE BATTERIES



... Acid Proof patent double grease cup terminals... Micro-porous pasted plates... high capacity... long life... exceptional strength. Models for every Car and Motor Cycle... list M.2.

When you send your order don't forget to say you "saw it in the W.M."

# Good-bye to Savoy Hill

The B.B.C. staff is preparing to move to new quarters in Broadcasting House. In this article our Special Commissioner recalls some of the outstanding events that have happened at Savoy Hill during the past eight years. His notes will be read with interest by every listener.

**GOOD-BYE** to Savoy Hill. Never a farewell, even to one's Lares and Penates, was said with so much regret as it seems this one will be by the B.B.C. staff. The last few weeks of work in the little backwater off the Strand are revealing a deep attachment for what is virtually the cradle of British broadcasting.

## Atmosphere of Domesticity

Probably because Savoy Hill is but a building designed mainly as residential flats and some officials work in rooms which were formerly a dining-room or a drawing-room, or even a kitchenette—the place where the old water pipes were fixed still showing on the walls—an atmosphere almost of domesticity pervades the place.

The building is oldish, but the corridors are dead straight, with small but symmetrical rooms opening out of them on either side. No cubby holes or hiding places there. Broadcasting House, on the other hand, is full of them.

For departmental heads, who are separated from their staffs, rooms measuring either 10 ft. by 8 ft. or 8 ft. by 6 ft. seem to have been an obsession with the designers. The low-pitched ceilings of the curving corridors, lower than the ceilings in the rooms themselves, the narrow doors, show that the building was planned on the lines of a big ship.

One would hardly be surprised to find that portholes had been fitted instead of windows, or that the Central Tower, which contains the studios, had been finished off with a gigantic dummy funnel sticking out above the roof.

Other curiosities of construction will be presently apparent to visitors; but at the moment let us just recall some incidents from the past eight years at Savoy Hill.

In the diligent search for a suitable site for Broadcasting House, when various places in the West End were under consideration, history was only repeating itself. The same thing happened before Savoy Hill was finally decided upon in 1923; but at one time there was a strong probability that broadcasting would find a home in a narrow court in the heart of London's theatreland.

Here was an old building which had been originally a gold "flattening" mill and, when the building was evacuated by its former occupants, every inch of flooring was torn up in order to recover any specks of the precious metal which had worked into the crevices during the opera-

tions of rolling and beating.

It was a building about which many excellent stories might have been written if the B.B.C. had actually become located there. However, at Savoy Hill, some rooms which had been used as medical offices were eventually selected and these had a different sort of history.

They were connected with a laboratory where somewhat gruesome pathological experiments were carried out and the gateway still exists, separating the older from the new sections of broadcasting headquarters, through which corpses were driven into a courtyard and thence taken into the laboratory for dissection.

## The First Studio

Only a few rooms were obtainable by the B.B.C. at first and a little room was retained for office purposes in the General Electric Company's headquarters in Kingsway. The Savoy Hill premises needed extensive alteration; but the first job was to build a studio.

Little was known at that time about the problem of acoustics and so the walls of this first studio were padded heavily with felt many inches thick, the ceiling was hidden by seven layers of canvas and carpets to a depth of six inches covered the floor.

The aim to exclude the slightest echo was achieved at the cost of four tons of draping and, incidentally  
(Continued on page 230)



THEIR MAJESTIES AT THE HENDON AIR PAGEANT

H.M. the King is seen on the right giving instructions to aircraft by wireless at one of the R.A.F. air pageants at Hendon. Her Majesty is sitting on the left. A special mike is kept exclusively for the King's use



# This man has **BETTER RADIO**

read his letter:—

83 HY 67

Messrs. A.C. Cossor Ltd.,  
Highbury Grove, N.5.

Dear Sir,

In 1928 I built the "Empire Five" Set described in the "Wireless Magazine." Set I installed two Cossor 2-volt Screened Grid Valves and was delighted with the large number of stations I received.

The other day I had the misfortune to break one of the three-year-old valves and replaced it with a new type Cossor 2-volt Screened Grid Valve. I was pleasantly surprised to find so many stations, new to me, coming in all over the dial, showing me how much I had been missing by retaining the old valves, after three years good service.

Probably others would get the same advantage if their attention is drawn to same.

Yours faithfully,

*Jan*

# COSSOR

## ALL-BRITISH SCREENED GRID VALVES

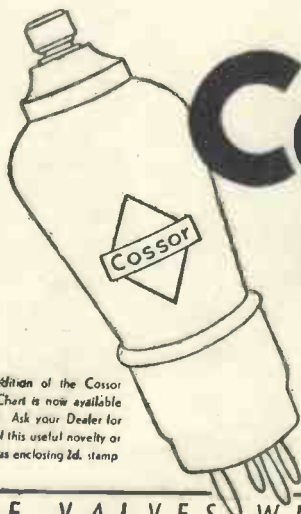

A new edition of the Cossor Station Chart is now available price 2d. Ask your Dealer for a copy of this useful novelty or write to us enclosing 2d. stamp

A copy of the 12-page Cossor Wireless Book B11 will be sent you free on application to A. C. Cossor Ltd., Melody Dept., Highbury Grove, London, N.5.

The original of this letter may be inspected at our Head Office

Is your Receiver giving you the best performance of which it is capable? Are you, like the writer of the above, now experiencing the full joys of Radio?

Cossor Valves have always enjoyed a high reputation for efficiency. The latest types give even better performance — this entirely unsolicited letter affords definite proof.

Every Radio Retailer sells Cossor Valves in types to suit Battery and A.C. Mains operated Receivers.

THE VALVES WITH THE MICA BRIDGE CONSTRUCTION

BRITISH MADE BY A. C. COSSOR LTD., Highbury Grove, London, N.5.

31 ♡ 9610

There is news in the "Wireless Magazine" advertisements

## GOOD-BYE TO SAVOY HILL—Cont. from page 228



UNCLE ARTHUR, LATE OF 2LO AND NOW AT GENEVA  
Mr. Arthur Burrows will be remembered as "Uncle Arthur" by early listeners. He is now at Geneva doing valuable work in the international broadcasting field

a veritable breeding ground for dust and germs was established.

So stuffy was the atmosphere that soloists and members of the Wireless Orchestra who had to broadcast from this mausoleum were reduced to physical wrecks after the experience.

I remember one prima donna of international fame who emerged from the studio after a recital looking like a painted zebra. Perspiration had transformed the cosmetics on her face into coloured streaks. Her gown literally clung to her plump figure like a rag and she was in despair because acute physical discomfort had resulted in a second-rate performance.

I remember also a well-known tenor who in the course of his recital shed first his coat, then his collar and finally his vest. "I thought the Savoy Turkish Bath was in the basement on the other side of the building," he remarked afterwards. "The B.B.C. must have had it moved to the top of the building."

### Constant Rush and Strain

At that time the staff had to dash down from their crowded quarters in Kingsway when the time for broadcasting approached, as their office accommodation was not yet prepared for them in their new quarters. The constant rush and the strain of twelve or fourteen hours' work each day began to tell on some of those who were laying the foundations of broadcasting.

programme was broadcast from the Savoy Hill studio, the first S O S message was given to listeners.

The address that evening was on Industrial Christian Fellowship and, having this in mind, when the telephone message came through from Middlesex Hospital, asking if the B.B.C. could announce that a man whose nearest relative lived in the village of Flitwick, near Ampthill, was lying dangerously ill in the hospital, the announcer decided without hesitation to try and get in touch with the wanted woman.

A local motorist heard the message and drove straight to the village, found the woman and motored her to Luton, where she caught the next train for London. He then telephoned to Savoy Hill and the information that the relative was on her way to the hospital was broadcast before the evening programme closed.

Nowadays only a comparatively small number of those concerned take the trouble to inform Savoy

Hill so quickly of the successful result of S O S messages.

Shortly after the staff took over the occupancy of the offices at Savoy Hill work was begun upon a second and larger studio. This was designed with the idea that vocalists required to be placed at a distance of about 20 ft. from the microphone, but one fine day along came Chaliapine to rehearse for his first broadcast, which was to take place that evening from the new studio, and it was found that this "latest word in studios," although 45 ft. in length, was not nearly large enough for such a voice.

It is worth recalling that on April 29, 1923, the first date on which an entire Sunday pro-

### "Soft Pedal"

Chaliapine was placed with his back to the wall on the farthest side of the studio; but still his vocal powers were too much for the "mike." In the end he had to keep the "soft pedal" on his fortissimo passages.

In those days, also, the "effects" officials taking part in a radio play had to station themselves in the lobby outside the studio, no room being found for them within.

By 1925, quarters had become so cramped that the B.B.C. decided to lease the block of residential flats facing Savoy Chapel, which were divided from the original offices by the courtyard mentioned above in

(Continued on page 232)



### A NEW B.B.C. GOVERNOR

Mr. Harold G. Brown has been elected to the Board of Governors of the B.B.C. for a period of five years. He is a City solicitor and receives £200 a year from the B.B.C. for his services





**TYPE  
PZ2**

**A RADIO BATTERY  
DESIGNED FOR  
RADIO**

**CAPACITY  
35  
AMPERE HOURS**  
WHEN DISCHARGED AT  
THE RATE OF 0.35 Amps

Rate of charge  
**2 Amperes**  
Length..... 7½ inches  
Width..... 3⅝ inches  
Height.... 4½ inches

**PRICE  
10/-**

**MADE IN  
ENGLAND  
BY**

**BRITANNIA BATTERIES LIMITED**

The "low-built" and "robust" construction of this accumulator makes it difficult to be knocked over and prevents breakage . . . fits practically any set with ease . . . provided with gravity indicator which tells when to recharge . . . the "Kaptive Karrier" affords great convenience in transportation . . . non-interchangeable terminal nuts prevent mistakes in Charging . . . no separators — the plates are held firmly in position by the ribs moulded in the clear, white glass box.

Because of their special construction, the sturdy plates, ½" thick, are capable of withstanding heavy rates of charge and discharge which makes this accumulator ideal for modern, high-powered multi-valve receiving sets.

Your dealer can supply this modern accumulator, but should he happen to be out of stock please write and tell us his name and address and we will see that you are supplied.

**PERTRIX**  
TRADE MARK  
**ACCUMULATORS**

Advert. of Britannia Batteries Limited, 233, Shaftesbury Avenue, London, W.C.2.  
Telephone: Temple Bar 7971 (5 lines). Works: Redditch.

*When replying to advertisements, please mention "Wireless Magazine"*

# GOOD-BYE TO SAVOY HILL—Cont. from page 230



THE DIRECTOR-GENERAL ON HOLIDAY

The figure facing the camera on the right is Sir John Reith, the Director-General of the B.B.C. On his right is Dr. Bredow, the German statesman

connection with the medical research laboratory.

More studios were built—in the basement are No. 2, which was formerly a general store, and No. 9, which occupies what was formerly the Savoy Turkish Bath. On the first floor are Nos. 4, 5, 6 and 7.

It was from No. 5 that the news bulletins were read during the General Strike in 1926, and from here the Director General announced the termination of the strike. It was from this studio also that the Prince of Wales broadcast on the several occasions that he visited Savoy Hill.

No. 7 studio was the first "double-decker" to be built; twice the height was obtained by knocking away the floor of the room above.

No. 4 makes up in length what it lacks in height, the dividing wall between two rooms having been removed. A similar process was adopted for studio No. 8 on the second floor.

## Recent Additions

The most recent addition to studio accommodation was the converted wine store at a wharf adjoining Waterloo Bridge. This is known as studio No. 10. Nothing more than a brief mention of it is necessary here.

Savoy Hill has had its excitements, but to the staff the most unusual incidents have been regarded more or less as part of the day's work. A posse of regular police, reinforced by special constables, have guarded the approaches to Savoy Hill and have even invaded the corridors

when a Cabinet Minister has gone to broadcast a message to the nation.

Scotland Yard has also had its representatives on the spot whenever a member of our Royal Family or a distinguished visitor from overseas has paid the B.B.C. a visit; although often when a broadcast by an eminent person was to be given it has been the practice to avoid stating whether the broadcast would take place from Savoy Hill or elsewhere.

Mr. Ramsay MacDonald, for example, would sometimes elect to go to Savoy Hill; at other times he would speak from Downing Street or a friend's house.

With the exception of the King and Queen, who have never been there, Savoy Hill was visited at one time or another by practically every person of eminence in this country. Representatives of the black and yellow races have been seen in the studios.

## Lion's Broadcast

Birds, animals and insects have been brought along to broadcast; on one occasion a lion made a journey in a special cage, but got no further than the front entrance, as neither of the two lifts was large enough to take the cage up to the studio.

In former days children and adults came to Savoy Hill in battalions to see the aunts and uncles. Within the past year or so, since aunts and uncles went out of fashion, the centre of attraction has been Jack Payne and visitors from across the seas have been included among the thousands who have flocked to the B.B.C.'s old headquarters for the sight of the dance-band idol.

## THE LOG

*I sat at the table  
Compiling a log  
When a message from Mabel  
Said: "Take out the dog!"  
With a curse I obeyed  
(For the day was a freezer)  
Up the highway I strayed,  
With my gambolling Cæsar.  
But, later, returning,  
All my papers had gone:  
The fire was burning—  
A flame gaily shone.  
"What's the meaning of that?"  
I exclaimed in dismay,  
"Why, you've thrown (Oh, my hat!)  
All my papers away!"  
"Well, darling," cooed Mabel,  
"The cold was so dire—  
I just went to the table  
And threw your log on the fire!"*

C. P. P.



# "SQUARE PEAK"

Regd. Trade Mark

For circuit diagrams showing how to build a "Square Peak" Set, write for colour leaflet and for circuit folder

Z



## "WIRELESS MAGAZINE" says:

Prolonged tests . . . have proved beyond doubt the good qualities of the Varley band-pass aerial coil.

. . . Very desirable tuning characteristics.

. . . an almost perfect square-peak effect was obtained . . . band-width approximately constant between 200-2,000 metres . . . the resonance curve is very steep-sided, cutting off interfering stations in a surprising manner.

. . . the strength-from distant stations is a revelation . . . greater than that of any other band-pass arrangement yet tested.

"SQUARE PEAK" COIL, complete with mounting bracket, with or without wave-change switch - 15/-

# Varley

Why not give your receiver the wonderful improvements of "Square Peak" band-pass tuning?

Advertisement of Oliver Pell Control Ltd., Kingsway House, 103 Kingsway, London, W. C. 2. Telephone: Holborn 6303.

# ZONOPHONE PICK-UP . . .

## chosen as standard for the "ECONOMY" RADIO-GRAMOPHONE



PRICE 15/-

● Made by "His Master's Voice" the "Zonophone" Pick-up and Carrying Arm represents the best value in pick-ups at the lowest price — only 15/- for the combined unit. The output is over 1½-volts R.M.S., and is scientifically balanced to give true prominence to the bass.

# ZONOPHONE

PICK-UP THE FINEST VALUE IN THE WORLD

The British Zonophone Co. Ltd.,



363 Oxford Street, London, W. 1

Mention of the "Wireless Magazine" will ensure prompt attention.

# Secrets of Super-Het Success

In this article W. JAMES goes over some of the more important points to be noted about super-heterodyne circuits as used for the original Super 60, the 1932 Super 60, and the 1932 A.C. Super 60. His remarks will be of interest to all who have built, or are thinking of building, one of these successful "Wireless Magazine" receivers. He hints also that a one-knob super-het will soon make its appearance in these pages.

**A** SUPER-HETERODYNE receiver has five separate fundamental parts. These are shown in diagrammatic form in Fig. 1.

First is the input stage. This comprises a frame aerial and tuning condenser in the simplest of sets.

In other receivers, designed to be connected to an open aerial, a band-pass tuner is commonly used. This



Fig. 1.—The five essential parts of a super-het set as exemplified by the Super 60 series

has two tuned circuits, with a two-gang condenser.

The signals are very well filtered by a two-circuit tuner of this type, but even so, better filtering is often desired and the filter is used with a high-frequency stage which also has a tuned circuit.

### Three-Gang Condenser

These three circuits, which are to be found in the best super-heterodynes, are tuned by a three-gang condenser and the filtering provided is good enough for present-day purposes. The amplifying stage magnifies the signal and the result is that we have at the output terminals (Fig. 2) a well-filtered and strengthened signal.

Fig. 3 shows a tuned frame aerial, and Fig. 4 a tuned input filter of the two-circuit band-pass class. The

arrangement of Fig. 4 is often used, but the expense of the circuit of Fig. 2 and the fact that three circuits must be ganged prevents its general use. At the same time, it is the most satisfactory arrangement of all and should be used if possible.

### Mixer Circuit

The next part in a super-heterodyne receiver is the mixer circuit. This may have two valves, one being often called the first detector and the other is the oscillator.

Sometimes a single valve is used for rectification and for producing the oscillation.

In the circuit of Fig. 5 we have a frame aerial connected to the grid of a valve biased negatively to rectify. The oscillator has a tuned grid coil *G*, a reaction coil *R* and a coupling coil *C*. This valve oscillates at the frequency of the tuned circuit and oscillations are induced in the coupling coil *C*.

As this coil is connected to the filament and the centre point of the

oscillations produced by the oscillating valve. The result of the rectification is that in the anode circuit of the rectifier we have a signal of a new frequency.

In practice, we tune the oscillator in order that the new frequency shall be that of the amplifier. The frequency of the amplifier, which is called the beat or intermediate

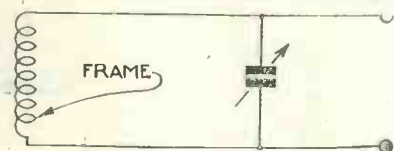

Fig. 3.—Frame-aerial input circuit

frequency amplifier, is 126 kilocycles in "Wireless Magazine" sets.

It is possible to produce the correct beat frequency in this instance (126 kilocycles) by tuning the oscillator to a frequency of 126 kilocycles above or below that of the signal being received. Thus, in the case of a signal having the frequency of 1,000 kilocycles (300 metres) the oscillator must be set to either 1,126 or 874 kilocycles.

This is one of the first points noticed by the user of a super-heterodyne set having a separate oscillator tuning control; you can get the same station with the oscillator condenser set in two places.

### Interference

Now it follows from these facts that interference may be produced by a second station. For suppose that the frame aerial is tuned to the 1,000-kilocycle station and our oscillator is tuned to 1,126 kilocycles, then, if there is a station working on 1,252 kilocycles, and it can get through the frame aerial to the grid of the valve, the chances are that it will interfere, because a 1,252-kilocycle station and 1,126-kilocycle oscillations produce a 126-kilocycle signal.

When the two-circuit band-pass arrangement of Fig. 4 is used, the interference is usually negligible, but for the finest results the three circuits of Fig. 2 before the mixer must be used.

(Continued on page 236)

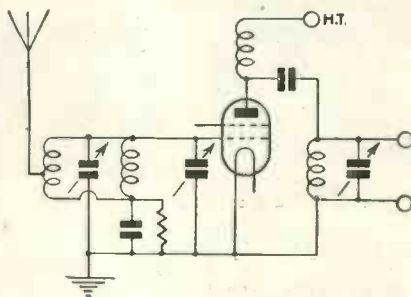

Fig. 2.—Band-pass input circuit with screen-grid high-frequency stage



# CHANGE FROM BATTERIES TO MAINS FOR ONLY **7/6** down

Now you can electrify your radio for only 7/6 down—much less than the cost of a good H.T. Battery. It is so easy, with Regentone. You have only to take out the run-down H.T. Battery and substitute a Regentone Combined Unit.

Connect up the leads that originally went to the H.T. battery to the Regentone Mains Unit. That is all you have to do. Now you can run your radio from the mains—no more trouble, no more expense, just simple, reliable, care-free radio.

Write for particulars of Hire Purchase Terms and the FREE Regentone Art Booklet—"All-Electric Radio"—or get them from your dealer.



Regentone Model W.I.F. (H.T. only). Three tapings (S.G., Detector, and Power).  
Output 120-150 volts. 12 m/a.  
Price 50/- or 7/6 down and 11 monthly payments of 4/7.



REGENTONE LIMITED, REGENTONE HOUSE, 21 BARTLETT'S BUILDINGS, E.C.4.

*Irish Free State Distributors: Kelly & Shiel, Ltd., 37 Fleet Street, Dublin*

Telephone: Central 8745 (5 lines)

# 10/- for your old

# LOUDSPEAKER!

For a limited period only you can sell your old loud-speaker to any radio dealer for 10/-. No matter what its make or condition, your dealer will take it in part exchange for one of the latest S.G. Brown speakers. He will allow you a 10/- rebate on either the famous 'Court' model (price 3 gns.) or the 'Ace' (price 4 gns.)—two of the latest and finest loud-speakers, made by the man who made the

first loudspeaker of all, Mr. S. G. Brown, F.R.S. Ask to hear them at your local shop. You will be astounded at the difference a first-class modern loud-speaker can make to a set. You will be surprised you could ever have put up with your old model. Take advantage of this phenomenal offer before it is too late! If any difficulty, write to us at 19 Mortimer Street, London, W.1

# S.G. Brown

# FAITHFUL RADIO

Better service results from mentioning "Wireless Magazine" when writing to advertisers

# SECRETS OF SUPER-HET SUCCESS—Cont. from page 234

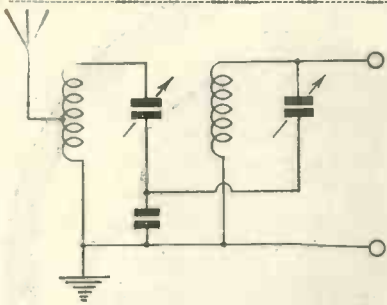

Fig. 4.—Band-pass aerial input circuit

It should be noted, as well, that an oscillator is liable to produce harmonics which will cause troublesome interference unless the signal selector is good enough.

In Fig. 5 we have a two-valve frequency changer, but Fig. 6 shows a single-valve circuit that rectifies and oscillates. Coil F is the frame aerial, which is connected to one of the grids of the four-electrode valve, and coils G and R are the grid and reaction coils of the oscillator, being joined to a grid and to the anode of the valve.

There must be no coupling between the frame and the coils of the oscillator and so it is usual to fit coils G and R in a metal box. In the instances where the input arrangements of Figs. 2 and 4 are used, the pairs of terminals shown go to the grid and filament of the four-electrode valve in place of the frame. All the coils are usually screened.

The circuit of Fig. 6 is an interesting one, successful in practice and widely used abroad. Although the coils are shielded, and the circuits generally, there is the coupling due to the capacity of the grids of the valve.

### Effects Not Harmful

Thus it is found, if a millimeter is included in the anode circuit, that when the input tuner is brought into tune with the oscillator the needle of the meter kicks. As a rule, however, the coupling of the circuits is not so close that the effects are harmful. An oscillator is not quite as simple as it looks on paper.

In the circuit of Fig. 5, for instance,

we have a reaction coil coupled to a grid coil. The circuit is made to oscillate very easily, but there are two points to watch. One is the current taken from the high tension, and the other is the strength of the oscillations.

If a meter is connected in the anode circuit, the current can be measured. Short-circuit the grid condenser for a moment and note the current. Then remove the short-circuit and, if the valve is oscillating, the current will be different. If you touch the grid with a finger, the anode current will change, as probably the circuit stops oscillating when the grid is touched.

Now tune over the whole range of the oscillator and you will probably find that the current varies considerably. Probably the circuit

increase, the voltage drop over the resistance tends to increase, leaving less for the valve. This, therefore, tends to lower the current.

The resistance feed also decouples the circuit, but its primary object is to restrict the amount of the current.

### Size of Reaction Coil

When experimenting with oscillators it will be found that the size of the reaction coil and its position relative to the grid coil are the factors that affect the results. The usual mistake is to use too large a reaction coil.

It is necessary also to consider the generation of harmonics, which must be reduced as much as possible. The strength of the oscillations should be no greater than necessary and the valve ought to be adjusted, as regards

its anode voltage and grid bias, to provide the greatest freedom from harmonics.

In the case of the four-electrode type, shown in Fig. 6, the position is one of greater difficulty. The valve has to produce oscillations and to rectify the mixed signal in order to produce the 126-kilocycle signal in the output circuit. The results can be made quite satisfactory, however, but a good input filter is required.

Sometimes a grid condenser and leak are connected in the grid to which the filter is connected.

This gives the grid a little negative bias under working conditions, as grid current tends to flow through the grid-leak circuit. The bias lowers the damping imposed  
(Continued on page 238)

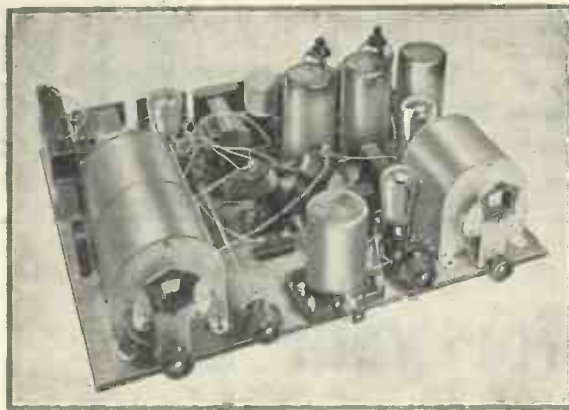

THE 1932 SUPER 60 ALL READY FOR USE

This set, full details of which were published in January, looks like repeating the success of the original model. Thousands have already been built. Have you started on yours yet?

oscillates much more strongly at the higher frequencies and you may find the current is too high for practical purposes. At the other end of the scale the current may be much smaller.

By properly proportioning the coils, using a suitable valve and high tension, the current can be made much more uniform over the range. But with some commercial coils it is necessary to stop the great increase in current in another way.

In the Super 60, for example, I connected a resistance between the high-tension supply and the reaction coil. This acts to make the current taken by the valve from the high tension practically uniform over the tuning range. If the current tends to

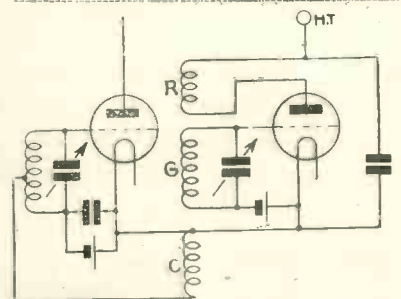

Fig. 5.—Circuit with separate detector and oscillator valves





**'Oh! that's not long!  
Mine has lasted much  
longer than that!**

**Mine's a Drydex'**

● **THE Exide DRY BATTERY**

Made entirely in England employing British labour and British capital.

Obtainable everywhere from all good dealers in sizes and types to suit every wireless set. Also for torches, pocket lamps, cycle lamps and bells.

Mr. S. of Hereford, says:—

"I have had a Drydex in use on my 3-valve set for eleven months and it still shows a voltage of 90. The life of other makers' batteries (and I have had many) were mostly three months, so in future Drydex for me."

Exide Batteries, Exide Works, Clifton Junction, nr. Manchester. Branches at London, Manchester, Birmingham, Bristol, Glasgow, Dublin & Belfast

# SECRETS OF SUPER-HET SUCCESS—Cont. from page 236

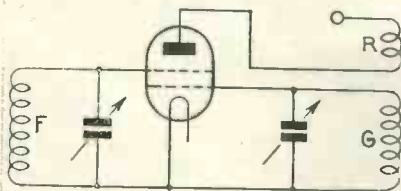

Fig. 6.—Four-electrode valve used as combined detector and oscillator

upon the input circuit and sharper tuning is obtained.

It is possible to gang the tuning of the oscillator and input tuning circuits with satisfactory results. As already explained, the oscillator must be tuned to a frequency above or below that of the input circuits. If we begin with condensers of the same capacity and shape, we shall obviously have to alter the inductance of the oscillator coil to bring it into tune.

### Smaller Oscillator Coil

In practice, the inductance of the oscillator is reduced, so that the oscillator tunes to a higher frequency than the input circuits, the difference being 126 kilocycles. But if the inductive value is adjusted at the highest frequency end of the tuning range, and then the tuning condenser is turned to the other end, that is, to the lowest frequency in the range, the circuits no longer gang properly.

Actually, the oscillator at this setting is producing oscillations of too low a frequency. The oscillator coil cannot be altered again, but a condenser can be joined in series with the section tuning the oscillator to increase the frequency of the oscillations.

### Trimmers

This is done in practice, and Fig. 7 shows the connections. Trimming condensers may be joined across  $C_1$  and  $C_2$  and the tuning may be made correct at the two ends of the range. But the tuning is not correct at all other points, though practical experience shows that the results obtained are not too bad. In fact, some American commercial sets employ this scheme, and with broad tuning in-

put circuits the method works.

When tuning over the long-wavelength range it is found that with a suitable oscillator coil and added condenser fair results can also be obtained.

A better solution of the problem is, naturally, to use a specially-made gang tuning condenser, the part used in the circuit of the oscillator having the vanes so shaped that the circuits are correctly tuned at all points.

There is now a British-made tuning condenser having the properly designed oscillator section and it works extremely well. In fact, no electrical efficiency is lost by its use and the true one-knob tuning obtained is very pleasant in use. The set tunes as easily as any ordinary straight high-frequency set having one-knob control.

It is easy to trim the circuits, too, but special coils, having the correct inductive values, must be used.

Following the mixer stage is the long-wavelength amplifier. This may have one or two stages. As a rule one stage is enough with A.C. valves and when there is a high-frequency stage before the mixer as in Fig. 2. When the maximum magnification is required in other cases, two stages will be used in the amplifier, but often a single stage is all that can usefully be employed. The amplifier, working at a fixed frequency, uses fixed coils tuned by the makers to 126 kilocycles. They are quite strong in their copper pots and hold their tune.

Next comes the detector, often called the second detector to distinguish it from the rectifier used in

the mixer. A grid condenser and leak type is generally used, being sensitive enough and able to deal with signals of the desired strength.

### Adequate High Tension

Input signals are usually larger than those normally applied to a rectifier and the valve must therefore have adequate high tension. But the design of the detector is bound up with that of the output stage. With a small output stage the detector may be of less capacity.

Filtering is always important in the detector circuit. By-pass condensers and a choke are often used, and if the choke is not inserted the condensers must be of fairly large capacity. I have used two of .001 microfarad, but

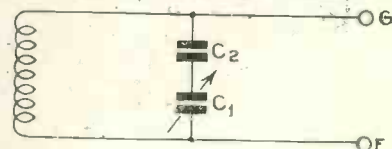

Fig. 7.—Circuit for ganged tuning

the question of the low-frequency output must be considered; with some intervalve transformers and when a pentode is used the relatively large condensers do not spoil quality.

### High-frequency Current

They do practically stop high-frequency current entering the power valve and improve the efficiency of the detector. If high frequency reaches the loud-speaker, it is possible that, owing to the coupling of the aerial with the loud-speaker leads,

whistling may result. A point to note is that there may be a coupling with the detector valve that will have the same effect. The detector should for safety be of the metallised type, but no trouble is experienced when the layout of the set is satisfactory.

There are many parts in a super-heterodyne set and the finding of faults might well appear to be a difficult proposition. But, actually, this is not so. Experience has shown that the proportion of troubles met with is no greater than in the case of simpler sets.

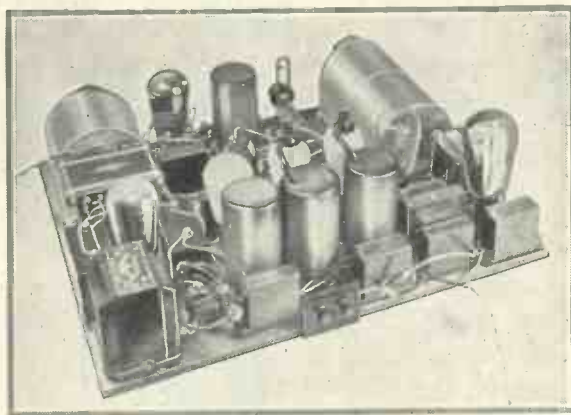

A.C. VERSION OF THE 1932 SUPER 60

Full details of this A.C. version were published in the February issue. It is a receiver de-luxe for the man who wants the very best



# The "Quality Amplifier"

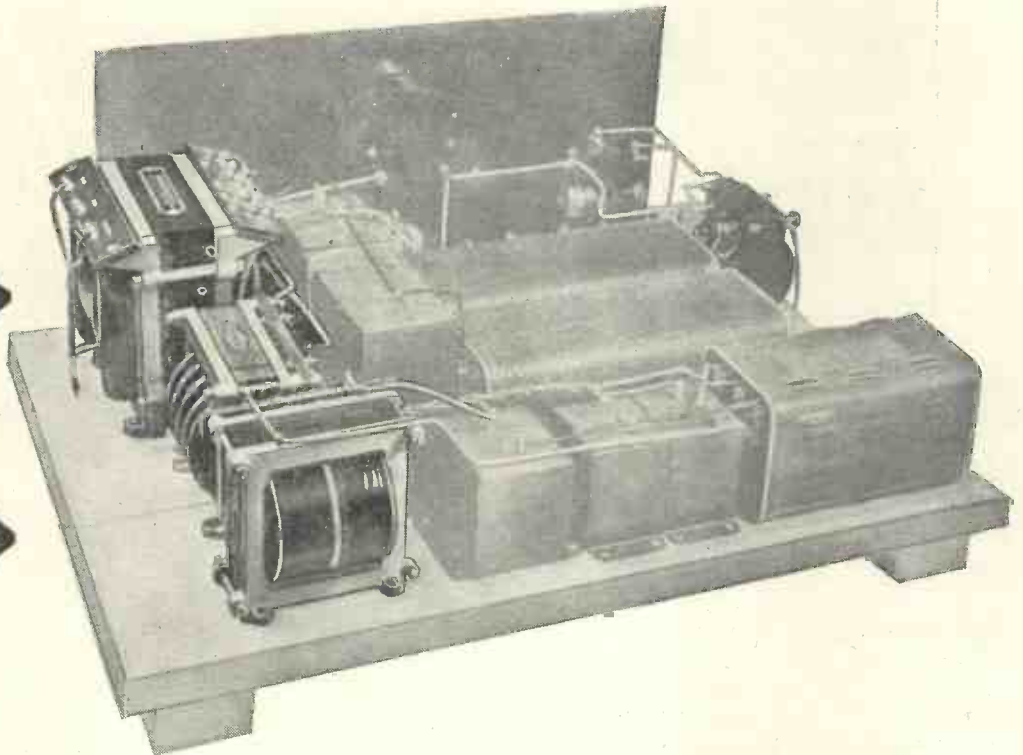

**embodies two chokes  
and one transformer  
all **PARMEKO****

On page 211 of this issue Mr. P. K. Turner describes his latest amplifier. He names it the "Quality Amplifier" because quality of performance has been the main consideration in its design. Consequently his choice of chokes and transformer should be interesting. One—two—three—all are PARMEKO! Forgive us for saying "we told you so," but you will notice for yourself that time after time when performance is the consideration, PARMEKO components are chosen. And the prices? Not enough difference to worry about—judge for yourself from the details below.

- |          |  |                   |
|----------|--|-------------------|
| <b>1</b> | CHOKE, 60 henries 30 m.a.  | Price £1 : 7 : 6  |
| <b>2</b> | CHOKE, 30 henries 50 m.a.  | Price £1 : 7 : 6  |
| <b>3</b> | TRANSFORMER, Primary 200/230/250 volts 50 cycles; Secondary 350 volts 150 m.a., 125 volts 100 m.a., 4 volts C.T. 2 amps., 4 volts C.T. 4 amps. | Price £2 : 15 : 0 |

Ask your dealer about PARMEKO apparatus, or write for price list of Transformers, Chokes, etc. to

## PARTRIDGE & MEE, LTD.,

LEICESTER (Central 22276) & 74 New Oxford St., LONDON, W.C.1 (Museum 5070)

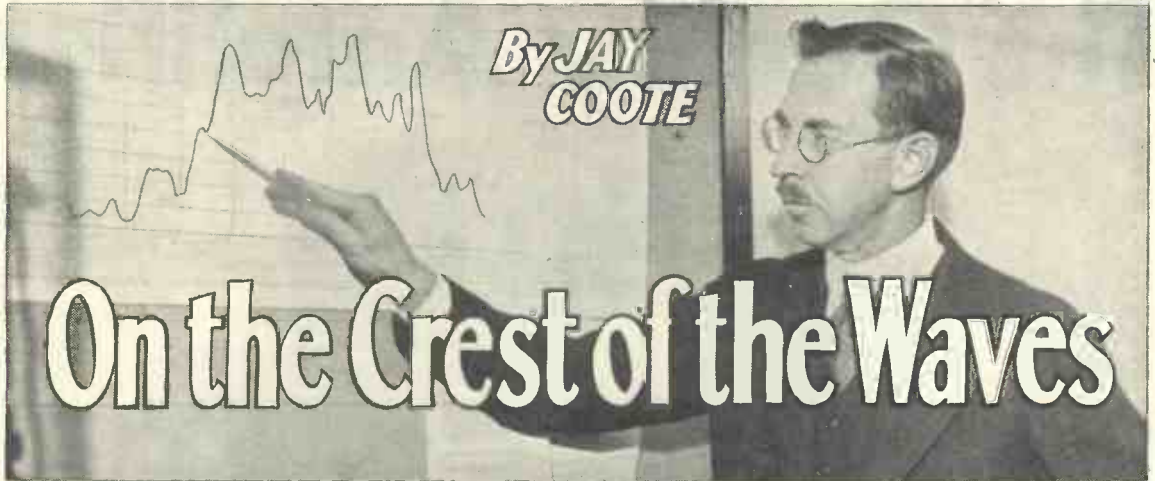

CHECKING THE EFFECT OF SUNSPOTS ON RADIO RECEPTION

Checking a graph on which is recorded the relationship between the intensity of radio signals and the activity of solar storms. Radio signals are weaker when solar storms are at their height

THE power of Limoges (PTT) has been increased since January 14 and its programmes on 293 metres are now well heard in the British Isles.

Contrary to rumour, the Polish authorities are not erecting a 200-kilowatt station at Poznan, but the power of the plant is to be increased to 18 kilowatts in the near future.

Broadcasts are now made daily by Reykjavik (Iceland) between 11 a.m. and 1 p.m. G.M.T. on 1,174 metres, in addition to the usual evening transmissions.

Paris (PTT) is on the lookout for a suitable interval signal and desires to find one which may show some signs of originality. Tests are to be made with a record reproducing the crowing of a typically French rooster.

For the benefit of Belgian residents in the Congo Free State, the Brussels broadcast programmes are to be relayed through the Ruysselede (Bruges) short-wave transmitter on 15.625 and 29.04 metres.

The new 60-kilowatt Langenberg station has now taken over the entire transmission of the Cologne programmes; the smaller plant is being kept in readiness as a standby in the event of a breakdown by its big brother.

An agreement has been reached between certain makers of gramophone records and the German broadcasting stations. In future

transmissions of canned music must not exceed a period of two hours daily.

Japan now boasts of over one million registered licence holders. There are eight main broadcasting stations of which the most important are situated in Tokio and Osaka. Five new transmitters are under construction.

An ultra short-wave station has been erected at the Vatican (Rome) for two-way communication with the village of Castel-Gandolfo, in which the Pope owns a country seat. It is situated at about 16 miles from the Italian capital.

In view of the power of the Sottens (Switzerland) transmitter the original Champ de l'Air transmitter, which from the outset relayed the Lausanne wireless programmes, has now reverted to its former duties, namely aviation control.

No drastic changes in wavelengths of broadcasting stations are to be made before the end of 1932. All suggested alterations are to be discussed at the International Wireless Telegraphy and Telephony Convention to be held at Madrid in September next.

The Soviet Union now possesses fifty-five stations ranging in power from 3 to 100 kilowatts. With a view to popularising radio, no listening tax is charged and receiving stations may be installed without any compulsion on the part of the

owner of going through any form of registration.

In order to attract the special attention of listeners to the importance of certain official communications broadcast in the course of the evening news bulletins, the Polish stations precede the particular announcement by the roll of a drum. The sound is produced by the ubiquitous gramophone record.

Considerable improvements in the Swedish broadcasting system are to take place during the current year, if financial conditions permit. It is planned to erect further transmitters in the northern districts of the country. Another high-power station similar to that at Motala may be built in 1933.

A report has been received in Switzerland to the effect that a concert broadcast from Beromuenster was well received in New Zealand; a programme relayed from Helsinki by Viipuri (Finland) was also logged by a listener at Cawnpore (India). Such is the efficiency of the modern wireless receiver.

There is a likelihood that the Portuguese authorities may establish a broadcasting system in that country in the course of 1933. As a start it is proposed to install a transmitter at Barcarena and a studio at Lisbon. Although a wavelength has not yet been fixed, it is possible that a channel such as 455.9 metres (658 kilocycles) may be adopted.

(Continued on page 242)





# 5 SPECIAL FEATURES of the VIBRANTI CABINET

1. Lowest priced radiogram cabinet yet offered.
2. Motor board ready drilled.
3. Fine appearance and design. Exceptionally well made.
4. First-class in Oak, Walnut, or Mahogany finish.
5. Expressly designed for the "Wireless Magazine" Economy Radiogram and approved by its designers. Ideal for many other sets.

## The STARTING POINT of your "Wireless Magazine" ECONOMY RADIOGRAM

*... and the finishing touch!*

THE most satisfactory way of building your Economy Radiogram is to get your cabinet first and build the radio into it. And that's all you need to do with this new VIBRANTI Cabinet—for it is ready fitted with Collaro Double Spring Motor, Turntable, Pick-up and Arm. Or you can have it with the motor board ready drilled for your own fittings.

And this cabinet adds the finishing touch to your Economy Radiogram, too—for its handsome appearance and fine design and finish make a fine piece of furniture you will be proud to own.

Little wonder that this cabinet is included in an economy specification—it is absolutely the lowest-priced cabinet yet offered—and the finest value.

Order from your usual retailer or direct from:

**VIBRANTI PRODUCTS CO.**  
308 Euston Road, London, N.W.1.

### CABINET AND FITTINGS

Ready installed, Collaro Double-spring Motor, Turntable, Pick-up and Arm.

**£4.10s**

As above, but without pick-up,

**£3.12.6**

Or with Single-spring Motor,

**£3.4.0**

### CABINET ONLY

Motor board drilled without extra cost. When ordering state whether for single or double-spring motor.

**£2.5s.**  
CARRIAGE PAID.

# VIBRANTI CABINETS

# Specified by the designers of the "ECONOMY" RADIOGRAM

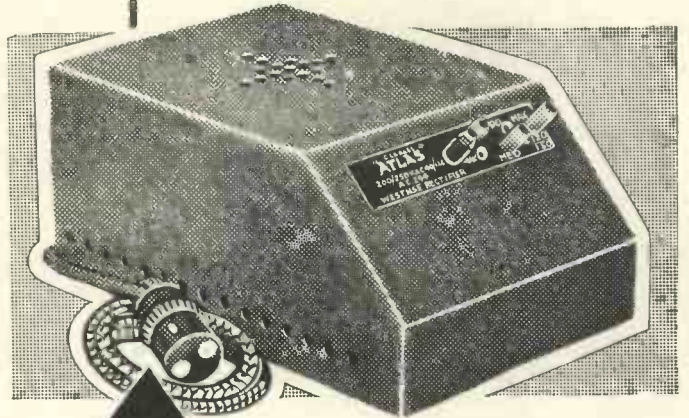

**10/-  
DOWN  
AND BALANCE  
IN EASY  
MONTHLY  
PAYMENTS**

CONSTRUCTORS of the "Economy" Radiogram, described in this number, will achieve far cheaper, better and more reliable results by running it from the mains. After personal tests and comparison, the designers exclusively specified the famous "ATLAS" Mains Unit, Model A.C.244, for this receiver.

The Unit provides three H.T. Tappings with five intermediate positions, to give fine voltage adjustments, and supplies 20 mA at 120 volts. Cash Price 59/6.

A corresponding Model, A.K.260, provides, in addition, a Trickle Charger for 2, 4, and 6-volt L.T. Accumulators. Cash Price 90/-.

Both Models incorporate Westinghouse Rectifiers and are fully guaranteed for 12 months.

Insist on "ATLAS" Mains Units, winners of the Olympia Ballots in 1930 and 1931.

# "CLARKE'S" "ATLAS" MAINS UNITS

FREE  
BOOKLET

H. CLARKE & Co., (M/CR) Ltd., Old Trafford, Manchester  
Phones: Trafford Park 1744-5-6. Southern Offices: Bush House,  
W.C.2. Phone: Temple Bar 7130. Glasgow Office: 24 Oswald  
Street, Glasgow. Phone: Central 5119.

● **POST THIS COUPON NOW**

H. CLARKE & CO., (M/CR) LTD., Eastnor St., Old Trafford, Manchester.  
Please send me FREE copy of "Power from the Mains," telling me how to convert my battery set to Mains Operation.

NAME

(In capitals)

ADDRESS

When you send your order don't forget to say you "saw it in the 'W.M.'"

## ON THE CREST OF THE WAVES—Continued

Two special cables are to be laid between Geneva and Basle, and between the former city and Zurich, in order to permit the linking up of the Swiss studios with the international broadcasting system. By this means the relay of concerts from the principal Swiss centres will be made possible by landline to Paris, London, Berlin, Rome and Vienna.

The Italian stations at Milan, Genoa, Turin and Trieste have now been amalgamated into one group for the simultaneous broadcast of the greater part of the day's programmes. When such an S.B. is carried out the call put out by the announcer is "Radio Nord Italia." On other occasions the names of the stations are detailed.

On some nights during the week the Russian studios prolong their transmissions until 11.30 p.m. (G.M.T.) and even until a later hour, with special concerts for workers on night shifts. Stations such as Leningrad, Moscow, Kharkov and Kiev open up daily at 3 a.m. with physical exercises and the first morning concert.

In view of Bolshevik propaganda put out in the Finnish language by the Leningrad station, the Helsinki authorities have decided to carry the war into the enemy's camp and propose to build a giant station on the actual frontier of the Soviet republics. It is to be used for contra-propaganda talks likely to be of interest to listeners in Russia.

Radio pirates in Rumania are treated to a microphone publicity which has achieved excellent results. From time to time the local station broadcasts the names and addresses of owners of wireless receivers who have omitted to take out licences. Following these transmissions the post offices are usually besieged by forgetful fans!

On April 1, the Dutch stations will again exchange wavelengths for a further period of three months. The A.V.R.O. broadcasting association which transmits through Hilversum will then bring into action the old PHOHI transmitter, of which the power has been raised to 20 kilo-

watts. The wavelength will be 298.2 me.res.

The Italian authorities have taken over a new theatre at Turin with a view to its utilisation as a special studio for broadcast operatic performances to which the general public can be admitted. Although it has not yet been formally opened it has already been successfully used for the transmission of concerts to the Radio Nord Italia group of stations.

At a cost of nearly 750,000 French francs, the General Council of the Lower Pyrenees has decided to transfer the Bordeaux-Sud-Ouest broadcasting station, lock, stock and barrel, to a site in the immediate neighbourhood of Pau. The transmitter is to be dismantled and re-erected in the course of the summer months. Studios will be opened at Pau and Biarritz.

Experiments by amateur transmitters have been carried out at Zevoli and Vallona to ascertain the possibility of erecting a broadcasting station in the immediate neighbourhood of Tirana (Albania). If authority can be obtained a concession will be applied for by a local syndicate. It is expected that the plant would be installed by an American concern.

In future, the programmes of the Belgian broadcasting stations are to be extended and the transmitters will work from Monday till Friday until 10.30 or 11 p.m., and to a later hour on Saturdays and Sundays. Radio Schaerbeek, a private station which had been broadcasting for over two years, was closed down by the authorities. Its studio possesses a "speaker" (announcer) who was too "plain spoken"!

Sweden has decreed that in order to cut down operating expenses no transmissions are to be carried out by its broadcasting stations after 10 p.m. G.M.T. The measure has also been taken in view of the existing police regulations, which forbid the use of loud-speakers in apartment houses after that hour. For reasons of economy, it is anticipated that Norway may adopt the

same principle and will also instruct its studios to close down earlier.

Statistics recently published in Holland show that at the end of September, 1931, there were 278,891 registered listeners to the broadcast programmes. These entertainments were also received by 414,438 subscribers to the recently established wired-wireless systems working in conjunction with the telephone services. In Holland no tax is levied from listeners; the studios are supported by voluntary contributions.

According to a rota, Breslau, Heilsberg and Langenberg carry out a relay of U.S.A. programmes three times weekly between 8 and 9 p.m. G.M.T. Every Sunday at 7.30 p.m. G.M.T. the Columbia Broadcasting Company of New York rebroadcasts a talk given in London by some well-known British authority. These transmissions are relayed to the United States *via* Rugby and are broadcast by a number of American stations, including short-wave transmitters.

Work on the buildings destined to house the new 25-kilowatt Frankfort transmitter situated on the Heiligenstock in the neighbourhood of the city is progressing so well that it is hoped to get the station completed by the end of the summer. Contrary to the usual method adopted, the transmitter will retain its 300-ft. steel aerial masts as the site does not offer facilities for their replacement by wooden structures such as have been erected for the other high-power plants.

In view of the recent financial distress in Chicago the municipal authorities put forward a proposal to conduct the schools by wireless. A scheme was drawn up to permit families who do not possess radio receivers of forming themselves into "neighbourhood groups" and thus enable their children to be taught by broadcast through loud-speakers. It was stated to be the only practical alternative if the State of Illinois could not come to the assistance of the city as, failing such help, funds were not available to maintain the schools and over 500,000 children would be idle.



# Meteorise Your Old Set

## METEOR III KIT

Complete Kit of Components, **75/-**  
or 9/- down and 7 monthly payments  
of 10/6.

**METEOR III STANDARD CABINET MODEL**  
Complete Kit of Components and Cabinet  
to house set only ... **89/6**  
or 11/- down and 8 monthly payments of 11/-.

**METEOR III CONSOLETTA CABINET MODEL**  
Complete Kit of Components and Cabinet, to house  
set, speaker and batteries—equal in  
appearance to a 15-guinea model ... **£5 0 0**  
or 11/- down and 9 monthly payments of 11/-.

### PRICE LIST OF METEOR COMPONENTS

Manufactured by R.I., Lewcos, Graham  
Farish, T.C.C., Ready Radio, J.B., etc.

	s.	d.
1 Panel, drilled and fitted with brackets	4	6
1 Baseboard	1	8
2 Slow-motion dials, complete with escutcheon plates and fixing screws	5	0
1 Push-pull on-off switch	10	
1 Wave-change switch	1	6
1 .00045-mfd. variable tuning condenser	6	6
1 .00025-mfd. solid dielectric reaction condenser, with bracket, extension rod, and insulating coupler for connecting up to slow-motion dial...	6	0
3 Valve holders	1	6
1 L.F. transformer	6	9
1 100,000-ohm anode resistance and holder	1	6
1 2-megohm grid leak	10	
1 1-megohm grid leak	10	
1 Grid-leak holder	6	
1 Coil holder with wooden strips to act as supporting spacers	5	6
1 .0015-mfd. fixed condenser, tag type	1	4
1 10,000-ohm link resistance	1	0
2 Connection strips with various leads eyeleted thereto	1	0
1 Radio-gram switch	2	9
1 Set of 7 flex leads fitted with plugs	2	6
6 Spare plugs for external connections	1	0
1 Packet of fixing screws	2	0
1 Set Meteor "Jifilinx" for wiring	2	0
1 Meteor dual-range high-selectivity coil...	10	6
1 Meteor short-wave coil with special adjustable aerial coupling coil...	7	6
	<b>75</b>	<b>0</b>

There is no longer any need for you to suffer the inconvenience and expense of a *separate* short-wave set—build the Meteor or convert your old set and you will have a receiver which will cover **ALL** wavelengths.

In addition to tuning in Australia, America, Africa and other far distant countries on the Ultra-Short Waveband you will have an excellent choice of programmes from home and abroad on the medium and long wavelengths also.

The wonderfully efficient Meteor Coils and all Meteor parts are now obtainable **separately**. Choose the components you need from the list and modernise your old set now.

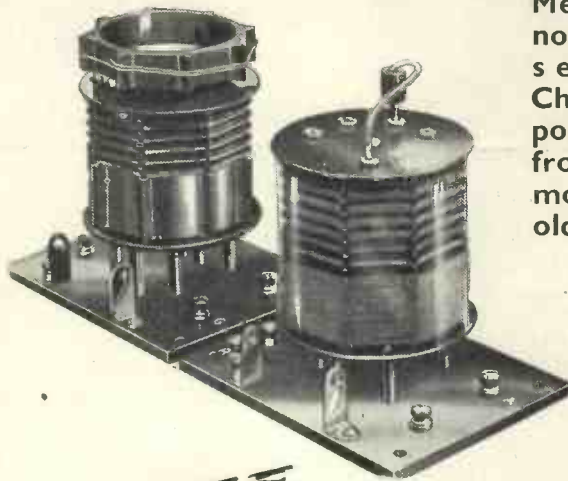

Full size wiring plan and theoretical diagram of the Meteor free with all Meteor Coils.

*Ready Radio*

# METEOR III

Daily demonstrations of this wonder receiver at the Ready Radio Show-rooms: 159, Borough High Street, London Bridge, S.E.1.

(2 minutes from London Bridge Station).

### ORDER FORM

To: Ready Radio Ltd., Eastnor House, Blackheath, S.E.3

Please send me .....

for which I enclose .....

Name .....

Address .....

W.M.3.32

- Meteor Dual Range Coil, with special adjustable selectivity device (windings enclosed in dustproof overing) **10/6**
- Kendall Loose-Coupled Meteor Short-Wave Coil, 20 to 50 metres **7/6**
- Meteor Coil Base (incorporating grid leak holder, grid condenser and "range" condenser) **5/6**

Complete kit as above **23/6**

Additional Meteor Short-Wave Coil covering 10 to 40 metres - **7/6**  
Full instructions with every Coil. Any Coil may be purchased separately

Ask your radio dealer for your Meteor Folder. If he is out of stock, post coupon now to: — Ready Radio Ltd., Eastnor House, Blackheath, S.E.3. If you also enclose four 1½d. stamps we will send you Mr. Kendall's latest book entitled "Ten Hows for Modern Radio Constructors." Packed full of useful information.



# FREE..

# Our Tests of New Apparatus

Peak Fixed Condensers :: R. and A. Loud-speaker :: R. I. Low-frequency Choke :: Bulgin Signal Lights :: Baker Moving-coil Loud-speaker

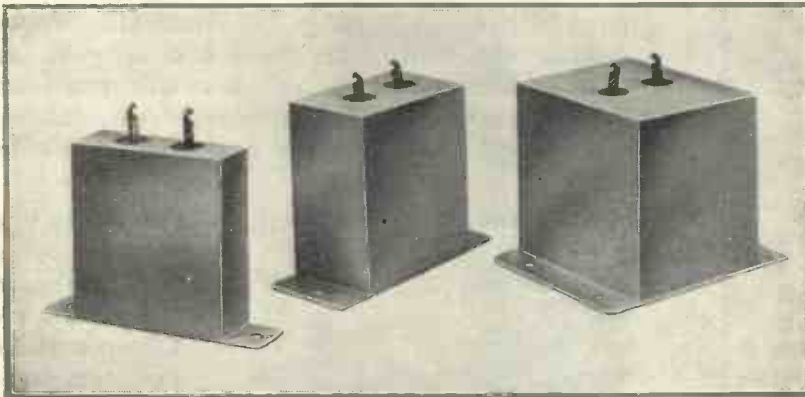

A NEW RANGE OF FIXED CONDENSERS  
Three of the new Peak condensers marketed by Wilburn and Co. Terminals can be obtained instead of soldering tags if desired. The prices are very attractive

## PEAK FIXED CONDENSERS

APPARATUS: Peak fixed condensers, (a) 4-microfarad and (b) 1+.1-microfarad.  
PRICE: (a) 6s. 9d., (b) 2s. 6d.  
MAKERS: Wilburn & Co.

THERE has long been a need for the introduction of a range of cheap high-voltage large-capacity condensers of reliable construction, and it was with considerable interest that we received some samples of the new Wilburn range of Peak condensers having capacities varying from .1 to 4 microfarads, with a tolerance of + or - 10 per cent.

These condensers are tested to 1,500 volts D.C. and consequently have working voltages of 500 volts A.C. or 700 volts D.C. Also in this range is a .1+.1 microfarad 1,000-volt A.C. test condenser for use in A.C. mains circuits to prevent oscillation of the rectifier valve.

### Normal Construction

The construction, as far as external appearance goes, is quite normal. Metal cans are used, with soldering tags or terminals for the connections.

Two samples were tested, a 4-microfarads and 1+.1-microfarad. The actual capacities were found to be within the limits allowed, the actual measured values being 3.8 microfarads and .097+.096 microfarad respectively in the two cases. The insulation resistance was excellent, it being too high to obtain any definite reading on our instrument.

If the construction of these condensers is consistently as good as that of the samples tested, and we see no reason why it should not be so, the range should make a wide appeal. The condensers retail at prices ranging from .1s. 10d. to 6s. 9d., which are very attractive figures.

## R. & A. LOUD-SPEAKER

APPARATUS: Moving-iron loud-speaker chassis, type 40.  
PRICE: 16s. 6d.  
MAKERS: R. & A. Reproducers, Ltd.

A WELL-MADE moving-iron loud-speaker chassis which we have tested this month is the R. & A. type 40. This employs a large white-paper diaphragm of the free-edge type, approximately 11 in. in diameter and 4 in. deep.



A CONE CHASSIS  
This is the R. and A. type 40 cone chassis, with adjustable unit that gives good reproduction

The diaphragm is suspended by means of rubber-backed white fabric from a stout metal chassis provided with a compartment at the back for housing the operating unit. This latter is of the differential type. Two bar magnets are used in parallel, the polepieces and operating coil being mounted between them.

### Dust Cover

The unit is further provided with a dust cover to prevent extraneous matter from getting into the gap and causing rattle. The terminals for external connections are mounted at the back of the chassis, which is finished in black enamel, the whole assembly making a very neat job.

On test the loud-speaker gave very good results, the overall frequency response appearing good from 200 up to about 3,500 cycles, but falling off rapidly outside these limits. One or two small resonances were noticed at about 2,500 and 1,000 cycles, but these were not serious.

The sensitivity was quite up to standard and the reproducer should give good results with all small power receivers. The overall dimensions are 14 in. in diameter by 5 in. deep.

## R.I. LOW-FREQUENCY CHOKE

APPARATUS: Low-frequency choke, type Dux Audirad.  
PRICE: 8s. 9d.  
MAKERS: Radio Instruments, Ltd.

A VERY interesting new component which we have tested this month is the R.I. Dux Audirad choke. The unique feature of this choke is that it includes a hank-wound high-frequency choke in series with the main winding to act as a stopper to any high-frequency currents which may be present in the supply.

The low-frequency choke is of the constant-inductance type, rated at 25 henries with a D.C. current of 50 milliamperes in the winding.

The choke is housed in a moulded bakelite casing, maroon in colour, which is shaped to fit the laminations

(Continued on page 246)



# Specified & used in the 'ECONOMY'

## RADIO-GRAM

described in this number

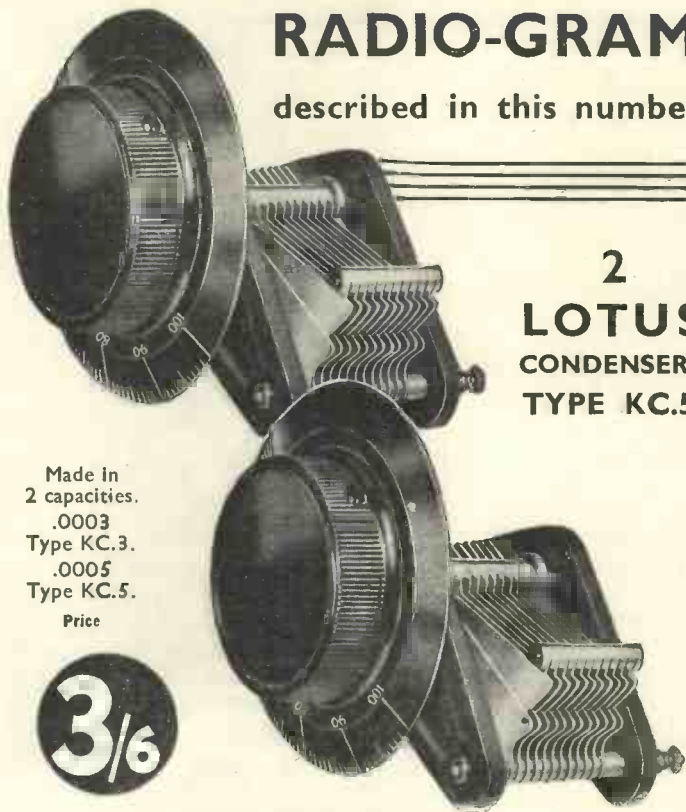

2  
**LOTUS  
CONDENSERS  
TYPE KC.5.**

Made in  
2 capacities.  
.0003  
Type KC.3.  
.0005  
Type KC.5.

Price

**3/6**

The chief reason why the designer of the "Economy" Radio-gram chose, uses, and specifies Lotus Condensers is their wonderful workmanship combined with extremely low cost. There can be no substitute for the guaranteed efficiency, rigid construction, heavy aluminium vanes, highest grade bakelite end-plates, and locked spacing of the famous Lotus Condensers.

Post the coupon below for your FREE Copy of the Lotus Component Catalogue. It is full of interesting information to constructors.



**RADIO COMPONENTS**  
LOTUS RADIO LTD., MILL LANE, LIVERPOOL

**POST THIS COUPON NOW**

To: LOTUS RADIO LTD., MILL LANE, LIVERPOOL.  
Please send me a FREE Copy of the Lotus Component Catalogue.

Name .....

Address .....

# Triple Wave THREE Kit



Price  
without  
valves

**KIT  
COMPLETE  
£35.0**

AN  
"AMAZINGLY SIMPLE"  
SET TO BUILD AND HANDLE  
WONDERFUL RANGE & SELECTIVITY

## ULTRA-SHORT, MEDIUM & LONG WAVES with NO COIL CHANGING

This easily constructed Kit provides you with the opportunity, never offered before, of tuning in to the world's ultra short-wave stations in addition to the host of medium- and long-wave broadcasts—by the simple turn of a neat panel switch.

Another feature of this wonderful efficient three-valver is that when the ultra-short coils are in circuit, the capacity of the tuning condenser is reduced to .00015. The efficiency of the Kit is assured by the use of the

### FAMOUS MAZDA VALVES

numbers P220, L2, and HL2, which are obtainable from all Radio Dealers.

**TRIPLE WAVE COIL ONLY.** Price 17/9 Prov. Pat.

**"ECONOMY 3" KIT.** Price 39/6

**FREE BOOKLET** Simple wiring instructions are described and illustrated in this

Booklet, obtainable FREE from your dealer or address below.

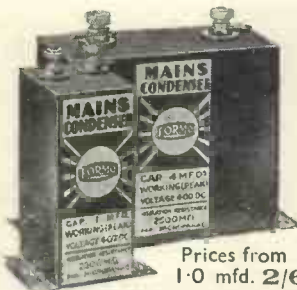

## MAINS CONDENSERS

Formo Condensers are tested by the sudden application of the test voltage, and not, as is usual, through a non-inductive series resistance. Higher test and working voltage result, with greatly increased efficiency.

Prices from  
1-0 mfd. 2/6

**ARTHUR PREEN & CO. LTD.**

Golden Square, Piccadilly Circus, London, W.1

When replying to advertisements, please mention "Wireless Magazine"

# OUR TESTS OF NEW APPARATUS—Cont. from page 244



LOW-FREQUENCY CHOKE

The Dux Audirad low-frequency choke made by Radio Instruments, Ltd. It includes a high-frequency choke as well

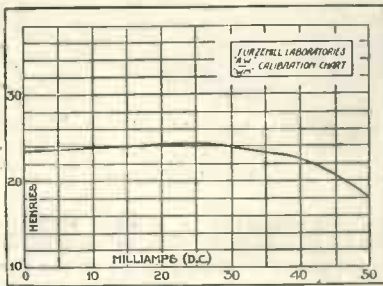

INDUCTANCE VALUES

This curve shows the inductance values of the Dux Audirad choke with different values of D.C.

of the core. The high-frequency choke, being small, is located against one side of the main winding.

### Inductance Values

The inductance was measured with different values of D.C. in circuit, and as can be seen from the accompanying curve, the value obtained was approximately 24 henries with D.C. currents up to 40 milliamperes, this figure falling to 18 henries at 50 milliamperes. A steady A.C. current of 1 milliampere was superimposed on the D.C. throughout the test.

The inductance of the high-frequency choke alone was 130,000 microhenries, which is a normal value for a choke of this type, and should be quite satisfactory in preventing high-frequency currents from reaching the valves in the receiver. The total D.C. resistance was approximately 900 ohms.

### BULGIN SIGNAL LIGHTS

APPARATUS: Bulgin signal lights. (a) type D16 and (b) type D9.  
PRICE: (a) 2s. 6d., (b) 2s. 6d.  
MAKERS: A. F. Bulgin & Co., Ltd.

IT is now no longer a luxury but a necessity to have some kind of signal to give warning when the

receiver is switched on. This is especially so with battery-driven receivers, which are normally completely silent when no signal is being received.

Very satisfactory and easily seen types of signal are those which employ flashlamp bulbs, these being wired in parallel with the filaments of the valves. Low-consumption bulbs can be used and the extra drain on the accumulator is practically negligible.

### Single-hole Fixing

We are reviewing this month two slightly different types of signal made by A. F. Bulgin & Co., Ltd. Both these are arranged for single-hole mounting,

The first type has a lamp-holder built up from a small piece of nickel-plated brass tubing threaded at one end to take the clamping rings and the cap which carries the ruby glass. One contact is, of course, the body of the lamp-holder, while the other consists of a spring held in a piece of insulating material which fits into the back end of the holder.

The lamp itself is screwed into a small collar, this being a sliding fit in the holder, and is thus readily removable for renewal.

The second type is simpler, but quite as effective as the first. An L-shaped piece of nickel-plated brass carries at one end the ruby glass and fixing nut, and at the other end a normal type of lamp-holder. Both these types are strongly made and can be recommended.

### BAKER MOVING-COIL LOUD-SPEAKER

APPARATUS: Permanent-magnet moving-coil loud-speaker, type PPM.  
PRICE: £3 15s.  
MAKER: Baker's Selhurst Radio.

ONE of the best permanent-magnet loud-speakers which we

have had opportunity to test recently is that manufactured by Baker's Selhurst Radio. Although this instrument is quite conventional in design so far as can be seen, the fact remains that it must be placed at the top of its class from the point of view of performance.

The loud-speaker employs a large cobalt-steel permanent magnet, this being bolted to the back of the chassis. The magnet is completely enclosed in a sheet metal casing, which is extended to act as a support for the complete instrument.

The diaphragm assembly is suspended by a leather surround from a clamping ring at the front of the

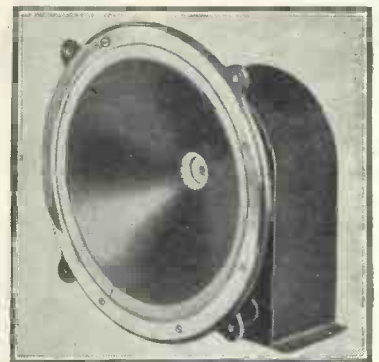

PERMANENT-MAGNET MODEL

The Baker type PPM permanent-magnet moving-coil loud-speaker which has an excellent performance

chassis. The moving coil employed is of the low-resistance type, and the necessary input transformer is provided with the loud-speaker and is built into the magnet housing.

On test the performance was excellent, as has already been stated. Reproduction of speech and music was quite natural, with no trace of boom or paper rattle, the balance between the upper and lower frequencies appearing to be just right. The sensitivity was good.

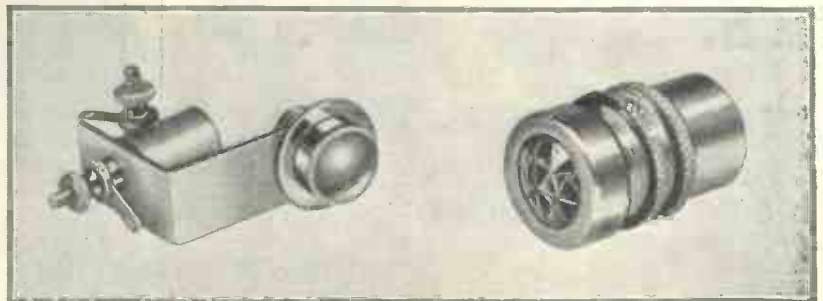

SIGNAL LIGHTS TO SAVE YOUR BATTERIES

With one of these Bulgin signal lights on your set you will never leave it switched on when it is not in use



# DO YOU KNOW?

*How to obtain correct tracking*  
*How a pick-up works*  
*How to fit a volume control*  
*How to fit a radio-gram switch*  
*How to obtain feather weighting*  
*How to minimise record wear*

Revealing the hidden beauty in your Gramophone Records

**Harlie**

How to eliminate needle scratches

**Harlie**

**IN SIMPLE WORDS THIS BOOK TELLS YOU HOW FREE!**

To Harlie Bros. (Edmonton) Ltd.,  
 Balham Road, Edmonton, London, N.9  
 Please send me the Harlie "Pick-up" Book  
 Name .....  
 Address.....  
 W.M.1 .....

Harlie Products are stocked by all dealers

## CONVERT YOUR SET INTO A SHORT-WAVE HETERODYNE AND HEAR THE WORLD DIRECT

Insert this converter in the aerial lead to your set. It can be used with any battery, D.C. or A.C. mains receiver providing one or more stages of H.F. amplification are present. Extremely simple to operate.

*It converts your present receiver into a short-wave super-heterodyne following the latest practice.*

### EDDYSTONE SHORT-WAVE CONVERTER

Complete in oak cabinet (10 in. x 6 in. x 9 in.) including Mullard PM2DX valve, 60 volt Pertrix H.T., Eide L.T. (Royalty included)  
**£4-17-6**

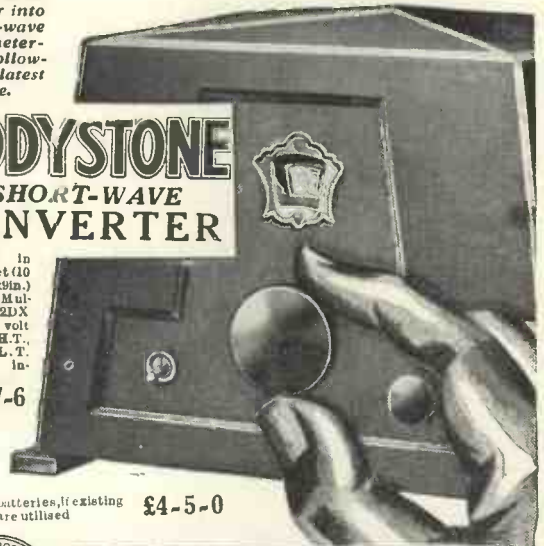

Without batteries, if existing battery are utilised **£4-5-0**



STRATTON & Co., Ltd., Bromsgrove St., Birmingham  
 London Service Depot:  
 Webb's Radio Stores, 164 Charing Cross Road, W.C.2

## CLIX

An advantage to any set...

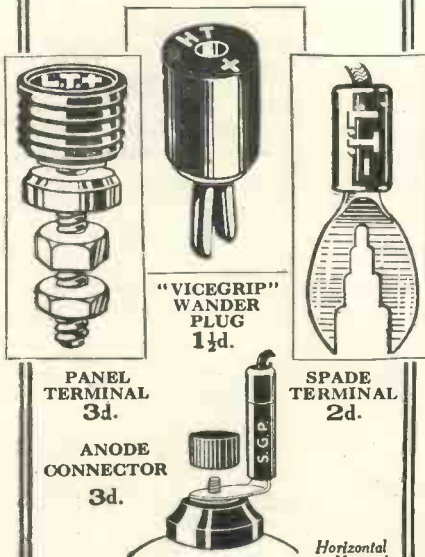

**Cheapest PERFECT Contact**

Lectro Linx, Ltd., 264 Vauxhall Bridge Road, S.W.1

**BATTERY SETS MADE ALL-ELECTRIC FOR 9/2**  
 and 11 payments of 8/8 or  
**CASH PRICE £4:15:0**

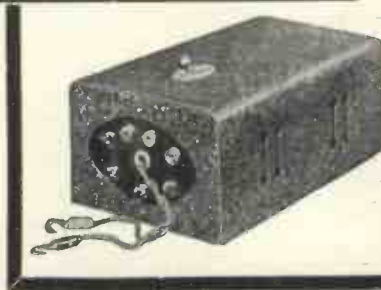

### TANNOY RADIO for the CONNOISSEUR

#### TYPE G.B.1

**H.T.** 150 v. at 15 m/a. or 120 v. at 20 m/a. Also S.G. and Det. Tappings.

**G.B.** 3 Tappings up to 12 v. Independent of H.T.

**L.T.** 2, 4 or 6 v. Trickle Charger.

Similar to above but larger output.

#### —TYPE G.B.3

TANNOY mains units incorporate independent G.B. Pat. No. 353375.

Write for particulars

## TANNOY PRODUCTS

Dalton St. :: West Norwood  
 Tel.: STREATHAM 6731/2

### BARGAINS. Half Price.

Six-and eight-valve Receivers All-Electric absolutely new and guaranteed by makers. Also six-and eight-valve chassis and six-valve Radiograms. Moving-coil speakers. Finest ever offered. All half-price to clear.

MORGAN HASTINGS, LTD.,  
 212, New Kings Road, Fulham, S.W.6.  
 Opposite Putney Bridge Station.

## "ASTRA"

**DIALS AND CONDENSERS**  
 "Masterpieces of Precision"

Send for Catalogue W. giving complete range  
 ENKABE RADIO CO., LTD.,  
 47 Farringdon Road, E.O.1.

Better service results from mentioning "Wireless Magazine" when writing to advertisers

# The FREESTONE QUALITY SERVICE GUARANTEES—

- THAT in the construction of receivers ONLY specified components are used—this ensures identical results to those obtained by the designer.
- THAT every component used is thoroughly tested and that the assembled receiver is given the severest possible aerial test before leaving the works.
- THAT the promised time for delivery which is given to every customer is strictly adhered to WITHOUT EXCEPTION.
- THAT every customer has the satisfaction of the finest "after sales" service in radio.

*If you have any particular receiver in mind write for a quotation; our terms are remarkably low considering that FREESTONE is a quality service.*

V. E. FREESTONE & CO LTD  
102 WEMBLEY HILL ROAD  
WEMBLEY MIDDLESEX

Phone, Wembley 1443

THE "STAR" RECEIVER OF 1932  
The 1932 Super 60 Battery Model  
£16-10-0 completely finished,  
aerial test, including royalties

## IN THE "DOUBLE BAND-PASS FOUR"

because of these unique advantages:—

- (1) 37 Permanent engravings.
- (2) Name does not rotate.
- (3) Head cannot come off.
- (4) Terminal cannot twist loose.
- (5) Fully insulated.
- (6) Soldering unnecessary.
- (7) The highest class finish.

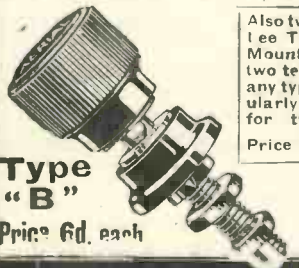

Type  
"B"  
Price 6d. each

Also two Belling-Lee Terminal Mounts, to take two terminals of any type. Particularly suitable for type "B." Price 8d. each

**BELLING-LEE**  
FOR EVERY RADIO CONNECTION

Adv. of Belling & Lee, Ltd., Queensway, London's E.C.4.

## FAMOUS CRAFTSMANSHIP



for YOUR SET or RADIO GRAM. Piano Tone and Style brings a thrill no words can convey.  
(Over 3,000 delighted clients.)  
(Radio Press-leading Experts.)  
DIRECT from makers. APPROVAL 7 days FREE. 35/ to £15. Cash or EASY PAYMENTS. Photographs FREE.  
PICKETS Radio Furniture Makers. (M.G.) Albion Rect Bexleyheath, Kent.

# A Power Pick-up

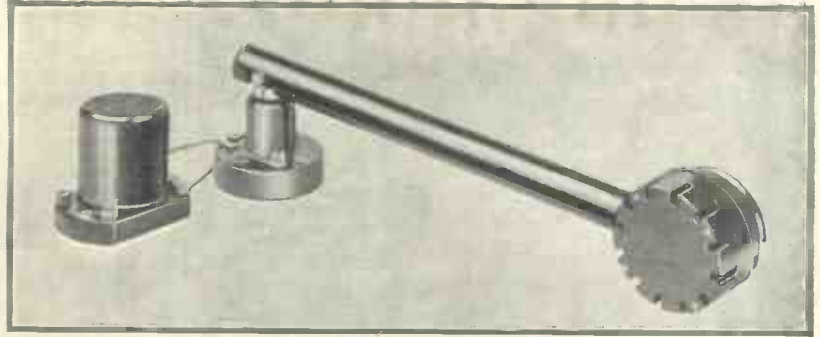

FOR PLAYING RECORDS WITHOUT AN AMPLIFIER  
This is the Microbox, made by S. G. Brown, Ltd. It is the invention of Mr. S. G. Brown, F.R.S., and will interest every radio enthusiast

WITH the introduction of the Brown Microbox it is possible to reproduce gramophone records through a loud-speaker direct, without the use of a valve amplifier. This instrument is indeed revolutionary and should have a great future.

In place of the usual pick-up mechanism there is a differential microphone, supplied by current from a battery or mains unit. Sufficient power is obtained from this source to work a loud-speaker at full volume.

It will be seen from the photographs on this page that the Brown Microbox is similar in appearance to an ordinary pick-up, but it is slightly larger and weighs a little more.

By putting this device on an ordinary gramophone in place of the soundbox, a complete electrical record reproducer is obtained and a loud-speaker can be used as if a valve amplifier were incorporated in the outfit.

We have had one of these Microboxes on test and found that the results were good. Volume is surprisingly great and is comparable to that obtained with a normal two-valve amplifier. Quality of re-

production was reasonably good.

The only disadvantage we can see about this instrument is that it takes rather a large current, actually .5 ampere at 10 volts. As far as country listeners are concerned, therefore, it does not present any real solution of the battery-charging problem.

### Special Mains Unit

For those who have A.C. mains a special unit can be obtained for operating the Microbox, the price of which, by the way, is 3 guineas. The price of the mains unit is £3 15s.

With each instrument is provided a differential transformer to suit any standard loud-speaker. The only expense for converting an ordinary gramophone into an electrically operated one, therefore, is that of (1) the Microbox itself, (2) a battery or mains unit, and (3) a loud-speaker.

Talking of loud-speakers, it is worth noting that S. G. Brown, Ltd., are offering an allowance through their dealers of 10s. for any loud-speaker as part payment for a Brown model. This offer is made irrespective of type and should certainly interest those who want to change old horn models for a more up-to-date Court or Ace reproducer.

Besides the particular model of Microbox described here we understand that two larger models are also available. The largest gives so great a power output that it has to be water cooled!

This particular Microbox has been developed specially for public address work by Mr. S. G. Brown and should interest those who have occasion to organise sports meetings, dances, etc. Further details can be obtained from the makers. The address is 19, Mortimer Street, London, W.1.



SMALL IN SIZE  
The Brown Microbox is very little larger than a standard electromagnetic pick-up



# for the 1932 SUPER 60

R.I. components are universally acknowledged as scientifically and constructionally BEST. Their inclusion in all modern circuits is a definite safeguard in time and expenditure.

The technical information supplied with all R.I. transformers is the guarantee, before you buy, that they will do their job—there is no speculation about R.I. productions.

Specified for the  
Battery and All Mains Models

## 7 to 1 TRANSFORMER

In all circuits employing high ratio amplification this transformer gives exceptionally high amplification with amazing uniformity over all wanted frequencies, with the complete elimination of all interference frequencies—ensuring utmost perfection in reception. It is a big transformer encased in black bakelite and constitutes the finest value at its extraordinary price.

Size, 3½ x 1½ x 2½ ins. high.  
Weight, 1 lb.



List No. DY21a

10'6

Recommended for the  
All Mains Model

## VALVE RECTIFIER TRANSFORMER

The popular valve rectifier mains unit is rendered definitely surer and more efficient by fitting an R.I. transformer. The EY30 type recommended for the "1932 Super 60," is a really dependable model at a popular price. For use with the standard full-wave rectifying valves, including Mullard, Mazda, Osram, etc. Valve rectifier output 5 to 6 milliamps.

30'6



Type EY30

The latest R.I. catalogue is the finest radio component reference published. Ask your dealer or us for a copy.



Advt. of Radio Instruments Ltd., Croydon, England. Phone: Thornton Heath, 3211 (5 lines)

Specified for the

Economy Radiogram

## MAGNUM FADER

10'6



Recommended for the

Economy Radiogramophone

## MAGNUM SPAGHETTI

## RESISTANCES

20,000 ohms - - 1/6 each  
30,000 ohms - - 1/6 each  
50,000 ohms - - 1/6 each

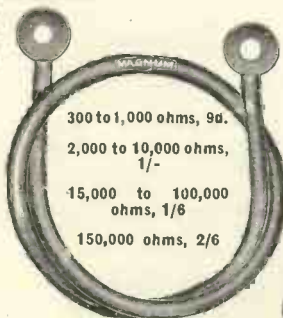

300 to 1,000 ohms, 9d.  
2,000 to 10,000 ohms, 1/-  
15,000 to 100,000 ohms, 1/6  
150,000 ohms, 2/6

A list of leading short-wave stations together with an interesting booklet describing the famous Stenode Receiver, Magnum Mains Sets and high-grade components.—Free on request.

## BURNE-JONES & CO., LTD.

"MAGNUM" HOUSE, 296 BOROUGH HIGH STREET, LONDON, S.E.1

Telephone: Hop 6257 and 6258

Scottish Agent - - Mr. Ross Wallace, 54 Gordon Street, Glasgow, C.1

ENJOY Short-wave Reception  
on your present set with the

## MAGNUM SHORT-WAVE CONVERTOR

No extras are required and it can be connected in a few seconds.

Supplied complete and ready for use including two coils 20/40 and 40/80 metres, Plug and Adaptor.

£3.15.0

Sent on 10 days' free trial against cash.

NOTE. This Convertor is suitable only for battery operated sets.

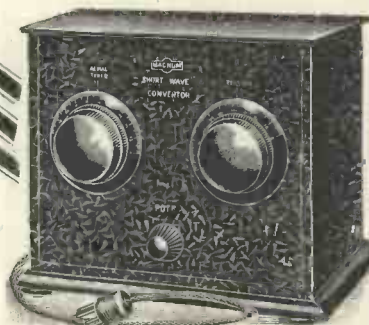

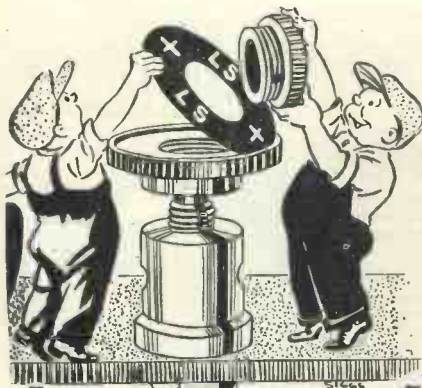

## The NEW 1932 MODEL

Improved type T2LC

The new T2LC terminal is similar to the old type but on the new model the indicating tabs are interchangeable. The head cannot be lost as it is non-detachable.

Here are the specifications:

- (1) Hole in top to take any standard plug.
- (2) Engraved top. Positive, Red, Negative, Black, 40 types all interchangeable.
- (3) Pillar Terminal to take spade, wire or similar connection.
- (4) 'Phone type terminal for connecting 'phone or similar ends.
- (5) Soldering tag to enable wire to be soldered if necessary.
- (6) Slot in shank to take square wire, so that soldering may be dispensed with.

PRICE 4½d. each

### SAFETY FIRST

The Ealex Testing Prods should be in



every tool kit.

For testing sets with intricate wiring, they prevent short circuits, and save you money in replacements. PRICE 3/6 per pair

WRITE FOR LIST K6

J. J. EASTICK & SONS  
Ealex House, 118 Bunhill Row,  
LONDON, E.C. 1

'Phone: Metropolitan 0314/5/0

# Design Data Sheets

By J. H. Reynier,  
B. Sc., A.M.I.E.E.

"W.M." Design Data

No. 41

## BREAK THROUGH, ELIMINATION OF

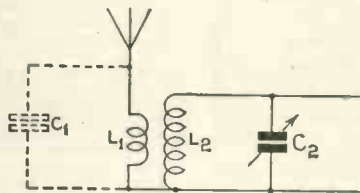

Simple coupled aerial circuit

A SERIOUS difficulty with simple circuits to-day is the break-through of medium-wave transmissions at the bottom of the long-wave band. The ordinary tuning properties of the circuit are completely lost and all that can be heard is the jamming from the local transmitter, sometimes both programmes at once.

This trouble arises from a tuning effect in the aerial circuit. The diagram herewith shows a simple coupled aerial circuit and it will be clear that the aerial capacity  $C$  will tune the small inductance  $L_1$  to resonance at some wavelength or other.

It so happens that, with the number of turns usually chosen to give good results on the long-wave band, this tune is situated in the middle of the 200-500 metre band and will, there-

fore, be responsive to any powerful transmitter working within that band.

The tune is very broad, so that it is not necessary for the aerial to be exactly in tune with the local station for this effect to be obtained.

The remedy, in design, is to arrange matters so that the aerial tune is outside the broadcast band. This may be done by increasing the number of turns on the long-wave aerial winding and moving this winding farther away from the long-wave coil so that the net coupling is still of the required order, but since the number of turns is much larger the tune of the aerial circuit is clear of any local transmissions.

Similar results can be obtained by deliberately allowing self-capacities to occur between the windings.

In the case of an existing coil one remedy is to include a small choke coil in series with the aerial circuit. This may consist of about three hundred turns on a 1-in. former, and it must be cut out when receiving on the broadcast band.

Alternatively, a .0003-microfarad condenser may be connected across aerial and earth. This will often cure the trouble and may still be left in circuit on the broadcast band.

"W.M." Design Data

No. 42

## NEON LAMP TESTER

THE familiar Osclim lamp may be utilised in a simple tester which has a variety of uses. The basic circuit of the arrangement is shown in the accompanying diagram. The lamp is connected across a source of D.C. of at least 180 volts and preferably more. In series with the lamp is a high resistance and a pair of telephones, while across the lamp is a fixed condenser.

The neon lamp is a gas-discharge tube which is normally non-conducting until the voltage rises above 165 volts. A discharge then takes place, giving the familiar pink glow which is associated with this type of lamp. This will continue, once started, even if the voltage is reduced, until at about 140 volts it suddenly stops and will not restart until the voltage exceeds 165 again.

This principle is utilised in the testing circuit. On switching on, the condenser  $C$  begins to charge up. It does this relatively slowly because of the high resistance  $R$ . After a time, however, the voltage on the condenser reaches the critical value of 165 volts, and the lamp becomes conducting. The condenser thus discharges until the voltage falls to 140, when the lamp goes out. The process now repeats itself and

will continue to do so indefinitely, the charge and discharge following one another at a regular rate. This can be heard in the telephones as a musical note.

The frequency of the discharges depends on the voltage, and on the product of the resistance and capacity. With a constant voltage, therefore, we

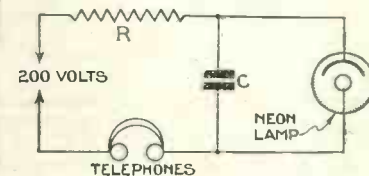

Neon-lamp testing circuit

can use the method to compare resistances or condensers. With a given condenser and resistance we observe the frequency of the note in the telephones. If we change either  $R$  or  $C$  and listen again we can tell whether the new component is of the same value as before. If not, the note will be changed. A lower note means a higher value of  $R$  or  $C$ , and vice versa.

Musical notes can be obtained if the product  $RC$  is of the order of .001

(Continued on page 252)



# All Portable Sets need a spare —

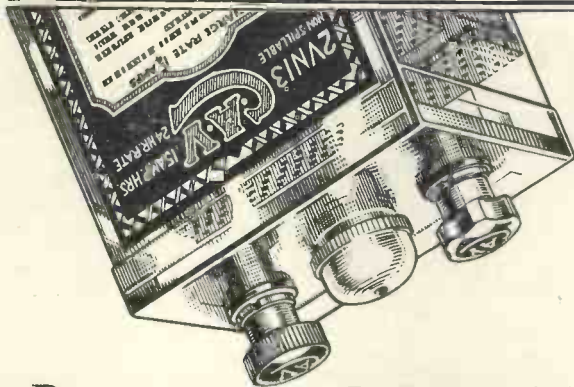

## C.A.V. JELLY ACID

### NON-SPILLABLE

If your accumulator runs out too quickly — if there is an annoying break while it is being charged, then end this inconvenience by buying a C.A.V.

The C.A.V. Jelly Acid accumulator is clean, compact and non-spillable—there is no free acid to spill.

There is a C.A.V. accumulator suitable for every type of receiver.

*Have you tried the C.A.V. H.T. Dry Battery yet?*

*Examples of batteries for Popular Portables.*

Pye Q and Marconiphone	..	..	..	..	12/6
Pye Twintriple	..	..	..	..	14/-
McMichael	..	..	..	..	14/-

## Perfect for all Portables

FREE: A useful book on the charging and maintenance of C.A.V. L.T. and H.T. Accumulators. A post card will bring you a copy.



Department I.4.

**C. A. Vandervell Ltd.**  
WELL STREET, BIRMINGHAM.

## SPECIALLY CONSTRUCTED

FOR THE  
**James "1932 Super 60"**  
and specified for the  
**Wireless Magazine "A.C. Super 60"**  
ALSO SUITABLE FOR THE WIRELESS MAGAZINE NEW "DOUBLE BAND-PASS FOUR"



This Fine  
**OSBORN**  
QUEEN ANNE  
RADIO  
CABINET

Model No 218

A Queen Anne Radio or Radio Gramophone Cabinet. 3 ft. 10 in. high, 2 ft 2 in. wide, 1 ft. 6 in. deep. Size of baffle board behind fret, 24 in. x 24 in. Metallic fabric for fret front included. Opening at top and back. Cabinet takes panel 2 ft. x 9 in., or smaller complete with Motor Board

PRICES:

Machined ready to Assemble: Oak £3.10.0, Mahogany £3.15.0. Assembled ready to polish: Oak £4.10.0, Mahogany £4.15.0. Assembled and polished: Oak £5.10.0, Mahogany £6.5.0.

All Models Carriage Paid  
Send 3d. in stamps for new 1932 Beautifully Illustrated Catalogue

**CHAS. A. OSBORN**

DEPT. W.M. The Regent Works, Arlington St. London, N.1.  
Tel.: Clerkenwell 5095. And at 21, ESSEX ROAD, ISLINGTON, N.1  
(1 min. from the Agricultural Hall) Telephone: Clerkenwell 9634



## The NEW LOEWE RADIO

### PICK-UP with CARRIER ARM & VOLUME CONTROL

*... to capture the best in every record*

Perfect gramophone record reproduction at last! Capture the best of every record with the New LOEWE RADIO PICK-UP, type L.R. 50. Novel magnetic needle grip that eliminates tiresome screwing in of needles. Extreme sensitivity. New method of construction that obviates usual rubber buffer. Particularly soft armature for minimum wear of records.

Retail Price with Carrier Arm and Volume Control 33/6

## LOEWE RADIO

THE LOEWE RADIO CO., LTD.  
Fountayne Road, Tottenham, N.15

Phone: Tottenham 3911

Advertisers take more interest when you mention "Wireless Magazine"

MOVING  
COIL  
SPEAKER

MOVING  
COIL  
SPEAKER

**PERMAG**

A Remarkable NEW Speaker—at  
a really AMAZINGLY LOW PRICE



Price 38/- without transformer  
47/- with transformer

Low as these prices are we give a Baffle  
Case FREE with every chassis.  
(See illustration below)



Compare this value with any other M.C. Speaker offered at the price, then ask your Dealer to demonstrate it. Specification includes a large Cobalt Steel Magnet of new design, giving high flux density. A high efficiency output Transformer carrying up to 65 m.A., and a specially designed lightweight Diaphragm and Coil. This highly efficient job is so sensitive that wonderful results can be obtained from a small two-valve receiver and it is positively unbeatable on all points with anything on the market to-day.

SEND FOR NEW  
LITERATURE TO-DAY!

**BAKER'S**  
*'Selhurst'*  
**RADIO**

OFFICES:  
★ 89 SELHURST ROAD, S. NORWOOD, S.E.25  
★ WORKS & DEMONSTRATION ROOM:  
42 CHERRY ORCHARD ROAD, E. CROYDON  
(16 minutes from Victoria or LONDON BRIDGE)  
Phone: CROYDON 1618.

# DESIGN DATA SHEETS—Cont. from page 250

"W.M." Design Data

No. 43

## MAINS FUSES

ANY A.C. mains receiver should carry a fuse in the mains lead. If this fuse is correctly designed it is capable of protecting the receiver in the event of a short-circuit.

A common form of trouble is a faulty rectifier valve, one of the anodes short-circuiting to the filament and thereby placing a direct short-circuit across one half of the rectifier winding.

Another form of trouble is a breakdown of the reservoir condenser or one of the smoothing condensers. This draws a heavy current from the transformer, although in the second case the current is automatically limited by the resistance of the smoothing choke. This form of trouble occurs with metal rectifiers as well as valve rectifiers.

If faults of this nature are allowed to develop in the set, the current drawn from the transformer winding may be so large that either the primary or the secondary will burn out. If suitable protection is included in the circuit to disconnect the mains in the event of the current rising above a reasonable value much damage can be saved at little expense.

For satisfactory protection, however, the fuse must be arranged to operate at a current only a little over the safe

value. The I.E.E. regulations call for a fuse operating at not more than 2 amperes, but this is intended to be considered as an outside limit. For safe operation the fuse in the average mains set requires to blow at between .5 and 1 ampere.

When switching on an A.C. set there is a sudden current rush due to two causes. In the first place, the transformer has no magnetism in it, and a relatively large current flows momentarily to set up the magnetic field. Secondly, the heaters of the valves are cold and take a much larger current than their rated value at the instant of switching on. Allowance must be made for these factors in providing the fuse.

For example, with a set taking 100 milliamperes from the mains one might provide a fuse rated to carry this current and blowing at about 200 milliamperes. Such a fuse would blow every time the set was switched on, due to the rush of current just mentioned.

It is, therefore, necessary to allow a slightly wider tolerance, and experiments indicate that if the fuse in use is rated to carry twice the normal working current of the receiver, and to blow at four times the normal working current it will provide adequate protection.

"W.M." Design Data

No. 44

## PRIMARY CURRENT

THE current which a transformer will take from the mains is proportional to the load on the secondary. Due allowance must be made for the difference in voltage on the primary and secondary sides. For example, suppose we have a transformer wound for a primary voltage of 200 and having two secondary windings, one of 250 volts delivering 100 milliamperes and the other of 4 volts delivering 2 amperes.

The product of the current and the voltage may be assumed the same on both sides of the transformer. Thus the equivalent primary current to the 250-volt load would be  $100 \times 250 / 200 = 125$  milliamperes. The primary current due to the 4-volt load would be  $4 \times 2,000 / 200 = 40$  milliamperes (since 2 amperes = 2,000 milliamperes).

The transformer, however, will take a small current even when there is no current taken from the secondary. This is termed the no-load current and is due to the fact that the iron circuit of the transformer requires a small current to keep it magnetised.

This current depends on the number of turns in the primary winding. If the primary has a large number of turns, the inductance of the winding

will be high and the magnetising current will be small. As we reduce the number of primary turns the magnetising current increases somewhat rapidly.

Commercial design uses as few turns on the primary as are necessary to give satisfactory results. If the reduction of the winding is carried too far saturation of the iron circuit occurs and the transformer has a large leakage field and also distorts the wave form, so that the voltage on the secondary is not a pure sine wave.

Both these effects give rise to hum and the extra precautions which have to be taken in the receiver outweigh the slightly lower cost of the transformer.

Generally speaking, the winding is designed so that the maximum flux density in the iron circuit shall not exceed 60,000 lines per square inch. If  $E$  is the primary voltage,  $f$  is the frequency and  $A$  is the area of the core in square inches, the number of turns on the primary should be:—

$$\frac{22.5E}{fAB} \times 10^6,$$

where  $B$  is the flux density in the iron, which should not exceed 60,000 as just mentioned. The figures given in Sheet No. 24 are based on this formula.



# FOR EVERY CIRCUIT AND PURPOSE THERE IS A-



Select a Dario Valve from the Valve chart. There is one for every purpose. Choose Dario every time—it will ensure better results and economy.

Write for illustrated folder giving full particulars.

**IMPEX ELECTRICAL LTD.,**  
538, High Road, Leytonstone London,  
E.11



**MIRROR LIKE**

**PERMANENT PERMCOLO**

Use PERMCOLO the modern Ebonite guaranteed never to spoil your set by discolouring. Black, Mahogany or Walnut finishes, perfect mirror polish, highest insulation, easy to cut and drill and costing only 4/6 for 7" x 18" panel. Ask your dealer or write to us for list. Any panel size cut. Cash or C.O.D. by return.

**BRITISH HARD RUBBER Co., Ltd.,**  
MIDDLESEX  
PONDERS END

**PERMCOLO**

## A FREE COPY OF WIRELESS MAGAZINE

*THE* interest and pleasure which you derive from the "Wireless Magazine" will be greatly enhanced if you can discuss its monthly articles with a friend who is also familiar with its contents.

In order that anyone you know who is interested in wireless but is not yet a reader of "Wireless Magazine" may become acquainted with it, a complimentary copy will be sent to him gratis and post free, if you will kindly complete the attached coupon, or if you do not wish to mutilate your copy, send your request on a postcard.

*THE "WIRELESS MAGAZINE" IS "THE BEST SHILLINGSWORTH IN RADIO."* Tells you every month all you want to know about recent progress in Radio Design. Look out for the April issue on March 23!

### ELECTRADIX BARGAINS

of everything

### RADIO & ELECTRICAL

Send 4d. Stamp NOW for Illustrated Catalogue and latest Sale List

**ELECTRADIX RADIOS**  
218 Upper Thames St., E.C.4  
City 0191

### YOUR OLD COMPONENTS

are worth money. Sort out the spare radio parts you no longer require and advertise them in the "Miscellaneous Columns" of **AMATEUR WIRELESS**. You will be surprised how quickly they will be snapped up.

Your announcement will cost you 3d. a word. Send your list of parts, together with your name, address and remittance, to:

"Small Advertisement" Dept.,  
**AMATEUR WIRELESS**  
58-61, Fetter Lane, London, E.C.

## POST THIS COUPON NOW!

**WIRELESS MAGAZINE**  
58/61 FETTER LANF, E.C.4

**FREE COUPON**

To the Publisher,  
"Wireless Magazine,"  
58/61 Fetter Lane, E.C.4

Please send a specimen copy of the  
"Wireless Magazine," free and post  
free, to my friend:

My own name and address are:

Put this coupon in an unsealed envelope bearing 4d. stamp

Better service results from mentioning "Wireless Magazine" when writing to advertisers

Stories of the Operas

PARSIFAL

(Wagner)

CHIEF CHARACTERS

AMFORTAS AND KING . . . . Bass-Baritone  
 TITUREL, his father and former ruler . . . Bass  
 GURNEMANZ, . . . . .  
 veteran Knight of the Grail . . . . . Bass  
 KLINGSOR, a magi-ian . . . . . Bass  
 PARSIFAL . . . . . Tenor  
 KUNDRY . . . . . Soprano  
 Time : Middle Ages. Place : Spain.

ACT I

*The Holy Grail, the vessel from which Christ drank at the Last Supper, is in the keeping of Titurel. The Knights also possess the Sacred Spear, with which the Roman soldier pierced the Saviour's side. Titurel has built a castle in which to house the sacred relics against the pagan world, and particularly against Klingsor, an evil genius.*

*Klingsor, by using the lovely Kundry, succeeds in enticing several knights, making them serve him against the King. Even Amfortas, king though he be, has fallen a victim, but has tried to kill Klingsor with the Sacred Spear. This he accidentally drops and is wounded by it; the wound will not heal. Only the touch of the Spear itself will be of avail, and only Parsifal can get it from Klingsor.*

*Kundry is ever on the watch. She, by the way, was condemned to wander for laughing at Christ as He bore His Cross. Klingsor changes her into a beautiful woman, but she is his servant. In Act I a wounded swan, the sacred bird of the Grail Brotherhood, is killed, and Parsifal is accused of having killed it. Gurnemanz realises that Parsifal is ignorant of the wrong he has done.*

*The scene changes to the hall of the Grail Castle. Titurel calls upon Amfortas to uncover the Grail.*

ACT II

*Klingsor's magic castle. Klingsor, gazing into his magic mirror, beholds all that takes place in the castle of the Grail. He sees Parsifal come out, and summons Kundry to lure Parsifal into the castle grounds. Parsifal enters, determined to obtain the Sacred Spear. Kundry kisses him—enough for the other knights—Parsifal thrusts her from him.*

*Mad with rage, she calls Klingsor, who appears on the wall and hurls the Spear at Parsifal. It rises in its flight and remains suspended in the air over Parsifal's head. Parsifal, seizing it, signs the Sign of the Cross. The castle disappears, Kundry falling as dead.*

ACT III

*Years after, Parsifal, after wandering about, finds himself on the edge of the Grail forest. Kundry discerns his approach. He is knighted King of the Knights of the Grail by Gurnemanz. The new King baptises Kundry. Gurnemanz leads the way to the castle of the Grail. Amfortas is there, still in pain from the wound that will not heal. Parsifal heals the wound with a touch of the Sacred Spear.*

WHITAKER-WILSON.

# News of the Short Waves

THE news that the B.B.C. at last intends to provide a real Empire short-wave service appears to have stirred up considerable interest. Although the service itself will not be of any use to us in the British Isles, it will be of immense benefit to the colonies and will help strengthen the bonds between colonial listeners and the home country.

This colonial broadcasting idea appears to be spreading. The Dutch were presumably the first to start it, with their very successful service to the East Indies, which has since developed into a two-way commercial telephone service through stations PLE and PLF at Bandoeng.

Then the Italians put up their short-wave station 12RO at Rome, working on 25.4 and 80 metres. When this station is operating on the lower wave its signals are heard practically all around the world, but when the longer wave is in use it provides a service intended for the Italian colonies.

After this station had been in use for some time, the French authorities put up their colonial station, FYA, at Pontoise, Paris, which works on various wavelengths and is heard in the French African colonies.

Actually, our G5SW station was probably the second station ever built intended for colonial use—the first being the Dutch PCJ—although the somewhat restricted service provided by G5SW in the past has hindered progress in this direction somewhat. When our new Empire station is open, it should stir up considerable interest in the colonies—and incidentally open new business channels for British manufacturers.

A considerable number of newcomers to the short waves appear to be somewhat puzzled as to what is actually the best method of coupling the aerial to the short-wave tuning system. Actually, there are four different methods of doing this, each more or less giving the same effect.

The simplest and most popular is to couple the aerial direct to the grid end of the tuning coil through a very low capacity condenser, .00005 microfarad being about suitable.

The second method is to couple the aerial through a separate coupling

coil, thus making up a loosely coupled two-circuit tuner.

The third method is to take the aerial to a tapping on the coil. The tap has to be near the earthed end of the coil, otherwise the damping will prove too great and the circuit will refuse to oscillate.

## Separate Coupling Valve

The fourth method is to use a separate coupling valve—generally an untuned screen-grid valve. This last method, although it is in some respects expensive and wasteful, since the valve consumes the usual high-tension and low-tension current and yet gives no appreciable amplification, provides the smoothest working and is quite free from “loop-hole” effects, where the receiver refuses to oscillate at certain wavelengths.

However, many people do not want to incur the extra expense of this method and rely on one of the first three methods, the first of which is perhaps the most popular. It must be remembered that the coupling of the aerial has a distinct bearing on the final operation of the receiver.

If the coupling is too tight, all kinds of nasty effects take place. The aforementioned “loop-holes” will appear, threshold howling is likely to make itself heard and body-capacity troubles will become more pronounced.

Keep the aerial coupling as loose as possible, therefore, and, even although a certain amount of signal strength may be lost by doing this, the result will be worth while.

## Short-wave Telephone Links

The number of inter-continental telephones using short-wave links appears to be increasing. A great number of telephone stations have sprung up and whilst these are now somewhat of a nuisance to the short-wave listener, they are useful for calibration purposes.

Speech distorters are usually employed whilst commercial telephone calls are on the air, although these do not appear to be always used when engineers' tests are taking place and so it is sometimes possible to catch the call sign of the station.

Mander Barnett.



# USE A "W.M." BLUEPRINT TO BUILD YOUR SET!

A blueprint of any one set described in the current issue of "Wireless Magazine" can be obtained for half price up to the date indicated on the coupon (which is to be found on the last page) if this is sent when application is made. These blueprints are marked with an asterisk (\*) in this list and are printed in bold type. An extension of time is made in the case of overseas readers.

## CRYSTAL SETS

6d. each, post free

1931 Crystal Set . . . . . AW308

## ONE-VALVE SETS

1s. each, post free

Short-wave One-valver (6d.) . . . . . AW327  
 "B.B.C." One . . . . . AW280  
 Easy-to-Build One . . . . . AW304

## TWO-VALVE SETS

All these 1s. each, post free

Brookman's Two (D, Trans) . . . . . WM168  
 Five-point Two (D, Trans) . . . . . WM220  
 Aladdin Two (D, Trans) . . . . . WM231  
 Ever-tuned Regional Two (D, Trans) . . . . . WM241  
 Station-finder Two (D, Trans) . . . . . WM243  
 Music-lover's Two (D, Trans) . . . . . WM260  
 New Economy Two (D, Trans) . . . . . WM265  
 B.B.C. Selective Two (D, Trans) . . . . . AW292  
 The Room-to-Room 2 (D, Trans) . . . . . AW298  
 Big-volume Two (D, Pentode) . . . . . AW309  
 Two Star 2 (D, Pen) . . . . . AW315  
 The 25/- Two (D, Trans) . . . . . AW330

## THREE-VALVE SETS

All these 1s. each, post free

Five-point Short-waver (D, 2 Trans) . . . . . WM223  
 Regional Three (SG, D, Trans) . . . . . WM236  
 Band-pass Inceptordyne (SG, D, Pen.) . . . . . WM244  
 Ether Marshal (SG, D, Trans) . . . . . WM247  
 Five-Advantage Three (D, RC, Trans) . . . . . WM257  
 Everybody's Radiogram (SG, D, Trans) . . . . . WM258  
 Meridian Short-waver (D, RC, Trans) . . . . . WM255  
 Double Band-pass Three (SG, D, Trans) . . . . . WM259  
 Everybody's Radiogram (with Automatic Grid Bias) . . . . . WM262  
 New Economy Three (SG, D, Trans) . . . . . WM263  
 New Plug-in-Coil Three (D, 2 Trans) . . . . . WM270  
 Tran-portable Three (SG, D, Trans) . . . . . WM271  
 Square-peak Three (SG, D, Trans) . . . . . AW293  
 Universal Short-wave Three (SG, D, Trans) . . . . . AW301  
 Olympian Three (SG, D, Trans) . . . . . AW306  
 Tonality Three (D, RC, Trans) . . . . . AW321  
 35/- Three-valver (D, 2RC) . . . . . AW323

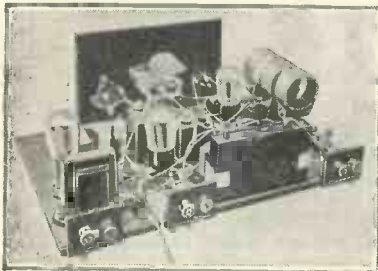

**USES TWO-PIN COILS**  
 The New Plug-in Coil Three is very efficient and easy to build

Do you realise that, except for one or two in a range of more than 270, all "Wireless Magazine" blueprints are full-scale drawings? They are not small-scale drawings which, as you know, are useless as patterns and templates.

Do you appreciate the fact that they save much time and trouble in construction, as they can be used as panel and baseboard templates for marking the centres for drilling holes and laying out components?

Further than this, do you know that all the connecting wires are numbered separately, so that they can be assembled easily and automatically?

"Wireless Magazine" and "Amateur Wireless" are the only papers that can supply full-size blueprints of every set described.

Baby Three (D, RC, Trans) . . . . . AW324  
 1932 Ether Searcher (SG, D, RC, Trans) . . . . . AW325  
 World Wide Short-wave Three (D, RC, Trans) . . . . . AW332

## FOUR-VALVE SETS

All these 1s. 6d. each, post free

Five-point Four (SG, D, RC, Trans) . . . . . WM216  
 Brookman's Three-Plus-One (SG, D, RC, Trans) . . . . . WM233  
 Ether Rover (SG, D, RC, Trans) . . . . . WM266  
 Quadradyne (2SG, D, Trans) . . . . . WM273  
 ★Double Band-pass Four (SG, D, RC, Trans) . . . . . WM274  
 ★Economy Radio Gramophone (SG, D, RC, Trans) . . . . . WM276  
 The Orchestra Four (D, RC, Push-pull) . . . . . AW167  
 All-Europe Four (2HF, D, Trans) . . . . . AW173  
 Stability Four (HF, D, RC, Trans) . . . . . AW182  
 £3 3s. Four (SG, D, RC, Trans) . . . . . AW303  
 £3 3s. Four (Improved Model) . . . . . AW303a  
 Everybody's Radiogramophone . . . . . AW310  
 Four-star Four (SG, D, RC, Trans) . . . . . AW318  
 The 50/- Four (SG, D, RC, Trans) . . . . . AW331

## FIVE-VALVE SETS

All these 1s. 6d. each, post free

Overseas Five (3SG, D, Trans) . . . . . WM191  
 Regional D.C.5 (SG, D, LF, Push-pull) . . . . . WM252  
 James Quality Five (2SG, D, RC, Trans) . . . . . AW227  
 Britain's Super (Super-het) . . . . . AW311  
 A.C. Britain's Super (Super-het) . . . . . AW322  
 Mains section (1/-) . . . . . AW322a  
 James Short-wave Super-het . . . . . AW328

## SIX-VALVE SETS

All these 1s. 6d. each, post free

Super 60 (Super-het) . . . . . WM229  
 A.C. Super 60 (Super-het Radiogram) . . . . . WM239  
 A.C. Super 60 (Super-het Table Model) . . . . . WM245  
 Super 60 (with Wearite Base) . . . . . WM249  
 Super 60 (with Lewcos Base) . . . . . WM251  
 1932 Super 60 (Super-het) . . . . . WM269  
 1932 A.C. Super 60 (Super-het) . . . . . WM272

## SEVEN-VALVE SET

1s. 6d., post free

Super Senior (Super-het) . . . . . WM256

## PORTABLE SETS

Super 60 Portable (Super-het) . . . . . WM238 1/-  
 Home and Garden Three (D, RC, Trans) . . . . . WM246 1/-

## AMPLIFIERS

All these 1s. each, post free

Radio-record Amplifier (DC Mains) . . . . . WM183  
 Selecto Amplifier (HF Unit) . . . . . WM210

Each blueprint shows the position of all components and every wire, and makes construction a simple matter. Copies of "Wireless Magazine" and of "Amateur Wireless" containing descriptions of most of these sets can be obtained at 1s. 3d. and 4d., respectively, post free. Index letters "A.W." refer to "Amateur Wireless" sets and "W.M." to "Wireless Magazine" sets.

D.C. Fader . . . . . WM242  
 Quality Amplifier (D.C.) 1s. 6d. . . . . WM264  
 ★A-P-A. (Public Address) . . . . . WM275  
 A.C. Push-pull Amplifier . . . . . AW291  
 Add-on H.F. Screened-grid Unit . . . . . AW296  
 Universal Push-pull Amplifier . . . . . AW300  
 "A.W." Record Player (LF, Push-pull) . . . . . AW319

## MISCELLANEOUS

"W.M." Standard A.C. Unit . . . . . WM214 1/-  
 "W.M." Standard D.C. Unit . . . . . WM215 1/-  
 Loud-speaker Tone Control . . . . . WM234 -/6  
 "W.M." Linen-diaphragm Loud-speaker . . . . . WM235 1/-  
 Two-minute Adaptor for Short Super 60 . . . . . WM248 1/-  
 Simple Neon Oscillator . . . . . WM251 1/-  
 Plug-in Adaptor . . . . . WM267 1/-  
 Super-het Adaptor . . . . . WM268 1/-  
 H.T. Unit and Trickle Charger for D.C. Mains . . . . . AW272 1/-  
 2-Watt A.C. Amplifier . . . . . AW283 1/-  
 Booster Speaker . . . . . AW286 -/6  
 "A.W." Tone Changer . . . . . AW288 -/6  
 "A.W." Selectivity Unit . . . . . AW290  
 B.B.C. Official Selectivity Unit . . . . . AW294  
 A.C. Trickle Charger . . . . . AW305 1/-  
 Amateur's Linen Speaker . . . . . AW307 1/-  
 D.C. H.T. Unit . . . . . AW312 1/-  
 Output Unit for Pentode Sets . . . . . AW316 1/-  
 "A.W." Short-wave Adaptor . . . . . AW317 1/-  
 Short-wave Plug-in Adaptor . . . . . AW326 -/6  
 Super-het Short-wave Adaptor . . . . . AW329 -/6



**EVERYTHING FOR 65/-**  
 The New Economy Two can be built for 65/- including valves, loud-speaker and batteries

Send, preferably, a postal order (stamps over sixpence in value unacceptable) to

# Wireless Magazine

**BLUEPRINT DEPT.,**  
 58/61 FETTER LANE,  
 LONDON, E.C.4

## BLUEPRINT COUPON

Valid only until March 31, 1932 (or until April 30, 1932 for overseas readers)

### FOR ONE BLUEPRINT ONLY

If you want a full-size blueprint for any ONE of the sets constructionally described in this issue for half price, cut out the above coupon and send it, together with a postal order, to Blueprint Department, WIRELESS MAGAZINE, 58-61 Fetter Lane, London, E.C.4.

This coupon is valid for a blueprint of any ONE only of the following sets at the prices indicated:—

**DOUBLE BAND-PASS FOUR** (page 174), No. WM274, price 9d., post free.

**A-P-A** (page 211), No. WM275, price 6d., post free.

**ECONOMY RADIO GRAMOPHONE** (page 192), No. WM276, price 9d., post free.

## INFORMATION COUPON

Valid only until March 31, 1932 (or until April 30, 1932 for overseas readers)

If you want to ask any questions cut out the above coupon and send it, together with a postal order for 1s. and stamped-addressed envelope, to the Information Bureau, WIRELESS MAGAZINE, 58-61 Fetter Lane, London, E.C.4.

Note that not more than two questions may be asked at a time and that queries should be written on one side of the paper only.

Under no circumstances can questions be answered personally or by telephone. All inquiries must be made by letter so that every reader gets exactly the same treatment.

Alterations to blueprints or special designs cannot be undertaken; nor can readers' sets or components be tested.

If you want advice on buying a set a stamped-addressed envelope only (without coupon or fee) should be sent to the Set Selection Bureau, WIRELESS MAGAZINE, 58-61 Fetter Lane, London, E.C.4.

## ODD NOTES

SOME constructors of the 1932 A.C. Super 60 are in doubt about the R.I. mains transformer recommended. This is rated at 5 amperes on the low-tension side and the set needs 6 amperes.

There is some misapprehension that the transformer will not give sufficient voltage, but this is not the case. The voltage drop for the extra ampere that will be taken from the winding is less than .1 ampere, so that the valve heaters will be getting something like 3.9 volts instead of the full 4 volts.

In a test report of the Atlas D.C. unit, model DC15/25, published in the January issue of "Wireless Magazine," the price was incorrectly given as £1 15s. 6d. This should have read £1 19s. 6d.

In the test report on the Lotus three-valve A.C. set that appeared on page 43 of the last issue it was stated that no equivalent D.C. model was available. This was incorrect; a similar Lotus set can be supplied for operation from D.C.

## UP TO THE MINUTE RECEIVERS

Why be content with an out-of-date set when, for a reasonable charge, Scott Sessions will rebuild your set and completely modernise it? We are specialists in this work and will gladly quote you without obligation. Sets repaired or designed and built for special requirements.

## NEW SCOTT SESSIONS SHORT-WAVE SUPER-HET

Overseas buyers will be particularly interested in our new 5-valve Short-wave Super Heterodyne Receivers, designed with the latest valves, each giving maximum amplification and constructed throughout to withstand severest tropical conditions. Prices, including valves, battery model, £25; all-mains A.C., £35. (State voltage and periodicity when ordering A.C.)

# SCOTT SESSIONS

RADIO ENGINEERS  
MUSWELL HILL, LONDON, N.10  
Telephone: Tudor 5326.  
Contractors to H.M. Office of Works, etc.

## INDEX TO ADVERTISERS

	Page
Baker Selhurst Radio	252
Belling & Lee, Ltd.	150, 248
Benjamin Electric	131
Borst Chas.	241
British Blue Spot Co.	Cover iii
British General Mfg. Co.	137
British Hard Rubber	253
British Institute of Engineering	137
British Radiophone, Ltd.	140
Bulgin, A. F., & Co., Ltd.	131
Burne-Jones & Co., Ltd.	249
Carrington Mfg. Co., Ltd.	131
Celestion, Ltd.	225
Clarion Radio Furniture	141
Clarke, H., & Co. (M/cr.) Ltd.	241
Columbia Graphophone Co.	149
Colvern, Ltd.	141
Cossor, A. C., Ltd.	229
Drydex	237
Dubilier Condenser Co., Ltd.	135
Eastick, J. J., & Sons	250
Edison Bell, Ltd.	145
Edison Swan	151, 217
Electradix Radio	253
Emkabe Radio Co., Ltd.	247
Ferranti, Ltd.	225
Fluxite, Ltd.	137
Forno Co.	245
Freestone, V. E., & Co., Ltd.	248
Fuller Accumulator Co., Ltd.	227
Gent & Co.	145
Gramophone Co.	152
Harlie Bros., Ltd.	247
Hastings, M.	247
Heayberd, F. C., & Co.	150
Igranic Electric, Ltd.	146
Impex Electrical, Ltd.	253
Jackson Bros.	146
Lanchester's Laboratories, Ltd.	146
Lectro Linx, Ltd.	247
Limit Radio, Ltd.	139
Loewe Radio Co., Ltd.	251
London Electric Wire Co., & Smiths, Ltd.	Cover ii
Lotus Radio, Ltd.	135, 245
Ormond Engineering Co., Ltd.	140
Osborn, Chas. A.	251
Parker Wood, F.	137
Partridge & Mee, Ltd.	239
Pertrix, Ltd.	231
Peto-Scott, Ltd.	139
Pickett Bros.	248
Portadyne	143
Radio & Allied Sales	235
Radio Instruments, Ltd.	145, 249
Ready Radio (R.R.), Ltd.	243
Regentone, Ltd.	235
Reproducers & Amplifiers, Ltd.	139
Rotax, Ltd.	144
Scott Sessions, G., & Co.	256
Sovereign Products, Ltd.	141
Stratton & Co., Ltd.	247
Tannoy Products	247
Tekade Radio & Electric	143
Telegraph Condenser Co., Ltd.	223
Telsen Electric Co., Ltd.	Cover iv, 220, 221
Tunewell	131
Tungram Elect. Lamp Works, Ltd.	133
Vandervell, C. A.	251
Varley	233
Watmel Wireless Co., Ltd.	150
Westinghouse Brake and Saxby Signal Co., Ltd.	147
Whiteley Electrical Radio, Ltd.	150
Wilburn & Co.	150
Wright & Weaire, Ltd.	147
Zonophone, Ltd.	233



# BLUE SPOT...

## the Continental Express



IF there is one thing BLUE SPOT Receivers do superlatively well it is to bring in Foreign stations quickly and clearly. You can hear them as perfectly as if they were but a mile away.

The unusual circuit employed is responsible for this remarkable performance. It utilises two screened grid valves, detector and power output, and one H.F. stage is followed by the detector and two L.F. stages. The fifth valve is for rectification only.

A receiver capable of bringing in Foreign stations in this way has naturally an enormous reserve of power. Consequently, a special feature of BLUE SPOT sets is the very smooth volume control which enables local stations to be heard with ample volume and beauty of tone, free from distortion or overloading, the set is designed for A.C. mains.

Ask your dealer to demonstrate a BLUE SPOT Receiver and you will fully appreciate its fine performance.

**THREE CATALOGUES YOU SHOULD HAVE:** — Ask for

No. W.M.14. Blue Spot Receiver

No. W.M.14a. Blue Spot Loud-speakers

No. W.M.14b. Blue Spot Loud-speaker Units

### THE BRITISH BLUE SPOT COMPANY LTD

BLUE SPOT HOUSE, 94-96 ROSOMAN ST., ROSEBERY AV., LONDON, E.C.,  
Telephone: Clerkenwell 3570. Telegrams: "Bluspot, Isling, London."  
Distributors for Northern England, Scotland and North Wales: H. C. RAWSON, (Sheffield and London) Ltd., 100 London Road, Sheffield;  
2, St. Mary's Parsonage, Manchester: 183, George Street, Glasgow

BLUE SPOT Four-Valve Screened Grid Table Grand Receiver in walnut cabinet, with BLUE SPOT Moving Coil Loudspeaker. Price complete, with valves and royalties paid (for A.C. mains) 25 gns. Other models from £18 to 27 gns.

**BRITISH MADE**

You will also be interested in

#### THE BLUE SPOT PICK-UP



This Pick-up, fitted to your ordinary gramophone in place of the usual sound box and then attached to the gramophone point on your BLUE SPOT Receiver, gives you the equivalent of a radio-gramophone for a cost of 3 gns.

#### BLUE SPOT MAINS DISTURBANCE ELIMINATOR

which, when plugged in to your supply socket cuts out all electrical disturbances from the mains and ensures absolutely first-class reception. Price complete . 10/6



# NOW

## AMERICA, AUSTRALIA, AFRICA, RUSSIA and the FAR EAST

*on your present radio set*

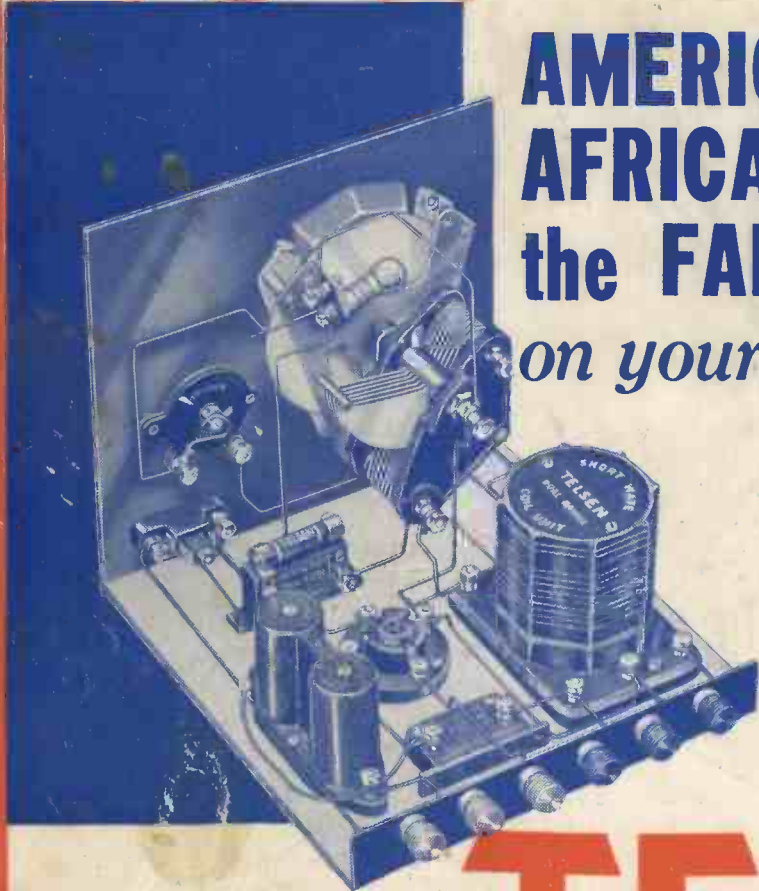

The Telsen Short-wave Adaptor Kit gives the ordinary receiver full command of the short waves, too. Thanks to the incorporation of the Telsen Short-wave Coil—the necessity for coil-changing is obviated—the greatest development in the history of short-wave radio. The Adaptor is easy to build and easy to operate.

### List of Components

- 1 Valve Holder.
- 1 .0001 Mica Condenser.
- 1 .001 Mica Condenser.
- 1 Grid Leak, 2 meg.
- 1 Short-wave Coil Unit.
- 1 .00025 Logarithmic Variable Condenser.
- 1 .0001 Reaction Condenser
- 2 Two-point Switches.
- 1 Binocular H.F. Choke.
- 1 Illuminated Disc Drive.
- Panel, 7 in. by 7 in.
- Baseboard, 7 in. by 7 in.
- Battery cords, Plugs and Terminals, Connecting Wire, Terminal and Escutcheon Plates, full-size Blueprint, and point-to-point Wiring Chart.

# TELSEN

## SHORT-WAVE ADAPTOR KIT

27<sup>1</sup>/<sub>6</sub>

