

30 PAGES FOR SET-BUILDERS :: 40 OTHER FEATURES

Wireless Magazine

No. 73

FEBRUARY, 1931

TWELVE READER-TESTED **SETS**
for **YOU TO BUILD**
16-PAGE TINTED SUPPLEMENT

1/-



SHOULD THE B.B.C. JAM MOSCOW? :: FIVE FULL-PAGE TEST REPORTS FOR SET-BUYERS :: "POWER" GRID DETECTION :: HAVE YOU A TALKIE VOICE? :: MÜHLACKER—THE NEW GERMAN REGIONAL STATION

A Favourite with Experts and Amateurs alike



The Lewcos Dual Screened Coil Unit DCG/2 consists of a tapped aperiodic aerial coil and screened-grid H.F. Transformer covering the medium broadcast waveband of 235 to 500 metres and the long waveband of 1,000 to 2,000 metres.

Both coils are astatically wound, i.e., fieldless, and are enclosed in a metal screen, as illustrated.

If desired, the change-over switching mechanism can be operated by means of a push-pull rod protruding through the receiver panel as in the "Push-pull Four" receiver, described in this issue. This rod (Reference SM15) is supplied free of charge when ordered with the DCG/2 Unit.

The **LEWCOS** (Regd.) **DUAL SCREENED COIL UNIT**

Price 45/-

THE LEWCOS DUAL SCREENED UNIT IS SPECIFIED FOR THE "PUSH-PULL FOUR" RECEIVER DESCRIBED IN THIS ISSUE.

WRITE FOR FULLY DESCRIPTIVE LEAFLET R66.



LEWCOS RADIO PRODUCTS FOR BETTER RECEPTION

Editor :

BERNARD E. JONES

Technical Editor :

J. H. REYNER.

B.Sc. (Hons.), A.M.I.E.E.

Wireless Magazine

The Best Shillingsworth in Radio

Vol. XIII :: FEBRUARY, 1931 :: No. 73

CONTENTS

SPECIAL SUPPLEMENT

(After page 32)

THE TRUSTY TWELVE	Page One
NEW BROOKMAN'S THREE	Page Two
DUAL-SCREEN FIVE	Page Three
REGIONAL A.C. FOUR	Page Four
WHICH SET SHALL I BUILD?	Page Five
FIVE-POINT TWO	Page Six
JAMES PORTABLE S.G.3	Page Seven
"W.M." STANDARD A.C. UNIT	Page Eight
HOW TO USE A "W.M." BLUEPRINT	Page Nine
FIVE-POINT FOUR	Page Ten
FALCON THREE AND A.C. MAINS UNIT	Page Eleven
FIVE-POINT SHORT-WAVER	Page Twelve
PRACTICAL HINTS AND TIPS	Page Thirteen
REGIONAL BAND-PASS FOUR	Page Fourteen
FIVE-POINT THREE	Page Fifteen
"W.M." STANDARD D.C. UNIT	Page Sixteen

GENERAL ARTICLES

BROADCAST IDENTIFICATION SHEETS. By Jay Coote	8
WAVELENGTHS OF THE WORLD'S BROADCASTERS	12
CHEAPER MAINS RADIO	16
IN TUNE WITH THE TRADE. By Fetter Lane	20
TALKING TO THE MILLION—OR A HANDFUL? By Bernard E. Jones	25
RADIO CULTURE. By Gerald H. Daly	29
SHOULD THE B.B.C. JAM MOSCOW? By Our Special Commissioner	31
RADIO MEDLEY. By B/M PRESS	33
RECORDING THEIR VOICES	42
TRANSATLANTIC RADIO	43
SECRETS OF BROADCASTING HOUSE. By Kenneth Ulyett	50
ALL ABOUT MÜHLACKER	60
PRINCIPAL GERMAN BROADCASTING STATIONS	60
BROADCASTS OF 1930	63
THE LEAKY GRID	64
B.B.C. MUSIC VIA ETHER	78
UNDER MY AERIAL. Halyard's Chat on the Month's Topics	82
"IS TELEVISION AT A STANDSTILL?" By Bernard E. Jones	88
A LISTENER'S LOG. By Jay Coote	90
RADIO IN REVIEW. By Morton Barr	93
A QUAINT INSTRUMENT. By Whitaker-Wilson	102
COWBOY RADIO	104
THAT WAS GERMANY! By J. Godchaux Abrahams	108
BLUEPRINT AND QUERY COUPONS	112
INDEX TO ADVERTISERS	112

FOR THE CONSTRUCTOR

THE BAFFLE-BOARD THREE. Something New in Set Design	36
THE BROOKMAN'S A.C. TWO. A Set with a Power Detector	55
THE SUPERTONE FOUR. A Gramo-Radio Set with Push-pull circuit incorporated	73
THE HYPERDYNE SHORT-WAVE ADAPTOR. By J. H. Reyner, B.Sc., A.M.I.E.E.	96

TECHNICAL FEATURES

VALVES TO USE IN YOUR SET	4
A PICK-UP WITH VOLUME CONTROL	16
A NEW SYSTEM OF PROJECTED TELEVISION	26
PLUG-IN COILS	30
METAL SCREENS	31
HAVE YOU A TALKIE VOICE? By Baynham Honri	40
WE TEST BEFORE YOU BUY	41
EDISWANE POWER PENTODE TWO	45
EDDYSTONE ALL-WAVE FOUR	46
BURNDEPT THREE-WAVE CONSOLE	47
MURPHY PORTABLE FOUR	48
COLUMBIA 310 RADIO GRAMOPHONE	49
THIS "POWER" GRID-DETECTION BUSINESS! By W. James	52
TRANSFORMER CURVES	54
SCREENED-GRID OVERLOADING	54
WHY NOT USE A TONE CONTROL? By J. H. Reyner, B.Sc.	62
TESTS OF NEW APPARATUS	106
SANS PICK-UP!	106

GRAMO-RADIO SECTION

NOTES AND JOTTINGS OF THE MONTH	65
MAKING RECORDS WITHOUT AN AMPLIFIER. By D. Sisson	66
Relph	68
SECRETS OF GRAMO-RADIO SUCCESS. By H. T. Barnett, M.I.E.E.	69
A VERY NOVEL MOTOR	69
CHOOSING YOUR RECORDS. By Whitaker-Wilson	70
THE NEW PHONYCORD FLEXIBLE RECORDS	71

Published by BERNARD JONES PUBLICATIONS, LTD., publishers of "Wireless Magazine" and "Amateur Wireless." Editorial and Advertisement Offices : 58-61 Fetter Lane, London, E.C.4. Telephones : City 3733, 3734. Telegrams : "Beejapee, Fleet, London." Published about the 23rd day of the month and bears the date of the month following. Subscription : Great Britain and abroad, 15s. 6d. a year, post free (Canada only, 13s. 6d.) Contributions are invited and will be promptly considered.

Research Consultant :

W JAMES

Assistant Editor :

D. SISSON RELPH

THE February WIRELESS MAGAZINE is a general-purpose number for all who are interested in radio and wish to get the best from it, but the presence of the tinted-paper supplement gives it a strong constructor flavour, inasmuch as in it I have gathered together circuit diagrams, layouts, photographs, and specifications of a dozen popular sets, among which there must be at least one to suit any particular need.

As these sets have been built and tested by readers all over the country, it follows that you can adopt them with absolute confidence. Will you turn to Page One of the supplement where these "Trusty Twelve" are listed and see the terms of the special arrangement by which you can obtain a blueprint of any one of the sets at half price.

I am offering you something

NEW IN SET DESIGN

this month in The Baffle-board Three, comprising set, cone loud-speaker, and batteries all assembled on the reverse side of a baffle board, an effort to make possible the use of a large-size baffle and yet achieve economy of space.

The month's mains set is the Brookman's A.C. Two, just for local-station use, but provided with a power grid detector which with one stage of low-frequency amplification gives good volume and quality.

The Supertone Four is a fine proposition—a grammo-radio set with push-pull output, while the Hyperdyne Short-wave Adaptor is the sequel to J. H. Reyner's Hyperdyne set of December, which I am glad to say has attracted much deserved attention.

TELEVISION DEMONSTRATIONS

I have seen two interesting quite recently, one at the Baird studio and the other at the H.M.V. works at Hayes, Middlesex. In an article on page 88 I give the impressions made on my mind by the Baird developments while, with regard to the other demonstration, I am able to publish, with the great help of the H.M.V. people, a detailed article upon the system and novel apparatus used.

The general articles this month are worth your attention. "Should the B.B.C. Jam Moscow?" asks the special commissioner responsible for our monthly account of the B.B.C.'s activities. He does not answer the question very emphatically, but since the subject has been

raised in the public press I think he does well to point out that the B.B.C.'s job is to provide a broadcast programme and that while other countries content themselves with the broadcast channels allotted to them, the B.B.C. can do nothing whatever to prevent British listeners receiving Russian broadcasts whether they be pleasant or unpleasant.

I see they are getting on with the new Broadcasting House—an elaborate, expensive job, which will make for the dignity of the B.B.C. and will—at any rate, let us hope so—reflect its up-to-dateness in

BETTER PROGRAMMES.

The programme's the thing! An article illustrated by photographs records the progress made in the building.

And how do you like the admixture of Mühlacker and London Regional? We give some pictures and details of the new German station in this issue. A power of 75 kilowatts in the aerial, you will note, and this can be doubled! Other stations just as powerful are on paper and will, in due course, set up new problems for Geneva and you and us to solve.

By the way, J. Godchaux Abrahams tells us how to recognise the German stations, the principal of which we list in the course of the Mühlacker article.

We are publishing test reports this month of a power-pentode two, an all-wave four, a three-valve console, a portable four, and a radio gramophone. Don't buy before we test.

In the belief that interest in

RECORD MAKING

at home is considerably on the increase, our Assistant Editor describes a system of making records without an amplifier; another item of novel interest in the Gramo-Radio Section is the new Phonycord flexible record with which, by the way, I helped to amuse some of my visitors at Christmas time.

Capt. Barnett continues his Secrets of Gramo-Radio Success, and if he does not know them all, he at any rate knows most of them, while Whitaker-Wilson reviews for readers notable records of the month.

So whether you build or whether you buy; whether you experiment or just listen, you will find in this issue, I am certain, much that will please and help you.

THE EDITOR

YOU
can make
this test in your
own home



OHMITE
Anode
Resistances.

100 ohms to
500,000 ohms,

2/3 each

Connect an Ohmite or Megite in series with a NEW H.T. battery and a pair of headphones, then observe the absolute silent functioning of the Resistance due to lack of molecular displacement, a feature of Ohmite and Megite Resistance.

Compare with any other resistance obtainable at the price and you will immediately endorse our claim that every Graham Farish component is the finest value for money obtainable.

Graham Farish components carry a written guarantee of accuracy.

GRAHAM FARISH
LIMITED · BROMLEY · KENT

MEGITE
Grid Leak.

All values, 1
megohm to
5 megohms.

2/- each

CLEARERTONE
In this, the leader among British valveholders, the whole platform supporting the valve is sprung. The springing is sensitive enough to damp out vibration and "pong" and yet dead beat enough to avoid any possibility of electro-mechanical resonance. A good job throughout

Write for Catalogue No 1142

The BENJAMIN ELECTRIC LTD.
Tarriff Road, Tottenham, N.17.
Tottenham 1500

BENJAMIN

TONAX

The greatest Tone Value ever offered to the public.
TONAX IS A NEW CHUCK

that definitely cuts out all "chatter." For use with all Cone Speakers and fits every size of reed or driving rod

BECAUSE of the Special Patented Taper Chuck, which with screwing device, firmly grips the reed or driving rod AT THE BACK of the cone, the quality of reproduction is VASTLY IMPROVED.

IT COSTS ONLY 1/- for a TONAX CHUCK (Nickel-plated finish), complete with 2 polished metal washers, 2 felt washers and 2 special flexible washers.

TONAX is easily fitted.

From most dealers or Post and Packing Free for 1s. 2d. Write Dept. A.

GARRATT STORES
193 Garratt Lane, Wandsworth, London, S.W.18

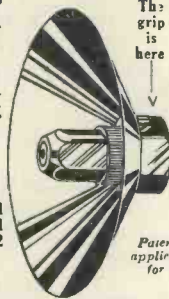

Patent applied for

CABINETS
KABILOK
OF
DISTINCTION

"KABILOK"
specified for the
"SUPERTONE FOUR"
in this issue

Special American Type Cabinet in Oak complete with baseboard and slotting as specified **42/-**
Mahogany to Order **49/-**

Illustrated Catalogue of "Kabilok" Loudspeaker, Pedestal and Radio-Gramophone Cabinets—FREE.

W. & T. LOCK LTD.
ST. PETER'S WORKS BATH
LONDON: 11, Red Lion Square Holborn, W.

COLUMBIA
RADIO BATTERIES
NOW COST LESS

COLUMBIA 4780, 60 volts, Triple Capacity, 17/6

Columbia radio batteries are still more economical now. The Columbia 4780 (60 volts Triple Capacity) costs only 17/6, though it outlives three ordinary batteries. More power for every penny; pure trouble-free reception night after night, without a suggestion of background. Say to your dealer—COLUMBIA 4780. If your dealer has not Columbia, in stock, send to us, giving his name.

Columbia
RADIO BATTERIES

J. R. MORRIS, Imperial House,
15 Kingsway, London, W.C.2.

Scotland: J. T. Cartwright, 3 Cadogan St. Glasgow.

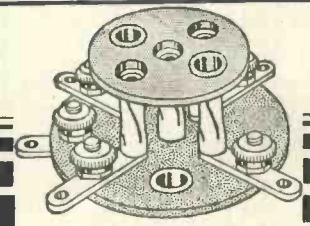

No. 27. Pro. Pat. Reg. Design

Built for Efficiency

Not for Appearance

A well-known Amateur Transmitter writes:—"I would commend it to all short-wave enthusiasts. I myself use one of these holders with great success on a frequency of 58,000 kc. p/sec., and shall be using it for Trans-Atlantic tests upon this frequency."

Modern valves do not require sprung valveholders. Because of the Resilient Sockets used in the Clix Valveholder, it is the only one giving perfect contact with SOLID as well as all other types of valve pins.

Type B for baseboard mounting

- 5 pin Model with screw terminals 1/-
- 5 pin Model without screw terminals 9d.
- 4 pin Model with screw terminals 10d.
- 4 pin Model without screw terminals 8d.

27 Different Clix Fitments for Perfect Contact. Folder on Request.

ELECTRO LINX, LTD.
254 Vauxhall Bridge Rd., S.W.1

BUILD THE 'BAFFLE-BOARD THREE'

	£	s.	d.
1 Magnum H.F. Choke	7	6	
1 No. 50 Plug-in Coil	2	6	
1 No. 60 Plug-in Double-tapped Coil	5	6	
1 No. 200 Plug-in Double-tapped Coil	7	0	
1 Magnum Fixed Condenser, .0002	1	6	
1 Magnum Fixed Condenser, .005	2	0	
1 Lissen Fixed Condenser, 2 microfarad	3	6	
1 Lotus .0005 Variable Condenser	5	9	
1 Lotus .0002 Reaction Condenser	5	3	
1 Formodenser, .0003 max.	1	6	
1 Lotus Slow-motion Dial	4	9	
1 Ebonite Panel, 12 in. by 6 in.	4	6	
1 Belling-Lee Terminal Block	8		
2 Lissen 2-pin type Coil Holders	2	0	
1 Magnum Grid-leak Holder	6		
2 Magnum Vibro. Valve Holders	2	6	
1 W. B. S.G. type Valve Holder	1	3	
6 Belling-Lee Terminals, as specified	1	6	
2 Belling-Lee Spade Terminals	9		
2 Belling-Lee A.E. Terminals	6		

	£	s.	d.
1 Magnum Spaghetti Resistance, 30,000 ohms	1	6	
1 Magnum Spaghetti Resistance, 80,000 ohms	2	0	
1 Lissen 2-megohm Resistance	1	0	
1 Magnum 1-megohm Potentiometer	7	6	
1 Igranic 3 to 1 L.F. Transformer	10	6	
1 Lissen Output Transformer, 1 to 1	12	6	
1 Baffle Screen	15	9	
1 H.T. Battery, 120 volts	15	6	
1 G.B. Battery, 16 volts	2	9	
1 C.A.V. 2-volt Accumulator	11	0	
1 Blue Spot Special Chassis	10	6	
1 Blue Spot Unit, 66R	1	15	0
1 Mullard PM1A	8	6	
1 Mullard PM1HF	8	6	
1 Mullard PM2	10	6	
Sundries, including Glazite, Rubber-covered Flex, 1 Baseboard, 1 Shelf, 2 Panel Brackets and 4 Wooden Supports	8	1	
	£11	3	0

Any parts supplied separately as required.
The Baffle-board Three, complete as above, ready wired and tested and Royalty Paid

£13 0 0

Now Enjoy the Short Wave Stations.

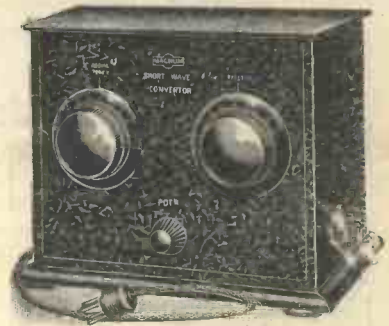

THE MAGNUM SHORT-WAVE CONVERTOR

Readily converts any battery-operated receiver into a highly-efficient short-wave receiver. Complete with two coils, 20/40 and 40/80 metres. Sent on ten days' free trial against **£3:15** cash

Full particulars, with list of leading short-wave stations on request.



Specified for
Regional A.C. Four
Five-point Four
Falcon Three
Regional Band-pass
Four
Baffle-board Three
etc., etc.

SPAGHETTI WIRE-WOUND RESISTANCES

600 to 50,000 ohms	1/6
80,000 to 100,000 ohms	2/-
150,000 ohms	2/6



H.F. CHOKE

Adopted by several leading set makers and recommended for all constructional kits. 7/6

We specialise in all sets described in "Wireless Magazine."
Full range of Lists, Free on Request.

BURNE JONES & Co., Ltd.

MAGNUM HOUSE, 296 BOROUGH HIGH ST., LONDON, S.E.1
Telephone: Hop. 6257 and 6258.
Scottish Agent: Mr. ROSS WALLACE, 54 Gordon Street, Glasgow, C.1



AS USED IN THE BROOKMANSTWO

(See page 55)

The Expert and the Amateur use HEYBERD POWER TRANSFORMERS. For the Set that must embody the best Components the Radio Market can offer there is no problem as far as the Transformer is concerned—

IT MUST BE A HEYBERD —to ensure success—

The theoretical diagram shows Model 715, as chosen for the Brookman's Two, described in this Magazine. The combination of two L.T. windings with the H.T. windings make this Transformer an ideal ALL MAINS MODEL.

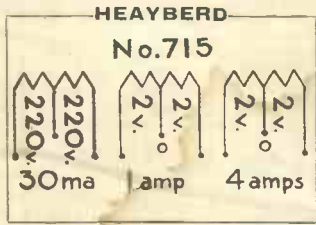

Price 28/6

There are several models to choose from.
Send a postcard to-day for the full list of Heayberd Transformers—free on request. Therein you will learn, with the aid of numerous diagrams, how to build an All Mains Eliminator best suited to the requirements of your particular receiver

F.C. HEYBERD & CO
10, FINSBURY ST. EC2
One Minute From Moorgate Station.

Phone: Met. 7516

Grams: Heayberd, Finsbury, London

The Sheer Brilliance of Reproduction



HYPERCORE

that is ensured by the employment of the

NIKALLOY

enables a high value of inductance to be obtained with a minimum self-capacity. This is the reason why it was chosen for inclusion in the "Regional Band Pass Four" and "Brookman's A.C.2"

the two new wonderful receivers described in this issue.

HYPERCORE

smoothing and output filter choke, a brilliant example of British radio enterprise. Inductance 30 henries. Maximum D.C. 80 milliamps. Weight only 18 ozs. Price **17/6**

Ask your dealer for leaflets giving full description of this and other R.I. Nikalloy components.



R.I. Ltd., Madrigal Works, Purley Way, Croydon.

Advertisers like to know you "saw it in the 'Wireless Magazine'"

VALVES TO USE IN YOUR SET

Make	Type	Impedance	Amplification Factor	Filament Current	Mutual Conductance	Anode Current at 120 volts	Grid Bias at 100 volts	Grid Bias at 150 volts
Two-volt Three-electrode Valves								
Dario ..	Resist	60,000	30	.1	.5	—	1.5	3.0
Mazda ..	H210	59,000	47	.1	.8	—	.5	1.0
Lissen ..	H210	58,000	35	.1	.6	1.1	—	1.5
Six-Sixty	210RC	55,500	39	.1	.7	1.6	1.0	1.5
Mullard	PM1A	51,000	36	.1	.7	.75	1.5	1.5
Cossor ..	210RC	50,000	36	.1	.72	1.5	—	1.5
Tungsram	R208	50,000	35	.1	.7	1.0	—	1.5
Narconi ..	H2	35,000	35	.1	1.0	.5	—	1.5
Osram ..	H2	35,000	35	.1	1.0	1.0	—	1.5
Six-Sixty	210HF	25,000	19	.1	.75	2.75	—	—
Tungsram	H210	25,000	25	.1	1.0	2.0	—	—
Mullard	PM1HF	22,500	18	.1	.8	1.0	3.0	4.5
Dario ..	Super HF	21,000	25	.15	1.5	2.0	1.5	3.0
Lissen ..	HL210	21,000	18	.1	.85	2.2	1.5	4.5
Mazda ..	HL210	21,000	26	.1	1.25	3.0	1.5	3.0
Cossor ..	210HF	20,000	22	.1	1.2	1.2	1.5	3.0
Marconi ..	HL2/c	20,000	22	.1	1.1	—	—	—
Osram ..	HL2/c	20,000	22	.1	1.1	—	—	—
Cossor ..	210Det.	13,000	15	.1	1.15	—	—	—
Six-Sixty	210LF	12,500	10.6	.1	.85	5.4	4.5	7.5
Cossor ..	210LF	12,000	10	.1	1.1	3.5	3.0	4.5
Mullard	PM1LF	12,000	11	.1	.9	3.0	4.5	7.5
Six-Sixty	217D	10,700	13.5	.17	1.25	7.0	—	4.0
Mullard	PM2DX	10,700	13.5	.2	1.25	3.0	3.0	6.0
Dario ..	Univ.	10,000	9	.1	.9	3.0	—	1.5
Lissen ..	L210	10,000	10	.1	1.0	3.5	3.0	7.5
Marconi ..	L2/b	10,000	15.5	.1	1.55	4.0	—	—
Osram ..	L2/b	10,000	15.5	.1	1.55	4.0	—	—
Mazda ..	L210	10,000	15.5	.1	1.55	5.0	2.5	4.5
Tungsram	LG210	10,000	10	.1	1.0	4.0	—	—
Dario ..	Super Det.	7,500	15	.15	2.0	3.0	1.5	3.0
Six-Sixty	220P	4,800	7.2	.2	1.5	7.0	10.0	16.0
Lissen ..	P220	4,700	7	.2	1.5	5.0	9.0	15.0
Dario ..	SP	4,500	9	.15	2.0	—	7.5	12.0
Mullard	PM2	4,400	7.5	.2	1.7	4.0	7.5	12.0
Cossor ..	220P	4,000	8	.2	2.0	7.5	4.5	7.5
Cossor ..	P215	4,000	9	.15	2.25	—	3.0	7.5
Marconi ..	LP2/c	4,000	8	.2	2.0	10.0	—	—
Osram ..	LP2/c	4,000	8	.2	2.0	10.0	—	6.0
Mazda ..	P220	3,700	12.5	.2	3.4	11.0	—	—
Tungsram	P215	3,300	5	.2	1.5	12.0	—	—
Six-Sixty	230SP	2,750	5.5	.3	2.0	32.0	12.0	23.0
Dario ..	Hyper	2,700	5	.3	1.8	10.0	10.5	15.0
Mullard	PM252	2,600	5.4	.3	2.1	14.0	9.0	15.0
Marconi ..	P240	2,500	4	.4	1.6	11.0	16.0	24.0
Osram ..	P240	2,500	4	.4	1.6	11.0	16.0	24.0
Tungsram	SP230	2,500	5	.3	2.0	15.0	—	—
Lissen ..	PX240	2,000	4	.4	2.0	14.0	12.5	22.5
Mazda ..	P240	1,900	7	.4	3.7	18.0	6.0	13.5
Marconi ..	P2/b	1,850	6.5	.2	3.5	15.0	—	—
Osram ..	P2/b	1,850	6.5	.2	3.5	15.0	—	—
Cossor ..	230XP	1,500	4	.3	2.3	18.0	12.5	22.5
Two-volt Screened-grid Valves								
Tungsram	S210	430,000	300	.12	.8	—	—	—
Mazda ..	215SG	400,000	450	.15	1.1	—	1.5	1.5
Cossor ..	215SG	300,000	330	.15	1.1	—	—	—
Dario ..	SG	250,000	250	.15	1.0	—	—	1.5
Mullard	PM12	230,000	200	.15	.87	—	—	—
Six-Sixty	215SG	220,000	190	.15	.87	2.0	—	—
Cossor ..	220SG	200,000	320	.2	1.6	—	1.5	1.5
Lissen ..	SG215	200,000	180	.15	.9	—	—	1.5
Marconi ..	S215	200,000	170	.15	.85	—	—	—
Osram ..	S215	200,000	170	.15	.85	—	—	—
Two-volt Pentode Valves								
Lissen ..	PT225	64,000	90	.25	1.4	7.0	3.0	6.0
Six-Sixty	230PP	64,000	80	.3	1.25	17.0	6.0	10.5
Mullard	PM22	62,500	82	.3	1.3	10.0	6.0	12.0
Dario ..	Pent.	55,000	100	.3	1.8	—	6.0	15.0
Marconi ..	PT240	55,000	90	.4	1.65	9.0	6.0	9.0
Osram ..	PT240	55,000	90	.4	1.65	9.0	6.0	9.0
Lissen ..	PT240	22,500	45	.4	2.0	12.5	7.5	10.5
Cossor ..	230PT	20,000	40	.3	2.0	15.0	6.0	7.5
Mazda ..	230Pen.	—	—	.3	1.8	13.0	9.0	9.0
Four-volt Three-electrode Valves								
Cossor ..	410RC	60,000	40	.1	.66	1.0	—	1.5
Dario ..	Resist	60,000	30	.075	.5	—	—	1.5
Marconi ..	H410	60,000	40	.1	.67	.5	1.5	1.5
Osram ..	H410	60,000	40	.1	.66	.35	—	1.5
Lissen ..	H410	60,000	40	.1	.66	1.6	—	1.5
Six-Sixty	4075RC	58,000	37	.075	.64	1.35	1.0	1.5
Mullard	PM3A	55,000	38	.075	.66	.3	1.5	1.5
Marconi ..	HL410	30,000	25	.15	.83	1.0	2.0	3.0
Osram ..	HL410	30,000	25	.1	.83	1.25	1.5	3.0
Lissen ..	HLD410	21,000	25	.1	1.2	2.5	1.5	3.0
Dario ..	Super HF	21,000	25	.1	1.2	2.0	1.5	3.0
Cossor ..	410HF	20,000	20	.1	1.0	1.75	1.5	4.5
Mullard	PM3	13,000	14	.075	1.05	2.0	3.0	6.0
Six-Sixty	4075HF	12,500	13.5	.075	1.1	7.0	3.0	5.0
Dario ..	Univ.	10,000	10	.075	1.0	3.0	—	1.5
Cossor ..	410LF	8,500	15	.1	1.76	3.2	3.0	6.0
Lissen ..	L410	8,500	15	.1	1.8	3.5	1.5	4.5
Marconi ..	L410	8,500	15	.1	1.76	3.0	2.0	4.5
Osram ..	L410	8,500	15	.1	1.77	3.5	3.0	4.5

Make	Type	Impedance	Amplification Factor	Filament Current	Mutual Conductance	Anode Current at 120 volts	Grid Bias at 100 volts	Grid Bias at 150 volts
Four-volt Three-electrode Valves—Continued								
Mullard	PM4DX	7,500	15	.1	2.0	2.0	3.0	6.0
Dario ..	Super Det.	7,500	15	.075	—	3.0	3.0	4.5
Six-Sixty	410D	7,250	14.5	.1	2.0	8.0	—	3.5
Marconi ..	P410	5,000	7.5	.1	1.5	6.0	6.0	10.5
Osram ..	P410	5,000	7.5	.1	1.5	6.0	6.0	10.5
Dario ..	SP	4,500	9	.1	2.0	7.5	6.0	15.0
Lissen ..	P410	4,500	9	.1	2.0	5.0	6.0	12.5
Mullard	PM4	4,450	8	.1	1.8	6.0	7.5	12.0
Six-Sixty	410P	4,200	7.7	.1	1.85	18.0	6.0	9.0
Cossor ..	410P	4,000	8	.1	2.0	17.5	4.5	9.0
Dario ..	Hyper P	2,700	5	.15	1.8	15.0	12.0	17.5
Marconi ..	P425	2,300	4.5	.25	1.95	14.0	9.0	16.5
Osram ..	P425	2,300	4.5	.25	1.95	4.0	9.0	16.5
Lissen ..	P425	2,250	4.5	.25	2.8	28.0	12.5	19.5
Cossor ..	415XP	2,000	4	.15	2.0	2.0	12.0	22.5
Cossor ..	425XP	2,000	7	.25	3.5	—	6.0	13.5
Mullard	PM254	2,000	4.2	.18	2.1	10.0	13.5	22.5
Six-Sixty	420SP	2,000	4	.2	2.0	41.0	12.0	22.0
Mazda ..	P425	1,950	3.5	.25	1.8	26.0	1.40	26.0
Cossor ..	4XP	1,100	3	.6	2.75	30	15	30
Marconi ..	PX4	1,050	3.5	.6	3.3	30.0	13.0	23.0
Osram ..	PX4	1,050	3.5	.6	3.3	30.0	13.0	23.0
Four-volt Screened-grid Valves								
Dario ..	SG	250,000	250	.075	1.0	2.0	—	1.5
Mullard	PM14	230,000	200	.075	.87	—	—	—
Six-Sixty	4075SG	220,000	190	.075	.87	3.0	—	—
Cossor ..	410SG	200,000	200	.1	1.0	—	1.5	1.5
Marconi ..	S410	200,000	180	.1	.9	3.5	1.5	1.5
Osram ..	S410	200,000	180	.1	.9	3.5	—	—
Lissen ..	SG410	200,000	180	.1	.9	—	—	1.5
Four-volt Pentode Valves								
Dario ..	Pent.	55,000	100	.15	1.8	—	—	15.0
Six-Sixty	SS4 Pent.	55,000	83	.275	1.55	10.0	10.0	14.0
Marconi ..	PT425	50,000	100	.25	2.0	8.0	4.7	7.5
Osram ..	PT425	50,000	100	.25	2.0	8.0	4.0	7.5
Mullard	PM24	28,000	62	.15	1.75	16.0	6.0	12.0
Six-Sixty	415PP	27,000	60	.15	2.2	—	6.0	10.5
Osram ..	PM24A	25,000	50	.275	2.0	15.0	6.0	21.0
Lissen ..	PT425	22,500	180	.25	2.0	15.0	7.5	10.5
Cossor ..	415PT	20,000	40	.15	2.0	14.0	6.0	9.0
Mazda ..	425Pen.	—	—	.25	2.0	14.0	14.0	14.0
Six-volt Three-electrode Valves								
Mazda ..	H607	90,000	40	.07	.45	1.0	.8	1.5
Cossor ..	610RC	60,000	50	.1	.8	1.0	—	1.5
Lissen ..	H610	60,000	40	.1	.66	1.0	—	1.5
Marconi ..	H610	60,000	40	.1	.7	.5	1.5	1.5
Osram ..	H610	60,000	40	.1	.7	.35	—	1.5
Six-Sixty	6075RC	58,00						



Mahogany Model

A popular priced Radio-Gramophone which is unique

As a popular musical instrument, this new Columbia Radio-Gramophone occupies an unassailable position. Here are a few of Model 310's outstanding points:—

- (1) Unequalled tone through coil-excited Moving Coil Speaker.
- (2) Screened grid circuit giving wide range of stations.
- (3) 8 watt super power amplification.
- (4) Tuning dial marked in wave-lengths.
- (5) Adjustable aerial coupling for separating near-by stations.
- (6) 'Normal' and 'Extra' power switch for records.
- (7) Electric motor with automatic stop.
- (8) Extreme economy ($\frac{1}{2}$ d. an hour at 6d. a unit.)

We advise you to hear it soon—a demonstration will convince you of its unquestioned superiority.

EVERYBODY'S ALL-ELECTRIC RADIO-GRAPHOPHONE by Columbia

MODEL 310
FOR A.C.
MAINS

OAK 40 GNS.
MAHOGANY
43 GNS.



* I should like to hear Model 310 playing in my home. Please arrange this without cost or obligation to myself.
* I should like a copy of the Columbia Radio Book and/or catalogue of Radio-Graphophones.

* Cross out if not required.

Cut this out and post it in an unsealed envelope bearing a 3d. stamp to:—

Columbia, 102, Clerkenwell Road, London, E.C.1.

NAME

ADDRESS

W.M. FEB.

It helps us if you mention "Wireless Magazine"

VALVES TO USE IN YOUR SET—Continued

Make	Type	Impedance	Amplification Factor	Filament Current	Mutual Conductance	Anode Current at 150 volts	Grid Bias at 100 volts	Grid Bias at 150 volts
Six-volt Three-electrode Valves								
Lissen ..	P62A	1,500	4.5	.25	3.0	12.0	13.5	24.0
Six-Sixty	625SPA	1,500	3.9	.25	2.6	60.0	12.0	22.5
Mullard	PM256A	1,400	3.6	.25	2.6	—	—	—
Marconi	LS6A	1,300	3.0	2.0	2.3	—	—	—
Mazda ..	P650	1,300	3.5	.5	2.7	30.0	12.0	25.0
Osram ..	LS6A	1,300	3.0	2.0	2.3	—	—	—
Marconi	DA60	835	2.5	4.0	3.0	—	—	—
Osram ..	DA60	835	2.5	4.0	3.0	—	—	—
Six-volt Screened-grid Valves								
Six-Sixty	SS6075SC	210,000	190	.075	.9	—	—	—
Osram ..	610SG	200,000	200	.1	1.0	—	—	1.5
Mullard	PM16	200,000	200	.075	1.0	—	—	—
Osram ..	S610	200,000	210	.1	1.05	4.0	1.5	—
Six-volt Pentode Valves								
Marconi	PT625	43,000	80	.25	1.85	10.0	6.0	15.0 (at 250v)
Osram ..	PT625	43,000	80	.25	1.85	—	—	—
Six-Sixty	SS617PP	28,500	54	.17	1.9	35.0	8.0	14.0
Mullard	PM26	25,000	50	.17	2.0	—	9.0	15.0
Lissen ..	PT625	24,000	60	.25	2.5	14.0	7.5	15.0
Osram ..	615PT	20,000	40	.15	1.5	14.0	—	—
A.C. Mains Valves								
Six-Sixty	SS4SGAC	1,330,000	1,600	1.0	1.0	1.5	—	—
Mullard	S4V	909,000	1,000	1.0	1.1	—	—	—
Mazda ..	AC/SG	800,000	1,200	1.0	3.0	5.0	.5	.5
Marconi	MS4	500,000	550	1.0	1.1	2.2	1.5	1.5
Osram ..	MS4	500,000	550	1.0	1.1	2.2	—	—
Mullard	S4VA	430,000	1,500	1.0	3.5	1.7	—	—

Make	Type	Impedance	Amplification Factor	Filament Current	Mutual Conductance	Anode Current at 150 volts	Grid Bias at 100 volts	Grid Bias at 150 volts
A.C. Mains Valves—Continued								
Osram ..	41M5G	400,000	1,000	1.0	2.5	2.0	—	1.5
Mullard ..	S4VB	257,000	900	1.0	3.5	4.0	1.5	1.5
Osram ..	M41RC	20,000	35	1.0	1.75	2.4	1.5	3.0
Tungsram	G150	20,000	10	.5	.5	—	—	—
Tungsram	R150	18,000	25	.5	1.4	1.5	—	—
Six-Sixty	SS4GPAC	14,500	35	1.0	2.4	3.0	—	3.0
Osram ..	M41HF	14,000	32	1.0	2.3	2.5	1.5	3.0
Tungsram	AR4100	14,000	33	1.0	2.0	1.5	—	—
Mazda ..	AC/HL	13,500	35	1.0	3.0	4.5	1.5	3.0
Mullard	354V	11,700	35	1.0	3.0	2.0	2.0	3.0
Marconi	MHL/4	8,000	20	1.0	2.5	5.0	3.0	6.0
Osram ..	MHL/4	8,000	20	1.0	2.5	5.0	3.0	6.0 (at 200v)
Tungsram	AG4100	8,000	16	1.0	2.0	5.0	—	—
Osram ..	M41LF	7,900	15	1.0	1.9	4.5	4.5	6.0
Six-Sixty	SS4Det.	—	—	—	—	—	—	—
Mullard	164V	6,650	16	1.0	2.4	5.0	4.5	6.0
Osram ..	M41P	5,000	10	1.0	2.0	6.5	4.5	7.5
Tungsram	L190	4,200	10	.9	2.4	8.0	12.0	16.5
Marconi	ML4	3,000	9	1.0	2.0	9.0	10.0	22.0 (at 200v)
Osram ..	ML4	3,000	9	1.0	2.0	9.0	10.0	16.0
Six-Sixty	SS4PAC	3,000	10	1.0	3.3	10.0	5.0	8.0
Mullard	AC104	2,850	10	1.0	3.5	—	—	10
Mazda ..	AC/P	2,650	10	1.0	3.75	14.0	6.0	12.0
Tungsram	P190	2,500	6	.9	2.4	8.0	—	—
Osram ..	M41XP	2,000	4	1.0	2.0	15.0	12.0	19.5
Mazda ..	AC/PI	2,000	5	1.0	2.5	25.0	15.0	25.0
Mullard	AS064	2,000	6	1.0	3.0	15.0	9.0	14.0
Mullard	AC/44	1,150	3.4	7	3.5	7	16.5	7.8

Remember the Date !
FEBRUARY 20 ◆

On that day will be published the March issue of WIRELESS MAGAZINE. It will contain another special supplement, of interest and use to all set owners.

H.T., L.T. and G.B. FROM A.C. MAINS

The Six-Sixty Power Unit is a super-eliminator for your battery set, giving H.T. and G.B.—takes no more room than existing batteries. Price £6:6:0. Get and use one now, and if later you wish to change over to all-mains operation you merely buy Six-Sixty A.C. Valves and Valve Adaptors—no internal wiring alterations. Or “go all-mains” now—the complete Six-Sixty A.C. All Mains Conversion equipment costs from £8:5:0.

WRITE FOR FREE BOOKLET. It tells how any set may be improved and brought up to date, and all about the famous Six-Sixty Valves and Equipment.



SAY SIX-SIXTY

(B.V.A. RADIO VALVES AND EQUIPMENT)

SIX-SIXTY RADIO Co. Ltd., Six-Sixty House, 17-18 Bathbone Place, Oxford St., London, W.1
Telephone: Museum 611477

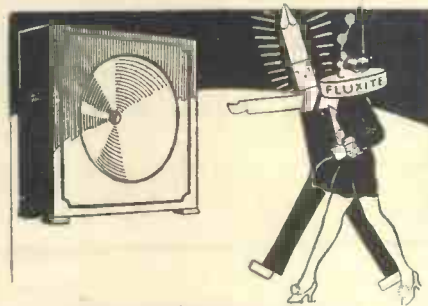

“We’re Fluxite and Solder—The reliable pair. Famous for Soldering. Known everywhere! If there’s trouble with Wireless Loud-Speaker—or Set, just call US to help you—You’ll be glad that we met.”

See that Fluxite and Solder are always by you—in the house, garage, workshop—anywhere where simple, speedy soldering is needed. They cost so little but will make scores of everyday articles last years longer! For Pots, Pans, Silver and Brassware; RADIO: odd jobs in the garage—there’s always something useful for Fluxite and Solder to do.

ANOTHER USE FOR FLUXITE. All Hardware and Ironmongery Stores sell Fluxite in tins. 8d., 1/4 and 2/8. Hardening Tools and Case Hardening. Ask for Leaflet on improved method.

FLUXITE SOLDERING SET

Simple to use and lasts for years in constant use. Contains special “small-space” soldering iron with non-heating metal handle; pocket blow-lamp, Fluxite, Solder etc, and full instructions.

COMPLETE 7/6, or LAMP only 2/6

FLUXITE LTD.,
(Dept. 32)
ROTHERMITHIE, S.E.16

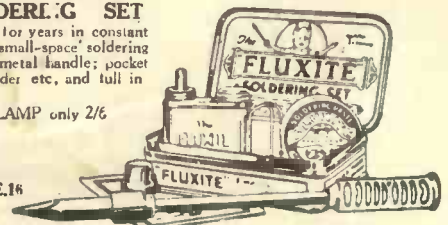

ALL MECHANICS WILL HAVE
FLUXITE
IT SIMPLIFIES ALL SOLDERING



PRECISION CONDENSERS

for Selectivity

J.B. Precision Instruments have many unique features. They are scientifically designed—they are the work of practical radio engineers.

Rigid in construction and built of the finest material, nothing is left to chance in J.B. Precision Condensers.

J.B. Precision ensures accuracy of workmanship. J.B. design cuts away all surplus material without in any way impairing strength. The two together combine to give you increased selectivity, louder signals on weak transmissions and condensers of which the calibration will never vary.

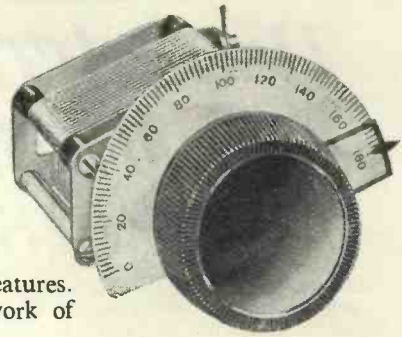

J.B. TINY CONDENSER

.0005	- - -	10/-
.0003	- - -	9/6
.0002	- - -	9/-
.0001	- - -	8/6

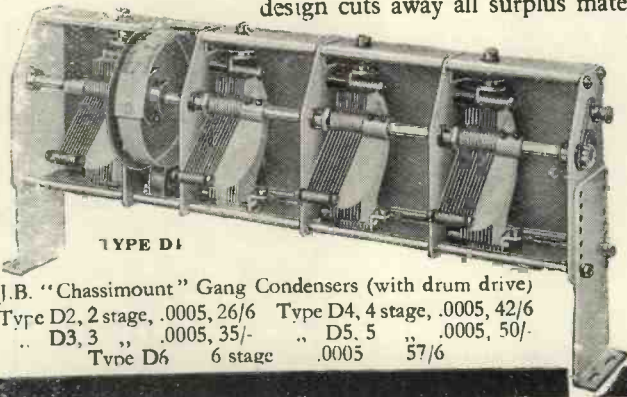

TYPE D1

J.B. "Chassimount" Gang Condensers (with drum drive)
 Type D2, 2 stage, .0005, 26/6 Type D4, 4 stage, .0005, 42/6
 " D3, 3 " .0005, 35/- " D5, 5 " .0005, 50/-
 Type D6 6 stage .0005 57/6



PRECISION

INSTRUMENTS

Advertisement of Jackson Bros., 72 St. Thomas Street, London S.E.1.

Telephone: HOB 1827.

THE BEST POSSIBLE REPRODUCTION FROM YOUR SPEAKER.

THE VIBRANTI BAFFLE

THIS IS ASSURED IF YOU USE—

SUPPLIED IN SIX ATTRACTIVE FINISHES:—

OAK	9/6 each	OXIDISED SILVER ...	10/6 each
MAHOGANY ...	9/6 "	OXIDISED COPPER STUCCO	11/6 "
OXIDISED COPPER	10/6 "	OXIDISED SILVER STUCCO	11/3 "

SCREEN FITTINGS:

Comprising Two Floor Supports and One Handle.

OXIDISED COPPER	5/3 set
OXIDISED SILVER	6/6 set

100% EFFICIENCY

BUILD THIS NEW SUPER SET AND SPEAKER OF 1931.

Details appear in this issue of W.M.

SIZE OF BAFFLE, 24" x 24" x 3/8"
 CENTRE OPENING, 9 1/2" or 12" Diameter

FROM RADIO DEALERS or in case of difficulty write:

CHARLES BORST & SONS
 308, EUSTON ROAD, LONDON, N.W.1



Rear View

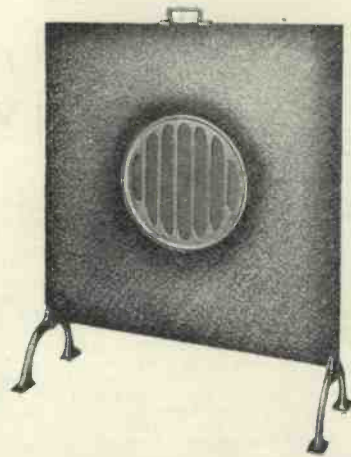

Front View

Please mention "Wireless Magazine" when corresponding with advertisers

Broadcast Identification Sheets

For the benefit of readers we are publishing each month a series of panels specially compiled for the WIRELESS MAGAZINE by Jay Coote.

In these, readers will find a ready means of identifying foreign stations. To prevent any confusion in a.m. and p.m., the times are given on the Continental twenty-four-hour system. Example: 8 a.m. = 8.00; 8 p.m. = 20.00.

In the event of alterations in wavelength, power or call, a special panel bearing the alteration will be published at the earliest opportunity.

These identification sheets should be cut out and filed either alphabetically or in order of wavelength as they appear.

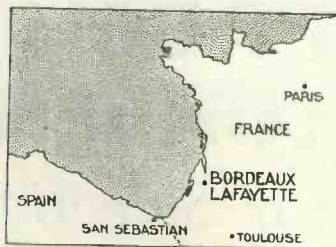

462 miles from London

304m.
(986 kc.)

Power: 35 kw.

BORDEAUX-LAFAYETTE
(France)

Standard Time: Greenwich Mean Time.

Announcer: Man.

Call: *Allo! Allo! Ici la station du reseau d'Etat Francais de radiodiffusion des Postes et Telegraphes de Bordeaux-Lafayette*, abbreviated during intervals to *Ici Bordeaux Lafayette PTT*.
No special interval signal.

Main Daily Programme: G.M.T. 12.40, concert; 20.00, children's hour, talk, etc.; 20.30, main evening entertainment. Frequently relays Ecole Supérieure (FPTT Paris).
Closes down with usual French good night, followed by *La Marseillaise*.

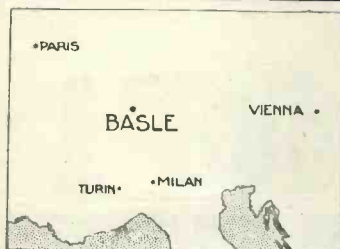

440 miles from London

(Revised)

319m.
(941 kc.)

Power: .5 kw.

BASLE
(Switzerland)

Standard Time: Central European (G.M.T. plus one hour).

Announcer: Man.

Call: *Hallo! Hallo! Radio Basel* (phonetic: Bar-zel).

No special interval signal.

All announcements are made in German, except when Berne is relayed, when French is also heard. Also occasionally relays Zurich broadcasts.

Main Daily Programme: G.M.T. 08.00 (Sunday), sacred service; 11.30, time signal, weather, concert; 16.00, outside broadcast; 19.00, main evening entertainment; 21.10, relay of concert from Hotel Metropole; dance music (Saturdays).

Good Night: *Gute nacht, meine Damen und Herren*.



802 miles from London

424m.
(707 kc.)

Power: 2 kw.

MADRID
(EAJ7)
(Spain)

Standard Time: Greenwich Mean Time.

Announcer: Man.

Call (phonetic): *Ay-ah-rhola-see-yet-tay* (EAJ7) *Oo-nee-own Rah-dee-owe Madrid*.
Transmissions open with a short melody (Siegfried's Bugle Call from Wagner's opera) played on piano.

Main Daily Programme: G.M.T. 11.30 (Sunday), outside broadcast; 19.00, dance music; 21.30, main evening entertainment: dance music or relay of concert or opera (Thursday, Friday, and Saturday).

Time Signal and Chimes: (four notes, rising) relayed from Home Office buildings at 13.00, 19.00, 21.30, and 24.00.
Also relays Barcelona (EAJ1).

Good Night: *Buenas Noches, Senores, hasta manana* (till to-morrow), followed by Spanish National Anthem.



760 miles from London

(Revised)

516.3m.
(581 kc.)

Power: 20 kw.

VIENNA
(Austria)

Standard Time: Central European (G.M.T. plus one hour).

Announcer: Man.

Call: *Hallo! Hallo! Radio Wien* (phonetic: Veen).

Opening Signal: Morse V (. . . —).

Interval Signal: Fast-beating metronome (265 per minute).

(NOTE.—If the beats are given in groups of, say, 2, 3, 4, or 5, they indicate the number of minutes to elapse before broadcast is resumed).

Main Daily Programme: G.M.T. 09.20 (Sunday), organ recital, concert; 12.00, gramophone records, then continuous until 19.30, main evening entertainment; 22.00, late concert or dance music.

Good Night: *Gute Nacht, meine Damen; Gute Nacht, meine Herren. Ich wuensche allseits recht angenehme Ruhe. Vergessen sie nicht Ihre Antenne Zu erden und die Gashaehne in Threr Wohnung Zu Schliessen*. Usually closes down with the morse signal, SK (. . . — . . . —).
When international concerts are broadcast all announcements are made in both German and French.



712 miles from London

(Revised)

1,060m.
(283 kc.)

Power: 75 kw.

OSLO
(Norway)

Standard Time: Central European (G.M.T. plus one hour).

Announcer: Man.

Call: *Hallo! Oslo her* (phonetic: Ou-zlo).

Opening and Closing Signal: Musical box playing first four bars of National Anthem (*Ja vi elsker*).

Main Daily Programme: G.M.T. 09.20 (Sunday), carillon-sacred service; 11.55, time signal, gramophone records; 16.00, concert or relay; 18.30, talks, etc.; 19.00, time signal; 19.30, main evening entertainment; 22.00, dance music (Wednesday, Saturday, and Sunday). Sometimes relays foreign transmissions.

Good Night: *God nat* (twice).

Relays: Stavanger, 235.5 m. (1,275 kc.); Kristiansand, 240.6 m. (1,247 kc.); Fredriksstad, 368 m. (815 kc.); Notodden, Rjukan, 445 m. (674 kc.); Nidaros, Tromsø, Aalesund and Porsgrund, 453 m. (622 kc.); Hamar, 587 m. (511 kc.).

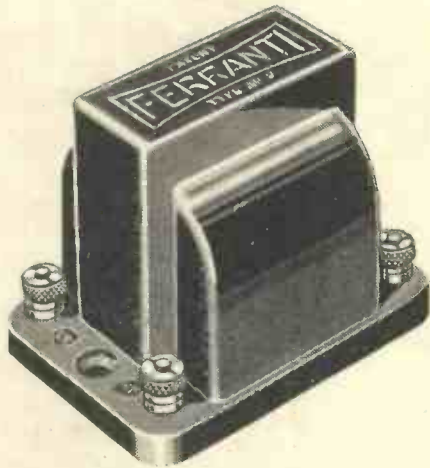

NOW—!
A GOOD
TRANSFORMER
FOR 11'6!

TYPE AF8. RATIO 1:3.5

FERRANTI

FERRANTI LTD. HEAD OFFICE & WORKS: HOLLINWOOD, LANCs. LONDON: BUSH HOUSE, ALDWYCH, W.C.2.

Edison Bell

COMPONENTS

Give Satisfaction

**The Latest
Scratch Filter and Volume
Control**



A device for incorporation in pick-up circuits rendering possible smooth and efficient control of volume and embodying a filter circuit for the elimination of scratch and surface noise.

Cat. No. 441

Price 15/6

**Resistance Capacity
Coupling Unit**

Recommended for use in the new "WIRELESS MAGAZINE" DUAL SCREEN FIVE SET

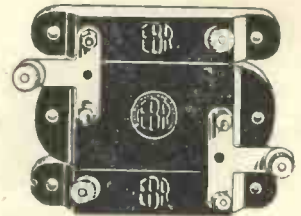

Price 4/3

Cat. No. 380

FIT EDISON BELL COMPONENTS and YOU WILL NOT BE LET DOWN

Send for Wireless Catalogue

EDISON BELL, LIMITED, 62 Glengall Road, LONDON, S.E.15 and HUNTINGDON

When replying to advertisements, please mention "Wireless Magazine"

HEGRA for TONE

Type
"V"
£3-5-0

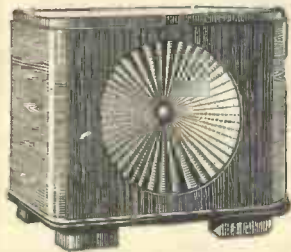
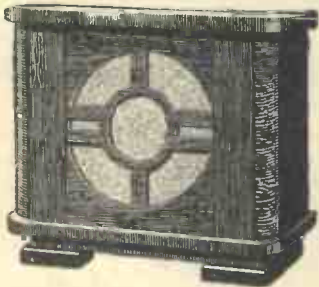

Type
"T"
£2-12-0



The Magnet
Dynamic complete
chassis
56/-

All these Hegra speakers have a triple lead giving various impedance values according to the type of output valve used. They give perfect reproduction—Hegra speakers are famous for their tone.



If you have any difficulty, write to—
GEO. BECKER, LTD.
Grafton Street, Tottenham Court Road, W.1

m.c.23

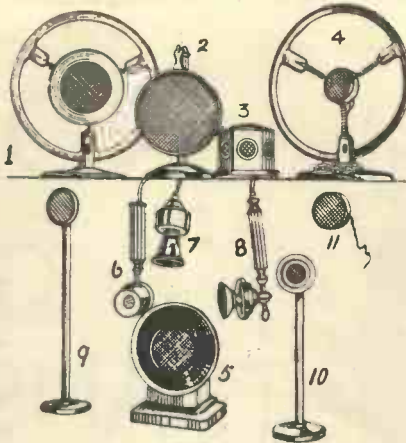

ELECTRADIX MICROPHONES For Home Recording

It is impossible to make successful records at home unless a really sensitive "Mike" is used.

We have supplied thousands of Microphones during the past ten years for Wireless Transmission and Voice Amplification. These are still giving good service because they are robustly made. Fragile, flimsy cased tin-tid Mikes soon fail. We have Mikes for every purpose from Pocket Voice Amplifier to Public Address Stand Models.

AND OUR PRICES ARE RIGHT!
You will find our Microphones remarkably cheap and efficient for all purposes. We have all types from 1/- to £20, and illustrate a few. Prices: No. 11 (Single) 4/6; No. 7 (Special Panel) 12/6; No. 10 (Pulpit) 12/6; No. 3 (Hand) 15/-; No. 4 (Pedestal) 17/-; No. 3 (Table Multi.) 50/-; Nos. 1 or 5 (Announcer's P.A.) 65/-

Send addressed envelope for our new Sale Bargain List of everything radio and electrical.

ELECTRADIX RADIOS,
213 Upper Thames Street, London, E.C.4. (City 0191)

WHICH SWITCH ?

Which switch have you been in the habit of using? See that your new set includes a "Gripso"—the inexpensive switch with fool-proof contacts. The technical experts of the WIRELESS MAGAZINE use them constantly. Below are four new receivers described in this issue using GRIPSO SWITCHES.

FIVE-POINT TWO

One 2-point switch marked "on" and "off," 1s. 9d. One 2-point switch marked "long" and "short," 1s. 9d.

FIVE-POINT THREE

One 2-point switch marked "on" and "off," 1s. 9d. One 2-point switch marked "long" and "short," 1s. 9d.

FIVE-POINT FOUR

One 2-point switch marked "on" and "off," 1s. 9d. One 3-point direct switch marked "long" and "short," 2s. 0d.

FIVE-POINT SHORT-WAVER

One 2-point switch marked "on" and "off," 1s. 9d.

GRIPSO SWITCHES

Obtainable of all good radio dealers. If you have any difficulty in obtaining, write to sole makers.

Illustrated list sent FREE on request.
THE GRIPSO COY., 32 Victoria Street, London, S.W.1

ELEX

SPADES, PINS, HOOKS & EYES
6 Colours, 2d. each

Write for List P 82
J. EASTICK & SON,
118, Bunhill Row London, E.C.1

FRANKLIN

**MOULDED CASE CONDENSERS
FULLY GUARANTEED**

Make a neater job of your next circuit. Put in these new Franklin Condensers. See the splendid finish of their brown moulded cases, note the hermetic sealing which makes them proof against leakage, loss or shorting dangers and remember the

FULL 6 MONTHS' GUARANTEE!

*Any Franklin Condenser, developing any fault whatever, will be replaced free within 6 months of purchase.

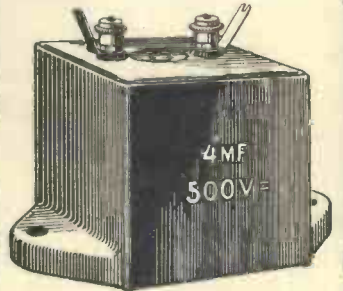

PRICES:

Tested at 500 v. D.C. Working Voltage	Tested at 1,500 v. D.C. Working Voltage
240 v. D.C. or 160 v. A.C.	700 v. D.C. or 500 v. A.C.
1 mfd. 1/8	1 mfd. 2/3
2 " 1/2	2 " 2/3
3 " 2	3 " 2/3
4 " 2	4 " 2/3
5 " 2	5 " 2/3
6 " 2	6 " 2/3
7 " 2	7 " 2/3
8 " 2	8 " 2/3
9 " 2	9 " 2/3
10 " 2	10 " 2/3
11 " 2	11 " 2/3
12 " 2	12 " 2/3
13 " 2	13 " 2/3
14 " 2	14 " 2/3
15 " 2	15 " 2/3
16 " 2	16 " 2/3
17 " 2	17 " 2/3
18 " 2	18 " 2/3
19 " 2	19 " 2/3
20 " 2	20 " 2/3

A recent testimonial received by us says they are "truly wonderful."

Please apply for detailed price list.
FRANKLIN ELECTRIC CO. LTD., 187-189, Ilford Lane, ILFORD, Essex. Phone: Ilford 0281

LET RADIO EXPERTS BUILD YOUR SET

Sets described by WIRELESS MAGAZINE and other receivers are scientifically constructed to specification without delay. Accuracy in



every detail is a great point of our service and another great point to remember is that our prices are very moderate considering the high standard of craftsmanship. We will also mod. raise, repair or overhaul your present receiver. Scott Sessions and Company, the Leading R. & Co. Doctors of Great Britain, will diagnose your most intricate radio trouble and offer you the simplest and most inexpensive solution.

Write for list giving price for building the following sets described in this issue—
"The Balfour 8," "Brookmans A.C. 2," "Supertone 4," "Hyperdyne Short-wave adaptor," Also the 12 W.M. Sets described in the supplement.

G. S. OTT, SCOTTIONS & CO., Muswell Hill, London, N.10. (Phone: Tudor 5326)

"HOW TO GET REALISTIC REPRODUCTION"

WRITE NOW for our new FREE 32-PAGE BOOK. It will tell you how—TO GET TO-DAY!



BAKER'S
"Selhurst"
RADIO
89 Selhurst Rd.,
S.E. Norwood, S.E.25



Spec fied by the designers of the
 "5-POINT SHORT-WAVER"

described on page Twelve
 of supplement.



"ASTRA" Type No. 2.
 "Astra" are the only dials
 manufactured under
 Ormond licence.

"ASTRA"
 DIAL NO. 2

The marvellous geared
 movement of the
 "ASTRA" is a "master-
 piece of precision," and
 enables really accurate
 adjustments to be ob-
 tained.

No backlash. Noiseless
 action. Both slow motion
 and direct drive are avail-
 able. The "Astra" is
 adjustable to fit any con-
 denser spindle and is easily
 mounted. Finish: Black or
 brown moulding with
 aluminium scale or all
 black.

"ASTRA" Type No. 2.
 Diameter, 4 in. Price 5/-

"ASTRA" Type No. 1.
 3 in. diameter. Finish:
 Black or brown moulding
 with aluminium scale or
 brown with gilt scale. 3/6

Send for Free Illustrated Catalogue of "Astra" Dials
 and Condensers, also details of "ASTRALITE,"
 the Luminous Dial.

EMKABE RADIO CO., LTD. 47 FARRINGTON RD.,
 LONDON, E.C.1

SPEAKERS
 THAT TELL
 THE TRUTH!



The Colassion Super loud-
 speakers are the result
 of several years of extensive investigation and ex-
 periment, carried out for the purpose of pro-
 ducing a loud-speaker with a reproduction better
 than a moving-coil at a reasonable price. Four
 models have been produced, the Colassion Junior,
 Colassion Super, Colassion Hyper Chassis and
 Colassion Hyper Cabinet. These instruments will
 give beautiful reproduction on two valves and
 will also take the power from the largest sets or
 the most powerful amplifiers, without the
 slightest trace of overloading. The Prices,
 considering the quality of reproduction are very
 low—

Colassion Junior, £5. Colassion Super Cabinet, £7. 10. 0
 Hyper Chassis, £5. Hyper Cabinet, £10. with rollers.



£7 10 0

COLASSION
 Super Loud-speakers

TO HEAR IS TO BELIEVE

Call and hear these instruments for
 yourself. We feel sure a demon-
 stration will convince you that you
 cannot buy a better speaker at any
 price. Further details and copies of
 testimonials of hundreds of our satis-
 fied customers sent free on request.

W. L. COLASSI
 Mark Lane Station Buildings, E.C.

Better service results from mentioning "Wireless Magazine" when writing to advertisers

SPECIFIED
 FOR
 "Wireless Magazine"
 CIRCUITS

NEW BROOKMAN'S THREE

One pair of Wearite 1930 Binowave Coils,
 types A and B, with ganging
 device. Price £1.17.0
 With Wearite 15-ohm variable
 resistance. Price 1s. 6d.

REGIONAL A.C. FOUR

One pair of Wearite 1930 Binowave Coils,
 types C and E, with ganging
 device. Price £1.17.0

JAMES PORTABLE S.G.3

One Wearite 3-pole, 3-way
 switch. Price 7s. 0d.

FIVE-POINT SHORT-WAVER

One Wearite 400-ohm variable resistance,
 type Q.14, with grid-leak
 clips. Price 3s. 0d.

REGIONAL BAND-PASS
 FOUR

One pair of Wearite 1930 Binowave Coils,
 types C and E, with ganging
 device. Price £1.17.0
 One Wearite 15-ohm rheostat.
 Price 1s. 6d.

FOR BETTER RADIO
 ALWAYS USE

WEARITE
 COMPONENTS

Send for Complete Illustrated Catalogue, post free.

WRIGHT & WEAIRE, LTD.
 740 High Road, London, N.17

Phone: Tottenham 3847-8-9. Write for Free Illustrated List

WAVELENGTHS OF THE WORLD'S BROADCASTERS

Wave-length	Name of Station	Dial Readings	Country	Wave-length	Name of Station	Dial Readings	Country
19.6	Schenectady (W2XAD) ...		United States	312	Wilno ...		Poland
19.72	Pittsburgh East (W8XK)		United States		Bremen ...		Germany
25.4	Rome ...		Italy	316	Natan-Vitus ...		France
25.3	Pittsburgh East (W8XK)		United States		Marselles (PTT) ...		France
25.53	Chelmsford (G5SW)		Great Britain	318	Dresden ...		Germany
31.28	Eindhoven ...		Holland	310	Basle ...		Switzerland
31.38	Zeesen ...		Germany	320	Liebon ...		Portugal
31.5	Schenectady (W2XAF) ...		United States	322	Göteborg ...		Sweden
	Lyngby ...		Denmark	325	Breslau ...		Germany
32.5	Paris, Eiffel Tower (FL)		France	328	Grenoble ...		France
32.58	Sydney (2BL)		Australia	329	Poste Parisian ...		France
41	Radio Vitus ...		France	332	Naples ...		Italy
43	Madrid ...		Spain	338	Poznan ...		Poland
49.7	New York (W2XA1)		United States		Velthem (Louvain)		Belgium
50	Barcelona ...		Spain	342	Brunn ...		Czecho-Slovakia
58	Prague ...		Czecho-Slovakia	345.2	Strasbourg		France
80	Rome ...		Italy	349	Barcelona (EAJ1)		Spain
172	St. Quentin ...		France	352	Graz ...		Austria
200	Leeds (2LS)		Great Britain	358	London Regional ...		Great Britain
	Radio Roubaix ...		France	360	Mühlacher ...		Germany
206	Antwerp ...		Belgium		Algiers ...		North Africa
210	Verviers ...		Belgium	364	Frederikstad ...		Norway
216	Budapest ...		Hungary		Seville (EAJ5)		Spain
217	Chintelneau ...		Belgium	368	Hanburg ...		Germany
218	Konigsberg ...		Germany	372	Manchester (2ZY)		Great Britain
	Flensburg ...		Germany	376	Radio Toulouse ...		France
221	Salzburg ...		Austria	385	Frankfurt ...		Roumania
221	Helsinki ...		Finland	390	Bucharest ...		Great Britain
223	Fécamp ...		France	394	Glasgow (5SC)		Switzerland
224	Cork (IFS)		Irish Free State	399	Berne ...		Poland
227	Cologne ...		Germany	403	Kattowitz ...		Irish Free State
230	Malina ...		Sweden	409	Dublin (2RN)		North Africa
232	Kiel ...		Germany	418	Radio Maroc ...		Germany
234	Lodz ...		Poland	418	Berlin ...		Spain
235	Nimes ...		France	424	Madrid (EAJ7)		Jugoslavia
239	Stavanger ...		Norway	431	Belgrade ...		Sweden
	Nürnberg ...		Germany	436	Stockholm ...		Italy
	Beziere ...		France	441	Rome ...		France
240	Kristianssand ...		Norway	447	Paris (Ecole Sup. PTT)		Italy
	Oporto ...		Portugal		Bolzano (IBZ)		Austria
242	Belfast (2BB)		Ireland	453	Klagenfurt ...		Norway
243	Courtrai ...		France		Nidros ...		Germany
244	Schaerbeek ...		Belgium		Danzig ...		Switzerland
244.7	Cracow ...		Poland	459	Zurich ...		Spain
246	Ghent ...		Belgium	460	San Sebastian ...		France
246	Cassel ...		Germany	466	Lyon-la-Doua ...		Germany
248	Linz ...		Austria	473	Langenberg ...		Great Britain
248	Juan-les-Pins ...		France	479	Midland Regional ...		Czecho-Slovakia
251	Barcelona ...		Spain	487	Prague ...		Italy
253	Leipzig ...		Germany	501	Milan ...		Belgium
256	Toulouse (PTT)		France	509	Brussels (No. 1) ...		Austria
257	Hörsby ...		Sweden	516	Riga ...		Latvia
259	Gleiwitz ...		Germany	525	Munich ...		Germany
261	London National		Great Britain	533	Sundsvall ...		Sweden
263	Moravska-Ostrava		Czecho-Slovakia	542	Budapest ...		Hungary
265	Lille (PTT)		France	550	Kaiserlautern ...		Germany
266	Barcelona (EAJ13)		Spain	560	Hanover ...		Germany
270	Augsberg ...		Germany	566	Freiburg ...		Germany
272	Rennes ...		France	570	Ljubljana ...		Yugoslavia
276	Heilsberg ...		Germany	574	Lausanne ...		Switzerland
279	Bratislava ...		Czecho-Slovakia	790	Moscow ...		Russia
281	Copenhagen ...		Denmark	760	Geneva ...		Switzerland
	Innsbruck ...		Austria	770	Ostersund ...		Sweden
	Magdeburg ...		Germany	800	Kiev ...		Russia
283	Stettin ...		Germany	824	Sverdlovsk ...		Russia
	Berlin ...		Germany	1,000	Leningrad ...		Russia
286	Radio Lyons		France	1,060	Oslo ...		Norway
	Montpellier ...		France	1,071	Scheveningen-Haven		Holland
	Swansea (58X)		Great Britain	1,153	Kalundborg ...		Denmark
	Stoke-on-Trent (68T)		"	1,200	Reykjavik ...		Iceland
	Sheffield (6LF)		"	1,216	Stamboul ...		Turkey
	Plymouth (5PY)		"	1,250	Boden ...		Sweden
288.5	Liverpool (6LV)		"	1,304	Tunis Kasbah ...		North Africa
	Hull (6KH)		"	1,348	Moscow Stchelkovo ...		Russia
	Edinburgh (2EH)		"	1,380	Motala ...		Sweden
	Dundee (2DE)		"	1,411	Bakou ...		Russia
	Bournemouth (6BM)		"	1,446	Warsaw ...		Poland
	Bradford (2LS)		"	1,481	Eiffel Tower, Paris		France
	Newcastle (5NO)		"	1,554	Moscow (Kom)		Russia
291	Vilpuri ...		Finland	1,635	Midland National		Great Britain
294	Kosice ...		Czecho-Slovakia	1,635	Norddeich ...		Germany
295	Liège ...		Belgium	1,635	Zeesen ...		Germany
296	Reval ...		Estonia	1,725	Radio Paris ...		France
	Limoges ...		France	1,796	Lahli ...		Finland
	Turin ...		Italy	1,875	Hilversum ...		Holland
299	Huizen ...		Holland	1,935	Kaunas ...		Lithuania
	Radio Idzerda ...		Holland	1,961	Ankara ...		Turkey
301	Aberdeen (2BD)		Great Britain				
302	Falun ...		Sweden				
304	Bordeaux (PTT)		France				
306	Zagreb (Agram)		Jugoslavia				
310	Cardiff (5WA)		Great Britain				
312	Genoa ...		Italy				

A special article on identifying German broadcasts appears on page 108; on page 60 there is a description of the first German regional station—Mühlacher.

The perfected jelly acid battery . . .

in the Gel-cel Exide have overcome all the defects of jelly acid batteries.

The Exide Gel-cel compares in efficiency with the best liquid acid



JZ4
2 volt, 40 amp. hrs - 18/6
Other sizes and types available.

batteries and yet is absolutely unspillable and leak-proof. Note its construction. Moulded case

— no seams to leak. Double bottom for greater strength. Improved acid trap for extra safety.

Exide Long Life Plates. For Portables always

insist on the **Exide Gel-cel**

For hungry sets

the Exide "C" Series Battery for low tension.

The battery for big current demands. Famous

Exide Long Life Plates that give generously

without failure or flinching. Patented separators

that preserve the plates and prevent shorting.

Non-interchangeable and differently shaped

terminals that can be recognised even in the

dark. Available in transparent leak-proof cellu-

loid or glass containers. The **Exide "C" Battery**

From Exide Service Stations and all reputable dealers. Exide Service Stations give service on every make of battery

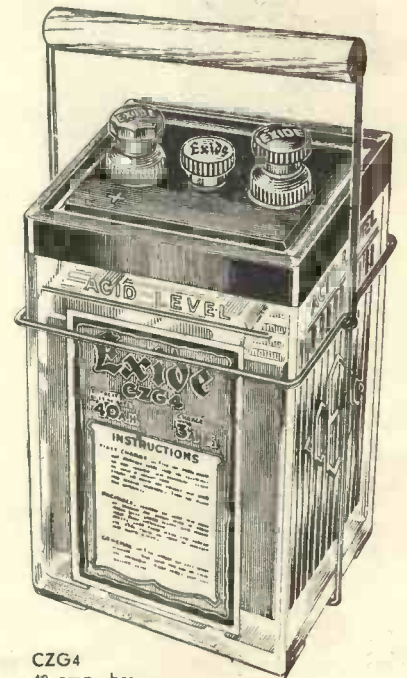

CZG4
40 amp. hrs.
19/- per 2 volt cell.
Ask for Catalogue "W" for other types.

Exide Batteries, Clifton Junction, near Manchester. Branches at: London Manchester, Birmingham, Bristol and Glasgow

L.62

Speedy replies result from mentioning "Wireless Magazine"

EPOCH

16,500 LINES!

N.P.L. test of the Model 101 (Domino) shows the Domino to have a flux density of 16,500 per sq. cm. **WITHIN** the air gap (about 20,000 to 35,000 lines per sq. cm. according to old methods of measurements).

A RECORD for a speaker made expressly for Home use.

The enormous achievement will be appreciated when it is realised that the average moving coil Speaker, including so-called "supers," generally measures between 3,000 and 8,000 lines per sq. cm. by the same method of measurement.



WHAT DOES THIS MEAN?

- (1) 4 to 33 times the sensitivity of an ordinary Moving Coil Speaker.
- (2) Equivalent to adding one or two distortionless stages to the set.
- (3) Power, more than sufficient from a modest set.

QUALITY?— EPOCH

Prices from £6.15.0

EPOCH RANGE OF PERMANENT MAGNET AND ENERGISED FIELD MOVING COIL SPEAKERS are the finest and most advanced in the world. Models for every requirement from the tiny portable to the giant Cinema Speakers as used in 600 cinemas,

New Edition Booklet MS4a now ready—it is free for the asking

EPOCH RADIO MANUFACTURING CO. LTD.,
FARRINGDON AVENUE, LONDON, E.C.4

"CONFIDENTLY RECOMMENDED"

AFTER EXHAUSTIVE TEST BY "WIRELESS MAGAZINE" EXPERT TECHNICAL ENGINEER.

What finer Testimony could there be?

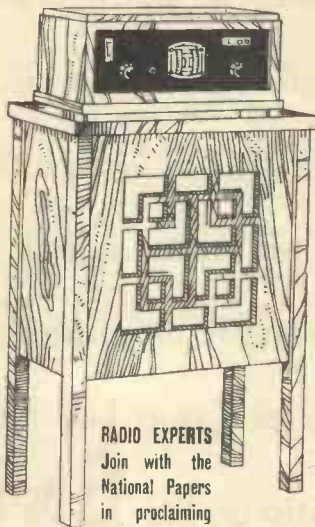

RADIO EXPERTS
Join with the
National Papers
in proclaiming
this fine set to be

THE LEADER OF THE 4-VALVE CLASS



"All Electric 4" Set complete. 4 valve S.G. receiver (as illustrated on top of cabinet speaker) in handsome polished walnut case ready for reception. Provided with pick-up sockets. Price £25 or £24.8 first payment.

All Electric Set with Pedestal Cabinet Loud Speaker Complete (as illustrated), incorporating the the Wates 20 in. Double Cone Chassis and Wates Star Unit. A handsome piece with remarkable tonal quality and volume. Price £31.8.0 or £2.15.8 first payment.

All Electric Radio-Gram. Paillard Electric turntable motor. Wates Double Cone Speaker, Unit and Pick-up and Wates A.C. all mains 4 receiver and amplifier. A superb instrument. Mahogany £51.10.0 or £41.1.8 first payment. Walnut, £54.10.0. Oak, £50.

Hear it demonstrated. Your dealer can supply.

Guaranteed for twelve months by:

The Standard Battery Co.

(Dept. W.M.), 184/188 SHAFTESBURY AVENUE LONDON, W.C.2

M.B.

-SOLVE ALL H.T. TROUBLES

Per doz.	No. 1.	No. 2.
	s. d.	s. d.
Jars (waxed) ..	1 3	1 6
Sacs ..	1 2	1 9
Zincs ..	10	11
Rubber Bands (24) ..	4	4
Terminals ..	8	10

Trade Supplied



LONG LIFE : SILENT : ECONOMICAL

Sample doz. (18 volts), complete with bands and electrolyte. No. 1, 4/1; No. 2, 5/-; post 9d., terminals extra. No. 3, with terminals, 7/6 (10,000 milliamperes). Sample unit, 6d. Orders 10/- carr. paid. New illustrated catalogue post free.

FREE. Bargain List of Receivers, Amplifiers & Components.

B. TAYLOR, 57 Studley Road, Stockwell, London



ROTOR OHM

for

QUALITY

Over 2 1/2 million Rotor-ohms are in use to-day. Used by the most discriminate constructor and are to be found in the very finest sets. They are suitable for all circuits and purposes where a control is necessary, therefore refuse substitutes and insist on Rotor-ohm. "A whisper to deafening volume" with one turn of the knob. In all capacities **6/-**. To pay less is false economy—to pay more is sheer extravagance.



ROTOR ELECTRIC LTD.
2-3 Upper Rathbone Place, London, W.1

AMAZINGLY SELECTIVE

This is the key-note of the wonderful "1931 ETHER SEARCHER" which is so selective and powerful that 50 stations can be received without any overlapping.

From the FULL-SIZE WIRING DIAGRAM and constructional details contained in AMATEUR WIRELESS dated January 17th, anyone can build this easy and cheap set,

As it will be the most-talked-of Set of the Season, you should make a point of reading all about it in

AMATEUR WIRELESS

dated January 17th

Obtainable from any Newsagent or Book-seller. **3d.**

Speedy replies result from mentioning "Wireless Magazine"

A Perfect Combination of British and American Radio Engineering Genius

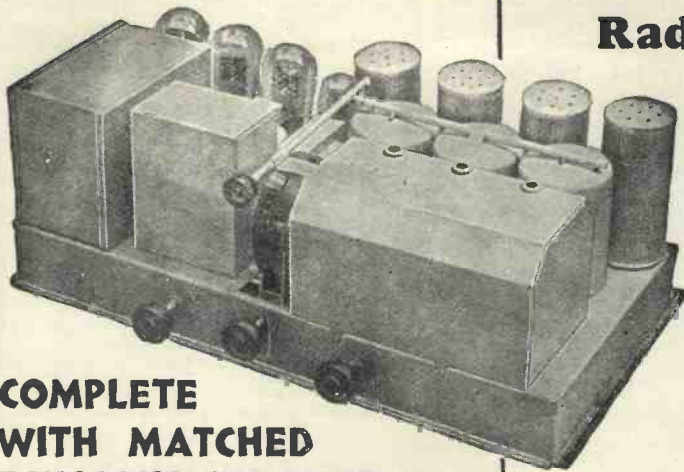

COMPLETE WITH MATCHED DYNAMIC SPEAKER AND VALVES

Peerless A.C. Screen Grid 8

3-Screen Grid Radio Frequency. Power Detector. Power Output. Oversized Volume Pack Dynamic Speaker Reproduction. Complete Wavelength Range (200-2,000 metres). Marvellous Selectivity, Sensitivity and Tone. Completely Shielded and A.C. Operated. Illuminated Drum Dial Tuning. Noiseless Volume Control.

The New Peerless Screen-Grid Eight is undoubtedly the finest value in A.C. operated radio sets. The design and performance of the Peerless is unchallenged and embodies improvements which are years in advance of all other types of radio receivers. Consider the following outstanding merits of the Peerless Eight and consider the marvellous value which we offer to our customers. A big demand is being created by national advertising. Write to-day for full particulars.

£36

Royalty £2 net. 110-volt or 220-240-volt 50 cy. A.C.

The **Rothermel Corporation Ltd.**
24 MADDOX ST., LONDON, W.1
 Phone: Mayfair 0578/9

Continental Sales Office: 27 QUAY DU COMMERCE, BRUSSELS, BELGIUM

H & B

Hyperdyne Short-wave Adaptor

	£	s.	d.
1 Bulgin H.F. Choke, type HF3	3	0	0
2 Lewcos 6-pin Short-wave Coils, AMS2	12	0	0
1 T.C.C. Fixed Condenser, .0003 flat	1	3	0
2 Formo Variable, .00035 mfd.	9	0	0
1 Formo Variable, .0002 mfd., Midget type	2	9	0
1 Formo Pre-set, .0001 mfd. max.	1	6	0
2 Ormond Slow Motion Dials, R/320B	7	0	0
1 Trelleborg, 10 in. by 7 in. Panel	3	6	0
2 H. & B. Coil-holders	3	0	0
2 Lotus Valve-holders	2	0	0
1 Lissen 15-ohm Rheostat	2	6	0
Glazite Wire	0	6	0
1 Ebonite Knob	0	6	0
1 Baseboard, 10 in. square	1	3	0
1 H. & B. Four-way Multiple Cable Plug	2	0	0
1 Terminal Strip, 1½ in. square	0	3	0
1 Ever Ready 9-volt Grid Bias	1	3	0
1 Belling-Lee Aerial Terminal	4	½	0
3 Belling-Lee Wander Plugs, G.B., G.B.+ , H.T.+	0	9	0

CASH PRICE £2 14 4½

NOTE.—We supply Kits for any set described in "A.W.", "W.M.", etc. Any Kit built to your specification. Prices on application.

For the convenience of "Wireless Magazine" readers, we have specially compiled a 12-page folder giving complete details of the sets described in the supplement given with this issue. This folder gives full details of the components, prices, of all the twelve sets and units.

H. & B. Kits contain all necessary wire and screws. H. & B. Kits have the panels and strips ready drilled.

H. & B. Kits are sent complete in every detail. H. & B. Kits contain full-size blueprints. H. & B. Kits are sent always carriage paid.

Cut this address out and paste it on your envelope. It will save you:

H & B RADIO CO.,
34, 36, 38 BEAK STREET,
LONDON, W.1.

KIT for the "BROOKMAN'S A.C. TWO"

	£	s.	d.
1 R.I. Hypercore L.F. Choke	17	6	0
1 Wearite 1930 Binowave Coil type C	17	0	0
1 T.C.C. .0001-mfd. Fixed Condenser, upright type	1	6	0
1 T.C.C. .0005-mfd. Fixed Condenser, upright type	1	6	0
1 T.C.C. 1-mfd. Fixed Condenser, type 80	3	9	0
2 T.C.C. 2-mfd. Fixed Condensers, type 80	10	0	0
2 T.C.C. 4-mfd. Fixed Condensers, type 80	17	0	0
1 Burton .0002-mfd. Variable Condenser	4	0	0
1 Utility .0005-mfd. Variable Condenser, with drum dial	14	0	0
1 Ebonite Panel, 12 in. by 8 in.	4	0	0
1 Belling-Lee Terminal Block .002-mfd. max. type W. Variable Condenser, Formo	0	8	0
2 Telsan Five-pin Valve-holders	2	0	0
1 Telsan Four-pin Valve-holder	1	3	0
1 Bulgin Mains Plug	1	6	0
1 Dubilier 25-meg. Fixed Resistance	1	9	0
1 Magnum 1,500-ohm Spaghetti Fixed Resistance	1	6	0
1 Magnum 10,000-ohm Spaghetti Fixed Resistance	1	6	0
1 Clarostat 1,200-ohm type FW1200	2	9	0
1 Clarostat, 30-ohm Potentiometer Variable Resistance	2	9	0
1 H. & B. Panel Bracket	1	3	0
1 Bulgin Twin Fuse-holder, with fuses	2	6	0
1 Bulgin Mains Switch, type 728	2	3	0
2 Belling-Lee Terminals, Aerial, Earth	0	6	0
1 Telsan Radio Grand 3-1 L.F. Transformer	12	6	0
1 Heayberd Mains Transformer, type 715	1	8	6
1 Ferranti Output Transformer, type OPM1	1	2	6

CASH PRICE £8 16 8

1 Cabinet in Oak, 35/- extra. Mazda Valves, £2/7/6 extra.

Any kit made up to your specification if desired. Quotations by return.

Carriage Paid on All Orders accompanied by Cash. C.O.D. Charges Paid on orders over £1.

Super-tone Four

	£	s.	d.
1 Telsan H.F. Choke	2	5	0
1 Lewcos Dual-coil Unit, type DCG/2	2	5	0
1 Telsan .0001-mfd. Fixed Condenser	1	0	0
1 Telsan .0002-mfd. Fixed Condenser	1	0	0
2 Telsan 1-mfd. Fixed Condensers	5	0	0
1 Telsan 2-mfd. Fixed Condenser	3	6	0
2 Polar .0005-mfd. Universal Variable Condensers	15	0	0
1 Polar .0003-mfd. Midget	2	9	0
1 Lewwoodens, .0002-mfd., P/M type	2	6	0
2 Polar Drum Dials	17	0	0
1 Trelleborg's Panel, Ebonite	7	0	0
3 Lissen Grid Leak Holders	1	6	0
3 Telsan Valve-holders	3	0	0
1 Junit S.G. Valve-holder	1	9	0
7 Belling-Lee Wander Plugs, G.B., G.B.—1, G.B.—2, H.T.—1, H.T.—2, H.T.—3, H.T.—	1	9	0
2 Belling-Lee Spade Ends, L.T.—, L.T.—	0	9	0
2 Bulgin 600-ohm Resistances	3	0	0
1 Bulgin 20,000, flexible type	1	3	0
2 Lissen 100,000-ohm Grid Leaks	2	0	0
1 Lissen 2-megohm Grid Leak	1	0	0
1 Sovereign 100,000-ohm Potentiometer	4	6	0
1 H. & B. Screen, 7 in. by 6 in.	1	6	0
Glazite Wire for connecting	1	6	0
Length of Lewcodex	0	3	0
4-in. Shielded Cable for S.G. Connection	0	9	0
Anode	0	9	0
1 Pioneer On-off Switch	1	6	0
1 Pioneer Three-point	1	9	0
4 Belling-Lee Terminals, 2 red, 2 black	1	4	0
2 Belling-Lee Terminal Blocks	1	4	0
1-pair Varley Push-pull Transformers	2	10	0
Royalties	3	0	0

CASH PRICE £9 5 8

Cabinet in hand-polished Oak, £2 extra. 4 Valves, Mazda or Mullard, £3 10s. 6d. extra.

To H. & B. Radio, Please send me by return post free one of your leaflets giving full details of the Receivers described in the W.M. supplement.

Name.....

Block Letters

You will get prompt replies by mentioning "Wireless Magazine"

CHEAPER MAINS RADIO



This is the Regentone D.C. combined unit No. 2, price £2 12s. 6d.

THERE is good news for all interested in the operation of radio sets through electric-light mains from the makers of Regentone apparatus, who have just announced a number of new mains units and reduced prices for others that are already on the market.

Most WIRELESS MAGAZINE readers will be familiar with the Regentone high-tension unit for portable sets which incorporates a trickle charger. The original model was type W5 and sells at £5 17s 6d. This still remains available, but from now on there will also be a second model which will be sold at £4 15s.

Three Fixed Tappings

The high-tension output from both units is the same, but whereas the original W5 model had a variable tapping for a screened-grid valve and two fixed tappings, the new W5A unit will have three fixed tappings.

One of these is taken from a potentiometer arrangement for screened-grid valve supply, while the other two tap-

pings are taken through ordinary series resistances. This model also has a trickle charger with tappings for 2-volt and 6-volt accumulators.

For D.C. Mains

Listeners with D.C. mains will be interested in a new D.C. combined unit (No. 2), which is priced at £2 12s. 6d. The output when connected to 220-volt mains is 20 milliamperes at 130 volts. Charging current for an accumulator is obtained by means of an ingenious adaptor, which plugs into the electric-light socket. The lamp usually used for illumination purposes is placed in this adaptor. By this method, while the lamp is being used to light a room, the accumulator is receiving a charging current at—for all practical purposes—no cost.

The value of the charging rate is controlled by the wattage of the lamp used—the higher the wattage of the lamp, the higher being the charging rate. The

usual 60-watt lamp, used in most houses, gives a charging rate of approximately .25 ampere.

A really cheap A.C. high-tension unit for use with ordinary receivers is the revised model W1D, which is now provided with three fixed tappings instead



Revised model W1D, for A.C. mains, price £3 7s. 6d.

of only two. The price of this unit is only £3 7s. 6d., and the output is 18 milliamperes at 120 volts.

Attractive Prices

These new units (at prices which are lower than would be the case if the listener were to construct them himself from component parts bought at ordinary retail prices) will prove attractive to all who want to make their sets as efficient and trouble-free as modern technique makes possible.

Further details and prices can be obtained from the Regent Radio Co. of 21 Bartlett's Buildings, Holborn, E.C.4. This firm also makes a complete all electric four valve set with single tuning control. The price is 30 guineas.



A cheaper combined A.C. unit, the model W5A, at £4 15s.

A PICK-UP WITH VOLUME CONTROL

THREE particularly interesting features of the Blue Spot type 88 pick-up will appeal to many gramophone enthusiasts. Here they are: (1) The pick-up arm incorporates a volume control, (2) the head of the pick-up can be turned for the easy insertion of new needles, and (3) a very well designed fixing template is provided.

Volume Control

As can be seen from the photograph reproduced here, the volume control is mounted at the top of a drum which the carrier is pivoted. Control of input to the amplifier is, therefore, very conveniently obtained. To insert new needles the pick-up head is turned

through 180 degrees to the right, when needles can be inserted from above. The action of tuning the head automatically lifts it clear of the turntable, so

that both hands are left free.

The fixing template is one of the best of its kind we have seen. The position of the holes for the fixing screws can be marked without difficulty.

The price is £3 3s. We should like to see provision made for the use of a counter-balance weight, for the pressure on the record is somewhat heavy.

Cobalt Steel

Cobalt steel is used for the magnet system, while the armature is made of Swedish charcoal iron.

On test bass reproduction was found to be much better than reproduction of the top notes, but the results were not unpleasing. The volume was good.

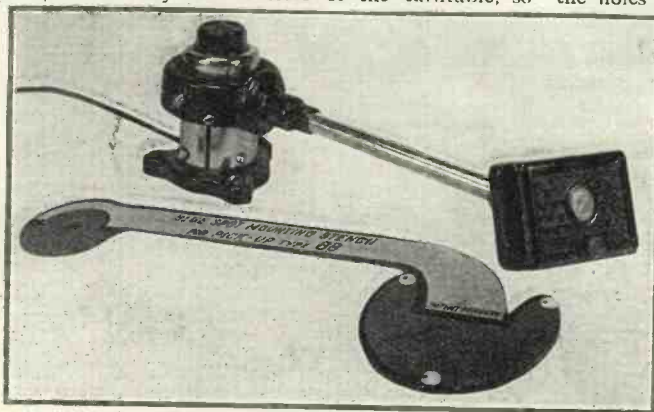

The Blue Spot type 88 pick-up incorporates a volume control. The pick-up head can be turned for the easy insertion of needles.

TONE

Clear, Divid

LIFELIKE

TONE

PRICES.			
60 v. Standard	8/-	60 v. Super	13/-
90 v. "	11/9	100 v. "	21/-
100 v. "	13/-	120 v. "	25/6
120 v. "	15/6	150 v. "	31/-



Hear that harmony, smooth and clear! Feel that warm vibrant rhythm; melodious, realistic, satisfying. That's the kind of reproduction you hoped for when you bought your set . . . that's what radio *can* bring to you.

But you can't expect this kind of reception unless your batteries are right. If your set seems to lack the power it had when it was new it's time to change to Pertrix.

There are two reasons for their super quality. First, NO sal-ammoniac is used in their construction—second, they are made as a good battery *should* be made . . . of nothing but the best.

Try one and hear—your dealer has them.

Did you know that you can get Pertrix Batteries for your flash-lamp? They are 6d. each, with an unlimited guarantee.

PERTRIX

NON-SAL-AMMONIAC
DRY BATTERIES

"For Colossal Power"

Advt. of PERTRIX LTD., Britannia House, 233 Shaftesbury Avenue, London, W.C.2

Telephone: Temple Bar 7971 (4 lines).

Telegrams: Britannicus, Westcent, London.

P.103

When you send your order don't forget to say you "saw it in the 'W.M.'"

VOX-VERITAS

MOVING COIL SPEAKER



Its realism is acknowledged as truly remarkable for speech and music reproduction. It is capable of responding without a perceptible peak from 45 to 8,000 frequencies, thus being well below and above the useful audible range. A deposit of 10/- brings this new-type Moving Coil to your home. Enjoy perfect reproduction NOW.

D.C. Mains
£3:15:0

Deferred payments
10/- deposit,
balance monthly
Immediate delivery.

Write for free illustrated leaflet.

VOX VERITAS
12, Union Court, Old Broad St., E.C. 2
Phone: London Wall 8216.



EBONITE PANELS

ARE SPECIFIED FOR THE "FIVE-POINT 2," THE "REGIONAL BAND-PASS FOUR" AND THE "SUPERTONE FOUR" DESCRIBED IN THIS ISSUE.

When building your "Five-Point 2," "Regional Band-Pass Four" or "Supertone Four" receiver, see that the ebonite panel carries the BECOL Trade Mark. Prices 3/8, 7/7 and 8/11 respectively. It is the guarantee of the highest quality in ebonite.

Sole Makers:

THE BRITISH EBONITE CO., Ltd.
HANWELL, W.7

"Excellent Selectivity"

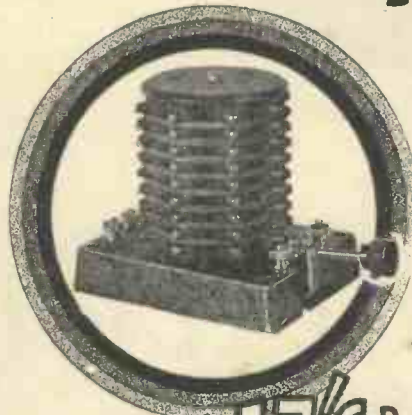

for **17'6"**

DESIGNED to meet the new Regional Scheme requirements, the Watmel Tuner serves as the Aerial tuner for practically all circuits embodying reaction; also it acts as a wave trap, since the loose aperiodic aerial coupling gives great selectivity and a considerable degree of stability. Radio Paris and 5XX are easily separated, as also are both Brookman's Park transmissions.

All moulded parts are of attractive Walnut-mottled Bakelite. The switch is a robust positive specially designed push-pull type, concealed in the base.

Price complete **17/6**

If you cannot get this Watmel product at your dealers, write direct to us and enclose remittance, the tuner will be sent to you by return.

THE WATMEL BINOCULAR H.F. CHOKE gives maximum efficiency, very low self-capacity and an extremely restricted field.

Type DX3
Inductance - 200,000 mh.
Self Capacity - 1.6 m.mfd.
D.C. Resistance, 1,400 ohms.
Price 6/-

Type DX2
Inductance - 40,000 mh.
Self Capacity - 1.2 m.mfd.
D.C. Resistance, 450 ohms.
Price 4/-



Watmel

WATMEL WIRELESS CO., LTD.
Imperial Works, High St., Edgware
Telephone: EDGWARE 0323

TANNOY

PRODUCTS
Not massed produced - but individually built

FOR MAINS UNITS

INCORPORATING WESTINGHOUSE RECTIFIER

for H.T. or L.T. suitable for immediate use on either A.C. or D.C. mains.
H.T. (A.C.) 120 v. at 15 m/a.
£2.17.6

Combined units for both H.T. and L.T. suitable for practically any receiver including portables and incorporating Westinghouse Rectifier, **£5.10.0**

DALTON STREET, S.E.27

EASIER TUNING



The Lotus Differential Condenser is made with moving and fixed vanes interleaved with bakelite discs of the highest possible dielectric qualities. All brass parts are chemically treated. Price from 5/3 From all Radio Dealers.

LOTUS

DIFFERENTIAL CONDENSER

Write for illustrated Catalogue to
GARNETT, WHITELEY & Co., LTD., LIVERPOOL.

A Cabinet De-luxe for YOUR SET or RADIO-GRAM



"the nicest I have seen" says "Wireless Constructor"

The sort people desire to possess and keep. Tasteful beauty—Piano finish—advantages also of PIANO TONE baffle chamber. The BETTER REPRODUCTION—that your Set and Speaker is really capable of—gives you a joyous sense of achievement.

Sent ON APPROVAL—direct from the makers—Prices £4 to £15 (Cash or Deferred) you may return at our expense if you wish to part with it.

Photographs and lists FREE!
PICKETTS Radio Furniture (M.G.)
Albion Road, Bexleyheath, Kent.

BUY "AMATEUR WIRELESS"
3d. WEEKLY

Advertisers like to know you "saw it in the 'Wireless Magazine'"

Perfection in every stage of every circuit

YOU will notice the difference the moment you fit Varley Components. Use them for your new receiver and get perfection in every stage. Build them into that older set and bring it up to date.

From aerial coil to output transformer, the long Varley range includes almost everything you need. Varley Components have built up a reputation for accurate workmanship and careful design. Every one has in it Varley's specialised experience of over 30 years.

Your dealer stocks Varley Components—call and examine them.

Write for the section of the Varley Catalogue that interests you.

Section A. All-Electric Receivers and Radio-Gramophones, Pedestal Loud-speakers, Gramophone Pick-Ups, Auto-Arm and Volume Control.

Section B and C. H.F. Chokes, Coils, Resistances, Potentiometers, Rheostats, R.C. Couplers, Anti-Mobos.

Section D. L.F. Chokes and L.F. Transformers (Inter-valve, Push-Pull, Output, etc.).

Section E. Mains Transformers, Mains Chokes, Power Resistances, and Power Potentiometers.

VARLEY
IMPEDANCE
MATCHING
OUTPUT
TRANSFORMER 22/6



Varley

Advertisement of Oliver Pell Control Ltd., Kingsway House
103 Kingsway, London, W.C.2 Telephone: Holborn 5303

THERE'S STUTT GART

— NOW
LONDON

How many times have your explorations round the dial been rewarded with piercing oscillation? It is your valves which make the difference. You need **TUNGSRAM BARIUM VALVES** to bring in far distant stations. First **STUTT GART**, clear and strong. The least pressure on the dial—little more than 3 metres separate them—then **LONDON**—or almost any programme you wish.

And there are other reasons why **TUNGSRAM BARIUM VALVES** are better for your set. They are more economical—they make more of your batteries. And they give better performance, long range, volume, perfect tone and long life. Yet remember they cost considerably less than any other valves of similar quality.

For full particulars of the Tungfram range write to department V.107.

TUNGSRAM BARIUM VALVES

TUNGSRAM ELECTRIC LAMP WORKS (GT. BRITAIN), LTD.,
Radio Dept., Commerce House, 72 Oxford Street, London, W.1.
Branches: Belfast, Birmingham, Bristol, Cardiff, Glasgow, Leeds,
Manchester, Newcastle, Nottingham and Southampton.
Lamp, Valve and Glass Factories: Austria, Czechoslovakia,
Hungary, Italy and Poland.



2 v. and 4 v. Screened Grid Valves, 13/-;
4 v. A.C. Screened Grid Valves, 16/-;
L.F., 5/6; H.F., 5/6; R.C., 5/6; Power,
7/3; Super Power, 8/-; A.C. Indirectly
Heated H.F. and L.F., 9/6 each; A.C.
Directly Heated Power, 9/6 each; A.C.
Directly Heated H.F. and L.F., 7/9;
Rectifying Valves, 10/- each; Tungfram
Photo-Electric Cells, Nava E., £2:17:6;
Nava R., £3:3:0.

Handwritten notes and calculations:

25/6
13/6
38/6
16/6
8/6
24/6
11/6
6
11
13
8
32

13/-
5/6
8/-
26/6
16/-
9/6
9/8
35/-

IN TUNE WITH THE TRADE

FETTER LANE'S Review of Catalogues and Pamphlets

SEND TO US FOR THESE CATALOGUES!

As a keen wireless enthusiast you naturally want to keep abreast of all the latest developments and this special feature will enable you to do so with the minimum of trouble and the cost of only 1/4d. for postage.

Here we review the newest booklets and folders issued by six well-known firms. If you want copies of any or all of them just cut out this coupon and send it to us. We will see that you get all the literature you desire.

Just indicate the numbers (seen at the end of each paragraph) of the catalogues you want below.

My name and address are:—

Send this coupon in an unsealed envelope, bearing 1/4d. stamp, to "Catalogue Service," WIRELESS MAGAZINE, 58/61 Fetter Lane, E.C.4. Valid till Feb. 28

A FINE VALVE LIST

MULLARDS have just sent me an illustrated folder which I certainly intend to keep on the radio bench, for it gives details of all the Mullard 2-, 4- and 6-volt, mains and rectifier valves.

Some new valves have just been produced in the A.C. power class, and while it is unnecessary for me to give details of these here, for they are fully dealt with in this folder, they certainly deserve mention. A new battery-type 2-volt power valve has just been produced also and you will find full particulars of this in the chart.

By full particulars I should explain that in the case of ordinary valves these include price, filament voltage and current, maximum anode voltage, impedance, amplification factor, mutual conductance, and grid volts at a given anode voltage. These details cover practically everything that the average man wants to know about his valves, and no amateur should, with this chart at hand, have any difficulty in picking out the requisite valve for any particular job.

169

THESE BLUE-SPOT LOUD-SPEAKERS

THERE is a Blue Spot loud-speaker available now for every requirement, as you can see for yourself if you write, as I did, to the British Blue Spot Co., for the current folder describing the whole range. From the very popular 41K model, which, as you may know, is the "fifty-bob" job in a really attractive walnut cabinet, up to the big six-guinea models, each loud-speaker suits a particular set requirement.

Obviously in the short space which I have here, I cannot describe each type

for you, but I do advise you wholeheartedly, if you are in search of a new reproducer, to drop a line to Blue Spots.

In addition, there are the two new Blue Spot pick-ups which are bound to find place in many radio gramophones. One type of pick-up is available with a universal fix-in for attachment to the gramophone tonearm. Another type is available complete with carrier arm and volume control.

The experience that the Blue Spot people have had in magnet construction, and the use of high flux density and cobalt steel, has been put into these pick-ups and very full details are given in this folder.

170

FOUR USEFUL CATALOGUES

VARLEY (Oliver Pell Control, Ltd.) have a useful scheme of indexing their catalogues so that at a glance you may select the right one for any special requirement. I should like to make reference to four catalogues which have just been sent me and which you can obtain free through my usual service.

Of these, catalogue Section A deals with sets, radio gramophones and the Varley pick-up and auto-arm. Sections B and C (in one book) deal with tuning and high-frequency components, resistance-capacity couplers and resistances of all kinds. Section D deals with transformers and chokes for valve coupling and output purposes, while section E deals with the heavier components suitable for mains working, such as power transformers, smoothing chokes, power resistances and potentiometers.

Out of this comprehensive batch I find it very difficult to select any one item for special mention, but I would say that in Section D you will find full details of some of the finest low-frequency transformers on the market.

171

A NOVEL BOOKLET

A GOOD idea is the booklet called *British Broadcast Conditions*, produced by Voltron Electric, Ltd., and written by Capt. Eckersley and W. H. Murad. One of the chief features of this is a reprint of an extensive test report on the Voltron Dynaplug Three made by "Set Tester" of *Amateur Wireless*.

There are also interesting articles on the manufacture of these receivers, and I feel sure that anyone who contemplates making up a kit set such as the Dynaplug Three will find something to interest them in this booklet. A blueprint and constructional details for this kit receiver are also available.

Listeners who prefer to make up sets from their own layouts should note that most of the components incorporated in the Dynaplug Three, such as the condensers, switches, chokes and transformers, are obtainable as separate components and are listed in a folder to be obtained from Voltron Electric, Ltd., through my service.

172

BULGIN FOR 1931

I AM writing these notes at the beginning of the New Year and already I have received from an old acquaintance, A. F. Bulgin & Co., Ltd., a comprehensive catalogue and instruction book for the new season's Bulgin parts.

I reviewed this last year and, as you may remember, I had some pleasing things to say about it, and they were well merited. This year's book is even better. Roughly half of it is devoted to the leading parts in the Bulgin range (and there is bound to be something of interest to you in this extensive gamut of components), while the second half gives very many helpful circuits and hints which, although particularly applicable to Bulgin parts, are nevertheless of very great general interest.

I feel sure that every amateur who likes to make use of auxiliary gadgets in a set, in order to improve its appearance, performance or convenience of operation, will want to have this book, which can be obtained through my service from A. F. Bulgin & Co., Ltd.

When writing you might also care to make application for two or three leaflets which have just been produced, dealing with new parts—among them being the Sinus volume controls and variable resistances, and the Filta condensers, for which friend Bulgin is the sole London distributing agent.

173

HOME-BUILT MAINS UNITS

THERE is certainly no reason why you should not, if you are contemplating changing over from battery to mains operation, make up your own mains unit. In fact, after reading through some folders which I have just received from F. C. Heyberd & Co., it seems to me that there are many good reasons why you should make up your own mains apparatus.

The first and, I suppose, chief reason is cost, because naturally it is cheaper for you to build your own unit from parts than it is for a manufacturer to make units and then retail them. Secondly, the constructional work is not at all difficult, as I gather after perusing the explicit diagrams and photographs shown on these folders, and the great advantage is that you can make up a unit to suit your own particular requirements.

Maybe you require some special low-tension output arrangement or special valves for screened-grid and subsidiary voltage tappings. When you are making up your own unit you can suit these things to your set, but when you are buying a ready-made unit then your pocket may limit you to a type of unit which does not exactly fill the bill.

These, you will agree, are concrete advantages in favour of home-construction, and when you have read these Heyberd folders, which I advise you to do, you will be more than ever convinced that this represents the easiest way of making the change over to mains operation.

174

WESTINGHOUSE METAL RECTIFIERS for ALL-MAINS RADIO

Why have the trouble... the worry... the expense of batteries and accumulators if your house is on the mains? Why risk missing a specially good programme because "the battery's down again"?

Our booklet, "The All Metal Way, 1931" gives complete information as to the most suitable type of rectifier for converting any battery-run set into an all-mains set.

If you are buying a mains set, make sure that it incorporates the Westinghouse Metal Rectifier—most of the good makes now do. If you are building such a set, send for the forty-page

booklet, "The All Metal Way, 1931." It is written by our technical staff and contains informative sections on radio sets, eliminators, battery chargers, moving coil loudspeakers, etc.

(Please enclose 3d. for your copy)

PRICES of the Westinghouse Metal Rectifiers are from 15/-



USE YOUR A.C. MAINS AND A WESTINGHOUSE RECTIFIER

THE WESTINGHOUSE BRAKE & SAXBY SIGNAL CO., LTD.
82, YORK ROAD, KING'S CROSS, LONDON, N.1. Phone: North 2415

COUPON.

Please send me your forty-page booklet, "The All Metal Way, 1931," for which I enclose 3d. in stamps.

NAME _____

ADDRESS _____

PLEASE WRITE IN BLOCK LETTERS.

W.M.2/3



Flush Signal Lamp for portable sets ... 2/6

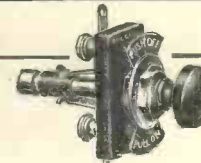

Push Pull Switch with pure nickel silver contacts and N.P. fitting 1/6

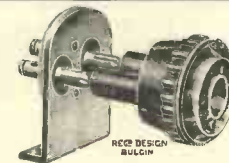

Large Safety Mains Plug and socket. Non reversible, shock proof ... 3/9

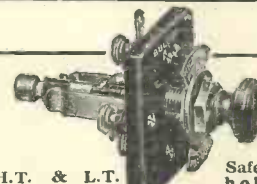

H.T. & L.T. Switch disconnects both H.T. and L.T. with one movement 2/6



Safety Fuse-holder and Spare Carrier takes all standard fuse bulbs 1/3



Baseboard Wire Wound Resistor prevent back coupling through battery or eliminator. 600 and 1,000 ohms 1/6, 2,000 ohms 1/9

THE TRUSTY TWELVE

Not only twelve, but ten times that number of trusty, highly finished components are listed in the Bulgin catalogue. Every Bulgin part is made to the highest standards of electrical efficiency and can be relied upon to ensure the highest satisfaction. Send now for the famous Bulgin 60 pp. catalogue, 2d. post free from

A. F. BULGIN & CO. LTD.,
9, 10, 11, Cursitor Street, Chancery Lane, London, E.C.4
Phone: Holborn 1072 & 2072

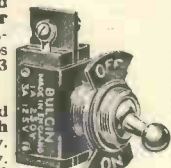

Toggle On and Off Switch carries 250 v. 1 amp. or 125 v. 3 amp. ... 1/9

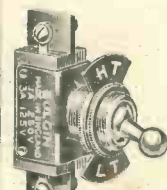

Toggle 2 Way Switch for changing over connections, such as H.T. to L.T. Trickle Charger ... 2/-



Quick make & Break On & Off Switch positive in action and efficient in operation ... 2/-

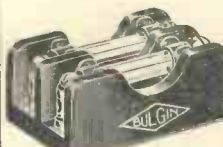

Baseboard Twin Fuse Holder with fuses. Occupies minimum space 2/6

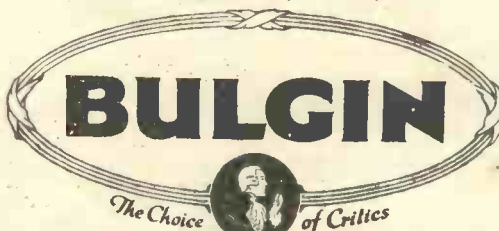

BULGIN
The Choice of Critics



Rotary On & Off Switch totally enclosed snap action 1/9



Horizontal C Leak Clips Perfect insulation allows interchangeability of leads ... 9d.

Advertisers like to know whence the business comes—please mention "W.M."

ELECTRAD Royalty Potentiometers

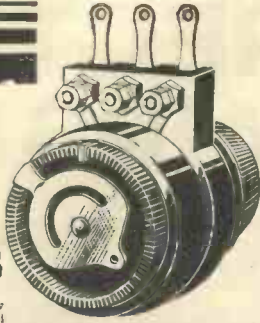

Now you can purchase the famous Electrad Royalty resistances in potentiometer style at greatly reduced prices.

Remember when you purchase wire-wound high resistances be sure to specify Electrad Royalty, the original units used by the leading manufacturers, experts, and in laboratories throughout the world. Do not accept imitations and infringements. Manufacturers should note that special models are available for production use.

TYPE A	1/10th to 7 megs.	.2 ma.	6/3 each
B	1,500 \pm 100,000 ohms	5	.. 6/3 ..
C	500 \pm 50,000 "	7.5	.. 6/3 ..
D	10,000 \pm 700,000 "	2	.. 6/3 ..
E	0 \pm 500,000 "	2.5	.. 6/3 ..
F	0 \pm 2,000 "	37.5	.. 6/3 ..
G	0 \pm 10,000 "	16.5	.. 6/3 ..
H	0 \pm 25,000 "	10.5	.. 6/3 ..
J	0 \pm 200,000 "	4	.. 6/3 ..
K	0 \pm 5,000 "	23	.. 6/3 ..

Complete with bakelite arrow knob.

If you have not received the complete Electrad catalogue of Royalty resistances, Truvt fixed and variable resistances, Nichrome wire resistances, Super Tonatrols and Lathin White Amplifiers, write for your copy to-day. It's free and post free.

Specify
ELECTRAD
and ensure
Dependable
Resistances

THE ROTHERMEL CORPORATION LTD.
24 Maddox Street, London, W.1

Phone: MAYFAIR 0578/9

Continental Sales Office:—
27 QUAI DU COMMERCE, BRUSSELS, BELGIUM

ALL BEFORE YOU!

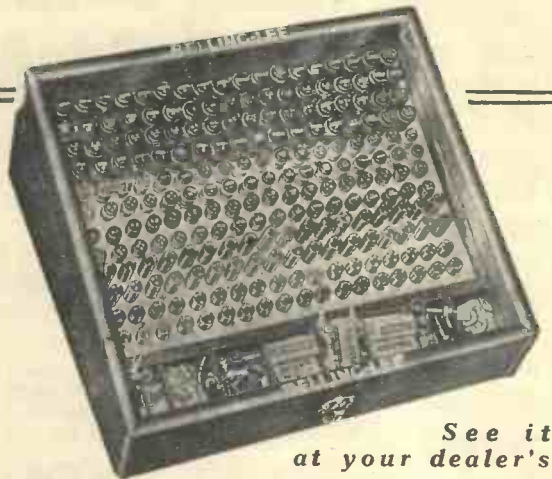

See it
at your dealer's

The whole range of Belling-Lee Radio Connections! From this glass-topped showcase you can pick out instantly the gadgets you require, the letterings you are looking for.

Belling-Lee Radio Connections are the last word in safety and efficiency. That's why designers specify them, why set manufacturers are standardising them.

Write for the Free Belling-Lee Handbook
"Radio Connections" (2nd. Edition).

BELLING-LEE
FOR EVERY RADIO CONNECTION

Agents of Belling & Lee, Ltd., Queensway Works, Pontiers End, Middlesex. F.W.G.

A NEW H.F. CHOKE

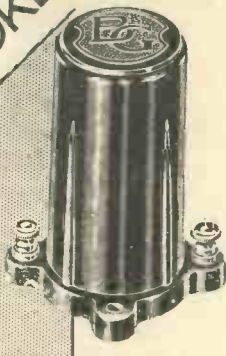

An example of British General excellence in design and construction at its very best—a choke of high inductance and low resistance resulting in a performance curve which is almost perfect. Well and sturdily built to give long and satisfactory life.

PRICE

5/6

From all dealers of repute or direct from the Manufacturers:

BRITISH GENERAL

MANUFACTURING COMPANY, LIMITED
Brockley Works London, S.E. 4

"There is always room for
Something 'Better'."

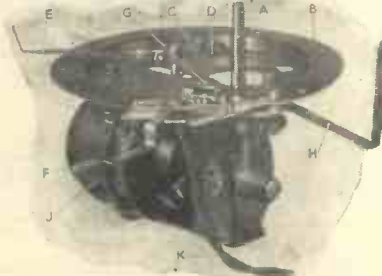

THE NEW
"DIEHL"
"ARISTOCRAT"
ELECTRIC
MOTOR

The Price?—Remarkably Low—
Only 84/- Complete!

AT LAST!—A NEW,
BRILLIANTLY
"ORIGINAL"
ELECTRIC GRAMO-
PHONE MOTOR
THAT IS DISTINCTLY
"BETTER!"

Produced by the
DIEHL MFG. CO., Electrical Division of the World-Famous SINGER SEWING MACHINE CO., and distributed exclusively by "LYONS." That we are behind this new motor is sufficient warranty that it marks a step forward in correct design; it is really superfluous to add that Singers' 46 years' experience in the World's largest Small Motor Plant is also backing and positively guaranteeing this proposition. NEW FEATURES INCLUDE; Bakelite Non-Rusting and Non-Warping Turntable; Spring Suspension; One-Hole Fixing; Induction Motor; Guaranteed Humless; Non-Interfering; No Brushes; Worm-Driven with Single-Plate Cork Clutch; Speed Indicator; Automatic Stop and A.C. Snap Switch.—IN FACT, DEFINITELY THE BEST MOTOR NOW AVAILABLE, AND WHAT A SURPRISINGLY LOW AND ATTRACTIVE PRICE... ONLY 84/- COMPLETE!

Special Folder Free on Request by Return. Large Stocks.
EXCLUSIVE DISTRIBUTORS IN GREAT BRITAIN:

CLAUDE LYONS LTD.,

76 Oldhall St., LIVERPOOL. LONDON, 40 Buckingham Gate, S.W.1.

You will get prompt replies by mentioning "Wireless Magazine"

NOTICE!

The Low-frequency Choke specified for the Regional A.C.4 and the Low-frequency Transformer for the Brookman's A.C.2

IN THIS ISSUE ARE



"The best— regardless!"

PARMEKO Apparatus is now well known among serious amateurs for its excellence. Every stage of its manufacture is governed by one principle and one only—to make it "The best—regardless." Buy PARMEKO always, and when necessary pay a little more. The improvement in your reception will justify every extra penny a thousand times.

PARTRIDGE & MEE, LTD.

Dover Street, Leicester and 74 New Oxford St., LONDON, W.1

ELECTRICAL CONTINUITY. INSULATION. REGULAR SPACING OF VANES. LOW LOSS CHARACTERISTICS. MOVEMENT FREE FROM BACKLASH AND NOISE.

The Points that matter when buying
CONDENSERS



KNOB CONTROL DOUBLE CONDENSERS W.296 2

A component of outstanding merit, design and finish. Controlled by our new Drum Dial—the only Drum Dial that makes a complete revolution. Left-hand condenser fitted with...

PRICE 27/6 EACH

"Utility"

Condensers of "Utility" manufacture offer you perfection in design and finish and highest possible values. See that your set or kit of parts includes them and you'll be certain of satisfaction. Dealers everywhere stock "Utility" Instruments. Illustrated List may be had post free from the makers

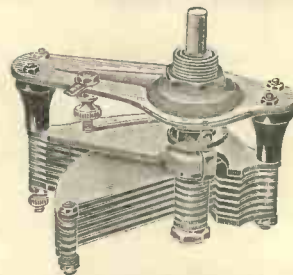

STANDARD CONDENSERS No. W.160

A low loss Condenser in every respect. Ball-bearing movement—no noise or backlash. Internal connection fitted in addition to customary pig-tail.

	PRICES:
.0005	8/6 each
.0003	7/6 each
.0002	6/6 each
Vernier	6/6 extra

WILKINS & WRIGHT, LTD.,
"UTILITY" WORKS, HOLYHEAD ROAD, BIRMINGHAM

When replying to advertisements, please mention "Wireless Magazine"

CHEMICAL MAGIC

AS THE BASIS FOR A SECRET PROCESS PRODUCING SUPER-NORMAL CURRENT-PER-CELL FROM A LISSEN HIGH TENSION BATTERY

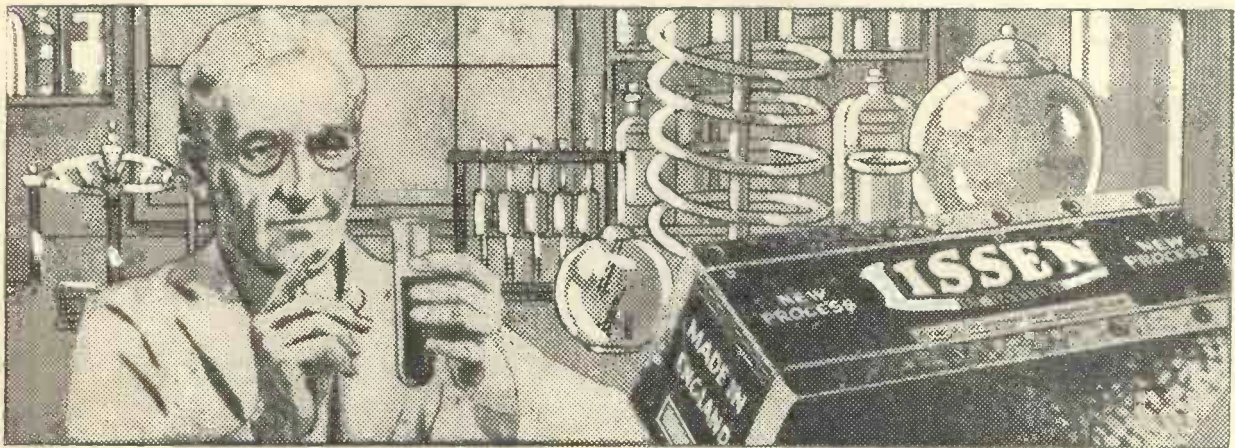

How to save money on your outlay for H.T. current and how to capture anew the thrill you enjoyed when first you heard radio!

The reason you get more power from a Lissen Battery is because more power is put into it by the exclusive process and chemical combination which you can only get in a Lissen Battery.

No battery delivers more pure power for so long and for so small an initial outlay. The active chemicals in a Lissen Battery are so perfectly balanced that their chemical activity continues much longer than has ever before been known in the cells of high-tension batteries. *So much for economy.*

Then for purity of power, for noiselessness of current flow, for smoothness, for the entire absence of any ripple or hum, the Lissen Battery has never been rivalled. Even after months of use the power of a Lissen Battery is so pure that your loud-speaker utterance is still natural and true.

**LISSEN BATTERY POWER
GIVES SPARKLE AND
BRILLIANCE OF TONE TO
EVERY ITEM !**

BE FIRM IN THE WAY YOU SAY YOU WANT A LISSEN BATTERY

LISSEN LIMITED, WORPLE ROAD,
ISLEWORTH, MIDDLESEX.

60 volt 7/11 100 volt 12/11

Also made in all sizes, all voltages, all capacities to suit your needs.



An Editorial Word

Talking to the Million—or A Handful?

HAVE you seen "B.B.C. Talks"? It is a readable guide to the talks that will be broadcast between January and April of this year, and following guides will deal with later periods.

It is the fashion to sneer at "talks." I have often sinned in that way myself, but when I look at this publication I am lost in admiration of the thoroughness with which the B.B.C.'s Talks Department does its work. I don't know how many people constitute that department, but it works, and I should think it works hard. The amount of planning, negotiation, and preparation necessary before such a programme as "B.B.C. Talks" can be issued must be extremely great.

The programme covers an extraordinary variety of interesting subjects, for each of which there will be a listening public, some larger than others. Nearly every one of the talks could be fascinating in its appeal. It is simply a question of whether treatment will be right and the voice and delivery good. The subjects, for the greater part, interest people who are in a thoughtful mood, and that is the trouble.

There is rather an "external university" flavour about them as a whole, although each could be made interesting, but many of them demand a technique of presentation which they will not get in all cases, and so I fear that, good as the subjects are, many of the speakers will be merely "talking on the air," not to the million that the broadcaster conjures up when he places himself in front of the microphone, but just to the handful who, by reason of their special inclination, are awaiting what he has to say.

I have just been reading a life of Lord Northcliffe (a Christmas present), the journalist who is so often hailed as the inventor of the modern newspaper. One thing he most certainly did was to make every subject he touched—politics, art, economics, the humanities—understandable to everybody who could read. And that was a very great accomplishment.

Every editor knows how difficult it is to present material in such a way that his readers shall easily comprehend it. Northcliffe insisted that his writers and editorial men should do the cogitating and that his readers should assimilate, with scarcely perceptible mental effort, the meaning of the written sentences.

Northcliffe as "O.C. Talks, B.B.C.," would have insisted on many alterations being made in the present B.B.C. methods. He would have recognised that factual accuracy and encyclopædic knowledge, however essential, were not in themselves particularly attractive to the public—indeed, sometimes the very reverse. He would have known that the average broadcast talk depends for success more on its manner than on the information conveyed by it. He would have insisted on a proper technique of presentation being observed.

He never allowed anybody to write "over the heads" of his readers. Just as he knew that every column occupied by matter which his readers could not understand, or which did not interest them, was just a column wasted; so, as "O.C. Talks, B.B.C.," he would have known that every twenty minutes occupied by a lecturer, however learned and well-informed, in talking "over the heads" of his listeners or in speaking in a way that failed to interest, was just a waste of the B.B.C.'s very expen-

sive time and a source of irritation to an immense public.

As I turn over the pages of "B.B.C. Talks," I see scores of most fascinating titles—"What is Science"; "European Influence Upon Asia"; "The Gold Situation"; "Industrial Health"; "Public Money, Whence It Comes"; "The History of the Drama"; "Commerce the Peacemaker"; "Is Cooking an Art?"; "Illnesses that are Catching"; "What is Good Food?"; "The Day's Work in Other Lands"; "What is Beauty?"; and scores and scores of others, every one, as I have said, capable of not only holding a body of listeners, but actually fascinating them. But, in fact, will they?

The authors, men and women, are notabilities—not just hacks. Every one of them carries authority. But knowing a subject and knowing how to present it—what an immense difference between the two! How many thousands of people really "know" wireless, for instance; yet there is just a handful of them who can explain it to a popular audience. And I fear in so many cases these wonderful talks, full of facts and fancies, the clever and painstaking work of well-informed men and women, will fall on deaf ears, because the presentation will be faulty.

What the B.B.C. needs is a Talks Presentation Editor, preferably someone with both journalistic and elocutionary experience, who faces up to the fact that only a few people in their recreative moments will listen to anything serious. Such a man would know that it is really difficult to "get across" a talk to any considerable portion of the listening public.

He would see to it that the form of each talk was right, and to his wishes in this respect every speaker would be obliged to bow, but he would be careful not to destroy that magic thing, personality. Then, when this super-man had ensured that the talk was in a form that the public could not only understand, but positively enjoy, he would see that the lecturer knew how to speak.

Sometimes I forgive bad delivery because of the insight into the speaker's personality which his voice and style convey, but I generally find that bad delivery alienates listeners at once and they promptly turn to something more interesting. I know, of course, that B.B.C. speakers already are given trial auditions and that some of them have good broadcasting voices, but I think that something more than a trial audition is often necessary—definite microphone education is necessary in a large majority of cases.

It would be the task of the Presentation Editor, or of some skilled colleague to teach the speaker how to make the best of his medium. He would be shown how not to drop his voice at the end of a sentence and how to avoid other equally commonplace mistakes; he would be assisted in making his style attractive so as to please as well as interest his listeners, and if perchance some of the speakers objected to be taught, what would it matter? They would not have been listened to, anyway.

Bernard Jones

Another Step Towards Everyday Radio Pictures



A New System of PROJECTED TELEVISION

WE have just seen television having a real entertainment value. Sitting back in comfort, we have viewed a variety of scenes and actions projected on to a screen measuring 24 in. by 20 in.

H.M.V. Activities

The demonstration was in the laboratories of the H.M.V. works at Hayes, Middlesex, where H.M.V. research engineers disclosed the exact stage in their development of television.

Without attempting to devise an original system, the company has shown what can be done with existing ideas when fully exploited under laboratory conditions. It is emphasised that the television we saw is a laboratory product, not intended to be interpreted as a commercial activity.

Frequency

One of the factors tending to restrict television development, irrespective of system or country, is the limited frequency channels allotted to broadcasting stations.

The 9-kilocycle separation between stations was not arbitrarily decided; for that amount of "spread" is the minimum to ensure the transmission of all musical frequencies. If the channel

were restricted still further musical detail would be lacking. So would vision signals; a wide frequency band is needed to provide detailed images.

It will be recalled that a printed photographic illustration consists of an enormous number of small dots, of different sizes and degrees of blackness. The more dots there are in a given area, the finer is the texture

of the picture and the more readily is detail recognised. If the number of dots is reduced the picture lacks detail and graduation.

Picture Projection

This well-known fact about the make-up of a printed picture has to be remembered when considering television systems. Another simple idea needs to be known before one can understand anything about modern television apparatus. We refer to the principle involved in the motion-picture projector.

The successful projection on to a screen of moving objects depends upon the fact that the human eye tends to retain an image for an appreciable time after the object has been removed. This persistence of vision gives the illusion of a continuously moving picture, provided that not less than twelve pictures per second are passed before the eye.

120,000 Dots

If we consider a picture in which there may be as many as 10,000 constituent dots, each of these small dots must be reproduced twelve times per second to give the transmitted image the illusion of moving. So for this picture to be handled by television no less than

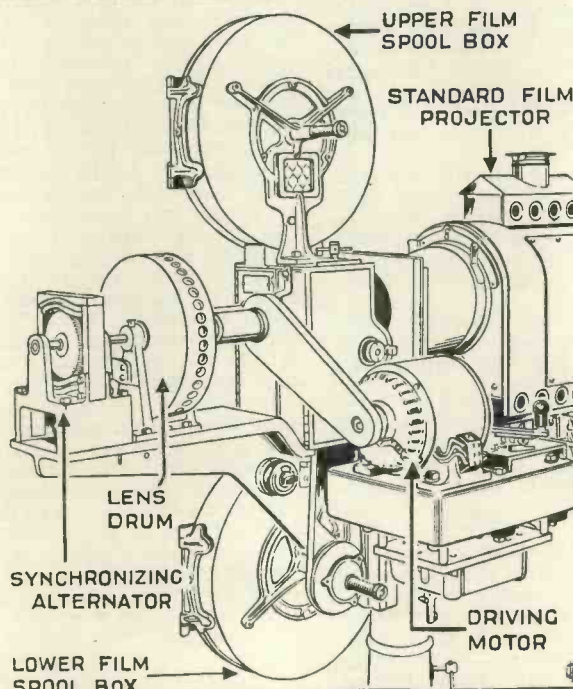

TRANSMITTING FILMS BY RADIO

The new His Master's Voice system splits the picture to be televised into five vertical sections. Here is part of the apparatus

120,000 individual signals would have to be transmitted per second.

When these simple facts are understood, some idea of the immensity of the problem of television can be gained. Up to the present time there has undoubtedly been a tendency to gloss over the need for detail in order to encompass the television signal within the limited broadcasting channel.

Preventing Perfection

This policy has prevented the perfection of the image to such an extent that any entertainment value has been negligible.

The advance development section of the H.M.V. research department decided that their immediate work should be the production of a perfect television image. Having ascertained how much real entertainment value could be secured, it was then proposed to see how this standard of perfection could be maintained as the laboratory system developed into a commercial proposition.

Entertainment

Our visit came at the completion of the laboratory work, when all the equipment had been erected in preparation for the projection of television having entertainment value. "Without entertainment value," states the Gramophone Company, "television must fail as a popular commercial proposition." We agree with this.

As soon as the demonstration started we realised that an entertainment value could be attached to the H.M.V. television apparatus. With a dozen or so others we were seated near the screen to view in comfort the various film "shorts" put through the near-by cinema projector.

Tram Numbers

Some idea of the detail of the television image as projected on to the screen can be gauged from the fact that the numbers on the trams in a London street scene were clearly visible.

It is a great compliment to the apparatus to say that the results we saw were comparable with the results

obtainable from a home cinematograph projector. It seemed hard to realise that the animated scene on the screen had passed through all the processes of television before its final projection.

We saw such scenes as the Changing of the Guard and a cricket match, with a definition of surprising perfection. It was noted that the complete scene was built up of five



LOOKING IN TO TELEVISION

Television reception being made on an experimental Baird apparatus. On the extreme right is Mr. Barton Chapple, who has contributed television articles to "W.M."

it is made to operate the television transmitting apparatus.

No attempt has yet been made to transmit still or live objects. Because of this, the television image received is really a second-hand image, just as a broadcast record is second-hand sound

Lighting

It is considerably easier to transmit the images on a film than the likeness of a human being, for example, because the lighting problem is greatly simplified. We were asked to remember that H.M.V. television is a laboratory experiment, in which the use of film for transmission is thought to be

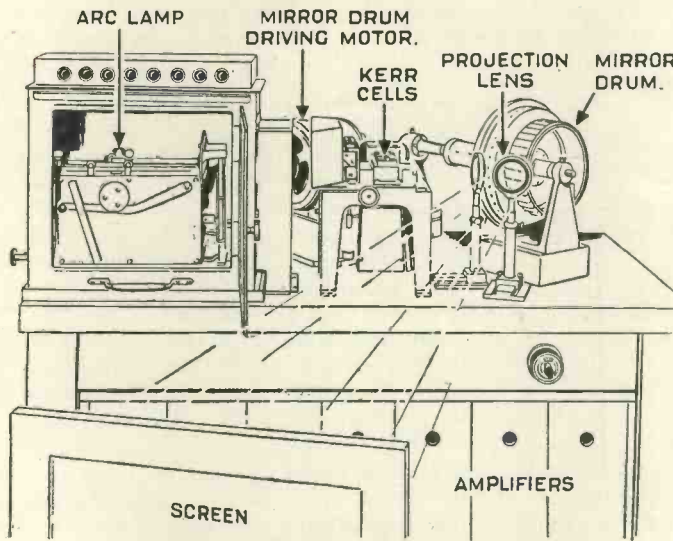

PROJECTING THE PICTURE ON A SCREEN

In the His Master's Voice system of television the picture received is projected on to a screen measuring 2 ft. wide by 20 in. deep

sections; vertical lines occasionally running across the picture were the only evidence that what we were seeing was television and not direct projection.

After the demonstration we were allowed to see how it was done. As the drawings indicate, a film is passed through a cinematograph projector before the light reflected from



AN AUSTRIAN SYSTEM OF TELEVISION

Denis von Mihaly, the Austrian television investigator, with one of his receivers. His apparatus is similar in appearance to Baird's first models

A NEW SYSTEM OF TELEVISION—Continued

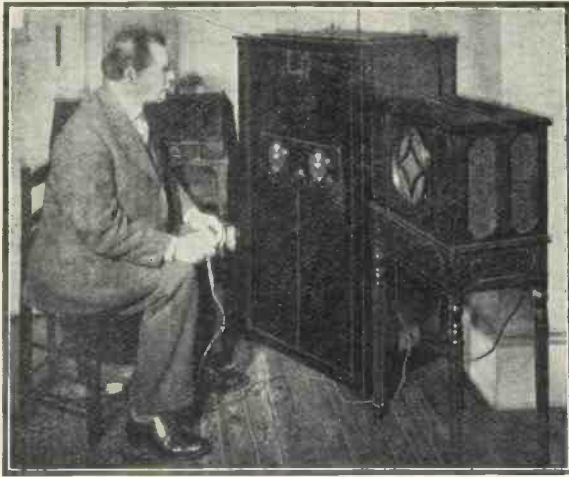

A TELEVISION RECEIVER FOR THE HOME
Here you see Dr. E. F. W. Alexanderson, the famous radio pioneer, with an American television receiver for use in the home

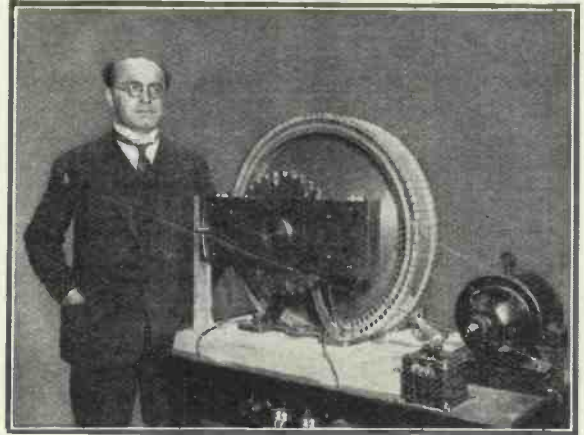

THE INVENTOR OF THE KERR CELL

Introducing Professor Karolus, the inventor of the Kerr cell, which has been used extensively in television and talkie reproduction. This cell is a device for modulating light rays by a varying electric current and is particularly reliable in action

justified, in order that the rest of the chain of events can be perfected.

news pictures. Few people would be able to tune in to a television broadcast of say, the Grand National, owing to the inconvenient time, but every listener would like to see the race that evening on a television receiver.

one-fifth of the total picture. The cells interpret light variations as current variations, which are amplified by a remarkable amplifier specially developed for television, and so passed along the transmission lines to the receiver.

Arc Lamp for Reception

At the receiving end is the powerful arc lamp, the light from which is modulated by what are known as Kerr cells. These cells are situated between the arc lamp and a revolving drum, having on it highly polished mirrors rotating at exactly the same speed as the transmitting lenses.

Films would "bottle" events for future projection, just as records have "bottled" the King's speech for later broadcasting in the evening.

The two guiding principles in the H.M.V. system of television are the large number of picture elements used and the modulation of a brilliant light at the receiving end to ensure adequate illumination of the screen. In order to get definition and to ensure brilliance, five separate transmission channels are used.

Scanning

The film at the transmitting end is scanned in five separate sections by means of a revolving drum fitted with a series of lenses, which reflect the light from the film in turn upon five photo-electric cells. Each cell takes care of

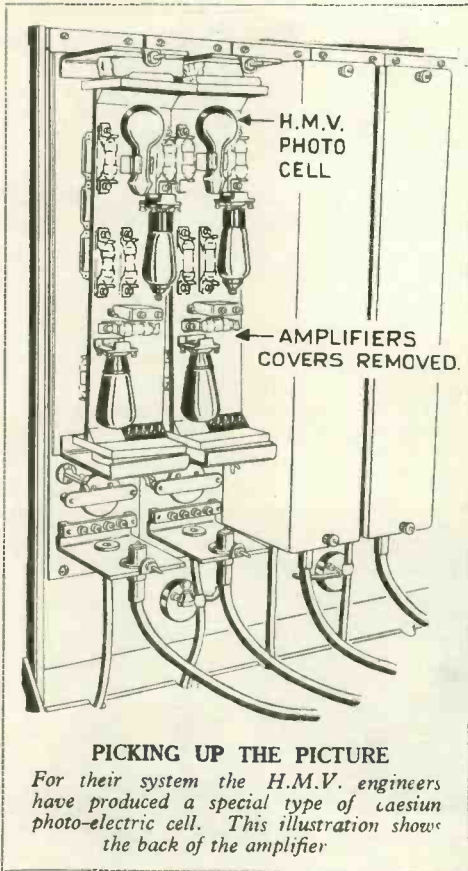

PICKING UP THE PICTURE

For their system the H.M.V. engineers have produced a special type of caesium photo-electric cell. This illustration shows the back of the amplifier

In passing, it is profitable to note that, should television become practicable, the use of film would be necessary for the transmission of

lenses, which reflect the light from the film in turn upon five photo-electric cells. Each cell takes care of

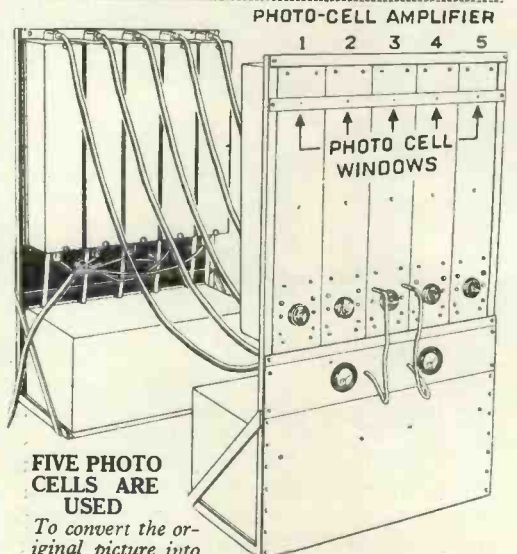

FIVE PHOTO CELLS ARE USED

To convert the original picture into electric currents five photo-electric cells are used in the His Master's Voice system

FROM Germany comes the report that a scientist has caused plants to mature very much sooner than usual by means of wireless waves.

While there is not much hope that we shall soon be using wireless waves for fertilising our gardens, instead of buying the fertiliser from shops, it is now quite certain that electricity, and wireless waves of some frequencies, can be made to have a beneficial effect on plant life.

Aurora Borealis

As far back as 1885, Professor Lemstrom noticed that, in spite of the short summer in the Polar regions, the crops grown there were in some cases quite as good as those grown in sunnier climates. After investigation, he put forward the theory that this was due to the greater electrification of the atmosphere there, caused principally by the Aurora Borealis.

He then set out to develop a system



An electrostatic machine which supplied current to a network of aerial wires supported about 10 in. above the crop

of electro culture, as it is called, in order to prove his statements, and today there is no doubt of the correctness of his theory.

Professor Lemstrom's method of electro culture is now widely used by investigators, and it is apparently by this means that the German horticulturist has achieved such remarkable results.

Electrostatic Machine

The early apparatus of Lemstrom consisted of an electrostatic machine which supplied current to a network of aerial wires supported about 10 in. above the crops. This produced electrification of the air immediately over the crops, and that this had a distinctly beneficial effect was proved by the fact that similar crops under precisely the same conditions, but without any electrification, were very

inferior and took considerably longer to mature.

Recently, in place of the electrostatic machine, the dynamo, an induction coil, together with valve apparatus specially designed by Sir Oliver Lodge for the purpose, have been used, and more recently still alternating current with transformers and metal rectifiers have demonstrated clearly that this form of culture is likely to revolutionise agricultural methods when applied on a large scale.

With the modern apparatus, the aerial wires are erected about 18 ft. above the field and about 9 ft. apart; this makes it possible for the farm workers to attend to the plants or crops without any danger of a shock. Attendants have worked in this electrified atmosphere for considerable periods and no ill-effect on their health has been noticed. The aerial wires are charged to a potential of from 80,000 to 100,000 volts, so of course care has to be exercised in the matter of insulation.

Supplying the aerial grids direct with high-frequency currents of the same frequency as used in wireless



Attendants have worked in this electrified atmosphere for considerable periods



Does radio affect the growth of plants? Read this interesting article by **GERALD H. DALY** and form your own conclusions

has also proved beneficial to the growth of plants, but the great drawback to this method is the possibility of interference to wireless communication.

For Small Gardens

For small gardens, less elaborate equipment is necessary. Aerials 10 ft. in height and spaced 6 or 7 ft. apart, and supplied with a potential of some 20,000 volts, are said to give very good results. Of course, any one who wishes to experiment can, like Professor Lemstrom, build a small network of a few inches above the ground and supply it with 2,000 or 3,000 volts from a small induction coil and rectifier. Care must be taken to use the induction coil so that it does not interfere with wireless reception, otherwise the Post Office may object.

Why plants should respond to electrical treatment of this nature is still something of a mystery, but the famous Indian scientist, Sir J. C. Bose, has contributed a great deal towards the solution of the problem.

Electrical Resurrection

He has shown how electricity plays an extremely important part in plant life and in one of his now famous experiments, he killed a plant stone dead and then proceeded to bring it to life again by electrical treatment.

(Continued at bottom of next page)

PLUG-IN COILS

USUALLY when one wishes to change the wavelength range of a set with two-pin plug-in coils, it is necessary to fumble inside the cabinet and change them by hand. However, by the arrangement shown, the tuning can be altered from Brookman's Park to 5XX or the Eiffel Tower by a flick of a two-way switch.

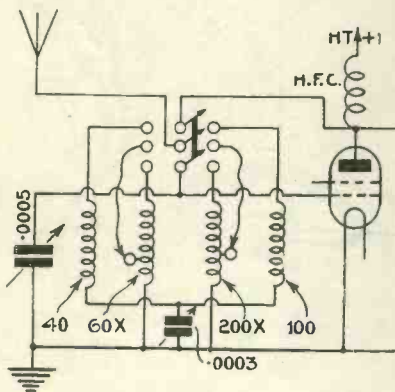

How to use a three-pole change-over switch with tapped coils

This brings into play a new pair of coils, enabling the best reaction to be obtained.

There is no reason why this idea should not be used for double- or centre-tapped coils, but a three-way switch will be necessary. The arrangement shown has been adopted

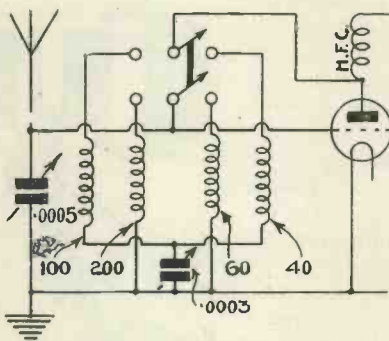

Untapped coils need only a double-pole change-over switch

for the Celerity Three, where it proves very efficient.

Flex connects the second pair of terminals on the switch to the tap-pings on the X coils. G. H.

[This hint will appeal to many constructors, for two-pin plug-in coils are still extraordinarily popular and are selling in great quantities. Many old sets can be given a new period of utility by taking advantage of the scheme indicated in this note.]

METAL SCREENS

I CAME across a set recently which seemed to lack power on the high-frequency side. It took over an hour to trace the cause of the trouble and by that time most of the high-frequency components had been pulled out and replaced.

It transpired that a faulty contact to the screen (separating the high-frequency valve from the rest of the set) was the cause of the trouble. Some screens are covered with a transparent cellulose lacquer in order to preserve the bright appearance of the mottled metal and this covering is, of course, a tolerably good insulator.

Capacity Coupling

In this faulty set, the covering had not been properly scraped away and a connection which had been made to the screen, in order to earth one of the condensers, was only making a capacity coupling, electrically speaking, although the contact screw was tightened down well.

The thin coating of lacquer prevented the lead from making electrical contact. This is a point which should be watched. K. U.

RADIO CULTURE—Continued from preceding page

He has proved that every variation in a plant from the seed to full growth is accompanied by attendant electrical variations, and if the root of a plant is negatively charged the stem and leaves are positively charged.

We know that a tree can be made to act as a moderately efficient aerial, and the reason for this is that the sap, which acts as the aerial, is insulated from earth. This insulation property is not coincidence, but has a definite value in the life of the tree. It has also been discovered that certain plants radiate their own electromagnetic waves.

Effect of Aerials

It is sometimes reported by a wireless listener that, since the erection of his aerial, a rose tree or other plant immediately underneath has greatly improved, and the question is asked if this is due to the currents in the aerial wire.

There is no data on the subject, but when we consider that the currents in the aerial are infinitely small and the

attendant field surrounding the aerial over the plants must be very weak indeed, there seems no likelihood of the ordinary aerial affecting the plants one way or the other.

However, it would be fatal to be dogmatic on such a point for an electromagnetic field, however weak,

certainly does exist in the vicinity—a field which was not in existence before the erection of the aerial, and any factor which tends to concentrate electromagnetic waves on one point is likely to assist the growth of plants in the vicinity, basing our supposition on what we have learnt from electro culture.

High-power Transmitters

No data is available concerning the affect of the currents of a high-power wireless transmitter on the plants in the neighbourhood, but it would be interesting to know what the effect of, say, the Post Office station of Rugby is on the plants in the immediate vicinity.

There is no doubt whatever that all electromagnetic waves, whether naturally or artificially produced, do have a very definite effect on life on this planet and some day we may have wireless stations radiating wireless waves, not only for fertilising crops and plant life, but also for assisting and invigorating human life.



Since the erection of his aerial, a rose tree or other plant immediately underneath has greatly improved

SHOULD THE B.B.C. JAM MOSCOW?

By Our
Special Commissioner

SOME curious views on the functions of the B.B.C. were disclosed in the latter weeks of the past year, when alarmist reports were prevalent in connection with Moscow's broadcast talks in English.

Most people looked to the B.B.C. to "do something" about it. That it was a matter for Government consideration did not enter their minds.

One fervent patriot inquired seriously of Savoy Hill what method it was adopting of jamming the Moscow transmission. Some people telephoned to the B.B.C. and asked permission to pay a visit to headquarters in order to listen to the Russian broadcasts; which prompted one humorous official to suggest that the B.B.C. might provide a diversion by relaying one of the propagandist transmissions to the B.B.C. stations.

In the Pay of the Soviet!

The possibility that by doing so the B.B.C. would be accused of being in the pay of the Soviet squelched effectively this display of enterprise!

The B.B.C. cannot express any official view of transmissions of the character of those from Moscow, because the purpose of its existence is to provide a broadcasting service for British listeners.

If any of the latter choose to tune in to a wavelength which is not among those utilised by the B.B.C., the Corporation has no mandate to prevent them either from doing so or



THEY SEEM TO ENJOY RADIO IN RUSSIA!

These members of a Communist youths' association in Russia seem to be enjoying the political broadcasts that are causing so much controversy over here

from hearing whatever is being broadcast on that wavelength.

Listeners who want B.B.C. programmes would not seek for them on a wavelength of 1,304 metres; and it might perhaps be said that if the B.B.C. were given the right to interfere with foreign transmissions it would be practising no outrage by blanketing the transmissions from Radio Paris and certainly those from Motala and Kharkov, which are adjacent to Moscow in wavelength.

Those whose duty it is to preserve the integrity of wavelength allocation know only too well that in order to maintain the transmission channels with any degree of freedom from interference, strict adherence to the privileges granted at the Prague conference is essential.

Departure from that principle would only lead to reprisals and in no other social service are reprisals easier than they are in broadcasting.

Nothing attracts so much publicity as a new list of B.B.C. pronunciations and it is clear that quite an army of critics is at present nursing a grievance against Savoy Hill for daring to have the temerity to lay down rules respecting the English tongue.

Curiously, too, a feeling exists which seems to approach pretty close to fear, as regards the influence which the B.B.C. may exercise on local dialect through what have been termed "arbitrary" decisions as to the way

in which certain words should be spoken.

The general misapprehension is voiced by one critic who said that "the efforts of the B.B.C. to lead us in the correct ways of pronunciation are not without a certain pathos." Heaven alone knows why.

Is it not, however, very probable that such criticism is in itself pathetic? For it misses entirely the purpose of the B.B.C. in having an Advisory Committee which formulates rules for the Corporation's officials' own guidance.

For Announcers

Savoy Hill never intended to do more than standardise the pronunciation of the announcers at its various stations. Prior to the institution of the Advisory Committee, it was frequently pointed out to the B.B.C. that its announcers did not appear to be in agreement in matters of pronunciation.

Sometimes listeners would request a ruling from Savoy Hill upon a certain word and when it had been given, according to the Savoy Hill standard, the inquirer would retort: "Then why did the announcer at — station, last Tuesday, say something different?"

Such cases did not call for disciplinary action against the harassed announcer; he could, perhaps, produce sound authority to support his case, if he were asked for it.

SHOULD THE B.B.C. JAM MOSCOW?—Contd.

But these cases did point to the need for setting the B.B.C. house in order and regularising debatable words. Thus the meticulous mind is robbed of the opportunity of regarding the home of broadcasting as a modern Tower of Babel.

Programme Referendum

The October issue of WIRELESS MAGAZINE contained the first intimation of the B.B.C.'s intention to explore the possibility of conducting a referendum on its programmes; and it was explained that as a beginning a statistical survey would be made of the tastes, habits and requirements of listeners in the field of broadcast education.

It is obvious that the task of building a talks programme would be greatly simplified if the views of different sections of listeners could be obtained. It would, for instance, make it easier to determine the most appropriate method of presentation for different kinds of talks and discussions and the most suitable timing in particular for educational talks.

Ways and means of making an inquiry on these lines are calling for the careful consideration of the Central Council for Broadcast Adult Education, the B.B.C. and statistical experts.

After a suitable method of approach has been determined, the wider question will be considered of extending the investigation to cover all broadcast programmes; for, as WIRELESS MAGAZINE pointed out three months ago, if the onus of settling what the public would like can be thrown back upon listeners themselves, so much the easier it will be for the programme staff at Savoy Hill.

"War" at Savoy Hill

In the meantime, a correspondent, evidently intrigued by the WIRELESS MAGAZINE statement, proceeded to evolve in another quarter a theory that the day of broadcast educational talks was done; that what listeners wanted was entertainment and not education and that an educational "war" was developing at Savoy Hill.

The hint at dissension in the B.B.C. camp was quoted widely, without any effort being made to verify the facts. Indeed, if such an effort had been made there would have been nothing

but the skeleton of a story; for certainly no skeleton is to be found in the B.B.C. cupboard.

Some difference of opinion does exist in the Talks Department at Savoy Hill; but it may be summed up in this way: one school of thought favours the development of the group discussion system in order to cater for the adolescent. Whereas children and adults are avowedly considered in the broadcast programmes, the adolescent is as yet largely outside the scope of broadcasting activities.

The peculiar characteristics of his age prevent his getting much benefit from either the children's or the adults' programme and he remains neglected at an age when he is most in need of help and influence. He is best to be reached in the environment in which his life is spent.

IF IT'S ANY-
THING RADIO
—WRITE TO
"W.M." ABOUT
IT!

We Are Always
Glad to Hear
Our Readers'
Views on All
Wireless Matters

The other school of thought inclines to the belief that group listening is not of paramount importance; that while it is desirable to find a place in the sun for the adolescent listener, the conditions under which he shall be encouraged to the receiving set are merely matters of personal convenience.

Hence he and others who are most nearly concerned with educational broadcast reception should be given the opportunity of expressing their predilections, if they have any, on such questions as the timing of the educational talks and similar details.

This emphatically does not indicate any weakening in policy as regards the principle of adult broadcast education. When one considers that more than 100,000 copies of the B.B.C.'s talks' syllabus are distri-

buted each session, and that the circulation of some of the Aids to Study pamphlets has reached 30,000, it is superfluous to inquire whether the educational talks have a public or not.

Why, it may be asked, did the B.B.C. decide to extend the survey at some future date to include the general programmes?

Proving Impartiality

The explanation is that the higher officials ruled that in order to be absolutely impartial and to avoid any semblance of special regard for educational broadcasting, the proposed statistical survey should contain the widest possible terms of reference.

The really difficult job is to formulate the method of undertaking the survey; but it is certain that broadcasting programmes of the future will be framed along lines of what listeners themselves desire.

The significance of the decision to lease a site at Westerglen, near Falkirk, for the Scottish dual transmitters, is that the Aberdeen station is to remain in service when the regional scheme is completed.

Aberdeen listeners, who have been particularly zealous and vocal in the matter of their local broadcasting service, will be glad that technical considerations, among others, have cast the die in favour of the retention of their local transmitter.

It should be stated that no adamant rule has been laid down by the B.B.C. over the future of the existing transmitters in other parts of Great Britain.

Local Necessities

The introduction of the regional system of broadcasting was, it may be remembered, regarded by many listeners as a scheme for the entire replacement of low-power transmitters; but Savoy Hill has always held the view that local necessities should be kept in mind.

Where listeners have been catered for locally in districts which are not definitely within the service area of a regional transmitter, then the drastic step of closing down the local transmitter should be at any rate postponed. Aberdeen is not the only case in point. Newcastle and Plymouth will come within the same category.

An Invaluable and
Authoritative Source of
Up-to-the-minute Construc-
tional Information for Old
Hands and Beginners Alike

This is the Fourth Con-
secutive Special Supplement
to be presented with
"Wireless Magazine"—Keep
It for Future Reference

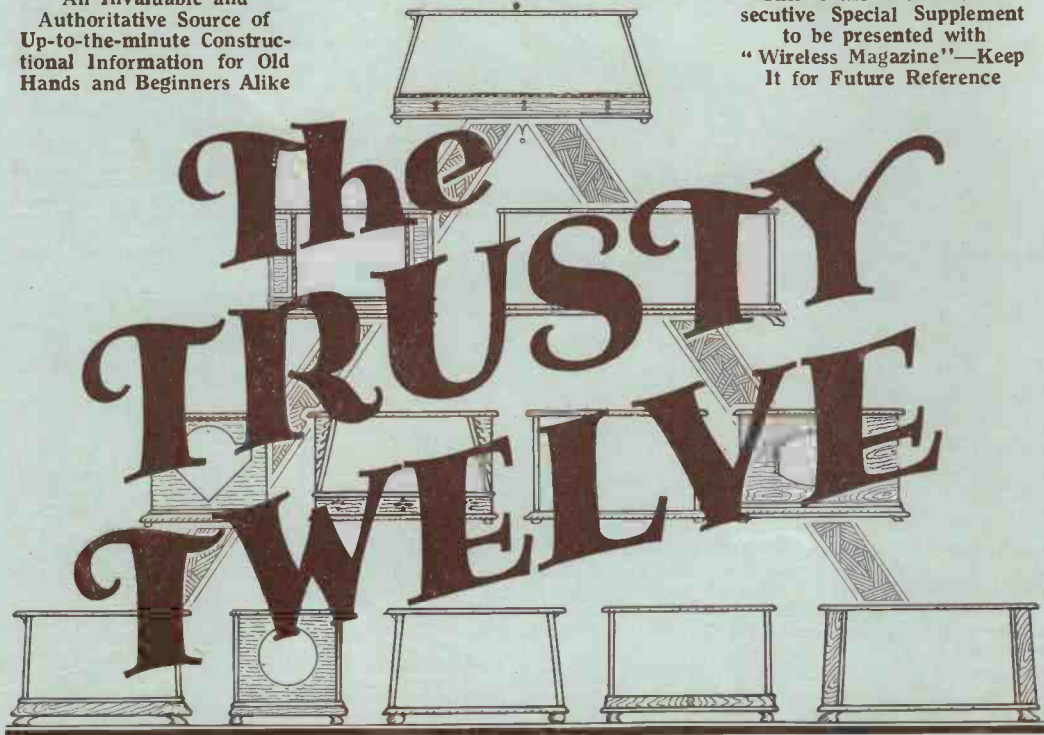

IN this supplement we present details of twelve home-constructor sets and mains units—we have called them the Trusty Twelve—that cover every listening and gramo-radio need. All of them have been used and tested by numerous readers; you can build any with absolute confidence.

To encourage as many readers as possible to build one of these up-to-date receivers—we believe that far too many obsolete sets are still in use—we are offering full-size blueprints of any of the Trusty Twelve for a limited period at half-price.

This means that you can get a full-size blueprint, layout and wiring chart with all the connections separately numbered for 6d. if the set does not contain more than three valves and for 9d. if more than three valves are employed. No such offer has ever before been made to constructors and we are prepared to supply, without delay, the thousands of copies that readers will want. Use must be made of the special coupon on Page Nine if advantage is to be taken of this fine offer.

A whole page is devoted to details of each receiver—there is a circuit diagram, reduced-scale layout and wiring guide, photographs, and a complete component specification for each design.

A feature of particular value about the specification is that the price of each individual part is indicated. If you already have a number of parts on hand you can in a few moments estimate the cost of the remainder of the components needed for any particular set.

The Trusty Twelve—all reader-tested sets, remember—comprise a battery-operated two-valver, two battery three-valvers, two battery four-valvers and a battery-operated five-valver with two screened-grid stages; also

an A.C. three-valver, A.C. four-valver, a portable screened-grid three, and a three-valve short-waver. For those who want to convert a battery set for mains operation, there is an A.C. high-tension unit and a D.C. unit.

From this fine selection you will be able to select a design to suit your needs. Every set is up to date and the component parts can be obtained without difficulty.

Following is a complete index to the contents of this special home-constructor's supplement.—

New Brookman's Three	Page Two
Dual-screen Five	Page Three
Regional A.C. Four	Page Four
Which Set Shall I Build?	Page Five
Five-point Two	Page Six
James' Portable S.G.3	Page Seven
"W.M." Standard A.C. Unit	Page Eight
How to Use A "W.M." Blueprint	Page Nine
Five-point Four	Page Ten
Falcon (A.C.) Three and Mains Unit	Page Eleven
Five-point Short-waver	Page Twelve
Practical Hints and Tips	Page Thirteen
Regional Band-pass Four	Page Fourteen
Five-point Three	Page Fifteen
"W.M." Standard D.C. Unit	Page Sixteen

If you have never yet taken advantage of the WIRELESS MAGAZINE full-size blueprint service, here is your chance. Not only do these blueprints show the exact position of every component, but each connecting wire is numbered separately in the most convenient order of assembly. You cannot go wrong or miss out a connection if you work from a "W.M." blueprint. Tell your friends if they do not already know!

Have Better Radio with One of These Sets!

THE NEW BROOKMAN'S THREE Approved by W. James

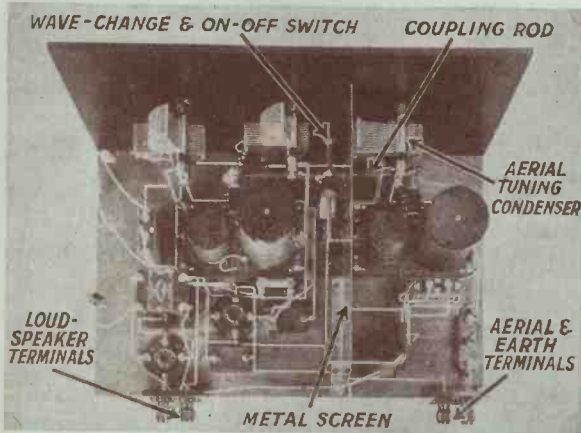

From this plan view of the New Brookman's Three the disposition of all the components will be clear

THIS set is a revised and cheapened version of W. James' original Brookman's Three—the most popular set ever described in WIRELESS MAGAZINE. The original set was first described in October 1929 and the New Brookman's Three was published in November, 1930.

Use is made of the famous Binowave coils designed for WIRE-

LESS MAGAZINE by W. James. In this design a single wave-change switch controls both coils.

Even when used close to a regional transmitter this receiver is sufficiently selective to ensure the reception of a large number of Continental programmes.

Hundreds of readers are getting good results from this set. Why not try it yourself?

COMPONENTS NEEDED

COILS

- 1—Pair of Wearite Binowave coils, types A and C, with ganging device. £1 17s.

CONDENSERS, FIXED

- 1—Graham-Farish .0001-microfarad, 1s. (or Lissen, Edison Bell).
- 1—Graham-Farish .0002-microfarad, 1s. (or Lissen, Edison Bell).
- 2—Franklin 1-microfarad, 4s. (or Lissen, Mullard).

CONDENSERS, VARIABLE

- 2—Formo .0005-microfarad, 9s. (or Utility, Jackson).
- 1—Formo .00035-microfarad, 4s. 6d. (or Utility, Jackson).

- 1—Sovereign pre-set, .0003-microfarad maximum, 1s. 6d. (or Formo, Ormond).

DIALS, SLOW-MOTION

- 2—Ormond, 5s. (or Brownie, Utility).

EBONITE

- 1—Red Triangle panel, 16 in. by 8 in. 8s. (or Becol, Trelleborg).
- 2—Junit terminal blocks, 1s. 4d. (or Lissen, Belling-Lee).

HOLDER, GRID-LEAK

- 1—Bulgin, type G6, 9d. (or Lissen, Dubilier).

HOLDERS, VALVE

- 2—Brownie, 2s. (or Clix, W.B.).

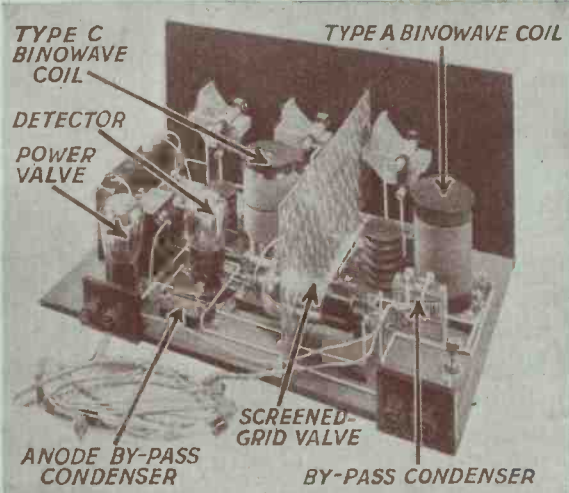

This set is ideal for those who want a powerful but not too expensive receiver which is also very selective.

- 1—Parex screened-grid, 2s. (or W.B. Junit).

PLUGS

- 6—Belling-Lee, marked: Grid—1, Grid—2, H.T.+1, H.T.+2, H.T.+3, H.T.—, 1s. 6d. (or Clix, Ealex).

RESISTANCE, FIXED

- 1—Lissen 2-megohm, 1s. (or Watmel, Dubilier).

RESISTANCE, VARIABLE

- 1—Wearite 15-ohm, 1s. 6d. (or Lissen, Ormond).

TRANSFORMER, L.F.

- 1—Varley Ni-core 2, 17s. 6d. (or Lewcos, Philips).

ACCESSORIES

BATTERIES

- 1—Pertrix 120-volt, standard type, 15s. 6d. (or Ever Ready, Grosvenor).
- 1—Pertrix 9-volt grid-bias, 1s. 6d. (or Ever Ready, Grosvenor).
- 1—Exide 2-volt accumulator, type CZG4, 13s. 6d. (or C.A.V., Lissen).

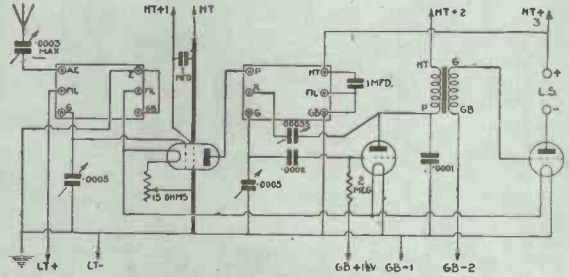

The circuit of the New Brookman's Three comprises a screened-grid stage, leaky-grid detector, and power valve

SUNDRIES

- Glazie insulated wire for connecting.
- Rubber-covered flex for battery leads.
- 1—Knob for reaction condenser.
- 1—Pair Lissen panel brackets, 8d. (or Keystone, Camco).
- 1—Parex screen to specification, 2s. 9d. (or Ready Radio, H. & B.).

CABINET

- 1—Osborn, with 10-in. baseboard, 15s. (or Lock, Carrington).

LOUD-SPEAKER

- 1—Tunewell cabinet cone, £3 3s. (or Blue Spot, Loewe).

VALVES

- 1—Cossor 220SG, £1 (or Mullard PM12, Dario SG).
- 1—Cossor 210HF, 8s. 6d. (or Mullard PM1HF, Dario Super HF).
- 1—Cossor 220P, 10s. 6d. (or Mullard PM2, Dario SP).

TERMINALS

- 4—Belling-Lee, type B, marked: Aerial, Earth, L.S.—, L.S.—, 2s. (or Igranic, Clix).
- 2—Belling-Lee spades, marked: L.T.—, L.T.—, 9d. (or Clix, Ealex).

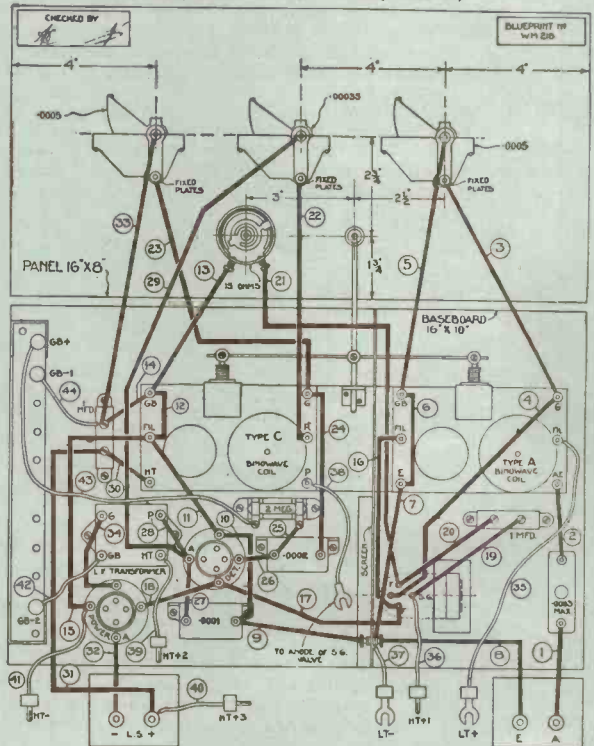

As can be seen from this diagram, the layout is quite straightforward and wiring is not difficult

THE DUAL-SCREEN FIVE

A reactionless set with two screened-grid stages. Fine grammo-radio combination.

THIS receiver is an attempt to produce a powerful set to get plenty of foreign stations without reaction. Two screened-grid valves are used for this reason.

That this object has been achieved is proved by a report from a reader in Paris, who has been able to get forty stations on the loud-speaker—"under very bad conditions," he adds.

Not only is the receiver excellent

The Dual-screen Five is an excellent receiver and you will not be disappointed with the results if you build it.

Full details were published in March, 1930.

COMPONENTS NEEDED

CHOKE, LOW-FREQUENCY

1—Varley, type DPI2, £1 1s. (or Climax, Formo).

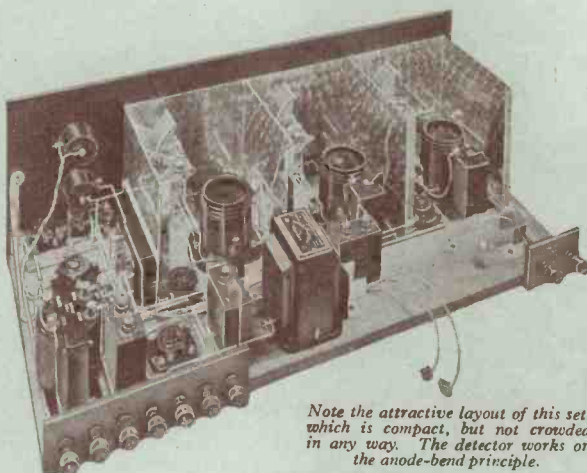

Note the attractive layout of this set, which is compact, but not crowded in any way. The detector works on the anode-bend principle.

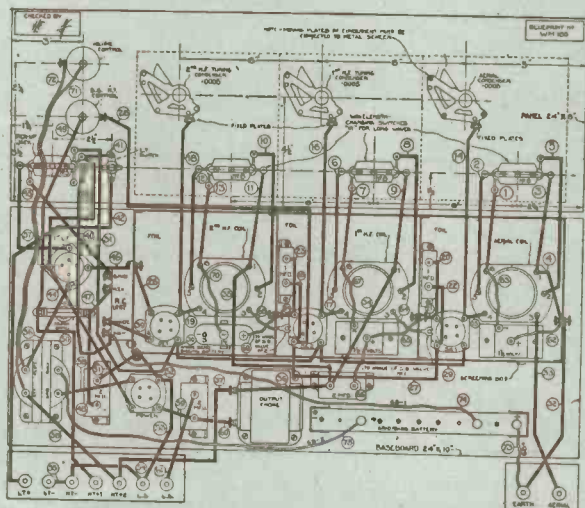

The Dual-screen Five is a fine set for those who want quality of reproduction—here is a much reduced wiring diagram

for radio reception, but provision is also made for the use of a pick-up, so that gramophone records can be reproduced electrically.

For the sake of quality an anode-bend detector is used, this being followed by two stages of low-frequency amplification.

Separate tuning condensers are used for the high-frequency transformers, which are, of course, of the dual-range type. A choke-capacity output circuit is incorporated.

Volume Controls

Two volume controls are provided, one on the high-frequency side and the other on the low-frequency side. Both can be used for radio reception, while the second only is employed for controlling the volume of records.

Every precaution has been taken to get the most out of the screened-grid stages—adequate screening is provided and each valve has a separate grid-bias cell.

In order to prevent motor-boating, the detector-valve anode circuit includes a decoupling resistance and by-pass condenser. The pick-up is put in circuit when needed by means of a jack mounted at the right of the front panel. This can, of course, be omitted if desired.

COILS

3—Colvern high-frequency transformers, type T2R, £1 7s. 6d.

CONDENSERS, FIXED

2—T.C.C. 1-microfarad, 5s. 8d. (or Dubilier, Lissen).

3—T.C.C. 2-microfarad, 11s. 6d. (or Dubilier, Lissen).

CONDENSERS, VARIABLE

3—Ormond .0005-microfarad, with pointer dials, type R/375, £1 1s. (or Jackson, Polar).

EBONITE

1—Lissen 24 in. by 8 in. panel, 11s. 6d. (or Ready Radio, Becol).

2—Terminal strips, 7½ in. by 2 in. and 3 in. by 2 in.

HOLDERS, VALVE

5—Benjamin Vibroholders, 7s. 6d. (or Lotus, Burton).

PLUGS

3—Belling-Lee wander plugs, marked: Grid+1, Grid-2, 9d. (or Exelec, Clix).

RESIST.-CAPACITY COUPLING

1—Edison Bell, type R/380, 4s. 3d. (or Dubilier, Varley).

RESISTANCE, FIXED

1—Graham-Farish 50,000-ohm with holder, 2s. 9d. (or Ready Radio, Ediswan).

SUNDRIES

Glazite insulated wire for connecting. Length of rubber-covered flex.

1—Pair Keystone panel brackets, 2s.

SWITCHES

3—Lotus No. JS8, jack type, 10s. 6d.

1—Lotus No. JK5 jack, 3s.

1—Lotus plug, 2s.

1—Benjamin on-off switch, 1s. 9d. (or Burton, Gripso).

TERMINALS

9—Belling-Lee insulated terminals.

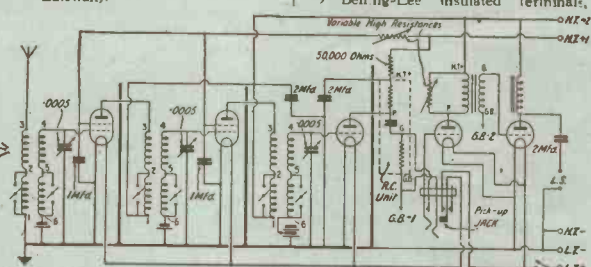

This set has two screened-grid valves, anode-bend detector, resistance-coupled low-frequency stage and transformer-coupled power valve

RESISTANCES, VARIABLE

2—Harlie Volustats, 15s. (or Clarostats, Regentstats).

SCREEN

1—Parex copper screening box, £1 1s. (or Ready Radio, Keystone).

marked: Aerial, Earth, L.S.+
L.S.—, H.T.+1, H.T.+2, H.T.—,
L.T.+1, L.T.—, 4s. 6d. (or Clix,
Burton).

TRANSFORMER, L.F.

1—Ediswan shrouded type, £1 2s. 6d. (or Sifam, Formo).

ACCESSORIES

BATTERIES

3—Ever Ready 54-volt, type W33, £2 14s. (or Siemens, Obeta).

1—Ever Ready 16-volt, type GB2, 3s. 6d. (or Siemens, Obeta).

2—Siemens 1½-volt, type GT, 9d. (or Ever Ready).

1—Siemens 4½-volt, type G1, 1s. 3d. (or Ever Ready).

1—Lissen 2-volt accumulator, 60-ampere hour, 17s. 6d. (or Young, C.A.V.).

CABINET

1—Ready Radio, upright type, £2.

LOUD-SPEAKER

1—Ultra double-diaphragm, type U14, £5 5s. (or Brown, Blue Spot).

VALVES

2—Marconi S215, £2 (or Mazda 215SG, Cossor 220SG).

1—Marconi HL210, 8s. 6d. (or Mazda HL210, Cossor 210HF).

1—Marconi L210, 8s. 6d. (or Mazda L210, Cossor 210LF).

1—Marconi P240, 13s. 6d. (or Mazda P220, Cossor 220P).

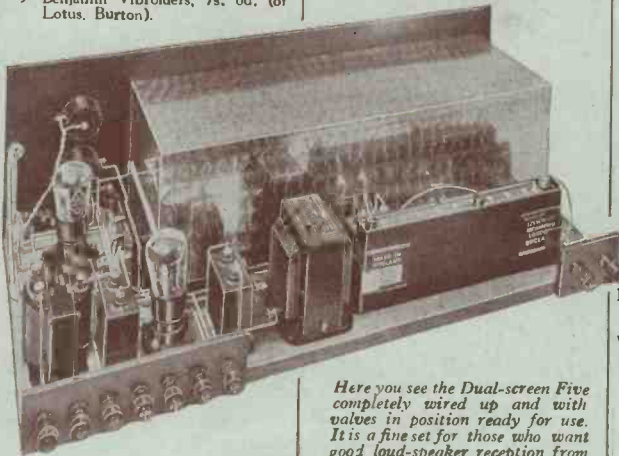

Here you see the Dual-screen Five completely wired up and with valves in position ready for use. It is a fine set for those who want good loud-speaker reception from many Continental stations.

THE REGIONAL A.C. FOUR

This set, designed by W. James, has band-pass tuning and takes all its current from A.C. mains

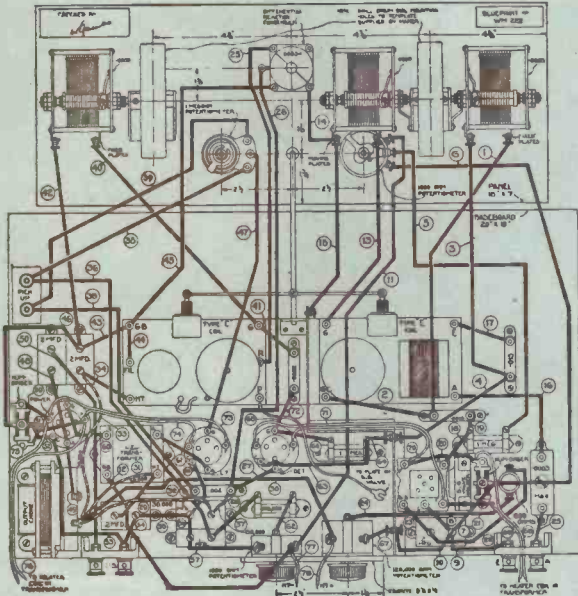

You will get a good idea of the layout of the Regional A.C. Four from this reduced wiring diagram

A FINE all-electric design by W. James for those who want an up-to-date gramo-radio combination is the best description of the Regional A.C. Four.

The set has been built to fit a standard gramo-radio cabinet and for this reason the mains unit is separate from the receiver itself.

A.C. current from the mains is rectified to D.C. for supplying to the valve anodes by means of a metal rectifier.

The anode circuit of each of the first three valves is provided with

a voltage-regulating resistance which also acts as a decoupler. There is no risk of motor-boating.

A feature of the set is the use of the famous Binowave coils, which have contributed to the success of so many WIRELESS MAGAZINE receivers.

The Regional A.C. Four can be relied on to give excellent results wherever it may be used. The construction was fully described in December, 1930, by W. James. Since then many good reports have been received from readers all over the country.

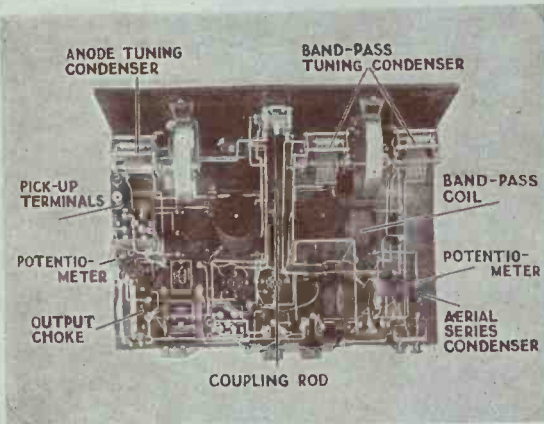

A plan view of the set, which takes all its current (even grid bias) from the A.C. mains

PARTS YOU WILL NEED

CHOKES, LOW-FREQUENCY

- 1—Igranite, type C30, 15s. 6d. (output choke).
- 1—Parmeko, £1 7s. 6d. (smoothing choke).

COILS

- 1—Pair of Wearite Binowave coils, types C and E, with ganging device, £1 17s.

CONDENSERS, FIXED

- 1—T.C.C. .0002-microfarad, upright type, 1s. 6d. (or Dubilier, Lissen).
- 1—T.C.C. .0005-microfarad, upright type, 1s. 6d. (or Dubilier, Lissen).
- 1—T.C.C. .002-microfarad, upright type, 1s. 10d. (or Dubilier, Lissen).
- 1—T.C.C. .015-microfarad, upright type, 3s. 3d. (or Dubilier, Lissen).
- 1—Franklin 1-microfarad, 2s. (or T.C.C., Hydra).
- 5—Ferranti 2-microfarad, 15s. (or Mullard, T.C.C.).
- 5—Franklin 2-microfarad, 13s. 4d. (or T.C.C., Mullard).

CONDENSERS, VARIABLE

- 3—Polar .0005-microfarad Universal ganged condensers, £1 2s. 6d.

RESISTANCES, FIXED

- 1—Magnum 600-ohm, 1s. 6d. (or Bulgin).
- 1—Magnum 80,000-ohm, spaghetti type, 2s. (or Bulgin).
- 2—Magnum 30,000-ohm, spaghetti type, 3s. (or Bulgin).
- 1—Magnum 20,000-ohm, spaghetti type, 1s. 6d. (or Bulgin).
- 1—Lissen 100,000-ohm, grid-leak, 1s.
- 2—Lissen 1-megohm grid leaks, 2s. (or Watmel).

RESISTANCES, VARIABLE

- 2—Clarostat 30-ohm potentiometers, 5s. 6d.
- 2—Regentstat 1,000-ohm potentiometers, 19s.

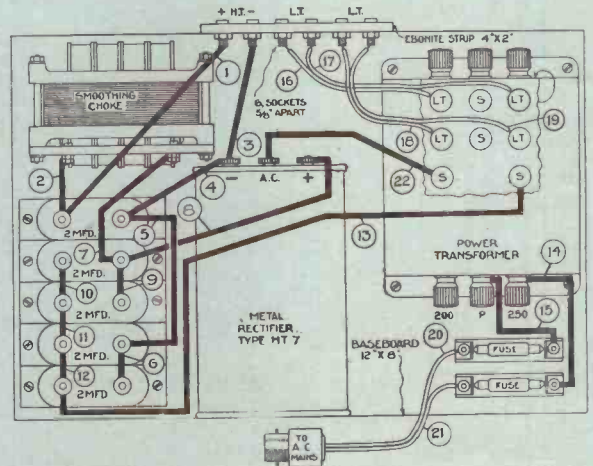

Here is a separate wiring diagram of the mains unit. A blueprint of this is supplied with the blueprint of the set itself

- 1—Lotus .00034-microfarad differential, 8s. 6d.
- 1—Formo pre-set, .0003-microfarad 1s. 6d. (or Sovereign, Lewcos).

DIALS

- 2—Polar, drum drive, 17s.

EBONITE

- 1—Trelleborg 18 in. by 7 in. panel, 10s. 6d. (or Becol, Lissen).
- 3—Belling-Lee terminal blocks, 2s. (or Lissen, Junit).
- 1—Panel, 5 in. by 2 1/2 in.
- 1—Panel, 4 in. by 2 in.

FUSES

- 2—Microfuses, 250-milliamper type, with holders, 5s.

HOLDERS, GRID-LEAK

- 3—Bulgin, 2s. 3d.

HOLDERS, VALVE

- 3—Telsen five-pin, 3s. 9d. (or W.B., Lotus).

METAL RECTIFIER

- 1—Westinghouse, type HT7, £1 1s.

PLUGS

- 6—Belling-Lee, marked: H.T.+, H.T.—, L.T.—(4), 1s. 6d.
- 6—Belling-Lee sockets, 1s. 6d.

- 1—Regentstat 120,000-ohm potentiometer, 11s. 6d.
- 1—Igranite 1-megohm potentiometer, type 2233/9, 6s.

SUNDRIES

- Glazite insulated wire for connecting.
- Rubber-covered flex for battery leads.
- 1—Peto-Scott screw to specification, 4s. 6d.

TERMINALS

- 6—Ealex, marked: Aerial, Earth, L.S.—, L.S.—, Pick-up+, Pick-up—, 2s. 3d. (or Igranite, Burton).

TRANSFORMER, L.F.

- 1—Varley Ni-core II, 17s. 6d. (or Telsen, Ferranti).

TRANSFORMER, MAINS

- 1—Regentone, type WRM, £1 7s. 6d.

ACCESSORIES

- 1—Carrington Waveflex radio-gramophone model, £5 10s.

VALVES

- 1—Mullard S4VB, £1 5s.
- 1—Mullard 354, 15s.
- 1—Mullard 164V, 17s. 6d.
- 1—Mullard 064, 16s.

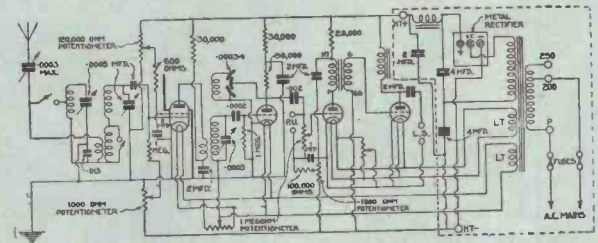

The valve combination is a screened-grid amplifier, leaky-grid detector, a resistance-coupled low-frequency stage and a transformer-coupled power valve



WHICH SET SHALL I BUILD?

Some practical advice to beginners.

UNLESS the listener has pre-conceived ideas on the subject, it is always a difficult matter to decide on what particular type of set will best meet individual needs. We have therefore prepared the following notes about the Trusty Twelve in order to simplify the choice of the best set.

Batteries or Mains

Probably the first point that the constructor will wish to decide is whether to build a battery-operated or a mains set.

If the house in which the receiver is to be used has a D.C. (direct-current) electric-light supply, then a battery-operated set, either with or without a mains unit for high tension, is the best proposition.

If A.C. (alternating current) mains are available, many listeners will prefer to have a set taking all its power from the electric supply. Provided that ordinary precautions are taken there is no danger either

Really good reception of a fair number of Continental stations is assured by the use of either of the three-valve sets detailed in these pages, and between these the cost of construction will probably be the deciding factor.

The reception of foreign transmissions will be easier and better if one of the four-valve sets is used. We would point out here that the set with band-pass tuning is, of course, more selective than the other; incidentally it is more expensive.

The five-valve set can be recommended to those who want to receive a large number of stations at really good quality, for the particular design dealt with in this supplement dispenses with a reaction control and the reproduction is therefore more than ordinarily pure.

Many constructors of so-called battery-operated sets will desire to obtain the high-tension supply



There is a thrill for every listener who builds his own set when he connects it up for the first time!

low-tension accumulator. In these pages details are given of two such high-tension units, one for use with D.C. mains, and the other for A.C. mains.

A point that should not be overlooked by the prospective constructor is the inclusion in the circuit of some means of connecting an electromagnetic pick-up for the reproduction of gramophone records. A number of sets illustrated in these pages are arranged for the convenient use of a pick-up when desired.

Lastly, for those who want a portable set, there is a battery-operated screened-grid "three," while others who are interested in the possibility of ultra short-wave reception from distant parts of the earth should not overlook the special three-valver intended for this purpose.

It is not at all easy to discuss the capabilities of a set in terms of distance from a particular broadcasting station. For instance,

London listeners with a three-valve set find it much easier to get Rome than to pick up Bourne-mouth, although the former is so far away.

Not only do the powers of broadcasting stations vary considerably, but they also employ varying degrees of modulation, with a consequent variation in range for a given power.

However, it is possible to be a little more definite in respect of the British stations.

Regional Reception

If it is desired to get only one of the high-power regional stations on the loud-speaker, then a two-valver will be suitable for distances up to fifty miles under normal conditions. Such a set might give good results 200 miles away, but the fifty-mile range can almost be guaranteed.

A three-valve set will give the regional transmissions at good up to a distance of 100 miles, but for greater ranges than this a four-valve receiver is recommended, unless the constructor can find out definitely from friends or a radio dealer that a smaller set is good enough for the locality.

Ask a Friend

It is always a good plan to discuss reception conditions of one's immediate localities with somebody who already has a radio set in use.

It is true that not all three-valve sets will give the same results, but you may be able to find out definitely that a two-valver will not give the particular stations you require in a particular neighbourhood.

There is also the question of variations in individual aerial and earth systems. Some indoor aerials are better than outdoor aerials, for instance.

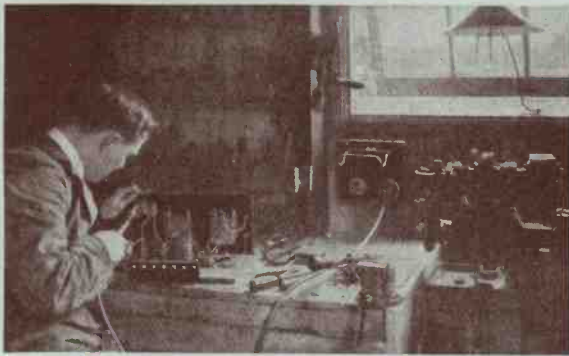

J. H. Reyner, Technical Editor of WIRELESS MAGAZINE, at work on an experimental set at the Elstree laboratories

in the construction or operation of such a set.

In this supplement details are given of an A.C. three-valver and an A.C. four-valver. Either of these sets will give satisfactory service, but of course the latter is more powerful. It should be remembered, however, that because of the high efficiency of modern mains valves a mains "three" will in most cases be as powerful as a battery-operated four- or five-valver.

Six Designs

If a battery-operated set is desired, the constructor has the choice in these pages of six different designs—a "two," two "threes," two "fours," and a five-valver. The two-valver is, of course, intended only for the reception of local stations, but under favourable conditions it will also pick up a number of foreign programmes.

from electric-light mains when these are available, although the valve filaments are still run from a

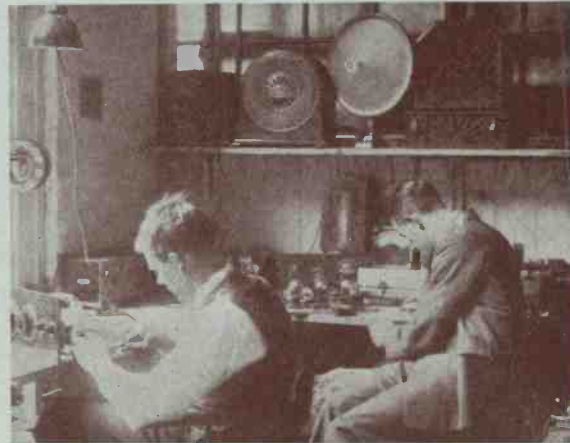

Radio-set construction is one of the most interesting hobbies anybody can have



THE FIVE-POINT TWO

A two-pin plug-in coil set that has a wave-change switch to avoid changing coils

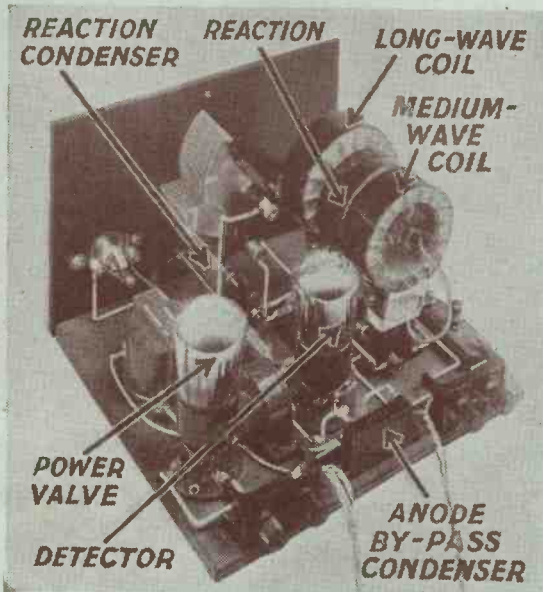

The simple design of the set is clear from this photograph, which shows the valves and coils in position

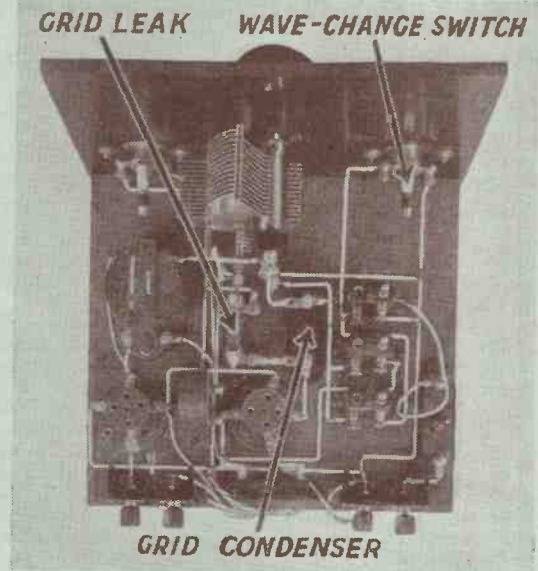

From this plan view the disposition of all the parts is clear. The cost of components is very low

EIGHT medium-wave stations on the loud-speaker have been obtained by a Plymouth constructor of the Five-point Two, which was fully described in

"W.M." for December, 1930. Although plug-in coils are used a single switch enables the operator to cover both wavebands.

This little set can be relied on to give really satisfactory loud-speaker reproduction within fifty miles or so of a regional transmitter under average aerial-and-earth conditions. A number of Continental stations may also be heard.

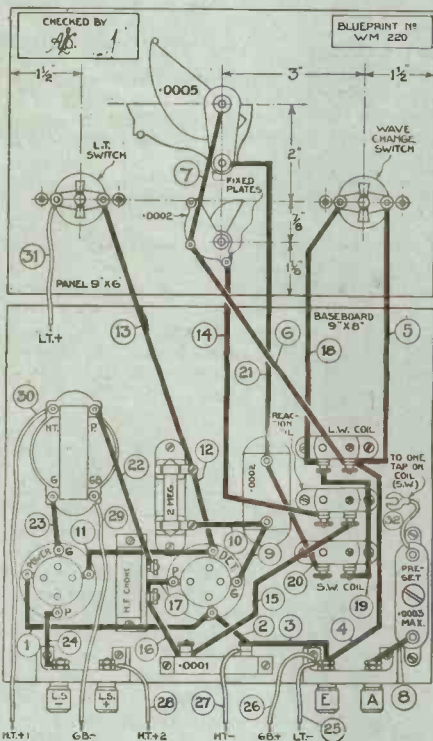

This wiring diagram shows how simple the set is to connect up—the construction will not take more than an hour or so

PARTS YOU WILL NEED

- CHOKE, HIGH-FREQUENCY**
 1—Telsen, 2s. 6d. (or Igranic, Lissen).
- COILS**
 1—Atlas No. 40 plug-in, 2s. 6d. (or Lewcos, Tunewell).
 1—Atlas No. 150 plug-in, 3s. 6d. (or Lewcos, Tunewell).
 1—Atlas No. 60 double-tapped plug-in, 2s. 6d. (or Lewcos, Tunewell).
- CONDENSERS, FIXED**
 1—Dubilier .0001-microfarad, upright type, 1s. 8d. (or Graham-Farish, Edison Bell).

- 1—Dubilier .0002-microfarad, 1s. 8d. (or Graham-Farish, Edison Bell).
- CONDENSERS, VARIABLE**
 1—Ormond .0005-microfarad, type R/426, with slow-motion dial, 6s. (or Jackson, Lotus).
 1—Burton .0002-microfarad reaction, 4s. (or Bulgin, Formo).
 1—Polar preset, .0003-microfarad maximum, 2s. (or Igranic, Lewcodenser).
- EBONITE**
 1—Becol, 9 in. by 6 in. panel, 3s. 3d. (or Lissen, Red Triangle).
 2—Belling-Lee terminal blocks, 1s. 4d. (or Junit, Lissen).

- RESISTANCE, FIXED**
 1—Dubilier 2 megohm, 1s. 9d. (or Walmel, Lissen).
- SUNDRIES**
 Insulated wire for connecting (Clarite). Length of rubber-covered flex (Lewcoflex).
- SWITCHES**
 1—Gripso single-pole, marked "On" and "Off", 1s. 9d.
 1—Gripso three-point, marked "Long" and "Short", 2s.
- TRANSFORMER, L.F.**
 1—Igranic Midget, ratio 1 to 3, 10s. 6d. (or Telsen, Brownie).

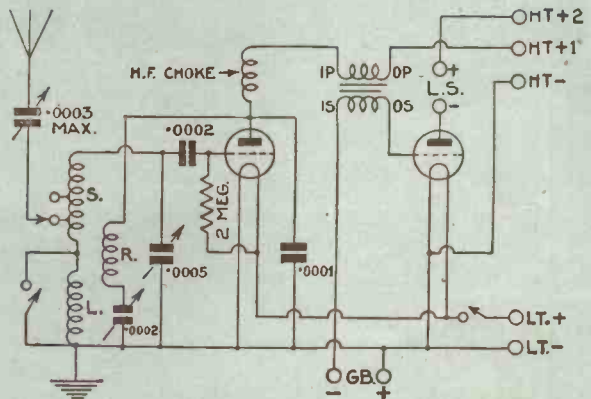

A leaky-grid detector followed by a transformer-coupled power valve is the combination used in the Five-point Two

- HOLDERS, COIL**
 3—Lissen, 3s. (or Lotus, Magnum).
- HOLDER, GRID-LEAK**
 1—Bulgin, type G6, 9d. (or Lissen).
- HOLDERS, VALVE**
 2—Clix 4/5 pin type, 1s. 8d. (or Benjamin, W.B.).
- PLUGS**
 5—Belling-Lee, marked: H.T.+2, H.T.+1, H.T.—, G.B.+ , G.B.—, 1s. 3d. (or Ealex, Clix).
 2—Belling-Lee spades, marked: L.T.+ , L.T.—, 9d. (or Igranic, Burton).

- ACCESSORIES**
- BATTERIES**
 1—Pertrix 120-volt, standard type, 15s. 6d. (or Ever Ready, Siemens).
 1—Pertrix 9-volt grid bias, 1s. 6d. (or Ever Ready, Siemens).
 1—C.A.V., 2-volt accumulator, type 2AG7, 11s.
- CABINET**
 1—Camco V.B., oak, 11s. 6d.
- VALVES**
 1—Marconi H2, 8s. 6d. (or Osram H2).
 1—Marconi P215, 10s. 6d. (or Osram P215, Mullard PM2).

THE JAMES PORTABLE S.G.3

As good as most four-valves!

"It is, as claimed, as good as most four-valve sets," says a Sevenoaks reader in reference to the James Portable S.G. 3. We have had many other enthusiastic reports about this receiver from all over the country.

The success of the set is due in large measure to the use of a special dual-range screened-grid coupling coil specially designed by W. James for this receiver.

Another feature of the set is that it is built up entirely on an

aluminium chassis that acts as an effective screen between the components. But that is not the case, for the dimension marks have been omitted from the blueprint for they would be superfluous on a full-scale drawing.

Little difficulty will be experienced in assembling the set if use is made of a metal chassis that is already drilled for fixing the components. Any of the well-known kit dealers will be able to supply the chassis ready for use.

We have received favourable

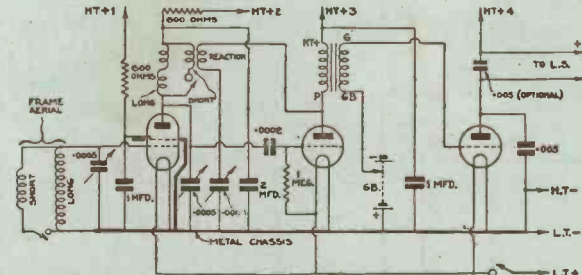

The circuit incorporates a screened-grid high-frequency amplifier, leaky-grid detector and a transformer-coupled power stage

reports from listeners all over the country, and considering its performance, the cost of construction of this portable set is very reasonable. Following is a complete list of all the components that will be required for the construction —

In spite of the fact that only three valves are used (the combination is actually a screened-grid high-frequency stage, leaky-grid detector, and a transformer-coupled power valve), it is possible to pick up a fair number of foreign stations at good strength on this portable set.

The chassis is arranged to fit into the suitcase type of portable cabinet, the batteries being arranged at the back of the case in the ordinary way. The loud-speaker and dual-wave frame aerial are contained in the lid of the cabinet.

Apart from the aluminium chassis and the special tuning coil, all the parts used in the James Portable S.G. 3 are standard and can be obtained without difficulty. Full constructional details were given in the July 1930 issue of WIRELESS MAGAZINE.

If it is desired to make the dual-range coil at home, full winding details will be found on page 82 of the August 1930 issue of WIRELESS MAGAZINE. Many constructors, however, will prefer to buy the coil already wound.

Any reader might be excused for supposing, after a glance at the layout diagram reproduced below, that the set is difficult to construct.

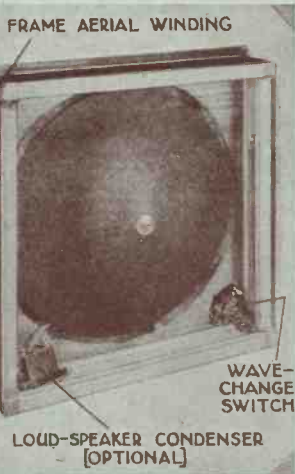

Here you see how the aerial and loud-speaker are mounted on a wooden frame that fits into the lid of a suitcase-type portable cabinet

COMPONENTS REQUIRED

- CONDENSERS, FIXED**
 1—T.C.C. .0002-microfarad, type SP, 2s. 4d.
 1—T.C.C. .005-microfarad, 2s. 6d. (or Igranic, Ormond).
 1—T.C.C. .005-microfarad, 2s. 6d. (or Edison Bell, Magnum). N.B.—This is optional across loud-speaker.

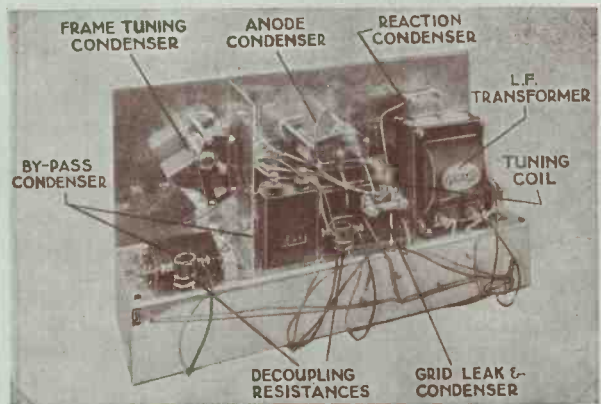

This photograph shows how the components are mounted on the aluminium chassis, which also acts as an efficient screen

- 2—T.C.C. 1-microfarad, 5s. 8d. (or Dubilier, Hydra).
 1—Dubilier 2-microfarad, type BT, 3s. 6d. (or Lissen, Hydra).
CONDENSERS, VARIABLE
 2—Jackson Tiny, with dials, .0005-microfarad, £1 (or Formo).
 1—Lotus .00034-microfarad reaction, type RC/34, 5s. 6d.
HOLDERS, VALVE
 3—W.B. rigid type, 3s. (or Lotus, Benjamin).
PLUGS
 7—Belling-Lee wander plugs, marked: H.T.—, H.T.+1, H.T.+2, H.T.+3, H.T.+4, G.B.—, G.B.+1, 1s. 9d. (or Clix, Igranic).
 2—Belling-Lee spades, marked: L.T.—, L.T.—, 8d. (or Clix, Ealex).
RESISTANCES, FIXED
 2—Berliff 600-ohm, 3s. (or Wearite, Ready Radio).
 1—Dubilier 1-megohm, 1s. 9d. (or Lissen, Watmel).
SUNDRIES
 Systoflex insulated sleeving and tinned-copper wire for connecting.
 Length of Lewcos rubber-covered flex. 2 oz. No. 30 d.s.c. wire (Lewcos).
 2 oz. No. 40 enamelled wire (Lewcos).
 1—Paxolin former, 2 in. diameter and 3 in. long, 9d.
 1—Paxolin former, 1½ in. diameter and 3 in. long, 8½d.
 3—Sheets of aluminium, 14 in. by 16½ in., 6 in. by 4 in., 2½ in. by 4 in., ready drilled, 10s. 6d. (Parex). No. 26 and No. 36 wire for frame aerial.
 1—Benjamin turntable, 7s. 6d. (or Ormond, Six-Sixty).
SWITCHES
 1—Lotus on-off, 1s. 6d. (or Bulgin, Watmel).
 1—Wearite 3-pole 3-way, 7s.
TRANSFORMER, L.F.
 1—Ferranti, ratio 7 to 1, £1 10s. (or Igranic, 6 to 1; Lewcos, 5 to 1).
ACCESSORIES
BATTERIES
 1—Siemens 126-volt, type 1075, £1 5s.
 1—Siemens 9-volt, type G2, 1s. 6d. (or Lissen, Ever Ready).
CABINET
 1—Neophone cabinet, £1 10s.
LOUD-SPEAKER UNIT
 1—Ormond, 12s. 6d. (or Blue Spot, Watmel).
VALVES
 1—Mazda 215 SG, £1
 1—Mazda HL210, 8s. 6d.
 1—Mazda P220, 10s. 6d.

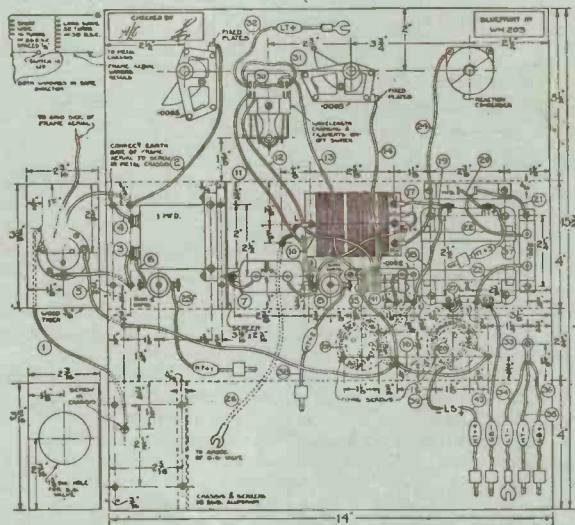

Actually the construction of the set is not nearly so difficult as appears from this reduced wiring diagram

"W.M." STANDARD A.C. UNIT

Supplies high-tension and filament current for mains valves

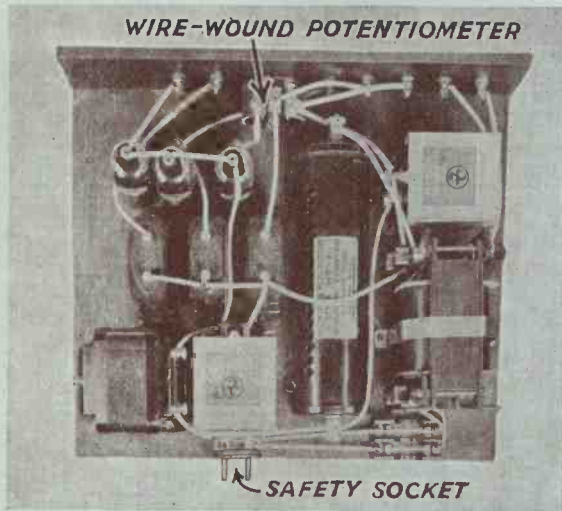

This photograph shows clearly how simple is the construction of the "W.M." Standard A.C. Unit, which incorporates a metal rectifier

SO many readers ask for details of mains units suitable for their particular sets that we decided early last autumn to publish a design for a standard high-tension battery eliminator that would be suitable for most two-, three-, and four-valve sets described in WIRELESS MAGAZINE. The "W.M." Standard A.C. Unit incorporates a metal rectifier that will provide an output of 20 milliamperes at 120 volts. Four

tappings are provided: H.T. +1 is of getting shocks is eliminated. To protect the apparatus in the event of a short-circuit, fuses are inserted in the main leads. The particular transformer employed in the original unit is provided with tapplings for 200- or 250-volt mains. Beginners should clearly understand that this unit can only be used for obtaining current from A.C. mains. It will not work at all on D.C. mains.

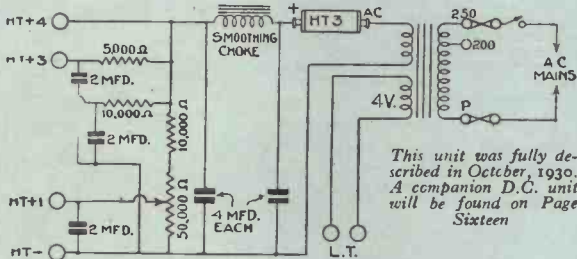

Four output tapplings are provided on this unit to supply different voltages, which can be altered by changing the values of resistances

taken from a potentiometer and is intended for supplying the screen voltage to a shielded valve. H.T.+2 and H.T.+3 are suitable for supplying a detector and first-stage low-frequency valve respectively, while H.T.+4 is for a power valve. It is intended that the unit when completed should be provided with a metal cover that can be permanently screwed to the baseboard. A safety plug and socket are provided so that the cover cannot be removed until the mains plug is withdrawn from the unit. In this way the possibility

The mains transformer specified is provided with a 4-volt secondary winding that can be used for supplying the heaters of mains valves. It will be evident that the "W.M." Standard A.C. Unit can therefore form the basis of an all-electric set, providing that grid bias is obtained in the ordinary way from a battery. There is space on the baseboard for the insertion of an extra voltage-dropping resistance and by-pass condenser if another output point should be needed. The value of resistance can easily be calculated.

PARTS NEEDED

CHOKE, LOW-FREQUENCY

- 1—Lewcos, 17s. 6d. (or Ferranti B1, Regentone).

CONDENSERS, FIXED

- 3—Hydra 2-microfarad, 8s. 3d. (or T.C.C., Dubilier).
- 2—Hydra 4-microfarad, 500 volt A.C. (or T.C.C., Dubilier).

- L.T.+1, L.T.-, H.T.+1, H.T.+2, H.T.+3, H.T.+4, H.T.-, 5s. 3d. (or Clix, Ealex).
- ### RESISTANCES, FIXED
- 2—Varley 10,000-ohm, with holder, 14s. (or Ready Radio, Lissen).
 - 1—Varley 5,000-ohm, with holder, 7s. (or Ready Radio, Lissen).
- ### RESISTANCE, VARIABLE
- 1—Colvern 50,000-ohm wire-wound potentiometer, 5s. 6d. (or Regentat, Rotorohm).

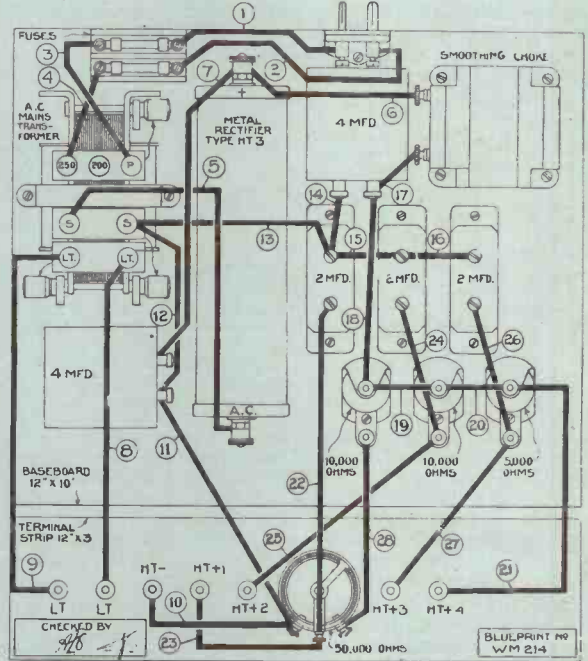

Even a beginner can build this unit without difficulty, as will be clear from this layout and wiring diagram

FUSE

- 1—Bulgin twin fuseholder, complete with fuses, 2s. 6d.

EBONITE

- 1—Terminal strip, 12 in. by 3 in.

METAL RECTIFIER

- 1—Westinghouse, type HT3, £1 1s.

PLUGS AND SOCKETS

- 7—Belling-Lee, safety type, marked:

SUNDRIES

- 1—Baseboard, 12 in. by 10 in.
 - Tinned copper wire for connecting.
 - Length of Sistoflex sleeving.
 - 1—Bulgin safety mains plug and socket, 3s. 9d.
 - 1—Neophrne metal case, 12s. 6d.
- ### TRANSFORMER
- 1—Regentone W.R.3 (stripped type), £1 1s.

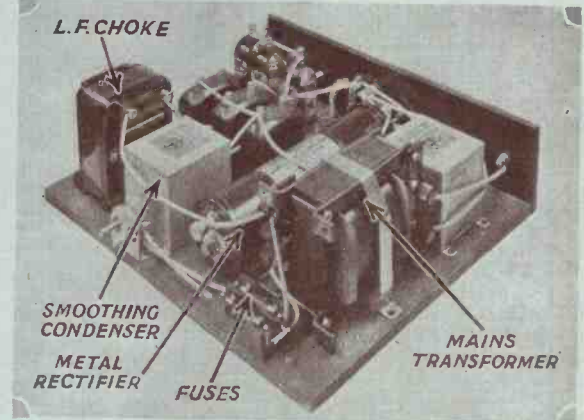

Another photograph showing the straightforward layout of this A.C. mains unit



HOW TO USE A "W.M." BLUEPRINT

THERE are several important things that every constructor should know about WIRELESS MAGAZINE blueprints, which greatly facilitate the construction of a radio set at home with the simplest of tools.

In the first place, it should be clearly understood that a full-size blueprint is available for every set of which the construction is described in WIRELESS MAGAZINE.

Secondly, we would emphasise the point that every blueprint is a real blueprint, produced photographically, and not an inferior printed imitation.

Full Scale

The third point that every constructor should appreciate is that WIRELESS MAGAZINE blueprints are absolutely full-scale drawings, showing the positions and sizes of all the holes to be drilled in the panel; the positions and dimensions of all the component parts; and all the internal connecting leads and any external leads that may be necessary.

As a fourth important feature we would point out that on WIRELESS MAGAZINE blueprints each wire is numbered separately so that the connections can be made in the most convenient order. If each lead is put in position in its proper numerical sequence there is no possibility of a mistake being made or of a connection being omitted.

For Beginners

From these remarks it will be evident that even a beginner will experience no difficulty in assembling any WIRELESS MAGAZINE design. It is impossible to go wrong if one of the full-size blueprints is used in conjunction with the photographs of the particular set to be built.

In order to encourage more listeners to build their own sets, we are offering full-size blueprints of any one of the Trusty Twelve (of which details are given in this supplement) for half-price until February 28, if the special coupon on this page is used when application is made.

Conditions

Not more than one blueprint for each of the twelve designs can be supplied for one coupon, but if desired blueprints of two or more different sets can be obtained.

This is one of the most generous offers ever made to home-constructors and in anticipation of the huge demand that will be made for blueprints by readers we have ready large extra supplies so that there will be no delay in obtaining them.

When the details needed for this coupon have been completed it should be sent, together with a postal order for the proper amount, to Blueprint Department, WIRELESS MAGAZINE, 58-61 Fetter Lane, London, E.C.4.

The best method of using one of these blueprints is to place the top part squarely over the ebonite panel and mark through with a sharp point the centres of all the holes that have to be drilled. The blueprint can then be removed, the holes drilled and the panel assembly completed before the baseboard layout is tackled.

If desired, the positions of the holes for the fixing screws of the baseboard components can be marked out in a similar way by placing the bottom part of the blueprint squarely over the baseboard. We do not recommend that the blueprint should actually be stuck to the baseboard and the components placed on top for if this is done some of the wiring connections may be obscured.

As each connecting wire is fixed in position it is a good plan to put a pencil mark through the corresponding number on the blueprint. If the wiring is then carried

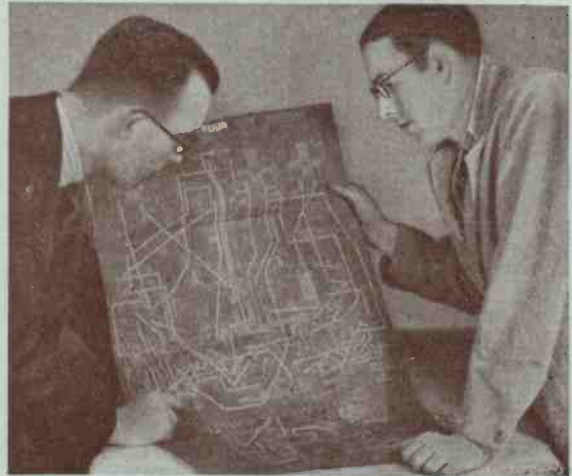

Construction of any WIRELESS MAGAZINE set can be undertaken without difficulty, even by a beginner, if a full-size blueprint is used

out in the proper numerical sequence, there is no possibility of making a mistake.

It will be appreciated from the foregoing remarks that full-size WIRELESS MAGAZINE blueprints make the construction of a radio

set almost automatic. Even a beginner can assemble what may, at first, appear to be a complicated receiver without any difficulty.

We are constantly receiving from readers, reports on even four- and five-valve sets which are stated to be first efforts in home construction.

For All Sets

New readers should note that full-size blueprints are available for all the sets of which the construction is described month by month. Blueprints of the sets described in the particular issue are always available for half-price up till the end of month of currency if the coupon to be found on the last page of the issue is utilised.

When the month is up blueprints of sets previously described can only be supplied at the full prices, that is, 1s., post free, if the set does not contain more than three valves; and 1s. 6d. if more than three valves are employed.

Name and Address

When applying for blueprints there is no need to send a stamped addressed envelope, but do not forget to indicate your name and address clearly.

It may be that some of your friends do not know of this valuable service of full-size blueprints. In such cases you will be doing us and your friends a service by bringing this special half-price offer to their notice. Home constructors have never before been given such an opportunity for building radio sets and mains units in the simplest and quickest way.

SPECIAL HALF-PRICE BLUEPRINT COUPON

Valid only until February 28, 1931

To Blueprint Dept., WIRELESS MAGAZINE, 58/61 Fetter Lane, London, E.C.4.

Please supply me, post free, with the following full-size blueprints at the half-prices mentioned:—

- One copy of NEW BROOKMAN'S THREE at 6d.
- One copy of DUAL-SCREEN FIVE at 9d.
- One copy of REGIONAL A.C. FOUR at 9d.
- One copy of FIVE-POINT TWO at 6d.
- One copy of JAMES PORTABLE S.G. THREE at .. 6d.
- One copy of STANDARD A.C. UNIT at 6d.
- One copy of FIVE-POINT FOUR at 9d.
- One copy of FALCON THREE and FALCON A.C. UNIT at 1s. the two
- One copy of FIVE-POINT SHORT-WAVER at 6d.
- One copy of REGIONAL BAND-PASS FOUR at .. 9d.
- One copy of FIVE-POINT THREE at 6d.
- One copy of STANDARD D.C. UNIT at 6d.

Total number of blueprints required.....

I enclose postal order for.....

My name and address are:—

.....

Place a cross against the blueprints required and delete those not required.



THE FIVE-POINT FOUR

An efficient grammo-radio set using the ever-popular type of two-pin plug-in coil

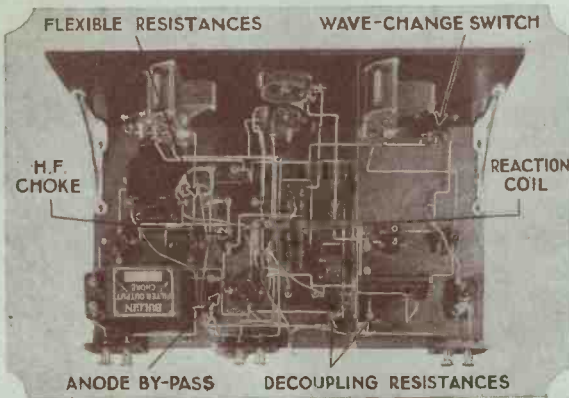

A plan view of the set, showing how the parts are arranged on the panel and baseboard

A FEATURE of this set is that, although standard two-pin plug-in coils, still very popular with a large number of constructors, are used for aerial and anode tuning, a single switch enables the operator to cover both medium and long wavebands.

Not only are good results assured for ordinary radio reception, but the circuit is also arranged

PARTS NEEDED

CHOKES, HIGH-FREQUENCY

- 1—Telsen, 2s. 6d. (or Lewcos, Polar).
- 1—Ready Radio, standard type, 2s. (or Polar, Igranic).

CHOKES, LOW-FREQUENCY

- 1—Bulgin, type LF4, 12s. 6d. (or Ferranti, Varley).

COILS

- 1—Atlas No. 50 plug-in, 2s. 6d. (or Lewcos, Tunewell).
- 2—Atlas No. 60 double-tapped plug-in, 11s. (or Lewcos, Tunewell).

- 2—Dubilier 2-microfarad, 7s. (or T.C.C., Mullard).
- CONDENSERS, VARIABLE**
- 2—Lotus .0005-microfarad, type LCS, 11s. 6d. (or Polar, Lissen).
- 1—Lotus .0002-microfarad reaction, 5s. 3d. (or Ready Radio).
- 1—R.I. Varicap pre-set, .0003-microfarad maximum, 2s. 6d. (or Polar, Igranic).
- DIALS, SLOW-MOTION**
- 2—Brownie, 5s. (or Ormond, Harlic).
- EBONITE**
- 1—Trelleborg panel, 18 in. by 7 in., 8s. (or Lissen).

- SUNDRIES**
- Insulating wire for connecting (Glazite).
- Length of rubber-covered flex (Lewcoflex).
- 1—Pair Keystone panel brackets, 2s. (or Lissen, Camco).
- 1—Peto-Scott screen to specification, 2s. 6d. (or Ready Radio, Neophone).
- SWITCHES**
- 1—Gripso single-pole, marked "On-Off," 1s. 9d.
- 1—Gripso three-point, marked "Long-Short," 2s.
- TERMINALS**
- 6—Ealex, marked: Aerial, Earth.

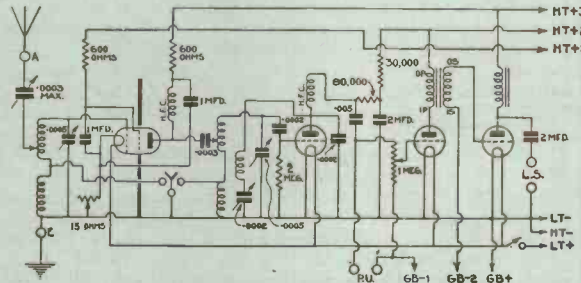

The circuit consists of a screened-grid amplifier, leaky-grid detector, a resistance-coupled low-frequency stage and a transformer-coupled power valve

- 3—Junit terminal blocks, 2s. (or Belling-Lee, Lissen).
- HOLDERS, COIL**
- 5—Magnum two-pin, 8s. 6d. (or Lotus, Lissen).
- HOLDERS, VALVE**
- 3—Telsen, 3s. (or W.B., Benjamin).
- 1—Peto-Scott S.G. holder to bolt on screen, 2s.
- PLUGS**
- 7—Belling-Lee plugs, marked: H.T.+1, H.T.+2, H.T.+3, H.T.—, Grid+, Grid—, 1s. 9d. (or Ealex, Clix).
- RESISTANCES, FIXED**
- 2—Bulgin 600-ohm, 3s. (or Wearite, Magnum).
- 1—Magnum 30,000-ohm, spaghetti type, 1s. 6d. (or Bulgin).
- 1—Magnum 80,000-ohm, spaghetti type, 2s. (or Bulgin).
- 1—Dubilier 2-megohm grid leak, 1s. 9d. (or Watmel, Lissen).
- RESISTANCES, VARIABLE**
- 1—Ormond 15-ohm, 2s. (or Geophone, Varley).
- 1—Igranic 1-megohm potentiometer, 6s. (or Rotorohm).

- Pick-up (2), L.S.+ , L.S.—, 2s. 3d. (or Burton, Igranic).
- 2—Belling-Lee spades, marked: L.T.+ , L.T.—, 9d. (or Clix, Ealex).
- TRANSFORMER, L.F.**
- 1—Burton, ratio 1 to 3, 10s. 6d. (or Telsen, Brownie).
- ACCESSORIES**
- BATTERIES**
- 2—Columbia 60-volt, £1 15s. (or Siemens, Lissen).
- 1—Columbia 9-volt grid bias, 2s. (or Siemens, Lissen).
- 1—Oldham U.S.L. 2-volt accumulator, 9s.
- CABINET**
- 1—Carrington, oak, £1 4s. (or Osborn, Pickett's).
- LOUD-SPEAKER**
- 1—Hegra cone cabinet, type T, £2 12s. (or W.B., Amplion).
- VALVES**
- 1—Six-Sixty 215SC, £1 (or Lissen SG215, Marconi S215).
- 1—Six-Sixty 210RC, 8s. 6d. (or Lissen H210, Marconi H2).
- 1—Six-Sixty 210HF, 8s. 6d. (or Lissen HL210, Marconi H2).
- 1—Six-Sixty 220P, 10s. 6d. (or Lissen P220, Marconi P215).

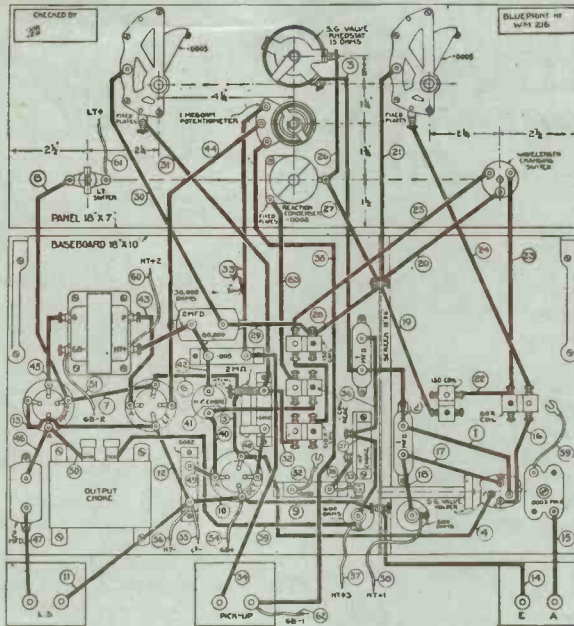

This wiring diagram shows that, for its type, the set is particularly simple

for the inclusion of a pick-up so that records can be reproduced electrically.

Two volume controls are provided. Both can be used during radio reception.

Full constructional details were published in November, 1930.

Following is a list of the parts needed:—

- 2—Atlas No. 150 plug-in, 7s. (or Lewcos, Tunewell).
- CONDENSERS, FIXED**
- 1—Dubilier .0002-microfarad, type 620, 1s. 8d. (or Graham-Farish, Trix).
- 1—Dubilier .0002-microfarad, type 620, with insulating clip, 2s. 2d.
- 1—Dubilier .0003-microfarad, type 620, 1s. 8d. (or Graham-Farish, Trix).
- 1—Dubilier .005-microfarad, type 620, 2s. 3d. (or Graham-Farish, Trix).
- 2—Dubilier 1 microfarad, 5s. (or T.C.C., Franklin).

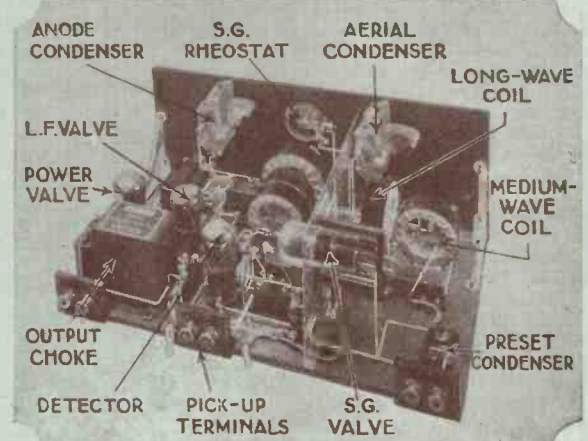

Another photograph showing the set completely assembled with valves and coils in position

FALCON THREE & A.C. MAINS UNIT

A FULL description of this set and mains unit was given in November, 1930. Following is a list of parts needed for the set:—

- CHOKE, LOW-FREQUENCY**
1—Bullphone, 10s. 6d. (or Atlas, Lotus).
- CHOKE, HIGH-FREQUENCY**
1—Ready Radio Hilo, 4s. 6d. (or British General, Lissen).
- COILS**
1—Lewcos dual-wave, type DWA, 15s.
1—Lewcos dual-wave, type DWG, 15s.
1—Lewcos ganging switch, type SM5, 2s. 6d.
- CONDENSERS, FIXED**
2—Watmel .0002-microfarad, 2s. (or Formo, Magnum).

- 1—Parex, S.G. type, 2s. (or Junit, W.B.).
- PLUGS**
9—Belling-Lee, marked: H.T.+1, H.T.+2, H.T.+3, H.T.+4, H.T.—, G.B.—, G.B.+; 2 plain red, 2s. 3d. (or Ealex, Clix).
- 1—Belling-Lee S.G. anode connector, 6d.
- POTENTIOMETER**
1—ClaroStat 30-ohm Hum Dinger, 2s. 9d.
- RESISTANCES, FIXED**
1—Watmel 2-megohm, with holder, 1s. 6d. (or Dubilier, Lissen).
2—Magnum 600-ohm, 3s. (or Wearite, Simmonds).
- SCREEN**
1—Parex, 10 in. by 6 in., 2s. (or Peto-Scott, H. & B.).

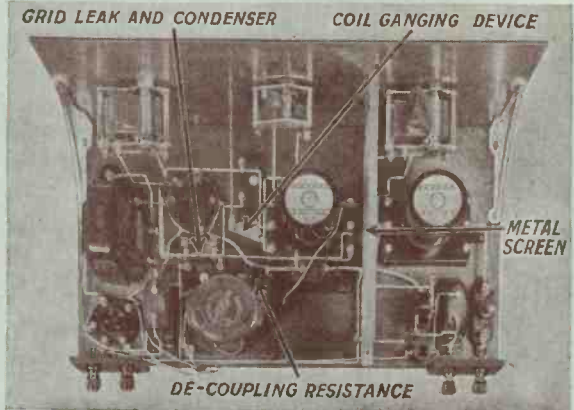

This plan view shows the arrangement of the parts in the Falcon Three, for operation from A.C. mains

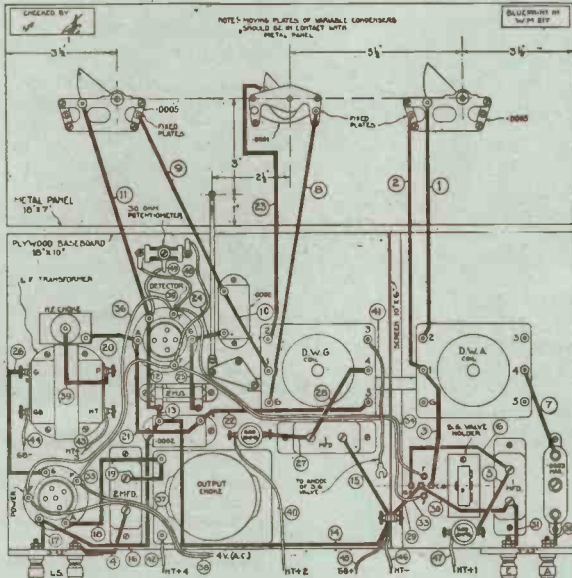

Layout and wiring diagram of the three-valve set. A separate mains unit is used

- 2—Hydra 1-microfarad, 4s. 4d. (or Lissen, T.C.C.).
1—Hydra 2-microfarad, 3s. (or Ferranti).
- CONDENSERS, VARIABLE**
2—Cylton .0005-microfarad Junilog, 17s. 6d. (or Igranic, Burton).
1—Polar .0001-microfarad Volcontype, 5s. 6d. (or Dubilier, Bulgin).
1—Ormond Varycondenser, .0003-microfarad maximum, 2s. (or Lewcos, Polar).
- DIALS**
2—Ormond plain, 1s. 6d. (or Cylton, Jackson).
- HOLDERS, VALVE**
2—Benjamin five-pin, 3s. 6d. (or Lotus, W.B.).

- SUNDRIES**
1—Parex metal panel, 18 in. by 7 in., 7s. 6d.
Glazite insulated wire for connecting.
1—Pair Keystone panel brackets, 2s. (or Lissen, Camco).
6—Yards rubber-covered flex (Lewcos).
- TRANSFORMER, L.F.**
1—Lissen Super, ratio 1 to 3, 17s. 6d. (or Brown).
- ACCESSORIES**
CABINET
1—Peto-Scott, with 10-in. baseboard, £1 5s. (or Pickett, Lock).
- LOUD-SPEAKER**
1—Lamplugh standard cabinet inductor, £5 10s. (or Brodersen, Cecophone).

- VALVES**
1—Mullard S4Vb, £1 5s. (or Cossor 41MSG, Six-Sixty SS4SGAG).
1—Mullard 354V, 15s. (or Cossor 41MFH, Six-Sixty SS4GPAC).
1—Mullard 164V, 17s. 6d. (or Cossor 41MP, Six-Sixty SS4Det.AC).
- 1—Baseboard, 11 in. by 8 in.
1—Sense metal box, 7s. 6d.
1—Bulgin safety mains plug and socket, 3s. 9d.
- TRANSFORMER, MAINS VALVE**
1—Heayberd, type 719, £2.
1—Marconi U9, £1 (or Osram U9).

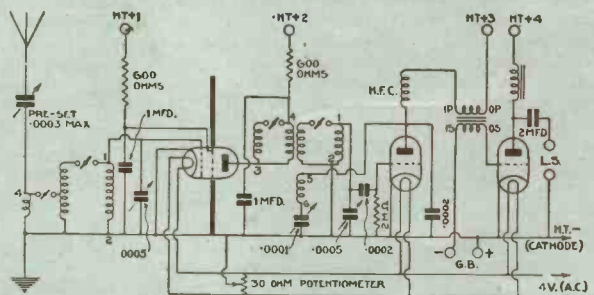

Circuit of the three-valve receiver—screened-grid valve, leaky-grid detector, and power valve

PARTS NEEDED FOR THE MAINS UNIT

- CHOKE, LOW-FREQUENCY**
1—Regentone, type LR, £1 5s. (or Ferranti, Atlas).
- CONDENSERS, FIXED**
3—Hydra 2-microfarad, 8s. 3d. (or Franklin, T.C.C.).
2—Hydra 4-microfarad, 12s. (or Franklin, T.C.C.).
- EBONITE**
1—Panel, 8 in. by 5½ in.
- FUSE**
1—Bulgin twin fuseholder, complete with fuses, 2s. 6d.
- HOLDER, VALVE**
1—Benjamin Vibrolider, 1s. 6d. (or Clix, W.B.).
- PLUGS AND SOCKETS**
7—Clix, marked: H.T.+1, H.T.+2, H.T.+3, H.T.+4, H.T.—, and two plain, 2s. 0½d. (or Belling-Lee, Ealex).
- RESISTANCES, FIXED**
2—Bulgin 50,000-ohm, flexible type, 3s. 6d. (or Magnum).
1—Bulgin 20,000-ohm, flexible type, 1s. 3d. (or Magnum).
- RESISTANCES, VARIABLE**
1—Centralab 50,000-ohm potentiometer, 10s. 6d. (or Rotorohm, Regentstat).
- SUNDRIES**
Glazite insulated wire for connecting.
Short length of rubber-covered flex

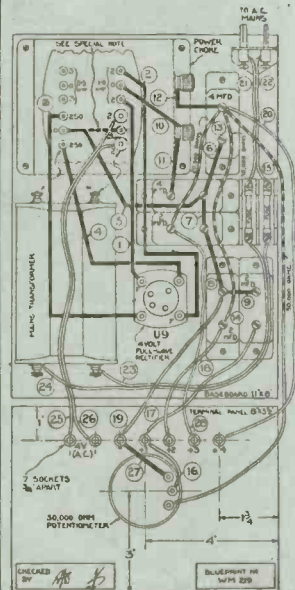

Layout and wiring diagram of the mains unit for use with the Falcon Three

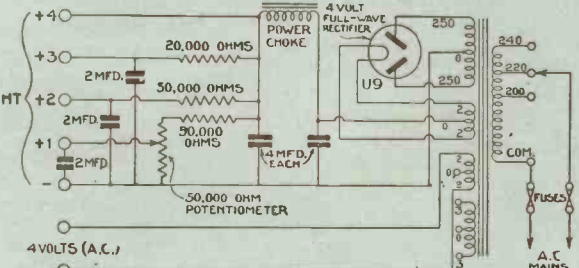

Circuit of the mains unit (separate from the set), which includes a valve rectifier



THE FIVE-POINT SHORT-WAVER

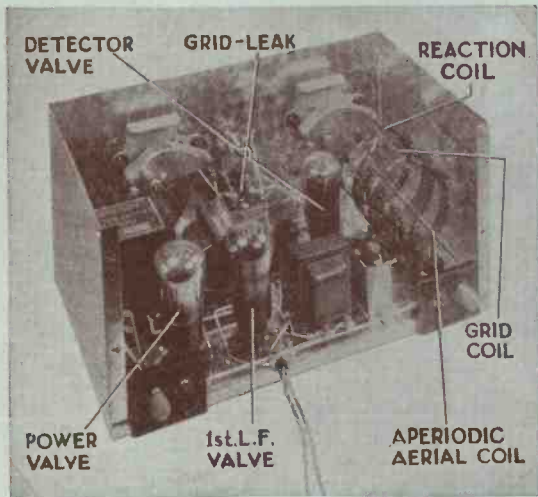

The use of an all-metal case ensures stability of operation of this short-wave set

EFFICIENCY of operation is ensured with this receiver by completely screening it in a metal case. Standard two-pin plug-in short-wave coils are utilised and the set can therefore be adjusted to cover all wavelengths from 10 to 150 metres.

There is nothing fancy about the circuit, as experience shows that the simplest and most straightforward arrangements always give the best results in the hands of constructors.

Complete details of this Five-point Short-waver were given in the January, 1931, issue of

WIRELESS MAGAZINE on page 588.

Good signal strength from far-distant stations is assured by the use of a leaky-grid detector, followed by two transformer-coupled low-frequency stages.

Three coils are used in the tuning circuit: (1) An aperiodic aerial coil, (2) a tuned grid coil, and (3) a reaction coil. Four different sizes of coils will get most of the short-wave stations worth hearing.

Reaction is easily controlled by a potentiometer, across which is tapped one end of the grid leak.

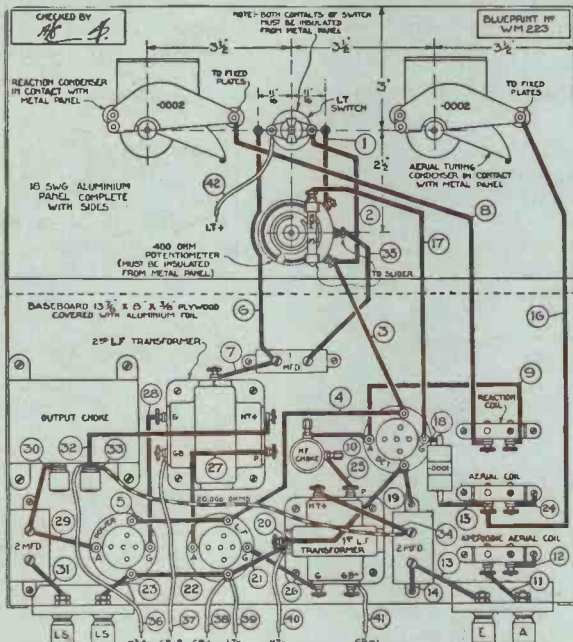

When wiring up this set, particular care should be taken to keep all the leads as short and direct as possible

COMPONENTS YOU WILL NEED

CHOKE, HIGH-FREQUENCY

1—Igranite short-wave, 2s. (or Wearite, Polar).

CHOKE, LOW-FREQUENCY

1—Bulgin 20-henry, 12s. 6d. (or Varley, Lotus).

COILS

4—Eddystone two-pin short-wave, No. 3, No. 4 (two), No. 6, 11s.

RESISTANCES, FIXED

1—Bulgin 20,000 ohms, flexible type: 1s. 3d. (or Magnum).
1—Dubilier 3-megohm, 1s. 9d. (or Lissen, Watmel).

RESISTANCE, VARIABLE

1—Wearite 400-ohm, type Q14, with grid-leak clips, 3s.

SUNDRIES

Glazite insulated wire for connecting. 5 yards rubber-covered flex (Lewco). 1 Set Eddystone Absorbos, for cabinet, 2s. 3d.

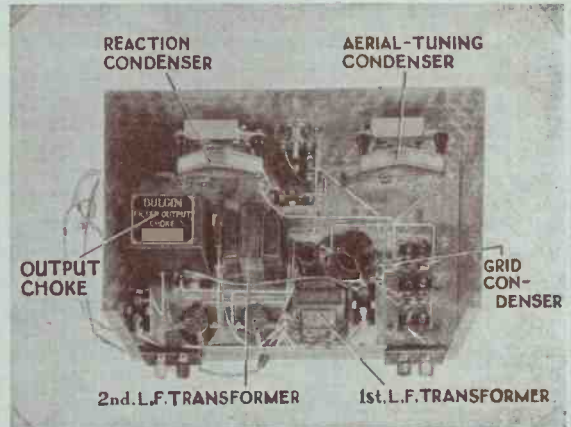

The disposition of the parts in this set will be clear from this photograph of plan view

CONDENSERS, FIXED

1—Graham-Farish .0001-microfarad, 9d. (or Edison Bell, Lissen).
1—Franklin 1-microfarad, 2s. (or T.C.C., Dubilier).
2—Franklin 2-microfarad, 5s. 4d. (or T.C.C., Lissen).

CONDENSERS, VARIABLE

2—Utility .0002-microfarad Log. Alum. type, 13s.

DIALS, SLOW-MOTION

2—Emkabe, Astra, 10s.

SWITCH

1—Gripao single-pole, marked "On" and "Off," 1s. 9d.

TERMINALS

4—Burton, marked: A, E, L.S.+ L.S.—, 1s. (or Igranite, Belling-Lee).

TRANSFORMERS, L.F.

1—Telsen Ace, ratio 1 to 3, 8s. 6d. (or Burton, Igranite).
1—Telsen Radiogrand, ratio 1 to 5, 12s. 6d. (or Burton, Igranite).

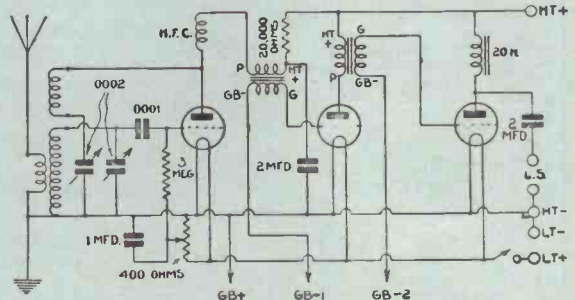

A leaky-grid detector and two transformer-coupled low-frequency stages are incorporated in this receiver

EBONITE

2—Junit terminal blocks, 1s. 4d. (or Lissen, Belling-Lee).

HOLDERS, COIL

3—Lotus two-pin, 2s. (or Lissen)

HOLDERS, VALVE

3—Clix, terminal type, 2s. 6d. (or W.B., Lotus).

PLUGS

5—Belling-Lee, marked: H.T.+ H.T.—, G.B.+ G.B.—1, G.B.—2, 1s. 3d. (or Clix, Eelex).
2—Belling-Lee spades, marked: L.T.+ L.T.—, 9d. (or Clix, Eelex).

ACCESSORIES

BATTERIES

1—Pertrix 120-volt, type 295, 15s. 6d. (or Ever Ready, Lissen).
1—Pertrix 9-volt grid bias, 1s. 6d. (or Ever Ready, Lissen).
1—C.A.V. 2-volt accumulator, type 2AG7, 11s. (or Lissen, Exide).

CABINET

1—Paroussi, aluminium, £1 1s.

VALVES

2—Cossor 210HF, 17s. (or Lissen HI.210, Mullard PM1HF).
1—Cossor 215P, 10s. 6d. (or Lissen P220, Mullard PM2).

PRACTICAL HINTS AND TIPS

Every constructor should read these notes

BEFORE beginning the construction of a set, see that all the components required—and tools and blueprint or wiring diagram—are ready to hand. You will not want to leave off in the middle of the assembly to look for a missing part!

In order to get good, straight connections, always stretch the

NEXT MONTH!

Make a note of the date—Friday, February 20.

On that day will be published the March issue of WIRELESS MAGAZINE, which will contain yet another fine supplement of interest to all listeners, and not only to home-constructors.

This will be the fifth WIRELESS MAGAZINE supplement presented to readers since November. The demand will be great, so order a copy in advance.

wire before using it. Clamp one end in a vice and pull as hard as you can at the other end until you feel a slight "give." Hold the wire with a large pair of pliers.

When a bluish colour appears in the flame of the fire or gas ring in which the soldering bit is being heated, you will know that the correct temperature has been reached.

A baseboard completely covered with metal foil is sometimes a considerable help in constructing a large set, as all the earth-potential points can be connected straight down, provided that the foil itself is earthed at one point.

It is worth while cleaning all contacts before applying flux and solder to a joint. The slightest film of dirt or grease will prevent the solder from running properly.

Always make sure that component terminals are screwed down tightly, otherwise the springiness of the wires may make them work loose.

Constructors will find thin blowpipe solder the easiest with

which to work. It can be applied without difficulty even to the smallest joint.

Electric soldering bits are to be preferred as they can always be maintained at a constant temperature.

When making connections to metal screens or panels take particular care to scrape the metal clean at the point of contact. Many metal panels and screens are lacquered or varnished when obtained from the makers.

It is an advantage when wiring to keep all the leads as close as possible to the baseboard. This avoids the necessity of having to thread the last few connections through others that have been made previously.

When leads go through holes in metal screens, either make the hole large or insulate the wire with a bush, otherwise the insulation will chafe on the screen and a short-circuit may occur.

In cases where components are mounted on metal bases, or on wooden baseboards covered with metal foil, see that no terminals or other contacts protrude and make contact with the metal underneath. If the contacts are found to touch, a piece of thin cardboard or thick paper should be used as an insulation.

When assembling a terminal strip, space the terminals far enough apart so that when the leads are connected they will not "short" across adjacent terminals.



Do not screw bakelite condensers of this type too tightly down on the baseboard or one of the fixing lugs may break off

If you are using a baseboard that was not supplied with the cabinet, see that it is trimmed $\frac{1}{8}$ in. under size in length so that it will be an easy fit.

When fixing screws in the edge of a plywood baseboard (for instance, for screwing a panel in position), make sure that the points of the screws go into the centre ply. There will then be no risk of splitting the ply open.

Always mark out a panel for drilling on the inner side, so that when the set is completed, no scraper lines will show on the outside and mar the appearance of the receiver.



Make certain that the accumulator you are going to use with the set will give a reasonable number of hours' working at each charge

The heat of soldering always tends to loosen terminal heads, so after soldering wires to connecting tags always tighten up the terminal nuts. This will prevent the possibility of poor contacts.

Before fixing switches or jacks it is a good plan to clean the contact points with a small magneto file, in order to make sure of proper working. These points are very difficult to clean when the component is in position in the set.

Always keep a stock of dial indicators on hand to avoid the necessity for scratching marks on the panel to record a dial reading.



When putting a plug-in coil in or taking it out of its socket, always grip the mount and do not take hold of the coil itself

Never solder a wire direct to a terminal shank. Use soldering tags which can afterwards be screwed down under the terminal nuts.

Before making connections with covered wire, remember to bare the insulation at both ends of the leads. Beginners frequently forget this point and then wonder why the set does not work!

If the set includes a screened-grid valve, it is worth while using a shrouded plug for making connection to the anode terminal. If an ordinary wire is used it may accidentally touch the screen and result in a short-circuit.

Remember that dirty grid leaks and clips can be a source of unpleasant noises during reception.

Make sure that blobs of solder do not drop between soldering tags or metal baseplates, or short-circuits may occur.

When stranded wire is used for making connections, it is a good plan to solder the strands together and bend them in the form of a loop. Failing this, carefully twist the strands together so that there are no loose wires.

All constructors should keep a stock of $\frac{3}{16}$ in., $\frac{1}{4}$ in., and $\frac{5}{16}$ in. screws for fixing components to baseboards. These should be of the round-headed variety; ask for No. 4's. If they are painted black they will not rust.



REGIONAL BAND-PASS FOUR

Specially designed by W. JAMES

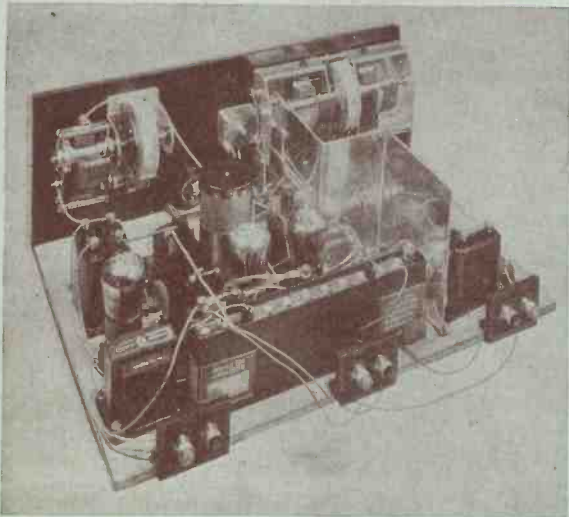

This photograph shows the compact nature of the design of W. James' star Exhibition set

THIS receiver was W. James' star design for the last Radio Exhibition. It is a particularly powerful combination and includes a band-pass tuning circuit for the very best results.

The high-frequency coupling is a standard Binowave coil, while the band-pass aerial coil is of a new type specially developed for this receiver. The set covers both wavebands by the operation of a single wave-change switch.

CONDENSERS, FIXED

- 1—T.C.C. .0002-microfarad, upright type, 1s. 6d. (or Dubilier, Trix).
- 1—T.C.C. .002-microfarad, upright type, 1s. 10d. (or Dubilier, Trix).
- 1—T.C.C. .015-microfarad, upright type, 3s. 3d. (or Dubilier, Hydra).
- 5—Ferranti 2-microfarad, 12s. 6d. (or Mullard, T.C.C.).

CONDENSERS, VARIABLE

- 1—Jackson two-gang Chassimount, .0005-microfarad, type C2, with drum dial, £1 6s. 6d.
- 1—Jackson .0005-microfarad universal log, with junior drum dial, 19s.

- 1—W.B. universal type, 1s. 3d. (or Junit).
- PLUGS**
- 7—Belling-Lee, marked: G.B.+ , G.B.-1, G.B.-2, H.T.-, H.T.+1, H.T.+2, H.T.+3, 1s. 9d. (or Ealex, Clix).
- 2—Belling-Lee spades, marked: L.T.+ , L.T.-, 9d. (or Ealex, Clix).
- RESISTANCES, FIXED**
- 1—Simmonds 600-ohm, 1s. 6d. (or Magnum, Wearite).
- 1—Magnum 30,000-ohm, flexible spaghetti type, 1s. 6d.
- 1—Magnum 80,000-ohm, flexible spaghetti type, 2s.

- 1—Pair Bulgin grid-bias battery clips, 6d.
- SWITCH**
- 1—Bulgim Midget on-off, 10½d
- TERMINALS**
- 6—Belling-Lee, marked: Aerial, Earth, L.S.+ , L.S.-, Pick-up (2), 1s. 6d. (or Ealex, Igranic).
- TRANSFORMER, L.F.**
- 1—Ferranti, type AF3, £1 5s. (or Varley, Philips).
- ACCESSORIES**
- BATTERIES**
- 1—Ever Ready power, 120 volts, £2 2s. 6d. (or Siemens, Pertrix).
- 1—Ever Ready 16-volt grid bias, stan-

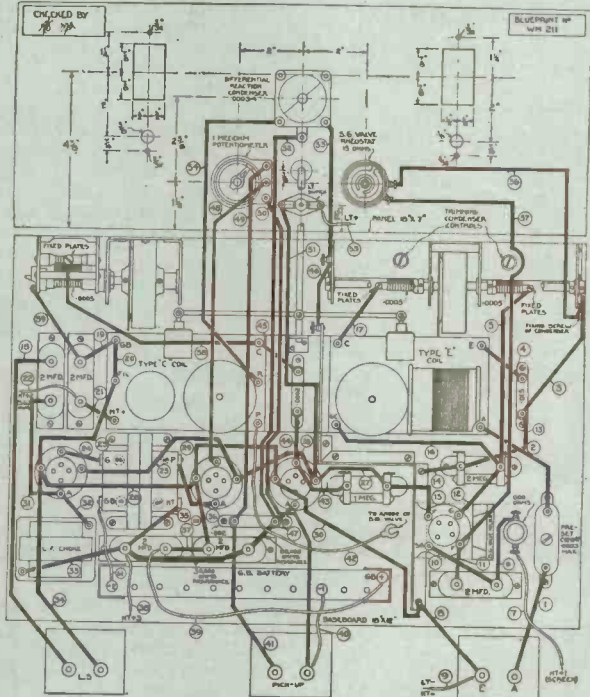

A greatly reduced layout and wiring diagram showing the arrangement of the parts in the Regional Band-pass Four

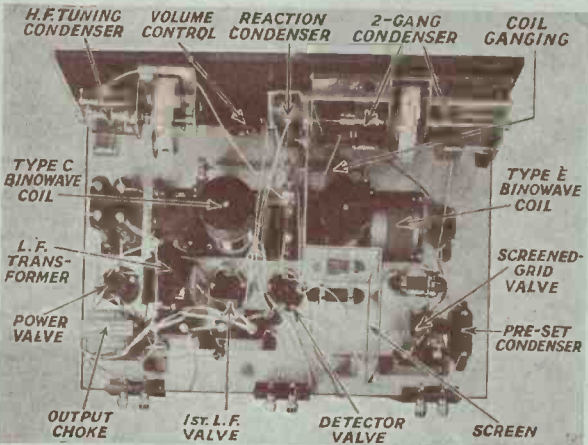

Here is a plan view showing how the parts are arranged on the panel and baseboard

Complete constructional details were given in October, 1930, and following is a list of the components needed for construction:

CHOKE, LOW-FREQUENCY

- 1—R.I. Hypercore, 17s. 6d. (or Climax, Varley).

COILS

- 2—Wearite Binowave, types C and E, with ganging device, £1 17s.

- 1—Lotus .00034-microfarad differential, 8s. 6d. (or Ready Radio).
- 1—Polar preset, .0003-microfarad maximum, 2s. (or Formo, Lewcos).

EBONITE

- 1—Becol 18 in. by 7 in. panel, 7s. 7d., (or Lissen, Peto-Scott).
- 3—Junit terminal blocks, 2s. (or Lissen).

HOLDERS, VALVE

- 3—W.B. rigid type, 3s.

- 1—Lissen 1-megohm, with holder, 1s. 6d. (or Dubilier).
- 1—Lissen 2-megohm, with holder, 1s. 6d. (or Dubilier).
- RESISTANCES, VARIABLE**
- 1—Rotorohm 1-megohm potentiometer, type M, 6s. 6d.
- 1—Wearite 15-ohm rheostat, 1s. 6d.
- SCREEN**
- 1—Parex to specification (or Ready Radio, H. & B.).
- SUNDRIES**
- Timed copper wire for connecting.
- Length of Sistoflex sleeving.

- 1—Lissen 1-megohm, with holder, 1s. 6d. (or Dubilier).
- 1—Fuller 2-volt, type LDG, 9s. 6d. (or Lissen, Marconiphone).
- CABINET**
- 1—Pickett table model, £1 1s. (or Camco, Digby).
- LOUD-SPEAKER**
- 1—Ediswan cone, £3 (or Amplion Lion *Celestion).
- VALVES**
- 1—Mazda 215SG, £1.
- 2—Mazda HL210, 17s.
- 1—Mazda P220, 10s. 6d.

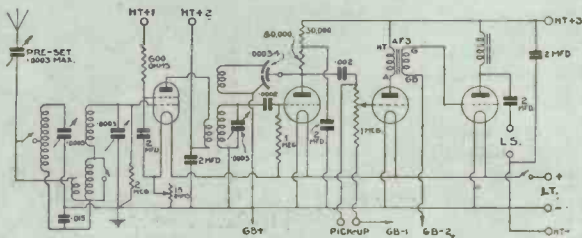

The circuit includes a screened-grid high-frequency amplifier, leaky-grid detector, a resistance-coupled low-frequency stage, and a transformer-coupled power valve

THE FIVE-POINT THREE

The first of the now famous range of "Five-point" receivers to be described

THIS set is the first of the now famous "Five-point" series of WIRELESS MAGAZINE receivers, and will appeal particularly to those who want a cheap but efficient three-valve set. Although the ever-popular two-pin plug-in coils are used, the wavelength range is controlled by a single switch.

Following is a complete list of the parts needed for construction:

CHOKE, HIGH-FREQUENCY

- 1—Lewcos, 7s. 9d. (or British General, Watmel DX3).

- 1—Franklin 2-microfarad, 2s. 8d. (or Mullard, T.C.C.).

CONDENSERS, VARIABLE

- 1—Ormond .0005-microfarad, small log, 8s. (or Lotus, Polar).
- 1—Formo Midget .0002-microfarad reaction, with knob, 3s. 3d. (or Dubilier, Bulgin).
- 1—Sovereign preset, .0003-microfarad maximum, 1s. 6d. (or Lewcodenser, Formodenser).

DIAL, SLOW-MOTION

- 1—Ormond drum, 5s. (or Lotus, Polar).

EBONITE

- 1—Potter 16-in. by 8-in. panel, 6s. (or Ready Radio, Raymond).
- 2—Junit terminal blocks, 1s. 4d. (or Lissen, Belling-Lee).

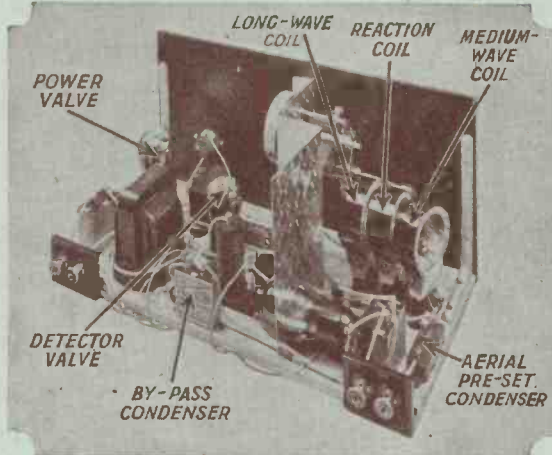

How the set appears when it is completely wired up, and the valves and coils are placed in position

CHOKE, LOW-FREQUENCY

- 1—Lissen, 12s. 6d. (or Igranic, Telsen).

COILS

- 1—Atlas No. 40 plug-in, 2s. 6d. (or Lewcos, Edison Bell).
- 1—Atlas No. 150 plug-in, 3s. 6d. (or Lewcos, Edison Bell).
- 1—Atlas No. 60 double-tapped plug-in, 5s. 6d. (or Lewcos, Edison Bell).

CONDENSERS, FIXED

- 1—Edison Bell .0002-microfarad, 1s. (or T.C.C., Graham-Farish).
- 1—Franklin 1-microfarad, 2s. (or Dubilier, T.C.C.).

HOLDERS, COIL

- 3—Lissen two-pin, 3s. (or Magnum, Lotus).

HOLDERS, VALVE

- 2—Telsen, 2s. (or Lotus, Igranic).
- 1—Junit Universal, 1s. 9d. (or Parex, W.B.).

PLUGS

- 8—Belling-Lee, marked: L.T.+, L.T.-, H.T.+3, H.T.+2, H.T.+1, H.T.-, G.B.+, G.B.-, 2s. (or Ealex, Clix).

RESISTANCES, FIXED

- 2—Bulgin 600-ohm, 3s. (or Wearite, Magnum).

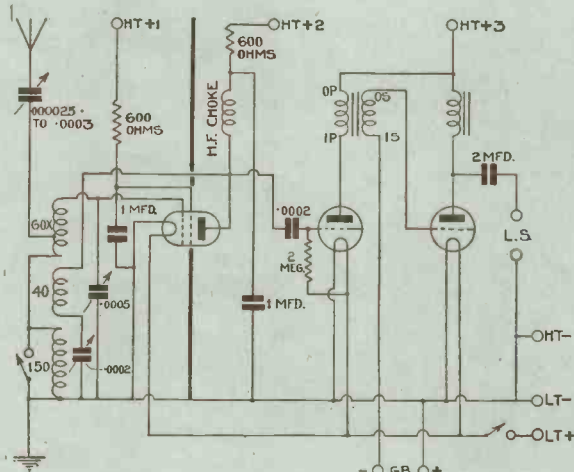

Included in the circuit are a screened-grid high-frequency amplifier, leaky-grid detector, and a transformer-coupled power valve

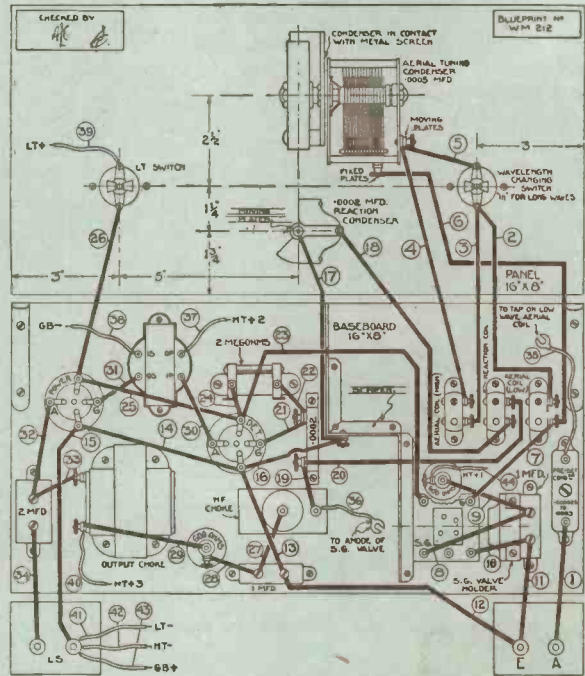

As can be seen from this wiring diagram, the construction of this efficient three-valve set is well within the capabilities of any beginner

- 1—Lissen 2-megohm, with holder 1s. 6d. (or Watmel, Dubilier).

SUNDRIES

- Tinned copper wire for connecting.
- Length of Sistoflex sleeving.
- 6 yards of rubber-covered flex (Lewcos).
- 1—Pair Keystone panel brackets, 2s. (or Camco, Bulgin).
- 1—Parex screen to specification 4s. (or Ready Radio, H. & B.).

ACCESSORIES

BATTERIES

- 1—Pertrix 120-volt, type 295, 15s. 6d. (or Lissen, Columbia).
- 1—Pertrix 9-volt grid-bias, 1s. 6d. (or Lissen, Columbia).
- 1—C.A.V. 2-volt accumulator, type 2AG7, 11s. (or Exide, D.P.).

CABINET

- 1—Neophone, table model, £1 (or Ready Radio, H. & B.).

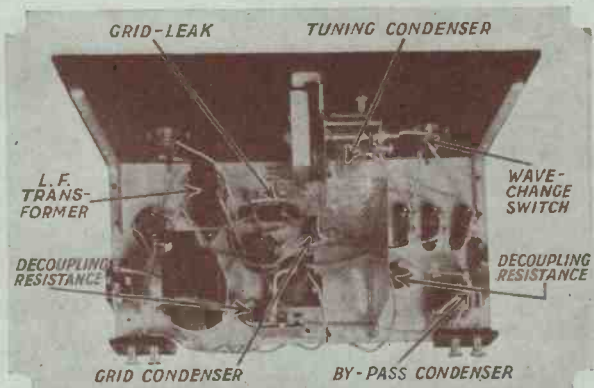

A photographic plan view of the Five-point Three, showing the disposition of the components

SWITCHES

- 1—Gripso single-pole, marked "On-Off," 2s. 3d.
- 1—Gripso single-pole, marked "Short-Long," 2s. 3d.

TERMINALS

- 4—Ealex, marked: Aerial, Earth, L.S.+, L.S.-, 1s. 6d. (or Belling-Lee, Igranic).

TRANSFORMER, L.F.

- 1—Igranic, type J, ratio 1-6, 17s. 6d. (or Telsen, Burton).

LOUD-SPEAKER

- 1—Blue Spot cabinet, type 41K, £2 10s. (or Wates, Loewe).

VALVES

- 1—Mullard PM12, £1 (or Six-Sixty 215SG, Cossor 215SG).
- 1—Mullard PM1HF, 8s. 6d. (or Six-Sixty 210HF, Cossor 210HF).
- 1—Mullard PM252, 10s. 6d. (or Six-Sixty 230SP, Cossor 220P).



"W.M." STANDARD D.C. UNIT

Supplies high-tension current only

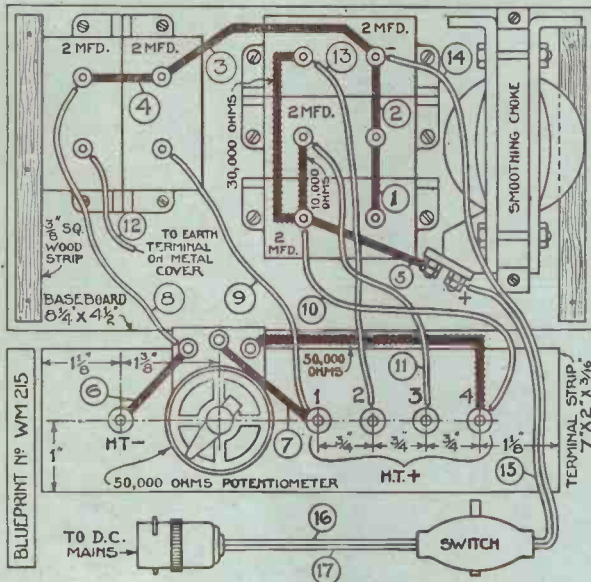

This layout and wiring diagram shows the simple nature of the construction, which can be undertaken by any beginner

HERE we present details of a companion unit to the "W.M." Standard A.C. Unit, which has already been referred to. Full details of this D.C. high-tension battery eliminator were given in the November 1930 issue. This unit will supply up to 30 milliamperes at the voltage of the D.C. mains to which it is connected. Unlike the Standard A.C.

the anodes of a detector or first-stage low-frequency valve. H.T.+4 supplies potential at nearly the D.C. mains voltage for running a power valve. It should be noted that this unit will not give a greater output than the mains input voltage, so that it will not be of much use on 100- or 110-volt mains. Although four output tappings

calculated for each particular set. When this unit is used the earth lead *must* be removed from the set and connected to the earth terminal on the mains unit. It should be noted that in this unit the three flexible voltage-dropping resistances form three connections between components. The five terminals and the screened-grid potentiometer are mounted on a strip of ebonite that is bolted at the back of a slot in the metal cover. Should ordinary battery valves

PARTS NEEDED

- CHOKE, LOW-FREQUENCY**
 1—Igranic, type C30, 15s. 6d.
- CONDENSERS, FIXED**
 5—T.C.C. 2-microfarad, type No. 50, 19s. 2d. (or Dubilier, Ferranti).
- EBONITE**
 1—Terminal strip, 7 in. by 2 in.
- RESISTANCES, FIXED**
 1—Bulgin 10,000-ohm link, 1s. (or Magnum).
 1—Bulgin 30,000-ohm link, 1s. 8d. (or Magnum).
 1—Bulgin 50,000-ohm link, 1s. 9d. (or Magnum).

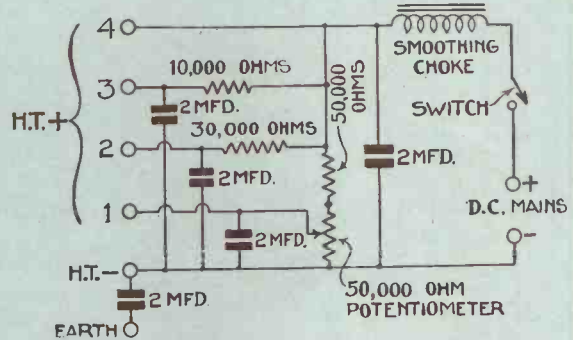

This unit supplies a maximum voltage approximating to that of the D.C. mains to which it is connected. Four output tappings are provided

be operated from this unit the output terminal marked H.T.×4 should not be used, unless a resistance and by-pass condenser are inserted in circuit, for otherwise the voltage applied will be too high. It will be noted that the mains switch is inserted in the flexible lead taken to the power socket. Its inclusion is not essential for no current will be taken from the unit when the valve filaments are switched off.

- RESISTANCE, VARIABLE**
 1—Rotorohm 50,000-ohm potentiometer, 6s. (or Regenstat, Colvern).
- SUNDRIES**
 Rubber-covered flex (Lewcoflex).
 Stiff insulated wire (Glazite).
 1—Baseboard, 8 1/4 in. by 4 1/2 in.
 1—Bulgin mains switch, type S18, 2s.
 1—Wholesale Wireless metal box, type No. 5, 4s. 6d.
- TERMINALS**
 6—Balling-Lee, type R, marked: H.T.+1, H.T.+2, H.T.+3, H.T.+4, H.T.-, E, 1s. 6d. (or Ealex, Clix).

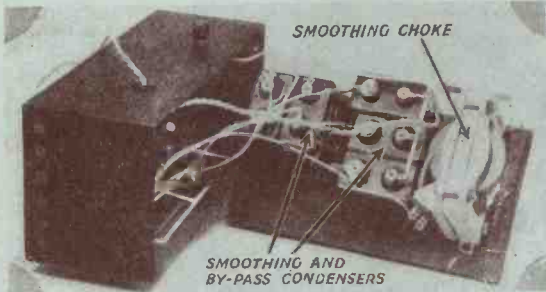

A photograph showing the appearance of the unit when the metal cover has been removed

Unit, it will not supply filament current for the valves. The design is very compact, largely on account of the fact that the new flexible or spaghetti type of resistance is used for the regulation of voltage obtained from the four output terminals. H.T.+1 is a potentiometer arrangement intended for supplying the shielding grid of a screened-grid valve. H.T.+2 and H.T.+3 are used for supplying voltage to

are provided any one of these can be omitted if it is not required for the particular set with which the unit is to be used. In order to avoid possibility of accidental shocks, the whole unit is enclosed in a metal case screwed to the baseboard, as illustrated in the bottom right-hand corner of this page. In some cases it may be necessary to change the values of the voltage-regulating resistances. The proper resistance should be

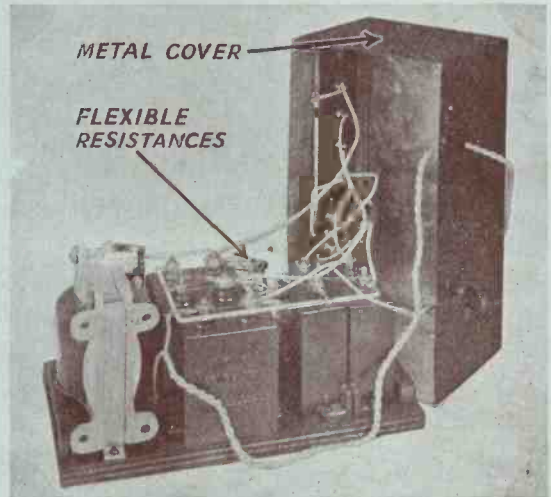

The strip for the four output terminals and potentiometer is fixed to the metal case, as will be clear from this illustration



CHECKED BY
[Signature]

BLUEPRINT #19
WM 105

NOTE - MOVING PLATES OF CONDENSERS MUST BE CONNECTED TO METAL SCREEN.

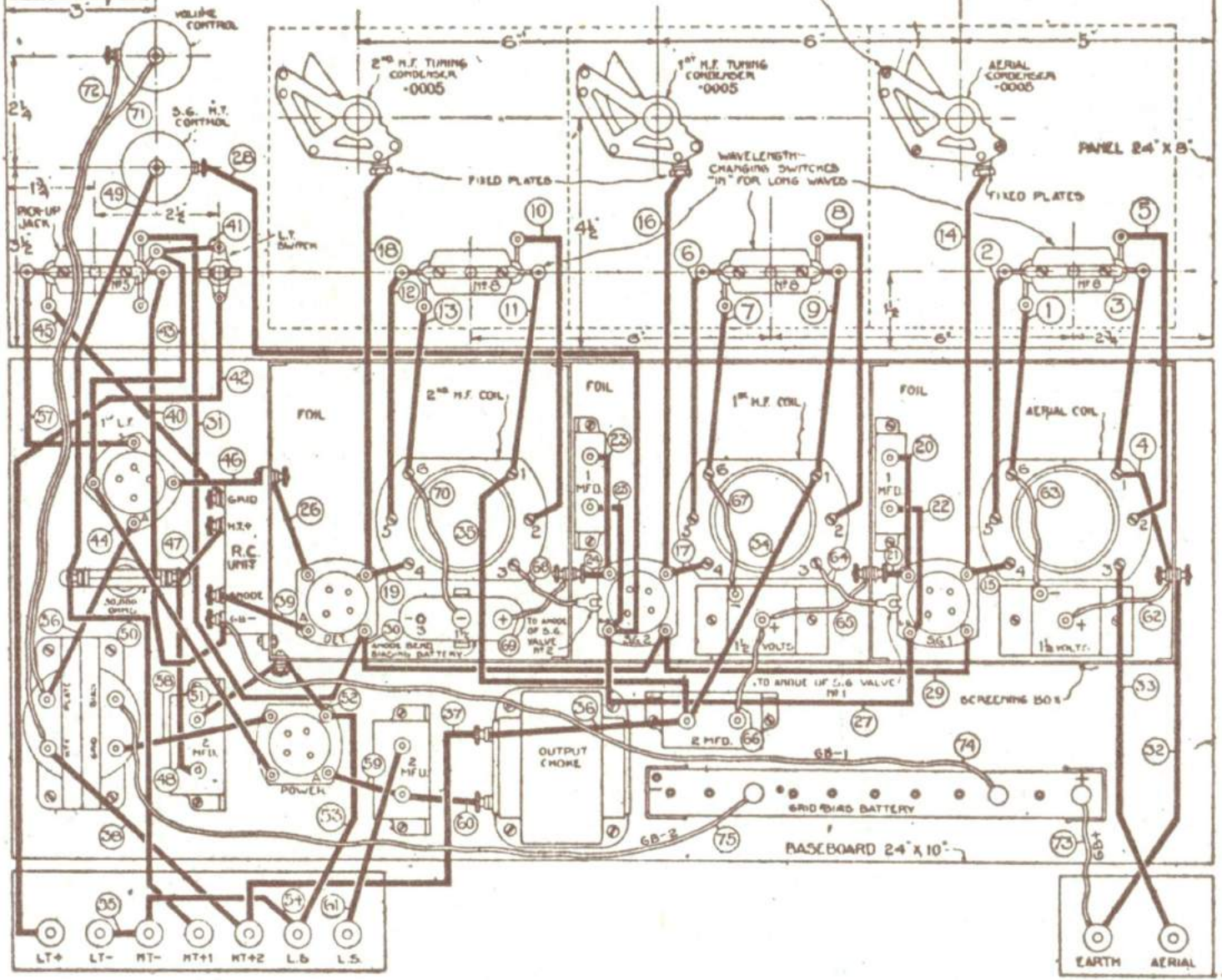

EARTH AERIAL

CHECKED BY

10 MPA

BLUEPRINT N°
WM 211

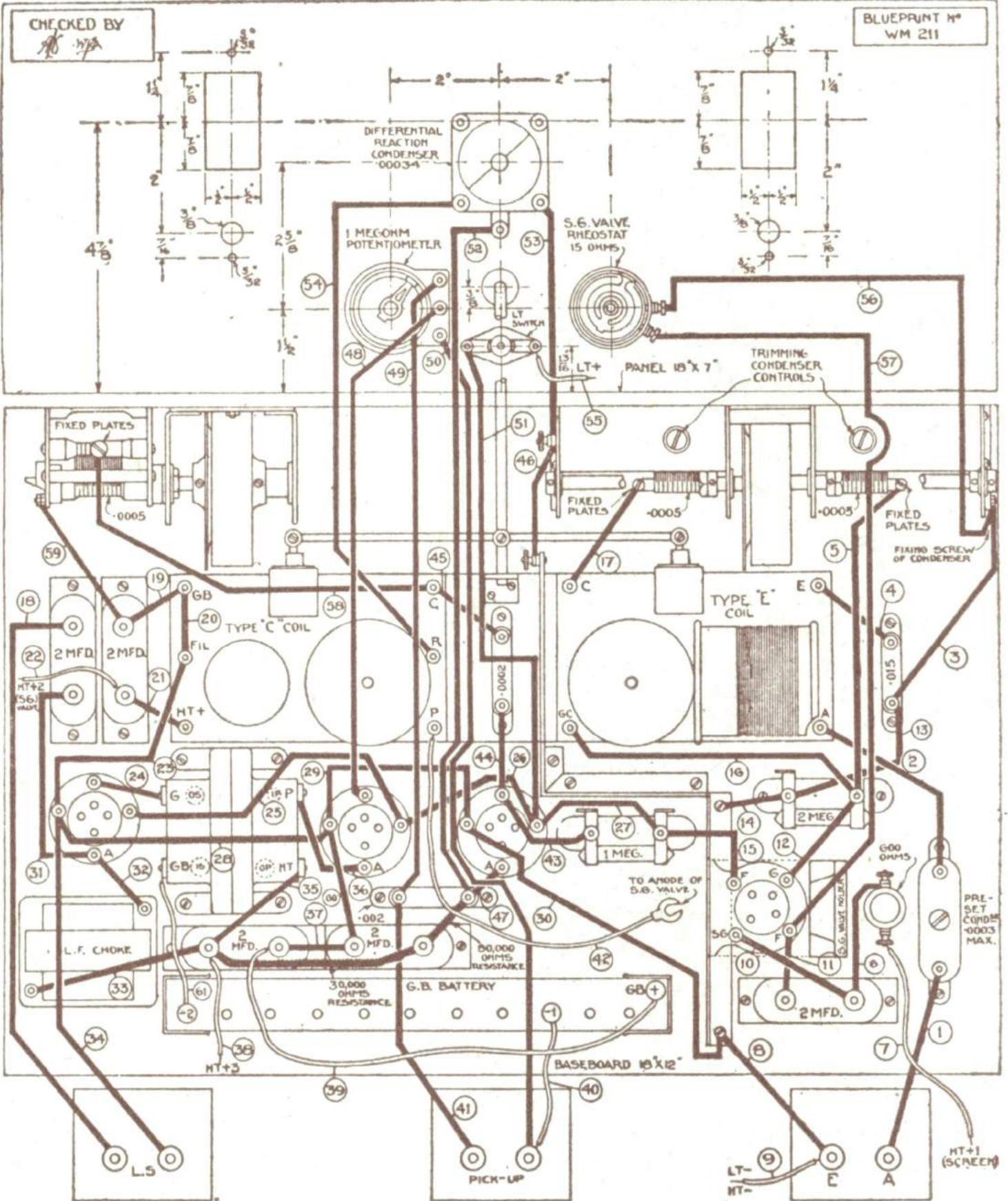

CHECKED BY

AKC [Signature]

BLUEPRINT NO
WM 212

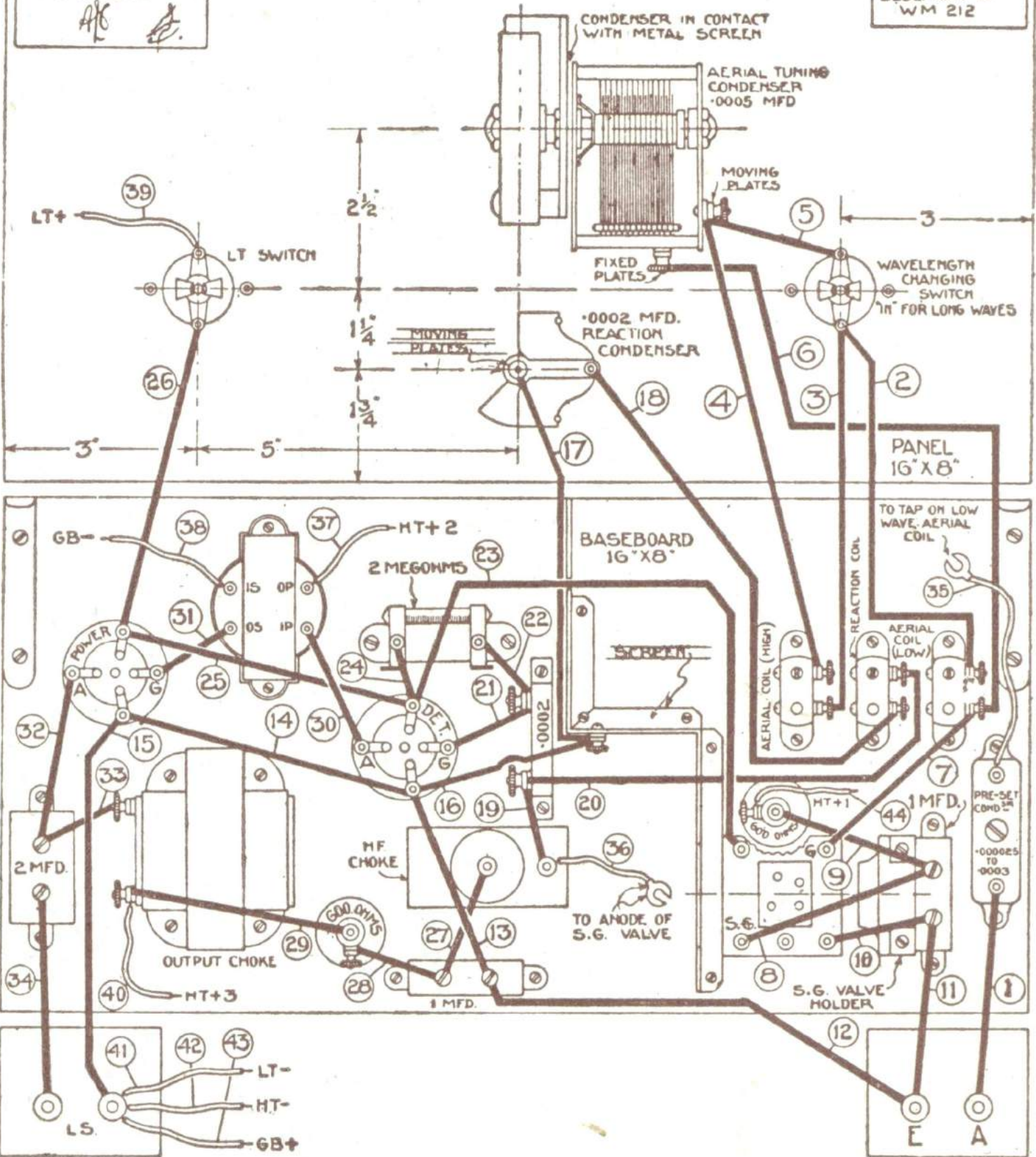

39
LT+
LT SWITCH

2 1/2

CONDENSER IN CONTACT WITH METAL SCREEN

AERIAL TUNING CONDENSER .0005 MFD

MOVING PLATES

FIXED PLATES

.0002 MFD. REACTION CONDENSER

WAVELENGTH CHANGING SWITCH 1\"/>

PANEL 16\"/>

BASEBOARD 16\"/>

TO TAP ON LOW WAVE. AERIAL COIL

HT+ 2

2 MEGOHMS

SCREEN

GB-

POWER

DET.

HF CHOKE

TO ANODE OF S.G. VALVE

HT+ 1

500 OHMS

1 MFD.

S.G. VALVE HOLDER

PRE-SET COND. 1/2

.000025 TO .0003

2 MFD.

OUTPUT CHOKE

1 MFD.

HT+ 3

LS.

LT-

HT-

GB+

E

A

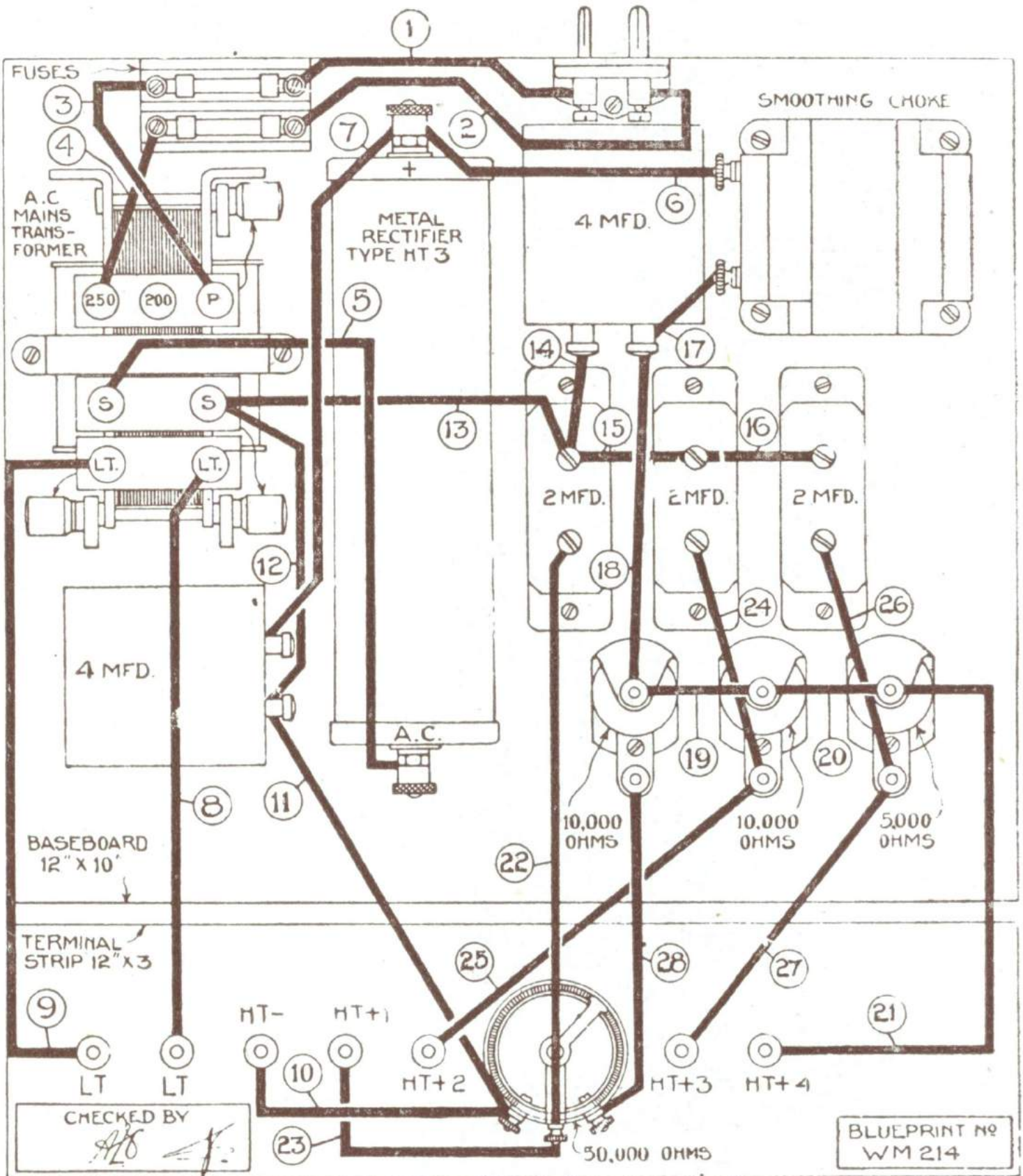

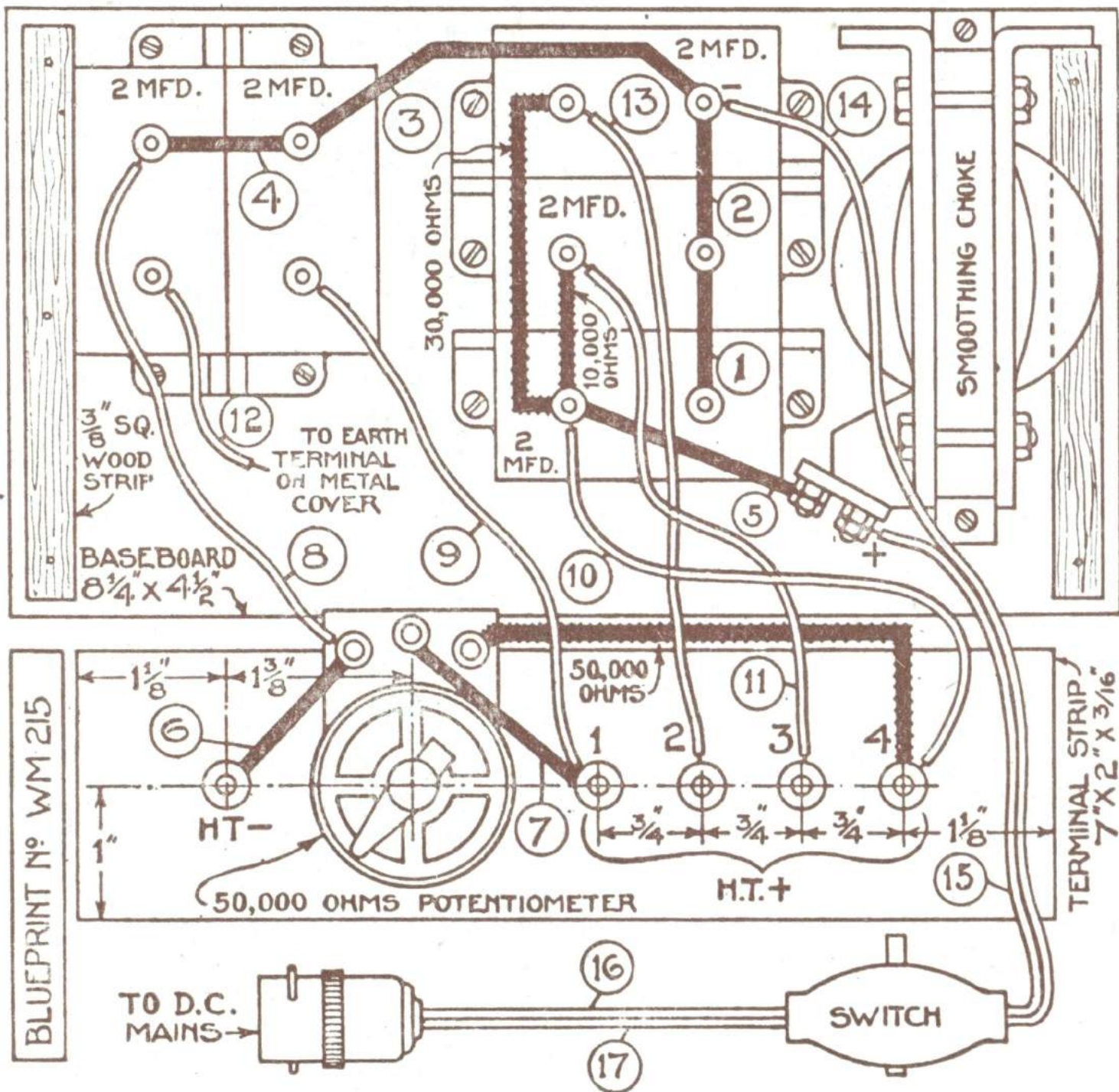

CHECKED BY

[Signature]

BLUEPRINT #
WM 216

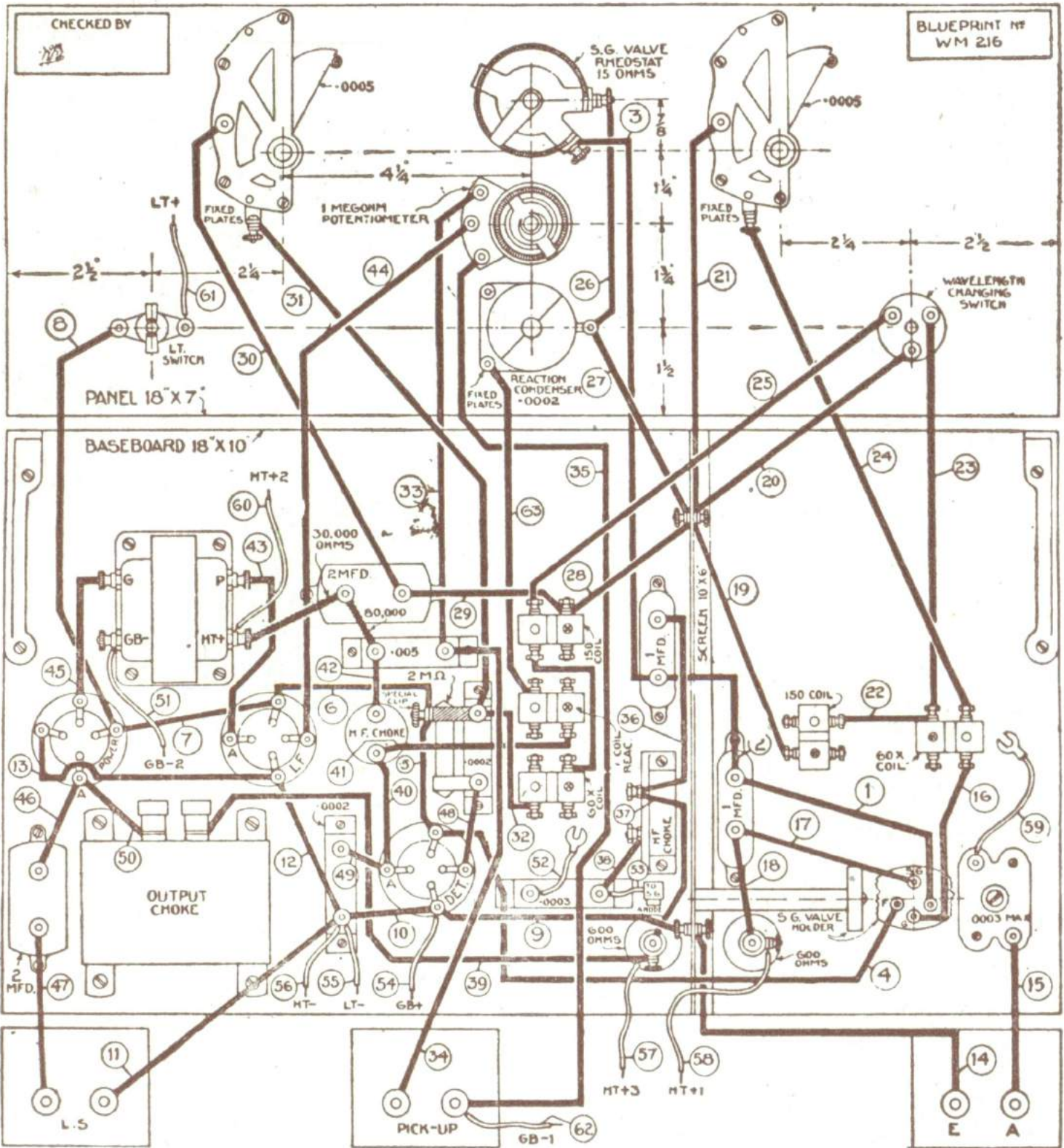

CHECKED BY

[Signature]

NOTE: MOVING PLATES OF VARIABLE CONDENSERS SHOULD BE IN CONTACT WITH METAL PANEL.

BLUEPRINT NO. WM 217

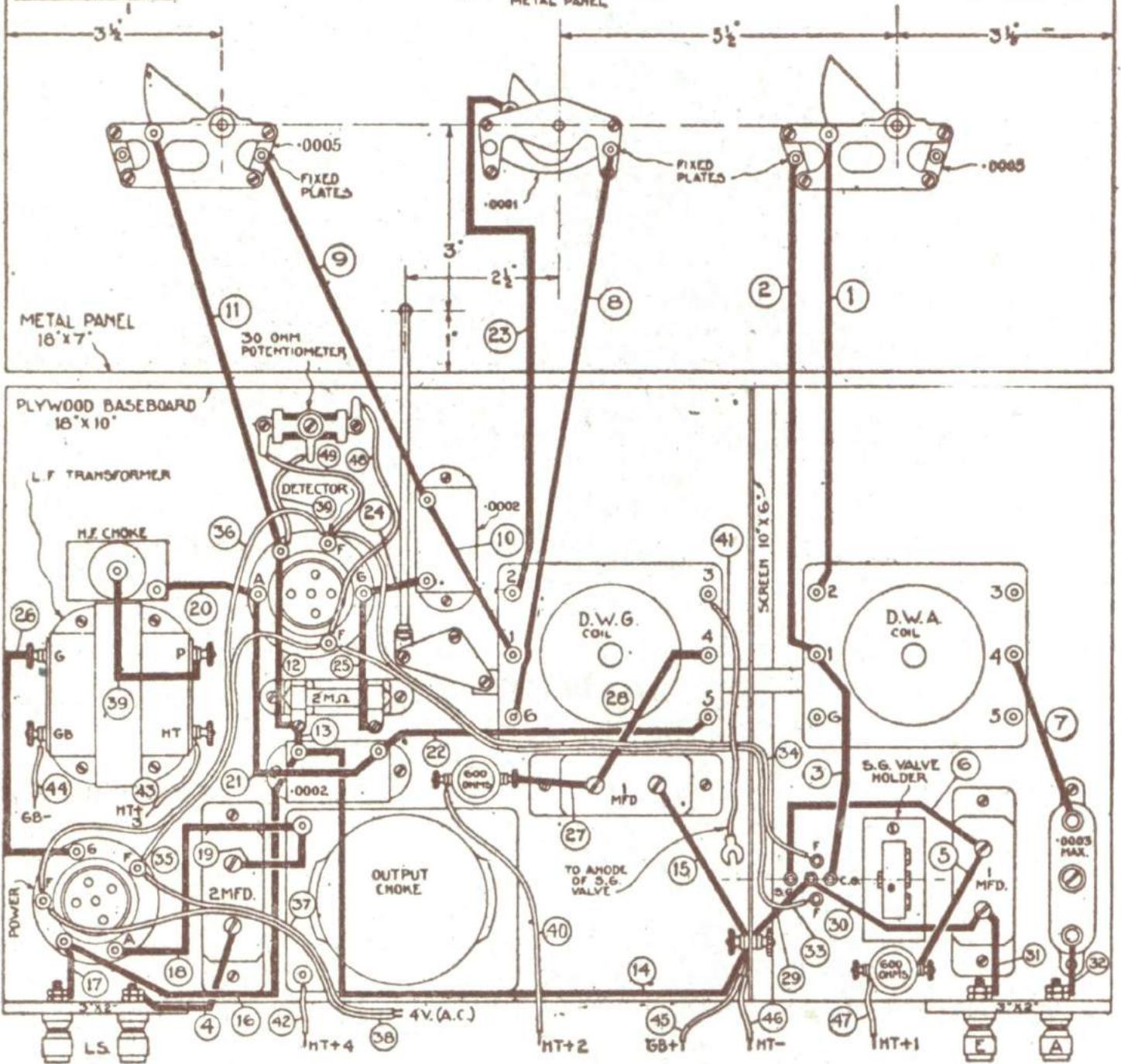

CHECKED BY

[Handwritten signatures]

BLUEPRINT NO
WM 218

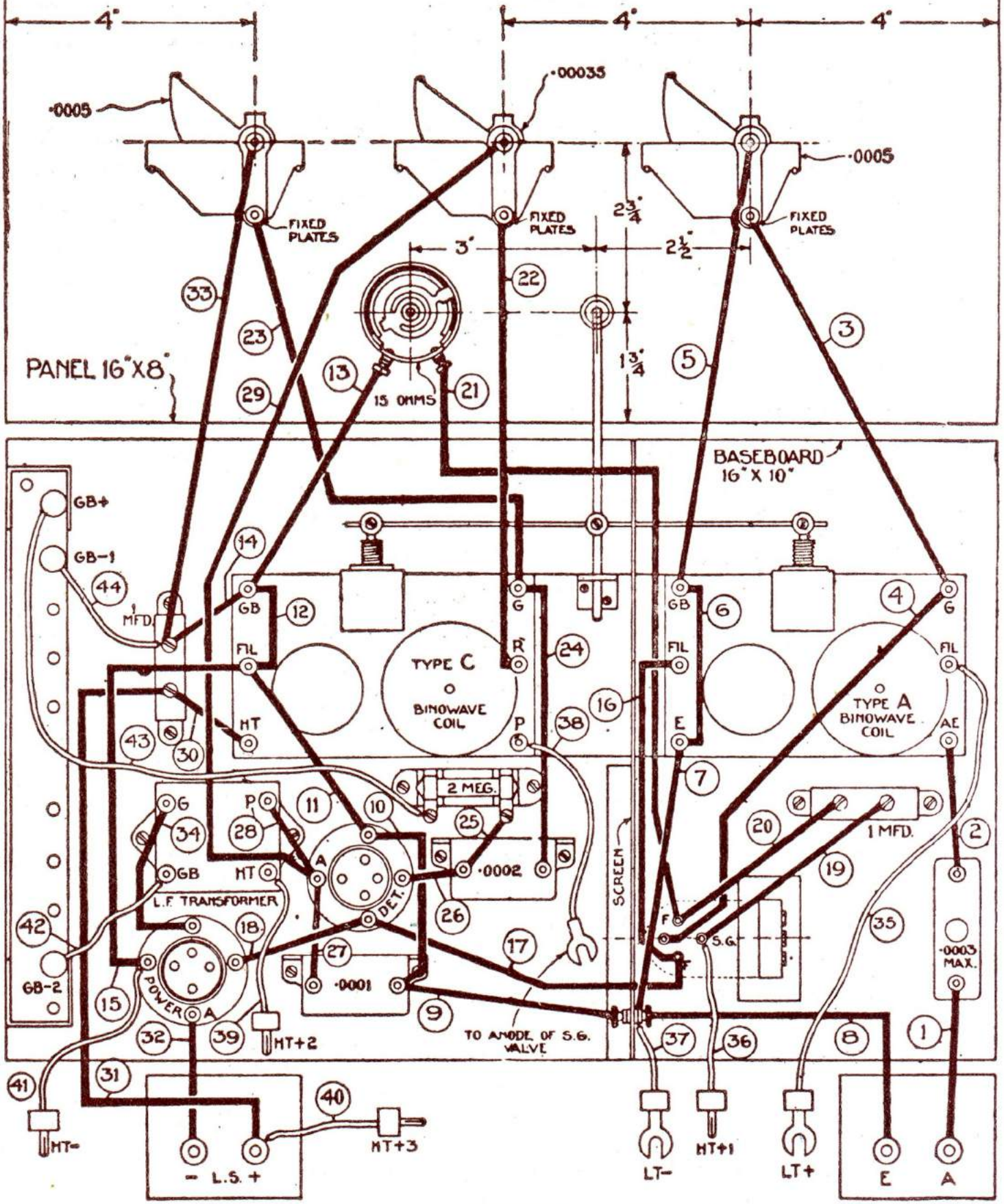

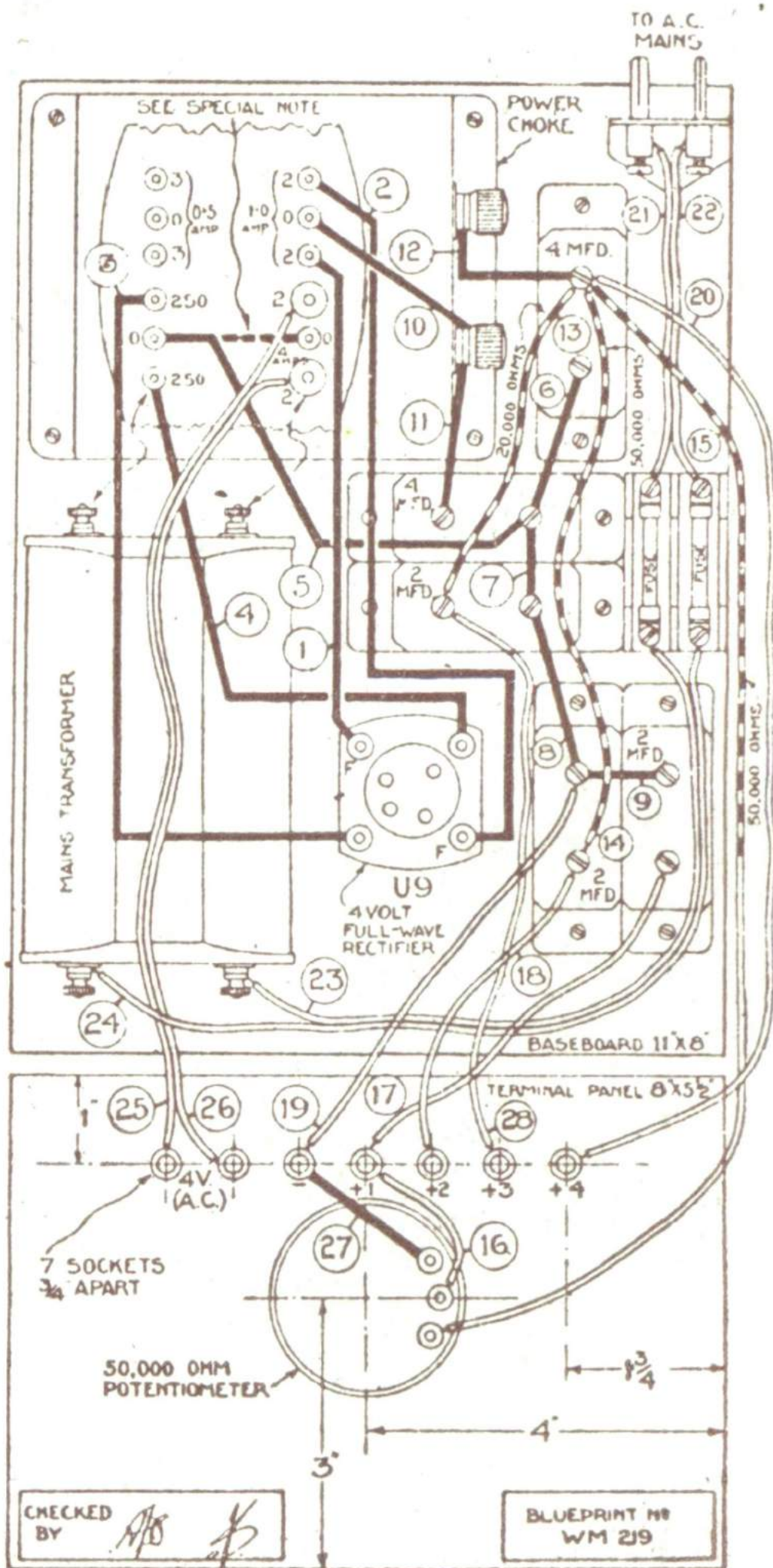

CHECKED BY

AK

BLUEPRINT No
WM 220

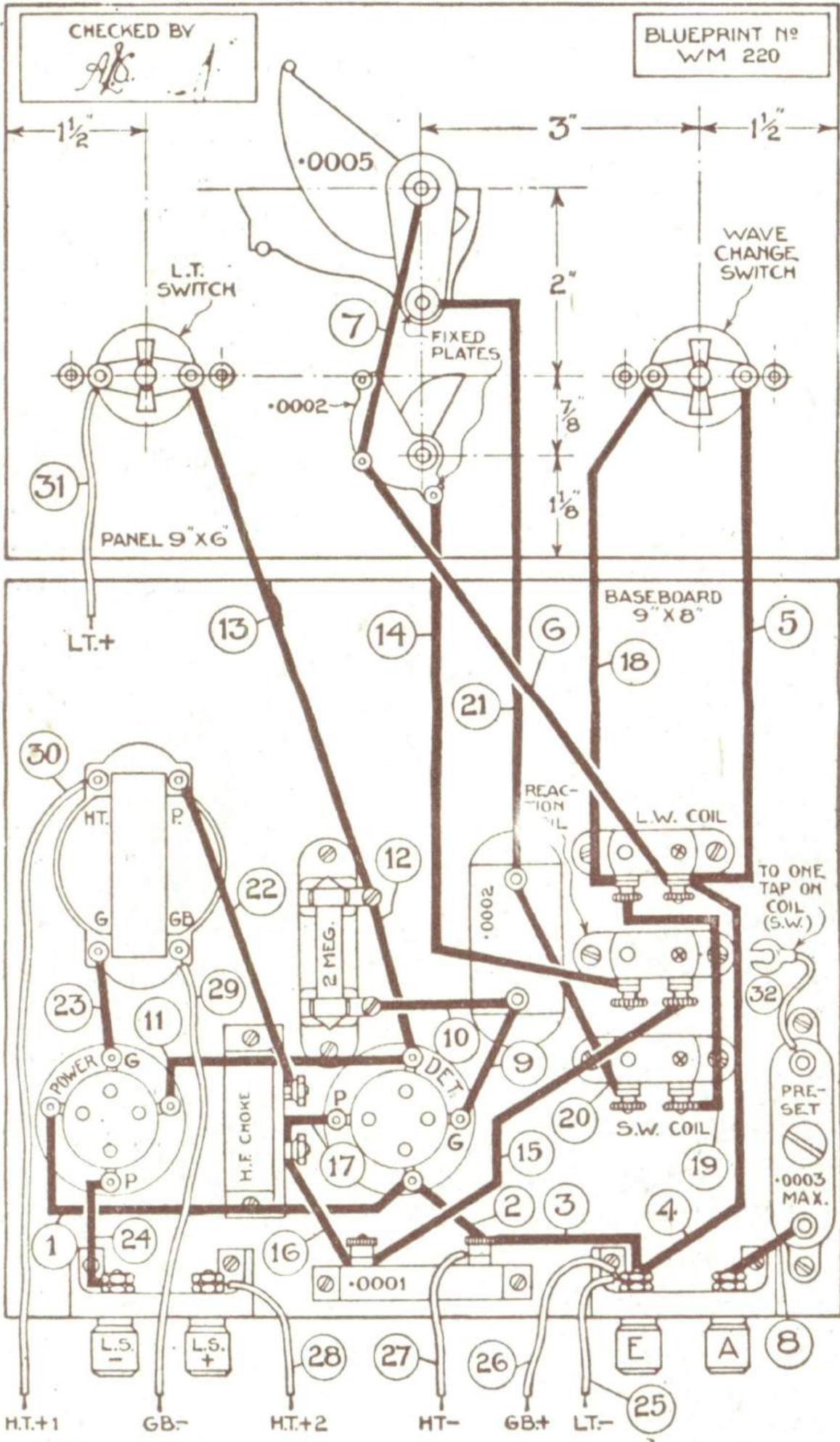

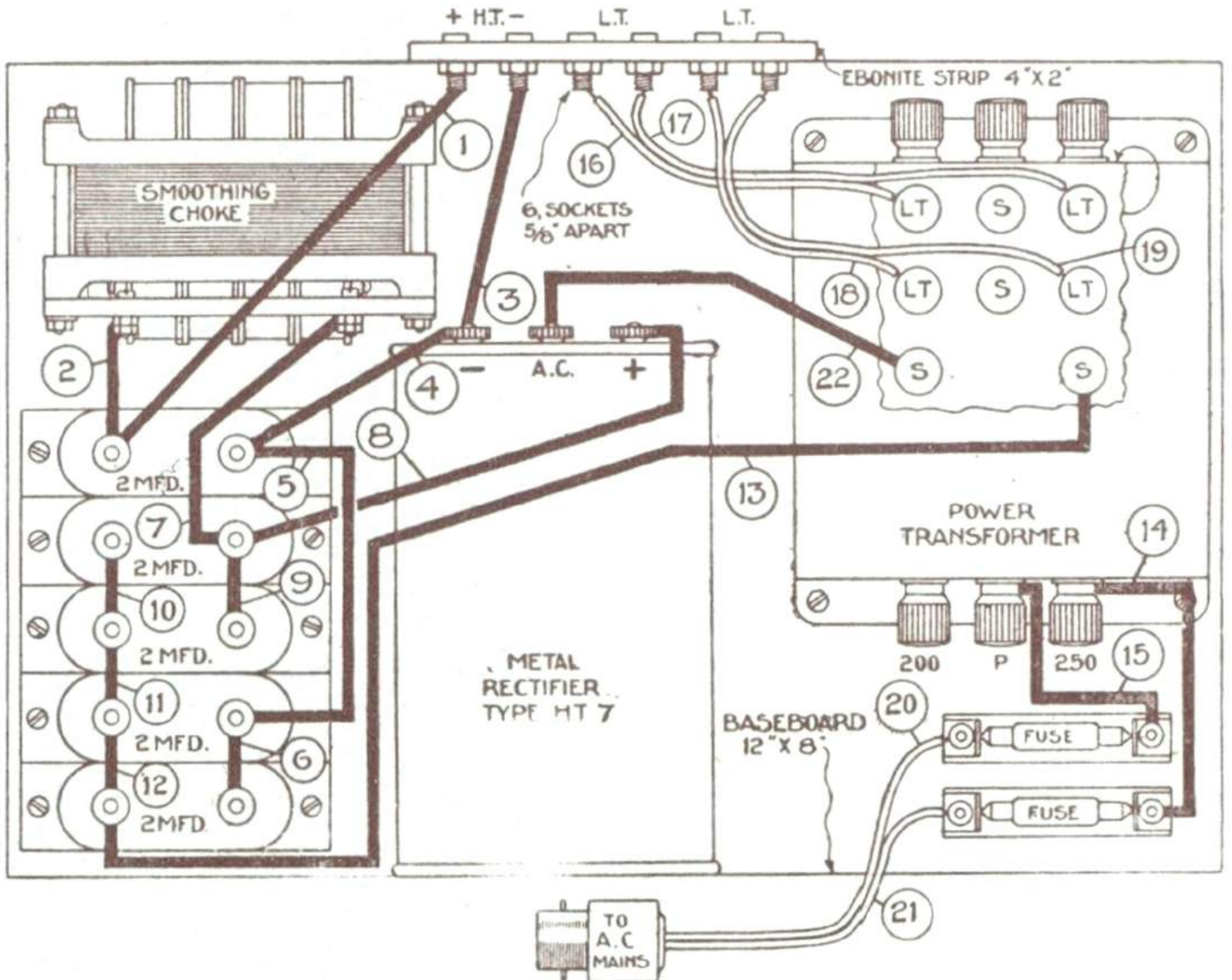

CHECKED BY

AF *F.*

NOTE:- BOTH CONTACTS OF SWITCH
MUST BE INSULATED
FROM METAL PANEL

BLUEPRINT NO
WM 223

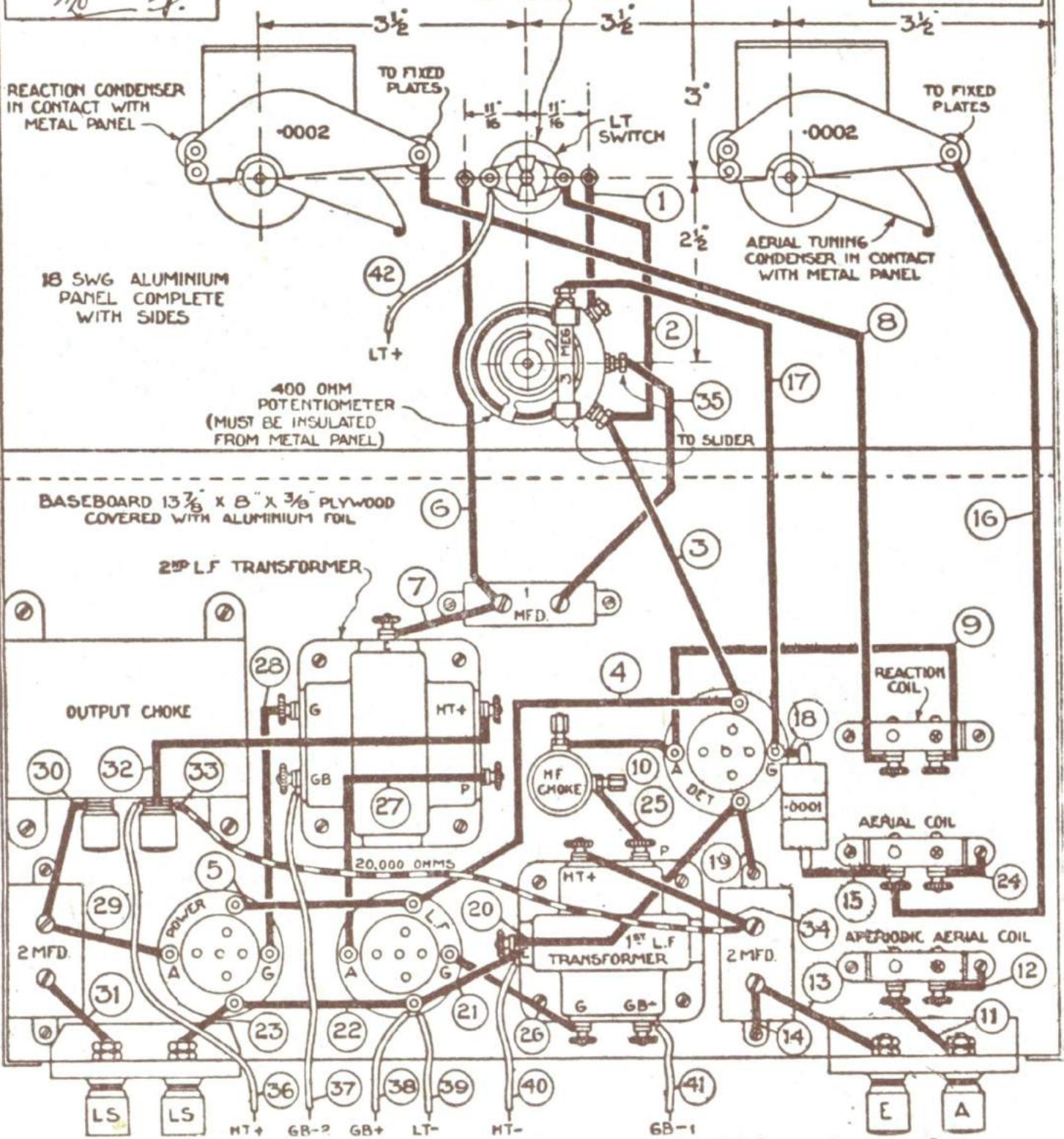



Giving Employment

HAS it ever occurred to you what effect the mass production of radio sets is having on other trades?

Figures recently issued by Kolster Brandes throw an interesting light on this subject. Their average sales recently have been over 5,000 sets a week.

I was interested to learn that one week's output of sets from their factory means the use of 3,879 miles of wire, 4,788 square yards of silk, 28,790 wander plugs, 215,209 eyelets, and 28,529 square yards of timber.

These figures demonstrate the growing importance of the radio industry. And you must remember that they refer to one manufacturer only.

The Old Gang

How many of the constructors who clamour for gang control realise the difficulties the designer has to face? Not only is there a shortage of good gang condensers, but matched coils also present a considerable problem.

I discussed this aspect with a coil manufacturer the other day. "The trouble," he said, "is that if we match coils we must pack them in separate batches for each set. That is all right until the dealer gets an order for an odd coil."

Breaking the Set

"In many cases, rather than order an extra coil when he already has two or three matched ones on his shelf, he will break open the packet and replace the coil with a different one later. And where is your matching then?"

Now you know one of the troubles that prevents home-constructed gang sets being as generally in use as they ought to be.

Screened-grid Fallacies

It is a fact that large numbers of listeners are badly misled by the large amplification factors published for screened-grid valves. Too few realise that figures like 200, 500, 1,000 (and even 1,500!) are only paper values and cannot be remotely approached in practice.

As Mr. W. James said at lunch the other day, when we were discussing the point: "It is all a matter of capacity." If the external capacity associated with the valve is very much greater than the internal capacity, as it is bound to be, the magnification is reduced to a very low figure.

I remember Captain H. J. Round showing me a set he had built with three screened-grid stages. When I asked what the amplification was he confessed that it was less than ten for each stage!

Practical Difficulties

That figure is, of course, very low and can be exceeded if the set is very carefully designed. It is largely a matter of getting the right tuning coils and providing effective capacity screens.

I believe that Mr. James still considers that he can get a bigger stable magnification from a properly neutralised high-frequency amplifier than he can from a screened-grid stage.

Caught Out!

One of my misfortunes recently was to move to a district where the electric-light supply is direct current. I had been led to suppose that A.C. was available and only discovered the truth when I found an A.C. mains set would not work.

Fearing the worst I had a look at the meter—it was marked "direct current!"

There was nothing to do but scrap all my A.C. gear for the time being. If you are thinking of moving take my advice and make certain beforehand what the electric supply really is.

Matched Knobs

I am not giving up my agitation for the constructor's need of marked components, but this month I want to say something about knobs.

Why cannot the makers of parts such as volume controls, rheostats, and switches—which have panel controls—come to some arrangement to supply matched knobs with their products? Here is a chance for the Radio Manufacturers Association to do some useful work.

At present you can never tell what a set will look like until the construction is finished. In many cases you find that the knob of the volume control on the right of the panel, for example, does not match in the very least with the screened-grid rheostat knob on the left. This is all wrong and makes home-constructed sets look much more "botchy" than they really are. We must insist on something being done!

RADIO MEDLEY—Continued

Mains or Batteries ?

In these notes last month I mentioned that it would be interesting to know what proportion of WIRELESS MAGAZINE readers use mains-operated sets.

I invited readers to let me know what they use (the address is "BM/PRESS, London, W.C.1"), but as these notes have to be written a day after the last issue was published, few post cards have yet come to hand.

What Readers Use

However, I have heard from three readers. Mr. J. F. Clarkson, of Orpington (Kent), uses his A.C. mains for high tension and low tension; he has a unit designed by Mr. J. H. Reyner in 1928.

Two other readers at Tunbridge Wells also use their A.C. mains. Mr. A. L. Thorne has a three-valve set with 6-volt valves; high tension at 200 volts 30 milliamperes is supplied by an Ekco unit.

"All mains—filaments, grid bias, everything" is the type of set being constructed by Mr. G. W. Park.

Use a Meter

I am convinced that far too few amateurs use meters. Failure to do so leads to all kinds of troubles and waste. For instance, have you ever measured the anode-current consumption of your set?

You really ought to, you know. Otherwise you cannot be sure that the anode battery or mains unit is not being badly overloaded.

By far the most useful gadget I have is a Ferranti valve tester. You remove the valve, put an adapter attached to the tester in the valve holder, and replace the valve in the top.

Then you can read, simply by turning a knob, anode current (0 to 10, or 0 to 100 milliamperes), anode voltage (0 to 100, or 0 to 300 volts) as well as the filament voltage. Unfortunately, the adapter cannot be used with five-pin valves.

Home Recording

Have you tried making any records at home? I can assure you it is great fun.

For the last few evenings I have amused myself—and the rest of the family, for this is a thing in which

everybody can join—with a new recorder invented by Mr. Arthur Kingston, who is a talkie and film expert.

What I like about the new system is that ordinary speech records can be made without any electrical amplification which, as you will agree, saves a great deal of trouble.

There is only one snag as far as I am concerned. I do *not* like fibre needles—it is such a business re-sharpening them!

Beginning of the End ?

I have just heard a most interesting rumour. It is that after they have sold their present stocks (which are reported to be big enough to last all this year) one of our most famous gramophone companies will no longer make mechanical machines, but will produce only electric models.

If this is true it is likely that the ordinary mechanical instrument will in a few years be a thing of the past. In common with other radio fans I rejoice over this piece of good news.

Rajahs at Savoy Hill !

This has nothing to do with the Indian Conference. I take the term from an article by Sir John Foster Fraser, in the *Sunday Graphic*, who says: "Thousands of us think Savoy Hill should be the successor of Tower Hill for the decapitation of bullying rajahs of the air who give us what they think we ought to have instead of what we know we want!"

Another comment will interest those who find fault with the programmes. "If the supreme rajah of Savoy Hill (Rajah Reith) is endeavouring to be a broadcasting St. Paul, all things to all men, which I doubt, he has learnt by now he has made a mess of things."

Although I, personally, have the greatest respect for the Director General and appreciate the difficulties with which those at Savoy Hill are faced, I think "Rajah Reith" is good enough to be kept in circulation!

That Boycott !

Last month I brought to your notice a denial of the statement that there is a boycott against German radio apparatus in Denmark. I also expressed the opinion that I had not misunderstood my informant, Mr. Tage Byskov.

Now Mr. Byskov has written to say how the slip arose. He says: "I told you—or would have told you—that I found it a shame that not more English components could be sold in Denmark as we are strong believers in English quality."

Interest in England

"I told you as an example of our interest in England that our farmers were angry about the German meat customs and that some co-operative farmer organisations had made a private boycott of German coal and in future would buy their coal from England.

"I think that you have understood this as a special boycott of German radio goods, which is not made and will not be made, I think."

A Black Scoundrel

Mr. Byskov adds an amusing comment, for he continues: "I am



RADIO CAN BE GREAT FUN !

Jack Hulbert and Cicely Courtneidge, two popular artistes, enjoying radio with a McMichael portable set

A RADIO FAN'S CAUSERIE

mentioning this because a wholesale dealer in Copenhagen, who specialises in German goods and who sends a little monthly to his customers, has made a dreadful attack on me in the latest number, telling people that I travel in England and make great lies to all who will hear me there.

"I am not afraid of a sort of Hitler attack from this angry Germanophile, but I think he will write and tell you what a black scoundrel you have had under your innocent roof. I don't hope that this little misunderstanding will disturb you."

On the contrary, I am sorry that Mr. Byskov has been so much disturbed by my original comment, which was made in good faith.

Stenode Reflections

A question I hear asked by many people is: "How much different is a Stenode from an ordinary super-het when the quartz-crystal gate is removed?"

The thought in some people's minds is this: The original Stenode with the quartz crystal gave results that were nothing short of revolutionary, but the broadcast model must necessarily be less selective, for the original could only be operated by expert technicians.

A number of manufacturers are wondering whether a modern super-het, not employing the Stenode principle, could not be made just as selective. In a few months we shall see some interesting developments, I am certain.

Flexible Records

Have you seen any of the new flexible records? They are extremely light and you could carry twenty or thirty of them without knowing it. They will be a boon to those with portable gramophones.

Mr. James is interested in them, he tells me, because two very young members of his family have been suspected of breaking the ordinary kind of record on occasion! There will be no such difficulty with the new type.

These records are most attractive, being finished in various colours. Special needles must be used; the angle of the ordinary type is too steep and results in the surface being cut up.

Short Waves at Sea

On the new motor vessel *Worcestershire*, which is being completed at Glasgow for the Bibby line, a special Marconi short-wave transmitter will be installed for communicating over exceptionally long distances, such as from the Indian Ocean to Great Britain.

The installation will work between 16 and 40 metres.

Are You a Short-waver?

I must confess that short-wave reception has never greatly appealed to me, although in the old days I did on occasion sit up half the night to hear America.

Do you ever listen to stations on wavelengths between 10 and 100 metres? If you answer "Yes" I will hazard the guess that you are more interested in the technical side of radio than in getting entertainment from your reception.

The fact is there is little entertainment to be obtained on the short waves; no doubt it will come in the future. In the meantime we shall get the most thanks from our families if we stick to the medium and long wave-bands.

A Pioneer

Recently Mr. Henry W. Allen, who is said to be the first person to enter the employment of any wireless-telegraph organisation in the world, was presented with an H.M.V. radio gramophone by his colleagues. He is retiring under the age rule.

Marchese Marconi, who made the presentation, referred to the help he had received from Mr. Allen when he first visited this country in 1896.

Mr. Allen was secretary of the

original Wireless Telegraph and Signal Co.

He remains a director of the Marconi International Marine Communications, Co. Ltd., and is a consultant of Imperial and International Communications.

Altogether a record of which to be proud.

Good Earths

Most people, I suppose, would say that there is nothing about the ordinary earth tube that could be improved to any great extent.



PRESENTATION BY MARCHESE MARCONI
Here you see Marchese Marconi (right) presenting an H.M.V. radio-gramophone to Mr. Henry W. Allen, who was secretary to the original wireless communication company

I thought so myself until I saw a new model being developed in the factory of a well-known firm of component manufacturers a few days ago.

I do not think I shall be going too far if I say that the new design has a special gadget that enables one to solder the earth wire to the tube without the need for either blow-lamp or soldering bit.

If you have ever tried soldering a wire to an earth tube out of doors you will appreciate this improvement.

BM/P.R.55

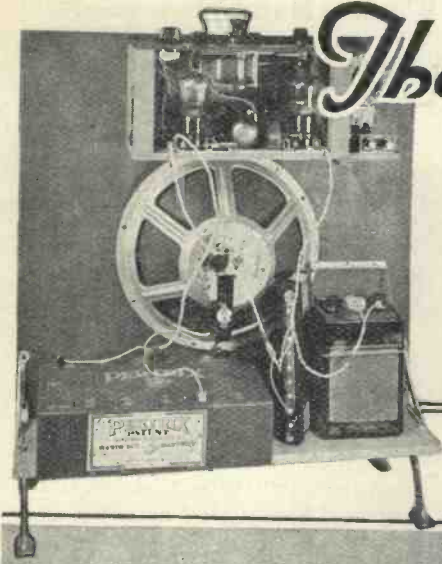

The Baffle-board Three

★ SOMETHING NEW IN SET DESIGN ★

You will like the fine quality of reproduction obtained from this simple set, which has been produced by the WIRELESS MAGAZINE Technical Staff

EVERYBODY knows that to get the best results from a cone loud-speaker it should be mounted on a baffle of substantial dimensions, but until recently such boards have not been particularly attractive and it was always a problem to listeners to know best how to place them in a room in the most convenient way.

Attractive Baffles at Low Cost

Lately, much more attractive baffle boards have become available, and it is possible to get them in various finishes—for instance, mahogany or oak, copper or silver, and oxidised copper or oxidised silver—at very reasonable prices.

Moreover, oxidised copper or oxidised silver handles and feet are now available, so that the baffle fitted with these gadgets can be placed anywhere in a room in the most convenient place, where it will cause the least obstruction.

It occurred to a member of the WIRELESS MAGAZINE Technical Staff that there is a lot of space on a baffle board that could be used for the mounting of a set.

Various experiments were tried and it was found possible to make a very neat and convenient assembly by fixing a small set at the back of the baffle just above the loud-speaker and providing a shelf at the bottom on which the necessary batteries could be placed (see photograph at this top of the page).

We present here details of the Baffle-board Three in the belief that this new type of construction will appeal to a large number of listeners. The constructor is saved the cost of a special cabinet for the receiver.

The whole baffle is self-contained and can be moved about the room to any convenient position as long as

the aerial and earth leads will reach far enough.

Although in this article we are describing the construction of a particularly suitable three-valve set, many amateurs will be able to adapt other designs of sets to this new form of construction.

Our intention in this case has been to produce a cheap and simple set for the reception of the regional stations and a few foreigners. With this object in view only the simplest components have been employed and use has been made of the ever-popular form of two-pin plug-in tuning coil, which has been used with such great success in the "Five-point" sets.

A glance at the photographs reproduced in these pages will show the straightforward nature of the construction. It is suggested that the receiver should be protected from dust by tacking thin plywood round it when mounted on the baffle board. We have photographed the set without any such covering so as to make all the points of construction quite clear.

Before considering the construction any further let us spend a few minutes dissecting the circuit diagram, which appears on page 38.

It is a fact that two-pin plug-in coils are not so selective as some other types of tuner that are available, but they have the advantage of cheapness and adaptability. Moreover, hundreds of constructors have a stock of these coils.

Building the Set at Little Expense

Indeed, most amateurs who have built two or three sets previously will already have the majority of the components needed for the Baffle-board Three and will, therefore, be able to assemble it at very little expense.

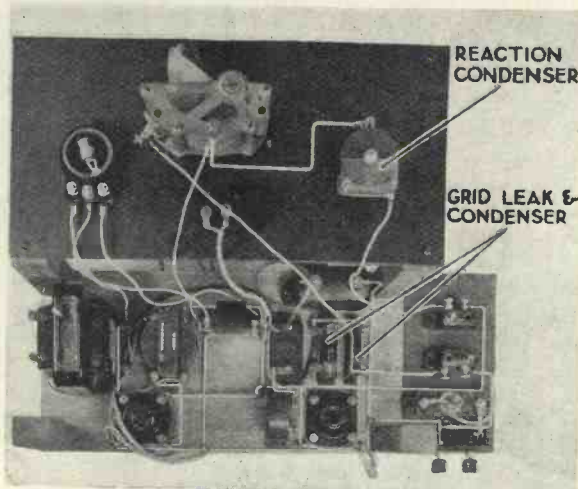

HOW TO WIRE UP THE SET

It is suggested that the panel should be temporarily screwed upside down on two of the wooden supports fixed to the baseboard

However, we are digressing and must return to the problem of selectivity. Experience shows that at a reasonable distance from a regional station, say, a minimum of ten miles, sufficient separation can be obtained by using a series aerial condenser and a double-tapped tuning coil. This, therefore, is the combination employed for the Baffle-board Three.

Results on Test in London

Under test in south-east London (at a distance of approximately twenty miles from Brookman's Park) this set gave five stations on the medium waves, with an 80-ft. outdoor aerial, without any signs of interference.

At 30 degrees on the aerial-tuning condenser the London National station was picked up at good strength; at 93 degrees London Regional came through; at 126 Rome was picked up at good strength; Midland Regional was heard at 138 degrees, and Vienna came in well at 159 degrees. On the long waves Daventry 5XX was heard at 139 degrees and Radio Paris came through at 153 degrees.

During this short test it was very apparent that the quality of reproduction was above the average, in spite of the fact that the power valve was not of very low impedance. Nobody who builds this set and uses the specified parts will be disappointed with the quality of reproduction.

For the sake of sensitivity the detector valve is arranged on the leaky-grid principle, with a .0002-microfarad condenser and a 2-megohm leak. Reaction is obtained by coupling a second plug-in coil to the aerial coil, the amount of feedback from the anode circuit to the grid circuit being controlled by a .0002-microfarad variable condenser. A high-frequency choke is included in the anode circuit of the detector valve to improve the reaction effect.

Valve Combination

Following the detector are two stages of low-frequency amplification, the first being resistance-capacity coupled and the second transformer-coupled.

In conjunction with the anode resistance of 80,000 ohms is a decoupling resistance of 30,000 ohms; this, in conjunction with the 2-microfarad by-pass condenser, effectively prevents any possibility of low-frequency oscillation, or motor-boating, as it is more usually termed. With these values of resistance it is intended that a valve with an impedance between 30,000 and 50,000 ohms should be employed.

Variable Grid Leak for Controlling Volume

The coupling condenser between the anode of the first valve and the grid of the second valve has a value of .005 microfarad. The grid leak has a value of 1 megohm, but this is made variable so that volume can be easily controlled within the desired limits. It will be seen that the grid of the second valve can be

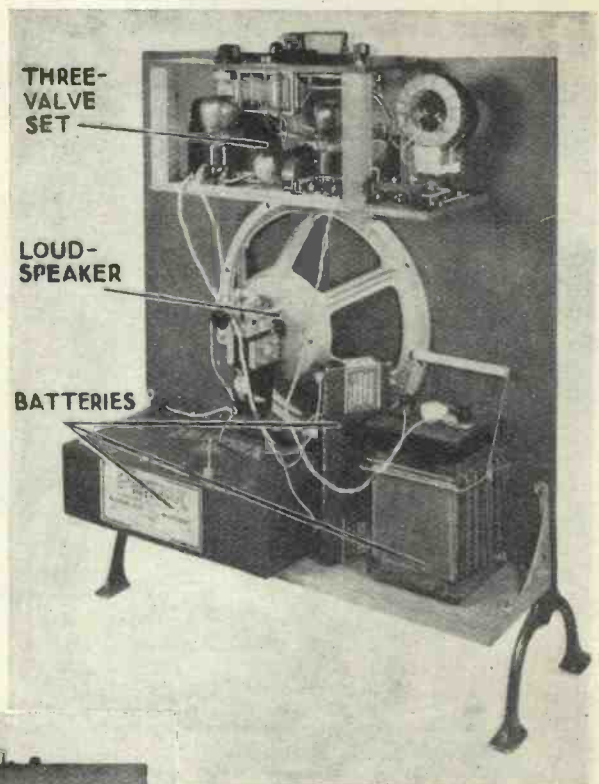

COMPLETELY SELF-CONTAINED

From this photograph it will be seen that the set is completely self-contained, except for the aerial and earth

tapped up and down the grid leak as required. Minimum volume is obtained when the grid is tapped down towards the grid-bias end of the resistance.

The connections of the low-frequency transformer in the anode circuit of the second valve are standard and need no comment. Any good transformer can be used in this position; it should preferably have a step-up ratio of about 1 to 3.

Output Management

Most constructors are aware that to get the best results from a loud speaker it is desirable to prevent the steady anode current of the power valve from passing through the reproducer windings. This can be done either by using a choke-capacity output circuit, or by the insertion of an output transformer between the power valve and the loud-speaker.

In this set we have used an output transformer with a ratio of 1 to 1. This is suitable for the average high resistance loud-speaker when an ordinary type of power valve is used. Other ratios are available for various purposes; for example, a step-down transformer would be needed if a low-resistance moving-coil loud-speaker were used.

It will be seen that two high-tension feeds are

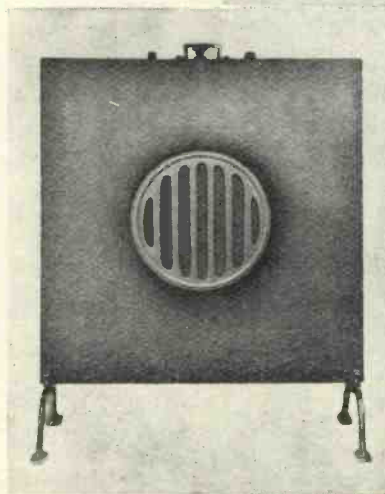

ATTRACTIVE FRONT VIEW

The control knobs can just be seen at the top of the baffle; six different finishes are available to match with different furnishing schemes

Tell Your Friends About This Special Set

THE BAFFLE-BOARD THREE—Continued

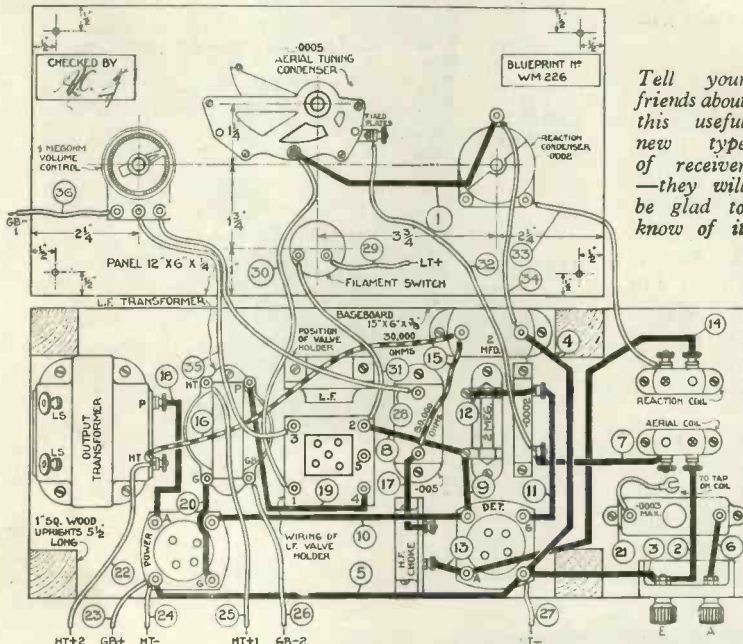

Tell your friends about this useful new type of receiver—they will be glad to know of it

LAYOUT AND WIRING GUIDE FOR CONSTRUCTORS

This quarter-scale wiring guide can be obtained as a full-size blueprint for half price (that is, 6d., post free, if the coupon on page 112 is used by February 28. Ask for No. WM225. When wiring up, connect the leads in the numerical order indicated

For the sake of convenience it is suggested that the set should be wired up as shown in the plan photograph on page 36, from which it will be seen that the panel has temporarily been screwed upside down to two of the wooden pillars fixed to the baseboard.

Connections between components mounted on the panel and other parts on the baseboard can conveniently be made with flexible rubber-covered wire.

How to Wire the Set

Wiring up will be accomplished in the quickest and most satisfactory way if the blueprint is carefully followed. It will be seen that every connecting wire is numbered separately; it is intended that the leads should be placed in position one by one in the numerical order indicated.

If this scheme is followed out carefully, there is no possibility of making a mistake and the wiring will automatically be built up in the most satisfactory way.

There is one point about the blueprint that should be noted. The holder for the first low-frequency valve is of the type for horizontal mounting of the valve itself, as will be clear from the photographs. For the sake of clearness, however, this holder is shown in detail on the blueprint in its horizontal as well as its vertical position, so

provided; the first (marked H.T. +1) supplies the first low-frequency valve, while the second (marked H.T. +2) supplies both the detector valve and the power valve. Two negative grid-bias tappings are also provided, the first for the transformer-coupled low-frequency valve and the second for the power valve.

No Special Parts Needed for Construction

It will be quite clear from this description that there are no special parts needed for the construction of the set and, as many amateurs have a good stock of components, the set can be made, as previously pointed out, at very little expense.

A feature of the design is the simplicity of construction, which will be quite clear from the photographs and wiring diagram reproduced in these pages.

Many constructors prefer to work from a full-size blueprint, and one of these can be obtained under the special half-price scheme up till the end of February. Send the coupon on the last page of this issue to Blueprint Department, WIRELESS MAGAZINE, 58-61 Fetter Lane, London, E.C.4, with a postal order for 6d. Ask for No. WM226.

that there shall be no confusion as to how the connections are made to it.

Resistances that Form Connections

Another point to notice is that the anode and decoupling resistances associated with the first valve are of the flexible or spaghetti type. These resistances actually form the connections numbered 15 and 16.

Before the set can be used it will be necessary to insert the coils and valves in their respective holders. We will consider the coils first.

For each waveband two coils are needed, for aerial tuning and reaction respectively. To cover the medium and long wavebands a No. 60 and a No. 200 coil are needed; these should both be of the double-tapped type.

Our tests have indicated that a No. 50 plain coil will give satisfactory reaction with either of the aerial coils recommended, so that in practice both wavebands can be covered by the use of three coils only. It should be observed that the reaction coil is that nearest the baffle board when the set has been mounted in position.

The question of valves is not a difficult one, but

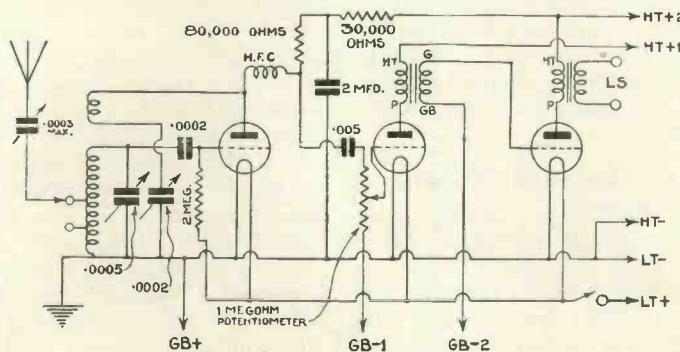

SIMPLE THREE-VALVE CIRCUIT

The valve combination employed for the Baffle-board Three is a leaky-grid detector followed by two low-frequency stages, the first resistance-coupled and the second transformer-coupled

SOMETHING NEW IN RECEIVER DESIGN

care should be taken to choose such types as are within the discharge rate of the high-tension battery to be used.

The detector valve, as already mentioned, should have an impedance between 30,000 and 50,000 ohms. For the second stage a valve of between 10,000 and 20,000 ohms impedance will give good results; it should be remembered that the higher the impedance the greater will be the magnification factor and, therefore, the overall amplification obtained from the set will be increased.

Suitable Power Valve

If a standard-capacity anode battery is to be used, some care should be given to the choice of a suitable power valve. If the ordinary standard-capacity battery (with economical discharge rate of 7 milliamperes) is used, then the power valve, if of the 2-volt type, should not have an impedance lower than 4,000 ohms.

It should be noted, however, that the actual battery specified in the list of components will stand a discharge of 12 milliamperes.

The best results will be obtained with a lower impedance power valve, say with an impedance in the neigh-

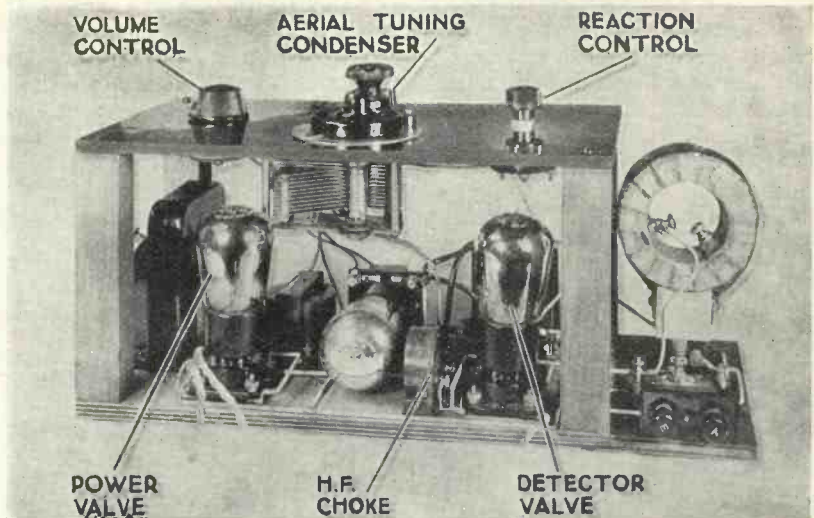

ACCESSIBLE TUNING CONTROLS

On the left of the panel is the volume control; in the centre the main tuning dial; and on the right is mounted the reaction condenser

the taps on the aerial coil. Next screw down the small knob on this semi-fixed condenser so that the maximum capacity is obtained.

Adjust the volume control (on the right of the panel, when the set is viewed from the front of the baffle) for maximum strength by turning it as far to the right as possible and then turn on the filament switch, which is just in front of the main tuning dial.

Adjusting Reaction Control

Set the main dial at zero and advance the reaction control until the set is heard to be on the point of oscillation; this is indicated by a rustling or hissing sound from the loud-speaker. Now slowly turn the main dial, at the same time advancing the reaction control step by step to keep the detector valve on the verge of oscillation. It will not be long before a station is picked up.

Increasing Selectivity

It will probably be found at first that the station spreads badly over a large part of the main tuning dial, but do not be alarmed, because this is not a sign that the set is inefficient. Tuning can be made sharper by unscrewing the knob of the aerial series condenser very slowly and by

picking the best of the two tappings on the aerial coil.

After a few minutes' experimenting it will be possible to arrive at the best compromise between selectivity and sensitivity. It is an unfortunate fact that all the simplest methods of increasing the selectivity of a receiver result in the volume of signals being reduced.

It may be found necessary to readjust the series condenser for the long waves if it has first been adjusted for the medium waves, and vice versa. But by trying different tappings on the medium- and long-wave aerial

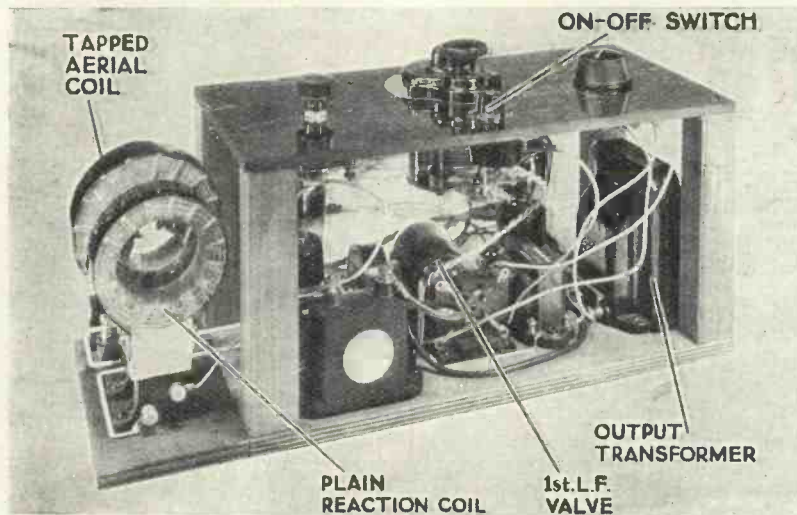

IT IS EASY TO CHANGE COILS

The plug-in coils are quite accessible and are easily changed when desired. The on-off switch is on the panel immediately in front of the slow-motion tuning dial

bourhood of 2,500 ohms. Such valves, however, as will be seen from the table on page 4 of this issue, take an anode current in the neighbourhood of 12 milliamperes and can only satisfactorily be used if a super-capacity battery or a mains unit is employed.

As soon as the set has been mounted on the baffle board and the necessary external connections completed, a preliminary test can be made.

First of all make certain that the flexible lead from one side of the aerial series condenser is fixed to one of

THE BAFFLE-BOARD THREE—Continued

coils it may be possible to arrive at a setting which is satisfactory for reception on both wavebands.

If it is desired to pick up foreign stations when the Brookman's Park (or other local) transmitters are not working, the sensitivity of the set can be increased considerably by setting the aerial series condenser at its maximum capacity and using the smallest tap on the

plied as a standard fitting and must be mounted in position by the constructor. It can conveniently be held in place by means of two ordinary panel brackets.

We are very pleased with the convenient nature of this type of assembly and believe that it will be equally attractive to large numbers of constructors. Whether you intend to build this set or not, we shall be pleased to have your opinion of its general layout.

Of course, if you do build it we shall also be glad to hear of the results you obtain. We can then pass your experiences on for the benefit of other home constructors.

Matching Your Furniture

Remember when ordering the baffle board for this set to state what finish you need. From the range available you will be able to choose the best to match with your furnishing scheme. It should also be noted that two sizes of loud-speaker opening are available; to be on the safe side you should mention the diameter of the particular cone you are going to use.

Should you desire to fix the baffle on a wall remember that the baffle can be obtained without the handle or feet. Quite a convenient assembly can be made by fixing the board to a bracket on a wall.

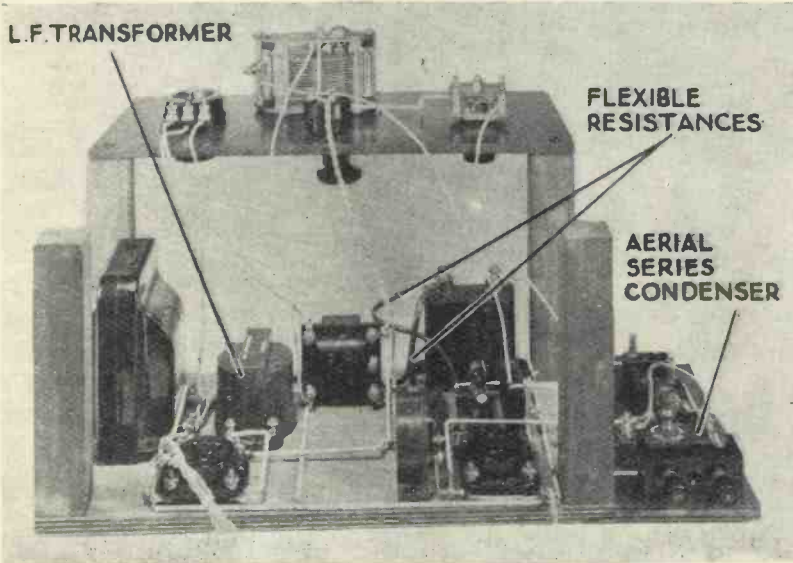

THERE IS NOTHING COMPLICATED ABOUT THE WIRING

This illustration shows clearly that the wiring of the set is very simple and can be undertaken without difficulty even by the novice. Note the temporary fixing of the panel to facilitate making connections

tuning coil. Under these conditions it will be possible to get a good bag of Continental stations.

Although double-tapped coils have been recommended, those who already have some of the centre-tapped type may be able to use them satisfactorily. It depends very largely on local conditions whether centre-tapped coils will give a sufficient degree of selectivity to avoid mutual interference when powerful transmitters are working.

Aerial Length

However, in many cases centre-tapped coils will be found selective enough, if the particular aerial employed is on the short side.

Some readers may be afraid that the type of construction employed for the Baffle-board Three results in a top-heavy assembly, but this is not the case, for the receiver itself is light in comparison with the high-tension battery and low-tension accumulator, which are placed on an additional shelf right at the bottom of the baffle board.

This shelf, by the way, is not sup-

COMPONENTS NEEDED FOR THE BAFFLE-BOARD THREE

- CHOKE, HIGH-FREQUENCY**
1—Telsen, 2s. 6d. (or Ready Radio, Igranic)
- COILS**
1—Atlas No. 50 plug-in, 2s. 6d. (or Lewcos, Lissen).
1—Atlas No. 60 plug-in double-tapped, 5s. 6d. (or Lewcos, Lissen).
1—Atlas No. 200 plug-in double-tapped, 7s. (or Lewcos, Lissen).
- CONDENSERS, FIXED**
1—Edison Bell .0002-microfarad, 1s. (or Formo, T.C.C.).
1—Edison Bell .005-microfarad, 1s. 6d. (or Formo, T.C.C.).
1—Lissen 2-microfarad, 3s. 6d. (or Ferranti, Franklin).
- CONDENSERS, VARIABLE**
1—Lotus .0005-microfarad, type LC/5, 5s. 9d. (or Lotus, Jackson).
1—Lotus .0002-microfarad, reaction type, 5s. 3d. (or Bulgin, Burton).
1—Sovereign pre-set, .0003-microfarad max., 1s. 6d. (or Igranic, Formo).
- DIAL, SLOW-MOTION**
1—Lotus, type VD/10, 4s. 9d. (or Harlie, Brownie).
- EBONITE**
1—Red Triangle 12-in. by 6-in. panel, 6s. (or Becol, Lissen).
1—Belling-Lee terminal block, 8d. (or Junit).
- HOLDERS, COIL**
2—Lissen, two-plu type, 2s. (or Lotus, Magnum).
- HOLDER, GRID-LEAK**
1—Bulgin, type G.6, 9d. (or Lissen).
- HOLDERS, VALVE**
2—Benjamin Vibroholders, 3s. (or W.B., Telsen).
1—Junit, S.G. type, 1s. 9d. (or Parex, W.B.).
- PLUGS AND TERMINALS**
6—Belling-Lee plugs, marked: H.T.+2, H.T.+1, H.T.—, G.B.+ , G.B.—1, G.B.—2, 1s. 6d. (or Clix, Ealex).
2—Belling-Lee spade terminals, marked: L.T.+ , L.T.—, 9d. (or Clix, Ealex).
- 2—Belling-Lee terminals, marked: A, E, 6d. (or Clix, Ealex).
- RESISTANCES, FIXED**
1—Magnum 30,000-ohm, spaghetti type, 1s. 6d. (or Bulgin).
1—Magnum 80,000-ohm, spaghetti type, 2s. (or Bulgin).
1—Rotor 2-megohm, type A, 1s. 6d. (or Watmel, Dubilier).
- RESISTANCE, VARIABLE**
1—Rotor 1-megohm potentiometer, 6s.
- SUNDRIES**
Glazite insulated wire for connecting.
Length of rubber covered flex (Lewcos).
1—Baseboard, 15 in. by 6 in.
1—Wooden shelf, 24 in. by 6 in.
1—Pair of Keystone panel brackets, 2s.
4—Wooden supports, 5½ in. by 1 in. square.
- TRANSFORMER, LOW-FREQUENCY**
1—Igranic midjet type, ratio 1 to 3, 10s. 6d. (or Brownie, Burton).
- TRANSFORMER, OUTPUT**
1—Lissen, ratio 1 to 1, 12s. 6d. (or Ferranti).
- ACCESSORIES**
- BAFFLE**
1—Borst baff. screen, 15s. 9d.
- BATTERIES**
1—Pertrix 120-volt, standard type, 15s. 6d. (or Ever Ready, Siemens).
1—Pertrix 16-volt grid-bias, 2s. 9d. (or Ever Ready, Siemens).
1—C.A.V. 2-volt accumulator, type 2AG7, 11s. (or Lissen, Exide).
- LOUD-SPEAKER**
1—Blue Spot special chassis, type 31R, 10s. 6d.
1—Blue Spot unit, type 66R, £1 15s.
- VALVES**
1—Mullard PM1A, 8s. 6d. (or Cossor 210RC, Marconi H2).
1—Mullard PM1HF, 8s. 6d. (or Cossor 210HF, Marconi HL210).
1—Mullard PM2, 10s. 6d. (or Cossor 220P, Marconi P215).
- The prices mentioned are those for the parts used in the original set; the prices of alternatives as indicated in the brackets may be either higher or lower*



MAKING A TALKIE

Here you see what happens in a talkie studio. Miss Ella Shields is seen on the extreme right. The orchestra is accompanying her

A
Special Article
By
**BAYNHAM
HONRI**

"I'll alwayth think of you, thonny boy," lisped the first talkies, such a little while ago.

That was before the talking-picture (*nee* broadcasting) engineers had really got down to the problem of turning up the ends of the musical scale for the more adequate recording and reproduction of the bass notes of organ and orchestra and the highest notes of the sopranos—and sibilants.

Unforgivable Lisp

It is a curious fact that public and press comment on the first talkies seemed to overlook the absence of bass notes, but could not forgive the lisp. "Our wireless sets and gramophone records don't lisp," they said, "so why should these talkies be afflicted with the complaint?"

There was a very good reason for the lisp, as it happened. The first really successful talking pictures were made with disc recording and reproduction, and the sound from gramophone records made in the ordinary way and reproduced in a large hall considerably magnified the amount of background noise caused by the scratch of the needle.

The particular range of frequencies which carried the sound of needle scratch into the hall via loudspeakers also included all "s" sounds. The needle scratch had to be kept down, and with this suppression most of the sibilants of the actors' speeches disappeared.

The engineers knew that they would get over the sibilant difficulty eventually but, in the meantime, the talkie boom had begun and recording gear which was designed for straight gramophone work was hurriedly converted and adapted for use in talkie making.

As a temporary measure, film artistes were asked to speak slowly and distinctly, emphasising the consonants of speech, "th," "sh" sounds and final "s's."

The same problem did not arise to anything like the same extent in recording the sound on film, as in Movietone and R.C.A. Photophone, but at that time sound-on-film recording had so many other technical difficulties to be overcome that the engineers hadn't time to become finicky about sibilants.

They were still coping with speed wobbles, developing and printing

troubles, track alignment and other little ailments that are outside the scope of this article.

At an early stage the disadvantages of disc recording became obvious. In the first place, a wax recording machine could not be stopped and started for short scenes as had been done in the days of the silent film. The recording of a complete reel of picture had to be undertaken at one time, and dialogue and action had to be measured out for a scene to occupy from ten to eleven minutes of running time.

Battery of Cameras

A battery of several cameras would be "shooting" at the same time, one camera taking a long shot, another a mid-shot, a third a close-up, and so on, and as these cameras were all turning in synchronism with the wax recorder, the film editor was able to secure a certain amount of variety of shot in the process of cutting, thus avoiding the monotony that would be caused by "holding" the entire scene from one angle only.

Sometimes several sets were erected side by side in the studio, so

Lisp or Needle Scratch :: Disadvantages of the Disc :: Recording Separate Scenes :: Sound-on-film Progress :: Coloured Films :: Testing Your Friends' Voices :: Position of the Sound Camera

HAVE YOU A TALKIE VOICE?—Continued

that the artistes could play from one room to another without causing a break in that precious ten minutes of continuous recording. Subsequently, an elaborate system was perfected whereby a number of short scenes recorded on separate discs could be re-recorded on one disc.

Sound-on-film Recording

Meanwhile, sound-on-film recording was making great progress. The speed troubles which marred the quality of music recorded on this medium had been overcome, and under the right conditions was capable of giving much finer results than the disc. Furthermore, the improved

sound-on-film recorders of R.C.A., Western Electric, Tobis, and British Acoustic were extremely mobile both in and out of the studio, and all of the systems gave a better rendering of bass notes and sibilants than had been possible with the disc.

Thus a stage was reached, some six months ago, when it became almost a universal practice to record a picture with the sound-on-film and, when it was edited and cut, to re-record the sound on disc for the benefit of cinemas only equipped for this type of talking picture.

In the case of most coloured pictures, it is necessary to have this transfer made from film to disc on

account of the coloured film base affecting the sound track.

In the studio it is no longer necessary for the artistes to speak slowly, emphasising consonants. On the contrary, the modern recording apparatus is extremely sensitive to over-emphasis, and defects of speech which were an advantage in the early days of talkies have now become a menace.

Testing Your Voice

One must remember that the microphone is a "one-ear" instrument. That is to say, it picks up exactly what we hear with one ear only, just as the camera photographs the equivalent of what we see with one eye.

In the quietness of your own room, listen to your friends speaking with a piece of cotton wool in one of your ears, in order to simulate the conditions of microphone pick-up. You will notice (1) the strength of sibilants, and (2) an echo of the voice, unless he or she is quite close to you.

The strength of sibilants and echo will vary with the strength of the voice, nearness of the speaker, and the direction of the delivery of the speech. Any defect of speech is cruelly emphasised, just as it is on the microphone.

These are the fundamental problems which affect the quality of sound-film recording, now that the initial mechanical difficulties have been overcome.

The extreme mobility of the mechanical side of talking picture apparatus has encouraged many studio executives to revert to production methods of the "mute" era. That is to say, sound and the presence of the microphone are ignored—until the "rushes" are heard and the scene has to be re-taken!

Forgetting the Sound

Trick shots, tracking shots, and extreme long shots are freely used without thought of what is going to happen to the sound. In fact, the tendency in some quarters is to give the cameraman his head and the freedom of the city, and push the sound down a speaking tube to a murky cellar, where it is recorded on a mass-production basis.

Just how short-sighted such a policy is will be realised when it is explained that the "clearness" of

RECORDING THEIR VOICES

THE greatest discovery of this age, and of all ages, is man's voice. And it is such a wonderful thing. It can love and hate; call and drive away; make the most fearful noises and the most wonderful music. The singer keeps a huge audience spellbound and the orator sways a crowd like a waving field of corn. That's a voice.

No wonder then that man has discovered ways and means of broadcasting it. What is wireless without a voice? Even the most heavenly music, if it were not interrupted occasionally by means of the human voice, would become boring.

And there is the gramophone, far more wonderful to me than radio, for it gives back the voice of a person that has passed out of our presence long since. It brings a singer from the other part of the world to dwell in our homes where we can hear him whenever we like.

Wings to Fly

Radio gives the voice wings that it may fly around the earth and enter homes and halls on the way. The gramophone gives the voice eternity and immortality, for once it is recorded it lives.

Now comes the day when most people can have their own voices permanently preserved for them on home-made records.

The children of the future will not only have the voices of the leaders of this age preserved to them,

but the voices of their grandparents, uncles and aunts will likewise be in the possession of the family.

In ages to come fathers will be able to say that their son has a voice exactly like that of the great-grandfather, or a daughter that of a great-aunt. Family voices will be handed down from one age to another. We shall be able to mark changes in accent and dialect; note the changes in emphasis and words.

Voices of Ancestors

Many evenings will be spent in ages to come going through the album containing the voices of ancestors, whereas now we go through albums of photographs.

Again, think of the difference this recording of our voices will make to relatives and friends we have not seen for years. Instead of taking a photograph to send to our friends for Christmas, we can take a record of our voice. When going abroad we shall be more concerned about taking the voices of our friends with us than their photographs. And we shall leave behind us a record of our voice that they may listen to it when we are far away.

And those relatives we have not seen for years, that brother or sister who is in Canada, Australia, or the United States of America, who are wondering how we speak, will be able to hear us when we shall be sending to them a monthly letter in the form of a record which we have dictated into our home-recording outfit.

E. B. R.

WHAT HAPPENS IN A MODERN STUDIO

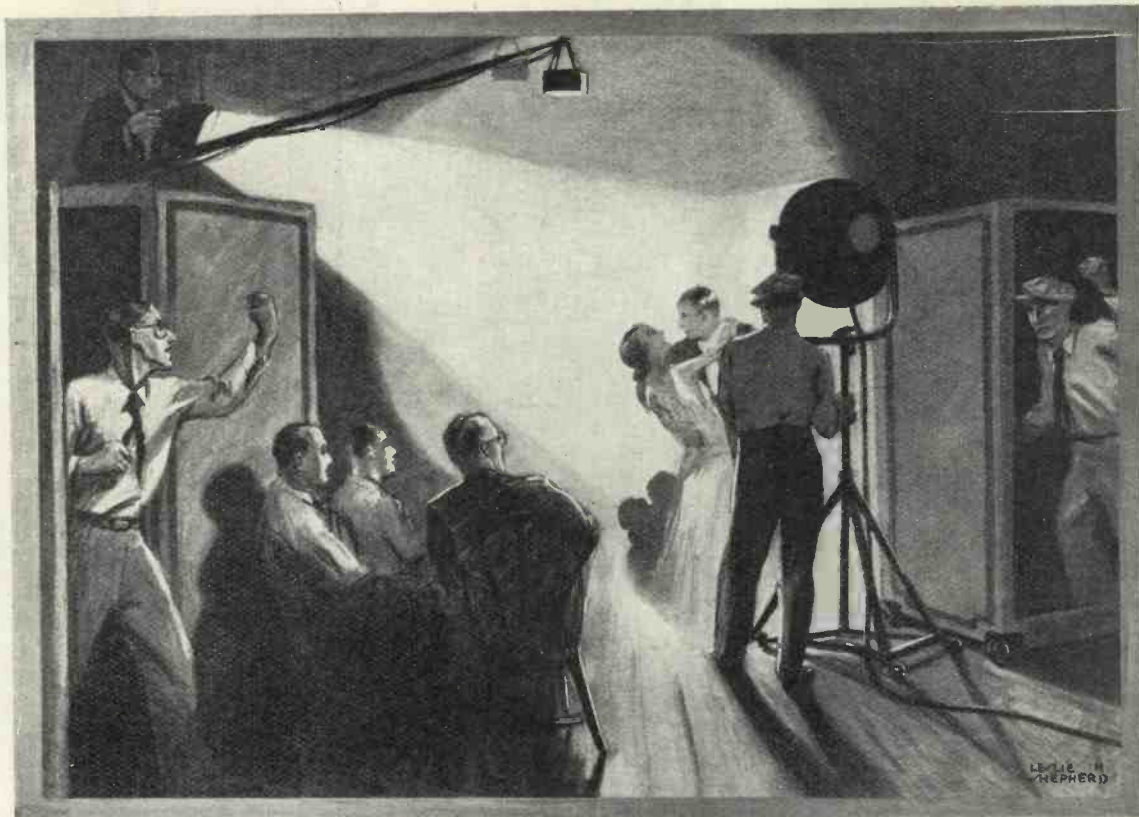

HARD AT WORK MAKING A TALKIE

Our artist's impression of a scene in a talkie studio—there must inevitably be a guerilla-like warfare between conscientious cameramen and recordists

the voices is entirely dependent on the microphone being placed as close as possible to the artistes, usually above and in front of their heads.

Naturally, if the "mike" is very close, it will be in the picture—and someone will get the sack. And so there must inevitably be a kind of guerilla-like warfare between the conscientious cameraman and the conscientious recordist; the latter demands that the microphone shall be low and close to the actors, the former insists that he must have plenty of head-room above the players in order to get correct pictorial composition.

Probably Prejudiced

I admit that, being a sound recordist, I am probably a prejudiced person.

But I cannot help remarking on the fact that not one per cent. of the cinema public cares a jot about pictorial composition; the remaining ninety-nine demand that the sound shall be clear and also (as an afterthought) that one should be able to see who is speaking!

TRANSATLANTIC RADIO

EVERY day, hundreds of persons converse over the trans-oceanic telephone circuits. This verbal exchange is carried so clearly from London to New York that the speech is readily understandable at each end.

The layman cannot understand why a similar system cannot be introduced so that the programmes from the "other side" can be introduced and picked up here as clearly and rebroadcast.

Radio engineers, however, hasten to point out that the requisite of the trans-oceanic telephone is merely "the transmission of understandable speech." This is inadequate for the high-grade transmission of music according to the best broadcast standards.

There are several other engineering points which must be considered, too. Stations in this country are Government subsidiaries. They are supported by the taxation of radio listeners. The listeners demand that their money be spent for the improve-

ment of programmes, not for the construction of super-power transmitting plants for the projection of programmes to foreign lands.

The transmitter used by the B.B.C. in sending out its programmes to foreign countries employs only 5,000 watts. The trans-oceanic telephone transmitter is a single side-band transmitter using 100,000 watts, which is the equivalent of a broadcast transmitter of 300,000 watts.

Reception Hazards

The greatest hazards in picking up America for rebroadcasting still are interference and atmospherics. The only way they may be overcome is by increased power at the transmitting end.

Engineers are agreed that no consistent service may be guaranteed. Britons eager to hear American programmes until the Americans are so anxious for us to hear them that they will make a tremendous power increase in their transmitter. F. P.

We Test Before You Buy



NOW YOU CAN ENJOY BETTER RADIO THAN EVER BEFORE

There are dozens of sets now on the market that are really good value for money—here is a Columbia model 307 in use. This forms the basis of the radio gramophone reviewed on page 49 of this issue of WIRELESS MAGAZINE

IN the following pages we give reports on five different sets—an A.C. two, a console, a radio gramophone, a battery portable and a four-valve short-waver. These sets are selected from a large number tested under both

laboratory and domestic conditions. By no means every set tested is reported upon, since we have space only for favourable reports.

Nearly every set reviewed has to pass certain key tests. Looking at the reviews, the

set-buyer will see that, after stating the maker and the price, we give the power supply and power consumption. From these figures it is possible to gain an approximate idea of running costs.

Then follows the valve

combination, which to the technical man is a good index of the set's potentialities.

Controls are always given our very careful attention.

Sensitivity, the next item in our reports, can be described as the measure of a set's ability to bring in foreign stations. Or, if the set is only a two-valver, on its ability to get the locals.

Selectivity is next discussed. This is the measure of a set's ability to cut out the locals in favour of more distant stations; and to separate one distant station from another. A fairly good idea of selectivity can be gained by noting the range of audibility on the tuning dial over which each station can be heard.

We tune in a local and then rotate the dial above and below this tuning point until signals are inaudible. The spread over is then recorded. In the London district a spread of 20 degrees for the National and Regional stations indicates quite satisfactory selectivity.

All our tests of sets are done in South London with a short aerial, usually an indoor wire of 50 to 60 feet.

Testing sets is only a part of our job. For we also advise on the choice of sets. The Set Selection Bureau conducts a free service for readers of WIRELESS MAGAZINE wanting to buy sets.

To take advantage of this service the reader is asked to state (1) the maximum price and whether this is for a complete installation or just for the set; (2) where the set will be used; (3) what particular stations are desired, that is only local stations or a selection of foreign stations as well; (4) whether a self-contained set (with or without aerial) or an ordinary set with external accessories is preferred, and (5) whether battery or mains operation is wanted; if mains operation, whether the supply is D.C. or A.C.

A stamped-addressed envelope for reply by return of post is the only expense. Inquiries should be addressed to Set Selection Bureau, WIRELESS MAGAZINE, 58-61 Fetter Lane, London, E.C.4.



EDISWAN POWER PENTODE TWO

"Passes the most rigid tests for selectivity."

Maker. — Edison Swan Electric Co., Ltd.

Price. — £14 19s. 6d.
Power Supply — A. C. mains. No corresponding model is available for D. C. mains.

Power Consumption. — 30 watts. This compares with the 60 watts of a bright electric-light bulb. The running cost, which is negligible, can be worked out by dividing the unit of electricity, the kilowatt-hour, by 30 watts. The answer is the number of hours that the set will run at a cost of one unit of electricity.

Valve Combination. — A Mazda AC/HL detector valve is transformer coupled to a Mazda AC/Pen output pentode valve. A UU60/250 Mazda rectifying valve converts the alternating current from the mains into direct current for the anode supplies. In a two-valve set these two very efficient valves, with filaments heated by alternating current, can be expected to give ample amplification for the loud-speaker reproduction of the local stations.

Type. — The Ediswan Power Pentode Two is a table-cabinet set requiring an external loud-speaker and aerial and earth. There are no batteries, owing to the fact that the mains are utilised for high tension, low tension, and grid bias.

Controls. — A preliminary examination showed that the controls have been well arranged. There is a large tuning disc with 0-to-100 degree divisions that are very easy to read. Above this tuning control are arranged three knobs for subsidiary control. That on the left is for fine tuning and that on the right is marked "Volume," although really it controls reaction. The knob at the top controls a switch for medium waves on the left and long waves on the right.

It is unusual in a two-valver to find a two-circuit tuner.

We note in the Ediswan set that primary and secondary tuning circuits are provided by the inclusion of separate and variably coupled coils working with a two-gang variable condenser. To bring these two circuits into accurate tune the aerial also has a fine tuning control.

The basket coils can be variably coupled by moving the red coil along a horizontal bar either away from or towards the green coil. Once the correct coupling for any required degree of selectivity has been determined by experiment the red coil can be locked in position.

The makers stress the fact that this unique variable coupling device is not intended as an additional tuning control and that once it has been set readjustment is unnecessary. We appreciate the maker's policy in producing a set in which such definite steps have been taken to ensure satisfactory separation of regional stations when the set is located in a regional area.

Before leaving the controls we should mention that at the back of the set is a switch so that the two valves can be arranged as an efficient gramophone-record amplifier. There is no master switch for the mains connection, but we noted the provision of a good safety plug

with a usefully long length of flex.

We say useful because it is often found that the nearest electric-light socket is several yards from the actual location of the set. Consequently a really long length of flex is often essential.

Selectivity. — We have mentioned that the makers have taken great precautions to ensure good selectivity. On our test aerial the set certainly had no difficulty in separating the two Brookman's Park stations, in spite of the fact that, due to the efficient valves, the overall volume from each station was considerable.

In this question of selectivity one must always remember that stations can readily be separated if a great sacrifice of volume is made. But with the coils adjusted so that really fine loud-speaker strength was obtained from the two stations, we recorded the following very satisfactory readings.

The Regional at 49 had gone at 58 and 38, a spread of 20 degrees. The National at 7 had gone again at 15, but could still be heard at zero, indicating a minimum spread of 15 degrees. Altogether we consider this two-valve set passes the most rigid tests for selectivity.

Sensitivity. — Although primarily designed for the reception of local stations, we are quite sure that with an ordinary aerial situated in most districts some of the more powerful foreign stations could be received. We ourselves were able to

get Midland Regional at 92 as a good loud-speaker signal Langenberg at 90 was quite strong as was Rome at 77.

Later we got Stockholm at 75 and Toulouse at 57, both at fair loud-speaker strength. Göteborg at 33, and

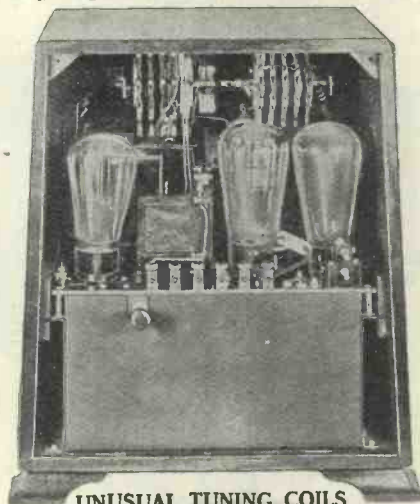

UNUSUAL TUNING COILS

Note the basket-type tuning coils just above the three valves. Two of them are for receiving and one for supplying anode current

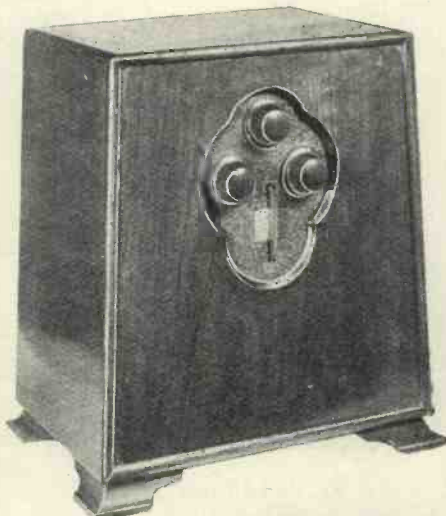

NEAT AND SIMPLE APPEARANCE

There is nothing frightening about the controls of this Ediswan two-valve A.C. set

Bratislava at 18 were surprisingly strong. As an indication of the sensitivity of the set we ought to mention that we counted 20 carrier waves throughout the medium wavelength band. Most of them could be resolved into some sort of loud-speaker reproduction.

Quality. — Working our standard moving-coil loud-speaker, the Ediswan Power Pentode Two gave first-class reproduction. We should like to dispel the impression that because a set has only two valves it is only worth a junior loud-speaker.

In the reception of the local stations a two-valver such as the Ediswan model under review is dealing with just as big signal amplitudes as a four-valver working on a volume control. The all-electric power supply imparts that roundness of tone so often unattainable with batteries.

Appearance. — The shape and finish of the dark walnut cabinet are very attractive. A neat-looking set that is a break-away from tradition is our verdict on this Ediswan production.



EDDYSTONE ALL-WAVE FOUR

"Undoubtedly the best short-wave set we have yet examined."

Maker.—Stratton & Co., Ltd.

Price.—£27.

Power Supply.—Batteries. To work the set tested we used a 2-volt accumulator and a 120-volt high-tension battery. A 15-volt grid-bias battery is included in the set.

Power Consumption.—With the recommended high-

The filament supply is switched on by a switch at the back of the set. Nearby are three jacks, one for the loud-speaker, another for using headphones on three valves only, and the third for a gramophone pick-up.

There is a small variable condenser mounted at the left-hand side of the case.

short-wave stations broadcasting in all parts of the world.

In tuning this set the reaction regulator plays a vital part. By means of reaction it is quite easy to keep the two tuning circuits in step with one another. For when these two dials are adjusted so that both circuits are in tune, the reaction requirement is at minimum. In practice this means that by setting one dial at any particular point, increasing reaction to about half-way, and then rotating the other tuning dial, a point will be reached where audible oscillation occurs. We found no difficulty in exploring the different wavebands provided, thanks to an admirable smoothness in the controls.

Sensitivity.—By an intelligent use of the four sets of plug-in coils it is possible with this set to receive broadcasting from all parts of the world. We ourselves got Buenos Aires at tremendous loud-speaker strength, as well as 2XAF, the short-wave relay of the General Electric Company in America.

The number of other stations logged on this set would, without exaggeration, make an article. But it will be sufficient for us to say here that if there is anything between 12 metres and 500 metres worth hearing, this set will get it. On the medium waves the Eddy-stone set gave an excellent account of itself, bringing in

most of the more powerful foreign broadcasting stations at full loud-speaker strength. What surprised us was the fact that the plug-in coils for the medium waveband could be tuned from 250 to 490 metres with the comparatively low-capacity variable condensers.

Although the construction of the set is conclusive evidence that the short waves are intended as the main *raison d'être*, very little, if any, efficiency has been sacrificed on the normal broadcast wavelengths.

Selectivity.—On the ultra-short waves the question of selectivity does not often arise, due to the fact that the smallest change in the capacity of the variable condenser means a big alteration in the wavelength received. But certain ultra-short wavelength ranges are so congested that even a short-wave set must now have a good measure of selectivity.

We can say that the Eddy-stone short-waver is extremely selective, although by no means critical in operation. The two tuning dials do not complicate tuning, but actually make it easier, because very critical settings are avoided. On the medium waveband selectivity was such that Langenberg was clear of the Midland Regional and Toulouse clear of the London Regional.

Quality.—Presumably due to the inclusion of a pentode power valve the tone was inclined to be high-pitched.

But with an average cone loud-speaker the general quality is pleasing. The clear-cut nature of the reproduction was found especially desirable when receiving some of the very distant short-wave stations.

Summary.—This is undoubtedly the best short-wave set we have yet examined. Its robust construction is fully justified by the stability of reception. For listeners in all countries the set offers scope for world-wide reception.



MADE FOR USE !

This set is housed in a very substantial cast-iron case that is most robust

tension and grid-bias voltages we found the total anode current consumption was 15 milliamperes. For reliable and economical working a triple-capacity high-tension battery would therefore be needed. The low-tension current for the filaments was found to be .6 ampere. A 30-ampere hour accumulator would therefore give 50 hours service per charge.

Valve Combination.—A screened-grid high-frequency valve precedes the detector, which is resistance coupled to the first low-frequency amplifying valve, which in turn is transformer coupled to the pentode output valve. This is a very good combination for a short-wave set. The screened-grid valve provides smooth reaction over the whole available tuning ranges. The pentode power valve at the end of the set gives an extra fillip to the many weak signals received from the other side of the world.

Controls.—Our first impression was the delightful ease of control. There are two tuners, with slow-motion dials on the left and right. A small slow-motion reaction control is fitted between.

This is a selectivity control. In operating this set, by rotating the two tuning dials, we found that the readings of the dials were fairly similar for any given wavelength. The wavelength ranges covered are 13 to 26 metres (blue coils), 22 to 45 metres (yellow coils), 40 to 85 metres (red coils), and 250 to 500 metres (green coils).

For example, on the blue coils we found that 24 metres was tuned at 72.5 degrees on the left dial and 80.5 degrees on the right dial. We found 33 metres was tuned on the yellow coil at 40 degrees on the left dial and 39.5 degrees on the right dial. With the red coils 41 metres was tuned at 19 degrees on the left dial and at zero on the right dial. These three calibrations are landmarks for short-wave listeners. As five calibrations are supplied for each of the three short wavelength bands we are quite sure the operator would have no difficulty in locating the innumerable

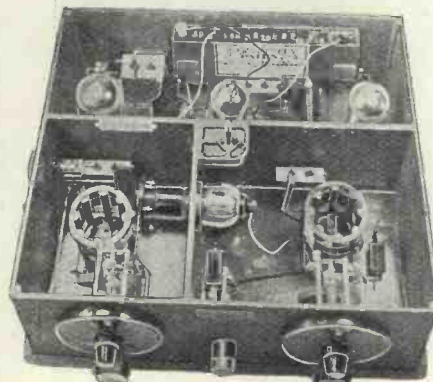

A WELL-PLANNED SET

Much thought has obviously been put into the design of this fine all-wave receiver



WE TEST BEFORE YOU BUY

BURNDIPT THREE-VALVE CONSOLE

Maker.—Burndept Wireless, Ltd.

Price.—33 guineas.

Power Supply.—A.C. mains. No corresponding model is available for D.C. mains or for battery operation.

Power Consumption.—34 watts. This power consumption is less than that of a small electric-light bulb. On the average electric-light bill the cost of running this set would be negligible.

Valve Combination.—This console has a three-valve receiving circuit. The first valve is for high-frequency amplification, the second valve is for detection, and the third valve is the power output. The combination is extremely powerful, because all three valves have A.C. filaments. The high-frequency valve is a screened-grid type and the output valve is an A.C. pentode.

There is another valve for converting the A.C. supply into direct current for the anode supply.

With an average external aerial and a good earth this valve combination will provide full loud-speaker reproduction of a considerable number of stations.

As a matter of interest, we ought to record the fact that no appreciable hum could be detected when the earth lead was disconnected.

Controls.—Our first impression was favourable, since the knobs are well spaced and of ample size for easy manipulation. There are two discs for tuning. The left-hand one is divided into 100 degree divisions. The right-hand one is calibrated in metres. Medium waves are marked from 210 to 560 metres, and long waves from 900 to 2,100 metres.

Below these tuning controls are three knobs. The left-hand one is a combined volume and selectivity control. The middle knob is for changing the wavelength

range and also for cutting out the high-frequency valve, so that the detector and power valves can be used as a two-valve gramophone amplifier.

The right-hand knob is for reaction, an indispensable control where only one stage of high-frequency amplification is included. Indispensable, that is to say, for the reception of distant stations, which can be heard very strongly provided that reaction is used with care.

We suggest that a positive stop on the reaction control would prevent inexpert operators from oscillating unnecessarily.

We must say that the mains switch fitted to the

length range, extending considerably above the Midland Regional section and considerably below the London National station. There is no falling off in sensitivity at the extremities of tuning. Four stations were clearly heard above the Midland Regional.

We found the calibrations on the right-hand tuning dial accurate. The setting of the left-hand dial is determined by the length of aerial connected to the set. We give below some extracts from our log, indicating the left-hand dial settings.

Starting on the long wave length range, Huizen was a good signal at 90. Radio Paris was exceptionally strong at 81. It was clear of

Davertry, which came in at 72. Eiffel Tower was the next station, very strong at 65. Then came Warsaw at 57, surprisingly strong and clear of Eiffel Tower. Kalundborg at 40 and Oslo at 30 completed a very creditable long-wave log.

On the medium waveband we received innumerable foreign stations at excellent loud-speaker strength. This is how some of the best received stations were logged:—

Budapest 95, Rome, 91, Brussels 90, Midland Regional 83, Langenberg 82, Rome 78, Berlin, 72, Frankfurt 66, Toulouse 65, London Regional 60, Bordeaux 45, Bratislava 37, London National 30, Nürnberg 21, Kiel 18, and Cologne 14.

Selectivity.—For such a powerful three-valver the selectivity was good. On a normal aerial we found the London Regional had a 10-degree spread on the left-hand dial, corresponding to a 42-metre spread on the right-hand dial. The London National had a 7-degree spread corresponding to 25 metres.

Langenberg was received quite clear of the Midland Regional. It was not possible to get Zeesen clear of Radio



A GOOD-LOOKER !

This console set includes its own loud-speaker, but needs a separate aerial and earth



NO CROWDING

The mains unit is mounted on a shelf just below the cone loud-speaker. There is plenty of space

right-hand side of the cabinet is very precise in action.

Sensitivity.—Following a test made on the evening of December 6, we are able to say that the sensitivity of the Burndept console is above the average. It is a fine station getter. Such stations as Rome, Toulouse, and Cologne were brought in with the volume and clarity one used to expect only from locals.

One of the outstanding points about the tuning of this set is the wide wave-

Paris and Daventry, but during the day-time Zeesen was received at full loud-speaker strength. In general, this set is selective enough for modern requirements. A fairly short aerial is all that is necessary and desirable.

Quality.—The general tone is very satisfactory. "Crisp and brilliant reproduction with adequate bass" is how the makers describe the quality. It is a fair description. The considerable volume is controllable down to a very moderate output.

Appearance.—Distinctive and sensible construction. We need more consoles of the type exemplified by this Burndept model. The dark finished oak pedestal cabinet is quite attractive.

Summary.—The Burndept console is an all-in set with the exception of the aerial and earth. Fifty feet of indoor wire would give a good selection of stations on this set, except under abnormally poor reception conditions. We were impressed with the powers of this set, especially the good distribution of the stations round the dials. For those with an electric-light supply the Burndept console is an attractive proposition.



MURPHY PORTABLE FOUR

"The selectivity of this portable exceeded our expectations"

Maker.—Murphy Radio, Ltd.

Price.—17 guineas.

Power Supply.—Batteries. Easy access to the compartment at the back, which includes a 2-volt accumulator and a standard-capacity 108-volt high-tension battery. The leads for these batteries are neat and durable.

Power Consumption.—A remarkably low total anode-current consumption was measured, namely 8.5 milliamperes. The total low-tension current consumption was .5 ampere, so the accumulator supplied with the set will last at least 40 hours.

Valve Combination.—A high-frequency amplifier is followed by a detector and two stages of transformer-coupled low-frequency amplification. The first valve is a Mullard PM12 screened-grid type, the detector a Mazda HL210, the first low-frequency-amplifying valve a Mazda HL210, and the power valve a Mullard PM2.

The makers advance a very interesting argument in favour of four-valve combinations with only one screened-grid high-frequency amplifier instead of two high-frequency amplifiers. They suggest that with one screened-grid high-frequency amplifier and two transformer-coupled low-frequency amplifiers the total gain might be 126,000, whereas the total gain of a two screened-grid set on a similar basis might be 150,000 or very little more.

Type.—This four-valve portable is housed within an upright cabinet. It would rightly be termed a trans-portable, since its construction is obviously more suitable for a semi-permanent installation than for true portability.

Controls.—The makers have struck a new note in the arrangement of the controls. Four knobs are arranged in line on the sloping control panel at the top of the cabinet. The makers' slogan "Making Wireless Simple" has been put into effect.

At the extreme left is a knob for wave-changing. An aperture in the dial shows "200-600" or "800-2,000" according to its setting. Next is the tuning dial, which rotates a calibrated scale. The medium waves are calibrated in steps of 20 metres and the long wavelengths in steps of 100 metres. We found the set notable for the ease with which stations



SIMPLE BUT EFFICIENT

There are no unnecessary controls on this set, which is one of the best-designed models yet tested.

could be logged.

Next is the reaction knob. An aperture shows marks "0-9" so that the actual degree of reaction can be logged for distant stations. This marking should be of great help to non-technical users. Lastly, on the extreme right is the volume control and through an aperture in this dial can be read "1,2,3,4," so that even the degree of volume can be calibrated. Altogether we must say how very impressed we were with the controls of the Murphy portable. The makers have spared no pains to simplify the operation.

Sensitivity.—We were able to gain some idea of the abilities of this set during a recent evening, when both long- and medium-wavelength bands were explored. Starting on the long waves, we first logged Huizen at full loud-speaker strength

using the maximum settings of the volume and reaction controls. Next came Radio Paris, a very good loud-speaker signal, provided that the volume control was set at its maximum. Then Zeesen, also good. Eiffel Tower did not need reaction, nor did Kalundborg which stations came in at excellent strength. Lastly, Oslo was logged at fair strength with-

out reaction. Switching over to the medium-wavelength band, we had no difficulty in logging seventeen stations at full loud-speaker strength. Budapest was fair, Vienna was good, Rome very good, as were Stockholm, Katowice and Toulouse. Hamburg was good and Strasbourg was very good. Dresden, Bordeaux, Bratislava and Turin were all well heard between the two London Regional stations.

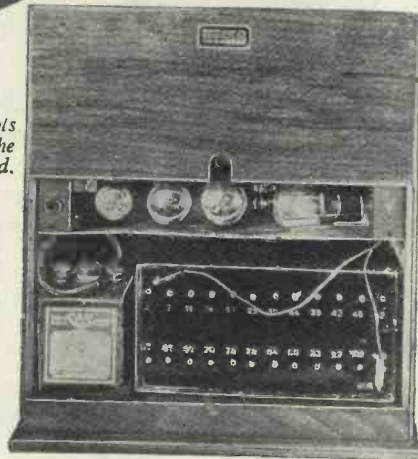

GOOD ACCESSIBILITY

As can be seen, the valves and batteries are easily accessible, a point of importance with portables

Below the London National we got Leipzig, Juan les Pins, Nürnberg, and Cologne at excellent strength. There were many more stations available, but we logged only those that could be listened to with enjoyment.

Selectivity.—We must frankly confess that the selectivity of this Murphy portable exceeded our expectations. London National at

261 had disappeared at 255 and 270 metres, a spread of only 15 metres. London Regional at 356 had gone again at 372 and 350, a spread of 22 metres.

Other indications of good selectivity should be mentioned.

Langenberg, for example, was received quite clear of the Midland Regional station. Due to the directional property of the frame aerial we were able to get Hamburg clear of the London Regional. This same property enabled us to get Zeesen clear of Daventry on the long waves. When tuning in all the stations mentioned we noted how easy it was to rotate the cabinet in any desired direction due to the fitting of the smooth working turntable underneath.

Quality.—Considering how low is the anode-current consumption we judged the quality to be very satisfactory. The volume must not be increased beyond a certain well-defined limit owing to the natural limitation of the power valve working at 108 volts. The bass was not fully reproduced, but tone generally was clear. We prefer this absence of deep bass to the most unnatural presence of artificial bass as produced by box resonance.

Appearance.—Extremely neat. The cabinet work belies the fact that this portable is only 17 guineas. It looks an expensive set. The fittings are of good quality and the whole set is designed so that it will fit in with the average domestic requirements.

Summary.—For those without an electric-light supply and for those who find difficulty in erecting any sort of aerial wire, the battery-operated portable is the obvious solution. And the Murphy portable is an inexpensive way of fulfilling these requirements. It is one of the best designed portables we have yet tested, irrespective of price.



COLUMBIA 310 RADIO GRAMOPHONE "The best value for money"

Maker.—Columbia Graphophone Co., Ltd.

Price.—40 guineas.

Power Supply.—A.C. mains
Power Consumption.—80 watts. This works out at approximately ½d. per hour, assuming electricity at 6d. per unit.

Valve Combination.—High-frequency-amplifying valve, detector and super-power output valve. The last two valves in this combination are utilised for amplifying gramophone records. The detector valve is then suitably biased as first low-frequency amplifying valve.

Controls.—In this radio gramophone the makers have embodied Columbia model 307 three-valver, which we reviewed in the November 1930 issue of WIRELESS MAGAZINE. In addition to the controls included in model 307, this radio gramophone has controls for varying the volume during gramophone record reproduction. Opening the lid at the top of the cabinet, we noted the turntable of the induction motor, together with the standard Columbia pick-up. Near by is the gramophone volume-control device. A small switch above the knob controlling the volume provides normal or extra loud reproduction.

This useful device will be appreciated only during the playing of different records.

Let into the top half of the front of the cabinet, below the gramophone motor, is the familiar escutcheon plate of Columbia model 307. Controls on this are for radio reproduction. The main controls are two thumb-

operated dials at the centre of the escutcheon plate. A small cowl, hiding a bulb that illuminates the dial, is mounted above them.

The right-hand dial is marked in wavelengths, between 225 and 540 metres in steps of 25 metres, and between 1,000 and 1,900 metres in steps of 100 metres. The left-hand dial is marked in degrees and is intended to be adjusted independently of the main calibrated dial.

The placing of these two dials side by side simplifies tuning operations, because once the relative settings of the two dials have been determined, they can be simultaneously rotated with the thumb. In effect, one-knob tuning is provided, with the added precision of separate circuit tuning in the reception of weak stations.

Below these tuning dials are two small knobs. That on the left is an intensifier, used to increase or decrease the strength of the incoming signals. Should the incoming signal be too strong this intensifier works very well in cutting down the volume. But should the incoming signal be too weak to give good volume, the reaction knob on the right can be adjusted to give an additional boost. In fact with these two knobs one can cope with all grades of signal strength.

Other fittings on this well-designed radio gramophone include a wave-change switch on the front escutcheon plate and a selectivity knob adjacent to the aerial and earth terminals, fitted to the left-hand side of the cabinet.

It is interesting to note that to energise the moving coil loud-speaker included in this radio-gramophone, high-tension current is delivered to the pot winding by the rectifier used for supplying high-tension current to the receiving valves. We understand the moving-coil loud-speaker takes about 60 milliamps at 250 volts.

Quality.—A very few minutes listen-

ing to this new Columbia radio gramophone was sufficient to convince us that the quality of reproduction is good. We were, in fact, surprised at the considerable volume that was handled without distortion. The use of a super-power valve in place of the pentode valve of the model 307 appears to be more than justified. We can hardly imagine the average family requiring any greater volume or any better quality than is delivered by this machine during the playing of records.

Ease of handling was particularly notable. Changing the needle, adjusting the speed of the motor and switching over from radio to gramophone were some of the tests through which this model passed with flying colours.

As regards possibilities on the radio side; well, there are all the possibilities of a good three-valve all-electric set. During an evening's test we had no difficulty in logging over 20 stations on the medium wavelength range. Many of these stations were brought in by the simultaneous rotation of the two tuning dials.

The selectivity is adjustable by means of the knob at the left-hand side of the cabinet. With an aerial of 60 feet we found it easy to cut out the National and Regional stations. This selectivity was not gained at the expense of decreased volume from other stations.

Volume control was outstanding on the radio side. The intensifier, as it is called, does much to avoid blasting during the reception of very strong stations. And the reaction control also works smoothly, building up

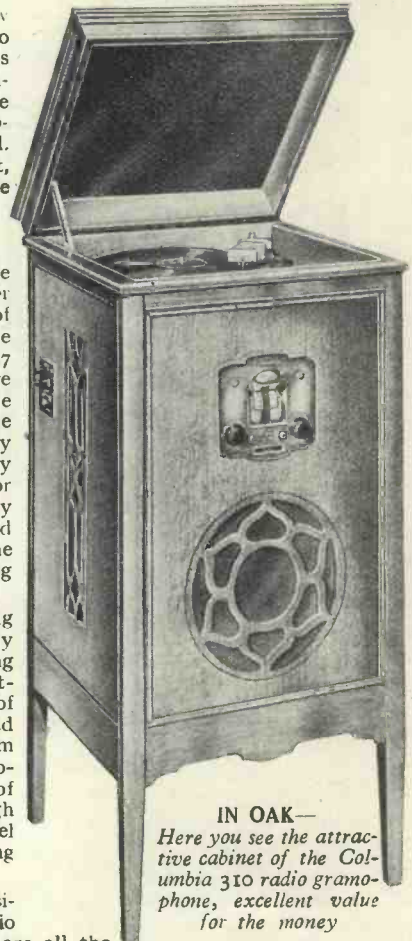

IN OAK—
Here you see the attractive cabinet of the Columbia 310 radio gramophone, excellent value for the money

weak foreign stations without fuss.

Appearance.—The oak cabinet of this radio gramophone is designed on severely modern lines. It is quite attractive, although, for those who prefer mahogany, there is another model available, price 43 guineas.

Summary.—Undoubtedly the best value for money so far experienced in our tests of radio gramophones. The Columbia Company will earn the thanks of many listeners of moderate means. So much good-quality apparatus in a radio gramophone so moderately priced is indeed rare. Those with an electric-light supply, and who can erect some sort of external aerial, should be specially interested, if they desire radio and gramophone reproduction of first-class quality at a moderate price.

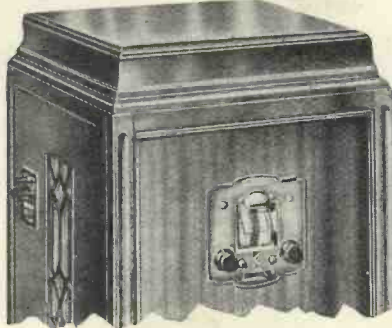

—OR MAHOGANY

This photograph shows the "piano" top of the mahogany model. The set is the same as with the oak model



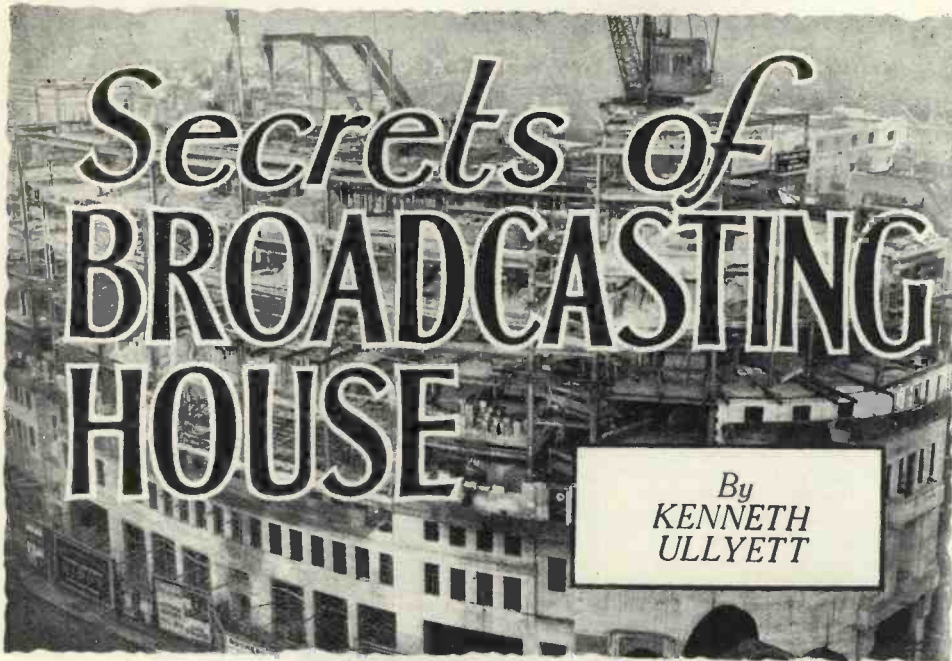

WELL ON THE WAY TOWARDS COMPLETION

Here you see how Broadcasting House is progressing. It is located in Portland Place, close to the Queen's Hall and the Regent Street Polytechnic

IT does not seem many months ago that the site on which the large white building, soon to be christened Broadcasting House, now stands was occupied by other buildings, the owners of which never dreamed that they would be replaced by what will be one of London's highest (and lowest) buildings, and the headquarters of British broadcasting.

Externally the building appears to be more or less complete, because the whole of the concrete work on the outside is finished and passers-by in Portland Place might be excused for thinking that the internal arrangements are also complete.

More Work to be Done

This is far from being the case, for there is a deal of work yet to be done in Broadcasting House and sacks of cement, steel girders and scaffolding now take the place of what, later, will be sound-proof studios.

It was officially forecast that Broadcasting House would be complete by 1932 and it does not seem that this prophesy will be wide of the margin.

It is true to say that the B.B.C. is exercising a certain amount of secrecy with regard to the final layout of the building. The architect's plans are,

naturally enough, not available to the public, and it is more than probable that this apparent secrecy on the part of the B.B.C. is due to a certain amount of indecision as to the final arrangements.

It is, however, possible to arrive at some idea of the final dispositions of the offices and studios, at least so far as the lower part of the building is concerned.

The novel feature about Broadcasting House, of course, is the so-called control tower. "Tower" is rather a misleading word to apply to this part of the building, for it leads one to think that it constitutes a real tower predominating above the normal upper storeys; this is quite a wrong impression. The top of the building is practically level, as any Londoner can see for himself, and the control tower consists merely of a central portion of the building surrounded by offices.

The rooms in this tower will be used as studios and there will be sound-proof arrangements outside these forming an acoustic insulation between the studios and the offices.

The building is so arranged that the offices, in turn, surround the whole of the tower, except at the top, and it is suggested that this large amount of

similar matters have been carried out, it seems quite on the cards that this studio, which will be a miniature Queen's Hall, will be used to a considerable extent and, owing to the novelty of seeing broadcasts in progress, it may become a competitor with existing amusement organisations. It is not safe to prophesy in this direction, though!

It has been arranged that this super-studio will have a concert platform and a fair-size organ. The huge balcony is already complete so far as the steelwork is concerned.

Taking Up Three Floors

This studio takes up the basement, ground floor and part of the first floor of Broadcasting House and it is reached by a wide stairway leading down from the main entrance and by two stairways from side entrances, one on each side of the building.

These side entrances will be used by the public for admission to the studio, the main entrance at the corner of the building facing down Regent Street being used only by artistes and by the B.B.C. staff.

In this entrance there will be a large vestibule and four lifts, while stone stairways also lead to the top of the building. Use will not be made,

brickwork between the studio tower and the street will insulate it from outside noises.

At the time of going to press only two studios are complete, one the giant triple-decker and the other the vaudeville studio, which incorporates a stage.

The giant studio is, of course, a novelty, for although Savoy Hill has at present a double-decker in No. 7 studio, it is not possible to admit the public to it. In this new triple-decker there will be seating accommodation for 1,000 people and as the L.C.C. regulations with regard to ventilation and

Will Better Studios Mean Better Programmes?

All About the B.B.C.'s New Headquarters

However, of the flat portions of the roof as an outdoor studio, although this has been tried with success at the big German broadcasting house in Charlottenburg near Berlin.

Immediately above the main entrance is a large room which on the plan is styled "Council Chamber," but this will probably be used as a large waiting room. Above this again is Sir John Reith's office, which can be identified from the outside of the building by the balcony.

Below the balcony is, at present, a large niche in the stonework where a statue will stand, but nobody seems to know quite whom the statue will represent!

Engineers Moving First

The final arrangement of offices will not be made, of course, until the Savoy Hill staff is transferred, which it will be in sections, the engineers going over first. It is believed though, that the more important offices—by which is meant, of course, the offices of the directors of engineering, programmes, and so on, will be located in the corner part of the building.

The basement is well on the way to completion and in examining this it is interesting to see the great retaining walls which have had to be built enclosing the boundaries of the site. This has been rendered necessary by an underground water strata, which has given the architect a deal of trouble.

The architect, by the way, is Lt.-Col. G. Val Myer, F.R.I.B.A., and it is his own expression that Broadcasting House resembles a ship, which it does very closely. The whole building is hull-shaped, the front being curved like the prow of a ship and the foundations, including the retaining wall, bearing an extraordinary resemblance to a ship's hull and also being practically sunk in water.

Use has been made of this water strata by a 600-ft. artesian well recently sunk, which will provide many thousands of gallons of water a day for use in Broadcasting House.

This artesian well is one of the novelties of the basement and it is not far from the vaudeville studio which, below the giant studio, is well down in the underground of London. The studio also has a balcony at right angles to the balcony of the giant studio above it. Outside the vaudeville studio smaller rooms are being built which will be used as test rooms and band rooms. Two echo rooms will also be provided.

There are three huge 5,000-gallon tanks with oil fuel for the water-heating arrangements. These are immediately below the main entrance, while the boilers are at the other end of the building.

The designers have found efficient ventilation a serious problem because, obviously, artificial ventilation is necessary in the control tower, which has no external face, and in the basement. Ordinary ventilation systems would provide sound conduits which would nullify the whole effect of the control tower construction and the sound-proof room.

However, a novel system of ventilation, making use of large non-

resonant and sound-proof ducts, has been installed and throughout Broadcasting House there are miles of huge tubes carrying fresh air to every part of the central tower and basement.

The Control Room

Half way up the tower, between the studios, will be a control room for all the studios and effects rooms in the building. This will be fitted out with the same type of control and landline gear as at Manchester. The Savoy Hill control room apparatus is out of date, of course, having been in constant working since 1928 or thereabouts.

Special arrangements will be made for wiring this centrally-placed control room with the studios in the control tower and the result of this will be that there will be no line interference.

It should be noted that although the B.B.C.'s wishes are being followed with exactitude in the construction of Broadcasting House, the building does not actually belong to the B.B.C. at present. It is being built by a syndicate on behalf of the B.B.C. by a well-known firm of contractors, and the B.B.C. may not take over full ownership for several years.

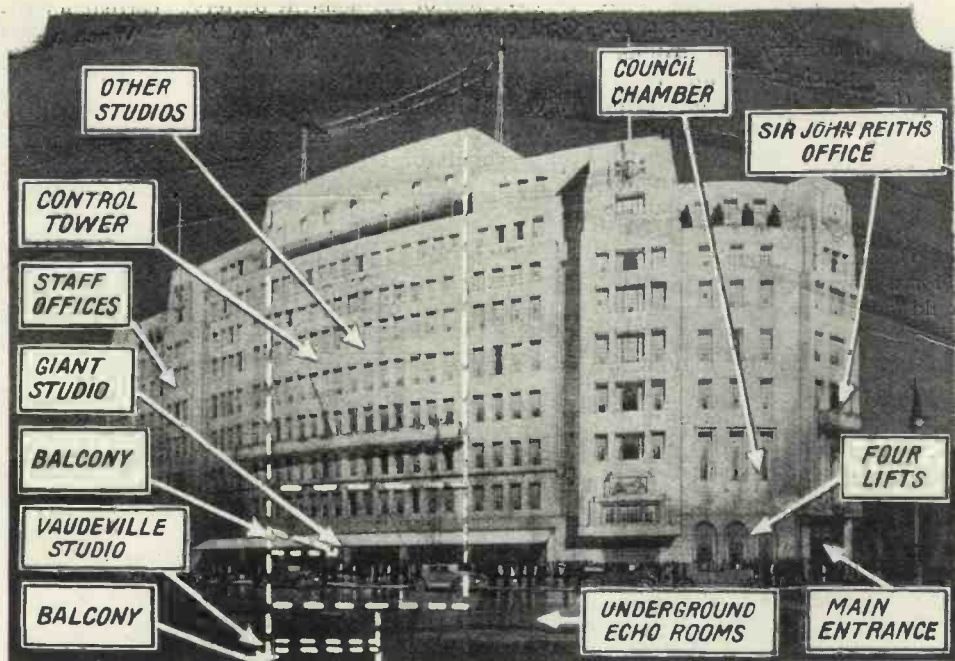

AN ARCHITECT'S DRAWING OF THE FINISHED BUILDING

This illustration shows how the studios and offices will be arranged in the new building, which will be a fitting headquarters for the B.B.C.

This "Power" Grid-detection Business!



W. JAMES explains how so-called "power" grid-detection differs from ordinary grid-detection practice. Every amateur should read this article—it is easy to understand and deals with a subject of particular importance just now.

ALL this talk about "power" grid detection is getting on my nerves.

We have to thank the Americans, I believe, for introducing in their clever way the attractive term "power" grid detection. It was introduced, no doubt, as a selling point and has considerable sales value, I am sure

If you have a power grid detector you have something better than a common-or-garden grid detector!

Amusing Point!

But the amusing thing is that the rest of the circuit is of as much importance as the arrangement of the detector. However, I will deal with this presently.

We do not have to go to America for the rectifying system itself. That has been used by some people for years in this country. I remember reading an article by Capt. H. J. Round (I believe it must be five or six years ago) in which he recommended a grid condenser of small capacity, a grid leak having a low resistance, and plenty of anode voltage for the valve.

This is actually a rough specification for a power grid detector, but I would add something which you might think, without considering the matter, really has nothing to do with the detector. This is that the power stage connected to the detector must be arranged for dealing with a relatively large grid input voltage.

Detector Distortion

If the last stage will not accept a grid swing of a magnitude depending upon the amplification of the signal after the actual rectification, then the detector will be a weak-signal detector and will distort.

Now what is the difference between a power grid detector and an ordinary grid detector? The only differ-

ence is that the power grid detector is designed to deal with signals of the order of a volt or two, while the ordinary grid detector will deal with fractions of a volt only.

But, you say, the power grid detector has a smaller grid condenser and a grid leak of lower resistance than the ordinary detector.

This is not quite true. The point is that the values are chosen in order to minimise distortion. A grid rectifier distorts in several ways. The first distortion, called frequency distortion, is produced by the grid condenser and valve capacity being in shunt with the grid leak and grid-filament path of the valve.

We have in the grid circuit a grid condenser *c* (Fig. 1), and a grid leak *R*. The grid leak is taken to the positive side of the filament battery. Grid current therefore flows in the circuit, made up of the grid leak and the path between the grid of the valve and its filament.

When no signal is present in the tuned circuit of Fig. 1, we have a

steady grid current, the voltage of the grid itself with respect to the negative end of the filament depending upon the valve and the value of the grid leak, as well as the voltage to which the filament end of the leak is connected.

If the voltage applied to the grid is slowly increased and decreased we obtain a varying grid current, as shown in Fig. 2. The current, you will see, starts at about zero for a given grid voltage. As the voltage is increased the current grows.

Rectification Point

It grows slowly at first and then rapidly increases. It is here in the grid circuit where the rectification occurs. Our normal grid voltage may be that marked *A*, the grid current flowing being *AB*.

When a signal comes in the positive half tends to increase the current, while the negative half produces but little effect as the current can only fall to zero. The point to note is that when the variations occur

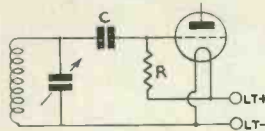

Fig. 1.—Typical grid-circuit arrangement

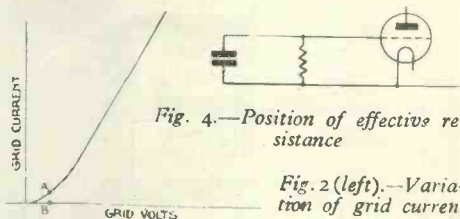

Fig. 4.—Position of effective resistance

Fig. 2 (left).—Variation of grid current

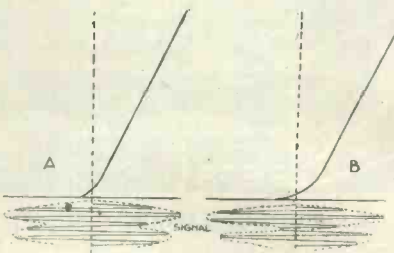

Fig. 3 (left).—How grid current is affected by signals

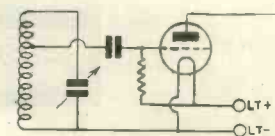

Fig. 5.—Tapping grid circuit down on tuning coil

over the straight-line part of the grid-current curve, the grid voltage varies practically exactly according to the low-frequency part of the signal.

Thus if the curve of Fig. 3a represents the actual grid-current curve under working conditions, and the signal is as represented, then the voltage of the grid will vary according to the low-frequency signal.

Signal Components

The complete signal comprises, of course, high-frequency oscillations modulated by the audio frequency and it is the audio frequency part of the signal in which we are interested.

The next diagram B shows a more deeply modulated signal. Here there is evidently a little distortion owing to the curved grid-current characteristic.

A deeply-modulated signal will suffer a little amplitude distortion, therefore, while a signal not so deeply modulated will not.

But, to continue this simple explanation, we have in the grid circuit the grid condenser, and the valve itself has capacity. Also there is the grid leak having a definite resistance, as well as the path of the valve. For the low frequencies we therefore have in effect a resistance across which the voltage is built up and a condenser, represented in Fig. 4.

From this it is easy to see that the higher audio frequency voltages may tend to be weakened, owing to currents flowing through the condenser.

In practice, the weakening of the higher audio frequencies is easily detected when the capacity of the condenser is relatively large compared with the resistance of the grid circuit.

Uniform Impedance

The effect is less noticeable as the grid condenser is reduced in capacity or, alternatively, as the resistance is lowered, for the reason that the combination of resistance and capacity in parallel has a more nearly uniform impedance over the audio frequency range as they are reduced.

However, we do not wish to lose signal strength by cutting down the strength of the modulated high-frequency oscillations. The grid condenser is in series with the grid and if it is too small the voltage actually applied to the grid will be less than that developed across the ends of the tuned circuit connected to it.

In practice a value of .0001 microfarad is quite suitable and having decided this we have to see that the

grid resistance is of such a value that the higher notes are not reduced in strength relatively to the lower ones.

The grid leak may be as low as 100,000 ohms. A good value is 250,000 ohms or .25 megohm.

The point here is that the lower the resistance the better from the viewpoint of quality, but owing to the load across the tuned circuit, the voltages set up across it are less than when the rectifier is disconnected. At the same time the load broadens the tuning.

These two effects may be minimised by connecting the grid circuit to a point on the coil, as in Fig. 5. But there are times when this is not necessary, as no advantage worth

mainly with amplification. The voltage variations on the grid of the valve are magnified in the usual way.

Given a transformer having a primary winding with a large enough impedance we shall obtain across the primary magnified voltages corresponding with the grid voltages.

Linear Amplification

This is only true, however, when the amplification is linear. The valve must therefore be so adjusted that this straight-line magnification results.

Knowing the grid voltages we can find for a given valve exactly how much high tension is needed to give the desired straight working anode-

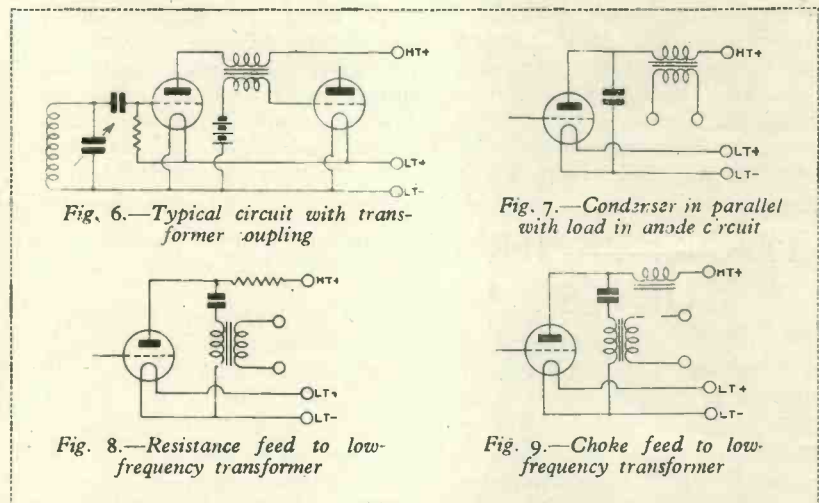

having is gained. Thus when the tuned circuit has a coil of relatively high resistance, the effective resistance of the tuned circuit at the resonant frequency is not very high. The loading effect is then not very marked.

We have discussed frequency distortion in the grid circuit and explained that it is due to the effect of the capacities shunting the resistances. We have also looked into the rectification in the grid circuit, the point being that the grid-current curve is curved at the bottom, but is straight over a considerable part.

Further, that the rectification in the grid circuit results in the grid having low-frequency voltage variations corresponding to the modulation of the high-frequency oscillations.

Now what does the rest of the valve do? We have so far ignored the anode circuit.

In this circuit is a coupling of some description, let us say a transformer, as in Fig. 6. This part is concerned

current curve. The anode voltage needed depends not only upon the grid voltage but also upon the characteristics of the valve.

For a valve of moderate impedance and amplification factor, a voltage of 100 or 120 may be needed. With valves having a higher impedance the voltage necessary to produce the desired length of straight working characteristic might be 150 and, of course, some valves simply will not deal with the strong signals without distortion.

Anode Rectification

Failure to provide the necessary length of straight characteristic means that distortion will occur. The signal is rectified in the anode circuit and is therefore distorted.

This point is often overlooked. It is essential to provide the straight working part adequately to handle the signal and failure to do so means that the signal is working over a curved as well as a straight part.

“POWER” GRID-DETECTION—Continued

A valve of too great an impedance must not be used as it cannot magnify the grid voltages without distortion.

In the anode circuit we also have high-frequency currents. They are not needed excepting when we apply reaction from the anode to the grid or other circuit.

Minimising Feedback

Owing to the capacity of the anode to the grid circuits there is a feedback. This reduces the magnitude of the grid-circuit voltages and is therefore to be avoided. A condenser must be joined between the anode and filament in order to minimise this effect.

It should always be made as large as possible in order the more completely to suppress the feedback. But we meet with a difficulty here. This condenser is in shunt with the load in the anode circuit, as indicated in Fig. 7.

The impedance of the anode-circuit load will then no longer be fairly constant over the audio-frequency range. The tendency will be for the impedance to fall off at the higher frequencies and for the strength of those high notes to suffer.

Thus there is a limit, imposed by quality, upon the size of the by-pass condenser. When the valve has a low impedance the condenser can be bigger than when the valve is of a higher impedance class.

Once again we have the effect already described in connection with the grid condenser and resistance. A careful choice of values will enable us to obtain the greatest efficiency and the best quality. The necessity for providing the valve with a considerable voltage, or in the case of a low-impedance type, of passing a fairly heavy current, introduces difficulties.

An ordinary transformer cannot

successfully be used, for example, when the anode current exceeds 4 or 5 milliamperes. And if we attempt to resistance feed the transformer, as in Fig. 8, we are up against the quite large voltage drop with resistance. With a 30,000-ohm resistance and a current of 5 milliamperes the drop is 150 volts. With 100 volts on the anode the total voltage is 250.

Choke Feed

When this is obtained from a mains unit we have the filter circuit as well, which also drops the voltage. We can, of course, use a choke feed, as in Fig. 9. The drop in the choke is very small and a lower total anode voltage can be used.

When the output from the rectifier is several volts and the transformer steps up the voltage three or four times the output valve must be arranged to take a large grid swing or distortion will result.

TRANSFORMER CURVES

LOW-FREQUENCY transformers of popular types have cores of stalloy (or similar material), of nickel-iron or a mixture of the two.

Curves showing the variation of the magnification of a stage comprising the transformer, with a valve joined to the primary and another to the secondary, are usually issued and no doubt they are compared.

Primary Current

Notes ought always to be made of the amount of the current flowing through the primary coil, however, as it is more than possible for wrong conclusions to be arrived at.

The nickel-iron cored transformer may show up best when the current is only 1 or 2 milliamperes, but the results may be no better than those from a cheap transformer having a stalloy core when the current is 4 or 5 milliamperes.

We do not use valves in these days with small currents. Power detectors or detectors passing 4 milliamperes, for example, are now regularly used and the valves employed in second low-frequency stages always pass about this current. An exception may be in portable sets, where the anode currents are kept down.

It therefore follows that the curves shown with small currents are not very valuable.

As a rule, increasing the current through a transformer having a nickel-iron core quickly affects the results. Not only is the effective inductance reduced, but the leakage may increase, with the result that the higher frequencies are affected. Nickel-iron transformers are probably best used with a filter circuit, fine results being obtained with parts of suitable value.

There is a need to-day for transformers capable of dealing with heavy currents, as it must be admitted that the plain transformer circuit is more easily used than the circuit having a filter feed.

W. JAMES.

**MAKE CERTAIN
OF GETTING
YOUR COPY OF
THE MARCH
ISSUE ON
FRIDAY,
FEBRUARY 20**

SCREENED-GRID OVERLOADING

A FREQUENT cause of distortion in sets having a screen-grid high-frequency stage is due to overloading of the first valve.

If you tune to the local station you may generate across the first grid coil a volt or two. Thus it follows that rectification occurs in the first stage unless the valve has a suitable working characteristic. Not many have, and when a screen voltage control is used the difficulty is increased.

Reduced Voltage

When a strong signal is received the screen voltage is reduced for the purpose of reducing the strength of the signal. This cuts down the working characteristic and causes distortion by rectifying the signal. I have noticed this fault with several commercial sets and nothing can be done except to cut down the input.

This means the use of a smaller aerial, as it is usually not possible to connect a component to the set without affecting the tuning. A condenser could be tried in the aerial circuit, or a potentiometer might be fitted across the grid circuit.

The condenser method is the most easily tried, of course, and might possibly suffice.

W. JAMES.

The BROOKMAN'S A.C. TWO

A LOCAL STATION SET WITH POWER GRID DETECTOR

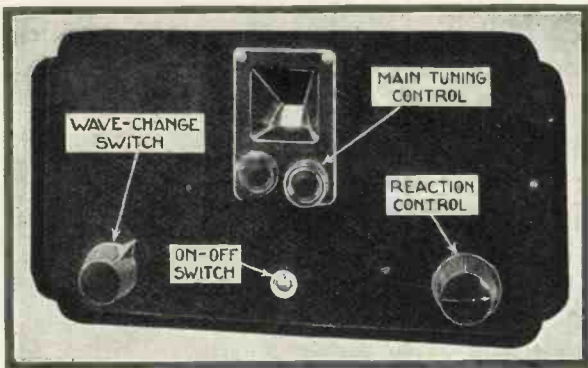

SIMPLE TUNING CONTROLS

Any novice can operate this set without difficulty—it is ideal for family use

THIS set has two outstanding features—the first is a Binowave dual-range coil for tuning and the second a power grid detector. Combined with a single stage of low-frequency amplification, the result is a receiver outstanding for volume and quality of reproduction from local stations.

All Power from the Mains

The Brookman's A.C. Two is ideal for family use where alternating-current mains are available. All the power needed for the operation of the valves is taken from the mains and there is no need even for a grid-bias battery. The set also has the merit of being very simple in operation and can be handled without difficulty even by the complete novice.

Throughout the design our object has been to achieve the greatest volume and the highest quality of reproduction when the receiver is used within fifty miles or so of a regional transmitter. Nobody who uses the set at this range will be disappointed with the results obtained.

Results of Independent Tests

Independent tests carried out by a member of the WIRELESS MAGAZINE Technical Staff who had nothing at all to do with the actual design and construction indicate that this receiver is one of the best two-valve A.C. sets yet tried out (commercial designs included).

Binowave coils need no introduction to regular readers of WIRELESS MAGAZINE. They were specially designed for this journal by W. James and have been used with the greatest success in a large number of receivers previously described in these pages.

They give a happy compromise between sensitivity

This console cabinet costs only 2 guineas



and selectivity, and are particularly suitable for a set of this type, which includes only a single tuning circuit, which must be sufficiently selective to separate twin regional transmissions without any tricks on the part of the operator.

Merits of the Power Grid Detector

Here there is no need to enter into a theoretical discussion regarding the merits of power grid detectors. W. James deals with the subject very thoroughly in an article that appears elsewhere in this issue, and readers are referred to his notes for further details of the subject.

We need only emphasise the point that a detector of this type gives the maximum volume that can be obtained with complete freedom from distortion.

Power for this set is taken from the A.C. mains by means of a transformer in association with a valve

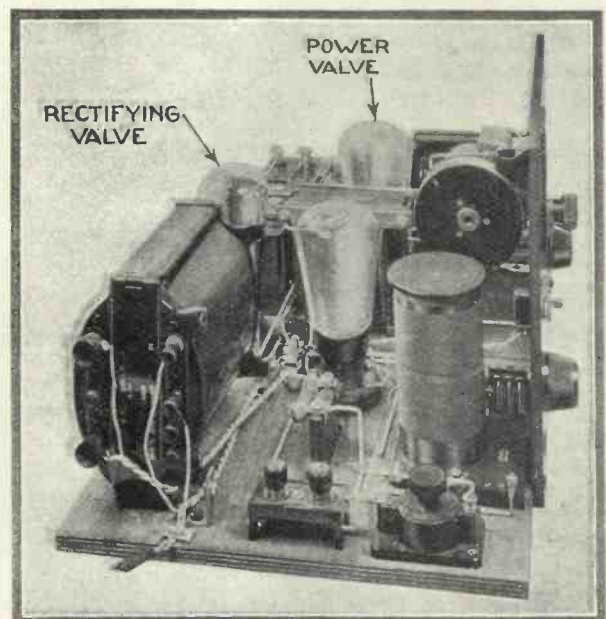

A FAMOUS COIL IS USED FOR TUNING

This set utilises one of the famous Binowave coils designed by W. James. That is one of the secrets of its good performance

THE BROOKMAN'S A.C. TWO—Continued

rectifier, which converts the alternating current into a direct supply for application to the anodes of the detector and power valves.

These, of course, are of the special mains type and are both indirectly heated from a 4-volt winding on the mains transformer.

The valve rectifier is rated at 250 volts 30 milliamperes and provides full-wave rectification. Its filament is

tap on the 460-volt secondary is the negative point

After rectification the current needs smoothing out or a hum results when the set is connected to a loud-speaker. This smoothing is done by means of a low-frequency choke and two 4-microfarad condensers. As the smoothing condensers have to stand a working voltage of about 200 volts, they should be of the type tested at 600 volts. Actually we have used condensers

of the 800-volt test type.

This point is emphasised because many constructors are in the habit of using condensers tested at only 400 volts and intended for 200-volt working. In this set a higher factor of safety is desirable.

Circuit Details

The detail arrangement of the circuit will be clear from the diagram on page 59. In series with the aerial lead is a semi-variable condenser with a maximum capacity of .0002 microfarad. This enables the most selective tuning to be obtained with any particular aerial system.

An advantageous feature of the Binowave coil is that it is assembled in one unit with the wave-change switch. The switch knob projects through the bottom left-hand corner of the ebonite panel. It is turned to the left for medium-wave reception and to the right for long-wave working.

The aerial portion of the coil is tuned in the usual way with a .0005-microfarad variable condenser. This is provided with a particularly smooth working drum-type dial, and the operation of tuning is very pleasant to the touch.

Unusual Values

In the grid circuit of the detector valve are the usual condenser and leak, but of different values from those usually employed. The condenser has a capacity of .0001 microfarad, while the leak is .25 megohm or 250,000 ohms.

Reaction is controlled by a .0002-microfarad variable condenser in the usual way. It should be noted that a satisfactory control is obtained without the use of a high-frequency choke. Detector efficiency is kept at a maximum by providing a .0005-microfarad fixed by-pass condenser between the detector anode and cathode.

The connections to the low-frequency transformer are standard, but the instrument itself is of a special type, that will carry currents up to 15 milliamperes through

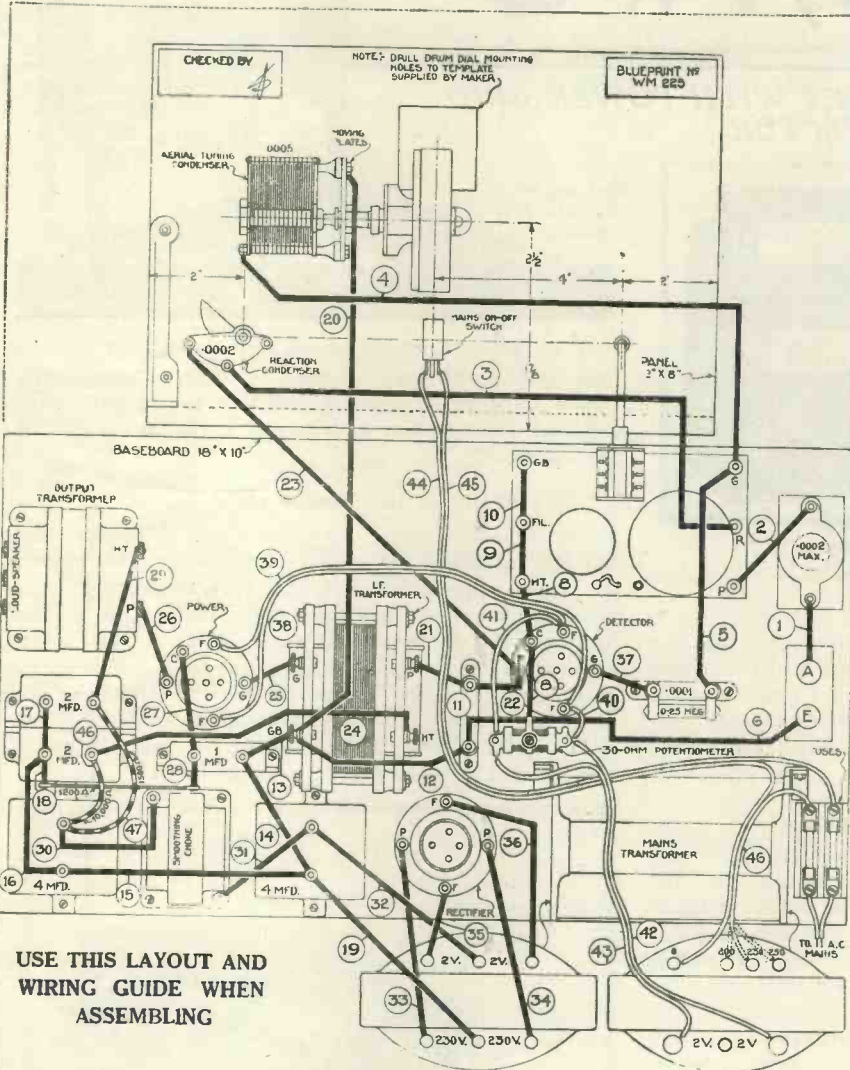

USE THIS LAYOUT AND WIRING GUIDE WHEN ASSEMBLING

This diagram is quarter scale. If desired, a full size blueprint can be obtained for half-price (that is, 6d., post free), if the coupon on page 112 is used by February 28. Ask for No. WM225. When wiring up connect the leads one by one in the numerical order indicated

supplied with raw A.C. at 4 volts (the consumption is 1 ampere) from a special centre-tapped secondary on the mains transformer. The two anodes of the valves are connected to the outer ends of a centre-tapped 460-volt secondary (230-volts each side.)

Those who have not previously used a valve rectifier of this type should notice that (as regards the direct-current supply for application to the other valve anodes) the filament is the positive side, while the centre

THIS SET HAS A POWER DETECTOR!

the primary. Although it has a step-up ratio of only 1 to 2, the overall magnification of the set is very great, owing to the large output obtained from the power detector.

We have already seen that a voltage of over 200 is available from the rectifying valve; as we do not need such a high value for the detector, a voltage-dropping resistance is placed in series with the primary of the low-frequency transformer.

No Motor-boating

The value of this resistance will be discussed in detail later. Associated with it is a 2-microfarad by-pass condenser, that prevents any possibility of low-frequency oscillation or motor-boating.

Grid bias is supplied to the power valve automatically by means of a resistance in its cathode circuit. This resistance has a 1-microfarad by-pass condenser placed across it.

In order to isolate the loud-speaker from the power circuit an output transformer is utilised. This has the further advantage that any type of loud-speaker can be matched up with the output valve, so that without any difficulty it is possible to use with the set any type of cone, inductor, or moving-coil reproducer by using the proper ratio of output.

As the power valve is rated at 200 volts and a higher value than this is actually obtained from the rectifier, a second voltage-dropping resistance is placed in series with the primary of the output transformer. In association with this there is also a 2-microfarad by-pass condenser.

Designed for New Type of Console

This set has been specially designed for use in a new type of console cabinet recently put on the market and, for the sake of convenience, the mains on-off switch has been mounted directly on the panel. It should be noted

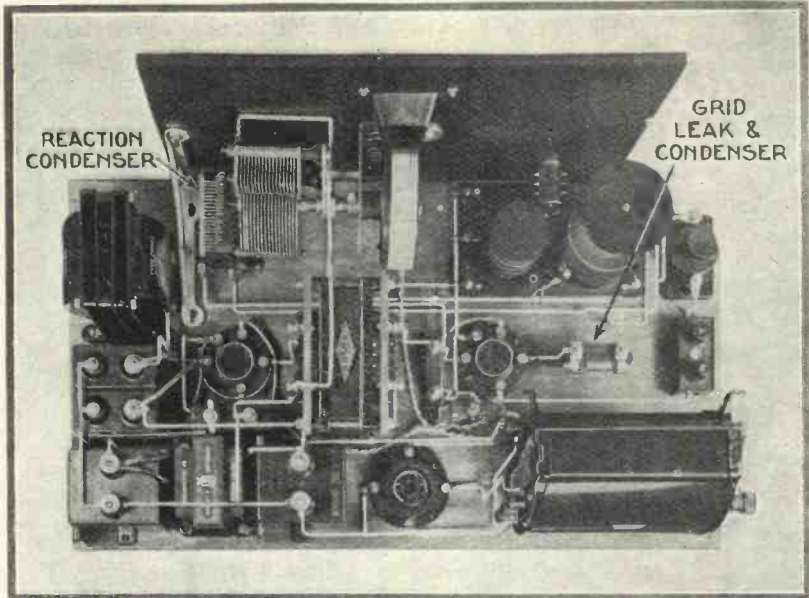

ONLY STANDARD PARTS ARE USED IN THIS RECEIVER

No special components are needed for this set. The above plan view makes clear the disposition of all the parts

that a twin fuse is inserted in the mains lead. The primary of the mains transformer is provided with tapings for inputs of 200, 230, and 250 volts. When the set is first connected up care should be taken to see that the proper tapping is used or the set may be damaged through the valves being overrun.

Simple Construction

It will be clear from the photographs reproduced in these pages that the assembly is quite straightforward and presents no difficulties even to the beginner.

If desired, a full-size blueprint can be obtained for half-price (that is 6d., post free) if the coupon on page 112 is sent to the Blueprint Department, WIRELESS MAGAZINE, 58-61 Fetter Lane, London, E.C.4, by February 28. Ask for No. WM225.

As the mains transformer has terminals at each end, it is not easy to show the connections in an ordinary

TEST REPORT ON THE BROOKMAN'S A.C. TWO

Sensitivity.—This set was connected to a 50-ft. aerial in south-west London. Turning the left-hand knob to the right, so that long-wave tuning was brought into circuit, we picked up Daventry at fair loud-speaker strength, at 116 degrees on the dial. Above Daventry, at 125 degrees, we could hear Radio Paris at weak loud-speaker strength clear of Daventry. Below Daventry we got Eiffel Tower at 104 degrees, with moderate volume on the loud-speaker.

Turning the left-hand knob to the left for medium waves,

we logged the London National at 30 degrees and the London Regional at 80 degrees. Both these stations were strongly received. Midland Regional at 125 degrees was moderately strong on the loud-speaker. Rome at 110 degrees was nearly as strong as the Midland Regional.

Selectivity.—Using the aerial mentioned above we found this set was quite selective enough to be worked near a regional broadcasting centre. London Regional, maximum at 80, was tuned out at 70 and 90 degrees, a

20-degrees spread. London National, maximum at 30, was tuned out at 20 and 40 degrees, again a spread of 20 degrees. Note that 30 degrees on the dial was silent between the two regional stations.

Operation.—Tuning on medium and long wavelengths is very satisfactory. The setting for any given station is not critical. Reaction works smoothly and the detector valve goes in and out of oscillation without fuss. A novice would have no difficulty in mastering the controls of this set.

Quality.—As this set has been designed for good quality of reproduction it was tested with a moving-coil loud-speaker. In the reception of the local stations the quality was first rate.

Summary.—As a result of tests, we can say of this set that the sensitivity is up to standard, the quality is better than usual and the operation is pleasingly simple. Used with a moderate size of aerial, this set is ideal for regional areas, where it is desired to receive twin transmissions without interference.

THE BROOKMAN'S A.C. TWO—Continued

plan view, we have shown on the wiring diagram both ends in detail (at the bottom of the baseboard).

There is little that need be said about the actual construction. In the original set the 30-ohm potentiometer connected across the 4-volt secondary (supplying current to the detector and power valves) is held in position

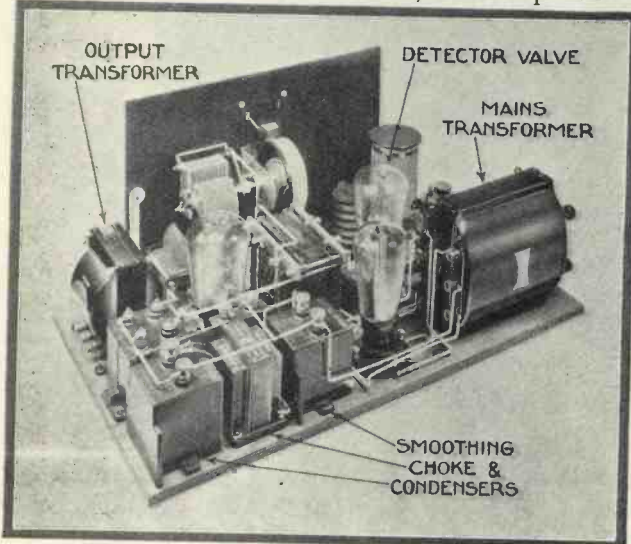

COMPLETELY ASSEMBLED AND READY FOR USE

This photograph shows how the set appears when it is completely wired up all ready for switching on

by the wiring, but if desired it could be screwed down to the baseboard.

In a similar way the 1,200-ohm fixed resistance seen at the bottom left-hand corner of the baseboard is also held in position by the wiring.

Another point to notice is that the voltage-dropping resistances are of the flexible or spaghetti type and actually form part of the wiring.

Every wire in the set is numbered separately. It is intended that they should be placed in position one by one in the order indicated. There is then no possibility of a mistake being made and the set will work directly it is completed and connected to the mains.

Suitable Valves

We have not yet considered what valves will be suitable for this receiver, but we must do so at this stage. The detector valve is a Mazda AC/HL and the power valve is an AC/PI. Alternatives are not recommended unless the constructor is prepared to work out the proper values of voltage-dropping resistances for different valves.

The AC/HL valve takes approximately 10 milliamperes at 150 volts. A resistance of 10,000 ohms in its anode circuit will produce a drop of 100 volts, so that, assuming a voltage of 230 from the rectifier, we shall

have approximately 130 volts on the anode of the detector.

For the power valve the voltage-dropping resistance has a resistance of 1,500 ohms. With a current of 20 milliamperes (which is approximately what the AC/PI takes at 200 volts) we obtain a drop of 30 volts. As we obtain approximately 230 volts from the rectifying valve, it will be apparent that with this value of resistance the power valve is being run at its proper rating.

As has already been mentioned, grid bias is supplied to this valve automatically by means of a fixed resistance in its cathode circuit. At 200 volts (on the anode) the AC/PI needs approximately 24 volts grid bias, and we shall obtain this value by using a 1,200-ohm resistance.

Calculating Resistances for Other Valves

From these figures it will be appreciated that if other valves are to be used the correct values of voltage-dropping resistances must be carefully worked out, or the valves will not be run at their proper rating and the set will give poor reproduction.

The calculations that have to be made are not at all difficult if it is remembered that for every 1,000 ohms resistance a current of 1 milliampere will produce a drop of 1 volt. It is safe to say that the voltage from the rectifier is 230 volts, so that the correct value of resistance to give the desired voltage drop with a known anode current can be worked out without difficulty. One example will be sufficient:

Suppose that the detector valve to be used takes 8 milliamperes at 140 volts. As we have 230 volts available, we must drop 90 volts in order to get the correct value. Making a simple transposition of Ohm's Law, we see that $R = \frac{E}{C}$, where R is the value of resistance in ohms, E is the voltage to be dropped and C is the current in amperes.

COMPONENTS REQUIRED FOR THE BROOKMAN'S A.C. TWO

CHOKE, LOW-FREQUENCY

1—R.I. Hypercore, 17s. 6d.

COIL

1—Wearlte 1930 Binowave, type C, 17s.

CONDENSERS, FIXED

1—T.C.C. .0001-microfarad, upright type, 1s. 6d. (or Graham-Farish, Edison Bell).

1—T.C.C. .0005-microfarad, upright type, 1s. 6d. (or Graham-Farish, Edison Bell).

1—T.C.C. 1-microfarad, type 80, 3s. 9d. (or Dubilier, Hydra).

2—T.C.C. 2-microfarad, type 80, 10s. (or Dubilier, Hydra).

2—T.C.C. 4-microfarad, type 80, 17s. (or Dubilier, Hydra).

CONDENSERS, VARIABLE

1—Burton .0002-microfarad, 4s. (or Bulgin, Formo).

1—Utility .0005-microfarad, with drum dial, 14s. (or Jackson, Lotus).

1—Lewcodenser .0002-microfarad max., type W, 2s. 6d. (or Sovereign, Formo).

EBONITE

1—Redfern Ebonart 12 in. by 8 in. panel, 7s. 3d. (or Becol, Lissen).

1—Belling-Lee terminal block, 8d. (or Junit).

HOLDERS, VALVE

2—W.B. five-pin type, 2s. 6d. (or Telsen, Benjamin).

1—W.B. four-pin type, 1s. 3d. (or Telsen, Benjamin).

PLUG

1—Bulgin mains plug, 1s. 6d.

RESISTANCES, FIXED

1—Dubilier .25-megohm, 1s. 9d. (or Lissen, Rotor).

1—Mazda AC/HL, 15s.

1—Mazda AC/PI, 17s. 6d.

1—Mazda U30/250, 15s.

1—Magnum 1,500-ohm spaghetti, 1s. 6d. (or Bulgin).

1—Magnum 10,000-ohm spaghetti, 1s. 6d. (or Bulgin).

1—Clarostat 1,200-ohm, type FW1200, 1s. 6d.

1—Clarostat 30-ohm potentiometer, 2s. 9d.

RESISTANCE, VARIABLE

1—Clarostat 30-ohm potentiometer, 2s. 9d.

SUNDRIES

Glazite insulated wire for connecting.

Length of rubber-covered flex (Lewcos).

1—Panel bracket.

1—Bulgin twin fuseholder, with fuses, 2s. 6d.

SWITCH

1—Clarostat mains switch, type 728, 2s. 3d. (or Bulgin).

TERMINALS

2—Belling-Lee, marked: A, E, 6d. (or Clix, Elex).

TRANSFORMER, LOW-FREQUENCY

1—Parmeko, ratio 1 to 2, £1 17s. 6d.

TRANSFORMER, MAINS

1—Heayberd, type 715, £1 8s. 6d.

TRANSFORMER, OUTPUT

1—Ferranti, type OPM1, £1 2s. 6d. (or Lissen).

ACCESSORIES

1—Peto-Scott Console, £2 2s.

LOUD-SPEAKER

1—Amplion cabinet cone, type A.B.6, £1 10s. (or Blue Spot, Ediswan).

VALVES

1—Mazda AC/HL, 15s.

1—Mazda AC/PI, 17s. 6d.

1—Mazda U30/250, 15s.

The prices mentioned are those for the parts used in the original set; the prices of alternatives as indicated in the brackets may be either higher or lower

All About

MÜHLACKER

GERMANY'S FIRST REGIONAL STATION

BRITISH listeners have heard a good deal of the new Stuttgart station since it opened in November last, for with its giant power of 75 kilowatts it is creating its quota of chaos in the European ether.

Many listeners think that this station is merely an enlarged Stuttgart working with high power, but there is really much more in it than that. This new station represents

Germany's first effort to copy our regional scheme.

It is anticipated that if Stuttgart proves to be a complete success then two other stations will be opened to cover the Northern and Central districts of Germany and then many other stations will, in course of time, be closed down.

This new station is in a new and specially built transmitter hall at

Mühlacker, a small town midway between Stuttgart and Karlsruhe. It is connected by a landline with studios in Stuttgart and, by means of the fairly comprehensive line network with which Germany is covered, it can be hooked up with other studio centres.

This station has been built by the Telefunken Co., who also erected the 60-kilowatt station just opened at Oslo, and there is a striking similarity between the two plants.

The station stands out high above the River Enz on the borders of Baden, and the two 350-ft. wooden masts are prominent landmarks. There is no doubt but that Mühlacker is in an excellent geographical situation, and this probably accounts for a large measure of the interference which is being caused with British stations.

Short-wave Practice

The aerial is some 600 ft. from the transmitter house and the "lead-in" is arranged with special dual feeder lines, the system being somewhat similar to that being used at short-wave stations. The Mühlacker building is about as big as that at Brookman's Park, although there is, of course, only one transmitter.

There are seven banks of valves and the last stage consists of 20-kilowatt water-cooled valves, two of

PRINCIPAL GERMAN BROADCASTING STATIONS

Wavelength	Station	Wavelength	Station
31.38	Zeesen	318	Dresden
218	Flensburg	325	Breslau
227	Cologne	360	Mühlacker
232	Kiel	372	Hamburg
230	Nürnberg	390	Frankfurt
246	Cassel	418	Berlin
253	Leipzig	453	Danzig
250	Gleitwitz	473	Langenberg
270	Kaiserslautern	533	Munich
276	Königsberg	560	Augsburg
283	Magdeburg	566	Hanover
283	Stettin	576	Freiburg
283	Berlin	1,635	Zeesen
316	Bremen		

For hints on identifying German broadcasts when you pick up foreign stations, see another article in this issue

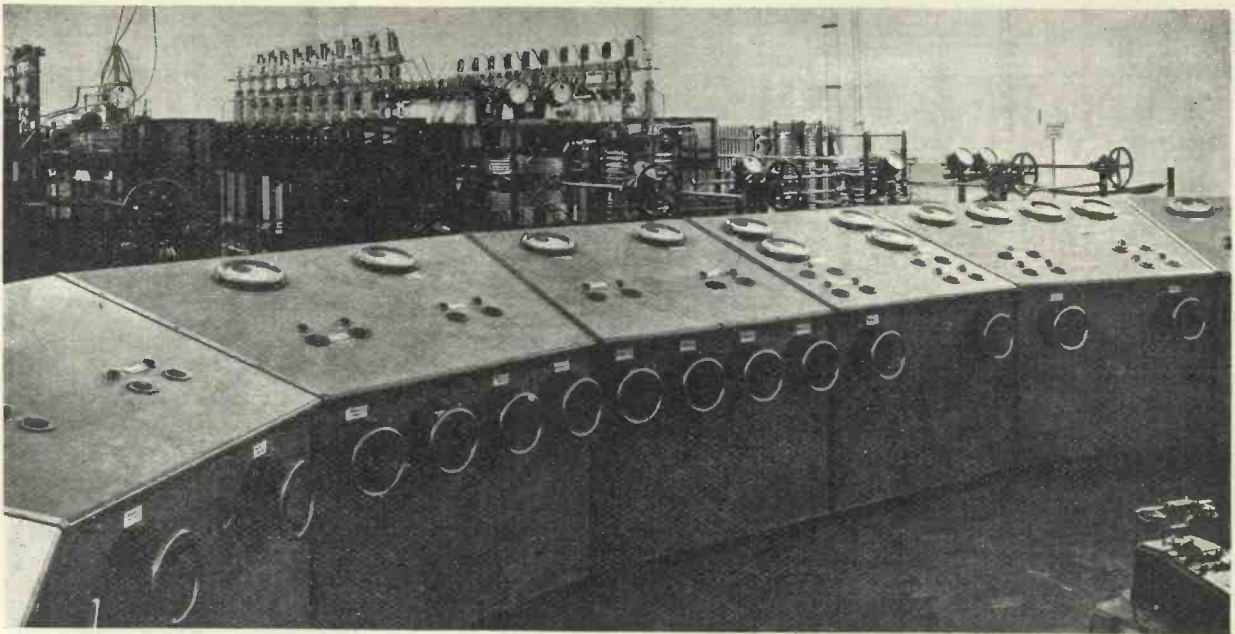

A NEW GIANT OF THE ETHER—HAVE YOU HEARD IT ?

It will be seen from this photograph of the control panels that the new German station at Mühlacker is the last word in up-to-date design. Unlike British transmitters, the various sections are not in metal cages. On the opposite page is a view of the aerial masts. The aerial power of this station is rated at 75 kilowatts, but the power can be nearly doubled if desired

which are kept as spares. The aerial power of the station, by the way, is rated at 75 kilowatts, although this can be practically doubled if necessary. In use are some of the largest water-cooled valves in existence and ample arrangements are made for cooling.

Breakdown Precautions

A special water tower has been built at the end of the main transmitter hall, and this is used as a storing centre for the valve cooling water.

This is quite different from the cooling arrangements at Brookman's Park. Here distilled water is used, on account of its greater resistance, and it is kept constantly in circuit, being itself kept cooled by radiators sprayed externally with tap water. The merits of each type of cooling depend on the associate valve apparatus in the transmitter, and the local water facilities.

Elaborate precautions are taken against a breakdown, and it is interesting to note that the high-tension supply, which is at 12,000 volts, can be obtained either from a motor generator or via banks of valve rectifiers from the local power supply.

A striking feature of the station is the control desk in the transmitter hall. This is a large semi-circular

affair carrying coloured indicating lights and subsidiary controls. Within easy reach also are the geared-down tuning and condenser controls. In these transmitters a variometer form of tuning is used in all the high-power circuits, the tuning coils being of heavy gauge copper tubing.

There are extensive landline arrangements, linking up, as has been said, with the studios in Stuttgart, and provision is also made for future

link-ups with other studio centres. When the other two German Regional stations, Heilsburg and Königswusterhausen are completed (the former is already testing), it will thus be possible for these three giants to broadcast simultaneously events of national importance.

The pressing problem of the moment, though, is confined to wavelengths for these new high-power ether-disturbers !

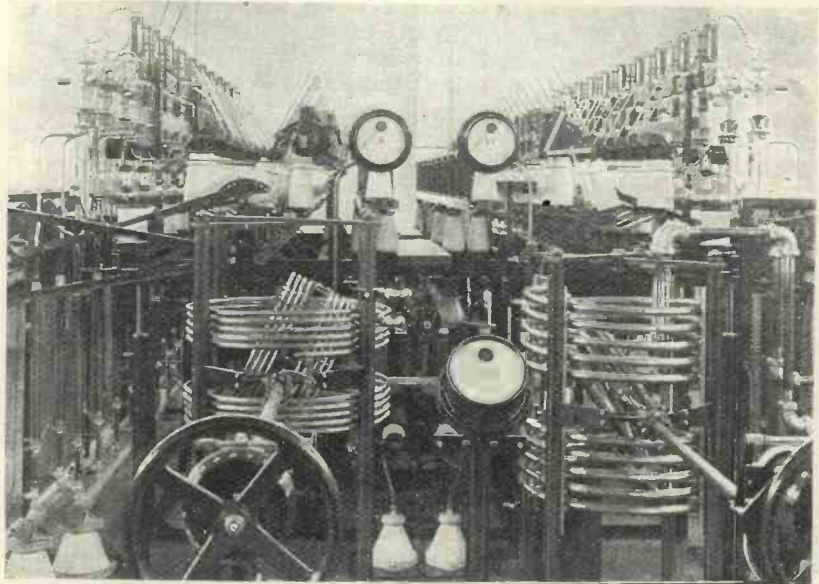

HOW WOULD YOU LIKE TO WORK THIS TRANSMITTER ?

This photograph shows clearly the large geared controls for adjusting the tuning circuits of the new station, which has a power of 75 kilowatts

Why Not Use A Tone Control?

By J. H. REYNER, B.Sc., A.M.I.E.E.

SEVEN SIMPLE METHODS

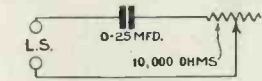

Fig. 1.—Removing the upper frequencies progressively

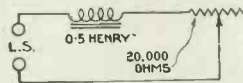

Fig. 2.—Similar arrangement for cutting out bass

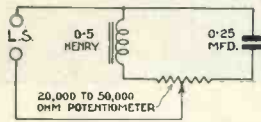

Fig. 3.—Combination of the arrangements shown in Figs. 1 and 2

Fig. 6 (below).—Internal method of cutting down upper frequencies

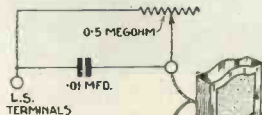
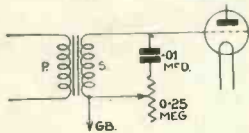

Fig. 4

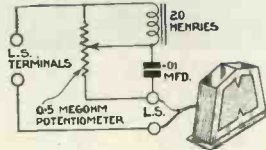
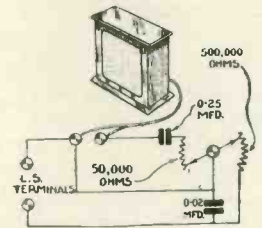

Fig. 5 (above).—Similar arrangement to Fig. 3, except that the series system is used

Fig. 4 (top left).—Condenser in series with loud-speaker

Fig. 7 (left).—Two effects linked up in one system, but controlled by single knob



resistance out of circuit altogether, and the top notes are cut off progressively as one moves the resistance round towards its minimum position.

Cutting Out Bass

A somewhat similar arrangement for cutting out the bass frequencies is shown in Fig. 2. Here instead of the condenser we use a small iron-cored choke of about half a henry. As the resistance is decreased the bottom frequencies are cut off to an increasing extent. This device, however, is by no means as successful as the Fig. 1 arrangement, since it causes a distinct drop in

VERY few radio users have an equipment in which the loud-speaker and the set are really nicely balanced. More often than not the set has been bought at one time and the loud-speaker at another, and the two are expected to work together without any further ado.

Up to a point the combination operates satisfactorily, but it is obviously not only possible, but probable, that by the addition of suitable devices the quality could be made more pleasing.

Suiting Different Tastes

Indeed, even when the apparatus contains a built-in loud-speaker the need for some form of tone control is desirable in order to allow for the variety of tastes of different users. One man's idea of pleasant reproduction may not coincide with another's. So much is this the case that all the principal sets marketed in America this year are fitted with tone controls.

This control of the tone may be obtained by means of devices incorporated in the set itself, or fitted externally. Those devices which are included in the set are dependent to a

great extent on the constants of the apparatus employed and, indeed, the designer takes into account all these effects when he is designing the receiver in the first place.

It is not always possible for the user to do this. He may not wish to break into his set, and even if he is willing to do this he often does not know the values of the various parts. Thus the more favourable forms of volume control are those which are applied externally to the set, between the loud-speaker terminals and the loud-speaker itself.

One of the simplest forms of volume control is that which removes the upper frequencies to a progressive extent, and this is shown in Fig. 1. This consists of a condenser of suitable value in series with a variable resistance shunted across the loud-speaker terminals.

A condenser of .25 microfarad is convenient, and the resistance should be variable from 10,000 ohms downwards. The more the resistance in the circuit, the less the shunting action of the condenser, so that the normal tone is obtained with the maximum resistance in or with the

signal strength as well as an alteration in the tone.

Fig. 3 illustrates a combination of both the above arrangements. Here a potentiometer is used, and the slider is moved from one side to the other.

If the slider is moved over towards the condenser side, then the top notes are cut off, while in the reverse direction the bottom notes are cut off, and the tone can, therefore, be balanced to suit one's own requirements rather nicely.

This arrangement is quite a pleasant one to use, and is very simple to construct.

Series Controls

So far we have considered devices shunted across the loud-speaker. It is possible to employ an arrangement in series with the loud-speaker, although as a general rule this is only practicable where one is using a choke-output or transformer-output circuit.

Fig. 4, for example, shows an arrangement of a condenser in series with the loud-speaker. Shunted across the condenser is a resistance,

BROADCASTS OF 1930

A CATALOGUE of outstanding events of the year 1930 would pay special attention to such broadcasts as those of Miss Amy Johnson on reaching Brisbane on May 29 and on her return to Croydon on August 4 from her great Australian flight; of the conversation on June 6 between Mr. Harold Nicolson in a B.B.C studio and a passenger on board the White Star liner *Homeric*, 1,200 miles from land; of the Thanksgiving Service for the preservation of St. Paul's Cathedral, which was relayed from the cathedral on June 25, of the first televised play, *The Man with the Flower in His Mouth*, which took place on July 14; of the return from Canada of R100 in August; and of the memorial service for the dead of R101, which was relayed from St. Paul's in October.

World Transmission

There were also such events as the world transmission on October 27 of speeches in connection with the deposit of Ratifications of the London Naval Treaty, requiring as it did the most complicated arrangements between international broadcasting authorities and Governments.

Consecutive speeches by the Japanese Prime Minister in Tokio, the President of the United States of America in Washington, the British Prime Minister and the Japanese Ambassador in London, were relayed by broadcasting stations in Japan, the United States and Great Britain.

From Tokio

The broadcast began with an announcement from a London studio, followed by an address by Mr. Hamaguchi, the Japanese Prime Minister, from Tokio. President Hoover next spoke from Washington and he was followed by Mr. Ramsay MacDonald speaking from Downing Street. The broadcast concluded with a translation of the Japanese Prime Minister's speech, by Mr. Matsudaira, the Japanese Ambassador to this country.

This was the first attempt to relay in this country a speech originating in Japan. The transatlantic telephone service was used for linking Washington to London and the extension from Washington to Japan was made by means of experimental short-wave link across the Pacific.

and here the arrangement is somewhat the reverse of the previous example.

When the resistance is at its minimum, the effect of the condenser is cut out, and one obtains the normal tone of the loud-speaker. Increasing the resistance removes the shunt across the condenser, and it begins to take effect.

In the case of the parallel circuit a condenser across the loud-speaker shunts the high notes. In this case it prevents the high notes from getting to the loud-speaker, so that instead of acting as a top cut-off it acts as a bass cut-off, and this system forms quite a good method of reducing the bass, if it should be over-predominant.

Strange as it may seem, there are cases to-day where this is desirable. The cry for more and more bass has in some cases produced an undue proportion of the lower frequencies.

Fig. 5 gives an arrangement similar to that of Fig. 3, except that a series system is used. We have here a choke in series with a condenser, and across the whole is a potentiometer. When the slider is moved towards the bottom, the effect of the condenser is cut out, so that the bass is accentuated.

Treble Accentuated

With the slider moved towards the top of the potentiometer exactly the reverse is obtained, and the treble is accentuated.

This device, however, suffers from the disadvantage that the signal strength is rather seriously reduced

when operating the device for reducing the top notes. It is not such a satisfactory system as some of those previously described.

A method of cutting off the upper frequencies to a progressive extent is that shown in Fig. 6. This is applied to the secondary of a low-frequency transformer in the set itself. It operates in much the same way as Fig. 1, except that the control is now across the transformer and not across the loud-speaker and, therefore, the values have to be somewhat different. A 01-microfarad condenser and a resistance having a maximum value of .25 megohm is satisfactory in this position.

Series and Parallel

To revert to the method of control on the loud-speaker, it will be clear from the circuits already given that a condenser shunted across the loud-speaker cuts off the top notes, while a condenser in series with the loud-speaker cuts off the bass.

This being the case, one naturally asks whether it is not possible to link up these two effects on one system, so that a combined and progressive tone control is obtainable.

Fig. 7 shows a system whereby this may be done. There is one condenser across the loud-speaker in series with 50,000-ohm resistance, and there is another condenser in series with the loud-speaker across which is shunted a 500,000-ohm resistance. The two resistances are ganged together, and a single rotation of the knob enables one to make the tone either "woofly" or shrill, exactly as one requires.



A MULLARD ORGOLA ON THE SCREEN

Here you see a scene from the publicity talkie made for Reckitt's Mullard Orgola three-valver

The set is a

THE LEAKY GRID

Not To Be Taken Too Seriously!

I HAVE an important announcement to make concerning the B.B.C.'s New Cacophony Concerts which may be soon broadcast simultaneously from the Queen's Hall and the Albert Hall.

I understand that the method will be to obtain the services of the two conductors who are considered to be most jealous of each other, and give them a time limit, one at each of the above halls. The result will be broadcast just as it comes out of the pot.

Marvellous Conception

I have been allowed to examine the score of the latest novelty specially composed for the Cacophony Concerts. It is a marvellous conception, being a concerto for two pneumatic street drills and full orchestra, composed by Jaila Crowbartok.

There are three long movements. First there is a charming slow introduction, one of those cloying movements that so attract the modern soul. It is marked *adagio excavato* and breathes of Holborn Viaduct under repair at sunset. The *adagio* gives way to a fine, sturdy *allegro*, in which great prominence is given to the introduction, at bar 3,086, of a complete set of four-wheel brakes.

Speaking critically, I should like to see records made of the slow movement which follows. It would only take eighty-seven complete records. Marked *aspirino calmato*, it breathes nothing but peace to the jagged nerves of the street-drillers. In fact I consider it a tone-picture of the poor things' nervous systems.

Moved to Tears

The last movement moves me to tears. Marked *allegro bibuloso*, it is a wonderful fugue on the theme of "Let's All Sing the Barmaid's Song." Mr. Crowbartok is to be congratulated on this, his first attempt at real simplicity of thought.

We understand that he has denied the rumour that he has written the last movement specially for America as a colossal satire against their artistic ideals.

I have other advance information. Not only do I find out what the

B.B.C. is likely to do long before anyone at Savoy Hill has thought of it, but I know all the secrets of the gramophone companies.

I have just found out that most of the leading houses (they are all leading really, only some of them don't like to say so) are going to issue some delightful descriptive records such as those I have been reviewing lately.

Decaphone, for example, will issue a double-sided twelve-incher of Maurice Chevalier adjusting his sock

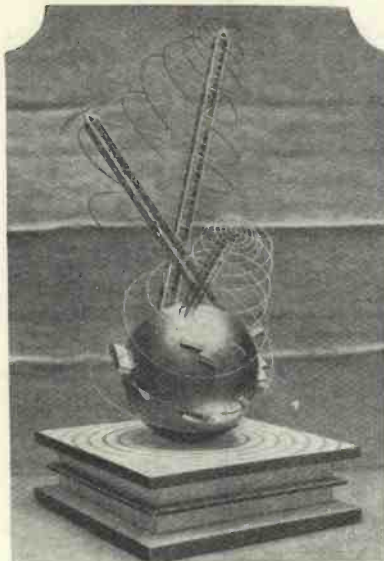

THE SPIRIT OF RADIO

This is a German model representing the world-wide power and appeal of broadcasting

suspenders prior to making his second debut at the Albert Hall, with full revue chorus.

Parlocast is releasing a clever representation of Dean Inge eating soup in a Soho restaurant while thinking out an article on *There's a Good Time Coming, Only It's EVER So Far Away*.

H.Mbia is producing a fine record of Margaret Bondfield washing up dishes before an audience of 3,000 domestic servants. Suitable music, such as *Honour and Arms*, will be heard in the distance.

Lastly, ColuMV is to issue a comic record of Bishop Barnes and Carnera singing *Fight the Good Fight*. All these will be reviewed as soon as they appear.

Owing to pressure on our space I am compelled to hold over my replies to many of my correspondents this month.

I have therefore made a selection, carefully omitting those which are of a highly technical nature in the hope that the correspondents will forget that they have written.

Henrietta, Southampton.—I am sorry you hate the Bach cantatas so much. I know how irritating Bach can be. I believe that if you handle your switch properly it is possible to get rid of the nuisance. Try it. If you are successful in shutting off the National programme you can have another half-hour's snooze until the Regional programme comes on.

In the Wrong

Ethel, Surbiton.—Ethel, dear, you and your fiancé must not quarrel about Mr. A. J. Alan's stories. I am sorry to give the verdict against you, but I do not think you were right in stating that he is systematically cut off before he has finished.

Cissie, Birmingham.—I feel for you deeply; it is rather upsetting to be named after a certain cow. I believe the cow only exists relatively, and you will recall with pleasure that either Mr. Clapham or Mr. Dwyer distinctly said that the difference between Cissie chewing cud and an American chewing gum was the look of intelligence on Cissie's face. So do not be discouraged.

O.H.M.S.!

Sandy, Aberdeen.—I quite agree with you that the B.B.C. is now a Government concern, but I do not think you are justified in sending your letters of complaint to Savoy Hill without a stamp, marking them O.H.M.S. Even OHMS, whether of the flexible spaghetti or the fixed macaroni type, have to be paid for, otherwise there would be government resistance.

George, Worcester.—No, George, we do not supply blueprints of the Beethoven symphonies.

"Shall we have glass records?" asks Mr. Barnett, who declares that though there may be tumblers amongst them, they will not easily break. W.-W.



A SPECIAL SECTION FOR THOSE INTERESTED IN ELECTRICAL REPRODUCTION

NOTES AND JOTTINGS OF THE MONTH

Induction Motors

ONE of the recent improvements in electric gramophones is the change over from universal to induction turntable motors. Where the electric-light supply is A.C., the new induction motor can be substituted for the old type, which was suitable for A.C. or D.C. supplies, but suffered from several defects.

One of the big advantages of the induction motor is that its speed is independent of the supply voltage, being governed by the frequency. Whereas the supply voltage fluctuates fairly considerably, the frequency is absolutely constant.

New H.M.V. Artistes

Two more famous pianists have now joined the company of recorders for H.M.V. One is Niedzielski, well known to concert goers, who brings his genius to our fireside with the Strauss *Thousand and One Nights*, giving full scope to the fascinating flow of his facile fingers.

Vladimir Horowitz, the young Pole who recently visited this country, makes his gramophone debut with Liszt's *Valse Oubliée* and the *Capriccio in F minor* by Dohnanyi. He proves that he is among the greatest executants of the day.

All the majestic power of a noble band of musicians is revealed by the London Symphony Orchestra

rendering Wagner's tremendous tone picture, *The Ride of the Valkyries*.

The well-loved airs of that old favourite, *Maritana*, are given to us by the Royal Opera Orchestra of Covent Garden, playing Wallace's tuneful overture. The same orchestra give a most cleverly compressed selection from *Faust*, and their performance makes one understand why this opera is regarded as everybody's classic.

A dainty number is found in Strauss's pot-pourri of waltz melodies, *Reminiscences of Vienna*, rendered by the Salon Orchestra. De Groot and his Orchestra have recorded *La Paloma* and *Destiny*.

From *Follow a Star*, hailed as the best musical comedy of recent years, the Light Opera Company cull the pick of the vocal gems, including *The First Week-end in June*, now all the rage.

Peter Dawson, firmly established as a composer, has two fine settings of Rudyard Kipling's poems, typical soldier songs, *Route Marchin'* and *Cells*.

Frank Crumit will make *Around the Corner* a universal ditty and in *Down on the Railroad Track* he gives full play to his insinuating voice, which is a comedy in itself.

There is quite a number of very attractive pieces from famous films. The all-conquering *Whoopee* pro-

vides the New Mayfair Orchestra with a fine selection, including such catchy numbers as *My Baby Just Cares for Me* and *A Girl Friend of a Boy Friend of Mine*. That amusing star of the show, Eddie Cantor, recently recorded exclusively for H.M.V. *Makin' Whoopee*.

Table Radiograms Wanted

Although I am impressed with the imposing array of console-type radio gramophones now available at reasonable prices, there does seem to be a lack of a type of instrument that would suit the needs of a considerable number of enthusiastic listeners and gramophiles.

I refer to the table-cabinet radio gramophone, of which I have come across but one solitary example. It is a matter for wonder that, while table-cabinet mechanical gramophones are as popular as console mechanical gramophones, makers do not seem to have considered the small cabinet idea for electrical combination instruments.

One of the drawbacks of the table cabinet for a mechanical gramophone is the instability of the machine when the motor is being wound up. But in an all-electric machine there is no winder. A quite compact radio gramophone could be designed on the lines of the familiar suitcase portable. A. S. H.

Making Records

Without An Amplifier

By **D. SISSON
RELPH**

ONE of the great advantages of having a home-recording outfit is that the whole family can get a considerable amount of enjoyment out of it; nearly everybody is interested in the possibilities of

demonstration of the new system. Undoubtedly the most interesting part of Mr. Kingston's invention

is the method of making records without any kind of amplifier; indeed, all one needs is an ordinary gramophone, which can even be of the cheapest portable type.

In this system of recording tracking is accomplished by running a guiding needle in grooves cut on a master disc, in the centre of which is fixed the aluminium blank for making one's own records.

The arrangement of the recording blank and the master tracking disc will be clear from the photographs reproduced in these pages. The blank is actually held on the master by means of three pins that project through specially-cut

cutting needle that indents a groove on the blank as it revolves. The soundbox is mounted on a carrier arm to which is also attached the tracking arm with a tracking needle, so that once the turntable has started revolving the process is automatic.

Easy to Use

Mr. Kingston made a number of records for me in his laboratory and I was also able to make some myself at home without any difficulty. In fact, with ordinary care anybody can make a record successfully as soon as the apparatus has been fixed in position; and it takes less than five minutes to get the device working.

Not only is the Kingston home-recorder particularly simple to use, but it is also very cheap. For £2 5s. can be obtained an outfit including a special recording soundbox and horn; a carrier arm and bush for fixing; a master tracking disc and three aluminium blank; two cutting needles (good for forty recordings each) and six tracking needles (each good for twenty records). Extra blanks cost 6s. a dozen.

It should be clearly understood that this outfit is suitable for making speech records only and is intended primarily for gramophone users who have no radio set. For



MAKING A VOCAL RECORD

It is necessary only to speak in a moderately loud voice into the horn attached to the recording soundbox. No amplifier is needed

making records of themselves and of their friends.

In this article I am able to give details of a new system by means of which records can be made at home without any kind of electrical amplifier.

Laboratory Demonstration

The new recorder is the invention of Mr. Arthur Kingston, a talkie and experimental engineer who has devoted many months to the development of a particularly simple outfit. I recently visited the inventor's laboratory and had the benefit of having a complete

the master by means of three pins that project through specially-cut slots. There is no need to lubricate the blanks with oil; they are already provided with a wax lubricant.

For acoustic recording one simply speaks into a short horn attached to a special soundbox which is provided with a hard-steel

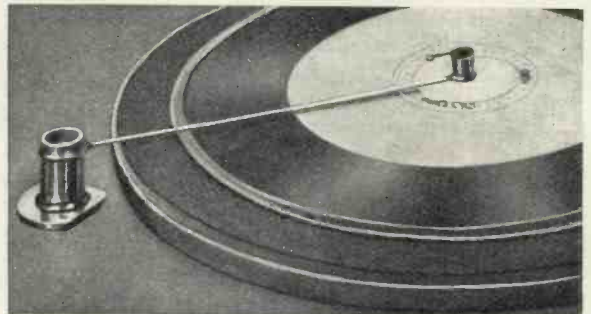

POSITIONING THE PIVOTING BUSH

Here you see the sensible jig provided for positioning the pivoting bush for the carrier arm

those with a radio set a more elaborate outfit is offered at £3 16s. 6d. This is identical with the outfit at £2 5s. except that a special cutter pick-up is also provided.

Making Speech Records

To make an ordinary speech record one clamps an aluminium blank on to the master disc and sets the tracking arm in relation to the recording soundbox so that when the tracking needle is near the outside edge of the master disc, the cut-

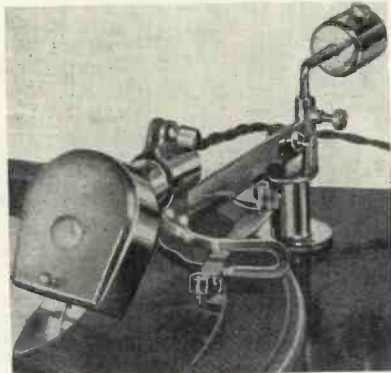

THE TRACKING DEVICE

The tracking arm and needle are seen at the right of the cutter pick-up

ting needle falls just on the aluminium blank.

The carrier arm is lifted until the turntable is revolving at its normal speed, when it is carefully dropped down into position. A record can then be made by speaking clearly and in a moderately loud voice into the horn, as illustrated in one of the photographs.

The setting-up of the apparatus is simple in the extreme. A wire jig is provided for the correct positioning of the bush into which the pivot of the carrier arm is inserted. The cutting needles are painted red and the tracking needles are painted green, so that it is almost impossible to make a mistake.

Needles for Reproduction

It is necessary to make quite clear the fact that only fibre or cactus needles can be used for playing back these aluminium records, but they can be reproduced either by means of a mechanical gramophone or an electrical reproducer.

By means of the cutter pick-up, which is specially damped to give the best recording, it is a simple matter to make records of any broadcast item picked up at moderate

volume on a radio set. Mr. Kingston made a number of records for me in his laboratory of broadcast items picked up on a McMichael portable working at ordinary strength.

It is possible to use the cutter pick-up for playing the records back through a grammo-radio outfit if the steel cutting needle is replaced by a fibre or cactus needle (by the way, Burmese Electrocolor needles are particularly suitable for reproduction from these aluminium discs).

It will be seen from the photographs that a counterbalance weight is fixed to the carrier arm. This is used to vary the weight on the cutting needle. In practice one uses the greatest weight possible without reducing the speed of the turntable.

For instance, for acoustic recording on a portable gramophone provided with a small spring motor it will be desirable to swing the counterbalance backwards to reduce



THE INVENTOR

Introducing Mr. Arthur Kingston, a well-known talkie engineer, who invented the new recording system



FOR RECORDING BROADCAST ITEMS

This illustration shows the cutter pick-up mounted on the carrier arm. The fixing slots on the aluminium blank can be clearly seen

the weight on the cutting needle and so avoid slowing up the turntable. Reproduction must be made at the recording speed, of course.

"Mike" and Amplifier

Vocal records can be made, of course, with the cutter pick-up, if a suitable microphone and amplifier are employed. But many people will not think it worth while going to this trouble, for the quality and strength obtained by the acoustic system are really amazingly good, especially in view of the low original cost of the outfit.

I have said enough to show that the Kingston home-recorder is full of interesting possibilities for the experimenter and will give a great deal of enjoyment in any home in which it is used. For making speech records there is no need for a special amplifier or electrically-driven turntable; the original cost is very reasonable and the apparatus is particularly simple to use.

In the United States, home-recording attachments are standard fittings on a number of receivers, so there is every reason to suppose that interest will grow quickly in this country. With the Kingston outfit experiments in this direction can be made at small expense. Everybody who has heard the vocal records I have made has been favourably impressed with the quality of the recording.

Demonstrations

In conclusion I will only say that demonstrations can be attended at "Radio and Gramophones," of 245 Tottenham Court Road, W.1. Readers who can get there will find it worth while to hear the reproduction from this system for themselves.

SECRETS OF GRAMO-RADIO SUCCESS

By H. T. BARNETT, M.I.E.E.

Needles and pick-ups form the subject of Capt. Barnett's notes this month. His comments will appeal to all who reproduce records electrically—and much of what he says will be of value to ordinary gramophone users.

This is the third and concluding instalment of the series entitled "Secrets of Gramo-Radio Success." New readers should look up the preceding articles, which were published in December and January.

THERE is a special kind of needle that fits directly into the soundbox without a grip and that may sometimes be used for dance records.

PERMANENT NEEDLES

It is the H.M.V. Tungstyle. It needs using with great care in order that the little piece of thin tungsten wire at its business end may not become bent. With a light pick-up or soundbox, well counterbalanced, it may be used all through a long dance.

Its reproduction is coarse in character and no matter how well it may be counterbalanced a single playing with it will spoil a record of pure tone.

GRIP NEEDLES

These are still the best reproducers possible for detail, quality of tone, and smallness of surface noise, but I have none except the Edison Bell pick-up that will permit their use when set, as they should be set, protruding only a very short distance from the grip.

Most pick-ups are so thick at the base that when using the correct needle angle of 50 degrees with a short-set grip needle the bottom back edge of the pick-up will touch the record and keep the needle away.

If we try to get over this difficulty by letting the needle stick out more the protruding end will then act as a little spring and give a whistling hiss that will annoy people with treble-sensitive ears.

Therefore, what I have to say

about grip needles must be taken as applying to soundboxes and to those few pick-ups with which they can be used—when short set.

THE SYMPATHETIC

This grip is the only one that will take any grip needle made. Its price is 1s. 6d. and it is an Edison Bell product. Needles for the grip are double ended and are sold in packets of twenty for one shilling.

These are the thickest grip needles made and fit the groove of the record well. Each needle if lightly weighted will play many records and it is always quite safe to go on playing until definition becomes audibly faulty.

I always take the little rubber washer off the grip and I also file a flat on the bottom portion of the conical nose (the flat to be parallel with the record surface), so that the

fear of damaging the record. It will be marketed shortly by the Murdoch Trading Co.

THE CHROMOGRAM

This needle is labelled "fine tone," and is sold at 9d. a hundred. It is the hardest needle previous to the Diamond and each needle lightly weighted may quite safely be used for half an hour. The point is long and fine. (Chromogram and Perophone, Ltd.)

OTHER NEEDLES

Quite a number of needles have been designed and put on the market in which (like the Tungstyle) there is a business end that wears away continuously, its shape soon after being put into use being that of a wedge. It is impossible to get good definition from a wedge; only a reasonably small point can follow closely those

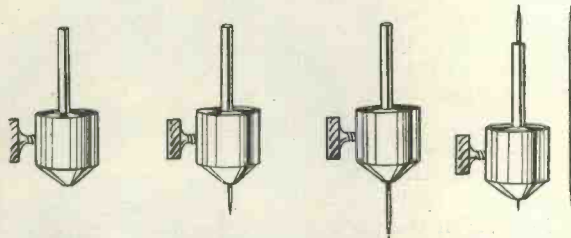

Grip without needle Position for soft volume Position for medium volume Position for full volume

HOW TO USE THE EDISON BELL SYMPATHETIC GRIP AND NEEDLES

needles may be used protruding from the grip only about one-sixteenth of an inch.

THE EUPHONIC

This grip will only take a very fine-gauge needle; the grip is 1s. 3d., and the needles 9d. for 50, single ended. The Murdoch Trading Co., Ltd., are the makers.

THE DIAMOND

This needle is a 6 per cent. tungsten steel product and is the nearest approach to a real diamond stylus yet made. I have an advance consignment and can easily use each needle for an hour without the least

tiny sinuosities on the record made by the very high harmonics that constitute tone characteristic.

It is claimed for some of these needles that because they are of soft metal they will not wear away the record. If there were any truth in such a claim we might play our records with the cut-off ends of pins!

It is *adhesion* that causes wear and such needles are less favourable to the record than hard steel used under *burnishing conditions* such as I have described in the two preceding issues of this magazine.

SOUNDBOXES

During the past year greatly improved reproduction from gramophones has been obtained by the use of soundboxes of larger diameter than has previously been customary. Each of these of importance has been or will be described in these columns.

PICK-UPS

These differ in their reproducing characteristics far more than soundboxes ever did. I have three fixed on the motor board of my own machine.

On the left I have the Edison Bell on its own tonearm; not very powerful, it is extraordinarily clean for vocal records and in it I use grip needles.

In the middle position, having taken the place of the new B.T.H. pick-up formerly there, I have a Limit pick-up on a Limit pick-up arm.

It is an all-round good reproducer. The treble cut-off is such as to suppress surface noise without interfering with the highest harmonics of tone characteristic; the bass (not reinforced) is particularly good owing to the small amount of damping that may be used and which can be varied by means of a set screw.

On the right I have a Parlophone pick-up on its own pick-up arm. This pick-up appears to be similar to that used on some well-known machines. It is very suppressive of surface noise and has what I should call a "romantic" tone.

With piano records, even hard-toned ones, the reproduction is *sweet* in character and jazz records are not unpleasant even in a small room. The tone volume all over its scale is a little less than that of the B.T.H.

NEEDLE WEIGHTING

This can be the smallest with the Edison-Bell combination. The Limit arm gives a little more weight, and the Parlophone arm (not adjustable as to weighting) gives the most, but even in the last case the weight is not enough to damage one's records.

LOUD-SPEAKERS

I suppose we are all going over to moving coils. I have the two most recent examples of high quality in use to-day.

One is the Dulcetto moving-coil (complete with exciting and input transformers), specially good in the bass and having an extremely high efficiency of conversion.

The case I am using for it is the same as is used with the loud-

The other loud-speaker, a little less powerful but quite as efficient, is the Edison Bell permanent-magnet moving-coil model, having a large Darwin magnet $5\frac{1}{2}$ inches in diameter.

The direct-current resistance of

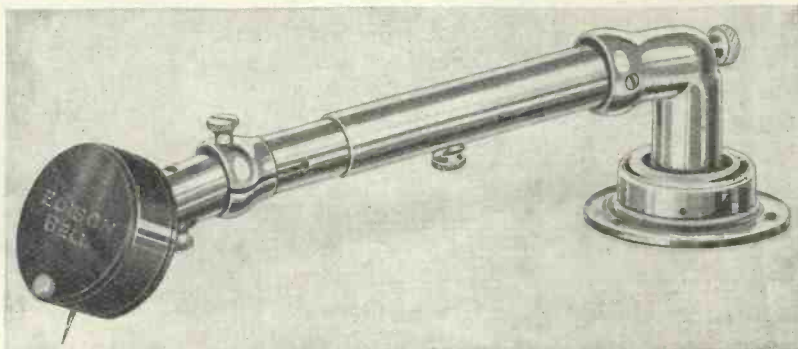

GOOD FOR VOCAL RECORDS AND TAKES GRIP NEEDLES

The Edison Bell pick-up on its own tonearm is not very powerful, says the author, but is excellent for vocal reproduction

speakers supplied after competition to our local (Portsmouth) corporation by the Dulcetto Company. This cabinet is a weighty thing, made of solid oak an inch thick, and gives the purest results I have ever heard from any baffle.

the moving-coil is 1,000 ohms, consequently it may be used with a pentode (last stage) valve without a step-down transformer.

Good in the deep bass, yet it is so delicate that on radio one can hear every announcer breathe.

A VERY NOVEL MOTOR

OF course, a gramophone manufacturer *must*, when choosing a standard electro-motor for his machines, take an "all-current" motor of the commutator kind, one that can be used either with A.C. or D.C. of any ordinary supply voltage; the best of this group in every way, in my opinion, being the new Garrard.

But for those who have alternating-current supply and who are not likely to be removing to a district where the supply is of the direct kind, or of a different alternating voltage, a far better proposition is the new motor manufactured by Paillard of Paris, and sold in this country by the Apollo Co.

The factors in its favour (no commutator, no belt, no series resistance, no gearing in the drive) are due to the new principle in its design.

Integral with the record table spindle there is a gunmetal open-topped drum, upon which a vigorous torque is produced by two sets of magnets, an external pair and

an internal pair supported by the upper member of the frame.

These magnets are so set that the currents produced in the gunmetal drum react against the magnetism so as to cause the drum to turn continuously in the desired direction.

Small as is the consumption of current, there is ample energy to waste on the centrifugal governor brake (hidden by the casing), so much so, in fact, that there is no audible difference in pitch between the inside and the outside turns of a 12-in. record.

No Pitch Variation

This is only the second motor I know of with which one may play through a symphony and not be offended by pitch variations.

I have now had one of these motors running a couple of months and cannot find the faintest complaint to make against it. It is a no-trouble, economical, absolutely noiseless interferenceless drive and I cordially recommend it to all who have a certain set voltage A.C. supply.

H. T. B.

CHOOSING YOUR RECORDS

Here are reviews of the latest releases by WHITAKER-WILSON, the "W.M." Music Critic. Read them carefully before buying your next batch of records. Outstanding records are indicated by an asterisk (*) against the title.



Classical Orchestral Music

Cavalleria Rusticana, Hastings Municipal Orch. (d.s.), 3s. 6d.
DEC K539

This is chiefly orchestral, but an aria is sung by Olive Groves (in Italian) with a certain amount of effect on the first side. The second side is entirely orchestral and the record was made at the White Rock Pavilion, Hastings.

★ **Leonora Overture No. 3**, (Beethoven), Symphony Orch. (d.s.), 3s. 6d.
DEC K541

This is very well done on two discs. I think 7s. for a good rendering of a Beethoven overture, especially one so popular as *Leonora No. 3*, is not expensive.

★ **Noel Fantasy** from "A Carol Symphony," Royal Opera Orch., Covent Garden (d.s.), 4s. 6d.
H.M.V. C1968

This is by Victor Hely-Hutchinson, of the B.B.C. Many of you will have heard it already. It is most effective and I warmly recommend it as being one of the best orchestral records to which I have listened. Pleasant scoring and thoughtful harmonies. Congratulations to him and H.M.V.

Oberon, Hastings Municipal Orch. (d.s.), 3s. 6d.
DEC K547

This is the last opera of Weber, written especially for England. It receives a good rendering here; the recording is not perfect, but is not too bad. Lovers of melodious orchestral music should ask to hear this; it will reproduce well electrically.

★ **Symphony No. 8 in B Minor**, *The Unfinished*, Philadelphia Symphony Orch. (d.s.), 6s. 6d.
H.M.V. D1779

The Symphony is in three complete records. Very good indeed; Stokowsky is the conductor. I do not agree with much of his interpretation, but that does not matter; what *does* matter is that the recording is admirable. All who love the immortal Schubert get this. He forgot to finish it for you, but be thankful you have these two wonderful movements!

Grand Opera and Classical Arias

Love Duet, Olga Olgina, sop., and Frank Titterton, ten., with orch. (d.s.), 3s. 6d.
DEC K549

This is quite well done. I miss the stage setting, of course, but to those of you who love *Madame Butterfly* I sincerely recommend this duet. Try it with a pick-up.

Light Opera & Songs

After the Ball, Maestros, with piano, 3s.
COL DB307

A good old chestnut, if you like! Very effectively rendered, if you want it. The same people do *Two Little Girls in Blue* on the other side.

Drake's Drum, Dale Smith, bar., with orch., 2s.
PIC 5104

This and *The Old Superb* are two fine manly songs by the late Sir Charles Stanford. The rendering is not above reproach; I feel Dale Smith's voice is not quite the right type. Anyhow, the speed is on the slow side in *Drake's Drum*. The other is the better.

Drinking Songs, Jack Hylton and his Orch. (d.s.), 4s. 6d.
H.M.V. C2074

Contains everything connected with the art; *Here's a Health*, *Little Brown Jug*, and others of that ilk. The refrains are sung. I don't know why this has been done or why Hylton has troubled to do it so well. Oh, dear!

Geisha, Anne Welsh, sop., and Victor Conway, bar., with orch. (d.s.), 3s. 6d.
DEC K548

This is very welcome; it is always worth hearing. I remember hearing the first production as a child and I have yet to hear a musical comedy with better music. You can safely buy this record.

Go Down, Moses, Emory University Glee Club, 2s.
PIC 5108

They are good, as usual. Hear them sing *Deep River*; very pleasing.

Good Company, J. H. Squire Celeste Octet (d.s.), 4s. 6d.
COL DX84

Here you are—all well-tried tunes! *The Girl You Left Behind You*, and *Simon the Cellarer*, and *Here's to the Maiden*, and *Old King Cole*, and a lot of others! I can't say much because it all bored me—but it was excellently done, and the record has a good surface. That's all!

If Your Kisses Can't Hold the Man You Love, Betty Bolton, with orch., 2s.
DEC F2010

And *That's Where the South Begins*. Both good rhythmically, but I have not fallen in love with Betty's voice. However, she sings cheerily enough!

★ **King Charles**, Norman Allin, bass, with piano, 3s.
COL DB300

He sings it splendidly; also



Norman Allin, bass.

Tommy Lad on the other side. A fine record!

La Paloma, Joan Revel, sop., mandoline, with piano, 2s.
DEC F1881

I am not sure I revel in all Joan does, but she would sound better if she did not force some of her notes. She sings well enough; it is just hard luck—her voice does not suit a microphone. *O Sole Mio* on the other side.

Le Reve Passe, Bernard Dudley, bar., with orch., 2s.
PIC 5105

A military effusion, which is rather appealing. His voice is good and he sings the song well. Ask to hear it.

Love Everlasting, Richard Crooks, ten., with orch., 6s.
H.M.V. DA1142

By Friml. On the other side is a serenade from Romberg's

Student Prince. I am in love with neither. H.M.V., you must not allow your tenors to yell! This record should be recalled and done again. It is too noisy to be pleasant. Sorry, but I cannot like it.

Maori Song, Rotorua Maori Choir (d.s.), 3s.
COL DB309

This has rather interested me: there is a quaint modal touch about the melodies which seem harmonised in a simple and rather conventional manner. Distinctly interesting!

Maurice Chevalier Selection, Jack Leon's Band (d.s.), 1s. 6d.
PIC 668

Not Maurice singing, though. At least, it does not say so and as I have not heard the gentleman I cannot say definitely. But the songs are his and include *Nobody's Using it Now*, *My Love Parade*, *Louise*, *Sweeping the Clouds Away*, *You Brought a New Kind of Love to Me*, and *Livin' in the Sunlight*. The production is good.

On the Sunny Side of the Street, Carl Brisson, with orch., 2s.
DEC F2006

And *Little White Lies*. He sings them well and has a voice a cut above the general run of dance-band voices.

Return of Abdul Abulbul Amir, Frank Crumit, ten., with orch., 3s.
H.M.V. B3569

He is no tenor and he sings with an accent, but his song is acceptable enough. *I'm Bettin' the Roll on Roamer* is the title of a jolly song on the other side. Despite his linguistic faults, the record is a good one.

She Wandered Down the Mountain Side, Megan Thomas, sop., with orch., 2s. 6d.
ZONO 5718

Megan wanders down very melodiously, but she might wander nearer the microphone next time! Her's is a sweet voice, though! She makes a good job of the *Pipes of Pass* on the other side, but she hardly comes through in places.

Songs My Mother Sang, Doris Vane, sop., with piano, 4s. 6d.
COL DX157

Hush-a-bye, Baby is the keynote of this medley. It may be useful for the children. She sings the *Kerry Dance* on the other side in an appealing manner. There is an atmosphere about the whole production which rather appeals to me.

Sweet and Low, Zonophone Concert Quartet, with orch., 2s. 6d. **ZONO 5733**

Why "Wind of the western sea"? The Zonophone Quartet may wind their watches, but the thing that blows is the wind. Otherwise no complaints—except why do it at all? Or *Hail, Smiling Morn*, on the other side! Still, perhaps, there are people who have never heard either of these two charming relics.

Unet-em Bargl im Trueb, Swiss Yodel "Edelweiss," 2s. **DEC F2048**

I hope this is their only "vice." I am not impressed with their noises but, as far as I am any judge, their technique is excellent. *Use Ults* is the companion. I don't use it myself.

Wayside Rose, Jan Zalski, ten., with orch., 2s. **PIC 5102**

And *Oh, Maiden, My Maiden*. He is not ideal for microphonic work, and I doubt if I can honestly call the record a success. I do not dislike the music of either side.

What Good am I without You? Betty Bolton, 2s. **DEC F2044**

Miss Bolton is a little pessimistic, surely? The companion of this is *What's the Use of Living without Love?* I do not admire her voice. Sorry, but she spoils a good tune.

You'll Never Realise, Pat O'Dell, with orch., 1s. 6d. **IMP 2360**

I believe this is popular. *The Same as We Used to Do*, its companion, certainly is. This is a good version of both.

Chamber Music

Air on G String, Leon Zighera, violin, with piano, 4s. 6d. **DEC T134**

Quite acceptable. It is Wilhelm's arrangement, and Zighera's tone is good. The piano accompaniment is a trifle heavy for this type of movement. On the other side Zighera plays a *Gavotta Variata* of Paganini, arranged by Corelli. Of the old Italian type, this is likely to please. Violin students might do worse than get it.

★Moment Musical, No. 3, Schubert, Lener String Quartet, 3s. **COL DB290**
And one of his minuets. Most beautifully played. This is of a very high standard of excellence. Congratulations to Columbia.

Organ Music

Hymn Medley, organ, Berkeley Mason (d.s.), 4s. 6d. **COL DX160**



Doris Vane, soprano

Introduces *Fight the Good Fight* and most of the hackneyed hymns. The organ sounds reedy, as the Central Hall organ always does. I am inclined to ask why an organist like Mason wastes his time on such trivialities. I would rather hear him play something interesting. I wonder if there is any use for this kind of thing, well produced though it be.

Spoken Records

Aladdin, Parts 3 and 4, Chas. Penrose and his Company (d.s.), 1s. 6d. **IMP 2352**

Candidly, I don't understand half of this. What is it intended to be? Ask to hear it and if you find out, let me know!

An English Christmas, Waits (d.s.), 4s. 6d. **H.M.V. C2078**

As a rule I am on my guard as soon as I read the label of these descriptive records, and was so in this instance. I think this, however, is commendable;

James' Church, London, N.W., 1s. 6d. **IMP 2348**

Quite as good as the other two records. See above, or below, as the case may be!

★(a) Hail, Holy Child (b), Sweet was the Song, Westminster Abbey Choir, 4s. 6d. **H.M.V. C2080**

There are two more delightful carols on the back. I have every confidence that I may recommend this beautiful production for the season. It is such a change to get away from *Nowell*, etc. *Very acceptable!*

Lost Chord, Tom Jones and his Orch., 3s. 6d. **DEC K540**

What's the matter, Decca? Are you so stumped for material that you must persuade Tom Jones to play this on one side and *Abide with Me* on the other? Why? He does it very nicely, of course, but let him do something worth doing next time!

O Come, All Ye Faithful, St. James' Church, N.W., Carol, 1s. 6d. **IMP 2349**

I suppose this must be St. James', *West Hampstead*.

THE NEW PHONYCORD FLEXIBLE RECORDS.

I am giving a special note to these remarkable records, mainly on account of their novelty. The quality of tone is amazingly pure and the track is very fine. The only disappointment is that special needles (steel) have to be used.

I imagine that this is the beginning of a new and satisfactory state of things; these records are flexible, of negligible weight, and not easily damaged.

The records to hand, by the way, include a couple of tenor songs from Pagliacci, two saxophone solos, and two dance records.

A word to Phonycord! Your excellent colour-scheme in these records is attractive. May I suggest that the colours define the nature of the record—classical music, dance records, opera, etc.? It seems to me worth while as your productions are so outstanding in their excellence.

WHIFAKER-WILSON

the children will love it; it is suitable for the tiny tots. I am putting it amongst the spoken records, although there is a certain amount of music.

Sacred Music

Christmas Memories, New Empire Orch. (d.s.), 2s. **DEC F2017**

There is nothing to recommend this that I can see. It is made-up bells and hackneyed carols. Perhaps this fact will recommend it!

Epilogue, Wireless Singers (d.s.), 3s. **COL DB211**

Most of the wireless epilogues have been well conceived; this, I think, is one of the best. The system of psalm-pointing used at the B.B.C. is the very last word in perfection. The rubbish we sing in our churches when we use the usual psalter makes the system, as used here, stand out in its excellence. This record contains the usual features of the epilogue; the psalm is part of that set for the twentieth evening (civ); the hymn is *O Worship the King* (A. & M., 167).

First Nowell, St. James' Church, London, N.W., 1s. 6d. **IMP 2347**

No better or worse than the other carol record. It may appeal; anyhow, the price is not prohibitive.

Good King Wenceslas, St.

The rendering of this and *Christians Awake* is conventional and useful for any purpose it may serve. That is non-committal, is it not?

Piano Solo

Nippy, piano, Billy Mayerl (d.s.), 3s. **COL DB288**

This effusion contains *Your Sunny Disposition and Mine, Anything, It Must be You, The Toytown Party, Two of Everything*, and *White We're in Love*, all of which are pounded out in Mr. Mayerl's customary manner. It should be very popular, for he is popular. The music, by the way, is his.

Light Orchestral Music

Ballet Egyptienne, Athenaeum Symphony Orch. (d.s.), 2s. **PIC 5097**

The present record contains Nos. 1 and 3 of this exceedingly attractive light orchestral suite. Ask to hear it. There is some good bass on this record.

★Blue Danube (w.), B.B.C. Chorus and Orch. (ds.), 3s. **COL DB301**

Very effective indeed. I sincerely recommend it as one of the best light music records I

have ever heard. The choral effects are splendid.

Der Rosenkavalier, Pierre Fol and his Salon Orch. (d.s.) 2s. **DEC F2049**

This is a little ambitious for so small a band, but the effect is not at all bad. The recording, however, is sadly amiss in places.

Dixiana, Million-Airs, orch. (d.s.), 2s. **DEC F2054**

A double-sided on the same subject. The selection includes most of the popular airs I have heard from this production. A good record.

Follow a Star, Million-Airs, orch. (d.s.), 2s. **DEC F2030**

A very good selection from this popular production. It is a cheap two shillings worth.

Highland Scene, Brooklyn Military Band, 2s. **PIC 5098**

Not being Scotch, this misses me a bit, but it may appeal to those who are. Rather a good band!

Idylle Passionelle, Tom Jones and his Orch., 2s. **DEC F2012**

Good lunch-time music. So is *Mignonette* on the other side. This is quite an acceptable piece of playing. Ask to hear it.

L'Extase, Tom Jones and his Orch., 2s. **DEC F2060**

Quite pleasing. The last chord I heard him play belonged to the *Lost Chord*! This is a decided improvement. I hope he will keep up his excellent standard and not play any more antiquated ballads.

Liebesfreud, Comodore Gold Medal Orch., 2s. **DEC F2037**

This very taking work of Kreisler is here played very effectively. It makes acceptable light music.

Lightning Switch, Lond. Palladium Orch. (d.s.), 3s. **H.M.V. B3649**

This is, I think, the first time I have heard a record by this orchestra. It is very virile. The music is tosh. I strongly object to rot of this kind, with a snatch of the *Halleigah Chorus* followed by *Lullie Brown Jug*. What is the sense of it anyway? If the London Palladium Orchestra cannot find anything better—never mind, I have thrown the record across the room, and feel better for having done so!

Little Tommy Tucker, Million-Airs, orch., 2s. **DEC F2053**

A selection. The other side is a further selection from *Nippy*. I think this will appeal to many lovers of light music. It is distinctly good.

National Emblem March, Solex Military Band, 1s. 3d. **SOLEX 12**

A good military band record, with *The King's Guard March* on the other side. The recording is not quite up to the standard of the other five discs by this firm which I have just tried, but the playing is good.

Nautical Moments, Comodore Gold Medal Orch. (d.s.), 2s. **DEC F1985**

Nautical "tripe," in other words. Oh, Decca, what are you doing? *Don't!*

Squirrel Dance, Gandino and his Orch., 1s. 6d. **IMP 235**

CHOOSING YOUR RECORDS—Continued

I like this. It has a go about it. Ask to hear it. You will not be disappointed in *The Water Mill*, on the other side. A good band.

★Tancredi, B.B.C. Wireless Military Band (d.s.), 4s. 6d.
COL DX155

Rossini's fine overture sounds admirable on the B.B.C. Military Band. It makes very acceptable light orchestral music.

Humorous Records

Carbolic Love Song, George Buck, com., with orch., 2s.
DEC F2007

A nice, clean sort of song, with a spice of humour in it. Let's have a Sing-song, on the other side, is jolly enough, and the title covers the sentiment of the song. The Editor was with me when I had it on, but neither of us laughed. Like Queen Victoria, we "were not amused!"

Diek Whittington, Columbia Sketch Company, with orch. (d.s.), 4s. 6d.
COL DX163

This has distinct merits in that it is a very good skit at the old type of pantomime. I rather appreciated it.

Hunting Tigers Out in India, Jack Payne and His B.B.C. Dance Orch., 3s.
COL CB151

This is really excellent. So is *Day by Day*, on the other side. Jack Payne's records are improving; each one is better than the last. Keep up the standard, Jack! See to it that you do not let a "dud" go through. But for heaven's sake make your vocalists sing! If they can't, sack 'em!

John Henry's Christmas Eve, John Henry and Company (d.s.), 3s.
H.M.V. B3665

John, you do not *elevate* us, do you? A scene of this kind does no one any good, as far as I can see. You used to be amusing, but I am disappointed in you. Get back into your old form again, and let us have something funny. This is a mere triviality, and thoroughly negative at that.

Laughing Policeman's Party, Charles Penrose, Kaye Connor and Company, with piano and cornet, 3s.
COL DB305

Rather vulgar and not too funny. I cannot see the sense of these effusions. You must listen to it and judge it; I cannot pretend to make any suggestion worth your reading. It had better go into the "tripe" section, labelled *humorous*!

Macpherson's Wedding Breakfast, Scottish com., with orch., 4s. 6d.
COL DX138

I prefer the *Railway Guard* on the other side, though I cannot honestly recommend either side as being really funny. But don't take my word either way; ask to hear it. You may feel differently about it.

New Year's Party, Tom Kinniburgh and "Greens" (d.s.), 1s. 6d.
IMP 2350

Imperial, I hope you will not think I am being discourteous to you, but I *must* suggest you produce something really humorous. This sort of thing cannot go very far, surely?

Old Sam, Stanley Holloway (d.s.), 4s. 6d.
COL DX168

I have heard this before. It has its humorous moments, but is one of those records which needs to be heard through. I certainly suggest you hear it.

Old-time Comedians, Frank Wood, com., with orch. (d.s.), 3s.
COL DB281

This includes 'Arl a Pint of Ale (Gus Elen); I ain't a-go'in' to tell (Hurley); I do like to be beside the seaside (Sheridan); You 'ave to 'ave 'em (Randall); Brighton (Knowles); Dandy Coloured Coon (Stratton); *At My Time o' Life* (Campbell). And very good they sound—or would, except that Frank Wood's voice is so coarse. He spoils what is otherwise an excellent record.

Smoking Concert, with orch. (d.s.), 4s. 6d.
H.M.V. C2079

Another of these atrocities! No; H.M.V.! You once produced an exceedingly amusing record called *Our Village Concert*, which I enjoyed very much because it was really funny. This is merely silly. Do let us have something to laugh at! I have gaped my head off, listening to it!

Spot of Bother, Clapham and Dwyer (d.s.), 1s. 3d.
BRDCST 645

Very good indeed, as they always are. They quarrel as usual. Get it, of course!

Tommy's Christmas, Rooster's Concert Party (d.s.), 4s. 6d.
COL DX137

A very full 12-incher. It begins as soon as you can get the needle on, and goes right up to the label. And it's all about a Christmas party. "Tommy" is not a typical boy, but the typical private of the War. To whom, perhaps, it will appeal. Personally I cannot see why a perfectly good matrix should have been so disfigured. Come, Columbia; rate our intelligence a bit higher! Your best is unequalled; your worst is worse than awful! I shall put it in the humorous section and try to forget it.

White Blackbirds, Parts 1 to 4; two complete records. Zonophone Minstrels (d.s.), 2s. 6d.
ZONO 5733

This is not an ornithological study, but a nigger minstrel show. It is thoroughly good patter, and the whole thing, in two records, is worth hearing. There is a good "darker" atmosphere about it.

Christmas Wedding Breakfast, Albert Whelan, 1s. 6d.
IMP 2351

I suppose these things must sell or there would not be so many of them, but honestly, I cannot imagine why they sell. I simply leave it at that and decorate my humorous column still further!

Dance Music

Alice Blue Gown (w.), Troubadours Dance Orch., 3s.
H.M.V. B5914

A very good waltz—a little on the quick side, but none the worse for that. *Beautiful Lady* is the title of another attractive waltz on the other side.

Blue Pacific Moonlight (w.), Roy Deller and his Orch., 1s. 3d.
SOLEX 24

This is my first Solex record, and very good, too. The Homophone Company's recording is splendid. *One Night Alone with You* is the companion. A good dance record.

Californian Serenade (f.), Arcadians Dance Orch., 2s. 6d.
ZONO 5731

A good dance record; the fox-trot is on the quick side. The fox-trot *Adeline* is on the other side. Both are admirably produced.

Dancing Taylor, Rudolph Star, 2s.
DEC F1990

A very jolly fox-trot rhythm. Rudolph does it on his xylophone and vibraphone. He, like all the rest, dances with tears in his eyes! The effort might have been called *Vibraphone Lachrimosa*!

Girl Friend of a Boy Friend of Mine (f.), Jock McDermott and his New Carlton Players, 1s. 6d.
PIC 670

Quite a good tune; the words are fair—what I could hear of them, that is. Jock and his people swing in a hammock on the other side. Not at all a bad edition of it.

Here Comes the Sun (f.), Million-Airs, orch., 2s.
DEC F2058

Very good. *Eldorado* is the companion; this is a very good version of it.

I'd Like to Find the Guy Who Wrote the Stein Song (f.), Million-Airs, orch., 2s.
DEC F2014

So should I! But the retribution the singer has in store would be nothing compared with mine. This is a jolly fox-trot. Perhaps the patter at the beginning rules it out as a dance record, but it is worth having. *Anchor's A-weigh* is the title of another good fox-trot on the other side.

Imperial Revels, Famous Imperial Artists (d.s.), 1s. 6d.
IMP 2359

A pot-pourri of the hits of 1930. It is very well done; I enjoyed listening to it. Ask for it!

Just Can't be Bothered with Me, Lou Abelardo, 2s.
DEC F1751

And another version of *With You*. Both up to standard.

King of Jazz, London Orch. (d.s.), 2s. 6d. ZONO 5714

Includes all the popular numbers from this popular show. It is one of the best versions I have heard of it.

King's Horses (f.), Jay Wilbur and his Band, 1s. 6d.
IMP 2355

This amuses me every time I hear it. A good version with

Adeline (fox-trot) on the other side.

Like a Breath of Springtime, Maurice Elwin, bar., with orch., 2s. 6d. ZONO 5719

Rather taking! A pity it is not properly sung; the voice is a dance-band voice but the diction is excellent. He dances with tears in his eyes on the other side. Admirable recording.

Livin' in the Sunlight, Lovin' in the Moonlight, Bob and Alf Pearson, 1s. 3d.
BRDCST 611

And *You Brought a New Kind of Love to Me*, which is very effectively done. The surface of these small discs is remarkable. I recommend this thoroughly.

Meet Me in My Dreams To-night, Jay Wilbur and his Band (w.), 1s. 6d.
IMP 2354

And *Lorette*. Good, as Jay Wilbur usually is.

Oh, Donna Clara (f.), Jock McDermott and his New Carlton Players, 1s. 6d.
PIC 677

This is a moderately fast fox-trot, with an effective counter-theme in the orchestra. It is one of the best tunes I have recently heard. The *Kiss Waltz* is the companion.

On the Sunny Side of the Street (f.), Roy Dellar and his Orch., 1s. 3d. SOLEX 13

And *Sittin' on a Rainbow*. Well done and suitable for dancing.

Polka, Debroy Sumers' Bänd, 3s.
COL CB169

Another Victorian memory (*See Me Dance the Polka*, etc.), with a barn dance on the other side. Soon everything our fathers knew will be with us.

Putting on the Ritz (f.), Rhythm Maniacs Orch., 2s.
DEC F1725

And *With You*. Both are good. The Rhythm Maniacs never fail you. Get this!

Say a Little Prayer for Me, Alex Mason, bar., 1s. 3d.
SOLEX 29

And *Falling in Love Again*, both very well done. He sings distinctly and clearly, an improvement on the average adenoidal tone that characterises these dance voices.

So Beats My Heart for You (f.), Buckingham String Players, 3s.
COL CB148

This seems unusually "high-class" for a dance record; the B.S.P.'s are by no means amiss. On the other side, the Cavaliers sing and play *The Kiss Waltz*. A very good dance record.

There's a Stranger in Heaven To-night, Honolulu Quartet, 2s.
DEC F1991

I find myself wondering how the sweet-toned quartet found that out, but I like their playing. Their instruments are very pleasant. The other celestial effort is called *Golden Gates of Paradise*, and is equally pleasing.

With My Guitar and You (f.), Waikiki Serenaders, 1s. 3d.
BRDCST 643

Another now-famous *Kiss Waltz*. I recommend this as a very acceptable dance record.

The Supertone Four

Specially
Designed for
Quality
♦ ♦
Novel Push-pull
Circuit
Incorporated
♦ ♦
Two Volume
Controls for
Radio
♦ ♦
An Ideal
Gramo-Radio
Combination

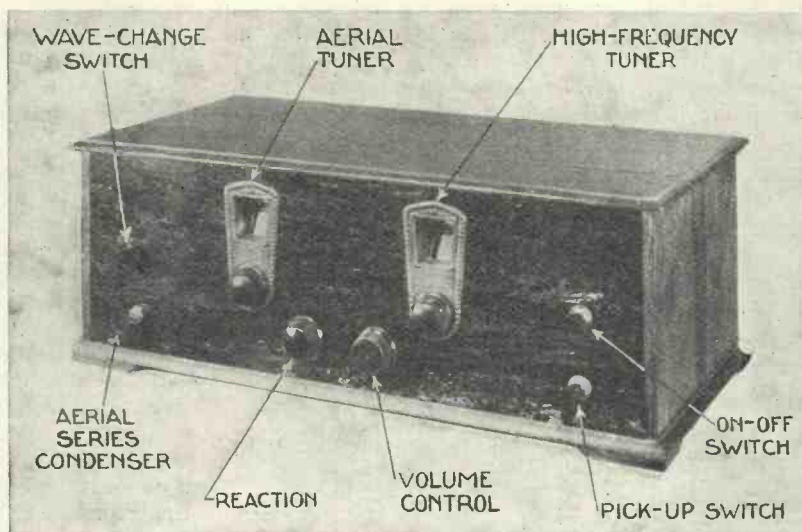

A Special
Dual Coil Unit
is Used
♦ ♦
Can be
Operated from
Batteries
♦ ♦
Pick-up
Always Ready
for Use
♦ ♦
Covers Both
Wavebands with
Single Switch

THE CONTROLS ARE EASY TO MASTER

This photograph shows clearly how the controls are arranged on the front panel

A Gramo-Radio Set with Push-pull Output

HERE we present details of a dual-purpose set, equally efficient for the reception of broadcast programmes or for the electrical reproduction of gramophone records. The circuit is so arranged that a pick-up can be permanently connected to the receiver; it is put in and out of circuit as desired by means of a pick-up switch mounted on the front panel.

Anode Battery

The set has been specially designed to give the very best quality of reproduction with battery valves, at the same time keeping the anode-current consumption within the economical running limitations of a super-capacity high-tension battery.

Push-pull Output Stage

The arrangement of the set is unusual in the fact that a push-pull output stage is connected directly to the detector valve without any intermediate stage of low-frequency amplification. In practice the combination is found to be most satisfactory both for radio and gramophone reproduction.

As the Supertone Four is intended for good quality of reproduction

rather than great range, it will appeal particularly to those who are satisfied with the reception of a small number of programmes really worth listening to, combined with first-rate gramophone reproduction.

From the photograph of the set that appears in the heading to this article it might be assumed by the uninitiated that the operation is difficult, because of the seemingly large number of controls on the panel.

This is not so in practice, however, because it is seldom necessary to operate more than three of the controls at any one time.

Panel Controls

It will be seen that the layout of the panel has been made symmetrical. At the extreme left and right there are two knobs arranged vertically one above the other. In the centre of the panel along the bottom there is another pair of knobs. The two main tuning dials are arranged between the three pairs of subsidiary controls.

The fact that the set is not difficult to operate will be better appreciated if we refer briefly to the functions of these eight panel controls.

Selectivity and Volume

Of the two left-hand knobs, that at the top is the wave-change switch; this is pulled out for medium-wave reception and pushed in for the long-wave stations. The bottom knob is an aerial series condenser, which performs two functions; it is used either for controlling the selectivity of the receiver or as a pre-detector volume control.

It should be noted that any alteration of this control will necessitate

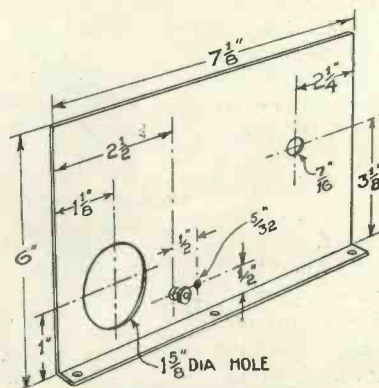

SCREEN DETAILS

The screen illustrated here forms a continuation of the screening provided in the coil unit

PUSH-PULL OUTPUT FOR GOOD QUALITY

transformer is a 100,000-ohm variable resistance to control the volume of reproduction, both for radio and gramophone use. Volume is decreased as the resistance is reduced.

The push-pull input transformer is, of course, provided with two grid terminals, for connection to each of the power valves. Normal practice is to use a centre-tapped secondary, but in this case a transformer having two separate windings is employed.

Separate Grid Bias

The advantage of this is that separate bias can be applied to the two valves if necessary, in order to keep the anode currents identical. Normally the same bias can be applied to both power valves; this is the arrangement shown in the circuit and in the wiring diagram.

Sometimes a high-frequency choke in a preceding stage is not sufficient to keep all high-frequency currents out of the push-pull circuit, so in order to provide an additional safeguard against this possibility, a 100,000-ohm fixed resistance is included in the grid circuit of each of the power valves.

The anodes of the two power valves are connected to the ends of the primary of the push-pull output transformer, the high-tension supply being applied through a centre tapping. The secondary of the output transformer is provided with tappings for the use of a high- or low-resistance loud-speaker.

It will be seen that three high-tension supply points are provided. The first feeds the screening grid of the high-frequency valve, while the second feeds the anode. The third point supplies the anodes of the detector valve and both the power valves.

Grid-bias Points

Two grid-bias tappings are also provided. The first is for biasing the detector valve negatively when the set is used for gramophone-record reproduction. The second point supplies bias to the two push-pull power valves in the ordinary way.

It will be seen from the photographs that the aerial coil and the

high-frequency transformer are both included in a single screened coil unit, which is fixed at the rear edge of the baseboard. There is a screening partition inside the box to shield the two sets of coils one from the other. The external screen on the baseboard forms a continuation of the screen between the coils in the unit.

There are several advantages to the constructor in the use of such a unit. A single switch adjusts the

condensers with ordinary dials mounted on the outside of the panel.

Many constructors will already have all the parts needed for the construction of this set, except for the special coil unit and a pair of push-pull transformers.

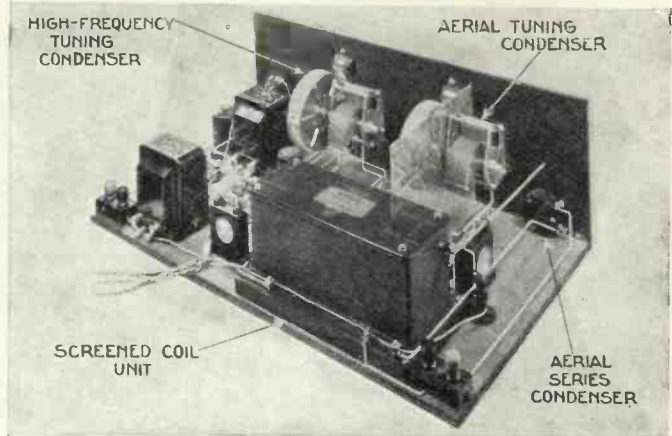

NOT AT ALL DIFFICULT TO BUILD

The illustration shows clearly that the set is not at all cramped and can be assembled without difficulty

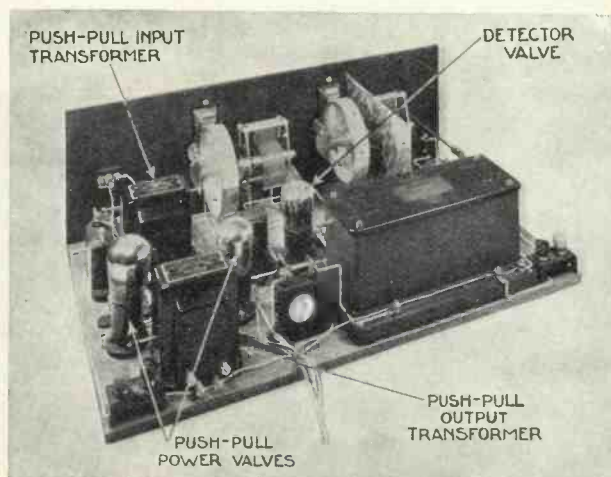

A COMPLETE COIL ASSEMBLY IS USED

On the right is seen the coil unit, which contains a dual-range aerial tuner and a screened-grid transformer

wavelength range of each pair of coils, and only one set of external connections has to be made. The layout of the components is also considerably more straightforward than if two entirely separate coils were employed.

The actual construction of the set is so straightforward that no detailed comments are necessary. In the original model we have used tuning condensers provided with drum dials but, if desired, the layout can be easily adapted for the use of con-

Blueprint

All the essential details for construction are included in these pages, but many readers will prefer to work from a full-size blueprint. One of these can be obtained for half price (that is 9d., post free), if the coupon on page 112 is used by February 28. Ask for No. WM227 and address your inquiry to Blueprint Department, WIRELESS MAGAZINE, 58-61 Fetter Lane, London, E.C.4.

The next point that needs consideration is the choice of suitable valves. It will be convenient to consider the last two valves first.

If the set is to be operated from batteries (as is intended), it will be necessary to choose power valves taking a relatively small anode current, but at the same time the impedance should be as low as possible.

Identical Valves Needed

When identical valves are used in a push-pull circuit (and it is essential that they should be identical in every respect), the total impedance is

THE SUPERTONE FOUR—Continued

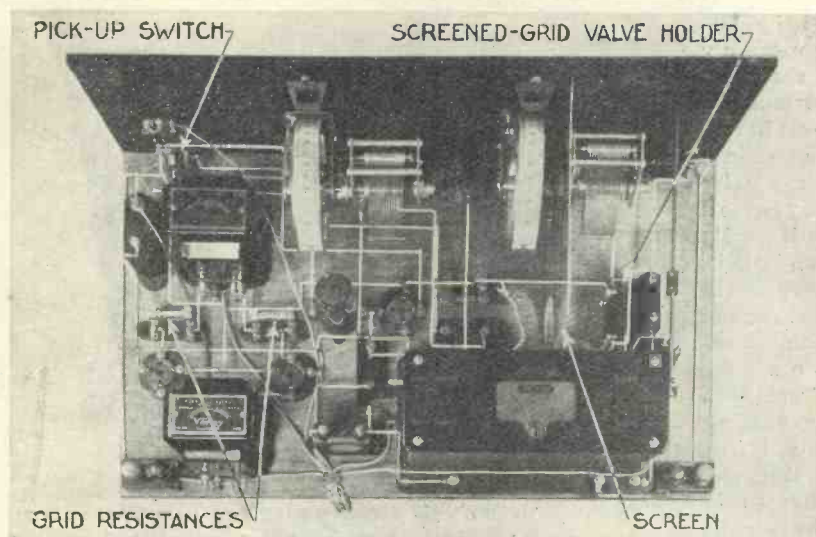

USE THIS PHOTO IN CONJUNCTION WITH THE BLUEPRINT

This plan view shows clearly the disposition of all the parts on the panel and baseboard

double that of either valve. For instance, if each push-pull valve had an impedance of 3,000 ohms the total output impedance would be 6,000 ohms.

Economical Running

For battery operation, it will not be economical to use valves taking more than 8 milliamperes anode current, for even then the total consumption will be in the neighbourhood of 20 milliamperes and triple-capacity batteries will be needed for economical running.

A glance at the valve tables on page 4 of this issue will show that there are no 2-volt valves taking an anode current of the order indicated and having an impedance lower than 4,000 ohms.

We shall be better off with 6-volt valves, for the Mullard PM6 takes 7 milliamperes at 120 volts and has an impedance of 3,550 ohms. This valve has a magnification factor of 8, and needs a bias of about $7\frac{1}{2}$ volts.

Loading the Power Valves

A bias of $7\frac{1}{2}$ volts means that each valve can take a grid swing of 15 volts, but as the two power valves in this case are arranged in push-pull, the total permissible grid swing is 30 volts. We must now work backwards and determine what detector valve used in conjunction with an average pick-up will load the push-pull valves up to give the maximum output.

The push-pull input transformer

has a step-up ratio of 1 to 2.5 for each phase, which means that the total step-up is 1 to 5. Therefore a change of 6 volts across the primary will produce a change of 30 volts across the secondary, which is what we need.

We must now consider the pick-up, which may give anything from .25 volt to 1.5 volts. Let us be prepared

for the worst and assume that our pick-up will give us only .25 volt.

A simple calculation then shows that a valve with a magnification factor of 24 will be needed to give a 6-volt anode swing when a .25-volt swing is applied to the grid. A glance at the valve tables already referred to shows that the Mullard PM5D has a magnification factor of 26 and an impedance of 20,000 ohms, which is a value suitable for use in conjunction with the particular push-pull transformer employed.

Screened-grid Valve

Lastly, we have to consider the screened-grid valve. Here we have no difficulty, for all the 6-volt screened-grid types at present produced have practically the same impedance. A Mullard PM16, which has an impedance of 200,000 ohms, will be quite satisfactory for this set.

We must emphasise again the fact that only a super-capacity battery will be suitable for the economical operation of this receiver. It should also be realised that, unless a model with a large output is employed, the use of a mains unit will not make it possible to use power valves taking a greater anode current than those

COMPONENTS NEEDED FOR THE SUPERTONE FOUR

CHOKE, HIGH-FREQUENCY

1—British General, 5s. 6d. (or Lewcos, Wearite).

COILS

1—Lewcos dual-coil unit, type DCG/2, with SM15 rod, £2 5s.

CONDENSERS, FIXED

1—Lissen .0001-microfarad, 1s. (or Dubilier, Watmel).

1—Lissen .0002-microfarad, 1s. (or Dubilier, Watmel).

2—Lissen 1-microfarad, 5s. (or Franklin, T.C.C.).

1—Lissen 2-microfarad, 3s. 6d. (or Franklin, T.C.C.).

CONDENSERS, VARIABLE

2—Polar .0005-microfarad, Universal type, 15s. (or Jackson, Igranic).

1—Formo .0002-microfarad, midget type, 2s. 9d. (or Bulgin, Burton).

1—Lewcodenser .0002-microfarad max., panel-mounting type, 2s. 8d. (or Sovereign, Ormond).

DIALS, SLOW-MOTION

2—Polar drum drive, 17s. (or Jackson).

EBONITE

1—Becol 21-in. by 7-in. panel, 8s. 11d. (or Red Triangle, Lissen).

HOLDERS, GRID-LEAK

3—Lissen, type LN100, 1s. 6d. (or Bulgin, Magnum).

HOLDERS, VALVE

3—Telsen, 3s. (or Wearite, Burton).

1—Junit, S.G. type, 1s. 9d. (or Parex).

PLUGS AND SPADES

7—Belling-Lee wander plugs, marked; G.B.+1, G.B.—1, G.B.—2, H.T.+3, H.T.+2

H.T.+1, H.T.—, 1s. 9d. (or Ealex, Clix).

2—Belling-Lee spades, marked; L.T.+1, L.T.—, 9d. (or Ealex, Clix).

RESISTANCES, FIXED

2—Bulgin 600-ohm, type R55, 3s. (or Magnum, Ready Radio).

1—Bulgin 20,000-ohm, flexible type, 1s. 3d. (or Magnum).

2—Lissen 100,000-ohm grid leaks, 2s. (or Dubilier, Rotor).

1—Lissen 2-megohm grid leak, 1s. (or Dubilier, Rotor).

RESISTANCE, VARIABLE

1—Sovereign 100,000-ohm, 4s. 6d. (or Rotor, Clarostat).

SCREEN

1—Parex, $7\frac{1}{2}$ in. by 6 in., 2s. (or Peto-Scott, H. & B.).

SUNDRIES

Glazite insulated wire for connecting.

Length of rubber-covered flex (Lewcos).

Shielded cable for S.G. anode connection.

SWITCHES

1—Bulgin on-off, 1s. 6d. (or Pioneer, W.B.).

1—Bulgin single-pole change-over, 2s. (or Pioneer).

TERMINALS

4—Clix, 2 red and 2 black, 8d. (or Belling-Lee, Ealex).

2—Belling-Lee terminal blocks, 1s. 4d. (or Junit).

TRANSFORMERS, LOW-FREQUENCY

1 pair Varley push-pull, types DP6 and DP7, £2 2s. (or Ferranti).

ACCESSORIES

BATTERIES

2—Ever Ready 60-volt, high-power type, £1 11s. (or Lissen, Pertrix).

1—Ever Ready 16-volt grid-bias battery, standard type, 3s. 6d. (or Lissen, Pertrix).

1—Exide Gel-cel 2-volt accumulator, type J24, 18s. 6d. (or C.A.V., Lissen).

CABINET

1—Kabilock, American type, £2 2s. (or Pickett).

VALVES

1—Mullard PM16, £1.

1—Mullard PM5D, 8s. 6d.

2—Mullard PM6, £1 1s.

The prices mentioned are those for the parts used in the original set; the prices of alternatives as indicated in the brackets may be either higher or lower

AN IDEAL GRAMO-RADIO COMBINATION

recommended. (Most 120-volt mains units, it should be remembered, will not supply a current greater than 20 milliamperes.)

Operating the Set

The operation of the set will be found quite simple. Let us consider ordinary radio reception.

It is first necessary to pull out both the switch knobs at the right of the panel—the top one to switch the set on and the bottom one to put the pick-up out of circuit.

Next, the volume-control knob in the centre of the panel should be turned as far as possible to the right for the greatest signal strength. (Volume is decreased by turning this knob to the left.)

The wave-change switch should be adjusted for the desired waveband (the knob of this is clearly marked, by the way) and the aerial series condenser should be set at its maximum capacity by screwing the knob to the right.

Set both the main tuning dials at zero and advance the reaction control slightly until the set is on the verge of oscillation. The best method of searching is then to advance the high-frequency tuning condenser (on the right of the panel) degree by degree, at the same time swinging the knob of the aerial-tuning condenser (to the left of the panel) backwards and forwards over an arc of about 20 degrees—that is, about 10 degrees either side of the reading of the high-frequency tuning condenser.

Advancing Reaction

As the tuning controls are advanced, it will be found necessary to turn the knob of the reaction

condenser slightly more to the right to keep the set on the verge of oscillation.

It will be best to start off by tuning in the London National and Regional stations, and noting how much they spread on the dials. The aerial series condenser should then be reduced in capacity (by turning the knob to the left) until the best compromise

To use the set for gramophone reproduction, it is only necessary to connect a pick-up to the appropriate terminals and push in the knob of the bottom switch on the right-hand side of the panel. As the screened-grid valve is not switched off the local station may be heard faintly if the set happens to be tuned to it; therefore detune the aerial condenser.

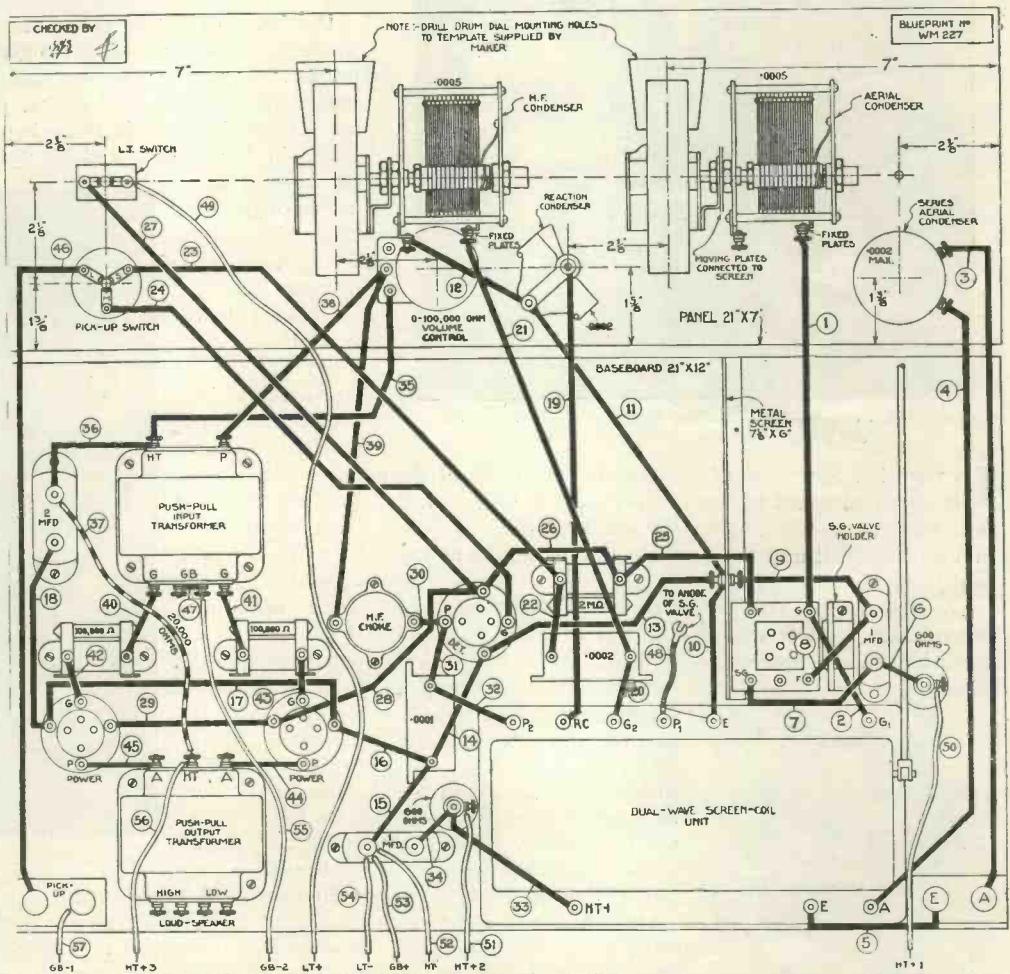

QUARTER-SCALE LAYOUT AND WIRING DIAGRAM OF THE SUPERTONE FOUR

This layout and wiring guide can be obtained as a full-size blueprint for half-price (that is, 9d., post free) if the coupon on page 112 is used by February 28. Ask for No. WM227

between selectivity and volume is obtained. Any alteration of this capacity will make a slight readjustment of the aerial-tuning condenser necessary.

A few minutes experimenting will give the operator the feel of the controls, but for convenience in future listening the dial readings for various stations should be logged as they are picked up.

Volume for gramophone reproduction is controlled in the same way as for radio reception by the right-hand knob in the centre of the panel.

That concludes the details of the Supertone Four. It now only remains for the reader to build it and get the maximum amount of enjoyment out of radio during 1931. Nobody who builds this set will be disappointed with the results.



Kenneth and George Western, both clever entertainers, are popular in vaudeville programmes

IN the New Symphony Orchestra we have one of the largest and finest bodies of musicians that have yet been brought together. They are just beginning to work in a unison spirit and future concerts should give us the best in music.

We are now at the height of the winter season of broadcasting and it will not be out of place to draw attention to one very important point in connection with the proper way to listen. In order to enjoy a



Astra Desmond, a noted contralto

serious-minded composition one must concentrate all the mental powers possible on the work and try to forget the existence of the medium by which the sound has been brought into the room.

One has no right to criticise an orchestral programme as being of an unpleasant character if it is being used as a back-



Herbert Menges, violinist and orchestra leader



Frederick Delius, the British composer

B.B.C. MUSIC

A Review of the Month's

ground to a general discussion on other topics.

Music, besides being an art, is a science of thought, and as such can be studied. In order to listen properly and obtain the full enjoyment of broadcast programmes the mind must be concentrated directly on such music or its true meaning will be lost.

Prospects of Better Programmes

Prospects of better programmes are much brighter. There is the new orchestra to give us the best classical music, rendered in a proper manner; opera subsidies to ensure regular relays of opera, performed at its best; and in the lighter vein there is one of the finest dance bands in Jack Payne and his B.B.C. Orchestra to give us the best dance music of the day, played in an intelligent manner. No one can honestly say that radio will be dull.

Progress in broadcasting technique during the past few years has been great, the field that has been opened up having almost unlimited boundaries. Landlines between ourselves and the principal cities of Europe have given us the opportunity of hearing some well-known Continental orchestras relayed by the B.B.C.



Cecil Baumer, a clever pianist, is often heard from London

By far the most important musical event broadcast recently was the Mass in D Major (Opus 123) by Beethoven, relayed from the Queen's Hall. This has been the crowning achievement in the first half of the winter season of the B.B.C. symphony concerts.

The orchestra and National Chorus were conducted by the German composer, Hermann Scherchen, and the soloists were May Busby, soprano; Muriel Brunskill, contralto; Parry Jones, tenor; and Horace Stephens, bass.

Intended for an Archbishop

This work, which occupied Beethoven in the years 1819 to 1823, was written with the intention of being sung at the enthronement of his pupil and patron, the Archduke Rudolph, as Archbishop of Olmutz, but was not finished in time.

Many must have noticed the numerous passages in

VIA ETHER

Broadcast Programmes

which the soprano soloist and chorus were engaged in singing on almost the highest notes a human voice is capable of reaching. In spite of the great strain entailed, the National Chorus did exceedingly well.

Arthur Catterall deserves praise for his solo violin work and his skill in leading the orchestra in this massive work.

Conducting Without a Baton

Hermann Scherchen is one of the very few who conduct an orchestra without using a baton. Many remarked on a jerky feeling noticeable in the Beethoven Symphony a week previous, but this was apparently due to the orchestra's not quite interpreting the full meaning



A popular broadcast contralto, Linda Seymour is noted for her excellent choice of songs. She has long been a favourite for her clear diction and has often brightened the Children's Hour.

of his actions. He is one, however, who knows exactly where and where not to emphasise various passages, and the result, on the whole, was pleasing.

A work which recently had its first performance at the Queen's Hall was Schonberg's symphonic poem, *Pelleas and Melisande*. Altogether, the result was rather disappointing. Schonberg, without a doubt, is a composer who has a good way of showing clearly his thoughts, but this work by no means

did him the justice he deserves. It seemed to be a jumble at times, in spite of Hermann Scherchen's masterly efforts in conducting the orchestra. It will be interesting to hear this work played again after the orchestra have had further time for rehearsing.

Attractive Works for the Future

Several other attractive works worth noting are in store for music-lovers in the second half of this series. The programme for February 4 will include the ever-popular overture to *Oberon*, by Weber, *Brigg Fair*, by Delius, and a new work by Arthur Bliss, *Morning Heroes*, arranged for orator, chorus and orchestra. The National Chorus will take part in the last item.

Gustave Holst's well-known suite, *The Planets*, and the concerto No. 4 in G Major, for piano and orchestra, by Beethoven, will be the chief items in the concert on February 11. Dr. Adrian Boult will conduct these.



Lady cinema organists are rare—Norah Milne broadcasts frequently from the Scottish stations

Before leaving the subject of these concerts special mention must be made of three of the principals in the orchestra. Arthur Catterall and Lauri Kennedy, the Australian 'cellist, who is well known to listeners for his studio recitals, have played well.

The man of the day is, however, Eugene Crufts, the leader of the double basses. These instruments are by no means easy to play, and in him we have an example of a really first-class musician.

We have gained appreciably by the disbandment of the Birmingham Studio Orchestra, this having led us to hearing better concerts given by the City of Birmingham Orchestra, under Leslie Heward. The concerts, always well rendered, are appreciated by all.

One point for those who want to hear even more



Olive Kavann, a popular singer



Eugene Crufts, a double-bass player



John Coates, the celebrated tenor

B.B.C. MUSIC VIA ETHER—Continued

symphony concerts—on a Saturday morning, at about 9.15 a.m., Radio Paris transmits a concert relayed from an outside source. During the last month several Beethoven symphonies, Tchaikovsky's Pathétique Symphony, and several other well-

concerning the number of repetitions that would be necessary.

There is a deal of truth in these remarks, but such pieces that are essentially orchestral should be left out of their repertoire altogether. To a musician Schubert's Unfinished

Symphony played by such combinations is heartrending. Nevertheless, when the Wireless Military Band gets down to real business and plays music composed for bands, there are few that can do better.

Cinema organs are still the target for a great many who fail to realise the in-

attention for which they were built and do not appreciate the light-hearted music that is usually played on them. Edward O'Henry at Tussaud's Cinema and Reginald New from Birmingham, two of the best cinema organists in this country, are relayed quite a deal in the midday programmes from Brookman's Park and are certainly a pleasure to hear.

Last month we suggested that organ recitals be given a prominent position in the evening entertainment and pointed out that, although there were ample in the daytime, they were entirely neglected in the evening.

It is, therefore, interesting to note that on New Year's Day the first evening organ recital for a considerable time was relayed from

All Saint's, Margaret Street. The organist was Walter S. Vale, who played a well-chosen programme, including the Prelude in D minor by Chaminade, Canzone in A minor by Guilmant, and Franck's Choral in A minor.

A Good Start

This was certainly a good start for the New Year, and it is to be hoped that our friends in the programme department will carry on with the good work.

A surprise sprung lately was the announcement that Billy Mayerl, the syncopated pianist, was to play the first movement of Grieg's piano concerto with the B.B.C. Orchestra and to conduct the orchestra in the suite, Pastoral Sketches, of which he is the composer. It is unusual for syncopated pianists to have a leaning towards serious work.

Vaudeville Items

Vaudeville entertainments are still maintaining a reasonable variety, although there appears to be difficulty in securing fresh talent. Walford Hyden and his Orchestra support most of these and adequately do what is expected of them.

A recent innovation was the introduction of a weekly theatrical cartoon, in which the impressionist is Elizabeth Pollock. These cartoons are amusing and well worth hearing.

Marius B. Winter and his Orchestra have broadcast several times from the studio lately. This band is fortunate in being able to introduce some novelty and it is by no means as boring as some other of our radio dance bands. Dance music is most tiring if one is not dancing; if it is of the "plugged" variety — then switch off!

T. F. HENN.

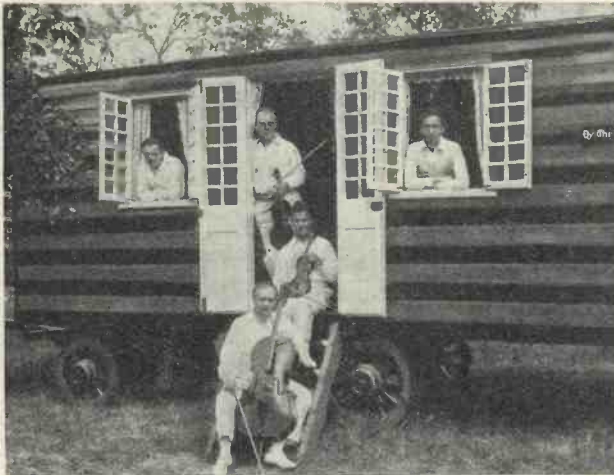

The Gershom Parkington Quintet, very popular with listeners of all tastes, seen in a happy mood!

known works have been heard.

Light music has become very prominent in the programmes of late. Everything embraced by this title is popular, and it follows that the best in light music is the best in radio.

Popular Hotel Relays

Relays from hotels on Sunday evenings have probably the largest audience of all. Tom Jones and his Orchestra, relayed from the Grand Hotel at Eastbourne, always seem to pick on the items with which everyone is familiar. Soloists at these concerts are always heard at their best, presumably on account of the freedom of draping in the hotel lounges.

Military and brass bands have given us some enjoyable programmes, but there is one point that needs some explanation. Concerts given by colliery and town bands are always of a pleasing nature, yet those given by the Wireless Military Band do not seem to conform with one's ideas of band music.

Avoiding Repetition

Certainly, as its conductor, D. Walton O'Donnell, stated recently, they have to provide 150 concerts a year, and if they kept to the type of music that really belongs to them there would be a lot of hostile criticism



One of 5GB's popular violinists—Eda Kersey is frequently heard

GRAMOPHONE RECORDS OF ALL YOUR RADIO FAVOURITES MADE IN YOUR OWN HOME!

THEY COST ONLY — 6^D
THEY'RE 6 INCH AND PLAY AS LONG AS A 10 INCH RECORD AND THEY'RE DOUBLE-SIDED TOO!



Many efforts have been made to produce a perfect home-recording outfit. At last it has made its appearance—the Kingston Home Recorder.

Two models have been designed. The first, the broadcast model for those possessing a radio set, consists of:

- (1) A wire gauge.
- (2) A tracking device.
- (3) A specially tuned pick-up.
- (4) Track arm.
- (5) Recorder sound box.
- (6) Needles.

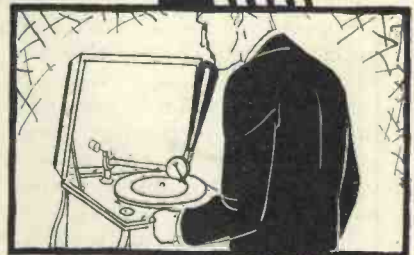

The fixing of the track arm to your gramophone (any type is suitable), is only a matter for a few moments. Then turn to your radio programme, select the items you wish to record, attach the lead from the special pick-up to the loud-speaker terminals of your set, and set your gramophone motor in motion.

Directly the recording has been completed, the record can be played back on the same gramophone. This model also enables you to record your own voice.

Just think of the marvellous possibilities of this little contrivance. Records of such favourites as Jack Payne and His B.B.C. Dance Band, Leonard Henry, Mabel Constanduros, and hundreds of other well-known radio artistes and programmes can be perfectly and permanently recorded.

This model is retailed at £3 16d. 6d.; records are supplied in two sizes. The popular size, which plays as long as an ordinary 10-inch record, is 6s. per dozen (Double-sided).

The acoustic model is very similar to the above, except that the equipment does not include the special pick-up.

It has been designed for those possessing gramophones and records speech only.

A small horn is fixed to the special sound box and it is into this that your message is spoken. The resultant recordings are not only of crystal-like clarity, but are exact reproductions of the voice tone.

The Kingston Home Recorder is not a gadget, not a toy, but a definite necessity for every home, and is the dawning of a new era in home amusement. Just think of the satisfaction of catching the voices of your children and always having them to listen to in the years to come.

This acoustic model retails at £2 5s.

You should know more about this remarkable home recorder—the invention of a famous "talkie" engineer. Descriptive literature sent free on request. Demonstrations at

Sole Distributors:

RADIO AND GRAMOPHONES,
 245 TOTTENHAM COURT ROAD, LONDON, W.1

Trade Enquiries: Harris & Russell, Ltd.,
 97, Tottenham Court Road, London, W.1.

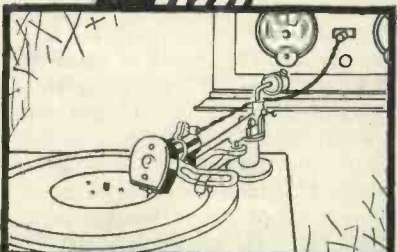
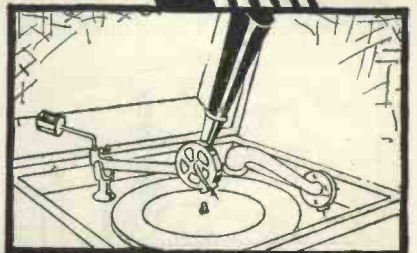

KINGSTON HOME RECORDER

"The Ear of the World"

UNDER MY AERIAL

**HALYARD'S CHAT ON
THE MONTH'S TOPICS**

**SPECIALLY ILLUSTRATED
BY GLOSSOP**

Broadcasting House

ONE of the greatest wireless events of 1931 will be the opening of Broadcasting House, the new headquarters of the B.B.C. in London. It is not known yet in what month the new building will be ready for occupation, but it seems likely that in the autumn of 1931 the B.B.C. will move from Savoy Hill to Portland Place.

Suppose you had to plan the opening ceremony of Broadcasting House, what would you do? Would you concentrate on a formal opening and broadcast the proceedings from all stations, or would you make the opening almost entirely a wireless affair?

I have been wondering if the doors of Broadcasting House could be first opened by distant wireless control by some great and famous radio personality in some distant part of the globe. The names of various famous men, chiefly American, come to my mind as suitable for such a task.

One of my ideas about the opening of Broadcasting House is that congratulatory messages might be received from all parts of the world and broadcast to listeners. An aerial is shown on the roof in most of the drawings of the building, so there ought to be no difficulty in picking up congratulatory messages.

And what about the first programmes broadcast from the new studios of Broadcasting House? The only suggestion I can offer is that



The opening ceremony

these might be chosen by listeners themselves, if only they would stir themselves sufficiently to write to the B.B.C. about it.

Television in 1931

What is going to happen to television during the present year? Are there likely to be developments or

shall we see television at the end of the year in the same state it is now?

At the present time it is very difficult indeed to find out the exact position. There are so few television receivers in use that information is very scanty and it is impossible



Latest television news

to compare television with wireless as it was in its early stages of development.

Although it may be of interest to a few television amateurs, it is not of any great interest to the bulk of listeners to know that the Baird transmissions are going on, and that the B.B.C. will do all in its power to help British television.

Now what do you really think about television? I still have the idea that some big thing has yet to be discovered, some big thing which will bring television into the home of the listener.

Of course, we all like to read the latest news about television. We like to hear that a new system has been evolved in "foreign parts," which system will put all other systems on the junk heap. Yes, we like to have the latest news, but we do not get unduly excited over it, for we know the exact number of grains of salt to take with television news these days.

A Dealer's Record

My very old wireless friend and trusted technical adviser, George, threatens to go into an entirely new line of business. If he keeps to his present determination he is going up to one of the big gramophone companies with his set in order to make a very special record of—but let me tell you how it all came about.

You will understand George's new move if I tell you the story as it actually occurred.

George and I had gone into the shop of our favourite local dealer with the intention of discussing a little "mains" problem with him. Our conversation was broken into by the appearance of another customer who sought advice on a fault in his portable set.

"Can you get anything from the set at all?" asked our dealer.

"A certain amount of noise at times," replied the customer.

"What kind of noise?"

"Well! it's rather hard to describe."

"Is it a hissing noise like this?" and our dealer proceeded to hiss.

"No."

"Is it a noise like this?" and our dealer gave a fair imitation of the increasing volume and gradually increasing note of a small siren.

"No."

"Does it go plop—plop—plop—plop—plop?"



A fault in his portable set

"No."

"Does it come on with a rush and go off quickly at irregular intervals?"

"Yes, that's it, that's it."

"Loose aerial connection from the lid to the set. Had lots of cases of that kind. Bring the set along this afternoon and we'll put it right for you in no time."

That's the story and that is how George got the idea of making a record of sound symptoms of trouble in a wireless set. He says every dealer in the country will buy one of his records, and I rather think they will.

Obsolete Receivers

How many obsolete receivers were scrapped during the year 1930, and how many ought to have been scrapped? It would be rather interesting to have actual figures in reply to these two questions, wouldn't it?

(Continued on page 84)

REPRODUCTION.... THAT MAKES YOU VISUALISE

The Apache

TENSE REALISM

The Apache—that dance of life . . . and death . . . full of tense movement and changing moods . . . now gay . . . now grim . . . holds the audience enthralled! and TELSEN . . . that greatest of all Radio Transformers . . . gives reproduction that is so vivid . . . so absolutely realistic . . . that when such music is broadcast . . . a mental picture . . . clear . . . lifelike . . . REAL . . . is unconsciously formed in the mind!

The outcome of many years practical radio experience, TELSEN Transformers are built on sound radio engineering principles—they will stand and have stood the TEST OF TIME. Put life . . . reality . . . into your set!—Get greater volume . . . greater purity . . . with

TELSEN TRANSFORMERS

- "ACE" 8/6
Ratios 3-1 and 5-1.
- "RADIOGRAND" . . . 12/6
Ratios 3-1 and 5-1.
- "RADIOGRAND" . . . 17/6
Super, Ratio 7-1.

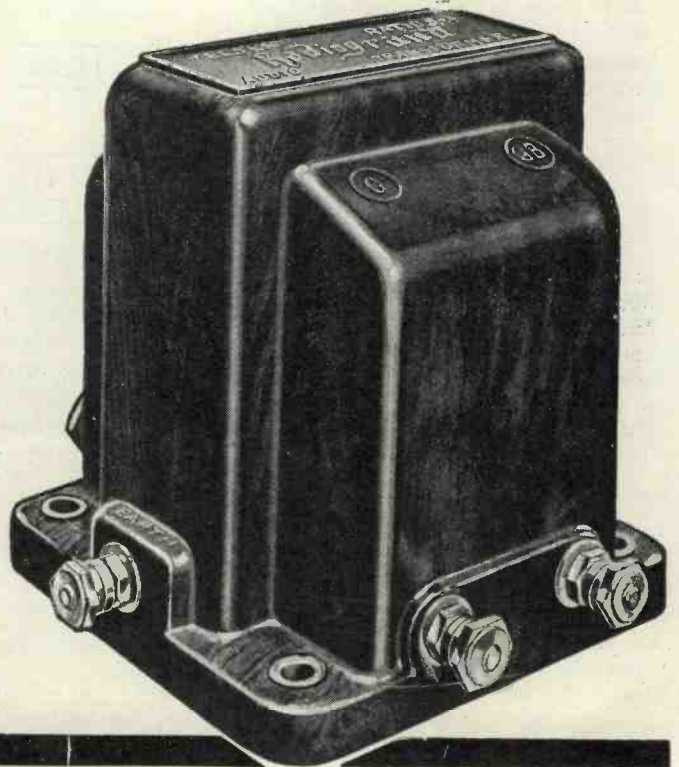

Advt. of Telsen Electric Co., Ltd., Birmingham.

It helps us if you mention "Wireless Magazine"

UNDER MY AERIAL—Continued



A very old set

If you were to travel about the country and see inside a large number of representative wireless repair shops, you would be amazed at the number of old-fashioned sets still in existence. The wonder of it is why people stick to these sets, which cannot possibly do justice to modern broadcasting. It is not as if it were an expensive business purchasing or constructing an up-to-date receiver these days.

The other day I saw a good example of a very old set still in use. The panel was horizontal and on it were the terminals, switches, filament rheostats, and the oldest of old variable condenser dials. Instead of valve holders there were groups of four valve legs screwed to the panel, the valves being vertical and above the panel. The whole set was assembled on the underneath side of the panel.

I realised that the conversion of that old set to a modern set would not have been difficult. Slow-motion dials fitted to the old variable condensers would have modernised the tuning controls. Practically the whole of the parts could have been used, the chief items required to make the set modern being a cabinet, baseboard and vertical panel.

The Earth

When I tried my three-valve general household and family set last Sunday afternoon, I was surprised to find that results were very much below normal. A quick glance round the set showed me that the falling off in volume was due to the earth lead having been disconnected by some unauthorised person.

I continued to use the set alternately without and with an earth on several of our British stations, and I was greatly surprised at the difference the earth made in every case.

Have you ever tried the effect of disconnecting the earth lead to your set? Do so, and I think you will be as surprised as I was. It is quite an

interesting experiment to run a set with aerial and no earth, and then with an earth and no aerial, in order to get an idea as to the relative efficiency of aerial and earth. Of course, when you are using an earth and no aerial, the earth lead should be taken to the aerial terminal of the set.

If you do carry out this interesting experiment, what I think you will find is that your earth is far more necessary and useful to you for near



Falling off in volume

stations than you imagine. Should you get down to the very, very short wavelengths, you might find that you can get on better without an earth than with one.

Interval Signals

During one of my nightly talks with George last week the subject of interval signals came up for discussion. I expect that, since the B.B.C. adopted their new interval signal, this same subject has come up for discussion on several occasions



Interval signals

between you and your friends. You will be interested, therefore, to hear my technical adviser's views.

First of all, George is as emphatic as I am that there should be a distinctive interval signal at each of our broadcasting stations. When we came to a consideration of the different distinctive and distinguishable signals in use I asked George what kind of an interval signal he preferred.

"A plain straightforward note, musical if you like, but plain," he replied.

"Don't you care for novel interval signals like the cuckoo call, or a gong,

or a pretty little tune, George?" I asked.

"No," he replied, "such things are only useful in serving to remind us that wireless is still in its infancy."

"What kind of interval signal would you yourself adopt for our British stations, George?"

"A simple buzzer note."

"The same for each station?"

"No. I would use the old letter call-signs in Morse, XX for Daventry 5XX, GB for Daventry 5GB, LO for London Regional, OL for London National—might have to alter that last one though—and so on."

"Simultaneous broadcasting would cause confusion, George."

"Not if I had my way. I should make each transmitter automatically transmit its own call-sign in the intervals."

"Rather difficult that, George."

"Well! the B.B.C. engineers have tackled and solved more difficult problems than that."

If we could have chosen the interval signals ourselves for our own broadcasting stations, would you have favoured George's suggestion, or have you a better one of your own?

Good-bye Junk

Have you ever had to part with a goodly portion of your collection of wireless junk? Sad business, isn't it? To my mind, the clearing out of old treasures is one of the saddest tasks that can befall the true enthusiast. I know, because I have just concluded such a task.

The powers that be decided that my wireless junk room must be thoroughly cleaned, and that a good deal of the "old rubbish" need not go back, since I never used it, and never should use it again. Well! with a heavy heart I had to set to work, and I made several reluctant journeys to the dust-bin.

On my first journey, I took no less than eight old low-frequency transformers, all with burnt-out primaries. (Some of these transformers (Continued on page 86)



Out of other people's sets

**A
WONDERFUL
COMBINATION**

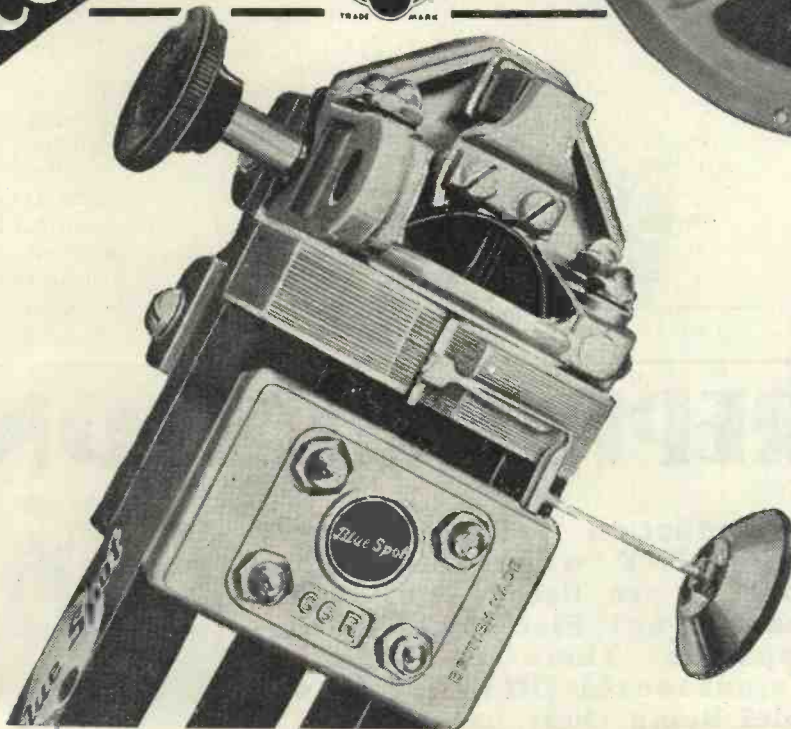
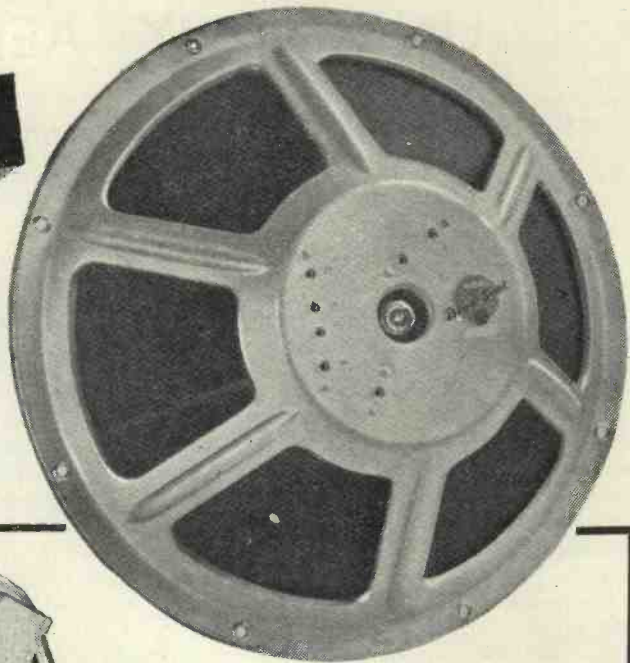

The union of the famous 66R Unit with the Special Chassis, results in the finest possible radio reproduction. Whether you are building a radio gramophone or your first loud-speaker, the only sure way to achieve perfection is to incorporate Blue Spot productions with your set.

- Blue Spot Power Unit, Type 66P - 27/6
- Blue Spot Power Unit, Type 66K - 25/-
- Blue Spot Major Chassis - 15/-

BLUE SPOT

**66R UNIT
35/-**

66R

**THE SPECIAL CHASSIS
10/6**

THE BRITISH BLUE SPOT COMPANY LTD

BLUE SPOT HOUSE · 94/96 ROSOMAN STREET · ROSEBERY AVENUE · LONDON · E C 1.

'Phone: CLERKENWELL 3570

'Grams: "BLUOSPOOT, SMITH, LONDON."

Distributors for Northern England, Scotland and North Wales: H. C. RAWSON (Sheffield and London), LTD, 100 London Road, Sheffield; 22 St. Mary's Parsonage, Manchester; 183 George Street, Glasgow

Better service results from mentioning "Wireless Magazine" when writing to advertisers

UNDER MY AERIAL—Continued

had come out of my own sets, and some out of other people's sets. I don't know why I had kept these transformers unless it were that I thought the frames and laminated plates might come in useful if ever I tried to make a transformer myself.

The derelict stuff on my second journey comprised old valve holders, old filament rheostats, old and very obsolete switches, and two broken variable condensers.

Other journeys ended in my saying good-bye to a pair of dud phones, three or four old and very bored panels and a miscellaneous collection of old coils, home-wound and factory wound.

The result of all this is a clean and tidy junk room. How long it will remain tidy I do not know, but I do hope it will be many years before I have to part with any more of my "rubbish."

University Wireless

Do you happen to know anything about the use and progress of wireless

Another Special Supplement of Interest to All Listeners will be Included in the March Issue of "Wireless Magazine"

in any of the universities in the British Isles? I had a talk the other day with an undergraduate of one of our older universities, and, to my surprise, I found that wireless is not very popular at his university.

For one thing, there are stringent regulations regarding the playing of musical instruments, which can be played only during certain hours of the afternoon and early evening. They must not be played outside those hours. Since wireless is classified as

a musical instrument, its use with a loud-speaker is restricted.

There are headphones, of course, but one can scarcely imagine a number of undergraduates sitting quietly round a room listening surreptitiously to a transmission with headphones just to defy the authorities. Still the serious experimenter would find no difficulty in carrying on with a pair of phones during the prohibited hours.

My undergraduate friend told me a good deal about a fellow undergraduate who holds a transmitting licence and who transmits from the university town. It was that that made me wonder whether wireless was seriously studied at our universities and whether we could look to them for progress in wireless in the near future.



Classified as a musical instrument

VIVID REPRODUCTION!



TELSEN H. F. CHOKES. Designed to cover the whole wave-band range, from 18 to 4,000 metres. Extremely low self-capacity, shrouded in Genuine Bakelite. Inductance 150,000 microhenries, resistance 400 ohms. Price 2/6 each.

Reproduction is astoundingly DIFFERENT when Telsan Components are used! Dull tones sharpen up! Flat voices take on a sparkle! There are a hundred reasons for this DIFFERENCE, the chief being their patent design, embodying many exclusive features, which means that Telsan reliability and vivid reproduction are unrivalled! See that your Set Incorporates

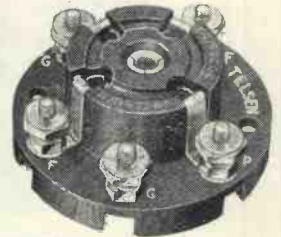

TELSEN FIVE-PIN VALVE HOLDER.
PRICE 1/3 each.



TELSEN FIXED (MICA) CONDENSERS. Shrouded in Genuine Bakelite, made in capacities up to .002 mfd. Pro. Pat. No. 20287/30. .0003 supplied complete with patent Grid Leak Clips to facilitate series or parallel connection. Can be mounted upright or flat. Tested on 500 volts. Price 1/- each.



TELSEN FOUR-PIN VALVE HOLDER.
PRICE 1/- each.

TELSEN COMPONENTS

Advt. of Telsan Electric Co. Ltd., Birmingham.

TELSEN VALVE HOLDERS. Pro. Pat. No. 20286/30. An entirely new design in Valve Holders, embodying patent metal spring contacts, which are designed to provide the most efficient contact with the valve legs, whether split or NON-split. Low capacity, self-locating, supplied with patent soldering tags and hexagon terminal nuts.

The Choice of Experts



IGRANIC
Type C30 L.F.
Choke
Price - 15/6

Igranic components have again been recommended for use in conjunction with the sets published in this issue. Such recommendations once more serve to prove that IGRANIC have always set the high standard of radio reliability. Igranic components are cheaper to buy than most—more efficient than any.

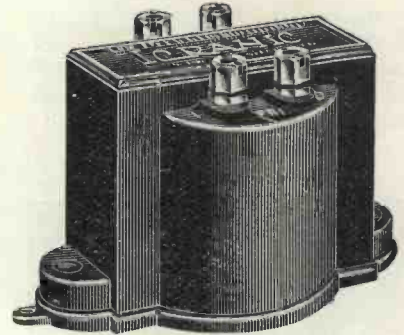

IGRANIC
Type J. L.F.
Transformer
Price - 17/6

A
**MASTERPIECE
IN MINIATURE**

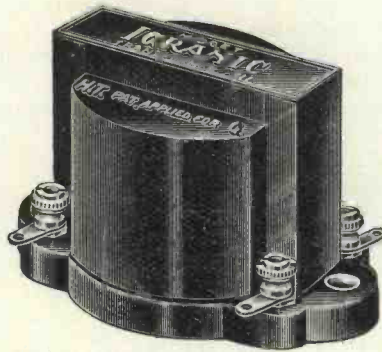

IGRANIC
"Midget" L.F. Transformer
Price - 10/6

◆ ◆ ◆
**ROBUST
and
RELIABLE**

◆ ◆ ◆
**HIGH
in
EFFICIENCY**

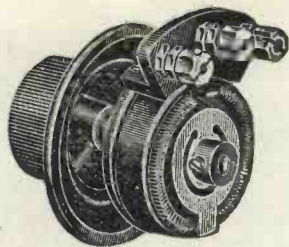

IGRANIC
High Resistance
Potentiometer
Price - 6/-

May we send you a
copy of our latest
Catalogue No. J.1110

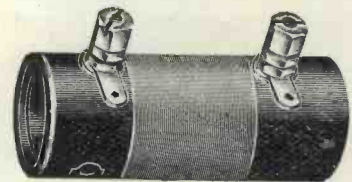

IGRANIC
Short Wave H.F.
Choke
Price - 2/-

149 QUEEN VICTORIA STREET, LONDON

When replying to advertisements, please mention "Wireless Magazine"

"IS TELEVISION AT A STANDSTILL?"

MY article under the above title in the WIRELESS MAGAZINE of last November was replied to in the December issue, on behalf of Mr. Baird, by Mr. Sydney Moseley, the Baird Television programme director, and his reply included an invitation that I should pay another visit to the Baird studios and "see for myself."

I accepted the invitation and had a most pleasant afternoon with Mr.



TELEVISION PERSONALITIES

On the left is Lord Amthill, chairman of the Baird Company, and on the right is Mr. John L. Baird, the inventor

Baird, but, unfortunately, too late in the working month to allow of my giving my impressions in my January issue.

I am not at liberty to do more than speak of the televised pictures which I saw, the Baird Company considering that the time is not yet ripe to publish details of their new apparatus and methods, for which I am rather sorry, because in the meantime the H.M.V. Company have demonstrated television, not, I think, on a new principle, but certainly with apparatus of new design and have provided this magazine with full particulars and first-rate drawings, which I am publishing on other pages.

Translucent Screen

I was shown in operation a television receiver—a home televisor—in which the picture appears upon a translucent screen, thus doing away with the necessity of viewing it through a magnifying lens; an obvi-

ous advantage, because a number of people can now see the image at one time, whereas in the older form it is difficult for two people to look-in.

The quality of the image is much as before, although the little screen on which it is projected measures as much as 8 in. by 5 in. This is undoubtedly an achievement, and I hope that the laboratory model which I saw will soon be translated into a commercial design. The home televisor in its laboratory form can now give a picture of two or three people from head to foot instead of just one or, at the most, two people, head and shoulders only. In the commercialising of the Baird Televisor this should count for much.

Perhaps the most interesting demonstration which I witnessed was television on an "extended screen," the principle being to divide the televised scene into three parts and transmit each of them on to an oblong strip of translucent material; there are three such strips, their vertical edges adjoining, forming one screen.

One result is that the illumination is three times more intense than if the scene were transmitted in the ordinary way to a screen of the same area as the three-piece screen.

By the way, the H.M.V. demonstration above referred to used a five-piece screen, but Baird is televising an actual scene taking place on a stage 12 ft. to 16 ft. in length, on which real people walk about, whereas the H.M.V. demonstration was restricted to the televising of cinematograph films. Mr. Baird on his triple screen showed me at least three or four people at a time, and the picture gave plenty of action.

Mr. Baird has been experimenting, to my knowledge, with the television of films for some long time, and on this occasion he transmitted from film a boxing match full of vivacity and detail.

A development with great possibilities is the Baird portable television transmitter. We can never get away from the fact that the public's idea of television is a service of "hot" news pictures. Such pictures can only be got where the news is made—at public occasions. In other words, O.B. television is what the public wants.

A step forward in this direction has been made by Mr. Baird in producing a portable televisor which could be used on special occasions to televise a picture, for example, of a public speaker or of anybody taking part in a public function, and I hope that he will have success in developing and commercialising the apparatus.

My Conclusions

In view of the questions asked in my article in the November issue, it is but fair that I should say what is the effect on my mind of the demonstrations accorded to me. I felt that Mr. Baird and his staff were doing their best to get down to realities and that they had made technical progress, but I was not aware, frankly, of much improvement in the quality of the ordinary televised picture.

By quality I have chiefly in mind detail, illumination, and that elusive thing, "likeness," but of course I admit that the use of the extended screen makes for better illumination than in earlier demonstrations and I am sure that in every case the pictures I saw were steadier, in other words "hunted" up and down the screen very much less.

Answering my own question, "Is television at a standstill?" I most certainly agree that television in the laboratory has gone forward, although as regards popular television—the provision of a satisfactory television service on the lines of the present sound-broadcasting service—I have a rather open mind.

B. E. J.



WATCHING WHAT?

This young lady certainly seems to be satisfied with what she is seeing in a Baird television receiver

Seven point suspension *definitely prevents* filament vibration

—the primary cause of
microphonic noises

The cause of microphonic noises in a Receiving Set is generally to be found in a faulty Detector Valve. Usually it is due to filament vibration. The new Cossor Detector Valve (210 Det.) has been specially designed to overcome this fault. Filament vibration is rendered impossible by a new method of seven point suspension. The diagram shows the four insulated hooks which secure the filament in position and damp out any tendency to vibration. The use of this "steep slope" Cossor Detector Valve not only eliminates microphonic noises, but ensures great volume with exceptional purity of tone.

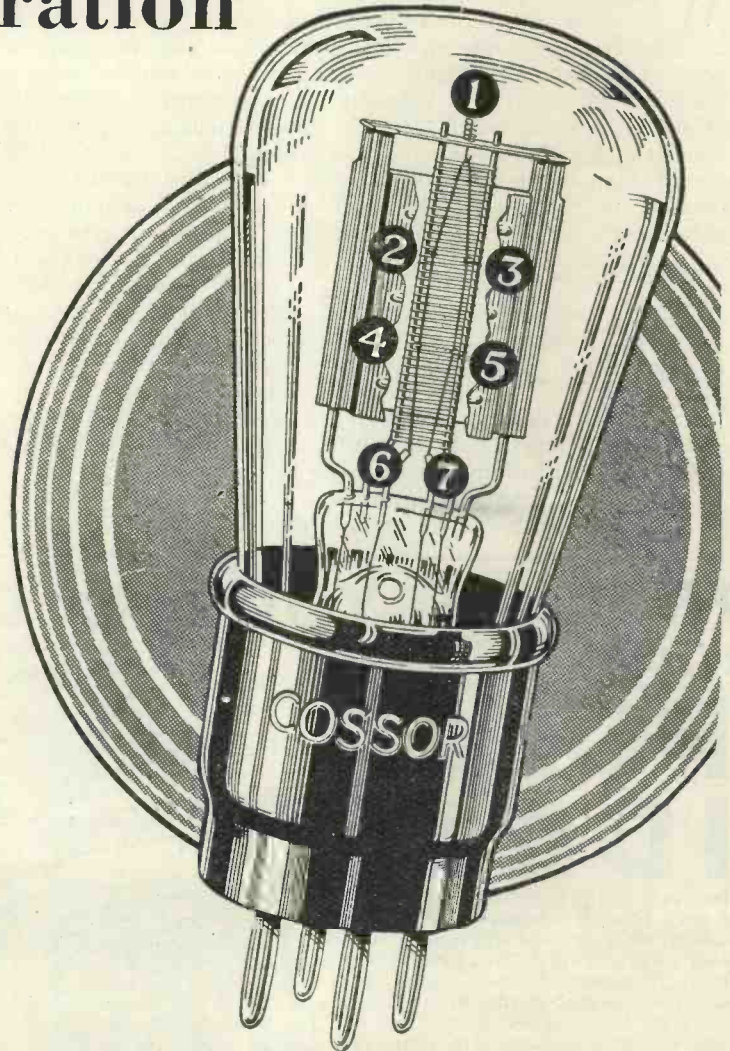

THE NEW
COSSOR
DETECTOR

The New Cossor 210 DET.,
2 volts, .1 amp. Impedance
13,000. Amplification Factor
15. Mutual Conductance
1.15 m.a. v. Normal working
Anode Voltage
90-150. Price **8/6**

*We have just issued a novel circular
Station Chart, which gives identification
details of nearly 50 stations, with space
for entering your own dial readings.
Ask your dealer for a copy, price 2d.
or send 2d. stamp to us and head your
letter "Station Chart W.M."*

DEFINITELY FREE FROM MICROPHONIC NOISES

A. C. Cossor Ltd., Highbury Grove, London, N.4.

♥ 7024

Advertisers take more interest when you mention "Wireless Magazine"

Compiled by JAY COOTE

A LISTENER'S LOG

What Is Moscow's Power? :: Short Wave Relay :: A Strange Call
"Our Apple Trees" :: Interval Signals

WHAT is the actual power of the Moscow Trades Unions' station to which so many references have been lately made in the daily press? Some will tell you it is 75 kilowatts, others mention "over 100," and now I am told that it radiates something like 165 kilowatts in the aerial on the occasion of these notorious international evenings.

Shaking the Loud-speaker

Judging from the way the signals shake my loud-speaker, notwithstanding the distance, it might be even more.

Apparently it does not work every night at full strength but only when the rabid Bolshies of divers nationalities shout their poisonous propaganda through the microphone I

have heard these tub-thumpers spout in English, French, Polish, Dutch, German and Spanish, and, although I understood some of them perfectly, I cannot realise how these senseless outpourings could impress any listener.

The international musical transmissions which accompany these verbose eruptions are poor and unattractive generally; personally, I find that a series of songs of liberty (or of oppression!) sung by untrained mixed choirs leaves me stone cold, but now and again one may hear a balalaika orchestra playing in a large hall.

When they restrict their repertoire to real Slavonic melodies they are worth hearing.

From a technical point of view, I grant that these transmissions may

be of interest, Moscow is some 1,550 miles from London and distance to the D.X. hound is everything.

Those who are interested in short waves may care to know that some of these broadcasts are relayed to REN, which re-transmits them on 46.6 metres. Announcements are made in many languages.

A Strange Call

On an evening or so ago I picked up a strange call in the ether; it was: "Hallo! Hallo! Radio Fer" Puzzles and mystery stations fascinate me as, no doubt, they do you, for the solving of these little radio problems adds spice and zest to casual listening.

Patience was duly rewarded, it was
(Continued on page 92)

REPLACE YOUR OLD CONDENSER with —

POLAR IDEAL

Here is a unique opportunity for you to save 2/- and to modernise your set. Substitute your old type condenser with a Polar "Ideal" or Polar "Ideal" Drum Control. These condensers have the finest Fast and Slow Motion Drive on the market to-day and are regarded as the standard of high-class design.

OUR OFFER. Take your old condenser (any type or make) to your Dealer and he will supply you with one of the Polar "Ideal" condensers listed below and allow you 2/- from the list prices quoted.

POLAR "IDEAL" with knob dial, '0005, 12/6; '0003, 12/-.

POLAR "IDEAL" Drum Control, right or left hand, '0005, 15/-; '0003, 14/6.

WINGROVE & ROGERS, LTD.
188-9, STRAND, LONDON, W.C.2
POLAR WORKS, OLD SWAN, LIVERPOOL



SPECIAL EXCHANGE OFFER

This offer holds good for January and February.

Take advantage of it now. Put new life into your set.

Scrap the ancient—
use the modern—
POLAR CONDENSERS



allowed on your old one

WORKING VOLTAGES OR TEST VOLTAGES?

AN
IMPORTANT
STATEMENT
BY THE
TELEGRAPH
CONDENSER
CO., LTD.

At the present time there is some confusion regarding the most suitable method of indicating Condenser voltages. Some manufacturers, including ourselves, mark their Condensers with their actual working voltages. Others adopt the more spectacular method of indicating test voltages.

Because test voltages are obviously much higher than actual working voltages, the Condenser buyer may be led to believe that the higher voltage indicates a more efficient and better insulated condenser. This is not necessarily the case.

In the past it has been fairly safe to assume that the continuous working voltage of a Condenser was half of its stated test voltage. Unfortunately, this method of grading Condensers can no longer be universally relied upon since it has been found that Condensers of similar capacity and size have been sold stamped with varying test voltages, but with no indication as to the working voltage. (This formed the subject of a statement issued by us earlier this year in reference to condensers of foreign manufacture).

We, therefore, recommend all users in their own interests to see that the Condensers they purchase are definitely marked with their maximum working voltage. This will always be found on "T.C.C." CONDENSERS.

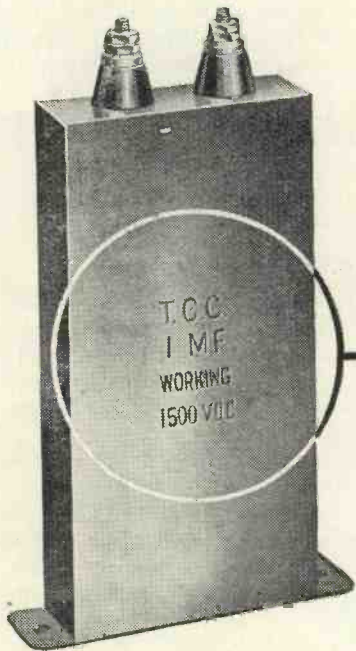

TELEGRAPH CONDENSER CO. LTD., N. ACTON, W. 3

Mention of the "Wireless Magazine" will ensure prompt attention



Now!
REPEAT SENSATIONAL
SUCCESSES WITH THE
SUPER PERFORMANCE
CHOKE
WITH BY-PASS CONDENSER

Every superlative feature that has always been aimed at by manufacturers is embraced in this moderately priced unit.

High inductance value, low self capacity, low resistance, free from resonance peaks, and blind spots. Uniform efficiency and in fact, a wonderful product that will improve any set in which it is installed.



FORMO H.F. CHOKE
 with By-pass Condenser
Price 7 6d.

- Type A. For use in detector anode circuit.
- Type B. For use as a coupling de ice between H.F. and detector valves.

Bring your receiver up-to-date and enjoy increased efficiency by fitting this new choke. From all good dealers. Send for folder W.M.

ARTHUR PREEN & CO., LIMITED,
 Golden Square,
 Piccadilly Circus, W.1.

FACTORY: Crown Works, Southampton.

There's nothing to beat this!

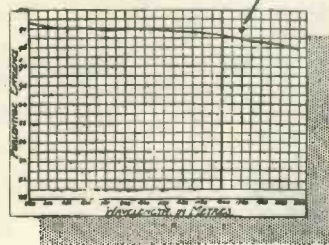

BUY YOUR RADIO WHERE YOU
SEE THESE
FORMO
Displays

The Sign of the Best Dealers Everywhere

A LISTENER'S LOG

(Continued from page 90)

not a "call from" but a "call to," and the caller was Radio Normandie. This little studio may only be a "one-horse" station at Fécamp, but it is surprising how its transmissions reach me on the south coast of England. Try for it between Cork and Cologne at any time after 8 p.m. G.M.T.

Now, Fécamp is in Normandy not very far from Le Havre and on the express trains between that port and Cherbourg, and also between the French coast and Paris, Radio Fer has equipped a number of passenger carriages with receiving apparatus

As a private transmitter, Radio Normandie is desirous of justifying its *raison d'être* and consequently almost nightly broadcasts a concert—mainly gramophone records—and a topical news bulletin for the benefit of travellers on these lines. The two calls are coupled at intervals and thus you hear Radio Fer and Radio Normandie in the course of the transmissions.

Possibilities of Future Extensions

There is every possibility of the Fécamp station assuming greater proportions as a French company has been recently constituted to take it over, lock, stock and barrel, and as it disposes of a capital of about one million francs some development may be expected.

By the way, for its time signal at 9 p.m. and sometimes when it closes down you may hear a melodious carillon of bells relayed from an old Bénédictine monastery.

It opens its broadcasts with a record of a local song, *Nos Pommiers* (Our Apple Trees), in view of its connection with the Normandy cider industry.

When the studio closes down for the night with its usual greetings to *Mesdames, Mademoiselles et Messieurs*, the last sounds to be heard are the strains of another vocal record, a very bright melody sung by a "top-hole" baritone. *Ma Normandie* is real patriotic sob-stuff comprising the conventional "land that saw my birth" and "my beloved country" music-hall poetry lines.

But for all that, Fécamp does not only supply canned music; it frequently switches you over to the wine bar of the Hotel Frascati at Le Havre. The orchestra you hear from that resort is a very decent one.

B.B.C.'s Interval Signal

Notwithstanding its apparent objection to their use, the B.B.C., for the National programmes at least, has been compelled to adopt an interval signal when short pauses occur in the programme.

It is a pity, however, that nothing more original than the ticking of a clock could be evolved by the big brains at Savoy Hill. There are, as it is, so many metronome noises on the air already.

It seems to me that something more distinctive could have been thought out, some sound which, conveyed to the ears of near and distant listeners, would have proved, without doubt, the presence of a British station. Why not, say, the first four notes of the National Anthem or the opening bars of *Rule, Britannia*?

The Italians are using a special signal for their individual groups of transmitters, but as an opening signal they have adopted a gramophone record of a carillon of bells to the accompaniment of organ and orchestra.

RADIO IN REVIEW

By MORTON BARR

Moving-coil Loud-speakers

THOUGH a moving-coil loud-speaker is capable of giving better reproduction than any other type of instrument, it will only do so when operated under proper conditions—and these are not always easy to obtain. For instance, it is often a difficult matter to get satisfactory quality from a moving-coil loud-speaker when fitted to a highly-selective receiver.

For selectivity the input and intervalve coupling circuits must have a sharp resonance curve, which has the effect of "trimming off" the outer sidebands of the signals or, in other words, of lessening the relative intensity of the higher notes.

Since a moving-coil loud-speaker tends to favour the lower notes, even under normal conditions when the input is properly balanced, its response to an input which has already been robbed of some of the higher notes naturally becomes a bit "woolly."

It is a curious fact that the older or moving-iron type of loud-speaker is better adapted to handle these particular conditions, because here the natural high-pitched resonance of the armature or reed-driven instrument comes into operation and tends to restore the proper musical balance.

Volume Control

Another point to bear in mind about moving-coil loud-speakers is the importance of volume control. For an orchestral performance, where of course this type of reproducer is heard at its best, the ear will tolerate a generous volume of sound, because one readily accepts the notion of being situated close to the band.

If, however, the next item on the programme is a talk, the speaker "shouts," so that it is necessary to jump up and re-adjust the volume.

Attempts are being made to overcome this particular difficulty by using an "automatic" volume control similar to that which has already been successfully employed for preventing "fading" when listening to a distant station. In one case the strength of the carrier wave is controlled, whilst in the other it is a question of regulating the effect of modulation.

Changing the Type

Again, a moving-coil loud-speaker is seldom heard at its best when used with a set originally designed for operating a moving-iron instrument. The reason is one to which reference has already been made. The ordinary or moving-iron type of loud-speaker tends to accentuate the high notes if fed with a properly-balanced input. In order to offset this tendency, a manufacturer will often deliberately design the valve couplings so as to over-accentuate the lower frequencies. The high-pitched resonance of the speaker then comes into play to restore the correct balance.

(Continued on next page)



MIDNIGHT REVIEW

"I wonder if it's the battery?" said father after puzzling over the set till midnight: and when he tried an Ever Ready instead, the reception was perfect. That's what the Ever Ready was designed for—to give perfect reception as well as to last a long time. All through its long life it stays up to pitch. You get no fading. You have no distortion. The Ever Ready is made by an exclusive process—an exceptionally thorough and careful process. It stays alive for months, and while it's alive it's awake! Every Ever Ready battery is guaranteed to give satisfactory service by a company which has been making reliable batteries for 28 years.

Ever Ready batteries are made for all wireless sets. If you own a portable you can obtain an Ever Ready of the right size and shape to fit it. Write for free list,

which gives full particulars, including exact dimensions in inches.

**BRITISH MADE
HIGH TENSION
BATTERIES**

**EVER
READY!**

The batteries that give unwavering power

The Ever Ready Co. (Gt. Britain) Ltd., Hercules Place, Holloway, London, N.7

RADIO IN REVIEW—Continued from preceding page

But when a moving-coil instrument is applied to the same set, the lower notes, being already over-strong, are still further accentuated in the loud-speaker, and the reproduction becomes unnaturally low-pitched and gruff. This simply emphasises the fact that in order to get the best out of a moving-coil instrument it must be used with a properly-designed amplifier. Otherwise the experiment of changing over from one type of loud-speaker to another may prove disappointing. The difficulty does not, of course, arise when, as is sometimes the case, the loud-speaker and amplifier are sold as one unit.

Using a Pentode

In a moving-coil loud-speaker the current flowing through the coils should be constant at all frequencies, if the high and low notes are to be correctly reproduced. Now a pentode valve delivers the same current no matter what impedance is in the plate circuit, and for this reason it is particularly suitable for driving moving-coil instruments.

A three-electrode power valve is equally suitable if it is driven from A.C. mains. But where the power supply is limited, as it is when drawn from batteries, or even from D.C. mains, the pentode is to be preferred, because it is able to pass a higher proportion of the available power on to the loud-speaker for conversion into sound.

With a pentode the loud-speaker impedance should be as high as possible, that is, there should be at least 2,500 turns on the moving-coil, or else a step-down transformer should be used. With a 4-1 ratio, the effective impedance is increased by sixteen, that is, by the square of the ratio.

By the way, if for any reason the loud-speaker is temporarily disconnected from a set containing a pentode output stage, care should be taken not to turn on the valves until the loud-speaker has been replaced. Otherwise very high voltages are liable to be created on the plate of the valve. With an amplification in the neighbourhood of 100, even a small input voltage may result in damag-

ing the valve unless it has a proper load (that is, the loud-speaker) to work into.

“Graded” Licences

The suggestion to replace the present uniform B.B.C. licence of 10s. a year by a sliding scale of fees, based upon the type of receiver used, has not so far been looked upon with favour by the authorities, possibly on account of the labour involved.

At the same time, there is something to be said in favour of letting the “crystal merchant” off a little more lightly than the man who indulges in a ten-valve super-het.

The change, if any, should, of course, be by way of a reduction of the tax now levied on the simpler sets. So long as the P.M.G. enjoys a handsome yearly surplus, and the B.B.C. can afford to subsidise grand opera, there is no necessity for increasing the present maximum of ten shillings, which is sufficient to cover any multi-valve set. The crystal user, and say the one-valver, might be let off at half-price.

CHEAPER ELECTRIC RADIO by



Cheaper Electric Radio by Regentone! A new range of Regentone Mains Units at lower prices. A model for your set, for any set, any portable.

Regentone Mains Units are made by the specialists with six years' experience of mains radio. Write for FREE Art Booklet, with colour supplement “Cheaper Electric Radio by Regentone”—or get it from your dealer.

Regentone Limited, Regentone House, 21 Bartlett's Buildings, Holborn Circus, London, E.C.4. Telephone: Central 8745 (5 lines).

Irish Free State Distributors: Kelly & Shiel Ltd., 47 Fleet Street, Dublin.

AN OUTSTANDING RANGE OF A.C. SCREENED GRID VALVES

Mullard A.C. types S.4V, S.4VA and S.4VB are indirectly heated screened grid mains valves having amplification factors ranging from 900 to 1,500. In conjunction with efficient circuits these valves make possible stage gains hitherto considered impossible, and definitely set a new standard for H.F. amplification. As with all Mullard indirectly heated mains valves, the rigid and compact design of the electrode system, results in very high performance. From this range of valves a choice of H.F. amplifiers to suit any circuit can be made.

PRICE 25/- each

Mullard THE MASTER VALVE

CHARACTERISTICS S.4V.

- Max. Heater Voltage ... 4.0 volts
- Heater Current ... 1.0 amp.
- Max. Anode Voltage ... 200 volts
- Positive Screen Voltage 75 volts
- *Anode Impedance ... 909,000 ohms
- *Amplification Factor ... 1,000
- *Mutual Conductance ... 1.1mA/volt

* At Anode Volts 100. Screen Volts 75.
Grid Volts Zero.

S.4VA.

- Max. Heater Voltage ... 4.0 volts
- Heater Current ... 1.0 amp.
- Max. Anode Voltage ... 200 volts
- Positive Screen Voltage 75-100 volts
- *Anode Impedance ... 430,000 ohms
- *Amplification Factor ... 1,500
- *Mutual Conductance ... 3.5mA/volt

* At Anode Volts 100. Screen Volts 75.
Grid Volts Zero.

S.4VB.

- Max. Heater Voltage 4.0 volts
- Heater Current ... 1.0 amp.
- Max. Anode Voltage ... 200 volts
- Positive Screen Voltage 75-100 volts
- *Anode Impedance ... 257,000 ohms
- *Amplification Factor ... 900
- *Mutual Conductance ... 3.5mA/volt

* At Anode Volts 150. Screen Volts 75.
Grid Volts -1.

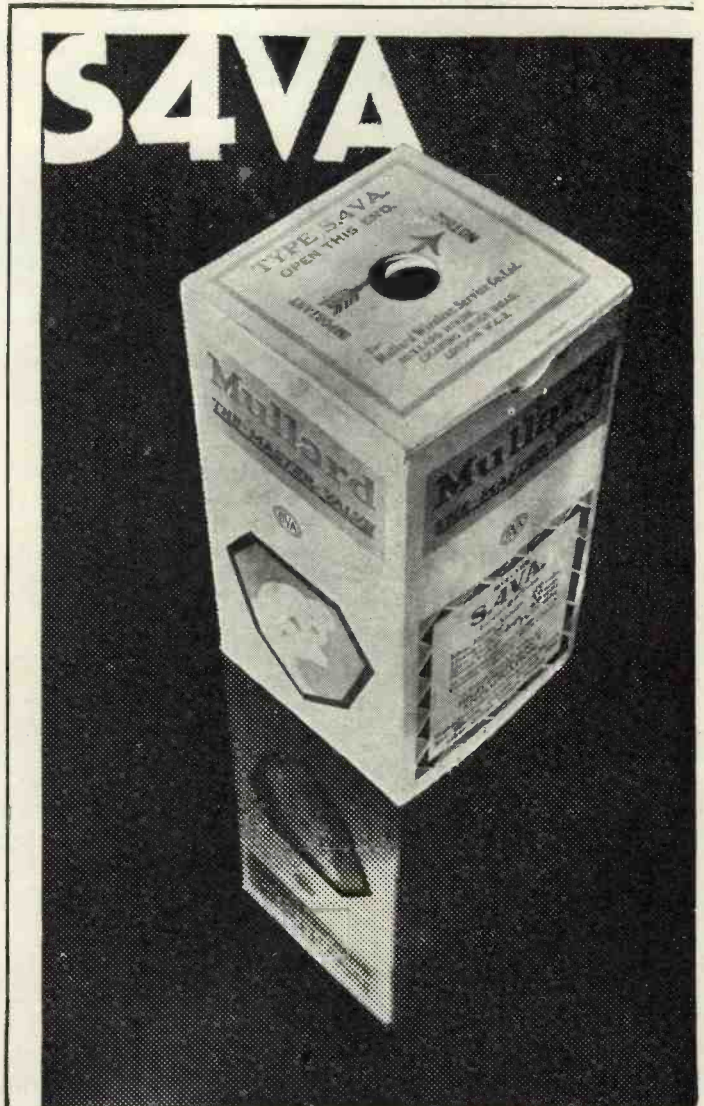
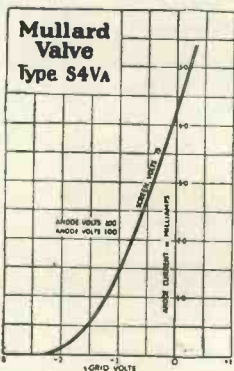

Adv. : The Mullard Wireless Service Co., Ltd., Mullard House, Charing Cross Road, London, W.C.2.

A1ks

THE HYPERDYNE

SHORT-WAVE ADAPTOR

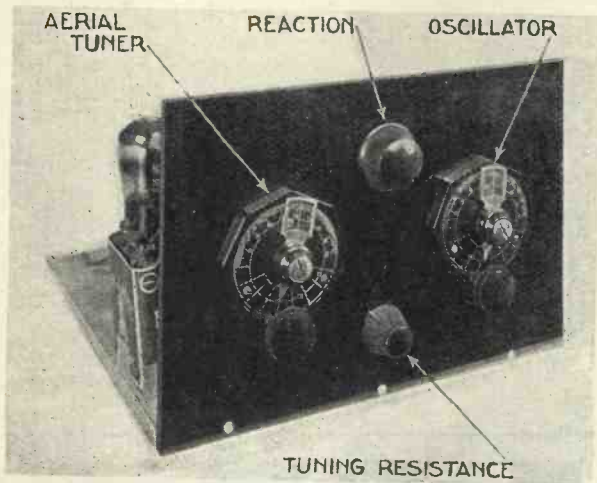

ACCESSIBLE PANEL CONTROLS

This photograph shows the arrangement of the controls on the Hyperdyne Short-wave Adaptor

I HAVE received a number of reports from readers on the performances of their own Hyperdynes. In the majority of cases the receiver has worked without any trouble and has given the specified performance straight away. In other cases some slight difficulty has been encountered, usually due to oscillation in the intermediate amplifier.

Symptoms of Oscillation

This can always be detected by the following symptoms: If the oscillator dial is rotated a number of whistles will be tuned in, and if the tune of the intermediate amplifier is varied slightly, the note of the whistle will alter. Normally no whistles are tuned in.

Although the original amplifier was quite stable and seemed to have a good factor of safety, one nearly always finds in these cases that slight differences in construction may be causing the trouble.

I therefore obtained a Hyperdyne which had been made up to the published details, but which was giving a quite unsatisfactory performance. I found at once that the intermediate amplifier was oscillating,

and on replacing it with my own amplifier the set behaved perfectly satisfactorily.

I examined the amplifier to find wherein the difference lay, and discovered a number of points of deviation from the original which had all conspired to make the set unstable.

I will set them out below in their order of importance:—

1.—The intermediate coils must be mounted horizontally in the position shown in the photograph on page 512 of the December issue.

2.—The connections to the first coil must be taken direct to the coil itself, and not to terminals on the top of the panel. If this latter arrangement is resorted to the leads come too near the anode of the first screen-grid valve and oscillation sets in.

3.—The grid leads to the second high-frequency and detector valve (Nos. 66 and 68 on the blueprint) should be kept short.

4.—On the two high-frequency coils, the primary windings (seventeen turns of No 34 d.s.c.) should be

kept towards the earth end of the secondary, as shown on page 511.

These were the principal points of difference. Provided that attention is paid to these matters the amplifier should be quite stable. The additional contact to the screening box (lead No 16) is important, as at these short wavelengths the screen is not all at the same potential, and earthing at one point is not enough.

The Hyperdyne is a new-style super-het with screened-grid valves and has been designed by

J. H. REYNER,
B.Sc., A.M.I.E.E.

Full details were given in the December and January issues. Here we present details of a simple unit by means of which the main receiver can be converted in a few minutes for short-wave reception.

If any difficulty should be experienced with self-oscillation, even after all these precautions have been tried, the condensers inside the intermediate amplifier, which are specified as .002 microfarad, can be increased to .01 microfarad. This will make the whole amplifier absolutely stable, even if the high-tension voltage is increased to 150 volts.

Oscillator Tuning

There is one final point at which some trouble might be experienced, namely the oscillator condenser. A .00025-microfarad condenser is shown in parallel, but it may be found that with this arrangement the circuit does not quite tune up to 2,000 metres. Should this be found to be the case, it is better to use a .0005-microfarad pre-set condenser, which can then be adjusted to give 2,000 metres with the dial at 180, as shown

(Continued on page 98)

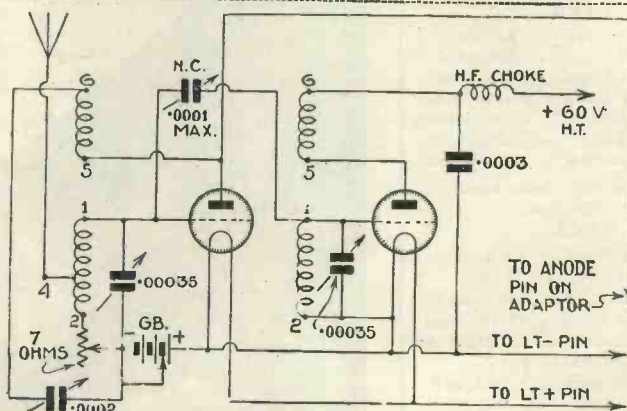

CIRCUIT OF THE HYPERDYNE ADAPTOR

Included in the circuit are a detector valve and an oscillator

When it's a Question of Control Specify Centralab

Centralab Potentiometer type Volume Controls are used as standard equipment by the leading radio set manufacturers throughout the world. The Centralab sliding shoe contact definitely ensures noiseless and perfectly smooth control from a whisper to maximum volume. When it's a question of control, you cannot go wrong if you specify Centralab.

Write for the Centralab Catalogue—it's Free.



Type	Resistance
P.109	0-200 ohms.
P.110	0-400 "
P.111	0-2,000 "
P.112	0-10,000 "
P.050	0-50,000 "
P.100	0-100,000 "
M.250	0-250,000 "
M.500	0-500,000 "
All Models, 10/6	

THE ROTHERMEL CORPORATION LTD.,
24 Maddox Street, London, W.1.
Phone: MAYFAIR 0578 9.
Continental Sales Office:
27 QUAI DU COMMERCE, BRUSSELS, BELGIUM.

MAKES A GOOD SPEAKER BETTER!

in performance and appearance

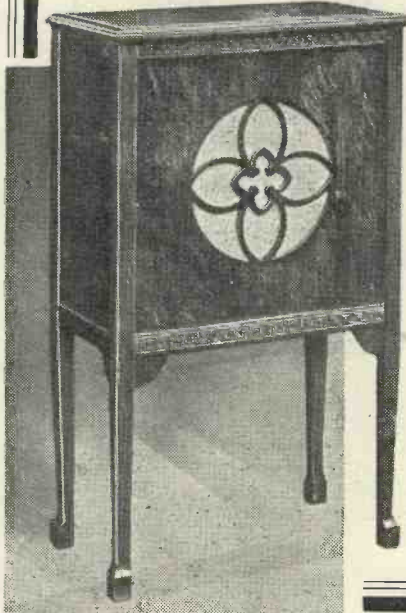

If you use a Camco Regent Pedestal Speaker Cabinet you will get the best from your Dynamic Moving Coil or unit, with a chassis up to 20". It stands 39 in. high with internal dimensions 20 x 20 x 11 in. deep. Its back is removable and designed to avoid resonance. Beautifully finished in Oak, £3



**REGENT
SPEAKER
CABINET**

Send coupon for Free Catalogue to:
CARRINGTON MFG. CO. LTD.,
24 Hatton Garden, London, E.C.1.
(Phone: Holborn 8209) (Factory: S. Croydon.)

Name.....
Address.....
.....
.....



RADIO manufacturers all over the world are using Dubilier Condensers because it is known that their robust construction and high electrical efficiency can make all the difference to the performance of their sets.

You can do no better than follow their lead and make use of Dubilier Condensers for efficiency, accuracy, and reliable Service.

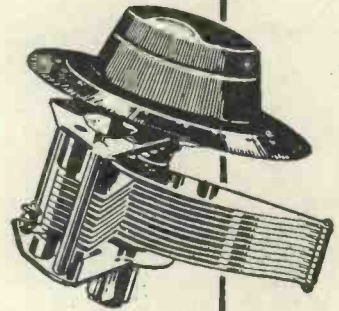

K.C. Variable Condenser
With knob dial and slow-motion device - - 11/-
Without knob dial or slow-motion device - - 7/6

DUBILIER CONDENSERS

DUBILIER CONDENSER CO. (1925) LTD.,
Ducon Works, Victoria Road N. Acton, London, W.3.

When replying to advertisements, please mention "Wireless Magazine"

THE HYPERDYNE ADAPTOR—Continued

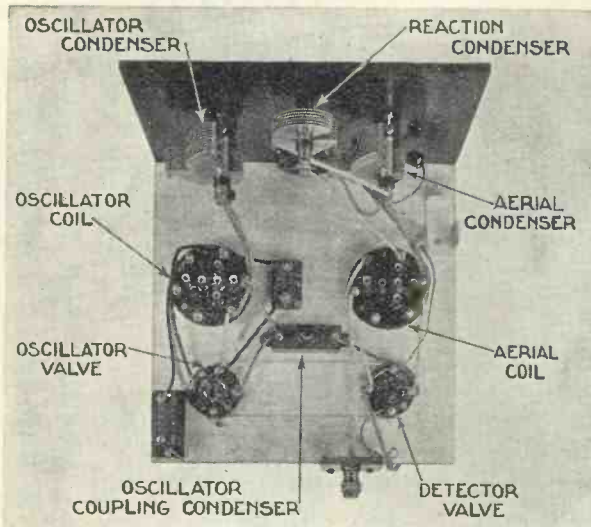

THE UNIT IS SIMPLE TO BUILD

The disposition of the parts will be clear from this plan photographic view

on page 511. I did not suggest this in the original instance as I did not want to increase the apparent difficulty of the receiver.

Once one has used the set, however, and got used to its operation, it

is quite a simple matter to replace the fixed condenser with a pre-set, which can be adjusted once and for all to give the correct setting.

One final point before passing on to the short-wave adaptor. Many readers have written in to ask whether the set can be used on a frame aerial. It can, of course, although to my mind one of its advantages is that it does not require a frame aerial.

The best plan is to use a frame and detector.

simply as a collector. Take one lead from the frame to the aerial terminal of the set, and do the tuning on the DWA coil included in the receiver.

If one wishes to use the frame as a frame, however, then the DWA coil

must be removed and the frame aerial must be substituted. The frame must be of dual-range variety, and it should have a reaction winding on it.

Owing to the decreased damping obtainable with a frame, however, it is possible to leave the reaction winding off, if this is felt to be absolutely necessary. The diagram on page 100 gives details of the connections to the frame aerial.

Short-wave Reception

Now to turn to the short-wave adaptor. It was my intention that an additional short-wave tuning circuit should be connected to the receiver and that the same oscillator should be used with a different coil.

There are one or two difficulties in this operation, however, and it was ultimately deemed preferable to make up a separate short-wave oscillator and detector.

These are both mounted in a small compact unit, and this system gives both the short-wave controls on the same panel, instead of one being on

(Continued on page 100)



TWO
LEWCOS ULTRA SHORT
WAVE COILS (Ref. AMS/2)
 are specified for the
ULTRA SHORT WAVE
ADAPTOR
 for the
"HYPERDYNE" RECEIVER
 described in this issue

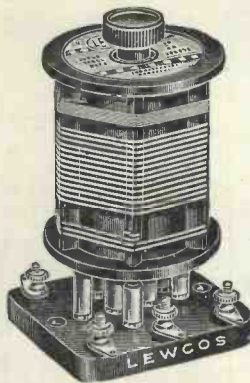

THE
 LEWCOS
 ULTRA
 SHORT
 WAVE
 COIL
 PRICE
6/- each

With Lewcos Ultra Short Wave Coils fitted in your set, you will find it an easy matter to receive the most distant stations across the world. Like every other coil made by Lewcos the Short Wave Coils live up to their manufacturer's world wide reputation for "Perfection in every detail."

A fully descriptive leaflet will be sent on request. Please quote Ref. R.64.



LEWCOS RADIO PRODUCTS FOR BETTER RECEPTION

THE LONDON ELECTRIC WIRE COMPANY AND SMITHS LIMITED, CHURCH ROAD, LEYTON, LONDON, E.10

EDDYSTONE

SHORT - WAVE APPARATUS
PLUG-IN S.W. COILS

EDDYSTONE S.W. coils have all the desirable features necessary to ensure efficient S.W. results. Lowest H.F. losses and self capacity. Wound with 16g. enamel copper wire almost entirely air spaced, they are yet unbelievably mechanically strong



No. 3	8-25 metres	2/6
No. 4	12-40	2/9
No. 6	14-60	3/-
No. 9	25-90	3/3
No. 12	40-120	3/6
No. 15	60-150	4/



ABSORBOS

These, mounted on the receiver cabinet, take up all shock and prevent microphonic noises. They also insulate the cabinet from earth, preventing any stray leakage. 2/3 Per set of four.

LOW LOSS VALVE HOLDER

A valve holder of low loss construction with one-piece air spaced sockets. Bakelite insulating ring. Can be mounted direct on metal base-board. Price 1/6
Send for list No. 38 of S.W. apparatus.

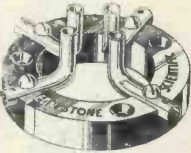

Sole Manufacturers:
STRATTON & Co., Ltd.
Bromsgrove St.
Birmingham

London Service Depot:
G. WEBB LTD.
164 Charing Cross Road
W.G.2

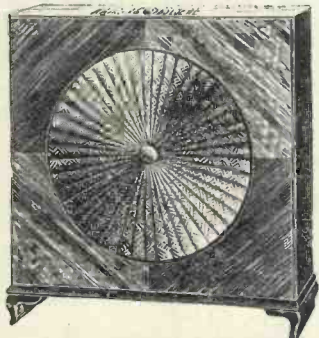

GREATEST IN CONE! SPEAKERS!

Never before has there been such a wonderful Speaker. Never before have you heard such amazing Tonal Purity and Volume. Retail, complete Unit only, 12/- Unit and Chassis, 16/6. Full details from:-

42/-

THE LOEWE RADIO Co., Ltd.
4 Fountainayne Road, Tottenham, N.15
Phone: Tottenham 3911/2.



The Easy Way TO PERFECT RADIO

FOREMOST and BEST

READ THIS!

SEE "W.M." SPECIAL REVIEW—CHOOSE YOUR SET and LET US QUOTE.

IMPORTANT NOTE. KIT "A" is less valves and cabinet. KIT "B" with valves less cabinet. KIT "C" with valves and cabinet. Any parts supplied separately.

SUPER TONE FOUR

Kit "A" { Cash } £9 11 0	Or 12 { 17/6
Kit "B" { Price } £12 0 6	monthly } 22/1
Kit "C" { Price } £13 18 0	payments of } 25/5

BROOKMANS A.C. TWO

Kit "A" { Cash } £10 7 11	Or 12 { 19/1
Kit "B" { Price } £12 15 5	monthly } 23/5
Kit "C" { Price } £14 17 5	payments of } 27/3

HYPERDYNE SHORT-WAVE ADAPTOR

Kit "A" { Cash } £2 18 9	Or 12 { 5/4
Kit "B" { Price } £3 15 9	monthly } 6/11
Kit "C" { Price } £4 8 3	payments of } 8/1

BAFFLE-BOARD THREE

Kit "A" less Valves, B.M. Board, Speaker Unit and Cone, £1 17 11. Or 12 monthly payments of 8/11.
Kit "B" with Valves but less Baffle Board, Speaker Unit and Cone, £5 5 5. Or 12 monthly payments of 11/6.
Kit "C" complete with Valves, Baffle Board, Speaker Unit and Cone (no Cabinet), £9 6 8. Or 13 monthly payments of 17/1.

TWO SPECIAL C.O.D. OFFERS

The "Kelsey Short-wave Adaptor"
YOU can receive the Ultra Short Waves with YOUR set by using the Kelsey Adaptor. SEND NO MONEY. PAY THE POSTMAN. Complete Kit "A" (excluding Pilot Test Meter) 31/- Post Free or Finished Unit, Tested and Ready for use (less cabinet), 35/- Post Free. Either of these offers sent C.O.D. or against cash we pay all charges.

ALL ORDERS CARRIAGE PAID

IMMEDIATE DELIVERY

MANUFACTURED KITS AND ACCESSORIES

- Send **10/-** COSSOR EMPIRE MELODY MAKER KIT. 1931 Model. S.G., Detector, and Power. Cash price, £6.17.6. Only Balance in 11 monthly payments of 12/9.
- Send **23/6** 1931 OSRAM MUSIC MAGNET KIT. 2 S.G., Detector, and Power. Cash price, £11.15.0. Only Balance in 12 monthly payments of 18/6.
- Send **14/8** MULLARD 1931 ORGOLA THREE-VALVE KIT, S.G., Detector, and Power. Cash price, 18. Only Balance in 11 monthly payments of 14/8
- All above Kit prices include valves and cabinet.
- Send **10/9** REGENTONE W.5. COMBINED H.T. ELIMINATOR & TRICKLE CHARGER, 1 S.G., 1 variable, and 1 fixed tapping for H.T., L.T. charging for 2, 4, and 6 volts. For A.C. mains. Cash price, £5.17.6. Only Balance in 11 monthly payments of 10/9.

- Send **8/6** EXIOE 120-VOLT W.H. TYPE ACCUMULATOR, in Crates. Cash price, £4.13.0. Only Balance in 11 monthly payments of 8/6.
- Send **6/5** FARRAND INDUCTOR SPEAKER for perfect reproduction. Unit and Chassis complete ready mounted. Cash price, £3.10.0. Only Balance in 11 monthly payments of 6/5.
- Send **6/5** LAMPLUGH INDUCTOR SPEAKER, for perfect reproduction. Unit and Chassis complete, ready mounted. Cash price, £3.10.0. Only Balance in 11 monthly payments of 6/5.
- Send **5/3** PETO-SCOTT AIR CHROME LOUD-SPEAKER, incorporating the famous Ultra K. Chassis Air Chrome. 14 in. by 14 in. Cash price £2 17 6. Only Balance in 11 monthly payments of 5/3.

ANOTHER SPECIAL FEATURE

THE KINGSTON HOME RECORDER

SEND ONLY 7/- Balance in 11 monthly payments of 7/-
Cash Price, £3 . 16 . 6

PETO-SCOTT CO. LTD.

OUR NEW CATALOGUE

describing ALL THE LEADING MAKERS' Receivers. Components, Radio Gramophones, Pick-ups, etc. A veritable guide to Radio. Get your copy to-day.
LONDON: 77 City Rd., E.C.1. Phone: Clerkenwell 9406-7-8
62 High Holborn, W.C.1. Phone: Chancery 8266
MANCHESTER: 33 Whitelaw Road, Chorlton-cum-Hardy. Phone: Chorlton-cum-Hardy 2028
NEWCASTLE. Steffs.: 7 Albany Road.

COUPON
Please send me FREE (a) your famous Easy Way Catalogue, (b) Your latest Pilot Chart.
NAME
ADDRESS
W.M. 2/31

PROMPTITUDE . . . FAIR DEALING . . . TRUSTWORTHINESS
(A customer's unsolicited testimony)

THE HYPERDYNE ADAPTOR—Continued

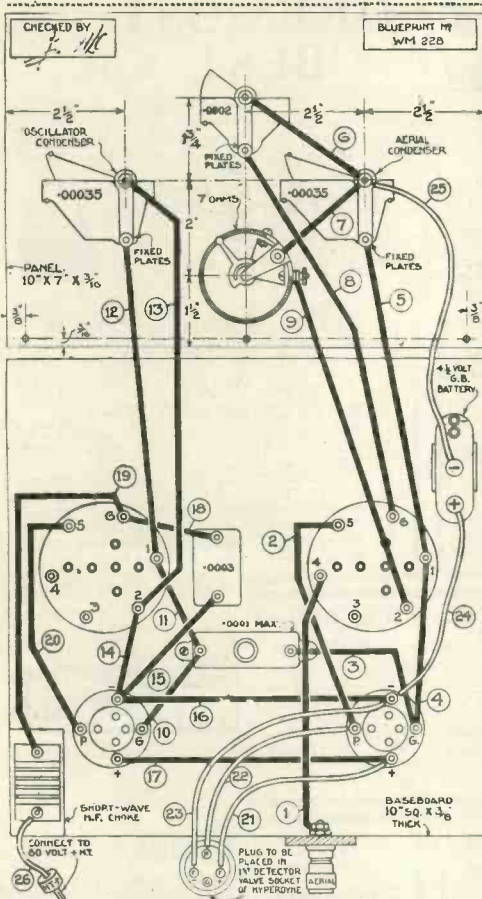

LAYOUT AND WIRING DIAGRAM
 This wiring diagram can be obtained as a full-size blueprint if the coupon on page 112 is used by February 28. Ask for No. WM228

the adaptor and the other on the main set. A small amount of duplication is required by this method, but results on the whole are better.

As will be seen from the photographs and diagrams, the adaptor is made in such a form that it obtains all its supply of energy by plugging it into the detector valve holder, the detector valve itself being removed and inserted in the detector socket of the short-wave portion

Oscillator Valve

The oscillator valve can either be the same as is used in the main set, being transferred from the main set to the adaptor, or, if convenient, another valve may be used. Thus no alteration is required to the connections. It is merely necessary to remove the two valves and plug in the adaptor, when the set is all ready for business, except that the H.T. + lead from the adaptor should be taken

to a tap of about 60 volts.

The adaptor itself consists of a detector tuning circuit of the normal type, together with an oscillator coupled thereto in the same manner as is used for broadcast reception.

The oscillation is, of course, at a different frequency, and an AMS/2 or AMS/4 coil is used, according to the wavelength to be received. A similar coil is used for the detector tuning and the two dials more or less go together

Damping Resistance

It will be seen that a resistance has been included in the detector circuit. This is put in with the deliberate intent to increase the damping. When the circuit was first hooked up it behaved in a very pleasant manner and the stations could be pulled in without trouble

When it was built in its final form nothing could be obtained on it for some time until it was discovered that the tuning was exceptionally sharp. Even when this fact had been realised it took the best part of a quarter of an hour to tune in a station, even with an expert hand. I felt that this was quite an impracticable set to publish.

After many experiments it was found that the inclusion of a resistance in the tuning circuit flattened the tuning sufficiently to enable the stations to be tuned in normally.

It was, indeed, the added damping arising from the higgledy-piggledy arrangement of the hook-up which made it behave so nicely. The surprising point is that the signal

strength does not suffer to any marked extent by this increased damping in the aerial circuit.

This is due to the fact that an oscillating detector is employed, for it is a well-known fact that the rectified current with this form of detector is practically independent of the strength of signal, and depends principally on the strength of the oscillator.

In tuning, the process is to start off with the resistance well in and



READY FOR USE

Here you see the adaptor ready for use with valves and coils in position. A plug on the unit is plugged into the set

find the station. The resistance may then gradually be cut out, retuning at the same time until a point is found where the tuning is becoming unpleasantly sharp.

At this point, which may occur before the resistance is completely cut out, the signal strength will be found to be as good as one requires. One can obtain quite good signals, indeed, by finding the average position of the resistance and leaving it set. The receiver is then in a good condition for searching, and at the same time the signal strength is quite good enough for ordinary purposes.

Simple Construction

I need not describe the construction. The arrangement is so straightforward and simple that no comment is required. I must emphasise the need for very good dials to avoid backlash. This is more than ever important on the short waveband.

I might also mention the desirability of keeping the leads from the tuning condensers to the coil holders close together, to make sure of getting down to the minimum wave-

(Continued on page 102)

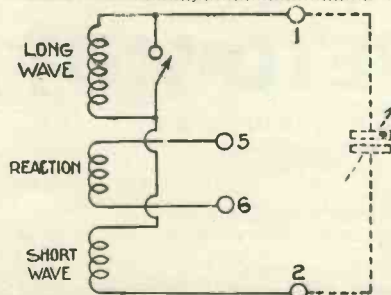

FRAME-AERIAL CONNECTIONS
 This diagram shows how to connect a frame aerial to the Hyperdyne

TROUBLE-FREE SET BUILDING

**USE
READY RADIO
GUARANTEED
KITS**

**USE JIFFILINX
FOR WIRING UP
NO SOLDERING**

You can buy any
**RECEIVER,
EQUIPMENT**
or
KIT OF PARTS
from
READY RADIO
for
CASH
or by **EASY
PAYMENTS.**

KIT "A"
is supplied less
VALVES
and
CABINET

KIT "B"
is supplied with
VALVES
less
CABINET

KIT "C"
is complete with
VALVES
and
CABINET

DUAL SCREEN FIVE

KIT "A" Cash £11 us. 10d. or 12 equal monthly payments of 20/3	KIT "B" Cash £14 11s. 4d. or 12 equal monthly payments of 26/8	KIT "C" Cash £16 11s. 4d. or 12 equal monthly payments of 30/4
--	--	--

REGIONAL A.C. FOUR

Supplied as **KIT C** only. Cash £20 7s. 0d. **37/4**
or 12 equal monthly payments of

**REGIONAL BAND-PASS
FOUR**

KIT "A" Cash £8 18s. 6d. or 12 equal monthly payments of 16/4	KIT "B" Cash £11 6s. 0d. or 12 equal monthly payments of 20/9	KIT "C" Cash £12 16s. 0d. or 12 equal monthly payments of 23/6
---	---	--

FALCON THREE

KIT "A" Cash £6 5s. 0d. or 12 equal monthly payments of 11/6	KIT "B" Cash £9 2s. 6d. or 12 equal monthly payments of 16/8	KIT "C" Cash £10 7s. 6d. or 12 equal monthly payments of 19/-
--	--	---

**STANDARD
A.C. UNIT**

COMPLETE KIT OF PARTS
Cash £8 17s. 10d.
or 12 equal monthly
payments of **16/4**

FALCON A.C. UNIT

COMPLETE KIT OF PARTS
Cash £7 0s. 0d.
or 12 equal monthly
payments of **12/10**

**STANDARD
D.C. UNIT**

COMPLETE KIT OF PARTS
Cash £6 7s. 3d.
or 12 equal monthly
payments of **11/8**

**FIVE-POINT SHORT-WAVER
KIT "A" KIT "B" KIT "C"**

Cash £5 7s. 0d. or 12 equal monthly payments of 9/10	Cash £6 14s. 6d. or 12 equal monthly payments of 12/4	Cash £7 15s. 6d. or 12 equal monthly payments of 14/3
--	---	---

FIVE-POINT TWO

KIT "A" Cash £2 12s. 6d. or 12 equal monthly payments of 4/10	KIT "B" Cash £3 11s. 6d. or 12 equal monthly payments of 6/7	KIT "C" Cash £4 6s. 6d. or 12 equal monthly payments of 7/11
---	--	--

FIVE-POINT FOUR

KIT "A" Cash £7 1s. 0d. or 12 equal monthly payments of 12/11	KIT "B" Cash £9 18s. 6d. or 12 equal monthly payments of 17/3	KIT "C" Cash £10 18s. 6d. or 12 equal monthly payments of 20/-
---	---	--

FIVE-POINT THREE

KIT "A" Cash £5 10s. 9d. or 12 equal monthly payments of 10/2	KIT "B" Cash £7 9s. 9d. or 12 equal monthly payments of 13/8	KIT "C" Cash £8 14s. 9d. or 12 equal monthly payments of 16/-
---	--	---

NEW BROOKMANS THREE

KIT "A" Cash £5 8s. 4d. or 12 equal monthly payments of 10/-	KIT "B" Cash £7 7s. 4d. or 12 equal monthly payments of 13/6	KIT "C" Cash £8 12s. 4d. or 12 equal monthly payments of 15/9
--	--	---

SEND NOW for THESE CATALOGUES

1931 **RADIO OUT OF
INCOME**
Free Catalogue of Sets,
Speakers, Equipment,
and Components, selected
by our experts as
representing the finest
value obtainable

A complete Encyclo-
pedia of all modern
Sets, Speakers, Equip-
ment, Components and
Accessories, including
particulars of everything
needed by the set builder
Price 1/- Post Free.

TO INLAND CUSTOMERS
Your goods are dis-
patched post free or
carriage paid

TO OVERSEAS CUSTOMERS
All your goods are very
carefully packed for ex-
port and insured, all
charges forward

Ready Radio (R. R. Ltd.), London Bridge, S.E.1

CASH OR EASY PAYMENTS

IMMEDIATE DISPATCH

Ready Radio
R.R.L.

159, BOROUGH HIGH STREET,
LONDON BRIDGE, S.E.1.

Telephone: Hop 5555 (Private Exchange) Telegrams: READIRAD, SEDIST

THE HYPERDYNE ADAPTOR—Continued

COMPONENTS NEEDED FOR THE HYPERDYNE SHORT-WAVE ADAPTOR

CHOKE, HIGH-FREQUENCY

1—Bulgin short-wave, type HF3, 3s. (or Wearite, Polar).

COILS

2—Lewcos six-pin short-wave, type AMS2, 12s.

CONDENSERS, FIXED

1—T.C.C. .0003-microfarad, flat type, 1s. 3d. (or Dubilier, Lissen).

CONDENSER, VARIABLE

2—Formo .00035-microfarad, 9s.

1—Formo .0002-microfarad, midget type, 2s. 9d. (or Bulgin).

1—Formo pre-set, .0001 microfarad max. type F, 1s. 6d. (or Lewcodenser, Igranic).

DIALS, SLOW-MOTION

2—Ormond, type R/320B, 7s.

EBONITE

1—Trelleborg 10-in. by 7-in. panel, 4s. 6d. (or Becol, Red Triangle).

The prices mentioned are those for the parts used in the original set; the prices of alternatives as indicated in the brackets may be either higher or lower

HOLDERS, COIL

2—Magnum six-pin, 5s. (or Lewcos).

HOLDERS, VALVE

2—Lotus, type VH/27, 3s. (or W.B., Clix).

RESISTANCE, VARIABLE

1—Lissen 7-ohm rheostat, 2s. 6d. (or Wearite, Varley).

SUNDRIES

Glazite insulated wire for connecting.

1—Ebonite knob.

1—Baseboard, 10 in. square (Pickett).

1—Bulgin four-way multiple cable plug, 2s.

1—Terminal, 1½ in. square.

1—Ever Ready 9-volt grid-bias battery, 1s. 3d. (or Lissen, Pertrix).

TERMINALS AND PLUGS

1—Belling-Lee terminal, marked: Aerial, 6d. (or Eelex, Clix).

3—Belling-Lee wander plugs, marked: G.B.+ G.B.—, H.T.+ , 9d. (or Eelex, Clix).

will be found without difficulty. A weak station may be increased by the reaction control at the top of the panel.

No Alterations

The main part of the receiver does not require any alteration. The intermediates should be left set at exactly the same position as is usually employed for broadcast reception, and to return to the broadcast band it is only necessary to remove the adaptor and reinsert the valve or valves in the detector and oscillator sockets. The H.T.+ from the adaptor can be left connected, if desired

[Since this article was written we have received the following additional notes from J. H. Reyner:—

"In the original set .002-microfarad condensers were specified between the H.T. points and earth. It has since been found that .01-microfarad condensers are better.

"The correct oscillator coil for the broadcast band is the AMS/9.

"In some cases intermediate amplifiers have been made up using paper-dielectric condensers. These amplifiers operate satisfactorily, but owing to the increased loss due to the solid dielectric between the condenser vanes, the efficiency is not as high as with the original air-dielectric condensers. For the best results, therefore, the specified condensers should be employed in the intermediate amplifier."

length required. If the leads are kept far apart the set may not tune down.

The operation is exactly the same as on the broadcast band. The oscillator dial is the more sharply tuned, but the difference is not so marked and both dials require careful handling. The manipulation is easier, however, in that the dials move more

together than they do on the main portion of the set. To find the stations in the first place, set the tuning dial and slowly rotate the oscillator dial around in the corresponding position.

At one point signals or mush will come up, showing that the circuit is in tune. The two dials may then be moved round together, when stations

A QUAIN T INSTRUMENT

THOSE of you who listen to the serious music in the broadcast programmes may have been interested in the quaint sounds of the old-world harpsichord, especially during the Bach cantatas on a Sunday afternoon and occasionally in the symphony concerts.

The twangy, plucking effect never fails to appeal to the intelligent listener as being exactly the right effect for music of a century or a century and a half ago.

Precursor of the Piano

The harpsichord, it need hardly be said, is the immediate precursor of the piano and in many ways resembles it. On the other hand, to compare the harpsichord with a modern grand piano is rather difficult, as the latest improvements take us further and further away from the principle of the former.

The piano, as we all know, depends largely on a perfect balance of the hammer each key controls; those with a perfect touch—and there are many nowadays—have quite elaborate actions.

By WHITAKER-WILSON

The pianoforte is so called because it was considered to be the soft (piano) and loud (forte) instrument at the time it was first made; it must be remembered that the harpsichord was incapable of tonal expression.

No amount of hitting the key would produce more sound; if one hit it too hard the key simply broke, or at least got out of gear. If you think of an instrument capable of producing all the harmonic effects you desire, but which could not record any accentuation at all you will realise the first of the limitations of the harpsichord.

In terms which will appeal to you from the wireless point of view, the harpsichord had no volume control on it. As often as not, the harpsichord was a mere scratch with a sound at the end of it.

The action of a harpsichord was undoubtedly an improvement upon any of its predecessors, but the makers must have felt themselves

that they had missed the 'bus, as we say, because the dulcimer, from which all these keyed instruments had been evolved, was struck with free hammers; you struck them yourself, of course.

One of the first improvements of the harpsichord was to make it a two-manual instrument (an idea borrowed, of course, from the organ), and to give two, three, or even four strings to each note. This latter device is still employed in modern grand pianos for all except the bass strings.

Contrasting Tones

Although there was no chance of accentuation or even gradation of tone as we now understand it, there was a possibility of contrasting the tone on the two manuals.

The principle of the harpsichord, in common with that of the spinet, the virginal, and the clavichord, was that instead of the string or wire being struck by a hammer (as in the piano), the far end of the lever belonging to the key was furnished with a jack in the centre of which a piece

(Continued on page 104)

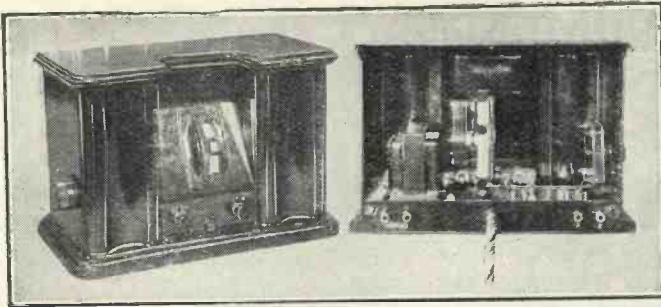

The **BurTon Empire Two-valve Receiver**
Two views showing the attractive external appearance and internal construction of THE BURTON EMPIRE TWO-VALVE RECEIVER. This set is built entirely with components of our own registered design and manufacture. It gives wonderful reception of all local station programmes and numerous foreign ones, too, under favourable conditions, at good loud-speaker strength. It is a very sensitive set and gives fine quality of tone. Exceptionally good value at **57/6**

without valves

THE SUCCESS OF BURTON RECEIVERS



The **BurTon BINOCULAR H.F. CHOKES**.

Scientifically designed to avoid peaks and external magnetic field. Covers wave band of 50-3,000 metres. Price 5/9 each. Also highly efficient model covering wave band of 20-2,000 metres. Price 3/9 each.

Proves the efficiency of

BURTON COMPONENTS

If you are building a set specify **BURTON COMPONENTS**—the parts that are guaranteed to be successful. Write for latest list fully describing the complete range of **BURTON CONDENSERS, VALVE HOLDERS, CHOKES, TRANSFORMERS, SWITCHES, TERMINALS**, etc.

C. F. & H. BURTON

PROGRESS WORKS, WALSALL, ENGLAND



The **BurTon AUDIO TRANSFORMER**.

A neat and compact instrument of the highest efficiency, being carefully wound to give correct ratios. Enclosed in a neat moulded case giving a high-grade finish. **TYPE B3 ratio 3-1..... Price 10/6**
.. B5 ratio 5-1..... 10/6

The **McMICHAEL RECEIVER** on the 10.10 a.m. **KING'S CROSS** to **LEEDS** train daily is operated by an



D. C. to A. C. ROTARY TRANSFORMER

M-L products are famous for their unfailingly dependable service. Used by Metropolitan Police, the Air Ministry, the B.B.C., the G.P.O., Marconiphone, the Gramophone Co. Ltd., etc., etc. The M-L D.C. to A.C. Rotary Transformer enables an A.C. All Electric Set to be operated from D.C. Mains, L.T. Accumulator or Private House Plant. Supplied to run from any voltage 12-250 v. D.C. 40 watt model, £13; 85 watt, £17.

The **M-L MAGNETO SYND., LTD.** Radio Dept. E, **COVENTRY**
Telephone: 5001.

NOT A MOVING COIL !



Farrand Patent

This is a statement that is hard to believe when you hear the original N & K Inductor Dynamic Speaker. It not only equals a moving coil, but improves on its sensitiveness, clarity and beauty of tone.

There are no running costs as no energising current is required. It is by far the greatest advancement ever made in loud-speaker design. The original N & K speaker can only be obtained from us.

The new N & K electric pick-up is an example of the latest development in pick-ups. As a result of its extreme light weight, record wear is reduced to a minimum. Pick-up only £1 17s. 6d., pick-up with tone-arm and volume control £3 3s. 0d.

Call for a demonstration or ask your dealer. Full details will be sent free on request on receipt of P.O.

A. BRODERSEN

11 Northampton Square, Goswell Road, London. E.C.1

Look out for our **March issue** published on **February 20**

It will contain a **Special Supplement** that will be of interest to every owner of a receiver

Make sure of getting **your copy**

March issue
February 20

LIMIT'S NEWEST SOUNDBOX

Try the new **Limit EXCELSIS**, the blue riband of soundboxes, against any other make. You will be astounded at the marvellous improvement in reproduction. In fact it is better than many soundboxes sold at double the price. Fit one to your own gramophone—you can get one to fit it. Any good dealer can supply. **15/6**

The original **Limit** soundbox, priced at 10/6, still maintains its high reputation in the gramophone world. If any difficulty in obtaining write for name of nearest stockist.



LIMIT Engineering Co., Ltd.

Albion Street, King's Cross, N.1

High-Grade QUEEN ANNE STYLE WIRELESS CABINET

Hand French Polished
Figured Oak £5 5 0
Figured Mahogany £8 8 0
Figured Walnut £6 15 0

Carriage paid.
THE ACME OF CRAFTSMANSHIP
Models from £22.0 to £20.
Thirty-page illustrated catalogue post free.

GILBERT Cabinet Maker. Established 1865. Swindon



Advertisers like to know you "saw it in the 'Wireless Magazine'"

A QUAIN INSTRUMENT—Continued

of crow quill was firmly embedded.

When the finger depressed the key (there was not much actual striking in harpsichord-playing) the jack was thrown up and the crow quill caught the string and twanged it. Hence, the peculiar twanging sound of the instrument which, by the way, broadcasts exceedingly well.

In Fig. 1 you see part of the action of any of the harpsichord family of instruments. The jack simply swings up as soon as the key is touched at the other end.

Cristofori

If you will compare this with Fig. 2, which is of Cristofori's invention (he was the first maker of a pianoforte), you will see how much more elaborate his ideas were in comparison with the earlier conceptions.

You will notice the pad which raises the second lever, the hopper, centred and controlled by the springs which I have indicated by dotted lines; it effects the escape of the hammer when the note has been struck. When the hammer is at rest the head of it lies in the fork of silk. When the key is depressed the tail of the second lever draws away the damper from the strings and therefore allows them to vibrate freely and so produce proper tone.

This illustration, which is only rough, may serve to give an idea of the improvement which Cristofori made. Naturally, the desire to produce more and more tone meant a stronger string; eventually it meant a stronger frame.

Light Hammers

Cristofori's hammers were light compared with the weighted hammers of a modern grand piano; even so, they were too heavy for the type of string used for harpsichords.

There are two of Cristofori's pianos still in existence, one at the Metropolitan Museum in New York, and the other at Leipzig. Harpsichords themselves are still made, though only for the special purpose of playing music intended for them.

It is a strange point, musically, that harpsichord music can rarely be rendered satisfactorily on a piano. The atmosphere of the instrument is

remarkable, but it must be remembered that it held an important place in music before the advent of the piano in the early part of the eighteenth century.

On the other hand, there is a great deal of pleasure to be derived from listening to a harpsichord in an orchestra. It is an old-world instrument and the effect it produces is old-world.

It is strange how one instrument should have the power to create an atmosphere; no other instrument in the orchestra could have done it, not even the oboe *d'amore*. But why not? After all, the violin is a far older instrument than the harpsichord; indeed, there are very few instruments in a modern orchestra that are not older than the harpsichord.

I suppose the real answer to the question is that those other instruments exist in practically their original forms; at any rate they are there to play what they are required. But the harpsichord has since been replaced by the piano which is the instrument of the home.

That last fact is very important, of course. However unfamiliar some of us may be with orchestral instruments, there are few of us who are not familiar with the tones of a piano.

We owe the harpsichord a great deal; from it our own piano was directly evolved, to begin with; but, apart from that, we owe it a debt of gratitude for its power to take us away from this present, so to speak, and to give us an occasional glimpse into the artistic past

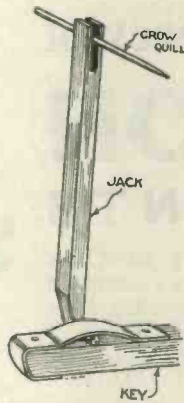

Fig. 1.—Part of the action of the harpsichord

COWBOY RADIO

IN the Argentine, on a cattle ranch, 60 miles from the nearest city, Walter L. Kelly is closely in touch with world affairs. The answer is radio.

The Kelly estancia, which means much, when translated, is divided into fields—fields for cattle, some for sheep, others for linseed, corn, alfalfa.

The fields are separated by wire fences and the topmost wire of the fence is used for an inter-communication system which connects the house and office with all the tenants, with the hotel in front of the railway station at Solis, about 60 miles from Buenos Aires.

Talking on the Fence

The main house and out-buildings are connected by a sixteen-station electric inter-communication system, so that from any room in the house it is possible to talk with any one on the outside fence system.

The telephone system, therefore, serves a double purpose. It may be used for communication purposes on affairs of the ranch or, in the evenings, Mr. Kelly may distribute to his tenants the output of his short wave radio receiving set. With a suitable receiver, it is possible to tune in on the radio programme at any point on the fence.

This enables the operator to tune his receiver for a particular station and then, at the hour stock or produce market reports are on the air, to tune in at whatever point of the ranch he happens to be at that time.

Radio reception from the fence at any point requires only an ordinary sensitive telephone receiver without batteries.

F. P.

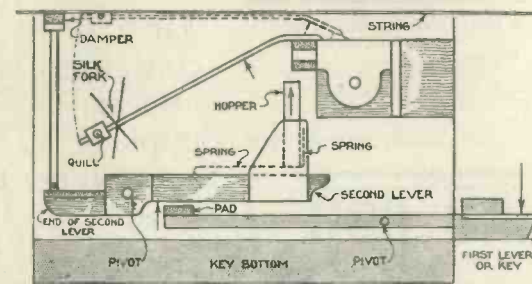

Fig. 2.—How Cristofori's action worked. There are still two of his instruments in existence

The harpsichord is a link with the past, and a link that is not likely to be broken yet awhile, if ever. Fortunately, the B.B.C. is not listening to the cries of the low-brows who advocate the total abolition of chamber and symphony concerts; it will be a sad day for England's artistic soul when the low-brow prevails.

To render music faithfully

Is the Aim and Achievement of the

"UNDY"

8 POLE DYNAMIC SPEAKER

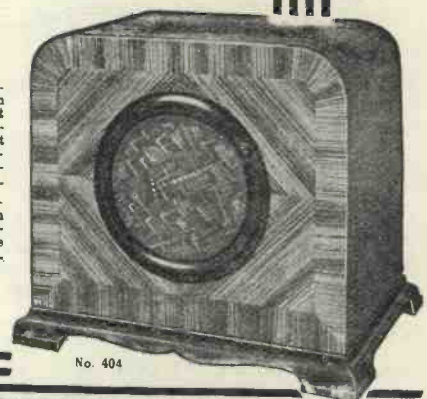
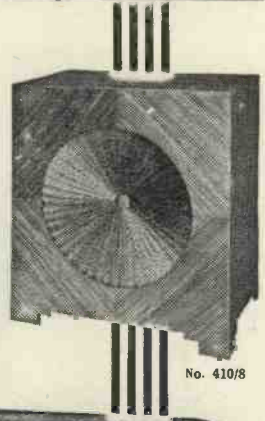
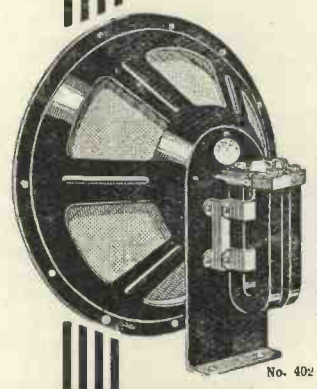

CHOOSE FROM THESE FOUR TYPES

- No. 402 Complete 8-pole Unit with Chassis ready for building into Cabinet or Baffle Board. **50/-**
- No. 410/8 Undy 8-pole Dynamic Loud-speaker in polished Walnut Cabinet. The loud-speaker for the most exacting requirements at a reasonable price. **55/-**
- No. 404A Undy 8-pole Dynamic Loud-speaker in attractive Oak Cabinet. **70/-**
- No. 404 Undy 8-pole Dynamic Loud-speaker in highly polished Walnut Cabinet De Luxe. **90/-**

Obtainable from your usual dealer.
Ask for Demonstration.

No. 404A

No. 404

H & B

COILS

For Super Efficiency H. & B. Coils are wound on Frellborg's 12,000 volt per m/a Test Ebonite. Losses are therefore cut to the minimum.

- Set of coils for the Reyner's Hyperdyne ... 17 6
- Special short-wave H.F. choke ... 2 0
- "CHALLENGE TWO," with reaction winding ... 10 6
- "CHALLENGE THREE," carefully matched, per set ... 1 0
- "CHALLENGE FOUR," three Coils exactly as specified and carefully matched 11 6
- "CHALLENGE" RADIO GRAMOPHONE Aerial and Arc Coils exactly as specified 1 0
- "MUSIC MONITOR," "W.M.," September 7 6
- "SEARCHER TWO," "A.W.," August 23, per set ... 9 6
- "A.B.C TWO," "W.M.," August ... 5 0
- "BROOKMAN'S BY-PASS" ... 3 0
- "U.S.C LEADER "A.W." ... 10 6
- "JAMES' S.G. PORTABLE 3," "W.M.," July ... 9 6
- "JAMES' A.O.5," "W.M.," Jan. Set of 4 Coils ... 1 10 0

NOTE:—We supply Coils for any set described in "W.M.," "W.M.," etc. Any Coil built to your specification. Prices on application.

For the convenience of "Wireless Magazine" readers, we have specially compiled a 12-page order giving complete details of the sets described in the supplement given with this issue. This order gives full details of the components, prices, of all the twelve sets and units.

H. & B. Kits contain all necessary wire and screws.
H. & B. Kits have the panels and strips ready drilled.
H. & B. Kits are sent complete in every detail.
H. & B. Kits contain full-size blueprints.
H. & B. Kits are sent always carriage paid.

Put this address out and paste it on your envelope. It will save time:

H & B RADIO CO.,
34, 36, 38 BEAK STREET,
LONDON, W.1.

SCREENS

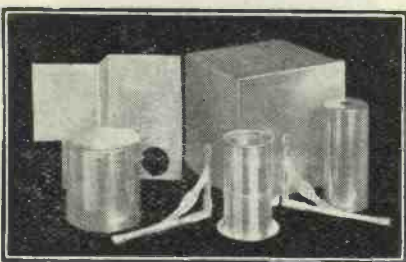

COILS

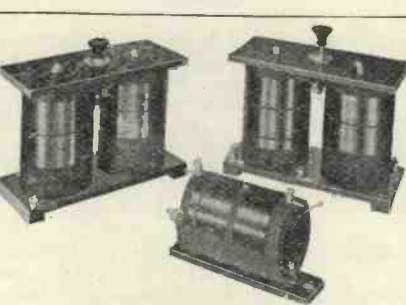

Any kit made up to your specification if desired. Quotations by return.
Carriage Paid on All Orders accompanied by Cash
C.O.D. Charges Paid on orders over £1.

SCREENS

Every screen made of heavy gauge British aluminium, exactly to specification, and supplied with necessary earthing tags and screws.
Every screen listed below is in stock and can be despatched immediately.

	s.	d.
Standard 10 in. by 6 in., with two terminals	1	8
Lodestone 8 and 4"	1	8
James S.G. Quality 5" set	5	6
Brookmans 3"	2	0
Brookmans 4" set	5	6
Sunshine Portable	1	6
Clarion 1930 3"	1	6
"Interceptordyne" and foil	5	6
"Ether Searcher" panel screen and base	11	6
"Music Leader" Box	5	6
"Horizon Four"	2	0
"Continental Portable"	1	6
"James S.G. Portable" chassis	9	6
Challenge Four with Foil	3	6
Challenge Three with Foil	2	6
Challenge Radio-Grand with Foil	2	6
Short-wave Adaptor with valve-holder attached, 8 in. by 7 in.	3	6
Regional A.C. Five (2), boxes and foil	19	6
Regional A.C. Four	2	6
Five Point Three	2	9
Falcon A.C. Three	1	6
New Brookmans Three	1	6
Five Point Four, with valve-holder fitted	2	6
Regional Band Pass Four	2	6
Aluminium Cabinet for Five Point S/W Three, complete with 5-ply baseboard covered with foil	18	6

Any screen or screening box made to any specification; quotations given by return.

TO H. & B. RADIO,
Please send me by return, post free, one of your leaflets giving full details of the Receivers described in the W.M. supplement.

Name

Work Letters.

When you send your order don't forget to say you "saw it in the 'W.M.'"

TESTS OF NEW APPARATUS

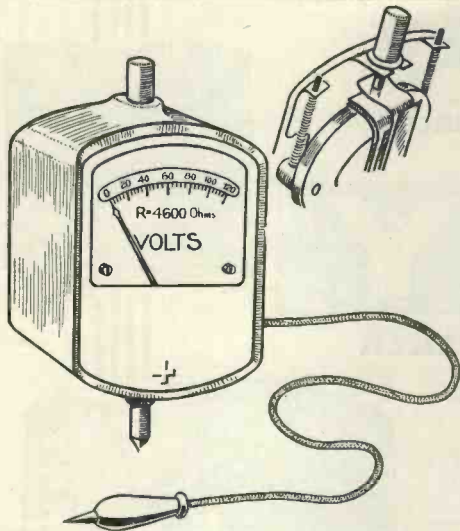

AN INGENIOUS METER

This is a new Ripault dual-range voltmeter. In the top right-hand corner is shown the press-button mechanism for bringing either of two scales in use

RIPAULT METER

MULTI-SCALE meters are enjoying wide popularity at the present time, owing to the save in cost as against two or three instruments performing a single function.

We have just received for test a rather ingenious double-range pocket voltmeter, marketed by Ripault's, Ltd., of Kings Road, N.W.1. This appears to be a single-range voltmeter, having a scale reading from 0 to 120 volts, and the standard fixed and flexible prod connections. A press button at the top, however, not only alters the range, but changes the scale to read from 0 to 6 volts, and thus avoids a multiplicity of scales.

The possibility of burning out the meter, by connecting it across an H.T. battery on the L.T. scale, is unlikely to occur, owing to the necessity for depressing the push-button to its lowest point in order to obtain an L.T. reading. Should the button slip while making the test no harm will occur, as the meter will then be operating on the 120-volt scale.

Degree of Accuracy

Tested against our standard laboratory instrument, this meter was found to be accurate on the low-tension range to within 2 per cent.; the H.T. range, however, read some 8 per cent. low. This is not an exceptional error for a moving-iron instrument. The total resistance is 4,600 ohms, which works out at a resistance of 38 ohms per volt. When measuring 120 volts on the meter the current consumption will be 26 milliamperes. This is a well-constructed instrument, and has several ingenious features.

COLASSION LOUD-SPEAKERS

WITH the object of producing a loud-speaker capable of giving good quality at a reasonable price, the Colassion models have been produced by W. L. Colassi, of Mark Lane Station Buildings, E.C.3. The first model we tested was the Colassion Junior, price £5. This was tried on a small two-valver and on our standard power amplifier. As a result of tests we can say that the sensitivity is above the average.

The cabinet of this cone loud-speaker has been designed to eliminate "boominess." It is nearly one inch thick. The overall dimensions are 19¾ in. by 19¾ in. by 10½ in. The cone diaphragm is driven by a reed movement having an exceptionally large permanent magnet. The whole construction is robust and the workmanship praiseworthy.

In view of the fact that a reed movement is used instead of the more usual balanced armature, we were particularly interested to note that considerable power could be handled without reed chatter. As regards sensitivity, the Colassion Junior was well up to standard.

constructors. We were very satisfied with the performance of the chassis as regards both sensitivity and frequency response.

SANS PICK-UP!

MANY interesting demonstrations of the advance made in the design of loud-speakers, pick-ups, and home-recording apparatus were demonstrated by Mr. S. G. Brown, of S. G. Brown, Ltd., during a lecture given by him at the Institute of Electrical Engineers recently.

Probably the most interesting exhibit of the evening was a novel method of reproducing gramophone records on a loud-speaker without the use of an intermediate amplifier or electromagnetic pick-up. The latter was replaced by a new differential microphone, which consists of carbon granules placed each side of a centre disc similar to that in an ordinary mechanical soundbox.

Good Volume and Quality

This microphone, connected in series with the loud-speaker and a 6-volt accumulator, gave results that compared favourably with that of many electromagnetic types of pick-up. Volume was good and the quality, taking into consideration that the idea is in its infancy, was quite passable.

Mr. Brown then showed his recent developments with home recording apparatus. The recorder consisted of a circular plate about 6 ins. in diameter that was kept revolving by a spring motor in which the gearing had been lowered in the ratio of three to one in order to secure greater power in the drive.

A pick-up was carried on the end of a hinged arm which was screwed steadily forward at about 100 threads per inch.

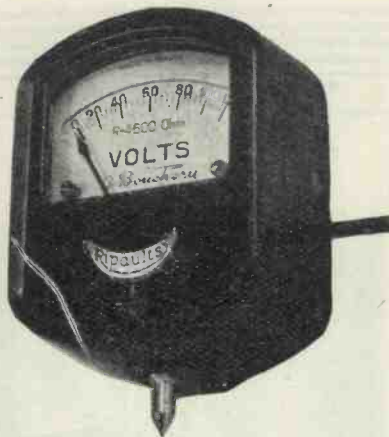

NEAT IN APPEARANCE

This photograph shows how neat is the moulded case of the Ripault dual-range voltmeter

Tested with a frequency record, the response of this model was found to be quite constant over the greater part of the audible range, especially between 350 and 4,500 cycles. The response appeared to be accentuated on the lower register. Altogether the tone was very pleasing.

The Colassion Hyper loud-speaker is a more expensive model, price £10. The Hyper impressed us with its power-handling capabilities. The full output of the amplifier was handled without distress. Quality of reproduction was excellent.

For constructors, the Colassion chassis, price £5, is available. The massive unit and robust workmanship of this powerful chassis will make a great appeal to

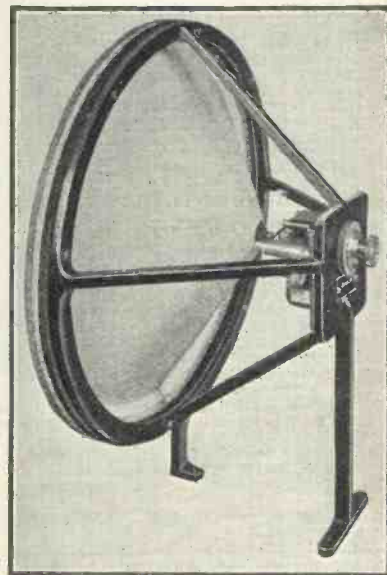

A CONSTRUCTOR'S CHASSIS

This Colassion chassis was found to give excellent results on test. It has a massive unit

“—exclusively used with unfailing reliability”

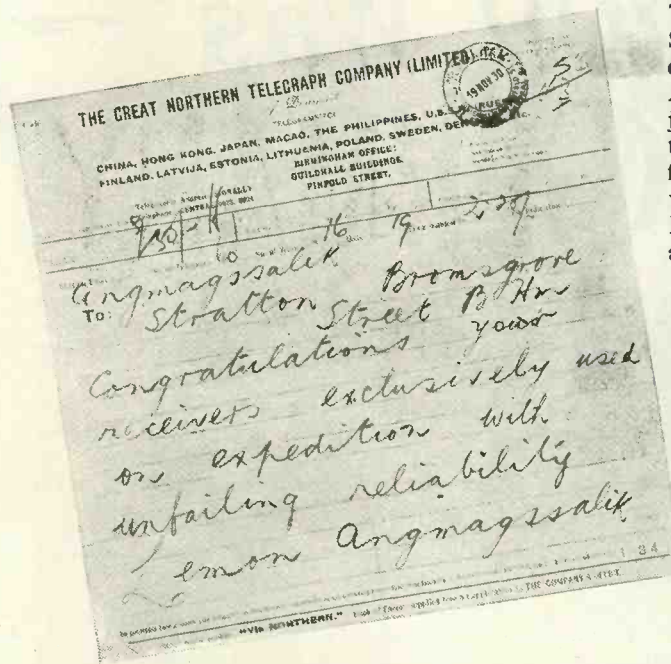

The “EDDYSTONE” ALL-WAVE FOUR SHORT-WAVE RECEIVERS which were exclusively chosen by the BRITISH ARCTIC AIR ROUTE EXPEDITION are more than justifying the confidence placed in them, as this remarkable telegram indicates. To give faultless service throughout the gruelling vicissitudes of an expedition to uncharted Polar regions is testimony to the efficiency and reliability of the

EDDYSTONE

ALL-WAVE FOUR SHORT-WAVE RECEIVER

A set designed for use in any climate of the world, and adaptable for all wavelengths between 12.5 and 2,000 metres. Provides Loud-speaker reception of short-wave or broadcast stations of all continents. Perfect short-wave reception without capacity effects and with smoothest reaction control. Simple to use and nothing to go wrong. Headphones can be used on three valves only and jack for gramophone pick-up insertion is fitted. Eliminators can be supplied for H.T. from D.C. or A.C. mains.

With valves, leads, grid-bias battery, short-wave coils 12.5-85 metres and broadcast coils 250-550 metres.

PRICE £27

Write for list No. W.M.23 giving full details

STRATTON & CO., LTD., BROMSGROVE ST., BIRMINGHAM
LONDON SERVICE DEPOT: C. WEBB LTD., 164 CHARING CROSS ROAD, W.C.2

VOXKIT JUNIOR

(Registered Design)
RADIO Console Cabinet as illustrated. Takes panels up to 18" x 12", 8" x 12" baseboard. Speaker Chamber 18" x 15". Overall height 3 ft. Lift-up lid, removable back. Handsome fret fitted with silk. Made in the best figured oak, french polished. Price 45/-. Packing and carriage free to any part of England and Wales. Any type of loudspeaker fitted free at the cost of the speaker only.

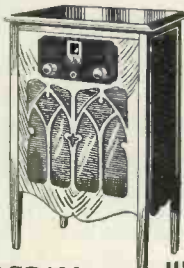

VOXKIT RADIOGRAM

Fitted with Motor, Pick-up and Volume Control. Prices from £4.15. Carriage free. Send for free illustrated leaflet.

PETO-SCOTT CO. LTD.
77 CITY ROAD, LONDON, E.C.1
62 HIGH HOLBORN, LONDON, W.C.1

FARRAND INDUCTOR



COME AND HEAR

THE BEST Speaker IN TOWN

£3 10 From Stock

WILL DAY LIMITED
19 LISLE STREET, W.C.2 Regent 0921

BUY—

“AMATEUR WIRELESS”
3d. Weekly

(PAREX)

SCREENS COILS
Products PAR-EXcellence

as used and specified in the

“NEW BROOKMANS THREE”

Special screen with hole, 2/9
Screened Grid valve holder, 2/-

“DUAL SCREEN FIVE”

Special screening box.
Aluminium, 17/6; copper, 27/6

“JAMES' S.G.3 PORTABLE”

Special chassis drilled and bent ready for use, 10/6
Dual Wave Coil, 10/6

“FALCON THREE”

Special imitation wood aluminium panel, 7/6
Aluminium screen, 2/9
Screened Grid valve holder, 2/-

“FIVE POINT SHORT WAYER”

Special thick aluminium cabinet with foil-covered baseboard, 21/-

“REGIONAL BAND PASS FOUR”

Special aluminium screen, 4/6
Ditto for REGIONAL A.C.4, 4/6

“FIVE POINT THREE”

Special aluminium screen, 4/-

Screens and Metal Cabinets for all circuits

E. PAROUSSI

10 Featherstone Bldgs., High Holborn, W.C.1
Phone: CHANCERY 7010

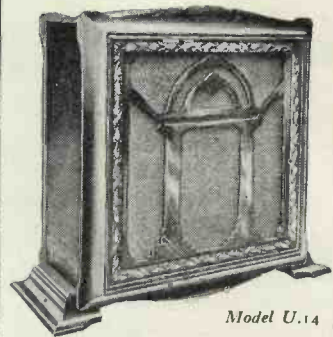

Model U.14

SPECIFIED FOR THE DUAL-SCREENED 5

IN designing the Dual-Screened 5, it was felt it deserved the best speaker—so an Ultra Air Chrome Double Linen Diaphragm Speaker (Model U.14, price £5:5:0) was specified. This model gives wonderful tone and volume, bringing into Radio the thrill that real Music alone can give.

Chassis Models from 37/6, Cabinet Models from 50/- All of Ultra quality.

ULTRA

ULTRA ELECTRIC LIMITED,
661/3, Harrow Rd., London, N.W.10

Mention of the “Wireless Magazine” will ensure prompt attention

Read This Article Carefully and You Will Know



Enjoying reception with a Marconiphone receiver and loud-speaker

That Was — GERMANY!

Another title for this article by J. GODCHAUX ABRAHAMS might be "Broadcast German Without Tears." The author is an acknowledged authority on Continental broadcasting and has considerable linguistic abilities. In these notes he explains just the few words and expressions needed to identify German transmissions without any doubts. Last month French words and phrases were explained

"WAS that Germany?" is a question which you must have asked yourself many times in the course of a single evening. Did you get a satisfactory answer?

You were listening to the local station and then, your fingers idly twirling the dials—only a slight movement, perhaps—you heard a transmission which held your interest for a while. It was a foreigner. On that point you were certain, but—well, your knowledge of languages is, shall we say, weak? Was it a German, or —?

Distinguishing Signals

Last month I tried to give you a few pointers which might help you to identify a French station; I think it is possible to show you how to distinguish whether the signal heard emanated from Germany, Austria, Switzerland, or whether a Swede, Dane, Dutchman, Italian, Spaniard, or Czech was responsible for the broadcast.

If you tuned in just as the station came on the air you could solve your problem immediately for it is the German only who uses the word *Achtung* (phon. : *Ar-toong*) in front of his call; the Austrian, Swiss, and Dutchman say *Hallo*. But possibly you did not pick up the call or, alternatively, no mention was made of any particular city or town.

Germans, in their language, are very fond of abbreviations; it is true that they are popular on this side of the Strait, but in their case it is a necessity if too much time is not to

be wasted, as words of fifteen and even twenty letters are currently used in ordinary conversation.

For this reason, therefore, wherever possible these unwieldy sounds are curtailed. Take as an example the call you get from the new Mühlacker (Stuttgart) transmitter. How would you like to hear, at regular intervals—*Hier Sueddeutsche Rundfunk Aktiengesellschaft, gruppe Stuttgart (or Mühlacker) und Freiburg-im-Breisgau?*

No, it has been gratefully shortened to *Hier Suedfunk* and such shortened calls apply equally to Berlin (*Funkstunde*), Hamburg and relays (*Norag*); Langenberg - Cologne - Aachen - Muenster (*Coeln*), the Leipzig group (*Mirag*), and others.

The literal meaning of the word *funk* is spark, and was first adopted by wireless-telegraphy stations, hence *Bordfunke* ("Sparks," the operator on board ship). When it came to telephony another term had to be found, and *rundfunk* was coined to denote broadcasting.

Teutonic Roots

With very few exceptions the Germans are averse to the importation of words of foreign origin into their language and prefer to work out their own terms, putting aside the Latin and Greek in favour of Teutonic roots. As an example, although the word telephone is understood from the borders of the Baltic down to the Swiss frontier, and from the western to the eastern boundaries, officially it is only known

as *Fernsprecher* (distant speaker), a very clumsy expression.

Stunde (*shtoonde*), actually "hour," is also used in this sense. From Berlin you will hear *Funkstunde* (spark hour), which, as the name of the authorised body controlling the various stations becomes a synonym of *Rundfunk*; Munich calls itself *Die Deutsche Stunde in Bayern* (the German broadcast hour in Bavaria).

Some Other "Funks"

Funk is coupled to many other words, for instance, *Schul* (*shool*) *funk* or broadcast to schools, and *Sport* (*shport*) *funk*, needing no translation. *Kinderfunk* (Children's hour) will also be heard during the afternoon.

Again, you cannot listen to a German station for long without hearing such a word as *Musik* (*moo-zeek*). You will find it in conjunction with *Unterhaltung* (entertainment) or light popular compositions; *Opernmusik*, from operas, especially during the later evening hours; and *Tanzmusik*, which you may translate for yourselves.

Here I must draw your attention to the pronunciation of certain letters of the alphabet. It is not a difficult task and should assist you greatly in understanding words heard. They are not difficult and can be easily memorised.

A as in father, *e* as ay, *g* (hard) as gay, *j* as y, *v* equals *f*, and *w* is the English *v*. Bear in mind that the German *u* is pronounced *ou* except

(Continued on page 110)

Here's why you should use this PICK-UP—

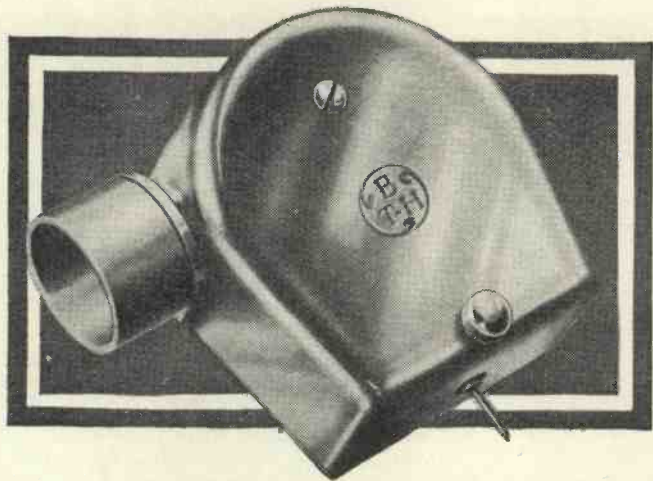

... it is chosen by the experts

PRICE

with 4 Adaptors

27/6

THE



PICK-UP
and ADAPTORS

The B.T.H. Pick-Up is always used where perfect reproduction is vital. Experts are unanimous in their choice of Pick-Up. They have proved that the carefully balanced design of the B.T.H. Pick-Up ensures the finest reproduction with minimum record wear.

Your records cannot give of their best until they are reproduced with the aid of a B.T.H. Pick-Up. Fitting necessitates no alterations to your machine because the four adaptors supplied with the B.T.H. Pick-Up fit any standard tone arm.

Voted the best in its class

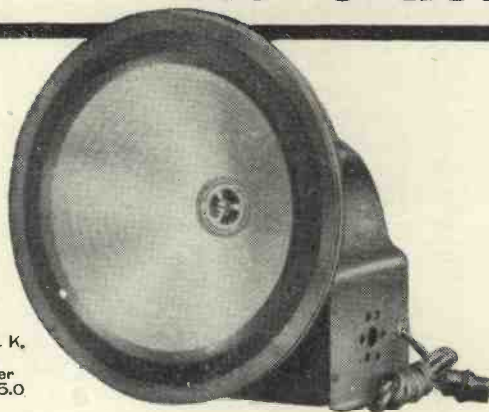

SENIOR R.K. UNIT
Without rectifier
Price - £6.15.0

JUNIOR R.K. UNIT
Price - £4.15.0

PERMANENT MAGNET R.K. UNIT
Price • £6.15.0

SENIOR R.K. UNIT (illustrated) with built-in rectifier for A.C. Mains Field Excitation. Price - 10 Gns.

The B.T.H. R.K. Senior Reproducer was recently voted the best in competition with eight other makes of moving coil speakers—another instance of R.K. leadership. For over four years B.T.H. R.K. Reproducers have set the standard of first-class reproduction by which other speakers are judged. No other reproducers have such absolute fidelity, such infinitely variable volume without sacrifice of tonal quality. **Make your choice from the R.K. range.**

B.T.H.



REPRODUCERS



THE EDISON SWAN ELECTRIC CO. LTD.
Radio Division,
1a Newman Street, Oxford Street, W.1
Showrooms in all the Principal Towns

EDISWAN W.124

Advertisers like to know you "saw it in the 'Wireless Magazine'"

THAT WAS GERMANY!—Continued

where modified with the two dots, in which case it is the sound you know in *Mueller*. Also *s* followed by *t* can be rendered as *sht*-and.

The last letter of the alphabet, *z*, is hard, as if preceded by a *t*. The word *Zeit* (time), therefore, would be *tsite*, *ei* being equal to a long *i*.

Frequent Words

Whilst on this point may I give you examples of other words which occur frequently? They are *Konzert* (*kontzert*), *Zeitung* (*tsi-toong*) newspaper, *Tanz* (dance), and *zwischen-sender* (*tswishenzender*), relay station.

transmitting station; *Sendung*, the transmission proper; and *Programm*, which although apparently misspelt, is the synonym of our word for the same object.

On more than one occasion an announcer has told you *Wir bringen zunachst eine Uebertragung aus* (or *von* (as the case may be) followed by the name of a city or of some concert hall; possibly also a theatre or cabaret may have been mentioned.

Just analyse that German sentence, it's so simple. You can guess the first word. Yes, it's "We." *Zunachst* means "next" and *uebertra-*

Gramophone records, as you know, are largely used in Continental studios; in the German programmes they are a regular daily feature. They will be referred to as *Schallplatten* (sound plates), or if the name of the make is given it will appear as a direct translation, namely, H.M.V. (His Master's Voice) becomes *Die Stimme seines Herrn*.

Familiar Announcements

Certain announcements such as *Meine Damen und Herren* (ladies and gentlemen) must be familiar to all; it is a phrase not only used at the end of the transmission before the final *Gute Nacht* greetings, but by almost every lecturer who prefaces a talk in this manner.

However, there are exceptions, for if he desires to be less formal and more familiar he may address his unseen audience as *Liebe Hoerer und Hoerinnen*.

In English we only possess the word *listeners* as a general appellation, in German, as you see, there is a distinction of sex.

Flowery Speeches

At times, too, the studio announcer is inclined to be flowery in his speech; he will introduce a *Vortrag* (lecture) "to my respected or revered listeners" in the most starchy and ceremonious manner; at other times, such as when he compères a cabaret, he takes on the duties of what is styled in Teutonic circles a *conférencier* and generally endeavours to give an atmosphere of gaiety to the proceedings.

It is a curious fact that although *conférencier* is the French term for lecturer, in Germany it loses its true meaning entirely and merely denotes any person acting as M.C. to a variety show or cabaret. As an announcer in the studio he is a mere *Ansager*.

Announcing Music

If your receiver is one which brings in Continental transmission on many evenings you will have captured a concert from abroad. The speaker charged with the duty of giving to the listeners details of the programme will have said a few words regarding the orchestra, its conductor, the vocalists or instrumentalists.

(Continued on page 112)

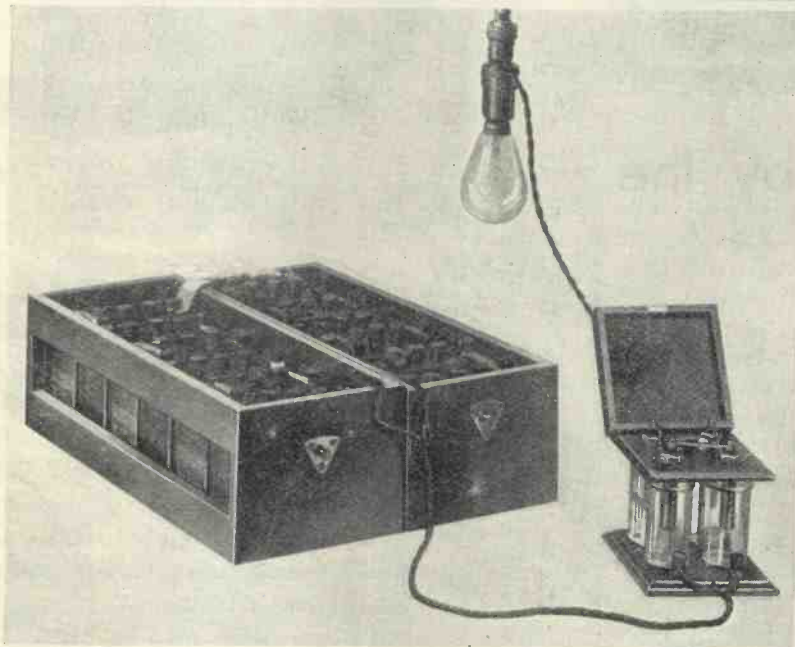

CHARGING H.T. ACCUMULATORS FROM A.C. MAINS

Those with high-tension accumulators and A.C. mains will be interested in the Young chromal rectifier, which costs only £1 5s., complete with series lamp holder. The charging rate is controlled by the wattage of the lamp used and the liquid in the rectifier is non-acid and non-inflammable

Syncopated Melodies

The German announcer when informing you that syncopated melodies will be put over invariably uses the word *jazz* and its pronunciation at most studios is an exceptional one, namely, a sound like *yatz*, usually followed by a well-known fox-trot number. The Teuton in his term makes no distinction between the nigger jazzy atrocity and the more melodious dance tune much more in favour to-day.

Some expressions, you will have noted, require little explanation; of such are *Sender* as applied to the

gung indicates "relay." And there you have it. "We bring you next a relay from (or of)." If it is a dramatic performance, the word *Theater* (*lay-ar-ter*) follows, if a concert, possibly *Konzertsaal* or *Festsaal* (French: *Salle des Fêtes*), literally *Fête Hall*, or again, *Kursaal*, which is the hall attached to a *Kurhaus* or the principal place of entertainment in any watering, sea-side, or health resort; actually, the cure-house or, usually, pump-room.

Here you see how many English and German words possess the same origin.

**YOU CANNOT GO WRONG
IF YOU USE A**

FULL-SIZE BLUEPRINT

CRYSTAL SET
6d., post free
Regional Crystal Set .. WM176

ONE-VALVE SETS
All these 1s. each, post free.
Special One .. WM116
Hartley Single One-Valver .. WM198

TWO-VALVE SETS
All these 1s. each, post free.

Ether Ranger (D, Trans) .. WM156
Brookman's Two (D, Trans) .. WM168
A.C. Two (D, Trans) .. WM175
Programme Two (D, Trans) .. WM177
New Crusader (D, Trans) .. WM182
Radio-Record Two (SG, D) .. WM187
Gleaner Two (D, Trans) .. WM201
Music Monitor (D, Trans) .. WM208
Merlin Two (AC Set) (D, Trans) .. WM213
Five-Point Two (D, Trans) .. WM220
★Brookman's A.C. Two (D, Trans) WM225

THREE-VALVE SETS
All these 1s. each, post free.
Lodestone Three (HF, D, Trans) .. WM129
Brookman's Three (SG, D, Trans) .. WM161
Community Three (D, RC, Trans) .. WM164
New Q3 (SG, D, Pentode) .. WM167

A blueprint of any one set described in the current issue of the "Wireless Magazine" can be obtained for half-price up to the date indicated on the coupon (which is always to be found on page iii of cover) if this is sent when application is made. These blueprints are marked with an asterisk (*) in the above list and are printed in bold type. An extension of time will be made in the case of overseas readers.

Brookman's Push-pull Three (HF, D, Trans), 1s. 6d. .. WM170
Celerity Three (SG, D, Trans) .. WM173
All-nations Three (D2, Trans) .. WM178
Inceptordyne (SG, D, Pen.) .. WM179
Brookman's A.C. 3 (SG, D, Trans) 1/6 .. WM184
Music Marshal (D, 2 Trans) .. WM190
Gramo-Radio D.C. Three (SG, D, Trans) WM196
Concert Three (D, 2 Trans) .. WM199
New Lodestone Three (HF, D, Trans) WM205
De-Luxe Three (D, RC, Trans) .. WM209
Five-Point Three (SG, D, Trans) .. WM212
Falcon Three (AC Set) .. WM217
New Brookman's Three (SG, D, Trans) WM218
Five-Point Short-waver (D, 2 Trans) WM223
★Baffle-board Three (D, RC, Trans) WM226

FOUR-VALVE SETS
All these 1s. 6d. each, post free.
Standard-coil Four (HF, D, 2RC) .. WM122
The Drum Major (HF, D, RC, Trans) WM137
Music Player (HF, D, RC, Trans) .. WM144
Arrow Four (SG, HF, D, Trans) .. WM154
All-electric Four (SG, D, RC, Trans) .. WM162
Outpost Four (SG, D, 2 Trans) .. WM165
Brookman's Four (2SG, D, Trans) .. WM174
Transportable Four (SG, D, 2RC) .. WM180
Super Q (SG, D, 2 Trans) .. WM189
Lodestone Four (HF, D, RC, Trans) .. WM193
Searcher's Four (SG, D, RC, Trans) .. WM194
Invitation Four (SG, D, RC, Trans) .. WM200
Regional Band Pass Four (SG, D, RC, Trans) .. WM211
Five-Point Four (SG, D, RC, Trans) WM216
Regional A.C. Four (SG, D, RC, Trans) WM222
★Supertone Four (SG, D, Push-pull) WM227

FIVE-VALVE SETS
All these 1s. 6d. each, post free.
All-wave Lodestone Five (HF, D, Push-pull) .. WM146
Dual-screen Five (2SG, D, RC, Trans) WM185

Radio-Record Five (SG, D, Trans-Parallel) .. WM188
Overseas Five (3SG, D, Trans) .. WM191
Regional A.C. Five (3SG, D, Trans) WM224

SIX-VALVE SET
Hyperdyne (Super-het) .. WM221

PORTABLE SETS
Wayfarer Portable (Super-het) .. WM139 1/6
Pedlar Portable (D, Trans) .. WM195 1/-
Pedlar Portable (D, 2 Trans) .. WM197 1/-
James Portable SG3, (SG, D, Trans) .. WM203 1/-
Foursome Portable (SG, D, 2 Trans) WM206 1/6

AMPLIFIERS
All these 1s. each, post free
Auditor Amplifier .. WM132
Concentrator (HF Unit) .. WM169
Radio-Record Amplifier (DC Mains) .. WM183
Universal Push-pull Amplifier .. WM204
Selecto Amplifier (HF Unit) .. WM210

MISCELLANEOUS
"W.M." Linen-diaphragm .. WM172 1/-
Trimmer (Selectivity Unit) .. WM181 -/6
Brookman's "Wipe Outs" (Wave-traps) .. WM186 1/-
Staminator Unit for A.C. Mains .. WM202 1/-
Outspan Short-wave Adaptor .. WM207 1/-
"W.M." Standard A.C. Unit .. WM214 1/-
"W.M." Standard D.C. Unit .. WM215 1/-
Falcon A.C. Unit .. WM219 1/-
★Hyperdyne S.W. Adaptor .. WM228 1/-

Each blueprint shows the position of each component and every wire and makes construction a simple matter. Copies of "Wireless Magazine" containing descriptions of all these sets can be obtained at 1s. 3d., post free. Index letters "W.M." refer to "Wireless Magazine" sets.

Send, preferably, a postal order (stamps over sixpence in value unacceptable) to

Wireless Magazine

BLUEPRINT DEPT.
58/61 FETTER LANE,
LONDON, E.C.4

"AMATEUR WIRELESS" HANDBOOKS 2/6 each net.

Of all Newsagents and Booksellers, or 2/9 post free from Cassell and Company, Limited, La Belle Sauvage, London, E.C.4

THE SHIELDED FOUR-ELECTRODE VALVE Theory & Practice. By H. J. Roubh, M.C.

Capt. Round is one of the greatest authorities in the world on radio science and practice, and his book is a complete guide to the principles under which this latest and most remarkable valve should be operated.

WIRELESS-CONTROLLED MECHANISM For Amateurs. By Raymond Phillips

This book is an illustrated practical guide to the making and using of short-range wireless control apparatus, and it has been written so simply that it can be understood by any enthusiast possessing an elementary knowledge of wireless.

THE PRACTICAL "SUPER-HET" BOOK

Explains what the Super-het is, what it does, how it works, and how to build a number of super-het sets made of tested, British-made components.

THE SHORT-WAVE HANDBOOK

By Ernest H. Robinson (5YM)

Describes in very simple language the wireless apparatus used in short-wave work, shows how to make and how to use it, and explains the technical principles with which the beginner will need to become acquainted.

THE PRACTICAL WIRELESS DATA BOOK

The intelligent novice, and particularly the home constructor and the keen wireless amateur who is always rigging up different circuits and experimenting for progress, will find this Data Book extremely helpful.

THE BOOK OF THE NEUTRODYNE

By J. H. Reyner, B.Sc. (Hons.), A.M.I.E.E.

Contents: Why Neutralising is necessary; Systems of Neutralising; Difficulties Encountered in Neutralised Circuits; How to obtain Good Selectivity Without Loss of Quality; Design of High-Frequency Transformers; Lay-out in Neutralised Receivers; Some Suitable Circuits.

Price 1/6 net, or post free for 1/9

BLUEPRINT COUPON

Valid only until February 28, 1931 (or until March 31, for overseas readers)

If you want a full-size blueprint for any one of the sets constructionally described in this issue for half price, cut out the above coupon and send it, together with a postal order, to Blueprint Department, WIRELESS MAGAZINE, 58-61 Fetter Lane, London, E.C.4

This coupon is valid for a blueprint of any one of the following at the prices indicated:—

BAFFLE-BOARD THREE (page 36), No. W.M.226, 6d., post free.

BROOKMAN'S A.C. TWO (page 55), No. W.M. 225, 6d., post free.

SUPERTONE FOUR (page 73), No. W.M.227, 9d., post free.

HYPERDYNE SHORT-WAVE ADAPTOR (page 96), No. W.M.228, 6d., post free.

INFORMATION COUPON

Valid only until February 28, 1931 (or until March 31, for overseas readers)

If you want to ask any questions cut out the above coupon and send it, together with a postal order for 1s. and stamped addressed envelope, to the Information Bureau, WIRELESS MAGAZINE, 58-61 Fetter Lane, London, E.C.4.

Note that not more than two questions must be asked at a time and that queries should be written on one side of the paper only.

Under no circumstances can questions be answered personally or by telephone. All inquiries must be made by letter so that every reader gets exactly the same treatment.

If you want advice on buying a set a stamped addressed envelope only (without coupon or fee) should be sent to Set Selection Bureau, WIRELESS MAGAZINE, 58-61 Fetter Lane, London, E.C.4.

THAT WAS GERMANY!

(Continued from page 110)

An ordinary or "common" band-master is a *Kapellmeister*; if of a better quality, he may be called a *Dirigent*, but if famous it will be stated that the *Orchester ist unter der Leitung von* . . . (under the direction of). Now it is in such circumstances that you will stumble across sentences which puzzle you.

Similarly to the principle adopted by the B.B.C., important transmissions of more than local interest are simultaneously broadcast by a number of regional and relay stations. In such cases you would get the call and a series of other towns taking the S.B. included as *angeschlossene Sender* (connected transmitters).

Before Switching Back

Then, later, previous to their switching back to their individual programmes, you would pick up words to this effect:—*Nach kurzem Pause kommen alle Sender programmässig mit ihren eigenen Uebertragungen wieder* (after a short interval all stations will come on the air again with their individual transmissions).

But few German studios run a continuous non-stop programme; in most of them there are short waits during which an interval signal is broadcast. Usually before this is done the announcer will say:—*Die Musik uebertragung aus . . . or Der Vortrag von Herrn Doktor X ist beendet or am Ende. Auf Wiederhoeren um . . .* (the musical programme from . . . or the talk by Doctor X—they are all doctors in Germany!—is ended).

Coined Expression

Auf Wiederhoeren is an expression which was coined shortly after the advent of broadcasting in Berlin some years ago. The experimental "fan" morsed C U L (see you later), but as in broadcasting it was a question of hearing some other formula had to be discovered to convey a similar idea. Hence, "to our further hearing at . . ." and then follows the ticking of the metronome or whichever signal has been adopted to fill the gap.

Running commentaries on sporting events are also popular features; for the word "commentary," however, *reportage* is used.

INDEX TO ADVERTISERS

	Page
Bakers Selhurst Radio	10
Belling & Lee, Ltd.	22
Benjamin Electric, Ltd.	2
Borst, Charles, & Sons	7
British Ebonite Co., Ltd.	18
British Blue Spot Co.	85
British General Mfg. Co.	22
Brodersen, A.	103
Bulgin, A. F., & Co., Ltd.	21
Burne-Jones, Ltd.	3
Burton, C. F. & H., Ltd.	103
Carrington Mfg. Co.	97
Chloride Electrical Storage Co.	13
Colassi, W. L.	11
Columbia Gramophone Co., Ltd.	5
Cossor, A. C., Ltd.	89
Day, Will, Ltd.	107
Dubilier Condenser Co., Ltd.	97
Eastick, J. J.	10
Edison Bell, Ltd.	9
Edison Swan Electric Co., Ltd.	9
Electradix	Cover iv, 109
Emkabe Radio Co., Ltd.	10
Epoch Mfg. Co.	11
Ever Ready Co. (Gt. Britain), Ltd.	14
Ferranti, Ltd.	93
Fluxite, Ltd.	9
Forno Co.	6
Franklin Electric Co.	92
Garnett Whiteley & Co., Ltd.	10
Garratt Stores	18
Gilbert, J. C.	2
Graham Farish	103
Gripso Co.	2
H. & B. Radio	10
Hayberd, F. C., & Co.	15, 105
Hegra	3
Igranic Electric Co., Ltd.	10
Jackson Bros.	87
Kingstophone Co., Ltd., The	7
Lectro Linx, Ltd.	81
Lock, W. & T., Ltd.	2
Loewe Radio Co., Ltd.	2
Limit Engineering Co., Ltd.	99
Lissen, Ltd.	103
London Electric Wire Co. and Smiths, Ltd.	24
Lyons, Claude, Ltd.	Cover ii, 92
M. L. Magneto Synd.	103
Morogoro	18
Morris, J. R.	2
Mullard Wireless Service Co., Ltd.	95
Paroussi, E.	107
Partridge & Mee, Ltd.	23
Pertrix, Ltd.	17
Peto Scott, Ltd.	99, 107
Pickett Bros.	18
Radio Instruments, Ltd.	3
Ready Radio	101
Regentone	94
Rothermel Corp'n., Ltd.	15, 22, 97
Rotor Electric Ltd.	14
Scott Sessions, G., & Co.	10
Six-Sixty Radio Co., Ltd.	6
Stratton & Co., Ltd.	99, 107
Tannoy Products	18
Taylor, A.	14
Telegraph Condenser Co., Ltd.	91
Telsen Electric Co., Ltd.	83, 86
Tungstram Electric Lamp Works, Ltd.	19
Ultra Electric, Ltd.	107
Undy	105
Vandervell, C. A., & Co.	Cover iii
Varley	19
Wates Products	14
Watmel Wireless Co., Ltd.	18
Westinghouse Brake and Saxby Signal Co., Ltd.	21
Wilkins & Wright, Ltd.	23
Wingrove & Rogers, Ltd.	90
Wright & Weaire, Ltd.	11



THE ORIGINAL Jelly Acid Non-Spillable Cell

TYPES and PRICES.

Type	Volts	Cap. at 20 hour rate	Weight Charged	Dimensions (in inches)			Price
				L	W	H	
2NS9	2	10	2 lbs	1 1/4	3 1/2	4 1/4	12/-
2NS13	2	15	2 1/2 lbs	2 1/2	3 1/2	4 1/4	14/6
2NS17	2	20	3 1/2 lbs	3 1/2	3 1/2	4 1/4	16/-
2NS21	2	25	4 1/2 lbs	3 1/2	3 1/2	4 1/4	18/-
2AN7	2	30	5 1/2 lbs	2 1/4	4 1/4	7	16/-

The popularity of the C.A.V. Jelly Acid Battery is not explained by the mere fact that it contains jelly electrolyte—there are other jelly electrolyte batteries! There are three reasons why the C.A.V. is the most effective non-spillable yet produced.

THE JELLY ACID. Its composition is unknown outside our own laboratories. It maintains perfect contact with the whole of the plate surfaces, yet allows unrestricted gassing when on charge. It is chemically pure, and allows maximum conductivity.

THE CONTAINER. Of special construction, contains a baffle plate and moistening pad, which serves the triple purpose of arresting acid spray during charge, feeding the electrolyte with moisture to maintain an even consistency, and definitely confines the jelly to the plate chamber.

THE PLATES. These have been specially developed to give the utmost possible capacity when used with C.A.V. Jelly acid.

THE WHOLE. The C.A.V. is the lightest, cleanest, and most compact non-spillable on the market. By avoiding cumbersome acid traps, the greatest possible capacity for bulk is obtained.

Obtainable from our Depots and Battery Agents throughout the country and from all Radio Dealers.

- AND BEST

May we send you copy of our latest Catalogue giving particulars of all types of C.A.V., H.T. and L.T. Accumulators. Write to Dept. 74

C.A.V. Vandervell & Co. Ltd.
ACTON, LONDON, W 3



ALL POSITION
NON-SPILLABLE



Perfect for Portables

Get that Amazing Performance

The amazingly high efficiency achieved by the Mazda A.C. Series is a topic of conversation where radio enthusiasts gather. You have only to glance at the characteristics to know the reason.

The narrow limits in which Mazda valves are tested and the long production experience of our engineers ensure that with Mazda valves in all positions in your set you will get better results than ever before.

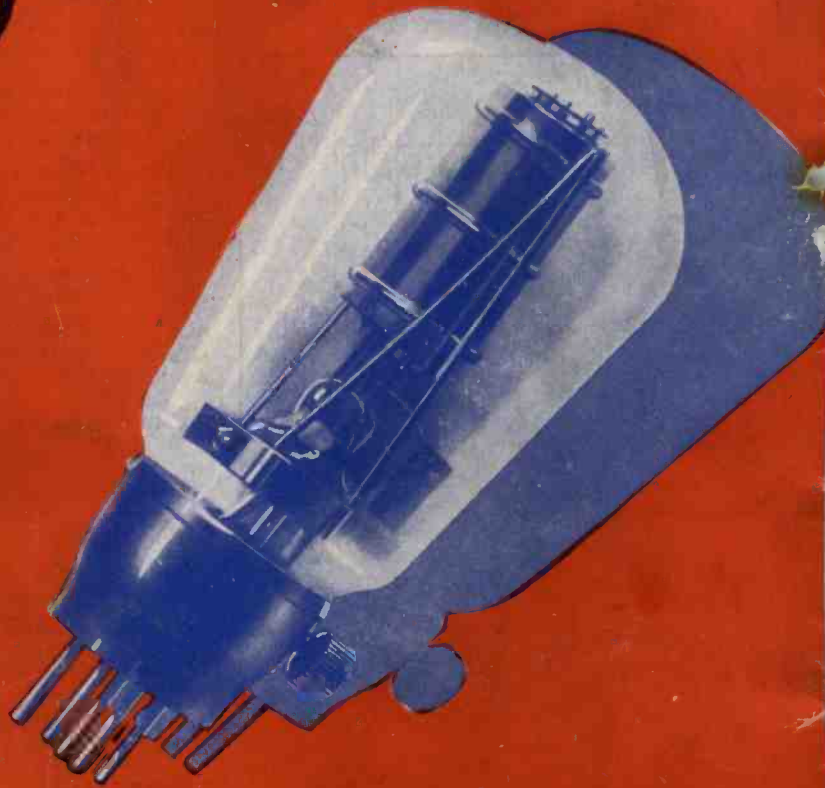

with
THE AMAZING

MAZDA

A.C. VALVES



THE EDISON SWAN ELECTRIC CO., LTD.
*Incorporating the Wiring Supplies, Lighting Engineering,
and Radio Business of The British Thomson-Houston Co. Ltd.*

Radio Division:
1a Newman Street, Oxford Street, W.1
Showrooms in all the Principal Towns

EDISWAN

V 79

	AC/SQ	AC/HL	AC/P	AC/PI	AC/PEN
Fil. Volts . . .	4	4	4	4	4
Fil. Amps . . .	1	1	1	1	1
H.T. Volts . . .	200	200	200	200	250
Aux. Grid Volts . . .	80	—	—	—	200
Magnification	1,200	33	1.0	5	—
Impedance . . .	—	1,700	2,650	2,000	—
Mutual Conductance	3	3	3.75	2.5	2.2
PRICE . . .	25/-	15/-	17/6	17/6	27/6