

Page 7

The Wireless Constructor

AND TELEVISION REVIEW

PRICE
6^D

VOL XIX
NOVEMBER
1934
No. 97



HOW TO BUILD
The
**MIDGET
SUPER**

and
**A
ONE-DIAL
A.C.-D.C. SET**

PACKED WITH INFORMATION



the latest Ferranti literature for home constructors

Full of interest and value, these latest Ferranti lists will prove to be of service to all constructors who desire to have the most up-to-date and efficient receivers.

Wa 560. New complete Valve Catalogue.

Wf 522. New list, Mains Components.

Wa 561. New list, Potentiometers.

Wg 550. New Speaker List.

R 2. New complete catalogue of components.

Wi 526. New catalogue, Radio Meters.

Any of these publications will be sent on receipt of 1½d. stamp, or all of them on receipt of 3d. postage.

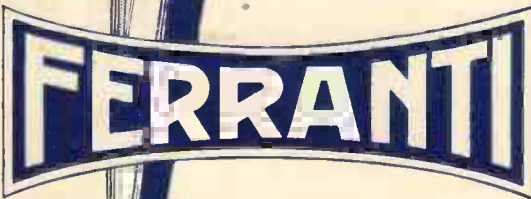

DEPT. C,
FERRANTI LTD.,
HOLLINWOOD, LANCASHIRE

UNIQUE



Prices do not apply in I.F.S.

ONLY "ATLAS" HAS THESE 6 OUTPUTS

THIS wonderful new "ATLAS" T.10/30 is quite unique. It has no less than 6 TAPPED OUTPUTS. This ensures correct H.T. supply to any and every battery set—straight, superhet, Class "B" and "Q.P.P." Not only is it the ideal mains unit for your present set, but it is also the ideal unit for every set you may buy or construct in the future.

In addition to H.T. supply it embodies a trickle-charger to keep your accumulator always fully charged.

FOR A.C. MAINS

H.T. Tappings 60/80 v. (min. and max.) 50/90 v. (min., med. and max.), 120 v. and 150 v. Tapped Outputs 10, 20 or 30 m/A. at 120 or 150 v. Trickle Charger 2 v. at 0.5 amps. Westinghouse Rectifiers. Guaranteed 12 months

H.P. Terms: 10/- deposit and 8 monthly payments of 8/6 each

Ask your dealer to-day for a demonstration.

OTHER MODELS from 39/6 CASH or 10/- Deposit.

ATLAS

MAINS UNITS CLARKE'S "ATLAS"

H. CLARKE & CO. (M/CR.), LTD., Patricroft, Manchester. London: Bush House, W.C.2. Glasgow: G.E.S. Co., Ltd., 38, Oswald St. I.F.S. Distributors: R. Marks Ltd., 27, Upper Liffey Street, Dublin. ©17

POST THIS COUPON NOW

Messrs. H. Clarke & Co. (M/CR.), Ltd., Patricroft, Manchester. Please send me FREE copy of Folder 95, telling me how to run my battery set from the Mains.

Name
Address

CONTENTS

	Page		Page
The Editor's Chat	3	The Battle of the Humps ..	21
Britain's New National Station	4	A One-Dial A.C.-D.C. Set ..	23
"Hotting Up" Your Set .. .	5	The New Broadcasting in Germany ..	27
The Midget Super	7	A Fascinating Novelty ..	28
B.B.C. News	11	Questions I Am Asked ..	30
Schemes for Cutting Out Droitwich ..	13	From Circuit to Layout ..	31
Matching Set and Loudspeaker	15	As We Find Them	33
Short-wave Notes	18	In Lighter Vein	34
Wireless in the Great War ..	19	The B.B.C.'s Convent ..	38

As some of the arrangements and specialties described in this Journal may be the subjects of Letters Patent the amateur and trader would be well advised to obtain permission of the patentees to use the patents before doing so.

PUBLISHED BY THE
AMALGAMATED
PRESS LTD THE
FLEETWAY HOUSE
FARRINGTON STREET
LONDON E.C.4



A sudden noise - or an equally aggravating silence . . . inefficiency somewhere in your set! Take your AvoMinor and find out at once. The AvoMinor is an investment in permanent security, for it is a precision instrument, accurate to a critical degree, and made to stand up to hard usage and even abuse. It is, in fact, a younger brother of the famous Avometer, the instrument used by all the leading manufacturers and their service engineers. With the AvoMinor you can test circuits, valves, components, batteries and power units with the dependable accuracy of the technical expert.

There is no substitute for the AvoMinor. It is a moving-coil combination testing meter—ten accurate instruments in one. Supplied in convenient case with leads and interchangeable testing prods and crocodile clips, and complete instruction booklet adequately illustrated.

Fully descriptive Folder post free from:

THE AUTOMATIC COIL WINDER & ELECTRICAL EQUIPMENT CO., LTD.
Winder House, Douglas Street, London, S.W.1. Telephone: Vic. 3404/7.

TEN ACCURATE METERS IN ONE

- | CURRENT | VOLTAGE |
|-----------------|-------------|
| ● 0.6 milliamps | ● 0.6 volts |
| ● 0.30 " | ● 0.120 " |
| ● 0.120 " | ● 0.300 " |

RESISTANCE

- | | |
|-----------------|-----------------|
| ● 0-10,000 ohms | ● 0-60,000 ohms |
| ● 0-1,200,000 " | ● 0-3 megohms |

40/-

Size 4" x 3" x 1 1/2".
Total Resistance:
100,000 ohms.
Full scale deflection
on 3 milliamps.

Deferred Terms if desired.

THE
D.C.

AVOMINOR

REGD. TRADE MARK

TELLS THE WHOLE TRUTH

"Radio Servicing Simplified"
Everyone should have this invaluable new book. It explains every phase of fault-tracing step by step in non-technical language. The comprehensive information and numerous diagrams make testing a matter of straightforward procedure.

2/6
post free
2/9

For the Midget Super

*the precision
tuning of
the famous*

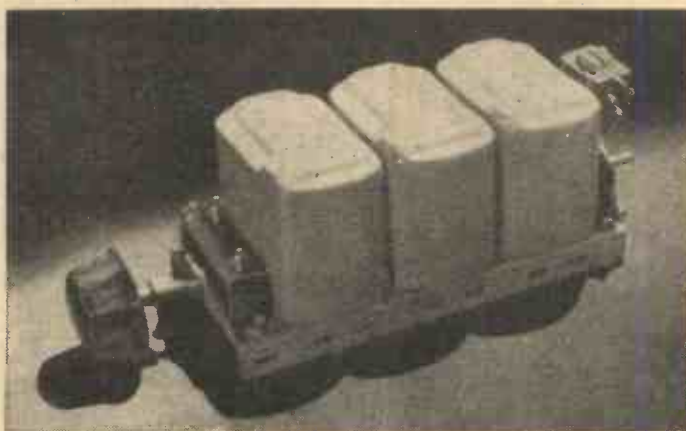

Ferrocart Coils

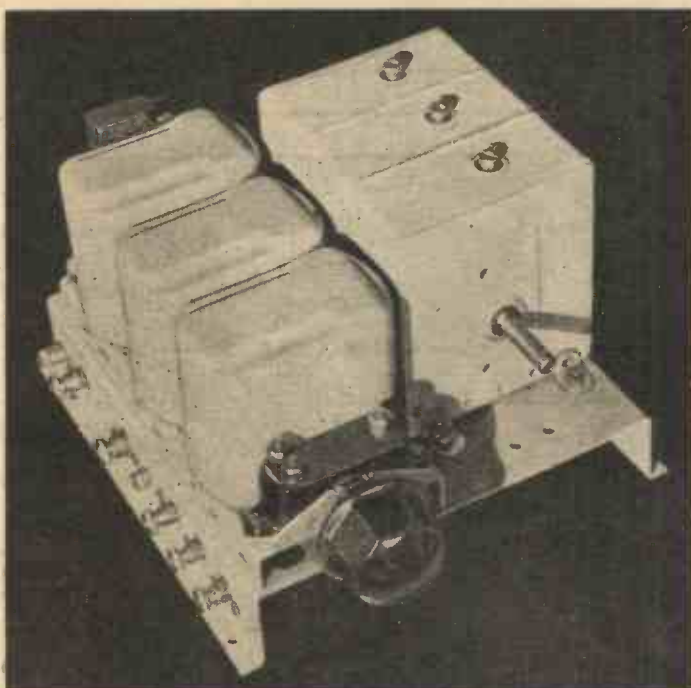

Their unwavering quality, and the fact that they are made to the finest specification known to modern wireless, accounts for the continued preference by experts for Ferrocart coils. Do not compromise with perfect clarity and performance—follow the designer's specification. Exclusively specified, 1 set of Ferrocart coils, G.1, G.2, G.8, complete with battery switch, 39/-.

Also specified

1 Colvern Ferrocart I.F. Transformer, type F.C.110 - 12/6

1 Colvern Ferrocart I.F. Transformer, type F.C.110A, 12/6

Made under licence from the patentee, Hans Vogt.

Write to-day for latest Colvern booklet, Radio List No. 13, to Colvern Ltd., Romford, Essex.

COLVERN

The World's finest tuning unit

COLPAK

Note the compactness, simplicity of design and beautiful finish of the Colpak. With its unequalled efficiency, no wonder it is acclaimed by expert and amateur constructors alike all over the country. Price type H. complete - - - **57/6**

free

BLUEPRINTS OF SPLENDID SPECIALLY DESIGNED SETS

To COLVERN Ltd., Romford, Essex. Please **COLPAK CLASS B** send me full details and Blueprint of the **(A.C. MAINS SET)** ★

★ Strike out name of blueprint: not required.

Stamps value 3d. to cover postage are enclosed.

NAME.....

ADDRESS.....

W.C.I.

If you would like a copy of our Ferrocart Booklet, please put a X here.....

THE
EDITOR'S
CHAT

THE WIRELESS CONSTRUCTOR

AND TELEVISION
REVIEW

An Important Announcement—"The Book of Practical Radio"—A Splendid Free Gift

WE are pleased to be able to announce in this issue important news concerning the future of this journal—news which, we feel sure, will be received with considerable interest by our many thousands of readers.

On November 15th, when you stop at your bookstall to purchase your copy, will you please ask—not for the WIRELESS CONSTRUCTOR—but for—WIRELESS. You will not be asked by the bookstall clerk to pay more than the customary sixpence, but when you look inside the issue we forecast that you will be surprised that you have not been asked to select a shilling from your loose change instead of the smaller coin.

Of Interest to All

To begin with, you will find that our new title WIRELESS lives up to its name. Not only will all constructors find that the issue contains more than ever to interest them, but readers in general will find new features, of a technical and non-technical nature, which will cover every aspect of the hobby of radio. WIRELESS AND TELEVISION REVIEW will be an extraordinarily comprehensive magazine devoted to the interests of all classes of amateurs, experimenters, and listeners.

And, furthermore, the issue of WIRELESS on sale November 15th will include two magnificent free gifts—a most ingenious and practical "Radio Rule," and a full-size 1s. blue print of a new set.

An Exclusive Offer

Readers will also have a great chance of acquiring on the most advantageous terms the latest wireless work written by Mr. John Scott-Taggart, F.Inst. P.—a work which will undoubtedly be eagerly sought after by everyone interested in the art of radio reception.

You will remember "The Manual

of Modern Radio," which we offered at extraordinarily low terms about a year ago? Well, Mr. Scott-Taggart's new volume—which you could not purchase in the normal way under a

"WIRELESS"

and Television Review

Will be the New Title of the
"Wireless Constructor"
next month.

Look out for it on all book-
stalls on November 15th.

Price 6d. as Usual

The indispensable Monthly
Magazine for all set-owners
and
television experimenters.

guinea—will be available at "bargain terms."

"The Book of Practical Radio"—for such is the title given to his new work by the distinguished author—will prove a worthy companion to "The Manual of Modern Radio." In it Mr. Scott-Taggart has invested that wealth of knowledge for which he has been universally acclaimed as one of the few really *leading* authorities in the world. Every phase of radio reception is dealt with in the author's own inimitable style—clear, lucid and fascinating as ever, he places at your disposal the quintessence of over twenty years practical experience. And it is

safe to say that he has written a "magnum opus" of unique value.

Amazing Practical Detail

Every page, every sentence even, bears the imprint of a genuine understanding of the practical problems involved in radio. The author himself has so obviously done everything he writes about—there is no hearsay opinion, no slipshod advice, no evasion of a problem.

Incidentally there are special sections dealing with all the S.T. sets, while throughout the book the practical detail is amazing.

No reader can afford to miss the chance of securing this great new volume. And in our next issue you will see that you can be *absolutely certain* of getting your copy for a very trifling expenditure.

About our practical gift, "The Radio Rule," we do not wish to say too much at this juncture. This gift is so ingenious that it would not be good policy to disclose full details at the moment, but we are confident that when you open next month's WIRELESS and your "Radio Rule" slips into your hand, you will be more than agreeably surprised.

Some Vital News

Finally, we shall make a very important announcement next month concerning Dr. J. H. T. Roberts, F.Inst. P., the distinguished physicist and wireless engineer.

Dr. Roberts' name is a household one. His research work at the Cavendish Laboratory, Cambridge, his many inventions, his wide knowledge of the science of radio and his clear, explanatory style of writing, will be familiar to those who have studied radio literature.

And the news we shall have to tell you about Dr. Roberts next month will undoubtedly make you "sit up and take notice."

BRITAIN'S NEW NATIONAL STATION

The high-power long-wave transmitter at Droitwich which took over the full service from Daventry on October 7th, is now going strong. Here are some details of this new B.B.C. giant broadcaster.

by
P. R. BIRD

BRITAIN'S new National station at Droitwich—which has only just settled down to regular working—has already set a new standard for broadcasting in Europe.

Sweden has ordered a similar station. So has Rumania. And other orders are sure to follow, for Droitwich is already an outstanding success. It is the founder of a new line of high-powered transmitters, superior to their forerunners in both strength and quality.

The Greater Power

As regards sheer strength, the loudspeakers in nearly all parts of the country receive rather more than twice as much input from Droitwich as from the old 5 X X station, which it replaces. And the quality is immeasurably superior.

An incidental advantage of the use of high power is that fading then becomes less apparent. So although Droitwich is not a "fadeless" station—there is no such thing in existence—it is a far, far more reliable programme provider for outlying districts than its predecessors.

The actual power rating is 150 kilowatts. Compare this with the 25 kilowatts of the original Daventry 5 X X, which was later raised to 30 kilowatts; and to the 50 kilowatts of the new Regional stations at Brookman's Park, Moorside Edge, Westerglen and Washford Cross.

This super power is generated in the Droitwich station itself, from oil. Three hundred tons of this fuel are stored in underground tanks, so Droitwich is completely independent of all power supply companies, etc.

Self-Contained

If the need arose, Droitwich could run for three months, on its own resources, without the slightest help from outside its own grounds.

Four huge Diesel engines generate the power, which is in the form of A.C. (not D.C., as in the B.B.C.'s Regional stations). And the waste heat of their "exhaust" is sufficient to provide the main heating for the whole building!

In addition to its unique power supply, Droitwich has another "pull"

over the Regional stations. Its aerial is a 700-footer, this being 200 feet higher than any aerial previously used by the B.B.C. So the higher power is also more efficiently radiated.

There are various other striking differences which render Droitwich a pattern, on which other stations are

S.T.600

By
JOHN SCOTT-TAGGART

will be published in
our sister journal

"POPULAR WIRELESS"

(Price 3d. Weekly)

On Wednesday,
OCTOBER 24

to be modelled. And two of these new features must be specially mentioned.

One is that a "series-modulation" circuit has been employed. The effect of that is to gain linearity. In other words, *better quality*.

The other important difference is this; before being passed to the aerial the output from the aerial goes through a "transducer," which is a special unit that ensures good "top" response on the wavelength of 1,500 metres. In other words, *still better quality*.

Droitwich, in fact, is Europe's model station for quality. It has straight-line-frequency response from the lowest notes right up to 9,000 cycles per second.

In actual appearance and layout the station is quite remarkably straightforward. There are only two masts, and one of these is to be used additionally to support the "5 GB" aerial when the Midland Regional is transferred to Droitwich.

The transmitter hall, which is the heart of the equipment, is entirely different from that of any other B.B.C. station. It is two-storied, having a gallery to house the actual transmitter units.

The Transmitter Units

Each of these is placed right over its own power gear, located on the ground floor immediately below, the gallery thus making for efficient grouping and easy inspection. In receiver parlance, we should call it "a well-spaced layout."

In all the Regional stations the H.T. is derived from motor generators, but Droitwich uses mercury-arc steel-tank rectifiers for this purpose. Another exclusive feature of the new station is that the power supplies of the transmitter can be switched on

(Please turn to page 44)

THE DROITWICH BUILDINGS AND MASTS

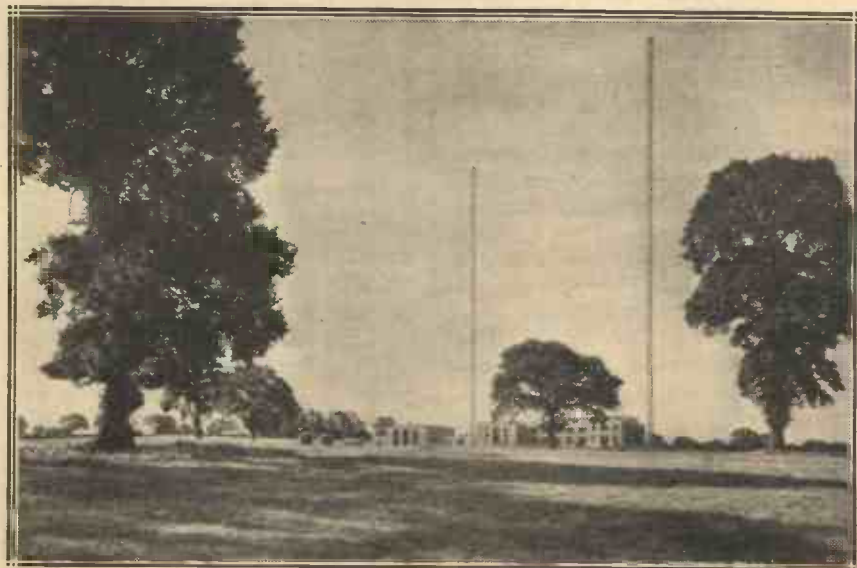

The efficiency of the Droitwich transmitter is not dependent upon power alone. Every effort has been made by the B.B.C. engineers to attain a very high standard of radiation efficiency, and the aerial is 700 feet in height, 200 feet higher than any aerial previously used at a B.B.C. station.

"HOTTING UP" YOUR SET by VICTOR KING



An Article of
Value to All
Constructors

A RADIO receiver constructed on orthodox lines will give certain results. And these results can be pretty closely predicted even before the set is built. But don't misunderstand me. I mean on a comparative basis.

Obviously, the results obtained by individual listeners on the same kind of set will vary enormously as with differences of local conditions and operating skill.

Cost and Compromise

But what we can say with certainty is that a particular set has a certain degree of selectivity and that its overall amplifying powers are of a such-and-such order.

And one can just as surely anticipate improvements or otherwise if certain things are done.

Perhaps many of you think that a set designed by an expert who knows

Sensitivity has to be sacrificed in order to gain a required standard of selectivity or, perhaps, to achieve that "rock-like stability" you have all heard a lot about.

Selectivity may be sacrificed to keep the sensitivity up, or quality in

However, there is no need for the amateur to take his set entirely as he finds it. He can modify it to suit his own needs. Mind you, the man who knows little about radio engineering who tinkers haphazardly with his outfit may not get what he wants. That is so obvious that it does not need enlarging upon.

AN INGENUOUS SCHEME

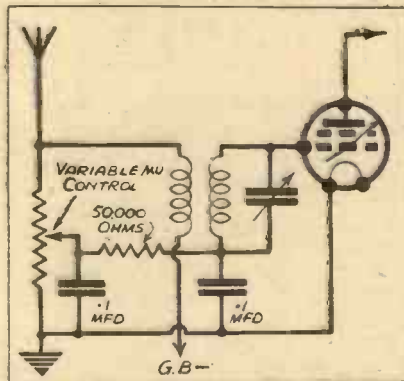

The Two Receivers

As to the technical ethics of certain of the things which can be done well, I must admit that I do not feel on very firm ground. Take for example the deliberate departure from that "rock-like stability" which is supposed to be such a grand virtue.

There can be two sets having exactly the same general circuit arrangement, but the one is considerably more sensitive than the other; it brings in more stations at greater strength.

USING A SERIES CONDENSER

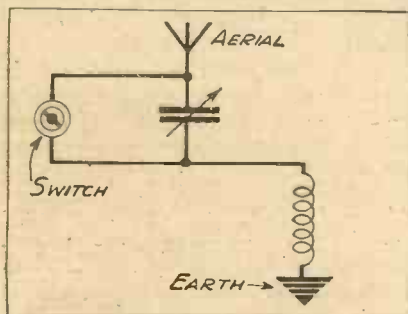

Many sets can be improved by inserting a small series condenser in the aerial lead (left). If a switch is joined across the condenser terminals it can easily be cut out of circuit when required. The diagram above depicts an ingenious method of combining together the variable-mu control and a potentiometer for adjusting the aerial input. On the right is a scheme for enabling some degree of tone compensation to be achieved. When the .01-mfd. condenser is out of circuit the high notes are emphasized, as is desirable when a fair amount of reaction is employed.

CONTROLLING THE TONE

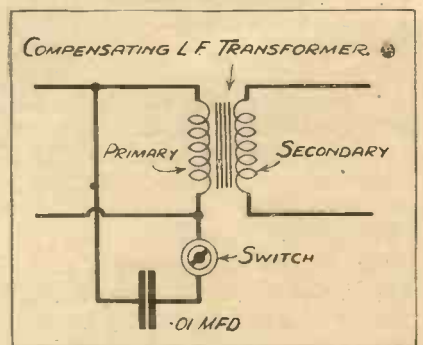

his job gives just about as much selectivity, power and quality of reproduction as the number of valves used can be made to give.

But it doesn't. Any radio set must inevitably be a mass of compromises unless it is built regardless of cost and has an enormous number of controls on it.

order to permit of simpler smoothing in a mains set. And so on and so on.

In the end, however, the expert designer gives you very good value for your money and constructing time. That is his job—to make as much available of all the desirable qualities in the simplest way and at the least cost.

It is perfectly stable so long as the volume control is not taken hard over to maximum, at which point howling begins. That points to incipient or even full-blooded instability.

The other, and less sensitive set, cannot be made to howl or show the slightest sign of an approach to

Why Low-Frequency Compensation is Desirable

condition even when the volume control is at maximum.

Which is the better set? Is there anything wrong in employing instability as a positive advantage in garnering programmes?

Now I am going to be very blunt about this. In my view the initial design of a set must be such that complete stability is achieved. After that, controlled H.F. feed-back applied in an engineering manner is quite permissible.

As you will have guessed, the reason for the difference between the two sets I gave as examples is crystallised in that term "H.F. Feed-back." The volume controls were of the variable-mu type. That is to say they worked in conjunction with variable-mu H.F. valves and thus controlled the amplification of these valves.

Clearly, if there is to be instability this will more likely be evinced when the valves are operating at their full power. If they can't do that without there being instability, then the set has been wrongly designed or an essential compromise has had to be made.

Dangerous Instability

The set which developed instability in its designing and had to be held down by bringing in a variable-mu control, or something else, is a bad set even though it might give better results than its "rock-like" equivalent.

A capricious, freakish, erratic instability, an instability of unknown origin is dangerous. It might turn out to be quite unmanageable in some duplicates of the design.

But you can take your good set and try the effect of applying "instability" in order to increase its sensitivity. I think that is perfectly permissible.

It is surprising what striking effects can be obtained in this way. Those who have not had experience with variable-mu sets which verge on to the edge of instability and even go right over at maximum on the "varmu" control, may find it difficult to credit this.

A set brought to the edge of instability with a smooth variable-mu control seems to double its sensitivity. But it must be H.F. instability or, in other words, H.F. feed-back which is the cause of the effect.

The Secret of Success

L.F. instability is always bad and, as far as I know, there are no claims of any kind which can be made for it even if it is quite manageable, which it seldom is.

The instability of which I am writing is purely and simply H.F., and although they did not probably realise it, it is this which has been the

introducing one of these ultra-efficient modern H.F. valves and control the instability? It is very well worth trying before you finally decide to rebuild the set. You can even risk the introduction of a more efficient coil.

If there is a tendency for a set to spill over on the insertion of what is known to be a more effective coil or H.F. amplifying valve, then it is always worth trying the effect of some means of controlling the instability, and the first and most obvious method is to apply damping to the tuned circuit of the H.F. stage by joining a variable resistance across it.

I don't think I would do that though. I should feel tempted to use a valve of the variable-mu type, for the variable-mu method not only enables stability to be controlled to a nicety, but also is in itself an excellent volume control against which there can be no criticisms.

Tone Balance

To many all my previous words will appear as so much heresy. As a matter of fact, I believe this is the very first occasion on which anyone has ever advanced arguments in favour of instability!

There may be disadvantages, but I do not know of them. There is, I think, only one thing which must be considered carefully and that is the effect on quality of the "on edge" working.

The effect won't be there until you are "on edge" or near it, and so it can quite well be said that if the extra sensitivity gives you stations

otherwise unobtainable then you have no right to question their tone!

However, looking at the matter more generously, I would say that it is not a difficult matter to adjust tone if required. On many sets there is a tone control, anyway.

What the additional reaction effect does is to make the reception more "peaky," and that means a loss of high notes. But every set that uses normal reaction *ought* to have a tone compensator!

Automatic Tone Balance would
(Please turn to page 41).

UNDERGOING THEIR FINAL TESTS



The manufacture of radio receivers in Germany has reached a very high standard of efficiency. Here is a corner of the Siemens factory where the complete sets undergo special high-tension voltage tests.

secret of the success of many constructor's hook-ups which theoretically ought, at the best, have been no better than any other sets.

Try a Better Valve

Very fine results, comparatively speaking, would have been obtained on many sets which their owners felt obliged to rebuild except for an instability resulting from the use of a more efficient H.F. valve than, perhaps, was available when the set was designed and first built.

But why not "hot up" your set by

The MIDGET SUPER

Compactness, sensitivity, and ease of control are the three main features of this latest design in battery superhets, which makes full use of the recent developments in multi-electrode valves.

Designed and Described by the Research Department

ONE of the inherent troubles that have beset the designer of superhets in the past has been the unwieldy size that they have been prone to assume. Parts have been bulky, there have been of necessity a large number of valves, and the whole task has been rendered more arduous owing to the need for specially designed screening between the stages.

Nowadays things are different, for the number of parts has been reduced

intermediate transformer are excellent examples of this, for we have in them modern designs that easily outstrip anything that could previously be done without making the component horribly bulky.

As regards the valve advances, we now have such types as the heptode, which is at once the first detector (or mixer) and oscillator. Moreover, it carries out the two duties internally, thereby greatly assisting the con-

structor of the set, who has things nicely cut and dried for him by the valve makers and the coil manufacturers.

The Helpful Heptode

There are no questions as to whether grid, anode or cathode coupling (or injection) shall be carried out. The heptode settles all that problem, and as the valve carries out its tasks very well, there is no need for a lot of experiment in that stage of the set.

Then there is the double-diode-triode, which will do three things at once. The most important is that it will act as a really efficient rectifier without overloading.

The trouble with the old-fashioned triode second detector in the superhet circuit was that it would insist on overloading, owing to the large inputs fed to it from the intermediate stages, an unfortunate feature that went very much against the success of the set.

The diode will not overload at any



COMPACT AND SENSITIVE

The photograph illustrates clearly how the receiver, complete with batteries and speaker, packs into the cabinet. Below is the theoretical circuit of the set, from which it will be seen that there are three valves each doing more than one task.

owing to the fact that valves can in many instances carry out more than one task, while the sizes of the parts have been reduced, particularly in the cases of tuning coils and intermediate transformers.

Screening, too, is simplified, for most of the "vulnerable" components are provided with their own screens, and there is no need for additional shielding to be erected.

A Great Aid

To the arrival of the iron-cored inductance we owe much of this advance, for iron-cored coils can be very much more compact than the air-cored types, and, if properly designed, can be very much more efficient.

The Ferrocort coil and the Ferrocort

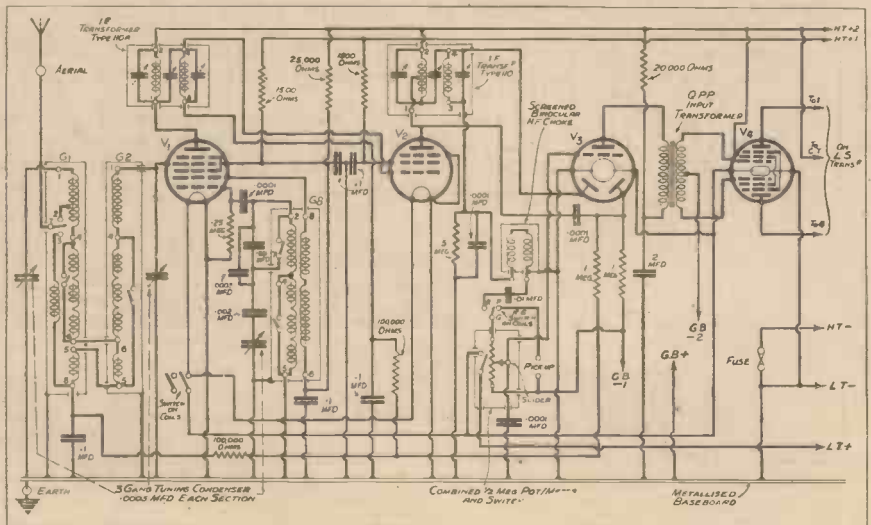

The Q.P.P. Output Safeguards the H.T. Battery

instead of remaining constant no matter what the strength of reproduction, or whether any modulation was being received or not.

Thus a great saving of H.T. power is obtained, for on weak passages of music or speech the anode current of the output valve is ridiculously small, and it only rises as the reception becomes louder.

Thus we see that the designer of the present-day superhet. has very much more at his command than the designer of a couple of years ago.

With iron-cored coils, screened components and the up-to-date valves we have mentioned, he has material for really remarkable receivers, with comparatively little difficulty in getting them to operate at first-rate efficiency, while the constructor who follows the designer's arrangement has a remarkably simple and sure task.

Results Certain

He is certain of his results, for everything is so standardised nowadays that set performances can be duplicated with a certainty that until recently was unknown.

And with that certainty comes the possibility of compactness, a most important factor in radio set construction, for nobody wants a

great, straggly contraption if the same results can be achieved with a neat, compact all-in type of receiver.

Everything Incorporated

And so it came about that the "Midget Super" illustrated here was designed. It incorporates everything except the aerial and earth. Loudspeaker, batteries, the chassis—everything is housed in the modern type of cabinet specially made for the receiver.

The loudspeaker is one of the latest

W.B. "Stentorian" baby models, having an extremely high degree of sensitivity and incorporating in its design the necessary Q.P.P. transformer for coupling it to the double pentode output valve in the set.

The receiver contains only four valves, yet it gives results comparable with that provided by a six-valve receiver using ordinary valves. This feature being due, of course, to the fact that three multi-purpose valves are incorporated in the design.

Band-pass tuning of the aerial input circuit provides a high degree of selectivity with good quality, while the band-pass type intermediate transformers carry on the good work after the heptode valve.

These intermediate transformers are iron-cored, and are variable in their band width, it being possible by adjustment of the small condenser at one end of the top of each to increase the selectivity to as high as 6 Kc. separation.

Ease of Operation

Single-dial tuning is arranged for by the special oscillator coil coupling, so that we obtain a set with knife-edge selectivity, enormous sensitivity and an ease of operation that is outstanding.

All the coils are self-

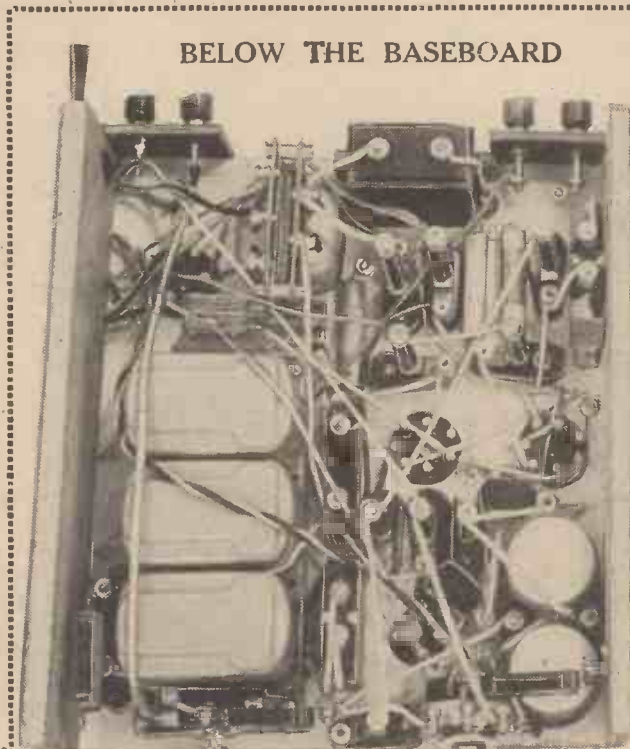

COMPACT ECONOMICAL EFFICIENT

THE COMPONENTS, VALVES, AND BATTERIES REQUIRED FOR THE MIDGET SUPER

- 1 J.B. Nugang 3-gang tuning condenser, each section .0005 mfd. type A.
- 1 Set Colvern Ferrocart superhet coils, types G1 : G2 : G8 (with battery switch).
- 1 Colvern Ferrocart I.F. transformer, type 110.
- 1 Colvern Ferrocart I.F. transformer, type 110A.
- 3 Clix chassis-mounting 7-pin valve holders with screw terminals.
- 1 Clix chassis-mounting 5-pin valve holder with screw terminals.
- 1 T.C.C. 2-mfd. fixed condenser, type 50.
- 2 T.M.C.-Hydra 1-mfd. fixed condensers, type 25.
- 3 T.C.C. 1-mfd. tubular fixed condensers, type 250.
- 1 Dubilier .01-mfd. fixed condenser, type 670.
- 1 Dubilier .002-mfd. fixed condenser, type 670.
- 1 T.C.C. .001-mfd. fixed condenser, type 34.
- 1 Dubilier .0003-mfd. fixed condenser, type 665.
- 1 Dubilier .0001-mfd. fixed condenser, type 620.
- 1 Dubilier .0001-mfd. fixed condenser, type 670.
- 2 Dubilier .0001-mfd. fixed condensers, type 665.
- 1 Erie combined .5 meg. potentiometer and on/off switch.
- 2 Graham Farish 1 meg. Ohmite grid leaks in vertical holders.
- 1 Graham Farish 1/2 meg. Ohmite grid leak in vertical holder.
- 2 Graham Farish 100,000-ohm Ohmite resistances in vertical holders.
- 1 Graham Farish 25,000-ohm Ohmite resistance in vertical holder.
- 2 Graham Farish 1,500-ohm Ohmite resistance in vertical holders.
- 1 Dubilier 250,000-ohm resistance, 1 watt type.
- 1 Graham Farish screened Binocular H.F. choke, type L.M.S.

- 1 Wearite Q.P.P. input transformer, type P.P.A.
- 1 B.R.G. mounting bracket, type 22/1.
- 1 Peto-Scott Metaplex (inside) chassis, 9 ins. x 10 ins. with 10 ins. x 3 ins. runners.
- 2 Peto-Scott terminal strips, 2 in. x 1 1/2 in.
- 1 Peto-Scott special cabinet.
- 5 Clix wander plugs.
- 1 Belling & Lee wander fuse
- 2 Clix accumulator spades.
- 4 Clix indicating terminals.
- 1 Length Goltone spiral screened sleeving.
- 2 Clix valve-cap clips.
- 2 Lengths B.R.G. "Quikon" connecting wire.
- Screws, flex, etc.
- 1 W.B. Stentorian Baby loudspeaker.

BATTERIES.

- Accumulator.—2-volt Block type B/45.
- H.T.—120 volts. Full O' Power Standard.
- G.B.—9 volts. Ever-Ready.

VALVES.

- | | | | |
|------------------|---------------|------------------|------------------|
| Heptode | Intermediate | D.D.T. | Q.P.P. Output |
| Ferranti V.H.T.2 | Hivac V.P.215 | Marconi or Osram | Marconi or Osram |
| | | H.D.21 | Q.P.21. |

The Single-Dial Tuning Simplifies Station Reception

contained with their wavechange switches, and are screened. Moreover, they are obtained in one three-gang unit on its own metal platform so that they can be mounted in position straight away.

The Coloured Leads

The coil connecting wires are supplied with the coils, being provided in different colours according to the points with which they make contact. All that has to be done by the constructor is to straighten out the leads under the coil unit, and to pass them through the requisite slots in the base so that they run in the right directions

for the construction, as shown in the wiring diagram of the under side of the chassis.

It will be noted that there are two red leads for the G.8 coil section, so that care must be taken that the right ones are taken to the points shown on the diagram. To enable this to be carried out without mis-



The speaker is situated at the side of the chassis, as shown in this photograph.

PLENTY OF PROGRAMMES AT FULL SPEAKER VOLUME

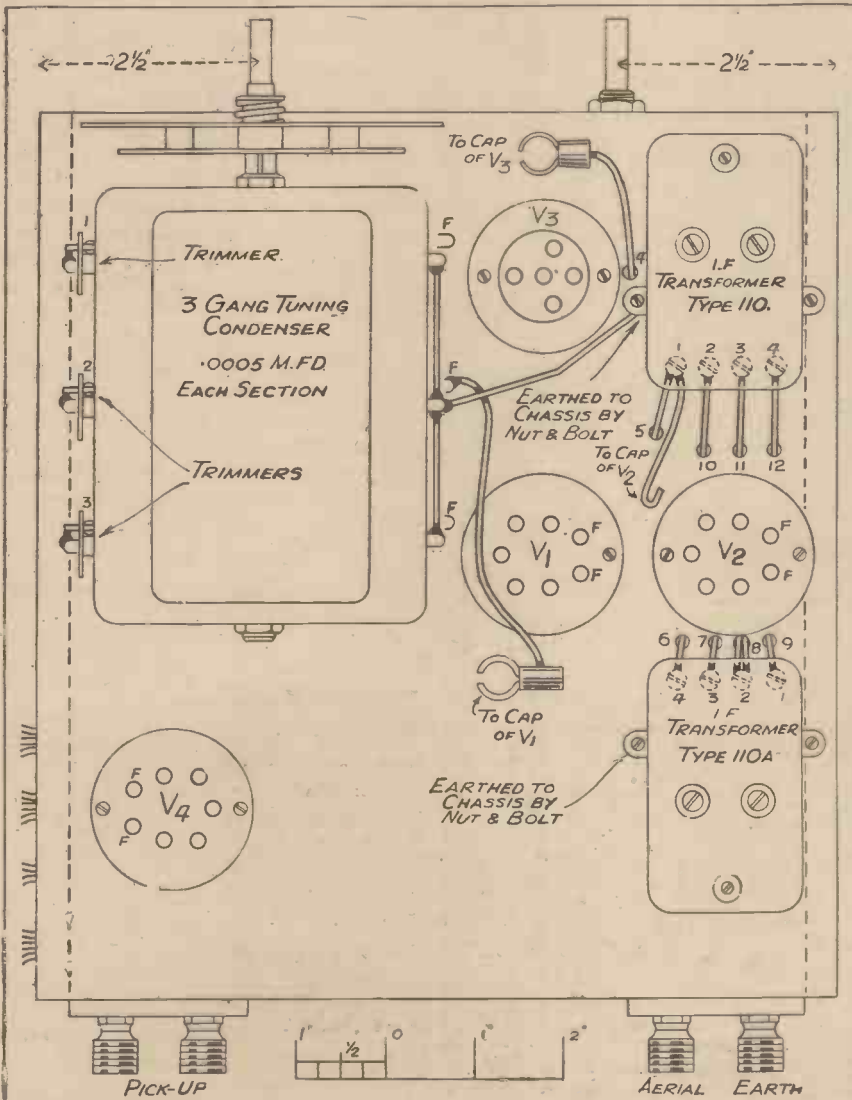

A clear top deck is achieved by the simple chassis method of constructing the receiver. The sensitivity of the set and the Q.P.P. output provide full-strength reception of a large number of stations.

take we have numbered the leads as well as marked their colours in this particular instance, and the numbers should be checked up with those on the underside of the coil unit G.8 to make sure the right leads are being used.

“Metaplex” Chassis Used

The construction of the set is like that of any other chassis design, with the chassis made of metal-covered plywood; “Metaplex” board is used. This should be purchased in ready-made chassis form, for then it will be properly sprayed, and the various pieces of wood comprising the chassis will be electrically bonded by means of the spraying process.

If desired, the chassis can be obtained ready drilled for the chassis mounting valve holders, but if you decide to do this at home it is easily accomplished by drilling a number of holes round a circle of suitable size and knocking out the centre when the circle of holes has been completed.

A pick-up changeover switch is incorporated in the set so that records can be played as a change from radio reception, and this switch is part of the main coil unit as supplied by Colvern. At the other end of the coil unit is a Q.M.B. on-off switch actuated by a lever that comes round when the wavechange switch knob is turned to OFF.

For Record Reproduction

This lever has to be changed in position so that the switch is turned to off when the knob reaches G, and the switch is then used to switch out the heptode and intermediate frequency pentode when the set is to be used for gramophone reproduction.

(Please turn to page 42.)



A Special Broadcast

The Benevolent Fund

Programmes from the Continent

CECIL LEWIS tells me that he is about to undertake a novel series of programmes for the B.B.C. from the Continent. In the past the B.B.C. has contented itself with using the artists, the material, and the producers actually available at foreign stations. The result has not been altogether satisfactory. Now, thanks to the inspiration of Cecil Lewis, himself a former director of B.B.C. programmes, features of this kind will be produced by B.B.C. officials sent abroad for the purpose. The series will run through the winter and will include Rome, Vienna, Prague, Budapest, Berlin, Copenhagen, and Oslo.

The Prince on Armistice Day

The Prince of Wales will probably do a special broadcast greeting to old comrades of the war on the evening of Armistice Day. This should be a very impressive broadcast and a good precedent for the future.

Relays from America

For the first time, the B.B.C. is about to spend money freely in getting representative talks from America. Beginning with the relay of Frances Perkins from Chicago in October the series will continue at fortnightly intervals for fourteen weeks. This incidentally will have the effect of removing a sense of grievance which American broadcasters have been nursing for some time.

BY OUR SPECIAL CORRESPONDENT

I mean the feeling that while they have been anxious to take material regularly from the B.B.C., there has been little reciprocal action of the same kind. The forthcoming series will endeavour to give to British listeners a comprehensive survey of American points of view.

The Winter Proms.

This year the B.B.C. will revive the winter "Proms" which last year were suspended. These will run from December 31st to January 12, and most of the conducting will be done by Adrian Boult. The opportunity will also be taken to try out new talent and new composers.

The B.B.C. and "Hard Cases"

Rightly or wrongly, the B.B.C. has gained the reputation for being heart-

International Relays

Uncensored Talks

less in dealings with its staff. Perhaps it is to live down such a reputation that the Governors have established a special benevolent fund out of which grants are to be made to alleviate misery. This is a good idea, but a better one would be to get salaries evened up. There are still glaring inequalities and injustices.

The Royal Wedding

Broadcasting House has been trying its best to secure official permission for the broadcasting of the Royal Wedding. As it is certain to be filmed and given much prominence in the press of the world, I think that we can count on a broadcast running commentary which will be relayed throughout the British Empire and over most of Europe and America.

A New Programme Future

Eric Maschwitz is responsible for devising a new programme series to be entitled "Short Story with Music," the first of which will be given under the author's direction in the National Programme on Friday, November 9th, at 10 p.m.

From all accounts this promises to be a tuneful and diverting novelty. Mention of Eric Maschwitz reminds me that his name has occurred recently in the list of "possibles" published by a Hollywood production journal. This may mean another attempt to raid the B.B.C. on behalf of films.

So far I have no further details on the subject.

AS FIRM FAVOURITES AS EVER THEY WERE



The tables turned. Clapham and Dwyer, the popular variety stars, listen in to a "spot" of radio entertainment on a Portadwyne receiver. We wonder which they enjoy more—listening or performing?

Broadcasting Houses for All Regions

A Cancelled Visit

The cancellation of the visit to the United States and Canada of Captain Cecil Graves, Director of Empire and Foreign Services of the B.B.C., has caused a good deal of comment in North America. It is stated there that the itinerary had been actually arranged down to minute details, and then came the news of cancellation without explanation.

I have taken the trouble to find out that it was nothing but pressure of work that caused the change. I believe that when Captain Graves went to Southampton to see Sir John Reith off to South Africa the latter suggested that Captain Graves should postpone his contemplated visit to the New World. I hope the visit will soon materialise, for the postponement has naturally caused much disappointment on both sides of the Atlantic.

The Problem of Peace

How to keep the peace of the world is the subject of a big series of talks that will run through the late autumn and early winter. All the main panaceas will be ventilated, speakers including Mr. Churchill, Sir Austen Chamberlain, Lord Cecil, Lord Beaverbrook, and others. They will be uncensored, so we should have some fun when "personalities" begin to be exchanged, as undoubtedly they will be.

More Broadcasting Houses

The Board of Governors of the B.B.C. has decided to proceed with the con-

struction of replicas of Broadcasting House, London, in all the Regional centres. This will mean the replacement of existing premises in Birmingham, Manchester, Cardiff, Edinburgh, and Belfast, with a duplicate at Glasgow and possibly at Bristol.

There will be new studios at Nottingham and Wrexham. I have not heard how the scheme is to be financed, but the fact that it is approved seems

MORE AMERICAN TALKS



The B.B.C. is to spend more money in getting relays of representative talks from America. Our picture shows the announcer at W A B C introducing a talk by a world-famed personality. Do you recognise her? She is Mrs. Helen Wills-Moody, the famous tennis player.

to indicate that the B.B.C. is optimistic about getting a larger share of licence revenue as a result of the changeover of Charter in 1936.

Wireless Exchanges and the B.B.C.

The appointment of Mr. W. W. Wakefield as Public Relations officer of the

Relay Association of Great Britain makes the beginning of an effort to establish better relations with both the B.B.C. and the Radio Manufacturers' Association. In the past, relations have been none too good, the B.B.C. resenting the right of the relay companies to mix foreign with British programmes, and the R.M.A. fearing loss of business in wireless sets.

Experience, however, has proved that the progress of the exchanges has had no disastrous effects, and now Mr. Wakefield is acting in harmony with his opposite numbers in the B.B.C. and the trade, Mr. Gladstone Murray and Major Robertson, respectively.

'Ware the Cleaners!!

Captain Chilman, the house superintendent at Broadcasting House, has now completed elaborate precautions to prevent any repetition of the anti-Fascist flag-hanging incident, when someone disguised as a labourer walked into the building, went to the top and displayed a banner for the edification of Portland Place.

Cleaners and attendants have been specially drilled and instructed not only in the detection but also in the subsequent detention of unauthorised persons who may secure entrance unobtrusively. Also, in future, all cleaners and workmen will be provided with special passes subject to inspection at any time. Captain Chilman has had several impressive parades of his cheerful troops of both sexes.

OUTDOOR aerials sometimes have to be erected in confined spaces that do not admit other than a bare pole. No straining wires can be staked to earth away from the pole owing to lack of space.

An aerial pole to be erected under these circumstances can be made reliable in the following manner.

About half-way up the pole, where the strain is always most pronounced, fix as depicted four pieces of wood about 18 ins. long. The actual method of fixing matters not, it being only necessary to stop any slipping action.

Fixing the Wires

But it is a good idea to bore holes in the pole where the rods are to be fixed, and to force them tightly into these holes, finishing off with a nail.

On the opposite end of each rod a screw eye should be fixed. Then the

ERECTING AERIALS IN CONFINED SPACES

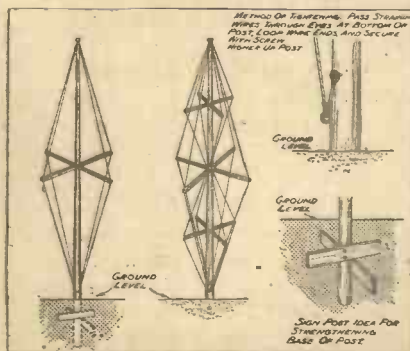

How a mast may be stiffened without the use of the usual widely staked stays. A valuable method for use where space restrictions do not permit the usual types of guy ropes.

straining wires can be threaded as shown in the sketch, and will prove almost as effective as if they were taken to stakes in the ground some distance from the pole's base.

It is not a bad idea when putting up the straining wires to leave a good spare length at the bottom of the pole for the purpose of tightening, should it be necessary at any time. This can be made an easy job if a loop is made in each of these ends, turned through a screw-eye at the bottom of the mast, and fixed a yard or so up the pole.

The above idea makes it possible to use a mast 20 ft. high, made out of 2½-in. square deal scantling, which is much cheaper than a larch pole of good quality. But, of course, the deal must be free of large dead knots and shakes. To reinforce the idea, additional straining wires may be used in the manner shown.

Schemes for CUTTING OUT DROITWICH

OUTSIDE THE SET

The suggestions made in this section of the article do not entail any modifications or alterations whatever to the receiver itself.

"How can we eliminate the new station? Droitwich is swamping us, what can we do?" Such are examples of the questions reaching us from readers within the swamp area of the new long-wave giant, an area embracing a large portion of the Midlands, Welsh Border, and Gloucestershire.

Many people with up-to-date band-pass receivers, superhets and so forth are not upset by the big power being employed by Droitwich, but owners of older and simpler sets are not having too good a time.

A BAND-PASS H.F. UNIT

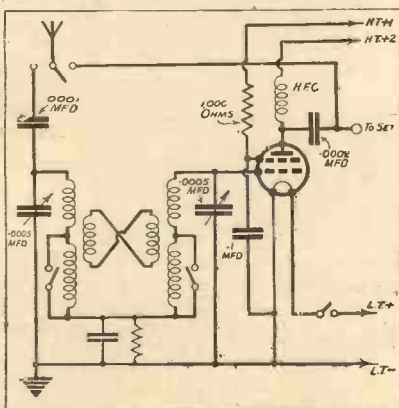

The circuit of a band-pass H.F. unit that can be added to a battery receiver in a very few moments.

But their cases may not be hopeless, by any means, for the addition of one or two selectivity devices external to the set, or some slight internal alteration may completely remove the swamping and enable the sets to cope with the newly arisen problem on the long waves.

There is no certain remedy, it is a question of trying this or that, for local circumstances come into the

question, but among the various cures we are giving on these pages distressed readers should find a great deal of assistance.

The simplest remedy of all is a series condenser in the aerial circuit. Either a pre-set or a variable of the solid dielectric type would be suitable, and it is a good idea to fit a shorting switch across the condenser so that it

REJECTING THE "SWAMP"

Three simple components which when connected in series with the aerial lead, form an efficient wavetrap.

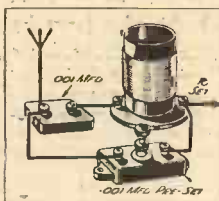

can be shorted out of circuit if required when the set is tuned to the medium wave-lengths.

This condenser will inevitably cut down the strength of other stations besides Droitwich, but such a reduction can usually be made up quite easily by means of reaction, thereby further increasing the selectivity.

Then there are various wave-traps that can be inserted in the aerial feed to the receiver. One type consists of a coil of wire of about 100 turns, wound on a former of about 3 or 4 inches diameter, while across the coil is connected a pre-set condenser of .001-mfd. capacity.

A Good Wavetrap

The scheme consists of tuning the coil to the wavelength of the unwanted station. The aerial is tapped into the coil, the position of the tap being varied to give the best results.

A better trap is that illustrated. It also consists of a coil of about 100 turns and across it are connected in series a fixed condenser of .001-mfd. capacity and a .001-mfd. pre-set. The aerial feed is taken to the junction between the condensers.

The tuning of the circuit is carried out by variation of the pre-set con-

denser, the tuning being done as before on the unwanted station, with the set itself tuned to a nearby wave-length.

A very useful selectivity device is the band-pass tuner, which, of course, consists of two tuned circuits fairly loosely coupled by inductance or capacity, or both. Thus it is an easy task to convert the ordinary plain-coil tuner of a set into a band-pass circuit by the addition of a second tuned coil coupled by a condenser to the first one.

Easily Switched Out

This scheme is shown in practical form in the sketch below. A switch has been included to enable the user to cut the band-pass out of circuit and revert to his normal receiver tuning if he so desires. Both the additional coil and the one in the set have to be simultaneously tuned by the variable condensers when the switch is over to band-pass.

A better method of obtaining selectivity, and one that adds strength to the reception of other stations as well as providing easy cut out of the unwanted local is the addition of a

"ADDED" SELECTIVITY

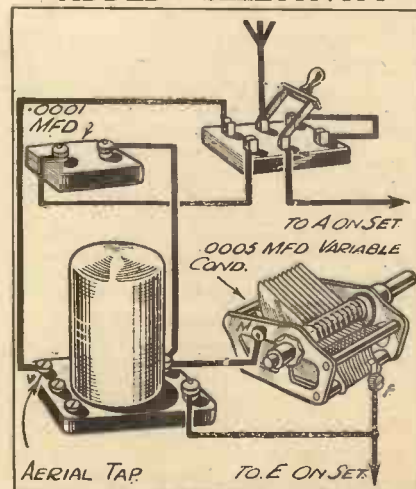

These are the connections for an additional tuned stage for connection "in front" of the set.

Ideas for the Home Constructor

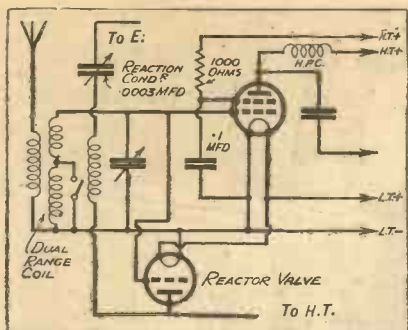

The anode of the separate reactor valve is connected through a choke or resistance to an H.T. tap. The moving vanes of the reaction condenser go to earth.

small band-pass H.F. unit in front of the present receiver.

This unit can be constructed on a piece of baseboard, and enclosed in a wooden box if desired. It can be attached to the present set and left connected, or if desired the aerial switch incorporated in it can be thrown over and the aerial transferred straight to the original set, thereby cutting out the H.F. band-pass unit.

The latter consists only of a screened band-pass coil unit, with a two gang condenser, a valve holder and the usual decoupling resistance for the S.G. feed, a condenser or two, and the two switches and a few terminals.

Simple Connections

The second switch, of course, is to control the L.T. feed to the unit, and should be operated in conjunction with the L.T. switch of the main receiver.

The connections are obvious by the diagram. The earth of the unit goes to the L.T.—terminal of the set, the aerial goes to the A terminal on the unit, and the output terminal on this is taken to the aerial terminal of the set.

For the rest the unit is treated just like an ordinary H.F. stage, the anode H.T. tap going to about 120 volts H.T. and the screen tap to 80 volts. The L.T. is connected direct to the two L.T. terminals of the set.

INSIDE THE SET

Some further schemes which concern the interior of the set, and will appeal specially to users of home-constructed receivers.

By making this article very comprehensive, we have endeavoured to provide a solution of the Droitwich problem for everyone who is troubled by it. Only the most impossible conditions, and the very obsolete type of set, will fail to yield to one of the schemes outlined.

Of course, some are more elaborate than others, and, generally speaking,

the most elaborate ones are likely to prove most effective. But it is desirable to try the simpler schemes first.

By dividing the article into two sections, one dealing with external schemes and the other with internal, we have conveniently grouped them for those who do not want to touch the wiring of their sets, and for those who are home constructors and do not mind even extensive structural alterations.

In the first group we include the owners of commercial receivers. Any of the schemes outlined in the first section of this article are usable by them, while those in the present section are more applicable, though not confined to home-constructed receivers.

Direct Pick-Up

First of all we have a very simple internal idea which calls for very little alteration to the set. It is specially useful to those very near to the new station and who are using old sets employing unscreened coils.

Due to the strong field from the powerful station in localities immediately adjacent to it, it is quite possible for the tuning coils themselves to pick up the transmission direct. Thus

loose coupling of the aerial, and pre-detector tuned stages are largely nullified so far as selectivity is concerned.

This direct pick-up can be overcome by individual screening of the tuning units by aluminium cans. The can itself must be connected to earth as illustrated immediately below.

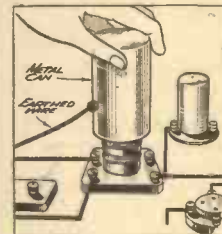

"CAN" THE CHOKE

This is always worth trying. It has advantages other than those concerning the selectivity.

Incidentally the can should be as large as space will permit, so that good spacing may be obtained at all points between it and the windings of the coil. If such spacing is not present, the screen will upset the tuning range of the coil so much that some stations may be driven right off the dial.

In any case it is likely that stations will tune in at settings at least two or three degrees different from their previous readings.

Next we come to an internal scheme which is in the nature of an addition.

It introduces an extra control, although one which need not be constantly adjusted. At the same time, unlike a lot of selectivity schemes, it will probably produce an increase in



AN EFFECTIVE METHOD

Where there is room in a receiver, changing to band-pass tuning as illustrated here is a well-worth-while method of increasing the set's selectivity.



the strength of distant transmissions as well as in selectivity.

It consists in applying reaction to the aerial circuit of

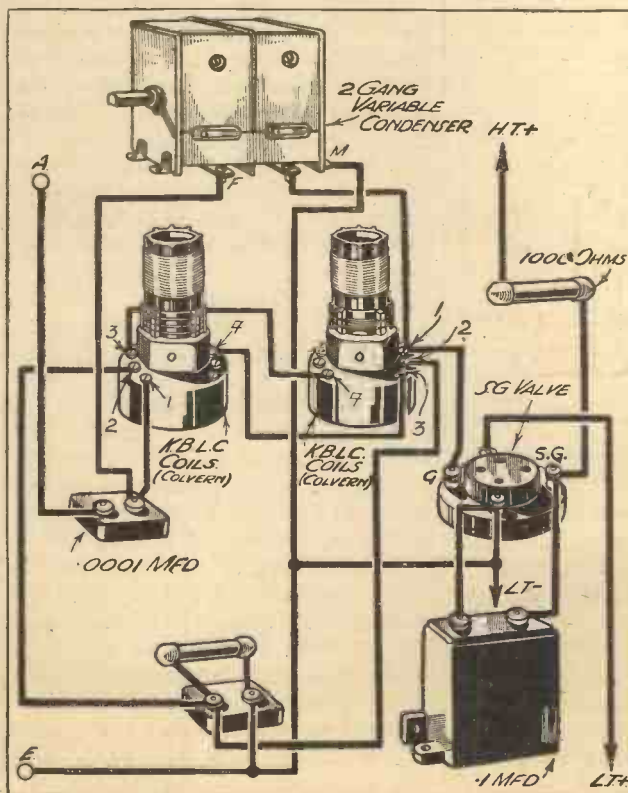

MATCHING SET *And* LOUDSPEAKER

In the bad old days nobody bothered much about such a thing as matching the loudspeaker to the output stage of the set by means of a transformer or a tapped choke. The quality of the speakers themselves was so poor when broadcasting was young that there was no great point in taking special steps to obtain anything particularly fine in the way of reproduction.

Modern Improvements

In the high-frequency circuits of the set we suppressed a great part of the treble by removing sidebands, since we worked our sets close to the point of oscillation with the reaction coupling well and truly tightened. As no bass worth speaking of was sent out at the transmitting stations, that could not be received in any case. We were thus left with little or nothing but the middle register for the loudspeaker to reproduce.

FOR "PUSH-PUSH"



A specially designed output transformer for quiescent push-pull (or "push-push") circuits.

Band-pass tuning, tone control and well-designed circuits on both the high and low frequency sides have rendered the receiving set capable of giving a faithful reproduction over a very

Amazingly life-like radio and record reproduction is possible with modern apparatus, as those who visited the recent radio exhibitions will agree. But to obtain the remarkable quality that is available it is essential that the output valve and the loudspeaker of the receiver be properly matched. In this particularly lucid article, R. W. Hallows tells how this is accomplished.

wide band of frequencies nowadays. Transmitting plants have been improved out of all recognition and the sounds that occur in the studio are sent out for us to hear. And beyond all this our ears have been educated in a remarkable way.

In the early days of broadcasting even people with genuinely musical ears would frequently comment upon the extraordinary fidelity of the reproduction of, say, a piano solo or an orchestral piece. We know now that this reproduction must have been horrible. In its time it was the best that could be done in the way of electro-mechanical reproduction, and the ear accepted it as such. Now our ears have become much more critical. We know that first-rate quality can be obtained, and we take a great deal of trouble in many ways to ensure getting it from our own sets and loudspeakers.

An Important Point

For this reason the importance of matching up set and loudspeaker is becoming more and more appreciated.

It is no exaggeration to say that there are few sets whose performances cannot be improved by careful attention to this business of matching.

The makers of loudspeakers are in no way to blame for this state of affairs. If you glance down a list of triode output valves, and note the figures of their impedance or "A.C. resistance," you will find that these range from under 1,000 to over 5,000 ohms. The manufacturer cannot possibly make his loudspeaker to suit one make and type of valve only.

What he does is to produce an instrument wound in such a way, or provided with a built-in transformer of such a kind, that it will more or less suit a large variety of triode valves. By "more or less suit" I mean that when used with any of them it will give reasonable volume without violent distortion. Loudspeakers designed for use with pentode valves have to be dealt with in very much the same way owing to the comparatively wide range of pentode figures.

Each type of output valve has what is known as its optimum load. If it is made to work into this load by means of proper matching, repro-

TRANSFORMER INCLUDED



This Rola F.P.M. is a typical example of modern loudspeaker design, with its tapped matching transformer incorporated.

duction is at its best. On the other hand if the load is incorrect the volume must suffer, distortion creeps in and there is over-emphasis of the frequencies at one end or other of the musical scale.

The Valve "Load"

What exactly do we mean by the term "load"? Work is done by the valve in driving alternating audio-frequency current through the windings of the loudspeaker. These windings offer impedance, which is

When Only One Valve Works at a Time

measured in ohms, and we therefore speak of the load as one of so many ohms.

Impedance is to alternating current very much what plain resistance is to direct; but impedance is made up of a combination of resistance, inductance and capacity, and varies with the frequency.

The A.C. Resistance

For working purposes we use for the valve itself a factor sometimes known as the impedance, but better called the A.C. resistance, since frequency does not enter into it. To find the resistance in a direct current circuit we divide the steady volts by the steady amperes according to Ohm's Law. In the output circuit of the valve both the voltage and the current are constantly changing in value and the A.C. resistance is found by dividing the change in plate voltage by the change in plate current.

Suppose that on raising the plate voltage by 10 we find that the plate current is increased by one milliampere: then a change of 10 in the plate volts produces a change of .001 ampere in the plate current. Dividing 10 by .001, we have 10,000 ohms, which is the A.C. resistance of this particular valve.

The impedance of the loudspeaker's windings varies actually from note to note over the whole musical scale. For matching purposes we generally use a figure for the impedance of the loudspeaker at a frequency near the middle of the speech frequency scale.

When a table of valve data is available the closest matching can be done by using not the A.C. resistance but the carefully calculated optimum load for the particular type of output valve that is being dealt with.

A Simple Calculation

And now let us come down to brass tacks! We want, let us say, to match a P.M.202 valve and a moving-coil loudspeaker for which the maker's figure is 5 ohms. On referring to a valve data table we find that the optimum load for the valve is 3,700 ohms. To the uninitiated it might seem that the method would be to divide the 5 into the 3,700, which would show a step-down ratio of 740:1! Fortun-

ately for transformer manufacturers the calculation is quite different. The basis rule for all calculations made from the optimum load figure is:

$$\text{Step-down ratio} = \sqrt{\frac{\text{optimum load}}{\text{loudspeaker impedance}}}$$

Do not be frightened by that square-root sign. The calculation is a very simple one. For the P.M.202 valve it is:

$$\begin{aligned} & \sqrt{\frac{3,700}{5}} \\ & = \sqrt{740} \\ & = \text{Approximately } 27:1. \end{aligned}$$

The best output transformer ratio is thus 27 to 1, but any transformer with a step-down ratio of from 25 to 1 to 30 to 1 will be suitable.

Moving-Iron Speakers

All the calculations hitherto made concern moving-coil loudspeakers of low impedance. To show that the output matching transformer can do

So far we have dealt only with output valves used singly. Slightly different methods are required where two valves are used in the output stage, as, for instance, when we are working a pair in parallel or in ordinary push-pull or "push-push," including both Q.P.P. and "Class B."

Parallel and Push-Pull

When valves are in parallel the A.C. resistance or the optimum load for the pair is only half that of one alone. Hence in working from the optimum load figure we divide this by two before starting to make the calculation from the formula.

Valves used in ordinary push-pull are effectively in series; we have, therefore, to calculate from twice the optimum load figure.

When we come to Q.P.P. we find ourselves confronted by entirely new considerations. For both Q.P.P. and "Class B" purposes, makers supply what is known as the "plate-to-plate" load, and this is the figure used for output matching calculations.

And what exactly is meant by plate-to-plate load? The plate-to-plate load means the equivalent load across the whole transformer primary, since the plates are connected to the ends of its windings. Owing to the fact that the two Q.P.P. valves or the two parts of a "Class B" valve are effectively in series, the normal optimum load per valve is multiplied by two, and this again requires a further two-fold multiplication because of the step-up effect in the transformer primary. The plate-to-plate load is thus four times the optimum load for a single valve working under "quiescent" grid-bias conditions.

For Q.P.P. and "Class B"

The formula for both Q.P.P. and "Class B" is:

$$\text{Transformer ratio} = \sqrt{\frac{\text{plate-to-plate load}}{\text{Speaker impedance}}}$$

Though it is desirable to match as closely as possible, results will not, as a rule, suffer appreciably if the actual ratio differs by five per cent or even more from the calculated figure.

THE TAPPED CHOKE

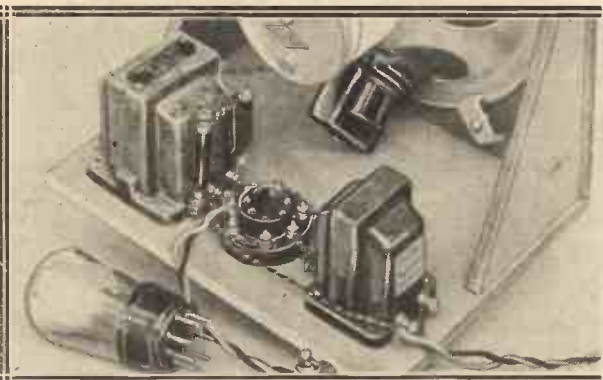

This photograph shows a specially designed "Class B" output amplifier. A tapped choke is used to match the valve to the loudspeaker.

good work also with the balanced-armature loudspeaker let us take one or two examples of matching this to commonly used output valves. The average B.A. loudspeaker, has an impedance of 2,000 ohms. Suppose the optimum load of a valve is 8,000 ohms. The calculation is thus:

$$\begin{aligned} & \sqrt{\frac{8,000}{2,000}} \\ & = \sqrt{4} \\ & = 2:1. \end{aligned}$$

The L.P.2 with an optimum load of 7,100 ohms requires a similar step-down ratio.

NEXT MONTH! LOOK OUT FOR NOVEMBER 15th

Our next issue of this magazine, on sale November 15th, will be under the new title of

"WIRELESS"

AND TELEVISION REVIEW

The Indispensable Monthly Magazine for every Set Owner

Look out for next month's issue : it will be enlarged—but the price will be the same—it will have a new title, but the scope of the journal will be greater than ever. Constructors, listeners, short-wave enthusiasts, television experimenters, owners of commercial sets—all will find much to interest them in the new and revised "Wireless Constructor."

Every reader will be presented with

THE RADIO RULE

A unique mystery gift of interest to every set owner. This ingenious instrument constitutes one of the most practical and useful gifts ever offered by a wireless journal. Be sure you do not miss your copy of

"WIRELESS"

AND TELEVISION REVIEW

The issue will also contain full details of a magnificent new wireless book written by

JOHN SCOTT-TAGGART, F.Inst.P., A.M.I.E.E.

This work will rank as a classic of its kind. It is a guinea volume you will be proud to have on your bookshelf next to "The Manual of Modern Radio." You can obtain this fine presentation volume at the most advantageous terms. Full details will be found in this journal, on sale

NOVEMBER 15th

Next month's contents include many new features and full description of a new three-valve set of outstanding interest, together with a full-size

1/- BLUE PRINT FREE

LOOK OUT FOR "WIRELESS"!

SHORT-WAVE NOTES

By W.L.S.

That short-wave receivers are really worth while was ably demonstrated last month by our short-wave expert; this month he points out that they are not difficult to manage, and that there is no need to expect trouble.

LAST month I endeavoured to prove that short waves offer every possible attraction to the radio enthusiast who wants to tackle something new and interesting. This, I think, is now admitted by all except the most confirmed sceptics, and they really believe more than they care to admit!

Unfortunately, however, there still seems to be an impression that short-wave work is necessarily difficult and complicated. People I meet, both personally and through the post, often say:

"Yes, short waves must be jolly interesting, but I haven't the necessary technical knowledge to get any results."

"Just Experience"

This, to put it bluntly, is pure bunk. People were saying that about valve receivers in 1920, and the same people were getting excellent results in 1921. In fact, people were probably saying that about crystal receivers earlier still.

The point is that the technical knowledge that one needs most is the kind of knowledge that no one can impart to you; it is just *experience* that counts.

Short waves, in spite of the fact that they have been with us now for over ten years, are still "coming." No one can foretell the uses that will be made of them by the time another ten years have elapsed; but, in their possibilities, they are almost as exciting as television, and, indeed, almost as far removed from the general realm of radio as it concerns broadcast entertainment.

What is a Short Wave?

Now for the important question: "When is a wave a *short* wave?" We have got ourselves to blame for a lot of confusion in this matter, and I don't propose to enter the fray here. So let us settle among ourselves that when we talk of "short waves," we mean anything below 100 metres.

Now the ordinary broadcast receiver will generally go down to 200 metres, or a little below. If it is of the home-constructed variety, and particularly if it uses interchangeable coils, there is no difficulty in taking it down,

without any alteration other than in the inductance values, to 140 or 130 metres.

Imagine a very simple two-valve broadcast set of the detector-and-L.F. type, such as we were all using ten years ago. Simply by substituting plug-in coils of suitable size, that receiver could be taken right down to 10 or even 5 metres, provided that it was reasonably well constructed in the first place.

It is that word "provided" that starts the trouble. It might have been thoroughly efficient for broadcast reception, but it might *not* be any good

the coil and its condenser—a perfectly negligible quantity with a 50-turn coil—becomes a serious matter with a 2-turn coil. In fact, the inductance of the stray wiring may be greater than that of the coil.

Similarly, .0005-mfd. covers a satisfactory range of frequencies with a 50-turn coil, but we shall want something less than one-tenth of that size if we are to handle it at all comfortably with two turns.

Must Be Properly Built

That is practically the whole case. You will see at once that a broadcast receiver "cut down" will never make a really good ultra-short-wave set.

If someone without the slightest knowledge of short-wave work were to make a receiver that was a kind of broadcast set on a small scale, he would probably be successful right away.

Imagine a detector-and-L.F. set with very small coils (grid coil, 9 turns; reaction, 6, for example), a .0001

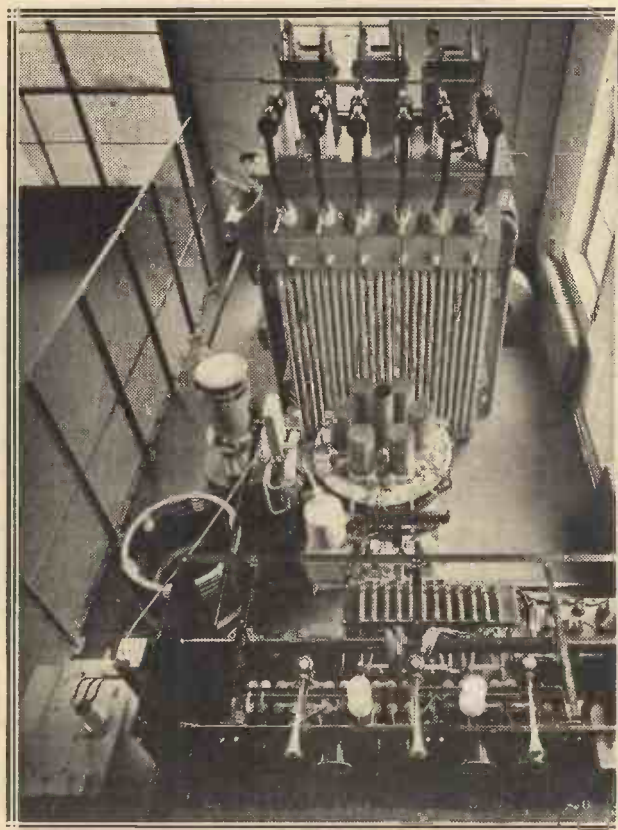

★ ★ ★
THE
"MAINS
UNIT"
AT
DROITWICH

This view in the machine room of the Droitwich station shows the H.T. transformer, mercury-arc rectifier and switch-board. Now that this station has leased the old 5 X X aerial, the latter is to be incorporated in the Empire short-wave system and should provide some interesting reception.

★ ★ ★

below 100 metres. Generally speaking, the trouble would be caused by the layout and wiring-up of the parts.

On the broadcast band we probably use a .0005-mfd. tuning condenser connected across a coil of 50 or 60 turns. By the time we have got down to 10 metres that coil will have two turns or less!

The snag that arises now is this: four or five inches of wire between

tuning condenser, and very short and *direct* wiring between the coil and the condenser; there you have a successful short-wave receiver.

Next month, I propose to give one or two circuits and lay-outs putting the above statements into practice, so that anyone who feels sufficiently interested to "break in" on short waves may make up his mind.

WIRELESS IN THE GREAT WAR

THE ADVENTURES OF THE MYSTERY SHIPS



THE scene is in the Atlantic off the West Coast of Ireland. Autumn of 1915, wartime. A decrepit looking tramp steamer is ambling along, evidently bound westward with a cargo of timber, at least her decks are lumbered up with timber.

The look-out appears to be half asleep and the skipper, with his ragged moustache, dirty muffler and greasy double breaster, is lolling against the "dodger" on the bridge, apparently lost in thought.

Apart from the tramp the seas are deserted. But wait—something resembling a broom handle is lifting itself above the fairly calm surface of the sea. It only appears for a few minutes and is soon lost to sight. Presently it breaks water again, undoubtedly it is the periscope of a submarine, hostile in all probability.

Torpedo—Then Panic

The rheumy eye of the tramp skipper is gazing in that direction but apparently he does not see the periscope, or if he does, thinks it is some broken spar flung up by the sea. The look-out, whose head has lolled so that he, too, is looking in the direction of the periscope, dozes steadily on.

Obviously the submarine is getting into position to fire a torpedo and in a moment or so the white wake of the torpedo can be seen making its way towards the unsuspecting tramp. The target is remarkably easy and almost impossible to miss.

With a terrific explosion the torpedo strikes the ship. Pandemonium breaks loose on the decks—skipper and crew make a rush for the boats, which are lowered in the most panic stricken fashion. One boat even turns over and is useless. After much confusion, shouting and general bad management,

the crew gets away in the boats together with a mangy parrot complete with cage, which the mate holds in one fist while he shakes the other at the submarine. His language is also

.....
... The tramp appears to be sinking and the enemy submarine comes to the surface. Suddenly an amazing transformation takes place; the slanting deck of the tramp is alive with men, deck houses and timber stacks disappear, revealing guns, large and small. In a few moments the submarine is a shattered wreck, with oil gushing from her splintered sides
This is an episode in this month's story of wireless in the Great War.

By Radiat.

.....
 of that choice variety at which merchant service mates excel.

The tramp now appears to be sinking and deserted, so the submarine comes triumphantly to the surface to examine its prize more closely. The com-

tramp is alive with men, deck houses and timber stacks disappear revealing guns, large and small. Before those on the submarine have time to think these guns are blazing away, the deck of the tramp is one blinding sheet of flame.

The surprise is complete; in a minute or two the submarine is a shattered wreck with oil gushing from her splintered sides and very soon the sea closes over her.

The innocent-looking tramp was, of course, a mystery ship specially disguised to decoy submarines to disaster. Her sloppy-looking crew, despite sleepy looks and ill-fitting clothes, some of the bravest sailors in the service of the Empire.

Hidden Radio Equipment

Life on a mystery ship was undoubtedly one of the most hazardous and nerve straining experiences which it was possible to undergo, and, as usual, wireless was well to the fore in these remarkable adventures.

Ordinary wireless equipment was not possible on these ships. For example, very few tramp steamers were fitted with wireless in the early part of the war. Submarine commanders would therefore have become very suspicious had they spotted a wireless aerial between the mast of some old and decrepit tramp steamer. On the other hand, wireless was essential to the mystery ships,

for, in addition to messages concerning the location of enemy submarines and important service telegrams, it was often possible for the wireless operator to tell if submarines were in the vicinity by the latter's wireless. Such information was invaluable to a mystery ship commander.

THE Q31 AT FULL STEAM AHEAD

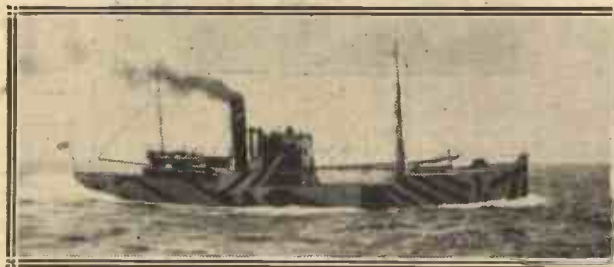

This mystery ship, H.M.S. "Gunner" Q31, sank two submarines during the Great War. It looks just like a small coastal tramp, doesn't it? The strange markings on the hull were common to all merchantmen during one period of the war, the idea being to mislead the enemy submarine as to the size and speed of the target, and so increase the difficulty of hitting it. The dodge wasn't successful for long!

mander springs out of the conning tower followed by some of the crew, they are now drawing quite close to the sinking vessel.

Suddenly, from some concealed point a bell rings out clearly. As if by magic an amazing transformation takes place; the slanting deck of the

A Nerve-Racking and Risky Existence for All

In consequence it was necessary to disguise or conceal the ships' wireless equipment. The main difficulty was of course the wireless aerial. Many arrangements were tried out; a single wire having the appearance of a bracing stay wire, slung between the two masts, was the most favoured idea for an aerial.

The down-lead and lead-in were made to resemble signal halyards. So realistic were these that on more than one occasion pilots and others not in the secret were stopped from touching the halyards only just in time. They would, of course, have received a shock in more ways than one.

Real Tramp Ships

The wireless cabin was completely disguised and situated near or under the bridge. From outward appearances it seemed to be anything but a wireless cabin.

Mystery vessels were recruited from real tramp ships. When one was required, the naval official concerned (himself disguised) would visit some likely port, such as Cardiff, and without a word of warning arrange for the commandeering of a certain vessel, together with her cargo. In the case of the South Wales ports, this would usually be coal, and this coal might stay on the ship throughout her life as a mystery ship, or until it became dangerous to carry it any longer.

So trampish were some of the mystery ships that they had no electric light or electrical equipment of any sort, and to run the wireless a special generator had to be installed. As has often happened before in the annals of the merchant fleet, the wireless generator and batteries were soon supplying various people on the ship with electric lighting.

A New Complication

Later in the war a better class of vessel was employed, and as by this time even the most decrepit tramp carried wireless, a new complication arose.

When, for instance, a submarine attacked a ship by gunfire, its first objective would be the aerial and wireless cabin. This was to prevent any wireless signals being radiated which would give away the submarine's position.

To circumvent this, mystery ships were then once more equipped with concealed aerials and wireless rooms

in addition to the standard aerial and cabin, these being used merely as dummies. Thus, when a submarine attacked the mystery ship it would blaze away at the elaborate dummy aerial and cabin, wrecking them both.

Making Sure of It

In the meantime, with luck, the real aerial and cabin, being concealed, would be left intact. As a rule no wireless messages were sent while a submarine was attacking a mystery ship, in case the submarine happened to be listening in.

The main object of mystery-ship-cum-tramp was to attract the submarine to the surface and entice it up to the guns of the ship. When it



Captain (now Vice-Admiral) Gordon Campbell, V.C., D.S.O., whose exploits as a mystery-ship commander during the Great War earned him fame.

was sufficiently near, the concealed guns would then blow it out of the water. So keen were some of the mystery-ship commanders to get their submarine, that they would allow the latter almost to wreck them before revealing that they were merely a decoy.

The usual practice was for the pseudo tramp skipper to allow his ship to be torpedoed. On many occasions, if the torpedo was badly aimed, the ship would be navigated so that it came right in the path of the torpedo. In fact, the ship would strike the torpedo rather than the torpedo strike the ship.

Immediately the torpedo had struck

the vessel, a special section of the crew known as the "panic party" would dive headlong for the boats and leave the supposedly sinking and deserted ship to its fate.

On one famous mystery ship—i.e. that commanded by Captain Campbell, V.C., a stuffed parrot in cage always went with the "panic party" to give a touch of realism. Another humorous gag was to leave behind a particularly dirty and unkempt stoker who, just as the boats were drawing away from the ship, would rush up to the side and hawl at the boats to return for him.

A Game of Patience

The rest of the crew, including the wireless operator, remained hidden in the ship, ready to man the guns on the word of command from the Commander. The strain on these men can be imagined; the ship sinking, somewhere a submarine gazing at them suspiciously, or maybe, approaching and blazing away with its guns. Explosions taking place all around them, and invariably the ship would be on fire, sometimes blazing pretty furiously in some parts.

Yet they must remain inactive, crouching down behind whatever concealment might lend itself at the moment. If any man gave way to panic under the strain, or moved literally so much as a finger, then all would be lost.

In the wireless cabin the strain was just as great as elsewhere, the operator sitting at his desk waiting. Any moment the ship might founder, or a shell blow his cabin and himself into a thousand pieces.

The Tension Relieved

This waiting was, of course, the most trying part of the whole affair, but all experiences, even the worst, must end some time. After what would seem like the passing of centuries, the command to man guns and fire would ring out, and the guns respond as if they, too, had felt the tension. With luck the submarine would be caught wholly unprepared.

That night the mystery ship operator would report that still another German submarine was calling its mate in vain on the wireless; and the mystery ship itself would be towed into harbour, the damage repaired and the vessel made ready for yet another of these desperate adventures.

The Battle of the Humps

by G. P. Kendall B.Sc.,

THIS is not an article about camels. Neither is the title a veiled allusion to the possible state of mind of the reader on finishing an article of the kind which usually accompanies such diagrams as you see on the pages of this one.

I admit those diagrams do look very much as though this was going to be just one of those wearisomely theoretical yarns which the highbrows love to spin, but I promise that I'm not really embarking on anything of the sort, so don't go away. I think I can promise you an interesting time if you will come along and join me in the speculations which the diagrams are intended to illustrate.

Modern Requirements

You see, it has been borne in upon me for some while that it is high time we all did a spot of clear thinking on the question of the two rival methods of designing selective receivers. It really amounts to making an attempt to forecast which of the two schemes will outlive the other and find a place in the perfected sets of the future, a pastime which I, personally, always find of absorbing interest when it can be based on sound reasoning.

Of course, one can always wait and see, for the process of evolution is a sure and certain one, but there is one

great advantage in making up your mind in advance; if you guess right you can be sure of choosing the best method to use right away.

Let us make a start, then. First, let me remind you that to get the selectivity we need nowadays in a real long-distance set by means of the type of circuit we used a few years ago would

There are two ways in which the problem of providing selectivity with quality is being tackled. Their respective merits are explained in this article, and a forecast is given of which is likely to survive in the long run.

involve a certain definite loss of quality. The tuning of the circuits has to be made so excessively sharp that the reproduction becomes low-toned, with an excess of bass and a deficiency of the higher frequencies.

This is what happens when the "resonance curve" of the set is like Fig. 1, consisting of a single sharp peak with a very narrow top. A set like this responds most strongly to the lowest frequencies in the modulation, and more and more weakly as the modulation frequency goes up. In plain English, sounds of low pitch are heard more loudly than those of high pitch.

Improving the Quality

Just why that should be is a point over which the pundits still wrangle, but it is sufficient for our present purpose to know that the trouble is connected in some way with the extreme narrowness of the resonance curve. If we widen the peak we find that the quality improves, but, of course, we lose the needful selectivity.

These difficulties led to the introduction of what are called band-pass circuits, which aim at a resonance curve with steep sides but a flat top which shall ensure equal response to all the modulation frequencies we

want to hear. Such a curve is shown in its ideal form in Fig. 2.

That is the curve of theory. In practice it is decidedly difficult to achieve anything like such perfection, and what we often get is a misshapen affair like Fig. 3, or even Fig. 4. Quality is not as a rule too bad under such conditions, but selectivity may be no better than is obtained with much more primitive circuits, and it is this fact which is responsible for most of the disappointment sometimes expressed by those who have just had their first taste of band-pass work.

Faults of Ganging

The trouble is not inherent in the band-pass system, but merely results from imperfections in present apparatus, and the fact that it is not too easy for the home constructor to make certain preliminary adjustments with the absolute accuracy they demand.

In fairness to the system, it should, perhaps, be added that these troubles are not often present in a severe form. More usually they are comparatively slight, and do not prevent us from getting quite good results, only a little below those theoretically possible.

In still further defence of band-passing it must be confessed that the imperfections noted are very often the result of slight inaccuracies in ganging,

THE "PEAK" METHOD

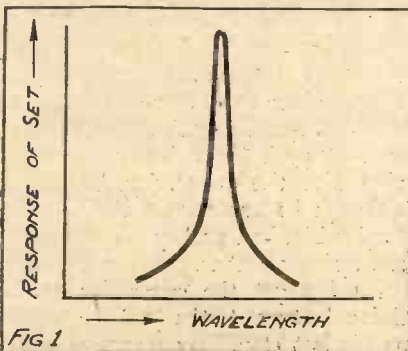

FIG 1
When the resonance curve of a set's tuning is like this reproduction tends to be low-toned, with an excess of bass.

BAND-PASS TUNING

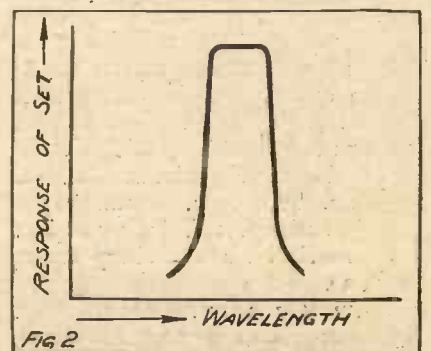

FIG 2
This is the type of resonance curve which is aimed at in theory by band-pass methods. It has steep sides and a flat top.

The Use of Tone Control in Obtaining Selectivity

and are not due to any defect in the band-pass apparatus itself. It is not very easy to secure really correct ganging without the aid of the special gear used commercially.

From which careful attempt to present the case fairly it will be seen that I am not running down the band-pass system as such. I am merely trying to point out those drawbacks which often accompany its use, and which must be taken into account when trying to balance it up against its rival.

Too Easily Upset

To sum up, it seems to me that while we must admit the band-pass method to be capable of giving the results we want, it is equally beyond question that the arrangement is too easily put off its stroke by very slight imperfections to be regarded as ideal.

For this reason alone, then, it would seem wise to look very closely at the attractions of the rival scheme. If we find that the rival has at least equal technical merits, then it may well be that its greater reliability will be the deciding factor.

Let us examine this opposition system of set design. It is commonly called Tone Correction, a term which I, personally, dislike because it concentrates attention on the question of reproduction quality, whereas the fundamental matter involved is one of selectivity.

"A Baby Matterhorn"

The system is based upon a totally different conception of the proper way to treat those humps which are the symbol of the whole argument. Instead of regarding an extremely sharply peaked resonance curve as a calamity, the exponent of tone correction hails it with glee, and does all he can to train it up into the sharpest possible kind of baby Matterhorn.

He knows perfectly well that by so doing he will produce certain effects on the quality, but he concentrates first on the question of selectivity, and sees to it that his tuning circuits are capable of giving him the standard he wants. That done, he turns to the quality business, and finds out how much mischief his over-sharp tuning has done.

Presumably he will discover that the reproduction is very low-toned, with music which seems to be mostly bass, and chesty speech of poor intel-

ligibility. In other words, the set has a "falling characteristic," whereby the loudness of the sounds heard varies in proportion to their frequency; sounds of low frequency are heard strongly, but those of higher pitch are heard more and more weakly as the frequency goes up the scale.

IN PRACTICAL FORM

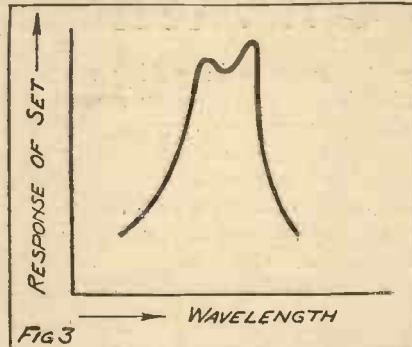

Although the curve of Fig. 2 is what is aimed at in band-pass tuning, it is seldom approached in practice. What is usually obtained is something in the nature of the curves shown in these two diagrams. There is either a cavity in the flat top part of the curve, or a considerable falling away of one side of the plateau form.

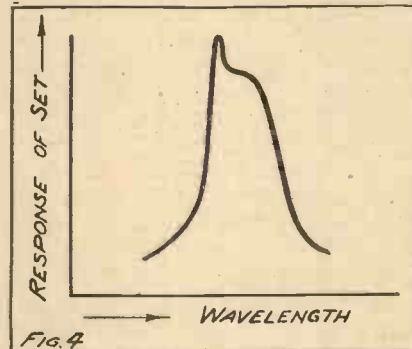

Now, as soon as the defect could be expressed in this way the solution of the problem became obvious. All that was required to put matters right again was a low-frequency amplifying circuit having a rising characteristic of such a slope that it just counteracted the falling characteristic set up in the tuned circuits.

Not Very Difficult

If the two effects were properly balanced to each other the result would obviously be quality of quite normal tone, and this condition is not nearly so difficult to achieve in practice as one might imagine. It should perhaps be confessed at this point that it is by no means essential to do the job with complete accuracy;

few people can detect errors of balance between bass and treble until they become quite large.

I may perchance be telling tales out of school, but that is one of several apparently unimportant and little-known facts which do much to make the set designer's life tolerable. Anyway, it is true that considerable liberties can be (and are!) taken with tone balance, and yet the result is accepted as satisfactorily good quality by the vast majority of listeners.

Gradual Attenuation

It is interesting to note that the tone correction principle became a practical scheme only when it was realised that the effect of excessive sharpness of tuning was to produce a progressive attenuation of the higher modulation frequencies. It had for a long time been believed that these higher frequencies were shut out altogether, in which case it was evident that no amount of tone correction could put them back.

In the light of recent research, however, we know that the process under practical conditions is not one sharp cutting off at some particular point in the frequency scale, but of a gradual fall which starts at the bottom and extends to the top.

However sharp the tuning, it is now argued that there must remain some trace of even the highest frequencies, and hence they can be brought up to normal again if it is practicable to apply sufficiently intensive correction in the L.F. circuits. It is conceivable, of course, that circuits could be designed in which the high note attenuation would be so great as to be beyond the powers of present-day methods to correct, but such extreme "peakiness" of tuning is not called for under practical conditions.

Designing the Receiver

Let me just summarise the tone-correction scheme before we go further. The designer who favours this method starts off by making his tuning arrangements "peak" sufficiently sharply to give him the selectivity he wants, although he knows that this is going to give him bad quality unless he does something about it.

Having got the selectivity to his liking, he turns to the quality question as his last step. By means of a low frequency amplifying side which gives

(Please turn to page 42.)

in their ranges of commercial models. At the last Olympia Show no less than eighteen firms had universal mains receivers on show, and since then even more have entered the market.

This WIRELESS CONSTRUCTOR "universal" receiver, which forms the subject of the present article, is a particularly attractive proposition and evinces the benefit we have gained from a now quite long experience of the principle concerned.

Straightforward to Build

It really is quite as straightforward to build as the simplicity revealed by the photos would appear to indicate. The layout is a satisfactory compromise between the "American" and the chassis form, and there are only a few items underneath the baseboard.

A new-type tuning dial is employed, which is quite a breakaway from conventional patterns. It has full-vision and this is a feature which will no doubt appeal strongly to many constructors.

The old-time, and still often used, circular condenser dial had full-vision. That is to say, the operator could see the full range of readings at a glance and gauge the position of any particular setting relatively to them.

For instance, if it were a 180° dial, and the setting was 30, it could be seen that one was pretty well down towards the bottom end of the dial.

It might be said that one would know this, anyway—for a moment's thought would give one a "30 over

180." vision of the proportion of the tuning dial lying below the reading which might still be "active." But

a 100° scale—differ considerably from those on a scale marked to 180°. Quite apart from the rather argu-

NO MAINS TRANSFORMER IS EMPLOYED

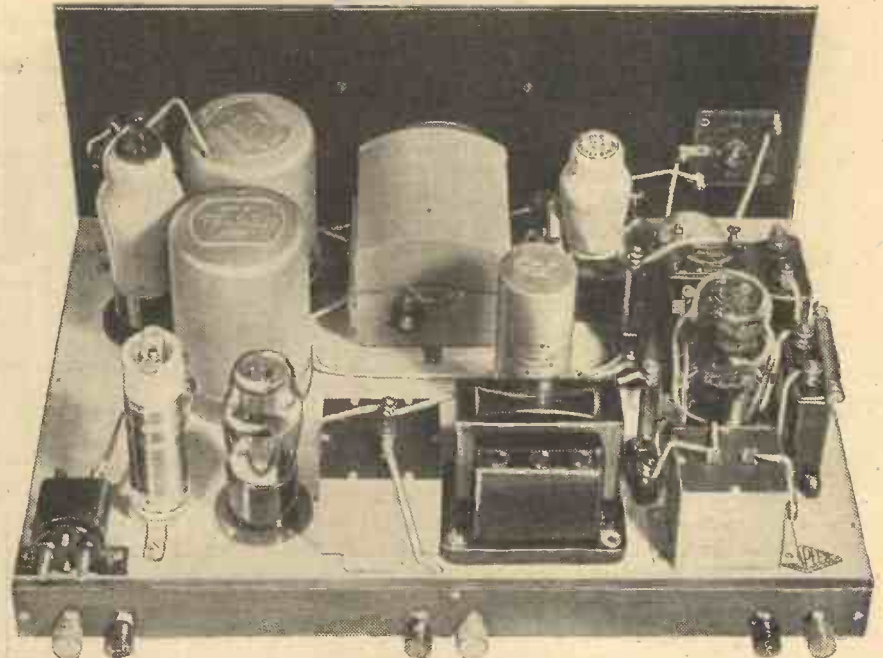

Even if the set is never likely to be used on D.C. mains it has the advantage for A.C. users that expense is cut by the absence of a mains transformer.

when "escutcheon" dials came in and the readings visible were restricted to a mere 5° or 10° to be seen through a small aperture, this was not found to be as easy as it seems, for some dials were marked to 180° and some to 100°.

The relative positions of any settings, relative to the whole dial—that is, on

able satisfaction of knowing what lies above or below a certain dial reading in terms of active dimensions of condenser movement, there is the obvious fact that many tune more or less by angular movements.

Instead of looking closely at the dial of the set for particular dial readings, they swing the pointer round until it lies at about the "two o'clock" or "ten o'clock" point at which they know they will hear the station desired.

This can't be done at all with an aperture type of dial. With a full-vision scale such as appears on THE WIRELESS CONSTRUCTOR One-Dial A.C.-D.C. set, you can adjust both by readings and pointer position with the utmost facility.

HOW THE WIRING RUNS BELOW THE CHASSIS

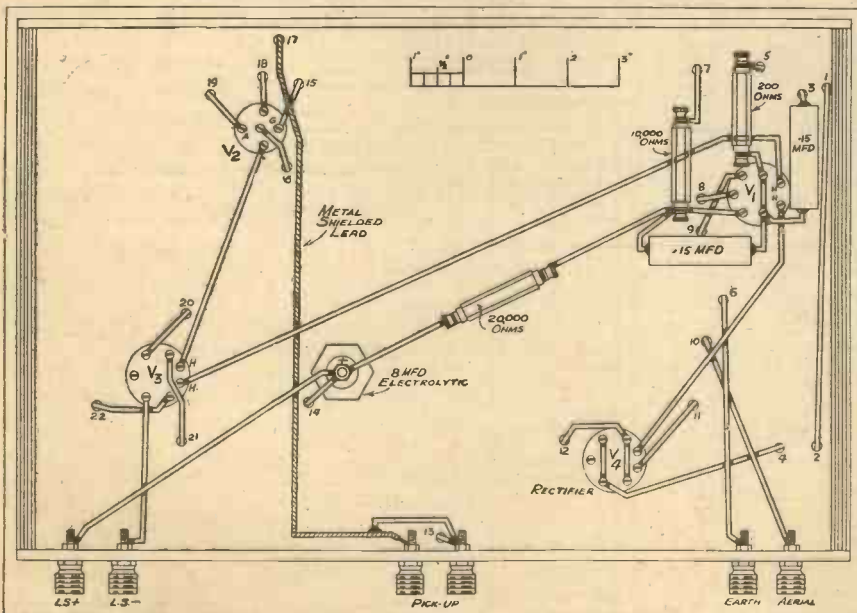

There are few components below the chassis, and they are wired as in this diagram. The numbers against the holes correspond with the numbering in the wiring chart on the opposite page.

Sensitivity Not Sacrificed

That term "One-Dial" reminds us of another important point. The set sacrifices nothing at all in the way of sensitivity because it has only the one tuning dial.

The reason is to be found in the trimmer which can be operated from the front of the set. Actually this trimmer adjustment is possible by means of the small knob which is concentric with the main tuning knob.

The tuning is accomplished by means of this latter and reaction is supplied in the usual way. When the best settings have been obtained the final

3½ Watts Output from Radio or Record

ounce can be got out of the set by a trifling variation one way or the other of the position of the trimmer control knob.

A very effective volume control is a further feature of this fine receiver. It is a variable-mu control. The amplification of the variable-mu screened-grid, high-frequency valve is adjusted by means of a potentiometer.

Now this valve is the first valve in

the set to which the energy received on the aerial is led. Therefore, by regulating in this way the degree of amplification it provides to the received energy none of the following valves has to handle any more input than is necessary to build up the desired volume.

Overloading Avoided

Thus detector overloading, for in-

stance, cannot occur, and clearly there can be no overloading of the H.F. valve. This has a most important bearing on quality and explains why THE WIRELESS CONSTRUCTOR "Universal" is so outstanding in regard to tone.

The volume control is linked with the on-off switch so that a further movement of this control after minimum volume is reached switches the

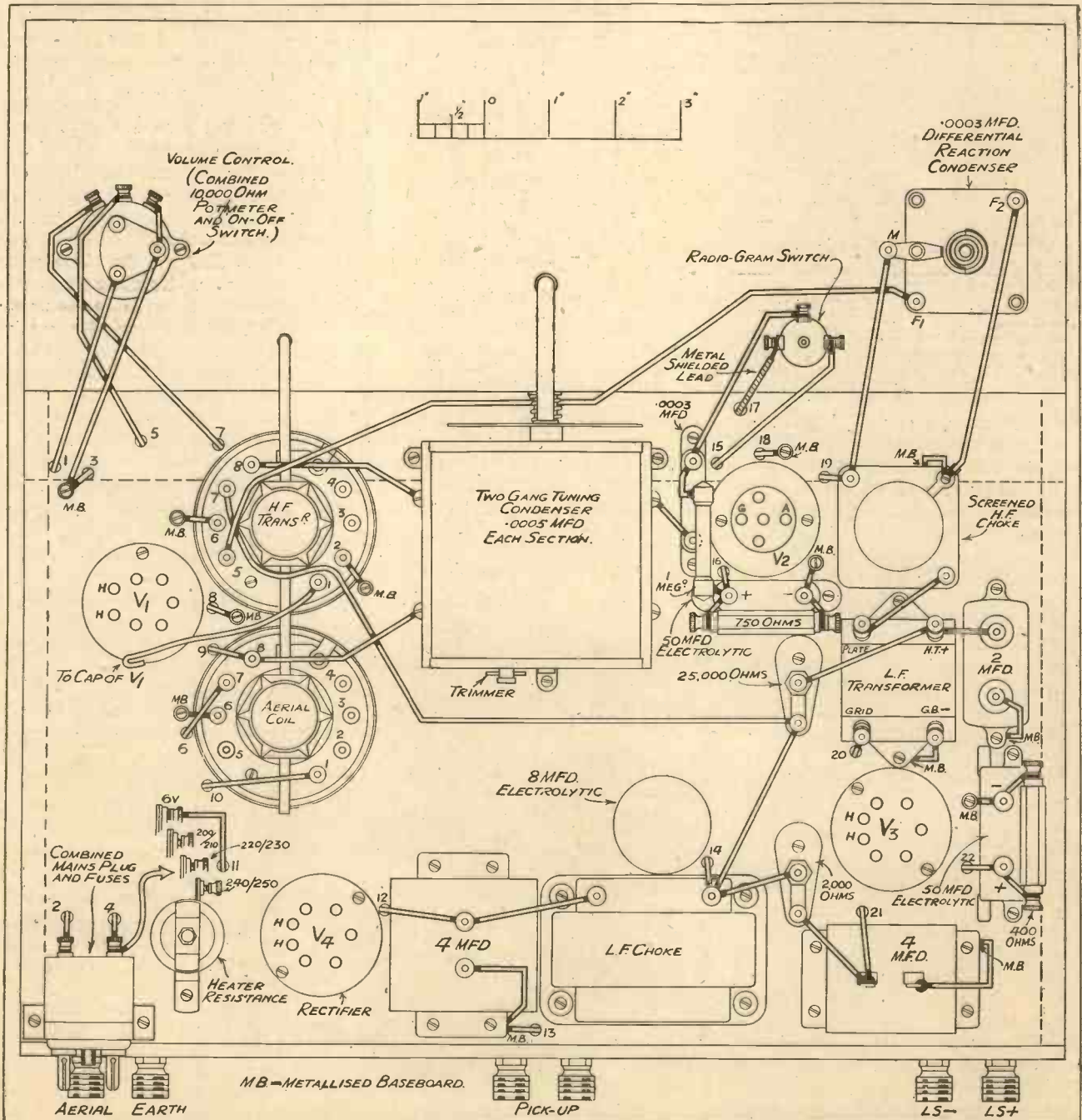

The above-chassis wiring. Note that the connections to the four valve holders and to the 8-mfd. electrolytic condenser are made underneath, as shown in the diagram on the opposite page.

Precision Tuning Achieved on Every Station

set off. And in switching the set on the operator is bound to start with minimum volume so that those loud extraneous noises which often herald the switching on of a mains set because it runs straight into maximum volume are not heard.

is to discourage them from this practice by pointing out that to divert from our component list is to divert from our design.

The construction of the set commences with the drilling and cutting of the panel, fixing the baseboard,

of fair quality, such as American white-wood or deal, will serve.

The panel drilling is done with ordinary twist drills and if you have only small drills the larger holes will need to be reamed out to size with the tang of a file or, using it carefully, the blade of a pair of scissors.

No, there is no large hole to be cut out for the condenser dial. You might think so at first sight, but all the panel work comprises merely ordinary circular holes which you can easily mark out and drill by means of our diagrams and the template supplied by the condenser itself.

THE PANEL CONTROLS AND THEIR POSITIONS

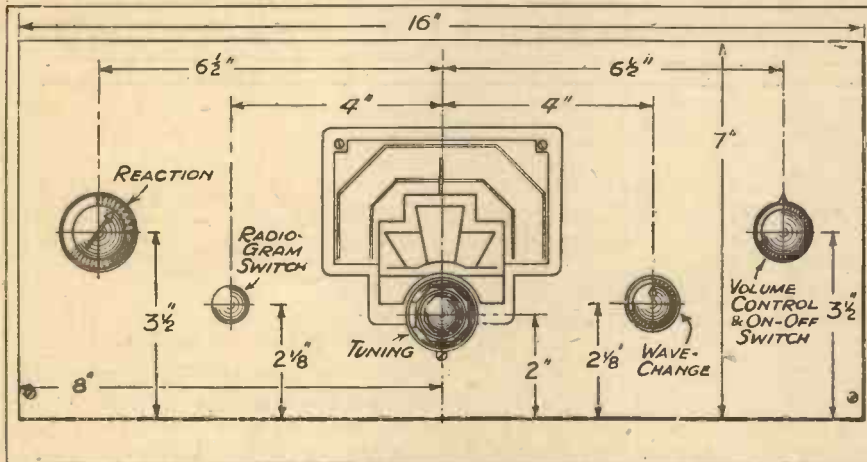

Although an attractive dial is employed for the variable condenser, there are no awkwardly shaped holes to be cut for it. And, in any case, the panel may be obtained readily drilled by those who desire this.

The receiver is also equipped with radiogram switching, terminals for a pick-up being provided at the back. It is a fine set for pick-up work. Two stages are operative and these provide ample amplification with quality and stability.

Actually nearly three and a half watts output are provided by this receiver, and readers who can appreciate the meaning of that will realise that there will be adequate volume for all domestic purposes and pretty well enough for a hall.

Commencing Construction

There is also good selectivity contributed by an aperiodic aerial coupling and transformer coupling for the H.F. stage. But, of course, it isn't super-heterodyne selectivity, though ample for all conditions except those where the listener can see the broadcasting station's aerial towering above neighbouring housetops!

We are not giving alternative makes of the components but have carefully chosen one make for each part to ensure that the most satisfactory team possible shall be used by each constructor. It is true that we cannot prevent constructors from using other makes if they make up their minds to do so. All that lies within our power

runners and terminal strip together.

The 1-in. wood runners are for the purpose of raising the baseboard so that some small parts can be accommodated underneath it. Half-inch wood

The Valve Holders

Holes must be cut in the baseboard for the valve holders, one inch diameter holes for all of them except the rectifier and for this a hole 1 1/4 ins. in diameter is required.

There is also the 8-mfd. electrolytic condenser. To mount this inlet the big nut of its base into the underside of the baseboard by cutting away a couple of the layers of the ply-wood (Metaplex is metal covered ply-wood) in the form of a hexagon, the same size as the nut. Lay the nut in this depression (it should fit nice and snugly), and then cut through the remaining layers to make a circular

(Please turn to page 40.)

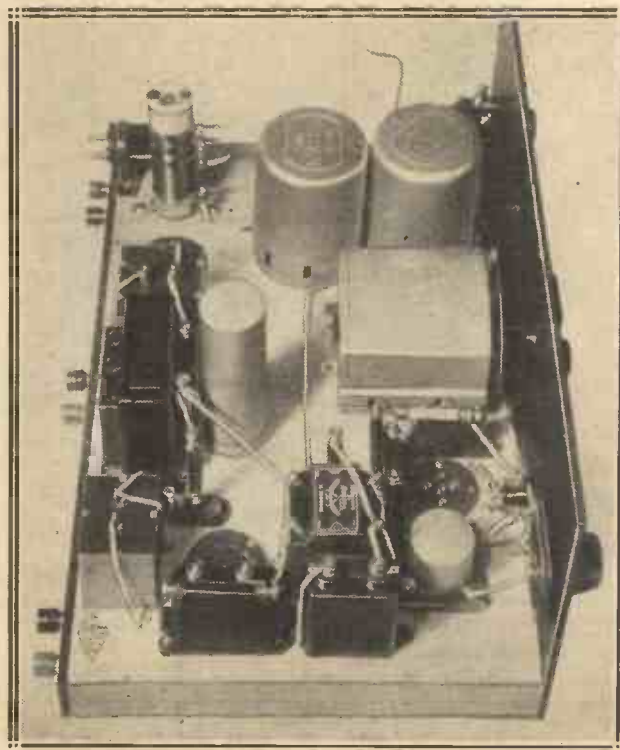

FOR VARIOUS MAINS

Not only is the receiver suitable for A.C. or D.C. mains, but by a simply adjusted resistance can be adapted for various voltages. This resistance is visible in the photograph at the top left-hand corner of the baseboard.

The NEW BROADCASTING IN GERMANY

By
Rosita Forbes

At this moment German broadcasting may be described not only as the eyes, ears, and voice, but as the composite mind of tens of millions.

America has commercialised broadcasting until the air is little more than an advertising agency. Russia uses her multiple stations for unceasing educational propaganda. But it has been left to Germany to create by specialised use of the radio, not a mere political party, but a united nation.

"Better Than Print"

Much has been written concerning Hitler's masterly use of the ether, for the propagation of Nazi politics. And it is true that the Leader's voice echoes in stupendous periods from one end of Germany to another. During the funeral of Hindenburg at Tannenburg I watched Bavarian foresters, who had not seen a newspaper for weeks, tramp out of their sunless woods to stand for hours in the toy square of a gaily painted village, with priests and choristers beside them, heads uplifted towards the loudspeaker attached to the church tower, above the vast, untidy nest of a stork.

From 2,000 miles away came Adolf Hitler's peroration—"And now, dead Leader, enter into Valhalla!" Tears trickled down the seamcd leather cheeks of the giant who stood next to me. "That is good," he said, "better than wearing the eyes out over print, hein?"

A Typical Scene

On the eve of the Presidential election I sat under some chestnut trees in Saxony and talked with peasants who smoked yard-long pipes and drank their beer out of tankards labelled with their full names. Behind us was a barn-like eating-house, midway between two villages and in front, the dusty road, with ox-drawn waggons passing along it. From a loudspeaker in the tap-room came the thunder of a political speech; but the ancients were not interested.

They'd already heard a son of the ex-Kaiser, an international tennis champion, an Atlantic flyer, a scientist interested in the stratosphere, a cinema

Can you imagine political speeches being relayed to the accompaniment of music, the beat of turbulent young feet, the sobs of women in the audience, and the strange thunderous clap of a thousand flags unfurled? Or a radio "flying-squad" van breaking all speed limits in dashing back to its broadcasting-station with red-hot news of a fire or an accident? These are but two of the aspects dealt with in this fascinating first-hand impression of broadcasting in Germany to-day.

star, and an ex-unemployed ex-communist tell them why they should vote for Hitler, and they'd made up their minds to do so, anyway, long ago, because there wasn't anybody else, so what was the use of all this speech?

What they wanted to know about was potatoes. The crop had failed in East Prussia, and before there was all this fuss about electing a new President a farmer from the Elbe district had broadcast the most interesting news

A NATIONAL SET



This is the chassis of the "Volksempfänger," the German standard broadcasting receiver, which, with its three valves and loudspeaker, sells at 76 R.M. (about £6). The set is made in battery, A.C. and D.C. mains types.

on blight. They hoped he was going to continue and they explained, with some surprise, that, although he was a Prussian, he talked German.

From the Baltic ports to the Austrian frontier, newspapers are losing ground. I doubt if there is one German paper whose circulation has not dropped during the last two years.

To begin with, a newspaper consisting of four pages is liable to cost anything from threepence to fivepence in the provinces, and to go on with, the language, lettering and construction

of the sentences render the reading of it laborious to untutored eyes and minds. Moreover, German wireless is quicker with the news. Transmitting stations in the big cities have their flying squads and no sooner is a fire, an accident, or any other happening reported by telephone than a news van breaks all speed limits to the spot, with the result that, before the story comes out in a morning paper, listeners can hear it with all emotional accompaniments "on the air."

The News is Red-Hot

For German broadcasting does all but reproduce the last struggles of a murderer's victim, or the swish of an executioner's sword. It is, in its lighter moments, an intensive dramatisation of life, so that the listener hears, not only the tramp of marching footsteps, the smack of sails in a racing wind, the crescendo of hooves passing the winning post, but the hiss and lick of flames, and the cries of a child caught in a burning attic, the babel of conversation in a train, the stammer of an explosion, the rush of a fire-engine, the crash of a collision. The news is red-hot. It beats the cinema.

Often I have come out of a more or less empty picture-house and seen a café crowded to suffocation, or a throng wedged in the street, listening to a far more exciting story than the screen (shackled to propaganda) could unfold.

Vivid Presentation

Even Hitler's speeches are not words alone. They are relayed to the accompaniment of music and the beat of turbulent young feet, the sobs of women in the audience, and the strange, thunderous clap of a thousand flags unfurled. But this dramatisation of life and news which makes the ether more attractive to the average worker with none too many pennies in his pocket, than the printed page, or the screen, is the least interesting aspect of German broadcasting. For when Hitler or Göbbels (who is the Genius of propaganda) decided to establish by means of the ether the unity desired

The Whole Country is Being Consolidated by Radio

for the land, the first thing he had to do was to teach Bavarians, Saxons, Württembergers, Silesians, Prussians, that they were all Germans.

Until eighteen months ago these different races had only really been united in the trenches, and there was no sort of understanding between them. Hence, the surprise of the Saxon peasant to hear the Elbe farmer talking the same language.

The Nazi Government started by arranging wholesale tours of artisans and labourers, by means of which steel-workers from the Rhineland were familiarised with the docks of Hamburg or the new, experimental, small-holdings in Pomerania. During the course of such a tour the men listen to wireless lectures on local conditions. When they return to their factories or to their villages, they elect a spokesman to express their views on what they have seen, and the speech is broadcast in the district they have visited. Thus every group of workers is gradually being familiarised with conditions in other industries, and other classes of work.

Local Problems

There are farmers' conferences on the air during which stock-breeders and agriculturists in different parts of Germany give their views on local problems and prospects. I have heard blast-furnace men, riveters, engineers, salesmen, manufacturers and chemists speak according to the general interest of their subject. And

I have heard interesting lectures describing the Baltic ports for the benefit of coal-miners in the South, or heavy industry for the sake of grain-growers East of the Corridor.

"A Map of Germany"

In this way, the ordinary German, listening as a matter of course to the wireless which is only turned off during the few hours devoted to sleep, learns, not only all that is going on in Germany, but how he himself is likely to be affected by it.

Since foreign news is scarce, and

BRINGING THEM IN TOUCH



In Germany broadcasting has penetrated into every corner of the countryside, and thus the working-man is able to keep in touch with every event of national importance in a way hitherto undreamt of. Not only does he hear Presidential and Ministerial speeches, but he also gets a plentiful supply of news, a variety of first-rate entertainment, and interesting talks which he can understand and appreciate.

consists chiefly of selected opinions laudatory to the Nazi régime, the ether must seem to the average listener as national as the German speech which unifies the interests of half-a-dozen ex-kingdoms.

So it is that when the peasant turns on the wireless in his wooden hut half-way up a mountain side, conscious that there are enough logs stored for winter and the harvest has been good, his ears take the place of his eyes in that they show him a map of Germany. Without stirring from his hard chair he is taught, not only a stirring and apparently effective political creed, but a popularised version of geography and history, emphasised by the views of people just like himself.

More Listeners

No wonder that the number of German listeners has increased threefold during the last eighteen months, or that men who have never written more than a signature on a receipt, are laboriously scrawling their newly-discovered opinions for the benefit of their local stations.

Only the women are silent, for there is one noticeable difference between German and other broadcasting. No special appeal is made to women and no time devoted to their interests.

They are supposed to follow their men, and when I asked Hitler what he was going to do for his countrywomen, he replied, quite simply; "What can I do, except give them better husbands?"

Six quite new jig-type puzzles, a jolly party game and over one thousand extremely funny pictures—that is what you get for one shilling when you buy "Grandfather's Whiskers," the puzzle-game that is now being sold all over the country.

Entertainment for All

This immensely interesting and humorous three-in-one novelty provides entertainment for every member of the family. And it can be enjoyed either singly or by groups of any number of children or grown-ups.

A FASCINATING NOVELTY

It consists of a pack of forty-eight beautifully printed cards, and they are all used for the game. This is straightforward fun of the best and cleanest type. It is extremely simple to play and there are no complicated rules, but there is much more in it than there is in most of the family games played.

The majority of these have been handed down to us from our ancestors,

for the past few decades have been most unproductive of new games suitable for all to play.

Grandfather's Whiskers will probably in its turn be passed into future centuries to entertain our descendants!

The numerous four-colour pictures which figure in this diverting game take the form of comical "heads" and "tails," and when any two cards are laid together, a complete picture is made. It might be anything, for over one thousand such combinations are possible.

(Continued on page 37)

POLAR

MIDGET GANG CONDENSERS



Send for NEW
POLAR
CATALOGUE

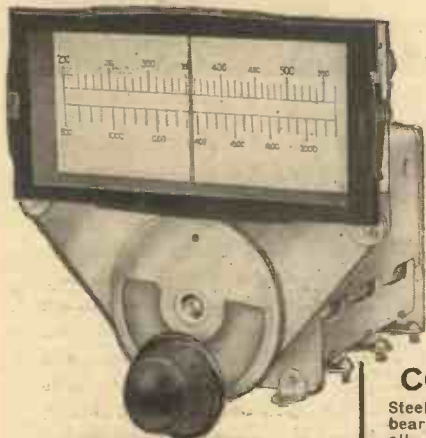

and
POLAR
DRIVES

POLAR MIDGET GANG CONDENSERS

Steel Frame and cover. Ball-bearing shaft. Small overall dimensions. Trimmers operated from top. Matched within 1 per cent or 1 mmfd. whichever is the greater.

Two Gang (condenser only) **11/-**
Three Gang (condenser only) **16/6**
Three Gang Super-het (condenser only) **16/6**

POLAR V.P. HORIZONTAL DRIVE

(as shown on condenser above)
Slow-motion drive with vertical moving pointer. Two lampholders provided. **6/6**

POLAR VERTICAL C.K. DRIVE

Slow-motion drive. Horizontal pointer. Lampholders provided. **6/6**

POLAR ARCUATE DRIVE

Slow-motion drive—bevelled scale. Moulded Escutcheon. Lampholders. **5/9**

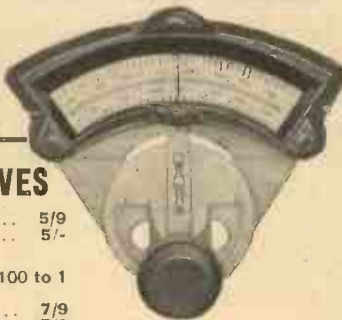

... OTHER POLAR DRIVES

Polar Semi-circular 5/9
Polar Panel Mounting 5/-

POLAR MICRO-DRIVES

incorporating two reduction ratios, 100 to 1 and 7 to 1.
Micro-drive Arcuate 7/9
Micro-drive Horizontal 7/9
Micro-drive Semi-circular 7/9
Micro-drive Moving Scale 6/6

WINGROVE & ROGERS, LTD.,

188-189, Strand, London, W.C.2.

Phone: Temple Bar 2244/5/6.

Polar Works: Old Swan, Liverpool.

SPECIFIED

FOR THE



ONE-DIAL AC/DC RECEIVER

Amplion chosen because "Lion" Speakers can be correctly matched to every class of output. They excel in life-like reproduction, have fine tonal balance, are super sensitive yet handle heavy input without the slightest signs of distortion.

Both models are fitted with Universal Transformer 1 to 20 and 2,000 to 40,000 ohms. Provision is also made for volume or tone control and use of an additional speaker.

"LION" 47/6 "LION SUPER" 55/-
(7 in. cone) (10 in. cone)

Literature on Amplion Speakers and Receivers Free.

AMPLION

Amplion (1932) Ltd., 82-84, Rosoman Street, Rosebery Avenue, London, E.C.1

QUESTIONS I AM ASKED



by
JOHN SCOTT-TAGGART

Q. 106. In a mains receiver circuit I notice that a fixed resistance is included in the cathode lead, in addition to a variable resistance for volume control. What purpose does this resistance serve?

A. This will have been noticed in connection with a variable- μ H.F. amplifier valve. The anode current of this valve will pass through these resistances making the cathode positive with respect to the other end of the resistances. In other words, this other end will be negative with respect to the cathode, and if we connect the "bottom end" of the tuned circuit to this negative point the grid will become negative.

The variable resistance enables us to obtain varying grid-bias voltages, but the fixed resistance, usually of about 100 ohms, ensures that there will always be a small negative voltage on the grid. This safety voltage serves two purposes. One is that it may be used to ensure H.F. stability under all working conditions and the other is that it becomes difficult to set up grid currents. These grid currents would be produced on even small strength signals if the steady grid potential were zero. The result of grid current is poorer selectivity on the tuned circuit and weaker signal strength.

Without a fixed negative bias, the probability is that signals would increase as one "turned up" the volume control but would weaken again somewhat in the extreme maximum position of the volume control.

Q. 107. How can I tell whether my two-gang condenser is working correctly. I can get good signals but do not know how to be certain that I am properly in gang.

A. When tuned in to a station which is not too strong, turn the main knob a little each way. Signals should become weaker. This is actually no proof of correct ganging. Now alter the front trimmer a little to each side

of its normal adjustment. Signals should become weaker when the original setting is altered.

Leaving the front trimmer where it was originally, try altering the rear trimmer a little to each side of its adjustment. This should likewise produce a falling off of signal strength if the set is properly ganged.

Q. 108. Why is it so necessary to keep the high-frequency currents out of the low-frequency amplifying circuits?

A. There are several very good reasons. One is that the high-frequency currents tend to cause overloading of valves intended only to amplify the low-frequency "audio" currents. The result is distortion. This occurs particularly on those valves whose so-called grid acceptance is small—i.e.,

Mr. Scott-Taggart's replies on this page to varied questions raised by readers provide a very good insight to some of the technicalities of radio. They are clear explanations which every listener will be able to follow.

where only small input voltages are permissible to avoid overloading. A pentode output valve is an example.

Another reason is that with H.F. drifting through the L.F. circuits, the set will tend to be unstable, the L.F. circuits may themselves amplify the H.F. currents after detection—e.g., in a resistance-capacity coupling arrangement following a detector valve.

Q. 109. Signals on my receiver now sound distorted, although three months ago results were excellent. Nothing whatever has been altered.

A. That's probably the trouble. You ought to have altered something. I feel that probably your high-tension voltage is down. The first rules in radio, in my opinion, are to have a good H.T. and a good aerial. Unless

you are easily satisfied as regards volume, 120 volts H.T. is the minimum voltage to give good quality, and 150 volts is very much better.

I should say that nine out of ten amateur-built sets overload on the last valve. The greed—and perfectly laudable greed—for volume too often results in distortion, particularly on the last valve. You yourself are probably obtaining a distortion through the grid-bias voltage being excessive for the anode voltage under new conditions. As your H.T. runs down, your grid bias should be reduced and you should make no attempt to keep signals as loud as they used to be. Be satisfied with a smaller output, or get a new battery.

Of course, your G.B. battery may be faulty. They get that way with old age. A very likely fault, if the distortion began suddenly, is a bad contact on a bias plug.

I assume, of course, that your accumulator is kept at an adequate voltage. A run-down accumulator will cause distortion.

A further possible cause of trouble is that the valve "emission" is down. Measure your output valve anode current (and preferably that of each other valve) and compare the figure with that for similar bias and anode voltage in the maker's catalogue. If appreciably lower in your case, this alone would account for the distortion.

Q. 110. How long should a valve last?

A. One thousand hours is a common rating. But valve manufacturers are worried because many valves are lasting much longer. Vibration in a cabinet containing speaker as well as set tends to reduce the life of the valves. The life of a valve, however, should not be judged by the time taken for the filament or heaters to burn out; valves often deteriorate in characteristics before the final burn-out.

From CIRCUIT to LAYOUT



IN the first article I dealt only with the very simplest of circuits in order that the purpose of the scheme should be clear. It is fairly obvious, however, that no one could make a very serious mistake in arranging the layout of a straightforward single-valve receiver, with or without the assistance of diagrams.

A Two-Fold Benefit

I should like to emphasise once more the two-fold benefit resulting from this idea of the redrawing of circuit diagrams. It is certainly a vast help to the uninitiated, who hitherto have fought shy of reading circuit diagrams. By comparing what I may call the "scrambled" circuit diagram with the layout plan they cannot fail to grasp, almost at a glance, the significance of the conventional signs used, which is, after all, the only thing one really has to learn in connection with circuit diagrams.

Then, working back the other way, it helps those who are not very experienced in laying out a receiver to do so with a high degree of success, right from the circuit diagram itself, without the intermediate stage of a layout plan.

The Variable Condensers

As the examples considered become more and more complicated, such small points as the drawing of the variable condensers down in the "foreground" instead of in their conventional position may very well be dropped. It is safe to assume that no one laying out, say, a three-valve set directly from the circuit diagram would be quite so devoid of intelligence as to plant the variable condensers in the middle of the baseboard!

Let us, without further preamble, consider the case of a straight two-valver comprising a detector and transformer-coupled L.F. stage.

This is the second article describing an ingenious method of deriving an efficient layout direct from the circuit diagram of a receiver. The first article was published last month, when very simple circuits were dealt with.

By L. H. THOMAS, A.M.I.R.E.

To start with, let us look well into Fig. 1, the circuit diagram, correctly drawn, of our typical two-valve set. Let the less experienced readers ask themselves how they would set about building this set without any further help, either in the way of text or diagrams.

How many mistakes in layout would they make? I take it that, by studying

IN CONVENTIONAL FORM

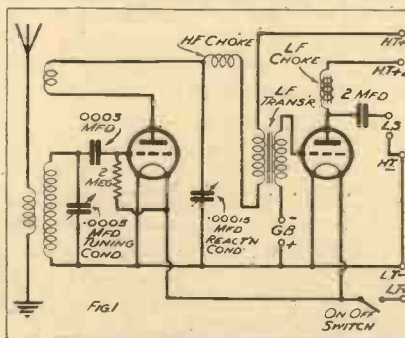

This is the straightforward two-valve circuit dealt with in this article. The text explains how a satisfactory layout may be derived by first redrawing the circuit.

a list of conventional signs, they would be able to plant their components down somehow and wire them up without making a mistake. It would be the laying out of components to the best advantage that would cause them much thought and trouble.

As a matter of fact, even at this stage, one wouldn't go very far wrong if one placed the parts on a baseboard roughly in the positions in which they appear in this theoretical diagram, with the glaring exception of the variable condensers.

By fixing the terminal strip on

the right-hand edge of the baseboard (looking from the front) one could arrange a very creditable copy of this diagram. This month, however, we are going to be a little more conventional.

When you have soaked in the circuit diagram thoroughly, take a glance at Fig. 2, which shows a very, very ordinary panel-and-baseboard layout for the same set. See if you can spot the discrepancies between the two diagrams.

Position of Terminals

I have purposely made my own task more difficult this month by putting the terminals in their usual position at the rear of the set. Please note that, though this is what I call an "ordinary" layout, there is nothing deficient about it. It is the kind of arrangement of a two-valve set of this type that could hardly be bettered after hours of shuffling and reshuffling.

The one weak spot about the whole thing is the position of the reaction condenser. From the operating point of view it is excellent, and it also gives us our beloved symmetrical panel layout, but it *does* mean a long, awkward wire from the point where the H.F. choke is joined to the reaction coil.

A "Futuristic Version"

I have left this, however, because it is the sort of thing that one does come up against in almost every type of set, and it is not my purpose to deal with layouts that are absolutely ideal. For one thing, they don't exist as yet. If they did we should always use them and nothing else, and there would be no point in these articles at all.

Now look at Fig. 3, which is the "futurist" version of the circuit diagram, showing a very close approximation to the actual layout of Fig. 2. All the major components are in the

Trying Out New Circuits and Set Designs

same positions. The wiring is not quite the same, but that really doesn't matter at all.

After all, once you have screwed your components down on a base-board with some sort of a plan, you simply wire them up in the shortest possible way, after the manner of those once-popular puzzles concerned with joining up seven taps to their respective water-supplies—except that there is no restriction about crossing wires in this case!

An Improvement

You will notice that I have improved the weak spot about which I was speaking. By placing the H.F. choke as in Fig. 3, to the right of the valve holder instead of behind it, I have considerably shortened the lead to the fixed plates of the reaction condenser. Another component that has shifted, for no particular reason except clarity of drawing, is the 2-mfd. coupling condenser from the last valve to the loudspeaker.

It is, of course, impossible to portray accurately the wiring of the valve holders, since they invariably have a filament terminal on either side, and we always depict a valve in our circuit diagrams with the filament at the bottom. There might be a spot of bother with pentodes and double-diode triodes, but that need not worry us.

The Constructional Side

I cannot lay too much emphasis on the importance of the constructional side of a receiver. Naturally, the very first thing is the theoretical circuit that we employ; if that is basically bad the thing can't possibly give good results except through the medium of 'freaks.'

But we must not overlook the fact that it is the easiest thing in the world for an inexperienced set constructor to ruin a perfectly good circuit by rigging it up roughly and hurriedly

with a downright bad layout. This doesn't apply to the faithful followers of THE WIRELESS CONSTRUCTOR who build all the star sets and adhere faithfully to the designer's recommendations and diagrams.

HOW THE SET MIGHT BE ARRANGED

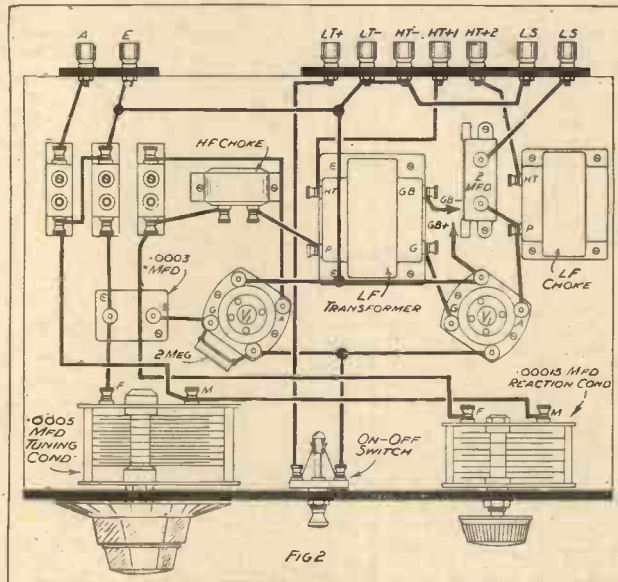

In practice the circuit of Fig. 1 would be arranged usually on the lines shown here. The positions of the components should be compared with those of their equivalent symbols in Fig. 1.

I feel, however, that there are many readers who consider themselves a little bit "advanced," and proceed to try out new circuits in half an hour or

THE NEW METHOD

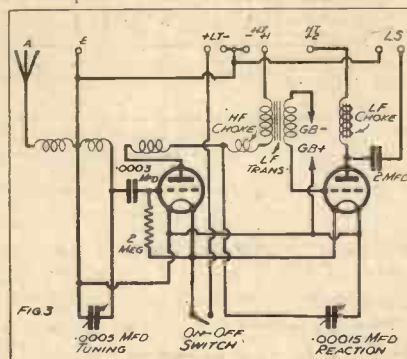

By redrawing the two-valve circuit in this manner one is able to see just how to arrange the layout without ever seeing a practical diagram of the set.

so by just laying the parts about the place and wiring them up roughly. I know, because I've met them and seen them at work.

Let me assure them in all sincerity that this operation is not trying out

a circuit; it is strangling it at birth! Sometimes one of these untidy "lash-ups" (I believe that is *le mot juste*) happens to work well; generally they do the most appalling things and are scrapped and forgotten immediately. Unfortunately, however, there is a faint echo of such calamities—a word going round that the So-and-so circuit is no good—"unstable, you know . . ."; "howled like anything when I tried it out the other day . . ." and so forth. And just how funny that "trying-out" business was; nobody but the perpetrator knows.

INTERFERENCE ON SHORT-WAVES

LISTENERS of long standing will remember, when high-powered broadcast transmitters were something new, how there always seemed to be a German station coming in well, and usually so well as to interfere with the reception of some other station or stations.

Present-day listeners on short-waves will have noticed a repetition of these circumstances, some German station appearing at all times to be working, and producing interference.

This interference will probably have puzzled the non-technical, who will claim that they have been given to understand that there is ample room on short waves for thousands and thousands of broadcast stations, and that tuning was always very sharp on the short waves.

A Matter of Kilocycles

The explanation is quite simple. First of all the width of the bands (in kilocycles) allocated to broadcasting on the short waves are smaller than the medium-wave broadcast band. At the same time there are an amazing number of stations to accommodate. So the separation between them may not be more than around the 9 kcs. mark, just as on medium and long waves.

Secondly, the sharp tuning is only apparent. It is due to the fact that the capacity of the tuning condenser used is often such that a one-degree movement covers more kilocycles than one degree of the familiar 0.005 does on medium waves.

A. S. C.



**AS WE
FIND
THEM**

NEW APPARATUS TESTED

Utility Components

OUR laboratory tests this month include those of the new Utility condensers and drives. Two models (a 2 and a 3 gang) of the firm's condensers have been tried out with highly satisfactory results. The first impression on picking up one of these condensers is its robust construction. A ganged condenser must be sturdily built if it is to maintain its matching

STRONGLY CONSTRUCTED

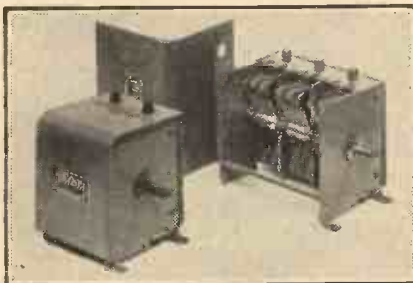

Two of the latest Utility ganged condenser units. On the left is a two-gang, and on the right a three-gang with the metal cover removed. The trimmers are located on the tops of the condenser chassis.

unchanged over a long period, and these Utility components certainly fulfil this essential factor.

Another essential is a perfectly smooth movement. There must be no sticking at any point and backlash must be absent. Utility ganged condensers are provided with a ball-bearing movement, and the moving vanes rotate with a delightful freedom. We could not detect the slightest trace of stickiness or backlash.

Each ganged assembly is fully screened and trimmers are fitted to each section. These trimmers are conveniently located on the top of the component, and are easily adjusted with the aid of the usual wooden "screwdriver."

In addition to the ganged condensers we were also able to test two of the latest Utility drives. The first, which has a full-vision scale, is supplied in two forms. In one case there is a two-colour scale marked in wavelengths

and 0-100 divisions. In the other a plain black scale marked in 0-100 divisions is fitted.

The drive has a ratio of 12:1, and the indicator is mounted on a metal tape and moves across the scale in direct proportion to the angle of rotation of the knob. Beautifully finished throughout with a perfectly smooth movement, this drive sells at the very moderate price of 6s. 6d. The type with a wavelength-calibrated scale is, of course, intended for use with special coils and Utility W.347 and W.349 condensers.

The second drive, known as the "Straight Line Micro Dial," has a somewhat more elaborate slow-motion movement than the model we have

just described. It has two large diameter control knobs giving ratios of 12:1 and 150:1, and lends itself particularly to short-wave receivers.

The makers are Wilkins & Wright, Ltd., Holyhead Road, Birmingham.

TWO CONTROLS IN ONE

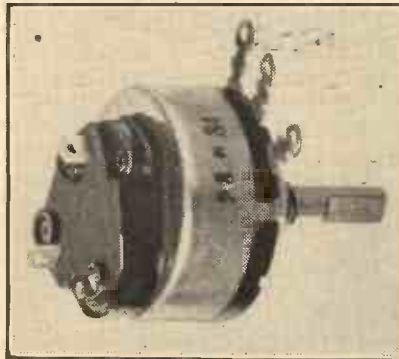

A very neat Polar-N.S.F. combined volume-control and switch. This control is available in values suitable for H.F. and L.F. work.

just described. It has two large diameter control knobs giving ratios of 12:1 and 150:1, and lends itself particularly to short-wave receivers.

The makers are Wilkins & Wright, Ltd., Holyhead Road, Birmingham.

Polar-N.S.F. Volume Control

The present day tendency is to reduce the number of controls to a minimum. If two controls can be combined and operated from the one

knob so much the better, provided the simplification does not detract from the efficiency of the set.

It is, for example, perfectly logical to combine the volume control and "on-off" switch. This is done in the case of the Polar-N.S.F. series of volume controls.

In appearance the component is little different from the normal volume control, but at the back, neatly ganged to the spindle, is the switch.

This switch comes into operation when the control is at its minimum position. To switch on the set you turn up the volume control. After switching on any further clockwise rotation of the knob increases the volume until the maximum position is reached. The reverse operation, viz., decreasing volume gives a gradual "fade out" effect until the minimum position is arrived at and the set is automatically switched off.

The Polar-N.S.F. control is available in values suitable for H.F. and L.F. circuits. One can obtain 5,000 and 10,000 ohm potentiometers for H.F. use, and 50,000 ohm, 100,000 ohm, $\frac{1}{2}$ and $\frac{1}{4}$ megohm values for L.F. purposes.

The controls are quite silent in operation and the spindles themselves are insulated. They are first-rate jobs throughout, and the price is 6s. The makers are Wingrove & Rogers.

SMOOTH AND POSITIVE



The new Utility slow-motion drives dealt with on this page. The steel tape upon which the indicator is mounted can be clearly seen.



SINCE a brand-new wireless season is now well under way, and many new chums have joined our ranks, I feel sure that some hints for beginners from the Professor and myself will be widely appreciated. Other and lesser pens have, of course, dealt with the subject before this, but never has the beginner had, as now he has, the opportunity of obtaining information straight from the horse's mouth. On no previous occasion have the world's two greatest experts (both modesty and the fact that it is unnecessary to do so prevent me from naming them) put their heads together to make the path to wireless knowledge easy for him.

Acquiring a Set

The first step in wireless is to acquire a receiving set. There are many ways of doing this, including buying, building, begging, borrowing, cat-burglary, hire-purchase, wangling, winning and so on. There are other methods, too, into which I have not space to enter here; but if you don't

FINDING THE METER



The man of unadventurous mind will go down to the coal cellar and remove the three or four tons of coal.

believe me that they exist, ask any member of the Mudbury Wallow Wireless Club who has had a visit lately from Professor Goop or me.

When acquiring a set, bear in mind that what you will chiefly do with it is to tune-in stations. A convenient tuning system is, therefore, of vital importance. Nowadays, there are sets with all kinds of tuning. There is clock-face tuning and barometer tuning and station-name tuning and kilocycle tuning and wavelength tuning and degree tuning, and, for all I know,

there may be thermometer tuning and speedometer tuning, and hydro-meter tuning and almanac tuning as well.

Which, then, are you to select? I hesitate to offer advice, knowing as I do that you will either disregard it or take precisely the opposite course.

WIRELESS WAYFARER GIVES (SELF) HELPFUL ADVICE ON HOW TO OBTAIN AND INSTALL A RADIO RECEIVER

You should, though, realise clearly the vast importance of selecting just the right method, and you should keep before you the fact that all tuning devices may be divided into two broad and widely different classes. In the one a pointer travels over a dial; in the other a dial travels past a pointer.

Important Trifles

Naturally, there are variations of these themes. I mean, sometimes the dial (or the pointer) moves horizontally, whilst sometimes again the pointer (or the dial) travels vertically. Choose the one best suited to your temperament, and most likely to give you free rein for self-expression. It is things like this, which the unthinking might regard as mere trifles, that make all the difference to real success as a wireless man.

Having come by your set, the next thing is to connect it up to the source of Power. Note that capital P, as well as to the Collector System (note the capital C and the capital S), consisting of the aerial and earth.

That Long "Dog-Lead"

And here, such is the flow of valuable hints generated by the Professor's brain and mine, in parallel, that my pen can hardly keep pace with them.

One terminal on the set is marked with a plain letter A; another, E. Not a few wireless beginners who failed to figure

in the spelling prizes at school take it that A stands for Arth and E for Erial. Carefully avoid this mistake, for it may lead to your receiving both speech and music inside out.

If the set is intended for mains operation, it will have a two-prong plug at the end of what looks like a dog-lead, but is really a length of flexible wire. This is meant to be inserted into a wall socket.

Before you insert the plug into the socket, satisfy yourself that you have chosen a set to suit your mains. That is to say, be sure that if your mains are A.C., the set is also A.C., or if they are D.C. that the set is similarly labelled.

Checking the Mains

There are two ways of doing this. The man of unadventurous mind, who never bets except on certainties, will go down to the coal cellar and spend a happy afternoon in removing the three or four tons of coal that are barring his access to the meter. He will then examine the said meter and determine

THE BEST FIREWORKS



The prettiest fireworks are obtained by connecting the L.T. leads to the high-tension battery.

the nature of the current, its voltage and its frequency.

The more spectacular method is just to insert the plug and switch on. If the set works, then it is exactly right for the mains supply. If it goes up in blue flames, then you must start all over again.

In the case of battery sets, manufacturers have paved the way to all kinds of fun by providing anything up to ten different wander-plugs and things. These are all carefully labelled L.T. +, L.T. -, G.B. + 1, H.T. + 3,

"Tunes Itself In all Round the Dial"

and so on. The beginner can spend happy and instructive minutes in sorting them out. The best radio results are obtained by making the connections properly; the prettiest fireworks by connecting the L.T. leads to either the high-tension or the grid-bias battery.

Those Dutchmen

And now comes the process of tuning in foreign stations. I won't insult you by telling you to tune in the local, for you may find that it tunes itself in sort of all round the dial.

We will suppose that you have selected a set with a station-name dial and that you decide that Hilversum shall be your first foreign capture. You therefore turn the switch to medium waves and twiddle the knob so that the dial travels behind the pointer (or the pointer over the dial) until Hilversum is reached. Strains of music greet you and you are elated by your success until the announcer presently informs you that you are listening to Huizen.

Thinking that you must have turned the wave-change switch the wrong way, you flick it over and swing the dial (or the pointer) round to Huizen.

Ere long a voice announces that you are listening to the Hilversum programme.

Do not be dismayed. Just as the oyster changes its sex every six months,

WHERE THEY VARY

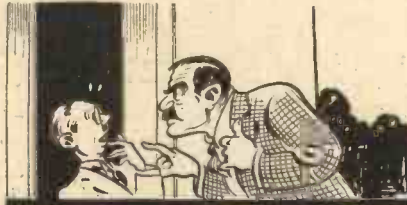

The difference between the "straight" and the superhet is that the squeals of the former annoy your neighbour whilst those of the latter annoy you.

so Hilversum becomes Huizen and vice versa every three.

Professor Goop and I have recently patented our Calendar Dial, which, besides automatically making the necessary changes, also follows the

French and Spanish stations in their weekly jumps from one wavelength to another.

But joking apart, with a dial marked off in station names you always know exactly where you are. If, for instance, you require Leipzig you turn to the Midland Regional or Rome, and should you desire to hear Turin, all that you have to do is to set the pointer (or the dial) at Bordeaux or Frankfurt. Simple, is it not?

Two Main Classes

One point that should be borne in mind in choosing a receiving set is that (quite apart from tuning dials) there are two entirely different classes. The first are known as "straights"; the second as superheterodynes.

The difference between the "straight" and the superhet is that the squeals of the former annoy your neighbour, whilst those of the latter annoy you. In making a choice between sets of these two categories two proverbs should be kept in mind. The first is: "Charity begins at home"; the

(Please turn to next page)

**SOONER OR LATER
YOUR RECTIFIER VALVE
WILL NEED RENEWING.
WHEN YOU GET A NEW
RECTIFIER, GET ONE
THAT WILL GIVE YOU A
CONSTANT UNDETER-
IORATING HIGH TENSION
SUPPLY WITHOUT ANY
RENEWAL OR REPLACE-
MENT.**

GET A PERMANENT

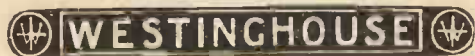

METAL RECTIFIER

THE WESTINGHOUSE BRAKE & SAXBY
SIGNAL CO., LTD.

82, York Road, King's Cross, London, N.1.

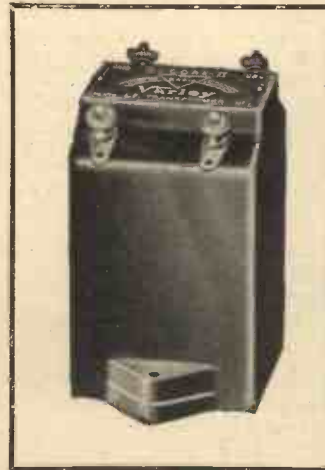

**ONLY
VARLEY
NICORE II
L.F. TRANSFORMER
SPECIFIED IN THE**

● Sole and special choice for the One Dial A.C.-D.C. Set, there can be no doubt as to the efficient working of the Varley Nicore II. L.F. Transformer. The designer knows that Varley traditions of good workmanship and reliability are as alive today as they were in the early days of radio.

**ONE-DIAL A.C.-
D.C. SET described in
this number of The W. Constr.**

Advertisement of Varley (Oliver Pell Control Ltd.) Bloomfield Road, Woolwich, S.E.18.
Telephone—Woolwich 2345

IN LIGHTER VEIN

—continued from previous page

second, "Do as you would be done by." You will soon discover whether the next-door fellow has a "straight" or superhet, and he will no doubt make a similar discovery about you. If he happens to be a large and muscular chappie apt to run amok with billhooks and coke hammers and things, a superhet will be your best bet.

Now we come to the reception of American stations. Nobody can call himself a true wireless man until he has sat at the controls till the cocks begin to crow, and he has identified at least half a dozen stations across the Herring Pond.

Don't Worry the Wife

Transatlantic reception is almost ridiculously easy. All the experts agree in telling us that (a) it is no use starting a search until after midnight; (b) if you then hear a station it is sure to be American; and (c) the most fruitful part of the medium waveband to search over is that between 200 and 300 metres.

And here let me give one fundamental hint about sitting up for America. Your better half no doubt retires to roost at about ten pip emma. Do not run upstairs all dithering with excitement at three in the morning to bring her down to listen to Chicago or Schenectady or Springfield.

The First Station

The first (and last) time Professor Goop did this he got such a swat in the eye from a bedroom slipper that he thought seriously of abandoning wireless and taking up all-in wrestling as a hobby.

The witching hour of midnight

NOT INTERESTED!



Professor Goop got such a swat in the eye from a bedroom slipper that he thought seriously of abandoning wireless and taking up all-in wrestling.

(Shakespeare, I think) having struck, switch on your set and tune slowly upwards from the bottom of the medium

waves. Strains of music! Here is America! Out with the list of stations and let us wait for the call-sign!

"Hullo, everybody, Fécamp calling!" says the announcer chappie, and with a little sigh, off we go again. This time there is no doubt about it. Well knowing that we ought to be in bed and still better knowing that we aren't going there at any price, we listen to musical items and announcements by someone whose English has the desired degree of nasality.

Keep on Trying

We are thrilled; we are exalted; bed seems utterly unimportant. And then comes the voice of someone speaking in German, who remarks that Breslau is relaying Miami.

A bit hard, isn't it? These are merely the trials and tribulations through which the beginner must pass until he becomes a fully-fledged wireless man. He must not be downhearted. Perseverance is necessary—and a deaf ear to the family's protests, then success is sure. Presently he will really receive America and shortly after that he will join the noble band of radio-liars, who habitually get Chicago at full loudspeaker strength on one valve or even, if the longbow is handy, on a crystal.

SOLELY SPECIFIED

for the W.C. "MIDGET SUPER"

J. B. NUGANG (Type A) - 22/6

(or 20/6 without cover).

Use the J.B. Nugang tuning condenser and be sure of satisfaction from your "Midget Super." The chassis of this condenser is rigid, built in one piece matched to within 1/2 m.m.f. plus 1/2 per cent. It has heavy gauge wide spaced aluminium vanes—with a trimmer to each stage. Each section .0005 mfd. Complete with disc drive. Remember that only J.B. Nugang (type A) is specified for the "Midget Super."



PRECISION INSTRUMENTS



Advertisement of Jackson Bros. (London) Ltd., 72 St. Thomas' Street, S.E.1. Telephone: Hop 1937

ALL SPECIFIED!

for

ONE DIAL

A.C.—D.C. RECEIVER

and

"MIDGET SUPER"

CLIX Chassis Mounting Valve Holders
7-pin Continental type .. each 1/-
7-pin Floating type .. " 1/-
5-pin Standard type .. " 9d.

CLIX Panel Terminals.
Type "A," each 2½d. Type "B," 4d.

CLIX Spade Terminals.
Small size 1½d. Large size, each 2d.

CLIX "Master" Wander Plugs.
For H.T. and G.B. Medium or short shank and insulator .. each 1½d.

CLIX Valve Cap Connectors.
For use with all valves having the new "Thimble" Caps .. each 1½d.

THERE IS A WONDERFUL RANGE OF CLIX PERFECT CONTACT COMPONENTS. WRITE FOR FOLDER "C."



Stocked by all Good Dealers.

LECTRO LINX LTD., 79, ROCHESTER ROW, S.W.

A FASCINATING NOVELTY

—continued from page 28.

But whatever the result, it is bound to be extraordinarily comical. Children, or grown-ups too, for that matter, can spend hours attempting to find the funniest effect. They will never reach that goal, for the haphazard matchings are all almost equally humorous!

Six Complete Puzzles

Even if Grandfather's Whiskers left off there it would have to be admitted that it represented one of the year's best shillingworth. But there are still the six jig-type puzzles. These are to be found on the backs of the cards. Eight cards are employed for each puzzle, and as the cards are plainly numbered, it is easy to divide them up quickly into the groups needed.

The first puzzle comprises the cards numbered from one to eight and it is a very simple one. A child of six or seven years of age ought to be able to solve it.

S.T. 600

Mr. Scott-Taggart's New National Receiver will be fully described on

OCT. 24

In our Sister Journal

POPULAR WIRELESS 3^D.

The second puzzle, for which the cards numbered from nine to sixteen are used, is a trifle more perplexing, and each successive group of cards presents a more difficult puzzle, the sixth being the most advanced one of the series.

Astounding Value

And all this is possible with the one shilling article remember—game, pictures and puzzles. Surely no previous single item of humorous entertainment has before been such astounding value for money.

A slogan used in connection with it is that "millions will be searching for Grandfather and his Whiskers this winter." That would appear to be a perfectly safe prediction to make.



The Pilot Kit SERVICE was founded in 1919.

**MIDGET SUPER ONE DIAL A.C.-D.C. SET
S.T. SUPER-GRAM DE LUXE
S.T. 300 STAR S.T.300 STAR MARK II**



See the PILOT on the carton. It's a real guarantee.

PILOT AUTHOR KIT EXACT TO SPECIFICATION

MIDGET SUPER ONE DIAL A.C.-D.C. SET

KIT 'A' Author's Kit of First Specified Parts, less Valves and Cabinet. Cash or C.O.D. Carriage Paid, £8/3/6. Yours for **15/-** and 11 monthly payments of 15/-

KIT 'A' Author's Kit of First Specified Parts, less Valves and Cabinet. Cash or C.O.D. Carriage Paid, £8/9/6. Yours for **11/9** and 11 monthly payments of 11/9

KIT 'B' As for Kit 'A' but with set of Specified Valves, less Cabinet. Cash or C.O.D. Carriage Paid, £11/4/0. Or 12 monthly payments of 20/6.

KIT 'C' As for Kit 'A' but with set of Specified Valves, and Peto-Scott Cabinet. Cash or C.O.D. Carriage Paid, £12/3/6. Or 12 monthly payments of 22/3.

KIT 'B' As for Kit 'A' but with set of Specified Valves, less Cabinet. Cash or C.O.D. Carriage Paid, £8/18/9. Or 12 monthly payments of 16/6.

KIT 'C' As for Kit 'A' but with set of Specified Valves, and Peto-Scott Cabinet. Cash or C.O.D. Carriage Paid, £9/16/3. Or 12 monthly payments of 18/-.

KIT-BITS You pay the Postman. We pay Post charges on all orders over 10/-, Great Britain only.

KIT-BITS You pay the postman. We pay Post charges on all orders over 10/-, Great Britain only.

	£	s.	d.
1 Peto-Scott Ready Drilled Metaplex Chassis, 9" x 10" x 3", as specified	3	6	
2 Peto-Scott Ready Drilled Ebonite Terminal Strips			9
1 J.B. Nugang 3-gang Tuning Condenser, each section .0005 mfd.	1	2	
1 Set Colvern Superhet Ferrocort Coils, with battery-type switch	1	19	
1 Colvern Ferrocort I.F. Transformer, type 110	12		
1 Colvern Ferrocort I.F. Transformer, type 110a	12		
1 Wearite Q.P.P. Input Transformer, type P.P.A.	13		
4 Specified Valves	3	0	
Peto-Scott Midget-Super Cabinet	19		
W. B. Stentorian Baby P.M. M.C. Speaker	1	2	

	£	s.	d.
1 Peto-Scott Ready Drilled Metaplex Base-board, 16" x 10", with 1" wood runners	3	6	
1 Peto-Scott Ready Drilled Ebonite Terminal Strip, 16 x 1 1/2"			9
1 Peto-Scott Ebonite Panel 16" x 7", ready drilled	3	6	
1 Bulgin 10,000 ohm potentiometer with switch, type V.M.32	5	6	
1 Formo 2-gang Tuning Condenser, with Mystic Drive and dust cover	12	6	
1 pair Telsen Twin Matched Screened Coils, type W.287	14	6	
1 Varley L.F. Transformer, type Ni-Core 11	11	6	
1 Ferranti L.F. Choke, type B.10	11	0	
4 Specified Valves	2	9	3
1 Peto-Scott cabinet to specification	17	6	

S.T. SUPER-GRAM DE LUXE

Described in September Issue

KIT 'A' Author's Kit of First Specified Parts for Radio Chassis, Amplifier Chassis, Radio Mains Unit Chassis, and Amplifier Mains Unit Chassis, less valves, cabinet, speaker and Garrard Record-Changer. Cash or C.O.D. Carriage Paid, £27/7/6. Yours for **67/6** and 11 monthly payments of 48/-

KIT 'B' As for Kit 'A' but including complete set of Specified Valves. Cash or C.O.D. Carriage Paid, £36/10/6. Yours for **£5.10.6** and 11 monthly payments of 62/-

VALVES: Complete Set of Specified Valves for Radio Chassis, Amplifier Chassis, and Amplifier Mains Unit Chassis. Cash or C.O.D. Carriage Paid, £9/3/0. Yours for **33/6** and 5 monthly payments of 33/6

ANY ITEM SUPPLIED SEPARATELY—ORDERS OVER 10/-

SENT C.O.D. CARRIAGE AND POST CHARGES PAID

STILL A FIRM FAVOURITE

S.T. 400 BATTERY MODEL

KIT 'A' Author's Kit of specified parts, Ready-Drilled Panel and full-covered Baseboard, but less Valves and Cabinet. Cash or C.O.D. Carriage Paid, £4/12/6. Send **8/6** only

Balance in 11 monthly payments of 9/6.

KIT 'B' As Kit 'A' but with Specified Valves only. Cash or C.O.D., £6/3/0. Carriage Paid, 11/3. Send **11/3** only

Balance in 11 monthly payments of 11/3.

KIT 'C' As Kit 'A' but with Valves and Cabinet. Cash or C.O.D., £7/0/0. Carriage Paid, 12/9. Send **12/9** only

S.T. 300 STAR MARK II

KIT 'A' Author's Kit of First Specified Components, including Ready-Drilled Panel, Terminal Strip and METAPLEX Baseboard. Cash or C.O.D. Carriage Paid, £4/0/0. Balance in 11 monthly payments of 7/3. Send **7/3** ONLY

KIT 'B' As for Kit 'A' but with Set of Specified Valves only. Cash or C.O.D. Carriage Paid, £5/5/0, or 12 monthly payments of 9/6.

KIT 'CT' As for Kit 'A' but with Valves and PETO-SCOTT Table Cabinet. Cash or C.O.D. Carriage Paid, £6/4/6, or 12 monthly payments of 11/6.

KIT 'CG' As for Kit 'A' but with Valves and PETO-SCOTT Console/tee Cabinet, with Shelf and Baffle, but less Speaker. Cash or C.O.D. Carriage Paid, £6/13/6, or 12 monthly payments of 12/3.

IF PETO-SCOTT P.M. SPEAKER REQUIRED WITH ANY OF ABOVE KITS, add 19/6 to Cash or C.O.D. Price, or 1/9 to Deposit and each Monthly Payment.

S.T. 300 STAR

KIT 'A' Author's Kit of First Specified Components, including Ready-Drilled Panel, and Terminal Strip, with METAPLEX Baseboard. Cash or C.O.D. Carriage Paid, £4/7/6. Balance in 11 monthly payments of 8/3. SEND **8/-** ONLY

KIT 'B' As for Kit 'A' but with Set of Specified Valves only. Cash or C.O.D. Carriage Paid, £5/12/6, or 12 monthly payments of 10/3.

KIT 'CT' As for Kit 'A' but with Valves and PETO-SCOTT S.T.300 Star Table Cabinet. Cash or C.O.D. Carriage Paid, £6/12/0, or 12 monthly payments of 12/-.

KIT 'C.C.' As for Kit 'A' but with Valves and PETO-SCOTT S.T.300 Star Console/tee Cabinet with Shelf and Baffle, less Speaker. Cash or C.O.D. Carriage Paid, £7/1/0, or 12 monthly payments of 13/-.

SEND US YOUR ENQUIRIES FOR EVERYTHING RADIO.

Miscellaneous Components, Parts, Kits, Finished Receivers or Accessories for Cash or C.O.D. or H.P. on our system of Easy Payments. Send us a list of your wants. We will quote you by return. C.O.D. orders value over 10/- sent carriage paid (GREAT BRITAIN ONLY). Any surplus refunded immediately. Hire Purchase Terms are NOT available to Irish and Overseas customers.

PETO-SCOTT CO. Ltd., 77, City Road, London, E.C.1. Telephone: Clerkenwell 9406-7. West End Showrooms: 62, High Holborn, London, W.C.1. Telephone: Holborn 3248. Dear Sirs,—Please send me CASH/C.O.D./H.P.

for which I enclose £
CASH/C.O.D./H.P.
NAME.....
ADDRESS.....
T.W.O. 11/34.

Buy by Post—its Quicker—CASH—C.O.D.—EASIWAY

Soldered contacts are better

ELECTRICALLY SOLDERED ARE BEST



Switch on a Solon Electric Soldering Iron and in three minutes it is ready for use. It plugs into a lampholder. Use a

SOLO
TRADE MARK
ELECTRIC SOLDERING IRON

7/6

65 watts 7/6
125 watts 22/6 (1 lb. 1 oz.)
240 watts 37/6 (2 lb.)

If unable to obtain, send us the name of your nearest dealer.

W. I. HENLEY'S TELEGRAPH WORKS COMPANY LTD.
Dept. Y. K. 15—HOLBORN VIADUCT—LONDON—E.C.1

MADE IN ENGLAND

Write for Illustrated Catalogue of

RADIO-GRAMOPHONE CABINETS



of exclusive modern design, made by craftsmen, in highly figured Oak, Walnut or Mahogany, post free.

REMARKABLE VALUES
Cabinets made to order a speciality. Maker, under license, of the

HOWE BOX BAFFLE
Recommended by the B.B.C.
Full details on request.

GILBERT Cabinet Maker - SWINDON
Estimates Free. Est. 1866

Engineers' Guide

containing the widest choice of engineering courses in the world

Outline the T.E.G.E.'s up-to-date, home study Courses in Wireless, Electrical and Mechanical Engineering, etc. Shows how to become A.M.I.E.E., A.M.I. Mech.E., A.Rad.A., etc., and how to qualify for a well-paid post. Training until Successful Guaranteed. WRITE NOW for Free Guide.

THE TECHNOLOGICAL INSTITUTE OF GREAT BRITAIN,
21, Temple Bar House,
London, E.C.4. (Founded 1917, 19,000 Successes.)



Free!
152 PAGES

To Success

PLEASE be sure to mention "Wireless Constructor" when communicating with Advertisers. THANKS!

THE B.B.C.'s CONVENT

By a Special Correspondent

Our Special Correspondent gives an exclusive description of the B.B.C.'s New Research Department headquarters in an old convent at Balham.

THE Convent of the Sacred Heart—full of batteries, valves, amplifiers, single-sideband transmitters, television sets, cathode-ray oscillographs, and a thousand and one other devices familiar to the world of wireless.

An Amazing Scene

Can you imagine it? I could not until I had been there and seen for myself how the B.B.C. has made use of a chapel; converted the Mother Superior's study into a laboratory, and turned the nuns' pantry into a photographic dark room.

Surely it is the most romantic of all the B.B.C.'s buildings? Not even the dentist's surgery, now a studio at Bristol, is so strange as these research rooms built in the ecclesiastical atmosphere of a convent.

The nuns—of the Order of Perpetual Adoration—have gone abroad. If they returned they would have the shock of their lives—if not from the high-tension batteries, at all events from the incongruity of seeing sausage aerials hanging from the Gothic windows of their dormitory.

The Site is Ideal

It was Mr. H. L. Kirke, chief of the B.B.C. Research, who took me over the convent. I am the first journalist so to be honoured—so I had better describe things in as much detail as possible.

The convent was taken over by the B.B.C. about a year ago, and has since undergone a remarkable transformation. It stands in one corner of Nightingale Square, Balham, and is quite close to the B.B.C.'s Equipment Department at Avenue House, King's Avenue, Clapham.

Mr. Kirke says it is absolutely ideal for his research work. He and his staff of about 30 have planned the whole building on a permanent basis, and since there is a garden with orchard at the back, he has plenty of room to expand when conditions demand it.

Single-Sideband Tests

I drove up the small drive before the convent and went in. Mr. Kirke has a beautiful Gothic office overlooking the orchard. ("How very different from Broadcasting House,"

I thought.) Then we started on our tour of inspection.

First of all, the single-sideband transmitter. This is an experimental layout constructed in what used to be the nuns' dormitory. A great many transmissions have been made, and Mr. Kirke tells me that already he has come to the conclusion that single-sideband transmissions are not for the B.B.C.

Many Technical Difficulties

"As things are," he said, "we cannot modulate deeper than about 15 per cent—which is absurd when you consider our requirements. However, we are continuing research, and perhaps we shall be able to improve on this. We keep this transmitter going for low-power tests, but can only use it out of broadcasting hours.

NEXT MONTH

FULL DETAILS OF A

MAGNIFICENT NEW

RADIO BOOK

SPECIALLY WRITTEN BY

JOHN SCOTT-TAGGART
F.INST.P., A.M.I.E.E.

DON'T MISS A
WONDERFUL OPPORTUNITY

"If we want to make higher-powered transmissions we must go to one of the Regional stations where there is less chance of our causing interference to listeners."

The transmitter is built on the most up-to-date lines, and except for certain very temporary sections is far from being a "hook-up." Much valuable data has been compiled on all manner of transmitting problems as a result of several months' experimenting with this transmitter, and no doubt many "tips" have been given to the designers of permanent B.B.C. transmitting stations.

(Continued on next page.)

THE B.B.C.'s CONVENT

—continued from previous page

As we walked along the corridors and into the various rooms I noticed the steel conveyer conduits running everywhere. These, I was informed, lead the various wirings from place to place.

For instance, high tension and low tension supply is available in every room. The main batteries and charging plant are in a small compartment (which was once the nuns' airing cupboard) completely isolated from all other apparatus. The walls of this chamber are painted with sulphuric-resisting enamel and the batteries themselves are so arranged that they need seldom be examined.

Analysing Water

A side line to the research work was shown to me in a big, light room in the front. It is used by draughtsmen who are kept constantly busy making blue prints and wiring plans of all the experimental apparatus constructed and installed there. Astonishing graphs and diagrams with intricate calculations at the side also take form in this room.

Another room is devoted to valve research; or rather, not so much research as testing.

"We leave it to the manufacturers to carry out valve research," explained Mr. Kirke. "The manufacturers send us samples of new valves, and we try them out on this testing board to see whether their characteristics are in any way suited to our requirements. Often we send valves back and say that if they are modified slightly in some way or another they would be very useful to us. The valve manufacturers are most helpful."

My biggest surprise in the convent came when I saw two laboratory assistants analysing water.

"What on earth do they do that for?" I asked Mr. Kirke.

Saving the Valves

He explained that every month samples of water are sent to the convent from every B.B.C. station.

"We analyse it to see that it does not contain certain salts, etc., which are injurious to the anodes of transmitting valves. As you probably know, the big water-cooled transmitting valves are very expensive, and we naturally wish to preserve them as long as possible. Experience has shown us that bad water can considerably shorten their lives, so we do all that we

can to see that the purity of the water is kept to a certain specified standard. As a matter of fact these water analyses probably save the Corporation thousands of pounds which might be spent upon ruined valves."

"Now come into the Chapel," said Mr. Kirke.

We ducked as we walked through a doorway and found ourselves in what was clearly at one time part of a Roman Catholic church. The inscriptions in Latin and the religious decorations were still there on the walls. But behind us was a great concrete wall with a door in the middle of it like the aperture of a meat-safe.

"This is the sanctuary, I believe," explained Mr. Kirke; "and we are reserving it for building experimental studios. Through that doorway, which you say is like a meat-safe, we have the dead room. Come through."

No Trace of Echo

Inside all was silent. Truly is it called "The Room of the Dead"! One's voice sounds strangely thin and lifeless in that completely echo-less room. The walls are double (air space between), and made of concrete built within the chapel walls themselves. The whole room stands on rubber and

(Continued on next page.)

"THE MOST MODERN DEVELOPMENTS IN SPEAKER DESIGN"

says "Wireless Constructor"



Stentorian Senior (PMS1), 42/-

100 per cent. dust protection oversize cone.

Stentorian Standard (PMS2), 32/6.

Stentorian Baby (PMS6), 22/6.

Write for new W.B. Stentorian leaflet.



Here is a speaker incorporating exclusive new features which will bring to your set a majestic volume and uncanny realism you never thought possible.

An amazing new magnetic material providing enormously increased strength at the same cost as an ordinary magnet, brings a sensitivity far beyond any previously known. It is exclusive to W.B. Stentorians. Its use in conjunction with a new method of speech coil assembly gives a crisp "attack" and full natural bass you must hear to believe.

"One of the sensations of the Radio Show," says one leading technical journal. "Eclipses the standards of last year," says another. Similar opinions have been expressed by every technical authority who has tested a Stentorian.

Hear one on your set to-day, and notice the extraordinary difference!

**SPECIFIED FOR THE
"MIDGET SUPER"**

STENTORIAN

Whiteley Electrical Radio Co., Ltd. (Dept. C), Radio Works, Mansfield, Notts.

Sole Agents in Scotland: Radiovision, Ltd., 233 St. Vincent Street, Glasgow, C.2.

Sole Agents in I.F.S.: Kelly & Shiel, Ltd., 47 Fleet Street, Dublin.

THE B.B.C.'s CONVENT

—continued from previous page.

cork to prevent vibration or transmission of machinery noises from below. The interior of the walls is covered with sound-absorbing board, four inches of rock-wool, and then a series of heavy drapings.

It was the aperture in the wall that intrigued me, though.

"Why have it there, two feet above the floor like that?" I asked.

Mr. Kirke explained that the room was for the more delicate acoustical

experiments connected with sound insulation.

"We try all sorts of doors fitted into that aperture," he said, "and we can tell from that what sorts of materials are useful to keep out unwanted noises when next we build studios."

Opposite Characteristics

At the far end of the chapel (you would never recognise this part as a chapel!) is a room with absolutely opposite characteristics to those of the Dead Room. It is an echo room.

"The whole room is built of thick concrete with glazed white tiles on roof, floor and walls. Sound is not

absorbed in that bathroom-like chamber—it just echoes about from wall to wall."

Mr. Kirke did try to explain to me how they made use of the room to discover the sound-absorbing effect of various objects placed in there, but I'm bothered if I could understand it all! (Mr. Kirke, I should explain, is a mathematical genius, regarded in the world of radio research as a wonder. So how could I, a layman, hope to understand everything that he showed me?)

Anyway, I saw enough to appreciate the importance of research to an organisation such as the B.B.C. It must save the Corporation thousands of pounds a year as well as keep it in the forefront of modern developments.

The oscillograph room (which I went into) is constantly being used to check the quality of transmissions. The big cathode-ray tubes give a visual indication of wave-forms, and so on. Photographs are taken (films sometimes) so as to provide a permanent record of the transmissions.

The Cat's Eye Lamp

The films are developed on the spot (in the nuns' wine cellar!), and I was most interested in the Cat's Eye Lamp they use there. Very fast films—red-sensitive—are used, which means that the ordinary dark-room red light is taboo. The B.B.C. therefore has an ingenious Kodak lamp which enables people to see in the dark. When I went into the room I would have sworn it was absolutely pitch dark, but after five minutes I could read in there! What the light is even Mr. Kirke does not know, so don't ask me.

There are a lot more rooms: the gramophone research laboratory, echo rooms, insulated rooms, listening rooms, and so on, and, of course, there is a workshop with lathes, drills, and other machinery. The Convent is self-contained, and is probably the finest radio research laboratory in the country. Certainly no pains have been spared in its equipment and conception.

**"There you are,
my dear..as good
as new. You can't
deceive a PIFCO
ROTAMETER"**



There's no doubt about a Pifco ROTAMETER. It traces faults in no time —any kind of radio fault.

There are 9 distinct meters in one handy-sized, polished bakelite case. The new De-Luxe model moving-coil ROTAMETER has a resistance of 200,000 ohms ensuring absolute accuracy, whilst the scale reading for voltage tests goes up to 400 volts. With these ranges available there is no test you cannot make with a Pifco ROTAMETER.

9 SEPARATE METERS IN ONE ROTAMETER-DE-LUXE

- 1. 0-5 volts.
- 2. 0-20 volts.
- 3. 0-100 volts.
- 4. 0-400 volts.
- 5. 0-10 milliamperes.
- 6. 0-50 milliamperes.
- 7. 0-250 milliamperes.
- 8. Resis/valve test.
- 9. Plug-in test for valves.



42/- ROTAMETER

- 1. 0-8 volts for low-tension voltage test.
- 2. 0-30 volts. For grid-bias voltage test.
- 3. 0-250 volts. For high-tension voltage test.
- 4. BATTERY TEST.
- 5. 0-20 M.A. For individual valve test.
- 6. 0-100 M.A. (For testing current taken by total valves in set.)
- 7. 0-250 M.A. (For testing current taken by total valves in set.)
- 8. FILAMENT AND RESISTANCE TEST (4,000 ohms). For D.C. and rectified A.C.
- 9. Plug-in test for valves.

Ask your dealer to show you one now or write for the new Pifco Testmeter Folder, describing all instruments. 10/- PIFCO LTD., SEUDEHILL, MANCHESTER, or 150, Charing Cross Road, W.C.2.



A ONE DIAL A.C.-D.C. SET

—continued from page 26.

hole large enough to enable the condenser to be screwed into its nut from the top of the baseboard.

The one pole of the condenser is now automatically connected because its case has been screwed into contact with the surface of the metallised baseboard.

(Continued on next page)

PIFCO ROTAMETERS

PIFCO ON THE SPOT WILL TRACE YOUR TROUBLES LIKE A SHOT

A ONE DIAL A.C.-D.C. SET

—continued from previous page

All the components under the baseboard, these are three resistances and two condensers, are held in place by their own wiring.

The wiring of any mains set demands rather more attention than that of a battery set, but the wire we specify in the list of parts is extremely easy to handle, and it is easier to use than many other types.

Only the one lead requires to be screened with the screened sleeving mentioned and that is the pick-up lead which runs from a pick-up terminal to the pick-up switch on the front of the panel. One foot of this sleeving will prove quite enough for the job.

As it so happens it is simplicity itself to join this sleeving to the earth-line—in other words, the metallised

thing when you go from the one type of mains to the other.

The rectifier valve is still "alight" when you are on D.C. mains and although it has none of its normal work to do it still has something of a useful function. It acts as a series valve and thus safeguards the electrolytic condensers against an inadvertent connection of the set the wrong way round.

Of course, it doesn't matter a scrap which way the mains plug is inserted when you are on A.C. mains, but it has to be the one way round for D.C. or the set won't work.

There is one trimmer on the gang condenser and having tuned in a weak station on about 250 metres with the application of reaction you can adjust this one trimmer so that you get the loudest signals.

Have the knob controlling the other trimmer, the knob on the front of the panel concentric with the main tuning knob, set at about half way.

NOVEMBER 15th!

Order your next month's copy right away, and don't risk missing your chance of securing

"THE RADIO RULE"

the most useful and *practical* gift ever offered to readers of a wireless paper

surface of the baseboard. The other pick-up terminal is connected to this by passing a short lead through the baseboard and holding its bared end underneath one of the mounting screws of the 4-mfd. fixed condenser.

Clearly then, to join the sleeving to the earth, all that has to be done is to connect it to that pick-up terminal.

The Earth Contacts

The connections of other leads to the metallised surface of the baseboard must mostly be done by means of small wood screws and washers or spare soldering tags. The end of the wire is bared and looped and then screwed down to the baseboard in that way. A quite efficient contact is made by so holding the wire to the metal surface by pressure.

Before the set is tried out make sure that you have the fuses correctly wired and that the heater resistance is connected right for the voltage of your mains.

The set is connected straight up to the mains whether they are A.C. or D.C. You do not have to alter any-

"HOTTING UP" YOUR SET

—continued from page 6

seem to be desirable. Failing this, a compensating L.F. transformer designed to emphasise the high notes with a switch working in conjunction with it to bring a condenser across its primary and "normalise" its properties when tone compensation is not wanted is well worth considering in any set using any reaction at all let alone H.F. reaction as well.

Some sets employ small aerial series condensers (fixed capacity) in order to increase the selectivity. But aerial series condensers reduce the sensitivity of a set just as much as a variable-mu control being turned down.

If you don't always seem to want all the selectivity given by a set incorporating such a device, and it has no means of easily cutting it out, I would advise a switch for that purpose. You could call this a "hotting up" control quite legitimately.

OHMITES

the most
reliable and
efficient
RESISTANCES
ever made



Admitted by Experts and Constructors alike to represent the highest standard of perfection yet achieved in reliable Resistances. Better than wire-wound. All values 50 ohms to 5 ohms.

1'6

HEAVY DUTY TYPE - 2/3

Send for full catalogue of Radio Components
GRAHAM FARISH LTD., Bromley, Kent.

GRAHAM FARISH PRODUCTS

Still Supreme

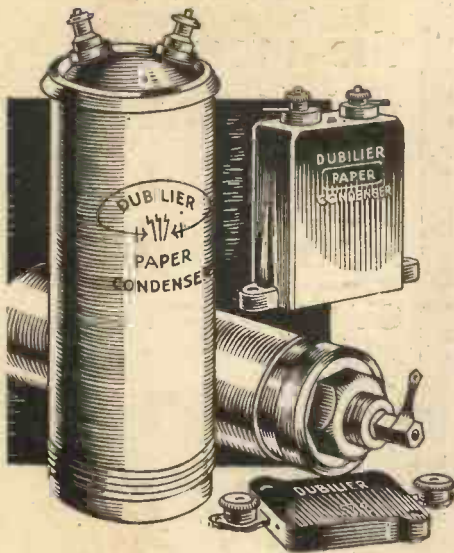

Dependability always demands DUBILIER

When buying Condensers and Resistances it should be remembered that Dubilier Condensers and Resistances mark the greatest advance in modern design and more than maintain Dubilier's firmly established position as the foremost manufacturers of the highest quality Condensers and Resistances at competitive prices.

There are Dubilier Condensers and Resistances specified for the Wireless Constructor One-Dial A.C.-D.C. Set and the Midget Super Four. Be sure to insist upon Dubilier when ordering.

It would be to your advantage to be more familiar with the latest developments in Condenser design. The new Dubilier booklet tells you all there is to know.

Write for your free copy.

DUBILIER

CONDENSERS

Dubilier Condenser Co. (1925),
Ltd., Ducon Works, Victoria
Road, N. Acton, W.3.

THE BATTLE OF THE HUMPS

—continued from page 22.

a distortion effect of opposite kind to that introduced by the sharp tuning, he corrects the tone balance, and gets a receiver which can compete with any other type in quality and selectivity.

One notable advantage of this method is that it eliminates the special form of coupling between circuits which is an essential feature of band-passing. The accuracy of this coupling has much to do with the results given by a band-pass receiver, and since it is very difficult for the home constructor to check or adjust, it is obviously one of those things best got rid of when we can.

Variable Band-Pass

Again, the behaviour of a band-pass circuit almost always varies a little, and sometimes a great deal, with wavelength, and so it is no very rare thing to find such a receiver giving quality which changes perceptibly from one end of the scale to the other.

True, the same thing can happen even more easily with a tone-corrected set, but the remedy in this case is much simpler. It must be admitted that this particular trouble is almost certain to occur with tone-correction in its simplest form, which raises an interesting and important question.

The question is just this: will the set of the future ever use tone-correction in its crudest, non-adjustable form, or shall we find that it will be of the variable type, either hand or automatically controlled?

The objection to the non-adjustable form is pretty obvious: in most sets, even to-day, there is some sort of variable reaction or regenerative effect, and this means that the sharpness of tuning is variable too. Hence the degree of correction needed will vary from moment to moment during tuning-in, and so I have my doubts about the ultimate survival of non-adjustable correction.

Adjusted at Will

Even in those larger sets in which there is no actual reaction adjustment, there is often some kind of selectivity control, and this usually produces somewhat similar effects.

Variable tone correction, then, is often desirable to enable us to get properly balanced quality in spite of variations in tuning characteristics. It is even more important, in my opinion, that such a control should be provided to enable us to get *improperly* balanced quality when we need it.

That, I imagine, sounds rather dreadful coming from an enthusiast for quality ideals in radio, but we must face facts: conditions in the ether are not likely to get better for a very long time to come, and it is quite possible that they will get worse. Therefore, I believe it will be of great advantage to have on our sets not merely a control of selectivity, but also a means of altering tone balance.

Clearing Up Reception

Then, when we are receiving a station which is well clear of other transmissions, we can set the controls for the best possible quality and hear our music properly. On other occasions when we want to hear a station which is nearly smothered in heterodyne whistles and side-band splash we can set the controls for a lower tone, thus suppressing much of the extraneous noise.

And that, of course, is the point at which I have been aiming all along; it is my belief that the tone-corrected set, with a good wide-range adjustable control, has a much more promising future for amateur use than the band-pass type. I am not suggesting that it is the more suitable for sets intended for the use of the lay public, nor that band-passing has no place at all in amateur sets, but I do believe that tone correction is the sounder principle.

THE MIDGET SUPER

—continued from page 10.

In addition to this slight change of the position of the lever (it is merely a change round to the next groove on the back of the splined switch rod), one more alteration must be carried out.

This is the simple one of turning the control knob round by one hundred and eighty degrees to make it read correctly when the coils are mounted upside down as they are in the design of the set.

These are the only little "wangles" that have to be done in order to make all shipshape for the completion of the set.

When the wiring has been completed and checked over, and the valves inserted and loudspeaker connected, the batteries should be joined up to the various flex leads as follows:

The L.T. connections are obvious, and the H.T. should be about 75 to 80 volts for H.T. plus 1, and the full 120 volts of the battery for H.T. plus 2.

Grid bias for the output valve will be a value around $7\frac{1}{2}$ volts, and

(Continued on next page)

THE MIDGET SUPER

—continued from previous page.

is applied to G.B.—2. A 9-volt battery will be ample.

For G.B.—1, 1.5 to 3 volts will be needed, and this should be adjusted to suit individual requirements concerning the automatic volume control. This bias controls the delay in this part of the set.

A Combined Control

The volume control operates the on-off switch, so that the set must be turned to minimum volume every time it is switched off, thereby avoiding that nasty thud when it goes off, and the more nasty sudden arrival of a loud programme when it is switched on.

The ganging of the set, by means of the trimmers on the variable condenser, and the intermediate transformers, is quite simple if it is done in this order.

**S.T.600
Demonstrations**

The S.T.600 is at present on a great National tour of Britain. The sensitivity and selectivity have been proved to be many times as great as that of the S.T.400, which consequently is displaced by Mr. Scott-Taggart's great new set.

The S.T.600 is being fully described in our sister journal, "Pop lar Wireless," on October 24th.

First trim on a weak low-wave station as accurately as you can, keeping the volume down by means of the volume control so that changes in the strength of the station can be noticed easily. You will have to go carefully, for the A.V.C. will to some extent mask the peak points of the trimmers.

I.F. Trimming

With the set ganged up on the medium waves, turn the wavechange switch to "long" and tune the set to somewhere round the top end of the waveband. If you can get Huizen so

much the better, but if not try Radio Paris. Droitwich is likely to be too loud in most places.

Now do not touch the trimmers on the variable condenser, but adjust those on the top of the intermediate transformers. The two trimmers are the two screws close together and side by side; the third is the coupling adjustment, which need not be altered unless the band width of the transformers is required to be changed.

Adjust the intermediates for loudest "signals," after which the set should be ready for use. Take care over these adjustments, for on the accuracy with which these are done depends the operating efficiency of the whole set. Trimming cannot be done in a few moments.

Housing the Set

When all these tests have been carried out to your satisfaction the set can be housed in its cabinet (it is best to carry out the trimming, in fact essential to do so, with the set outside the cabinet), and the batteries packed in alongside. There is plenty of room for them as well as the speaker, and the whole outfit forms a sensitive station getter that will provide endless enjoyment to its owner.

* **RADIO'S** *
* **FINE SHILLINGSWORTH** *

THE title of this short item refers to the Chronicle Wireless Annual, now on sale throughout the country. "Something of Everything for Everybody," is an apt description, but it must not give the impression that anything is skimped for the various articles are most complete.

It is not possible here to do more than give just a brief idea of the main contents. So first of all there are the constructional items. These cover all manner of sets and units, both simple and ambitious, and there are eight half-size wiring diagrams.

Then there are articles for all set users on logging stations, cutting out various forms of interference and adding an extra loudspeaker to a set. The latest valves and receivers, and short-wave reception are also dealt with.

"Building a Programme," and "From Microphone to Receiver" are chapters of interest to the non-technical. And finally we must make mention of the fact that television and home recording are also covered.

A. S. C.

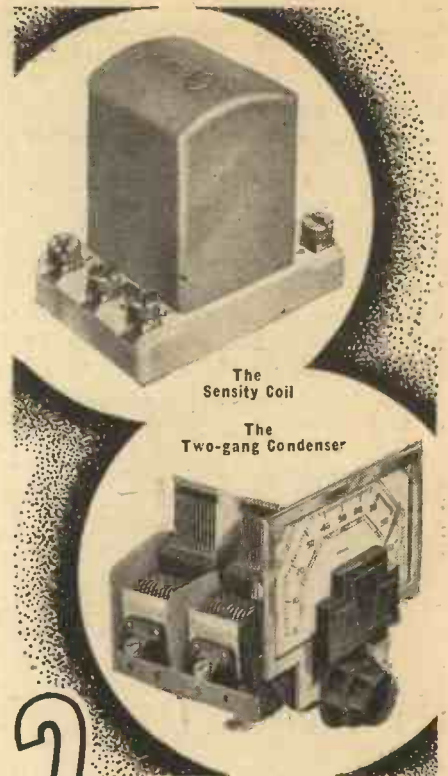

2 AMAZING COMPONENTS that emphasize FORMO leadership!

Always the leading name in components—Formo now steps even further ahead with these two spectacular products. Advanced in design and purpose they cost far less than their quality and efficiency would suggest. See them at your Radio Dealers to-day.

The SENSITY COIL

Represents greatest advance in scientific coil design in recent years. Comprehensive tests all parts of the United Kingdom, under widely varying conditions, indicate its enormous possibilities.

The air-cored Litzendraht winding is disposed on a bobbin moulded of an entirely new material and is mounted on a Steatite base having negligible H.F. losses.

- Aerial Coil, Type T.1 (without Reaction) - - - 5/-
- Aerial Coil, Type A.1 (with Reaction) - - - 5/-
- H.F. Coil, Type P.P. - - - 5/-

The TWO-GANG CONDENSER (Type DU5)

Extremely robust construction. Finished in dreadnought grey and supplied complete with Chrome and Bakelite full vision flood-lit drive. Price - - 11/- Dust Cover, 1/6 extra.



Write for new comprehensive folder, describing all Formo Products today to: Formo Products Ltd., Masons Hill, Bromley, Kent.

SCHEMES FOR CUTTING OUT DROITWICH

—continued from page 14.

a receiver with diode rectification. The components required are a valve, valve holder, and reaction condenser.

As will be seen in the diagram illustrating this arrangement, the reaction winding on the dual range coil can be utilised if it is isolated. That is to say, if neither end is permanently joined inside the coil to any of the other windings.

If it is, then the reaction winding should take the form of a few turns of insulated wire wound round the dual-range coil. If reaction is not obtained at first, the connections to this extra winding must be reversed.

Almost any valve will do for the reactor, although one of high-impedance is likely to be most satisfactory.

Reaction may be adjusted to a maximum with the .0003-mfd. condenser for each station tuned in, or this condenser can be set to give a fixed degree of reaction. In this case its value must not be set sufficiently high to allow the valve to oscillate at any point in the tuning range.

Permanent Band-Pass

We have already indicated in the first part of this article how valuable band-passing can be in improving selectivity. When there is room in a receiver, the extra components for this form of tuning may be permanently incorporated.

It is best to use a two-gang condenser for the band-pass coils, and then there will be no extra tuning controls added to the set. The dual-gang condenser takes the place of the single condenser which previously tuned the aerial coil.

In the case of a set already employing a gang condenser for the aerial and H.F. circuits, matters are a little

different. But even so there is no necessity for complications.

One section of the band-pass unit may be tuned by the gang condenser in place of the ordinary aerial coil, and a plain .0005 variable may be introduced for the other section of the band-pass unit. But the H.F. coil will have to be of a type that matches up with the band-pass coils.

The actual connections to employ depend on the particular coils chosen, but we show one circuit employing two Colvern band-pass coils. Apart from the actual coil connections, this diagram shows the general lines on which to work.

BRITAIN'S NEW NATIONAL STATION

—continued from page 4.

and off automatically, from the control table.

Thus, there is no need for the engineer to stop or start first one machine, then another, and so on;

and the current is 30,000 milliamps, instead of the 15 or so commonly used for reception.

A Giant Anode Current

An interesting feature of the H.T. arrangements is that provision has been made for the use of the new Midland Regional's H.T. on the long-wave transmitter, if this should ever be necessary. Normally, the Droitwich Regional station will need 15,000 milliamps H.T., at 11,000 volts; but if required its "stand-by" generator can be switched in series with the other, to give 20,000 volts for the long-wave transmitter.

In obtaining super quality by the new series-modulation circuit, the difficulty arises that the filaments of certain valves must be at least 10,000 volts above earth potential—and sometimes as much as 20,000 volts!

If batteries were used for the filament supply this would not be too bad; but to use motors for the purpose means that they must be placed in a special safety enclosure, entirely in-

NEXT MONTH

Every reader will receive a

FREE FULL SIZE 1/- BLUE PRINT

of a new three-valve set of outstanding interest.

the whole sequence is automatically carried out when the control switch is thrown over to "Start" or "Stop."

There is only one "small" battery at Droitwich—a 220-volter, of 1,500-ampere-hour capacity. It is not used for transmission, but merely for light, etc., when the main power is not running.

The long-wave transmitter requires 20,000 volts H.T., as compared with the usual 120 or 150 for a receiver;

insulated, and must transmit their power through porcelain couplings capable of standing up to 20,000-volts pressure without leakage!

Piano Tone CABINETS
 65/- RADIO-GRAM CABINET FOR 35/-
 No Middle Profits! Finest Radio Furniture as supplied to B.B.C.
PICKETT'S
 Piano Tone
 Cabinet (R.C.) Works, Bexleyheath, nr. London.

INDEX TO ADVERTISERS

	PAGE
Amplion (1932), Ltd.	29
Automatic Coil Winder and Electrical Equipment Co., Ltd.	1
Clarke, H. & Co. (Mfr.), Ltd.	Cover ii
Colvern, Ltd.	2
Dubilier Condenser Co. (1925), Ltd.	42
Ferranti, Ltd.	Cover ii
Formo Products, Ltd.	43

	PAGE
Gilbert, J. C. (Cabinets)	38
Graham Farish, Ltd.	41
Henley's W. T. Telegraph Works Co., Ltd.	38
Jackson Bros. (London), Ltd.	36
Lectro Linx, Ltd.	36
Peto-Scott Co., Ltd.	37
Pickett's Cabinet Works	44
Pifco, Ltd.	40
Romance of the Nation	Cover iv

	PAGE
Technological Institute of Great Britain	38
Varley Products	35
Westinghouse Brake and Saxby Signal Co., Ltd.	35
Whiteley Electrical Radio Co., Ltd.	39
Wingrove and Rogers, Ltd.	29

All communications concerning advertising in "Wireless Constructor" must be made to Advertising Department, John Carpenter House, John Carpenter Street, London, E.C.4.

GRANDEATHER'S WHISKERS!

GREAT 3 in 1 PUZZLE GAME

Grandfather's Whiskers is a most amusing and intriguing game that will thrill everyone. Any number of players can take part—no skill, no intricate rules to remember, nothing but clean, exciting fun.

The pack comprises 48 cards with brightly coloured pictures on the front which can be made into more than 1,000 uproariously funny figures. The backs of the cards form a series of six Jig Type Puzzles—simple ones for the children and more perplexing ones for grown-ups. You simply must join in the search for Grandfather's Whiskers this winter. The children will enjoy the fun as much as you.

Made by John Waddington, Ltd., Makers of the World's Finest Playing Cards.

The Greatest and Most Amusing Card Game Ever Devised



A Brilliant and Original New Book

The ROMANCE of the NATION

6^d
Weekly
Parts

Edited by Charles Ray (Editor of "The World of Wonder")

**THE MOST THRILLING STORY OF THE BRITISH PEOPLE EVER WRITTEN
AN ENTIRELY NEW KIND OF HISTORY
BRILLIANTLY AND INGENUOUSLY ILLUSTRATED**

THE magic pen of Robert Louis Stevenson could not have achieved a more interesting, instructive and thrilling book than THE ROMANCE OF THE NATION. It is a book for everybody, young and old, and one of striking originality, telling the wonderful story of the British People from early times down to the present day in a way that will hold the reader spellbound. It is history treated in a new way. THE ROMANCE OF THE NATION does for the past what the newspaper does for the present.

Here are thrilling adventures and exciting experiences, perilous voyages across the seas and magnificent achievements on

land, deep-laid plots and dark conspiracies, strange love stories of kings and queens and lesser people, and great popular delusions, all told in a way that holds the reader with a grip of magic. It is not alone in its vivid writing that this enthralling book makes such an irresistible appeal, but its illustrations are as novel and interesting in treatment as the book itself.

There are hundreds of specially drawn pictures showing historical events and places and how things work and move, and also the greatest gallery of British costume ever brought together within the covers of a single work.

THE ROMANCE OF THE NATION is beautifully printed, and when bound will form a handsome book of never-ending interest. The complete work will contain about

- 1,000,000 WORDS of reading matter
- 350 THRILLING CHAPTERS
- 4,000 PICTURES, including
- 500 FULL-PAGE EXPLANATORY DRAWINGS



PARTS 1 & 2

NOW ON SALE

At all Newsagents & Bookstalls.