

The **Wireless Constructor**

6^D
MONTHLY

EDITED BY
PERCY W. HARRIS, M. I. R. E.
Vol. VIII. SEPTEMBER, 1929. No. 35.

IN THIS ISSUE
THE "S.M.L."
THREE
*-Short-Medium-
and Long-*



**THE SET WITH
THE BUILT-IN
WAVE TRAP**

As British

as Britannia!



**The Sensational
NEW
Brown
"VEE" UNIT**

Price

25/-

with Cords

Chassis (with 12" Cone) - - 15/-

Overloading impossible

* * *

Cannot chatter or distort

* * *

Instantly fixed to Brown Chassis—a complete loud speaker in 2 mins.

* * *

Widest frequency range of any Unit

* * *

Utilises entirely new principles

* * *

Ask your Dealer to demonstrate

"Re-creates the Living Artistes"

Advt. : S. G. Brown, Ltd., Western Ave., N. Acton, London W3

CONTENTS

	Page		Page
The Editor's Chat	247	Radiogramophonics	276
Queer Queries	248	Transmission and Reception on Ten Metres	277
Build the "Wireless Constructor" All-Electric Gramophone	249	A Universal Filter	280
Happenings at Savoy Hill	255	In Lighter Vein	281
Brookman's Park	257	More About the 1929 Super-Quality Amplifier	284
Comments from Constructors	259	Mercury Control	287
The "S.M.L." Three	261	An Interesting Short-Wave Converter	287
Within the Vacuum	267	Our News Bulletin	292
Controlling Volume	269	A Simple R.C. Unit	301
Chats at the Work-Table	271	Primary Cells for Filament Heating	302
What's New	273		

As some of the arrangements and specialities described in this Journal may be the subject of Letters Patent, the amateur and trader would be well advised to obtain permission of the patentee to use the patents before doing so.

EDITED BY

PERCY W. HARRIS, M.I.R.E.

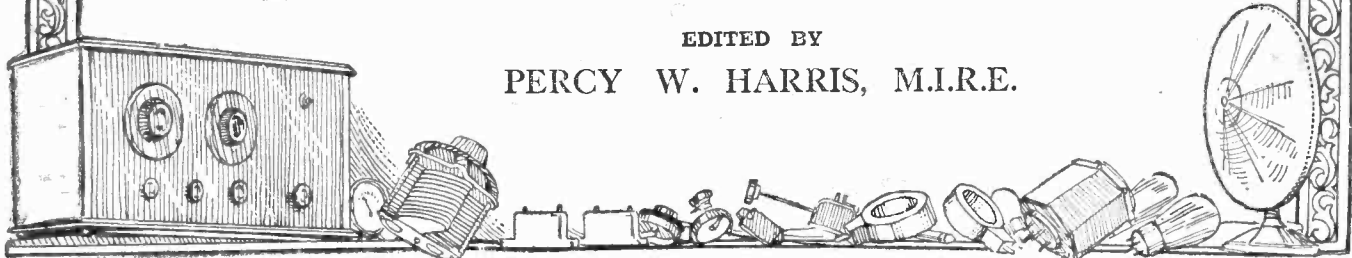

The Sure Path to Perfect Reception

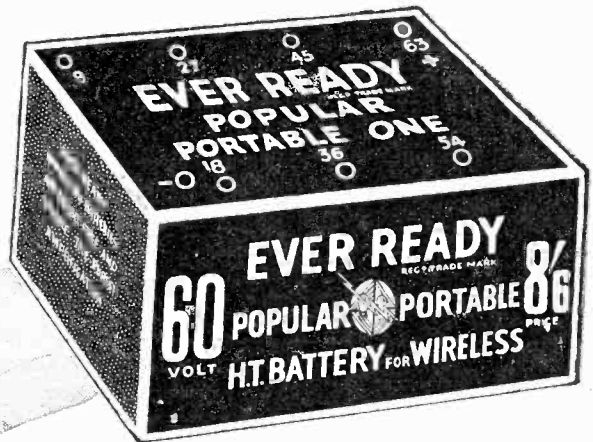

SPECIAL UNITS FOR PORTABLE SETS
 PORTABLE 1. 63 volts 8/6. Size 6" x 5" x 3"
 PORTABLE 2. 99 volts 13/6. Size 9" x 5" x 3"
 PORTABLE 3. 108 volts 15/-. Size 10" x 5" x 3"

EVER READY

BRITAIN'S BEST BATTERIES

SHOCK PROOF!

NOISE PROOF!

BREAK PROOF!

INTER-LOCKED!

The wonderful new system of Interlocked Construction used in the Cossor Screened Grid Valve is the greatest advance in valve design since the introduction of the Dull Emitter. Interlocked electrodes—each element rigidly secured top and bottom—definitely prevent damage due to even the hardest shock. Look at the illustration—see the girder-like construction of the Cossor Screened Valve. Every joint is electrically welded. No other Screened Grid Valve has such strength or rigidity. For any Screened Grid Receiver demand Cossor—Britain's strongest and most dependable Screened Grid Valve.

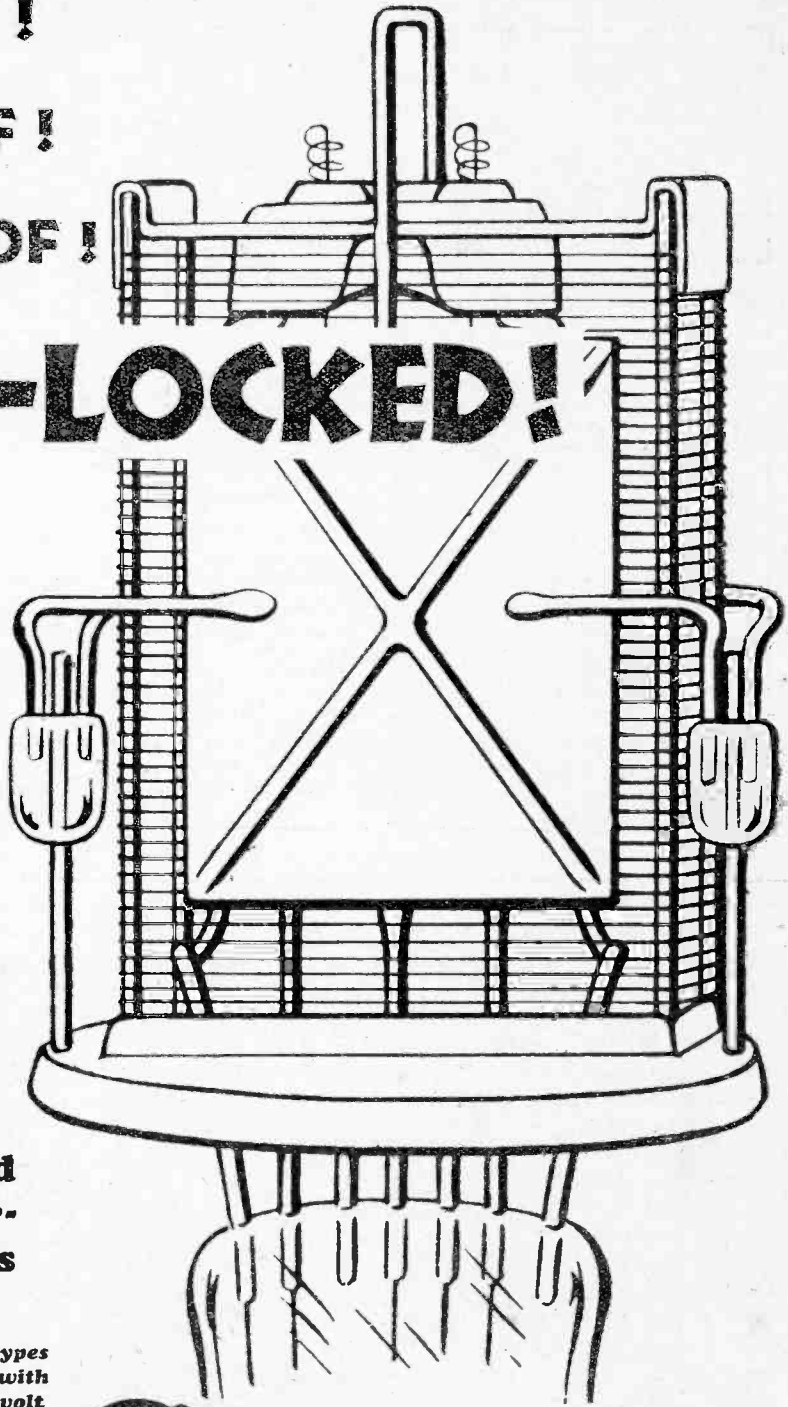

Only Cossor Screened Grid Valves have interlocked Electrodes



Technical Data

Filament Amps. .1, Max. Anode Volts 150, Impedance 200,000, Amplification Factor 200, Grid Bias 1.5 volts at max. anode Volts. Price (either type) **22/6**

A. C. Cossor, Ltd., Highbury Grove, London, N.3.

Made in 3 types for use with 2, 4 and 6-volt Accumulators.

Get full details of this wonderful valve, write for Leaflet No. L 10.

Cossor
Screened Grid
BRITAIN'S FINEST S.G. VALVE



THE WIRELESS CONSTRUCTOR

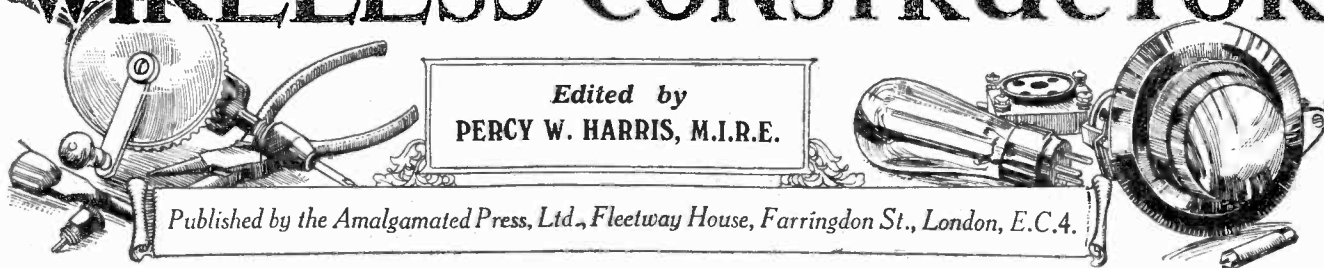

Edited by
PERCY W. HARRIS, M.I.R.E.

Published by the Amalgamated Press, Ltd., Fleetway House, Farringdon St., London, E.C.4.

THE EDITOR'S CHAT

In this article Percy W. Harris, M.I.R.E., the Editor of "Wireless Constructor," discusses the "S.M.L." Three, an all-wave-length receiver described in this issue.

A UNIVERSAL wave-length range and a very high selectivity—these are but two of the advantages of the "S.M.L." Three described in the current issue. Deriving its name from "Short-Medium-Long," it is yet another set brought out as the result of careful study of a large number of readers' request letters. Not only does it cover the short, medium and long waves, using simple plug-in coils, but the inclusion of anti-motor-boating and output filter devices enables first-class quality to be obtained on the ordinary wave-band.

Sharp Tuning

Another feature is the special astatic wave-trap built into the receiver so as to sharpen up the tuning to an extent sufficient to enable the user to listen to a number of stations without interference while the local station is working at full strength. The set is particularly simple to build, wiring having been brought down to a minimum and the cost is also commendably low. All these features will, we think, cause the set to have a wide appeal.

* * *

The widespread interest in the electrical reproduction of gramophone records, regularly catered for in the WIRELESS CONSTRUCTOR for some time past, has led us to publish in the current issue, as promised last month, the complete design of the WIRELESS CONSTRUCTOR All-Electric Gramophone. Here we have an instrument of many unique qualities giving a fidelity of rendering which will amaze all those who have not heard what can be done with the best types of electric gramophone.

Not only this, but the benefit of the Super-Quality Amplifier, and the special loud speaker incorporated in this instrument, are made available for use with any ordinary wireless set, even if it be of the crystal variety, as it is but a matter of a few seconds to join up the receiver to the amplifier and so obtain full volume from the loud speaker.

* * *

The increasing number of letters received by the Editor from readers overseas has done much to assist and encourage us in making the WIRELESS CONSTRUCTOR a magazine of the widest appeal, and we are very glad indeed to find that so many WIRELESS CONSTRUCTOR sets are functioning excellently in the Dominions. We

hope that the "S.M.L." Three, described in the current issue, will do still more to popularise home construction in these parts, particularly as it will enable many readers who are out of touch with the Home Country to receive the transmissions from 5 S W, the B.B.C.'s short-wave station.

The Wireless Exhibition

The next issue of the WIRELESS CONSTRUCTOR will be our special enlarged Wireless Exhibition number. In addition to many other special features, a particularly full description of the exhibits to be seen at this year's show will be included. Every reader should make sure that he gets his copy by ordering in advance.

RADIO IN THE AIR

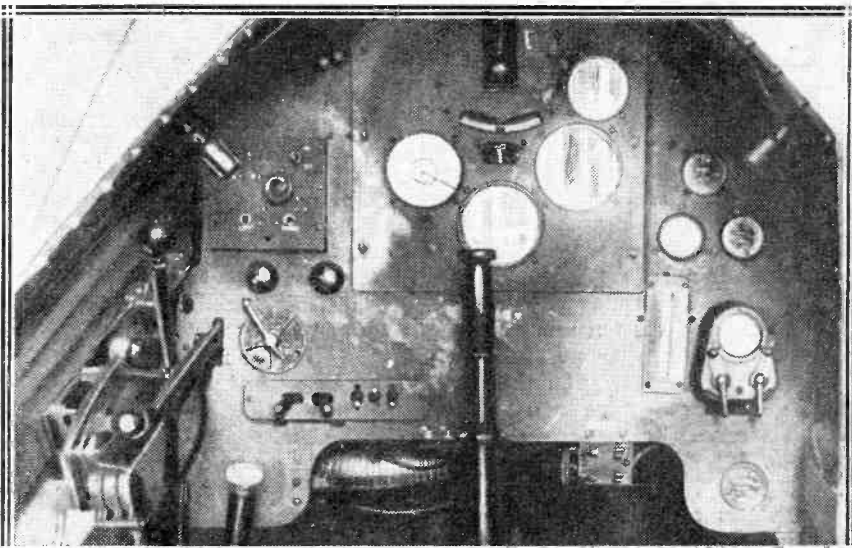

As an aid to safety in flying, radio is largely used on the various air-liners and mail-carriers in many countries. This photograph shows the pilot's cockpit of one of the latest air-liners, with the wireless panel up on the left of the dashboard.

QUEER QUERIES

*Some typical radio faults
reviewed and questions
answered.*

By P. R. BIRD.



"THIRTY days hath September," and somewhere between the first and thirtieth day you will wake up one fine September morn and say to yourself: "I really must get ready for my winter radio." Once again the radio bug will bite you, you will get down your soldering iron, cast your eye over your drill, and turn your thoughts to fixing-screws and flux.

Before starting your activities in the autumn let me remind you that in radio, as in sartorial embellishment, a stitch in time saves nine! There is far more fun in well-carried-out construction than in all this rush and bustle to get the set done at the earliest possible moment. The time spent in preparation and planning is never wasted, and very often a little deliberation will save a lot of expense.

Many are the curious coincidences that come to light and queer are the queries which arise as the result of too-hurried construction.

Check Your Components

How many of us take the trouble, for instance, to examine new components carefully before we mount them on the baseboard? There should be none of this blind tearing off of wrappers and hurried mounting, for accidents will happen in the best of regulated radio workshops. Remember that by rushing your wiring and saving perhaps ten minutes you may be making some mistake that will take you hours to get right.

One friend of mine wired-up a variable condenser in such a hurry that he did not notice it was provided with two terminals for the fixed plates and that he had used both of them! Needless to say his tuning effects were decidedly below par, and worse than this was his lost

prestige, for he has never been allowed to forget the incident! Yet many of us will be doing the same kind of thing this year instead of looking carefully at our components and taking proper precautions over our wiring.

THE TECHNICAL QUERIES DEPARTMENT

Are you in trouble with your set?

Have you any knotty little Radio problems requiring solution?

The WIRELESS CONSTRUCTOR Technical Queries Department has been thoroughly reorganised and is now in a position to give an unrivalled service. The aim of the department is to furnish really helpful advice in connection with any radio problem, theoretical or practical.

Full details, including the scale of charges, can be obtained direct from the Technical Queries Department, WIRELESS CONSTRUCTOR, Fleetway House, Farringdon Street, London, E.C.4.

A postcard will do. On receipt of this the necessary literature will be sent to you, free and post free, immediately. This application will place you under no obligation whatever. Every reader of the WIRELESS CONSTRUCTOR should have these details by him. An application form is included which will enable you to ask your questions so that we can deal with them expeditiously and with the minimum of delay.

London readers please note: Inquiries should not be made in person at Fleetway House or at Tallis House.

Despite the careful checking that now characterises radio production and the high standard of quality and accuracy that is maintained, careful examination will sometimes display an amazing blunder on the part of the manufacturer. Not long ago the Editor showed me an excellent case in point. At first glance all one noticed was a good-looking valve holder of the anti-microphonic type, with a disc in the centre attached to its base by spring supports. On the base were the two filament terminals (marked F), the grid (G), and the plate (P). The central disc had its four sockets beautifully laid out—two filaments

and a grid and plate. But instead of being affixed to their respective terminals on the base, the disc had in some amazing fashion been given a quarter turn before being joined to its holder!

The Filament Tragedy

Anyone wiring up that valve holder in a hurry would have had some startling fireworks when switching on! Used in a H.F. transformer circuit, for instance, that G would have gone to one end of a secondary, and the P on the base would have been joined to H.T. positive via the primary. Owing to the misplacements of the centre-piece, these two sockets on the base were internally connected to the filament sockets, so anyone inserting a valve into that holder would place the full H.T. across its filament.

Not one of Shakespeare's third-period tragedies is so poignant to the listener as a little affair of this kind, which can only be obviated by keeping a careful eye on the components before they are put into service. It should not be thought that this particular one was an extreme case either, because there are plenty of instances where similar mistakes have happened with other components.

There are other ways of mishandling the valve holder, too; and I remember one case which gave a lot of trouble until it was discovered that the only satisfactory way of getting good contact with the filament terminals was to press heavily upon the valve. Without a weight it sprang up into the "bad contact position."

To detect a fault of this nature it would be necessary to test the pin and socket contact.

The Valve That Went Too Far!

That instance reminds me of one that, when the four legs of the valve were pushed down, went through the valve holder altogether, and came into contact with the copper shield on which the valve holder was mounted, thereby burning out the valve and producing one of the prettiest firework displays that that particular set had ever experienced! These mistakes do not often happen, but because the manufacturers are extremely good we should not get into the habit of considering them perfect. Faith in British products is all right, and no one could wish for better-made components, but however great is the name upon the carton, do not forget to give every component the "once over" before you mount it into place.

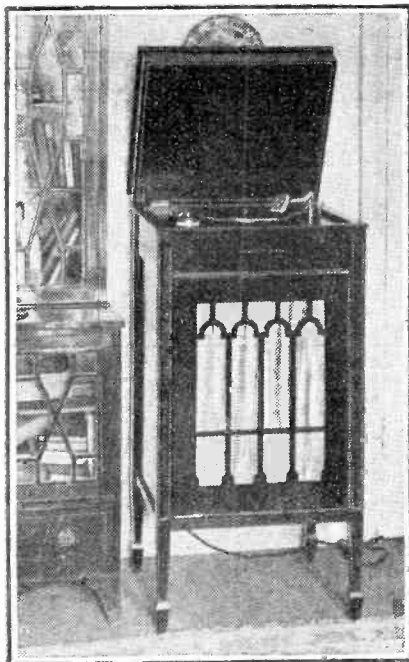

A general view of the instrument.

LAST month we described the "1929 Super-Quality Amplifier" and our new high-power A.C. mains unit for high-tension supply. An indication was also given of the manner of assembly into an electric gramophone.

This month we have great pleasure in presenting to our readers the complete design for a WIRELESS CONSTRUCTOR Electric Gramophone, which, as will be observed from the photographs, is not only an ornament to any home, but an extremely interesting piece of electrical apparatus. The constructional work was planned with great care, so as to be as simple as possible, many new ideas are introduced and, in accordance with the consistent policy of the WIRELESS CONSTRUCTOR, the widest possible latitude is given to the reader in the choice of his components.

Wonderful Reproduction

In this way many will be able to assemble almost the whole instrument from existing parts, at a cost which will be correspondingly smaller. First of all, let us examine carefully what it is we are able to obtain.

The modern electrically-made gramophone record is a marvellous example of modern applied science, and only the very best gramophones are capable of extracting from it the wonderful shades and tones which we know are inscribed there. The older types of gramophones depending upon the vibrations of a small mica diaphragm to produce sound waves

BUILD THE "WIRELESS CONSTRUCTOR" ALL-ELECTRIC GRAMOPHONE

The final details of the assembly of the all-electric gramophone, the power and amplifier units of which were described last month.

By PERCY W. HARRIS, M.I.R.E.

in some form of horn (either external or internal) suffered badly by reason of the fact they were unable to reproduce the low tones faithfully, while many of them had had resonances which accentuated certain frequencies, giving a very unnatural tone to the reproduction.

With the advent of electrical reproduction a new era was opened, for no longer were we tied to certain mechanical limitations. By using a properly designed pick-up which will convert the vibrations of the needle into electric currents, these can be amplified as desired and passed to some suitable form of loud speaker. Furthermore, both quality and volume are far more controllable than heretofore.

The WIRELESS CONSTRUCTOR has always kept before its readers the possibilities of electric reproduction of gramophone records, and indeed for some time we have devoted a monthly section to this branch of the art. As the electrical reproduction

of gramophone records is so closely allied to ordinary wireless technique, it is only natural that in our laboratory much time has been devoted to a careful examination of the various methods available.

Many Suitable Pick-Ups

A large number of excellent pick-ups (means of converting the needle vibrations into electric currents) is available, and with the improvements in amplifiers, tending to make them really distortionless magnifying instruments, some very interesting experiments were made possible. The problem which has given us much concern, however, is the form of loud speaker to be used, for no matter how good the pick-up, and how perfect the amplifier, unless we have something particularly good to turn these amplified electric currents into sound waves, many of the advantages will be lost.

The moving-coil speaker immediately suggests itself, as the



The turntable, on-off switch, and B.T.H. pick-up which form the top section of the electric gramophone.

“Wireless Constructor” All-Electric Gramophone—*continued*

best of the moving-coil speakers, properly driven, has given us the finest reproduction so far obtainable in radio. The disadvantages of the moving-coil type are nevertheless by no means inconsiderable, for if good sensitivity is to be obtained we must have an electro-magnet to produce the field, and this will always absorb considerable power.

The Loud Speaker Used

Furthermore, a large number of moving-coil speakers made up from kits, while giving fair low-note reproduction, are very deficient in the high tones, and many have peculiar accentuations of certain low notes which produce that “booming” which so many people consider as characteristic of all moving-coil speakers. A deficiency of response in the upper register means that speech and much music lack that crispness which is so vitally necessary to natural reproduction.

A further point is that to give its best results a moving-coil speaker has generally to be driven with considerable power, and in many (but not all) moving-coil speakers the quality falls badly off unless the volume of sound produced by the instrument is somewhat above that comfortable for an ordinary living-room. We thus were led in considering a home electric gramophone to see whether the

results we wanted could not be obtained by some other type of speaker. Among those we have examined, the Ultra Air-Chrome loud speaker seems admirably suited to our needs.

This loud speaker, which is reviewed separately in the current

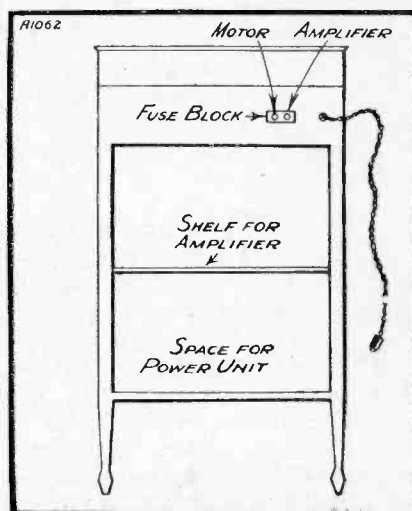

issue, not only gives a low-note reproduction comparable with the best moving-coil speakers, but also is quite good in the upper register, thus giving the “brilliance” which is so much needed. Several sizes are made, but the instrument with the largest area gives the best reproduction, both in quality and sensitivity.

“Extremely Sensitive”

The model chosen for the WIRELESS CONSTRUCTOR Electric Gramophone measures 18 in. by 23 in., and consists of two specially doped linen diaphragms, one large and one small, joined in the centre and operated by a particularly well-designed balanced-armature movement. The virtue in this loud speaker lies in the whole design and not merely the use of the linen diaphragms, which, by the way, this speaker was the first to utilise. Although of American origin, we are glad to see that the Air-Chrome speaker is now being made in England. Its suitability for the WIRELESS CONSTRUCTOR Electric Gramophone lies in the fact that it gives a remarkably uniform response to a wide band of frequencies, is extremely sensitive, requires no special magnet-energising current and is very reasonable in price.

An all-electric gramophone consists of a pick-up with its supporting arm, electrically driven motor with turn-

table, an amplifier to magnify the currents produced in the pick-up, a power supply for the amplifier, and a loud speaker. The power supply, amplifier, and loud speaker have already been dealt with, and we now come to the two remaining items, the pick-up and the motor.

LIST OF COMPONENTS.

- 1 Special “Wireless Constructor” electric gramophone cabinet (Camco). (This cabinet was specially designed in conjunction with The Carrington Mfg. Company, and is obtainable in either oak or mahogany.)
- 1 Electric gramophone motor (Igranic Electric Co., Ltd.).
- 1 Double-circuit jack (Bowyer-Lowe). (Lotus, Ashley, Igranic, etc.)
- 1 Pick-up complete with tone-arm and clip (B.T.H.). (Regarding alternatives see note in article.)
- 1 Ultra Air-Chrome loud-speaker chassis, 18 in. × 23 in. model.
- 1 Mains fuse block, with fuses (Gambrell).
- 1 On-and-off switch (ordinary electric light pattern). Do not use the ordinary filament switch, as the mains voltage is connected to it. The standard house pattern, either as shown or one of the many fancy varieties, can be obtained from your local electrician.
- 1 1929 Super-Quality Amplifier, as described last month.
- Special A.C. mains H.T. unit, as described last month.
- 1 Hanging socket, as used for electric light pendants.
- Suitable length of electric lighting flex, with adaptor for lamp holder.

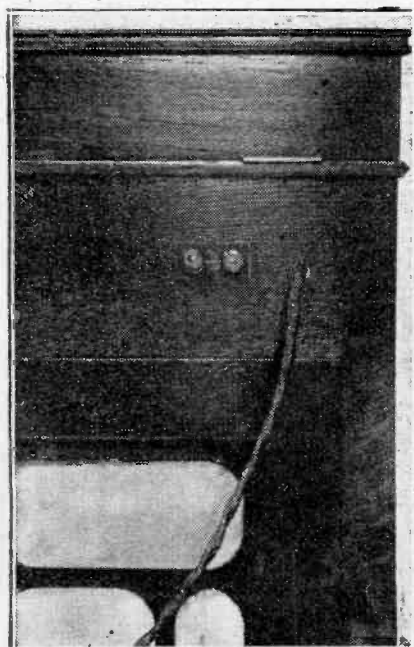

This photograph shows the twin fuse unit in the back of the cabinet.

While any good pick-up can be used, in the model illustrated the new B.T.H. pick-up and arm were chosen, as this particular pick-up gives an excellent frequency response and is sold complete with supporting arm ready for mounting on the instrument for only £2 5s. At the same time, it is not desired to suggest that other good pick-ups are not equally suitable for this instrument, and those who have already purchased such devices and have their own tastes in the matter may like to use their existing model.

The simplicity of the B.T.H. tone-arm and pick-up mounting is a very good point in its favour, as when mounted according to the template it works with almost perfect tracking; and our investigations spread over some time indicate that there is practically no record wear, certainly no more than is given by the ordinary gramophone sound-box.

There now remains the electric driving motor. Here the Igranic

“Wireless Constructor” All-Electric Gramophone—continued

electric gramophone motor admirably suits our needs, being both efficient and reasonable in price.

With our power supply, amplifier, pick-up and tone-arm, electric motor

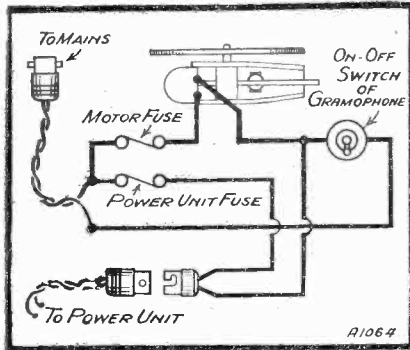

all chosen, there remains only the cabinet. This required to be specially designed in order to accommodate the particular loud speaker chosen, but otherwise is very simple in structure. It consists of an upright cabinet carrying at the front a sheet of silk beneath a well-designed fret, and opening at the back to enable the Air-Chrome loud speaker to be slid into position against the front fret.

When the speaker is in position a shelf is inserted to carry the amplifier, while the power unit stands at the bottom of the cabinet. When the lid of the cabinet is lifted a hinged board is seen, and on this are mounted the motor, pick-up and tone-arm, on-and-off switch, a jack for using the amplifier and speaker with your existing wireless set, and a volume control. At the back of the cabinet is mounted a fuse block with two fuses, one of these being connected to the electric motor and the other to the power unit.

Fuses Act as Switches

These fuses are easily taken out, so that while the on-and-off switch on the top of the cabinet turns on both motor and power unit simultaneously, the withdrawal of one fuse enables the motor to be run without the amplifier, and the other the amplifier to be run without the motor, as when it was desired to connect up an existing wireless set to this machine. The special arrangement of the volume control enables this to be used when the amplifier and speaker are connected to your wireless set; a very useful feature not incorporated in some of the commercial gramophones, where the volume control is connected to the pick-up, and is therefore cut

out when one is using a wireless set with the amplifier and speaker.

After connecting together the various parts, the first thing to do is to take the template provided with the Igranic electric motor and drill the top board of the cabinet as indicated. The best way to do this is to undo all the screws holding this, take it out and do the work on a table; but if you have not the right size bits or drills your local carpenter or joiner will do this work for you for a small charge.

The Volume Control

At the same time drill holes for the volume control (which if you have already built the amplifier described last month you should detach from this instrument and place on the top panel) and for the jack. As most jacks are made to mount on panels of

$\frac{1}{4}$ in. thickness at the most, the hole for the jack, after being drilled for the proper diameter, will have to be recessed somewhat.

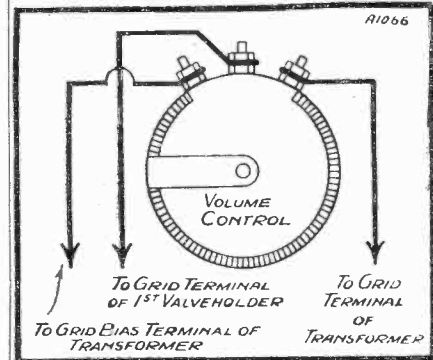

Mounting the motor itself will be found very simple if the instructions issued by the makers are followed, and the on-and-off switch is also simply

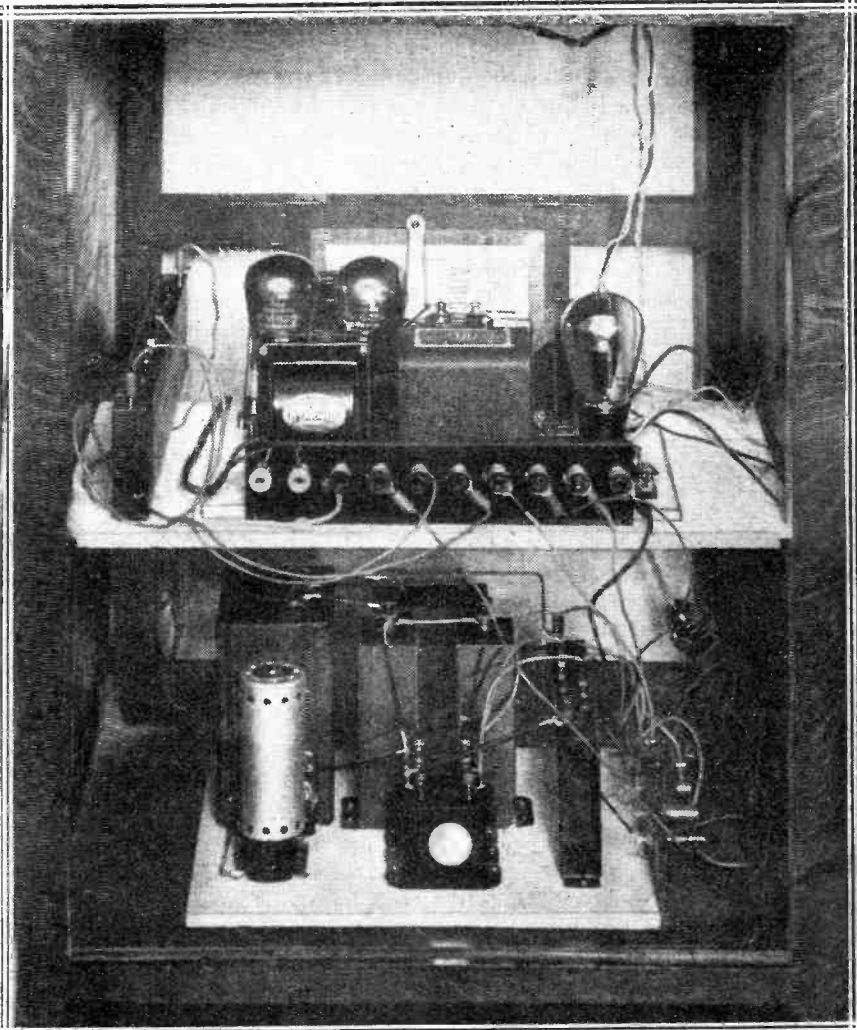

This photo shows how the amplifier and power unit are arranged behind the loud speaker.

“Wireless Constructor” All-Electric Gramophone—continued

fitted. The turntable is, of course, provided with the electric gramophone. The top plate can now be replaced and the screws inserted, but do not yet screw down the front portion which lifts up.

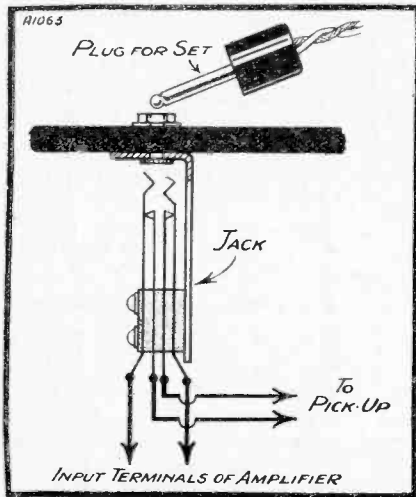

By screwing down the back portion only you will be able to lift up on hinges the whole assembly of tone-arm, electric motor, volume control, etc., which will, of course, facilitate wiring.

After the tone-arm is in position a small hole should be drilled immediately behind it, and through this the flexible wire from the tone-arm should be threaded. Now drill the back of the cabinet to take the fuse block, and also drill a hole in some suitable posi-

tion through which you will lead the wire which comes from the electric-light socket providing the power.

After you have threaded this wire knot it on the inside, as this will prevent it being pulled out, and then connect up the flex leads as shown in the diagram. You will notice that instead of connecting the plug from the power supply unit directly to the line, I have used a pendant socket into which the plug already fixed to the end of the wire coming from the power unit can be inserted. The object of this is to enable you to remove the power unit for exterior use if desired for as described last month. This can be used to run any set, and it is probably not desired to “lock up” too much apparatus for one purpose.

A Slight Modification

When the power wires have been connected to the fuse block, electric motor, and the pendant socket, as well as to the on-and-off switch, place the power unit in the bottom of the cabinet, insert the shelf, and place the amplifier in position. A slight modification of the amplifier for use in this gramophone is simply understood by examining the diagram.

In order that the amplifier could be used as a complete unit it was provided (last month) with an end ebonite plate to carry the input terminals and the volume control. This plate has now been removed and the volume

control transferred to the upper panel, while the two input terminals of the transformer are connected to the jack. The three wires from the volume control should be twisted together and

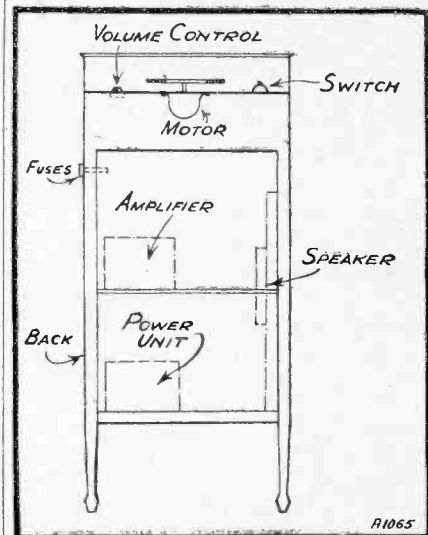

brought down to the secondary of the input transformer and to the grid respectively, taking care if you use the Igranic Megostat as a volume control to connect the terminals as explained in the leaflet issued with this instrument.

If you do not follow the connections recommended the volume control will tend to come on too suddenly, whereas with the correct connection the control is very gradual in operation.

Connecting the Speaker

The rest of the connections explain themselves and will be easily understood from the diagram. There is, however, a right and a wrong way for connecting the loud speaker, for even though an output transformer is used the quality will be distinctly better one way than the other.

When built all into one cabinet there will be a certain amount of hum present, but this will not be noticed immediately the gramophone is played. The hum incidentally would not be reproduced on a speaker which does not give genuine low notes, but the sensitivity of the Ultra Air-Chrome loud speaker to the low frequencies enables it to be produced. The amount of hum you will obtain will differ in different houses, but if it should be more than you care for, then you will find one or two

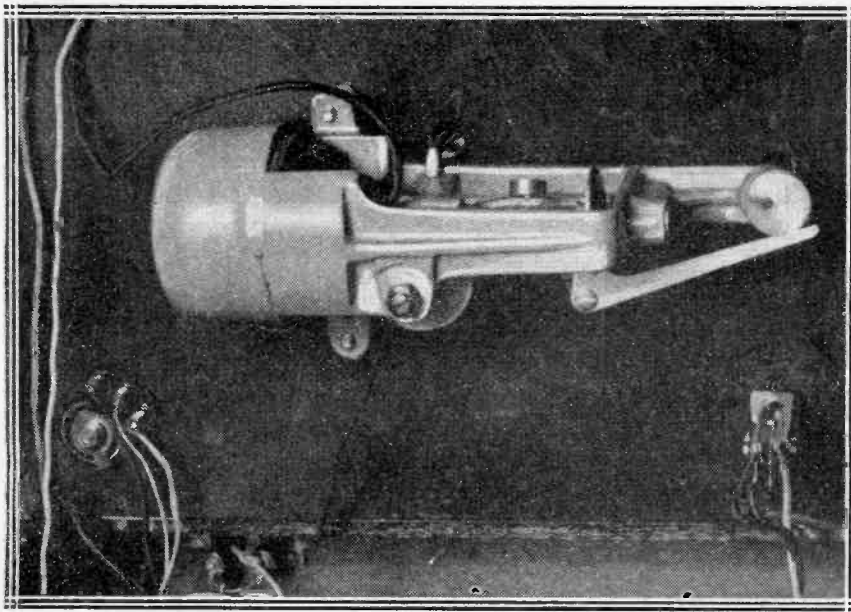

The Igranic Phonomotor used for providing the drive for the gramophone turntable.

“Wireless Constructor” All-Electric Gramophone—*continued*

simple modifications of valve arrangements described in a separate article in the current issue.

By this time you will naturally be very anxious to try out the instrument, and to do this all that is necessary is to place a record on the turntable, insert a needle, and switch on. Before playing, however, I would recommend you to set the speed accurately.

Setting the Speed

To do this place something on the turntable which has a plain marked line to enable you to count the number of revolutions easily (a piece of white paper or cardboard with a black line marked on it will do) and switch on the motor with pick-up and record “on.” Now adjust the speed until the turntable makes a definite 78 revolutions per minute. Once the correct speed has been found it need not be touched again for some time, but it should be occasionally checked.

You will be astounded by the volume and purity given by this instrument, and for normal use you will always have to use the volume control. For dancing, however, or for use in the open-air, you may care to run it at full strength. My experience is that the medium needles suit the instrument best, loud needles being used only in those cases where very big volume is required. The soft needles seem to give an inferior quality of reproduction.

Be particularly careful to mount the tone-arm accurately according to the template provided, and see that its lower edge is parallel with the record. Be sure, too, when you insert the needles to push them in carefully and screw up the needle holder tight. The total current consumption of this instrument, by the way, is very low, being little more than that used by an ordinary lamp, so that it can be plugged into any lamp holder without fear of blowing house fuses.

Batteries Instead of Mains

“This is very nice,” I can hear readers saying, “but unfortunately I have no A.C. mains in the house, or even in the village. Is it not possible for me to build this machine with some slight modifications?”

The answer is yes! The amplifier will be constructed in exactly the

same manner as that already described, but the terminal marked “centre” is now joined to that marked “L.T.—” and L.T.— and L.T.+ terminals are used with an ordinary accumulator. To economise current the first valve can be any of the 1 amp. or .075 valves having an impedance of 7,000 to 10,000 ohms, as it is found best to have a valve of fairly low impedance here.

The push-pull output valves can be any of the good super-power types, and as far as H.T. voltage is concerned this should not be less than 120. The current demands of this amplifier are rather high, and therefore if dry batteries are used the largest types available should be adopted or preferably high-tension accumulators.

Of course, you will not be able to use an electric gramophone motor, but there are many excellent clock-work motors obtainable, and these are easily mounted and worked in the normal fashion. The Air-Chrome loud speaker, volume control, jack, etc., will also be used as before, and

the volume obtainable when 120 volts are used and a pair of super-power valves in the output will be fully adequate for a large dance even in the open-air.

Other Loud Speakers

Loud speakers other than the Air-Chrome can, of course, be used with this gramophone provided they have good characteristics, but do not forget that many of the loud speakers sold, particularly the moving-coil types, are comparatively insensitive; the high sensitivity of the Air-Chrome being one of the reasons which dictated its choice for this instrument.

Another excellent speaker with high sensitivity and a good frequency response is the Amplion Lion, which can also be obtained in chassis form, but owing to its depth a slight rearrangement of the apparatus in the cabinet may be needed. The Air-Chrome loud speaker is very shallow, and therefore leaves adequate room for the parts shown behind it.

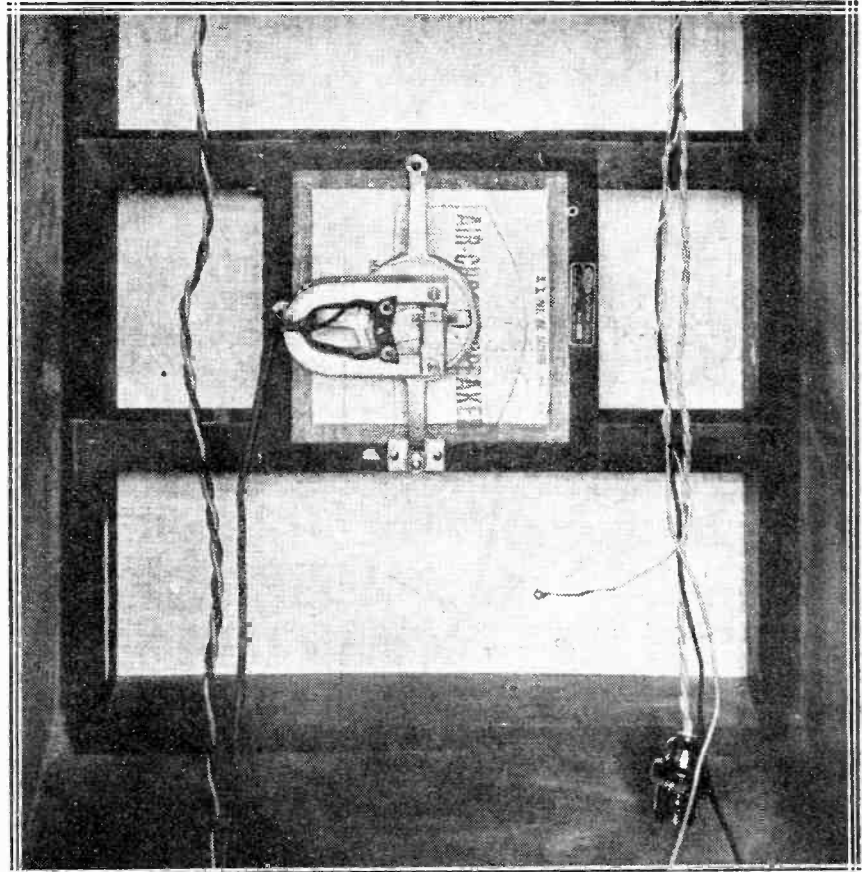

The back of the loud speaker, shown mounted in position ready for the insertion of the shelf with the amplifier.

"Wireless Constructor" All-Electric Gramophone—continued

To connect the amplifier and loud speaker to an existing wireless set, all that is necessary is to insert a plug into the jack, leads from the output terminals of wireless set going to this plug. The jack automatically cuts out the pick-up and substitutes the wireless set. When this is done the fuse connected to the motor should be withdrawn, otherwise the motor will be running needlessly.

 * **CLEANING PANELS** *

It is unfortunate that many ebonite panels, while excellent in appearance when new, suffer considerably by exposure to sunlight. The examination of a panel which has been placed in strong light for a con-

siderable period will show a kind of powdery surface in place of the original gloss, while a greenish tint takes the place of the jet black which looks so well when the panel was first bought. Mere dusting or rubbing the surface is generally insufficient to restore its "bloom of youth," so other methods are necessary.

A procedure which is most convenient is as follows: First of all make sure that nothing will be harmed in the set by turning the cabinet so that the panel is placed horizontal, and then remove the dials so as to expose as much as possible of the ebonite surface.

Now take a dry, clean duster and rub the panel vigorously all over. This will remove a good deal of the powdery substance (which is often free sulphur). Next take one of the kitchen soaps not intended to wash

clothes, such as Brookes' Monkey Brand, and clean the panel carefully, using as far as possible a straight-line motion, rubbing lengthwise on the panel.

The Final Polish

When this preliminary cleaning is finished, dry the panel thoroughly and then finish it off with a good motor-car polish, of which a small tin can be obtained quite cheaply at any garage. "Furmoto" is a car polish which we have found to give excellent results on ebonite panels without leaving the smeary surface which characterises some of the wax polishes.

Do not be tempted to finish off an old panel by rubbing it with oil, as while this gives a temporary black appearance it will soon pass away and the final result will be worse than ever.

H. P. W.

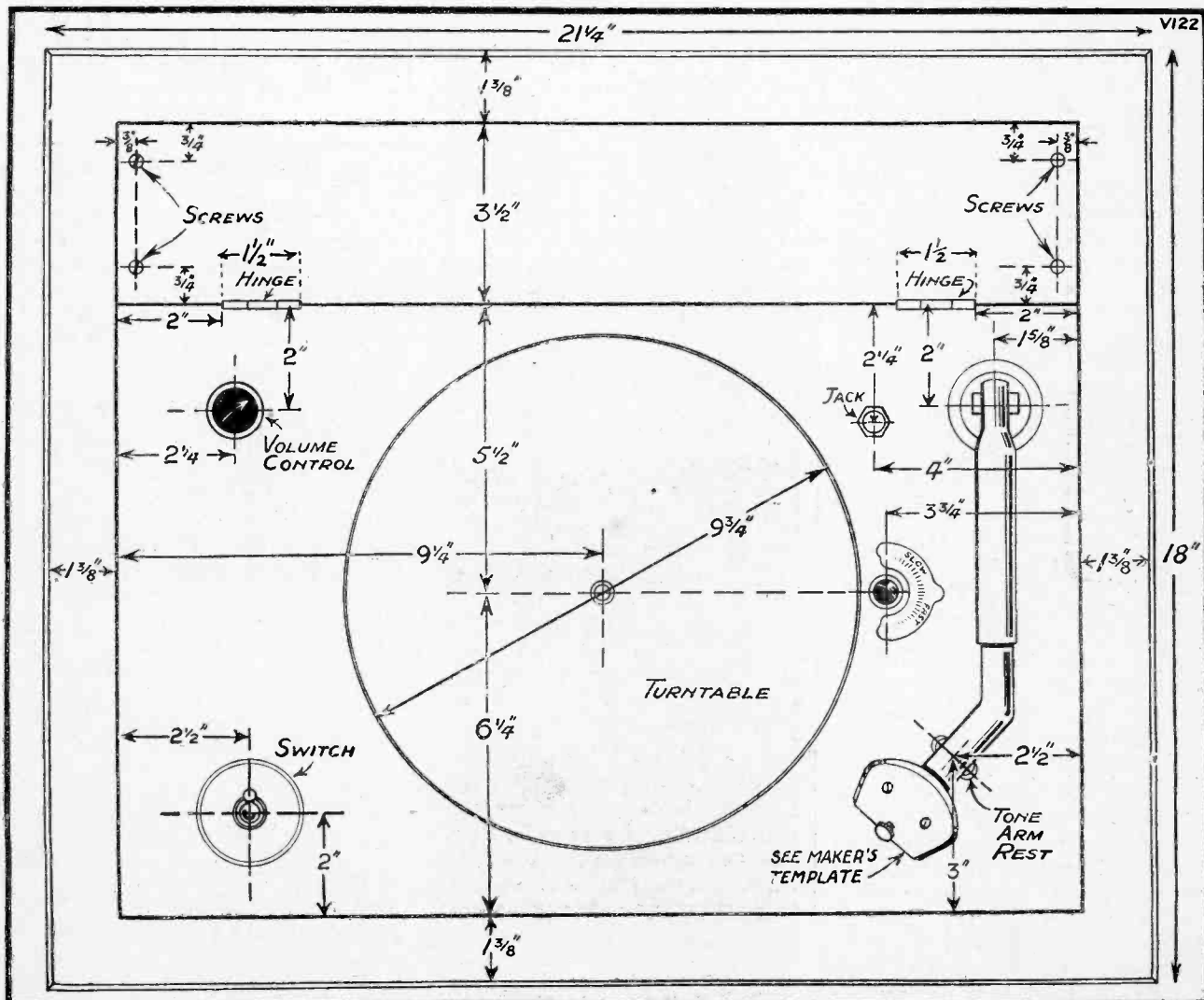

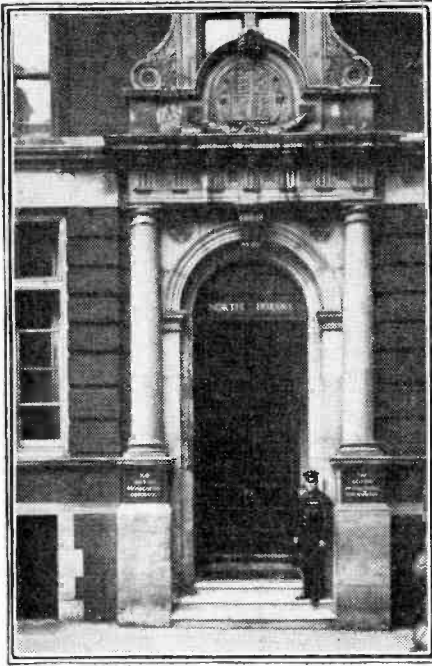

HAPPENINGS AT SAVOY HILL

By OUR SPECIAL COMMISSIONER

January 1st, 1923, and June 1st, 1929. Of this total, 84 resigned and 59 were "told to go." Of the main total, 60 were engineers.

The staff of the B.B.C. was less than 100 in 1923, but had reached 1,079 on June 1st, 1929. Comparatively, therefore, the defections and dismissals are quite small. Probably it would have been a good deal better for broadcasting if there had been more changes. Anyway, deficiency in this respect will soon be remedied.

Future Resignations?

The total of defections and dismissals for the first five months of 1929 was 29, the same figure as for 1928. But the "Gold Rush" is only begun. I know of at least six prominent people at Savoy Hill who will not be there in a year's time. I believe Sir John Reith will be one of the early "sensations," when he accepts one of the many big jobs coming his way these days.

The "talkies" have not yet got into their stride, when they do they will want several more "sound" experts from Savoy Hill. Australia has already asked for some programme officials to get broadcasting

started in a big way "down under." Canada's intentions are not yet clear, but should the Government approve the recommendations of its Royal Commission on Radio, efforts to secure staff from the B.B.C. are inevitable.

Various gramophone companies are known to be in treaty for the services of B.B.C. experts in programme work. In addition to Sir John Reith, I should not be surprised to see the following leave the service of the B.B.C. within a year: Mr. Gerald Cock (Outside Broadcasts), Mr. Gladstone Murray (Information), Mr. Lindsay Wellington (Programme Balance), Miss Hilda Matheson (Talks), Mr. K. A. Wright (Music), Mr. Val Goldsmith (Administration).

I am in a position, however, definitely to deny the rumour that Admiral Carpendale, Mr. R. H. Eckersley, or Mr. Filson Young have any intention of resigning. The real point, however, is that the B.B.C. will go on much the same whatever happens to its personnel. The broadcasting service is established, and no government would dare to let it drift into inanition or incompetence.

New Repertory Company

Mr. Val Gielgud has now been in charge of B.B.C. dramatic work for six months, and there is agreement that he has succeeded beyond all expectation. There is now much more real character and enterprise in B.B.C. dramatic effort. It is obvious that Mr. Gielgud has faith in his medium and is determined to destroy the impression that broadcasting is merely a mechanical offshoot of the stage.

The new repertory company is being assembled. This will consist of competent actors and actresses who will depend entirely on the B.B.C. for their means of living. It is hoped, therefore, that Savoy Hill will make this reasonably decent in order to get and hold the right material.

Vienna Imperial Court Choir

I hear that there is a strong possibility that this choir will be on the

ON June 7th, without previous warning, the B.B.C. announced wave-length changes for June 30th which would have deprived London listeners of 5 G B, the only station that the vast majority care anything about. Under the so-called Prague Plan it was proposed to move London from 358 to 356 metres, and 5 G B from 482 to 399; leaving a clearance between them, after June 30th, of only 43 metres, or less than 80 kilocycles.

If this had been applied there would have been widespread dissatisfaction among listeners and much unnecessary hardship in the wireless industry. The R.M.A. lost no time. They mobilised publicity and then sent a strong deputation to Sir John Reith. The deputation was headed by Mr. Mould, who minced no words in describing the views of the industry to the head of the B.B.C.

The result was that three days later the B.B.C. announced a new schedule of wave-lengths, giving a difference of over 120 metres between 5 G B and 2 L O. This prompt recantation was creditable to the B.B.C., but one cannot help wondering why the obvious error of the previous scheme had escaped notice. There is clearly need for closer liaison between the trade and the B.B.C. to prevent the recurrence of such stupid mistakes.

B.B.C. Staff Changes

I have been looking through some statistics of B.B.C. staff changes since the beginning in 1923. Not including typists, office boys and casual labour, 143 people left the employ of the B.B.C. between

RAILROAD RADIO



The Vice-President of the Canadian National Railways telephoning a radio message from a train speeding across Canada at forty-five miles per hour.

Happenings at Savoy Hill—continued

air in England in the early autumn. It consists of seventeen boys, and recently concluded a remarkably successful tour of the United States.

The "Proms"

During the Promenade Season, that is for the eight weeks beginning August 10th, London is giving its main news bulletin at 9.40 p.m. every day. When 5 G B is taking a Prom. it will try to synchronise with London by taking news at 9.40; otherwise, 5 G B will give its news at 9 p.m.

Imported Music

The B.B.C. has been considering a proposal to import the principal German Wireless Orchestra for a series of concerts in London next April. The idea appears to have been mooted through Scherchen, the eminent German conductor, who appeared for the B.B.C. last symphony season. Savoy Hill has decided in

it is only very grudgingly and apologetically that the results of important races (without odds) are given with the news bulletins.

The tremendous success of the Derby and Grand National commentaries does not seem to have made any difference to the official attitude of the B.B.C. Now that alternative programmes are getting near, the B.B.C. will be urged more definitely than ever before to consider the wishes of that vast section of its public intensely interested in horse-racing.

I strongly advise the B.B.C. to head off this particular "popular storm" by extending its racing information service to cover the odds of "one-two-three," and to give some more details of, and better prominence to, racing in its bulletins.

A Famous Toastmaster

Mr. Knightsmith, the world's best known and most competent toast-

Beauty Broadcasts

At Mr. George Grossmith's suggestion, the B.B.C. is trying to prepare a satisfactory series of beauty talks. The aim will be to suggest the best and most healthy ways of improving appearance for both sexes. I would feel happier about this idea if I thought it was going to be handled and put through by the redoubtable "G. G." himself, who, by the way, is as active as ever at Savoy Hill, to the advantage of entertainment.

Wireless Exchanges

Captain Eckersley was at one time very keen on the B.B.C. developing wireless exchanges, and proposals to this end were known to have been made to the Post Office. This was in the time of the Conservative Government, which would not agree to the B.B.C. being given any further monopolistic rights, and I believe it was on this ground that the matter was dropped.

The matter is now to the fore once more, and it remains to be seen whether the change in complexion of the politics of the Postmaster-General will make any difference to the attitude of his department on this matter. If the scheme does go through it will mean a big extension of the work and responsibility of the B.B.C.

THEATRE BROADCASTS IN GERMANY

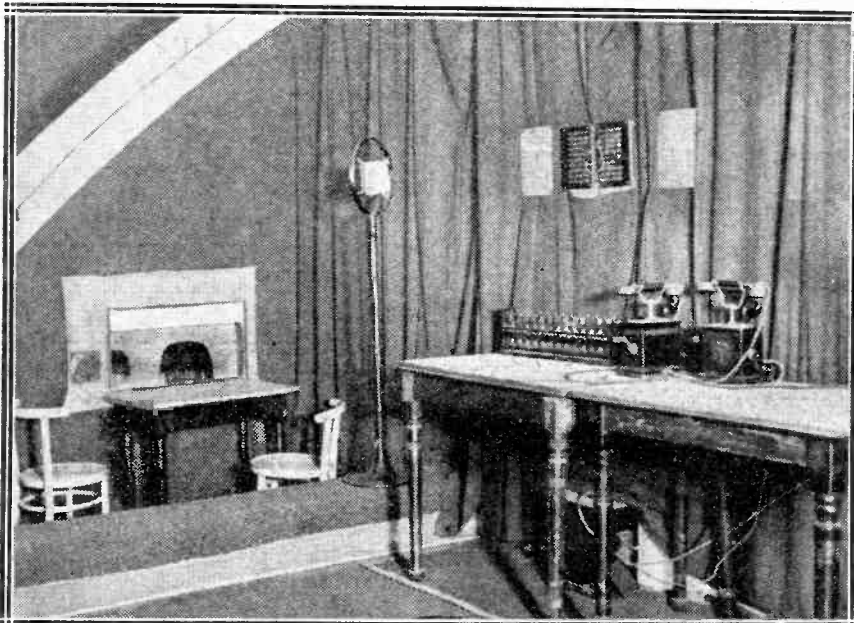

The radio transmission room near the stage in Berlin's largest theatre. This theatre holds 4,000 people, and its performances are frequently broadcast.

the end not to import the orchestra physically, but to take a special series of concerts from them through Cologne by land-line.

Radio Racing Reports

There is growing irritation among listeners at the attitude of the B.B.C. towards horse-racing. Savoy Hill has always frowned upon this sport, and

master, will be on the air in the autumn if negotiations now in progress are successful. Mr. Knightsmith is reputed to have been toastmaster at over 10,000 functions of importance, and to have introduced more Prime Ministers and Royalty than most educated people could remember. His reminiscences should be of very keen general interest.

* LABEL YOUR VALVES. *
* *****

A PIECE of plain paper stuck on the bulb of the valve and marked with the date of purchase and the general characteristics will often save a lot of hunting through data sheets, and also show whether the valve has given reasonable life. Do not use ordinary stamp paper, or even ordinary pastes or gums, but one of the stronger adhesives, such as Seccotine or Croid, otherwise the paper may scale off when dried by the slight heat of the valve.

The most generally useful facts to put on this label are date of purchase, maximum plate voltage, filament voltage, impedance, amplification factor, and, in the case of super power valves, anode current and grid bias.

BROOKMAN'S PARK

A review of the important developments which will follow the opening of the B.B.C.'s new station, and the inauguration of the Regional Scheme.

By a Special Correspondent.

IF all goes well, by the end of August the new station at Brookman's Park should be beginning its preliminary public broadcasts, and when that happens it looks as though listeners who are not provided with reasonably selective sets will be in for a pretty lively time. Those of our readers who remember the Old Testament will remember that Balthazar saw the writing on the wall, and those of us who are in close touch with broadcasting can see similar signs and portents to those which dazzled the eyes of Balthazar.

B.B.C. Prepares Pamphlets!

For one thing, we understand the B.B.C. is preparing a new selectivity pamphlet for special distribution among listeners in regional areas. Another pamphlet is under way for the benefit of listeners who find programmes from the new transmitter at Brookman's Park weaker than programmes they now receive from 2 L.O. Now, the B.B.C. does not prepare pamphlets without good reason, and the reason obviously is that they anticipate no little confusion when the new 2 L.O. gets going.

Well, that is more or less inevitable, and we mustn't kick. Every innovation has its inaugural trials and troubles, but they are always worth while if the ultimate benefits are substantial, and there is no doubt that, regarded as a whole, the Regional Scheme is a very substantial benefit—not only to listeners, but to the trade and to the general trend of progress.

Gradual Change-Over

However, one step at a time, and the first step is the Brookman's Park station. Preparations, first on a closed circuit and then on an open aerial, are at the moment well in hand, and if these engineers' tests go well, and the apparatus now installed doesn't cause undue trouble, the end of August should see the station on the air.

Of course, the complete change-over from the present 2 L.O. in London to this new station will be gradual, just as it was when the Oxford Street aerial was completed and was ready to supersede the old transmitter at Marconi House. Several months went by before the change-over was made absolute.

The recent progress at Brookman's Park is certainly remarkable. All four masts are now in position, two of them complete. Most of the heavy engineering gear is installed, and already the Diesel engines have had a

trial run for the purpose of battery charging.

The Two Transmitters

As was pointed out in our contemporary "Popular Wireless" the other day, there will eventually be two transmitters at Brookman's Park, both transmitting different programmes on separate wave-lengths, but, of course, at equal strength, in order to attain uniform radiation.

But, again, one step at a time—for it will be some months, perhaps over a year, before both stations are

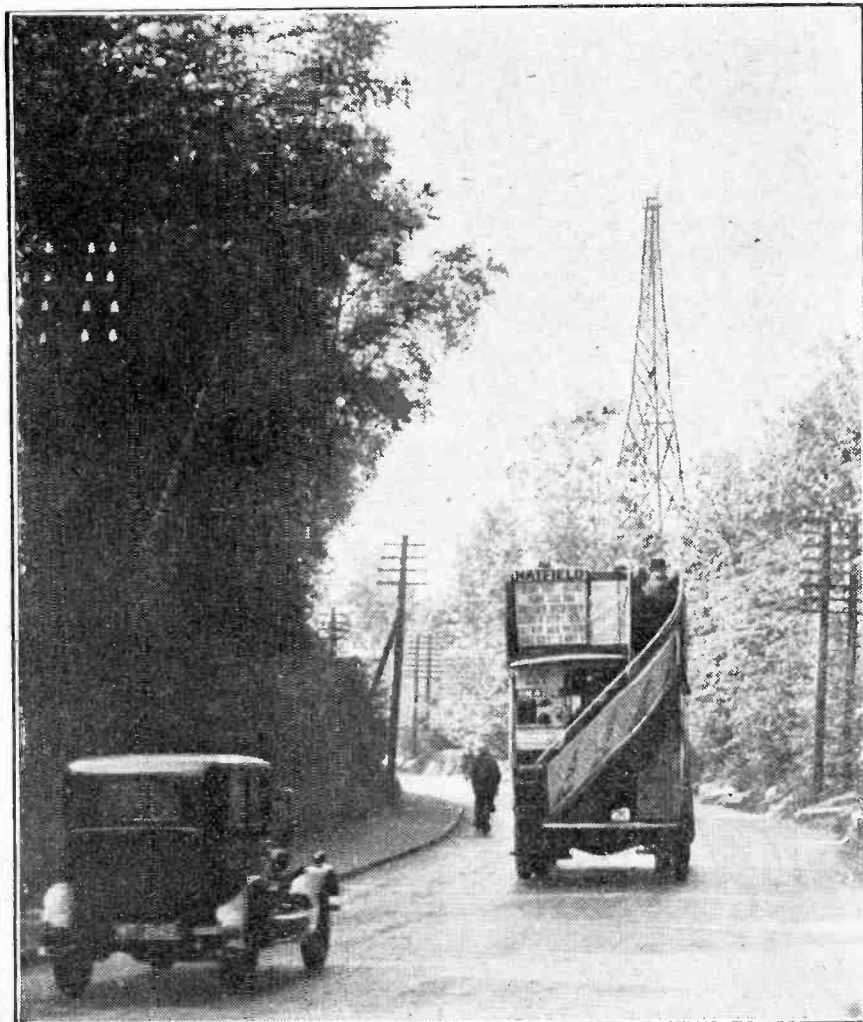

A view of one of the new Brookman's Park masts, from the Great North Road.

Brookman's Park—continued

actually working. Slow but sure seems to be the motto with the whole of the Regional Scheme. It is certainly slow, and we see no reason why it should not, in the end, prove sure. But there are undoubtedly complications ahead, at any rate for those listeners who have ignored our repeated warnings about selectivity and the necessity for keeping their sets up to date, and failed to note all the recent modifications which have been brought about because of this urgent necessity for selectivity looming up ahead.

No doubt some amateurs who pick up quite a lot of stations at the present time may find that the new 2 L O wipes them out a bit. However,

much likelihood of the B.B.C. and the Baird Company coming to a complete and thorough understanding.

The P.M.G.'s Suggestion

The negotiations were first of all proposed last March at the suggestion of the Postmaster-General in the last Government, and, in consequence, the B.B.C. again investigated the Baird Company's claims, etc., and decided that the suggestion of the Postmaster-General should be adopted in a limited way—that is, to the extent of giving the Baird Company facilities for experimental transmissions outside normal broadcasting hours. However, it appears that the Baird Company wanted definite transmissions

A Baird Company official stated in an interview with the "Daily Telegraph" the other day: "So far as we are concerned, the negotiations are at an end, and we have referred the matter back to the Post Office. The negotiations have failed on the question of facilities."

An Official Statement

Later on, the Baird Company issued this statement: "A demonstration was given at the request of the late Postmaster-General before a selected deputation of Members of Parliament and himself. As a result of this demonstration on March 27th last, the late Postmaster-General gave consent to the B.B.C. using one of their broadcasting stations for the purpose of transmitting television, and expressed himself as anxious that facilities should be afforded so far as was practicable without impairing the broadcasting service for continued and progressive experiments with Baird apparatus.

"The B.B.C. thought they were complying sufficiently with the requests of the late Postmaster-General by offering three broadcasts weekly in the mornings of one quarter of an hour as a sufficiently adequate length of time either for continued or progressive experiments or for interesting the public.

"The Baird Television Development Company, Ltd., is, of course, unable to regard this offer as in any way adequate, and has appealed once more to the Postmaster-General."

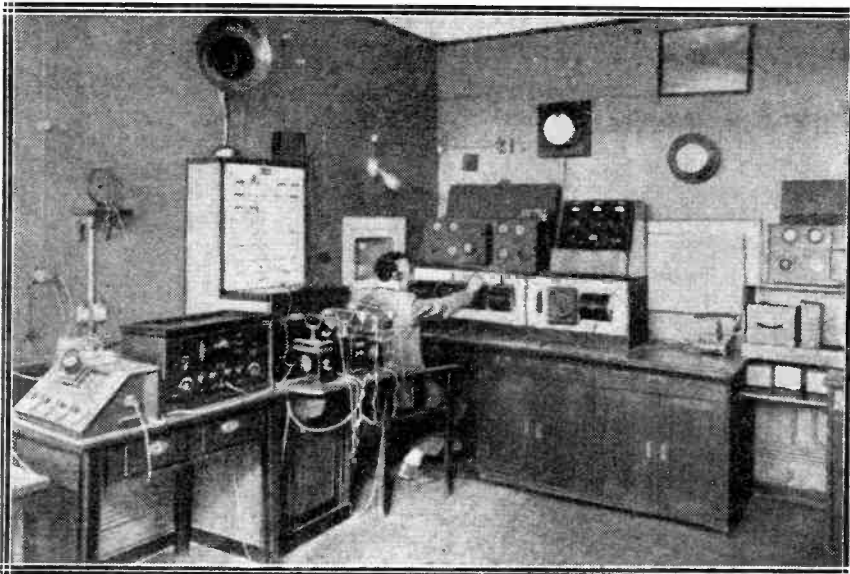

The control room in Königsberg, one of Germany's high-power stations.

it is hard at the moment to forecast, but undoubtedly there will be a sense of newness in the ether for quite a number of amateurs with sets which are, quite frankly, not up to scratch.

Those Television Negotiations

One of the exciting possibilities of the new Brookman's Park station was the fact that it was to have been the scene of the first television experimental broadcasts, but these are not now likely to take place. The fact that negotiations between the B.B.C. and the Baird Company have been broken off seems to have been a surprise to some people, but those who have been in close touch with the negotiations are well aware that even at the beginning there was not

to take place in programme hours; the B.B.C. could not agree to this, and so negotiations were broken off.

The Baird Company seems to have an idea that they might be able to obtain a broadcasting licence, and thus establish their own stations for the transmission of television programmes, but this is extremely unlikely, as any student of broadcasting will realise.

For one thing, the Baird Company would want two distinct wavelengths, one for television and one for the accompanying speech transmission. And, furthermore, it would mean the necessity of legal complications in connection with the revision of the B.B.C.'s charter.

Shelved—For the Time Being

We cannot agree with the last paragraph. There is no question of "of course" about the facilities offered by the B.B.C. being inadequate. To begin with, they are more than adequate, and if the Baird Company have the goods we see no reason why they should not jump at any chance of demonstrating to the public that they have a system which, on its own merits, warrants public attention and the inclusion of regular television broadcasts in normal broadcasting hours. Apparently the matter is now shelved until the new Postmaster-General has had time to look into the question. But whether he will instruct the B.B.C. to grant the Baird Company the facilities they require is a matter which must be left in abeyance until more facts come to light.

COMMENTS FROM CONSTRUCTORS

Some interesting experiences of the "Air Commander," the "Radiano Four," "Big Ben," etc., from readers who built one of these famous "Wireless Constructor" sets.

A Set to be Proud of!

SIR,—I am writing to inform you that I fitted up "Big Ben" last January, and must say I am very pleased with the quality of the set. It is the best I have heard so far, apart, of course, from a set capable of driving a moving-coil speaker. I am using a very decent cone, and the bass reproduction is very good.

Being one of those who cannot fix an outdoor aerial, I have to force reaction a little more than I like to receive Hilversum, etc., on the long waves. I can get a few of the high-power stations on the short waves. Taking all things into consideration I think it is a set to be proud of.

Best wishes.

Yours, etc.,

W. C. DODWELL.

Camden Square,
London, N.W.1.

"Big Ben" in Bolton!

SIR,—I feel I must write and acquaint you with the very successful results I have achieved with your "Big Ben" receiver.

I constructed this receiver primarily for the good quality reception of the local station (2 Z Y), and for this purpose it gives superb results, the volume being simply majestic and the quality all that can be desired, the low notes being reproduced with remarkable fidelity. This is no doubt due to your de-coupling device and the use of a Ferranti A.F.5 transformer and a Marconi super-power valve with ample H.T.

The results obtained with distant reception have been no less satisfying. I have received the following stations (among many others) at really loud strength: Nurnberg, Toulouse, Cologne, Prague, Leipzig, San Sebastian, Kattowice, Frankfort, Milan, Stuttgart, Langenberg, Dublin, Hilversum, Motala, Radio Paris, and Kalundborg.

As I write I am listening to a delightful concert from Turin, and considering that this is over 700 miles away the strength is simply astounding.

I have not yet tried short-wave

coils in this set, but have no doubt that the results will be equally satisfactory.

The provision of the switching device for wave changes is remarkably efficient and proves exceedingly useful.

The set is ideal for all-round work, and should prove very popular with all the readers of WIRELESS CONSTRUCTOR, as it can't fail to give the utmost satisfaction.

I am, Sir,

Yours faithfully,

W. O.

479, Bury Road, Bolton.

"Radiano Four" a Winner!

SIR,—I wish to thank and congratulate you in giving me such pleasure since building your "Radiano Four" S.G. I had waited for you to create such a circuit, because having heard your "Radiano Three" I knew the "Four" would be the set I had been looking for, and it certainly is.

I wanted a set that would give me music, etc., any time, free from interference, with good tone and enough power to make listening enjoyable.

This set has done all this and more. One day I tuned-in W J Z, W G Y, and Pittsburg with sweet tone and on the loud speaker. I swung from station to station with no fear of losing them, because I could hear them several degrees of correct setting on dials.

W J Z was playing a Wurlitzer organ, "In a Monastery Garden." It was delightful and sweet. I listened to this station until it closed down. I was very keen on building the set and collecting my components. I started one Saturday at 6 p.m. and worked right through until Sunday 5 p.m. By 5.45 I was thrilled by tuning it in, and was much amazed at the stations I could hear, and the volume was so much that I had to control them.

I never tune-in any station without 'phones, because even though I have 69 logged that I can get by setting the dials, I like to make certain that the set is absolutely at its best setting. Sometimes a degree may make all the difference one night, then again one can't annoy other people with a set well in hand, after all. I think that a lot depends on how you tune in a

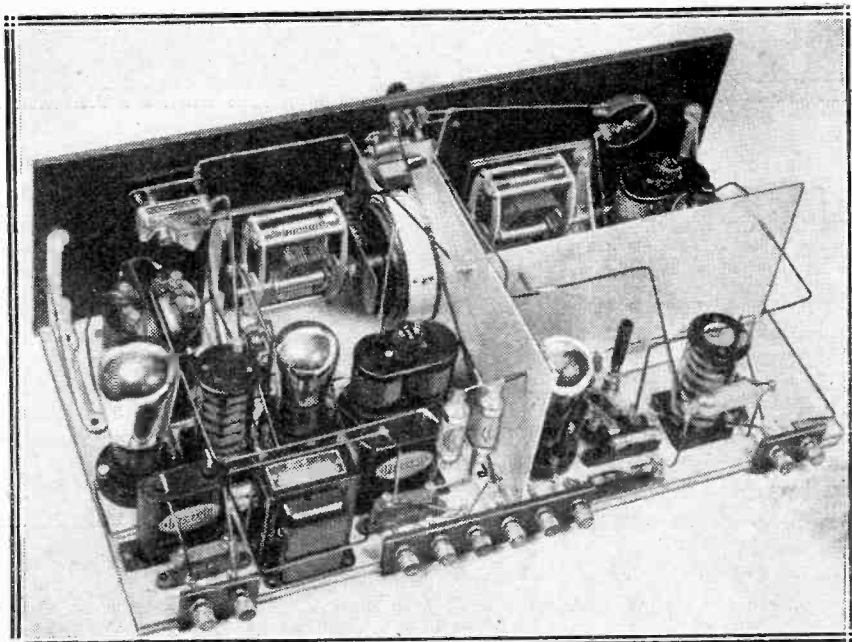

A view of the "Air Commander"—a set to which enthusiastic references are made on the following page.

Comments from Constructors—continued

station (I know I have pulled in stations on fellows' sets they have never heard before).

The "Radiano Four" requires no skill, but I have always used 'phones, and then with a switch change over to loud speaker. I set the volume control according to strength. The reaction I have almost forgotten about. I daresay it will be set up when I use it. Your change-over from one wave-length to another is very simple and efficient, and is much admired by friends.

The tone from any station is really remarkably sweet; this is amongst the set's star performances, and it has many.

And now believe me to be,
Yours very sincerely,
M. RYDER.
Garston, Liverpool.

I am badly handicapped with regard to aerial (the length, including lead-in, being 25 ft.), and earth which measures fully 20 ft.; it is evident I need a good set to get good results.

Having built the "Commander" exactly to specification, except that I added a fifth valve or two L.F. (both super-power), I was not at all disappointed to find the tuning absolutely flat; in fact, local saturation was so much in evidence I could do away with aerial and earth, and yet have signals strong enough to operate a loud speaker.

Knowing a wave-trap was useless to eliminate a direct pick-up, I decided to screen the whole receiver.

As will be seen from the accompanying photograph*, the cabinet is made entirely of aluminium, while aluminium screens are also fitted to

undoubtedly be clear, from a point of view as an indication of overloading or oscillation I generally leave it in the L.F. stage.

The two jacks shown give the option of using either the 3, 4 or 5 valves, with, of course, another push-pull on the fifth valve; the remaining switch above rheostat is the original filament breaker for all four valves in your given circuit. After trying two- and six-volt valves I decided to use two-volt, with which the set appears to give better control.

"Highest Efficiency"

Although we could scarcely call conditions favourable at the present time, it is very rarely I am called on to use the fifth valve, which, by the way, is coupled by an R.I. and Varley straight-line transformer with an obtainable ratio of 2.5 to 1. Apart from these minor alterations I have not deviated in any way from the original circuit.

In conclusion I must say that the "Air Commander," if not the best of your published circuits, ranks with the very highest efficiency receiving sets of to-day in range, quality and volume.

Yours sincerely,
W. H. MACWILLIAM.
115, University Road,
Belfast.

* Not reproduced.—EDITOR.

GOING—GOING—GONE!



A scene at the bidding for an old master at Christie's, from whence a sensational safe was broadcast recently.

The "Air Commander"

SIR,—In response to your invitation in the July issue of your most interesting and useful magazine, I would like to describe the results I have had from the circuit recently published and known as the "Air Commander."

Let me say here that I have taken a very keen interest in the development of wireless since the first British broadcasting station issued licences. During this time I have purchased all publications regarding wireless that were obtainable, the most helpful of these, to my mind, being the WIRELESS CONSTRUCTOR.

Well, to get down to business. Firstly, I happen to reside within a mile of the 2 B E station. Secondly,

the back of the panel—the whole being heavily enamelled on the inside and earthed.

In conjunction with the wave-trap this gave remarkable results; better indeed than I have had with a superhet. As will also be seen, there are two push-pull switches on the extreme left, the top one cuts off the filament of the neutralised H.F., the bottom one de-neutralises this same valve by bringing a .0001 fixed condenser into circuit, with the result that only three valves are in use for the local station.

To Denote Distortion

The milliammeter I would not be without, as it can be thrown into circuit in the detector or first L.F. stage at will; the benefit of this will

* **KEEP YOUR DATA!** *

WIRELESS constructors should not throw away the leaflets, templates, valve data, etc., received in the packing of the various components and valves, as you never know when they will be needed again. This is particularly the case with templates, and although you may think that once having mounted some component by means of this template you have no further use for the guide, do not forget that the time may come when it is desired to remove the particular condenser, drum mounting, etc., and place it on a new panel.

A good plan is to go to some stationers specialising in office equipment and purchase an index box file. You can then file your paper templates and other data either alphabetically or under any separate section you may care to mark.

H. P. W.

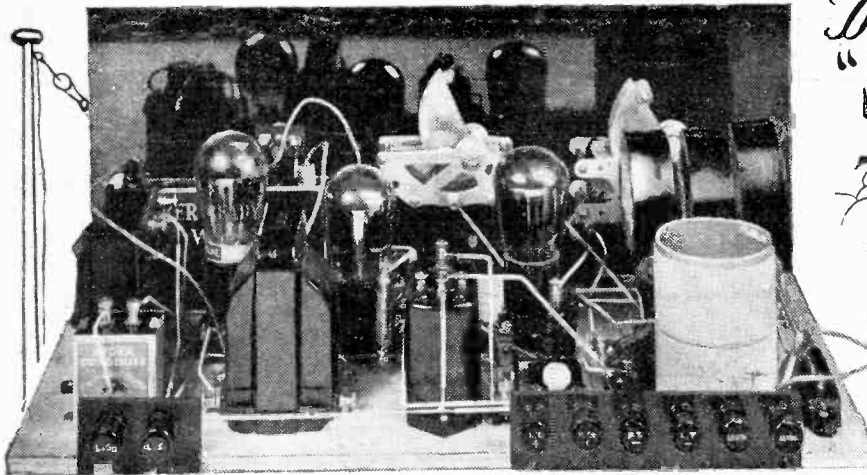

The
"S.M.L."
THREE
by
PERCY W.
HARRIS M.I.R.E.

Full constructional details of the latest product of the "Wireless Constructor" laboratory. This three-valver covers all wave-length ranges—short, medium or long—at will.

THERE is a sound reason for the maintained popularity of the three-valve combination. First of all, almost any of the well-known combinations will give adequate loud-speaker strength on several stations; secondly, such a set is reasonably easy to build; and, thirdly, both first-cost and maintenance are reasonable.

A number of three-valve combinations of high efficiency have appeared from time to time in these pages, each with its individual advantages, and we make no excuse for presenting still another—the "S.M.L." Three—which has a number of points of novelty and utility to meet what is a comparatively new need.

The design, like that of many others in this journal, arose from a reader's letter. More accurately, a reader's letter summarised the general require-

ments of a number of other communications. The letter in question read as follows:

Special Requirements

"In common with many other readers of the WIRELESS CONSTRUCTOR, I find my general requirements met by a three-valve set, and I have built several of your designs with great satisfaction. In looking back, however, I do not find one which meets what I consider to be a general requirement of the present time. I want a receiver which uses standard plug-in coils (of which I have a good collection), which will go right down to the new very short-wave broadcasts and will also act just as efficiently on the ordinary bands, including 5 X X and Radio-Paris.

"If these requirements alone were sufficient, several sets which have

appeared in the WIRELESS CONSTRUCTOR would fill the bill, but I also want one which has much sharper tuning than the normal, particularly now that we have the interference problem facing us more persistently than ever, and I certainly want one with an output filter and anti-motor-boating devices, so that the set will work well when my high-tension battery is no longer in its first youth, and, if necessary, will work satisfactorily with an inexpensive high-tension mains unit which I hope to buy."

My post had already indicated a demand for a set possessing these advantages, and, as this letter seemed to crystallise the position, I set to work on the bench to see what could be done with a detector and two low-frequency stages. It was manifestly impossible in such a set to use

COMPONENTS REQUIRED

- | | | |
|---|---|--|
| 1 Cabinet, 18 in. × 7 in. (Cameo). (Areraft, Pickett, Caxton, Raymond, etc.) | (Lotus). (Or other good make such as above.) | Wearite, Lewcos, Lissen, etc.) |
| 1 Baseboard for same, 10 in. deep. | 1 Adjustable condenser, .0005 mfd. maximum (Formodensor). (Igranie Preset.) | 1 Anode filter (Varley anti-mobo). (Wearite.) |
| 1 Panel, 18 in. × 7 in. × $\frac{1}{8}$ in. or $\frac{1}{4}$ in. (Ripault). (Becol, Radion, Ebonart, etc.) | 1 Former, 2 $\frac{1}{2}$ in. diameter, 3 $\frac{1}{2}$ in. long (Atlas Pirfoid). | 1 100,000-ohm anode resistance and holder (Metro-Vick). (Varley, Precision, Magnum, Mullard, R.I., Lissen, Dubilier, etc.) |
| 2 Panel brackets (Magnum). (Peto-Scott, Cameo, Ready Radio, etc.) | Small quantity No. 24 D.C.C. wire. | 1 2-megohm leak and holder (Metro-Vick). (And any good make as above.) |
| 2 On-and-off switches (Decke). (Igranie, Lotus, Benjamin, etc.) | 1 Fixed condenser, .0003 mfd., with clips for series connection (Dubilier). (T.C.C., etc.) | 1 $\frac{1}{2}$ -megohm grid stopper (Pye leak or Lissen with terminals). |
| 2 Vernier dials (Indigraph). (Ormond, Utility, Lissen, etc.) | 1 Fixed condenser, .0003 mfd. (Dubilier). (Lissen, T.C.C., Igranie, Atlas, Mullard, etc.) | 1 Good low-frequency transformer (Lissen 3 $\frac{1}{2}$ to 1). (Brown, R.I. Hypermu, Varley, Igranie, Ferranti, Cossor, Marconiphone, etc.) |
| 1 Terminal strip with six indicating terminals, 6 in. × 1 $\frac{1}{2}$ in. (Belling-Lee). | 1 Fixed condenser, .015 mfd. (Dubilier). (Note.—Any good make of not less than .006 mfd. will do here.) | 1 Output choke (Wearite type H.T.3). (R.I., Magnum, Varley, Pye, etc.) |
| 1 Terminal strip with two indicating terminals, 2 in. × 1 $\frac{1}{2}$ in. (Belling-Lee). | 1 2-megohm grid leak (Lissen). (Dubilier, Mullard, Igranie, etc.) | 1 2-mfd. condenser (Hydra). (T.C.C., Dubilier, Ferranti, Lissen, etc.) |
| 3 Baseboard-mounting coil holders (Lotus). (Raymond, etc.) | 1 Fixed potentiometer (Polar). (Lewcos.) | 1 H.T. fuse (Magnum). (Microfu, Ready Radio, etc.) |
| 1 Variable condenser, .0005 mfd. (Igranie Lokvane). (Lissen, Ormond, Utility, Ripault, Formo, Dubilier, Jackson, Lotus, etc.) | 3 Valve holders (Formo). (Benjamin, Lotus, W.B., Wearite, Marconiphone, C.E., Precision, etc.) | 3 Wander plugs (Belling-Lee indicating). (Lisenin, Clix, etc.) |
| 1 Variable condenser, .00025 mfd. | 1 Radio-frequency choke (Ready Radio). (R.I., Magnum, Varley, | Valves and coils as explained in article. |

The "S.M.L." Three—continued

wave-change switching unless, of course, the set was to be made unduly complicated and expensive, and, for that matter, a further paragraph in this reader's letter (not quoted above) indicated that he had no special wish for wave-changing by switching.

While on this subject it is as well to point out that no simple wave-change scheme yet has given the same efficiency as can be obtained with interchangeable plug-in coils, for in this, as in many other matters, certain advantages are only gained by the sacrifice of others. The WIRELESS CONSTRUCTOR has published a number of excellent wave-change switching schemes, but none has the degree of selectivity possible with a specially arranged design of more conventional pattern.

A New Wave-Trap

It is not so difficult to design a set to cover the wave-length ranges specified, using the ordinary plug-in coils, which—at least, in the best makes—compare favourably with the "six-pinner"; particularly as with these latter, on the long-wave band, in order to get the inductance into reasonable dimensions either very fine wire or slot winding has to be indulged in.

"eliminator." Sharpness of tuning, however, is quite a big problem—sharpness of the kind our reader manifestly wants; and here, although we have the choice of many methods, it was decided to design and build into

Reaction is obtained by the "throttle" method, a variable condenser adjusting this as desired, and resistance-capacity-coupling from the detector to the first L.F. valve is adopted; an anti-motor-boating device

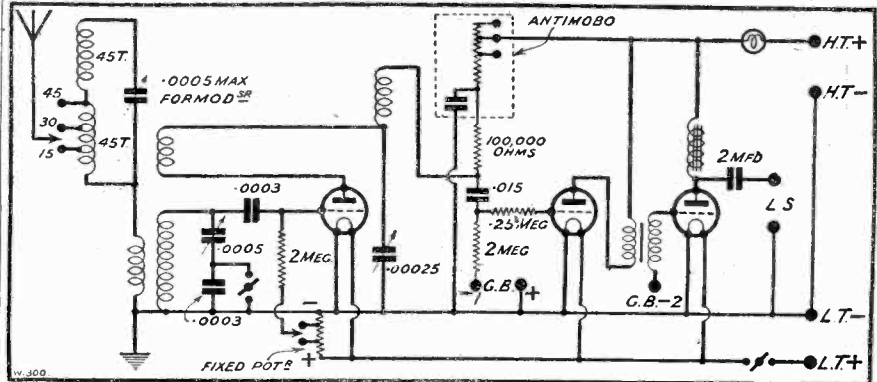

the receiver a special form of wave-trap, about which more will be explained later.

The circuit finally chosen is illustrated above, from which you will see that the aerial is taken to the wave-trap and a lead from this is taken to an aerial coupling coil, the size of which can be chosen to suit the particular conditions.

This coil is coupled to a grid coil, and it will be noticed that the grid return is taken to a tapping on a fixed

being fitted in this circuit. The choice of resistance-capacity coupling here was dictated by two considerations. Firstly, in conjunction with the fixed potentiometer and the other circuit arrangements it gives remarkably smooth reaction, and, secondly, the cost is quite low, being appreciably less than that of a transformer giving good quality.

The magnification, however, is not so great as that obtainable with a good transformer here, but as this stage is followed by a first-class modern transformer with a good step-up, the overall magnification was found to be as much as needed for all ordinary work. Furthermore, in my experience this combination is less liable to reaction troubles on the very short waves.

Simplifying S.-W. Tuning

The first low-frequency valve is coupled to the output valve, as mentioned, by a good low-frequency transformer, and in the plate of this circuit is included an output choke and a 2-mfd. condenser. The choice of panel and cabinet size is such that there is adequate room to lay out the set efficiently and to include the grid-bias battery in the cabinet.

In order to facilitate tuning on the very short waves, a .0003-mfd. fixed condenser is placed in series with the .0005-mfd. tuning condenser, together with a shorting switch, so that on the medium and upper bands this condenser is shorted out. The maximum capacity with the condenser in series, as when used on the short-wave band, is just under .0002 mfd.

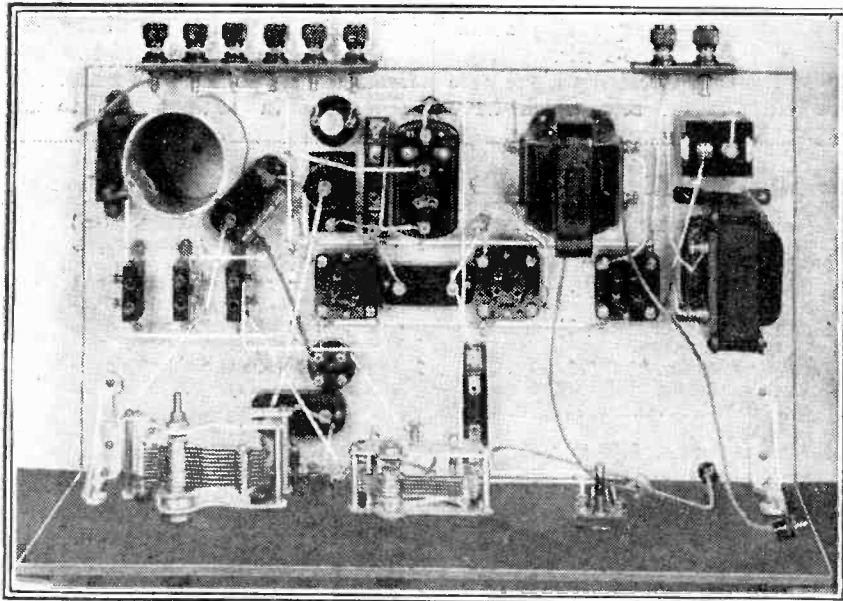

The simplicity of the wiring is a prominent feature of this remarkable receiver.

Anti-motor-boating devices have been thoroughly worked out in the WIRELESS CONSTRUCTOR laboratory, and all sets now put out are perfectly satisfactory on any good commercial

potentiometer, which incidentally enables very smooth reaction to be obtained—a point of considerable importance on the very short waves and not to be despised on any adjustment.

The "S.M.L." Three—continued

This enables the short wave-lengths to be spread well on any given coil, but, of course, if it is found that the maximum obtainable with any given coil is insufficient in this way, a touch

The other two tapping points, at 15 and 30 turns, are easily made by one of several methods.

My own practice is to wind the coil without tappings, and then to count

lifted wire. The wire can then be scraped free from insulation and a short, straight piece of thicker wire soldered to it, without the soldering iron coming into contact with the other turns.

A piece of ordinary soft wood is cut to act as a "bung" in one end, and a couple of small brads are hammered through the walls of the tube to hold the wood in place. The tube is then placed with the wood in contact with the baseboard, and a single screw is passed through its centre into the baseboard. The adjustable condenser is then placed at one side and wired up as shown in the practical wiring diagram.

An Important Point

Constructional work commences, as usual, with drilling the panel, I would strongly advise the use of good vernier dials without any trace of backlash on this receiver, for, while a slight amount of backlash

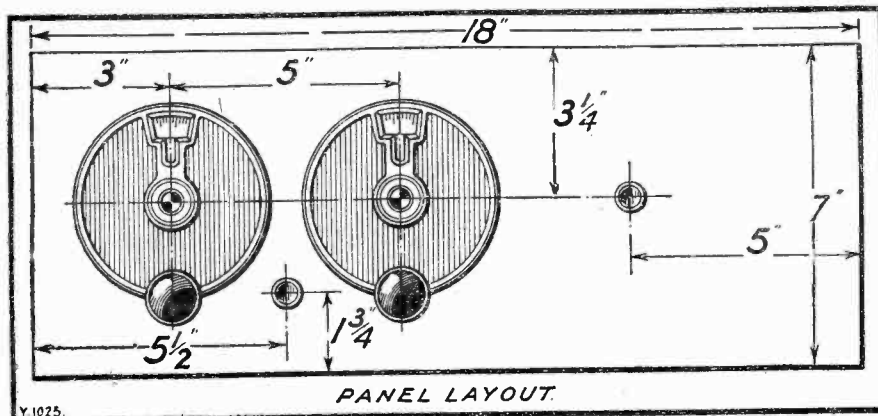

of the switch will bring in the full .0005 mfd.

And now about the wave-trap, which consists of an astatically wound coil with three tappings, the whole coil being tuned by an adjustable condenser of .0005 mfd. maximum. The aerial is connected to one of the three taps (the best is found by trial), and then by turning the knob of the adjustable condenser any station spreading itself too much over the tuning band can be sharpened up very considerably.

Astatic Winding

The novelty about this trap is the astatic method of winding. The object here is to prevent the field of this coil straying widely and interfering with the plug-in coils used in the receiver for tuning and reaction purposes. Many experimenters have found that if they bring a trap too close to the set sharpness of tuning suffers badly, and this, of course, is easily understood when we consider that the trap is tuned to the frequency you want to get rid of, and therefore if it itself is radiating that frequency to the nearby tuning coils, the advantage of the trap is lost!

The trap is very easily and inexpensively made up, all one needs being a 2½-in. diameter tube, 3½ in. long, and a quantity of No. 24 D.C.C. wire; 45 turns are wound in one direction and then 45 in the other. The simplest way is to wind each coil separately and to join the two ends in the centre, this junction being used as one of the tapping points.

off the number of turns until the tapping-point is reached, to prise up the wire at this point with a sharp instrument, such as a scribe, and then to slip a match underneath the

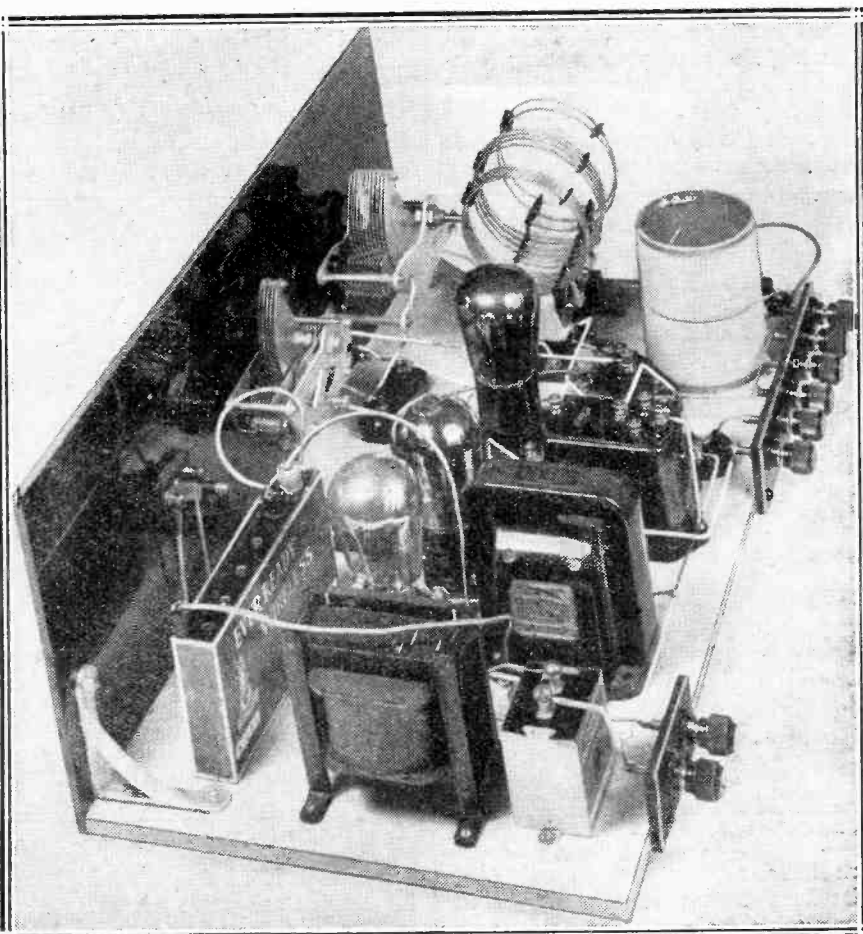

In this photograph the set is ready for the short waves, with a special combination of coils for the reception of KDKA on 25.25 metres.

The "S.M.L." Three—continued

will not worry you on the ordinary band, it will render the receiver unmanageable on the very short waves.

Those dials actually used in the receiver and named as alternatives can be relied upon to be free from backlash when properly mounted, and are quite suitable for the purpose. It is not suggested that these are the only vernier dials without backlash, but if the reader desires to use others he should satisfy himself on this point before adopting them.

Rigidity Essential

The actual drilling will depend upon the make of vernier dial used, but in all cases full instructions and, if necessary, templates are issued with the dials. Although with modern and fairly light variable condensers and the comparatively small amount of apparatus mounted on the modern panel it is possible to dispense with the panel brackets, in this particular receiver I strongly advise their use, as rigidity is essential when working in the short-wave band. Be sure your tuning condenser is of first-class quality, working smoothly and making good contact between the moving plates and the fixed contact terminals. Fortunately

Follow the layout of this receiver as closely as you possibly can, being particularly careful to space the coil holders at the distances shown on the practical wiring diagram. This spacing is of great importance on the very short wave-band, and although it can be varied from the distances given, the effects obtained may not be quite the same as with the dimensions given.

Provided the layout is followed, the wiring of the set will be found to be extremely simple, and, of course, the simpler the wiring the more efficient the set is likely to be. A flexible lead is soldered to the aerial terminal together with a crocodile clip, so that a choice of tapings may be easily made, while if the clip is taken to the terminal of the adjustable condenser near the panel the trap is cut right out. This position is recommended when working on the very short waves.

The H.T. Fuse

It will be noticed, too, that the terminals are arranged to give the simplest possible wiring, and that the H.T. fuse is placed immediately in the high-tension *positive* lead and not, as is usually recommended, in the

still further simplification of the wiring.

A very important point in the layout and wiring of this set relates to the position of the pins and sockets of the baseboard-mounting coil

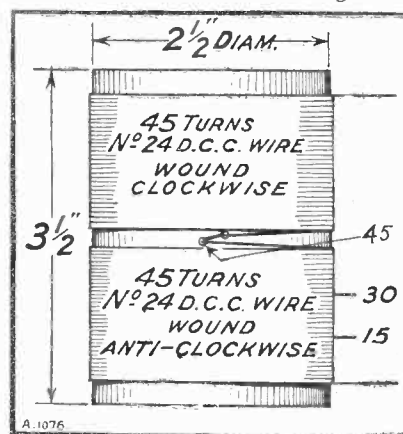

holders. Notice that the pin and the socket is clearly marked in the practical diagram and see that your holders are attached to the baseboard in the correct manner, and that the leads go exactly to the points indicated. Unless you follow the wiring carefully here the reaction will not function properly.

Flexible rubber-covered leads are used for the grid-bias connections, and I have used the new Belling-Lee indicating wander plugs, which are very convenient, although any standard wander plugs will suit. There is plenty of room for either a single 9-volt grid-bias battery or two in series side by side if you are using a super-power output valve. Experience shows that the centre-tapping of the three H.T. tapings on the anti-motor-boating device suits the receiver, and therefore a flexible connection is not provided here, but if the reader likes to try the various connections he can, of course, use a flexible lead and try the positions available.

Suitable Coil Values

The quarter-megohm "grid stopper," which is really a quarter-megohm grid leak placed in series with the grid of the first low-frequency valve, does not need a separate holder if one uses either a Lissen with two terminals, or the Pye, which has wires at each end, enabling it to be soldered and held in position. This quarter-megohm grid stopper is not always necessary, but should be

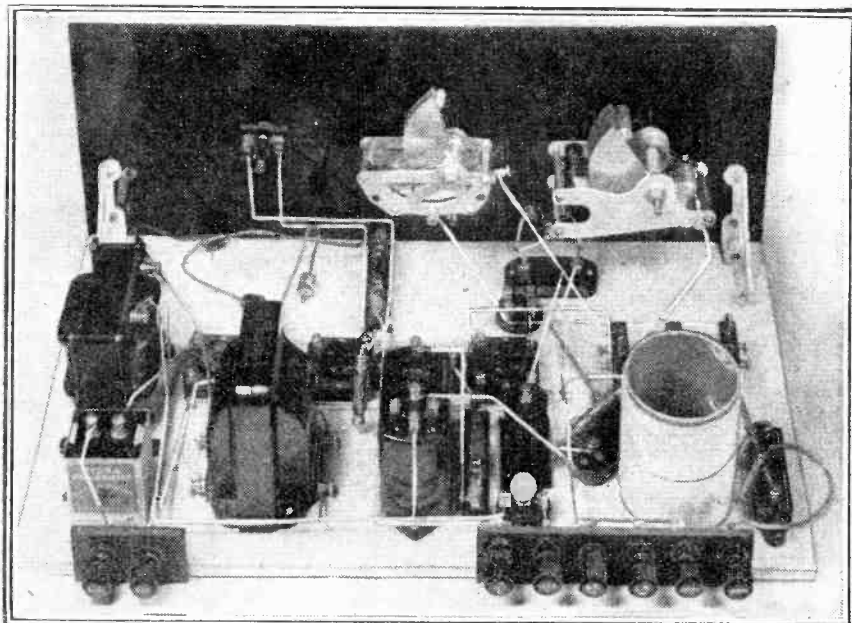

The size of the baseboard facilitates a simple and logical disposition of the parts.

we have a very large number of excellent makes now available at reasonable prices. Any of those named in the alternative list can be relied upon.

negative lead or between the high- and low-tension negative leads. Personally, as this set has only one high-tension positive, I prefer the position shown, particularly as it leads to a

The "S.M.L." Three—continued

included as a precautionary measure. With regard to the coils, many readers who build this set will have a selection of these available, and generally it will be found that either a No. 35 or 40 will suit the ordinary wave-band in the aerial coupling, a No. 60 for the grid coil, and a No. 50 for the reaction when using an H.F. type of valve as the detector.

On the Short Waves

Remember that the smaller the aerial coupling coil the sharper the tuning, but, at the same time, the strength will go down (sharpness of tuning here will mean sharpness when the wave-trap is *out* of circuit). It is one of the advantages of this set that one can have a fairly large aerial coil, which normally would be too flat in tuning, the trap taking charge of the elimination of the local station when desired. On the long waves a 75 or a 100 in the aerial coil, a 250 for the grid circuit, and a 100 or 150 for the reaction, will generally serve.

On the very short waves I have used with success the Atlas short-wave coils, of which there are four—two, four, six and nine turns respectively. The leaflet issued with these coils gives the various bands they cover. One or two other firms also make short-wave plug-in coils for these holders, and I have also used the Igranic short-wave coils with considerable success. Furthermore, the reader who is clever with his hands can easily wind his own short-wave coils, and attach them to standard coil plugs.

On the short-wave band, follow the recommendations of the makers of the particular short-wave coils for the sizes of aerial, grid and reaction.

With regard to the valves, I have used the high-frequency type in the detector socket, another of this type in the first L.F., and a power or super-power in the output, but a resistance-capacity coupling valve will also function well in the detector circuit.

KDKA on the Speaker

For the very short waves, such as from 20 to 40 metres, some valves are better than others, and it is just as well to try among those you have to see which is best, but if an ordinary high-frequency valve is used it will generally be found to function satisfactorily on all wave-lengths.

The receiver was finished late one evening, and it was decided to give it an immediate test on the short waves. It must be remembered that this test was carried out in the summer-time, when short-wave conditions are frequently much inferior to those in the winter months. About a quarter to twelve, faint telephony signals were picked up on the loud speaker on about 25 metres, and in a short time KDKA broadcasting on 25 metres was heard quite well at loud-speaker strength.

number of other short-wave programmes were heard very successfully.

Medium-Wave Broadcasting

The procedure on the ordinary 200- to 600-metre band is first of all to tune-in with the wave-trap out of circuit (connecting the clip to the terminal of the adjustable condenser nearest to the panel), choosing as an aerial coil one which gives reasonable selectivity with good signal strength. If now the local station is spreading itself over too wide a band, all that

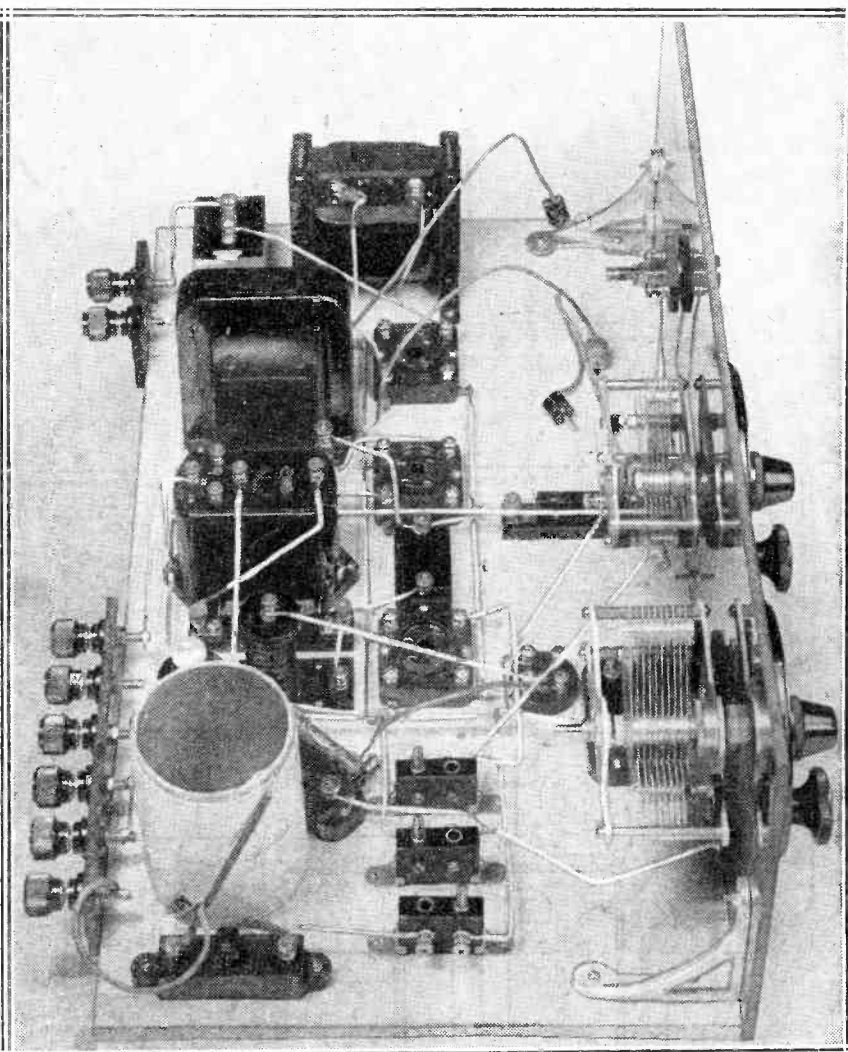

The spacing of the wave-trap coil and coil holders is extremely important. This photo gives a good general idea of the set.

The programme was held for between an hour and a half to two hours, the first portion being sponsored by the Maytag Washing Machine Co., and the second being a programme provided by "Yeast Foamers." On further evenings a

is necessary is to transfer the crocodile clip on the aerial to one of the tapings on the wave-trap, say, No. 30 as a start, and then tune-in the local station at best strength.

Now with a piece of wood cut at one end to the shape of a screw-driver,

The "S.M.L." Three—continued

and turn the knob of the adjusting condenser backwards and forwards until a point is found where the local station comes in at minimum strength. It will then be found that tuning of the set will be exceedingly sharp as far as the local station is concerned, and you will be able to tune-in a number of others quite close to it, which otherwise would be completely swamped by the strength of the local.

On the upper band the wave-trap will not be used normally, but it sometimes happens that the particu-

lar aerial coil used roughly tunes to a shorter wave station, and therefore the local station seems to come in over the long-wave band to quite a considerable extent. If this is the case, leave the wave-trap in and adjust it to get rid of this interfering station, but normally it will be out of circuit on the upper band.

Special Choke Unnecessary

Do not forget to pull the condenser switch OUT for normal working on the medium and upper band, and for

short-wave working push it in, unless the particular arrangement of coils requires more than the capacity referred to.

The particular circuit used does not seem to require a special short-wave H.F. choke, and any good normal band choke seems to function satisfactorily.

In conclusion I should like to add that I should be glad if readers who build this set will write and let me know how they get on and the results they obtain.

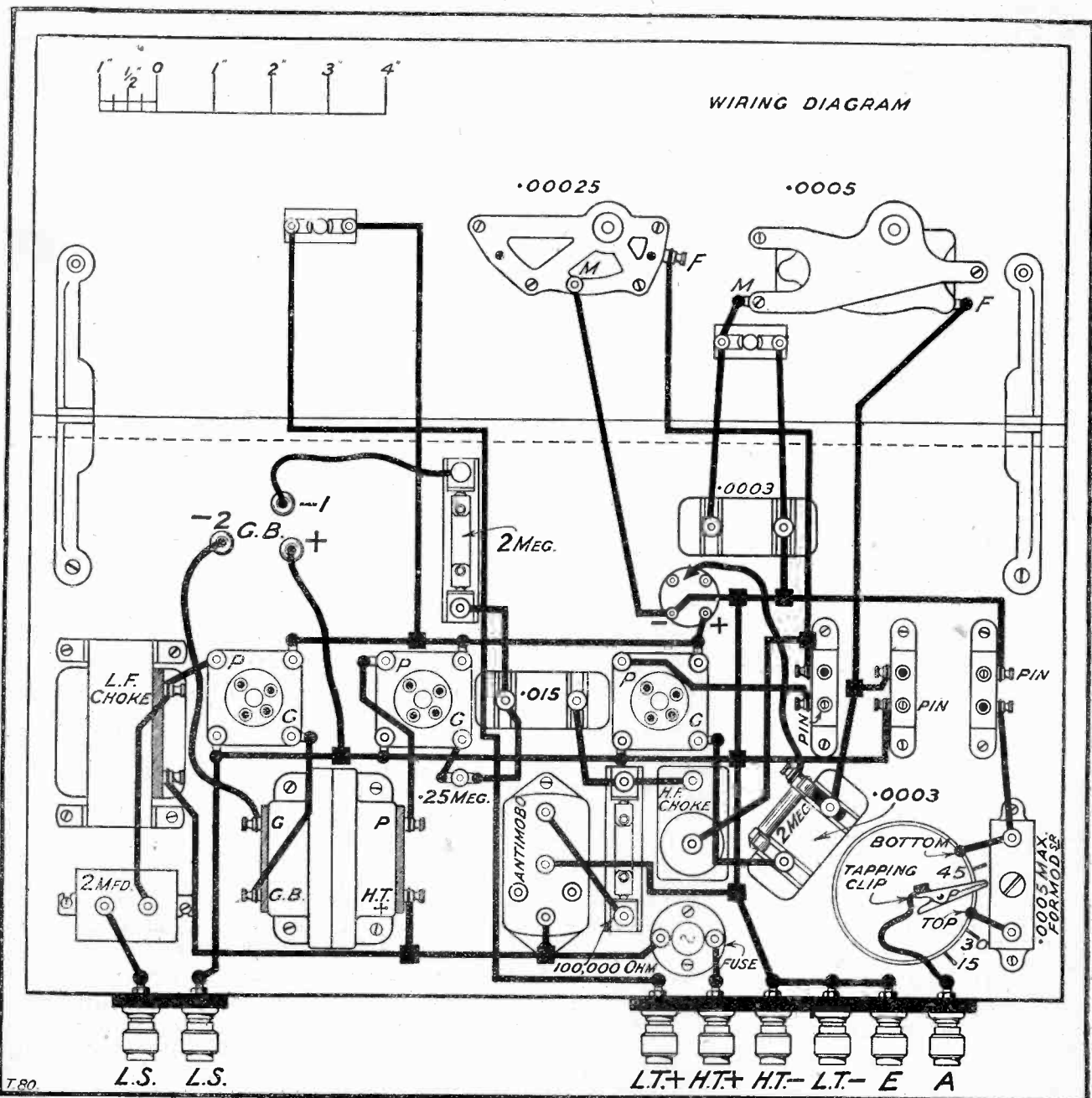

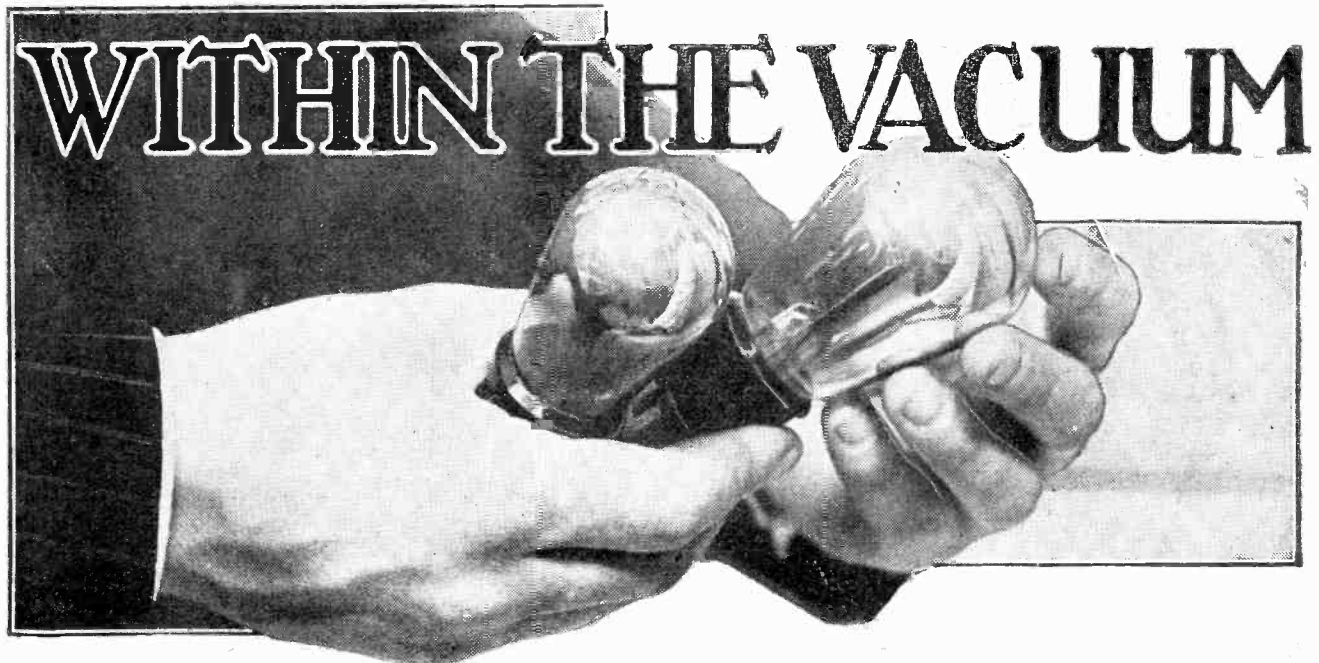

The pentode valve has come to stay, but its peculiar characteristics make it a somewhat difficult valve to use. The practical side of the pentode is discussed in this article.

By KEITH D. ROGERS.

THE five-electrode valve, more commonly known as the pentode, did not come into public prominence with the same fanfare of trumpets as did the screened-grid H.F. valve, but, nevertheless, it has during the last eight or nine months come very much to the forefront, and the question whether to use a pentode or not has at some time or another arisen for every home constructor.

That question—"Shall I use a pentode or not?"—is not an easy one to answer, unless one realises what are the advantages and what are the drawbacks of using such a valve as compared with the ordinary power valve.

An Output Valve

It must not be forgotten that the pentode valve is an output valve pure and simple. It *will* work as a detector, but it was for an output valve, in the place of a super-power valve, that it was really designed, and used as such it requires a little care if the best results are to be obtained from it.

The first thing to realise concerning the pentode valve is that it has a comparatively small grid swing, and so cannot be expected to take the place of a super-power valve in a multi-stage set; but used as the last valve following directly after a detector, or, better still, after a detector and one note-magnifier, the average pentode can be used with great success.

It is not, of course, a cheap valve, and one has to consider very carefully

the technical aspects before one decides whether one shall part with the 25s. for the ordinary pentode, or 27s. 6d. for the super-power type, or expend 15s. on a super-power valve. Incidentally, one also has to consider the type of loud speaker which will be used with the valve before one decides definitely whether it is worth while buying it.

I might say definitely that if you have a cone type loud speaker (or a horn type loud speaker for that matter) which will insist on em-

phasising the high notes, probably having a resonance peak round about the 2,000 or 3,000 range, and which will not bring out the low notes properly even with an ordinary super-power valve, then the pentode is *not* the valve to use.

In such a case, if you use the pentode *with an ordinary choke filter output circuit* the tendency of the loud speaker to emphasise the high notes will be still further noticeable, and the reproduction will be shrill and unnatural.

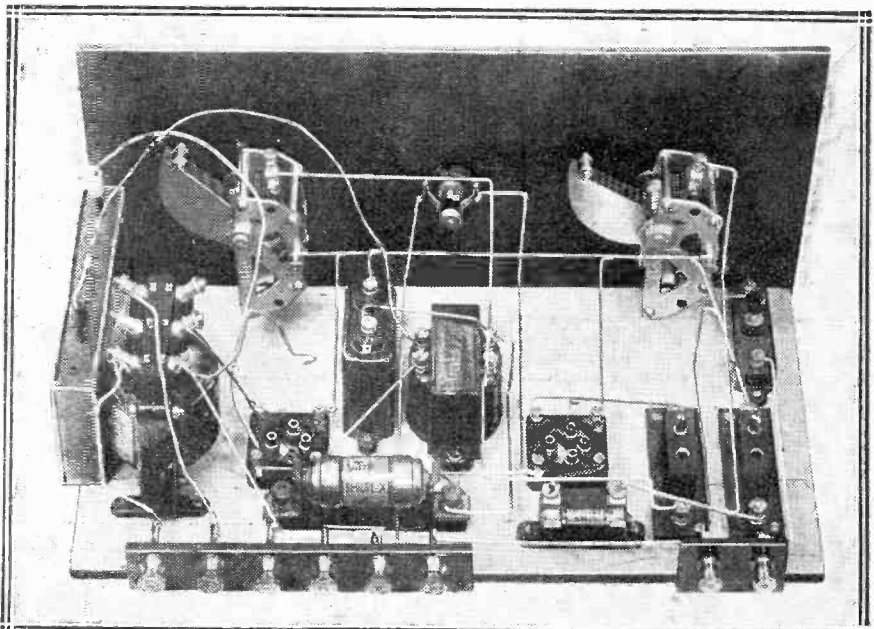

A short-wave set using a pentode for the output valve in order that maximum amplification shall be obtained.

Within the Vacuum—continued

If you have a special output transformer the results you get would be practically the same as those from the super-power valve, perhaps a little louder. You probably would not get any more bass, and the original tendency to emphasise the high notes will still be there.

On the other hand, if you have a loud speaker which gives adequate bass and which has no tendency to emphasise the high notes, then the pentode valve used with the ordinary output filter circuit, and *not* the output transformer specially designed for the pentode, may give you very fine reproduction.

With moving-coil speakers, provided they are not peaky on the higher notes, the pentode gives excellent reproduction when used with the ordinary filter circuit, as it gives a fairly straight response curve which it is difficult, if not impossible, to get with the ordinary output valve.

Power Transference

As you probably know, with the ordinary loud speaker, which is capable of giving quite good bass and quite a successful middle register, the lower the impedance of the output valve the more bass you get.

There is not room to go deeply into the whys and wherefores of this, but

that, although it is in a way working somewhat inefficiently, the power transference at the various frequencies is approximately the same.

The valve impedance does not vary with frequency, but the speaker impedance does, and as one gets higher power transference when the loud-speaker impedance equals that of the valve impedance, it is obvious that with an ordinary super-power valve the greatest transference of power is going to take place when the loud-speaker impedance is equal to that of the valve, say 3,000 ohms.

Important Considerations

As the impedance of the loud speaker increases, due to the increase in frequency as the notes get higher, while the valve impedance remains the same, so the power transference becomes less; but in the case of a pentode valve the valve impedance is always very much higher than that of the loud-speaker impedance, even on the highest notes of the musical scale, so that the power transference is practically equal over the whole of the musical range, although it might not be so great as that which would be obtained if the loud-speaker impedance became equal to that of the valve at any particular point.

The pentode does not give its true

current, though not really much more than the ordinary power valve and not so much as the super-power valve; and (3) it requires very careful grid biasing and does not carry a very big grid swing.

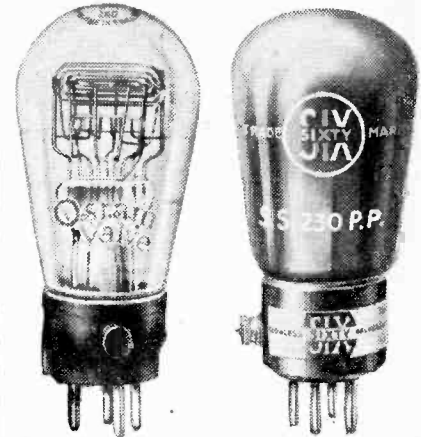

Two popular pentodes—the Osram and Six-Sixty two-volters.

Furthermore, you must also consider your speaker circuit, and remember that if the speaker tends to over-emphasise the high notes, the pentode will probably make matters worse; but if the speaker over-emphasises the bass or gives a fairly even response, then the pentode should be very valuable indeed.

It rests solely upon the characteristics of the speaker, for the pentode tends to give a rising characteristic towards the high notes.

When Not to Use It

The pentode should not be used indiscriminately and just to "give more punch." It may give "punch," but it is ten to one it will be distorted "punch" with hard top notes, unless you go carefully into the question of your speaker. If you have too much treble already, take the old advice and "don't."

The special output transformer tends to counteract the "extra treble" part of the business and to place the pentode on the same line as the ordinary valve as regards reproduction. With a filter circuit the "extra treble" does come into the question, and it is under such conditions—with moving-coil speakers or speakers lacking in high notes—that the pentode is at its highest value. It is undoubtedly a good valve, but it needs careful use, and is definitely not merely a "plug in and improve your set" valve.

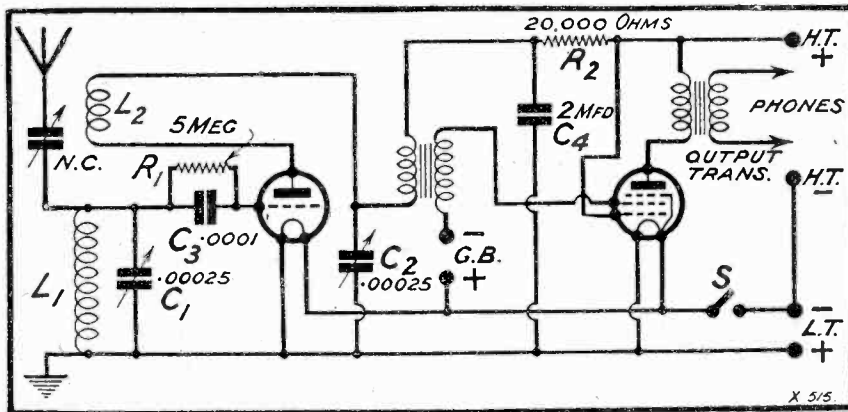

The use of a pentode in this circuit enables the highest amplification to be obtained, while the use of the output transformer enables the ordinary loud speaker to be used without any alteration in the response curve.

it boils down to the fact that within certain limits the lower the impedance of the valve the more the power transference from the valve to the loud speaker at the lower frequencies. Unfortunately, however, this power transference decreases at the higher frequencies.

In the case of the pentode the impedance of the valve itself is so high

magnification under such circumstances, but it gives quite sufficient magnification for all practical purposes, and very good reproduction can be obtained from it.

So before you decide whether you will have a pentode or not, do not forget (1) that the valve costs 25s., as against 15s. of the ordinary valve; (2) it takes a great amount of H.T.

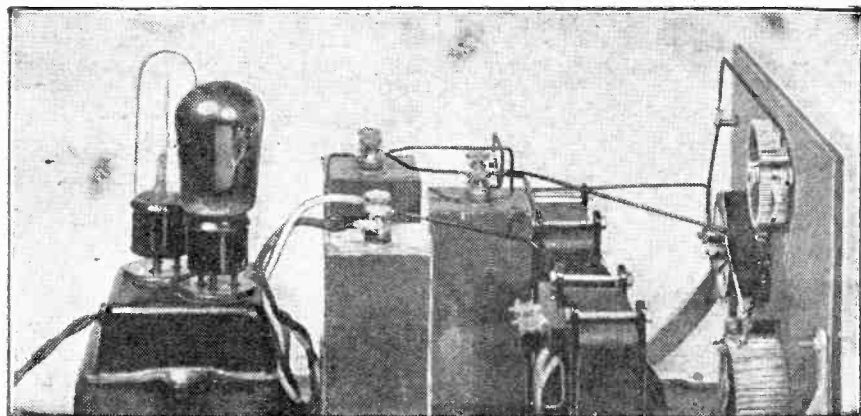

Controlling VOLUME

In this interesting article the pros and cons of controlling the strength of reproduction are discussed from a practical view-point.

By W. MAXWELL.

EXCEPT in the case of very small sets or sets which are a very long way from any powerful broadcasting station, some means of controlling the volume is required. In the case of sets with a single tuned circuit and when reaction is not required, it is possible to adjust the volume from a local station by simply detuning the set. This means, however, cannot be resorted to in other cases, as it would almost certainly result in distortion or interference from another transmission.

Although the volume can be altered by having a variable resistance in the filament circuit, this only applies in certain cases. To reduce the current in the filament of an L.F. valve below its correct rating will introduce distortion unless very small volume is required.

Potentiometer Control

Nowadays, a volume control usually takes the form of a potentiometer. It has three terminals, the two outside ones generally being connected to the two ends of the resistance.

The third and middle terminal being joined to the slider, which is arranged to run over the whole length of the resistance element. It is thus possible to make contact with any part of it, and therefore any potential between zero and the maximum voltage of the points across which the resistance is connected may be obtained from the slider.

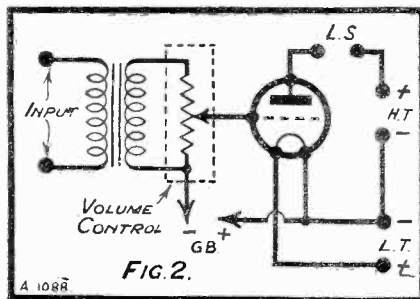

Using a volume control with a transformer.

The volume control is placed at different points in different circuits. It will be found, however, that it either takes the place of the grid leak in an R.C. unit or else is placed across the secondary of an L.F. transformer.

The best place for such a volume control is before the first L.F. valve. Obviously if it is placed between two L.F. stages it is possible for the first one to be overloaded when the volume is cut down so that the second

the arrangement is similar to an ordinary R.C. unit without a volume control in circuit. As the slider is moved towards the lower end the voltage passed on becomes less and less, until at the lower end of the resistance no signals whatever will be heard.

In Fig. 2 we show a single L.F. stage with a volume control across the secondary of the transformer. This arrangement could have been used

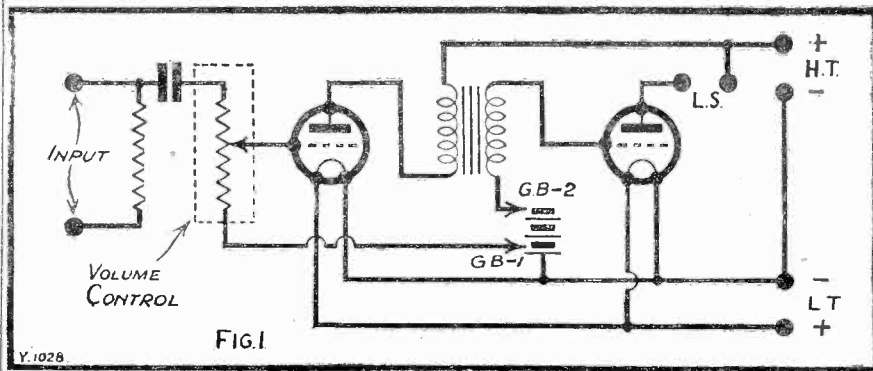

Here the volume control takes the place of the grid leak.

one is not overloaded. If the volume control is placed before the two L.F. valves it will be possible to avoid either of them being overloaded.

Of course, there are times when it is not possible to put the control before the first L.F. valve.

A Typical Example

In Fig. 1 a two-valve L.F. amplifier is shown. The first valve is R.C. coupled to the second transformer, which is the most usual arrangement. The volume control is connected in place of the grid leak. It will be seen that the total resistance is employed for the leak, the amount of volume passed on to the first L.F. valve being governed by the position of the slider on the resistance.

When the slider is at the top the whole of the voltage is passed on, and

in the previous case if necessary, but, as already pointed out, it is as well to have the volume regulator as early.

(Continued on next page.)

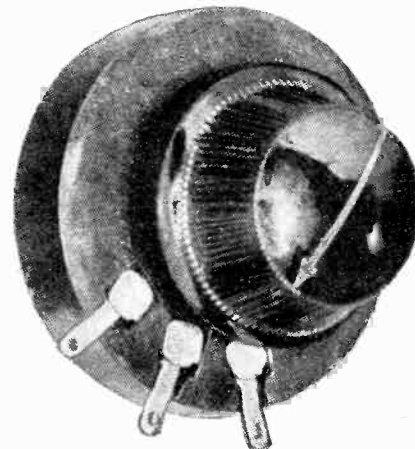

The usual type of volume control to which reference is made on this page.

* **TRADE JOTTINGS** *

Radio Pictures

FROM The Wireless Pictures (1928), Ltd., 14, Regent Street, London, S.W.1, comes the news that, following Prague and Budapest, other continental stations are rapidly acquiring Fultograph transmitters. Brussels, whose 10-kw. transmitter programmes are proving so easily receivable in this country, is one of the new Fultograph enthusiasts, while Rome, Madrid and Barcelona on the medium waves, and Hilversum and Radio-Paris on the long waves, are other newcomers to radio picture technique.

Judging, too, by the way in which these pictures are now being transmitted by the Fultograph process, it seems that this method may have great potentialities, like the system of telegraphy had when all the leading dailies decided to acquire their own installations and staff for the telegraphic exchange of news.

Music and Health

For some time past in the Middlesex Hospital in London the professors have been experimenting to discover the effect of music on human blood pressures. For this purpose an H.M.V. gramophone and wide variety of records were used, about 80 people in good health (many of them students) submitting themselves as subjects for the tests.

Even emotional and powerful music had no detrimental effect whatever, and in practically every

trial the results of music were beneficial. The professors noticed, and this is a tip for listeners, that the subject should remain comfortably seated for a few minutes before a record is turned on.

It looks as though music may become an important factor in the treatment of convalescing patients, for apart from the enjoyment resulting

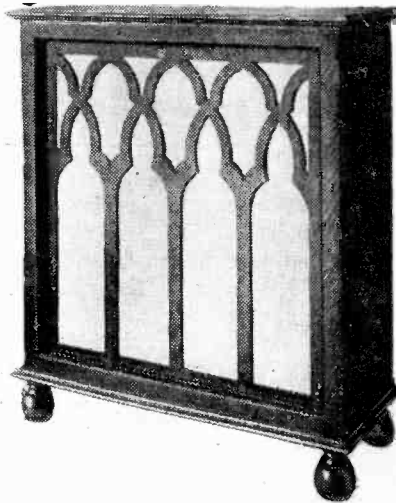

The Amplion "Lion" loud speaker, pedestal-cabinet type, is a de-luxe instrument of large size, capable of a very remarkable fidelity of reproduction.

from it, the professors of physiology consider music may have marked medicinal value.

Burne-Jones' New Products

Burne-Jones & Co., Ltd., of 296, Borough High Street, S.E.1, inform me that leaflets are now available dealing with the Magnagram all-electric reproducer (for A.C. or D.C. supply), the Magnum Universal Three receiver which operates on the ultra-

short waves of 15 metres up to 2,000 metres, and the Magnum portable. The latter is a five-valve receiver covering the wave-length ranges between 200 and 500 and 1,000 to 2,000 metres.

The Radio Show Poster

Parr's Advertising, Ltd., of Craven House, Kingsway, W.C.2, inform me that out of 500 entrants for the R.M.A. poster competition this year they secured second place. The idea of the poster was thought out by one member of the staff and illustrated by another, Mr. E. I. Fisher, to whom the second prize was awarded.

Ediswan Grid Leaks and Anode Resistances

Readers will probably remember that not long ago a substantial reduction was made in the prices of the above components. Originally sold at 2s. 6d., the price of both anode resistances and the grid leaks has been reduced to 1s. 6d. each. The former range in value from 20,000 to 250,000 ohms, and there are six values of grid leaks, viz., .5, 1, 2, 3, 4, and 5 megohms.

The Pye Portable

Readers who are toying with the idea of a portable set will be interested in the book of the Pye, which is obtainable from Pye Radio, Ltd., Paris House, Oxford Circus, London, W.1. An artistic little production, the book introduces the Pye portable and explains how demonstrations may be arranged for those who would like to hear this popular receiver in action. P.R.B.

in the circuit as convenient. In a two transformer-coupled amplifier the second stage would follow on the circuit shown.

The action of the volume control in the case of a transformer is the same as when it is used as a grid leak. The whole of the potentials from the transformer are dropped across the resistance element, and the amount passed on is controlled by the position of the slider.

Sometimes the volume is controlled with a transformer-coupled stage by connecting a variable resistance across the secondary and leaving the grid joined up in the usual way. As the resistance is decreased so the load on the secondary of the transformer is increased, with a consequent reduction in the strength of the results.

* **CONTROLLING VOLUME** *
* —continued from previous page *

There is a drawback to this method, however. When a resistance is connected across the secondary of an L.F. transformer the characteristics of the transformer are altered. If the resistance is sufficiently low to have much effect on volume it may alter the characteristics in an undesirable manner, thus introducing distortion.

Values to Use

The resistance of the average volume control is too high to have any appreciable effect on the transformer. The potentiometer for volume control should not have a resistance

of less than about 500,000 ohms, in the case of a transformer circuit. In the case of a resistance-coupled stage, its value must be near to that of the grid leak that it replaces. Usually a one or two megohms is quite suitable.

It was indicated at the beginning of this article that in certain circumstances volume could be controlled by means of the filaments. This applies when there is one or more stages of H.F. amplification. The adjustment of the filament voltage must be on the H.F. valve or valves only. Also it must not be carried too far, as it is possible to ruin dull-emitter valves by running them at too low a temperature, also it is just possible that distortion might be introduced.

CHATS AT THE WORK-TABLE

Many points of practical interest to amateurs and set constructors are dealt with under this heading.

By R. W. HALLOWS, M.A.

A Lighting Suggestion

BY some perverse fate it often happens that the only place for the wireless set in the living-room is either a dark corner or a position in which anyone operating the controls or exploring the interior of the cabinet must stand between the apparatus and the light.

If we strike matches when changing coils, replacing valves, or making small adjustments, concentration on the work in hand frequently results in burnt fingers and profanity. In theory it is perfectly sound to keep a flashlamp on the wireless table, so that it may be available for supplying the required illumination at need;

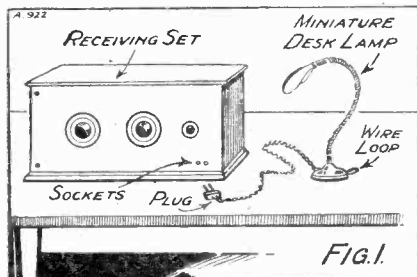

in practice the scheme does not work out as it should, owing to the way in which other members of the family borrow the flashlamp "just for a second" for purposes of their own, and invariably forget to return it to its proper place.

A satisfactory emergency light which will not burn one's fingers in moments of forgetfulness and will always be available when wanted would clearly be a boon to many wireless enthusiasts. Certainly, I have found it so on innumerable occasions and in innumerable ways. So far I have tried out two simple systems, each of which has proved its worth. As one may suit one set of circumstances and one another, I will describe them both. The reader can then pay his money and take his choice.

A Simple Method

A lighting system that is very simple to install is illustrated in Fig. 1.

The lamp is one of those of the miniature desk variety which can be bought at any electrical shop for three or four shillings.

It takes a standard flashlamp bulb, and the user can obtain bulbs requiring very little current to light them up suitable for 2, 4, or 6 volts, according to the accumulator used. The most satisfactory type of bulb is that requiring from .1 to .2 ampere, for with these very little is taken out of the accumulator even if the light is in use for long periods on end, as is very seldom the case in practice. The lamp should have a metal cowl shading the bulb, and the holder should have a ball-and-socket joint so that the light may be directed upwards or downwards at will.

Easily Fitted

The only other fittings necessary are a miniature wall plug with socket to match, and a short length of twin flex. One may, of course, fix the twin socket on to the panel in its original state, but a far neater job is made if the metal parts are removed from their original housing and are mounted flush with the panel.

Alternatively, a pair of Clix, Eastick, or Lisenin flush sockets may be used, the ends of the flex leads being provided with corresponding plugs. The sockets on the panel are, of course, connected to L.T. + and L.T. -; their presence is useful in another way, for it enables the voltage of the filament accumulator to be taken with a minimum of trouble.

The handiness of this kind of lamp will be readily appreciated. With it one can read the dials of slow-motion condensers to a hair's-breadth. Since the lamp is portable one can use it for inspecting accumulator and high-tension connections, provided, of course, that there is a sufficient length of flex.

But the time when one is most

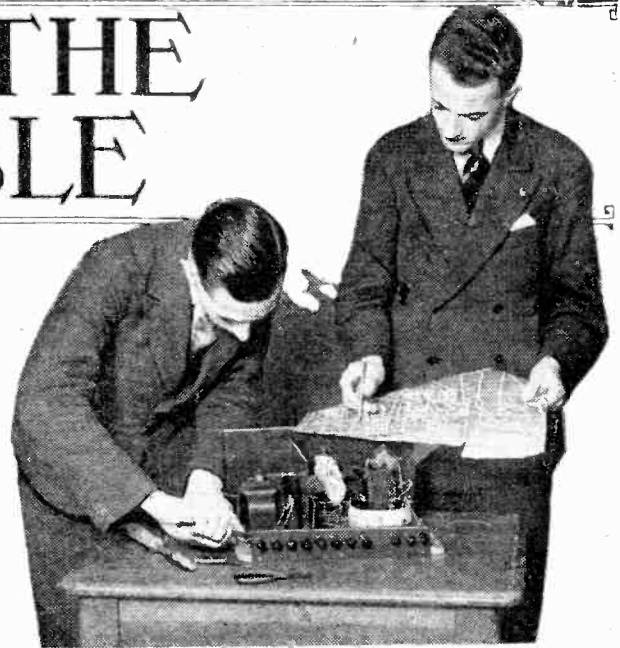

thankful that such an emergency light has been rigged up is when something requires attention inside the cabinet. Most of these desk lamps have a small loop of wire or sheet brass attached to the base, by means of this the lamp may be suspended horizontally so long as there is a screw for the loop to be hooked over and a flat surface for the base to bear against.

Two screws, one at the H.F. end and one at the L.F. end, may be driven into the underside of the lid of the cabinet. The lid having been fitted with a prop which will keep it fixed open in a more or less vertical position, the lamp enables every part of the contents of the cabinet to be

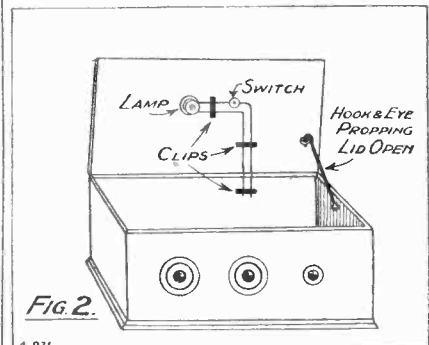

illuminated brilliantly. Such a prop is easily made: a swinging hook attached to the inside of one end of the cabinet and an eye screwed into the underside of the lid answer the purpose admirably.

Method No. 2

The alternative method of illumination is to fix a lampholder—

Chats at the Work-Table—continued

or two if the set is a big one—to the inside of the lid. With a small batten holder and a miniature switch a very neat job can be made. Care must, of course, be taken to mount both lamp and switch in positions where they are well clear of components within the cabinet when the lid is closed.

The leads, which should be of good rubber-covered flex, are fixed by means of wiring clips to the lid and to the inside of the back of the cabinet. The free end of each is fitted with a small plug; corresponding sockets, connected to the low-tension busbars, are mounted in any convenient position on the baseboard. It is necessary to use these plugs and sockets so that the set may be withdrawn from its cabinet when it is required to do so.

Interior illumination, which provides a simple job for the home constructor, has several advantages. There is no lamp on the table, simply asking to be knocked over, and no addition is entailed to those trailing outside leads which prompt the uninitiated at times to ask why it's called *wireless*.

If dials of the semi-transparent type are used there is no need to have a separate bulb for each; that inside the lid of the cabinet will give light enough for all. The system, though, lacks one good point that the first

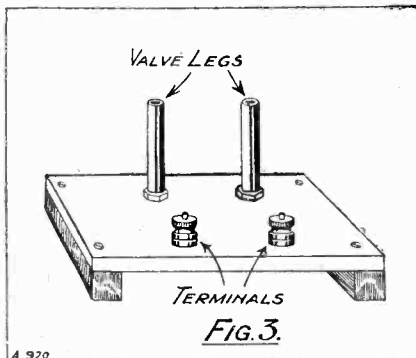

described possesses: the lamp is not portable, and cannot therefore be used to inspect outside connections.

Changing H.F. Chokes

I find it a very great advantage, both when experiments are in progress and for ordinary reception, to be able to change high-frequency chokes without going to all the trouble of disconnecting leads, unfixing one component, fixing a second in place, and remaking the connections.

A very simple arrangement makes all the chokes in my rather extensive stock interchangeable in a moment, and I can heartily recommend it to the reader. Instead of wiring a choke permanently into circuit I use a small holder like that illustrated in Fig. 3.

Quick Tests Made Easy

This consists of a piece of $\frac{1}{4}$ -in. ebonite $2\frac{1}{4}$ in. long by 1 in. wide, on which are mounted a pair of valve legs spaced 1 in. apart and a pair of small terminals. Each leg is connected to its terminal by a short piece of bare wire below the ebonite. Small wooden battens enable the shanks of terminals and valve legs to clear the baseboard. Each choke as it comes in is fitted with a mount, consisting of a small piece of $\frac{1}{4}$ -in. ebonite provided with two valve pins with the same spacing as the sockets of the holder.

Short lengths of single flex or of Glazite connect the terminals of the choke with the pins of the mount. The first and most obvious advantage of making chokes interchangeable is that one can be tried against another in the easiest way, the change-over being a matter of a second or two. For the experimenter, therefore, it is most handy.

If he has not time to fit a newly received choke with a mount at once he can attach to each terminal a piece of flex supplied with a valve pin. But there is more in it than just the comparison of chokes. In many sets nowadays, such as those employing parallel-feed H.F. coupling, two chokes are used, the second being used to enable capacity-controlled reaction effects to be obtained between the plate circuit and the grid circuit of the detector valve.

Finding Peak Effects

If two chokes of the same type are used it may be found that the reaction control lacks smoothness in certain places, since both tend to "peak" at the same frequency. It pays, therefore, to discover by trial which kind of choke allows the best amplification to be obtained in conjunction with the parallel-feed coupling, and then to make a further set of experiments to find which allows the smoothest control of reaction.

It may well be that the ideal combination for the short waves is not the same as that for the long. The

mount-and-holder method is useful also for other small components besides chokes.

Simple But Indispensable

There is one "tool" that I absolutely could not do without in wireless constructional and experimental work. That is an ordinary table knife with a blade of good quality steel—the old-fashioned steel, not the stainless variety.

The ideal knife for the purpose is an old one such as is to be found somewhere or other in most houses. The most likely place to come across a suitable implement is the kitchen drawer. If the knife has been discarded because its handle had come loose, have it rehatted with the

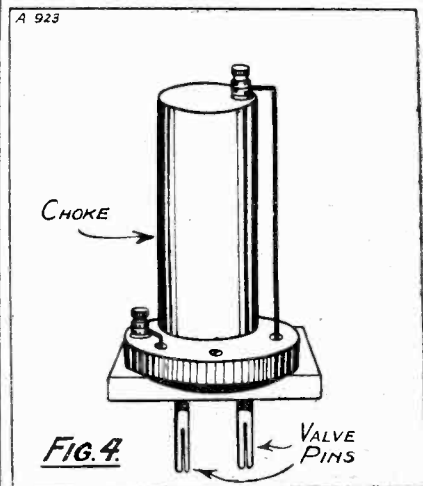

cheapest and stoutest form of handle, or fit the tang tightly into a file handle.

There are a thousand ways in which the old table knife proves its usefulness, so long as it is kept well sharpened. For this purpose I know of nothing better than one of the small knife sharpeners fitted with carborundum rollers which can be bought very cheaply at any ironmonger's. There is nothing like the table knife for sharpening pencils, for baring the ends of leads, or for taking out those little shavings from the holes in the backs of cabinets whose removal is often necessary to make terminal panels slide through as they should.

As an emergency chisel, as a scraper, as a trimmer of edges of wood or even of ebonite, the table knife is a tool beyond price. Add one to your equipment and it will not be long before you wonder how you ever managed to do without it.



A Pentode Transformer

Messrs. RADIO INSTRUMENTS, LTD., whose new Hypermu transformer was recently reviewed in our pages, have now produced an excellent output transformer specially designed for the

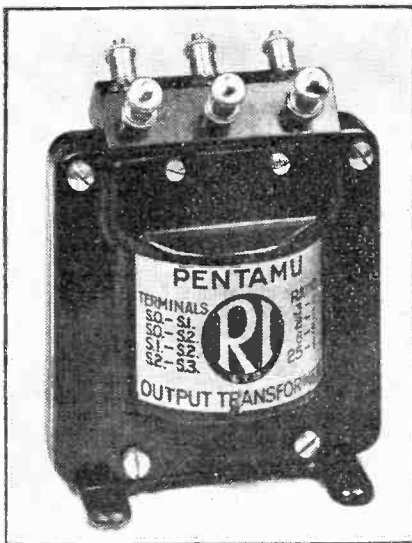

An output transformer specially designed for use with a pentode.

popular pentode valve. In order to get the best quality—or even, to our mind, any satisfactory quality—with a pentode valve, it is essential that a properly designed output device be used, and the ordinary output transformer designed for use with power and super-power valves is quite unsuitable.

The "Pentamu," being designed specially for use with a pentode valve, gives, as would be expected from the products of this well-known firm, a thoroughly satisfactory performance, and has the advantage that the output side of the transformer can be fed to any type of loud speaker by choosing the correct terminals.

Readers who are using a pentode set which does not include any output device are recommended to obtain a transformer of this type, when they will be surprised at the improvement in reproduction which occurs. A thoroughly well-made product which can be recommended for use in any set with a pentode valve.

Short-Wave Coils

Messrs. A. H. Clarke & Co., Ltd., of Manchester, have sent us a set of their "Atlas" short-wave coils for test and report. These have been found to be very efficient, and one method of using them will be found in the article describing the "S.M.L." Three in the current issue. A set of four coils is made, the cost of the set being 10s., and two sets are recommended to the short-wave enthusiast. The sizes are two, four, six and nine turns respectively, and in the standard type of circuit, such as that used in the "S.M.L." Three, two sets of these coils will cover all the requirements for waves from 15 to 100 metres. Thus from 15 to 25

metres the makers recommend a No. 2 in the aerial, 2 in the grid circuit and 4 for reaction. For the 20 to 50 band a 2 or 4 in the aerial, a 4 in the grid circuit, and a 4 or 6 in the reaction and so on.

OUR MONTHLY REVIEW OF TESTED APPARATUS

Note: All apparatus reviewed in this section each month has been tested in the Editor's private laboratory, under his personal supervision.

The coils are mounted on porcelain plugs, are wound with thick wire and well spaced by special separators which enable the spacing to be accurately maintained. The coils are certainly efficient and are recommended to short-wave enthusiasts.

It should be pointed out in passing that Messrs. Clarke still maintain a non-standard connection for their coils, for whereas practically all other makes are interchangeable in the reaction socket of a set using ordinary plug-in coils, the insertion of an "Atlas" coil in this socket will be

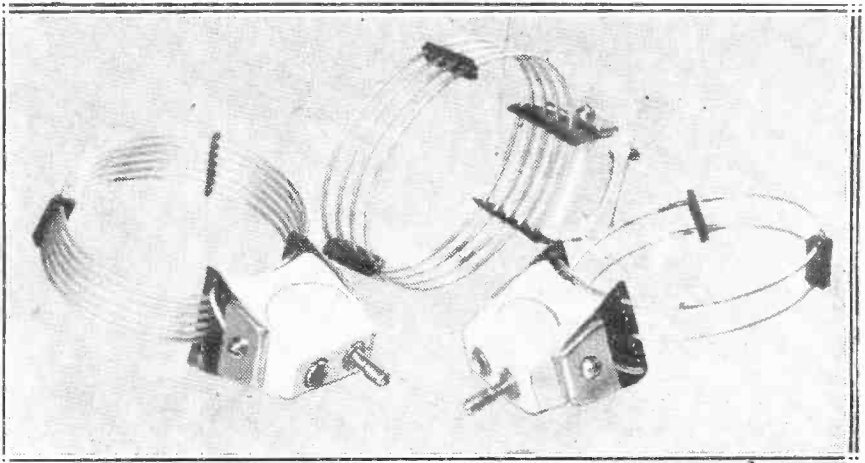

Some of the "Atlas" short-wave coils referred to above.

What's New—continued

found to result in a reversed reaction. Of course, if an "Atlas" coil is used in the grid as well as in the reaction socket correct reaction effects are obtained, but we do think that Messrs. Clarke might come into line with all the other manufacturers in this matter.

A Good Reaction Condenser

A well-known reaction condenser with a nominal maximum of .0001 mfd. and fitted with a more than usually good knob has been sent us for review by Messrs. Burne-Jones & Co., Ltd., makers of the Magnum components. The knob, which will be seen from the illustration is quite large, is a distinct advantage in such a condenser when fine control is needed, while the provision of a moulded pointer on the knob is also useful.

On test the minimum capacity was found to be of the very low figure of .000006 mfd. and a maximum of .000009 mfd. This latter is sufficiently near to the nominal rating for such a device, although we prefer any error of this kind to be on the other side.

Contact between terminals of the moving plates and the moving plates themselves is sound and smooth and the whole condenser is well finished. A special shaping of the moving plates enables a smooth increment of

capacity to be obtained at the lower end—an advantage not possessed by all makes of reaction condensers. This device can be recommended to our readers. The price is 4s.

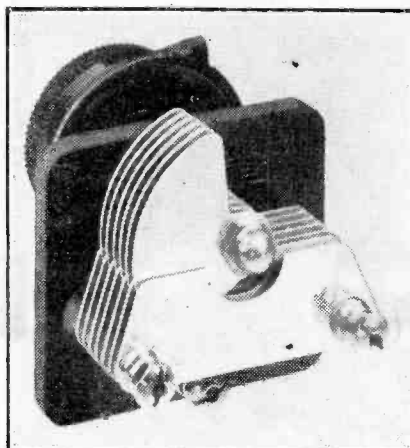

This "Magnum" reaction condenser is reviewed above.

Handy Wander Plugs

Messrs. Belling & Lee have sent us for review and test specimens of the Belling-Lee Indicating Wander Plugs, the appearance of which can be judged from the accompanying illustration. These wander plugs, which have well-designed and strongly-fitting split-pins, are easily attached without tools or soldering to any flexible wire and will grip both wire and frayed ends.

A wide variety of markings is given, including such very useful indications as Pentode Grid, Screened Grid, 1, 2, etc., while, of course, the usual grid bias and H.T. markings are provided. In the laboratory we have found them very useful, as the ease with which each particular lead can be identified without tracing it back to its particular terminal is no small advantage where a large number of circuits have to be tested and many experiments conducted.

Useful Wave-Change Switch

The development of wave-change switching has brought forth the need not merely for single switching, but for double or inter-connected switches, so that the change-over for two or more separate and distinct stages can be carried out by one movement. Messrs. Wright & Weaire have recently sent us the well-made and ingenious switch illustrated in the accompanying photograph, which certainly fills a definite need.

Two of their well-known anti-capacity double-pole double-throw switches are joined by an extension piece which can be connected in a moment for mounting, and it is thus a very simple matter to mount one of the switches inside a screening box and the other in the preceding stage.

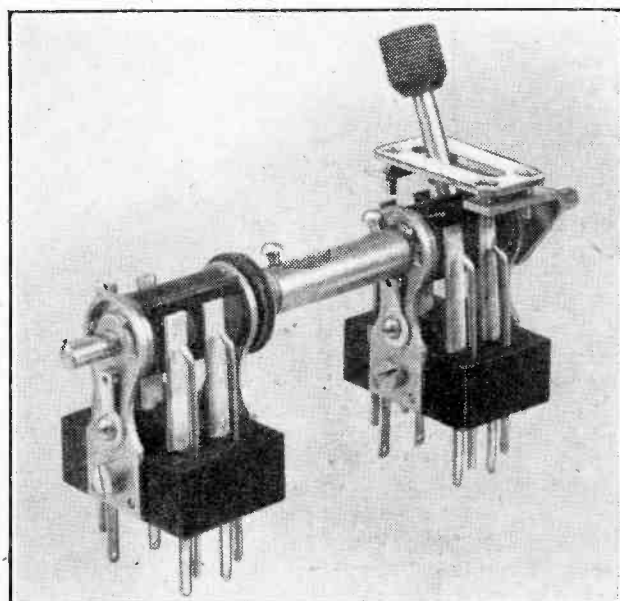
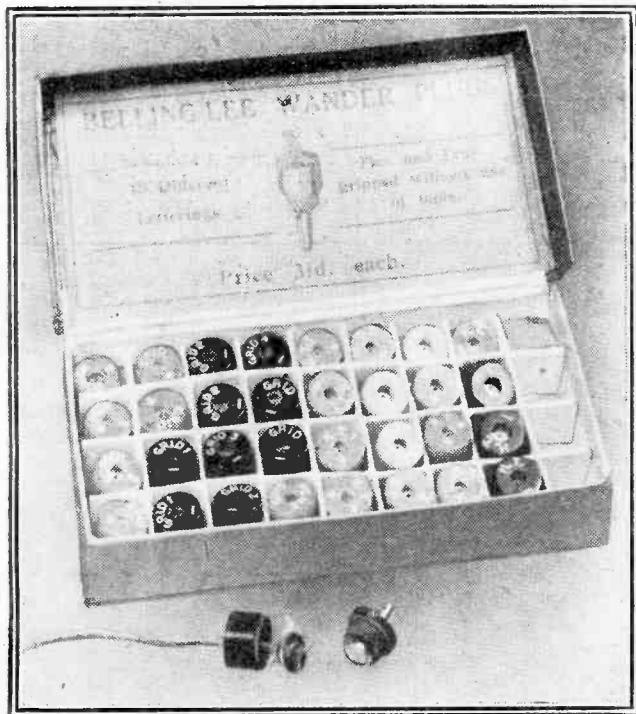

The Belling-Lee wander plugs are shown to the left, whilst the photograph above illustrates the "Wearite" inter-connected switches.

What's New—continued

The switch in the screened stage can be mounted by the one-hole-fixing method on the side of the screen itself, with the spindle extending through the screen for connection to the link already mentioned. While a pair of switches are shown in the illustration, obviously any number

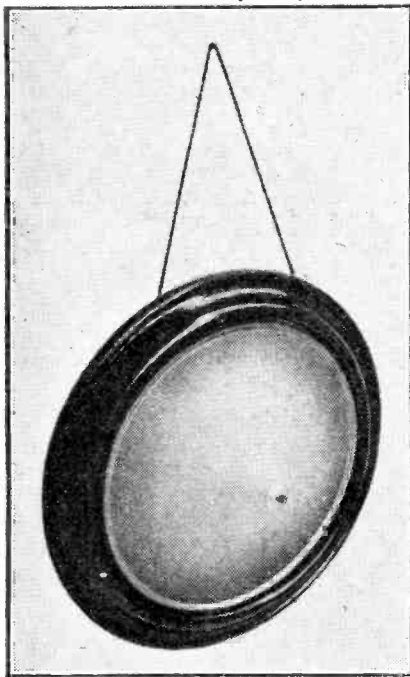

The Amplion Guinea Cone.

could be joined in series by means of similar links, and all controlled by one switch. It is a very well-made product and can be recommended.

Handsome Wall Cone

The new Amplion Guinea Cone, an illustration of which appears herewith, represents perhaps the most remark-

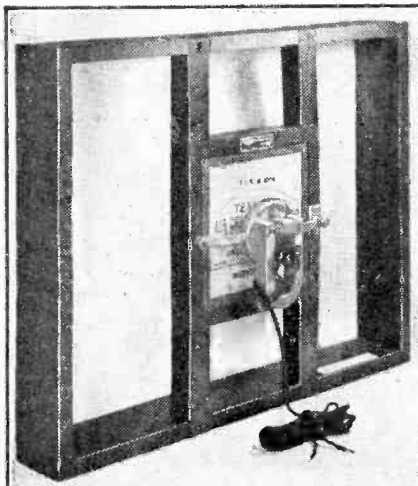

The back of the Air-Chrome loud speaker.

able value in loud speakers which has yet come to our attention. Considerable ingenuity has been displayed in the design of this speaker, and both appearance and performance are excellent. The rim and framework of the speaker are in moulded bakelite of a pleasing mottled brown finish, giving the impression of polished walnut, while the cone itself is of stiff fabric, spray finish, in graduated bronze.

The cone itself is attached at its edge to a strip of what appears to be felt, and this is supported lightly on the bakelite rim. The driving unit, supported by three screws on the central portion of the bakelite framework, is adjustable by means of a knurled knob, and substantial terminals are fitted together with a silk cord for hanging to a wall-hook. Reproduction with this cone is of a pleasing quality, even if a little deficient in bass; the sensitivity is good, and there is nothing in any way cheap about its appearance. It is no exaggeration to say that this guinea cone represents marvellously good value, and can be recommended to all who require an inexpensive loud speaker.

The Latest in Speakers

A loud speaker of more than usual interest is the Ultra Air-Chrome, which has been submitted to us for test and report by the makers, The Ultra Electric Co., Ltd., of Harrow Road, N.W. This company has acquired the rights for England of the Air-Chrome loud speaker, which has already established for itself an excellent reputation in the United States.

It is made in three sizes, the second of which is illustrated here, and consists of two specially doped linen diaphragms brought together in the centre, the front diaphragm being much larger than the back, the combination of different sized diaphragms enabling an excellent frequency response to be obtained. The driving unit is a special and very well-made balanced-armature movement, and the speaker has been designed as a whole to give a uniform response curve over a very wide band of frequencies.

On test the speaker certainly gives a remarkable performance, and in the 18 in. by 23 in. model (that illustrated is the 14 in. by 14 in.) labora-

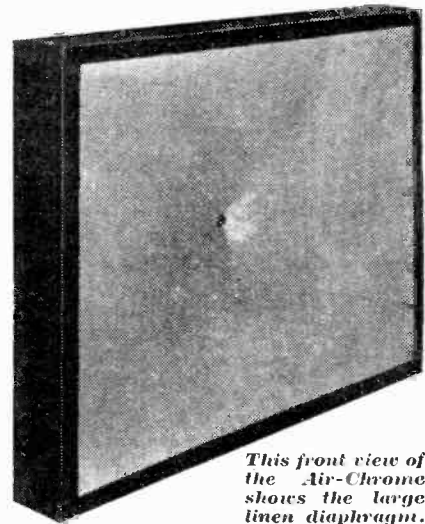

This front view of the Air-Chrome shows the large linen diaphragm.

tory tests showed that the genuine low-tone response was definitely better than that of any speaker other than the best moving coils we have tested. It is thus, as far as low-tone reproduction is concerned, in what may be termed the "moving-coil class," but it differs from the latter speaker in having a more uniform

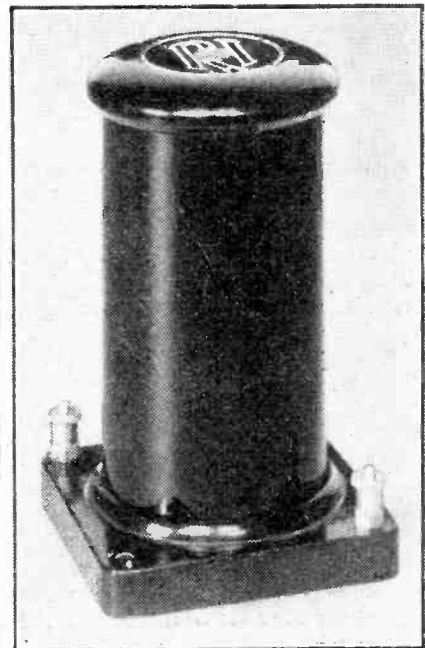

The R.F. choke is specially designed for choke-coupling efficiency.

response in the upper frequencies, whilst its sensitivity is extremely good.

To get the best results some form of baffle is required, and in our own case we had made up a kind of open-back box with 8 in. sides, into which

(Continued on page 300.)

RADIOGRAMPHONICS

Pick-up Arms—Suitable Loud Speakers—"Signal Strength"—Earth Connections—Volume Control.

By A. JOHNSON-RANDALL



It is becoming a more and more common practice for manufacturers of gramophone pick-ups to sell them with special tone-arms. At first it may appear that there is no advantage in having an extra tone-arm, and that the money spent on one is really wasted. This, however, is not so, and there are two reasons why such a fitting is desirable.

The first of these concerns the question of correct tracking. On a gramophone the tone-arm is of such a length, and in such a position, that with the maker's sound-box the needle is always as nearly in the proper track as possible. Therefore when the sound-box is replaced by a pick-up, unless the needle happens to fall in exactly the same place relatively to the tone-arm as it does with the sound-box, tracking will not be so good.

Changing Over

The special tone-arm is arranged to suit the pick-up with which it is sold, so that with it tracking will be as nearly correct as it can be made. The second advantage of another tone-arm is one of convenience.

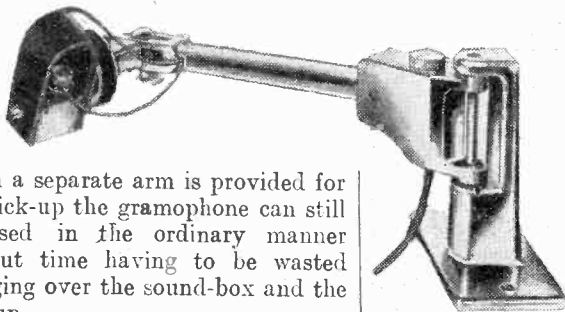

When a separate arm is provided for the pick-up the gramophone can still be used in the ordinary manner without time having to be wasted changing over the sound-box and the pick-up.

Suitable Loud Speakers

Although a great deal of time and a lot of thought is often spent on the choice of a suitable set for pick-up work, the question of the best type of loud speaker very seldom receives much attention. Actually, the loud speaker is just as vital a part of the installation and needs as

much consideration if good results are to be obtained.

A loud speaker which responds to at least as large a range of frequencies as the gramophone is necessary. Therefore the use of an ordinary horn type loud speaker is not desirable, as good modern gramophones are far ahead of such instruments as regards frequency response. Therefore we must choose either one of the modern cone loud speakers or a moving-coil speaker.

Radio-Gram Amplifiers

The latter is always more desirable if a suitable set is available for it, but unless the amplifier is especially suitable for this type of speaker, just as good, if not better, reproduction will probably be obtained with an ordinary cone speaker.

The question of the volume desired for a given set of conditions can be very deceiving. Volume may seem ample in an empty room, but if a large number of people are to listen

** * **
Special supporting arms, which are obtainable for many of the gramophone pick-ups on the market, have amongst their advantages that of convenience when making pick-up connections, and also of good tracking.
** * **

at the same time, you may be very disappointed at the apparent weak results. This fact is well brought home by the "talkies," where the volume is altered as the theatre is filled, the difference between the power in use when a full house is present and when only a moderate audience is attending being very surprising.

In a similar way you will want much more volume if the loud speaker is in a room with thick carpets and a lot of furniture than if the room is sparsely furnished and has only small rugs on the floor.

Using an Earth

When the L.F. stages of a wireless set are employed for pick-up work the earth is left in place and the batteries and their associated wiring are always at earth potential. In the case of a special gramophone amplifier it is not usual to provide an earth connection to the L.T., and consequently it is possible for the batteries and many of the leads to be at a potential above earth, which may account for a whistle or other trouble caused by L.F. instability.

A Safety Condenser

Should such noises be experienced, it is therefore worth while experimenting with a good earth connection joined to the negative of the L.T. battery. When the amplifier is being used with an eliminator it is necessary to connect a 2-mfd. fixed condenser in series with the earth lead in the same way as it is necessary with a receiver.

Volume Control

A volume control is generally necessary with an amplifier for all pick-up work. Unlike receiving broadcasting there is no reaction condenser to adjust volume, nor is the possibility of detuning present. Therefore a volume control is the only means we have of preventing the L.F. valves from being overloaded, or of lessening the volume when it is too great. The latter is often necessary with good pick-ups, as they are very sensitive.

TRANSMISSION and RECEPTION ON TEN METRES

BY
W.L.S.

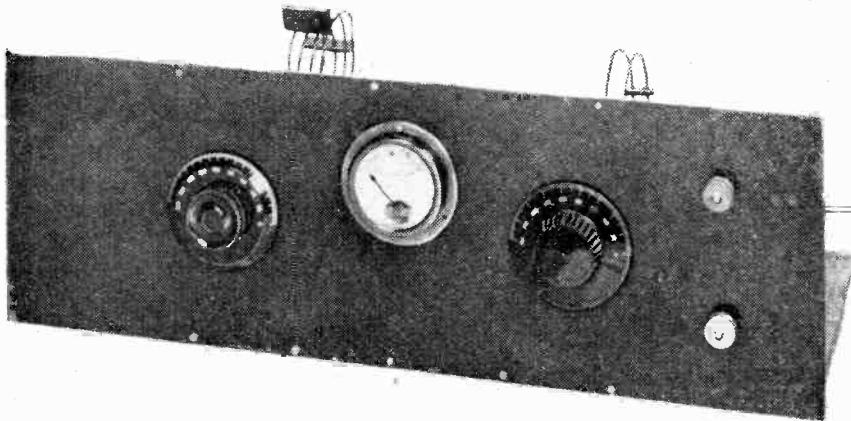

Some invaluable information is given, and some fascinating experiences are recounted, by a well-known expert.

UNTIL the last year or so, no wave-length much below 18 metres or so had ever been tackled for transmission purposes, either for commercial or amateur uses, with the exception of that of about 8 metres, which had received a certain amount of attention on the part of a small and enthusiastic band of amateurs.

ness, this band will accommodate nine times as many stations without interference as the more used band from 41.35 to 42.53 metres. Speaking in terms of frequency, the band is 1,800 kilocycles in width; it will therefore accommodate 180 stations 10 kilocycles apart, at which spacing they will not interfere with each other.

length, the communication in most cases being more reliable than is usual on any other wave-length with equal power. In addition, G 5 M L (Coventry) has been in touch with V T 2 K T (India), and a South African station has been in frequent communication with the States. Probably by the time this appears in print the Antipodes will have been worked. That in itself should be enough to stir up some enthusiasm. Personally, I have no doubt whatever that 10 metres or thereabouts is a potential home for several broadcasting stations!

"D.X." on Ten Metres

"Ten metres," also speaking with frequency in mind, is sufficiently removed from "8 metres" to behave in quite a different way.

As was natural, until a few bold spirits had done some pioneering work the band was overlooked, and no one seemed to think that it even had possibilities. When three or four stations had been patient and energetic enough to show that it was an excellent wave in many ways, a huge amount of interest was immediately taken, and tests followed by varying amounts of success were carried out.

The position at present is that about fifteen British stations have worked across the Atlantic on this wave-

An Experimental Transmitter

The low-power transmitter seen in the photographs accompanying this article is one of many that I have made up for test purposes, and is described chiefly on account of its extreme simplicity. The circuit is absolutely conventional in every way, the layout quite ordinary, and except for the de-basing of the valve no special precautions seem to have been taken in the construction of the set.

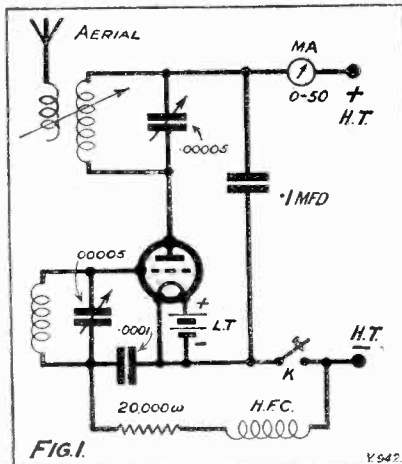

With the new wave-lengths enforced by the Washington Conference, under which amateurs are allowed the use of a new band in the neighbourhood of 10 metres, however, matters were considerably altered, and during the last few months startling developments have taken place, with the result that it now seems quite likely that waves of this order will be in great demand in the future, both for long-distance work and for more local experiments.

Not Really Narrow

The actual band allowed for use by amateurs in this country is from 10.03 metres to 10.67 metres, and, in spite of its apparent narrow-

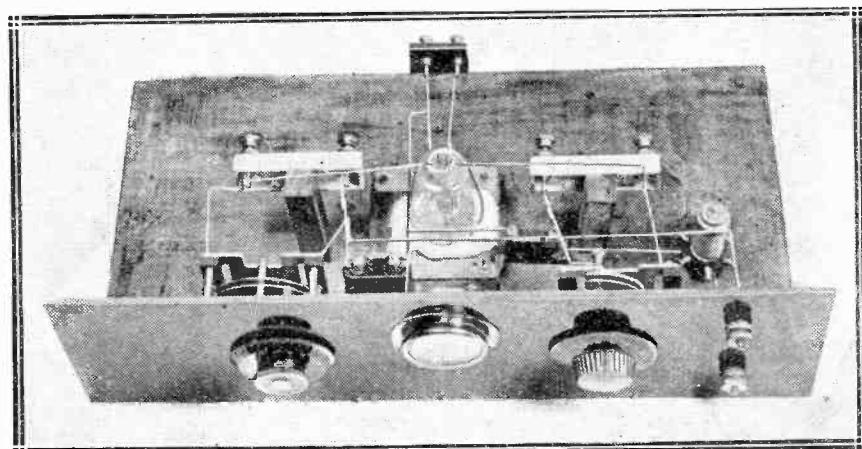

The low-power transmitter made up by W. L. S. for test purposes. A front-of-panel view is given above in the heading.

Transmission and Reception on Ten Metres—*continued*

The circuit is the well-known Armstrong or "tuned-plate tuned-grid" arrangement, which is made to oscillate by tuning the two circuits to resonance, feedback taking place by way of the internal capacity of the valve.

This circuit gives quite high efficiency, is very easy to operate, lends itself to a neat layout, and is used chiefly for the reason that I am more used to handling this than any other, and that in itself would be a point in favour of this as compared with a strange circuit. The diagram in Fig. 1 shows the actual arrangement, complete with values.

Condensers and Coils

The variable condensers are of a well-known make, and are simply two ordinary receiving condensers "stripped" until only two fixed and two moving plates remain. These are double-spaced. The effective capacity of the final arrangement is about .00005 mfd.

The mounting for the two coils consist, as the reader will probably have noticed, of two bases from old single-pole double-throw switches, with terminals mounted at each end. This makes a very convenient arrangement for quick changing of coils, etc., and the transmitter, although designed primarily for 10-metre work, is therefore suitable for practically any other wave-band. The condensers, being so small, necessitate careful choice of

the right size of coil, however, and this may be rather a disadvantage.

The valve actually used was an L.S.5, the base being removed by means of methylated spirits. Probably no great benefit was derived from doing this, but I had been warned that all sorts of dreadful things would

happen in any case if I attempted to overload an L.S.5 on 10 metres, so that I thought the loss of the valve was inevitable in any case!

as one would expect, is taken right round "behind the key" to the actual H.T.—terminal. This forms a rather good method of keying powers of this order. If the key is connected directly in the negative high-tension lead, heavy sparking and bad clicks somewhat mar the transmission (and the neighbours' receivers). With this arrangement, when the key is up the grid receives a high negative bias by way of the grid leak. Keying is, therefore, clean-cut and altogether better than when the more usual method is used.

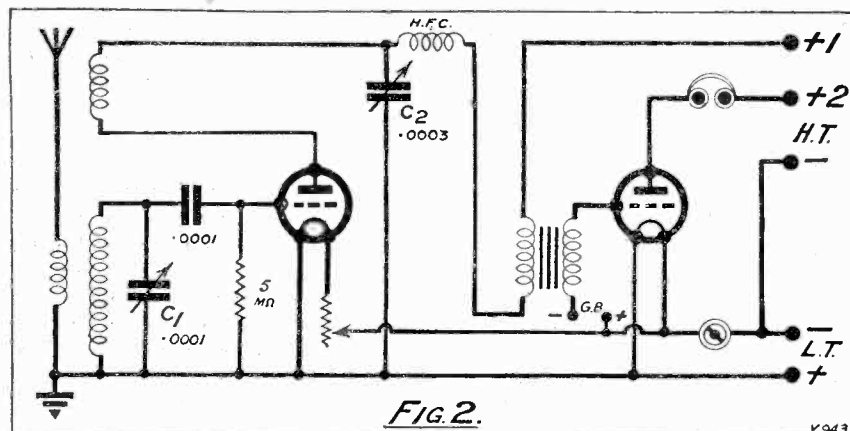

FIG. 2.

V943

happen in any case if I attempted to overload an L.S.5 on 10 metres, so that I thought the loss of the valve was inevitable in any case!

Avoiding Key-Clicks

Several valves have recently cracked across the "pinch" where the grid and plate leads are taken out rather close to each other, and I understand that the manufacturers have been warning transmitters that they will not accept responsibility for any valves that are treated in this

as one would expect, is taken right round "behind the key" to the actual H.T.—terminal. This forms a rather good method of keying powers of this order. If the key is connected directly in the negative high-tension lead, heavy sparking and bad clicks somewhat mar the transmission (and the neighbours' receivers). With this arrangement, when the key is up the grid receives a high negative bias by way of the grid leak. Keying is, therefore, clean-cut and altogether better than when the more usual method is used.

Not Difficult to Build

It will be seen that the coils are getting very small by the time one reaches 10 metres. The anode coil is of four turns (3 in. diameter) and the grid coil only two. I was wondering whether I should ever succeed in producing a workable five-metre transmitter with so conventional a layout as this, but it seems that the coils would be the limiting factor in that case! The internal capacities of the valve, with an inch of wire to supply some inductance, would probably tune to a wave-length higher than that on which one wanted to work!

The fact remains, however, that it is preferably practicable to make such a transmitter as this for 10-metre work without introducing any serious deviations from standard practice,

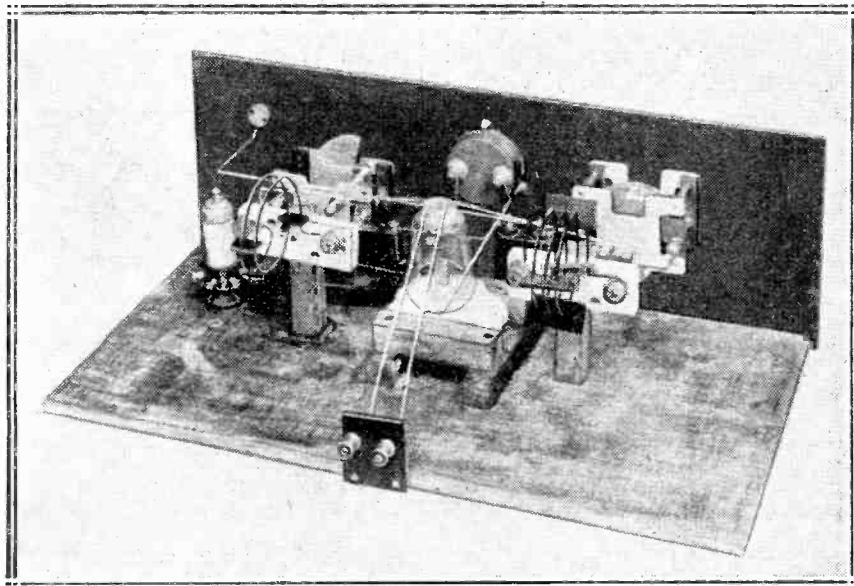

Another view of the ten-metre transmitter used by "W.L.S."

Transmission and Reception on Ten Metres—*continued*

and this in itself seems to indicate that the wave-length in question is a "tameable" one and will ultimately prove useful in many ways.

With a plate voltage of 250, and the aerial neither connected nor coupled to the set, the input to the L.S.5 is about $2\frac{1}{2}$ watts. This rises to something in the neighbourhood of 8 watts when the aerial is connected and tuned to resonance. In my particular case an aerial exactly 10 metres long is used and tapped directly on to the anode coil, about one-third of the distance up from the H.T. end.

The Receiving End

There is room for plenty of experimental work on the reception side on 10 metres, and the shorter wave-lengths still, and it is to be hoped that readers will show an interest in this particular side of short-wave reception and make their success known either to the Editor or to myself, since every little fact helps to build up a really sound knowledge of the peculiarities of a new field such as this. Here again there is no particular need to be unconventional. Standard receiver circuits and layouts function quite well if reasonable care is taken, although the variable condensers naturally need to be very small indeed if one is to "hold" a station once it has been tuned in.

The coils I have always used in the receiver are of 2 in. diameter, wound with No. 20 D.C.C., and the grid coil consists of two turns, and the reaction of one and a half! Probably two turns for each would be quite satisfactory, although I have met several cases in which cramped layout, etc., has necessitated cutting the grid coil down to one turn.

The usual throttle-control circuit, shown in Fig. 2, is my own particular favourite, and may always be relied upon to give good signals, smooth reaction control and (usually) absence of "threshold howl."

Slow-Motion Dials

A good slow-motion dial on the tuning condenser C_1 is an absolute essential, and, in my experience, one cannot decide upon a good one without first trying it. Two or three particular makes of dial that have always given me complete satisfaction on the broadcast wave-lengths emit the most appalling noises on 10 metres, while

others are perfectly quiet, for no apparent reason.

With this circuit, since the moving plates of both condensers may be

Incidentally, if you "double-space" a condenser or strip some plates off to bring it down to a useful size for the receiver, see that you arrange it

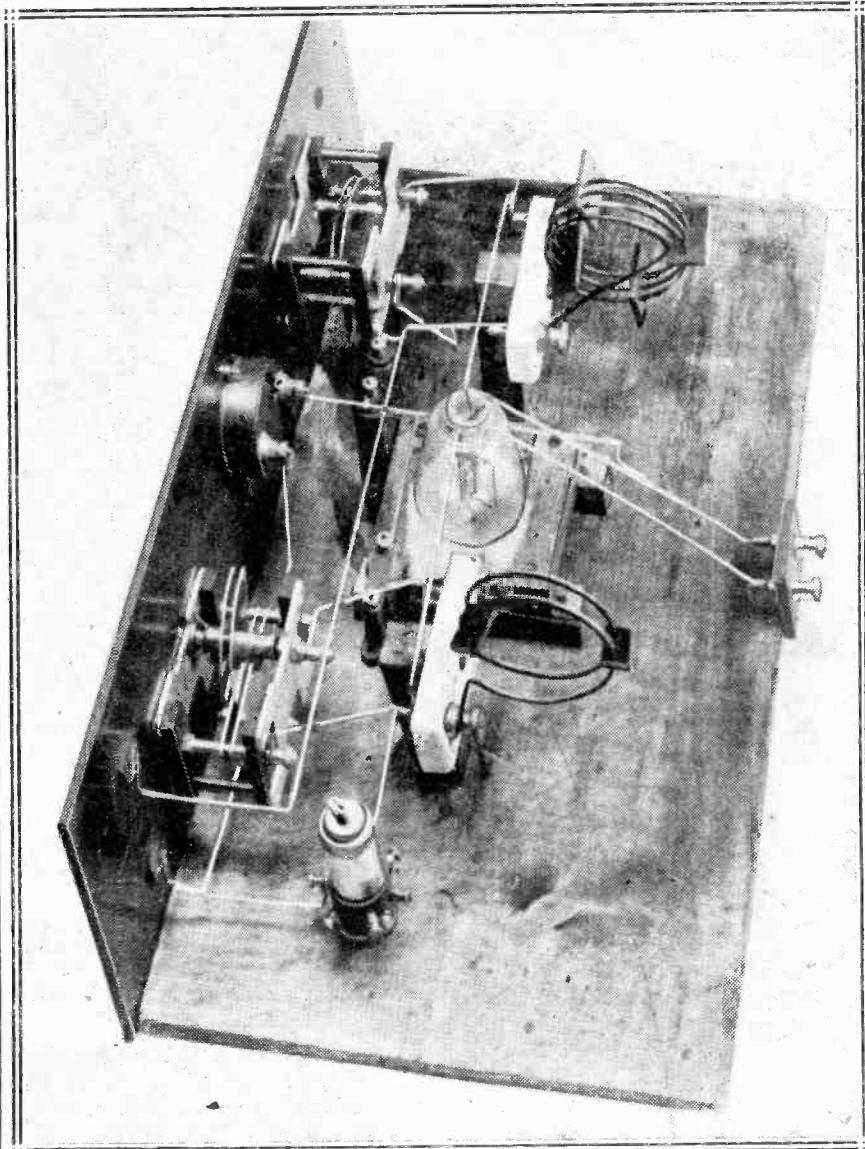

A photo which very clearly shows the construction of the ten-metre transmitter.

connected to earth, there should be no need to use a metal screen behind the panel, or any similar device, to avoid hand-capacity effects. I have not even troubled myself to earth the metal part of the slow-motion dial. The set is perfectly free from capacity effects without even taking this precaution! In some cases, doubtless where the reader has a long earth lead or is unfortunately situated in some other way, this sort of thing will not do, but at all events, there is no need to use long extension handles or anything of that kind.

so that there is a moving plate nearest the panel. This will then act as a small shield between the hand and the nearest fixed plate, particularly when one is nearing the "all-in" position.

Condensers, too, can be very noisy on these high frequencies, and it is practically useless to attempt to tune a station in if it is at all weak and if the variable condenser produces loud scratching noises when it is rotated. A pigtail with a soldered connection is an absolute *sine qua non*, but luckily is easy to fit if the condenser is not already so provided.

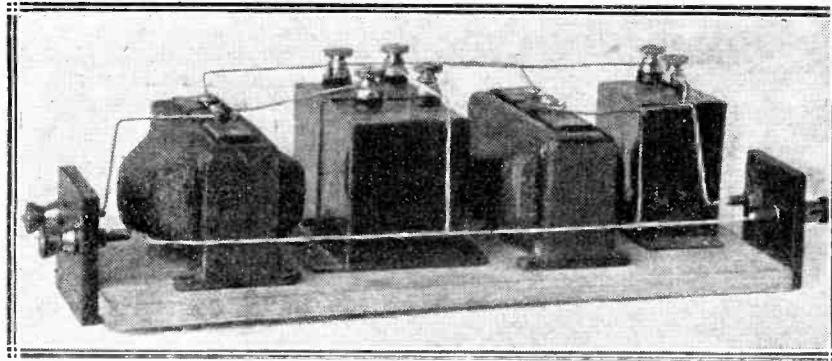

A UNIVERSAL FILTER

Details of a simple but useful home-made smoothing unit.

By L. H. THOMAS

THE little filter unit described herewith, and seen in the photographs, is really the result of an attempt by the writer to make one article do two jobs! It was required to operate a low-power

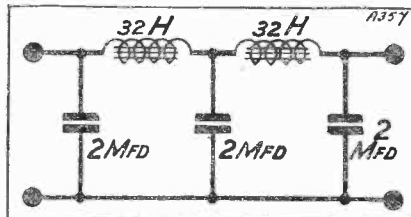

transmitter and a large broadcast receiver from the mains, not together, but alternately, and, all the usual smoothing apparatus being in use in other directions, it was decided that the only thing to do was to use a common filter for the two.

The filter described worked so well at loads rather larger than the average broadcast receiver would ever require that a few words of description may not be out of place.

Only Three Condensers

It will be seen from the sketches of the circuit and the wiring that the only condensers incorporated are three 2-mfd. "Mansbridge" type condensers of the 400 working volts variety. These were not at first

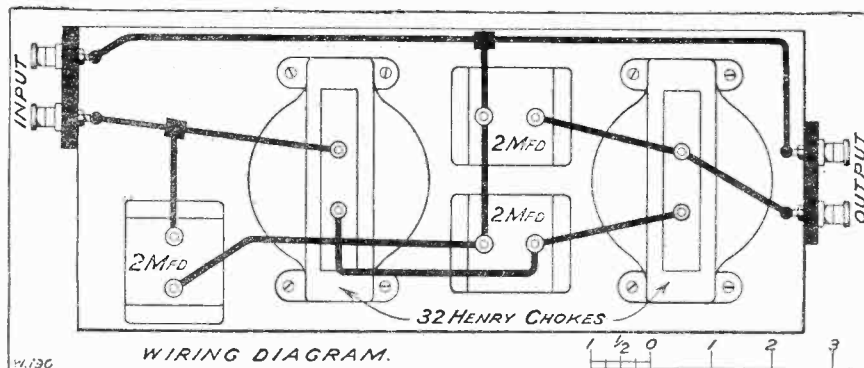

intended to be the only condensers in the whole unit, as an extra 2 or 4 mfd. may be added externally

across the "output" terminals, or, which comes to the same thing, across the H.T. terminals of the receiver.

No A.C. Hum

In practice, however, it was very seldom found necessary to do this. At a load of 20 milliamperes at 250 volts no A.C. hum whatever was noticeable on a loud speaker in the anode circuit of a three-valve receiver.

Of course, the full voltage was applied only to the final stage, the

COMPONENTS REQUIRED

- 2 32-henry chokes (Pye in original. Any equivalent type of good make).
- 3 2-mfd. condensers, 400 working-volt (D.C.) type (T.C.C. in original. Any standard make, Dubilier, Hydra, etc.)
- Baseboard, about 12 in. x 5 in.
- 2 2-terminal strips.
- Wood screws and wire.

very slight ripple will give a sharp quality to the note which is a distinct improvement for long-distance work. An ideal note was obtained with just

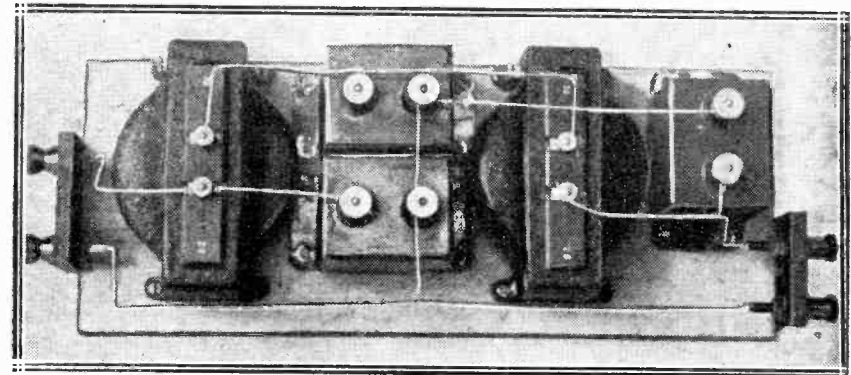

Three 2-mfd. condensers and two 32-henry chokes complete the requirements of this valuable "gadjet."

H.T. for the detector and first note-magnifier being cut down by a potential divider externally. The smoothing unit was, of course, directly in the output from the rectifier valve.

this filter and no other smoothing with an input of 40 milliamperes at 400 volts.

It is interesting to note, however, that the filter has been regularly run since then with currents as high as 60 m.a., and the degree of smoothing is still quite good. The same filter, without alteration, may, however, be used as a smoothing unit for D.C. mains as well.

Further Smoothing Unnecessary

The writer being blessed with A.C., it was not possible to make a test "first-hand," but it was tried out by a friend whose house is supplied by notoriously bad D.C. mains, and he reported to the effect that no further smoothing was necessary; he had tried a further 4 mfd. across the output terminals and found no improvement.

On the transmitter a perfectly pure D.C. note was not required, since it is generally found that a



"HAVE you ever seen a talkie?" asked Mr. Hercy Parris.

"Come, come," I smiled (I had had lunch at his expense, and was in that peaceful state which makes one gentle and polite to all the world). "Come, come; one can't talk about *seeing* talkies, can one?"

"There seems to be a lot of 'talk' about that last sentence," returned Mr. Parris, who, having paid for my lunch, was doubtless in not such a good frame of mind as I was.

"Very well, then; one can't *spea*k of seeing the talkies any more than one can speak of hearing the what d'you call 'em?—seeies, I suppose. A new word is obviously required!"



"Where did you get that cigar?"

Mr. Parris saw the point at once, and became so immersed in thought that I was able to have another glass of port, a fresh cup of coffee and a Corona Corona put down on his bill without his noticing it.

Been to the Talkies?

After much cudgelling of our brains we failed to find a suitable portman-teau word and agreed that it was best to get round the difficulty by saying, "Have you *been* to the talkies?"

"Very well, then," said Mr. Parris, "have you been—Where did you get that cigar?"

"Oh, the waiter brought it," I said. "He seemed to think that I ought to have one whilst you were thinking."

Mr. Parris sighed.

"Well, *have* you been to the talkies?" he inquired.

I confessed that I had not. Mr. Parris then informed me that it was my clear duty to do so at once in order to investigate the level reached by those responsible for sound repro-

duction arrangements, synchronisation, etc., etc.

"Here," he said, "is a free pass for two to the Frivoli. Go to-morrow and then write me a critical and technical account of it for the WIRELESS CONSTRUCTOR."

"I suppose you are paying expenses?" I inquired. "Lunch and tea and taxis, and all that kind of thing?"

Mr. Parris handed me fourpence.

"This," he said, "is for your bus fares. Must you really be off. Well, well, good afternoon."

It seemed obvious that if readers of the WIRELESS CONSTRUCTOR were to know what the most eminent experts in the country think of the talkies my companion on the following afternoon must be Professor Goop. Readers have doubtless realised long before this that when he and I put our heads together something *rather* special is to be expected.

The Double-Jointed Racquet

Returning home to Mudbury Wallow I made my way round to "The Microfarads." The professor was on the tennis court, trying out a new double-jointed racquet that he has invented, in a single with Goshburton Crump.

The whole idea of the thing is this. When you, reader, try to do an American service, you first of all tie your body into knots and then bring down the racquet with a kind of twisty motion, the general result being that either you deliver a sound swat at the place where the ball was an instant before, or if you do hit it you drive it into the net or your neighbour's pigsty, according to the angle of impact.

The professor argued that to deliver an American service properly with an ordinary racquet a double-jointed body was required. Matters could therefore be enormously simplified by using an ordinary body and a double-jointed racquet. It is also extremely good for returning those beastly balls with a screw on them.

With the ordinary racquet you hit the place where you think the ball is,

though it isn't. With the Goop Racquet you never know quite where you are hitting and the odds are on your delivering an express return that catches the chappie at the net in the solar plexus and puts him out of action for the rest of the afternoon.

I got there just in time to see Goshburton Crump take the count, which was most convenient since it meant that the professor and I could have our little chat undisturbed.

A Much-Married Man

"Have you any experience of the talkies?" I asked, as soon as we had settled down in his den.

A slow, sad smile spread over the professor's face.

"Don't do it!" I yelled. "Don't do it!"

"Don't do what?" said the professor.

"Don't go and tell me that you have been married for twenty-five years. Believe me, old chap, that jest has already been cracked in every country of the world and in every known language."

"If you are suggesting," remarked the professor, lovingly fingering the double-jointed racquet, "that I was about to give vent to a stale joke; if, I say, you were suggesting—"

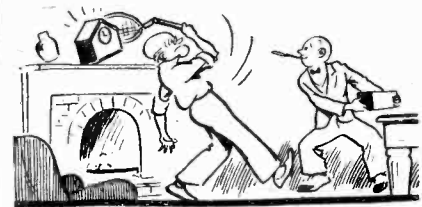

The professor missed me and hit the clock.

I assured him that I was not; that nothing could have been further from my intentions, and that in any case it was a rotten joke.

"It wasn't, it isn't!" screamed the professor. "For I am the author of it."

"You're not," I shouted, "for I made it seven years ago."

"Take that," roared the professor, aiming a swat at me and hitting the clock.

In Lighter Vein—continued

"And you take *that!*"

"That" was an unspillable accumulator. The professor took it all right on the third waistcoat button, but the thing, for some reason or other, failed to live up to its name when it rebounded from him on to the carpet.

Having rendered first-aid to the professor, I set about removing the slight stain that had been produced by the spilling of a pint or so of dilute sulphuric acid. In case any reader does not know how to remove such stains from a carpet, let me tell him at once a method which is absolutely infallible. Drive in tin tacks all round the discoloured patch, then cut it out with a sharp knife.

Taxi-Fare Trouble

When the professor was himself once more, I told him that I had come to warn him for duty at the talkies on the next day.

"Can't!" bleated the professor.

"Must!" said I.

"Shan't!"

"Shall!"

"Won't!"

Sadly I banged his head three times against the wall.

"I almost think I will," he murmured.

I gave his cranium three more bangs, after which he was quite persuaded that he would. When I had told him exactly what our mission was he became quite keen, and promised to give me every possible help.

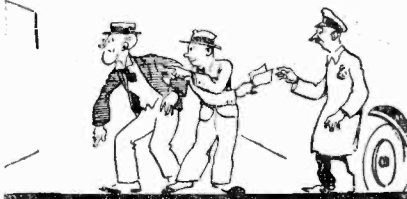

"Look out!" I cried.

On the following day I called for him at "The Microfarads," and on reaching the High Street signalled to a taxi.

"Heavens, man," cried the professor, "a taxi from here to the Frivoli is going to cost about a couple of pounds!"

When we alighted at the door of the Frivoli, I began to fumble hard. I think I can claim to be one of the world's best fumbleers when it comes to paying a taximan and I have any-

body else with me. The professor, however, runs me a very close second, and when we had both been at it for ten minutes or so I thought that something would have to be done.

"Look out!" I cried, remembering my Edgar Wallace, and pointing over the professor's shoulders. As he swung round I neatly extracted a couple of notes from his inside pocket and passed them over to the taximan. This was the amount registered on the clock; I added twopence as a tip from the little store given me by Mr. Hercy Parris, for I have always found that there is nothing like being generous with taxi drivers.

We walked into the vestibule of the Frivoli, where we were halted by an admiral of the Yugotoblazian navy, who told us that the ticket office was over there.

The Dead-Heads

"We have free passes," I said haughtily.

"Oh, dead-heads!" said the admiral.

"W-w-w-what did he call us?" inquired the professor, trembling with rage and proceeding to strop his clasp-knife upon his boot. I think there would have been quite a little scene had I not explained to the admiral that it would be just as well if he did not try any monkey tricks with Mr. Fugless Darebanks and Mr. Madolphe Anjou.

"Sorry, gents," said the admiral. "I didn't recognise yer."

"That's all right," I said, placing an eyeglass in my eye and giving him a courtly wave of the flipper. "Rustle up a pair of Number One seats and—er—by the way, you had better keep a third in case Mary turns up. She's expecting to meet Fugless here."

"When the Organ Starts to Peal"

We were shown into a box. The admiral apparently got busy after leaving us, for in a very short time everyone was having sixpennyworth of opera glass and turning it on us. The professor and I rose and bowed.

Suddenly the lights went out, and the place was filled with music. I reminded the professor that it was our job to be thoroughly critical.

"Meant to be an organ, I suppose," I remarked.

"I imagine it is," said the pro-

fessor. "But you will notice a complete suppression of both the upper and lower audio-frequencies."



"Dead-heads!"

I agreed. I also pointed out that there was a very distinct suspicion of overloading, and that the loud speaker was clearly not up to the mark.

Just then the manager came in.

"Good up to a point," I said; "in fact, very good indeed. It is curious, though, how it just fails to sound like a real organ."

"Well, now, that is curious," remarked the manager.

"How do you mean?"

"Why, because it is a real organ. The film hasn't started yet."

"Oh!"

The organ ceased, and then a concealed orchestra began.

The Lullaby that Worked

"Anyhow," I remarked to the manager, "we won't be had this time. We will withhold our criticisms until the film starts."

"It has started," he said. "That's a loud speaker that you are hearing now."

"Oh!"

The manager left us at last, and we were able to go on criticising like anything. To be quite serious, we were both firmly of opinion that the talkies are jolly good if only the male characters had not double-bass voices and the female characters single bass. That word "bass," by the way, rhymes with ease and not with crass; Mr. Wallace Beery was not in the cast.

Unfortunately, though, in the first quarter of an hour of the film the heroine sang a lullaby with the object of putting her baby to sleep. So excellent was the rendering that both the professor and I dozed off, and I am unable to offer so complete a criticism of the rest of the film as I would like. One thing I will say, though, and that is this. The chairs in the boxes are *jolly* comfortable.

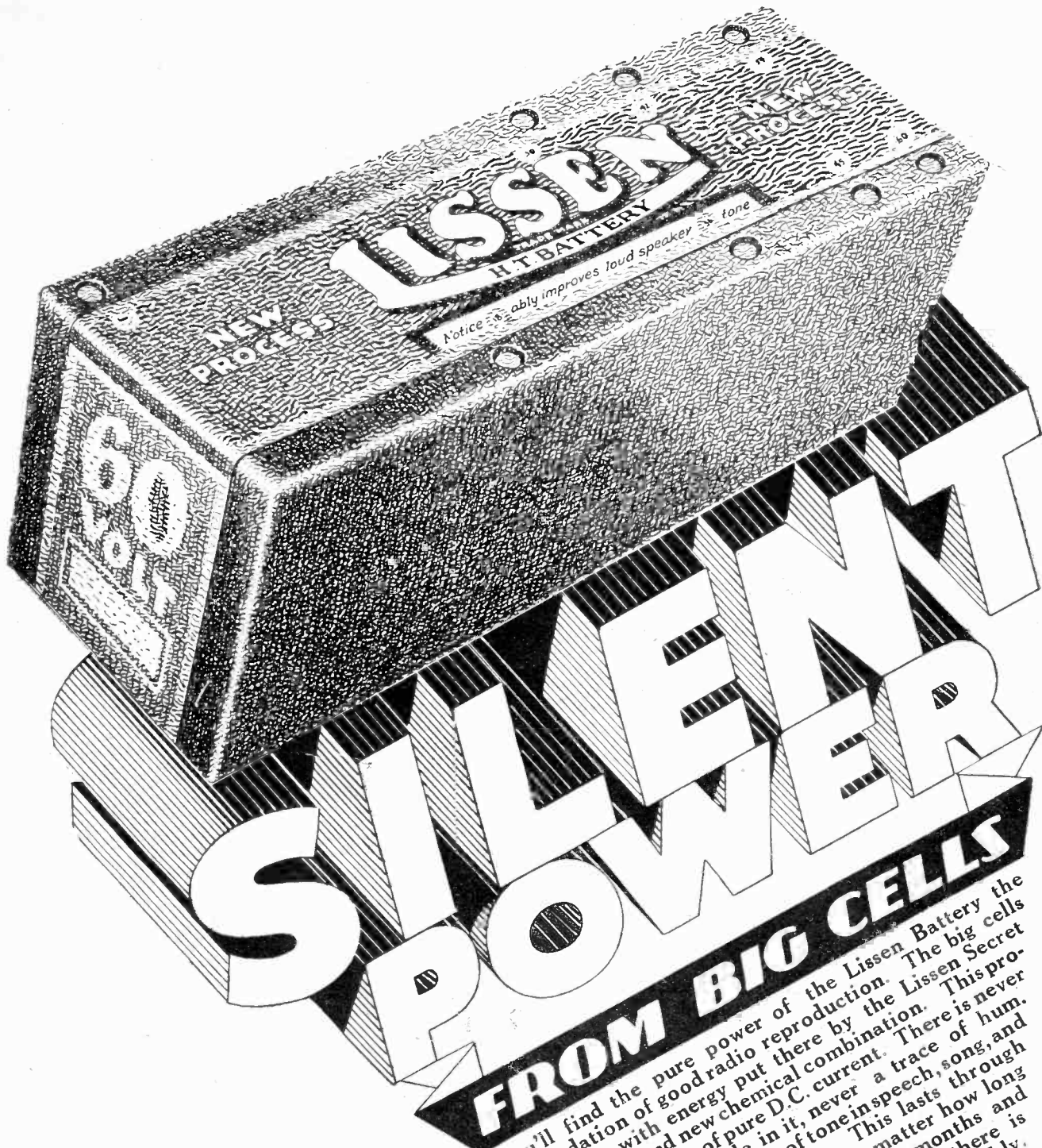

SILENT POWER FROM BIG CELLS

You'll find the pure power of the Lissen Battery the foundation of good radio reproduction. The big cells are live with energy put there by the Lissen Secret Process and new chemical combination. This produces a flow of pure D.C. current. There is never a sign of ripple in it, never a trace of hum. Notice the clarity of tone in speech, song, and instrumental music. This lasts through every programme, no matter how long it is, and throughout months and months of use. Always there is ample power flowing smoothly, sustainedly.

You will get fine current for radio if you ask for "LISSEN NEW PROCESS BATTERY" and take nothing else.

PRICES:

60 volt (reads 66)	7/11
100 volt (reads 108)	12/11
120 volt (standard cells)	15/10
36 volt	4/6
60 volt Super Power	13/6
9 volt Grid Bias	1/6
4½ volt Pocket Battery	each 5d.
	4/6 doz.
Single Cell Torch Battery	4½d.

MADE IN ENGLAND.

LISSEN, LIMITED,
26-30, Friars Lane, Richmond, Surrey.
 (Managing Director: THOS. N. COLE.)

More About the 1929 Super-Quality Amplifier

Alternative valve combinations for the amplifier described last month.

By THE EDITOR.

THE interest aroused by the publication of the 1929 Super-Quality Amplifier suggests that a few notes on alternative valve combinations may be of value to our readers. For example, a number of home constructors may not wish to use this amplifier with the all-electric gramophone described in the current issue, but may desire to build it into an existing receiver in place of the present audio equipment, so as to take advantage of the remarkable quality this amplifier gives.

In such circumstances, the question of choosing a valve which works well on raw A.C. does not arise, as the filaments of the amplifier valves will be connected to the ordinary supply. Instead of the recommended D.E.5 valve, which, as explained in the last issue, has a quarter-ampere filament with considerable temperature lag, any of the .1 or .075 L.F. valves having an impedance of approximately 7,500 to 10,000 ohms will be found suitable. In this class most of the valves termed "L.F." in the various makers' lists.

Good Grid Swing

Such valves can handle quite a good grid swing without distortion occurring, and certainly seem to give the best results with the particular choke-capacity feed in conjunction with the transformer specified. Those readers who do not want quite so much power as is obtainable with 120 volts and the 625A type of valve, will find admirable results are obtainable with any of the super-power valves using 120 volts on the plate. The ordinary super-power valves designed to be used at a maximum voltage of 150 should not be used on the highest tapping of the special mains H.T.-A.C. unit described last month, as this will give more than that figure.

A suitable voltage will be found on one of the taps below this (using a "1,000 ohms per volt" meter for measuring), and in such cases where only one H.T. tap is used, the small 2-mfd. condensers placed across each

tapping can be paralleled and put across the tapping used, as explained last month.

Where A.C. mains are available, and it has been found that the hum given by the standard arrangement is too pronounced, a slight modification will effect the necessary reduction of hum. Disconnect the filament leads of the first valve in the super-amplifier, and arrange that the terminals marked L.T.- and L.T.+ are connected only to the push-pull valves and to the fixed condensers shown.

Curing Hum

A potentiometer, either of the fixed variety with a centre-tap, or the ordinary baseboard-mounting potentiometer with a slider, should now be

the two fixed condensers across the filament, should now be disconnected from that point and joined to the slider of the potentiometer, to which also should be taken a lead joined to the positive of a separate grid-bias battery, which should now be used on the first L.F. valve.

Grid-bias negative 1 terminal is connected correctly already, and will be used as before, but the lead will be taken to the necessary negative tapping on the separate grid-bias battery, the positive of which will be connected as explained to the slider of the potentiometer. The rest of the arrangement remains as before.

"Indirectly-Heated" Valves

We are now in a position to use any directly-heated A.C. valve here, such as one of the .8-volt, .8-amp. L.F. valves obtainable from either the Marconi or Osram people, as the first valve of the amplifier. The two leads taken from the potentiometer ends should now go to a small separate mains transformer capable of giving .8 of a volt. Several such transformers are available at reasonable prices.

Another arrangement is to connect the filament terminals of the first

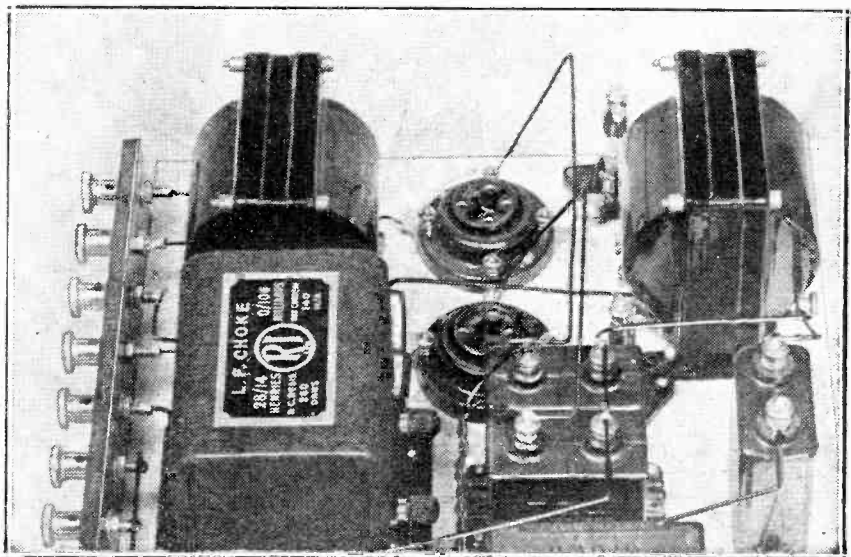

The terminal of the input push-pull transformer, which is connected to the junction point of the two fixed condensers (clearly shown above), can be joined to a potentiometer, as explained here, where A.C. mains are available.

mounted in some convenient position, and leads taken from the two ends of the potentiometer to the filament terminals of the first valve. A pair of flexible leads should also be taken from these points for connection to a suitable filament transformer to be mentioned later.

The terminal of the input push-pull transformer, which is at present connected to the junction point of

valve (after disconnection from the leads shown in last month's wiring diagram) to separate terminals, dispense with the potentiometer and join the terminal of the new grid-bias positive to the lower end of the push-pull input transformer primary, and this same point to the cathode terminal of an indirectly-heated A.C. valve for use with indirectly-heated cathode valves.



FOR YOUR PROTECTION

The amazing popularity of the Blue Spot Unit has resulted in certain unscrupulous persons taking advantage of the great demand for these units by passing off certain units in plain boxes as Blue Spot units.

Genuine Blue Spot units are retailed in specially designed cartons, which

are clearly marked with the price 25/- and the famous Blue Spot trade mark. Every genuine carton contains a 12 months' guarantee and for your own protection insist on the guaranteed and genuine Blue Spot Unit--the unit that has revolutionised loud-speaker reception.

F. A. HUGHES & CO., LIMITED, 204-6, Gt. Portland St., London, W.1 (Tel.: Museum 3630.)

Distributors for Northern England, Scotland, and North Wales: H. C. Rawson (Sheffield and London), Ltd., 100, London Road, Sheffield, and 185, Princess Street, Manchester. (Tel.: Sheffield 26006.)

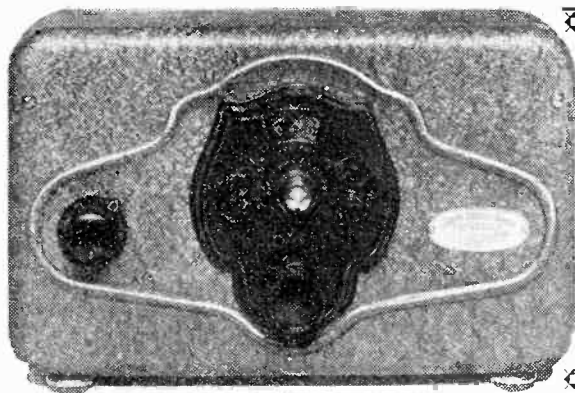

AN INTERESTING SHORT-WAVE CONVERTER

Details of a useful commercial adaptor for short waves.

THE "Aero Short-Wave Converter," illustrated herewith, is a very ingenious instrument. "Converters" of this type have been popular in America for some

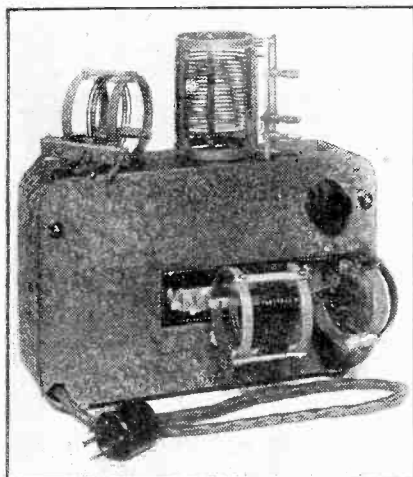

Showing how the coils fit into the back of the unit.

time, but for some reason or other have not attained any degree of popularity in Great Britain. This is all the more surprising in view of the number of people who have a good broadcast receiver which they do not want to "maul about" to enable it to receive short waves, and at the same time do not want to make another receiver specially for the purpose.

Plug-In Adaptor

The principle of the short-wave converter is that it provides a complete short-wave detector unit, the audio-frequency output being fed into the first note-magnifier of any existing receiver. In this case the output is taken to a four-pin plug (to which the filament connections are also taken), so that one simply has to remove the existing detector valve of any type of set, place it in the socket of the converter, and insert the four-pin plug of the latter in the detector socket, now vacant.

Thus nothing of the existing

receiver but the note-magnifier is used.

With the coils provided, the "Aero" unit covers a range of approximately 16.5 to 89.5 metres, embracing all the most interesting of the commercial amateur short-wave stations.

The entire unit is housed in a metal box, and no hand-capacity effects whatever appear to be present. Good screening and efficient choking combine to produce this desirable result.

The small knob to be seen on the front of the box is labelled "volume control," but it is in reality a control of reaction by means of a variable resistance.

Another resistance at the back of the box acts as an "anti-mobo" device, but in the writer's own case it was not necessary to use this; it was, however, found convenient as a control of H.T.

A good slow-motion dial is fitted to the main tuning control, and the veriest novice should have no difficulty in operating this unit on the short wave-lengths.

The whole unit is surprisingly small and compact, the overall dimensions being 9 in. by 5 in. by 2½ in. It may therefore be stood beside the existing

receiver, or even on top, without being unsightly or clumsy.

On a test extending over three evenings, practically all the known broadcasting stations on the shorter waves were logged, the set with which the unit was used being a straight detector and one L.F. The lowest station heard was W 2 X A D, on 19.56 metres; Drummondville, Quebec, on about 25 metres, was received at really excellent strength, and Winnipeg was also commendably good compared with the usual results from these particular stations on another receiver.

Almost Any Aerial Suitable

The converter does not appear to be at all particular in its requirements as regards aerials, since variable inductive coupling is provided, and almost anything from a reasonably good indoor aerial to something more than 100 ft. long will give good results.

The "anti-mobo" resistance was found useful as a preventive for "threshold howl," although this is not mentioned by the manufacturers as one of its uses. The unit is sold in this country by the Rothermel Corporation, and very complete instructions are included with the outfit.

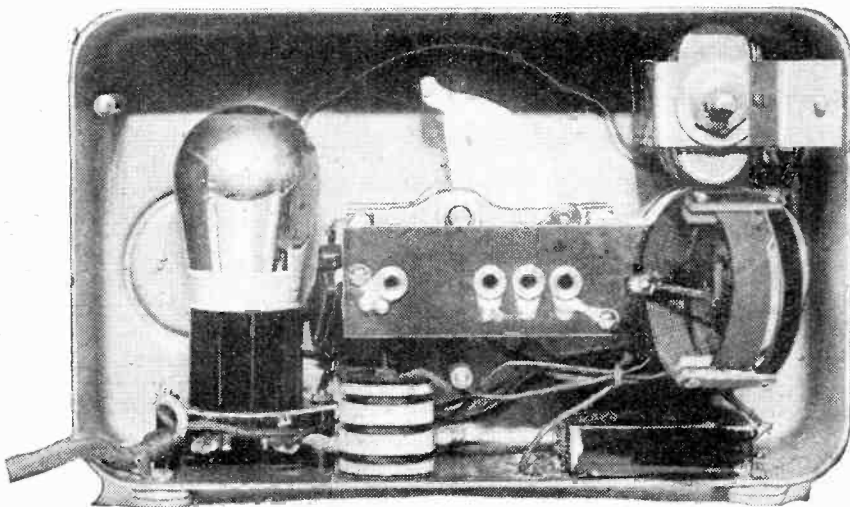

The interior of the set, which is completely shielded.

MERCURY CONTROL

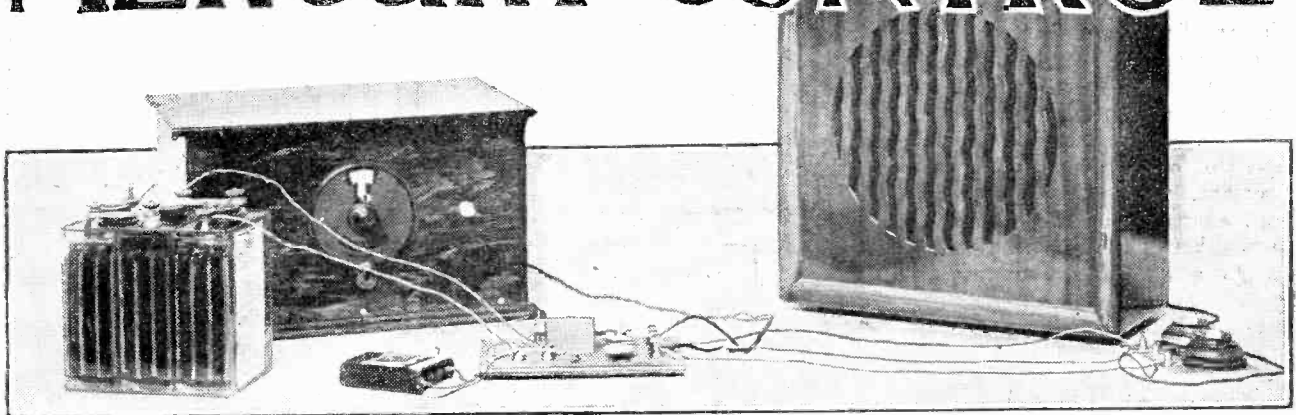

A simple remote-control unit that can be made by anyone for a few pence.

By A. S. CLARK.

THERE is no denying the handiness of a remote control for switching on and off your set. It is as useful in the garden in the summer as by the fireside in the cold weather. Complications in the apparatus and expense, however, often detract from the utility. The remote-control relay described in this article is simple, cheap and has several novel advantages.

Simple and Sure

One of the weakest points in the average relay used for controlling the filaments at a distance is the actual make-and-break scheme. Clean contacts, a good pressure and absence from sparking are all important requisites that involve expense and critical adjustments of the contacts. The idea employed in the present relay for making and breaking the L.T. supply is one that can be relied upon to give a good reliable contact always.

It consists of a small container holding mercury into which dips a piece of copper wire. Providing the wire is bright, a good contact will ensue which will be self-cleaning and capable of carrying a fairly large current. Another point of great advantage in the control is that only one extra wire is required beyond the loud-speaker leads. The third wire may be a length of ordinary D.C.C. wire.

How It Operates

A careful study of the photographs and the diagrams will be the best way to understand how the control works. There are two electro-magnets arranged at either end of a strip of flat, thin strip iron. This strip is fixed at

its centre to a spindle. Current can be momentarily passed through either of the magnet windings by pressing one of the push-buttons fixed on the control board, thus causing the spindle to which the armature is attached to move through a small arc. At the opposite end of the spindle to the magnets the piece of copper wire which dips into the mercury is attached. The wire is two or three inches long, so that a very small movement of the spindle will produce a considerable movement at the end of the copper wire, causing it to dip into, or come out of, the mercury, thus switching the set on and off.

The current for the magnets is obtained from one or two standard flash-lamp batteries. Since current is only taken momentarily when the set is switched on or off, these batteries will last for quite a long time. Actually the control could have been worked from the accumulator, but in this case separate wires would have been required for the loud

speaker, thus complicating the wiring to the relay.

The question of whether to use one or two batteries largely depends on the distance of the remote control from the receiver. If one does not seem sufficient to move the armature easily, two must be employed.

Cheap to Build

All the materials that are required are given in a list, although the various small pieces of wood and odd screws are not enumerated. It will be noticed that nothing expensive is required, in fact the materials are such as to be found in most "junk" boxes. Firstly, to wind the bobbins.

These are removed from any ordinary earpiece. The existing wire must all be removed from them, after which as much 32 gauge D.S.C. wire as possible should be wound on them. The actual gauge employed is rather important. Other gauges of wire were tried but were not found suitable with the voltage supplied by an

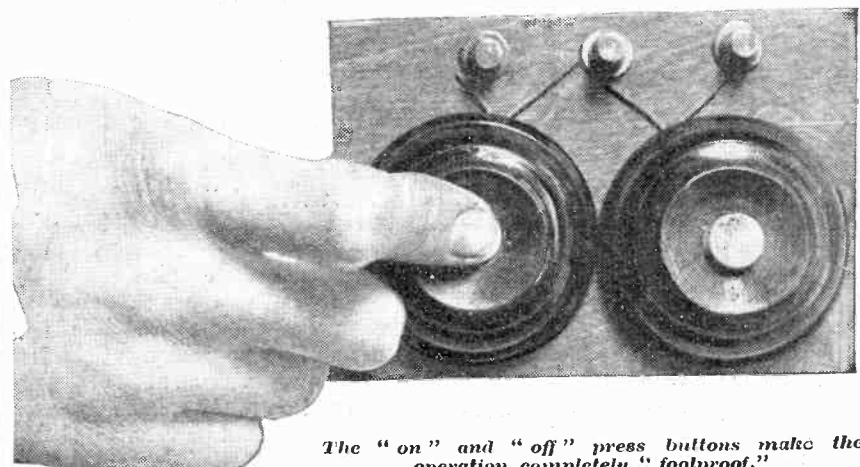

The "on" and "off" press buttons make the operation completely "foolproof."

Mercury Control—continued

ordinary flash-lamp battery. The end of the winding may be secured by merely twisting together with the beginning for a short distance.

The size of the baseboard and the disposition of the various parts is not important. You may have the baseboard what size you like and arrange the position of the magnets, etc., as you go along. The diagrams and photographs will show the details of the construction better than a lengthy description.

Cutting the Armature

Having wound the bobbins, screw them in place on the baseboard and take the wires from them through small holes to the underside. Now cut the piece of wood which acts as the bearing for the spindle. In this a hole must be drilled with a 2 B.A. clearance drill. It should be at a height about $\frac{1}{8}$ in. above the tops of the poles of the magnets.

Next cut a piece of tin for the armature. The shape of this can be gathered from the photographs. The "paddles" at its ends should be the same width roughly as the poles of the magnets. When cutting this piece of tin it should be cut longer than the distance between the two pole-pieces, as it will shorten a little

now be drilled in the baseboard. If desired, battens may be screwed to the ends of the baseboard to allow room underneath for the wiring and the terminal shanks. In the original the shanks were cut off flush with the

its bearing. Use a very thin piece of wire for making contact to the spindle, preferably with the outer rubber casing removed. If there is any spring in this piece of wire it may tend to twist the spindle one way, thus

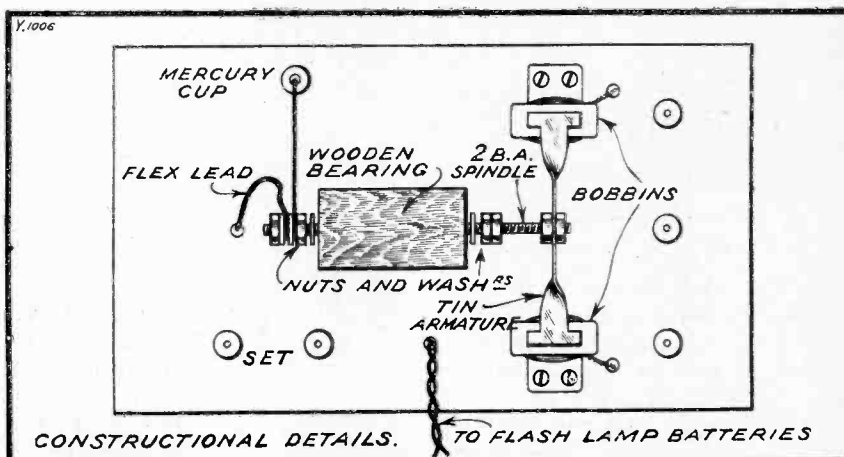

nuts so as to form legs for the relay to stand on.

The mercury container consists of one of the old-fashioned type of valve sockets. If possible, it should be drilled out a little larger so as to allow more clearance room for the piece of copper wire that dips into it. When the terminals and the cup have

preventing the L.T. remaining definitely on or off.

The connections to make under the baseboard can easily be followed from the wiring diagram. The two flex wires that run to the battery should terminate in spring clips for easy attachment to the springs on the flash-lamp refills.

The External Connections

A separate diagram is given showing the connections for the remote control and the loud speaker. When the make-and-break is joined in series with the L.T. battery, the L.T. switch on the set must be left permanently closed when the control is in use. There is no reason, however, why the make-and-break should not be connected directly across the L.T. switch so that the set can be turned on at receiver end if desired.

MATERIALS REQUIRED.

- 2 Wooden baseboards of suitable size.
- 1 Old telephone ear-piece.
- 8 Terminals.
- 1 Old-type valve-leg socket.
- Length of 2 B.A. screwed rod with several nuts and washers.

In this case there will be no need to alter the battery connections to the set at all. It will merely be necessary to connect a flex lead to either terminal, or soldering lug, of the L.T. switch, and to join the other ends of these two wires to the two

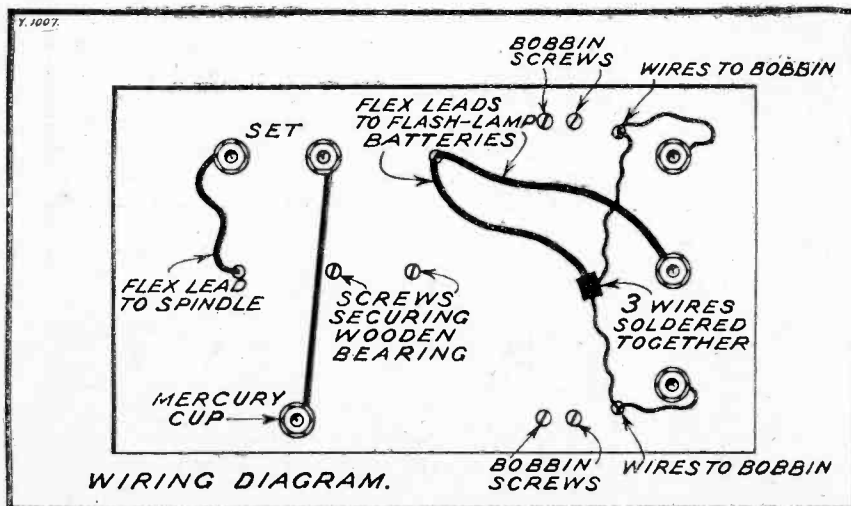

as it is bent to shape. It can afterwards be trimmed up. This armature may be cut out of an old cocoa or similar tin.

In the centre of the armature drill a 2 B.A. clearance hole to take the spindle. The holes to take the terminals and the mercury cup may

been mounted, the spindle with the armature and the length of copper wire may be assembled. The plan diagram of the instrument will clearly indicate what washers, nuts, etc., have to be fixed on to the spindle.

The nuts should be so adjusted that the spindle will just move freely in

IGRANIC



ESSENTIAL WITH PENTODES.

The Pentode Valve is a remarkable achievement but it cannot be expected to give the best results unless it is operated under the correct conditions. Its impedance is high—that of the average loud-speaker is low—a suitable step-down transformer is essential. The Igranic Pentodeformer is an output transformer specially designed for use between the pentode valve and the loud-speaker. It is worth your while to obtain full details.

Igranic Pentodeformer 30/-

Ask your local dealer for full details of this and other Igranic Radio Devices, or write direct to Dept J.911.



Works: BEDFORD

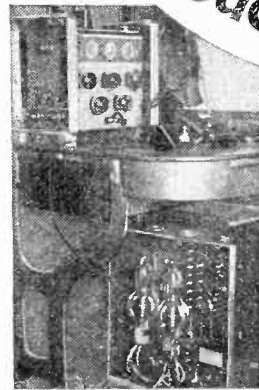
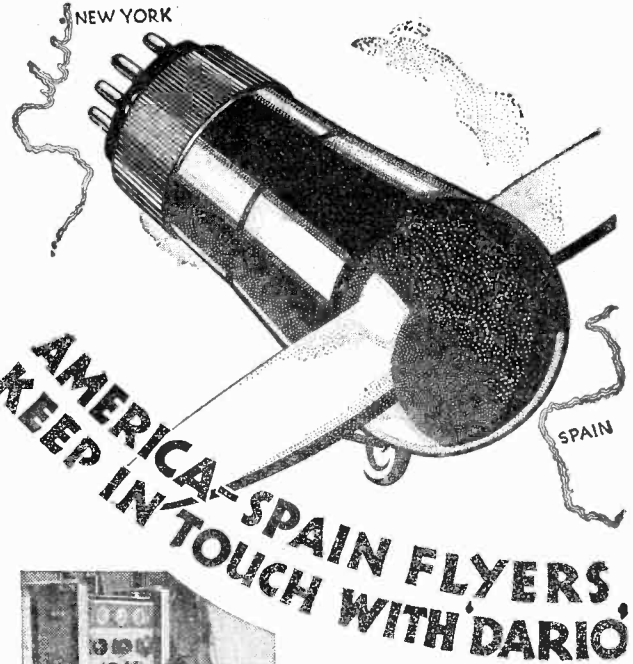

(On left) The wireless receiving and transmitting set on the airplane "Yellow Bird" shewing the "Dario" Valves.

THE Yellow Bird's, and its heroic occupants', flight from New York to Santander, Spain, is already well known. All the time on this journey wireless communication was maintained with Dario Valves. Why not use Dario Valves yourself—they've proved themselves in a matter of life and death—they will improve your set beyond all expectations. Dario prices are little short of marvellous—they are due to one of the biggest and most modern valve outputs in the World. Ask your dealer or write direct for full particulars.

5/6 G.P. & R.C.C. POWER **7/6**

TWO VOLTS	
General Purpose ..	5/6
R.C.C.	5/6
Super Power	7/6
Super H.F. & R.C.C.	7/6
Pentodion	21/-

FOUR VOLTS	
General Purpose ..	5/8
R.C.C.	5/8
Super Power	7/6
Super H.F. & R.C.C.	7/6
Pentodion	21/-

DARIO VALVES

WRITE FOR DARIO FOLDER!

IMPEX ELECTRICAL, LTD.,
DEPT. L. 538, HIGH ROAD, LEYTONSTONE, LONDON, E. 11

MERCURY CONTROL

—continued

terminals on the control marked "SET." Of course, if the set is switched on with the L.T. switch, it will not be possible to turn it off by means of the relay. It will be possible, however, to turn the set off at the receiver when it has been switched on by the relay. This can be accomplished by simply pushing the armature over with the finger.

Wiring the Control Panel

Up to the present no mention has been made of the wiring of the control panel. While this is quite simple, it will be as well to describe the connections in full. To each bell-push there are two contacts, and to these points lengths of flexible wire should be attached. One of the wires from each bell-push has to be connected to the centre terminal of the three on the control panel. The remaining wires are connected to the two outside terminals. It is immaterial which goes to which.

The relay cannot be used as described for controlling a set which has an H.T. eliminator. An extra switch has to be controlled, and even if there is no objection to the H.T. eliminator being left connected, there is the fact that a set using an A.C. mains eliminator for H.T. must not be switched off until the eliminator is switched off. If the set is turned off first, there will be a sudden voltage rise in the eliminator which may result in a breakdown of one of the components.

There is no reason, however, why the experienced experimenter should

not construct two relays, one for L.T. and one for H.T., and control them both from the one set of pushes. Care must be taken in this case to cover the mains relay up so as to avoid shocks being received by the

of all recognition by the introduction into the amplifying system of a deliberately distorting stage, which would raise the response to the higher frequencies and would repress some of the low.

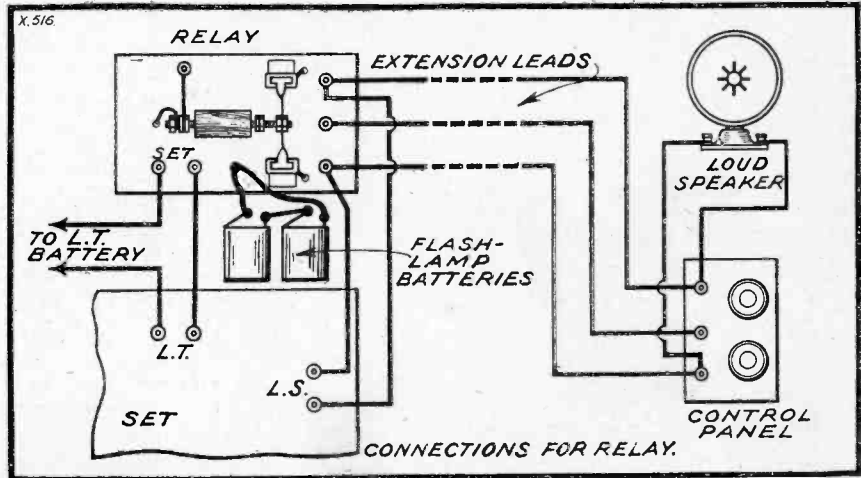

uninitiated. Also the windings on the bobbins must be carefully insulated, and the baseboard must be dry. Of course, the two relays must be connected up so that they are both "on" at the same time.

* **LOW AND HIGH?** *

OWING to the absence of high-note reproduction, many moving-coil speakers, while making some music sounds very natural, are very irritating and worrying in general use. This is also the reason why so many "talkie" installations give such a woolly and "plummy" reproduction of speech. Several we have heard would be improved out

How soon, we wonder, will some "talkie" engineers realise that as the response curve of the best loud speaker is much worse than the best amplifier, and as we *must* use loud speakers as they are, then the only satisfactory way of tackling the "overall" problem is to introduce distortion into amplifiers to compensate for the defects of the loud speakers.

These notes will, we hope, give a little comfort to a by no means negligible body of listeners who, in spite of the arguments of their friends regarding low-note reproduction, have still a preference for the old horn type of loud speaker, bad as it is in low-note response. Unless the low notes can be obtained without sacrificing the vital higher frequencies, then the change may not be worth making.

NOTHING TO GO WRONG—ALL DONE IN A FLASH

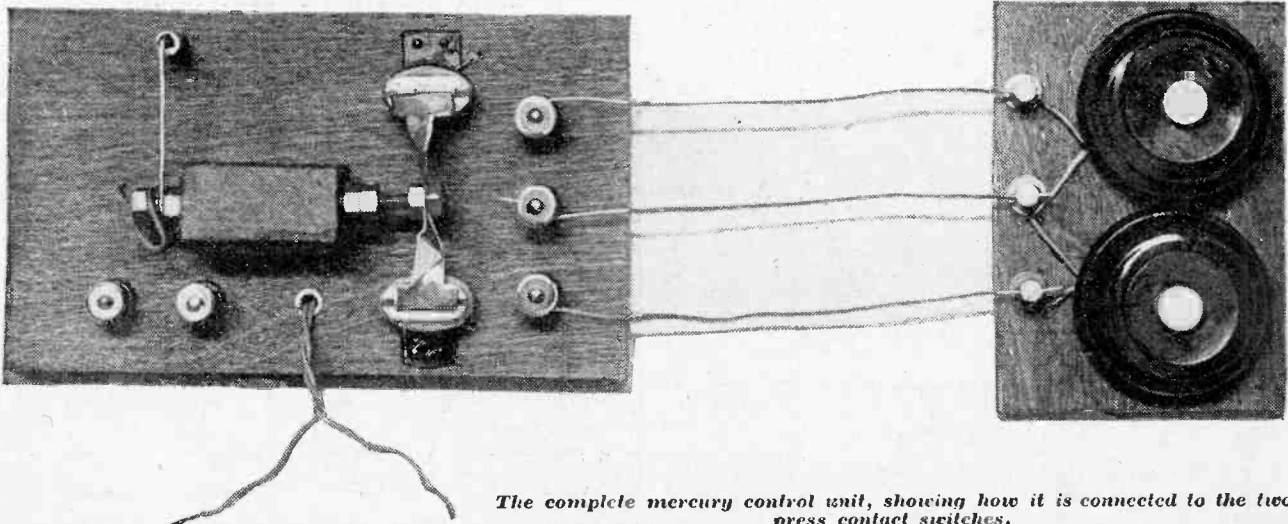

The complete mercury control unit, showing how it is connected to the two press contact switches.

Special
announcement
by
LEWCOS
REGD.

In view of the alteration in the wavelengths of British Stations it will be found very necessary to have an efficient Wavetrap for separating the stations.

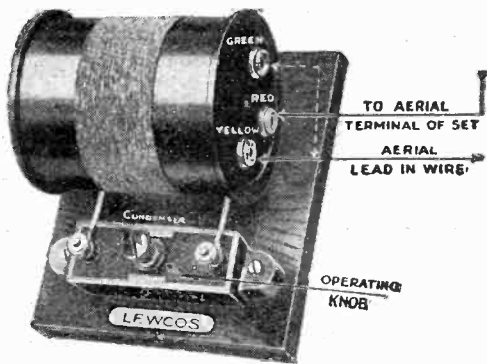

The Lewcos Wavetrap

Be sure of efficiency over all wavebands—use Lewcos Wavetraps, which are available in the following ranges:—

Ref. No.	Wavelength Range in Metres	Price
WT4	235—400	Each 13/6
WT5	350—550	
WT15	1,000—1,500	
WT20	1,500—2,000	

Leaflet R39 giving full instructions sent on application

LEWCOS
RADIO
COMPONENTS
are available at
7, Playhouse Yd.,
Golden Lane,
London, E.C.1.

Reduction in price of
GLAZITE
BEST MADE REGD.
Old price:
10d. per 10-ft. coil.
New price:
8d.
per 10-ft. coil.

**THE LONDON ELECTRIC WIRE COMPANY
AND SMITHS LIMITED**
Church Road, Leyton, London, E.10.

Trade Counter and Cable Sales: 7 Playhouse Yard, Golden Lane, E.C.1

Varley

for
**ANODE
RESISTANCES**

Everybody knows them—everybody has confidence in them—they are the admitted standards for comparison in the British Isles.

All our Resistances—including Tapped and Variable—are wire-wound on the famous Varley Bi-duplex principle—and to the man who knows, this means efficiency and reliability. Insist on VARLEY Resistances—we make a complete range to meet every requirement, and all good Dealers stock them.

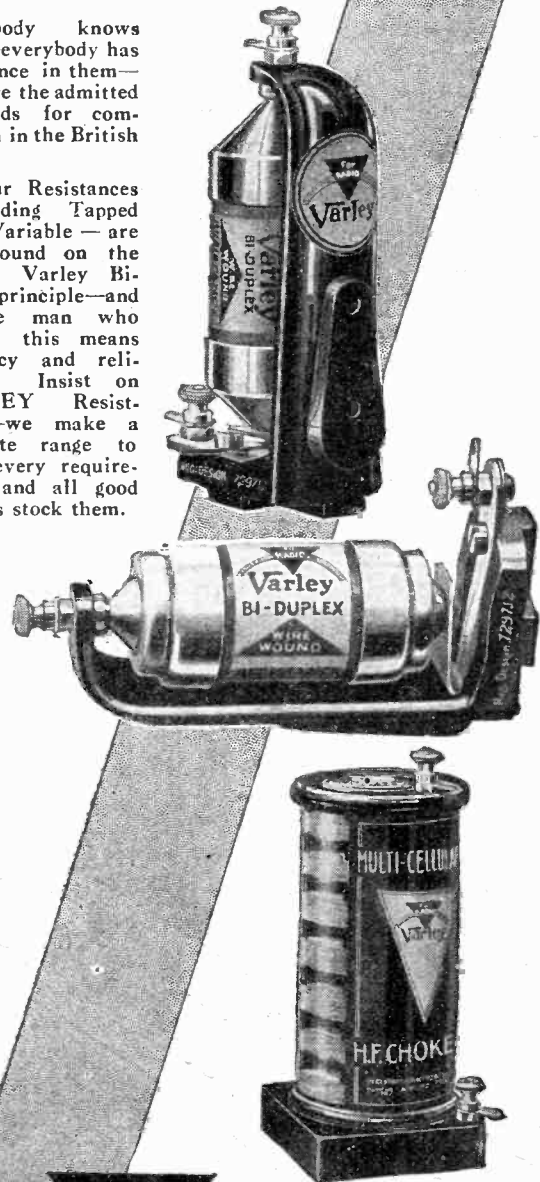

For
RADIO
MANUFACTURE
Varley

Here's another Varley Bi-duplex wire-wound product—the famous H.F. Choke. See that you have one in your Set: it will improve reception.

Price **9/6** Complete

Advt. of Oliver Pell Control, Ltd., Kingsway House, 103, Kingsway, W.C.2. Telephone: Holborn 5303.

OUR NEWS BULLETIN

*Some of the More Interesting Happenings
 in the Radio World this Month.*

High Class !

THE Carnarvon Choral Society has accepted a rather curious proposal put to it by the B.B.C. In short, it has accepted the invitation of the B.B.C. to broadcast a concert from the summit of Mount Snowdon during September. Doubtless we shall be able to appreciate some high-class singing when this experiment comes off.

Hats Off to the Beam

It was reported in the "Daily Telegraph" the other day that Canadian listeners have started an agitation for more inter-Empire broadcast programmes by the Beam system. This agitation seems to be a direct result of the great success of the re-broadcast to Australia of the Abbey Thanksgiving Service for the King's

recovery. Letters from all parts of the Dominions have been received by the Marconi Company congratulating the Company on the success of the broadcast.

The Empire's Thanksgiving

The Service was heard as clearly in all parts of Canada as a first-class local broadcast. It was transmitted from England over the Beam circuit by means of the new Marconi-Matthieu Multiplex System, which enables telephone and telegraph services to be carried out simultaneously over a single Beam circuit.

All Quiet on the B.B.C. Front

Lord Gainford recently stated that the broadcasting service "is going on quite normally." Lord Gainford, of course, was formerly the Chairman of the old B.B.C., and is now one of the

Governors of the new B.B.C. This was his reply to a question put to him by a Press man regarding the statement that six more members of the engineering staff at Savoy Hill had resigned their posts to take up jobs elsewhere.

Talkie Money Talks

"I can tell you that they have left to get promotion elsewhere, and that is all there is in it," went on Lord Gainford.

Nevertheless, why should these young engineers have to go elsewhere to get promotion? If the exodus from the B.B.C. goes on, it is inevitable that there will be a shortage of men who really understand B.B.C. technical engineering methods. If, of course, there is an influx of new engineers to the B.B.C., that helps matters a bit. But it is disconcerting to find good men going elsewhere for promotion. Fifteen resignations have already occurred this year, and most of the jobs the men have gone to have been in connection with talkies or with gramophones—often at salaries twice the size of those offered by the B.B.C.

Telling the World

A few days ago a conversation was carried on by means of the telephone
(Continued on page 294.)

THE MOST FAMOUS OF ALL LOUD-SPEAKERS CELESTION

Now obtainable at big price reductions

MODEL	OLD PRICE	NEW PRICE
C 10 ...	£ 5 10 0	£ 3 15 0
C 12 ...	£ 7 5 0	£ 5 12 6
C 14 ...	£ 13 10 0	£ 11 0 0
C 24 ...	£ 24 0 0	£ 20 0 0

These substantial reductions are made possible only by reason of the greatly improved production facilities, made available in the new and extensive Celestion factory.

Obtainable from any high-class Radio Dealer

Write for free Booklet to:
 CELESTION, LTD., Dept. L, KINGSTON-ON-THAMES

THE VERY SOUL OF MUSIC

INSTANT RESPONSE

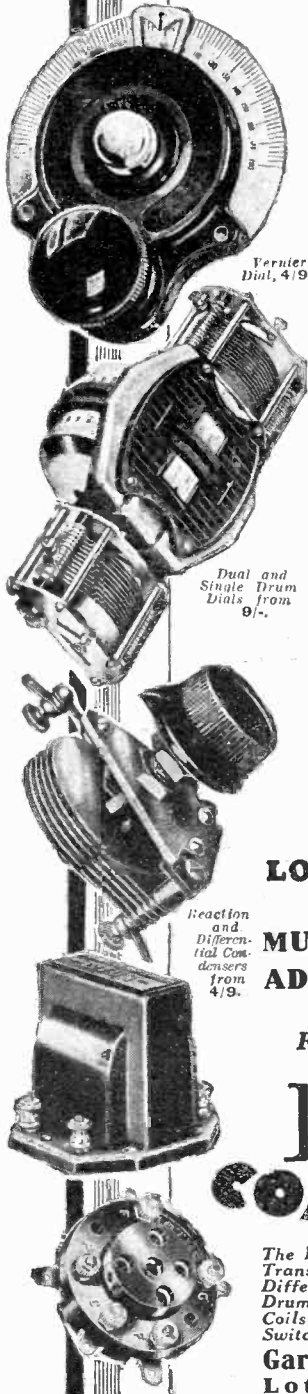

No fiddling about with nuts and connections once you've built your set with Lotus Components—easy to fix, quick to assemble, neat, compact and utterly reliable, Lotus Components work together in perfect harmony and ensure instant response and fulfilment of your highest hopes.

Every Lotus unit is faultlessly accurate—every one is compact, practical and of the latest and best pattern. All good circuits recommend Lotus Components; they are the best and safest choice for every set.

Use
LOTUS COMPONENTS
for the
MULLARD AND OTHER
ADVERTISED CIRCUITS.

From all radio dealers.

LOTUS COMPONENTS

The Lotus range includes L.F. and Power Transformers; Variable, Reaction and Differential Condensers; Value Holders; Drum Dials; Flat Vernier Dials; Dual Wave Coils; H.F. Chokes; Coil Holders; Jacks; Switches; Plugs, etc. Send for literature.
Garnett, Whiteley & Co., Ltd.,
Lotus Works, Liverpool.

Caution

The ULTRA AIR CHROME SPEAKER

AS USED IN THE
WIRELESS CONSTRUCTOR
All-Electric Gramophone described by
MR PERCY W. HARRIS

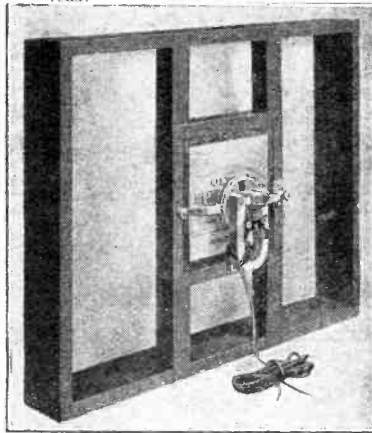

THE many exclusive and patented features of the Ultra Air Chrome Speaker reproduce most faithfully broadcast music and speech. Visit your local dealer—he will demonstrate to you that the Ultra Air Chrome Speaker gives results comparable only with an original performance.

The performance curve shows that the Ultra Air-Chrome Speaker gives uniform response well beyond the extreme limits required for the faithful reproduction of musical sounds.

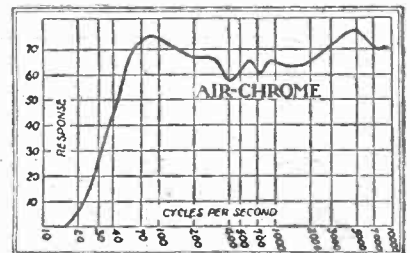

Performance curve of Ultra Air-Chrome Speaker.

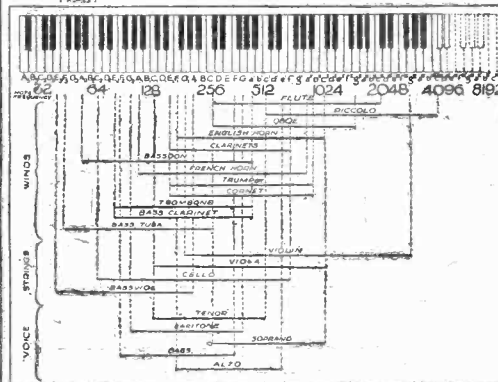

Type	Size
*F	18" x 23"
	84/-
K	14" x 14"
	52/-
L	12" x 10"
	42/-

* Type "F" is the one used by Mr. PERCY W. HARRIS, and illustrated.

Illustrating frequency range of musical sounds.

The Ultra Air-Chrome Speaker combines a patented Double-Diaphragm and Balanced Armature Unit—an exclusive sound-reproducing system.

Advertisement of Ultra Electric Ltd. 661-665, Harrow Road, N.W.10. Telephone: Willesden 4544.

OUR NEWS BULLETIN

—continued from page 291

quarters in Portland Place, Oxford Circus, and it is estimated that the cost of the building, when complete, will be about half a million pounds. The area of the site is approximately 20,000 square feet, and the floor space will be about 100,000 square feet. This building will contain at least twelve studios, of which two will be twice as big as the largest now in use at Savoy Hill. There will also be a super-studio, which will be for the accommodation of large orchestras, choirs, massed bands, etc. These studios will occupy the centre of the building, and will be grouped one above the other. All the studios will be "noise tight."

Royalties Reduced

As we write we are glad to learn that the Marconi Company has decided to reduce the rates of royalties on wireless sets. Till now the royalty has been 12s. 6d. per valve, but in future it is to be only 5s. per valve, as a result of the recent case brought about by the Brownie Wireless Co. to challenge Marconi's

on the rate of royalties that radio manufacturers have to collect from the public. Marconi's won the appeal, but as a result of a series of meetings with members of the trade the whole royalty question was thoroughly investigated. The new rates will come into force on the condition that manufacturers come to a suitable agreement with the Marconi Company for a period of years.

Broadcasting Talkies

Emile Shauer, who controls the sale of Paramount Pictures outside the United States, declared recently on his arrival in London that in five years' time talking pictures will be broadcast. Paramounts, he stated, in anticipation of a closer alliance between picture production and broadcasting, have purchased half interests in the Columbia Broadcasting Corporation of America. This Corporation, as our readers know, controls fifty-three stations throughout the United States, having a weekly audience of 120,000,000.

New Blood

There was a rumour the other day that Mr. H. S. Robertson, the conductor of the Glasgow Orpheus Choir, was likely to be made a Scottish

representative on the B.B.C. Board of Governors. However, late news indicates that this was only a rumour, and that Mr. Robertson has no knowledge of any such appointment.

It would be a good thing, of course, to appoint a well-known personality from Scotland, and also one from Wales, to the B.B.C. Board, for there are still two vacancies, and some new blood is badly needed.

Newcastle's Troubles

It appears that Newcastle is being interfered with by Leipzig under the new Prague scheme, and we have had a lot of letters from readers grumbling at the trouble they are experiencing. Newcastle's wavelength under the old arrangement was always troubled by Nurnberg, but now it is out of the frying pan into the fire on account of the interference caused by Leipzig.

Well, the Prague Plan is bound to have its faults, but the consensus of opinion is that, on the whole, it is working better than the old Plan de Bruxelles.

According to the "Sunday Times," broadcasting has made greater progress last year than during any other period since wireless became a popular

(Continued on page 298.)

TELSEN

TRANSFORMERS

Ratios 5-1
or 3-1

To ensure real Quality reproduction you cannot do better than install TELSENS

Entirely British.

All models with detachable feet.

Ratios 5-1 or 3-1.

Standardised by all leading Set Manufacturers.

RADIOGRAND
12/6

TELSEN ELECTRIC Co., Ltd., Head Offices: Miller St., Birmingham

EXACTLY RIGHT - every one tested

EDISWAN GLASS-ENCLOSED VACUUM RESISTANCES.
(Grid Leak or Anode)

Ediswan are the only British made resistances of this type on the market. All resistances are thoroughly tested before leaving our works, and are absolutely accurate and noiseless in operation. Obtainable in values from 5,000 ohms to 5 megohms. Overall length, 45 mm.

CARTRIDGE CONDENSERS.

These condensers are ideal for the man who likes to experiment. In a second, you can pull one out of the clips and put in another of a different value. They are made in values from .0001 mfd. to .001 mfd. Overall length, 45 mm.

For the best results.

EDISWAN

Made only by The Edison Swan Electric Co. Ltd., 12315, Queen Victoria Street, London, E.C.4.

Weston sets the world's standard

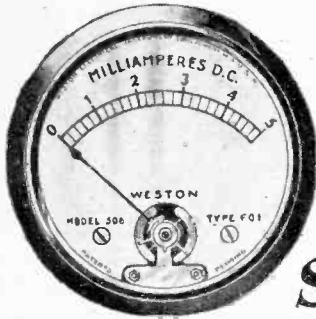

Our Model 506 MIL-AMMETER Panel Mounting type should be placed in the High-Tension Circuit of the valve to ensure correct operation and to check distortion.

Prices £1 : 15 : 0—£2 : 15 : 0

Write now for your copy of "Radio Control," the Weston FREE Booklet that explains the necessity for accurate electrical control of your Radio Receiver, and gives much helpful advice.

Address your postcard to :—

WESTON

STANDARD THE WORLD OVER

Pioneers since 1888

WESTON ELECTRICAL INSTRUMENT CO., LTD.,
15, Great Saffron Hill, London, E.C.1.



Fighting Talk

If you're a drifter you won't read far in this advertisement. If you're not you will want to know who is responsible for your not getting ahead faster. We'll tell you. It's YOU! The man who won't be beaten, *can't* be beaten. If you're a drifter you'll always wish for success, but never do anything worth while to win it. The earth is cluttered with that kind of man.

If you're a fighter you will set about doing something. You'll get the special training that will qualify you for a better position and better pay.

In sparetime, at home, you can acquire the training you need through the International Correspondence Schools. Thousands of other men have lifted themselves out of the rut and into well-paid, responsible positions by I.C.S. study. The time for action is this minute.

We have nearly 400 Standard Courses, including many in the following subjects :

- | | | |
|------------------------------|-------------------------------|-----------------------|
| Accountancy and Book-keeping | Engineering, all branches | Salesmanship |
| Advertising | French, Spanish and Italian | Scientific Management |
| Architecture and Building | General Education | Shorthand- |
| Chemistry | Plumbing | Typewriting |
| Commercial Art | Poster Designing | Showcard Writing |
| Commercial Training | Railway Equipment and Running | Textiles |
| Draughtsmanship | | Window Dressing |
| | | Wireless Engineering |
| | | Woodworking |

ALL EXAMINATIONS—Commercial, Technical, Matriculation and Civil Serv. ce. Write to-day for free Booklet containing full information regarding the Courses in which you are most interested.

International Correspondence Schools, Ltd.,
172, International Buildings, Kingsway, London, W.C.2

A NEW VERNIER DIAL



Black, **3/-** Walnut,
Brown, Mahogany

(Black supplied unless otherwise stipulated).
Centre Knob Nickel Plated.

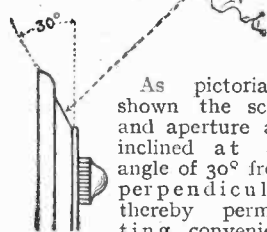

As pictorially shown the scale and aperture are inclined at an angle of 30° from perpendicular thereby permitting convenient unobstructed view of scale without need to crouch or stoop.

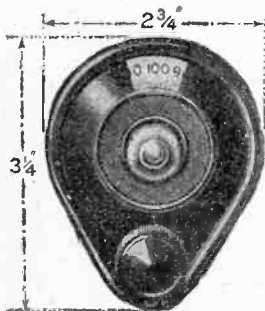

SMALL—EXTREMELY ELEGANT—EFFICIENT

MECHANICALLY PERFECT. POSITIVE SOLID BRASS CONTACT drive on SOLID BRASS SCALE, ensuring smooth movement, with absolutely NO BACKLASH. NO SLIP. ROBUST in Construction and TROUBLE-FREE.

3/-

The DIAL you would Buy even at **DOUBLE THE PRICE**

3/-

CROWN WORKS, CRICKLEWOOD LANE, LONDON, N.W. 2

NOW ON SALE

Full constructional details of
The "Radiano" Three
and

The "Concert" Four
are obtainable in Envelope form in

THE WIRELESS CONSTRUCTOR ENVELOPE SERIES, Price 1/6 ON SALE EVERYWHERE

By post, 1/9, from Wireless Constructor Envelopes, The Amalgamated Press, Ltd., Bear Alley, Farringdon St., London, E.C.4



CABINETS

THE "WIRELESS CONSTRUCTOR"

ALL-ELECTRIC GRAMOPHONE CABINET

as specified by

Mr. PERCY W. HARRIS and as illustrated in this issue

Oak Mahogany
£6 : 10 : 0 £7 : 5 : 0

Manufactured by

Carrington Manufacturing Co. Ltd.
Camco Works, Sanderstead Rd,
South Croydon.

Telephone : Croydon 0623 (2 lines)

OUR NEWS BULLETIN

—continued from page 296

science. The number of British listeners has still increasing, and in 1928 the number of licensed receiving sets totalled 2,284,000.

Going Strong

Five years ago, broadcasting was introduced in Germany. The total number of listeners registered during the first year was less than 100,000. During the last three years the increase has been 50 per cent annually. In Germany the Government collects a tax of about 2s. monthly on each set, and the income is divided between the broadcasting authorities and the Government. On analysis it will be seen that the German programmes consist of 39 per cent of music; the educational features, which include lectures, speeches, etc., amount to about 16 per cent, while 10 per cent of programme time is devoted to general literature.

A Baird Development

Negotiations between the B.B.C. and the Baird Television Development Company have been broken off

by the Company. Our readers would remember that negotiations were opened last March at the suggestion of the Conservative Postmaster-General, and the B.B.C again investigated the Baird system.

Appeal to P.M.G.

Eventually the B.B.C. offered quarter-hour periods for television

**LOOK OUT
FOR OUR
SPECIAL EXHIBITION SET**

TO BE FULLY DESCRIBED IN THE

**OCTOBER
WIRELESS CONSTRUCTOR**

Don't miss Next Month's Number
On Sale Sept. 15th. Usual Price.

transmissions outside broadcasting hours. The Baird Company say they are dissatisfied with this offer, and require periods inside broadcasting hours. The B.B.C. refuses to give this concession.

As a result, the Baird Company is appealing to the Postmaster-General

again, and may yet demand facilities for erecting a television and speech broadcasting station. However, the likelihood of this concession being granted is extremely remote.

North's Regional Station

It looks as though the new North Regional Station is to be at Pole Moor, near Slaithwaite. Anyway, when work is started it will take at least eight months to complete the station. Its power will be 35 kilowatts, which should give it good signal strength for crystal sets up to 150 miles.

Fans Falling Off?

Dr. Leonard Sayce, at a recent meeting of the Radio Convention held at Newcastle, expressed the fear that the majority of radio amateurs in this country are too content to listen to B.B.C. programmes. They are not now so interested in their experimenting, which was so largely responsible for the advanced state in which radio science finds itself to-day. We think Dr. Sayce is rather pessimistic here. Anyway, the thousands of readers of the WIRELESS CONSTRUCTOR could probably tell him quite a different story.



DUMETOHMS

EACH
2/6

*25, *5, 1, 1/5, 2, 3, 4, 5, and 10 Megohms.
Other higher values specially to order.



HOLDERS
(Horizontal or Vertical)
EACH:—
1/-

RESISTORS

Any Standard Value
EACH
1/-



Holder
(Horizontal or Vertical)
EACH
1/-

If unobtainable from your dealer, write direct to us, giving his name and address.

DUWIROHMS



10,000 to 100,000 ohms 5/- 250,000 ohms .. 9/9
150,000 and 200,000 ,, 8/- 300,000 ohms .. 11/6
Holder .. 1/6

DUBILIER
RESISTANCES

Dubilier Condenser Co. (1925), Ltd., Ducon Works, Victoria Road, N. Acton, London, W.3. (R) 238/R

WEARITE

COMPONENTS

PRODUCED BY HIGHLY SKILLED INSTRUMENT MAKERS, AND HIGHLY RECOMMENDED IN ALL "WIRELESS CONSTRUCTOR" CIRCUITS.

	s.	d.
H.F. CHOKE	6	6
HEAVY DUTY CHOKE for Eliminators	10	6
H.T. CHOKE Constant Inductance	21	0
L.T. CHOKE TO PASS 1.5 AMPS.	18	6
BATTERY SWITCH, G22	1	0
WAVE-CHANGE SWITCH, G23	1	6
STANDARD LOADING COIL	7	6
TITAN COIL	15	0
WAVE TRAP	15	0
GRID LEAK HOLDER	6	6
BIAS BATTERY CLIPS, per pr.	6	6

Use the new Wearite A.C. Valve Holder in all your sets. Equally suitable for 5-pin A.C. Valves and ordinary valves. Price only 1/3.

Write for New List.

WRIGHT & WEAIRE, LTD.,
740, HIGH RD., TOTTENHAM, N.17.
Phones: Tottenham 3347-3348.

INVALUABLE TO EVERY AMATEUR & CONSTRUCTOR

"POPULAR WIRELESS" BLUE PRINTS

of Tested Circuits

The following is a list of the "P.W." 6d. Blue Prints for Constructors in stock, showing the different circuits available.

P.W. BLUE PRINT Number.

1. DETECTOR VALVE WITH REACTION.
2. OUT OF PRINT.
3. 1-VALVE L.F. AMPLIFIER.
4. CRYSTAL DETECTOR WITH L.F. AMPLIFIER.
5. H.F. (Tuned Anode) AND CRYSTAL WITH REACTION.
6. H.F. & CRYSTAL (Transformer Coupled, without Reaction).
7. 1-VALVE REFLEX AND CRYSTAL DETECTOR (Tuned Anode).
8. 1-VALVE REFLEX AND CRYSTAL DETECTOR (Employing H.F. Transformer, without Reaction).
9. H.F. AND DETECTOR (Tuned Anode Coupling, with Reaction on Anode).
10. H.F. & DETECTOR (Transformer Coupled, with Reaction).
11. OUT OF PRINT.
12. OUT OF PRINT.
13. 2-VALVE REFLEX (Employing Valve Detector).
14. OUT OF PRINT.
15. OUT OF PRINT.
16. H.F. (Tuned Anode), CRYSTAL DETECTOR AND L.F. (With Switch for Last Valve).
17. CRYSTAL DETECTOR WITH TWO L.F. AMPLIFIERS (With Switching).
18. 1-VALVE REFLEX AND CRYSTAL DETECTOR, with 1-VALVE L.F. AMPLIFIER, Controlled by Switch.
19. OUT OF PRINT.
20. OUT OF PRINT.
21. THE 2-VALVE LODGE "N."
22. "THE GUARANTEED REFLEX."
23. THE 1-VALVE "CHITOS."
24. THE "SPANSACE THREE." Three-Valve Receiver employing 1 Neutralised H.F. Valve, Detector with Non-radiating Reaction Control and 1 L.F. Valve.
25. OUT OF PRINT.
26. A "STRAIGHT" 4-VALVER (H.F., Det. and 2 L.F. with Switching).
27. OUT OF PRINT.
28. A "MODERN WIRELESS" 5-VALVER (H.F., Det. and 3 L.F.).
29. AN H.T. UNIT FOR DIRECT-CURRENT MAINS.
30. A REINARTZ ONE-VALVER.
31. OUT OF PRINT.
32. THE "CUBE SCREEN" THREE (H.F., Det. and L.F.).
33. A "KNIFE EDGE" CRYSTAL SET.
34. AN H.F. AND DETECTOR TWO-VALVER.
35. THE "UNIVERSAL THREE" (Det. and 2 L.F. stages resistance-coupled).
36. THE "SPANSACE FOUR" (H.F., Det. and 2 L.F.).
37. THE "LONG SHORT" CRYSTAL SET.
38. A TWO-VALVE L.F. AMPLIFIER.
39. THE "SYDNEY" TWO.
40. THE "SUPER SCREEN" THREE.
41. THIS YEAR'S "CHITOS" ONE-VALVER.
42. THE "Q AND A" THREE. A simple set (Det. and 2 L.F.).
43. THE "INEXPENSIVE FOUR."
44. THE "ECONOMY FIVE." For long-range loud-speaker work.
45. A SIMPLE A.C. H.T. UNIT.
46. THE "REGIONAL" THREE.
47. THE "WAVE-CHANGE" ONE.
48. THE "REGIONAL" CRYSTAL SET.
49. OUT OF PRINT.
50. THE "ANY MAINS" TWO.
51. OUT OF PRINT.
52. THE "BANDMASTER."

ALL "POPULAR WIRELESS"
BLUE PRINTS 6d. EACH

All orders for these Blue Prints should be sent direct to the "Popular Wireless" Queries Department, Fleetway House, Farringdon Street, London, E.C.4, enclosing a stamped addressed envelope and a postal order for 6d. for each Blue Print ordered.

DO YOU REMEMBER?

Hullo!
Hullo!! this is
Wrrr--ittle

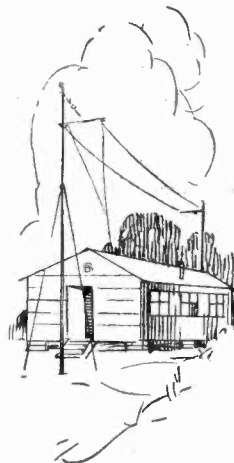

If you're a real "old stager" in radio you will remember "Wrrrle"—"Two Emma Toc," Capt. P. P. Eckersley's station. How his "Wrrrr-ittle" used to thrill us! Those were the days! The B.B.C. first official transmission—via 2LO—was in 1922—"Wrrrle" days were pre-B.B.C. days—days when we knew only "R" valves—long, cumbersome sliding tuners, and hefty .001 variables. In those days transmitting and receiving gear depended largely on T.C.C. Condensers for their efficiency.

It's the same to-day—the choice of serious experimenter and amateur alike is T.C.C. Be guided by them—ask for T.C.C. always.

There is a T.C.C. Condenser for every purpose. This is the .0003 mf. Upright Type Mica Condenser, price 1s. 10d. Other capacities from .0001 mf. to .25 mf. Prices 1s. 10d. to 18s. 0d.

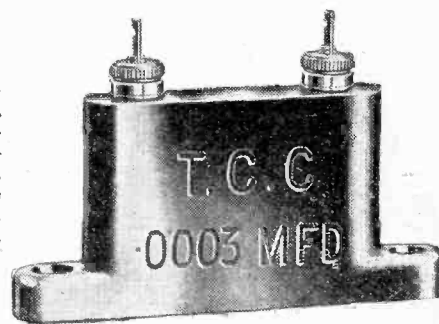

T.C.C. CONDENSERS

WERE USED THEN

Adv. Telegraph Condenser Co., Ltd., Wales Farm Rd., N. Acton, London, W.3

Ready Radio

SELECTIVITY UNIT (PATENT-PENDING)



PRICE 20/-

HERE ARE TEN GOOD REASONS WHY YOU SHOULD GET IT!

- R**esearch carried out by experts for many months has resulted in the evolution of an entirely new principle which makes this unit three times as effective as an ordinary wave-trap.
- E**xtra purity of reproduction is assured because all interference and background noise is cut out. "Listening" is given a new meaning.
- A**s long as it is in use reception of more than one station at a time—a fault that is common with unsselective receivers—becomes impossible.
- D**oubles the range of nearly every set because stations which were previously blotted out by interference become audible as soon as the unit is added.
- Y**ou can attach this unit without any alteration to your existing receiver and enjoy at once all the advantages it gives.
- R**equires no extra batteries or valves; there is nothing that needs replacement. The construction is robust and there are no loose parts to get broken.
- A**n ideal unit for improving the selectivity of any ordinary set, no matter how many valves are employed, including portables with aerial and aerial and earth terminals.
- D**oes all that is claimed without adding complications. Like most useful inventions, simplicity is one of its outstanding features.
- I**t does not derange the tuning of the receiver, a serious drawback common to other devices that have endeavoured to overcome the selectivity problem.
- O**wing to its small dimensions—4½ inches long, 3 inches wide and 1½ inches high—it can be added to any set without detracting from its appearance.

THE UNIT EMPLOYS A NEW PRINCIPLE, WHICH INCORPORATES A VARIABLE CAPACITY BETWEEN ASTATIC COILS, TOGETHER WITH AN ALTERNATIVE H.F. BY-PASS

READY RADIO
159, BOROUGH-HIGH ST.,
LONDON BRIDGE, S.E.1.

Phone: HOP 5555

WHAT'S NEW

—continued from page 275

the Ultra Air-Chrome chassis could be slid. The chassis, by the way, is not sold for use as it stands, and therefore some form of cabinet is needed. A practical application of this speaker will be found in the WIRELESS CONSTRUCTOR All-Electric Gramophone, described in the current issue.

The smaller models also have an excellent sensitivity and frequency response, and we understand the manufacturers are selling them in handsome cabinets. The price of the 18 in. by 23 in. chassis, which, by reason of its extraordinarily good performance, will make a wide appeal to the more discriminating listener, is four guineas, and, used with a distortionless amplifier such as the 1929 Super-Quality Amplifier, or with any good modern set capable of reproducing a good range of tone, this speaker will be found to be a real delight to use.

We must congratulate the manufacturers on this instrument and also on their enterprise in publishing a response curve of the speaker. The need for such curves has often been emphasised in these pages.

Ferranti Mains Unit

Although Messrs. Ferranti are best known for their excellent low-frequency transformers, they are by no means inactive in other directions, and the Ferranti H.T. supply unit which we have received for test is certainly in the very front rank of such units. It is not a cheap product (the price is £13 10s.), but it is nevertheless good value, for not only is the unit capable of giving 100 milliamperes at 200 volts, but the rectifying and smoothing system and means of adjusting output voltage are all of the highest quality.

Unlike most mains units sold, the Ferranti H.T. supply unit utilises the anode-feed system, which is certainly the best means of preventing interaction and eliminating tendencies to motor-boat. It requires more elaborate construction, and is therefore more expensive.

The virtues, however, are such that this mains unit will give a perfectly satisfactory performance with certain commercial sets which motor-boat violently and generally become hopelessly unstable with practically all other types of mains units sold.

The Ferranti H.T. supply unit is housed in a metal safety cabinet which is so arranged that it is impossible to open the lid without first shutting off the current from the mains. Two fuses are fitted, while the rectifier is the Westinghouse full-wave metal type fed by a Ferranti mains transformer. The filter system comprises both chokes and resistances as well as condensers, and the whole unit complies with the latest safety regulations of the Institution of Electrical Engineers and the supply authorities.

No less than five H.T. tapings are provided, and one can arrange the Ferranti interchangeable wire-wound resistances to give any voltage values needed. Change of voltage calls for a change of resistance, so a voucher is provided with the mains unit entitling the purchaser to change the resistances fitted for other values if required. The resistances fitted will, however, be found suitable in the great majority of cases.

Altogether this is a first-class instrument having certain definite advantages which well justify the fairly high price at which it is sold.

Useful Grid-Bias Battery

From The Marconiphone Company, Ltd., we have received a sample of their new 24-volt grid-bias battery tapped at every 1½ volts. The growing use of super-power valves requiring up to this figure in grid bias makes the need of such a battery felt by all experimenters, and we certainly welcome this addition to the Marconiphone lines. The battery measures 13½ by 7 by 2½ in. deep, and costs 5s. 3d., and we anticipate a very considerable demand for this most useful accessory.

Interesting New H.F. Choke

Messrs. Radio Instruments, Ltd., have just placed on the market a new radio-frequency choke designed to fill the new conditions in which such chokes are nowadays used, as well as to be perfectly satisfactory in the more normal usages.

The new choke is thus specially suitable for choke coupling as well as acting satisfactorily in all ordinary reaction circuits. Our tests show that the makers' claims for uniform choking effect are justified and the astatic feature also is one we welcome.

It can, indeed, be termed a universal high-frequency choke and will be found to function excellently in all designs published in this journal. This new choke is fully recommended to our readers.

FOR PERFECT VOLUME CONTROL

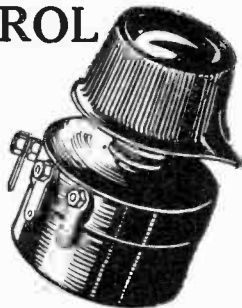

THE GAM-BRELL VOLUVERNIA

This is the ideal volume control for radio receivers and gramophone pick-ups. Gives firm, yet smooth action, has correct resistance value, accurate in construction and most compact. One turn of the knob controls volume from full strength down to the merest whisper without impairing quality. **PRICE 6/9**

STAND 62 OLYMPIA No mains user should be without the Gam-brell Twin Fuse Unit. Designed to blow at 1 amp., it fully protects Eliminators, Chargers, etc., also the house lighting system from damage. **PRICE 6/6**

FROM ALL DEALERS.

GAMBRELL RADIO LTD.

6, Buckingham St., Strand, W.C.2.

Please be sure to mention "Wireless Constructor" when communicating with Advertisers. Thanks!

WHY WORRY!

to make your Wireless Set when we will **BUILD AND TEST ANY RECEIVER FREE OF CHARGE?**

The Customer pays for Components and Marconi Royalty only.

ALL SETS made, Master 3 S.G.P., Titan 3, Lissen S.G., Osram Music Magnet, all "Constructor" Circuits, etc., etc.

EASY TERMS quoted by return. We have **EVERYTHING WIRELESS**

Complete Sets, Components, Loudspeakers, H.T. Units, Portables, etc.

Call or send a list of your requirements.

BEST MONTHLY TERMS BY RETURN.

The P.D.P. Co., Ltd. (Dept. "C"), 121, CHEAPSIDE, E.C.2.

Telephone: National 9846.



MICROFU

Stocked by all first-class Dealers **Saves Valves**

Complete Microfuses embody an entirely new principle in fuse construction. This is a gold fuse—no wire. Absolutely reliable. 100 per cent. British. As specially specified for use in The Air Commander, by Mr. Percy W. Harris, M.I.R.E.

Refills 1/6

MICROFUSES LTD., 3, Finsbury Sq., London, E.C.2

Make **The DAILY SKETCH** YOUR Picture Paper

ALL APPLICATIONS for ADVERTISING SPACE in "WIRELESS CONSTRUCTOR" must be made to the Sole Advertising Agents, **JOHN H. LILE, LTD., 4, LUDGATE CIRCUS, LONDON, E.C.4.**

A SIMPLE R.C. UNIT

By A. S. CLARK.

A SIMPLY assembled R.C. unit can be made out of components which the constructor is likely to possess already. There are three essential parts in an R.C. unit—the anode resistance, the coupling condenser and the grid leak. It is quite a usual practice nowadays to use a 1/4-megohm grid leak as the anode resistance, and this scheme is employed in the unit to be described.

The Parts Required

The following parts will be required: One .01 fixed mica condenser; this may be of any ordinary type to which grid-leak clips may be attached. One 2-megohm and one 1/4-megohm grid leaks. Two insulating grid-leak clips, and two ordinary grid-leak clips which will go with them.

Under either of the condenser terminals one insulating and one ordinary grid-leak clip have to be

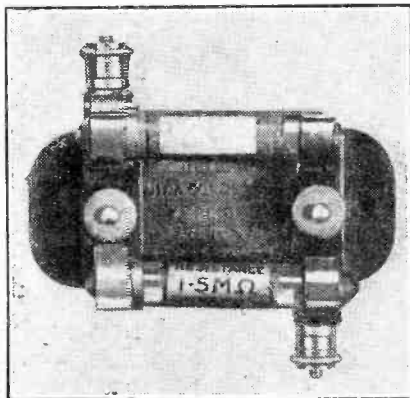

Here is the device all ready for use.

fitted. The insulating clips must be on opposite sides of the condenser, as also must the ordinary clips. The insulating clips are Dubilier, but apart from these the makes of the parts are immaterial.

Circuit Connections

When the grid leaks are in position, the unit is ready for connecting up. The terminal of the condenser that is connected to the 1/4-megohm grid leak has to go to the plate of the valve, and the other condenser terminal to the grid of the following valve.

The insulating clip connected to the remaining end of the 1/4-megohm grid leak goes to grid-bias negative, and the other insulating clip to H.T. +. The photograph shows clearly how the unit appears when assembled

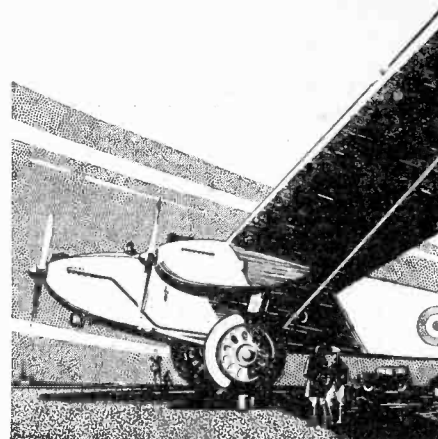

ENGINEERING PRECISION

When this huge Monoplane first streamed, roaring through the air, climbing, banking, diving, looping, its safety seemed a miracle—a favour from the gods. Yet it was not. It was the final compliment to man's toil, to the months of care expended on it, to the brains that designed it, to the accuracy and precision lavished on its construction.

Engineering precision is a feature of all J.B. wireless instruments. This J.B., S.L.F. Condenser (Plain Type) is made as if lives depended on its accuracy. And that is how a condenser should be made. The S.L.F. has the same mechanical and electrical features as the Logarithmic type, except that the Vane form is our very popular True Tuning S.L.F. Remember that True Tuning S.L.F. means selectivity with ease of tuning.

PRICES

complete with 4-in. Bakelite Dial:

.0005 - 11/6 .00035 - 10/6
.00025 - 10/- .00015 - 10/-

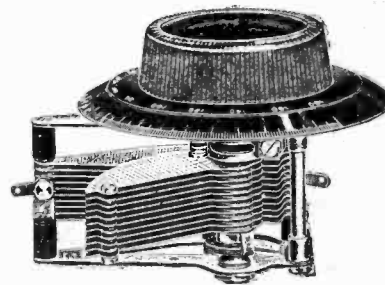

PRECISION INSTRUMENTS

Adv. of Jackson Bros., 72, St. Thomas' Street, London, S.E.1. Telephone: Hop 1837.

RAYMOND'S

27 & 28a, LISLE ST., LONDON, W.C.2
 Come to LEICESTER SQUARE TUBE
 This address is at the back of Daly's Theatre
 Phones: Gerrard 4637 and 2821

HOURS OF BUSINESS EVERY DAY 9 to 8
 SATURDAY 9 to 9
 SUN. MORN 11 to 1

"TITAN" UNIT

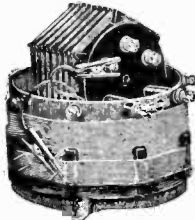

APPROVED EDITOR 15/-

THE "EASY" PAY HAS COME TO STAY
RAYMOND'S IS THE "ONLY WAY" BUY OUT OF INCOME
 (ORDERS OVER £3) All leading components stocked.

SPLENDID 3 VALVE LOUDSPEAKER SETS

READY TO USE.
 In Handsome Cabinet.
 Receives London, 5GB, 5XX, and many Continental Stations.

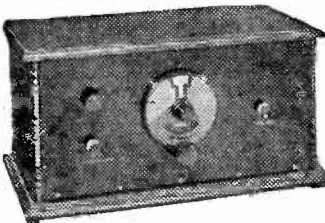

65/-

Nett Cash. Carr. and Packing 3/6
READY TO USE.
 Tax Paid.

STRAIGHT 3 CIRCUIT, OR MASTER 3 STAR CIRCUIT
JUST SWITCH ON—THAT'S ALL.
 Complete with 3 Dull Emitter Valves, S.M. Dial. All parts on Baseboard. Hinged Lid. Various Panel Designs.

ALSO

Splendid 2-valve sets with Dual coil for long and short wave, in cabinet, as above, S.M. Dial, 2 D.E. Valves. Nett cash 52/6
 Carriage and packing 3/6

Mullard Master 3 Star Circuit in Cabinet with Tunewell Dual Coil and 3 Mullard Valves. Nett cash 84/-
 Carriage and packing 3/6.

Or complete with 120-v. H.T., 2 L.T. Batteries, Cone Loud Speaker, Battery Cords, Aerial Equipment, with Set, Coil and Valves, ready to use. First payment of 19/6 and 11 monthly payments of 14/9
 Carriage and packing extra.

MULLARD S.G.P.

(Screened Grid, Detector, Pentode).
 Aluminium Panel, ready to use, 5/6; Junit Planoboard, 2/-; J.B. pair of Condensers, fitted Drum Dials, 40/- pair; Bebb's 0003, 8/-; Rheostat, 2/6; Benj. Batt. Switch, 1/3; 2 6-pin Bases, 4/-; Aerial and Anode Coils, H.P.O., 9/6; 2 H.V. Valve Holders, 3/6 pr.; 1 Valve Holder, 2/-; Mullard Combined Base, 0003, and Leak, 7/6; Chimax H.F. Choke, 7/6; Permacore L.F., 25/-; 2 Junit Mounts, 1/3; 4 Terminals, B.L., 2/-; Magnum Brackets, 2/6; Metal Screen, 10/6; 01 Fixed, 3/-; 25 Mansbridge, 2/3; J.B. Clips, Plugs, and Spades, Links, Flex and Screws, 3/6 the lot. (Coils for 5XX, 10/6 pr.)
 Cabinets from 25/- 3 Valves £218 0.
 Will quote inclusive cash price.
 or 18/6 first payment, very easy monthly payments after.

KITS OF PARTS FOR ALL CIRCUITS
 PLEASE SEND DETAILED LIST OF REQUIREMENTS

CASH OR EASY TERMS

PARTS, SETS, PORTABLES, H.T. UNITS
 We have some wonderful designs in Cabinets, with Battery space under for 18 x 7 panel.
 Cash or Easy Terms.

C.O.D. ORDERS OVER 10/- PAY POSTMAN

PRIMARY CELLS FOR FILAMENT HEATING

Some interesting facts and figures, together with many valuable hints and tips, are given in this practical article.

By R. W. HALLOWS, M.A.

THERE are many who, finding it impossible or inconvenient to get accumulators charged, make use of primary cells of one kind or another for heating the filaments of their valve receiving sets. Others who are without reasonable facilities for accumulator charging have possibly not realised that primary cells can be used and therefore confine themselves to the crystal receiver.

To both classes of readers some hints founded upon the results of practical tests upon the use of such cells may be of considerable use.

Wet Batteries

We may divide primary cells at once into two main classes: the wet and the dry. Wet cells include the Leclanché, the Daniel, the Bichromate, and the Fuller, all of which have certain possibilities which will be discussed in a moment.

Up to the present only one kind of dry cell has been evolved, at any rate as a popular commercial article. This is some form of the Leclanché.

The Leclanché cell has a carbon positive* electrode and a zinc negative.* These are immersed in a solution of sal-ammoniac and water. The action of the cell is very roughly as follows:

When the battery is placed upon closed circuit the electrolyte attacks the zinc, dissolving it away. Owing to the fact that the metal can pass into the solution only in the form of positive ions, the zinc thus obtains an excess of electrons and becomes negatively charged, whilst the solution receives an excess of positive ions and becomes positively charged.

The carbon rod is not acted upon in any way by the electrolyte; it serves merely to form a contact between the circuit and the positively charged solution. During discharge, however, hydrogen bubbles tend to cluster round the carbon rod, and if these were

allowed to accumulate the increasing resistance would soon put the cell out of action.

The rod is therefore surrounded by a depolariser consisting of a mixture of manganese dioxide and powdered carbon or graphite. (A molecule of manganese dioxide consists of one atom of manganese in combination with two of oxygen.)

It readily gives up one of its oxygen atoms to combine with two of hydrogen, thus allowing the formation

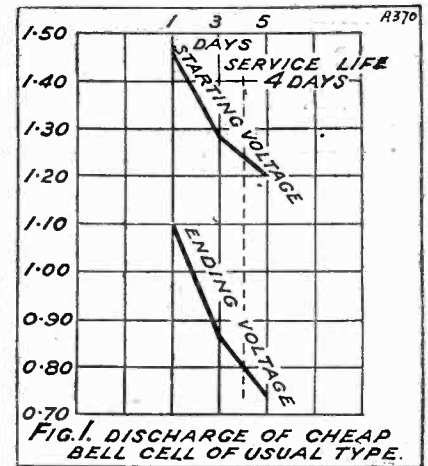

FIG. 1. DISCHARGE OF CHEAP BELL CELL OF USUAL TYPE.

of H₂O, or water. In this way the hydrogen is dispersed and a minute amount of water is added to the electrolyte.

The Dry Cell

In the wet cell we have, as a rule, a glass jar within which is a zinc rod and a porous pot containing the carbon electrode and its surrounding depolariser. In the dry cell the pot is made of zinc and itself forms the negative electrode.

The electrolyte is a paste or jelly made of sal-ammoniac and water and plaster of Paris or gum. There is no porous pot, but the carbon electrode is contained in a bag or sac filled with depolarising compound. The wet Leclanché cell can be recharged (unless the zinc or the depolariser are worn out) by merely changing the electrolyte.

The dry cell cannot be recharged profitably. The task could be

(Continued on page 303.)

* To avoid confusion, the electrode to which the negative terminal of a cell is attached is referred to throughout this article as the negative electrode, and that to which the positive terminal is attached as the positive.

**CONDENSERS
COME AND
CONDENSERS
GO** but

**HYDRA
stays on !
for ever**

PRICES :

Test Voltage 500
D.C. Working
Voltage 240 D.C.
or 160 A.C.

*001-1 MFD. 1 6
25 MFD. . . 1/9
5 " . . . 2/-
1 " . . . 2/2
2 " . . . 3/-
3 " . . . 4/-
4 " . . . 5/-

You can count the makers of condensers by the dozen—but the only condenser that counts is HYDRA. Because HYDRA have been making condensers all the time—HYDRA have never made anything but condensers—HYDRA therefore know more about the making of condensers than the rest.

That is why HYDRA sales are growing—that is why you too should insist on HYDRA.

—LOUIS—
HOLZMAN
37, Newman St.,
London, W.1.
Phone: Museum
—2641

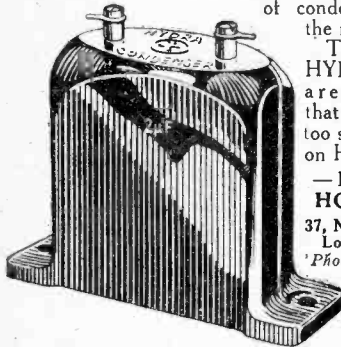

**SOLVE ALL
H.T. TROUBLES**

Per doz.	No. 1.	No. 2.
	s. d.	s. d.
Jars (waxed) -	1 3	1 6
Sacs -	1 2	1 9
Zincs -	10	11
Rubber Bands (24) -	4	4
Terminals -	8	10

Special sizes for Pentodes.

WET BATTERIES

TAYLEX

— SELF GENERATING —



LONG LIFE : SILENT : ECONOMICAL

Sample doz. (18 volts), complete with bands and electrolyte. No. 1, 4/1; No. 2, 5/-; post 9d. terminals extra. No. 3, with terminals, 7/6 (10,000 mill-amps), sample unit 6d. Orders 10/- carr. paid. New illustrated catalogue post free.

FREE Bargain List of Receivers, Amplifiers and Components.

C. TAYLOR, 57, Studley Road, Stockwell, London.

For the Best in Radio

WILL DAY LTD.

(THE BEST IN THE WEST)
10 LISLE STREET, LEICESTER SQUARE, LONDON, W.C.2.

OPEN TILL 7 P.M.
WRITE FOR OUR CATALOGUE
POSTAGE 84 PENCE TO GUILDS

Advertisements

As far as possible all advertisements appearing in "Wireless Constructor" are subject to careful scrutiny before publication, but should any reader experience delay or difficulty in getting orders fulfilled, or should the goods supplied not be as advertised, information should be sent to the Advertisement Manager, "Wireless Constructor," 4, Ludgate Circus, London, E.C.4

**PRIMARY CELLS FOR
FILAMENT HEATING**

—continued from page 302

performed provided that the zinc pot was not eaten through, but it would certainly not be worth while.

On the score of economy then it would seem that some kind of wet cell might be preferable for filament heating. Let us consider those that could possibly be used for the purpose.

The Voltage Drop

It may be said at once that the commercial wet Leclanché cell such as is used for working electric bells is absolutely unsuitable for the purpose. It is designed to supply a moderate amount of current—say from .25 to .5 ampere—for a second or so at fairly long intervals. A slow-acting depolariser is therefore used, and if the cell is placed on closed circuit for any length of time the voltage falls off very rapidly.

A special form of large sac Leclanché cell was placed on the market some time ago for heavy-duty purposes. In this the negative electrode takes the form not of a rod but of a cylinder, and instead of a porous pot a sac filled with a quick-acting depolarising compound is fixed round the carbon electrode.

If large-sized cells of this type are used fairly satisfactory working may be looked for. There are, however, certain points which require attention. Zinc as first produced from the ore contains a large amount of impurities and it is exceedingly difficult to refine it into a pure state.

Preventing "Local Action"

Since the impurities are largely composed of other metals, immersion in the electrolyte causes what is known as local action to be set up even when the battery is on open circuit. We may in fact regard an impure zinc plate as a collection of a vast number of tiny cells each of which is generating current when the metal is placed in a sal-ammoniac solution.

Current cannot be produced in the primary battery unless something is consumed, any more than heat can be produced in a boiler without the burning of coal. Every cell is in fact a little furnace in which zinc is burnt instead of coal.

When local action takes place the zinc is rapidly destroyed. Luckily, there is a way of minimising it. If

(Continued on page 304.)

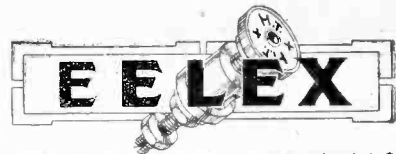

**TREBLE-DUTY TERMINALS
—for multiple
connections!**

They are the most efficient and adaptable terminals for the home constructor and experimenter. Use them in a variety of circuits in conjunction with EELX.

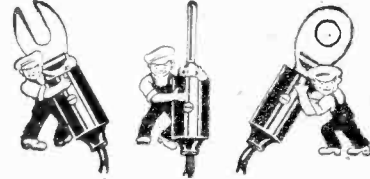

SPADES, PINS & EYES

There are 40 different indicating tops to the EELX Treble-Duty Terminal and six colours. Price (T2LC) 41d. each, or with plain tops (T2LM) only, 3d. each. Spades, pins and eyes are also made in 6 colours and cost 2d. each.

Write for new Catalogue Y71, which describes in detail all EELX Wireless accessories.

J. J. EASTICK & SONS

Eelx House,
118, Bunhill Row, London, E.C.1.

REPAIRS

Any make of L.F. Transformer, Loudspeaker or Headphones repaired and despatched within 48 HOURS—TWELVE MONTHS' GUARANTEE with each repair. 4/- Post free.

Terms to Trade.

TRANSFORMER REPAIR CO.,

Dept. "C"
214, High Street, Colliers Wood, London, S.W.19



**A
Bureau
for
Your
Wireless!**

ADAPTABLE TO ALL SETS!

Nothing to touch! The snug way those untidy, dusty parts, trailing wires and batteries are compactly enclosed will delight you. As a beautiful piece of furniture, the "RADIOLA" will add pride to the home because it is modern and stylish. Already over 3,000 delighted users. Highly recommended by the Radio Press and leading experts. "Radiola" de luxe, from £5.5 to £11.11. "Popular" Oak Model, from £3.15.

Cash or Easy Payments. A stately British-made Cabinet, trade-marked and guaranteed, sent on APPROVAL (if you wish to part with it we will willingly refund FULL MONEY and pay return carriage too!)

Full particulars, Booklet and Photographs FREE (they will interest you!) from the actual makers:

PICKETT'S, WIRELESS FURNITURE MAKERS,

"WC" WORKS, BEXLEY HEATH, KENT. Established since the beginning of Broadcasting.

The Picture Paper with the MOST News

—SUNDAY GRAPHIC—

PRIMARY CELLS FOR FILAMENT HEATING

—continued from page 303

mercury is allowed to run over a clean zinc surface it combines to form an amalgam. But it is only the zinc upon which it acts; it will have nothing to do with the other metals.

When therefore a zinc rod or cylinder has been amalgamated, it presents always to the electrolyte a surface of pure zinc. Local action is thus minimised and the life of the zinc is greatly prolonged. It follows that in any wet Leclanché cell used for filament heating purposes the zinc element should always be thoroughly amalgamated before the cell is charged.

This can be done by placing it for a short time in dilute sulphuric acid, washing it well, and then running a little mercury over its surface. Attention to this point will lead to a very great economy in the matter of zincs.

Advantages of the Leclanche

The advantages of the wet Leclanché cell are that its initial cost is comparatively low, that it can be recharged without difficulty, and that worn-out zincs or sacs can be replaced as required. Its drawbacks are that even if it is of large size the E.M.F. falls rapidly when it is placed under load, so that unless one is constantly adjusting the rheostats the best is not got out of the valves.

Another "possible" wet cell is the bichromate, which has again electrodes of zinc and carbon, but the electrolyte and the depolariser are different. Dilute sulphuric acid is used for the former, and bichromate of soda or bichromate of potash for the latter.

A variation of the bichromate cell is the Fuller. In this a porous pot is used to contain the carbon element and the depolariser. There is rather less local action, and the discharge curve is a little better, but the Fuller

cell has too many disadvantages to make it really suitable for general use as a source of filament current supply.

One of the best of all wet cells, and one which seems most likely to be useful for filament current supply, is the Daniel. In its simplest form zinc and copper electrodes are immersed in a solution of zinc sulphate and copper sulphate. The latter being the heavier remains at the bottom and acts as the depolariser. The zinc sulphate solution floats on top of it.

Electrolyte Risks

This battery has an E.M.F. of a fraction over 1 volt, and it gives a remarkably steady current for long periods on end.

On the whole one would recommend to any wishing to use wet batteries for filament heating purposes the porous pot form of the Daniel cell rather than anything else. It is by no means costly to run and it requires very little attention indeed.

Every wet cell, however, has the same disadvantages. It has to be treated with a certain amount of care since a breakage might be disastrous; it is rather messy and many people will not care about having any strongly corrosive fluids in the living rooms of their houses, where there is always a risk of children or domestic animals making too close an acquaintance with them.

Choosing Dry Cells

On the whole, if a primary battery is to be used instead of an accumulator for supplying filament current, I am strongly in favour of one made up of dry cells. Though they cannot be recharged, they are not over-costly; in fact, it is doubtful whether they cost much more to run than wet cells when we take into consideration the cost of renewing zincs, depolarisers, and electrolytes.

The dry cell is absolutely safe, and it requires no attention whatever.

A further point to consider is that an enormous amount of research work has been done by manufacturers in all parts of the world with a view to perfecting the dry cell

In the last twenty years comparatively little has been done in the way of improving wet primary batteries, but the dry cell has made tremendous strides. Weight for weight, the dry Leclanché cell has a far larger capacity than the wet, and the action of the depolariser is so good in specialised cells that a wonderfully level discharge curve results.

This does not mean that any dry-cell is suitable for supplying low-tension current to the wireless set. Those who merely go to the nearest dealer in electrical goods and purchase so many dry cells without specifying any particular kind are asking for trouble. What they will receive in nine cases out of ten is the ordinary bell cell, measuring about 2½ in. in diameter and 6½ in. in height.

A Four-Day Test

These cells are designed, like the ordinary wet Leclanché cell, for intermittent work with long periods of rest. The depolariser acts rather slowly, and the E.M.F. falls rapidly on closed circuit. Fig. 1 shows the discharge curve of one of these cells under a load of .3 ampere for three hours a day.

The load during the test was kept approximately constant by means of a variable resistance and an ammeter. It was found, however, that the rheostat required almost constant attention owing to the way in which the potential declined.

Bell cells are not suitable for wireless work, as the graph showing a service life of only 4 days clearly proves. To use them for this purpose is to ask them to perform work that they are not fitted to undertake.

(To be concluded.)

INDEX TO ADVERTISERS

	PAGE
Brown, S. G., Ltd.	Cover ii
Burne-Jones & Co., Ltd.	294
Best Way Wireless Books	295
Carrington Mfg. Co., Ltd.	297
Celestion, Ltd.	292
Cossor, A. C., Ltd.	246
Day, Will, Ltd.	303
Dubilier Condenser Co. (1925), Ltd.	298
Eastick, J. J., & Sons	303
Edison Swan Electric Co., Ltd.	296
Ever Ready Batteries	245
Formo Company, The	297

	PAGE
Gambrell Radio, Ltd.	301
Garnett Whiteley & Co., Ltd.	293
Holzman, Louis	303
Hughes, F. A., & Co., Ltd.	285
Igranic Electric Co., Ltd.	289
Impex Electrical, Ltd.	289
International Correspondence Schools, Ltd.	297
Jackson Bros.	301
Lissen, Ltd.	283
London Electric Wire Co. & Smiths, Ltd.	291
Microfuses, Ltd.	301
Metro-Vick Supplies	Cover iii
P. D. P. Company	301
Pickett's Cabinet Works	303
"Popular Wireless" Blue Prints	299
Radio Instruments, Ltd.	Cover iy

	PAGE
Raymond, K.	302
Ready Radio	300
Rothermel Corporation, Ltd.	294
Telegraph Condenser Co., Ltd.	299
Telsen Electric Co., Ltd.	296
Transformer Repair Co.	303
Taylor, C.	303
Ultra Electric, Ltd.	293
Varley Products	291
Weston Electric Inst. Co., Ltd.	297
Wingrove & Rogers, Ltd.	295
Wright & Weaire, Ltd.	298
"Wireless Constructor" Envelopes	297

All communications concerning advertising in "Wireless Constructor" must be made to John H. Lee, Ltd., 4, Ludgate Circus, London, E.C.4. Telephone: City 7261.



The Met-Vick
Model "B"
A.C. type
Eliminator.
H.T., G.B. & L.T.
£8 : 0 : 0

Feed your set from the electric light supply

Do away with the periodical charging of accumulators, and the renewing of dry batteries, by substituting Met-Vick All-Electric valves for your existing valves and coupling the Met-Vick Model "B" Eliminator shown above to your set.

Connected to a lamp socket or wall plug the Met-Vick Model "B" will supply you with unvarying current for H.T., L.T., and G.B. It is remarkably compact, and of regular shape, and can be easily included in existing cabinets in place of batteries.

The Met-Vick Model "B" is also available for H.T. and G.B. only.

Ask your dealer for Section "C" of Radio Catalogue which fully describes all the eliminators shown here.

H.T. & G.B. MODEL
A.C. TYPE 40-100 PERIODS

H.T. & G.B. MODEL A.C. TYPE 25 PERIODS

MODEL 3 H.T. & G.B. A.C. TYPE
40-100 PERIODS

MODEL B
H.T. & G.B. MODEL D.C. TYPE

L.T. MODEL
A.C. TYPE
40-100 PERIODS

SPECIAL 25 CYCLE L.T.
A.C. TYPE FOR
A.C. VALVES

H.T. & G.B.
MODEL D.C. TYPE
100-250 VOLTS

L.T. MODEL D.C. TYPE

MET-VICK ELIMINATORS

METRO-VICK SUPPLIES
(Prop. Associated Electrical Industries Ltd.)
155, Charing Cross Road
LONDON, W.C.2



The Best COMPONENTS for CONSTRUCTORS

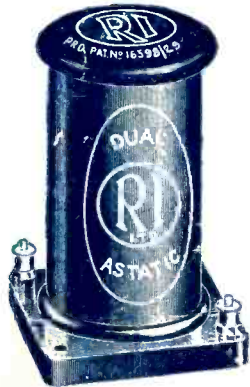

DUAL ASTATIC CHOKE

The first H.F. Choke free from absorption, and the most efficient Choke for modern valves (including screened grid) and modern circuits using parallel choke feed.

7/6

"Dual Astatic" Choke Leaflet Free.

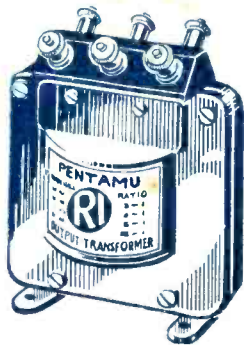

THE "PENTAMU"

A new output transformer specially designed for use with pentode valves. It has four ratios—2:1, 3:1, 6:1 and 25:1. Suitable for any type of loud speaker.

21/-

and the Best RECEIVER yet DESIGNED



The First ALL-ELECTRIC SCREENED GRID TRANSPORTABLE "3"

A wonderful receiver operated entirely from the mains, giving a wide choice of programmes without the use of an aerial. It has only one stage of L.F. amplification, and reproduces speech and music with a degree of fidelity hitherto thought unattainable.

A series of tests made in England and Scotland with both A.C. and D.C. types of this new R.I. Receiver gave astounding results. No aerial was necessary in most places for either local or continental reception, whilst with a small aerial in use a wide choice of loud-speaker programmes of amazing strength and fidelity were reproduced.



THE "HYPERMU"

The remarkable modern nickel alloy transformer, giving the highest and most uniform amplification from 25 to 6,000 cycles. It is the first metal screened transformer encased in Bakelite. Weight 14 ozs. Size 3 in. by 1½ in. by 3 in. A midget in size—a giant in performance.

21/-

"Hypermu" Leaflet Free.



L.F. CHOKE

The Choke adopted as the standard for modern smoothing and output filter circuits. Universally employed, and recommended by the technical experts.

21/-

STANDS 122, 123, 124 AT OLYMPIA FOR THE LATEST IN RADIO

RADIO INSTRUMENTS, LTD., Specialists in Sound Reproduction,

Sole Address: Offices, Showrooms & Factories: 12, HYDE ST., NEW OXFORD ST., LONDON, W.C.1.