

# The Wireless Constructor

6<sup>d</sup>  
MONTHLY

EDITED BY  
**PERCY W. HARRIS. M.I.R.E.**  
Vol. VII.      NOVEMBER, 1928      No. 25.

## IN THIS ISSUE THE "RADIANO" FOUR

MODEL B.  
FOR  
NON-  
SCREEN  
VALVE

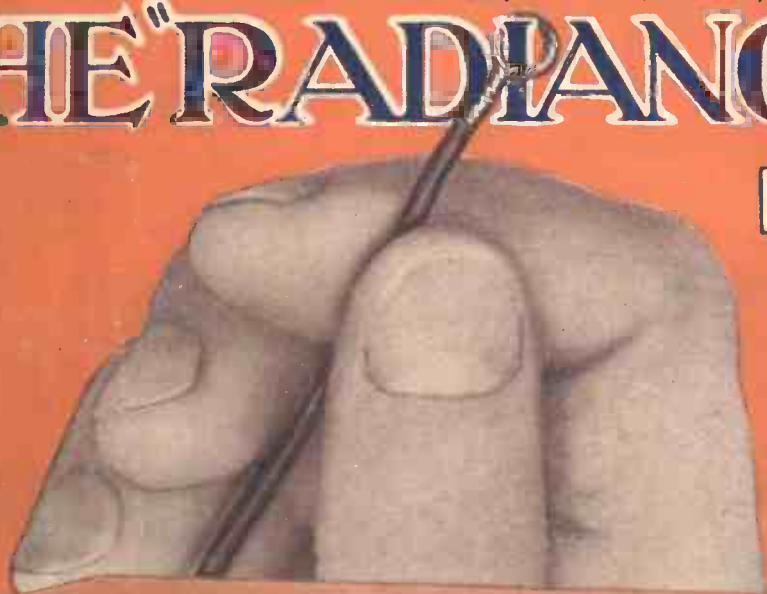

# 4 YEARS AHEAD

In 1924 Mullard invented a filament construction which is only now being attempted by other designers.

This four years' lead is maintained. The 1929 Mullard P.M. Radio Valves which you can now buy are virtually 1933 valves—still four years ahead.

Ask your radio dealer to-day for a set of Mullard 1929 P.M. Radio Valves for your receiver and enjoy better tone, greater volume and more distant stations.



**Mullard**  
**THE MASTER VALVE**

# CONTENTS

	Page		Page
The Editor's Chat	5	Laboratory Notes	33
The Connoisseur's Cone Loud Speaker	7	Squeezing Stations	37
The "Radiano" Four-Model B	9	Radiogramphonics	41
The B.B.C. and Education	15	Within the Vacuum	45
Notes on the "Stedipower" Units	17	Happenings at Savoy Hill	49
Comments from Constructors	19	Chats at the Work-Table	53
The "New-Way" Two	21	In Lighter Vein	57
The Art and Craft of Soldering	25	What's New	61
Getting Reaction with a Frame Aerial	27	Queer Queries	66
An Ultra-Selective Three	29	My Ideal Workshop	72
		Our News Bulletin	74

*As some of the arrangements and specialties described in this Journal may be the subject of Letters Patent, the amateur and trader would be well advised to obtain permission of the patentee to use the patents before doing so.*

EDITED BY

PERCY W. HARRIS, M.I.R.E.

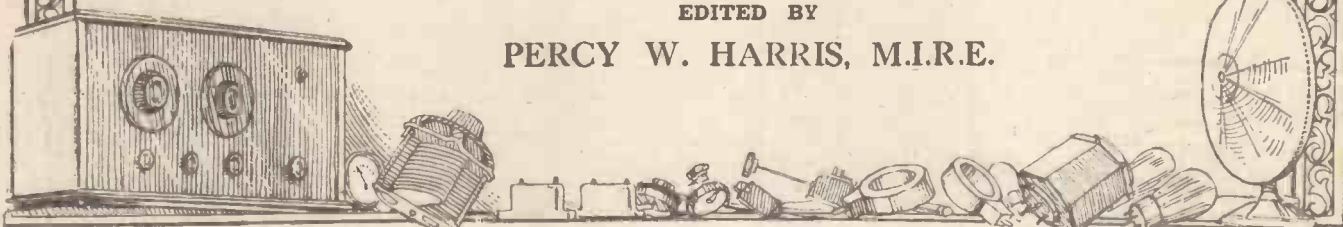

NEW

# MARCONIPHONE

## TRANSFORMERS

All the latest transformer developments are to be found in the new Marconiphone range. In conjunction with the present series they offer a choice which satisfies every demand of the constructor. Send now for descriptive booklet.



Showrooms:—  
 Marconi House,  
 Strand, W.C.2.  
 210-212, Tottenham  
 Court Road, W.1.

**UNIVERSAL TRANSFORMERS.**—These have a higher inductance than any other at a similar price, and offer extraordinary value. Two ratios are available, 2:7 to 1 and 4 to 1. Price 16/-.  
**POPULAR TRANSFORMER.**—An inexpensive but efficient little instrument, suitable for small receivers or portable sets. Price 12/6.

**HIGH-VOLTAGE POWER TRANSFORMER.**—Giving an output of 450 v. H.T. with a Marconi U.8 rectifying valve, it provides entirely for the power stage. Models for 100-125 and 200-250 volt mains, 40 cycles and over. Price £2 15s.

**TRANSFORMERS FOR A.C. VALVES.**—Giving 3.5 volts for Marconi K.L.1 or K.H.1 valves. 3.5 amps. at .8 volt for the new Marconi point 8 valves, and high tension in conjunction with Marconi U.5 valve. Two models. Price, either type, £1 17s. 6d.

**MOVING-COIL FIELD TRANSFORMER.**—Giving an output of 120 volts, 100 m.a. with a Marconi U.8 rectifying valve, and will excite the field of any moving coil speaker taking 100-110 m.a. Two models. Price, either type, £1 17s. 6d.

**UNIVERSAL OUTPUT TRANSFORMER.**—Has centre-tapped primary suitable for standard 4-6,000-ohm valve, pentode valve, or push-pull. Secondary is tapped to match any standard loud speaker. Price £1.

**THE MARCONIPHONE CO., LTD.,**  
 210-212, Tottenham Court Road, W.1.



# Controls That Improve Reception!

## Royalty Variable High Resistances

RECOGNISED for years as the standard of accuracy and dependability wherever resistances of this type are required in the circuit. There is a Royalty for every radio purpose, 11 types in all, designated A to L. Potentiometer and other types in all sizes. 8/- each.

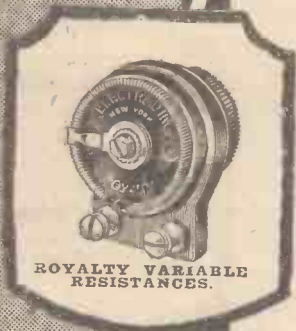

## Tonatrol

### A Complete Line of Volume Controls

In Electrad TONATROLS we offer the perfected and efficient means of volume and sensitivity control. Because of the necessity of specialised volume control in A.C. circuits, we have designed types of Tonatrols to meet the exacting A.C. requirements, as well as for battery power receivers.

Tonatrols, standard, or with filament switch or power switch attached. 8/- to 15/6 each.

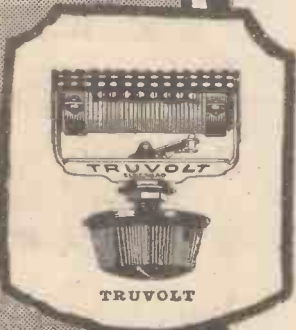

## Truvolt All-Wire Resistances

In Truvolt Variable Resistances the contact arm slides lengthwise over the turns of resistance wire; hence there is practically no wear on the resistance element. Their easy potentiometer control eliminates difficult calculation, and permits easy adjustment to valves and line voltages. 22 stock sizes. 15/6 each.

An exclusive feature of Truvolt Fixed Resistance is that the values can be changed and set at any point desired by the use of sliding clip taps. Made in all resistance values and current ratings of 25, 50 and 75 watt.

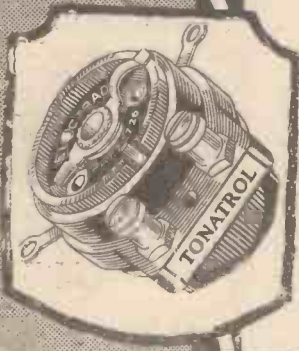

Please send me descriptive folder on all Electrad products and put me on your mailing list for similar literature.

I am particularly interested in .....

Name .....

Address .....

Represented by The  
**ROTHERMEL CORPORATION, LTD.,**  
 24-26, Maddox Street, London, W.1.

Phone: Mayfair 0578-9, 4285. Telegrams: "Rothermel," Wesdo, London.

# ELECTRAD

Inc

*Good News!*  
*Foremost in Quality.*  
*Lowest in Price.*

Magnavox leads again. The only moving coil speaker that has stood through every period of speaker development. Supreme in the beginning—supreme to-day.

Remember that all Magnavox units are supplied complete with Input Transformer, Filter System, 10-foot Input and Field Cords and Field Switch.

**DON'T HESITATE — BUY A MAGNAVOX.**

*Licensed under Lektophone Patents and manufactured under exclusive Magnavox patents.*

**Models for A.C. or D.C.**

TYPE D.80/1. For operation from A.C. lighting mains, 100/120 volt, 50/60 cycle, A.C. . . . . .	£11 0 0
TYPE D.80/2. For operation from A.C. lighting mains, 200/240 volt, 50/60 cycle, A.C. . . . . .	£11 0 0
TYPE R.5. For operation from D.C. lighting mains, 100/240 volt D.C. . . . . .	£8 5 0
TYPE R.4. For operation from 6-volt accumulator or Trickle Charger. Consumption $\frac{1}{2}$ amp. . . . .	£8 0 0
TYPE M.7K. Balanced armature unit . . . . .	£3 2 6
New Belvedere Fire Screen Baffle . . . . .	£4 0 0

**“THE GREAT VOICE”**

“The Great Voice” is a 32-page booklet, profusely illustrated and written entirely in your interests with a view to enabling you to obtain those better results for which you have persistently longed. This booklet tells you all about moving-coil speakers, baffles, power amplifiers for A.C. or D.C. volume controls and gramophone pick-ups. Send for your copy to-day. Price 3d., post free.

**THE  
 ROTHERMEL CORPORATION, LTD.,  
 24-26, Maddox Street, W.1.**

*Phone: Mayfair 0578-9, 4286.*

*Telegrams: “Rothermel, Wesdo, London.”*

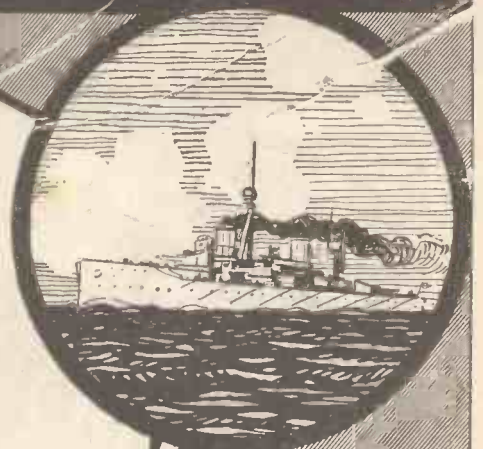

**MAGNAVOX**

**Here it is**  
 The wonderful **NEW**  
**Cossor Melody Maker**  
**THE SENSATION OF OLYMPIA**



**FILL IN THIS COUPON NOW!**

This wonderful new "Melody Maker" gives "knife edge" selectivity.... better tone... enormous volume.... longer range.... it will bring you programmes from over 20 stations.... amazingly simple to build.... no drilling.... no soldering.... no wireless knowledge required.... it's as simple as Mecano..... everything you need packed in a sealed carton.... even the tools.... and the handsome all-metal cabinet.... and the three Cossor Valves.... absolutely nothing more to buy.... fill in the coupon now!

**Built by anyone  
 in 90 minutes**

.....  
 Please send me free of charge one of your Constructor Envelopes which gives full details of the new Cossor Melody Maker.  
 Name.....  
 Address.....  
 W. Cass. Nov.

# The WIRELESS CONSTRUCTOR

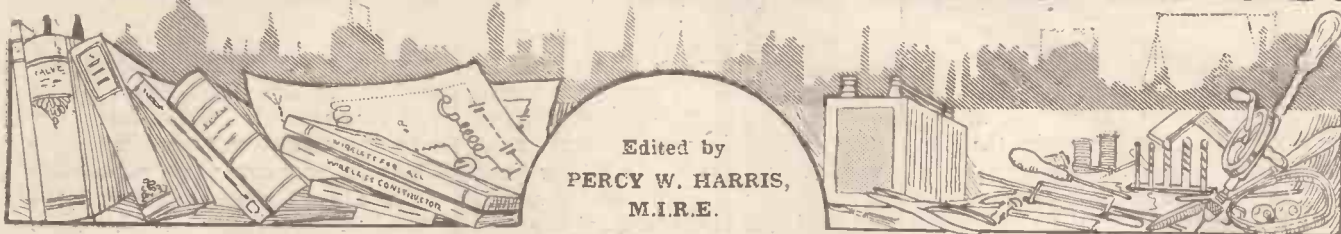

Published by the Amalgamated Press, Fleetway House, Farringdon Street, E.C.4.

## THE EDITOR'S CHAT

In which Percy W. Harris, M.I.R.E., the Editor of the "Wireless Constructor," discusses the recent Wireless Exhibition and other items of interest.

WITH the "Wireless Exhibition" over and the autumn season well started, it is interesting to take stock of affairs and to see just how we stand in the art of radio to-day.

Firstly, it is clearly evident that radio has passed the "stunt" stage, and that novelty alone is no longer an appeal. True, ridiculous and extravagant claims are still made for some commercial sets, notably one or two "portables," but in the main both sets and components are now honestly sold to a public which no longer accepts fantastic statements without proof.

As was to be expected in an industry which is now becoming stabilised on common-sense lines, the exhibition produced no startling novelties, but it did demonstrate an all-round and gratifying improvement in both sets and components. Once again, too, valves showed a marked improvement in efficiency and a welcome reduction in price. It is significant that this year's 2-volt super-power valves give a performance practically equal to last year's 6-volters, so that the reader who, for various reasons, is still compelled to use a 2-volt accumulator, no longer has to suffer a reproduction inferior to that obtainable with 6-volt valves.

### The "Stedipower"

Very considerable interest was shown at the exhibition in the Harris "Stedipower" L.T. Unit, which delivers the listener with A.C. mains from the bondage of accumulators, while in conjunction with any good H.T. mains unit it enables

practically any set to be run entirely from the A.C. mains. Many new mains H.T. units were shown, and a number of valves are now available with filaments lit directly by alternating current without any special smoothing.

The all-important question of quality of reproduction has many interesting facets. So far as the transmissions are concerned, although theoretically they are not yet perfect, in practice they reach the highest standards of quality, so that any lack

of naturalness in reproduction can, in ninety-nine cases out of a hundred, be attributed to the receiver and its accessories. Valves are now available which will handle very great power and deliver without distortion as much energy as we can handle providing we feed them properly with high-tension supply.

### On the L.F. Side

In low-frequency coupling devices both resistance-capacity and choke or transformer-coupling are, if properly used, all as good as one another, provided, of course, that the right components are chosen and used. In our opinion, it is now possible to make a transformer-coupled amplifier which, judged by ear, will give just as perfect reproduction as that obtainable with a resistance amplifier, although problems in design often make it advisable to use a combination of the two methods of coupling.

The loud-speaker position is rather curious, and is subject to definite changes of fashion from time to time. In the early years of broadcasting, when neither transmitters nor receivers had been freed from certain gross defects, volume rather than quality was often aimed at. The horn type was quite efficient for converting electrical input into sound output, but tended to exaggerate the higher tones while repressing any low tones (very few!) which happened to pass through the receiver. The advent of the cone type of speaker, with its greatly improved reproduction of low tones, was certainly a big step forward in the direction of natural

### A GERMAN TELEVISOR



There were several systems of Television on show at the recent Berlin Radio Exhibition. One of the televisors is shown above.

## The Editor's Chat—continued

reproduction, but the enthusiasm for the newly-found low tones caused many users to overlook the fact that the average cone is woefully deficient in the higher register! Of the cone loud speakers on the market at the present time many obtain the low notes by what is generally termed "box resonance," characterised by that "woofiness" which is so irritating to the discriminating ear.

### Brighter High Notes

Designers then turned their attention to a better reproduction of the higher notes, and there are several

in natural reproduction—and a revelation to the listener who first hears it. During the last season a very large number of moving-coil speakers and sets of parts were placed on the market. The reproduction of many of them is so good that the users were prepared to overlook their great weight, poor efficiency so far as the conversion of electrical input to sound output is concerned, and the need of supplying the magnet with energising current either from the mains or from an accumulator. The much more faithful reproduction given by moving-coil speakers has taught us how

Because of the difficulties of high-tension supply any improvement in the efficiency of loud speakers is of the greatest importance. An experimental model of a new loud speaker recently came into our laboratory, and on trial proved to be twice or three times as efficient as the most sensitive instrument we had previously tried, while giving a quality comparable with that supplied by the best moving-coil instrument.

### SWITCHING THE "RADIANO" FOUR

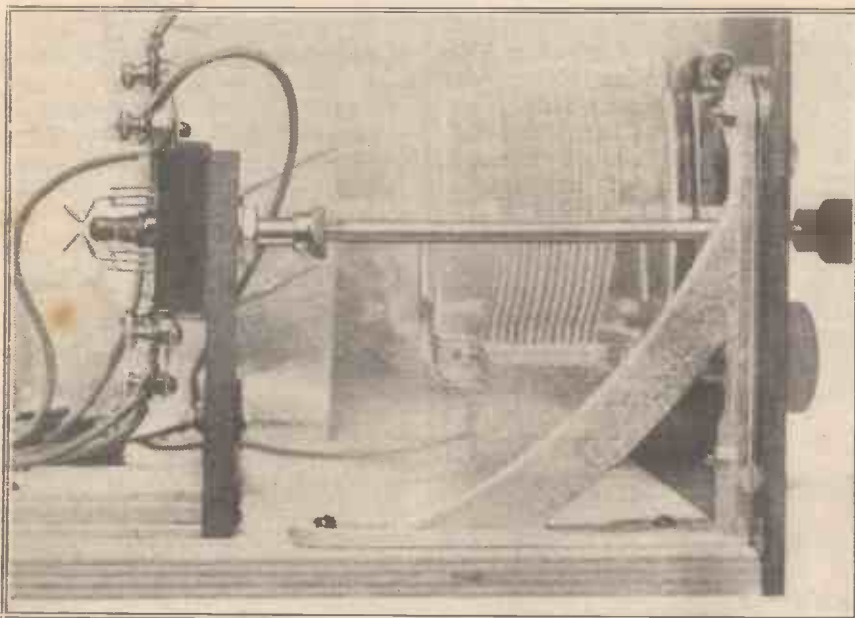

The method of mounting the switch and extension rod for the "Radiano" Four's first grid and aerial circuits is clearly shown in this photograph. (The original "Radiano" Four was described last month.)

cones the design of which has been arranged to give the high notes better at some sacrifice of the lower. Reproduction from these instruments is thus intermediate between some cones and the older horns. Sharpness and clarity of speech and, in particular, the proper reproduction of the "s" sound, require an adequate reproduction of the higher notes; the lower being much less important in this case, which accounts for the fact that some loud speakers are very good on speech and poor on music, while others are good on certain classes of instruments and fail badly on speech.

Next we had the moving-coil type of loud speaker—a very big step forward

to improve our amplifiers so as to do justice to our speakers, and much of the data obtained from study of the moving-coil reproducer is now available.

Perhaps the biggest problem the listener has to face in these days is that of his high-tension supply. Dry batteries, even of the largest type, are quite unsuitable for the latest super-power output valves, and high-tension accumulators, while in many ways the perfect supply, are a great nuisance in regard to charging unless one has one's own charging device available. Mains units of adequate capabilities are expensive and tend to produce troubles of their own in some circuits.

### BURNDIPT WIRELESS (1928), LTD.

By an unfortunate oversight an out-of-date letter from Burndept Wireless, Ltd., was printed on page 416 of our October issue.

Since it was written a new company (Burndept Wireless (1928), Ltd.) has been formed, and the organisation is now established on a sound financial basis. The Receiver was, of course, appointed to clear up the affairs of the old company prior to the formation of the new company, and we take this opportunity of wishing Burndept Wireless (1928), Ltd., the full success which the merits of their products deserve.

Whether or not it will be possible to produce this speaker in quantities on a commercial basis we do not yet know, but we do know that this particular instrument enabled us to cut down considerably the high-tension consumption of the set with which it was used. It is by no means unknown for an enthusiast to boast a set requiring 450 volts, several super-power valves in parallel, and almost incalculable milliamperes to obtain first-class quality from the local station on his moving-coil speaker, but real progress in radio is not made along such lines, and unless the sensitivity of the average moving-coil speaker can be considerably improved, the type will never become really popular. That sensitive moving-coil speakers can be made is proved by the fact that two or three have been tried in the laboratory which were quite comparable with the ordinary cone type in efficiency.





# The Connoisseur's Cone Loudspeaker

*A how-to-make article describing an up-to-date and sensitive instrument capable of giving extremely good results at a moderate price.*

By G. V. COLLE

(Technical Staff).

It is very unusual to come across a cone loud speaker which is capable of giving really fine quality of reproduction combined with sensitivity to weak inputs. This is a combination of qualities which may be expected in a really good moving-coil loud speaker, but not in the ordinary cones, so that when

#### COMPONENTS REQUIRED.

- 1 Aluminium framework, complete with front ring, six countersunk screws, and two metal supports for the reed movement (The Cromwell Engineering Co.).
- 1 Cone unit, consisting of reed movement, two coned washers and nuts, and double lead ready fixed to unit ("Blue Spot" unit).
- 1 Sheet "kraft" paper.
- 3 Pieces of suede leather or special Suedlin (F. Squire).
- 1 Loud-speaker cabinet. That shown in photograph was supplied by Messrs. Pearl and Pearl, but other suitable cabinets are made by Messrs. (The Carrington Mfg. Co., Peto-Scott, Artercraft Company, Caxton, etc.)

The diameter of the centre fret must not exceed  $8\frac{1}{2}$  in., which is the inside diameter of the aluminium rings.

Total cost of the loud speaker without cabinet, about 35s.

we hear a loud speaker of this latter type not only giving these results but also possessing the added advantage of being cheap, we are inclined to be impressed.

Yet this is the position in regard to the cone loud speaker described hereunder. When the Editor approached the writer and suggested the making and describing of a new cone speaker for the WIRELESS CONSTRUCTOR, the writer himself had no idea that such success would be possible. It is, therefore, with great pleasure that he is able to give details of a cone that is suitable both for home use in a cabinet and as a

unit in a portable receiver, setting a very high standard in quality for this type of speaker.

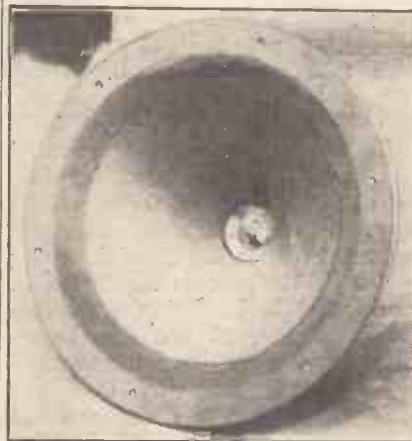

*The appearance is that of the moving coil, as can be seen here.*

As readers will observe from the photographs, the cone is remarkably

*The whole assembly is really very simple, and standard parts only are required.*

simple and fairly small, being used with a baffle either of the flat board type or made up in cabinet form. The sensitivity of the unit is entirely due to the efficiency of the reed movement, but the quality is also related to the choice of the right kind of paper for the diaphragm and the method of suspension. It is usual to expect a chatter, however slight, on loud passages in musical transmissions, but owing to a special damping on the reed movement and careful design this chatter cannot be heard.

#### Does Not Overload

The loud speaker will take a very large input before there is any tendency for unpleasant vibrations to take place. As an example, the unit in question was connected to the choke filter output of a set which is used for public radio demonstrations, and this set, going "all out," failed to upset the reed movement or to introduce unwanted noises.

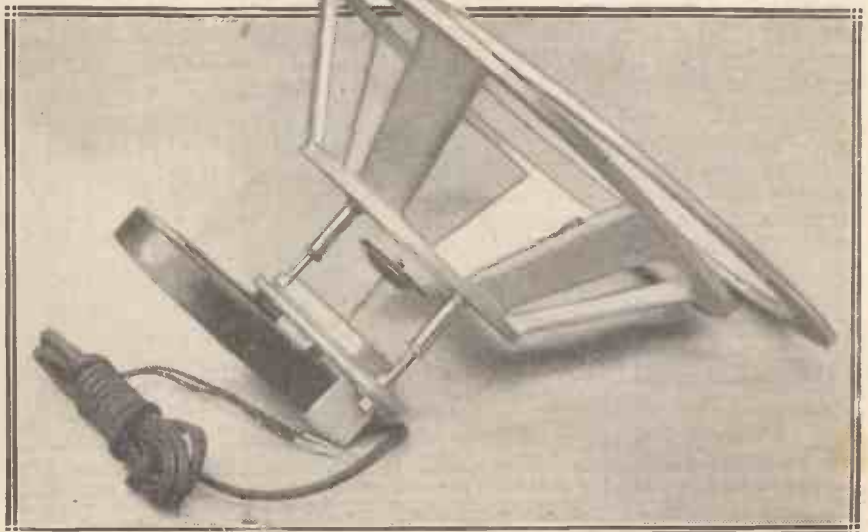

## The Connoisseurs' Cone Loudspeaker—continued

Lastly, in respect of the performance of the unit, it should be pointed out that if one expects the so-called "mellow" tone usually associated with a cone, the tone of the particular model will come as a surprise. Actually, when used without a baffle, the tone

speaker after no less than five different kinds of paper had been tried. The same paper and grade was the final choice some time ago when the writer was experimenting with moving-coil speakers.

There is nothing really complicated about the construction of the loud speaker if a few simple instructions are borne in mind.

First obtain the necessary materials, a list of which is given elsewhere, and then prepare them according to the following instructions.

A special type of leather called "Suedlin," and a suitable grade of Kraft paper, can be obtained from Messrs. Fredk. Squire, who will supply the leather in three strips cut to a suitable radius so as to stick round the periphery of the paper cone which will be formed.

### Commencing Construction

To commence the construction of the cone it will be necessary first to obtain a piece of cardboard of any suitable thickness and large enough to cover the aluminium ring which holds the cone diaphragm in position. The front ring of the aluminium framework can then be removed by withdrawing the six countersunk screws, and the cardboard clamped between the ring and the framework, after punching six holes corresponding with those of the ring. Now get a sharp knife and carefully pare away the cardboard which projects beyond the aluminium

ring, both inside and out. The object is to form a cardboard ring of the same diameter as the aluminium one.

### Marking Out

When the cardboard has been cut to shape, it can be removed from the framework, care being taken to mark the exact position of the ring so formed in the framework, so that it can be replaced correctly. It is advisable to also mark the face of the cardboard nearest the aluminium ring front, to ensure it is not reversed.

The next process which concerns us is to mark out on the Kraft paper the outline of the cone diaphragm, and here the constructor is advised

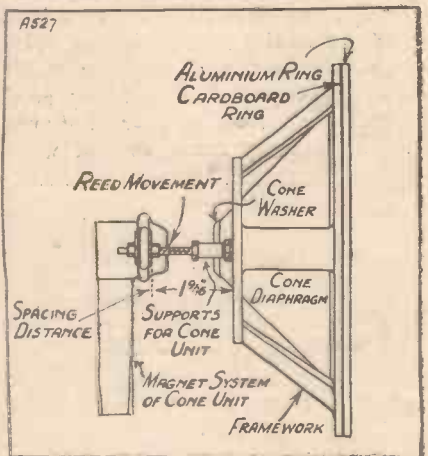
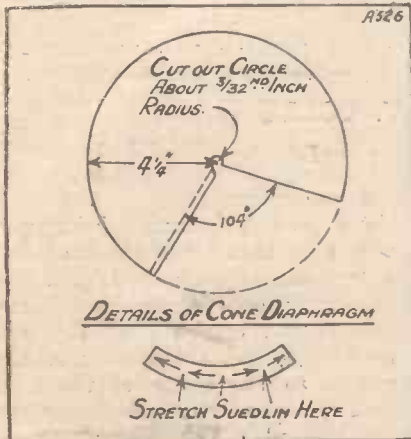

is rather high. When used, however, with a baffle, it becomes much "rounder" and more natural, although not quite so deep as a moving coil, so that speech is not "boomy," as sometimes occurs with the latter—more of an advantage than the opposite.

"Kraft" paper was chosen for the cone diaphragm of this loud

READY FOR MOUNTING



All the essential details for assembly are shown in the two diagrams above, and in this photograph of the unit ready for the cabinet.

to consult the sketch given with this article. After ascertaining that all dimensions marked on the paper are correct, it can be cut out with a pair of sharp scissors and is then ready for the next process, which is to stick the two edges together to form the cone. Groid, glue or Seccotine are all suitable adhesives, and should be applied carefully and allowed to get tacky before going further. About five minutes will suffice for this job, and it is then only necessary to overlap the edges of the paper and press well together, making certain the periphery of the cone is continuous and does not "step" at the joint.

### Mounting the Diaphragm

When the gum has set the pieces of leather can be attached to the inside surface of the cone, allowing about a quarter inch overlap all round. Many constructors will be content to guess the depth, but to make a neat job and stick the leather evenly a pencil line can be made on the inside surface.

(Continued on page 82.)

# RADIANO IV MODEL B



BY PERCY W. HARRIS M.I.R.E.

THE very large circulation enjoyed by the WIRELESS CONSTRUCTOR makes it necessary that this article shall be prepared for the press prior to the publication of last month's article on the construction of the "Radiano" Four, and it is therefore too early to deal with the reception afforded by our readers to the latest WIRELESS CONSTRUCTOR "star" set. Numerous demonstrations have, however, been given with this set since last I wrote, and further experience with it during that portion of the year when wireless conditions are at their worst fully confirms its sensitivity and high quality.

### For Ordinary Valves

Fortunately, too, since the last article was written I have received from the manufacturers examples of all the latest valves. This year's valves mark a very big step in advance, so that we now have, in the two-volt range, super-power output valves equivalent in their results to those obtainable last year only with the six-volt variety. Added to this, we have now a fine range of two-, four- and six-volt screened-grid valves, of the four-pin type, all improvements on last year's double-ended model and all working excellently in the "Radiano" Four. It is, nevertheless, the improvement in the two-volt super-power valve that we note with most interest,

*You can use an ordinary H.F. valve with model B. version of the famous "Radiano" Four. Full constructional details are given, together with many useful notes concerning both sets.*

for it is now possible to do justice with these valves to the many excellent loud speakers now on the market—

which was certainly not the case at last year this time.

While experimenting with the original "Radiano" Four model, and evolving the type of circuit finally chosen, it occurred to me that a very slight modification of the receiver would enable the reader to use the ordinary type of high-frequency valve in a neutralised circuit. Last month's

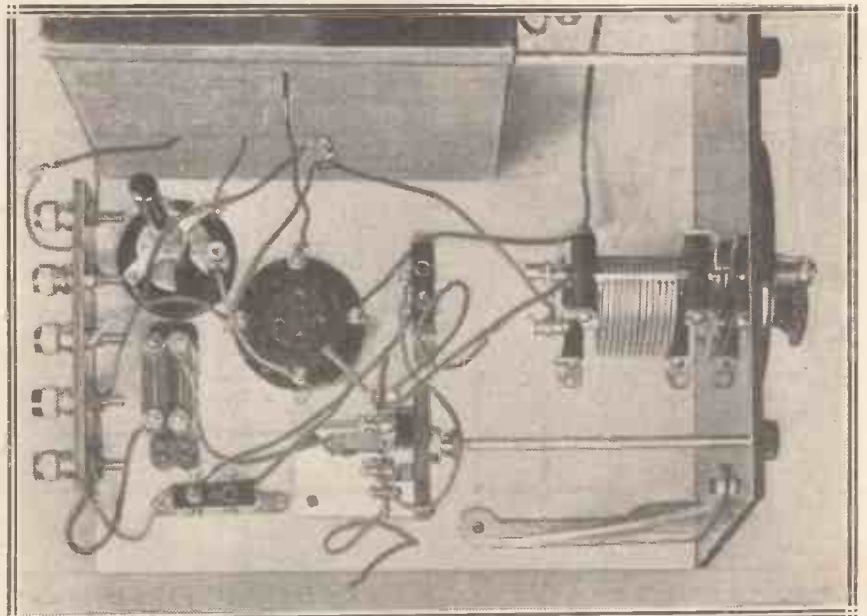

The H.F. end of the set, showing the neutralising condenser and slight re-wiring needed to transform the original "Radiano" Four into Model "B" with which an ordinary three-electrode valve can be employed instead of the screened-grid type.

# The "Radiano" Four—Model "B"—continued

design was made for the screened-grid valve, and this month I am publishing what may be called the Model B, which is simply a slight modification of last month's design in order that the ordinary type of high-frequency valve can be used.

## Very Simple Change-Over

The magnification obtained in this way is not so great, but it is still very high, and it will doubtless meet the needs of many people both in sensitivity and selectivity. A comparison of the wiring diagram given this month and that published in our last issue will show that the only structural change is the removal of the 1-mfd. fixed condenser near the high-frequency valve socket and the substitution of a small base-board-mounting neutralisation con-

and the H.T. positive terminal previously used to supply an 80-volt bias to the screening grid is now made to supply 80 volts, or any other suitable figure, to the plate of the high-frequency valve.

All other parts can remain as before. In order to save the reader the trouble of referring to two different diagrams for wiring up this set, the complete wiring diagram with the modification is reproduced in this month's issue, so that the man who wishes to make the "Radiano" Four with an ordinary high-frequency valve in a neutralised circuit can use this month's wiring diagram, while the man who prefers the higher efficiency of the screened-grid valve can follow last month's design. The constructional details for building the set are exactly the same as in last month's issue.

a process which obviously is not needed in the screened-grid model. The process of neutralising, however, is quite simple if the following instructions are carefully carried out, and after the neutralisation has been completed the set will be operated as in the screened-grid-valve circuit.

## How to Neutralise

In the Model B, use for the first valve socket one of the valves known as a "high-frequency" type, of the appropriate L.T. voltage. Use 80 volts on H.T. positive 1, and 120 volts on H.T. positive 2. Set the vanes of the baseboard-mounting neutralising condenser at their farthest apart position so that the capacity of this condenser is at its minimum. Now, without joining aerial or earth, but making all other connections for L.T., H.T., and G.B., and with loud speaker joined up, push the two wave-length change switches in for the short-wave positions, set the reaction condenser at zero, and turn the volume-control knob to the full ON position (which places the full voltage on the filament of the high-frequency valve).

Now place the first tuning dial at about 30 degs. and turn the second tuning dial backwards and forwards roundabout the same figure, when you should hear a plopping noise in the loud speaker due to the set going in and out of oscillation. With the first condenser at about 30, you will probably hear the set go into oscillation round about 20 on the second condenser and out again at about 40.

If you are used to handling a wireless receiver you will easily recognise the sounds of oscillation, but if you are inexperienced in it it will be very helpful if you ask a friend with more experience to assist you.

## A No-Interference Method

Remember that you are not tuning in any station yet, as aerial and earth are disconnected, and therefore you will not cause trouble to your neighbours with the oscillation which occurs before the set is properly neutralised.

Now turn the knob of the neutralising condenser so that the plates are slightly meshed and repeat this turning backwards and forwards of the second dial and you will find that the tendency to oscillation is reduced. After one or two further adjustments of the neutralising condenser you

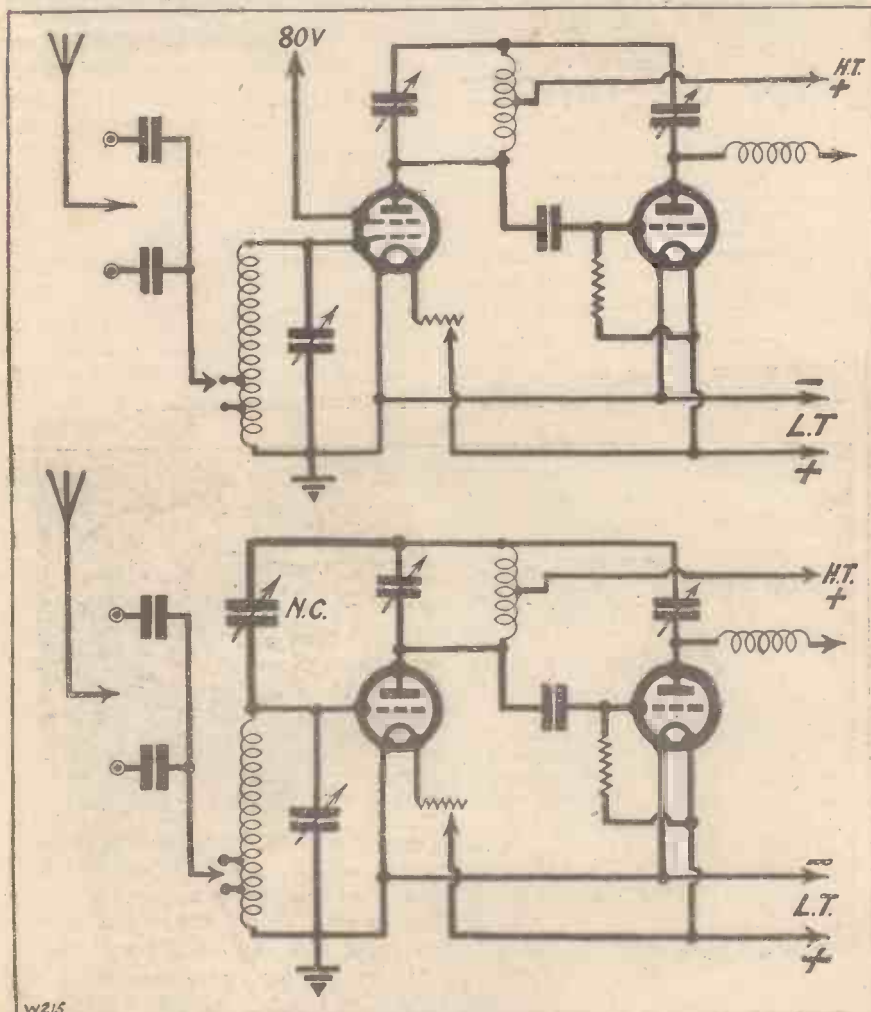

denser. One or two slight changes of wiring are needed—very simply carried out in the "Radiano" system—

When the "Radiano" Four has been built in the Model B fashion it will be necessary to neutralise the receiver,

## The "Radiano" Four—Model "B"—continued

should come to a point where no oscillation is heard. When this is reached, turn the first dial somewhere near its zero position, and repeat the turning backwards and forwards of the second condenser round about the zero position on that dial.

You may now connect aerial and earth, using, I suggest, the .0003-mfd. aerial fixed condenser and the higher tapping on each of the "X" coils. If you are within twenty miles or so of a main station, you will now have an opportunity of checking your neutralising very accurately, and carrying it out to a high degree of perfection.

### Effect on Local Station

The process when listening to the station nearby is as follows: First of all, tune in the station as loud as possible on the set, leaving the reaction condenser at zero. Now turn the volume-control rheostat as far to the left as possible, or to its "off" position, which extinguishes the filament of the high-frequency valve. If you are accurately neutralised you will hear nothing whatever of the local station in the loud speaker, even after carefully retuning both dials, but if you are imperfectly neutralised you will still hear signals.

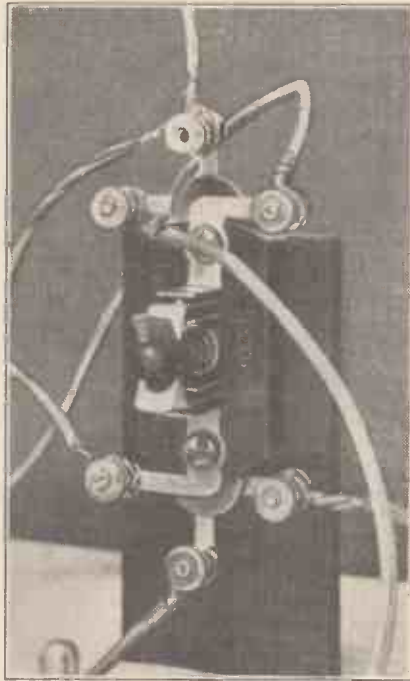

*The aerial and first grid switching is not affected by the Model "B" alterations.*

The signals will disappear at the correct setting of the neutralising condenser, and will reappear when you go beyond this point. Generally the plates of the neutralising condenser

require to be about a quarter or a third intermeshed, according to the particular make used, and you will find the neutralising position very sharp.

When you have no station as near as this, the following method is the standard recommended for neutralising by the Query Department of the WIRELESS CONSTRUCTOR.

### How to Neutralise

"Set the reaction control at minimum and likewise the neutralising condenser. Now, on setting the tuning condensers so that the two tuned circuits are in step with each other it will probably be found that the set is oscillating. To test for oscillation, touch one or other of the sets of plates of the tuning condensers" (in the "Radiano" Four—Model "B" this will be the fixed plates). "You will probably find that the set will only oscillate under the above conditions when the two circuits are in tune with each other, and this can be used as an indication. It is convenient to perform the operation at some point near the middle of the tuning range. Now, increase the capacity of the neutralising condenser. (In the case of such

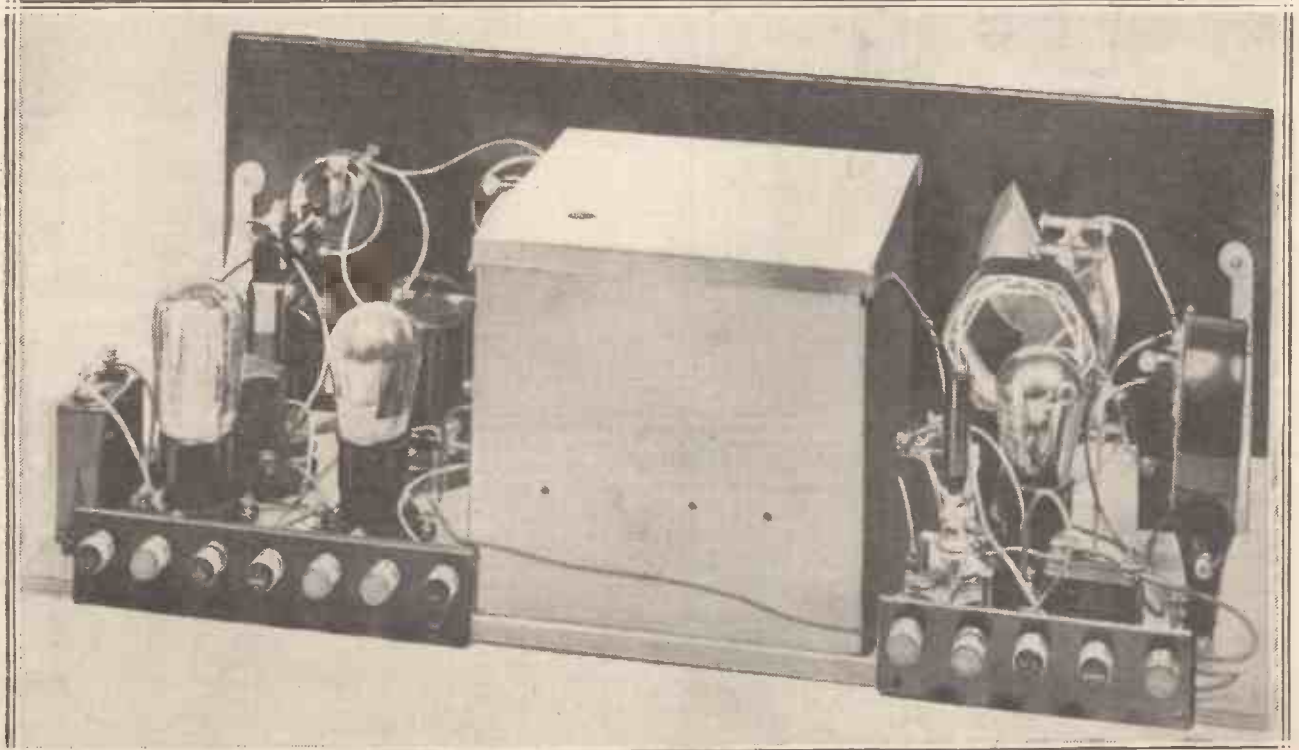

*A back-of-panel view of the "B" model clearly showing some of the revised connections. The neutralising condenser replaces a fixed condenser and slight alterations in wiring are made, such as the re-arrangement of H.T. plus terminals.*

## The "Radiano" Four-Model "B"—continued

condensers as the Gambrell "Neutro-vernina," this means screwing downwards).

Test at intervals for oscillation as this is done, and you will presently find that the set has ceased to oscillate and will not recommence even when the tuning dials are slightly readjusted. Now increase the reaction a little, until the set once more oscillates, and again increase the neutralising con-

setting no longer stop oscillation, but cause it to become stronger.

The object is to find such an adjustment of the neutralising condenser as will permit the greatest setting of the reaction condenser to be used without producing oscillation. It will then be observed that when the two tuned circuits are in step, and the set is brought to the verge of oscillation, a slight movement in

In the design published last month, the Igranic four-terminal audio-frequency choke was used, the four terminals being designed so that the two halves of the choke can be used either in series or in parallel; the parallel arrangement being chosen for this set. As other makes of chokes have only two terminals, the opportunity has been taken when re-drawing the diagram for the Model B to show the arrangement for wiring up the ordinary two-terminal choke.

Considerations of space prevented my dealing very fully with the reaction arrangement of the receiver in the last issue, and the following notes are intended to apply to both Model A with the screened-grid valve and Model B with the non-screened valve.

### Smooth Reaction Control

Accurate and smooth reaction control is a great advantage in any receiver. The actual amount of reaction required, or rather the amount of capacity required to produce reaction, is dependent upon a number of factors, including the particular resistance-capacity unit and the particular valve and plate voltage used.

In order that the "Radiano" Four should have the widest possible flexibility in this regard the reaction arrangements are carried out by means of two reaction condensers in series, one being mounted on the panel with a variable control operated from the front, the other being of the adjustable type mounted on the baseboard, with a knob which can be adjusted by means of the fingers or a screwdriver, as required. The idea of this arrangement is that the total amount of reaction capacity available at the maximum setting of the panel control can be varied to suit any particular conditions.

### The Two Condensers

With the particular circuit used the maximum is always small and much less than the .0001 mfd., which is the maximum capacity of the Midget condenser placed on the panel. By placing in series with this another condenser we can adjust the maximum capacity available from a little above zero up to slightly below .00003 mfd., and somewhere between these limits will be

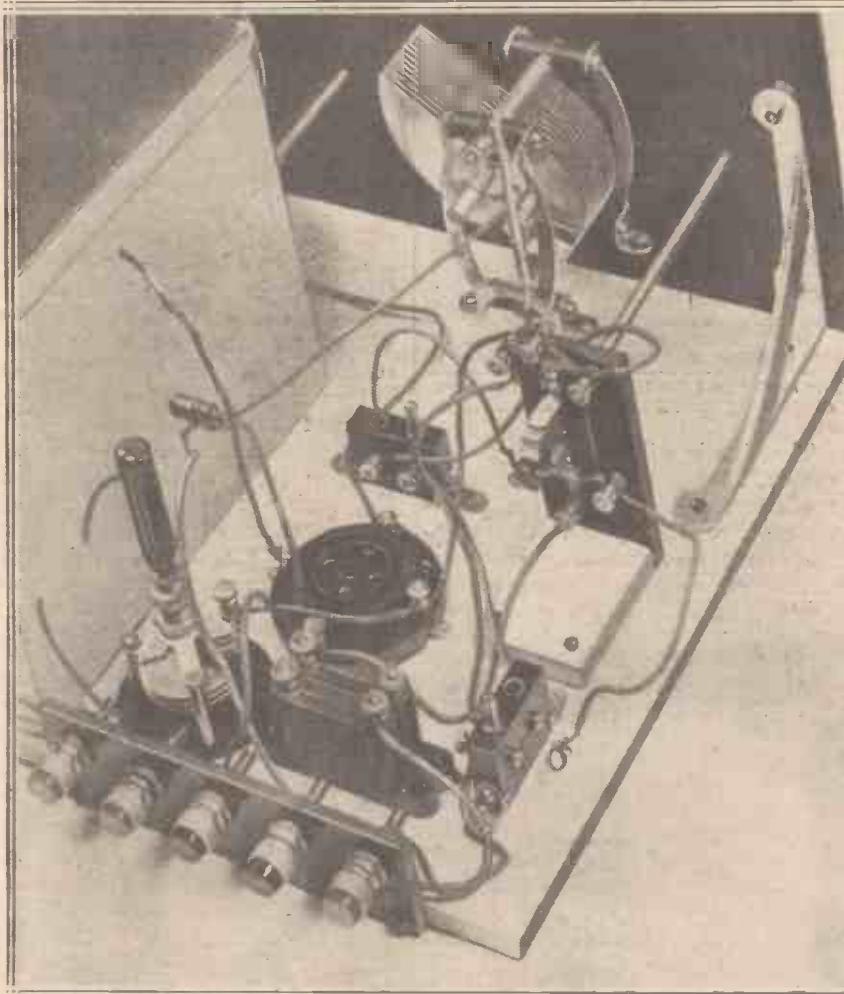

Owing to the introduction of the new "Radiano" wiring system alterations such as would be necessary to change "Model A" into "Model B" are extremely easy to make. Constructors who so desire can in a comparatively short time change the set from one form to another, and then back again.

denser setting until oscillation ceases. Slightly readjust the tuning condensers again to make sure that the set is completely stable once more. Proceed in this way until it is found that the correct adjustment of the neutrodyne condenser has been over-shot. Once this point has been passed it will be observed that further increases of the neutrodyne condenser

either direction of the neutrodyne condenser will cause the receiver to break into oscillation.

**STRIKING NEWS!**

**"BIG BEN"**

**NEXT MONTH.**

## The "Radiano" Four—"B" Model—continued

found a setting to suit any particular combination of circumstances.

To arrive at the best setting proceed as follows. After everything has been properly connected up, and aerial and earth joined in either model, (and, with Model B, after correct neutralisation has been obtained,) screw the baseboard reaction condenser to its smallest value position, which means turn the knob as far as possible in an *anti-clockwise* direction, and turn the panel-mounted reaction condenser to maximum. The set will not oscillate in these conditions.

### The H.F. Choke

Now, leaving the panel reaction condenser at maximum, carefully turn the knob of the baseboard condenser, by means of a wooden rod cut as a screwdriver, slowly in a clockwise direction. You will soon reach a point when the set will oscillate. Now, leaving this condenser at this particular adjustment which gives the effect desired, turn the panel condenser away from maximum and oscillation should stop. Turn both tuning condensers so as to tune in the longest wave possible on the shorter wave-band (round about 600 metres), and again try to see whether reaction is possible at the maximum setting of the panel-mounting condenser. If it is not, increase the value of the baseboard condenser until such a point is reached.

Inaccurate neutralisation will prevent a proper smooth reaction effect being obtained, as will also the use of a radio-frequency choke of wrong characteristics. As mentioned in last month's article, all radio-frequency chokes will not suit this set, for the placing of the choke inside the metal box has a considerable effect on the choking obtainable.

### Selectivity and Strength

A radio-frequency choke which does not suit this set will demonstrate this fact by refusing to allow any reaction effect at any setting of either of the reaction condensers at some point or other on the tuning scale. For example, it may be found that reaction is very easy from about 250 metres up to about 400, and that none can be obtained after this. The three chokes mentioned in the last issue perform satisfactorily inside

the box, while a number of otherwise excellent chokes will not do so.

If you have a choke which is normally very good in another circuit, but does not seem satisfactory in this, you may, if you so desire, remove the choke from the interior of the box and place it outside, near the resistance-capacity unit. Be careful, however, that the connections to it are as before. You will then probably find the necessary reaction effects.

As explained in last month's issue, six degrees of selectivity are obtainable with this set. The high amplification given by the modern screened-grid valve enables the aerial coupling

to be made very loose without too great a sacrifice of strength. When using the ordinary type of neutralised high-frequency valve, the tuning will probably be found quite sharp enough for most cases by joining the flexible lead which goes from the aerial terminal of the set to the point where the .0001- and the .0003-mfd. fixed condensers are joined together and taken to the switch.

### With "High-m<sub>2</sub>" Valves

When this connection is made the series condenser is cut out, and we use the tapings on the "X" coil directly. It should be remembered that the higher the magnification

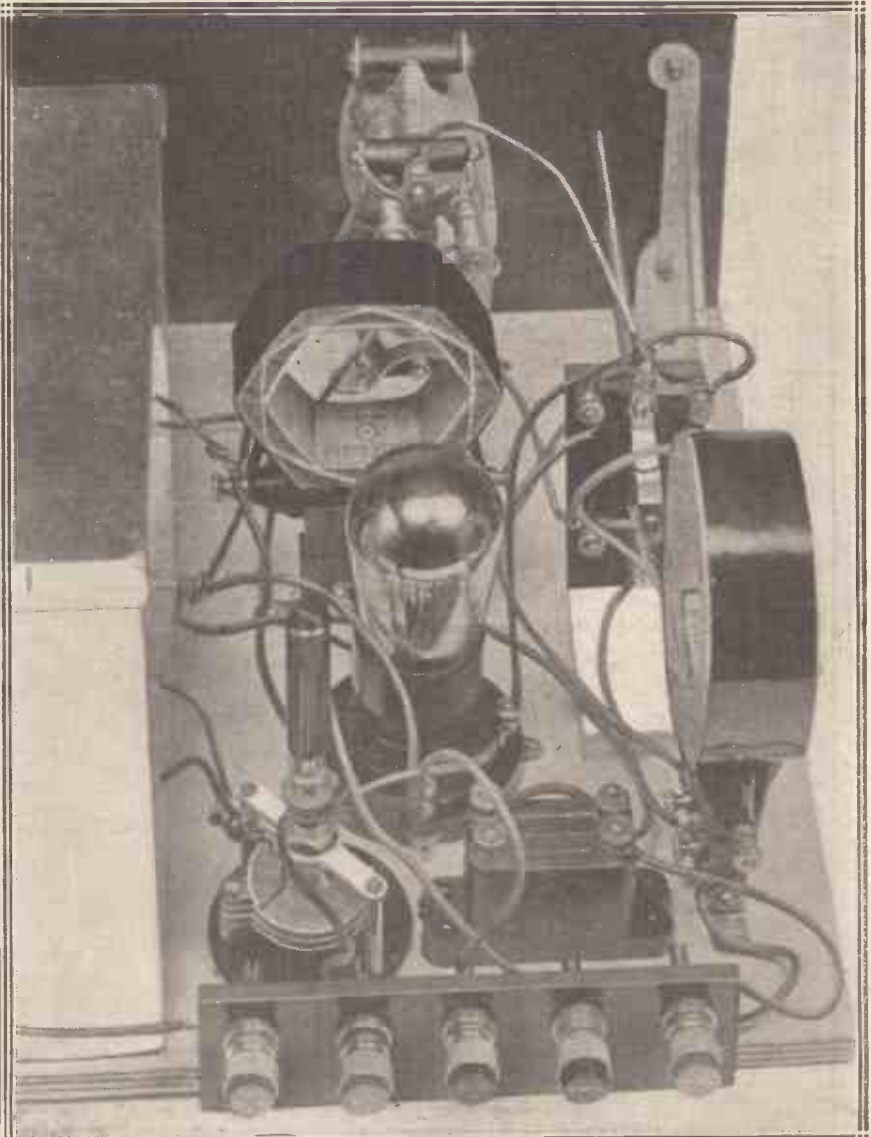

A "close-up" of the H.F. stage in which you will be able to identify the components with the greatest of ease.

# The "Radiano" Four—Model "B"—continued

given by a high-frequency valve, the flatter the tuning may seem, and so when we are using a very high-magnification screened-grid valve we may hear a background of an undesired station which would not

make itself audible with the ordinary type of valve. The degree of selectivity chosen depends so much upon local conditions, size of aerial, the nearest interfering station, and other factors, that no particular recom-

mendation can be given and the reader should try out the arrangements for himself.

One very interesting point regarding the "Radiano" Four is that one can

(Continued on page 83).

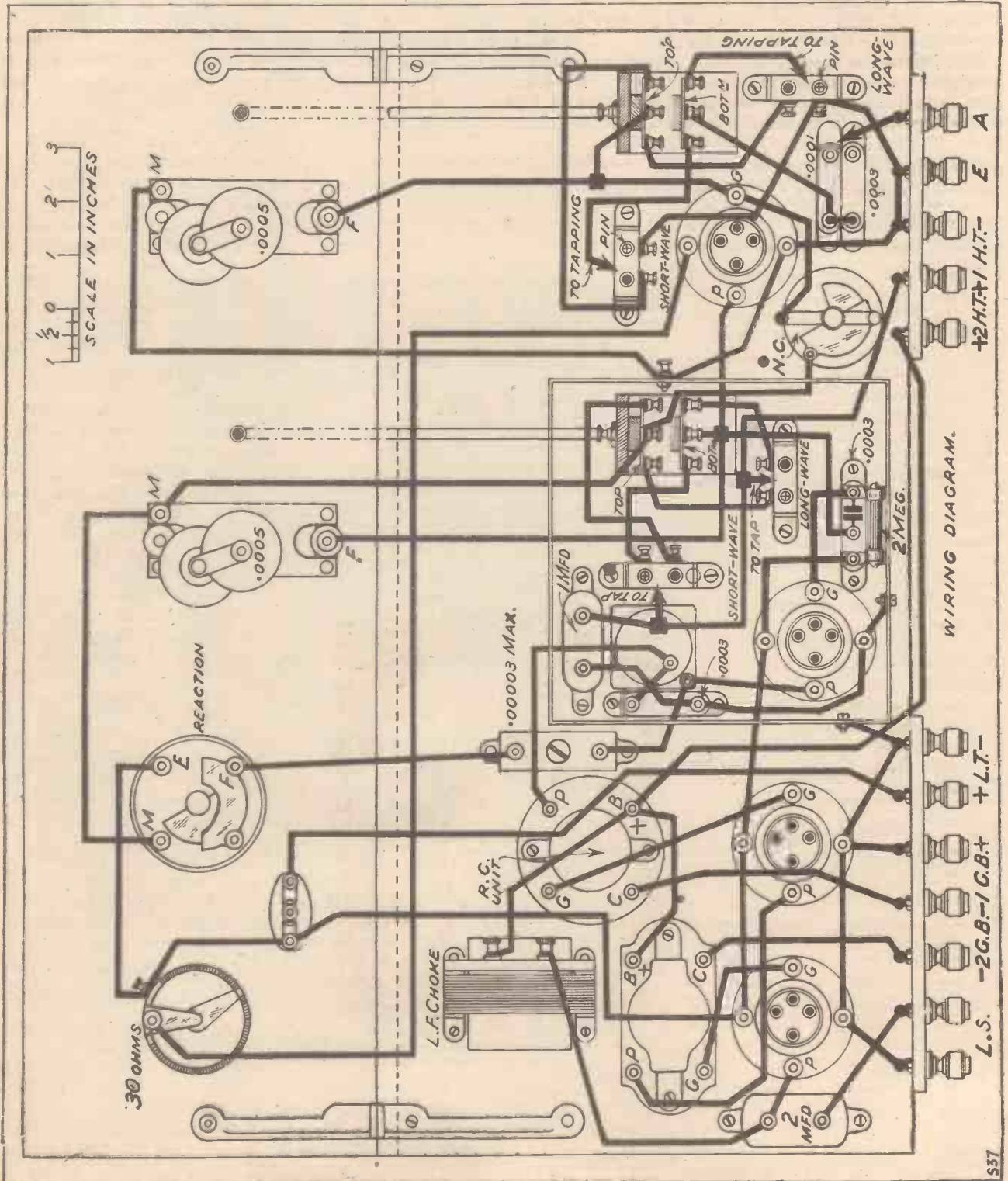



# THE B.B.C. AND EDUCATION

Mr. Stobart's Views

By a Special Correspondent



At the recent British Association Meeting, Mr. J. C. Stobart, the Director of Education for the B.B.C., and many other well-known educational authorities, including Sir William Bragg, President of the British Association, and Sir Oliver Lodge, spoke on the general and educational aims and the present developments of broadcasting.

For some time past many critics of broadcasting have been trying to ascertain exactly what the B.B.C.'s views and ideas were on educational broadcasting. Various press attacks on the B.B.C.'s attitude towards educational broadcasting have resulted in statements being made from Savoy Hill from time to time, but which have failed to clear up the matter at all.

## "Cultural Influence"

Some recent official announcements seemed to indicate that the B.B.C. was gradually going to develop education by broadcasting until it dominated the entertainment side, but other announcements seemed to indicate that the education broadcasts were merely intended to influence the cultural development of broadcasting as a whole, and that whatever happened entertainment would never be relegated to a second position.

Mr. Stobart, in his address, which was entitled: "Wireless in the Service of Education," devoted a good deal of his talk to this question of the general cultural influence of broadcasting. He maintained that from the very first the B.B.C.'s programmes had been conducted in the spirit of a national public utility service, and although he admitted that the primary function of wireless was undoubtedly entertainment, he pointed out that for thinking people the provision of serious drama, debates, talks, news, etc., was not merely education, but

also entertainment. This, of course, is in itself a matter of argument.

Mr. Stobart argued that the public have shown their appreciation and approval of these subjects being broadcast by the steady increase in the number of listeners' licences taken out, and that, on the whole, the B.B.C.'s stand for high cultural level in general programmes had been appreciated throughout the country.

## "Highbrow" Popular?

The effect of five years' broadcasting had, in his opinion, been an advance in public taste, so that the "highbrow" and the classic were more and more coming to be accepted as popular. One thing Mr. Stobart said at this point was extremely interesting, and that was that in his opinion an impartial view of economics, biology,



Sir Oliver Lodge, F.R.S., who took part in the British Association's debate upon broadcast education.

religion and other controversial subjects could now be broadcast without arousing agitation and alarm.

Mr. Stobart announced that the B.B.C. is now engaged in doing special

work in order to strengthen and support the more formal educational organisations of the country. A Central Council for broadcast adult education was being formed in which it was hoped (and believed) the Universities, local educational authorities, and voluntary educational bodies would co-operate. The Council would be charged with the planning of educational programmes and publications, the carrying on of experiments at the listening end and the attraction of new sources of revenue for the development of the work.

It is this statement which has created a good deal of argument as to how far the B.B.C. should go in its educational propaganda. The idea that broadcasting should have a general cultural influence is a good one, and the idea that the type of entertainment broadcast by the B.B.C. should be, on the whole, of a cultural type, will not be disagreed with, but when Mr. Stobart announces that a General Council is going to be formed in order to support and assist the Universities and other educational authorities, surely that is an indication that the B.B.C. is taking itself far too seriously with regard to educational broadcasting.

## Programmes for Schools

It has already been proved, time after time, that certain lectures given by the B.B.C. are of a distinctly academic type and have not been successful simply because people cannot appreciate the details of an abstruse subject when given verbally. Subjects which require concentration cannot be assimilated merely by word of mouth. The printed word will always beat the B.B.C. in this particular respect.

Mr. Stobart also stated that about three thousand schools now regularly used broadcasting as a means of

## The B.B.C. and Education—*continued*

instruction, but, following his speech, Mr. Salter Davies, another well-known educational authority, who has had a good deal of experience in connection with educational broadcasting in Kent, said the results showed broadcasting could never in any degree replace the living teacher.

### Only Limited Use

It seemed in his opinion, however, that broadcasting could greatly assist the teacher. It had a real but *limited* use for school purposes. Isolated rural schools with a single teacher, and schools of all kinds, benefitted by hearing a different voice and by contact with the first-hand experience of the traveller or the coal miner, etc.

The same argument holds good with 5 S.W. That station costs £10,000 a year, and it is of use and interest primarily to the listener abroad. But it is kept up by money supplied by British listeners.

If this educational broadcasting scheme is to expand, and if more and more time is to be allocated to it in the B.B.C. programmes, and if more and more money is to be spent on developing it, then it is only fair that the educational authorities should subsidise the B.B.C., and not have these educational broadcasts paid for out of the pocket of the ordinary listener.

Later on in the discussion, Sir Oliver Lodge spoke on the question.

produced, a certain portion of the time given to that cinema film or play should be devoted to educational information for the audience. That is not the case, for the simple reason that cinema and theatre managers realise that it is not their vocation in life and that they have not a suitable medium to do this form of educational propaganda.

### Misused Money

The B.B.C. considers it has. It is a matter of opinion. But in the opinion of many critics, the newspapers, books, libraries, and the hundred and one other easy methods of access to knowledge these days are sufficient and need not inspire the B.B.C. with a desire to allocate more and more time and money to the propagation of educational information which could be obtained and assimilated more easily and more satisfactorily elsewhere.



*This is the sort of thing that listeners really like to hear, though the idea that broadcasting should have a cultural influence is a good one.*

Granted this may be true, and that there is a considerable benefit in certain types of educational establishments where broadcast receivers are installed. But, again, the B.B.C. loses sight of the fact that the general listener is paying his licence fee not to supply a popular educational broadcast service, but to supplement various local educational authorities.

If the B.B.C. is going to broadcast educational matter for the benefit of certain schools and educational authorities, then surely those educational authorities should pay a separate licence fee to the B.B.C.

He thought the education of the average Briton was appalling, but he did not believe that people in this country were so stupid as not to want to know what was going on in the world if it could be made clear.

### More Reliable Sources

Nobody will disagree with Sir Oliver's argument here, but the point is: do people want to know what is going on in the world through the medium of the B.B.C.? There are so many other much more reliable mediums. It might be said that every time a cinema film is shown, or a play

### THE "TRAPPER" TRAPS THEM

SIR,—A few months ago I made up the "Trapper," published in the October, 1927 issue, but have added another L.F., and would like to give you a report on results obtained. The set is *the best* I have had the pleasure of using. In the last two years I have tried about fifteen sets, including the "Radiano" 3, "Sampson," "The Powerful Twin" and the "Guaranteed Reflex" ("P.W."), but not one has given me the satisfaction and pleasure I have had, and am having, from the "Trapper." I have received on loud speaker about thirty stations clear of interference from the local (2 Z Y). On the long waves I receive regularly in addition to 5 X X the following: Kalundburg, Hilversum, Berlin and two more not identified. Since making a short-wave coil I have had 2 X A F, 2 X A D, 5 S W and P C J J on 30.2 metres. I had the latter all in one afternoon (Saturday) on the loud speaker, using two valves. (I am sending a report to P C J J.)

Very many thanks for the circuit from a regular and satisfied reader.

E. L. B.

Lancashire.

# NOTES ON THE "STEDIPOWER" UNITS

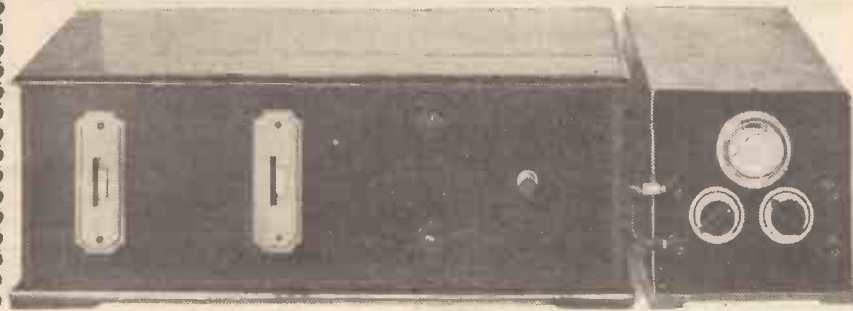

*Some further interesting items concerning the remarkable H.T. and L.T. Units which constitute a revolutionary advance in radio set power supply.*

By PERCY W. HARRIS,  
M.I.R.E.

SINCE writing last month I have been able to give a very thorough test to the production model of the Westinghouse special dry rectifier which this company has produced for use with the Harris "Stedipower" L.T. Unit. It is, without doubt, a very fine job and the makers are to be congratulated on producing the finest dry rectifier we have yet tried. Four substantial terminals are provided, two for the A.C. input and

is designed, it is *not* suitable for the "Stedipower." Remember that although six volts are required at the output, more than six volts are needed from the rectifier, owing to the voltage drop in the chokes and condensers. This is the reason why a rectifier designed to give six volts at the output will give less than six volts if used in the "Stedipower" Unit.

obtainable through any wireless dealer, just as are the ordinary types of T.C.C. condensers of standard pattern.

It should be noted that two separate units of T.C.C. condensers are used, whereas with the Tobe-Deutschmann both of the condensers are enclosed in one unit. Notice particularly, too, that the terminals of the T.C.C. condensers are marked red and black for positive and negative respectively. It is vitally important that the correct connections shall be made to these condensers, as shown in the original article.

**"BETTER THAN A NEWLY CHARGED BATTERY!"**

Dear Sir,—I cannot but write and thank you for your details of your "Stedipower" L.T. Unit. I have made same and I am delighted with the results—a full six volts and better than a six-volt battery newly charged. It is running a five-valve set, which I converted from "Transatlantic" Six.

Its results are wonderful, and I appreciate the great move made in wireless. I have run valves off the main, but the "Stedipower" L.T. Eliminator is far superior.

With thanks and prosperity to wireless in general.

Yours truly,  
HARRY MASKERN,  
A.M.I.E.E.

Doncaster.

I am pleased to be able to report, too, that The Telegraph Condenser Company's electrolytic condensers for the Harris "Stedipower" L.T. Unit are now on the market. Readers will remember that in the first article describing the "Stedipower" Unit detailed drawings were given showing how to use the T.C.C. condensers, but that they were not then quite ready for the market. They are now in quantity production, and by the time this article appears they will be

**Remote Control**

Readers who wish to equip their home installation with distant control when using the "Stedipower" L.T. system can now use the Lotus All-Mains Relay Control very effectively for the purpose, and, indeed, I have wired my own house in this way and

two for the D.C. output, and the unit is designed to work with the transformers and chokes already produced for the Harris "Stedipower" Unit.

**Use Right Type**

It is necessary to point out that when ordering a *Westinghouse* metal rectifier for the "Stedipower" Unit, the type A-3 *must be specified*. The Westinghouse Brake & Saxby Signal Co., Ltd., manufacture a large number of dry rectifiers in various arrangements and suited to various purposes. For example, do not try to use the Westinghouse R4-2-2 in the "Stedipower" Unit, for while this unit is excellent for the purpose for which it

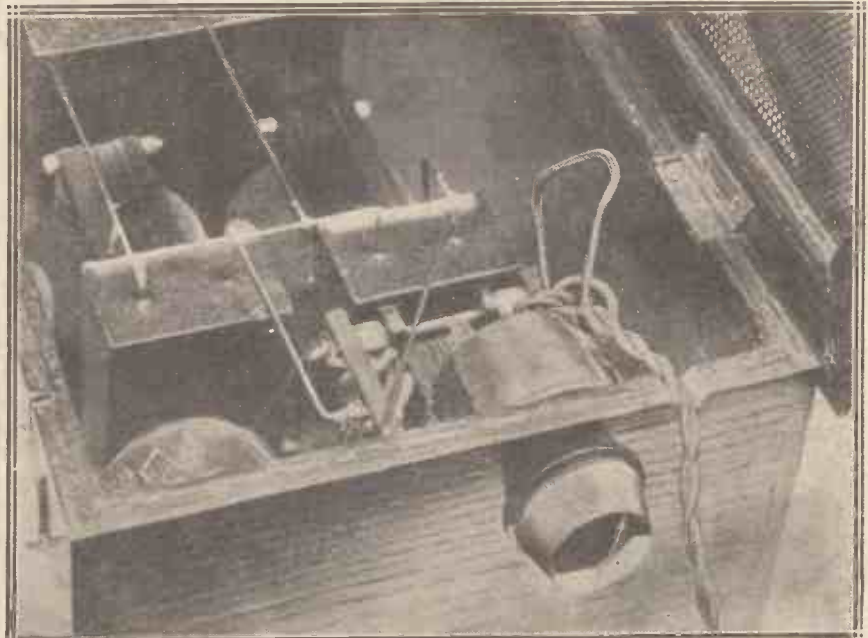

*By inserting a power resistance of a variable nature in series with the input, fluctuations in the mains supply can be countered. The resistance is shown in the foreground.*

## Notes on the "Stedipower" Units—continued

find it very successful. In the Lotus scheme special wall jacks are provided, one being placed in each room where it is desired to have a loud-speaker connection.

The relay itself is placed near to the set, which can be in any convenient room. When a loud-speaker plug is inserted in any of the jacks it will immediately turn on the set and operate the loud speaker. If a

relay suitable for different purposes, and that the one to choose when using the "Stedipower" L.T. Unit is the "Lotus All-Mains Remote Control." This particular all-mains relay can be used with the "Stedipower" L.T. Unit and ordinary dry battery or accumulator H.T., with a "Stedipower" L.T. and H.T. units, or with the "Stedipower" L.T. Unit and any other mains H.T. unit.

obtainable when required, and it is always very simple to add to the system when it is desired to wire up further rooms.

When using the "Stedipower" L.T. and H.T. Units or any other type of

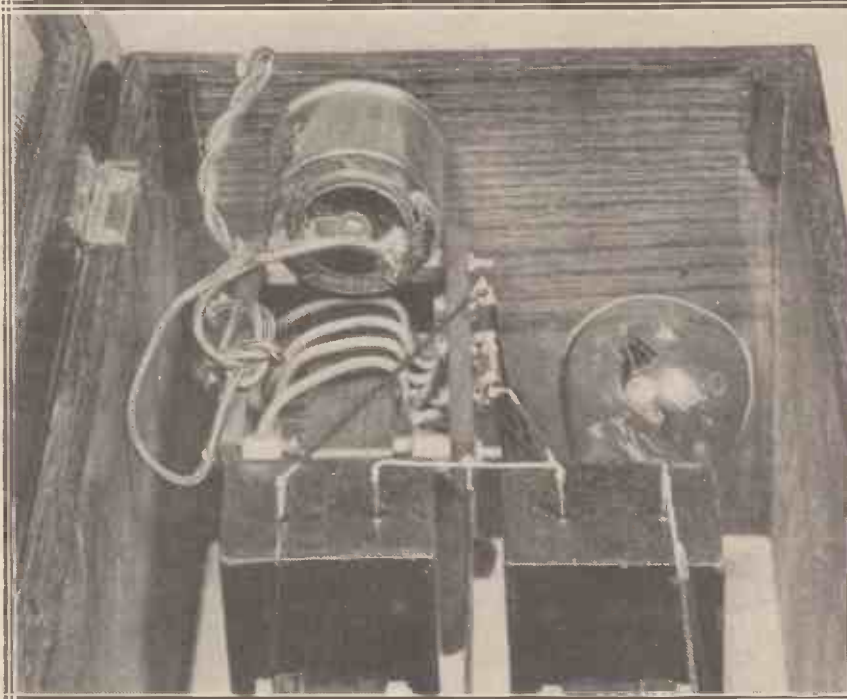

Another view of the "Stedipower" H.T. Unit with the series resistance fitted. As will be seen, its connections are of a very simple character.

second loud speaker is inserted in another room while the first is working, it will simply be placed in parallel. The withdrawal of a jack from any room cuts off the loud speaker and the withdrawal of the last jack in use turns off the set completely.

It should be pointed out that the Lotus people make several types of

A complete outfit for two rooms comprises the relay, two filament wall jacks, two jack plugs and twenty-one yards of special wire, together with a three-volt dry cell from which practically no current is taken, as it merely serves to operate the relay momentarily. Additional filament control wall jacks and wire are

### HARRIS "STEDIPOWER" UNIT. AMPLE CURRENT AND NO HUM!

Dear Sir,—I have just constructed the above unit from parts as prescribed by you, and I am pleased to say the results are excellent. I can detect no hum on my Celestion loud speaker, and there is ample current for my five valves, requiring 0.25 each.

I did not follow your layout exactly, as I was rather cramped for space. My first layout was as below. (Sketch not reproduced.—Ed.)

I found the hum was bad. It occurred to me that this would be due to induction effects from the power transformer. Last night I removed same to about three feet away and the results are excellent. I intend bringing the leads from B and C to the front of the panel to facilitate a change when required.

I should like to thank you very much for bringing out a set that removes another bugbear of wireless. I eliminated the H.T. bugbear some two years ago and I have been wishing I could do the same with the L.T.

Yours truly,

C. H. E. RIDPATH.

Rickmansworth, Herts.

[Editor's Note.—The layout of the original design should be accurately followed if compactness of the unit is desired, and with such an arrangement there is no hum. In a completely built-in set including the "Stedipower," the transformer should be kept well away from the L.F. side. It is just as well to keep the "Stedipower" a foot or two away from the set, as is also advisable with H.T. mains units of any type.]

H.T. unit, and this distance control device, you can forget about the set for months on end, as there is nothing to deteriorate, the set being simply switched on or off as required. Valves, of course, do not last indefinitely, and

(Continued on page 80.)

—And then he built a Harris "Stedipower" Unit.



# COMMENTS FROM CONSTRUCTORS

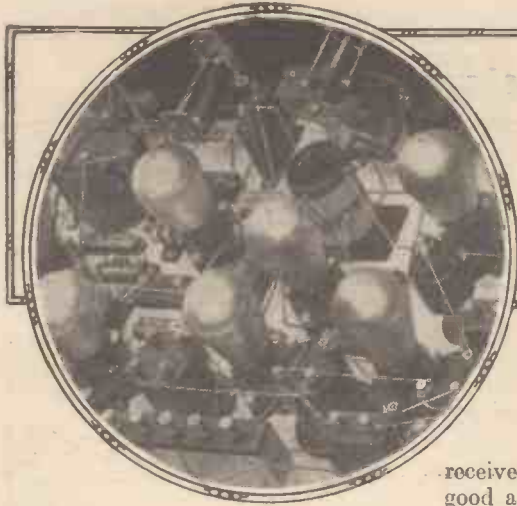

*More Catches by "The Trapper"—The "Short-Wave Three"—"The Quality is Perfect"—"Rudiano" Three—The "Roadside" on Holiday etc.*

## More Catches by "The Trapper"

SIR,—I built the two-valve "Trapper" published in the WIRELESS CONSTRUCTOR of October, 1927, and added a one-valve amplifier. No doubt the readers of your paper would be glad to hear that this set is good on short waves. I have picked up the following stations during the last seven days, using 6-volt valves (P.M.5X. and two P.M.6). This set is absolutely free from atmospheric on the long and short waves, which is one of the advantages of using a set of this description. P.C.L.L. (Holland), loud speaker. P.C.J.J., Thursday, the 9th, "A Midsummer's Night's Dream," in English, was perfect, R.9; A.F.K.; amateurs in France, Belgium, and Portugal, and about 30 British amateurs in England, Scotland, and Ireland (on 45 metres); one station in Italy; K.D.K.A. (27 metres); one which I believe is Long Island (waiting confirmation by "World Radio"); 2.X.A.D. (New York). On Sunday, the 12th, at 12.30 a.m., I picked up a station which I believe was 2.X.A.D., although I did not know that station worked on Saturday. I listened to two speakers on behalf of Mr. Hoover, in his election campaign, when he himself was announced about 1 a.m. I then picked up 2.X.A.F., and was surprised to hear the same programme and the strength that it came through. I switched on to loud speaker at 1.5 a.m., until 1.20, when I shut down and retired. It was a fine speech by a very fine speaker, as clear as a bell at R.7, and no sign of fading and no atmospheric. I am just trying P.C.J.J. with 2-volt valves (P.M.1 H.F. and P.M.1 L.F., and P.M.2). I have just heard two piano solos (Tuesday, at 8 p.m.), which were very good, but the bands following seemed to be interfered by Morse. Only recently for the first time I have

received 5 S.W., and reception was good at R.7. The coil that I use is not perfect—2 aerial, 3 grid, and 11 reaction—as there is a dead-spot which covers the main place that I am ambitious to get direct, that is, 3.L.O. (Melbourne). So I want to get 2 N.M. (Caterham), and then I know that I am on the right track. Thanking you again,

Yours faithfully,

J. H. EMERTON.

Grest, near Crewe.

## The "Short-Wave Three"

SIR,—Although you have received so many appreciations of your "Short-Wave Three," I feel that my experiences, showing as they do the remarkable sensitivity and ease of handling possessed by your set, will not be misplaced.

Recently I constructed your "Short-Wave Three" as an experimental layout, and differing from your specification in the following details: Both L.F. valves transformer-coupled, .0005-mfd. grid-tuning condenser, no S.M. dials, separate grid and reaction coils.

of the transmission was remarkably good, and the announcements could be followed with moderate ease. Towards 9.30 p.m., "X's" became rather troublesome, but the announcer's concluding "Good-morning, everybody," could be heard all over the room.

A point of interest was that a .0003-mfd. grid condenser was found to be the most useful, yielding stronger signals than the lesser values. The tuning was naturally extremely critical, but the mere fact of being able to tune in 3 L.O. on your set without any vernier dial shows how efficient the circuit, properly made up, would be. Hoping to hear more from your pen on the subject of short waves.

Yours faithfully,

RICHARD K. SHEARGOLD.

Shepperton,  
Middlesex.



*One interesting use for a rectifying unit is to provide current for a moving-coil loud speaker from A.C. mains, as shown above.*

I conducted my first test on Sunday evening (5th ult.), using an Igranic 2 as an antenna coil, and Eddystone 4 and 6 as grid and reaction coils respectively. At 7.45, B.S.T., I received 3 L.O. (Melbourne) at weak L.S. strength. The clarity

## "The Quality is Perfect"

SIR,—I feel I must write in appreciation of the "Rudiano" Three which I have constructed, mostly with components cheaper than those specified in the WIRELESS CONSTRUCTOR. The set is in every way satisfactory.

## Comments from Constructors—continued

it gives deafening volume on the loud speaker from 2 L O (30 miles), and also from 5 G B. I have also received over 20 other stations at fair to good loud-speaker strength, and of these 16 are Continental, including Barcelona and Madrid. The tuning was done with the loud speaker only. One night I tested the receiver on the short waves, and at 24.0 G.M.T. I received KDKA at good loud-speaker strength and with admirable purity, and listened to a concert until 1.30 a.m. Atmospherics and fading were negligible.

The quality of tone of the set is perfect.

Wishing your paper every success,  
Yours sincerely,

ALLAN PROCTOR.

Harpenden, Herts.

### "Radiano" Three

SIR,—I thought perhaps you would be interested to know the splendid results I have received with the "Radiano" Three, which I have had in use about two months. London can be heard all over the house, and the speech and music is remarkably



An outdoor radio laboratory established on the banks of the Potomac River.

clear, using only 60 volts high-tension. I have received Continental stations too numerous to mention on 'phones.

The following stations came through at good strength on the loud speaker: London, Daventry (5 G B), Daventry (5 X X) and Langenberg.

My aerial is not very high, and is badly screened by buildings.

Now for the latest achievement of this receiver:

Several nights recently I made a test to receive WGY, New York, on 379 metres. I received this station on about four nights out of six, but the best reception was on two wet nights.

On the last occasion the station call was heard plainly several times, and at 2 a.m. G.M.T. the 9 p.m. time-signal was given from studio, and then followed an hour's programme by the Goodrich Tyre Co., at Ohio. At 3 a.m. signals could be heard 2 in. from the earphones.

I have made several receivers, but this is the first one I have received America on. I consider that a receiver that will do this under rather poor conditions as regards aerial is well worth recommending.

Thanking the WIRELESS CONSTRUCTOR for this splendid circuit,

I remain, yours truly,

W. L. GIBSON.

Caledonian Road, N.1.

### "Roadside" Four on Holiday

SIR,—Congratulations on the "Roadside" Four. I have used this set in Torbay, also at Llangollen, with very successful results. I herewith enclose photograph showing the set in operation in Torbay.

Wishing you every success.

I am,

Yours faithfully,

F. CLEGG.

Coventry.

### The "Trapper's" Haul

SIR,—I feel I must write and tell you of my experience with your perfect two-valver, "The Trapper," as by all I have heard it is better than any other "2" yet published. I might go as far as to say, better than some three-valvers. I am now writing because I think this set should be more widely used than it is—constructors seem to have overlooked it.

Firstly, I am well within eight miles of 2 L O, but can receive both Leipzig or Stuttgart absolutely clear of background. This shows the sensitivity of the tuning controls, trap, etc. One Friday I tuned in Nurnberg, Muenster, Cologne, Munich and Berlin (Witzleben?) at quite good loud-speaker strength. During a complete evening I have tuned in as many as 47 stations on the telephones; these are not merely whispers, but absolutely clear reception, which could easily be separately identified if one only had the time.

The above number is no fallacy, it is absolute truth, and, to go a stage farther, I have on two occasions, with short-wave coils, received 3 L O Melbourne, and almost every evening that 2 X A F or 2 X A D, KDKA (America) or PCJJ (Holland), and 6 X A R (San Francisco), etc., can be tuned in.



The "Roadside" Four referred to in the letter from Mr. Clegg on this page.

With congratulations and thanks for the most excellent two-valver I have ever heard and which several friends would confirm.

Yours faithfully,

H. W. SELLS.

London, S.W.17.

### "Short-Wave Three" in Western Australia

SIR,—I am a Western Australia reader of your WIRELESS CONSTRUCTOR. I feel as if I must write you and tell you of my success. I have had on your wonderful "Short-Wave Three." It is really the best circuit I have built. I am going to give a few of the long-distance short-wave stations I have received on good 'phone strength. Here we go: PCJJ, PCLL (on 16 metres), WSSR (Siberia), WGY, 2 X A F, IAB (Singapore), RFM (Russia), and others in and around Australia. 3 L O on 300 metres comes in on good loud-speaker strength.

It will work as low as 15 metres and as high as 1,250, which our local station works on, with plenty of volume. So I must congratulate you on your wonderful circuit. I think it is marvellous.

Yours faithfully,

E. R. PICKETT.

East Fremantle.



# The "NEW-WAY" TWO

UNTIL very recently, little attention has been paid to wave-change sets, for the perfectly good reason that the use of a switch almost invariably resulted in inefficiency.

During the last few months,

An inexpensive, easy-to-build set which covers both broadcast wave-lengths without coil-changing.

By G. T. KELSEY

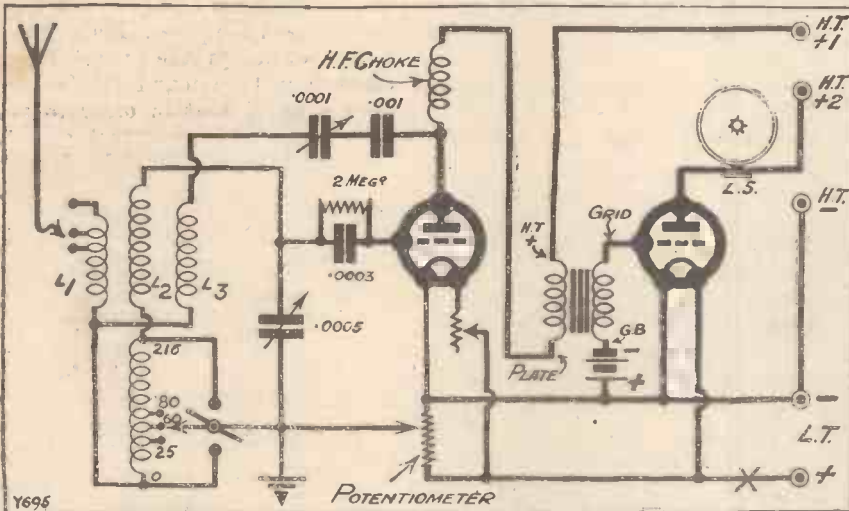

however, considerable experimental work has been carried out by Mr. G. P. Kendall with a view to

finding a method of switching a set from short to long waves without loss of efficiency.

While it is safe to say that the question of switching was the most important, it should not for one moment be imagined that this was the only difficulty. There were various other troubles to overcome, and now that a really satisfactory scheme has been found it is of little wonder that I have contracted a mild attack of "switchitus"!

The reason for my present burst of enthusiasm is to be found in the "New-Way" Two, which, to come to the point, is our old friend the popular "Det. and One," with an all-wave switching arrangement which really is efficient.

To my way of thinking this combination forms an ideal set, and the wonderful convenience of a switch for changing the wave-length range is one of those things that must be tried to be thoroughly appreciated.

### Very Popular Circuit

About the merits of the circuit I need say nothing, or, at least, very little. It is without a doubt the most popular arrangement of two valves, and this, coupled with the fact that it incorporates all-wave switching, results in a set which is really worth building.

From the London listener's point of view I am quite prepared to agree

### YOUR SHOPPING LIST

- 1 Panel 14 in. × 7 in. × 1/4 in. (Ebonart, Radion, Becol, Red Seal, Trelleborg, "Kay Ray," or other good branded material).
- 1 Cabinet to suit above panel, and baseboard 9 in. or 10 in. deep (Pickett, Raymond, Cameo, Aircraft, Bond, Caxton, Makerimport, etc.).
- 1 .0005 variable condenser and dial (Igranic or other good make, Cyldon, Formo, Raymond, J.B., Lissen, etc.).
- 1 potentiometer, 400 ohms (Lissen, or similar type).
- 1 2-meg. grid leak (and holder if grid condenser has no clips) (Mullard, Igranic, Lissen, Dubilier, etc.).
- 1 Grid condenser, .0003 mfd. (Lissen, T.C.C., Dubilier, Igranic, Mullard, Clarke, etc.).
- 1 Fixed condenser, .001 (see above).

- 1 Filament switch (Benjamin, Lotus, Lissen, Igranic, etc.).
- 1 On-off switch for wave-changing (see note in text) (Lotus, Lissen, etc.).
- 2 Anti-microphonic valve holders (Redfern, Lotus, Igranic, W.B., Benjamin, Burne-Jones, Marconiphone, Burndep, B.T.H., etc.).
- 1 Variable resistor, 6 ohm, baseboard type (Igranic, Lissen, or similar type).
- 1 H.F. choke (R.I. and Varley, Cosmos, Colvern, Lissen, Climax, Igranic, Lewcos, Dubilier, Burne-Jones, etc.).
- 1 Miniature-type reaction condenser, .0001 or .00015 mfd. (Peto-Scott, Cyldon, Bowyer-Lowe, etc.).
- 1 L.F. transformer (British General in set. Any good make of fairly low ratio).

- 1 Terminal strip with 7 terminals, and one with 2 (Engraved or indicating terminals, such as Igranic, Ealex, Belling-Lee, etc., give a neat appearance).
- Wire, flex, spade tags, tapping clip, screws, etc.
- Short-wave coil :
  - 1 Former, 4 in. long, 3 in. diam. (Pirtoid used for original. Any good insulating material).
  - 1/2 lb. No. 22 D.C.C. wire.
  - 2 oz. No. 28 D.C.C. wire.
- Standard loading coil :
  - Can be obtained ready-wound from Messrs. Burne-Jones, Paroussi, Wright & Weaire, etc.
  - To make it you will require :
    - Piece of ribbed ebonite former 2 in. diam. and 1 1/2 in. long (Becol).
    - 1/2 lb. No. 26 D.S.C. wire.

## The "New-Way" Two—continued

that at first sight there is nothing very attractive in a set which can be changed over from London to Daventry by the movement of a switch. What, it may be argued, is the advantage of listening to a duplication of the local programme via Daventry?

### Choosing Components

The answer is, of course, that there are three or four excellent stations on the long-waves apart from 5 X X, and what is more, the "New-Way" Two gets them!

For the convenience of readers who are thinking of building this set, a list of the components required is given elsewhere in the article, and although, as is customary, the various makes used in the original are given first, it should clearly be understood that the receiver is not at all critical in the matter of components.

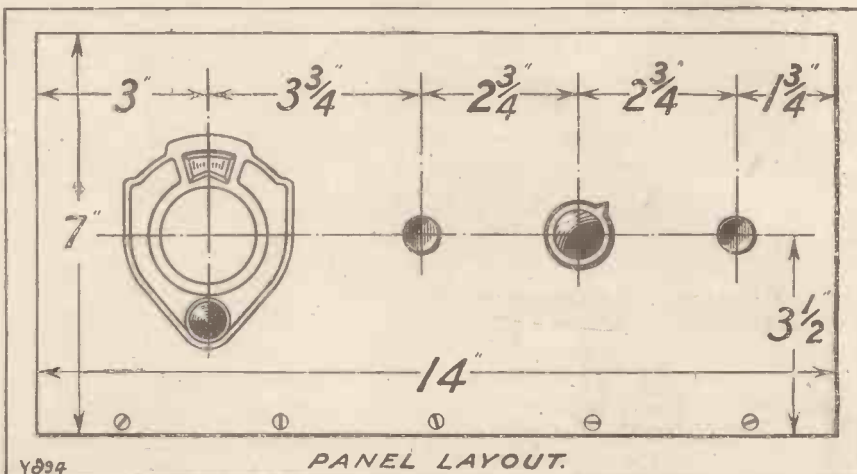

The main point to note is that whatever is finally chosen should be of a reliable make, and in the case of condensers, etc., of the values specified.

With the components to hand, the actual construction can be commenced, and the first-job is to mark out and drill the panel. For this particular operation the panel layout diagram will be found helpful, but do not forget that in order to preserve a neat front-of-panel appearance the scribing should be done at the back, and the layout will, therefore, need to be reversed.

Panel brackets are not necessary with a simple set of this kind, and when the ebonite has been drilled it should be fixed to one edge of the baseboard with wood-screws.

It is always worth while to make the back-of-panel appearance of the set as neat as possible, and in this connection a thick solution of permanganate of potash and water painted over the baseboard prior to the fixing of components will leave a pleasing brown finish.

### The Short-Wave Unit

The panel components can next be fitted, but before those on the baseboard are fixed into position it is advisable to make the coils. It would be as well just to mention before dealing with the coils that the wave-change switch on the panel must be of the type that has two metal contacts which are shorted when the switch is in one of the two positions.

The aerial, grid and reaction coils for the broadcast band are all wound on the same former. Commencing at a point about half an inch along the former wind on 60 turns of No. 22 D.C.C. wire, and at a distance of half an inch from this winding place on 30 turns of No. 28 D.C.C. wire. This latter winding is for reaction, and care should be taken to see that it is

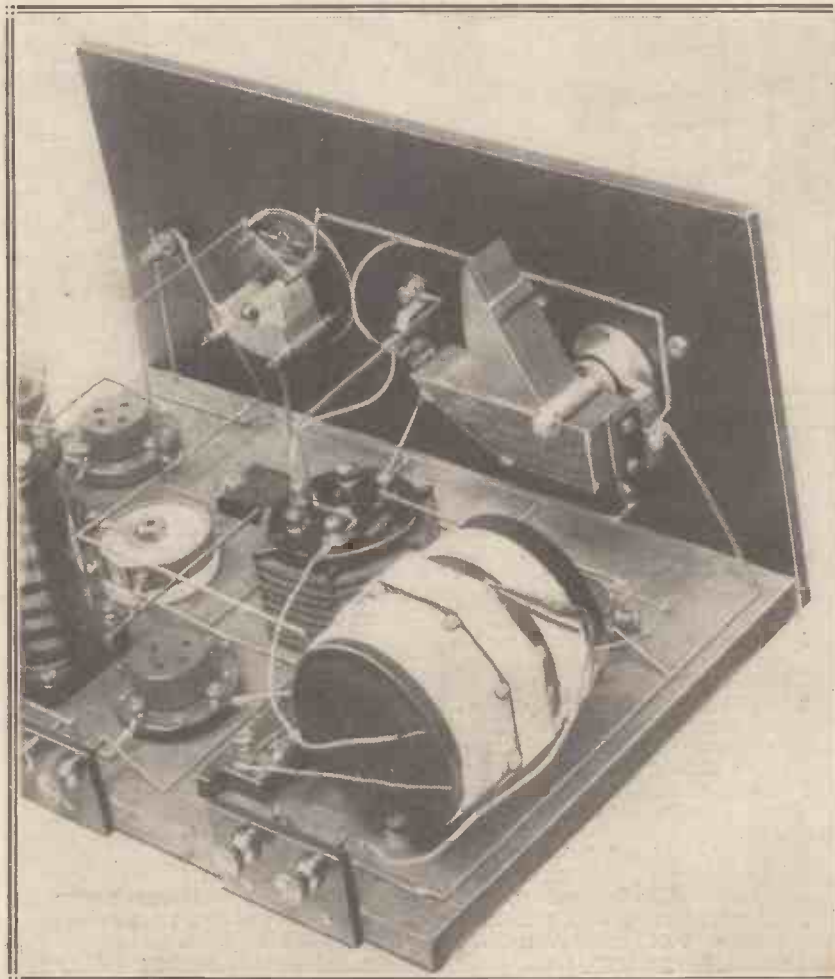

Here you see the two vital items of the "New-Way" Two, the aerial coil unit and the standard loading coil. These enable one to change over from the ordinary broadcast band to that of 5 X X, Hilversum, etc., merely by operating a simple push-pull switch on the panel.



## The "New-Way" Two—continued

wound on in the same direction as the first winding.

As will be seen from the various photographs and drawings, the aerial coupling coil is overwound at one

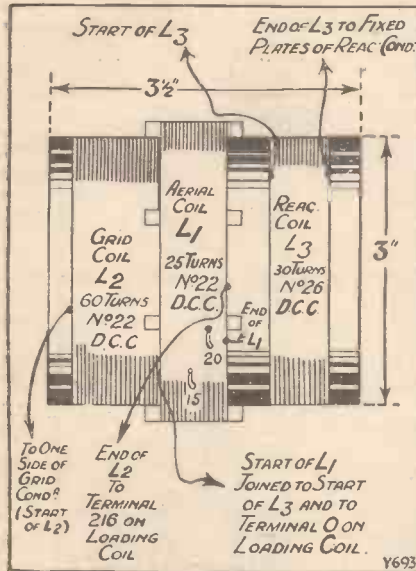

end of the grid winding. It consists of 25 turns of No. 22 D.C.C. tapped at the 15th and 20th turns.

The actual method of making tappings is not of very great importance, and loops can be made in the wire when the appropriate positions are reached, or alternatively the whole winding can be done and the tappings made afterwards by prising up the 15th and 20th turns, and placing matchsticks underneath them.

### The Standard Loading Coil

It will be noticed that the aerial winding is held away from the grid winding by means of eight spacers. These can be of wood or ebonite, whichever happens to be most convenient, but it will be necessary to arrange for them to be held in position until the winding is done.

When making the original coil this was done by a piece of wire passed right round the former over the top of the spacers.

The standard loading coil, which enables the set to be used on long waves, can, if desired, be purchased at a reasonable price ready made; but for those readers who wish to make their own, the constructional details are as follow:

The former consists of a 1 1/2-in. length of ribbed ebonite tubing such as "Becol," with an outside diameter of 3 in. There are six ribs spaced

equally round the former, and in each one of these, eight slots should be cut to the depth of the rib, each slot 1/16 in. wide and spaced at 1/8 in.

The winding consists of 216 turns of No. 26 D.C.C. or D.S.C. wire, and since there are eight slots there will be 27 turns in each slot. Incidentally, the winding should all be done in the same direction.

### Wiring the Set

Tappings are taken at the 25th, 60th, and 80th turns, and when the winding is complete it should be found that there are five loose ends, namely, the start, the finish, and the three tappings. To complete the coil then mount a circular piece of ebonite on one end of the former, and on it fix five terminals.

To the first of these take the start of the winding and mark the terminal "0." The first tapping, which must be at 25 turns from this end of the coil, is taken to the second terminal; and this time the terminal should be marked "25." The 60- and 80-turn taps and the end of winding should be joined to terminals three, four, and five respectively, and in each case the terminals should be marked. If this numbering of the terminals is carefully carried out, the finished coil will agree with that shown in the back-of-panel diagram.

With the coils completed, proceed by fixing them in position on the base-

board together with the remainder of the components. It is a difficult matter to show clearly the connections to the ends of the short-wave coils, and so that there will be no possibility of mistake a separate drawing of these coils and connections is given.

The wiring in the original set was carried out with square-section tinned copper wire; but Glazite or any of the other types of connecting wire will be quite suitable, and the choice is therefore left to readers.

If, as in the original, you do use tinned copper wire, be careful to work with a really hot iron, otherwise dry joints will result.

When commencing to wire the receiver the wiring diagram will provide you with all the information required. I will therefore pass on to the testing of the receiver, which is the next operation.

### Necessary Batteries

For this you will require two valves, an H.T. battery (100- or 120-volt type is recommended); an accumulator to suit the valves, a 9-volt grid-bias battery, and phones or loud speaker, as the case may be. With regard to the valves, those of the 2-, 4-, or 6-volt variety are quite suitable for the "New-Way" Two, and in the first stage—that is to say, the detector socket—you will require one of the

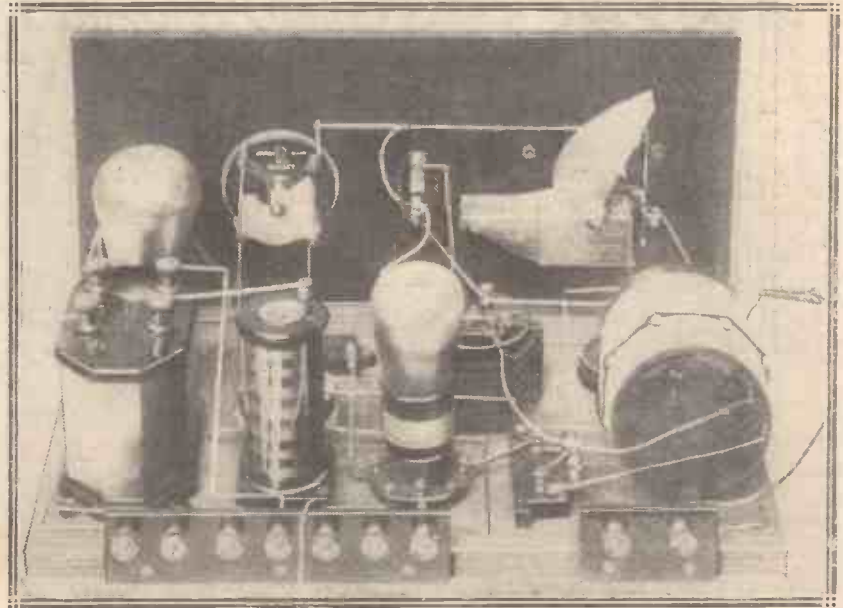

Here is the completed set with valves inserted in their holders. You will see that it is quite a simple set despite the usefulness and versatility of its circuit arrangement.

## The "New-Way" Two—continued

type usually styled "H.F." In the second position a small power valve will be most suitable.

Join up the aerial, earth, battery and 'phone or loud-speaker leads, and connect the flexible lead from the aerial terminal to the 20-turn tapping on the aerial coil.

The question of correct H.T. voltages is one which cannot be answered with any degree of accuracy, since it depends upon the particular valves chosen. As a rough guide, however, take the H.T. +1 lead to a tapping at about 50 volts, and H.T. +2 to 100 or 120 volts.

Now, with the wave-change switch in the position which places the set suitable for short-wave broadcasting, turn the reaction condenser to zero (plates all out) and move the L.T. switch to the "on" position:

By rotating the tuning condenser (Continued on page 70.)

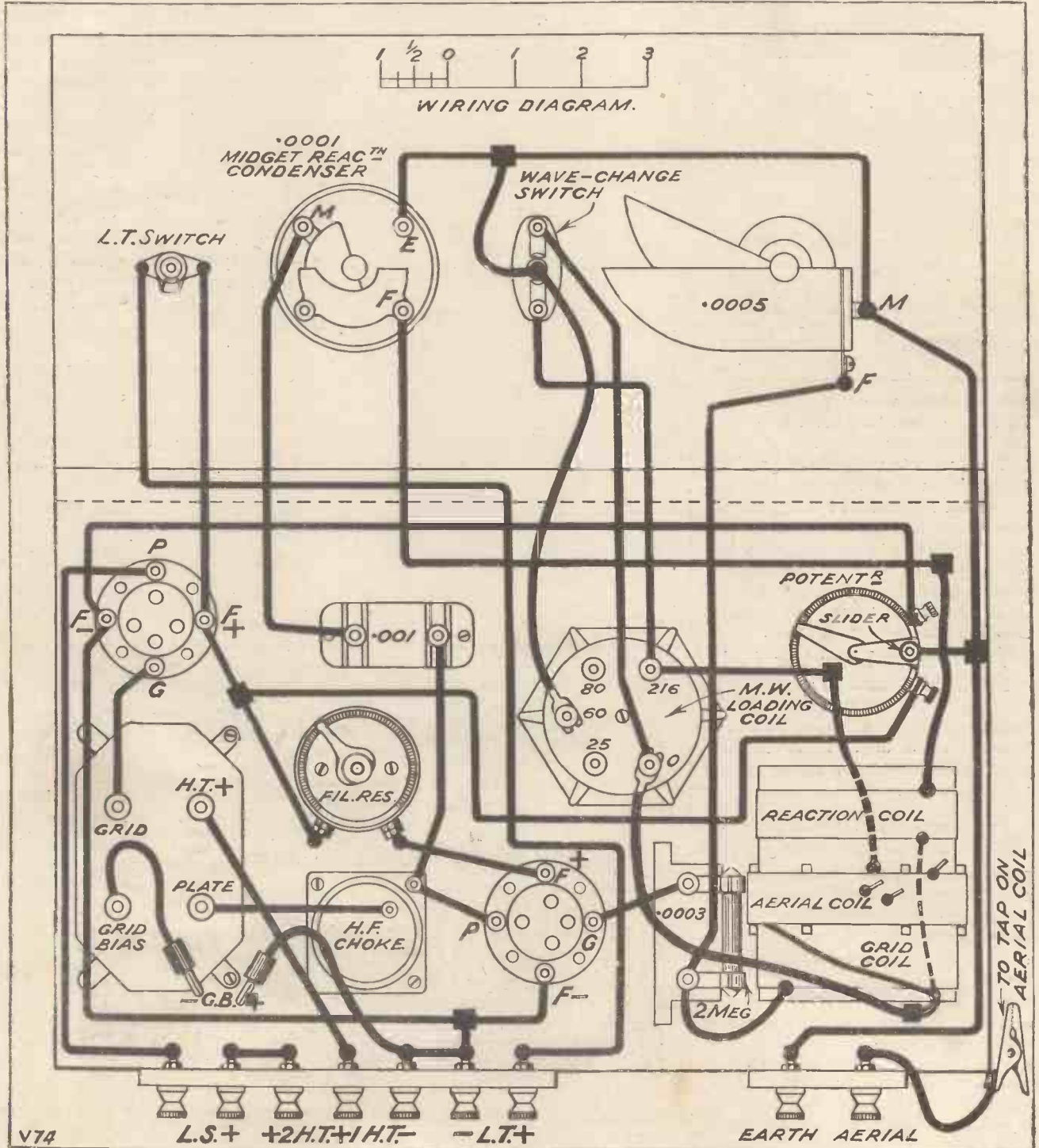

# The ART and CRAFT of SOLDERING

A few useful tips upon one of the tasks of the radio constructor that often proves troublesome and tedious.

By E. W. REVELL.

THE making of permanent soldered joints in wireless receivers is one of the greatest difficulties the constructor has to face. Soldering is really an art and, moreover, one which not everyone can learn. As one who has done a fair amount of soldering both in set-building and in

Thus we see that to make a good joint it is important that the two surfaces to be joined, however small, must be well "tinned" first, and must be in close contact at the actual moment of joining. What really happens apparently is this: The solder really partially amalgamates with the metal (not merely adheres to it) and results in a joint being formed between the alloy composed of the solder and copper, or brass, etc.

The reason why it is more difficult to make joints between small surfaces, such as terminal ends and wire than between larger surfaces such as a metal box, I think resolves itself into a question of temperature. In joining a box the whole—or at any rate a large area of it—can be brought to the desired temperature, but in the case of a terminal passing through ebonite it is necessary to confine the heat to a small area with the result that sufficient heat is rarely used.

Another difficulty is in the manner of applying the heat. For obvious reasons a very large soldering iron cannot be used. A small iron loses heat too rapidly, and although perhaps of the correct temperature when

withdrawn from the fire or flame, by the time the two surfaces to be joined are brought together the iron though still able to melt the solder is not hot enough for the job. What happens then is the metal (copper or brass) is at a slightly lower temperature than the molten solder, and thus does not properly amalgamate with it.

## Cause of "Dry" Joints

Moreover, the flux gives off a gas which, being imprisoned between the solder and the metal, keeps the two elements apart—a "bubble" round the joint is formed—the well-known "dry" joint. If the following hints are followed I think more constructors will be able to make a satisfactory job of their soldering.

**The iron.** This must be of good quality (there are different qualities even in soldering irons). As large a size as possible should be used, and if this is filed to a long wedge-shaped point it will assist matters considerably. For preference the "bit" should be attached so that it can be used at various angles to the handle. The handle itself must not be too long—and the "grip" of



The iron should be carefully kept clean and free from oxide deposits.

other directions I should like to give a few hints, trusting I may be the means of helping someone in their difficulties.

## Solder Itself Not Strong

First of all, it is necessary to remember that solder itself has no great mechanical strength. If two pieces of wire are joined end to end with a gap of, say,  $\frac{1}{16}$  in. between them—the gap being bridged with solder—a very fragile joint is formed. On the other hand, if two flat metal plates are "tinned," and the tinned surfaces placed together under great pressure and then heated, a joint is formed which is almost impossible to separate—in fact, an attempt to do so often results in tearing the actual metal.



The iron should be carefully heated in a gas flame until it commences to "burn" with a greenish flame.

## The Art and Craft of Soldering—continued

good size. A smaller iron can be kept for use where it is impossible to use a larger one.

**"Tinning."** Heat the iron in a clear fire or flame till green flames appear. File the two surfaces clean (one at a time), instantly dip in flux and apply a small amount of solder. Rub over with a clean dry cloth.



If both the wire and the soldering tag are tinned, a mere touch of the iron will be sufficient to make a firm joint.

Only one surface need be tinned all the way up. Hold the iron in the right hand (if you are not "left-handed," when the opposite applies) across the body, the "bit" to the left, and "tin" the whole surface towards you. The opposite surface need only be tinned about a  $\frac{1}{4}$  in. up.

### Heating the Iron

In bringing the iron to the correct temperature it is necessary to be able to do this with some degree of



Tinning the wire before making a joint will save time and trouble in the long run.

certainty. If made too hot the "tinning" will be burnt off, so get into the following habit. Withdraw the iron from the fire and hold about 4 in. from the cheek. It should instantly feel "hot." After a little practice this becomes automatic, and a very reliable guide to temperature.

**Repairing joints for soldering.** These should be filed bright immediately before soldering, and smeared straight away with "flux." The purpose of flux is not to help the solder to stick—that is, not directly—but to prevent contact with the air, which causes immediate oxidation, sufficient to prevent the solder "taking."

### Actions of Fluxes

This corrosion takes place so rapidly with some metals that ordinary fluxes are useless—aluminium, for instance, which cannot be soldered by ordinary means at all.

The reason why "killed" spirits of salts is such a good "flux" is probably because all the time the joint is being made it is eating away the surface of the metal, thus counteracting the effects of the air, and, in addition, being a liquid, is rapidly vaporised from the surface, leaving no greasy film between the brass and solder.

Withdraw the iron from the fire and, if of the correct temperature (always aim at keeping it as hot as possible), wipe rapidly with the cloth, dip into the flux and touch it with the solder—melting a small quantity.

Apply this to both prepared surfaces, moving about till a film of solder is formed all over. Do not be in a hurry to remove the iron, but let the parts become well heated. (Remember that terminals, etc., can be "tinned" before insertion in the panels, but nuts must be screwed on first, otherwise it may be almost impossible to do so afterwards.)

### Test Every Joint

**Making the joint.** Smear on a little flux. Prepare the iron as before—have it really hot, bring the surfaces in close contact. Apply the iron, when the joint should instantly fuse. Hold in contact for a few moments, then withdraw, being very careful not to disturb the joint till the solder has "set." This is indicated by the "brightness" suddenly disappearing

and can be expedited by blowing thereon.

Now give the joint a good pull—try and lift the set by means of it. If



Tinning the tag of a valve holder before soldering on one of the connecting leads.

it breaks—the joint, not the set—have another go! If after several unsuccessful attempts failure results, it is perhaps as well to call in an expert (not the local plumber, though! There is a difference between the "joints" he makes and the "joints" you want.)

### Buy Good Solder

Finally, it is important to get good solder. Don't buy penny solder sticks, but obtain it from a trader whom you know can use it himself,



The completed connection, after cleaning with duster.

and mention that it is not to mend holes in kettles with.

The real stuff is generally sold by weight in triangular sticks, and at a fair price. A stick 1 ft. long can be bent double, but not easily.

In conclusion, I do not think that the passage of electrical currents has any appreciable effect on solder. Vibration seems to be its chief enemy—causing crystallisation.

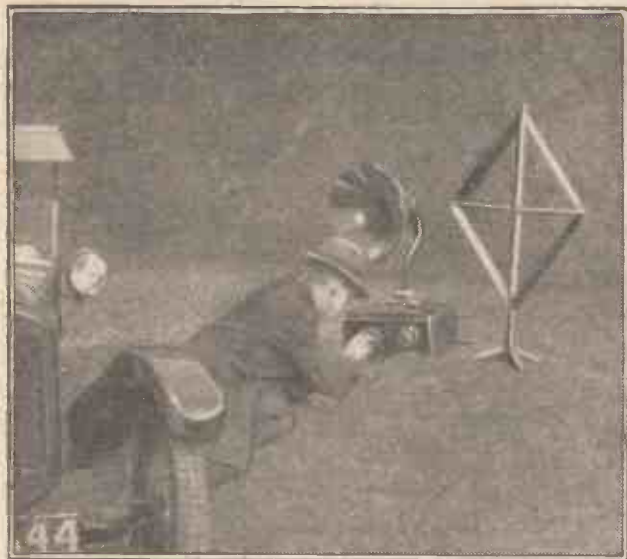

# GETTING REACTION WITH A FRAME AERIAL

*The efficiency of a receiver employing a frame aerial is very largely dependent upon the methods employed for providing reaction.*

By C. P. ALLINSON, A.M.I.R.E.

**I**N these days of highly efficient wireless receivers it is wonderful what can be done in the way of long-distance reception on a frame aerial, using detector and L.F. amplification only.

It is important, however, that reaction be applied to the frame in some manner, and a few notes on the different methods of applying reaction to a frame aerial may prove of interest to those who wish to carry out reception by this means.

## Excellent Results

As regards the results which can be obtained with a frame, excellent loud-speaking can be obtained with a 3-valve set (det. and 2 L.F.) from the local and main broadcasting stations

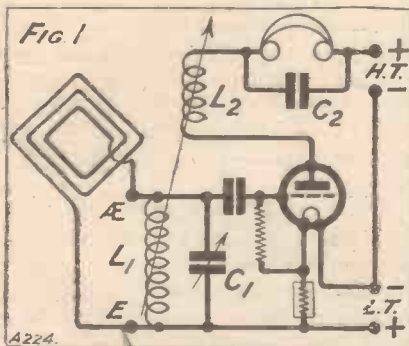

up to within five or ten miles, and sometimes further, while on the headphones it should be possible under favourable conditions to go the round of a number of Continental stations.

In order to enable reaction to be obtained with a frame when using a detector valve, there are three chief methods which can be used: (1) is to connect a coil in parallel with the frame and apply reaction to that; (2) is to connect a coil in series with the

frame and apply reaction to it, and (3) is to employ a tapped frame by means of which Reinartz or capacity reaction can be used.

Where it is desired to use a frame aerial with an existing receiver, without in any way altering the wiring in it, probably the most convenient arrangement to employ is the parallel arrangement shown in Fig. 1. In this case the frame aerial is merely connected between the aerial and earth terminals, as shown, so that it is now in parallel with the tuning coil shown at  $L_1$ , to which the reaction coil is coupled in the usual way.

This enables you, therefore, to make a simple preliminary experiment without in any way disturbing your receiver to determine what measure of efficiency you can expect—and probably the most important point—what kind of performance you will obtain from your local station.

## Inductance Reduced

It should be noted in this case, however, that since the coil and frame will now be in parallel, the effective inductance of the two will be less than that of either singly—in conformity with the well-known formula relating to inductances in parallel ( $L_1$  and  $L_2$ )—so that the total inductance  $L = \frac{L_1 \times L_2}{L_1 + L_2}$

It will therefore be necessary to have a larger grid coil than that normally used, and the frame, too, should be made larger if the best results are to be obtained.

The second method of obtaining reaction by placing a coil in series with the frame aerial is shown in Fig. 2A in theoretical form.  $L_1$ , the coil to which the reaction coil is

coupled, is shown connected in series on the filament side of the frame. The size of the coil  $L_1$  need only be a 20- or 25-turn coil, while the reaction coil should be as small as possible consistent with giving oscillation control over the whole tuning band of the receiver.

## Effect on Wave-length

It should be noted that if the loading inductance  $L_1$  is too large it will not be possible to tune in the very low wave-length broadcast stations unless the size of the frame also is reduced.

It is sometimes contended that placing the inductance  $L_1$  on the grid

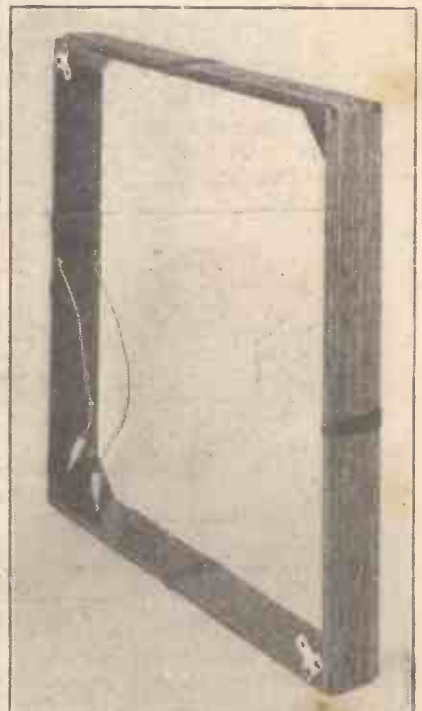

*A closely-wound frame aerial which fits inside the case of a portable receiver.*

# Getting Reaction with a Frame Aerial—continued

side of the frame aerial will give greater efficiency than on the low-tension side, as shown, but though this may be so in some cases the

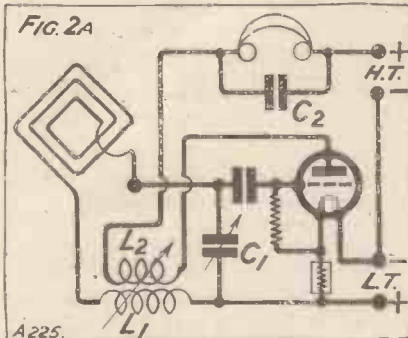

effect of the reaction on tuning will be far greater than by connecting it as in Fig. 2A.

### A Further Improvement

Since the above method of applying reaction to the frame entails a slight alteration to the receiver with which you are carrying out the experiment, a further alteration will also greatly increase the ease of handling the set. You will no doubt realise that with a frame aerial, where there is so little damping, the control of reaction becomes a matter requiring a little added skill, and the use of a swinging coil becomes rather clumsy and in some cases difficult to control. The method known as throttle control, however, gives wonderful ease of adjustment, though certainly it requires the introduction of a couple of extra components. The method of applying this form of control is shown in Fig. 2B. The two coils  $L_1$  and  $L_2$  as

means of a variable condenser, shown at  $C_2$ .

In order to obtain this control, however, it is necessary to connect an H.F. choke, shown at  $L_3$ , in series with the reaction coil. The functioning of the circuit is such that with the condenser  $C_2$  placed at its minimum setting (with the moving vanes all out) no reaction is obtained, but as the value of the condenser is gradually increased by interleaving the moving vanes and the fixed vanes, more and more reaction is obtained.

### Most Economical Method

In practice it is found that a delightfully smooth and progressive control of reaction is given by this method and it certainly has far less effect on the tuning than the swinging reaction coil, and it is also free from any possibility of mechanical backlash such as may exist in a moving-coil holder.

What is probably, however, the most efficient and economical method, as well as the most convenient way of obtaining reaction when using a frame aerial, is to employ a tapped frame so that capacity reaction of the Reinartz description may be employed. This method is shown in Fig. 3, which illustrates the application of Reinartz reaction to a frame aerial in conjunction with a two-valve receiver. Assuming that the frame consists of 12 to 14 turns on a 2-ft. side, which is approximately correct for the reception of the broadcast wave-band, a further 3 to 5 turns should be wound on for reaction,

The frame aerial is connected so that 12 turns are connected in the grid circuit across the tuning condenser  $C_1$ , which has the usual

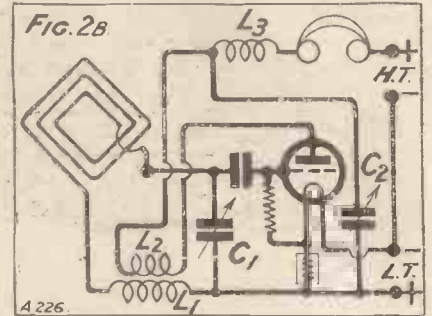

capacity of .0005, while the 3 extra turns are connected between L.T. and one side of the reaction condenser, shown at  $C_2$ . This needs to have a value not greater than .0001, in view of the low damping of the frame.

### Loud-Speaker Results

An H.F. choke is connected in the plate circuit of the detector valve in the usual fashion, and a transformer is used to couple the output from the detector to the L.F. valve.

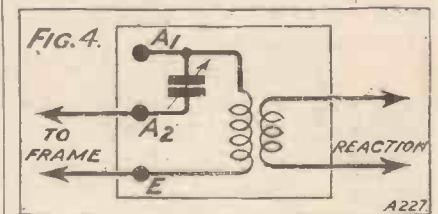

With a two-valve receiver built on these lines it is possible to obtain fair loud-speaker results within two or three or even five miles of the local station.

### No Alteration Necessary

If you happen to have a receiver in which two aerial terminals enable parallel or series tuning, to be obtained, then Fig. 4 shows a method of connecting the aerial without making any alteration to the wiring of the receiver. This drawing is self-explanatory, though it should be noted that the frame aerial should only have one or two turns on it, and the arrangement probably will not be so sensitive or so satisfactory in use as the other methods described. It, nevertheless, presents an easy solution to the question of adding a frame to an existing receiver where the terminal arrangement shown is employed.

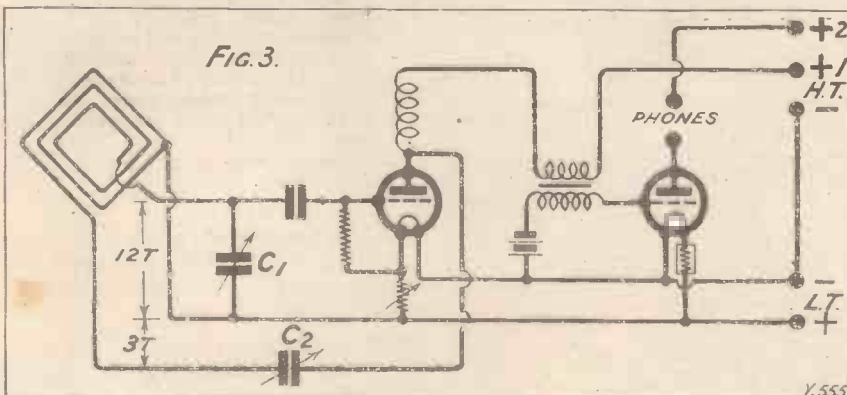

before enable reaction to be obtained, but instead of the coupling between the two being variable, the coupling is definitely fixed and the variable control of reaction is obtained by

the direction of winding being the same as the frame. The actual number of turns required depends on the method of winding and the valves and H.T. in use.

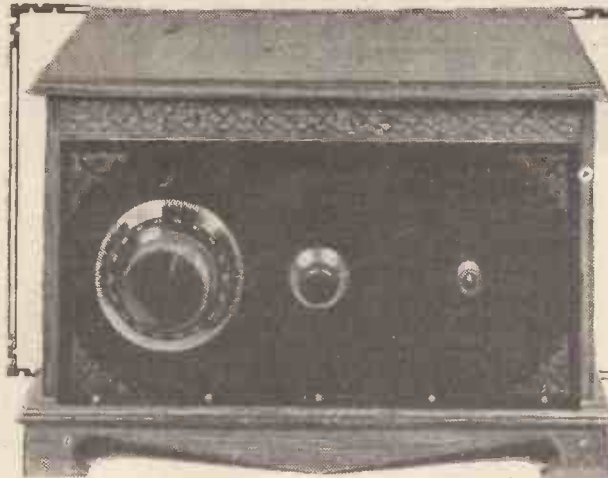

# AN ULTRA-SELECTIVE THREE

by L. H. THOMAS

Details of the construction of an easily operated three-valve receiver with an extremely high degree of selectivity.

MANY readers who desire a set that is reasonably selective without being either difficult to construct or tricky to operate seem nowadays to lose sight of the fact that a set can be quite selective without incorporating H.F. amplification. The last thing I should attempt to do is to advocate the adoption of an "H.F.-less" receiver as a general rule, but it is well to bear in mind the two facts that a

stations, it may safely be taken for granted that it is perfectly futile to use a receiver which has no amplification before the detector, if it has any of the usual forms of *direct-coupled* aerial circuit. There are so many simple circuits capable of giving the selectivity that is missing in these cases that it is difficult to see the reason for building such a set unless one does take reasonable precautions to make it selective, and, to

spondingly smooth control of reaction over a wide band of wave-lengths. Incidentally, owing to the great reduction of the aerial damping of the grid circuit, a much smaller reaction coil is necessary to make the set oscillate, and accordingly the reaction control (whether it be by capacity or "swinging-coil" method) has less effect upon the tuning of the receiver. That is to say, if we tune in a station with the set well below the oscillation point, and then increase the reaction control to bring the station up to full strength, it will not be necessary to retune the grid circuit of the set by means of the main tuning control.

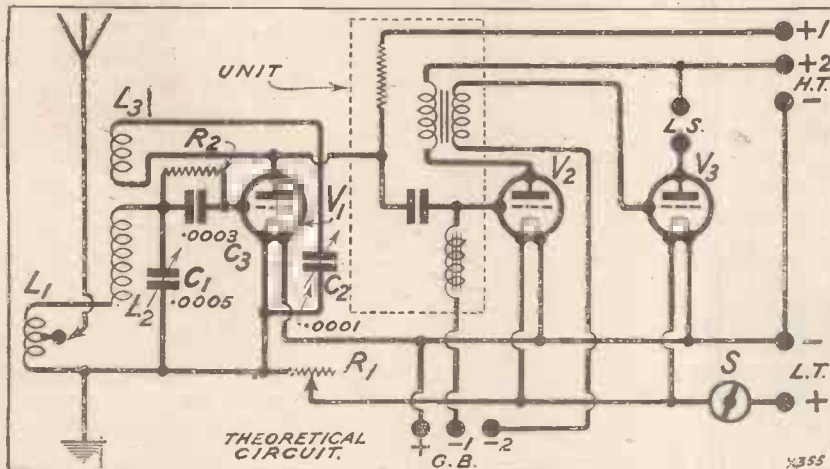

selective receiver need not be complicated while a complicated receiver need not be selective.

Home constructors, nowadays, seem to divide into two schools—those who always, habitually, build sets with at least one stage of H.F., and those who make a regular practice of "starting with the detector." The latter, when acting without proper guidance, often produce receivers of the most hopelessly inselective type, which do much to convince all who see and hear them that it is impossible to receive anything but the local station with any certainty unless one uses two or three stages of H.F.

With the ether in its present congested state, and with the high powers in use by several broadcasting

start the ball rolling, I have constructed this simple three-valve receiver to show what some of these circuits can do.

### No Strength Reduction

It is a mistaken impression among many constructors and listeners that by "loose-coupling" the aerial circuit one infallibly loses much signal-strength and gains nothing to compensate for it. In the first place, if the set is worthy of the name, no noticeable loss in signal-strength will, as a rule, result. Secondly, in addition to an indisputable gain in selectivity, many other advantages accrue.

Among these is the absence of "dead spots" due to the natural wave-length of the aerial, and corre-

### COMPONENTS REQUIRED.

- 1 Ebonite panel, 14 in. × 7 in., with gilt corner design (Resiston).
- 1 Cabinet for same with loose baseboard 7 in. deep.
- 3 Non-microphonic valve holders (Redfern, Lotus, Benjamin, etc.).
- 1 .0005 variable condenser (Ripault).
- 1 .0001 reaction condenser (Peto-Scott).
- 1 On-off switch (Lissen, Lotus, etc.).
- 1 Formo two-stage unit.
- 1 Baseboard-mounting rheostat (Pacent, Lissen, Igranic, etc.).
- 3 Baseboard-mounting coil sockets.
- 1 Grid condenser with clips, .0008 (T.C.C., Lissen, Mullard, Dubilier, etc.).
- 12-megohm leak (Dubilier Lissen, etc.).
- 1 Seven-terminal and 1 two-terminal strip.
- Wood screws, Glazite, etc., etc.

On far too many sets one finds the main tuning control and the reaction control interlock so beautifully that the whole tuning operation reminds one of a three-legged race. With a reasonably well-designed set it should be possible to swing the reaction condenser (it is, by the way, nearly always preferable to arrange for capacity-controlled reaction) from the zero position to the "half-in" position without seriously affecting the tuning of the set. On the set

## An Ultra-Selective Three—continued

described here it is possible to tune in a C.W. signal, and to swing the reaction condenser over quite a wide range without losing the signal, or even appreciably altering the beat-note.

Although the method of coupling the aerial to the set is perfectly simple, conventional and quite old, I do not remember having seen it used in another receiver myself. I often use a similar circuit for short-wave work and find it very satisfactory, but the chief advantages occur on the broadcast wave-lengths. It will be seen that the grid or "secondary" circuit consists of two coils, one of which is coupled to the reaction coil, the other being mounted at right-angles to it and being a centre-tapped coil. These two coils are, of course, connected in series, and the aerial is connected to the centre-tap on the "lower" coil. By arranging the sizes of these two coils we may alter the degree of selectivity obtainable to suit our own requirements.

### Compact Lay-out

Referring to the photographs and diagrams, it will be seen at once that the whole set, in spite of the extra space needed for the special

method of aerial coupling, is reasonably compact. This is due, in a large measure, to the use of the new Formo unit, which incorporates all the components necessary for a two-stage amplifier. The only other components necessary at the L.F. end of

the aerial coil being mounted with its axis parallel to the panel, the other being at right-angles to it. A flex lead from the aerial terminal is taken to the centre tap, on this coil.

The theoretical circuit is shown in one of the diagrams, in which all the

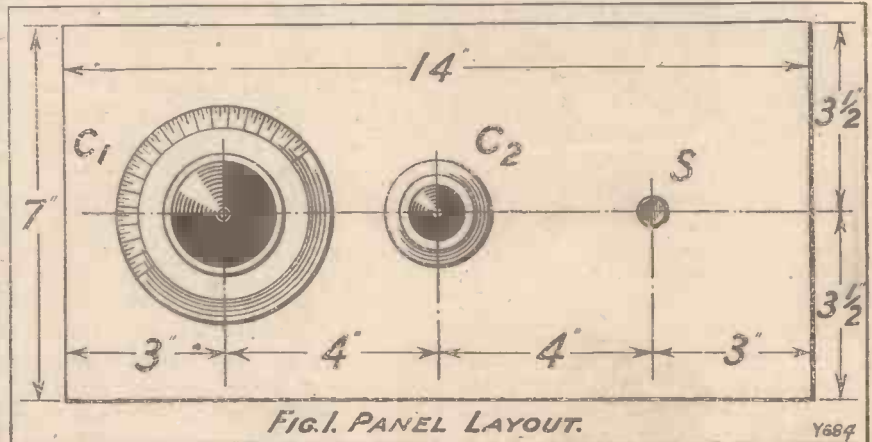

the set are the two valve holders! At the detector end it will be noticed that ample spacing has been allowed for the components, the coils being kept away from each other and from the variable condenser, etc., on the panel. The method of placing the coils which was adopted is probably the simplest and most convenient,

parts incorporated in the Formo unit have been enclosed by a dotted line. Reaction is controlled by the condenser  $C_2$ , which is the small condenser mounted in the centre of the panel. Its maximum capacity is in the region of .0001, which is ample for the purpose. The only other components on the panel are the main tuning condenser  $C_1$  and the L.T. switch. One filament rheostat only has been included, this being in the filament lead to the detector valve. Even this is not strictly necessary, as practically all the present-day valves are intended to function straight from 2-, 4-, or 6-volt accumulators. A rheostat in the detector lead is frequently useful, however, as certain valves are sometimes found which operate most satisfactorily with a slightly lower voltage than that at which they are rated, and, also, the reaction control is occasionally capable of improvement by adjustment of the filament voltage.

### Components Necessary

All the battery terminals are mounted, in the usual way, on the strip at the left-hand side of the baseboard (referring to the back-of-panel photographs), and the aerial and earth terminals are provided with a separate small strip. A full list of the necessary components is given elsewhere, the choice of the components used being a matter for the reader's taste

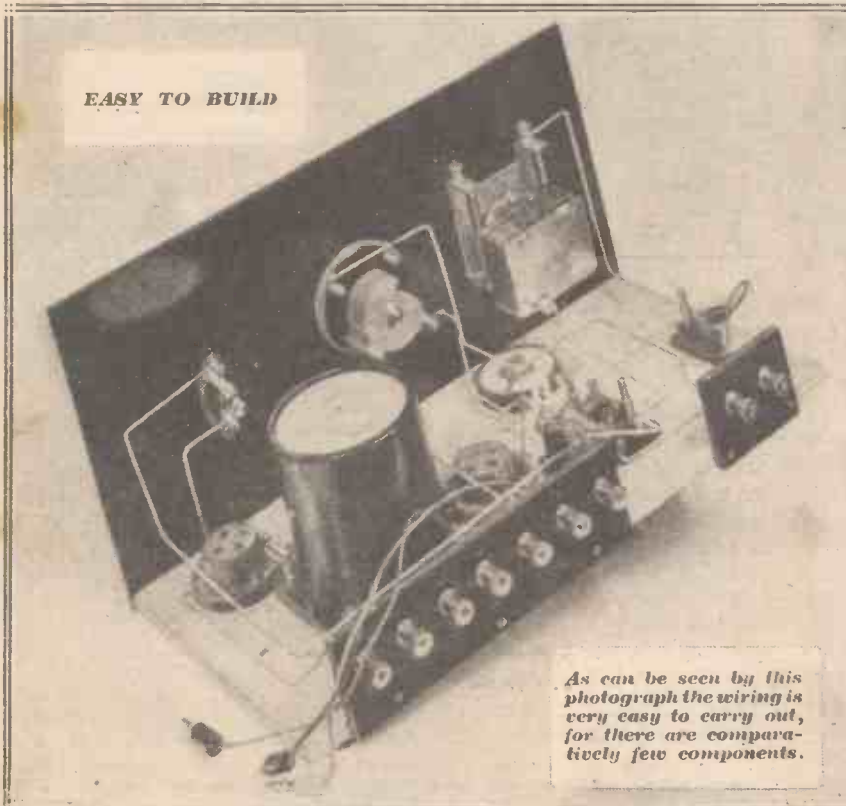



## An Ultra-Selective Three—continued

The first step in the construction of the set should be the drilling of the panel. Only three holes for components and five for small wood-screws are necessary, so that this is by no

plates are connected to the filament circuit. Actually no "hand-capacity effects" are noticed in connection with either the reaction control or the tuning condenser.

is infinitely worse than that produced by a wire tightly screwed down under a terminal. Soldering makes a neater job, and, for those who have the happy knack, a much quicker job than the other method.

One point which might be borne in mind is this: if you use the Redfern valve holders, as used in the original, use four screws for holding them down. Screws are provided with the valve holders, and if only two are used they tend to become rather too "non-microphonic" and allow the valves to swing rather violently! In any case, four holes and four screws are provided, and there is no objection to using them all.

### Suitable Valves

Returning to the method of reaction control, it will be noticed that a "throttle-control" scheme is employed without using a choke in the H.T. supply lead. The reason for this is, of course, that the 100,000-ohm resistance acts as a very effective barrier for H.F. currents, which will all choose the alternative path provided by the reaction condenser  $C_2$ .

The terminals on the Formo unit are marked for Grid Bias—, and the flex lead for Grid Bias— comes, of course, from the L.T.—terminal. The grid-bias battery stands conveniently on the baseboard near the last valve.

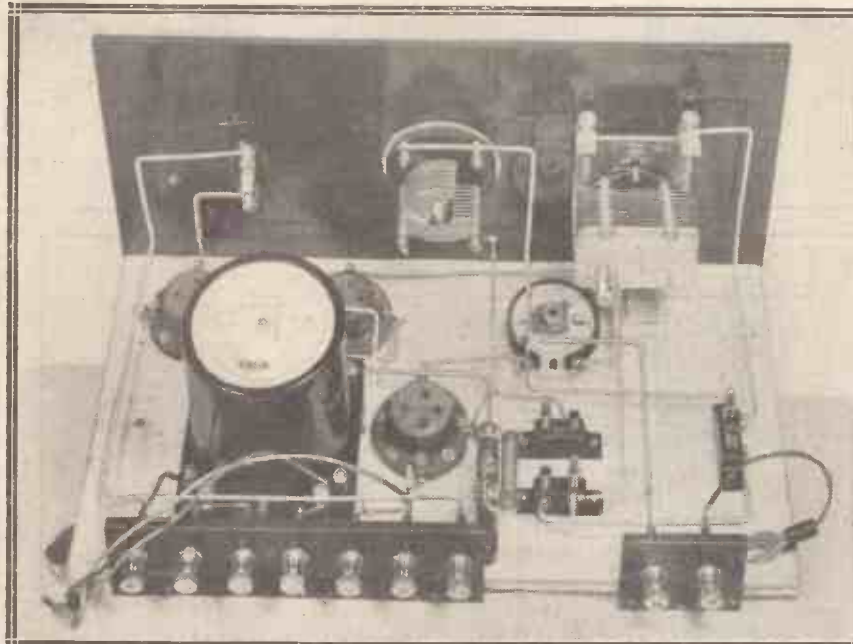

In conjunction with the wiring diagram this photograph forms a valuable guide to the layout and wiring.

means a long job. Next, mount the components on the baseboard as indicated by the diagram, and wire them all up. It will be found that this procedure saves a good deal of time and obviates several tricky corners. When all the wiring that is confined to the baseboard has been completed, mount the panel and complete the wiring. Only six more connections will have to be made.

The wiring should not present any difficulty. My only advice is—if you cannot solder reasonably well and neatly, don't! A badly soldered joint

### Reaction Condenser Connections

If the same make of Midget reaction condenser as was originally used is decided upon by the reader, it will be noticed that there are four terminals, two of which make contact with the fixed plates, one with the moving plates, and one with a metal screen. It is important to make sure that the right points are used for connections. One connection only is, of course, taken from the fixed plates, this going to the reaction coil  $L^2$ . The moving plates are then connected to the screen and the joint connection taken to the filament as shown in the wiring diagram. If the condenser used has no screening plate it will not matter, provided that the moving

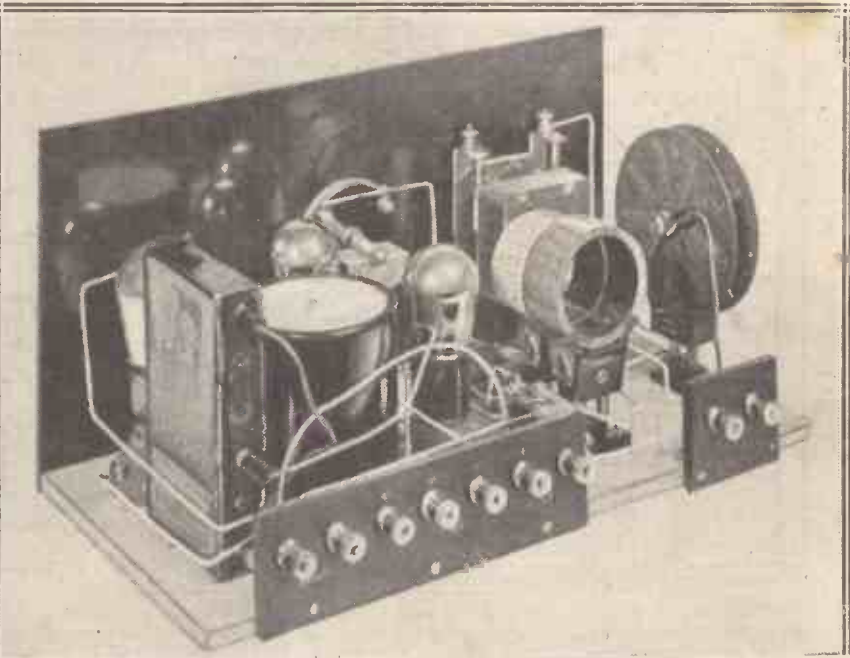

The Ultra-Selective Three ready for test, with valves, coils and grid bias on board. Note how conveniently everything is arranged, no space being wasted at any point.

## An Ultra-Selective Three—continued

With regard to suitable valves, such a wide range of them will work efficiently that it is unnecessary to say much on the subject. The detector should be a valve of the nominal H.F. type, with an amplification factor of about 20. Reference to valve-makers' curves will show that several are suitable, although valves with much higher impedances, such as the D.E.H.210, 410, and 610, etc., can also be used. For the first L.F. valve I prefer a small power valve, and the last a super-power valve.

Regarding H.T. voltages, it will be noticed that one terminal provides the H.T. + for both the L.F. valves, while the detector is provided with a separate terminal. In practice the same voltage may be applied to both terminals, since the detector valve's anode supply is subject to a considerable drop, across the 100,000-ohm resistance. Using 120 volts throughout, G.B.—1 will generally need to be about  $1\frac{1}{2}$  to 3 volts, while G.B.—2 will depend on the type of super-power valve used.

For all normal purposes the coils for ordinary broadcast reception should be:  $L_2$  50 turns,  $L_3$  30 or 35 turns, and  $L_1$  (centre-tapped) about 18 turns (Gambrell a2). This combination seems to give about the correct degree of aerial coupling. For local reception only, the  $L_2$  coil may be made slightly smaller and the  $L_1$  slightly larger, and this will also be the case where a very small aerial is in use.  $L_1$  may then consist of 25 or 30 turns. Conversely, with a high

(Continued on page 81.)

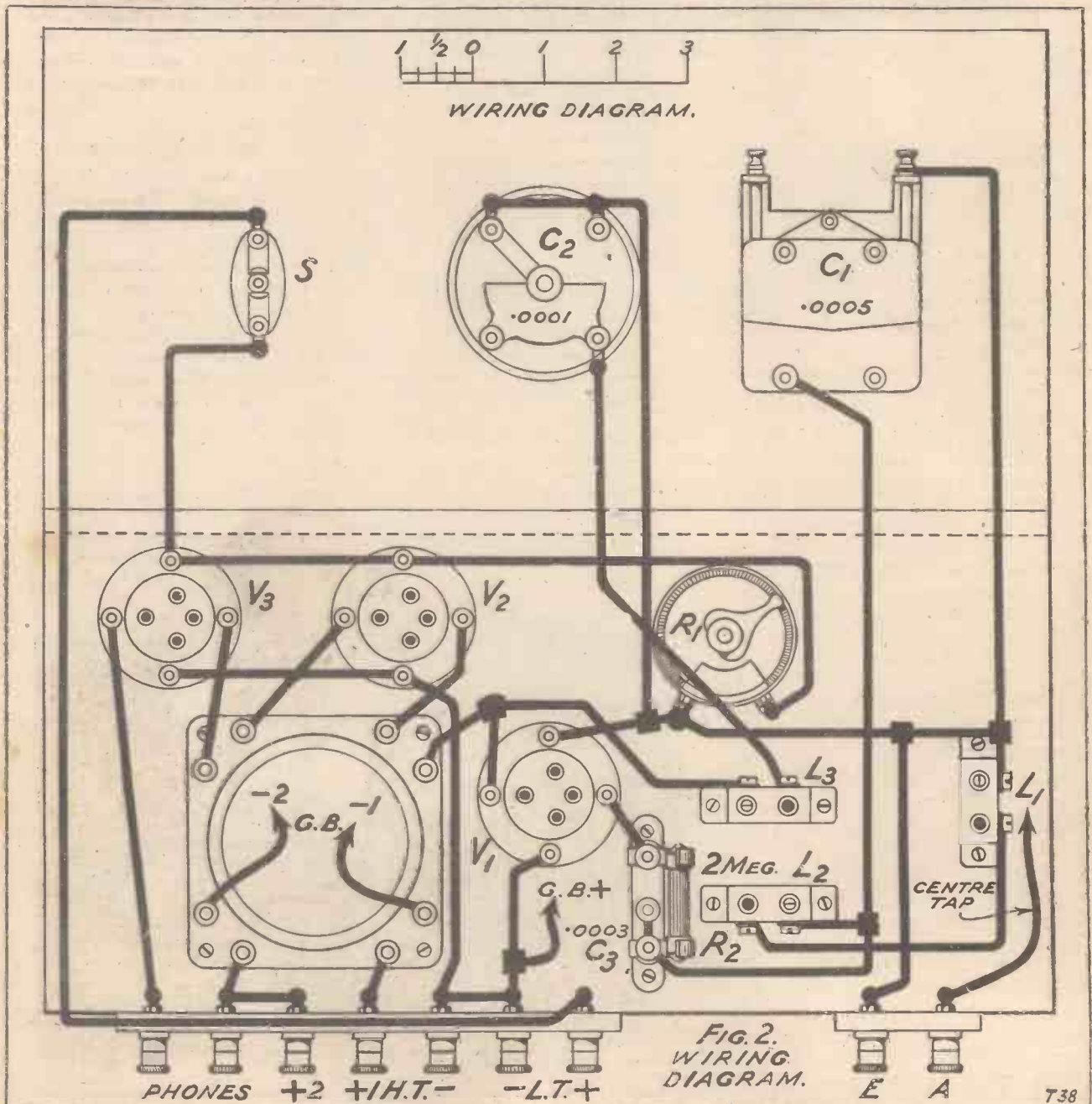

# LABORATORY NOTES

by the Editor



**M**ENTION has often been made in the columns of the WIRELESS CONSTRUCTOR of the troubles caused by inferior high-tension batteries. A set, for example, may howl vigorously or develop all kinds of irritating noises from this source, and in such circumstances the user is forced to take steps to remove the trouble before he can carry on with his reception. Frequently, however, the trouble is not so pronounced and is either not immediately recognised or else attributed to quite a different cause.

### Low-Frequency Interaction

The howling to which we are referring here must not be confused with the howl due to high-frequency oscillations and the production of a beat-note with a carrier-wave. We refer here to a continuous audio-frequency howl which frequently arises from interaction between the low-frequency stages.

A few moments' consideration will show that if we have in the grid circuit of a low-frequency valve both inductance and capacity, we have a tuned circuit, and the natural frequency of the circuit may be either above audibility or well within it. If now we have in some following circuit another tuned circuit which can be coupled in some way or other to the grid inductance, we can feed-back magnified signals into the grid circuit and produce self-oscillation as we do in our high-frequency circuits.

### Battery Feed-Back

Whenever there is sufficient back coupling in this way to produce audio-frequency oscillations we get that irritating howl to which we have referred above. The feed-back coupling to produce howling may arise

*Under this heading the Editor discusses some of the many interesting points revealed during his experiments in the "Wireless Constructor" laboratory.*

from interaction between two transformer fields, although this is rare nowadays; by capacitive coupling between plate and grid; or by a common resistance in the anode circuit.

As batteries get older their internal resistance rises, and as this resistance is frequently common to several circuits, voltages can easily be fed back through the battery from one

circuit to another. When the battery is bad enough to give this trouble, it can rarely be cured by the shunting of a large condenser across it.

Tests in the laboratory have recently shown that many bad cases of howling due to high-resistance battery feed-back may be cured by the use of a choke and condenser in the output so that the large audio-frequency currents in the plate circuit of the last valve are kept out of the battery entirely. In such circumstances a choke and condenser used as a filter is much superior to an output transformer, for in the latter the audio-frequency fluctuations pass to the

### HOW HE "HOWLS"!

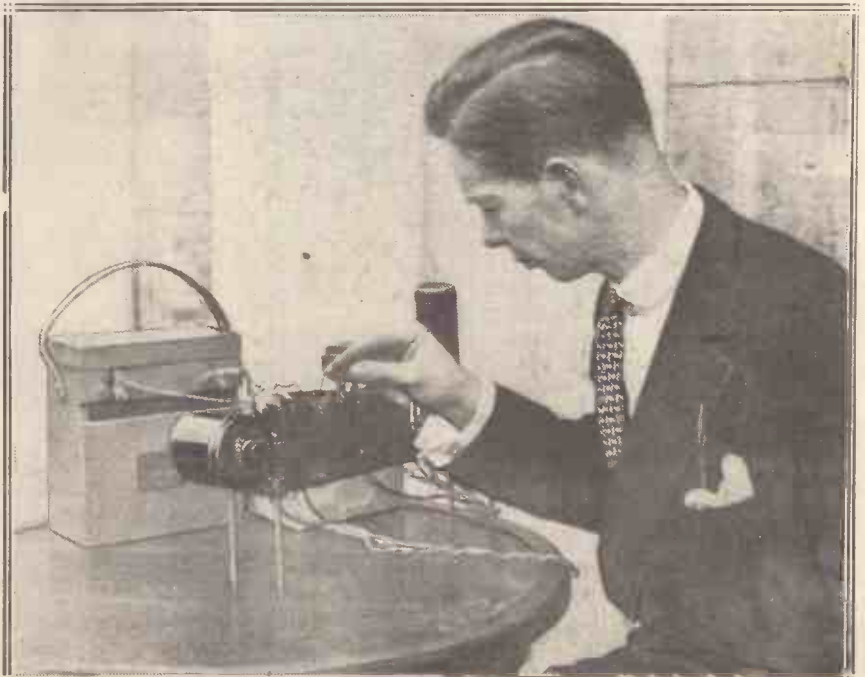

*With the instrument shown above, which operates on the heterodyned oscillating valve principle, it is claimed that musical notes can be rendered with exceptional ease just by movements of the hand in front of the apparatus.*

## Laboratory Notes—continued

battery in just the same way as if the loud speaker were in direct connection.

### Transformer Design

Some readers may wonder where we get the capacity to form the tuned circuit in an audio-frequency amplifier. Actually there is always a certain amount of self-capacity present in the windings, although in modern transformer manufacture this has been reduced to a very small figure.

In addition to this self-capacity we have the capacity of the valves, the capacity of the valve holder (quite high in the solid form of holder), and between wires (often the highest of all). Across the primary we often have a fixed condenser (frequently included inside the transformer casing), and this may have a value of .0003 or .0005 mfd. There is also a very appreciable capacity between the primary and secondary windings.

speakers will reproduce, so that it is no longer true to say that for pure reproduction we must use resistance-capacity coupling.

On the other hand, there is great difficulty in designing receivers so as to avoid a tendency to resonance between two stages of transformer coupling, and this tendency to resonance, while not sufficient to produce low-frequency oscillation, may rather exaggerate certain frequencies and thus destroy the uniformity of reproduction. The use of one resistance stage and one transformer-coupled stage is a very practical form of overcoming certain tendencies to resonance and distortion due not so much to deficiency in the transformers themselves, as the tendency to interaction when two are used together.

### A New Instrument

Speaking of howling, an instrument

nected to it, and the sensitivity at various frequencies and general performance checked.

### Surprising Revelations

It is most illuminating to compare the better moving-coil speakers and the ordinary cone types by means of a change-over switch. From the high frequencies down to frequencies of two or three hundred there is little to choose between them, but when we come to the really low notes, we find that what passes as a low note in the ordinary cone type of loud speaker is really a harmonic of it. For example, when the average cone type is compared with a good moving-coil speaker on the very low notes, a change-over from one to the other changes the reproduced note a complete octave!

### Varying Response

Another point which the audio-frequency oscillator brings out is the very un-uniform response of the average loud speaker to different frequencies. Passing steadily down the scale from top to bottom, the best moving-coil speakers give a fairly uniform response in strength, whereas a number of the ordinary cone types have sharp "peaks" on which strength rises perhaps to three or four times that given by the good moving-coil type, while a little lower down the scale it may be weaker. At the same time, even the best of the moving-coil speakers is deficient in many respects, and few give any genuine response below about sixty or seventy cycles.

### Watch Those Valves

Readers who use push-pull circuits should make a point of checking the emission of their valves from time to time to see that one or the other has not seriously fallen off, thus upsetting the balance. A paper label should be stuck on each of the push-pull valves, and the emission at zero grid volts for a given plate voltage marked when the valve is new. No elaborate apparatus is necessary to make this check. It is advisable not to keep the valve alight for more than a minute or so at zero grid volts. Some of the modern super-valve valves have a nasty habit of losing a considerable portion of their emission without warning, and a check of the kind mentioned should certainly be made from time to time.

### FAMOUS FIRM'S FACTORY

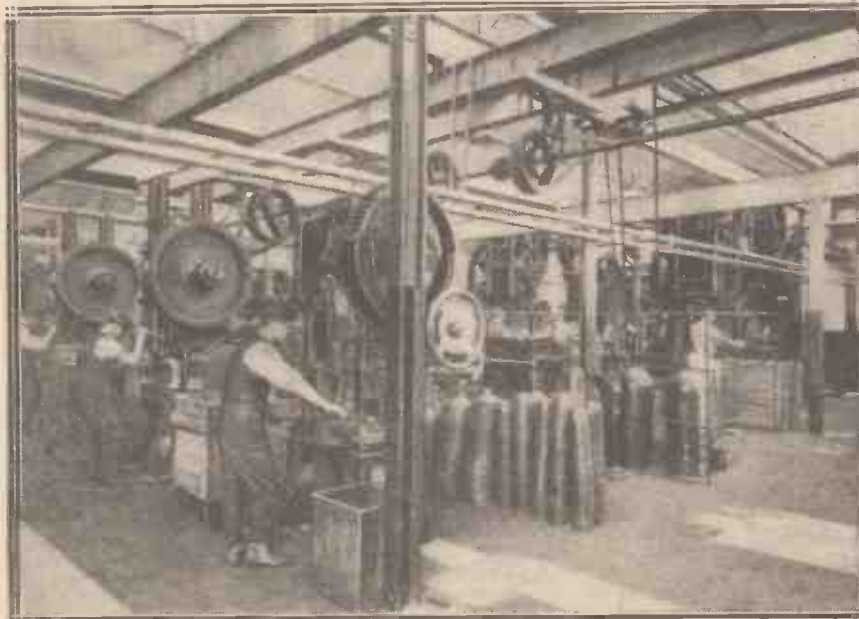

A corner of the works of Benjamin Electric, Ltd., the makers, among other things, of the famous anti-microphonic valve holders.

Transformer makers, in designing their instruments, have to take into account the various capacities present in order to get a uniform reproduction throughout the scale. There are several transformers now on the market which, when properly used, will give uniform reproduction of frequencies from the highest we need in practice down to notes far lower than any but special laboratory

has recently been put into commission in this laboratory which by means of beat-note effects between two radio-frequency circuits gives a perfectly controllable pure note audio-frequency howl from about thirty cycles up to ten thousand or more. Special precautions have been taken to provide a uniform output, and low-frequency transformers, loud speakers, and other reproducing instruments can be con-

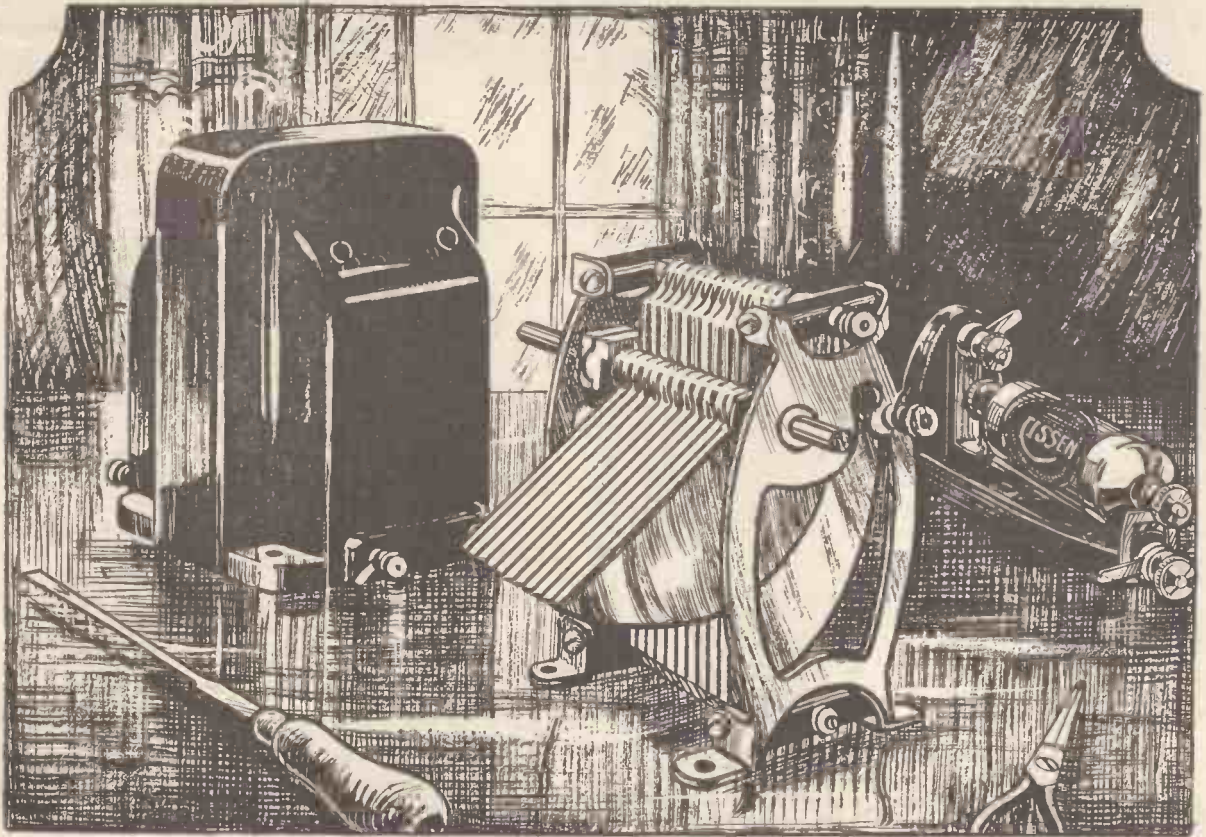

## Newcomers to the Lissen Range which will appeal to home constructors

Here are three additions to the Lissen Range of Radio Components, which will be welcomed by all who, in the course of construction, desire a complete range of balanced and interchangeable components. Each is a distinct advance on previous commercial components—each is designed to be of universal utility and to *replace any similar specified component with added efficiency* in any published circuit.

### LISSEN VARIABLE CONDENSER

You can use it as a standard condenser in any circuit.  
 You can gang it—two or three of them together.  
 You can use a drum control for it instead of a dial.  
 You can mount it on a panel and it has feet for baseboard mounting, too. One hole fixing, of course.

•0001 mfd.capacity	..	5/9
•0002 " "	..	5/9
•0003 " "	..	6/-
•00035 " "	..	6/3
•0005 " "	..	6/6

### LISSEN SUPER TRANSFORMER

Only now has the depth of radio technique yielded the knowledge which has made the Lissen Super Transformer possible. It represents a big saving in price to the transformer-buying public, in comparison with every other high-priced transformer available. Ratio  $\frac{3}{4}$  to 1.

Price **19/-**

### LISSEN WIRE-WOUND RESISTANCES

Suitable for use in power amplifiers—unaffected by current density or atmospheric changes. Made in the following values:

Ohms.	Price.	Ohms.	Price.
10,000 ..	3/6	80,000 ..	4/-
20,000 ..	3/6	100,000 ..	4/6
25,000 ..	3/6	150,000 ..	5/6
50,000 ..	3/6	200,000 ..	6/-
		250,000 ..	6/6

**LISSEN RESISTANCE BASES**  
 Price .. . . . . 1/-

**7 DAYS' APPROVAL.** You can get the new Lissen components from practically every radio dealer.

# LISSEN COMPONENTS

**LISSEN LIMITED, Friars Lane, Richmond, Surrey**

Managing Director: Thomas N. Cole

# IT'S AN INFECTIOUS DISEASE

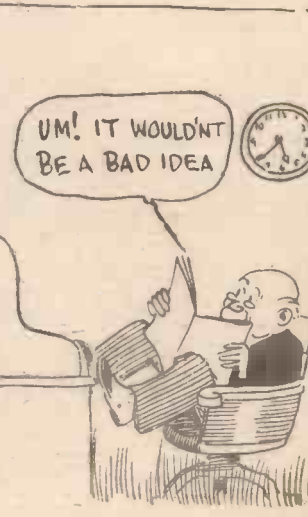
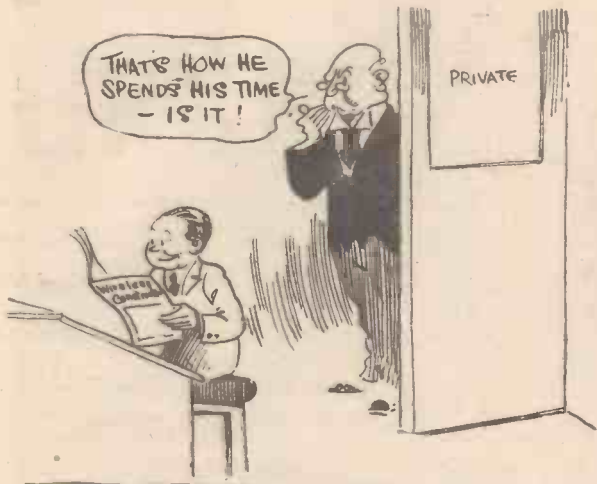

FRAN SHAW



# Squeezing Stations

*A solution to the vital problem of ether overcrowding.*

FROM A SPECIAL CORRESPONDENT.

OUT of the total range of practical wave-lengths available for wireless transmission—which extends, say, from 20 to 30,000 metres—European broadcasting has by international agreement been restricted to two channels, one covering a band of 200–600 metres, and the other from 1,000 to 2,000 metres. Outside these limits the ether is parcelled out amongst various other interests, including the commercial side of radio-communication and the naval and military services of the various countries concerned.

One of the problems of the moment is how to find room, within the two narrow channels allotted, for the constantly increasing number of new broadcasting stations. The International Committee which sits in Geneva is doing its best to keep the ether free from mutual interference, but as time goes on the task becomes increasingly difficult.

## Due to Modulation

In one sense the trouble lies in the present system of modulation. It is all very well to say that such and such a station has been allotted a wave-length of, say, 300 metres. In practice the station cannot be confined to that wave-length when it is actually broadcasting.

The unmodulated carrier-wave can certainly be kept constant, but directly the microphone currents are applied to it, side-bands are formed which convert the original carrier into a flat-topped wave. The extent to which the modulated wave overlaps its original value depends upon the range of frequencies contained in the modulating note.

The Geneva committee assumes as a reasonable standard that the low-frequency or microphone currents cover from 30 to 5,000 cycles per

second, i.e. that within this range good musical transmission is possible. It follows that the side-band "fringes" created when such microphone currents are applied to the carrier-wave must extend for 5,000 cycles above and for 5,000 cycles below the fundamental frequency.

## The Geneva Plan

Therefore, the committee insists that every broadcasting station must be separated from its nearest neighbour on the wave-length scale by a gap of at least 10,000 cycles. Otherwise interference is bound to occur.

only when one considers the number of different stations to be provided for that it is seen to be the source of serious trouble.

The side-band problem has for a long time past been a thorn in the side of the wireless engineer. Efforts have already been made in the direction of what might be called "bobbing" the wave by eliminating or entirely suppressing one or other of the side-bands, before the wave is fed into the transmitting aerial.

The resulting radiation certainly takes up less elbow-space in the ether, but unfortunately very special circuit arrangements are necessary at the

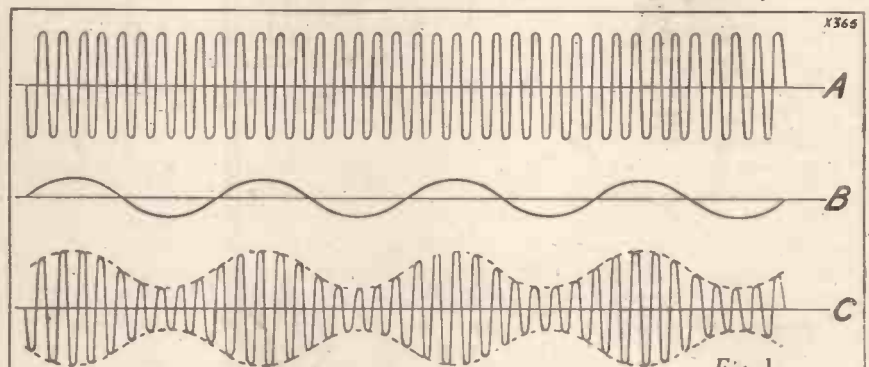

Fig. 1.

ILLUSTRATING THE STANDARD SYSTEM OF AMPLITUDE MODULATION.

In actual practice the low-frequency currents used, say, when transmitting an orchestral performance, will cover a frequency band more than double that mentioned above, with a corresponding widening of the side-band "fringe" of the radiated carrier.

Take, for example, a station with an allotted carrier wave-length of 300 metres. If it uses a modulation frequency covering 10,000 cycles, the corresponding overlap will extend from 297 to 303 metres. For a longer wave station the overlap in metres will, of course, be proportionally greater.

This may not at first sight appear to be a very formidable matter. It is

receiving end before the original message can be extracted from the mutilated carrier. As a matter of fact, such "narrow cast" transmission is practically "secret."

## Cutting Still Finer

It has recently been discovered that a much more drastic trimming of the side-band fringe—amounting in fact to a positive "shingle"—can be secured by using a new method of modulation in which the amplitude of the original carrier-wave is kept strictly constant, whilst its frequency is varied in the rhythm of the modulating current.

## Squeezing Stations—continued

The essential difference between the two systems is best explained by reference to the two diagrams shown in Figs. 1 and 2:

Fig. 1 represents the ordinary or standard system of modulation as at present employed. The curve A shows an unmodulated carrier-wave of constant frequency and constant amplitude. Curve B is a single-tone modulating current:

Curve C shows the modulated curve produced as the result of combining A and B. It will be noticed that the frequency of the carrier-wave remains constant, but its amplitude varies from point to point in such a way that the dotted-out line or "envelope" of the curve forms a replica of the modulating curve B.

### Frequency Modulation

The curve C does not show the individual frequencies forming the side-band fringe. Exactly why they are present can only be demonstrated by mathematical reasoning which must be taken as read. It is based upon a theorem due to one Fourier, who found out, in the course of last century, that any wave motion, however complicated (such as the curve C), is in fact formed of a number of simple sine curves of suitable frequencies and amplitudes.

Should any reader remain unconvinced on this point he can satisfy himself by a practical experiment, given the necessary apparatus. Adjust a valve oscillator to generate a constant wave, say, of 5,000 cycles. Modulate with a constant note, say, of

frequency of 5,500 (the sum frequency), and (c) a lower side-band frequency of 4,500 (the difference frequency).

We will now turn to the newly-discovered method of frequency-modulation illustrated in Fig. 2. Here curve (a) represents as before the pure or unmodulated carrier; (b) the low-frequency modulating note, and (c) the resultant wave as produced by the method described below.

It will be seen that in curve (c) there are no amplitude variations, but the frequency (or horizontal spacing) of each of the carrier components changes from point to point. They are crowded together where the curve (b) rises above the horizontal datum line, opening out to the normal spacing wherever (b) crosses the datum line, and are spaced most widely apart at the troughs of the modulating curve.

The method of producing this type of modulation is remarkably simple. Instead of applying the microphone currents directly or indirectly to the grid or plate of a modulating valve, they are applied directly to alter the capacity value of a condenser inserted in the main oscillating circuit of the transmitter.

### Easily Carried Out

For instance, the output from the microphone is first amplified by an ordinary valve, and the strengthened currents are then passed through an electro-magnet which directly vibrates the moving plate of a condenser tuning the transmitting aerial. Or

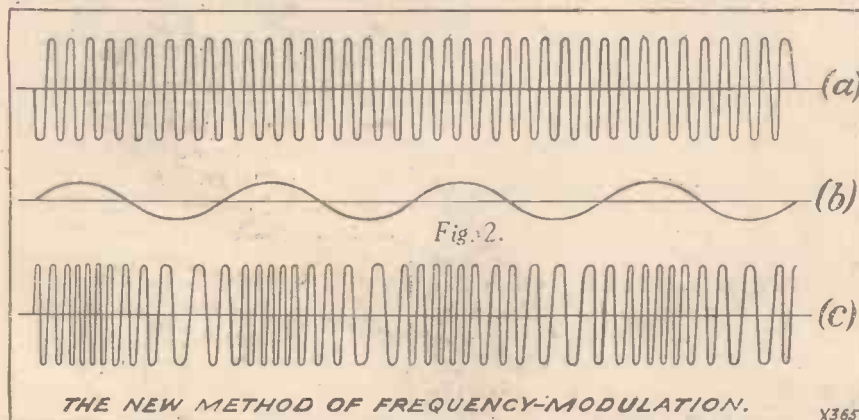

500 cycles. Then by using a sensitive wave-meter one can easily discover the presence of at least the following frequencies: (a) the "carrier" at 5,000 cycles; (b) an upper side-band

better still, the moving-plate condenser is shunted across the main tuning condenser.

In reception it is only necessary to convert the frequency changes present

in the incoming carrier-wave into corresponding amplitude variations. Once this has been done the usual methods of high-frequency amplification and rectification at once become applicable.

Fortunately the requisite change-over presents no undue difficulties. The theory of operation is illustrated in Fig. 3.

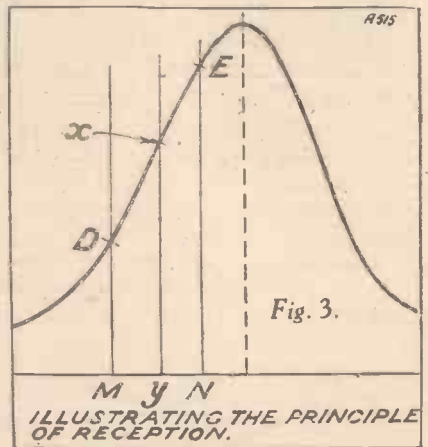

The curve shown is the well-known resonance curve of any sharply-tuned circuit, and illustrates how the value of current flowing in the circuit changes with variations in the received frequency. When the incoming wave coincides exactly with the tuning of the circuit, the induced current rises to a peak value, but falls off rapidly, as shown by the steep sloping sides, as the received wave alters in frequency.

Accordingly, when receiving a frequency-modulated wave, the receiving set is slightly detuned so that it is working say on the point x of its resonance curve. Then when the incoming frequency increases slightly the induced current increases in amplitude from a value xy, say, to a value EN.

### Easily Amplified

Similarly, when the carrier frequency decreases, the amplitude of the current in the tuned circuit sinks to the value DM. The changes in current amplitude so created are then applied either directly, or after further H.F. amplification, to the grid of an ordinary detecting valve.

It is obvious, of course, that the receiving set must be highly selective. An ordinary flat tuned circuit such as a crystal receiver would not give satisfactory results.



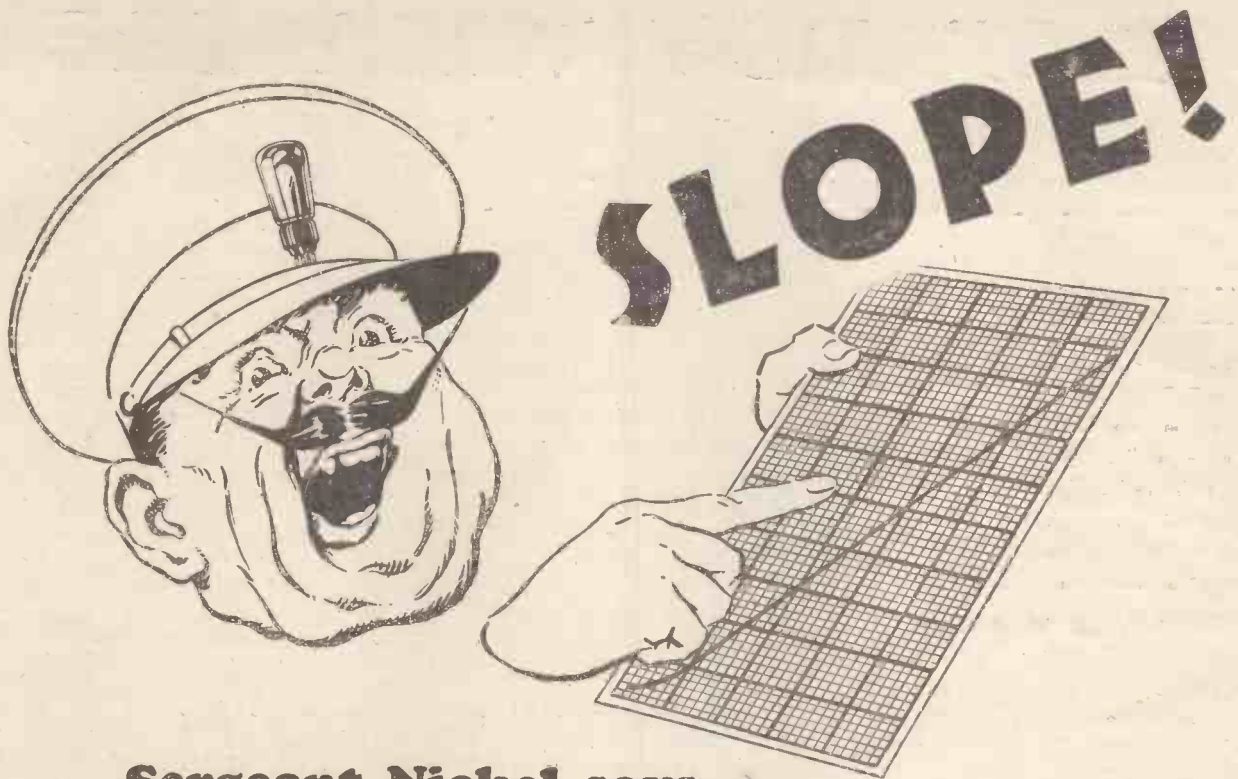

### Sergeant Nickel says

"It is steep, and that is just what is wanted in a valve."  
 The slope of a valve is the indication of its goodness;  
 the steeper the slope the greater the goodness.

Mazda Nickel Filament Valves have steeper slope characteristics than any other valves of corresponding types. Hence the reason for their invariable success. Remember that they are made and guaranteed by the greatest valve manufacturing organisation in the world.

*Ask your dealer for  
 NICKEL Filament Valves  
 They cost no more than  
 ordinary valves*

**MAZDA**  
*Steep Slope*  
 NICKEL FILAMENT  
**VALVES**

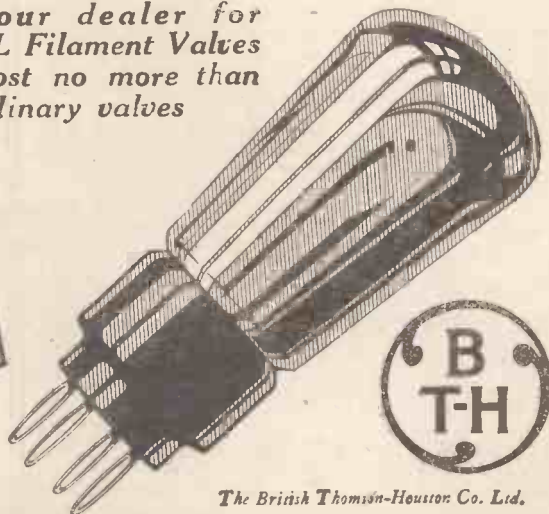

*The British Thomson-Houston Co. Ltd.*

# For use with the "RADIANO 4"

## LEWCOS "X" COILS

Cut out that local station by using a "LEWCOS" "X" Coil in the "Radiano 4." The high efficiency of this coil with guaranteed selectivity will enable you to tune in many stations not previously heard. Write for illustrated descriptive folder.



## LEWCOS CENTRE-TAPPED COILS

In this coil is selectivity that enables you to listen to your favourite programme without risk of interference from local stations. The LEWCOS Centre-Tapped Coil embodies every quality that radio science demands—namely, Inductive Constancy, Low H.F. Resistance, Free Magnetic Field, Effective Contacts. Write for illustrated descriptive folder.

## This Choke prevents Self Oscillation

H.F. CHOKE CURVES  
Showing the performance of the Lewcos H.F. Choke compared with other makes.

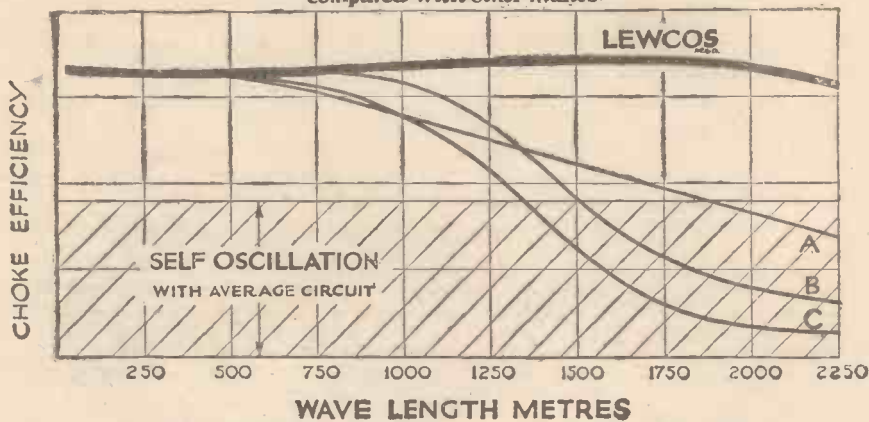

Use the LEWCOS H.F. Choke and get maximum efficiency from your set on all wave-bands from 20-2,000 metres. The diagram shows the percentage choking effect

of the LEWCOS H.F. Choke on wave-lengths from 20 to 2,250 metres, as compared with three other popular makes, A, B and C.



Self-Capacity, 1.62 micro-microfarads (N.P.L. test).  
Natural Wave-length, 5,200 metres.  
(Tested with Moullin Volt-meter.)

Price: 9/- each.

From any good Radio Dealer.

# LEWCOS RADIO PRODUCTS

REGD.

THE LONDON ELECTRIC WIRE COMPANY AND SMITHS LIMITED,  
CHURCH ROAD, LEYTON, LONDON, E.10.

Telephone: WALTHAMSTOW 2531.

Telegrams: LEWCOS, PHONE, LONDON.



# RADIOGRAMOPHONICS

A monthly article for the gramophone enthusiast.

The "Radiano" Four—A Useful Tone-Arm—High Mag. Valves—An Interesting Pick-up.

By A. JOHNSON-RANDALL.



MR. PERCY HARRIS'S new "Radiano" Four receiver will undoubtedly be one of the star designs of the coming season. No doubt readers will wonder whether they can use a pick-up with the set, when required.

For the benefit of such readers I have reproduced on this page the theoretical circuit of the "Radiano" Four.

## A Simple Method

It will be seen that the circuit arrangement makes use of two L.F. stages, designed for high-quality reproduction. Thus the L.F. amplifying portion is perfectly suitable for gramophone pick-up work. Two stages, however, are scarcely adequate, and it is advisable to bring in the detector valve, if possible, as an additional amplifier.

This can easily be done by employing one of the special pick-up attachments consisting of a plug which is inserted in the detector valve holder. The existing detector valve is then plugged into the adaptor.

This is the most straightforward method, and is the one which I should certainly employ myself. All that is necessary, therefore, is to remove the

detector valve, then plug in the adaptor and, lastly, to replace the valve in the adaptor socket.

Since a screening box is employed it is rather difficult to arrange a switching device to change over from radio to gramophone. Moreover, I feel sure that Mr. Harris would not approve of such a scheme, because it would be detrimental to the efficiency of the radio side of the receiver.

The WIRELESS CONSTRUCTOR Queries Department frequently receives requests for switching arrangements—some of them quite complicated—to enable the querist to change over from radio to gramophone in one movement.

## Retaining Efficiency

Such requests are often unfair to the set, and, as in the case of the "Radiano" Four, would entail a sacrifice in efficiency and a possibility of instability occurring.

It doesn't seem worth while to take this risk of spoiling a good

design when one can so easily make use of a plug adaptor to do the job.

I have recently come across a neat little gadget which should interest pick-up enthusiasts. It is an aluminium tone-arm intended for constructors who prefer to make up their turntables from parts.

## Varying The Tension

The arm has one special advantage which the ordinary gramophone tone-arm does not possess. At the point where the arm pivots there is a spring arrangement which is capable of adjustment by means of a milled-head screw. One can vary the tension (or perhaps I should say compression) of the spring so as to decrease the effective weight of the pick-up. Thus with a heavy pick-up the spring can be adjusted until the pick-up is just bearing on the record, the effective weight becoming only an ounce or so. This seems to be a step in the right direction, and should tend

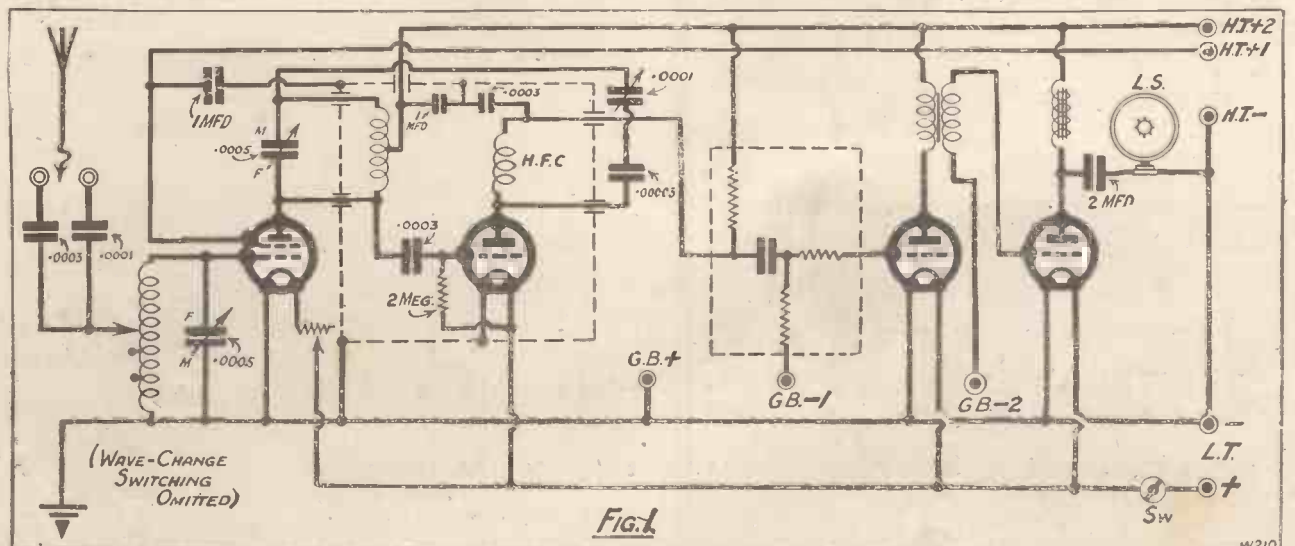

## Radiogramphonics—continued

to minimise wear on the record. The price is 13s. 6d.

We have also received one of the new R.I.-Varley pick-ups for test. It employs a system of suspension which, the makers claim, results in a remarkably even frequency response over a wide range.

The points which strike one at first glance are its excellent finish and lightness. The usual bakelite casing is absent, but the delicate magnet windings are neatly protected by a layer of hard, black insulating material. With some pick-ups the armature is heavily damped and semi-rigid. This is not so, however, with the R.I.-Varley, the impression formed in this case being that the armature is suspended on elastic.

### A Universal Fitting

This, in effect, is what happens, because the armature is delicately held against soft rubber buffers. There is no side-play, the arm simply pivoting backwards and forwards about a centre point. With such a system of suspension one would expect little wear to take place on the record, and this seems to be borne out in practice because there are certainly no signs of "ploughing" when the record is critically examined through a magnifying glass.

The device functions on the permanent-magnet principle, that is to say, no external voltage is necessary to operate it.

A universal fitting is provided, so that the pick-up can be adapted to any type of tone-arm. On test, in conjunction with a three-stage R.C. amplifier (low magnification per stage) and a moving-coil loud speaker, the results obtained were distinctly pleasing.

Perhaps the sensitivity was a little less than that obtained with the standard, but in fairness to the makers it should be stated that the pick-up was an early model and also that no attempts had been made to adjust it for maximum sensitiveness.

### The Question of Sensitivity

The device is obviously a high quality production, as one would expect from a firm of such standing, and it is evident that much thought has been expended on the design.

The pick-up can be well recommended. (The price is £3 3s.)

While on this question of sensitivity, it is as well to bear in mind that the average amplifier is designed for high magnification and that a very sensitive pick-up may easily produce blasting on the first valve.

Take, for example, a set which employs an R.C. valve as detector. When a pick-up is used, in nine cases out of every ten it is arranged to be plugged into the receiver so that this valve becomes an L.F. amplifier.

Now such a valve has a short curve because of its high amplification factor, and when used in a set working on moderate H.T. voltages there is not much permissible "grid sweep" to "play with."

### Controlling Volume

So from the point of view of reproduction it is perhaps preferable to employ a pick-up of average sensitivity and to build up the strength in the L.F. stages.

I am constantly receiving queries relating to volume control.

My correspondents seem to be very uncertain where they should connect the device.

Now in an amplifier consisting of an

R.C. stage followed by a transformer-coupled valve, there are three places where one can employ a strength control. The first is to use a potentiometer across the pick-up, thus adjusting the volume at the source. Such a control must be very gradual, otherwise a small change in the setting will produce a relatively big difference in strength at the output end. The second scheme is to employ a 1-megohm potentiometer in place of the R.C. stage grid resistance.

The grid resistance is removed and the two ends of the potentiometer resistance element are connected, one to grid bias negative and the other to the grid side of the coupling condenser.

The moving arm of the potentiometer is joined to the grid of the valve.

The third method is to connect a potentiometer having a value of 5 or 1 megohm across the secondary winding of the L.F. transformer.

### Fine Adjustment

The connections in this case are as follow: The two ends of the resistance element go to the two secondary terminals on the transformer. The connection between the transformer secondary and the grid of the last valve is removed and the moving arm of the potentiometer, usually the centre terminal, is taken to the grid instead.

Perhaps the last method is the most popular, but there is no reason why it should not be used in conjunction with a control across the pick-up itself. In this way a very fine adjustment of volume can be obtained, and in addition the fact that a resistance is joined across the transformer secondary helps to stabilise the amplifier.

### VOLUME—On the Moving-Coil LOUD SPEAKER.



HERE IS  
THE GREAT MYSTERY  
RECEIVER



# SIX-SIXTY

You can solve the Great  
Mystery Receiver at last!  
For the past three weeks  
the whole country has  
been on tiptoes awaiting  
this momentous day in  
the history of Radio.  
Fill in the coupon to-day  
and solve  
**THE GREAT MYSTERY  
FREE**

SIX-SIXTY RADIO COMPANY,  
122-124, Charing Cross Road,  
London, W.C.2.

Please send me the solution of THE  
GREAT MYSTERY RECEIVER.

NAME (Block letters) .....

ADDRESS .....

W. Con. ....

# CLIX-LOX

The Wonder Wander Plug.

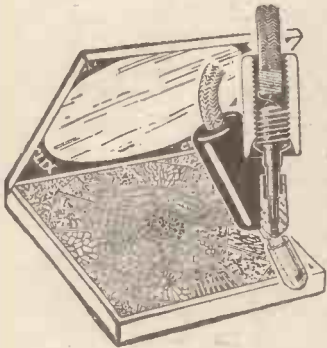

There is no risk of burn-outs or shorts if you use the Clix-Lox Wander Plug. It is adjustable and will fit the socket of any H.T. Battery. One turn of the insulator gives perfect contact and another locks it securely in position.

Price 2½d. each.

The Clix-Lox is one of the eight Clix practical aids to perfect contact displayed in the Showcase to be seen on your dealer's counter.

**Look out for this Showcase.**

*The Showcase includes:—*

- |                              |                                  |
|------------------------------|----------------------------------|
| Clix Parallel Plugs .. 2d.   | Clix Parallel Sockets 1d. & 1½d. |
| Clix Coil Pins .. 2d.        | Clix Pin Terminals .. 2d.        |
| Clix Spiral Wander Plugs 2d. | Clix-Lox Wander Plug 2½d.        |
| Clix Spade Terminals 2d.     | Clix Terminal Brackets 1d.       |

## CLIX ACCUMULATOR KNOBS

Clix Accumulator Knobs kill corrosion caused through the creeping of acid. By using these knobs perfectly clean L.T. connections are always assured.



Sockets are provided for connection by plug which allows speedier contact. Supplied in Red and Black.

Price 5d. each.

## CLIX-LOX CONNECTORS



For all wire extensions. Can be connected or disconnected in a moment - - Price 5d. each.

## CLIX MULTI-PLUG AND SOCKET

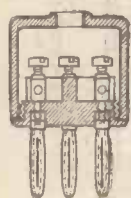

An extremely useful 4/5 way plug. Enables one to discard all terminals for Aerial, Earth, Batteries, Loud Speaker, etc., and gives instantaneous make or break connection. Multi-Plug, price 2/-. Multi-Plug Socket, price 1/-.



*Supplies and Illustrated Catalogues obtainable from all Dealers.*

**LECTRO LINX, Ltd.,**  
254, Vauxhall Bridge Road, S.W.1.

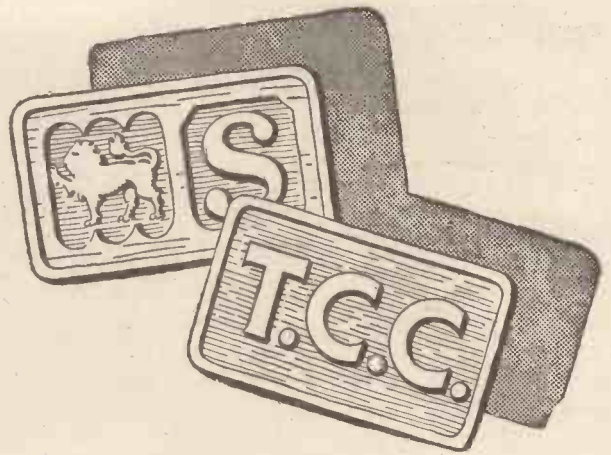

**THEY BOTH TELL THE SAME STORY -**

**T**HE Hallmark on the silver leaves no doubt as to its genuineness.

What the lion means to silver the letters "T.C.C." mean to a condenser.

The condenser that bears the "T.C.C." mark has been carefully made and individually tested. It is backed by a reputation of nearly a quarter of a century. It will pay you to buy T.C.C. instead of unknown and untested condensers, which may be a copper or two cheaper. T.C.C. Condensers are fully guaranteed. They are minutely accurate and unfailingly reliable.

For 22 years "T.C.C." has been the condenser hallmark. Buy with confidence when you see it.

*Specified for the  
Cossor "Melody Maker"*

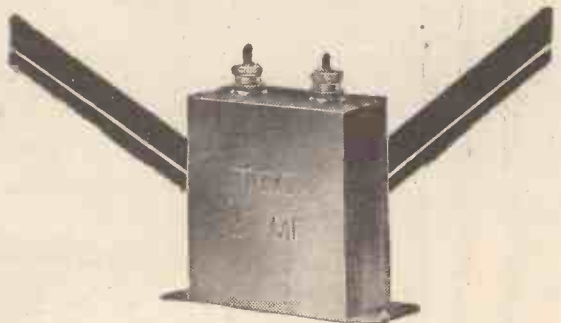

# T.C.C.

*Adv. Telegraph Condenser Co., Ltd., Wales-Farm Rd., N, Acton, London, W.3.*

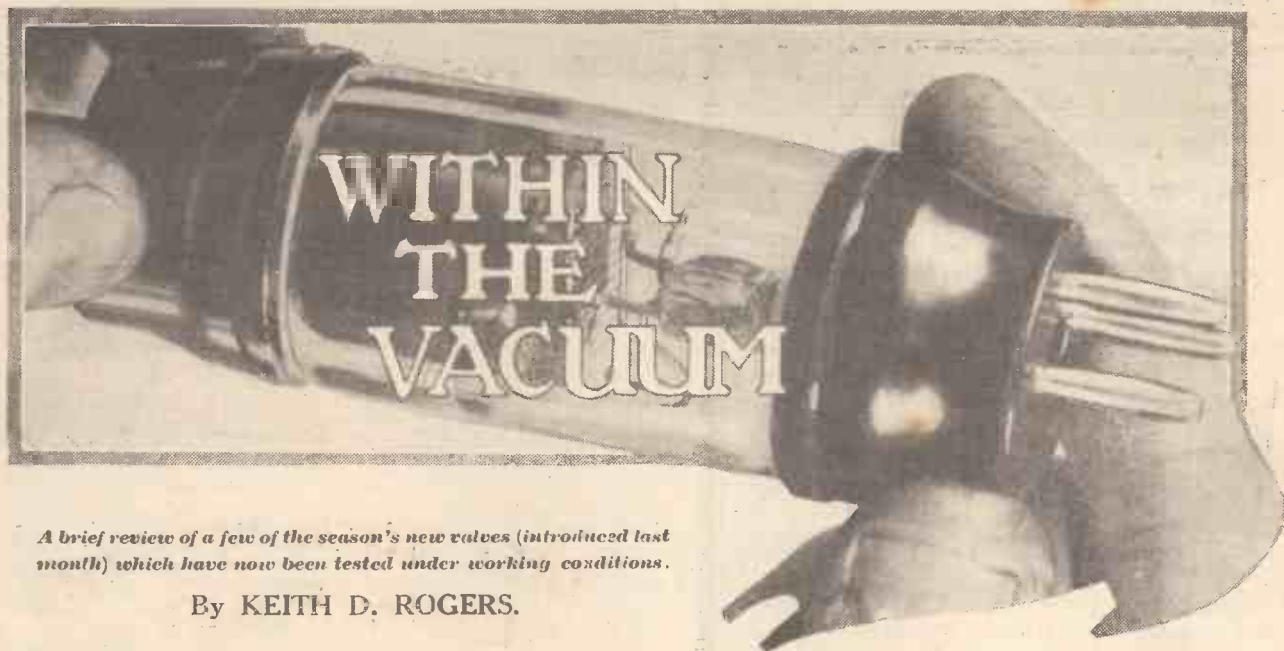

*A brief review of a few of the season's new valves (introduced last month) which have now been tested under working conditions.*

By KEITH D. ROGERS.

I HAD hoped this month to deal with the new valves which I mentioned last month, and which appeared for the first time at the National Radio Exhibition at Olympia, but so many different types have made their appearance that it is



*The Edison 2-volt screened-grid valve which has an impedance of 140,000 ohms and a magnification factor of 140. The Edison people are also placing on the market the 4- and 6-volt S.G. valves similar in characteristics to the 2-volter shown here.*

impossible adequately to discuss them in one article.

So I intend to mention just the outstanding valves (with the exception of the Pentode, which has already been mentioned several times in this paper) and to give a few details concerning their characteristics and actual tests.

### Two-Volt S.G.'s

I have tested recently a large number of the new two-volt screened-grid four-pin type valves, and one

and all have given satisfactory results, so that I can thoroughly recommend them to the attention of my readers. Those who buy Cossor and Ediswan screened-grid valves, however, must not be put off by the slight filament lag that these valves possess, as this is only caused by the filament heating up to its maximum temperature slightly more slowly than in the cases of valves using different kinds of filament. It in no way detracts from the efficiency of the valve, and if your valves are inclined to have that lag, you must not be puzzled and begin to wonder whether you have a slightly inefficient valve or not.

### Redesigned Types

As you will probably have noticed at the show, many of the old valves have been re-designed, and notably the D.E.L.610 has improved characteristics. The D.E.L. now has an impedance of 7,500 ohms with a magnification factor of 15, and on test it has proved itself a thoroughly wonderful little valve. In the old days it was good enough to warrant a considerable amount of praise, but now it has certainly surpassed itself.

Similarly, the H.L.610 (a new valve) is an H.F. or resistance-coupled L.F. valve which is certainly worthy of the highest commendation. As a detector or as a first L.F. amplifier, provided, of course, that it is not given too great a grid swing, it is superb. It has characteristics reminiscent of the famous D.E.5.B, in that it has an impedance of 30,000 ohms, but it is an improvement on the D.E.5.B, because it has a magni-

fication factor of 30 instead of the old 20, while the filament current is only .1 amp. instead of .25. The efficiency, therefore, is better than that of the D.E.5.B, and as a detector on the anode-bend principle or as a first L.F. this valve is certainly very efficient.

### Super-Power Valves

Other valves well worth mentioning are the P.625 and the P.625A, two new power valves made by the



*Compare this valve with the one shown in the heading, the S.625, and you will see how different is the new Marconi and Osram screened grid valve design. The S.625 is not being taken off the market, however, the four-pin design being confined to 2- and 3-colters at present.*

Marconi and Osram people. The former has an impedance of 2,400 and a magnification factor of about 6, while the latter has an impedance of 1,700 and a magnification factor of about 3.5. Both are remarkably

## Within the Vacuum—continued

efficient super-power valves, the former taking somewhere about 18 milliamps with correct grid bias with a voltage of about 150, and the latter somewhat more at the same voltage.



*The original B.T.-H. B.12 valve which takes 7.5 volts on the filament and a considerable current. Ideal for moving-coil work, it now has a "little brother" in the form of the P.X.650, which is a smaller valve but which is also suitable for the operation of moving-coil speakers and for the handling of large outputs.*

Nor have the two-volters been forgotten in the general progress which has been made in the valve world during the last few months. Messrs. B.T.-H. have brought out an exceedingly good little two-volt power valve, the P.227, which has an amplification factor of 4 with an impedance of only 2,900 ohms, while to keep this company the L.F.215, with an impedance of 7,000 ohms and a magnification factor of 7, is also introduced.

### Nickel Filaments

These valves come under the new Mazda nickel-filament valves, and are wonderfully efficient little fellows. Similarly, the four-volt valves of the same calibre consist of an L.F.407



*A good super-power valve, the P.625A, having an impedance of 1,700 ohms and a magnification factor of 3.5. It is an excellent output valve, and will handle a considerable input. For average "super-power" work, however, it is advantageous to use the P.625 shown opposite, which has a higher magnification factor and steeper slope.*

and a P.415, whose magnification factors are 8 and 5.5, with impedances of 5,700 and 2,700 ohms, while the P.615 and P.X.650, with magnification

factors of 6 and 3.5 respectively, and impedances of 2,600 and 1,750, are amongst the six-volt power valves, the latter being recommended for moving-coil loud-speaker work.

### Large B.T.-H. Range

These, however, by no means exhaust the B.T.-H. range, which is now complete with general-purpose, H.F., R.C., L.F. and power and super-power valves in the two-, four- and six-volt classes. All the valves have the new nickel filament. Truly a wonderful range of valves suitable for any receiver that might be built.

In the case of the R.C. valves in the B.T.-H. range, it will be noticed that the impedances are rather on the



*The Cossor version of the new five-electrode valve now popularly known as the Pentode. The terminal on the cap is that connected to the middle grid and is joined externally to the same H.T. terminal as the anode circuit of the valve. These Pentode valves are capable of providing an astounding amplification.*

high side, ranging between 86,000 and 100,000 ohms, while the magnification factors are, in every case, 40.

In many cases it will be found advisable where resistance coupling is concerned to use the H.F. valve of the filament voltage corresponding to that required. For instance, in the four-volt class, where the R.C. valve has an impedance of 100,000 ohms, the H.F. valve is only 21,000 ohms with a magnification factor of 18. So that where detectors are concerned and are followed by resistance-coupled stages, one might be tempted at first to use the R.C. valve with 100,000 ohms and a high resistance in the anode circuit, but in all probability in many cases unsatisfactory reaction might occur, and I would advise that the H.F. valve be used in its place, in spite of the fact that less amplification may be obtained.

### New A.C. Valves

So far I have been unable to test the new raw A.C. valves which have been put on the market, such as the

P.8 and others of its class, taking .8 amp. at .8 volt, so I must leave any remarks concerning those valves to a later date. It must be understood, however, that they do not, as some

*The Six-Sixty people have produced excellent screened-grid valves in both 2- and 4-volt types, the 4-volter being illustrated here. They have followed the new four-pin design, the anode connection being made by means of the terminal placed on the cap of the valve.*



people have imagined, do away with the independently heated class, such as the K.L.1 and the Cosmos A.C. valves, which latter have been reduced in price.

The one drawback in the new A.C. class which have raw A.C. on their filaments seems to be that they are not really suitable for detector work, and in this stage, in order to keep the hum within reasonable limits, it is advised that the independently heated cathode type should be used.

But more about those valves anon. Suffice it to say that with the majority of the new valves that have made their appearances at the show, constructors may be absolutely certain

*Having an impedance of 2,400 and a magnification factor of 6, this valve (P.625) is a useful "baby brother" to the big Marconi and Osram super-power valve shown on the left. It will carry a useful grid swing, but, of course, will not handle so much as the larger valve. It has, however, greater amplifying properties, and so the output obtainable is quite enough for full reproduction in most cases.*



that results greatly improved over those obtained with the valves of yesteryear will be noticed, no matter what valve set is employed.



# WORTH-HEARING

Listen to this—the new Philips Loudspeaker, Type 2007. It sounds well, sounds true to the actual transmission, produces every note of every instrument, even the low notes of the drum, piano and cello, and gives you mighty volume if you want it, for it is fitted with a cone of large surface area and the movement is a special new design perfected in the Philips laboratories. By means of a two-way switch you may choose a suitable impedance for the set you are operating without disconnecting it from the loudspeaker. In a variety of colour combinations.

**Price £5. 5. 0**

PHILIPS SEVEN CORNERED LOUDSPEAKER, TYPE 2016. A model of exceptional value. - Built on the lines of the most expensive types, it has beautiful tonal qualities and handles ample volume. The same switch is incorporated as in Type 2007.

**Price 50/-**

## Philips Receivers.

Type 2502. A general purpose Three Valve Set that is perfectly simple in use. Used in conjunction with Philips H.T. Unit 3005 and a 4-volt Accumulator, it will operate from D.C. Electric Light Mains. For A.C. Mains, either a Philips H.T. Unit 372 or 3002, together with a 4-volt Accumulator, are necessary. In addition, it will operate just as efficiently with the usual batteries when no mains supply is available. Price, complete with valves and connecting leads,

**£15. 0. 0**

Type 2501. This three valve receiver takes its L.T. current direct from A.C. Mains, whatever the voltage, and no battery charger or accumulator is necessary. For H.T. supply either Philips Unit 372 or 3002 should be used. Price, complete with valves and connecting leads,

**£16. 10. 0**

*Your dealer will be very pleased to demonstrate these receivers. Additional types of receivers for operation direct from the mains, either 2, 3 or 4 valves, are also manufactured and supplied by PHILIPS. Particulars can be had upon application.*

# PHILIPS

*for Radio*

**DON'T ARGUE!**

**RIPAULTS BATTERIES ARE BEST**

*RIPAULTS chosen for the new Cossor "Melody Maker."*

**RIPAULTS' SELF-REGENERATIVE H.T. DRY BATTERIES GIVE 50% LONGER LIFE.**

Standard Capacity	Double Capacity	Treble Capacity
60 volts .. 10 6	60 volts .. 15/6	60 volts .. 19/6
99 volts .. 16/6	90 volts .. 22 6	90 volts .. 29 6
9-volt Grid Bias .. 1 9	18-volt Grid Bias .. 3 6	

**Get a copy of our 24-page Booklet LIGHT ON THE H.T. BATTERY**

We have spared no expense in producing this 24-page Booklet, which has been specially written for us by one of the best known contributors to Radio publications who is recognised as an expert on H.T. Dry Batteries.

An extremely interesting and easily understood treatise on H.T. Batteries. Chock-full of sound advice on the correct choice of batteries for all types of receivers.

All requesting a copy of this 6d. Booklet, and who mention "Wireless Constructor," will have one sent them Post Free upon receipt of 2d.

**RIPAULTS' LATERAL-ACTION CONDENSERS IMPROVED IN DESIGN—REDUCED IN PRICE.**

The many special features of this condenser have all combined to give it a reputation for extreme sharpness in tuning coupled with absolute smoothness of control from minimum to maximum capacity.

PRICES: .00025, .0003, .0005, all at 10/6 each.  
 Slow Motion Dial, 4 6. Standard 4" Dial, 2 3.

Obtainable from all Dealers. Write for illustrated leaflets.



**A SUCCESS**

**"Two Stage" L.F. Unit**  
 One stage RESISTANCE and one stage TRANSFORMER in sealed Bakelite moulding

DELIGHTFULLY CLEAR REPRODUCTION AND VOLUME

**30'** - Reproduction of label on top of moulding.

Terminals conveniently arranged, making components extremely simple to wire.

**FREE Booklet "L.F. AMPLIFICATION"** contains BLUE PRINT of THREE VALVE SET incorporating the "TWO STAGE" UNIT, from your dealer or post free on receipt of post card.

**VALVE HOLDER ANTI-MICROPHONIC SHOCK ABSORBING**

Price 1/3

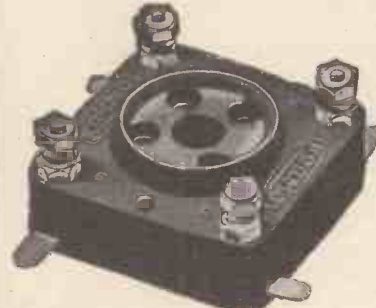

BAKELITE throughout, including BASE PLATE. Practically DUSTPROOF.

The springing is such that even rough usage will not affect its liveliness. The "float" is recessed on top, thus making easier the manipulation of valve when plugging into holder.

As illustration shows, Terminals are provided as well as soldering tags.

**"DE LUXE" CONDENSER**

This Condenser has an ingenious NOISELESS "PIGTAIL" incorporated in a manner unobtainable in any other Condenser.

Capacities: .0005 .00035 .00025 .00015

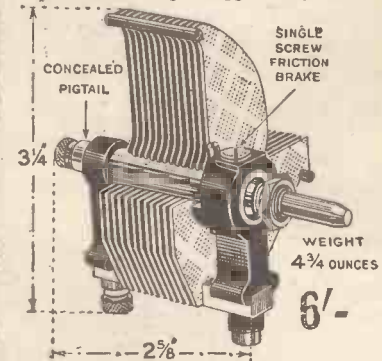

**6-PIN TWO RANGE TUNER**

(Reinartz) From high to low wave without change of coil. A very neat and efficient Aerial Coupler with 6 pins in standard position, thus can be used with any standard 6-pin base.

Price 10/6 Base 2/-

CROWN WORKS, CRICKLEWOOD LANE, N.W.2  
 Telephone: Hampstead 1787



# HAPPENINGS AT SAVOY HILL



By OUR SPECIAL COMMISSIONER

## Single Wave-Length Working

**I**N a few weeks now it will be known whether Captain Eckersley's confidence in single wave-length working is really justified. In the first few days of November all relay stations (Dundee, Edinburgh, Liverpool, Stoke-on-Trent, Leeds, Bradford, Hull, Sheffield, Swansea, Plymouth, and Bournemouth) will go on to 285.5 metres (1,040 kilocycles). Nottingham will be washed out. The relays will take the London programme during the main programme periods, but will try group transmissions of such items as the Children's Hour. What remains to be proved is whether the B.B.C. engineers can keep all these stations absolutely on this wave. If they can, then transmission in big towns such as Sheffield will be enormously improved.

## Broadcasting House

After too much delay and cogitation, the B.B.C. has actually, at long last, settled on a plan for a new permanent home for its headquarters. The site chosen is in the neighbourhood of Queen's Hall, and the construction will take from two and a half to three years. Thus the Regional Scheme and Broadcasting House should be ready at about the same time. I understand that the main studio in the new building will have accommodation for an audience of at least 1,000. Allowance is being made for picture transmissions.

## The B.B.C. and Picture Transmissions

The wisdom of the B.B.C. attitude of caution with regard to television is now more than apparent. In the matter of picture transmission, however, Savoy Hill showed readiness to test and experiment with any system that was *bona fide* and had a *prima facie* chance of success.

Thus the experiments with the Fultograph, although still not fully conclusive, have caused great interest

among listeners. The real point at issue in connection with these experiments with still pictures is the assessment of demand. There would appear to be considerable doubt whether there will be an effective continuous demand for the "daily cartoon," or the "daily illustration," which the B.B.C. might undertake to radiate in one or other of the proved transmitting methods.

## Decline of the Studio

Study of the advertised programmes of the B.B.C. for any representative period this year and for similar periods in former years will reveal the interesting fact that the studio plays a smaller part than formerly. It seems that "Outside Broadcasts" have been so skilfully developed that the peregrinations of the microphone are more varied and extensive as time goes on.

This tendency suggests that the studio may be doomed. Such, however, is not the case. In so far as there is a "microphone technique" it can only be demonstrated in studios. But the arrival of the technique is not yet, and, in the interval, the preponderance of "O.B.'s" is a tribute to the perception of the programme builders.

## The Schubert Centenary

The B.B.C. has made "extra-special" arrangements to mark the occasion of the Schubert Centenary. There will be a whole week of special programmes—from November 18th to 24th. Sir George Henschel will be the vocalist in the Schubert Chamber Concert on Monday, November 19th. All stations will take the London programme that week.

## 'PLANE WIRELESS THAT MADE HISTORY



This is Mr. James Warner, an American wireless operator who accompanied Capt. Kingsford Smith on the famous transpacific flight of the "Southern Cross." Mr. Warner is shown in his compartment on the 'plane, tapping the transmitting key with which he told the waiting world how the flyers were faring.

## Happenings at Savoy Hill—continued

### Continental Relays

The promise of Continental relays was not realised last winter. There is stronger hope, however, of satisfactory results this season. The B.B.C. system of repeater stations is now established at pivotal points on the Continent. Given a moderate measure of good luck, British listeners should be able to enjoy a concert in Vienna nearly as well as a concert in London by Christmas. While admitting the acceptability of occasional really good programmes from the Continent, I would warn the B.B.C. that it should

current interest. The free discussion is an improvement both on the debate and on the counter-lecture. It is, of course, immeasurably superior to the ordinary straightforward talk. I hear that Bertrand Russell and G. K. Chesterton will shortly provide a free discussion of unusual interest to all listeners:

### Captain Eckersley as Programme Builder

I was present at a dinner-party the other night when Captain Eckersley was prevailed upon to describe the

spirit of informality, spontaneity, directness, and flexibility. His early broadcasts in this series may be expected on 5GB just before Christmas.

### The News Bulletins

It is stated in Fleet Street that the B.B.C. has signed a two-years' agreement with the News Agencies for a continuation of the existing system of News Bulletins. In the absence of any statement from Savoy Hill, the truth of this report is presumed. It would appear that the only concession secured by the B.B.C. was the right to bring the first bulletin back from 6.30 to 6.15 p.m.

The broadcast news bulletin has not made anything like the same progress as other programme items during the past three years. It would appear now that it will stay as at present for another two years. Many students of broadcasting had expected the B.B.C. to devise and carry into effect an independent news service by 1930. There will be some disappointment as a consequence. It is to be presumed, however, that on balance Sir John Reith decided that funds were not available for an independent news service while the Regional Scheme and Broadcasting House were both being undertaken.

### THE BISHOP'S MOVE



Dr. Guy Warman, the new Bishop of Manchester, keeps in touch with the B.B.C.'s activities by means of his own wireless set.

be careful not to commit itself to the regular inclusion of any considerable admixture of material from over the Channel. British listeners would soon grow tired of an overdose of even the best music from Berlin, Vienna, or Paris.

### Controversy

The failure of the political parties to agree on any formula for political broadcasting has been followed by the introduction of a much happier expedient, devised at Savoy Hill. I refer to "Free Discussions," in which competent people exchange views candidly and informally before the microphone on subjects of genuine

plans he is about to apply in his newly-assumed role of auxiliary programme-builder. The genial chief engineer holds very strong views on programme matters, based largely on his early experience at Writtle.

It is an open secret that not even his brother, "R. H.," quite sees eye-to-eye with the gallant Captain. The chief engineer can pick a lot of holes in the present programme work of his colleagues. It is a very good thing that he is to be given an opportunity to demonstrate his theories. For one result can be depended upon. Whatever influence Captain Eckersley may have in moulding future programme policy, he will certainly secure a new

### The Governors

It is several months since the deeds and misdeeds of the B.B.C. Governors provided suitable "copy" for the Daily Press. From what I can pick up, the Big Five behind the scenes at Savoy Hill are very much on their good behaviour. They have stopped emulating the angels in "rushing-in." They have acquired habits of decorous silence and an attitude of self-abrogation which place them outside the stress and strain of current controversies, but the forthcoming meeting of Parliament is bound to be attended by a determined effort to disturb the tranquillity of the Titans of the ether.

**"BIG BEN" STRIKES  
A NEW NOTE.**

SEE NEXT MONTH'S  
"WIRELESS CONSTRUCTOR."

Choose the  
right valves for

# RESISTANCE COUPLING



**R.C. 210**  
2 V. RES. CAPACITY  
AMPLIFICATION 40  
IMPEDANCE 67,000

## R.C. 2

Fil. Volts 2.0 Amp. Factor 30  
Fil. Current 0.1 amp. Impedance 150,000

## R.C. 210

Fil. Volts 2.0 Amp. Factor 40  
Fil. Current 0.1 amp. Impedance 67,000

## R.C. 410

Fil. Volts 4.0 Amp. Factor 40  
Fil. Current 0.1 amp. Impedance 61,000

## R.C. 610

Fil. Volts 6.0 Amp. Factor 50  
Fil. Current 0.1 amp. Impedance 50,000

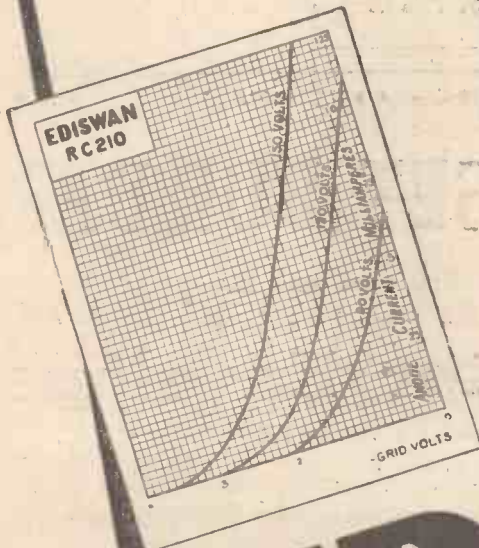

Specially designed for use as  
an L.F. Amplifier when the  
Resistance capacity method of  
coupling is employed. It will be  
found to give a high degree of  
amplification without distortion.

# EDISWAN NEW LOW TEMPERATURE VALVES

Clearer, Stronger, Last Longer



# Remarkable reproduction —the reason why



"One-o-one," the new cone speaker, incorporates our driving unit 66K, embodying the improved adjustment for armature and the High-Ideal filter cone, and the output is another and goodly step forward to perfect reception.

The filter cone is designed to damp down the dominant middle notes of the musical scale and to reproduce both ends of the audio range with equal volume and clarity.

The surrounding "Trolite" case is worthy of these two components. It is of bold and unconventional design and does not detract in any way from the faithful output of the unit and cone.

The price of the complete speaker is £3 13s. 6d. Alternatively, the constructor who prefers to build his own speaker, either to his own design or to one of the many designs that have been published, can purchase the separate driving unit for 25s.

The Blue Spot range of Cone speakers includes an attractive range of models of varying design, fitted with the Blue Spot driving units and varying in price from £1 17s. 6d. to £3 13s. 6d.

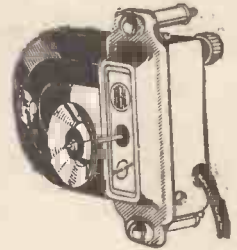

F. A. HUGHES & CO., LIMITED, 204-6, Gt. Portland St., London, W. 1.

Distributors for Northern England, Scotland and North Wales :  
H. C. Rawson (Sheffield) and London Ltd., 100, London Road, Sheffield.  
185, Princess Street, Manchester.

## GOOD NEWS FOR SET BUILDERS

In response to the urgent demand for first-class sets for family use, Mr. PERCY W. HARRIS, M.I.R.E., has now prepared the

## Wireless Constructor Envelopes

The first two of this series are NOW on Sale, price 1/6 per envelope (by post 1/9).

**Envelope No. 1.—THE RADIANO THREE** (*Recently reprinted*). A famous loud-speaker set which you can build in an hour or two—no soldering necessary and a wide range of components to choose from.

**Envelope No. 2.—THE CONCERT FOUR.** Made of standard parts, all easily obtainable, this is a highly-sensitive, long-distance set, giving powerful reproduction of wonderful quality. Covering both long and short wave-lengths, with a switch for 3 or 4 valves, it is essentially a set to enjoy both in building and operation.

In each envelope you will find every detail of the set simply explained; photographic reproductions and diagrams are included, as well as a full-size Blue Print.

**NOW ON SALE ————— Price 1/6**

By post 1/9, from Wireless Constructor Envelopes, The Amalgamated Press, Ltd., Bear Alley, Farringdon Street, London, E.C.4.

# CHATS AT THE WORK-TABLE

Many points of practical interest to all radio constructors are dealt with under this heading.

By R. W. HALLOWS, M.A.



**On "Holding" Things**  
 QUITE a number of amateur constructors of my acquaintance find considerable difficulty in fixing firmly in the vice small parts upon which jobs are being done without inflicting more or less serious injury upon them. There are, of course, certain very delicate parts that it is exceedingly difficult to hold satisfactorily in this way. But the majority of the things that we deal with when we are making wireless apparatus can be gripped with sufficient firmness to enable the necessary work to be done if one knows how to set about the business and takes a little care over it.

## Distributing Pressure

The main thing to remember is that sheer brutal compression must never be applied to delicate parts; in dealing with them we must always so arrange matters that the part in question can be firmly held by a light pressure or that some support is

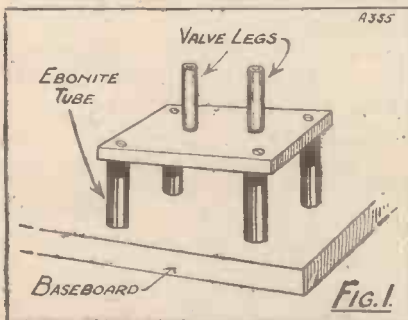

provided to take up most of the pressure.

Thin ebonite tube is an excellent case in point. Put a piece of it into

the jaws of the vice and you will find that a very slight compression is sufficient to make it crack and collapse. But by tackling the job properly we can apply the pressure not only to the outer walls of the tube but also to the inner.

This is done by placing within the tube a temporary core of some kind which is a fairly tight fit. On tightening the vice jaws now we do not crush the tube; the jaws press against the outer walls and these in their turn press equally hard against the core. The tube, in fact, behaves almost as if it were a solid piece of rod.

When tube of any kind has to be held it is sound practice to use as a core a solid piece of similar material. For an ebonite tube a piece of ebonite rod answers well, and for a metal tube a metal rod is indicated.

The reason is that in this way the elasticity of both the tube and its core are similar. Most of us use ebonite tube for a certain number of jobs. Short lengths of it make very handy distance pieces for variable condensers or any other components that we may wish to set back a little way from the panel.

## Using Tubing

Pieces of tube can be used similarly to raise baseboard-mounting components from the baseboard, as shown in Fig. 1, where a short-wave coil holder raised in this way is seen. Another handy use is illustrated in Fig. 2.

Here  $\frac{1}{2}$ -in. lengths of tube serve as safety conduits for leads through a metal screen in the receiving set. The little pieces of tube are

fitted into tightly-fitting holes in the aluminium or copper and are held in place by "blobs" of Chatterton's compound.

For these and for other jobs the only kinds of tube generally needed are those which will pass 2 B.A. and 4 B.A. screws. When you order tube I suggest that you order at the same time a small supply of "push-fitting" ebonite rod which can be used to make cores when you want to grip the tube in the vice, either for cutting off pieces with a hacksaw or for subsequently trimming up the ends with a file.

## Coil Formers

For winding coils or the simple chokes that are used in the short-wave receiving sets we make use either of finned formers or of plain ebonite tube. The internal diameter in such cases may range from about half an inch to  $3\frac{1}{2}$  in.

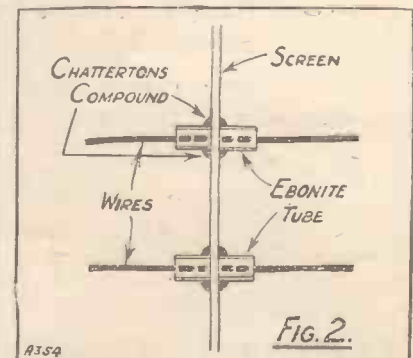

It certainly saves a great deal of trouble to buy one's formers ready cut to the required lengths, but cases often arise when cutting has to be done in the home workshop. This

## Chats at the Work-Table—continued

cannot be accomplished satisfactorily unless the former can be firmly gripped in the vice.

A core is actually essential if damage is not to be done. I find that one particular type of finned former for coils and one size of tube for short-wave chokes and other small jobs serve all my requirements. For each of these I have wooden cores as part of the workshop equipment. Wood answers very well, since its elasticity is not greatly different from that of ebonite, and large ebonite cores would be very costly.

The constructor who does not himself possess a lathe can easily get suitable cores turned up for him at very small cost. He will discover how very handy they are whenever he tackles such a job as the notching of the ribs of a finned former to hold the coil windings in place upon them.

A finned former must, of course, be so arranged between the jaws of the vice that these grip portions of the tube surface and do not touch the ribs.

### Unightly Marks

The use of a core, though it will preserve a tube of any kind from being crushed by the jaws of the vice, will not prevent its outer surface from being more or less badly marked unless a further precaution is taken. For holding ebonite of all kinds, sheet, tube or rod, I generally use jaw covers made of thick cardboard.

These can be constructed in a few minutes by cutting out suitable-sized pieces of cardboard and bending them

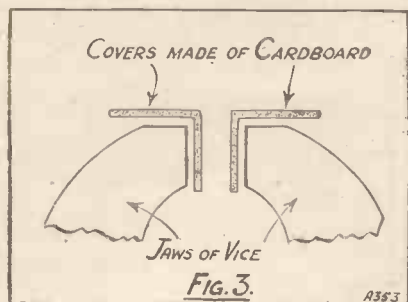

as shown in Fig. 3. The cardboard acts as a cushion between the metal jaws and the soft surface of the ebonite.

Even highly polished panels can be held in them without fear of damage to their appearance, though in this case I prefer to cover the panel with two or three layers of tissue

paper before placing it between the cardboard jaw covers.

Another good tip is to make a pair of covers for the vice jaws from pieces from an old motor inner tube. These allow a very great deal of compression to be applied quite safely.

### Metal Problems

From a 12-in. length of 4 B.A. studding we require to cut off a short piece. It must be placed in the vice and gripped quite firmly. But how is this to be done without injuring the threads?

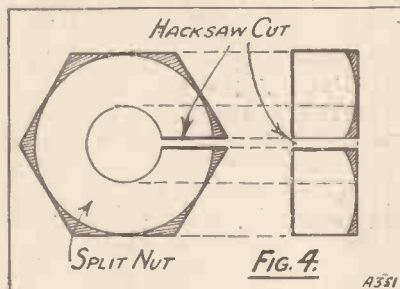

There are several ways of carrying out the job satisfactorily. The simplest method is to fold a piece of brown paper until it is several layers thick and then to wrap this tightly round the studding. The pad so made will preserve the threads from injury.

A much better method, however, and one which gives a far tighter grip, is that illustrated in Fig. 4. Obtain a thick nut of the proper size and make a hacksaw cut as seen in the drawing. Be careful that you make this cut at one of the corners of the nut; if it is made in one of the flats two corners will be presented to the jaws of the vice, which will therefore not be able to get a proper grip.

### A Simple Holder

Even better than an ordinary nut is a simple holder on the same lines specially made for the job. Cut off a piece of suitable square rod about half an inch in length, drill and tap it to the required size, and make a hacksaw cut down to the hole.

Whether you use the split nut or the special holder the procedure for mounting the work in the vice is the same. Screw in the rod until a little more than the length required protrudes, then place the nut or holder between the jaws of the vice and tighten up. The presence of the cut allows the studding to be firmly gripped, but since its threads lie

in corresponding grooves in the holder they are not damaged by the pressure.

For rather heavier work I would recommend the provision of a pair of lead jaw covers for the vice. These can be bought ready-made or they can be turned out in a matter of minutes from a piece of sheet lead with the help of the tin shears.

Both cardboard and lead protectors require a certain small amount of attention to keep them in good condition. The former, particularly, soon become permanently dented in various places, and they should be renewed at frequent intervals.

So long as lead jaws are used for holding flat work they will not suffer very much, but when they are employed for holding round or odd-shaped stuff they may acquire a number of dents. They are, however, very easily flattened out and brought back into proper condition by beating lightly with a wooden mallet.

### Very Small Articles

It is most difficult to hold very small articles such as nuts, screws, pins, and so on, properly in the large bench vice. Many constructors use a smaller vice also fixed to the bench, but I find it much more convenient not to fix down my smaller one.

Instead, I have a little hand vice whose wooden handle has been removed, leaving only the metal tang.

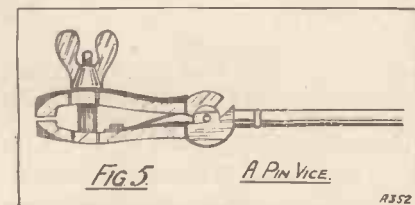

This can be fixed when desired between the jaws of the big vice, and small work is easily and conveniently held by the little fellow. For very fine work I have also a jeweller's pin vice, which is an exceedingly useful wireless tool.

The pin vice, which is obtainable from any good tool shop for about a couple of shillings, is illustrated in Fig. 5. The best pattern for the wireless constructor is that which is round shaft with no flutes upon it.

The pin vice is also an exceedingly handy tool when the soldering of leads is in progress, for it avoids burnt fingers.



# DON'T RESTRICT WIRELESS To ONE ROOM



Let your retailer demonstrate to you how you can have wireless in every room in your house when you fit the Lotus Remote Control.

**I**S YOUR wireless at every fireside—ready to switch on at the touch of a plug? The Lotus Remote Control provides simultaneous reception with independent control throughout the house. There's no interference—no weakening of signals—no extra current consumption. YOU can instal it, it is so easy. Neat, efficient, and reliable, the Lotus Remote Control is *the* wireless convenience of this winter.

Get a free blueprint from your retailer and ask him to demonstrate.

## LOTUS REMOTE CONTROL SUITS ANY SET

The Lotus Remote Control is made for every type of receiving set, as follows:

### RETAIL PRICES

Complete outfit for 2 rooms for a set using L.T. Accumulator and H.T. Battery, including 1 Lotus Relay, 2 Filament Control Wall Jacks, 2 Jack Plugs and 21 yards special 4-strand wire .. .. .	30/-
Complete outfit for 2 rooms for set using L.T. Accumulator and H.T. Eliminator .. .. .	45/-
Complete outfit for 2 rooms for any make of circuit using All from the Mains Set .. .. .	47/6

In each case, each additional room, 7/6 extra.

# LOTUS REMOTE CONTROLS

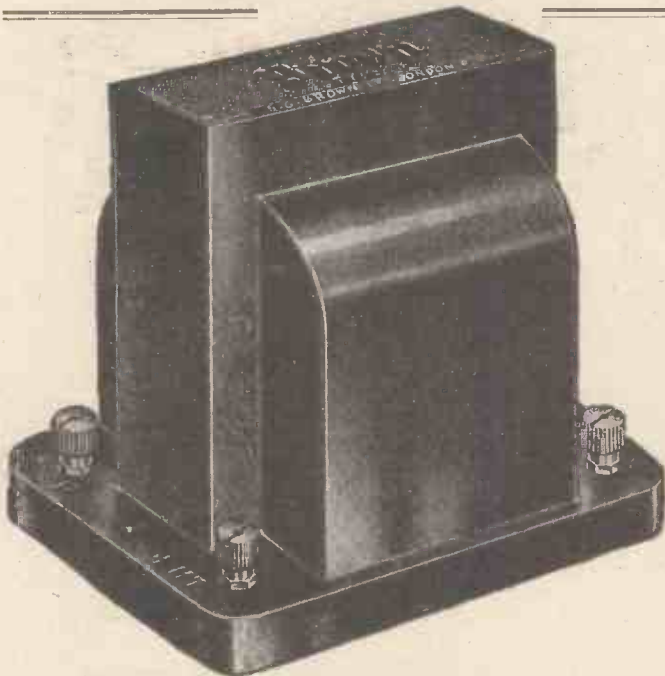

This new "BROWN" instrument is contained in a handsome specially moulded Bakelite case. It helps the receiver to perfect reproduction. From a background of perfect silence the high notes come smooth and clear—the low notes rich and sonorous without trace of distortion. Dimensions: height 3½ in., base width 3¼ in., base depth 2½ in. Ratio 3.5 to 1. Inductance 175–200 henries. Price 30/-

Now a **Brown**  
TRANSFORMER

*a newly invented core—a special method of winding—Tested and proved by the National Physical Laboratory.*

An innovation for Brown—and new standards of transformer performance. This new Brown transformer introduces new features in a special alloy for the core—the result of exhaustive research—and a unique method of winding. These features contribute to its superb performance. Accepted by the National Physical Laboratory for authoritative tests it has proved to have an even amplification throughout the whole musical scale. If you prefer only high-grade components then you are safe in depending on a Brown Transformer—a transformer typical of the well-known Brown standards.

Supplied by all first-class radio stores

**Brown**  
L.F. TRANSFORMER

S. G. BROWN, LTD., Western Avenue, North Acton, London, W.3.

5696

*Britain's Leading Wireless Magazine is*  
**MODERN WIRELESS**

All the latest news and developments in the wireless world are discussed in Modern Wireless—the best value for money ever given by a radio paper.

The October Issue—now on sale—contains a wonderful wealth of constructional and informative articles, covering every branch of Radio.

*Amongst the Special Articles are:—*

THE 'THOMAS' SHORT-WAVER  
THE "OLYMPIC" THREE

THE "JAMES" H.T. UNIT  
THE "HIGH-BIAS" ONE

and a special supplement for the music lover, entitled

**RADIO AND THE GRAMOPHONE**

**OCTOBER**  
ISSUE.

**MODERN WIRELESS**

Price:  
One Shilling.

# IN LIGHTER VEIN

By  
WIRELESS  
WAYFARER

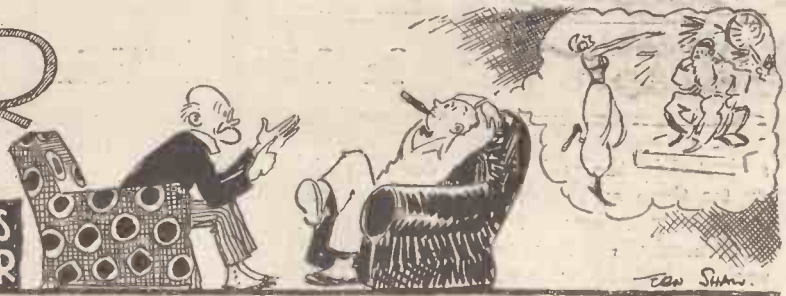

"I TAKE it," said Professor Goop, as we sat chatting in his study, "that you know what a tetrode is?"

"Why, certainly," I replied. "You mean those old johnnies who used to rule Palestine. Dear old Herod was one of them. You know the chappie I mean. His daughter, Salome, was the first person to introduce classical dancing into court circles."

"Idiot!" screamed the professor, reaching for the poker. "I said 'tetrode' not 'tetrarch.'"



"They rush madly towards those flappers."

As it was too hot to argue and certainly far too hot for any rough-house work I did not press the point, but asked the professor to be good enough to enlighten me.

"A tetrode," said the professor, "is a wireless valve. You know what's inside the bulb of the standard valve, or triode?"

"Why, of course!" I cried eagerly. "Emptiness and lots of it. When you drop them on the floor and they go pop it's because the emptiness or vacuum suddenly rushes out."

## The Three Electrodes

The professor held up his hand. As the said hand was grasping the poker I thought that it might be as well to exchange silver speech for golden silence.

"Within the bulb," said the professor, "are three electrodes, which we may term the anode, the cathode and the mesode."

"Whenever I get a valve," I put in, "there's generally a price owed, too. That makes four; so I suppose that all my valves are tetrodes?"

The professor having assured me that there would shortly be a doctor's

bill owed, too, if I didn't keep quiet, I returned to my silence. It's a funny thing, but I always find it very difficult to keep silent so long as my eyes are open; but, somehow, when I close my eyes and concentrate on what the professor is saying, I generally do it so thoroughly that I become completely lost to my surroundings. In fact, I am frequently known to snore slightly during the process of concentration. This just shows how completely the unconscious ego becomes sublimated, or something of that kind.

## Origin of "Tetrode"

Anyhow, the professor went on talking and I am sure that what he said was very good indeed. I had just had a jolly little dream (in which I was a wireless wave being distorted by a note-magnifying valve with a run-down grid battery), when I came back to earth to find that the distortion was being caused by the professor, who was sitting on my chest and using my head as a kind of hammer against the floor.

Since I cannot claim to be able to give you a verbatim report of the professor's account of the tetrarch—that is to say, the tetrode—I had, perhaps, better put an explanation into my own words, for I am quite sure that you don't really know the first thing about it, even though you may discuss it learnedly with your wireless pals in the 8.21 a.m. on the way up to London. After perusing my lucid explanation you may return the compliment if you feel so minded.

The tetrode obtains its beautiful name from the Greek *tetra*, meaning four, and *hodos*, meaning a road. I don't know in the least who invented the name tetrode, but whoever it was he ought to be shot for dropping his aitches.

## How it Operates

Inside the three-electrode valve all sorts of funny things happen. One of the funniest of all, provided that the valve is somebody else's, is when, in a moment of aberration, we

connect H.T. positive to L.T. negative."

In the ordinary way, electrons go bustling and jostling and hustling and pushing through the filament from one pole of the L.T.B. back to the other. As is quite usual when there is crowding, heat is generated. If the filament is of the bright-emitter type, or if you have applied a hundred volts instead of six, it glows brilliantly; should it be of the dull-emitter pattern or burnt out, it probably doesn't glow at all.

Intermingling with the rather plebeian low-tension electrons are the sporty boys from the high-tension battery. They come dashing in at one leg, taking all the corners on two wheels. Then away they go over the banking into the vacuum within the bulb. Here they feel the pull of the plate even more strongly than does Bill Sikes when he is engaged in drilling out the lock of the family silver chest. But they are nasty, unsociable little brutes, these electrons.

## Pushing and Jostling

They simply loathe the sight of one another. The result is that the johnnies in front are always pushing back the johnnies behind as hard as they jolly well can, whilst the johnnies behind are shoving away for all they are worth at those in front.

Round the filament you get just the kind of thing that occurs at the



"Ever hit a stone wall with a sports bus?"

gates at Wembley on a cup-tie day. Everybody is shoving everybody else and nobody gets much forrader. To get rid of this unseemly jostling you have to make the plate goodness knows how many volts positive in order to get a move on amongst the front electrons. They are so

## In Lighter Vein—continued

attracted by the positive fare dished up for them on the plate that they desist to some extent from their ungentlemanly conduct in damming back and blasting back and . . . [That will do. We've been to Wembley.—ED.] those behind.

This general rowdyism in the neighbourhood of the filament is known as the Space Charge Effect. A similar demonstration on boat-race night is known as the Vine Street Charge Effect. You will realise the full iniquity of this jostling habit on the part of electrons if you are the proud possessor, as no doubt you are, of a portable set. It is purely and simply on their account that your set weighs a stone when you start out with it, and the best part of a ton before you have gone more than a few hundred yards.

### The Second Grid

To supply the plate with positive charges, which we may liken to flappers, in sufficient quantities to attract the electron sporty boys and to persuade them to cease jostling one another unduly, a big and hefty H.T.B. is needed. This H.T.B. provides the straw that breaks the camel's back (that is, yours and mine), and incidentally helps to deal to our bank balances those little blows which wear them away just as drops of water wear away stone.

Very well, then. Something had to be done about it. A well-known genius, whose name for the moment I have forgotten, had the bright idea of introducing a second grid. "This,"



"Known as the 'Vine Street Charge.'"

he said to himself, with a smile, "will just about settle that hash." You see, with devilish cunning he placed grid number two inside grid number one, and gave the thing a positive charge. To put it into simple parlance so that it may be understood without the use of wet towels, he introduced a second row of flappers of a particularly attractive kind and placed them so near the filament that the

electron sporty boys were sure to respond.

They did. They do. They rush madly towards those flappers, forgetting all their unmannerly jostling habits in their ardour. And just when they are thinking of sitting down beside them on the inner grid they catch sight of the still larger rows of still more attractive flappers on the plate. They hastily change up again into top, step on the gas and go roaring off to the plate.

### Pentode Valves

And what about the pentode (pentode, not pin-toed), you ask?—At least, if you don't you ought to at this point. Here matters are a little more complicated. The pentode may be described as a screened-grid valve and then some. You see, the whole trouble in the screen-grid valve is that owing to its kinky curve you can't use it for L.F. work unless you like kinky speech and kinky music. As there isn't an inner grid we get the old space-charge business, and we push on to the plate an enormous voltage to pull electrons over to it through the screen.

Ever hit a brick wall in a sports bus at 90 m.p.h.? If so, you know something of what happens to an electron when he bumps into the plate at the speed at which he is going. He bounces. He biffs other electrons out of their places and these fly backwards. The screening grid is waiting with gently smiling jaws to receive them, and it mops them up like anything. Hence the poor old plate gets robbed of its visitors, and a kinky curve is produced.

The chappie who invented the pentode had a very brilliant brain-wave. Between the screen and the plate he quietly stuck another grid, connecting it to the middle of the filament. This was a nasty smack in the eye for bouncing electrons. They leap out of the plate, but owing to their bruises they are going rather tiredly.

### "A Nice Resting Place"

They observe the extra grid and think what a nice resting place it would make. But on this grid, instead of flappers, there is a crowd of their brothers wearing large and heavy boots. Just as each wandering electron is about to come to rest it receives a hob-nailed jolt that

pushes it gently back again to the plate. Electrons are taught a lesson and there are no kinks.

Meantime, there is great dissatisfaction in certain circles about the rough treatment now meted out to electrons. An R.S.P.C.E. has been formed with a committee which in-



"They're nasty, unsociable little brutes."

cludes some of the most influential cranks of the day. It is rumoured that at least £2,000 will shortly be spent in giving a Thermos-and-Dressing-gown dance in order to raise the £100 which is so urgently needed for the society's funds.

\*\*\*\*\*  
\* THE "RADIO" \*  
\* THREE \*  
\*\*\*\*\*

SIR,—After a few months with the wonderful "Radio" Three I think it might interest you and your readers if I gave you some of the results which I have had. Here are some of the "bag."

5 X X, 5 G B, 2 L O, Manchester, Sheffield, Leeds, Bradford, Newcastle, Aberdeen, Bournemouth, Glasgow, Belfast, Dublin, Cork, Cardiff, Koenigswusterhausen, Kovno, Radio Paris, Kharkov, Motala, Stamboul, Kalundborg, Hilversum, Vienna, Milan, Munich, Berlin, Langenberg, Rome, Frankfurt, Hamburg, Radio Toulouse, Stuttgart, Madrid (E A J 7), Leipzig, Prague, Breslau, Barcelona, and there are several unidentified with the above I get on the loud speaker; K D K A, 2 X A D, 2 X A F, W L W—Americans, and heard Sydney (2 F C) when the B.B.C. had to give it up. This I heard all the way through on 28.5 metres. Also 3 L O on 32 metres, P C J J, 2 N M, and I have a list here with about 40 amateur stations.

I use Ferranti transformers, Mulard 2-volt valves, long- and short-wave coils I have made myself.

Yours faithfully,  
J. O.  
Conisborough.

# NEW PRECISION INSTRUMENTS BY

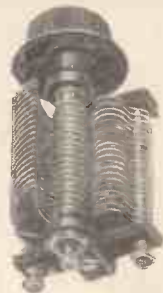
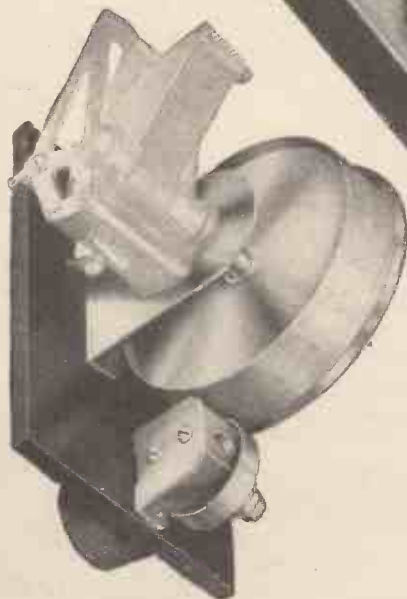
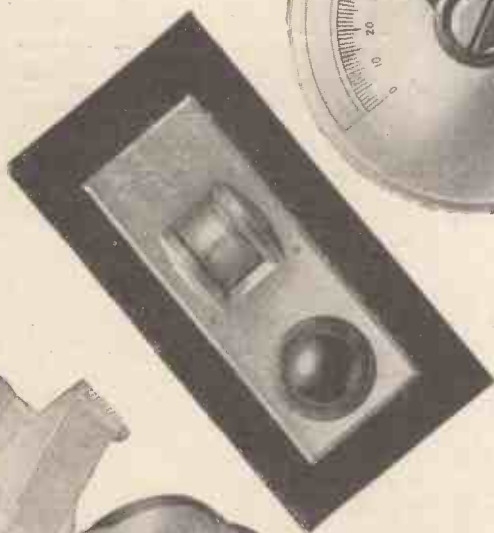
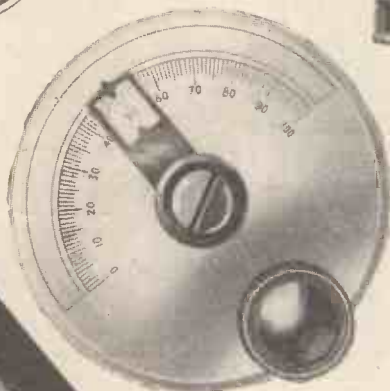

THE new range of J.B. Precision Instruments enhance still further the reputation of this famous firm. Every Radio man looks keenly at any new J.B. product, knowing that here is something really good. If anything, J.B. have this season surpassed themselves in the excellence of their new lines.

Reading from left to right on this page, the instruments illustrated are, firstly, the new J.B. Vernier Drum Dial. This is an exceedingly attractive job, which marks a terrific advance in the design of this type of instrument. For example, the dial protrudes through the panel, thus obviating the necessity for illumination as the scale can be read easily. Patents are pending for this arrangement. The dial is entirely insulated from the condenser.

Space forbids the mention of other numerous advantages, but briefly the J.B. Vernier Drum Dial is a wonderful engineering job and well up to the J.B. standard. The cost, exclusive of condensers, is 10/6.

The next illustration is that of the attractive Panel Plate in bronze finish which is supplied with the Drum Dial, and which gives a most artistic and refined appearance to the panel of a receiver.

Next is the new J.B. Vernier Dial, the most attractive and efficient of its class.

The new J.B. Vernier Dial is the only dial which is completely insulated.

This is an amazing advance over all older Models. The illustration shows clearly what an added attraction the J.B. Vernier Dial is to any receiver. The price is only 5/6.

Then there is the new J.B. Slow Motion Model as shown. Radio fans need no reminding of the wonderful results yielded by J.B. S.L.F. and Log. condensers. Further additions and refinements take these famous instruments even further ahead.

Lastly comes the new J.B. Midget Condenser, the smallest and best yet designed. Low minimum capacity is ensured by specially shaped vanes and the elimination of end plates. The J.B. Midget occupies less panel space than any other of its kind.

Write to us for fuller details of these new lines, enclosing your dealer's name and address.

**JACKSON BROS**  
& POLAND ST- OXFORD ST  
LONDON - W.1. Telephone GERRARD 7414

# A CONE SPEAKER OF EXCEPTIONAL MERIT

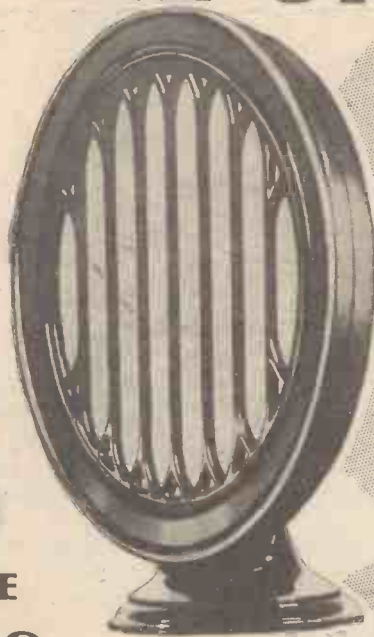

PRICE

£3.0.0

3042

# B.T.H. CONE SPEAKER

The British Thomson-Houston Co. Ltd.

HERE is the cone loud speaker you have been looking for! Just think—for £3 you can have a cone speaker of exceptionally good tone, giving sufficient volume for a large room, and having the all-round quality, finish and appearance of an instrument costing two or three times as much.

## SYNONYMOUS

As a synonym for Condenser the term "HYDRA" is well found. It means the finest Condenser ever offered to the British Public, as reports from all over the country testify. Get one and test our statement for yourself.



They operate at high voltages without fear of breakdown, have high megohm resistance and low variation, are rigid and compact. Made by the foremost of the world's paper dielectric condenser manufacturers.

**WORKING VOLTAGES :**

	240 D.C.	240 A.C.	450 D.C. or 300 A.C.
1 Mfd.	2/6	3/-	5/-
2 "	3/6	3/-	6/-
4 "	5/3	6/9	11/-

Etc. The above have been tested at double the working voltage.

LOUIS HOLZMAN,  
34, Kingsway, London, W.C.2.

# HYDRA CONDENSERS

## Experts USE the K.N. Electric Soldering Iron because



it is the most scientifically designed, the most reliable and efficient iron in the World. Consistent tests by large and expert users have proved this beyond all doubt. It is the iron you need, because it is years ahead of all others and has embodied in it special features which make it so superior to all other electric irons.

Here are some of them. There is a unique recess on the shank to keep the element immovable.

Each turn of wire on the element lies in a separate cavity which renders fusing impossible. The shank or container is in one single piece.

Every part of the K.N. is removable and replaceable. Can be used on A.C. or D.C. De Luxe model as illustrated, price 12/6. Complete with two bits, straight and angle, and 5 ft. flex and patent lamp socket adaptor.

Also four other models from 12 oz. to 2½ lb.

Ask your Agent about K.N., or if in difficulty, write direct to sole manufacturers and patentees.

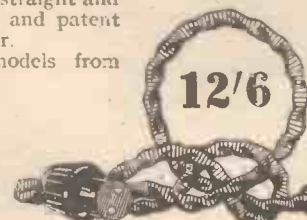

K.N. ELECTRICAL PRODUCTS LIMITED,  
87, Wardour Street, London, W.1. Phone: Regent 4632.

# WHAT'S NEW

## A Popular-Price Transformer

THE MARCONIPHONE COMPANY, LTD., whose Ideal transformer was one of the first to set the modern high standard of reproduction, is now producing a popular model, illustrated herewith, at the price of 12s. 6d. The transformer is considerably smaller than the well-known Ideal pattern, and the reproduction is, of course, inferior to that given by the higher-priced



The new Marconiphone "Popular" transformer which sells at 12s. 6d.

instrument, but considering the price charged the value is excellent and the instrument will commend itself to those constructors to whom the first cost of a set is a serious consideration and who want to do the best they can for the money they are able to spend.

A very noticeable feature is that the transformer is fitted with completely reversible feet, so that it can be fitted into awkward places, such as portable receivers, where space is limited. A ratio of 4 to 1 is used and four good terminals are fitted. Laboratory tests show that the quality of reproduction and the degree of magnification obtainable are good for the price charged. We are sorry, however, to see that the manufacturers have perpetuated the old form of marking OP, IP, OS, and IS, instead of the more modern and much more

## A MONTHLY REVIEW OF TESTED APPARATUS.

(Note: All apparatus reviewed in this section each month has been tested in the Editor's private laboratory, under his own personal supervision.)

sensible plate, H.T., grid, and grid bias.

As we have pointed out in these columns before, the modern user is not at all interested which terminal is connected to the beginning and which to the end of the winding, but he does want to know which terminal the manufacturer recommends to be connected to his H.T. and grid.

## Clix Coil-Pins

From Messrs. Lectro Linx, Ltd., we have received samples of the Clix coil-pins, consisting of split pins of a particularly good springy type and threaded stems with lock-nuts. With these pins, which sell for the very low price of 2d. each, the home constructor can arrange to fit any homemade coils to the standard sockets, for interchangeability. This is particularly useful when an experimenter possesses a receiver using one of the standard six-pin bases, and wishes to try as a temporary arrangement a coil of his own devising.

There is then no need to buy any special former fitted with six pins, for a shillingsworth of the Clix coil-pins can be fixed to a piece of ebonite with the correct spacing, and the temporary coil mounted on this. Many other uses will suggest themselves. The pins are very well made, there is an ample length of screw shank, and the pins fit in all the sockets we have tried, making a good, sound contact without jamming.

## New Pattern Ebonite

Messrs. Redfern's Rubber Works, Ltd., makers of the well-known and deservedly popular Ebonart panels, have now produced a series of panels in the standard sizes with a surface

finished to resemble moire silk. Owing to the limitations of printing reproduction processes it is somewhat difficult to give an idea of the exact finish, but the accompanying photograph will do a little in this direction. The panels themselves have all the electrical characteristics of the ordinary ebonite panels made by this firm, the difference being merely in the surface itself.

Not only is the appearance very pleasing, but it has other advantages not to be despised. For instance, the highly polished ebonite surface which is now popular among wireless constructors, while giving a very smart appearance to the set, has the great disadvantage of showing every finger-mark and scratch with startling clearness, so that a set which is in daily use soon loses its initial brilliance. In the case of the moire-finished panel,

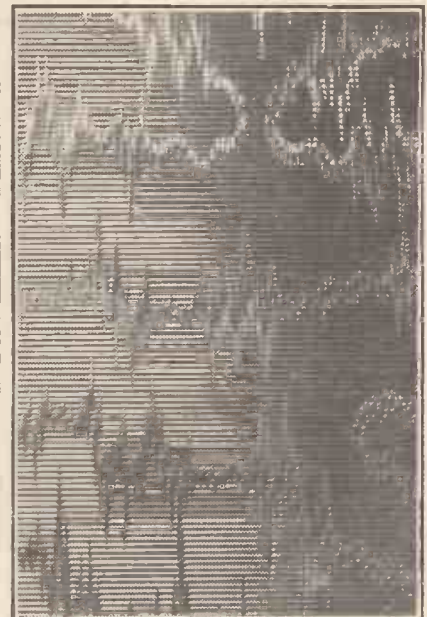

The novel appearance given to one type of ebonite panel sold by Redfern's under the name of Ebonart moire-finished panel.

however, they are actually scratch-proof, and the patterning very successfully hides any small injuries.

## What's New—continued

We have no doubt that this finish of panel will become very popular among home constructors.

### A New Small Transformer

The Igranic Electric Co., Ltd., of Bedford, have produced a new transformer, type J, in two ratios, 6 to 1 and 3 to 1, the price in each case



The new Igranic type J L.F. transformer.

being 17s. 6d. Although less than half the size of the type G Igranic transformer, the type J must not be looked upon as an instrument in which the material has been skimped, for the use of a new iron circuit has enabled a reduction in size to be made.

Amplification and quality of reproduction of the small model are good, the performance being well up to what we should expect from such a firm in a transformer of this price. The appearance of the instrument is particularly neat, a well-finished bakelite moulding enclosing the core and coils. Four good terminals are provided on the top of the instrument for connection, but we are sorry to see that the markings are Primary I and O and Secondary I and O respectively,

instead of the more practical Plate (or Anode), H.T., Grid and Grid Bias respectively.

For portable instruments this transformer should be particularly valuable, and its small size and neat construction makes it admirably suitable for such a use, while quality and amplification are satisfactory.

### Cason Valve Holders

Two ingenious valve holders, one of the anti-microphonic and the other of the "fixed" type, have been submitted for test by Cason Mouldings, of London. A good feature of both these holders is that the amount of solid dielectric between the individual sockets has been reduced to a minimum, without sacrificing mechanical strength.

High-frequency tests show that both holders are quite satisfactory in this regard. Both terminals and soldering lugs are fitted, a particular feature being the phosphor-bronze springs lining the legs.

Tests with the new valves, some of which are quite large and heavy, show that suspension in the anti-microphonic pattern is satisfactory. The prices are 1s. 6d. for the anti-microphonic pattern, and 10d. for the fixed pattern.

### A Very Useful Device

The wireless art has annexed to itself from time to time sundry strange terms, one of the latest being "motor-boating," the name given to the peculiar and persistent "putt-putt-putt" noise given by receivers in certain conditions.

While motor-boating can occur when dry batteries are used, it is a trouble which most frequently hap-

pens with sets using mains H.T. units, and while no perfect cure has been found which will suit all cases, certain methods are now recognised as satisfactory in the majority of motor-boating troubles. Messrs. R.I.-Varley, Ltd., who specialise in audio-frequency amplification, have now produced a very useful little unit called the "Antimobo," which can be inserted in a receiver giving this trouble, and one of these units will effect a cure in all but the most obstinate cases. In very rare occurrences two may be needed.

The unit consists internally of a tapped resistance and a high-grade fixed condenser of large value, with terminals so arranged that one is connected to the battery side of the set (transformer, choke or resistance),



A very useful device for the prevention of "motor-boating"—the R.I.-Varley "Antimobo" unit.

one of three terminals to the H.T. supply (which is used will depend on circumstances), and the third to high-tension negative. When the device is so connected a high impedance tends to keep the audio-frequency pulsations out of the high-tension supply, sending them back to the filament through the high-capacity condenser.

This method is a perfectly sound one, approved by all experts, and Messrs. R.I.-Varley are to be congratulated in putting up the necessary parts in so compact a form as such

(Continued on page 61)

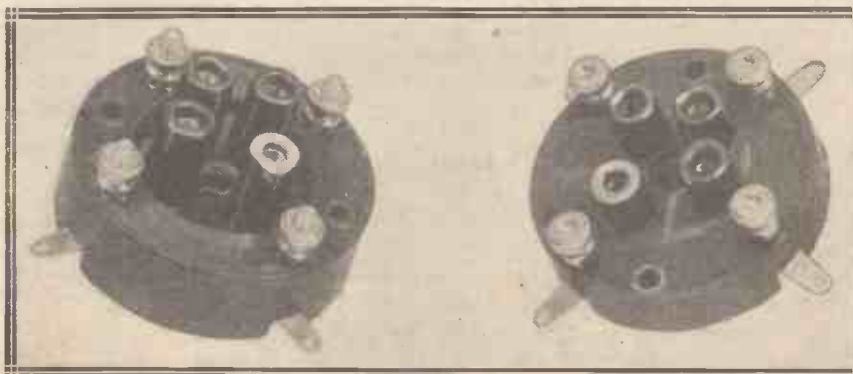

The two new Cason valve holders. (Left) The anti-microphonic holder, and (right) the rigid type.



# ORMOND SLOW MOTION DRUM DIAL



ACTUAL SIZE

This dial is of very attractive appearance, designed for simplicity and ease of attachment.

The movement is very similar to that of our S.M.D. 10 Cat. No. R/204, with no slip and no backlash. The control knob moves in the same direction as the dial.

CAT. No. R/321 ORMOND SLOW MOTION DRUM DIAL Price 5/-



**ORMOND ENGINEERING COMPANY, LIMITED,**

199-205, PENTONVILLE ROAD, KING'S CROSS, LONDON, N.1

Telephone—Clerkenwell 9344-5-6.

Telegrams—'Ormondengi, Kinross.'

Factories—Whiskin Street and Hardwick Street, Clerkenwell, E.C.1.

Continental Agents—Pettigrew & Merriman, Ltd.,

"Phonos House," 2 & 4, Bucknall Street, New Oxford Street, London, W.C.1.

WHAT'S NEW

—continued from page 62

a reasonable price. At 9s. 6d. it certainly represents excellent value.

An Interesting Automatic Charger

The Runbaken Automatic Charger is a very clever device designed to work in conjunction with an accumulator and wireless set, on A.C. mains. It consists of a small metal box containing a dry rectifier type of trickle charger, and a special relay connection with the electric light socket is made by a plug and cord. Two other leads go to the positive and negative of an accumulator, while a third lead goes from the charger to the L.T. positive terminal on the wireless set, the negative of the set being connected to the negative of the accumulator. When so connected, switching on the set by the ordinary on-and-off switch turns on the accumulator, and takes it off charge.

Directly the set is switched off, the accumulator is disconnected from the set and placed on charge at one ampere.

The charger has now been in daily use for over two months in conjunction with a distance-control relay and has functioned satisfactorily throughout this period. It has every indication of continuing the service satisfactorily for an indefinite period.



One model of the "Ultra Air-Column" Loud Speaker, price £6 6s.

A Novel and Efficient Loud Speaker

One of the latest loud speakers to make its appearance is the "Ultra Air-Column Speaker" submitted to us for test by Ultra Electric, Ltd. Its general appearance, or, rather, that of the oak cabinet model, can be gathered

from the accompanying photograph, and while handsome, does not greatly differ from that of many other speakers tested. Its internal construction and performance are, however, distinctly different.

It is actually a combination of a very long, specially shaped and coiled horn with an actuating mechanism possessing a tiny cone, this latter acting both through the horn and directly on to the air. The effect is to give good low-note reproduction with a thoroughly satisfactory range of high tones. The over-exaggeration of certain low tones, with a very poor high-note response, which is so characteristic of many cone speakers, is absent from this instrument, the performance of which places it in the very front rank. Indeed, at the time of writing, we have yet to hear a commercial loud speaker which for quality of reproduction combined with high sensitivity can equal it. While the quality of reproduction does not come up to that of the best moving-coil instruments, its sensitivity is far in advance of the moving coil type. Another important point is that it is able to handle tremendous volume without overloading, which very few speakers, other than the moving coil, can do. The price of the model shown is £6 6s.

HARRIS "STEDIPOWER" UNITS

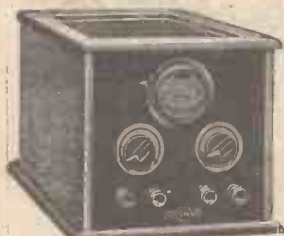

L.T. and H.T. from A.C. MAINS

The "Stedipower" L.T. Unit.

Ready wired and tested. Suitable for 2, 4, or 6-volt valves, the total consumption of which does not exceed 1 ampere.

£9 10s. Od.

The "Stedipower" H.T. Unit.

Ready wired and tested, and including a U.5 valve. Output 50 M.A. Two continuously variable and one fixed tapping is provided.

£13 Os. Od. Royalty extra.

If you wish to build these Units yourself, we supply the complete kits of components, including Cabinets, as follows:

L.T. Unit, complete kit of parts..... £8 17s. Od.

H.T. Unit, complete kit of parts (less valve)..... £10 10s. Od.

Construct the RADIANO FOUR

as described in last month's and also this issue.

Complete sets of parts.

Model A ..... £12 15 0

Model B, as described in this issue ... £12 17 6

Above Set ready wired and tested ... £14 15 0

Including Royalty.

Set of 4 Valves for above, £2 16 0.

Components supplied for all apparatus described in this issue.

MAGNUM UNIVERSAL THREE 15-2,000 metres.



A remarkable 3-valve Universal Receiver giving 5-valve results. Employs latest S.G. and Pentode Valves, Metal Cabinet, crystalline finish.

Price, including 4 "Twintuna" Coils 15-2,000 metres; 3-valves, and Royalty .. £18 Os. Od.

Free demonstration in your own home within 50 miles' radius from London. Full particulars on request. The most perfect receiver for overseas reception.

MAGNUM STANDARD LOADING COIL



as used in several sets described in "Popular Wireless," "Wireless Constructor," and "Modern Wireless." Price 7/6

or Machined Former complete and ready for winding 5/-

BURNE-JONES & CO. LTD., MAGNUM HOUSE

TELEPHONE: HOP 6257-8 288, BOROUGH HIGH ST. LONDON. S. E. I

The 1929 MAGNUM "SCREENED FIVE" and "PURITY THREE" are now available.

Full-size Blue Prints and instructions. Price 1/6

New season's catalogue and lists on receipt of 1d. stamp.

# LISENIN POSITIVE GRIP TERMINALS

(PATENTED)

"I have now given your Positive Grip Terminals a fair trial and am more than satisfied with the result. I am discarding all other makes I have now in use in favour of yours, and have ordered a supply of them from my dealers: The fact of spreading the multiple wires over the cone makes a most secure and safe joint, giving absolutely perfect contact, besides making a nice finish to any set and a really attractive appearance."

Selkirk.

T. W.

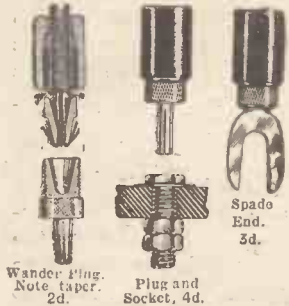

From the sectional illustration it will readily be noted that the flex covering is splayed over the cone and gripped by the sleeve, overcoming unsightly frayed-out, ragged ends to leads.



SPECIFIED BY THE DESIGNERS OF MULLARD'S AND MYSTERY FOUR SETS, AND AS USED BY LEADING MANUFACTURERS

In certain districts it has been found that reception is not good, and in others facilities for good aeriels are lacking. THE LISENIN IMPROVED TAPPED MELODY MAKER COIL has been designed to overcome those troubles. It has two extra stages of reaction, and is fitted with a Positive Grip Plug and Sockets, which facilitates the change of reaction.

Price 7/6 each.

"Wireless Constructor" H.F. Coil for Melody Maker 7/6 each. Screens 2/- each. Obtainable of all Radio Dealers, or direct. Write for copy of our No. X1 leaflet, free.

The Lisenin Wireless Co., 1C, Edgware Rd., London, W.2.

# Centralab Modu plug

CONSIDER VOLUME

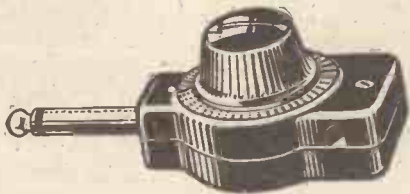

With your receiver or amplifier operating under full power you can now regulate the volume to suit your individual taste with the CENTRALAB MODULATOR PLUGS. Just turn the knob and your volume can be regulated from a mere whisper to full power. CENTRALAB MODULATOR PLUGS are available in two types. No. 1 for receivers equipped with jacks, and No. 2 for receivers equipped with terminals for loud speaker. No. 2 style is admirably suited for pick-up control as well as Radio.

List Price 10/6 each.

Write for the CENTRALAB CIRCUIT BOOKLET. It's free. Also particulars of Centralab Power Rheostats, Modulators, Potentiometers, etc.

THE ROTHERMEL CORPORATION, LTD.  
24-26, Maddox Street, London, W.1.

Telephones: Mayfair 0578-9, 4286. Telegrams: "Rothermel, Wesdo, London."

# Only Weston standards of Accuracy are sufficient



Model 506 Pin Jack Voltmeter with High Range Stand, measures High and Low Tension Voltages. The Weston free booklet "Radio Control" explains the uses of this and other Weston Radio Instruments. Write for your copy.

Price £2.10.0



Model 506 Mil-Ammeter should be placed in the H.T. circuit of the valve to ensure correct operation and check distortion. Panel Mounting type.

Prices £1.15.0—£2.15.0

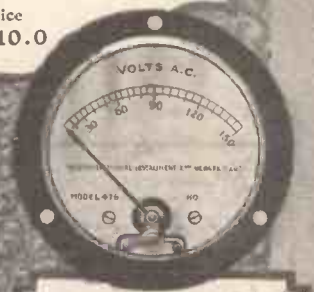

Model 506 Panel Voltmeters ensure permanent accuracy. With a high internal resistance of 125 ohms per volt, they make practically no load on the batteries. Neat and compact.

Prices £1.15.0—£2.15.0

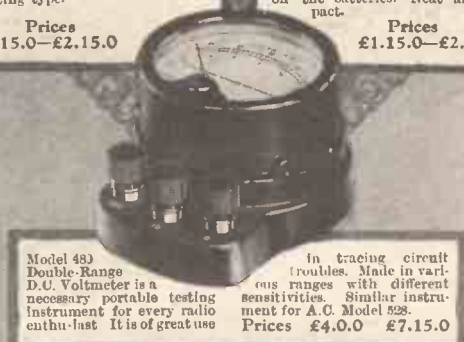

Model 493 Double-Range D.C. Voltmeter is a necessary portable testing instrument for every radio enthusiast. It is of great use

in tracing circuit troubles. Made in various ranges with different sensitivities. Similar instrument for A.C. Model 528. Prices £4.0.0 £7.15.0

# WESTON

STANDARD THE WORLD OVER  
Pioneers since 1888

WESTON ELECTRICAL INSTRUMENT CO. LTD.  
15, GT. SAFFRON HILL, LONDON, E.C.1.



By P. R. BIRD.

*Some typical faults and remedies reviewed.*

THIS month I should like to talk about the queer things that go wrong in that part of the wireless installation which is placed out-of-doors. In a few weeks reception conditions will be simply perfect, but it may then be too late to overhaul the aerial and earth systems in comfort, so now is the opportunity for this.

On the aerial side the chief points to watch are the cleanliness of the insulators (of which there should be a liberal supply), and particularly the efficiency of the lead-in connection. If this has done several months' work without attention it is high time you took the wire down, unscrewed it at the lead-in tube, and gave it a good polish up, cleaning

the contacts as far as possible before screwing down again. (If it is in rather an exposed position it is a good stunt to cover the whole lead-in connection with a blob of petroleum jelly, to protect it from corrosion, etc.)

There should not be any joints in the aerial wire, which should be of one piece, but if you have to have a joint in it make sure that it is a really well-soldered one that cannot be improved, or else you will soon have trouble there.

**Overcoming Humming**

Finally, and probably most important of all, do not forget the "earth." Although I have referred to this recently several times I make no apology for returning to the subject, because I have had so many appreciative letters from readers who have improved their results by the simple method of overhauling the earth connection. I should like to take this opportunity of thanking many readers who have written to me describing the peculiar faults which crop up in their sets and the methods they have of curing these.

This month I can quote a particularly interesting experience described

*(Continued on page 68.)*

**Keystone**

**THE HALL MARK OF QUALITY**

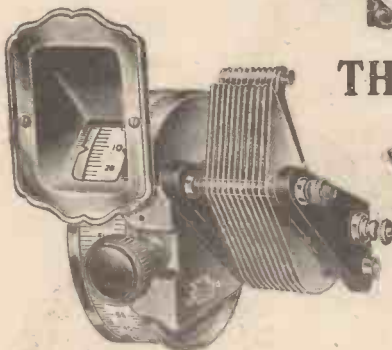

**KEYSTONE DRUM DRIVE.**

Designed to fit all standard condensers, which can be mounted either on the left or right of the drive. A delightfully smooth slow-motion drive gives a reduction of 9 to 1. Accurate tuning with a minimum of trouble is ensured. Drilling templates supplied.  
PRICE .. .. . 9/-



**KEYSTONE UNIVERSAL TUNING UNIT.**

An entirely new Tuning Unit embodying Reinartz reaction, designed to cover two wavebands of 250-600 and 1,000-2,000 metres, change over being effected by push-pull switch. The unit is fitted with standard 6-pin base. Coil is wound with high-grade wire on special low-loss former, thus obtaining maximum with minimum self-capacity.  
Price, complete with double range with 6-pin base and push-pull switch, 12/6. Short-wave coil extra, 20-45 metres, 7/6; 40-90 metres, 7/6.

Write for List No. 25, which gives full details of the range of Keystone components.

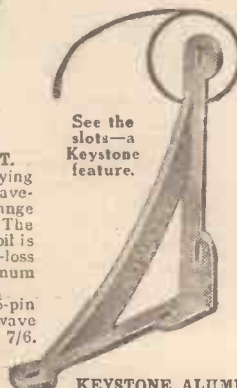

See the slots—a Keystone feature.

**KEYSTONE ALUMINIUM ANGLE BRACKETS.**

An entirely new form of angle bracket in which the screw holes are slotted, thus ensuring easy fitting. The overall size of these brackets is 4 in. x 4 in.  
PRICE .. .. . 2/- per pair.

THE success or failure of a set depends on the efficiency of its components. To build with inferior parts is to invite disappointment with the results. Don't build with them. See the Keystone device on all the parts you buy. It's a guarantee of quality. All Keystone parts are carefully made from highest-grade material. Your set will function perfectly if you build with Keystone components.



**KEYSTONE PUSH-PULL SWITCH.**

This splendid little switch has a perfectly smooth yet positive action. Highly nickel-plated and fitted with terminals for easy connections. One-hole fixing.  
PRICE .. .. . 1/3

**PETO-SCOTT CO. LTD.**

77, CITY ROAD, LONDON, E.C.1  
AND AT  
62, HIGH HOLBORN, LONDON, W.C.1



# This is an Ohmite

The new process resistances which are fieldless by reason of the Bakelite casing which is moulded round and which hermetically seals them.

They cannot possibly vary.

Specially made to stand heavy currents.

This is why

## GRAHAM-FARISH Ohmite ANODE RESISTANCES

are *Better than Wire Wound!*

PRICE PER SIZE UP TO 2/3 1/2 MEG

GRAHAM-FARISH OF BROMLEY KENT

### WIRELESS CONSTRUCTOR

#### Advertisement Rates

Single Insertion -	£60 0 0
per page and pro rata	
6 CONSECUTIVE Insertions	55 0 0
per page and pro rata	
12 CONSECUTIVE Insertions	50 0 0
per page and pro rata	
ONE INCH single col. (2 1/4" wide)	2 5 0
Minimum Space, half-an-inch	1 2 6

**IMPORTANT.** Copy and Blocks must be in hand by 20th of each month for issue placed on sale 15th day of the following month.

ALL communications respecting advertising must be made to:-

JOHN H. LILE, Ltd., 4, Ludgate Circus, London, E.C.4  
Phone: CITY 7281.

#### High-grade QUEEN ANNE STYLE FIGURED OAK CABINET

Height 3 ft. 3 ins. Depth 1 ft. 3 ins.  
For Panels up to 21 ins. x 7 ins.

£5.5.0

Packing Free. Carriage Paid.

Prices of other sizes in proportion. Manufacturer of all types of wireless cabinets and furniture of every description. Illustrated lists free.

GILBERT, CABINET MAKER, SWINDON.

Estimates Free. Estd. 1866.



# FERRANTI

## RADIO METERS



**ROBUST CONSTRUCTION**



**SUPERFINE WORKMANSHIP**



**EXTREME ACCURACY**



**COMPLY WITH BRITISH ENGINEERING STANDARD SPECIFICATION FOR 1st GRADE INSTRUMENTS**

**IN ALL RANGES, FOR ALL PURPOSES.**

**FERRANTI LTD., HOLLINWOOD, LANCASHIRE.**

**QUEER QUERIES**

—continued from page 66

in a letter to me from a Blackheath (London, S.E.10) reader. He says:

"I have just cured a curious fault. My set, 2-V-2 (A.C. eliminator), has been functioning perfectly for the past year. Last week it suddenly developed a hum.

"I bought a new rectifying valve for the eliminator—no cure! Tested the various components and wiring—no cure! Replaced all valves with new—no cure! Fitted resistances to all H.T. tapings—no cure!

"I was on the point of scrapping the eliminator altogether (though it was an expensive instrument) when it occurred to me to test a joint in the earth lead. This joint I had covered with insulating tape, and on removing the tape I found the wire had rusted and broken inside the tape.

"A new earth lead at once cured the trouble."—*Verb. sap.*

**Coupling Condensers**

Now that more and more readers are adapting mains units in order to get plenty of H.T. to the set, it becomes necessary to insert a word

of warning about coupling condensers.

Cases are continually cropping up where coupling condensers, having been subjected to a pretty high H.T. potential, give rise to distortion and

between its terminals, you may be pretty sure that the H.T. is going to find its way across to the grid of the succeeding valve.

One result, of course, is to nullify the effect of the grid bias negative, and the whole operation of the set will be thrown out if the coupling condenser does not completely insulate the grid from the preceding plate. So, if you are contemplating building a set and the designers specify mica coupling condensers, you say "mica" when ordering the parts, or you will probably say something much stronger when the set is tested.

**THE TECHNICAL QUERIES DEPARTMENT**

Are you in trouble with your set?

Have you any knotty little Radio problems requiring solution?

The WIRELESS CONSTRUCTOR Technical Queries Department has been thoroughly reorganised and is now in a position to give an unrivalled service. The aim of the department is to furnish really helpful advice in connection with any radio problem, theoretical or practical.

Full details, including the revised and, in cases, considerably reduced scale of charges, can be obtained direct from the Technical Queries Department, WIRELESS CONSTRUCTOR, Fleetway House, Farringdon Street, London, E.C.4.

A postcard will do: on receipt of this all the necessary literature will be sent to you free and post free, immediately. This application will place you under no obligation whatever. Every reader of WIRELESS CONSTRUCTOR should have these details by him. An application form is supplied which will enable you to ask your questions, so that we can deal with them expeditiously and with the minimum of delay. Having this form you will know exactly what information we require to have before us in order to solve your problems.

weak reception, and completely prevent enjoyment of the programmes. If there is the slightest tendency to bad insulation in a coupling condenser and there is any tendency to leakage

**A Potentiometer Poser**

One or two readers have been scratching their heads over problems of volume control, by means of a potentiometer.

By taking out the power valve's grid leak and putting a potentiometer's ends there, it is possible to get excellent volume control if the slider of the potentiometer is connected to the grid of the last valve. But it must be a high-resistance potentiometer (¼ megohm or so), and queer silences obtained by this method are often due to using the 400-ohm type, which is useless for the purpose.



*The new* **B.T.H. GRAMOPHONE PICK-UP**

THE introduction of the B.T.H. Gramophone Pick-up marks a very definite step towards fidelity in sound reproduction. It is a thoroughly reliable instrument of extreme sensitivity and is capable of translating the impressions on the gramophone record into electrical impulses over an exceptionally wide range of frequencies. A wonderfully designed balanced tone arm ensures correct needle weight, thus minimising wear on the record. Used in conjunction with the new B.T.H. Pick-up amplifier, and a moving-coil loud speaker, a most remarkable degree of tonal purity is obtained.

**Price £2 : 5 : 0**



**The B.T.H. Pick-up Amplifier**

This instrument will appeal to those who have their own power amplifiers, but require a further stage. In addition to the one stage of amplification, this instrument embodies a scratch eliminator and volume control.

**Price £3 : 7 : 6**



# SAFETY FIRST

**FIT THE FAMOUS  
SUPER SHROUDED  
TRANSFORMER**

and be sure of  
**Satisfaction**  
for  
**18/6**

The ideal transformer for all modern circuits. Designed on sound lines, made from the best of materials and excellently finished. Tested and recommended by leading designers and experts.



Guaranteed against faults for 12 months. Gives pure and distortionless reproduction throughout its long life.

Two ratios 5:1 and 3:1

PRICE: **18/6**

## BRITISH GENERAL

MANUFACTURING CO., LTD.

Brockley Works,

London, S.E.4

# PEERLESS VALVE HOLDERS

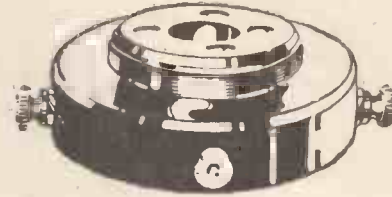

The "Peerless" shock-proof anti-microphonic Valve Holder is one of the most popular models on the British market. It represents the acme of reliability and efficiency and is designed to absorb all shock and vibration.

Retail **1s. 6d.** Price

Send for new Catalogue of our Standard Lines.

Further particulars from:—

**BEDFORD ELECTRICAL & RADIO CO. LTD.**

22, Campbell Road,  
**BEDFORD**

London:  
21, Bartlett's Buildings, E.C.4

Glasgow:  
113, St. Vincent Street, C.2

# IGRANIC FIRST AGAIN!

AT Olympia this year IGRANIC products again set the standard of advance. IGRANIKIT—the 2-Valve ALL-MAINS OUTFIT—£7.0.0—was the triumph of the Exhibition.

THE "UNIVERSAL" PORTABLE—with screened grid valves in the two H.F. stages, and ample battery power in the separate case—was right in the forefront. Covered in selected hide and selling fast at £33.4.0, including royalties.

COILS, which first made the name of IGRANIC famous in the radio world, were popular as ever. The "J" Type Transformer at 17/6 stood without an equal in its class.

Send for free catalogue of the best radio components.



## IGRANIC ELECTRIC CO. LTD.

149, Queen Victoria Street, LONDON, E.C.4

Works: BEDFORD.

Branches: MANCHESTER, BIRMINGHAM, CARDIFF,  
NEWCASTLE, LEEDS, BRISTOL, GLASGOW.

RADIO—HOW IT WORKS AND HOW TO GET THE BEST FROM IT.  
 Send this coupon with your name and address (1d. stamp) and get your copy, FREE.  
 Name .....  
 Address .....  
 Price 6d.  
 Nov. 1928

**THE "NEW-WAY" TWO**

*—continued from page 24—*

it should now be possible at one position to hear signals from the local station. Make a careful note of this setting, otherwise in the oscillation test which is to follow you may cause considerable interference to nearby listeners.

**Oscillation Test**

Starting with the tuning dial at zero, carefully increase the capacity of the reaction condenser until the set commences to oscillate. This condition can easily be recognised by a rushing sound which only occurs when the receiver is in a state of oscillation.

It should next be found if the set will oscillate over the whole range of the tuning condenser, but do not on any account forget to turn the reaction condenser to zero just before and until just after you have passed over the local station's setting.

Having tested the set for oscillation on this wave-band, alter the position of the wave-change switch and do exactly as before.

The spade tag on the end of the flexible lead from the switch knob should, for this test, be joined to the terminal on the top of the loading coil marked 60. If with it in this position it is found that the set will not oscillate, try the effect of changing it to the 80-tap terminal.

It is chiefly on the long-waves that the potentiometer comes into use, and it is therefore appropriate that I should say a few words about it before proceeding farther.

The detector valve is usually found to give the loudest signals when the potentiometer slider is on the positive side, that is, the side which is connected to L.T.+. When the set is changed over to long waves, however, it may be found that reaction is inclined to be "ploppy" or sudden.

**Obtaining Smooth Control**

If such is the case, a cure can be effected by moving the arm of the potentiometer just sufficiently towards the negative side to obtain smooth control.

For distant long-wave stations it may be found that the loudest signals are obtained with the spade tag on the 80-tap terminal, and there is no reason at all why this tapping should

not be used providing the reaction control is quite smooth.

When using the "New-Way" Two on short waves, the best position for the clip on the aerial coil should be found by trial, since it will depend upon the aerial in use.

**Test Report**

In searching for distant stations the set should always be operated just below the oscillating condition. In this connection it should be mentioned that the setting of the reaction condenser to bring the set just below the oscillating condition will not remain constant over the whole range of the tuning dial, and occasional readjustments should therefore be made.

In the original tests of the receiver, excellent loud speaker results were obtained from London at nine miles away, and signals from 5 G B and 5 X X could be heard very clearly on the loud speaker at nearly a hundred miles.

On the short-wave coil, Stuttgart, Toulouse, Langenberg, Hamburg, and one or two other Continental stations were all heard quite distinctly.

In the long-wave lists, Hilversum, Konigswusterhausen and Radio Paris as well as 5 X X were all quite worth listening to.

**AFTER OLYMPIA—  
VISIT  
WILL DAY LTD.**

(The Best in the West)

19, LISLE STREET, LEICESTER SQUARE,  
LONDON, W.C.2.

Phone: Regent 0921 & 0922. Grams: "Titles," Westrand, London.

If you appreciate the best in music and the spoken word, come to us as specialists and we shall be pleased to give you unbiased advice.

Get your supplies direct from the most up-to-date radio firm in town.

- The New Cossor Melody Maker Kits £7 15 0
- Pentode Valves . . . . . £1 5 0
- Pentode Valve Holders . . . . . £0 2 3
- The New Exide A.C. L.T. Charger £3 10 0
- H.T. Charger . . . . . £5 0 0
- Or L.T. and H.T. Combined . . . . . £8 0 0
- Fuller Trickle Charger, A.C. . . . . £1 17 6
- Wates Special Volt 2 Range } meter £0 8 6
- Miliamr. Range }

Special Attention is drawn to the new Soldome: a Sels designed for those who experience difficulty in soldering.

Demonstrations of Leaflet on Request.

Write for our comprehensive catalogue. Postage 6d. Free to Callers.

**OPEN UNTIL 7 P.M.**

**"CLARKE'S"  
"ATLAS"  
PIRTOID TUBING**

As approved by Wireless Journals and the Designers of the Cossor "Melody Maker" Coils and High-Frequency Coils.

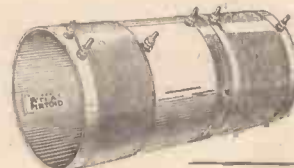

Cossor "Melody Maker" Coil. Price, ready wound, as illustrated, 7/6 each. Postage extra.

Cossor High-Frequency Coil. Price, ready wound, as illustrated, 7/6 each. Postage extra.

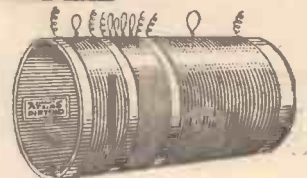

**H. CLARKE & CO. (M/cr.), LTD.  
"ATLAS" WORKS,  
OLD TRAFFORD, MANCHESTER**



# Orphean RADIO

## "SUPER" CABINET CONE SPEAKER

For those who prefer something more ornate than the ordinary cone speaker we recommend this artistic and beautifully made cabinet speaker which will add charm to the appearance of any room. It is made of solid oak and contains an 11-in. Orphean cone loud speaker which is famed for its purity of reproduction and tone. The size is 19 in. high, 15½ in. wide and 7½ in. deep. It is a speaker which is absolutely free from "drumming" effects and gives both high and low notes their true value. So do not hesitate any longer, write for our descriptive folder and the name of the nearest dealer, who will always be pleased to demonstrate.



Price: £6-0-0

### GRAMOPHONE PICK-UP

This neat Gramophone attachment has been designed to give the maximum sensitivity together with absolute purity of reproduction and absence of mechanical noise. The mechanism is contained in a bakelite moulding of walnut colour, and the whole instrument only weighs about 4 oz., so avoiding unnecessary record wear.

PRICE 50/-

LONDON RADIO MFG. Co., Ltd

Head Office & Works:  
STATION ROAD, MERTON ABBEY,  
London, S.W.19.  
Telephone: WIMBLEDON 4658.

### OTHER "ORPHEAN" BARGAINS

3-VALVE PORTABLE £21

"STANDARD" CABINET  
Cone Speaker £3-15-0

"THE ORPHEAN CONE"  
Loud Speaker £2

HORN TYPE LOUD SPEAKERS

"De Luxe" . . . . . 50/-

"Standard" . . . . . 40/-

"Gem" . . . . . 30/-

Send for List.

18-24



"I'm going to make more money"

"I am tired of working for a small salary—tired of the strain of endeavouring to keep up appearances—tired of seeing others beat me in the struggle for promotion—tired of the fear of unemployment;

"I've been blind in some ways, but now I see clearly that diligence, integrity, and long service are not enough. To succeed one must have a special vocational training. The men who are going ahead of me have only one advantage—they are trained, while I am not. That makes all the difference, but I am determined to raise myself to their standard without a day's delay. The International Correspondence Schools can help me, just as they have helped tens of thousands of others."

Many a man, at last realising that tremendous handicap of being untrained, has thought along those lines and then become an I.C.S. student, greatly to his advantage and happiness.

In every line of business men and women are holding important positions and receiving splendid salaries—because they became I.C.S. students.

You, too, by studying at home in your own time, can qualify for the position you want in the work you like best—no matter what your age, your occupation, or your means.

The I.C.S. originated spare-time technical training by post 37 years ago, and is by far the largest institution of its kind in the world. It has teaching centres in eleven countries and students in fifty.

Write to-day for full information as to how the I.C.S. can help you in your chosen vocation. There are 360 Standard courses, of which the following are the most important groups:—

- |                     |                            |                       |
|---------------------|----------------------------|-----------------------|
| Accountancy         | Draughtsmanship            | Salesmanship          |
| Advertising         | Engineering (all branches) | Scientific Management |
| Architecture        | French and Spanish         | Showcard Writing      |
| Building            | General Education          | Textiles              |
| Commercial Art      | Professional Exams.        | Window Dressing       |
| Commercial Training |                            | Woodworking           |

There is a special booklet for each group, which will be sent free on request. Tell us the one you would like to see.

International Correspondence Schools, Ltd.  
172, International Buildings, Kingsway, London, W.C.2



### SIX - PIN BASE

As shown. Size, 2½" x 2½". Moulded throughout including legs. Makes shorting impossible. Recommended for all circuits. Price, with terminals 1/6

B B VALVE HOLDER 10d.

TOGGLE SWITCH . 9d.

### CIRCULAR MOTION DISCOVERY

CASON MOULDINGS, CHISWICK ROAD, LOWER EDMONTON, N.9.



### ANTI - MICROPHONIC VALVE HOLDER

No matter how much you may jar your set, the circular motion of vibration of the NEW CASON VALVE HOLDERS guarantees safety to your valves. They will not swing sharply to and fro, but will rotate smoothly and without the least strain. Again the wonderful device is so finely sprung that it ensures perpetual valve-motion, a necessary quality to the best reproductions. 1/6

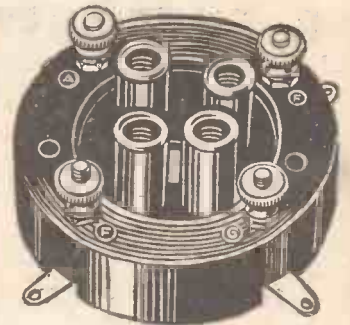

### A Small Condenser — with a Great Reputation

#### THE CYLDON "BEBE"

condensers were primarily designed for use as reaction condensers—but the larger capacities are ideal as tuning condensers where space is limited. Made in five capacities: '0001 7/6, '00015 8/-, '0002 8/6, '00025 9/6, '0003 11/-.

Complete with 2" knob and dial. Full particulars of all "Cyldon" condensers post free on request.

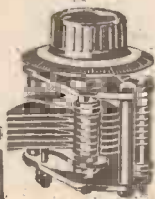

Specified for the "Radiano" Four and other leading circuits.



SYDNEY S. BIRD & SONS, LTD.,  
CYLDON WORKS, ENFIELD TOWN, MIDDLESEX.

### WHEN ORDERING CABINETS FOR

## THE SIX-SIXTY MYSTERY RECEIVER

THE MULLARD PORTABLE V, etc.  
BE SURE AND SPECIFY



AND ENSURE PROMPT DELIVERY

Send for our latest Lists to—  
CARRINGTON MFG. CO. LTD., CAMCO WORKS,  
SANDERSTEAD ROAD, SOUTH CROYDON.  
Phone: Croydon 0623

There must be a reason  
**WHY**  
**CELESTION**

is the most popular  
Loudspeaker in  
Europe—

and there is one  
It is  
**THE**  
**CELESTION**  
**REINFORCED**  
**DIAPHRAGM**

This conveys little to the non-technician. Suffice it to say that the Diaphragm (the hidden face of the Loudspeaker) of every conc speaker is the vital force in its powers of reproduction.

The foremost set manufacturers use Celestion with all their models. British made throughout, and under licence.

# CELESTION

*The Very Soul of Music*

Write to Dept. L.

**THE CELESTION RADIO Co.**

London Road, Kingston-on-Thames.

Phone: Kingston 5656 (4 Lines).

Showrooms:

106, VICTORIA STREET, S.W.1.

Associated Company:

**CONSTABLE-CELESTION & CO.,**  
69, RUE DE MONCEAU, PARIS.

Model C. 12.

Models from £5 10s.  
Write for New Booklet.



\*\*\*\*\*  
**OUR NEWS BULLETIN**  
\*\*\*\*\*  
*Some of the More Interesting Happenings  
in the Radio World this Month.*  
\*\*\*\*\*

### Radio Recipes

WHEN the B.B.C. made the announcement that it was willing to pay small sums for listeners' hints on recipes and household tips, etc., it is hardly likely it realised what it was letting itself in for. By the very first post after this announcement, over thirteen thousand letters were received from listeners giving suggestions, hints, etc.

### A Relay Reminder

WIRELESS CONSTRUCTOR readers are probably well aware of the fact that during November and December the relay stations will take over the national exclusive wave-length of 288.5 metres, but this information is reproduced here just as a reminder.

The process of changing will be a gradual one, each station changing its frequency as soon as the necessary plant is installed.

### Single-Wave Working

The B.B.C. states that heterodyne interference has become so serious on

tion given in our companion paper, "Popular Wireless," some months ago, concerning this change, it is an undoubted fact that during the next two years the B.B.C. headquarters will be moved into a new building, to be called "Broadcasting House."

It is quite likely that a new site has not yet been finally selected, but that a change will be made there can be no doubt.

### The New Pennine Station

The Postmaster-General has now given the B.B.C. permission to proceed with the remainder of the Regional Scheme stations. The next station to be erected will be near Manchester, i.e. in the Pennines, and the Manchester station should be operating by 1930.

### Contrasted Programmes

Captain Eckersley summed up the Regional Scheme rather well the other day when he said that the backbone of the Regional Scheme is five twin-wave transmitters located so as to give a service of two con-

### NEXT MONTH

Make sure of YOUR copy of the

## SPECIAL GIFT NUMBER

OF

## "THE WIRELESS CONSTRUCTOR"

Order your copy now and AVOID DISAPPOINTMENT

the international common frequencies that the service areas of relay stations have been reduced to a one-half to two-mile radius during the hours of darkness. Therefore, the change to single wave-length working should improve conditions of reception in the thickly-populated areas, of Liverpool, Stoke-on-Trent, Bradford, Hull, Sheffield, Swansea, Plymouth and Dundee.

### B.B.C.'s Headquarters

There has been a lot of talk in the papers lately about the B.B.C. moving into more commodious and palatial headquarters. Although these rumours have been more or less semi-officially denied, and some of the papers have taken upon themselves to contradict the exclusive informa-

trasted and uninterrupted programmes, with a maximum number of listeners. These stations will not cover all towns now served by single stations with their present signal strength, and will leave a very small minority outside this service area altogether.

### Tuning Troubles

Therefore it is likely that when the changes of power and the redistribution of wave-lengths take place there may be some slight confusion among listeners in different parts of the country in regard to tuning their sets, but it is not very likely this will prove an insuperable obstacle to the success and popularity of the scheme.

(Continued on page 76.)

# FOUR SHILLINGSWORTH

## for NOTHING!

**DON'T  
MISS  
THIS**

# BLUE PRINTS FREE

**A  
WONDERFUL  
CHANCE**

Wherever constructors are gathered together you will hear about the famous "P.W." Blue Prints. The Series has recently been extended, and eight fine Blue Prints are to be given away to every reader of

## POPULAR WIRELESS

This new series of Blue Prints includes:

- |                              |                             |
|------------------------------|-----------------------------|
| (1.) A REGIONAL CRYSTAL SET  | (5.) THE ANTIPODES ADAPTOR  |
| (2.) THE "WAVE-CHANGE" ONE   | (6.) THE "ANY MAINS" TWO    |
| (3.) A SIMPLE A.C. H.T. UNIT | (7.) THE "BANDMASTER"       |
| (4.) THE "REGIONAL" THREE    | (8.) THE "LONG-RANGE" THREE |

Full Constructional Details are given on the Blue Prints. Numbers 1 to 4 are being given away with every copy of "P.W." dated October 13th. The remaining four 6d. Blue Prints will be given away the following week (October 20th). Make sure of your copy, as there is sure to be a huge demand for

## POPULAR WIRELESS

**ORDER YOUR COPY NOW**

USUAL PRICE \_\_\_\_\_ **THREEPENCE ONLY**



**The World's BEST Battery Value**

The new 60 volt Columbia High Tension Battery (No. 4721) is definitely the world's best battery value. Costing only 10/6, it is a battery of extremely high capacity, its lasting powers are enormous, and its very name and high standard of excellence will commend it to every discriminating wireless man in the country.

In addition to this amazing offer, we have pleasure in announcing the following reductions in price of other Columbia Batteries.

- 60 volts. High (Triple) Capacity (No. 4780) . . . . . 20/-
- 45 volts. High (Triple) Capacity (No. 4767) . . . . . 16/6
- 45 volts. Vertical High (Triple) Capacity (No. 4772) . . . . . 16/6
- 22.5 volts. Power Grid (No. 4766) . . . . . 9/-
- 4.5 volts. High Capacity Grid (No. 4771) . . . . . 2/-

Write for our instructive brochure, "Why Radio is better with Battery Power."

J. R. MORRIS, Imperial House, Kingsway, W.C.2.  
Scotland: J. T. Cartwright, 5, Calogian Street, Glasgow.

**OUR NEWS BULLETIN**

—continued from page 74

**The Missionaries' Message**

Two missionaries in Beru, in the Gilbert Islands, one thousand miles north of Fiji and two thousand miles east of New Guinea, recently picked up this call:

"Hello G Z D. Hello, L M S, Beru. Ocean Island speaking. Stand by. I have a message for you."

According to the "Daily Chronicle," the two missionaries were using for the first time a wireless set taken out last year to the islands by the Reverend G. H. Eastman, of Long Melford, Suffolk, and with the set the missionaries had been awaiting a call from Ocean Island four hundred miles away.

**Lonely Outpost of Empire**

"It was undoubtedly the moment of the year," wrote Mr. Eastman to

**Grandfather Wireless**

According to the "Morning Post," an Oxford man, Mr. Lawley, has patented a four-valve receiving set built into a miniature grandfather clock. The upper portion of the clock has an eight-hour clock movement with open fretwork face, behind which is a super cone-type loud speaker. The central, or column, portion of the clock contains the wireless set itself.

By means of a clock switch the instrument can be made to switch on or off automatically at any given time.

**Baird's B.A. Demonstration**

A wireless correspondent in the "Observer," writing recently in that journal about the television demonstrations at Glasgow, said that the Baird televisor was duly demonstrated during the meeting of the British Association, and what was shown represented the very best that could be done in the present state of

Every Constructor should make sure of his copy of

**THE "WIRELESS CONSTRUCTOR"**

next month when

**A SPECIAL GIFT NUMBER**

will be offered

**AT THE USUAL PRICE**

Place an order Now.

Obtainable Everywhere.

Price 6d.

a friend at home in Surrey. "A few preliminary howls, some Morse, and then the long-anticipated miracle, the outside world actually speaking to Beru."

This is probably the first time in history of missionaries receiving definite information of a ship's arrival at these lonely outposts in the Gilbert Islands.

**The Pilgrim's Progress**

In connection with the B.B.C. Symphony season, a new work by Granville Bantock, called "The Pilgrim's Progress," will be broadcast on November 23rd. The composer will conduct, and at the same concert the new National Chorus will be heard for the first time.

During Sir Landon Ronald's concert on March 1st, 1929, Eric Fogg will conduct his own work: "The Hillside," for the first time in London, and on April 12th the B.B.C. Symphony Orchestra will be augmented to a strength of one hundred and thirty players for the first presentation in Britain of Mahler's Eighth Symphony, under the conductorship of Sir Henry Wood.

the art. The screen was a very small one, 3 in. by 3 in., or even smaller, and the image of a human head which was projected was lacking in all but the most prominent features.

"One saw hair, eyes that opened and closed, a mouth that opened and closed, a tongue that protruded, and smoke puffed from the mouth and rising from the end of a cigarette. It would be possible to recognise the image as representing the features of someone very well known. The image was blurred and very flickery."

**Some Bare Facts**

The writer goes on to say that the bare facts of the case are, however, that at present television is not in a state in which it is of the slightest public or practical use, and that any attempts to give a public television service immediately will only result in the disappointment of those who buy the necessary receiving apparatus, unless they are experimenters interested in the development of what must ultimately become of very considerable importance.

(Continued on page 77.)

OUR NEWS BULLETIN

—continued from page 76

Cell or Soul?

The Bishop of London, it appears, enjoys listening-in. Recently he was very shocked because he thought he heard someone say over the wireless that they would be able to make a "soul" in a laboratory. Obviously, the Bishop did not hear correctly. He misunderstood the word, which should have been "cell."

All this, of course, was in connection with the publicity given to the lecture on the "Mystery of Life," by Professor Donan, but it is a good example of how some people, listening in, are apt to misunderstand a word when broadcast by one of our modern "refined" announcers.

Broadcasting Co-operation

The B.B.C. announces that the Council and various committees of the International Union of Radio Telephony, which, at the invitation of the Chairman of the German Broadcasting Company, met in Berlin on August 31st last, concluded their work on September 5th.

The Council realised that it was now advisable to attempt a revision of the friendly agreements for the allocation of wave-lengths in Europe in order that European Governments, having in mind the ratification of the Washington Conference, might make the most efficient use of the wave-band reserved by the Convention for broadcasting.

The Conference has permitted each Government to lay down in its own country a favourable formula for the exercise of this right in the case of broadcast works. The Council followed the suggestions of the Rapprochement Committee for the establishment of uniform monthly statistics with the object of gaining the greatest possible advantage for listeners from the artistic and educational efforts of different countries.

"The Play's The Thing"

A new and what is likely to be a popular feature in the broadcasts for schools will be the fortnightly Friday afternoon plays. These will include "Henry IV, Part 1," on October 19th, and "As You Like It," on November 22nd. On October 5th, Sheridan's "The Rivals" will be given, and on November 9th, Drinkwater's "Robert E. Lee." On December 7th, the last of the series, "The Importance of

(Continued on page 78.)

K. RAYMOND

27 & 28a LISLE ST., LONDON, W.C.2

Come to Leicester Square Tube.

This address is at the back of Daly's Theatre. Phone: Gerrard 4637 and 2821.

WE ARE OPEN

ALL DAY SATURDAY  
ALL DAY THURSDAY  
ALL DAY EVERY DAY  
Hours: 9 a.m. to 8 p.m.  
Sat.: 9 a.m. to 9 p.m.  
Sunday morning: 11-1.

POINTS TO REMEMBER

for Quotations over 20/-

Please write plainly, state actual requirements, make out list of parts. By doing this you will help us to give you an

EVERYTHING FOR WIRELESS

IMMEDIATE KEEN QUOTATION

C.O.D.

Orders despatched same day as received where possible. Send ORDER with instructions and pay Postman. C.O.D. U.K. ONLY.

We stock Igranio, Climax, Ever-Ready, Hellesen, Siemens, Formo, Ferranti, Weatite, Ormond, J.B., Benjamin, Lotus, Mullard, Dubilier, Lissen, Lewoss, Utility, Magnum, Peto-Scott, Peerless, Burnedpt, Fye, Marconi, McMichael, Cosmos, Carborundum, E.F. Varley, Gambrel, Gurney, Storing, Amplions—in fact, everything it is possible to stock.

KITS of parts for all CIRCUITS. Make out LIST for keen quotation. DON'T worry, if it's Wireless WEHAVEIT.

MULLARD MASTER 3 STAR (Sept., 1928.)

This wonderful set will appeal to everybody interested in wireless. All parts available as Mullard's list.

Every component is available at short notice. This list is strictly to Mullard specification. 3 Valve Holders, Lotus, at 1/3. 1 Colven Combined Wave Coil, 17/6. 1 Permacore Transformer, 25/-. 1 Climax "LPA" Transformer, 25/-. 1 Climax H.F. Choke, 7/6. 1 Benjamin Battery Switch, 1/3. J.B. 0005 Log, 11/6. 00035, 10/6. Mullard 0003, Leak and Holder. Stone-Jones Panel Brackets, 2/6. Mullard 0001 Fixed Condenser, 2/6.

Total £5: 12: 6

IMPORTANT. If you add 3/6 to above sum (total £5/15/0) we will include the following: 4 Engraved Terminals, Set Links, 3 Plugs, 2 Spades, 2 Handome Slow Motion Dials, 2 Ebony Strips, 3 volt Grid Bias, Splendid Aluminium Panel, 18 x 7, Baseboard, Twin Flex, AND we will pay the carriage to any address

Oak Cabinet for 12/6. American type, hinged lid, carriage, 2/-.  
Valves, all latest stocked  
D. L.F., H.F., P., 10/6,  
12/6 each; D.U.10, 15/-;  
Mullard P.M.4.D., 12/6  
Cosfor, Mullard, Ediswan,  
Marconi, Osram, Six-sixty

COSSOR Latest Kit in Sealed Carton £7 15s. 0d.

THE ORIGINAL COSSOR MELODY MAKER

SPECIAL PRICE £4: 4: 0 Specified parts

2 Ormond 0005; 2 Do. S.M. Dials; 6 T.C.C. Condensers; 2 B.B. Clips; B.B. Rheostat; 3 Dubilier Leaks; 3 Lotus V.E.; Ferranti A.F.3; 2 Switches; 1 Cosfor Wound Coil; Terminals; Grid Bias; Handsome Oak Cabinet, 12/6. With baseboard, Carr. 2/-. Also Cabinets at 15/11, 18/11, and Mahogany Polished, at 20/-. Carriage 2/-.  
FREE with parts  
Drilled High-grade 21 x 7 Polished Panel and Strip, Wood Screws, Carriage 1/-.

COSSOR VALVES 2, 4, or 6-Volt for above. L.F. D., R.C., or H.F., 10/6 each. Power, 12/6.

PAROUSSI SCREENING BOXES STOCKED. M.W. and P.W. Loading Coils, 7/6

LEWCOS PRODUCTS

O.T. Coils, 40, 50, 60, 75, 3/6 each. 100, 150, 200, 5/3 each. Glasite 10d, 10 ft. Litz Wire, 9/38, 4/50 yds.; 9/38, all silk, 5/6 50 yds. Also in 20-yard reels, Litz, 27/42, 11/6 50 yds. Frame Aerial Wire, 3/6 100 ft. Battery Leads, 4-way, 5/6; 5-way, 5/6; 6-way, 7/6; 7-way, 8/6. All Bircul Coils. "Q" Coils, 21/-, Aerial, 15/-, in stock.

LISSEN

Valve Holders, 1/-; Fixed Con., 1/-, 1/6; Leaks, 1/-; Switches, 1/6, 2/6; Latest 2-way Cam Vernier, 4/6; Rheostats, 2/6; B.B., 1/6; Lissencola, 13/6; L.F. Transformers, 2/6; Coils, 60 X, 5/4; 250 X, 9/8; 60-v. H.T., 7/11; 100-v., 12/11; Super 60-v., 13/6; Grid Bias, 1/6; 4-5, 8d.

OCTRON BRITISH VALVES, 2, 4 & 6 volts. L.F., R.C., H.F., 5/- Power, 6/9.

Full Guarantee Chart FREE.

EBONITE cut while you wait at 1d. square inch, also 1 in. at 1d. Only the best supplied. No cheap rubbish.

Send your orders, wire, phone or write (plainly please). Personal attention to your requirements. Parts for most "Popular Wireless," "Modern Wireless" and "Wireless Constructor" Sets.

**100% ELIMINATOR EFFICIENCY**  
with a **SIFAM** ELIMETER

It has a resistance of 100,000 ohms, and is calibrated up to 220 volts. It can be connected in parallel across the — and any + or plate terminal of a good eliminator, and, greatest of all, the price is within everybody's reach.

**PRICE 30/-**

Heavy Nickel-Plated finish. White Ivory board dial. Calibrated up to 220 volts. Ask your dealer for particulars of the Sifam range, and send for free leaflet, "Detecting Distortion."



(Dept. Wires, Concl.)  
(Multi-meter) Howl-  
meters), THE  
SIFAM ELECTRICAL  
INST. CO., LTD., BUSH  
HOUSE, ALDWYCH,  
W.C.2.

**Cabinets of Quality for every Set.**

Full illustrated particulars from the Actual Manufacturers. V. C. Bond & Sons, 61, Hackney Grove, Mare St., London, E.8

**The HOME for your WIRELESS SET**

OUR STANDARD CABINETS

are DUSTPROOF and house the whole apparatus, leaving no parts to be interfered with. All you do is UNLOCK AND TUNE IN. Made on mass production lines, hence the low price. Provision is made to take panel from 16" to 30" wide. Carriage paid and packed free England and Wales. Thousands supplied with full satisfaction.

From £4 15 0. Write to-day for descriptive pamphlet and suggestions for adapting your receiver or panel in our Standard Cabinets. Immediate Delivery.

**MAKERIMPORT CO.**  
Dept. 20,  
9, York Street, LIVERPOOL.





## GNOMES OF EFFICIENCY

demonstrating the many connections that can be made to an Eelex Treble-Duty Terminal.

They are the little beings that look after the small things in a wireless set. Their life work is to perfect very important small accessories and see that they function efficiently to the utmost of their ability. Losses in a wireless set are enormous, and are in hundreds of cases due to faulty connections or bad joints.

Terminals are the centre of industry in a wireless set and unless secure joints can be made their efficiency is impaired.



### TREBLE DUTY TERMINALS

are so designed that anyone without any experience can make secure connections. Every constructor should write for our booklet 31, which tells you all about the Eelex gnomes of efficiency, Eelex Terminals and their accessories.

**J. J. EASTICK & SONS,**  
Eelex House, 118, Bunhill Row,  
Chiswell Street, London, E.C.1

\*\*\*\*\*  
**HOME-MADE CABINETS**  
 Some practical details for the set-builder.  
 By J. ROSCOE, B.Sc.  
 \*\*\*\*\*

MANY home constructors will cheerfully undertake the building of a fairly complicated receiving set, but when the question of making a cabinet arises they think twice and finally buy one or get one made by a cabinet-maker.

A simple cabinet is really very easy to make. The best woods are white-wood, mahogany and oak. The first two are soft, well-grained, and easy to work. Oak is rather harder and is apt to be a little more awkward ( $\frac{1}{2}$ -in. wood should be used).

Suppose now that we wish to make a cabinet for a set having a base-board 14 in. by 8 in. and a panel 14 in. by 7 in.

Take a piece of paper and stand the set on it; mark round the baseboard with a pencil; this will give the exact size of the base of the cabinet.

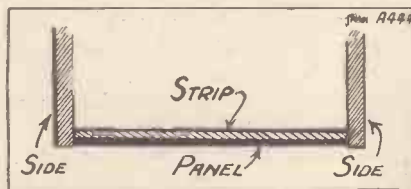

This should be pricked through on to a suitable piece of wood, and the base should be cut off. The set should be stood on this base and the rest of the cabinet can be built up. The back will be 14 in. by  $7\frac{1}{2}$  in.—that is the same size as the panel, only  $\frac{1}{2}$  in. higher to allow for the thickness of the base. The sides should be  $8\frac{3}{4}$  in. by  $7\frac{1}{2}$  in. The width of the baseboard is 8 in., but we must allow the sides to project  $\frac{1}{4}$  in. in front because of the thickness of the panel—usually  $\frac{1}{4}$  in.—and  $\frac{1}{2}$  in. at the back because the thickness of the back of the cabinet is  $\frac{1}{2}$  in.

The grain of the wood should run round the box in all cases. It only remains to fit a lid and to finish the work. The lid is 15 in. by  $8\frac{3}{4}$  in., exactly the same width as the sides but 15 in. long to allow for the sides.

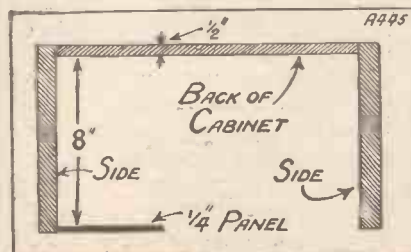

It may be thought that such a cabinet nailed together with what are known as coffin-nails would appear very crude. But it is now possible to buy  $\frac{1}{2}$ -in. mouldings or beadings in a variety of different woods and patterns, and it is an easy matter to run such a beading all round the base to hide the nails used to secure back and sides to the base, while a strip of beading round the lid will give a much better appearance than chamfering off the edge, which still leaves the end-grain exposed. No mention has

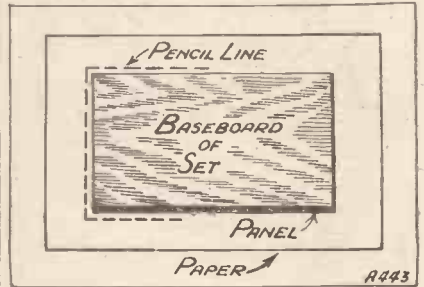

been made of cutting away part of the back to allow the terminal strips to project because the size and position of these strips varies, but doubtless the constructor will arrange this for himself.

The cabinet may be finished in a variety of ways. American whitewood may be stained and then wax-polished or varnished, or a pleasing effect may be produced by painting the cabinet with poster-paints and finishing with a good quality transparent varnish. The box may be lacquered. Mahogany and oak are woods beautiful in themselves. The former may be stained to darken it and then french-polished according to instructions recently given in this paper.

Oak may be fumed or stained and then wax-polished, but on no account should it be varnished.

### OUR NEWS BULLETIN

—continued from page 77

Being Earnest," by Oscar Wilde. The latter hardly seems the sort of play to broadcast to schools.

### Schubert's Centenary

Most of the nations will be honouring the centenary of Schubert in November, and the B.B.C. is going to make a special effort by beginning, on November 18th, a series of Schubert programmes to be broadcast from all stations.

On November 19th, which is the centenary date of Schubert's death, Sir George Henschel, the famous veteran singer, will broadcast some of Schubert's songs.

# VOLUME CONTROL



Here is a true volume control, one which does not create distortion. It gives you just the volume you desire and keeps your reproduction pure at all times. Don't detune—that is the cause of distortion. The "Voluvernina" gives perfectly smooth control from maximum to minimum. Can be used for your Gramophone Amplifier equally as well as for your Receiver.

Price **6/9** each  
From all Dealers.

[Write for Illustrated "Components Leaflets."]

## GAMBRELL RADIO Ltd.

6, Buckingham St., Strand, London, W.C.2

**"DON'T WAIT"**  
For the Winter  
**BUILD YOUR**  
**WIRELESS SETS NOW**  
**"DON'T WAIT"**  
until your ship comes home  
**BUY FROM US ON**

### EASY PAYMENT TERMS

and enjoy music in your own home. For a small first payment we deliver your order, and the balance is spread over 6, 9 and 12 months, paid from your income without disturbing your savings.

**WE SUPPLY COMPONENTS**  
for any Circuit or Receiver, including the New Cosmor Melody Maker, £7/15/0; Master 35, Radiano Four, Mystery 6.60, and all makes of Receivers, Eko H.T. Units, H.T. Accumulators, R.K. Loud Speakers, etc., etc.

**ALSO COMPLETE SETS:**  
Eye, McMichael, Rolls, Langham, Halsey, Brownie, Westminster, Rees-Macco, etc.  
We also manufacture the P.D.P. Super 3-Valve Receiver, 30-50 Stations on Loud Speaker, price £13/15/0, delivered for £1/10/0.

### EVERYTHING WIRELESS

From  
**THE P.D.P. Co., Ltd. (Dept. C)**  
121, Cheapside, E.C.2.  
Showrooms: 'Phone: City 9846.

**ARTCRAFT**  
**RADIO CABINETS**  
BRITAIN'S BEST VALUE  
New Catalogue Free  
**THE ARTCRAFT COMPANY**  
156, CHERRY ORCHARD RD, CROYDON

PLEASE MENTION "WIRELESS CONSTRUCTOR" WHEN REPLYING TO ADVERTISEMENTS.

## A HOME-MADE WIRE-HOLDER

BRIEFLY, as will be seen from the accompanying illustration, this wire reel holder consists of nothing more costly than an ordinary tin funnel, which can be procured for a penny or two at any hardware dealer's shop.

Two small holes are bored in the sides of the funnel, exactly opposite to each other. A short length of copper wire (say, No. 14's) is then passed through one hole in the side of the funnel, through the wire reel, and then through the hole in the opposite side of the funnel. The outer ends of this short length of stout wire are then slightly bent, in order to prevent it from slipping out.

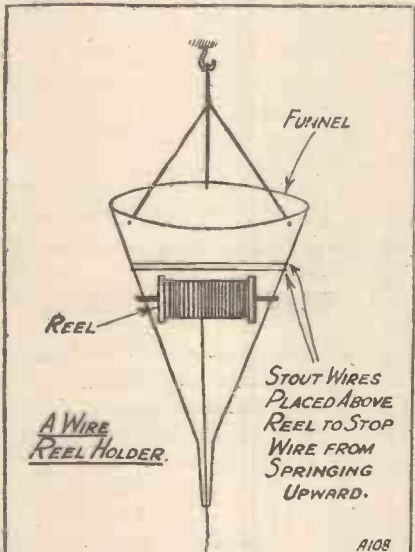

Three holes are made in the upper edge of the funnel for the purpose of suspending the funnel in a vertical position, as seen in the illustration.

### A Necessary Precaution

The free end of the reel of wire is threaded through the stem of the funnel, the narrow end of which should have previously been carefully rounded off with sandpaper, in order to prevent the possibility of the insulation being scraped off the wire as it is drawn through the stem of the funnel. Care should be taken, however, to see that the wire reel is free to revolve fairly readily within the funnel, so that no strain is placed on the wire.

### M.P.A. WIRELESS, LTD.

Owing to a printer's error we regret that in the advertisement of the above firm in last month's "Wireless Constructor" the price of the Dual Inductance Speaker was given as 5 guineas instead of 7 guineas.

# To avoid all Distortion

If it isn't one thing it's another! Either someone walking across the room, or closing the door, causing those horrible microphonic noises right in the middle of your favourite programme. We all know there's nothing more exasperating than that.

But there is a really effective way of stopping it. Fit W.B. Anti-phonic Valve-holders in your set and you kill all distortion.

The sockets of W.B. Valve-holders are sprung on specially shaped springs, so that all microphonic noises are definitely excluded from the valve. Also capacity between the valve legs is minimised by the removal of "dead" ebonite.

In addition to being specified for "Six-Sixty's Great Mystery Receiver" and the "Cosmor Melody Maker," W.B. Anti-phonic Valve-holders have been chosen for an enormous number of other well-known published circuits.

New reduced price:

**1/6**  
complete with terminals.

## USE THIS

**W B**



## ANTI-PHONIC VALVE HOLDER

**WHITELEY, BONEHAM & Co. Ltd.,**  
Nottingham Road,  
Mansfield, Notts.

## The "NEW JUNIOR" MOVING-COIL SPEAKER EQUIPMENT



**£3-10-0**

Complete equip-  
ment for 6 volts.

SPECIALLY designed to meet a demand for a GOODMAN'S product at a competitive price. The last word in up-to-date construction, it reduces the Constructor's difficulties of assembly to a minimum. The coil is sectionally wound, and has a new device which is self-aligning. The new design of Diaphragm, with an easy and permanent centring device, cone paper cut to shape, and a cleverly designed Moving Coil, eliminates practically any possibility of error in construction. The Pot Magnet is the already well-known Minor Model, and is remarkably powerful although consuming only 1 amp. at 6 volts. Lugs are provided for fixing to the Cabinet or Baffle Board.

Write for Illustrated Descriptive List.

**GOODMANS**  
27 FARRINGDON ST., LONDON, E.C.4  
Telephone: City 4472.

### WET H.T. BATTERIES



Solve all H.T. troubles  
SELF-CHARGING SILENT, ECONOMICAL  
JARS (waxed) 2 1/2" X 1 1/2" sq., 1/3 doz.  
Zincs, New type, 11d. doz. SACS 1/2 doz.  
Sample doz. (18 volts), complete with  
bands and electrolyte, 4/3, post 9d.  
Sample unit, 6d. Plus booklet free.  
Bargain list free.

AMPLIFIERS, 30/- 2-VALVE SET, 4/-  
C. TAYLOR, 57, Studley Rd.,  
Stockwell, London.

## MODERNISE YOUR WIRELESS

The  
"RADIOLA"  
BUREAU

Costing no more than  
a Loud Speaker,  
quickly transforms  
YOUR SET into  
a Stately Drawing-  
Room Receiver.

Highest approval,  
Radio Press, leading  
experts — and over  
3000 delighted clients.

FROM

**£5.5.0**

3 ft. high. Solid oak  
or mahogany. Beauti-  
fully polished.



De Luxe Model

Sent ON APPROVAL in sizes for every set.  
Send for full particulars — FREE.

**PICKETT'S**  
CABINETS

ALBION RD., BEXLEYHEATH, KENT.

## REPAIRS

Any make of L.F. Transformer, Loudspeaker  
or Headphones repaired and despatched within  
48 HOURS—TWELVE MONTHS' GUARANTEE  
with each repair. 4/- Post free.

Terms to Trade.

**TRANSFORMER REPAIR CO.,**

Dept. "C,"

214, High Street, Colliers Wood, London, S.W.19.

## NOTES ON THE "STEDIPOWER" UNITS

—continued from page 18

the grid-bias battery may have to be changed at long intervals, although some of the mains units even include grid bias from the mains.

I have recently been carrying out some experiments with a small device which can be added to any mains high-tension unit and occasionally proves very useful in cases where fluctuations of voltage occur in the house lighting mains.

It should be remembered that in the case where a high-tension unit steps-up the mains voltage, any fluctuation of mains voltage will be multiplied by the amount of step-up. Thus one may easily get twenty or thirty volts variation in a high-tension unit with some supply systems. In the case of the "Stedipower" L.T. Unit the voltage is stepped-down, and any mains variation which is likely to occur will make very little difference to the output.

The device to which I am referring is the Power ClarOstat, which can be

## BUY THE BEST.

All the articles in "Popular  
Wireless" are written

## BY THE BEST

radio contributors and set de-  
signers. Why not get  
"P.W."—and authoritative  
information?

Every Thursday. Price 3d.

inserted in one of the mains leads going to the transformer and used for reducing the voltage. The Power ClarOstat is a special device made to dissipate considerable energy and when used in such a position in a mains unit it will not become unduly heated. It is also useful in the case of some mains units where the output voltage on the maximum tapping is higher than is desired.

In such circumstances it is much better to reduce the voltage to the transformer than to reduce it at the output side by means of resistances. The device can be very easily attached at some convenient position, and in order to illustrate its use it has been fastened to the back of the cabinet of the "Stedipower" H.T. Unit as shown in the photograph.

## READY RADIO SUPPLY CO.

41, Newcomen Street, London Bridge, S.E.1  
Telephone: Hop. 5555 (2 lines).  
Telegrams: Ready Hop 5555 London.

## DEMONSTRATIONS

of the RADIANO 4, NEW WAY 2

and other Wireless Press Sets  
at our Works during Broadcasting Hours.

IMMEDIATE DESPATCH of  
ALL the CORRECT parts including  
valves for the  
"NEW-WAY" TWO

	£	s.	d.
1 Panel, 14" x 7"	6	2	
1 Cabinet, 14" x 7" x 10" (Oak finish)	19	6	0
1 .0005 mfd. Variable Condenser (Formo)	6	0	0
1 S.M. Dial (McMichael)	5	6	0
1 400-ohm Potentiometer (Lissen)	2	6	0
1 2-meg. Grid Leak and Holder (Lissen)	1	6	0
1 .0005 mfd. Fixed Condenser (Lissen)	1	0	0
1 .001 mfd. Fixed Condenser (Lissen)	1	0	0
1 On-Off Switch	1	0	0
1 Wave-Change Switch (Lissen)	2	6	0
2 Anti-Microphonic Valve Holders (Lotus)	3	6	0
1 7-ohm B.B. Rheostat (Lissen)	1	6	0
1 H.F. Choke (R.L. Varley)	9	6	0
1 .0001 Reaction Condenser (Peto-Scott)	5	6	0
1 L.F. Transformer (G.F.C. 4:1)	1	0	0
1 Short-wave Coil (Wound)	7	6	0
1 Loading Coil (Burn-Jones)	7	6	0
1 Terminal Strip, 14" x 2"	1	9	0
9 Terminals (Belling-Lee)	3	4	0
20 ft. Glazite	1	8	0
Flex, Spade Tags, Clips, etc.	2	0	0
2 Valves as specified (Marconi)	1	3	0
<b>Total</b>	<b>£6</b>	<b>13</b>	<b>5</b>

## READY BUILT SETS.

COMPLETE.  
"RADIANO" FOUR Price £19 (inclusive of  
"NEW-WAY" TWO " £9 Royalties.)  
TRADE ENQUIRIES.

INLAND: ALL ORDERS POST FREE.  
OVERSEAS consignments carefully packed  
and insured.

## SOLVES EVERY RESISTANCE PROBLEM

# CLAROSTAT

Volume Control Type	8/6
Table-Type (distant control of volume and/or "tone")	13/6
Standard (20 watts), for Eliminators, etc.	10/6
Standard (stripped type)	9/-
Power Type (40 watts), for super-power eliminators	15/-
Power Type (stripped)	12/6
Duplex ClarOstat (two 20- watt ClarOstats in one)	13/6
Variable Grid-Leak Type 8/6 (1/10th to 10 megohms).	

Our unique 8-page "POWER" PAMPH-  
LET, together with a new 20-page booklet  
with numerous new and interesting  
circuits, sent on receipt of 3d. stamps  
to cover cost of mailing.

Order these at your Dealers.  
Where not yet represented we  
will be pleased to supply post  
free at the above list prices.

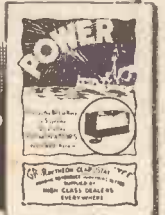

**CLAUDE LYONS LTD**  
76, OLDHALL ST.,  
LIVERPOOL.



# THE BATTERY THAT LASTS FOR YEARS!

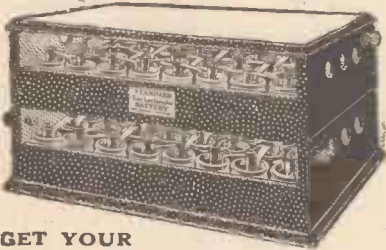

GET YOUR  
**"UNIBLOC" H.T. WET BATTERY FROM HALFORD'S CYCLE STORES on Cash or Deferred Terms**

ON top of the news that this wonderful battery could be had on special deferred terms, bringing permanent H.T. supply within the reach of all, a still further convenience comes to make the Standard Battery even more popular—HALFORD'S CYCLE STORES now stock and supply all types of the battery on cash or deferred terms. Simply go to your nearest branch, see the battery demonstrated, and secure on exactly the same terms as if you were dealing direct with us.

GET YOUR COPY OF THIS FREE BOOK! Send now for free booklet which explains in full all you want to know. The Standard Battery gives a smoother, steadier, non-sagging supply of current that ensures amazing purity of reception that is astonishing. This battery is a boon to all, it recharges itself while you sleep.

DEFERRED TERMS.  
 :: NO DEPOSIT. ::

96-volt Cabinet, complete with 64 No. 2 cells. Size 15 ins. x 8 ins. x 8 ins., assembled ready for use. Cash £2 6s. 5d., or 8/1 down and five monthly payments of 8/1.

**8/1**

DOWN

All radio dealers can supply on the same deferred terms as we do.

THE  
**STANDARD**  
 SAC BECLANCHE  
**WET BATTERY CO.**

(The Wet H.T. Battery Co.), Dept. W. Const.,  
 Head Offices, Showrooms and Warehouse:  
 184-188, Shaftesbury Ave. (nr. New Oxford St. end).  
 LONDON, W.C.2.

M.B. ■

**ALEXANDER BLACK,**  
 The Wireless Doctor,  
 will call and cure your set (London and Home Counties). A specialist in quality reproduction. Sets repaired and modernised.  
 2a, Woodville Grove, N.16. Sloane 5105. Cliffield 3657.

## DIX-ONEMETERS

are the Best Bargain ever offered to Radio users. £10 worth of precision, Multi-range Mirror scale, Jewelled knife-edge Instrument for **55/-**

NEW A.C. MODEL "One-meters." Ready Jan. 1st. Ask for A.C. Leaflet.

**ASTONISHING BARGAINS in our new catalogue**

72 pages, well illustrated and offering the greatest choice obtainable in radio products. Get a copy. Post Free 4d.

**ELECTRADIX RADIOS** 218 Upper Thames St., London, E.C.4



## AN ULTRA-SELECTIVE THREE

—continued from page 32

capacity aerial (whether the high capacity is due to great length or poor height),  $L_1$  should be kept as small as possible and  $L_2$  as large as possible. Generally speaking, however, the first combination quoted above will be found to cover the broadcast band very satisfactorily.

### "Perfectly Conventional"

If it should be desired to receive 5 X X and the other long-wave stations, a No. 150 coil should be used for  $L_2$ ,  $L_3$  consisting of 75 or 100 turns and  $L_1$  of 75 turns. It may be found that a No. 200 can be used for  $L_2$  in these circumstances. It should be borne in mind that the size of reaction coil necessary to make the set oscillate will be considerably smaller than usual on account of the absence of any great amount of damping effect from the aerial circuit.

Operation is perfectly conventional, and one has nothing to do but search on the dial of the tuning condenser and control reaction by means of a very slight movement of the small condenser  $C_2$ . If the set does not slide smoothly into oscillation when the latter control is manipulated, try another grid leak, or a slight variation in the filament voltage applied to the detector. The H.T. voltage on the latter valve will also have some effect.

### Results Obtained

With regard to results obtained, it is rather meaningless in these days to give a long list of stations received, but suffice it to say that well over a dozen of the Continental stations were tuned in on a perfectly normal evening in the space of twenty minutes—each one of these being held perfectly and identified either previously or later on. All these were received at sufficient strength to operate a loud speaker, while with the headphones in use innumerable stations were found between 200 and 450 metres, all apparently free from interference either by the local station at eight miles, or by others. 5 G B and Langenberg can, of course, be separated perfectly. For these tests the aerial in use was 75 ft. long and about 36 ft. high, but on a considerably lower aerial most of the same stations were found again "to order" on another night.

## THE HEAD OF A BELLING-LEE TERMINAL CANNOT COME OFF



Patent.

THE unique advantages of Belling-Lee insulated terminals are world famous, but probably the most important feature of these perfect terminals from the constructor's point of view is that the Head cannot come off. We all know the danger of exchanging heads of terminals, and Belling-Lee designers have successfully nullified this danger.

Fit Belling-Lee to your Receiver and relieve yourself of worry. These world-famous terminals are available at competitive prices, and are guaranteed to give absolute satisfaction.

### NEW REDUCED PRICES:

Type "B." Standard large insulated model. Polished black bakelite. 6d. each.

Type "M." As type "B" but with only the engraved top insulated. Rest nickel-plated brass. 4½d. each.

Type "R." Low-priced model with rotating name. 3d. each.

# BELLING-LEE TERMINALS

Belling & Lee, Ltd., Queensway Works, Ponders End, Middlesex.

# Here is a Panel that will not split or break or crack



and can be sawn, drilled or tapped with ease.

Resiston Panels, like Radion, are made from nothing but pure rubber. They are tough without being brittle. They can be sawn with ease, they can be drilled without fear of fracture, and when tapped will take a good thread.

With Resiston, the home constructor runs little risk of ruining his panel. Its strength, its perfect insulation, beauty of surface and colour permanence are lastingly assured.

*Send for new booklet.*

Please send me, free, a copy of your new booklet, "The Panel Makes all the Difference." "W.C." Nov.

NAME.....

ADDRESS.....



5787

American Hard Rubber Co., Ltd., 134, Foie St., E.C.2

## THE CONNOISSEUR'S CONE LOUD SPEAKER

*—continued from page 8*

The space between the pencil line and the periphery of the cone can now be coated with gum and allowed to get tacky. Leaving the cone for the moment, select a strip of the Suedlin and gently stretch it on its outside radius as shown in the sketch, so as to flatten it for sticking to the cardboard ring. The stretching makes the latter process much easier than it would otherwise be, though care must be taken not to disturb the inside radius. Three pieces of this leather can easily be treated in five minutes so that they are ready by the time the gum has set in a plastic state.

Pick out a piece of the leather strip with the rough side uppermost and gently press the opposite face on to the gummed portion of the cone, not beyond the pencil line. Another piece can then be applied allowing an overlap of about  $\frac{1}{8}$  in. between the pieces of leather. Do this for all the pieces and remove any surplus Suedlin with a pair of scissors, as three pieces will be found more than sufficient.

We now have a cone with an unbroken strip of leather stuck on to its periphery, and to complete this portion of the assembly the cone can be placed on a flat surface with the apex uppermost and the cardboard ring then stuck to the leather, leaving a ring of leather between the rim and the cone.

### Assembly

Gum the surface of the ring marked front, and when tacky apply the leather, taking care to get the cone central in the ring. If one has sufficient patience the cardboard ring can be so fixed in position that when screwed on to the aluminium framework the join on the cone diaphragm will be either to the top or the bottom of the unit. It is not important, as it has no bearing on quality or volume, but only on its appearance.

Do not pull the leather too tightly when on the ring, or the diaphragm will tend to resonate when working. The best tension is denoted by a slight bulge in the leather left between the cone and the cardboard ring. To complete the diaphragm remove the leather which covers the holes in the cardboard ring and then put it by ready for attaching to the framework.

It is understood that the Cromwell Engineering Co. can supply the aluminium framework ready fitted with a "Blue Spot" unit, in

which case the diaphragm can be fitted direct in the framework, after removing the aluminium ring. Should this not be the case, it will be found that the framework can be supplied complete with two supports for the reed movement, and it will only be necessary to purchase a "Blue Spot" unit separately and fix it to the supports provided, the rest being as above.

Two disc washers and four nuts are provided on the reed movement, and it is essential that these should be fitted at the extreme end of the screwed rod projecting from the movement with the apex of the cone diaphragm clamped between them.

### Testing The Unit

If we can assume the framework is already fitted with the reed unit on its two supports, then it will be necessary to remove the two nuts and top coned washer from the screwed rod on the latter to enable the diaphragm to be dropped into position. When the cone diaphragm is first in position its apex will be broken by a hole about  $\frac{1}{8}$  in. approximately in diameter, and the paper around the hole will be pressed into another shape by the two coned washers which are tightly clamped on the opposite surfaces by means of the nuts. This operation can either be done at the time of assembling the unit or before the diaphragm is permanently placed in position, the latter period probably making the actual construction easier.

Our unit will now be complete, and if possible it should be tested on a transmission before finally being placed in a cabinet or on a baffle. This test will consist of finding whether there is any pronounced rattle, especially on loud passages in the music, and if so a turn or two on the nuts holding the coned washers should effect some improvement. Should this adjustment effect no cure, then it will be advisable to obtain a small piece of rubber tubing of an internal bore equal to the screwed rod and pass it over the rod just below where the coned washers are fixed. The rubber sleeve is best used when all other means have failed, as its damping effect is often too effective, although the amount of absorbing it will do can be controlled by varying the length of the sleeve.

Finally, when everything is satisfactory, the complete unit can be attached to its wooden baffle by removing two of the metal screws in the aluminium ring (one at the top and one at the bottom), and replacing them with roundheaded wood-screws.

**"RADIO" FOUR—Model B**

—continued from page 14

have a different degree of selectivity for the long waves from that used on the short. This is a great advantage in certain local conditions. For example, a listener may find that on the lower wave-band his nearest local station is far enough away to prevent any serious interference with stations on wave-lengths near to this, while on the long waves he may find that Radio-Paris and 5 X X tend to interfere with one another. In such a case he can use the .0003-mfd. fixed condenser and the higher tap for lower wave-band, and on the upper wave-band the lower tap on the "X" coil, thus giving much sharper selectivity on the long waves.

**Control of Selectivity**

Selectivity, of course, is also controlled to a considerable extent by the manipulation of the reaction condenser, and experience with this will show how to separate stations which would normally be very difficult. For example, so far as selectivity is concerned, it is better to have sharper aerial tuning and the use of some reaction rather than flatter aerial tuning with increased strength and no reaction. On the other hand, where very sharp selectivity is not desired, slightly better quality will be obtained by using the longer aerial coupling and less reaction.

Altogether, the manipulation of the "Radiano" Four, while extremely simple, is such that the skilled user will find it has a very fascinating flexibility.

**An Important Point**

When the "Radiano" Four is used with the Harris "Stedipower" L.T. Unit the user should bear in mind that the volume control which dims the filament of the high-frequency valve will have a slight effect on the voltage applied to the other valves. Thus if all four valves are alight, and the maximum voltage being given by the "Stedipower" Unit, say two volts, the turning of the volume control towards its minimum position will reduce the current consumption, and therefore the voltage will rise slightly, although generally the increase of voltage will not be sufficient to do any harm to the valves. However, it is just as well to watch the voltmeter on the "Stedipower" when any use is made of this volume control.

# DARIO VALVES

*"No Radio without Dario"*

Radio Micro's New and Astounding  
1929 Dark Emitter Valves.

**LOWER  
PRICES  
THAN  
EVER**



## DARIO SUPER POWER

**HIGHEST QUALITY — PERFECT  
FINISH — LOWEST PRICES**

ALL BECAUSE Dario Valves are the products of the biggest valve organisation in the world to-day. The huge Dario output enables prices to be kept down to the lowest possible, and vast research keeps Dario design and finish ahead at all times.

2	v General Purpose, .05 amp. 5/6
	o R.C.C., .06 amp. - - - 5/6
	t Super-Power, .18 amp. - 7/6

4	v General Purpose, .05 amp. 5/6
	o R.C.C., .07 amp. - - - 5/6
	t Super-Power, .1 amp. - 7/6

From your dealer, or direct:—

**IMPEX ELECTRICAL, LTD., 538, HIGH ROAD, LONDON, E.11.**

**MY IDEAL WORKSHOP**

—continued from page 72

from a length of 1 in. by 12 in. prepared timber, obtainable from any yard.

A couple of 1/2-in. blocks, one at either end of the bench, serve to support a light rail, behind which stand pliers, calipers, and any other tools which the rack cannot accommodate. The bench contains two drawers, simply and inexpensively made from soap boxes and lengths of batten, sliding on runners constructed of the same material, and each furnished with a drawer handle supplied by the local ironmonger.

**Avoid Confusion**

Inside each drawer is a collection of small cardboard boxes and glass jars, containing the usual assortment of screws, nuts, terminals, and small brass parts, each neatly labelled to avoid confusion when in a tearing hurry; one or two airtight tins conceal well-greased-drills, taps, and dies, whose various sizes are plainly marked on tickets gummed to the lid. Spare components are also kept in these drawers, and are carefully wrapped in paper to keep them clean and free from dust, which is of great importance where variable condensers are concerned, as dust settling on the plates, and bearings is apt to cause a great deal of trouble in the way of crackles and so forth.

A gas ring occupies the space to the right of the green baize square, and next to this is a rest for the iron flux, and solder, which takes the form of one of the asbestos tiles which are used so much nowadays for roofing. This is fixed by means of four small nails at about an inch from each corner, as these tiles are rather brittle, and if nailed too close to the edge are likely to crack.

On the right-hand edge of the bench is mounted a small emery wheel, which is obtainable from any large ironmongers for six shillings, and is an invaluable adjunct to the workshop; the utility of such a tool is beyond question, and it is, in its way, as essential as the vice which is at the opposite end of the bench.

To the right of the vice are screwed two pieces of batten which hold a panel while being drilled or matted. They are, naturally, at right angles, and this is simply verified by means of an ordinary carpenter's square, which shares the space at the back of the rail.

Another feature of the bench fittings is a gadget which converts an ordinary wheel-brace into one of the fixed or bench-mounting type. This is another useful fixture whose construction should present no particular difficulty; two iron uprights, consisting of nine or ten inches of 3/4 in. by 1/2 in. iron or mild steel, having 1 in. bent at right-angles to the main portion for screwing to the bench, are drilled to take an arm of the same material 1 ft. in length.

**Scrap Material**

This arm is arranged so that it is fairly well balanced, and is provided with a clamp at the outer end to take the handle of the wheel-brace, and a spring sufficiently strong to lift the brace off the work. A piece of hardwood with a 1/2-in. hole drilled in the centre is fitted underneath in such a manner that the drill enters the hole when the handle is depressed.

The last item of note is a shelf above the bench, on which reposes all the large scrap material, such as baseboards, old panels, and so forth, which are too large to be accommodated in the scrap-box which stands underneath the bench.

\*\*\*\*\*  
\* **TWO USEFUL HINTS.** \*  
\* **A NOISE STOPPER AND** \*  
\* **A MAKESHIFT DRILL.** \*  
\*\*\*\*\*

**A Noise Stopper**

As a rule it is usual to employ a variable condenser on the short waves for controlling reaction. It is impossible to keep such a condenser completely free from dust, and any small particles which become lodged between the two sets of plates will cause a crackle and scraping noise as the condenser spindle is turned.

This trouble may be removed by inserting a fixed condenser in series with the variable one. The value of this fixed condenser may be in the neighbourhood of .001, although a much smaller one can be employed if the variable reaction condenser is found to be too large. Incidentally such a condenser acts as a safeguard for the valves in the event of the variable condenser becoming shorted, in which case it is possible for valves to be burnt out. As a matter of fact it is desirable to insert a series condenser for the above reason even on sets intended for reception on the higher waves.

**A Makeshift Drill**

It sometimes occurs that a small hole is required in an ebonite panel and no drill is available. An ordinary bradawl will make a very good substitute, and it is surprising how quickly it bores a hole.

The method of using is to rotate the tool backwards and forwards through about half a turn, pressure being applied to the handle. It is advisable to occasionally lift the point out of the hole and place it back in a different position so as to ensure that a really circular hole is made.

**INDEX TO ADVERTISERS**

	PAGE
American Hard Rubber Co., Ltd.	82
Ateralt Co.	79
Bedford Electrical & Radio Co., Ltd.	69
Benjamin Electric, Ltd.	71
Belling & Lee, Ltd.	81
Bird, Sydney S., & Sons, Ltd.	73
Black, Alexander	81
Bond, V. C., & Sons	77
British General Mfg. Co., Ltd.	69
British Thomson-Houston Co., Ltd.	39, 60 & 68
Brown, S. G., Ltd.	56
Burne-Jones & Co., Ltd.	64
Carrington Manfg. Co., Ltd.	73
Cason Mouldings	73
Celestion Radio Co.	74
Clarke, H., & Co. (Mfr.), Ltd.	70
Cossor, A. C., Ltd.	4
Day, Will, Ltd.	70
Dubilier Condenser Co. (1925), Ltd.	71
Eastek, J. J., & Sons	78
Edison Swan Electric Co., Ltd.	51
Electradix Radios	81

	PAGE
Ferranti, Limited	67
Fornio Company, The	48
Gambrell Radio, Ltd.	79
Gilbert, J. C. (Cabinets)	67
Goodman's	80
Garnett, Whiteley & Co., Ltd.	55
Graham Farist.	67
Holzman, Louis	60
Hughes, F. A., & Co., Ltd.	52
Igranic Electric Co., Ltd.	69
Impex Electrical, Ltd.	83
International Corres. Schools, Ltd.	73
Jackson Bros.	59
K.N. Electrical Products, Ltd.	60
Lectro Lnx, Ltd.	44
Lissen, Ltd.	35
London Elec. Wire Co. & Smiths, Ltd.	40
Lisenlu Wireless Co.	65
London Radio Mfg. Co., Ltd.	73
Lyons, Claude, Ltd.	80
Makerimport Co.	77
Marconiophone Co., Ltd.	1
Metro-Vlek Supplies, Ltd.	Cover iii
Morris, J. R.	76
Mullard Wireless Service Co., Ltd.	Cover ii
"Modern Wireless"	56
Ormond Engineering Co., Ltd.	63

	PAGE
Peto-Scott Co., Ltd.	66
Philips Lamps, Ltd.	47
Pickett's Cabinet Works	80
P.D.P. Co.	79
"Popular Wireless"	75
Raymond, K.	77
Ready Radio Supply Co.	80
R.I. & Varley, Ltd.	Cover iv
Ripaults, Ltd.	48
Rothermel Corpn., Ltd.	2, 3, 65
Sifam Electrical Inst. Co., Ltd.	77
Standard Wet-Battery Co.	81
Six-Sixty Radio Company	43
Taylor, C.	80
Telegraph Condenser Co., Ltd.	44
Transformer Repair Co.	80
Weston Electrical Instrument Co., Ltd.	65
Westinghouse Brake (etc.), Ltd.	72
Whiteley, Bonham & Co., Ltd.	79
Wireless Constructor Envelopes	52

All communications concerning advertising in "Wireless Constructor" must be made to John H. Lile, Ltd., 4, Ludgate Circus, London, E.C.4. Telephone: City 7261.

# An Elastic Aerial

**C**AN you imagine what it would mean to your Wireless reception if you had an aerial that you could stretch out from nothing to its full length or vice versa?

Even Elastic will not do that, but the new Met-Vick Elastic Aerial Unit will, *in effect*, enable you to vary your aerial backwards and forwards to any desired length, from your maximum length to zero, or zero to your maximum.

It is as though you had a thousand aerials, from the very shortest to the longest your situation allows; as if you had, whenever you wanted, the exact length of aerial to give the utmost selectivity combined with signal strength for any particular station you are trying to get.

With the new E.A. Unit, you can erect the biggest aerial, and still bring your set into its most sensitive condition for the reception of distant or difficult stations, without the "Local" or loudest station overpowering everything. It makes the most perfect volume control imaginable.

Simple and inexpensive, this device, which will add so greatly to the pleasure of thousands of Valve-Set users, is now available at all good radio dealers.

It sells for 12/6—14/-, according to the style of mounting.

## MET-VICK



E.A. Unit Table Mounting  
Price 14/-  
with series condenser.

Mains operated 3, 4, and 5 Valve Sets A.C. and D.C. Eliminators. New and interesting components. The whole range of Cosmos Valves, including the wonderful A.C. Valves with indirectly heated cathodes, rectifying valves, etc.

### METRO-VICK SUPPLIES LTD.

(Proprietors: Metropolitan-Vickers Electrical Co. Ltd.)

155, Charing Cross Road,  
LONDON, W.C.2.

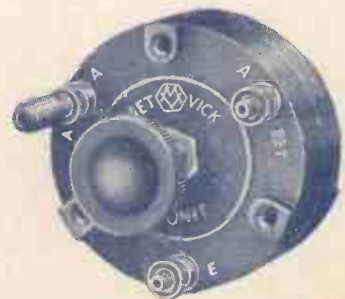

E.A. Unit Table Mounting  
Price 12/6  
without series condenser

# Do you know all the new products we have this Season?

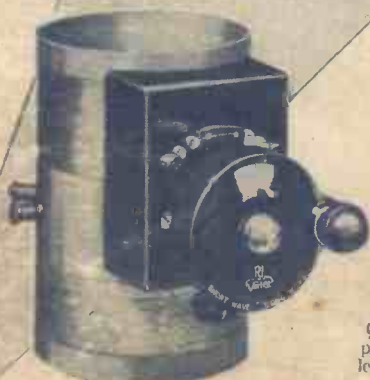

The new **APERIODIC TUNER** for both medium and long waves, 2d.

Last year R.I. & Varley was singled out as "the firm with all the new products." To be exact, we had 18 new lines—this year we have more than 30. This will give you some idea of the progress we have made, particularly when you realise that each of these is a real engineering job, embodying the most up-to-date advances in radio science, and possessing that degree of **QUALITY** for which R.I. & Varley products are famous throughout the length and breadth of the country.

Whether it be components, sets, gramophone electrical reproduction apparatus, complete eliminators, or eliminator components, R.I. & Varley make them all. Which of these are you interested in? Write to us and we will send you that section of our new Catalogue dealing with those particular products.

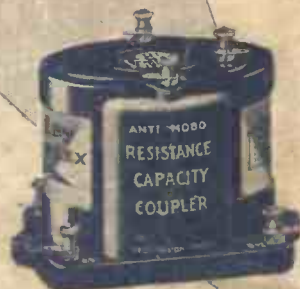

Anti-mobo Resistance Capacity Coupler.  
Type Z ... 25/-  
Type Y ... 25/-  
Type X ... 25/-



Gramophone Pick-up, £3 3/0.



Universal Power Transformer (for A.C. Valves, also Rectifying Valves), £2/7/6.



Bi-duplex L.F. Intervalve Transformer, 27/6.



L.F. Chokes.  
28/14 Henries, £1/1/0.  
14/7 Henries, £1/1/0.



THE MARK OF

AND  
**Varley**  
LTD.

BETTER RADIO

Kingsway House, 103, Kingsway, London, W.C.2.

Telephone: Holborn 5303.