

The **Wireless** **Constructor**

6^D
MONTHLY

EDITED BY
PERCY W. HARRIS, M.I.R.E.
VOL. VI. OCTOBER, 1928. No. 24.

SPECIAL EXHIBITION NUMBER



IN THIS ISSUE
THE "RADIANO" FOUR



Mullard

THE · MASTER · VALVE

CONTENTS

	Page		Page
Editor's Chat	359	Radiogramophonic:	396
This Year At Olympia	361	Within the Vacuum	399
A "Stedipower" Development	371	Why Not Read Morse	403
Make Your Choice at the Wireless Exhibition	372	Baird's Television Apparatus	407
The "Radiano" Wiring System	376	Happenings at Savoy Hill	411
The "Radiano" Four	377	Comments From Constructors	415
Building the "Radiano" Four	381	What's New	419
Telephotography and Television	387	In Lighter Vein	423
The Super-Regenerator on Short Waves	389	Queer Queries	427
		Our News Bulletin	428

As some of the arrangements and specialties described in this Journal may be the subject of Letters Patent, the amateur and trader would be well advised to obtain permission of the patentee to use the patents before doing so.

EDITED BY

PERCY W. HARRIS, M.I.R.E.

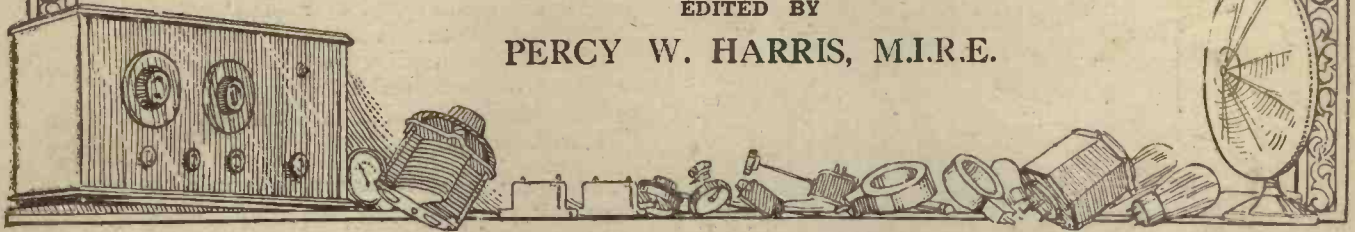

MARCONI VALVES

Advance Details for 1928-1929.

Most valves of the present Marconi range will remain standard, but owing to certain developments the characteristics have been improved as shown in the table on right:—

New Types of MARCONI VALVES Which will be introduced during next Season.

Type	Description	Fil. Volts	Fil. Amps.	Anode Volts	Imp.	Mag.	Price
P. 225	4r. Super Power Valve	4.0	0.25	150	2,300	4.5	15/-
P. 25A	6v. Super Power Valve	6.0	0.25	180	1,600	3.7	15/-
P. 25	"	6.0	0.25	250	2,400	6.0	15/-
HL 610	General Purpose 6v. Valve	6.0	0.1	150	30,000	30	10/6
H. 0.8	A.C. Directly Heated Cathode Valve for Res. Cap. Coupling or H.F.	0.8	0.8	150	35,000	40	15/-
HL 0.8	A.C. Directly Heated Cathode Valve, General Purpose	0.8	0.8	150	17,000	17	15/-
P. 0.8	A.C. Directly Heated Cathode Valve for L.F.	0.8	0.8	150	6,000	6.0	17/3
S. 0.8	A.C. Directly Heated Cathode Valve with Screened Grid	0.8	0.8	150	300,000	100	25/-
S. 215	Valve, Screened Grid	2.0	0.15	150	300,000	170	22/6
P.T. 225	Pentode Valve	2.0	0.35	150	53,000	90	25/-

Type	Fil. Volts	Fil. Amps.	Anode Volts	Impedance	Amplifn. Factor	Price
General Purpose Valves						
DEL 210	2.0	0.1	150	12,000	11	10/7
HL 210	2.0	0.1	150	25,000	21	10/6
DEL 410	4.0	0.1	150	8,300	15	10/6
DEL 610	6.0	0.1	150	7,500	15	10/6
Resistance Capacity Coupling and High Frequency Amplifying and Rectifying Valves						
DEH 210	2.0	0.1	150	50,000	25	10/6
DEH 410	4.0	0.1	150	50,000	43	10/6
LS 5B	4.25-5.25	0.8	400	25,000	20	25/-
DEH 610	6.0	0.1	150	60,000	40	10/6
DE 5B	5.6	0.25	150	20,000	20	12/6
Power Amplifying Valves						
DEP 215	2.0	0.15	150	5,000	7	12/0
DEP 240	2.0	0.4	150	2,300	4	15/-
DEP 410	4.0	0.1	150	5,000	7.5	12/6
LS 5	4.25-5.25	0.8	400	6,000	5	25/-
LS 5A	4.25-5.25	0.8	400	2,750	2.5	25/-
DE 5	5.6	0.25	140	7,000	7	12/6
DE 5A	5.6	0.25	150	4,000	3.5	15/-
DEP 610	6.0	0.1	150	7,500	8	12/6
Screened Grid Valve						
S 655	6.0	0.25	180	175,000	110	127/8
Indirectly Heated Cathode Valves						
KL 1	3.3	2.0	150	3,750	7.5	11/6
KH 1	3.3	2.0	150	25,000	40	16/-

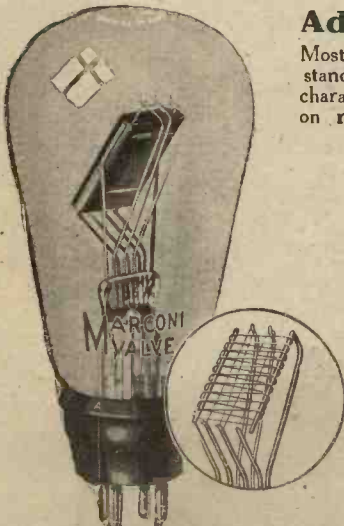

THE MARCONIPHONE CO., LTD., 210-212, Tottenham Court Road, W.1.

in itself! NEW B.T.H. PRODUCTS

Below are given the titles of the new apparatus. Make a point of seeing and asking about these wonderful instruments.

1. Bijou Crystal Receiver.
2. Two Stage Receiver.
3. Three Stage Receiver.
4. Four Stage Receiver.
5. Five Stage De Luxe Receiver.
6. Portable Receiver.
7. Cone Loud Speaker.
8. R.K. Moving-Coil Loud Speaker Unit.
9. Junior R.K. Loud Speaker (A.C. & D.C. models).
10. Senior R.K. Loud Speaker.
11. 5 m.a. H.T. Battery Eliminator.
12. 10 m.a. H.T. Battery Eliminator.
13. R.K. H.T. Battery Eliminator (A.C. & D.C. models).
14. Pick-up Amplifier, Scratch Filter & Volume Control
15. R.K. Amplifier (without R.K. unit.)
16. Pick-up and Tone Arm.
17. Constructor's Kit.
18. Two Stage Unit.
19. Variable Condensers
20. Flexible Aerial Unit.
21. Trickle Charger.
22. Two Stage Valve.
23. Screen Grid Valve.

The Complete Range of MAZDA NICKEL FILAMENT VALVES

Type	Max. H.T.volts	Ampl. Factor	Imp. (ohms)	Slope
TWO VOLTS				
G.P. 210	120	13	14,000	0.90
H.F. 210	150	20	28,000	0.70
R.C. 210	150	40	86,000	0.47
L.F. 215	120	7	7,000	1.00
P. 227	120	4	2,900	1.40
FOUR VOLTS				
G.P. 407	120	14	14,000	1.00
H.F. 407	150	18	21,000	0.85
R.C. 407	150	40	107,000	0.43
L.F. 407	120	8	5,700	1.40
P. 415	120	5.5	2,900	1.90
SIX VOLTS				
G.P. 607	120	14	12,500	1.10
H.F. 607	150	20	20,000	1.00
R.C. 607	150	40	90,000	0.45
L.F. 607	120	9	5,300	1.70
P. 615	120	6	2,600	2.30
P.X. 650	200	3.5	1,750	2.00

The prefix letters indicate the purpose of a valve, and the figures which follow, the filament volts and amperes. For example:—L.F. 215 represents a 2-volt low frequency amplifying valve taking 0.15 ampere.





Quality Tells!

MANY manufacturers of the finest receiving sets and eliminators use Electrad Resistance Controls. Scores of radio engineers and technicians specify them exclusively. Only controls of perfected designs, proven performance and dependability could enjoy such universal endorsement.

Electrad specializes in a full line of resistance controls for all radio purposes. Dealers everywhere sell them.

Truvolt All-Wire Resistances

The unique, air-cooled construction of Truvolts makes for unusual accuracy and permits the carrying of heavy current loads with a high factor of safety.

Truvolt Variables simplify H.T. Eliminator construction by eliminating difficult calculation and making all adjustments easy. Twenty-two stock types. **15/6 each.**

Truvolt Fixed resistors are adjustable to different set values by the use of sliding clip taps—an exclusive Truvolt feature! Made in all desirable resistance values and circuit ratings.

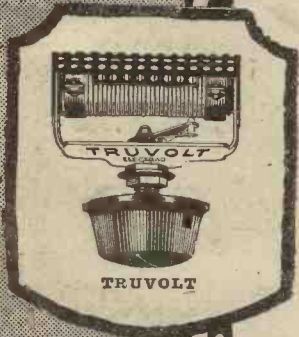

TRUVOLT

Royalty Variable High Resistances

Here is a Variable High Resistance that is entirely free from harmful inductance and capacity effects. It is widely recommended wherever a unit of this type is required in the circuit. Eleven types covering a range for every purpose. **8/- each.** Potentiometers **9/- each.**



ROYALTY VARIABLE RESISTANCES

TONATROL

Perfect control of volume to adapt your reception to the occasion and individual taste is necessary for the full enjoyment of your radio. Tonatrol Volume Controls are designed in types to meet the specific needs of all circuits—A.C. or conventional battery type. Furnished in standard types or with filament switch or power switch attached. **8/- to 15/6 each.**

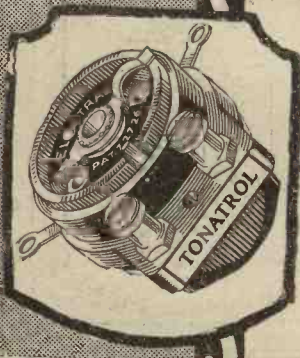

Please send me descriptive folder on all Electrad products and put me on your mailing list for similar literature.

I am particularly interested in

Name

Address

Represented by The
ROTHERMEL CORPORATION, LTD.,
 24-26, Maddox Street, London, W.1.

Phone: Mayfair 0578-9, 4286. Telegram: Rothermel, Wcsdo, London.

ELECTRAD

Inc

Leadership!

Radio's first Loudspeaker —still the finest

The moving coil type of loud-speaker was created by Magnavox in 1911. It is the only type of speaker that has stood through every period of speaker development. Supreme in the beginning—supreme to-day. Protected and controlled by Magnavox exclusive patents. There are nearly half-a-million Magnavox Dynamic Speakers now in use.

Realism—

You can hear the bowing of the strings of the double bass and the beats of the drum in their true tone-colour with a MAGNAVOX MOVING COIL LOUD-SPEAKER UNIT.

There are no jarring resonances, no "s" sounds missing, and the violin does not sound like a flute.

The unit is complete with input transformer, leads and field switch, ready for connecting right away to receiver or gramophone amplifier.

Models for A.C. or D.C.

TYPE D.80/1.	For operation from A.C. lighting mains, 100/120 volt, 50/60 cycle, A.C.	£11 11 0
TYPE D.80/2.	For operation from A.C. lighting mains, 200/240 volt, 50/60 cycle, A.C.	£11 11 0
TYPE R.5.	For operation from D.C. lighting mains, 100/240 volt D.C.	£10 10 0
TYPE R.4.	For operation from 6-volt accumulator or Trickle Charger. Consumption $\frac{1}{2}$ amp.	£9 10 0
TYPE M.7K.	Balanced armature unit	£3 2 6
New Belvedere	Fire Screen Baffle	£4 0 0

"THE GREAT VOICE"

"The Great Voice" is a 32-page booklet, profusely illustrated and written entirely in your interests with a view to enabling you to obtain those better results for which you have persistently longed. This booklet tells you all about moving-coil speakers, baffles, power amplifiers for A.C. or D.C. volume controls and gramophone pick-ups. Send for your copy to-day. Price 6d., post free.

THE
ROTHERMEL CORPORATION, LTD.,
24-26, Maddox Street, W.1.

*Phone : Mayfair 0578-9, 4286.

Telegrams : "Rothermel." Wesdo, London.

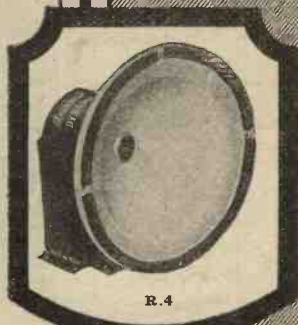

R.4



D.80



M.7K

MAGNAVOX

SEND FOR THIS FREE BOOK



and get the best out of your "Melody Maker"

If you own a Cossor "Melody Maker" you need this 48 page Book. From cover to cover it is packed full of invaluable and interesting information. Even if you don't own a Cossor "Melody Maker" you will find this Cossor Publication exceedingly useful for the information and instructions it contains can also be applied to any type of Receiver. It is fully illustrated—it tells you how to bring in those distant stations with ease and certainty—how to get greater volume—how to look after your accumulators and batteries—it is chock full of hints and tips that will enable you to improve your reception enormously.

No matter whether you own a "Melody Maker" or not—send for your copy to-day—it's free.

FILL IN THIS COUPON NOW!

To A. C. Cossor Ltd. Highbury Grove London N.5
Please send me free of charge a copy of your 48 page book
"How to get the best from your Melody Maker."
Name.....
Address.....
W.O. Oct.

COSSOR

The Valves that improve any Receiver

Advt. A. C. Cossor Ltd., Highbury Grove, London, N.5.

CA 5504

The WIRELESS CONSTRUCTOR

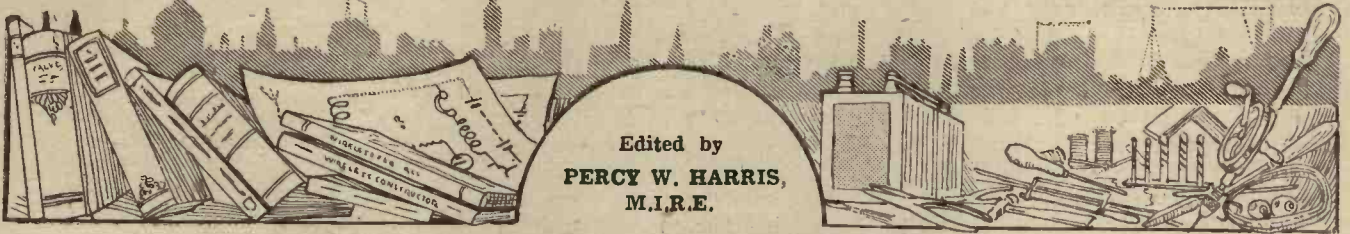

Published by the Amalgamated Press, Fleetway House, Farringdon Street, E.C.4.

THE EDITOR'S CHAT

In which Mr. Percy W. Harris, M.I.R.E., discusses the prospects of a record Wireless Exhibition attendance, and also the receivers which are described in this issue.

IF I can read the signs correctly, the National Radio Exhibition at Olympia this year will draw record attendances, which will be fully justified by interest of the exhibits. Radio has now passed beyond the scientific curiosity stage, freak receivers are becoming things of the past and the ever-insistent demand for quality is being excellently met on every side. Simplicity of control, high quality of reproduction, and a pleasing appearance, together with reasonable cost, are the features which the public ask to be provided, and it will be most interesting to see how far the manufacturers have progressed towards this ideal.

A Helpful Feature

Several new loud speakers are to be shown, and at last the public itself will have an opportunity of judging the much boomed subject of television. A big all-round improvement in the quality of components for the home constructor will be found, and in many directions the enthusiast will find so many good things that he will be embarrassed in making a choice.

Visits to any exhibition without a definite aim are apt to result in confusions of ideas, so that with the object of providing not only a helpful guide but an interesting series of notes for consideration at home, we are publishing in this issue four large circuit diagrams of well-tested circuits, and on opposite pages the names of the components without any indications of makers, leaving three columns for first, second and third choices.

If now the reader takes this issue with him to the Wireless Exhibition, he can pick a circuit to suit his general needs and jot down in the spaces provided his opinion of the best components for the particular purpose. By carefully examining the various exhibits he can build up in his own mind what he considers the best modern interpretation of that

circuit, with a second and third choice if need be.

In this way he will carry home with him not a confused idea of the exhibition, but certain definite opinions on which are the best components to make a good all-round set. It is not intended that he should necessarily build any one of these circuits, the idea being rather that

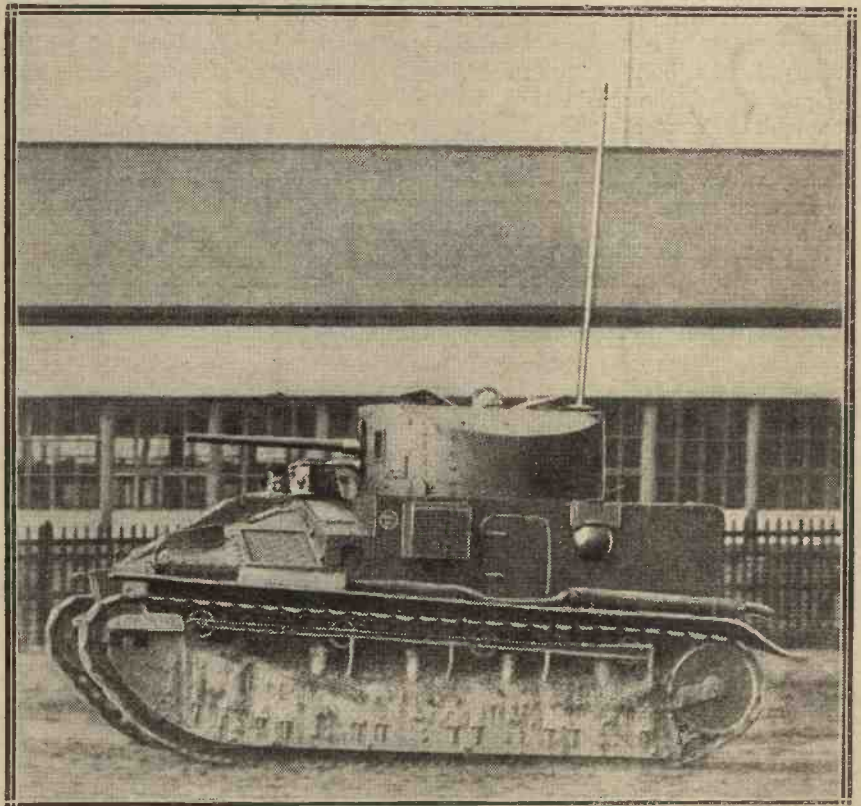

One of the experimental tanks having short-wave transmitters on board undergoing tests at the Woolwich experimental station. The steel mast is the only aerial used, no wires being employed.

Readers' Results

To America and Back Again!—Improving the Single-Valver—
The "Straight-Line" Four.

To America and Back Again!

SIR,—It may be of interest to you and readers of your valuable book, the WIRELESS CONSTRUCTOR, to hear the results I am getting with the "Short-Wave Threa." I built the "Radiano Short-Wave Two," and was so delighted with it that I have converted it into the "S.W.3." Up to the present I have had 2 X A F, 2 X A D, K D K A (62 m. and 26 m.), P C J J, two German experimental stations on 43 m. and 39 m., Radio L L, and Radio Vitus, all on loud speaker; about 70 British, 10 French, and 8 Belgian amateurs on 'phones.

Last night, however, provided the best treat I have had on short waves. I heard 2 X A F re-broadcast 5 S W (Chelmsford) for 20 minutes.

Fading was quite absent on 32 m., but was fairly bad on 24 m. However, I heard every word of the announcements from the Savoy Hotel after it had crossed the Atlantic in both directions (covering about 6,600 miles).

The American announcer seemed very pleased at the success of the experiment, but he was not half so pleased as I was; for the strength of 2 X A F was so great that his programme could be comfortably followed in the next room with the connecting door closed.

Thanking you for the many fine articles which have appeared in the CONSTRUCTOR, of which I have been a constant reader since No. 1.

I remain, yours faithfully,
BERNARD E. GILLETT.

Harborne, Birmingham.

"Improving the Single-Valver"

SIR,—In the February issue of the CONSTRUCTOR, Mr. L. H. Thomas described a set under the heading of "Improving the Single-Valver." Having a Collinson split-primary transformer lying idle, I hooked-up the circuit, using two Ormond S.L.F.'s as specified, and a Cosmos choke. The valve holders are not anti-microphonic, but with the addition of a Formo 5-1 shrouded transformer I get excellent loud-speaker results on London and 5 G B, fair from Dublin, Stuttgart, Frankfurt, Hamburg, Toulouse, Langenberg, and numerous others on the 'phones, including Cardiff, Bournemouth, and Edinburgh.

As I am a keen short-wavite, I made a six-pin former, using a Becol 3-in. former with three turns prim., four turns sec., and four turns react.; 0005 across sec.

I have received 5 S W, 2 X A F, 2 X A D, and K D K A on 60 m., and also on 26 m. (approx.), 2 N M and 2 M E (Melbourne). Of course, there are many amateurs using Morse.

The Australian station was heard last Sunday, but the others are regular fish. Last evening I had both stations of K D K A and 2 X A D, the latter strong enough to be heard on the speaker.

The detector valve was a Mullard P.M.3, 54 volts H.T.

Wishing the CONSTRUCTOR and Mr. Thomas continued success.

Yours truly,
F. C. SMITH.

Tooting, S.W.17.

P.S.—I might mention that I have not missed an issue of the CONSTRUCTOR since the first number, or of "Modern Wireless" since the "Elstree Six"; and also have all numbers of "Popular Wireless" for the past two and a half years.

The "Straight-Line" Four

SIR,—Congratulations on this receiver. I made this up, and have got wonderful results. Its purity and volume on foreign stations is remarkable. I tuned-in fifteen stations at full loud-speaker strength the first evening, and on Sunday morning got three stations all at Daventry strength.

Milan came in as loud as 5 X X; every word was distinct. (I understand Italian and French.)

Aerial, 100 ft. from receiver, top end 40 ft. high.

There was a four weeks' wait to get the necessary components and Leadex wire unattainable, but I used 18-gauge lead-covered wire. Another point:—Is it really necessary to bond all the lead covering and stop up any holes in boxes free or where the lead wires enter?*

In my opinion, this is the best set you have ever designed, and renders obsolete all neutralising schemes.

Wishing you every success.

Yours truly,
R. NOBILE.

Swindon,
Wilts.

P.S.—What about a short-wave screened-grid set?

[* Not absolutely necessary except when using a frame aerial.

—EDITOR]

THE EDITOR'S CHAT

—continued from page 359

when he does decide to build a set he can consult his notes, which will remind him that so-and-so's variable condenser looks extremely well on the front of the panel, while the small space occupied by the "this-and-that" model makes it particularly suitable in a compact design. Members of wireless societies will find that a very interesting evening can be spent in comparing their respective notes and, in fact, competitions can easily be arranged on these lines.

The "Radiano" Four, which makes its first appearance in this issue, is presented to the wireless public with full confidence that it will meet their requirements as a good all-round and easily-built four-valver. The extreme simplicity of building a "Radiano" set has been further improved by the introduction of the new "Radiano" wiring system, while the novel wave-change arrangement, using the standard plug-in coils, makes it unnecessary to lift the lid, and adds very considerably to the flexibility of the receiver.

Readers' Views Requested

Another useful and very practical set with an automatic wave-change

scheme, obviating the changing of coils, will be described by Mr. G. P. Kelsey next month, while the short-wave enthusiast will find Mr. Thomas's promised article on the super-generator on short waves a most fascinating contribution.

May we take this opportunity of asking readers who visit the Wireless Exhibition to let us have their views upon it, particularly regarding which features appeal to them most, what they think could be improved in future exhibitions, and what they missed or felt disappointed in not seeing. A selection from the correspondence will then be published in a future issue.

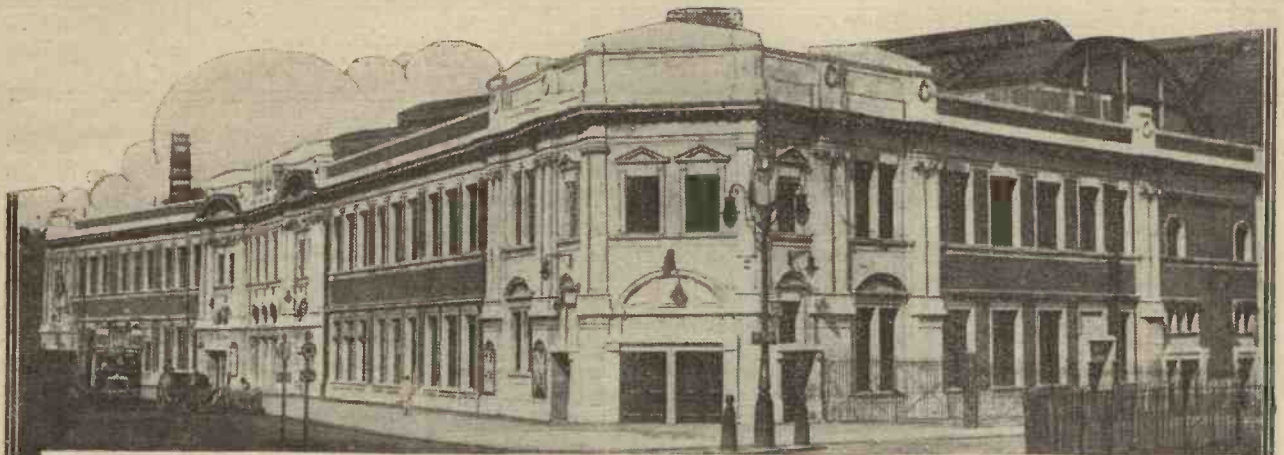

THIS YEAR AT OLYMPIA

A summary of the main exhibits to be seen at the Wireless Exhibition, commencing September 22nd.

Atalanta, Ltd. Stand No. 271.

Being specialists in small precision tools, screwdrivers, etc., this firm will be showing several tools and gadgets particularly designed for wireless assembly and adjustment. A special line of box spanners and screwdrivers will be shown, and, in addition, there is the "Atalanta"

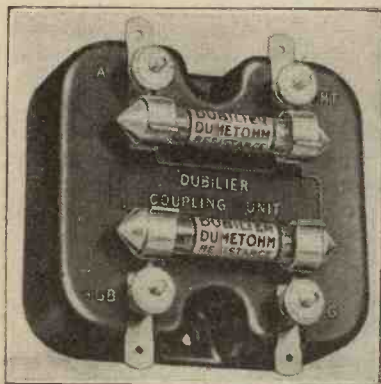

The Dubilier "R.C.C." unit is fitted with detachable resistances.

constructor's set of tools. This very handy outfit comprises two screwdrivers, three box spanners for 2, 4, and 6 B.A. nuts, one soldering iron and flux, one small hammer, three files, two pairs of pliers, scriber, and centre-punch. The complete set, together with the rack for mounting, costs 12s. 6d.

A. Baker, Ltd. Stand No. 172.

This firm is showing a variety of moving-coil speaker units, selling from £3 10s. upwards. Readers of the WIRELESS CONSTRUCTOR who are interested and are in search of good quality should certainly pay a visit to this stand.

Belling & Lee, Ltd. Stands Nos. 220 and 221.

Here will be found in profusion the indicating terminals which have made this firm so famous. In order to meet the requirements of the latest developments in radio, terminals are now made with new indications, such as "Pick-up," "Field," "Mains +," "Mains -," etc.

Constructors who in the past have coveted such terminals, but thought them too high in price, will be delighted with the sweeping price reductions which have been made; the large 9d. terminals being now only 6d., the 6d. being reduced to 4½d., while those formerly issued at 3½d. are now 3d. only.

Be sure to visit the
WIRELESS CONSTRUCTOR

Our Stands are Nos. 135 & 166,

and technical experts will be in attendance to talk over matters of radio interest with our readers.

George Bowerman, Ltd. Stand No. 213.

An amazingly efficient and cheap little cone unit is the chief attraction on this stand, all built with parts which cannot possibly come loose as is often found with other types of cone unit, and this little accessory should find a very ready sale. A companion also will be found on the stand in the form of an All-British headphone, to be sold at 12s. 6d. per pair. Each pair is guaranteed and is extremely light to wear and comfortable, while the magnets are of the finest copper steel.

Brandes, Ltd. Stand No. 118.

Matched-tone headphones, loud speakers, three- and four-valve sets, transformers, condensers, accumulators and high-tension batteries form the main exhibits on this stand. A special hire-purchase scheme run by this firm enables any of the products to the value of five pounds or over to be purchased out of income. Early next season the firm will be adding to the range.

British Ebonite Co., Ltd. Stand No. 38.

Here is a display of ebonite which will not only delight the prospective constructor, but would please any goldarn nigger by the sheer black beauty of it! Panels of all sizes and

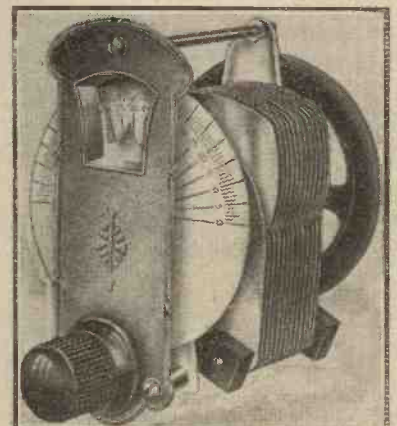

The Lamplugh "Epicyclic Visor" condenser, which is made of aluminium with specially shaped plates.

shapes, good to look at and guaranteed, are here in large variety. For the man who makes his own coils there are the "Becol" low-loss

This Year at Olympia—continued

formers—a large range of sizes, too! It is interesting to note that No. 5 is the original former which was incorporated in the set which took the gold medal at the Antwerp Exhibition. Another Becol line of special merit is the 4s. 6d. contact-former and base, made in such a way that it is impossible to make a false connection, when once the coils have been wound.

Brown Bros., Ltd. Stands Nos. 177 and 178.

Crystals, valves, amplifiers, L.T. accumulators, H.T. accumulators, charging apparatus, coils, chokes, condensers, resistance-coupling units, grid-bias batteries, H.T. batteries, loud speakers, and all sorts of radio components are to be found on this famous wholesalers' stand. A particularly comprehensive range of loud speakers will be shown, all types being represented, including the new moving-coil types.

Brownie Wireless, Ltd. Stand No. 104.

The chief exhibit on this stand will be the popular Brownie Dominion Receiver, being an all-wave model, covering wave-lengths from 200 to 2,000 metres and operated by a single selector switch, so that coil changing is completely obviated. The set is highly selective and an



The Edison screened grid two-volter, (left), and the P.V. 610 6-volt power valve.

additional and secondary aerial terminal has been introduced so that an extra degree of selectivity may be obtained by those who live very near to the coast and are troubled by Morse, or those who live very near to a main station. The price is re-

markably low for a set of this kind, and is £5 15s. 0d. without valves, batteries or royalties. In addition to these new lines, of course, the well-known Brownie crystal sets, etc., will be seen.

A. F. Bulgin & Co., Ltd. Stands Nos. 203 and 204.

In addition to a large range of push-pull switches, indicators, ammeters, milliammeters, panel brackets, chokes, etc., a large number of new lines will be on view for the first time on the 22nd.



The EKCO 3-valve mains-drive receiver, (E.K. Cole, Ltd.)

These include a junior pattern wall jack, central zero charge and discharge ammeter for panel-mounting, a filament tester, a small signal lamp, a baseboard-mounting on-and-off switch, a baseboard-mounting simple short-circuit switch, and an automatic station log which works on the roller-blind principle. Of these, the filament tester should be a most handy instrument, consisting as it does of a device for instantly finding out whether the filament of a valve is intact or not, by simply plugging the instrument into the valve holder. At the price of 2s. 6d. this should have a ready sale.

Burne-Jones & Co., Ltd. Stand No. 96.

All the "Magnum" products will be on view here, including the H.F. chokes, wire-wound R.C. units, volume controls, fixed condensers, calibrated rheostats, wave-traps, etc., that have won their way into so many sets and hearts. No constructor will be able to resist this display, rich in exactly the kind of gadgets that he wants to use.

Of especial interest to WIRELESS CONSTRUCTOR readers is the "Roadside" Four portable receiver, as described in the May, 1928, issue of this journal. Entirely self-contained and so simple a child can operate it, this receiver, including four valves, must be considered a great bargain at £17.

Other special Burne-Jones features which will attract the eye of the music-lover are the new 1929 model gramophone pick-up, the moving-coil loud-speaker outfit, and the push-pull power amplifier. The pick-up can be used on any gramophone in place of the usual sound-box.

There are three models of the moving-coil speaker outfit, at different prices, all incorporating the B.T.H. Rice-Kellogg unit. The push-pull power amplifier will be of especial interest to the man who is limited to about 150 volts H.T., and may be employed with anything from a crystal set to a gramophone pick-up.

The Camden Engineering Co., Ltd. Stand No. 152.

The Camden Engineering Co. are the makers of the well-known "Centroid" wireless products, which include variable condensers, slow-motion dials, fixed resistors, and six-pin coils. This year a special feature is being made of copper and aluminium screening, so if you are building a set embodying screening boxes or sheets look out for Stand 152.

The Cantophone Wireless Co., Ltd. Stand No. 253.

This stand contains an interesting array of complete receivers, including the Cantophone portable receiver, which is a two-valve set capable of a range of 100 miles on 5 G B without

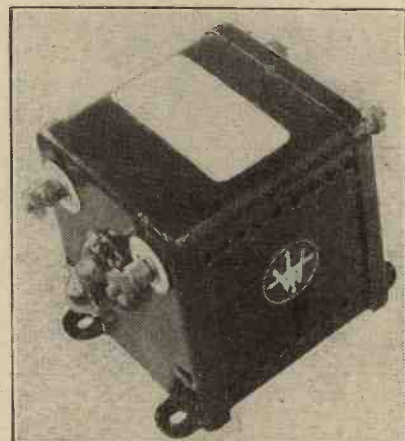

A new Westinghouse metal rectifier, capable of a D.C. output of 1 ampere.

an aerial or earth. There is also a most interesting innovation in the form of a combined gramophone and wireless receiver which takes the form of a five-valve wireless set, with a simple throw-over switch which enables electrical reproduction of the

This Year at Olympia—continued

gramophone to be enjoyed, the whole outfit being operated from the electric-light mains. The cabinet, which is of the stand variety, includes an electrical-operated gramophone as well as the wireless set and pick-up.

One of the "Dunham" receivers.
(Stand 257.)



No batteries or accumulators are required, the whole thing operating straight from the electric-light switch. One or two loud speakers can be used as desired, in addition to the loud speaker provided in the cabinet, which loud speaker is of the hornless type. Included also in the cabinet is a case for 42 records, while an automatic repeating device for the record will make special appeal to those fond of dance music. The price of the complete outfit (in walnut) is 95 guineas.

Celestion Radio Co., Ltd. Stands Nos. 19 and 20.

Celestion loud speakers need no introduction to the wireless public. There are many models, ranging in price from £5 10s. to £25, all good! Most listeners are aware of the Celestion reputation for sensitivity, but it will be a surprise to many to know that in the large model shown on this stand the diaphragm diameter is no less than 24 inches! And the instrument is fitted with an ingenious compensating device to preserve its adjustment and mechanical rigidity under all conditions.

The popularity of pick-ups for the gramophone is demonstrated on this stand, where the Celestion Woodroffe type of instrument is shown. With a view to reducing the wear on records to an absolute minimum, great attention has been paid in this model to the factor of lightness, and special damping arrangements are incorporated. Music lovers who have a train to catch are warned that if they visit the Celestion stand they are liable to miss it!

Clarke & Co. (Manchester), Ltd. Stand No. 161.

Before referring to the mains units which are a special feature of this display, mention must be made of those old, firm favourites, the Atlas coils. Complete ranges of several types are on show, including centre-tapped coils, "X" or double-tapped coils, and the new short-wave coil which covers a wave-length from 15 to 100 metres.

Another very interesting feature of this stand is the insulating materials, in such profusion that the uninitiated are apt to be staggered by the insulating sheets, washers, plates, cloths, silks, papers, mouldings, tubes, sleeves, and so forth.

The display of mains units (both for A.C. and D.C. mains) is so comprehensive that, no matter what the reader's requirements in the way of current or voltage may be, he is sure



This Dubilier Filter Unit is fitted with an earthing terminal.

to find his needs are catered for. Especial interest attaches to some of the A.C. models which incorporate the Westinghouse dry rectifier.

Messrs. Clifphone & Records, Ltd. Stand No. 176.

The chief exhibit on this stand is the new Clifphone armature loud speaker, which has been evolved after a number of years experimental work, and which is claimed to have a number of advantages over other instruments which have hitherto been considered very good. It is of the cone type, the cone being of special material and not reinforced. Reinforcement is stated to be unnecessary as no amount of power will distort the paper. Wonderful amplification properties, owing to the peculiar shape of the cone, are claimed for this loud speaker, and it should certainly form one of the interesting

exhibits of the show. The Clifphone Pelican four-valve transportable set is also to be on show, price £22 10s. 0d., and this also is fitted with the special type of cone loud speaker. It operates direct from the electric-light socket on alternating current, and is an entirely new departure in this type of set.

Climax Radio Electric, Ltd. Stand No. 80.

The Climax radio productions are mostly of the modest kind that do not call for a steep purse. Here will be found earths, low-loss insulators, shock absorbers, lightning arresters, folding frame aeriels, and similar gadgets of endless utility to the listener. The remarkable interest in reception from the mains is well illustrated again at this stall, where the display includes H.T. units for A.C. or D.C., grid-bias units, trickle chargers, Auto-Bat transformers, potential dividers, and several chokes of the special types required by the arduous conditions of modern high-quality reception from the electric-light system. A new model of the Climax portable receiver is also on show, and altogether this display is one to linger over.

E. K. Cole, Ltd. Stands Nos. 48, 49, and 50.

As specialists in this class of instrument, the E. K. Cole display has always been a sort of Mecca of the "mains man." Every wireless requirement of the man who has electric light laid on is catered for, from powerful mains-drive receivers down to the components, such as wire-wound resistances, etc.

One entirely new component is an "isolating" transformer which

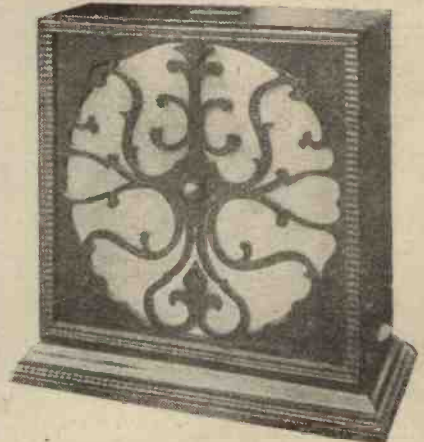

A good example of ornamental loud-speaker design (M.P.A. Wireless).

This Year at Olympia—continued

completely disconnects the loud speaker or 'phones from a set with a power supply unit in use, thus obviating all danger from shock when accidental breakage anywhere in the installation occurs.

Constructors whose bank balances are a bit anæmic will be interested

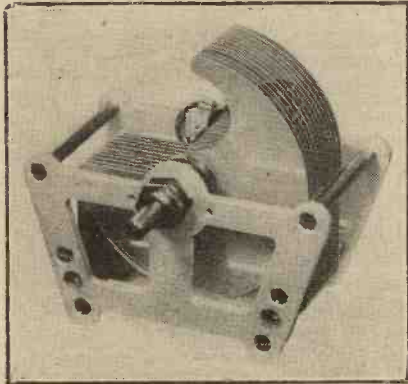

One of the popular Raymond condensers which sells for 0/11 (·0005 mfd.).

in the hire-purchase scheme inaugurated by this firm. Full details of this are available upon application.

Thos. De La Rue & Co., Ltd. Stand No. 235G.

Those who picture wireless as a sort of a side-line hobby will get a bit of an eye-opener at this stall, where there is a comprehensive display of the bakelite fireproof and plastic mouldings used in various branches of the radio business. Modern multi-way methods of manufacture have been applied, and many thousands of articles per week are turned out from the hardened steel dies for various wireless purposes.

Over sixty grades of material are required, and although its chief appeal will be to manufacturers,



The new Ediswan L.F. transformer with ratio of 3·5—1.

the constructor will no doubt find Stand 235 extremely instructive.

The Dionoid Battery Co., Ltd. Stand No. 245.

All sorts of interesting things are to be seen on this stand, where the display includes accumulators (both L.T. and H.T. types), a series of hydrometers, and other interesting gadgets. A useful 1s. 6d. worth is to be obtained here in the form of a tube of corrosive cure, which consists of a special paste for covering terminals. As the makers state, there are more volts lost by bad terminal contact than are generally recognised. The corrosive cure protects the terminals from acid, and is supplied in a handy tube, like toothpaste. The composition itself is stated to be of a good character, and its presence merely acts as a film on the terminals, and in no way impairs the conductivity of the accumulator.

The Dubilier Condenser Co. (1925), Ltd. Stands Nos. 102 and 103.

Such a bewildering display of condensers is to be seen here that we shall have to "condense" our remarks upon the various types. Not long ago the word "Dubilier" conjured up "fixed condensers" to the constructor, and very little else. But nowadays this firm has branched out not only into variable condensers as well, but into a comprehensive range of components including H.F. chokes, grid leaks, R.C. units, Toroid coils, filter units, and, finally, complete portable radio gramophones.

All these will be on view at the Dubilier stand, and amongst the variable condensers there is sure to be great interest in the K.C. (·0005 and ·0003 mfd.), and in the Midget variable condenser, which is designed for reaction control or for use when a neutralising condenser of relatively large capacity is required. Designed for panel-mounting and complete with a knob, this Midget has a capacity of ·0001 or ·0002 mfd., and is a bargain at 5s. 6d.

In addition to all the products specially suited to the wireless constructor, Dubilier's will be showing at their stand various types of condensers for high-power radio and amateur transmitting stations, so that the stand is attractive from a general interest point of view apart from its possibilities to the purchaser.

C. S. Dunham. Stand No. 257.

Complete receivers are a strong suit at this store, ranging from "Simplicity" two- or three-valve sets (which are operated by turning one dial only) to three- and four-valve sets which can, if so desired, be adapted to work

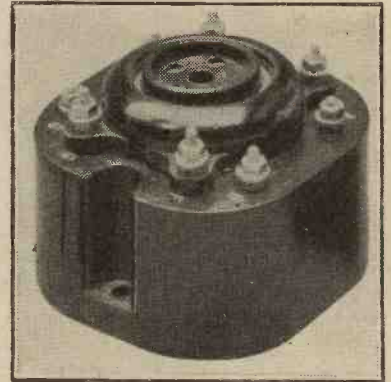

The B.T.H. R.C.C. unit comprises also a sprung valve holder. The unit can be had in a variety of resistance values.

off the electric-light mains. Apart from the complete set there is much to interest the constructor, including mains units of several types and the Dunham All-Wave Tuner, specially designed to simplify home construction.

For the purchaser who desires to experiment in long-wave reception without going to the expense of a powerful long-wave set, the comprehensive wave-length range of from 150 to 2,000 metres (covered in even the simplest two- or three-valve sets) will make a strong appeal, particularly as the expense and trouble of interchangeable coils for different wave-lengths is avoided altogether.

J. Dyson & Co., Ltd. Stand No. 1.

Complete sets, mains units, coils and condensers are amongst the exhibits here. The design of the



The Ediswan Home Charger works from A.C. mains and costs £2 17s. 6d.

This Year at Olympia—continued

microtune S.L.F. condenser is especially interesting. Consisting as it does of two separate knobs and pointers (one giving ordinary semi-circular calibration, and the other slowly moving 360 deg.), it is possible to calibrate this condenser to extremely fine limits. Valve holders, high-tension batteries, L.T. accumulators, and accessories make this an extremely interesting exhibit.

D.X. Coils, Ltd. Stand No. 223.

A strong feature of the D.X. coils which will be on show at this stand is the fact that they are wound only "on air," i.e. without a former. Standard coils, centre-tapped coils, and "X" coils with two tappings are available for the various circuit requirements, and the range includes the D.X. short-wave coil for use on the higher frequencies at which the absence of a solid former is particularly appreciable.

In addition this firm is marketing a low-priced L.F. transformer, and it is interesting to note that in this, too, the coils are air-wound, i.e. no former is employed, and the coil is an all-wire one. Not only the ordinary 1 to 1, 2 to 1, and 3 to 1 ratios are

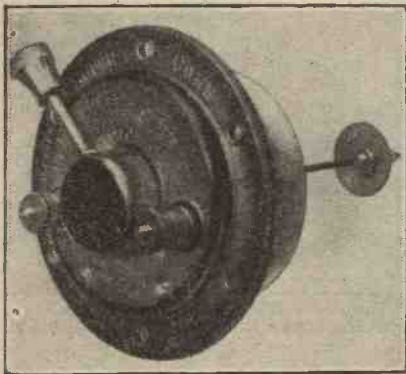

The Bowerman cone loud-speaker unit.

available, but this firm is also producing a special 25 to 1 transformer for use where the output of a set is to a moving-coil loud speaker.

J. J. Eastick, Ltd. Stands Nos. 218 and 219.

Here will be seen the full range of Eelex productions, including the popular Eelex terminals and the safety switch made by this firm, which combines a lead-in tube, switch and lightning arrester. Standardised plugs and sockets are other features, and those who are overhauling their sets for the winter and who contemplate renewing their earth arrangements

will be interested in the Eelex moisture-retaining earth, which can be examined by any visitor to this stand.



This "Mainten" H.T. unit is sold at 52s. 6d.

Edison-Bell, Ltd. Stand No. 129.

Messrs. Edison-Bell, Ltd., have recently been busy upon the production of new apparatus to be released in the autumn, and a special feature of these new lines will be made at this stand. Several new complete receiving sets are included, such as the "Compact Three" (which carries a cone-type speaker in the lid), and the five-valve portable with only two controls—tuning and reaction. In this set a switch is fitted for changing from the high to low wave-lengths, and independent connections for outside aerial and earth and speaker are provided for use if desired.

This firm is also showing an interesting electro-magnetic pick-up specially adapted for use with the complete sets already referred to.

The Edison-Swan Electric Co., Ltd. Stand No. 43.

The 1929 Ediswan R.C. Threesome will cause a great many people to break the Tenth Commandment at this stand. In its new and up-to-date form this famous receiver embodies several improvements, one sure-to-be-popular innovation being the new A-type unit, which has the windings for both long and short waves mounted upon it. With this unit the set can be switched over in a second to either the long or the short wave-lengths by means of a simple push-pull switch.

Represented here, too, will be all the large family of Ediswan valves. The whole range of these has been entirely revised to conform to the most modern standards, and several important additions have been made.

One feature which will appeal to the discriminating buyer and to the technically-minded set builder who knows exactly what he wants (and means to get it), is the marking of the new Ediswan valves. Not only the filament volts and current, but also the impedance and the amplification factor of each valve is etched on the bulb! This is an excellent idea which not only assists the purchaser all the time that the valve is in his possession, but also gives him a "good" feeling about the reliability and the constancy of the range of valves so marked.

Battery eliminators and chargers which pay for themselves in a few months are other features of this not-to-be-missed exhibit.

The Electron Co., Ltd. Stand No. 42A.

Famous for their series of Six-Sixty valves, The Electron Co., Ltd., are showing a new range of screened-grid and Pentode valves, the former for 2 and 4 volts, taking .15 and .075 filament amp., and the latter for 2 and 4 volts, taking .30 and .15 filament amp. There will also be on view the well-known Six-Sixty loud-speaker paper and the Six-Sixty cone speaker assembly and turntable. Visitors should make a point of visiting this stand, and especially of inspecting the new screened-grid and Pentode valves, as these are sure to come well to the fore during the present radio season.

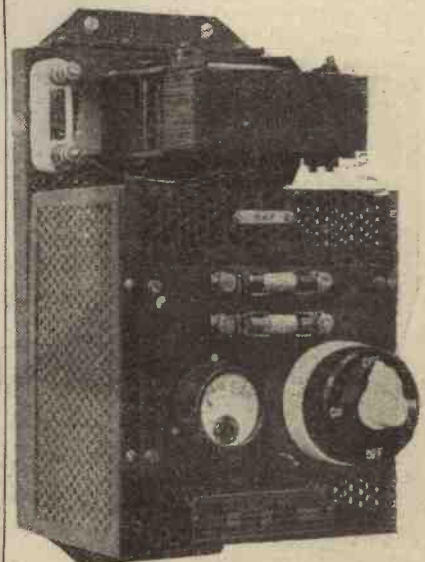

One of the many Westinghouse exhibits—the 12-14-volt, 3-amp. charging unit for 220-volt A.C. mains.

This Year at Olympia—continued

Falk, Stadelmann & Co. Stand No. 127.

"Efescaphone" complete receiving sets in great profusion will be on show here, including the now popular "Cromwell," "Wolfe," "Wellington," and "Kitchener" sets that were introduced to the public at last year's show. In addition, there are some promising new lines, including two screened "Fours" and a screened "Three." The latter is priced at £13 10s. (receiver only).

Several new H.T. battery eliminators are being added to the Efesca range, and in addition there are shown some very attractive components, including tuners, and an R.C. coupling unit for use with general-purpose valves.

Ferranti Ltd. Stands Nos. 84 and 85.

The astonishingly varied display of apparatus at this stand will be an eye-opener to those who have always associated the name Ferranti with transformers. Transformers there are, of course, in plenty, including the famous A.F.3, A.F.4 and the super type A.F.5.

A very interesting line of push-pull transformers will cause push-pull enthusiasts to push and pull their way through the crowds to inspect these, but apart from transformers the Ferranti people are catering extensively for other wireless needs. Their condensers, for instance, types C1 and C2, have a low internal resistance and extremely high insulation resistance. The test voltages for these condensers are 500 A.C. and 200 D.C. respectively.



The Eureka "Orthodyne Five" attache case model—a sensitive and extremely popular receiver.

In addition there are chokes for smoothing purposes, and for use in choke filter circuits; then there are the wire-wound anode-feed resistances (the anode-feed system was developed by the Ferranti Company) and many other interesting lines, including a loud speaker, a permanent L.T. trickle charger, radio meters (don't miss these!) and permanent metal rectifiers.



The "Godwin" Concert Grand receiver, incorporating the "Microtone" condenser dials, and made by Messrs. J. Dyson & Co.

One interesting point about the Ferranti display is well worthy of note. This famous firm, known all the world over as manufacturers of transformers and electrical equipment, has decided not to manufacture any transformers and other components for supplying to constructors to enable them to build eliminators giving output voltages higher than 250. Ferranti's feel that the practice of using voltages of the order of 400 or 500 is dangerous and may lead to serious accidents.

The careful constructor will therefore feel absolutely safe with this firm's products.

One thing that Ferranti's point out which is not generally realised is that in an eliminator using valves and providing voltages of about "400," there may be transformers with about 1,000 volts across them! So this decision, by such a famous firm as Ferranti, Ltd., should be carefully considered by everyone who is contemplating utilising the mains. A visit to the Ferranti display will provide convincing proof of the thoroughness with which these and the associated problems of radio reception have been investigated and catered for.

G. Forster. Stand No. 3.

Complete receivers are the attraction here, several models of three- and five-valve sets being on display. The "Advance" three-valve portable has a wave-length range of from 250 to 750 metres and will bring in 2 L O at

25 miles and 5 G B at 100 miles on the loud speaker. The price, including royalties, is eighteen guineas.

The "Advance" five-valve trans-portable receiver is similar in appearance to the three-valve but tunes to the long waves also, and its price is twenty-five pounds. The "Advance" five-valve set employs a screened valve, the wave-length range (in this case from 250 to 550 metres and from 1,000 to 2,000) is easily altered by means of a switch. The set is of the one-dial tuning variety, and the price, including royalties, is thirty guineas.

Garnett, Whiteley & Co., Ltd. Stand No. 115.

The "Lotus" components on view at this stand will include many famous old favourites. In addition to those Lotus lines which were so successful a few years ago—such as the Lotus two-way coil holder, the valve holder, and the great variety of jacks, switches, and gadgets for which this firm is famous—a number of new lines are being exhibited for the first time this year.

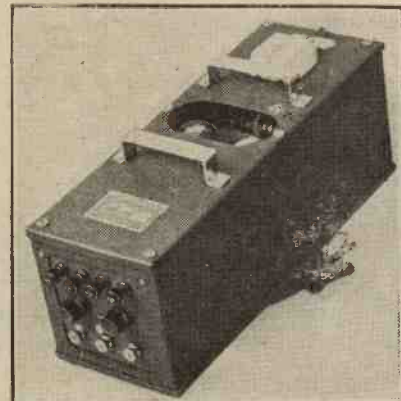

Messrs. Partridge & Mee have brought out the above H.T. supply unit for A.C. mains.

Included in these new lines are the Lotus portable set and the Lotus trans-portable set, but of special interest will be the three new Lotus components specially designed for the modern set. These are the new Lotus logarithmic condenser, the Lotus vernier dial and a new series of tuned coils.

Apart from all these attractions there is one other feature which will specially interest the man who has his set installed but fails to get the maximum enjoyment from it on account of the fact that the programme is only available in one room of the house. He should make a special

This Year at Olympia—continued

point of enquiring about the Lotus Remote Control. Several varieties of this are on view, all simple to instal and easy to use, by means of which the set can be switched on or off as you wish by the mere insertion or withdrawal of the loud-speaker plug in any room. A great stunt for the lazy or luxurious!

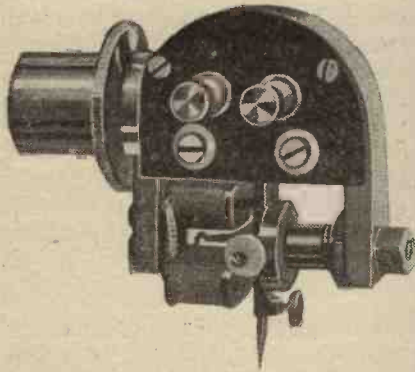

A popular gramophone pick-up is the "Woodroffe," illustrated here.

The Haleyon Wireless Co., Ltd. Stands Nos. 16, 17 and 18.

The aim of this company is to achieve a degree of wireless refinement which buyers of high-class sets have a right to expect, and they claim that the 1928-29 model which is shown on this stand is the last expression of modern technique in wireless telephony. The five-valve portable de luxe model and a special de luxe lightweight model form the chief exhibits, each receiver containing five valves and being capable of surprising results. A full-size Celestion type loud speaker is provided in each set, and provision is made for the use of telephones or an alternative loud speaker if required. The weight of the lightweight model is 31 lb. and that of the heavier de luxe model somewhat greater. The price of each is the same, namely, thirty-five guineas, and they can be obtained either cash down or on the hire-purchase system.

Hart Bros. Electrical Manufacturing Co., Ltd. Stand No. 215.

Another "gadget" stand, which no man who has on his mind a set to build will be able to pass without a struggle. The main features are the Harbros "Easyfix" flex battery cords, loud-speaker leads and instrument wires.

W. J. Henderson & Co., Ltd. Stand No. 258.

Portable receivers of the four- and five-valve varieties, employing

screened-grid valves, battery eliminators, battery switches and sundry components and accessories, are to be found on this stand, the portable receivers being obtainable in various designs and finishes. In addition a complete range of A.C. and D.C. battery eliminators, all conforming to the I.E.E. regulations, are offered to the public.

Hobday Bros., Ltd. Stands Nos. 173 and 174.

This exhibit constitutes quite an exhibition in itself, for Hobday Bros. (one of the foremost factors in the wireless industry) will be showing a comprehensive range of all the latest developments in radio, includ-

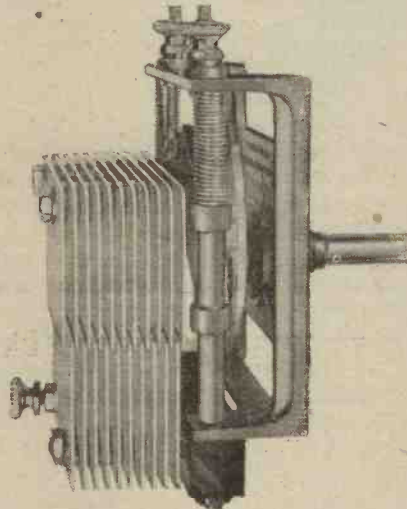

The novel and efficient Ripault lateral-action variable condenser.

ing a special show of portable sets by the leading manufacturers.

Although this is primarily a trade show, the very compactness and comprehensiveness of the exhibit will render it attractive to the ordinary visitor and purchaser.

Houghton-Butcher, Ltd. Stands Nos. 136 and 137.

This well-known firm is a wholesale house, but the ordinary listener will find on the stand an interesting summary of the leading lines of the various popular radio productions and successes.

A. H. Hunt, Ltd. Stand No. 273.

This firm is making a speciality of a very extensive and complete range of electrical measuring instruments (already famed), and there are several additions in calibrations and models which are sure to be popular, the low-priced double-scale voltmeters being particularly attractive.

Measuring instruments are now becoming recognised as essential pieces of wireless apparatus, and it is extremely satisfactory to find that not only is this demand being catered for so extensively, but that the latest development is a tendency not only towards greater accuracy but also to a reduction in prices.

The Jewel Pen Co., Ltd. Stand No. 261.

The crystal-detector user will find this a particularly interesting stand, for here will be shown a popular form of permanent detector which has done much to oust the cat's-whisker from popularity. A reduction in price of this detector is a particularly good sign of the times.

Lectro-Linx, Ltd. Stand No. 236.

The constructor who believes in good contact, first, second and all the time, will be particularly interested in the range of Clix specialities. Pin terminals, spade terminals, plugs, parallel sockets, and all sorts of gadgets and "doo-hickeys" are shown, all carefully designed with the idea of giving really good contact in any type of set—crystal or valve.

At this stand the Home Constructor will be in danger of forgetting the "Home," and will only remember the "Constructor" part of his hobby!

E. J. Lever (Trix), Ltd. Stands Nos. 255 and 256.

Some very ingenious insulators are amongst the many components on show at this stand, and the man who



One of the many thousands of fixed condensers placed on the market by The Telegraph Condenser Co.

This Year at Olympia—continued

is nervous of lightning, should not fail to see the lightning arresters which form a feature of the display.

Lithanode Co., Ltd. Stand No. 226.

Three different patterns of unspillable accumulators are on show and will be of especial interest to those contemplating the building of portable or trans-portable sets.

W. & T. Lock, Ltd. Stands Nos. 229 and 230.

A full range of cabinets suitable for moving-coil speakers is an interesting feature of this display.

The London Electric Wire Co. & Smiths Ltd. Stand No. 110.

Lewcos coils and Glazite wire have long been on the market, and this winter these two useful commodities are to be joined by a special Lewcos H.F. choke. It has a minimum self-capacity of only 21 micro-microfarads, and its natural wave-length is far above that of the longest wave-length used by any broadcasting station, being somewhere in the neighbourhood of 5,400 metres. The choke is

suitable for use on all wave-lengths from 20 to 2,250 metres.



The new Lissen wire-wound resistance for vertical or horizontal mounting.

London Metal Warehouses, Ltd. Stand No. 79.

Aluminium aerial wire is a novelty at this stand.

L. McMichael, Ltd. Stand No. 128.

Among the many lines for which this firm is noted, several new features will make their appearance, notably the McMichael gramophone pick-up, which is made on a new principle giving greatly improved reproduction. Sensitivity is extremely high, and may be varied to suit individual taste. In addition is the 1929 screened portable, which represents an outstanding achievement in its application of advanced design permitted by recent strides made by the valve manufacturers. The "McMichael Screened Three" is a mains-driven set which gives remarkably good quality. The whole set is easily connected to the mains in the same way as an electric iron or fan can be plugged in.

The Mainten Mfg. Co., Ltd. Stand No. 206.

This fast-developing firm of battery eliminator manufacturers is bringing out a series of new lines encased in metal, whereas the former eliminators have been cased in wood. All these

WHERE THEY ALL ARE

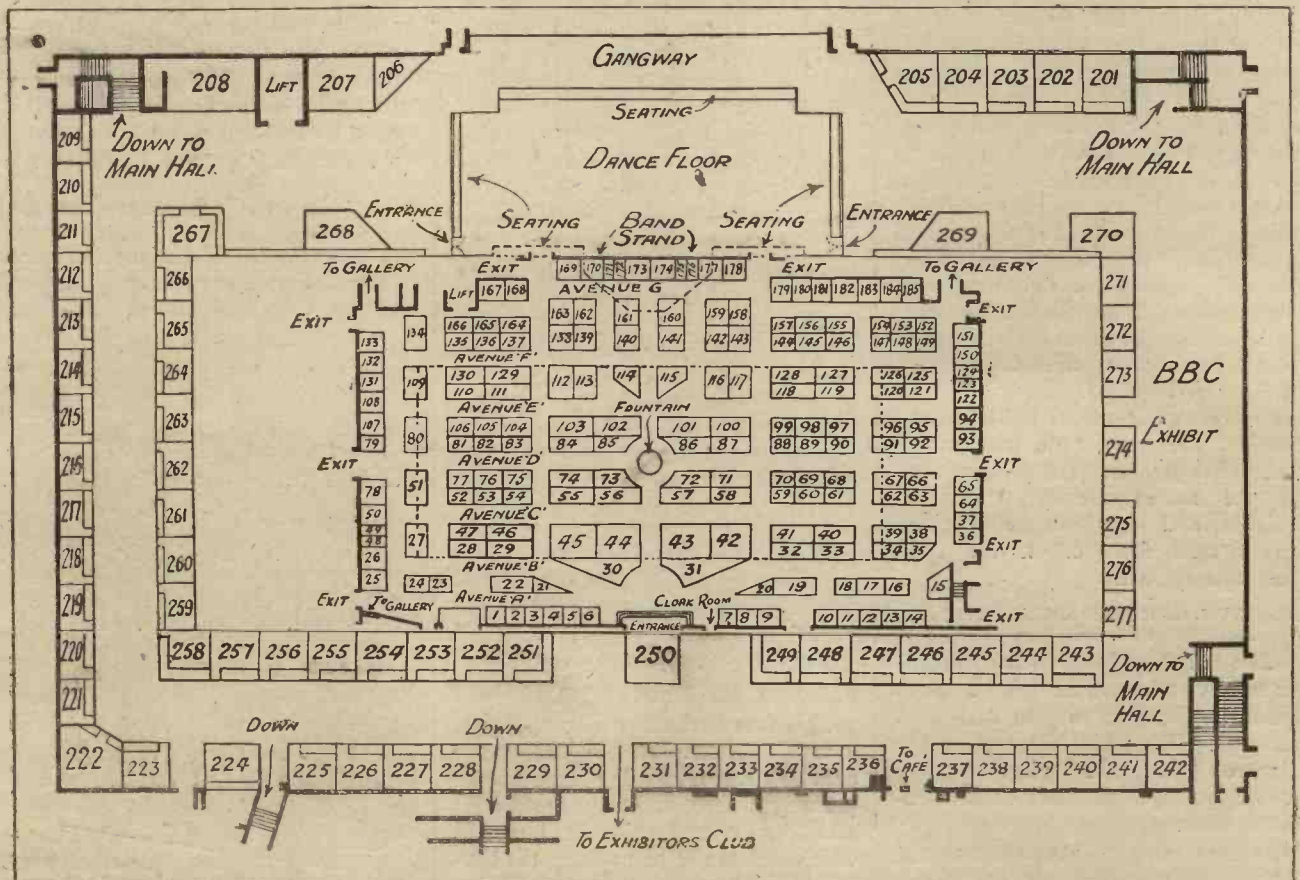

This guide to the stands at Olympia shows where the various firms are exhibiting. For Key to the numbers, see page 370.

This Year at Olympia—continued

—both for D.C. and A.C.—are guaranteed to be capable of working any average set.

Marconiphone Company, Ltd. Stands Nos. 59, 60, 61, 68, 69, 70, 232 and 233.

The eight stands which have been booked by the Marconiphone Co., Ltd., are of such extraordinary interest that it is impossible to refer in detail to the various exhibits. No matter what your radio requirements may be you will be sure to find something of especial interest here, whether your needs are in the nature of single components, units, transformers, valves or accessories in general, or the more ambitious field of complete receivers.

Many of these are too well known to need introduction, but the new Marconiphone portable receiver which will be on show is of particular interest if only for its small H.T. consumption, this being of the order of 7 to 9 milliamps only. For this a walnut cabinet is adopted as being more suitable for home use than leather, and it is an open secret that the makers have been delighted with the range of reception of this instrument which has proved to be quite remarkable.

Another interesting set is the Marconiphone short-wave receiver, Model 34, the original model of which was taken on a voyage to Singapore as a test. Even under these arduous conditions it succeeded in receiving 5SW, PCJJ, and the American short-wavers regularly. Standard plug-in coils also can be used in this instrument, with adaptor, so that it

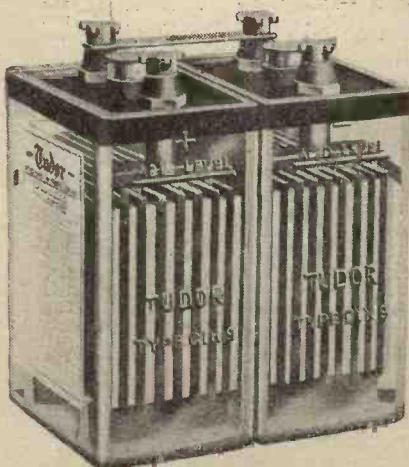

The "Tudor" C.L.H.3 1-volt 40-a.h. low-tension battery. The glass containers enable the condition of the plates and the acid level to be seen with ease.

is useful for the ordinary wavelengths as well as for the short waves.

Another interesting Marconiphone departure is the "Popular" transformer having a ratio of 4 to 1 and retailing at 12s. 6d.



The Ekco "All-Power" unit, Model C1A, for D.C. mains.

The Mic Wireless Co. Stand No. 9.

This company markets the Zampa components, two of which will be shown, namely, the Zampa moving-coil loud speaker and the Zampa tuner.

E. Paroussi. Stand No. 272.

Radio products *par excellence* of the PAR-EX brand will be shown here in great variety, and will prove of special interest to the man who uses or intends to use a screened valve. The Parex screened-valve holder, by the way, is now made to fit not only the ordinary screened-grid valve, but also the new Mullard S.G. valve.

Users of screened-stage receivers, whether of the kind employing screened-grid or ordinary valves, will be specially attracted, too, by the extensive display of screens of all types, to suit different circuits and receivers.

Partridge & Mee. Stand No. 147.

This firm, which makes a speciality of high-grade wireless and electrical apparatus, manufactures all types of transformers, chokes and eliminators. Amongst them will be found twenty-five different types of transformers, also chokes, output transformers and rectifying apparatus.

Philips Lamps, Ltd. Stands. Nos. 94 and 122.

This well-known firm will exhibit a complete range of mains units and battery chargers, together with a series of up-to-date receivers. As an example of these, the three-valve D.C. model, type 2582, can be operated from D.C. direct from the mains through a high-tension eliminator.

(Four volts are necessary for the filament supply voltage.) The circuit of this three-valve set is extremely interesting, as it comprises a screened-grid valve H.F., a special P.M.4 detector, and a Pentone in the last stage. All the coils in the set are brought into operation by means of a switch, which also controls the L.T. supply. Provision is also made whereby the set can easily be converted for A.C. work should occasion arise. The new Philips' inter-valve transformer will be well in evidence, while this firm will be pleased to demonstrate any particular model of receiver or loud speaker upon request, and for this purpose have made a point of taking extensive showrooms at West Kensington Gardens, almost opposite the exhibition, for the purpose of demonstrating any of their products. Finally, mention should be made of the new loud speaker recently placed on the market, in several models, which will form a prominent feature of the exhibit. This is one of the latest additions to Philips' radio products and is well worth careful examination.

Portable Utilities Co., Ltd. Stand No. 144.

Eureka! will exclaim the constructor as he looks at this stand.

Not only are there mains transformers, chokes, etc., but there is a particularly pleasing line of Eureka complete sets, including several new models. A Eureka "Orthodyne Four," for instance, brings in practically every one of the well-known European broadcasting stations, as well as some of the Americans.

The Eureka "Orthodyne Three" is by no means to be sneezed at, for no

(Continued on page 436.)



One of the most popular of loud speakers—the Celestion.

LIST OF EXHIBITORS

NAME	ADDRESS	STAND NO.	NAME	ADDRESS	STAND NO.
Amalgamated Press, Ltd.	Fleetway House, Farringdon Street, E.C.4	135 & 166	Hart Accumulator Co., Ltd.	Marshgate Lane, Stratford, E.15	95
Atalanta, Ltd.	1-3, Brixton Road, S.W.9	271	Hart Collins, Ltd.	38a, Bessborough Street, S.W.1	15
Automatic Coil Winder & Elec. Equipment Co., Ltd.	Winder House, Rochester Row, S.W.1	150 & 151	Hart Bros. Electrical Mfg. Co., Ltd.	4, Queensway, Ponders End, Middx.	215
Axuel Time Switches, Ltd.	45e, The Mall, Ealing, W.5	263	Henderson & Co., Ltd., W. J.	351, Fulham Road, S.W.10	258
Baird Television Development Co., Ltd.	133, Long Acre, W.C.2	11, 13, 14	Hobday Bros., Ltd.	21-27, Great Eastern Street, E.C.2	173 & 174
Bakelite, Ltd.	68, Victoria Street, S.W.1	160	Houghton-Butcher (Gt. Britain), Ltd.	88-89, High Holborn, W.C.	136 & 137
Beaver Electrical Co., The	5, Great Chapel Street, Oxford Street, W.1	2	Hunt, Ltd., A. H.	H.A.H. Works, Tunstall Road, East Croydon	273
Bedford Electrical & Radio Company	22, Campbell Road, Bedford	35	Igranic Electric Co., Ltd.	147, Queen Victoria Street, E.C.4, and Bedford	53, 54 & 75
Belling & Lee, Ltd.	Queensway Works, Ponders End, Middlesex	220 & 221	Iliffe & Sons, Ltd.	Dorset House, Tudor Street, E.C.4	145, 146 & 201
Benjamin Electric, Ltd.	Brantwood Works, Tariff Road, Tottenham, N.	171	Incorporated Radio Society of Gt. Britain	53, Victoria Street, S.W.1	227
Bowerman, Ltd., George	10 & 12, Ludgate Hill, E.C.4	213	J.R. Wireless Co.	6 & 8, Rosebery Avenue, E.C.1	228
Bowyer-Love Co., Ltd., The	Radio Works, Letchworth, Herts	51	Jackson Bros.	8, Poland Street, W.1	105
Brandes, Ltd.	Cray Works, Sidcup, Kent	118	Jewel Pen Co., Ltd.	21, Great Sutton Street, E.C.1	261
British Ebonite Co., Ltd.	Nightingale Road, Hanwell, W.7	38	Junit Mfg. Co., Ltd.	Napier House, 24-27 High Holborn, W.C.	93
British General Mfg. Co., Ltd.	Brockley Works, Brockley, S.E.4	10	Lampugh, Ltd., S. A.	Kings Road, Tyseley, Birmingham	81 & 106
British Radio Corporation, Ltd.	Elm Grove Road, Weybridge, Surrey	141	Langham Radio	96, Regent Street, W.1	55 & 74
British Thomson-Houston Co., Ltd., The	Crown House, Aldwych, W.C.2	86 & 101	Lectro Linx, Ltd.	254, Vauxhall Bridge Road, S.W.1	236
Brown, Ltd., S. G.	Western Avenue, North Acton, W.3	155 & 156	Lever (Trix) Ltd., E. J.	8-9, Clerkenwell Green, E.C.1	255 & 256
Brownie Wireless Co. of G.B., Ltd., The	Nelson Street Works, Mornington Crescent, N.W.	104	Lissen, Ltd.	Friars Lane, Richmond, Surrey	71, 72, 57 & 53
Bulglin & Co., A. F.	9-11, Cursitor Street, Chancery Lane, W.C.	203 & 204	Lithanode Co., Ltd.	190, Queen's Road, Battersea S.W.	226
Bullphone, Ltd.	38, Holywell Lane, Great Eastern Street, E.C.	42	Lock, W. & T., Ltd.	St. Peter's Works, Bath	229 & 230
Burdopt Wireless, Ltd.	Eastnor House, Blackheath, S.E.3	112 & 113	London Electric Wire Co., & Smiths, Ltd., The	7, Playhouse Yard, Golden Lane, E.C.	110
Burne-Jones & Co., Ltd.	288 & 296, Borough High St., S.E.1	96	London Metal Warehouses, Ltd.	Hill Street, Pooock Street, Blackfriars Road, S.E.1	79
Burton, C. F. & H.	Progress Works, Bernard Street, Walsall	184 & 185	London Radio Mfg. Co., Ltd.	Station Road, Merton Abbey, S.W	209 & 210
Carborundum Co., Ltd.	Trafford Park, Manchester	130	McMichael, Ltd., L.	Wexham Road, Slough	123
Carrington Mfg. Co., Ltd.	Canco Works, Sanderstead Road, South Croydon	107	M.P.A. Wireless	62, Conduit Street, W.1	21 & 22
Catesbys, Ltd.	64-67, Tottenham Court Road, W.1	25	Mainten Mfg. Co.	126, Portland Road, Hove	206
Cantophone Wireless Co.	Remo House, 310, Regent St., W.1	253	Marconiphone Co., Ltd.	210, Tottenham Court Road, W.1	59, 60, 61, 68, 69, 70, 232 & 233
Celestion Radio Co.	29-31, High Street, Hampton Wick, Kingston-on-Thames	19 & 20	Melhuish, C. D.	8, Great Sutton Street, E.C.1	240
Chloride Electrical Storage Co., Ltd.	217-229, Shaftesbury Avenue, W.C.	33, 40 & 241	Metro-Vick Supplies, Ltd.	155, Charing Cross Road, W.C.	32 & 41
Clarke & Co. (M/c.), Ltd.	and Clifton Junction, Manchester		Mic Wireless Co.	White Horse Place, Market Street, Wellingtonborough	9
Chimax Radio Electric, Ltd.	Atlas Works, Eastnor Street, Old Trafford, Manchester	161	Mullard Radio Valve Co., Ltd.	Nightingale Works, Nightingale Lane, Balham, S.W.12	88, 89, 90, 97, 98, 99, 133 & 267
Cole, Ltd., E. K.	Quill Works, Quill Lane, Putney, S.W.15	80	Odhams Press, Ltd.	93, Long Acre, W.C.	183
Collinson's Precision Screw Co., Ltd.	Ekko Works, London Road, Leigh-on-Sea, Essex	48, 49 & 50	Oldham & Son, Ltd.	Denton, Manchester	125 & 126
Cossor Ltd., A. C.	Provost Works, Macdonald Road, Walthamstow, E.17	91	Ormond Eng. Co., Ltd.	199-205, Pentonville Road, N.1	138, 162, 163
D.X. Coils, Ltd.	Cossor House, Highbury Grove, N.5	116, 117, 231 & 250	Paroussi, E.	10, Featherstone Bldgs., High Holborn, W.C.	272
Dayzite, Ltd.	542, Kingsland Road, E.8	223	Partridge & Mee, Ltd.	12, Belvoir Street, Leicester	147
De la Rue & Co., Ltd., Thos.	18-19, Lisle Street, W.C.2	248	Peto & Radford	50, Grosvenor Gardens, S.W.1	67
Dew & Co., A. J.	90, Shernhall St., Walthamstow, E.17	235	Peto-Scott Co., Ltd.	77, City Road, E.C.1	142 & 143
Dibben & Sons, William	33-34, Rathbone Place, W.1	181 & 182	Philips Lamps, Ltd.	145, Charing Cross Road, W.C.	94 & 122
Dionoid Battery Co., Ltd., The	St. Mary's Road, Southampton	109	Portable Utilities Co., Ltd.	Eureka House, Fisher Street, W.C.	144
Dubilier Condenser Co. (1925), Ltd.	Victoria Works, Prince of Wales' Road, Darnall, Sheffield	245	Pye & Co., W. G.	Granta Works, Montague Road, Cambridge	87 & 100
Dunham, C. S.	Ducon Works, Victoria Road, North Acton, W.3	102 & 103	R.I. & Varley, Ltd.	103, Kingsway, W.C.	56, 73 & 222
Dyson, J.	Elm Works, Elm Park, Brixton Hill, S.W.2	267	Radi-Are Electrical Co. (1927), Ltd.	Bennett Street, Chiswick W.4	6
Eagle Engineering Co., Ltd.	5, Godwin Street, Bradford, and 2, Coleman Street, E.C.	1	Redfern's Rubber Works, Ltd.	Hyde, nr. Manchester	123
Eastick & Sons, J. J.	Eagle Works, Warwick	139	Rees Mace Mfg. Co., Ltd.	39a, Welbeck Street, W.1	263
Edison Bell, Ltd.	Exelx House, Bunhill Row, E.C.1	218 & 219	Ripaults, Ltd.	1, King's Road, St. Pancras, N.W.1	24
Edison Swan Electric Co., Ltd.	Edison Bell Works, Glengall Road, Peckham, S.E.15	129	Sel-Ezi Wireless Supply Co. Selectors, Ltd.	6 Creek Street, W.1	12
Electramonic Co., Ltd.	123, Queen Victoria Street, E.C.	43	Siemens Bros. & Co., Ltd.	1, Dover Street W.1	23
Empire Electric Co.	Bear Gardens, Park Street, Southwark, S.E.	44	Standard Wet Battery Co.	Caxton House, Westminster, S.W.1	164 & 165
Enterprise Mfg. Co.	10, Fitzroy Square, W.1	247	Stapleton, A. W.	184-8, Shaftesbury Avenue, W.C.	7
Ever-Ready Co. (G.B.), Ltd.	83-87, Merton Road, S.W.19	237 & 238	Stevens & Co. (1914), Ltd., A. J.	19a, Lorrimore Bldgs., Lorrimore Street, S.E.17	211
Electron Co., Ltd.	Hercules Place, Holloway, N.7	44A	Stratton & Co., Ltd.	Walsall Street, Wolverhampton	83 & 131
Falk, Stadelmann & Co., Ltd.	122, Charing Cross Road, W.C.	42A	Telegraph Condenser Co., Ltd.	Balmoral Works, Bronsgrave Street, Birmingham	34
Fellows Mfg. Co., Ltd.	83, Farringdon Road, E.C.1	127	Trelleborg Ebonite Works, Ltd.	Wales Farm Rd., North Acton, W.	121
Ferranti, Ltd.	Cumberland Avenue, Park Royal, N.W.	36, 37, 64 & 65	Tudor Accumulator Co.	Union Place, Wells Street, W.	224
Forno Co., The	Hollinwood, Lincs. and Bush House Strand, W.C.	84 & 85	Turner & Co.	2, Norfolk Street, W.C.2	249
Gambrell Radio, Ltd.	Crown Works, Cricklewood, N.W.2	140	Vandervell & Co., Ltd., C. A.	54, Station Road, N.11	234
Garnett, Whiteley & Co., Ltd.	Merton Road Southfields, S.W.18	27 & 108	Watmel Wireless Co., Ltd.	Imperial Works, High Street, Edgware, Middlesex	157
General Electric Co., Ltd.	Lotus Works, Broadgreen Road, Liverpool	115	Westinghouse Brake & Saxby Signal Co., Ltd.	82, York Road, King's Cross, N.1	78
Goodmans	Magnet House, Kingsway, W.C.2	28, 29, 46, 47 & 225	Whiteley, Boneham & Co., Ltd.	Nottingham Road, Mansfield, Notts.	120
Graham & Co., R. F.	27, Farringdon Street, E.C.	269A	Whittingham Smith & Co.	110, Kew Green, Kew, Surrey	4
Graham Amplion, Ltd.	45, Cambridge Road, Kingston-on-Thames	212	Wilkins & Wright	Utility Works, Holyhead Road, Birmingham	152
Graham-Furish Mfg. Co.	25-26, Savile Row, Regent St., W.1	30 & 31	Wireless Retailers' Association of Gt. Britain	70, Finsbury Pavement, E.C.2	259
	17, Masons Hill, Bromley, Kent	119	Wright & Wearle, Ltd.	740, High Road, Tottenham, N.	251 & 252

A "STEDIPOWER" DEVELOPMENT

Westinghouse makes special Unit for Harris "Stedipower"—Soldering no longer necessary—
Further developments in a remarkable scheme.

By THE EDITOR.

THE enormous interest aroused by the Harris "Stedipower" L.T.

Unit in our August issue continues unabated, and I have received numerous letters not only from all parts of the United Kingdom, but from France and Germany and Holland, congratulating the WIRELESS CONSTRUCTOR upon being the first journal to publish a design which enables any of its sets to be worked direct from the A.C. mains. Deliveries of the special high-capacity condensers, transformers, chokes and rectifying units are now in full swing, and there is no reason whatever why any reader should not now be able to obtain supplies for making this fascinating and useful piece of apparatus within a day or two of placing the order with his dealer.

A New Rectifier

We are very pleased to be able to announce that the Westinghouse Brake and Saxby Signal Co., Ltd., makers of the Westinghouse dry rectifying unit, are now producing a special Westinghouse dry rectifier specifically designed to fill the need of the Harris "Stedipower" L.T. Unit. This will be available to readers of the WIRELESS CONSTRUCTOR at an attractive price by the time this issue appears on the bookstall. As the electrical characteristics of the Westinghouse dry rectifier are not quite the same as those of the Kuprox, slightly different transformer windings are necessary, so we have arranged with Messrs. Radio-Instruments, Ltd., to supply at the same price as the transformer already marketed for the Kuprox one designed to fit the Westinghouse unit. The "Stedipower" L.T. Unit can thus now be made up with either the Westinghouse or the Kuprox units. When ordering transformers and chokes for the "Stedipower" L.T. Unit the reader should particularly specify whether they are to be used with Westinghouse or the Kuprox dry rectifier.

Improved Condensers

We are interested to find that, although the price has not been increased in any way, the mechanical

make-up of the Tobe-Deutschmann 3,600-mfd. condenser used in the "Stedipower" L.T. Unit has been slightly improved. In the condenser already illustrated in this journal soldering lugs are used for the three connections, but in the latest model flexible wires are already connected to the condenser lugs, thus obviating the necessity of soldering and increasing still further the simplicity of construction.

No Soldering

It is now possible to construct the unit entirely without soldering, and the new "Radiano" wiring system described in this issue can be used perfectly satisfactorily for it. This is a big boon and will, we are sure, be fully appreciated by our readers.

We have also arranged with the Westinghouse Brake and Saxby Signal Co., Ltd., to supply their dry rectifier for the "Stedipower" unit fitted with flexible wires, clearly marked.

We should like to repeat, although it has already been clearly stated in

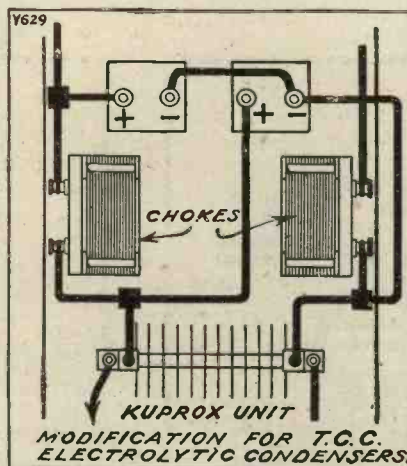

The theoretical circuit of the "Stedipower" unit.

the first article, that the "Stedipower" L.T. Unit is designed to work only from alternating current mains, and when made up according to the article will give an L.T. output up to 1 amp. at 2, 4, or 6 volts—or, indeed, at any voltage from 2 to 6. The output is perfectly hum-free and indistinguishable from the pure direct current available from an accumulator. The

cost of running the unit even with the seven-valve super-heterodyne is negligible—say, a shilling a month at the outside for quite heavy use.

We should also like to take this opportunity of pointing out that when it is desired to energise the 6-volt winding of a moving-coil speaker from the A.C. mains there is no need to build a complete "Stedipower" L.T. Unit. All that is necessary is to use the transformer and the dry rectifier, as the inductance of the field winding will give all the choking effect necessary for smoothing. In our own laboratory we use a transformer and a Westinghouse dry rectifier straight on to the field winding, and the result is quite satisfactory.

A D.C. Model?

While there is a very slight hum, it can only be heard by placing the ear quite close to the speaker during quiet periods, and even the weakest reproduction completely effaces what hum remains. A good combination for this purpose is the Pye transformer reviewed on another page, and the Westinghouse unit. In the Westinghouse series the R4-2-2 is recommended, with either a Radio-Instruments or Pye transformer designed for this unit.

The "Stedipower" L.T. Unit can not be used with D.C. mains. Experiments are now being conducted in the laboratory for the purpose of evolving the "Stedipower" D.C. Unit for L.T. supply, and as soon as satisfactory and reliable results are obtained the design will be published.

L.T., Not H.T.

Another question which has been asked is whether the Tobe-Deutschmann 3,600-mfd. condenser can be used in H.T. mains unit. The answer is emphatically *no*, as this condenser is designed only for low voltages, and would break down and be ruined with such use. Used at the voltages which are applied to it in the Harris "Stedipower" L.T. Unit, the condenser is thoroughly reliable, but it is not intended to be used at voltages above those produced in the unit described.

Make Your Choice at

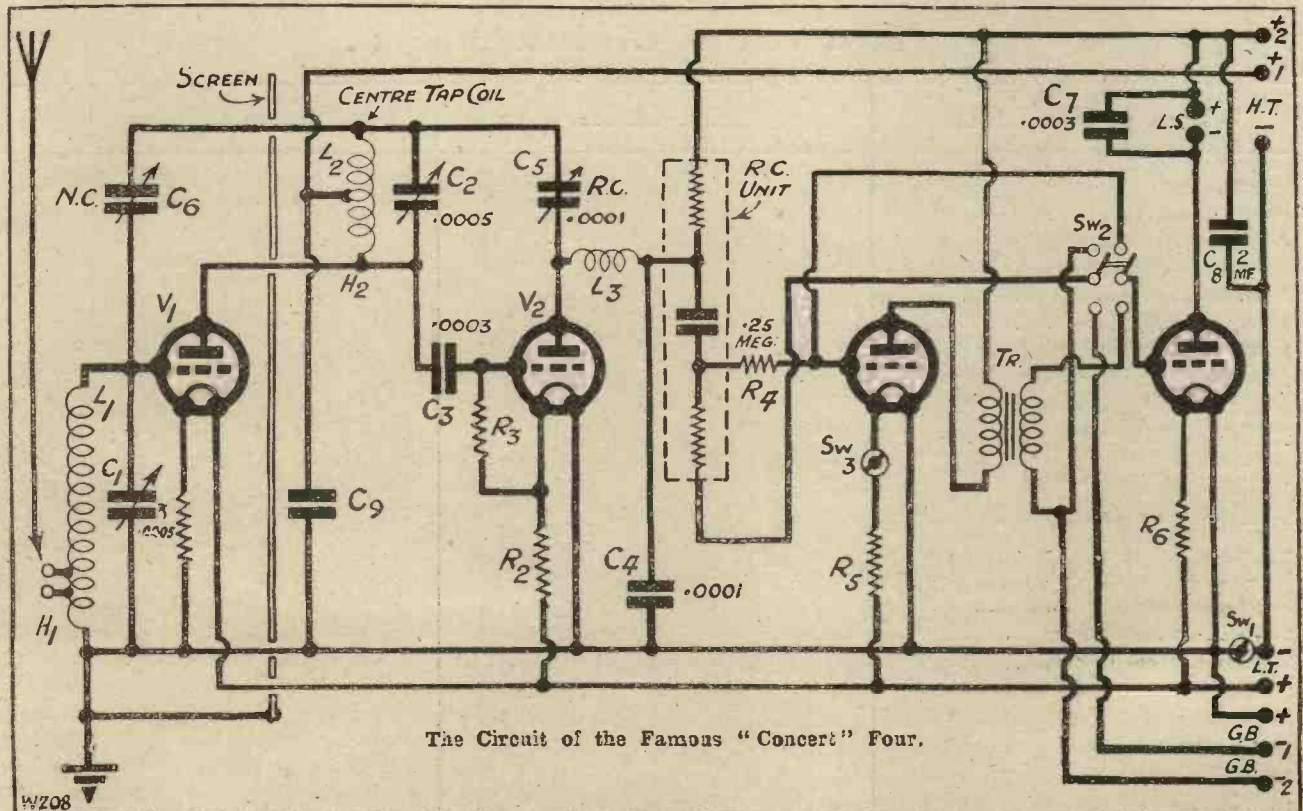
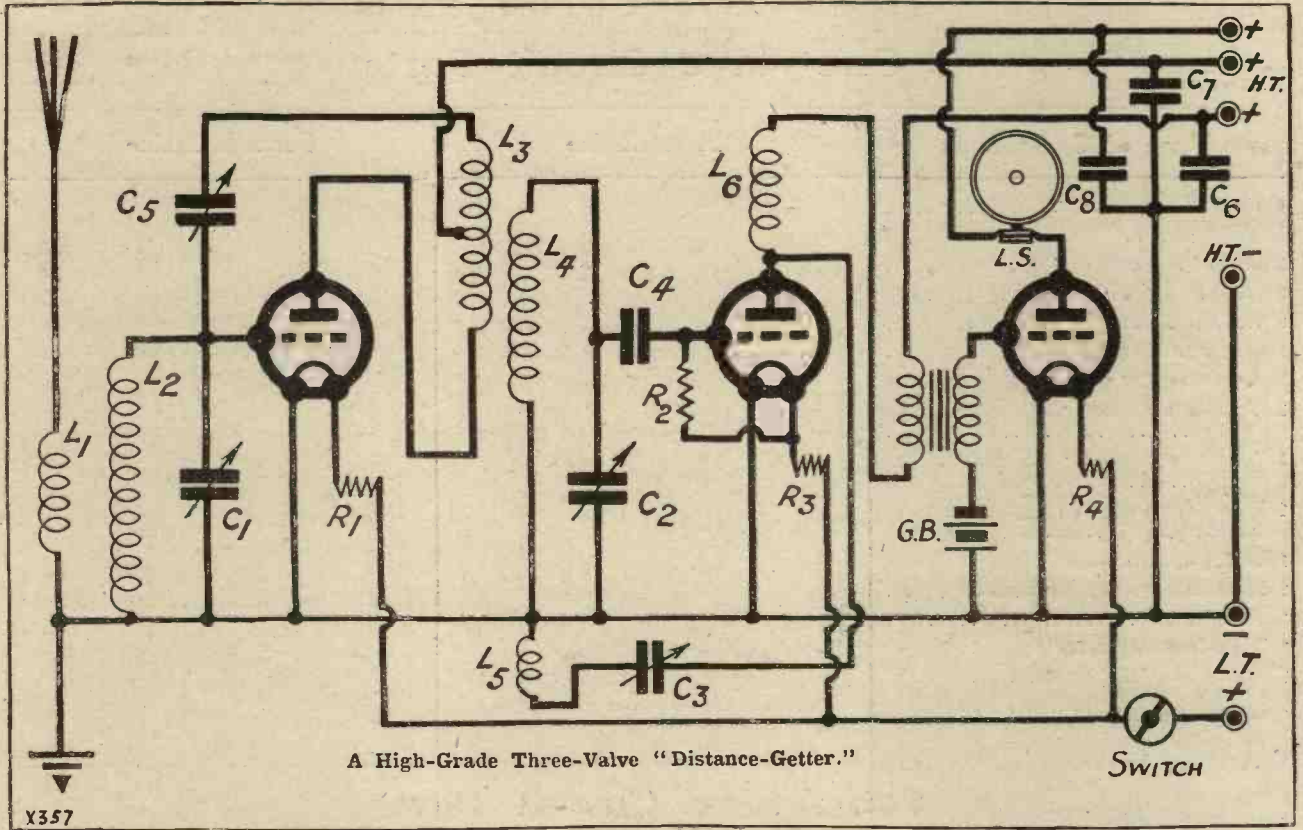

The Wireless Exhibition—continued

Three-Valve Circuit Parts

Type of Component	First Choice	Second Choice
Cabinet		
Panel		
Panel brackets		
1 Six-pin aerial coil for each wave-band (L ₁ , L ₂)		
1 Split-primary transformer for each wave-band (L ₃ , L ₄ , L ₅)		
2 Six-pin bases		
2 Variable condensers, .0005 mfd. (C ₁ , C ₂)		
1 Variable condenser, .0003 mfd. (C ₃)		
1 Neutralising condenser (C ₅)		
3 Valve holders (V ₁ , V ₂ , V ₃)		
3 Fixed resistors (optional) R ₁ , R ₃ , R ₄		
1 Fixed condenser, .0003 mfd. (C ₄)		
1 Grid-leak holder		
1 2-megohm grid leak (R ₂)		
1 Radio-frequency choke (L ₆)		
1 Low-frequency transformer (Tr.)		
1 On-and-off switch (Sw.)		
3 Mansbridge type condensers, 1 mfd. (C ₆ , C ₇ , C ₈)		
Terminal strip and terminals		
Accumulator		
High-tension battery		
Grid-bias battery		
Loud speaker		

Four-Valve Circuit Parts

Type of Component	First Choice	Second Choice
Cabinet		
Panel		
Panel brackets		
2 Variable condensers, .0005 mfd. (C ₁ , C ₂)		
2 Vernier dials		
1 Reaction condenser, .0001 mfd. (C ₅)		
1 No. 60 "X" coil (L ₁)		
1 No. 250 "X" coil (L ₁)		
1 No. 60 centre-tapped coil (L ₂)		
1 No. 250 centre-tapped coil (L ₂)		
2 Board-mounting coil holders		
1 Double-pole, double-throw lever switch (Sw ₂)		
2 Push-pull on-and-off switches		
1 Aluminium or copper screen, 8½ in. x 6 in.		
1 Terminal strip		
4 Valve holders		
4 Fixed resistors (optional)		
1 Neutralising condenser (C ₆)		
2 Fixed condensers, .0003 mfd. (C ₃ , C ₇)		
1 Fixed condenser, .0001 (C ₄)		
1 Fixed condenser, .01 mfd. (C ₉)		
1 Grid leak, 2 megohms, with holder (R ₃)		
1 Grid leak, ½ megohm, with holder (R ₄)		
1 Radio-frequency choke (L ₃)		
1 Resistance-capacity-coupling unit		
1 Good low-frequency transformer		
1 Mansbridge type condenser, 2 mfd. (C ₈)		
Accumulator		
High-tension battery		
Grid-bias battery		
Loud speaker		

THE NEW "RADIANO" WIRING SYSTEM

By PERCY W. HARRIS, M.I.R.E.

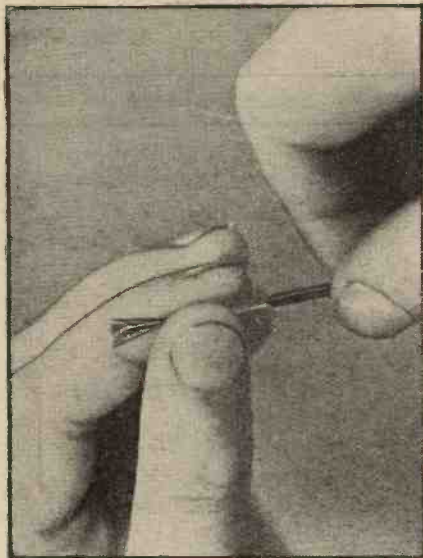

The first stage of the proceedings.

IN this year's "Radiano" set, instead of using flexible leads terminating in pinch-on tags, we have adopted a method which gives still better electrical contact and prevents any lead coming adrift once it has been secured in position.

Take, first of all, a reel of flexible rubber-covered wire, place the receiver, with all components, in position in front of you, and have on your left the wiring chart.

For your first connection—say that from the aerial terminal to the fixed condenser—measure off the wire length by holding the flexible wire between the two points. Now add two inches or so to this length and cut off the wire from the reel.

The Second Stage

The next step is to bare each end for about an inch and a quarter, twist the lead between the fingers, as shown, bend round the bared end so as to grip a loop with the fingers, give the loop a single twist, and then twist it still farther by inserting a thin pencil, a small piece of wood, or any round object, so as to make a tight and perfectly round loop of a size which will just go over the terminal. A finished loop is shown in one of the photographs. Complete the process at the other end, and you have a lead with two loops, each of which will fit over the terminal shank and can be secured in position with the greatest of ease, making a firm and sound joint.

Proceed from one point to another according to the wiring chart, making the leads long enough to pass round any obstacle, but short enough to prevent them being too loose and "floppy."

Check Your Wiring

As you make each connection, mark it off with a coloured chalk on the wiring diagram so that you can see which leads still remain to be done. By making the leads in this way one avoids all careful bending

of wires to templates, all laboriously made loops in exactly correct positions, and many of the difficulties which accompany some of the systems which have been put forward for wiring sets without soldering.

True, the appearance of the set wired in this manner is not so neat as with stiff wire, but the electrical efficiency will not be found to suffer, and the whole of the "Radiano" Four can be wired up in this way in an evening.

Additional diagrams are given to show just how to join the leads to the switch points, and an examination of the photographs will also aid in the wiring.

The Screening Box

With regard to those components which are mounted on the base-board within the box, a good deal of this wiring can be done before this inner base-board is placed in position.

It is a good plan where leads go out of the box to allow more than the length actually required, and to make the loop only at the ends where they join the components in the box making the other loop after.

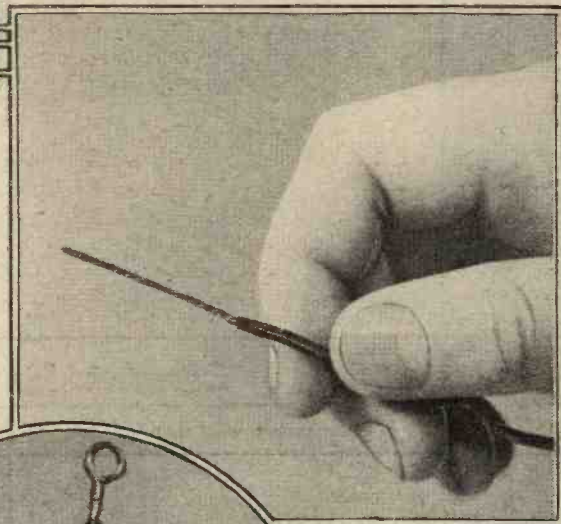

Above: The wire twisted and ready for looping.

Below: Twisting the loop to make it firm, and (left) the finished job.

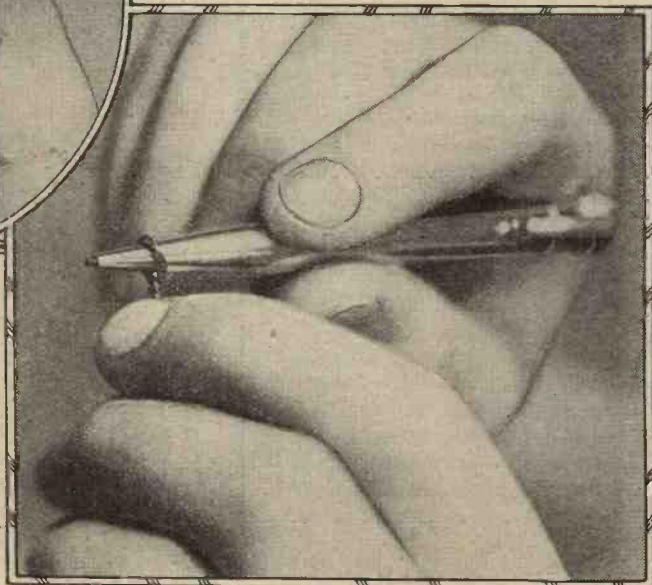
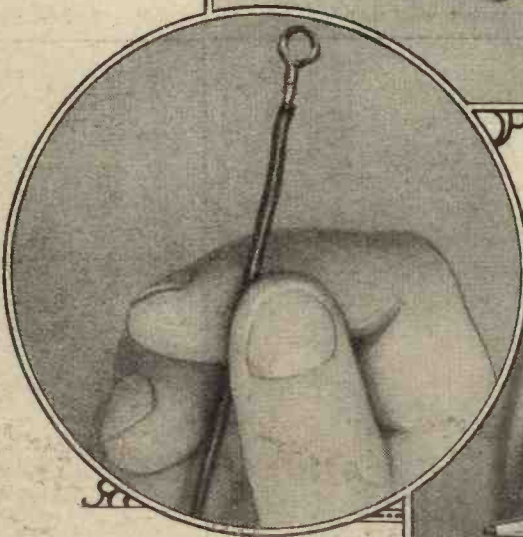

The "RADIANO" FOUR

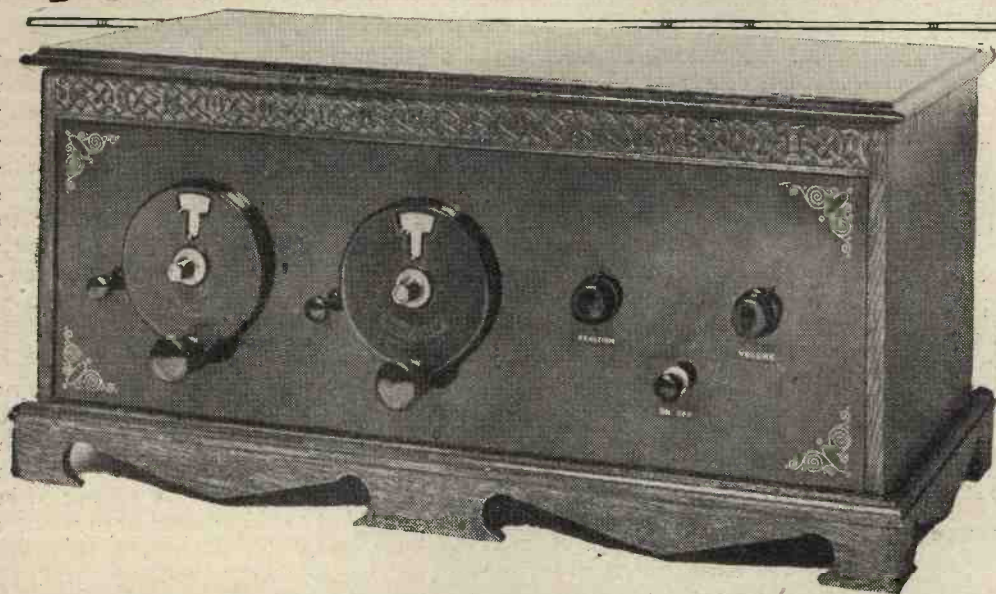

by
**PERCY
W.
HARRIS
M.I.R.E**

Following the success of the "Radiano" Three, the design of a four-valver using the special "Radiano" wiring scheme provides a set that goes a step further in sensitivity and efficiency.

THE great success of the "Radiano" Three, which shows no sign of diminishing, has brought an insistent demand for a four-valve set with one stage of high-frequency preceding the detector, and possessing the same features of simplicity in construction which had so much to do with the popularity and success of the original "Radiano" Three. It would, of course, have been simple to have published a four-valve design soon after the three, merely preceding the detector valve in the original set with a stage of neutralised high-frequency, but while this would doubtless have satisfied many readers, the good name of the original "Radiano" Three was a valued possession to be carefully guarded, and we had no desire to attach the word "Radiano" to a four which was not in itself as distinctive and as interesting as the original three.

Unique Wiring

The unique wiring system used in the "Radiano" Three, wherein flexible rubber-covered wire is adopted, enables the possessor of a "Radiano" set to change any one component for an improved model without upsetting the rest of the receiver.

Thus with the arrival of a new variable condenser of improved design, a better low-frequency transformer, an improved valve holder, or any other component which the experimenter desires to incorporate in his receiver, it is but the work of a few moments to substitute it for the

original model, and thus keep his set right up to date as far as component parts are concerned.

TWELVE STAR FEATURES OF THE "RADIANO" FOUR.

- No coils to change.
- Screened-grid high-frequency stage.
- Panel switch changes instantaneously to long waves.
- Standard plug-in coils used.
- Perfect volume control.
- Six degrees of selectivity at choice.
- No soldered connections.
- New wiring system.
- Will take single- or double-ended screened-grid valves.
- Works perfectly on 2-volt valves.
- Output filter incorporated.
- Low cost of construction.

It was my desire that the "Radiano" Four should not only be novel and distinct in its make-up, as well as

sound in its theoretical design, but that it should be of a type that will be likely to remain standard for a considerable period after publication, just as has the "Radiano" Three. In planning the "Radiano" Four in the laboratory the following features were set down as desirable if not essential:

1. A sound circuit not dependent upon any trickiness for its operation and enabling a wide range of components to be used so that the reader need not be tied down to any one make.

High Efficiency

2. High selectivity (preferably variable) to suit modern conditions.
3. No coil changing, so that the reader could switch from the medium to the long wave-band without even lifting the lid of the cabinet.

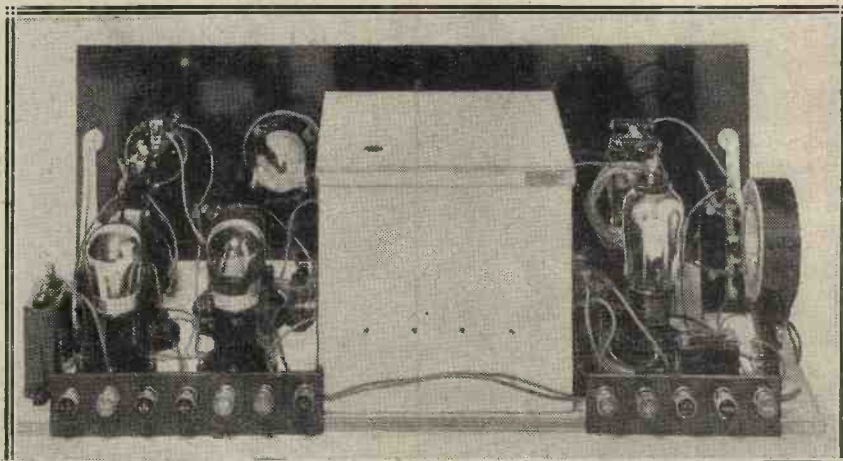

A general view of the new "Radiano" Four, showing the valves and coils in position.

The "Radiano" Four—continued

4. First-class tone quality.
5. High efficiency, not only on 6-volt valves, but on 2-volt, for the benefit of those who find the 2-volt valves suit them best.
6. High efficiency in the high-frequency stage, preferably by the use of a screened-grid valve.
7. Smooth and adequate volume control so that there should be no distortion in the reception of the local station even when fully tuned in.
8. The incorporation of an output filter for the most satisfactory operation of super-power valves when required.

Handsome Appearance

9. The use of reasonably priced standard components with no special or expensive hand-wound or high-priced commercial coils.
10. The utilisation of as many existing parts as possible for the benefit of those who were desirous of making the set without spending too much on new parts.
11. Satisfactory operation entirely from the mains where necessary.

12. A handsome appearance and a low cost of construction.

In the list of desirable characteristics given above no mention is made of solderless connections, simplicity of construction and ease of operation, as these are considered fundamental "Radiano" points which would have to be incorporated in any case.

Looking over this list it will be seen it presents a number of what may be considered formidable problems. Many experiments were made and many schemes in turn rejected. The final design of the receiver did not begin to take shape until the middle of this year, when each of the twelve points had carefully been considered in relation to the others. Now, as the result of much labour and numerous careful tests, the "Radiano" Four is presented to the public with every confidence that it will be a receiver not only of unequalled all-round performance, but of a type which is very badly needed and which is destined to prove exceedingly popular among all classes of users.

So many matters of interest arose during the experiments that it may

be well to deal with the points one by one, as well as with the reasons which led to the particular scheme finally decided upon. Point No. 1—the selection of a sound circuit with no trickiness in its operation and a wide range of components—led us naturally to the circuit with one high-frequency valve, a detector and two low-frequency stages.

No Neutralising

The use of a screened-grid valve as the high-frequency 'magnifier' meant that there would be no trouble in neutralising—one of the points which had given a good deal of trouble in the past to the inexperienced wireless set user.

Point No. 2, relating to high selectivity, is very important, particularly as the use of a screened-grid valve in the normal type of circuit, as recommended by the makers of these valves, generally furnishes a set which is far from being selective. In the "Radiano" Four, six degrees of selectivity are obtainable on either wave-band, so that wherever the listener may be situated he will have a variety of stations available without interference from one another. The particular degree of selectivity is decided upon when the set is first put into operation, and no further alteration is necessary.

The Switching Scheme

Point No. 3 was one of the most difficult of all to settle. It should be remembered that whatever switching scheme is chosen, it had to be one in which every connection could be made by means of a terminal and not a soldering lug, while, as we desired to keep the efficiency as high as possible throughout, the use of long leads in the high-frequency portion of the circuit was debarred.

The scheme ultimately decided upon is quite novel, very simple and highly efficient. It consists in using two double-pole, double-throw switches of the "push-pull" variety, two pairs of standard plug-in coils and two pairs of standard base-board-mounting coil sockets. The first pair of coils are the well-known "X" variety, and the second pair the equally well-known centre-tapped coils. Not only are these available everywhere in several makes, but a large number of readers will have

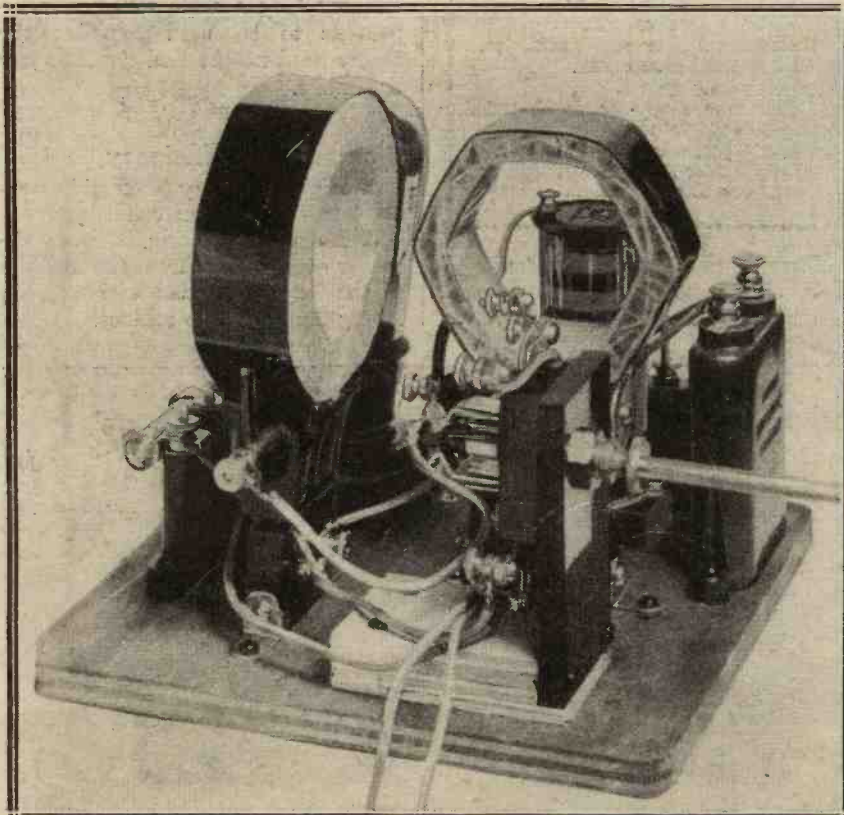

A photo of the screening-box baseboard showing how the second switch is mounted, and the fitting of the extension handle rod.

The "Radiano" Four—continued

them already in their possession, particularly those who have been in the habit of building the sets described from time to time in the WIRELESS CONSTRUCTOR.

Easily Arranged

In the aerial circuit the earth and filament connection is permanently made to both coils, the double-pole double-throw switch changing over the tap on one coil to the tap on the other, and the grid connections of the valve from one coil to the other. In the anode circuit of the high-frequency valve a similar D.P.D.T. switch changes over the connections which go to the two ends of the coil, the centre-tap connection on both coils being permanently in position and joined to H.T. positive. The circuit used is somewhat similar to that adopted in the highly popular "Concert" Four (WIRELESS CONSTRUCTOR ENVELOPE No. 2, 1s. 6d.), anode tuning and reaction on the tuned-anode coil being obtainable with only one coil.

The switches used require only very slight modification before fitting into this set. It is merely necessary to unscrew the insulated knob operating the switch, and to screw in its place an ordinary 2 B.A. brass terminal. The threaded plunger of the switch passes only half-way into the terminal, leaving the other half of the terminal open.

Switch Extension Pieces

Into this a short length of brass rod is screwed, and the insulating knob which has already been removed from the switch plunger is screwed in place at the end of this rod. This is clearly shown in the photographs, and as such threaded rod is available at almost every wireless dealer, the constructor can cut the necessary length himself in a few moments, or the complete switch with the length of rod can be obtained from a number of dealers.

By the use of these extension pieces it is possible to place the switches close to the coils and to operate them from the front of the set. There are two switch knobs, one by each tuning dial, and thus they are in the most convenient position for operation. The tuning range is particularly large, for when the switches are pushed in the band of wave-lengths from 200

to 580 metres is covered, while when the switches are pulled out we run from 900 to 2,400 or more (using a .0005-mfd. condenser in each case). Thus on the long wave-band we can listen to the aeroplanes and aircraft stations if we so desire, while the Eiffel Tower station can just be heard at the upper limit of the receiver's range.

Point No. 4, regarding first-class quality, is obtained by the selection of a high-grade resistance-capacity-coupling unit, a good transformer and an output choke, which, incidentally, I find has an important bearing on quality, as by using an output choke battery coupling troubles are largely eliminated. This was tested by using

gave excellent quality. Normally, of course, on a good make of dry battery in good condition there would have been no howl without the filter, but as all dry batteries ultimately deteriorate the incorporation of the filter was decided upon not only for other advantages, but because of this tendency to reduce battery coupling and therefore to maintain the quality at a high standard.

Two-Volt Valves

The point regarding high efficiency with 6-volt as well as 2-volt valves is of no little importance to readers who live in country districts where

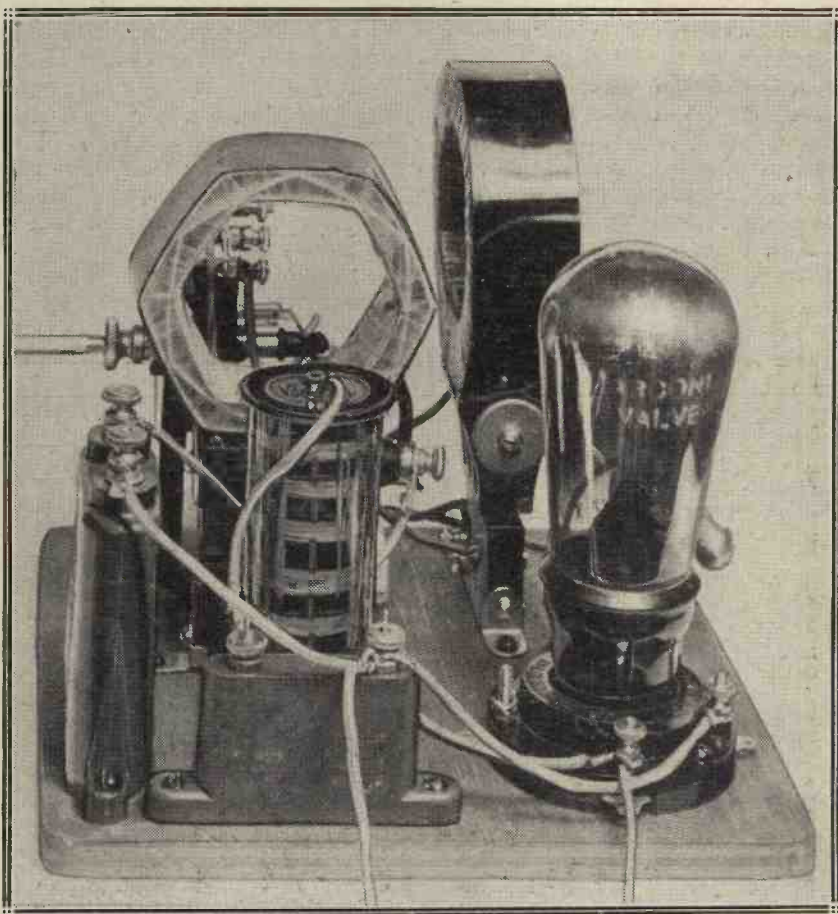

Another view of the baseboard which fits into the screening box and upon which the anode switch, choke, anode coils, detector valve, etc., are mounted.

a very old and high-resistance dry battery for the supply of the receiver, using direct loud-speaker coupling.

In such circumstances the set gave an audio-frequency howl, but by the introduction of the output filter scheme as shown, the howl was immediately silenced and the receiver

there is difficulty in getting the accumulator charged and where the weight of the accumulator itself is of importance. Statistics collected from the various valve makers show that there are far more 2-volt valves in use than of any other voltage, and therefore it was important that the

The "Radiano" Four—continued

"Radiano" Four should be thoroughly successful on 2-volt valves.

Fortunately we now have excellent screened-grid valves of the 2-volt variety made by Marconi, Osram, Mullard, Cossor and Ediswan, while 2-volt output valves of high quality, coming almost into the super-power class, are also now available. All the tests with the "Radiano" Four have been carried out with 2-volt valves throughout, and the results given in this article are those obtainable with such valves.

High Efficiency

Obviously improved results are obtainable with the 6-volt varieties, and those who have such valves and accumulators available are strongly recommended to use them, but the readers who are limited to 2-volt valves may rest assured therefore that the receiver is thoroughly efficient on such valves and will give them full satisfaction.

Point No. 6, regarding high efficiency in the high-frequency stage, is really a matter of set design, and by the use of a screened-grid valve this has unquestionably been obtained.

The volume-control point, No. 7,

voltage applied to the detector valve. In the "Radiano" Four this is done by means of a variable resistance controlling the filament of the screened-grid valve, and when this valve is extinguished, as can be done with the volume control, no signals whatever get through unless a very powerful station is very close to the set, when a slight whisper can be heard.

The Output Filter

Point 8, namely, the use of an output filter, has also been explained above, but here it should be said that not only has the output filter the advantage of reducing battery coupling troubles to a large extent, but also by removing the loud speaker from the path of the direct current flowing in the plate of the valve it enables a higher efficiency to be obtained with super-power valves, while protecting the loud-speaker windings from heavy currents, which would otherwise pass through it. The choke and condenser method is used here in preference to the transformer.

Point No. 9, relating to the use of standard components with no special or expensive coils, is of most importance in the design of a really popular

It is always the policy of the WIRELESS CONSTRUCTOR to design, as far as possible, efficient receivers utilising (very frequently in a new manner) parts already available, and, if possible, obtainable from several makers. Take, for example, the low-frequency transformer. Great Britain is particularly fortunate in having a number of makers who turn out really high-grade instruments, and while one particular make must be chosen when the set is designed, since all makes cannot be incorporated in one receiver, the choice of the particular instrument illustrated must not be taken as meaning that this is the only one for the purpose. Unless it is specifically stated otherwise, any other equally high-grade components can be substituted for those shown.

All Mains Operation

In point No. 10, reference is made to the use of existing parts. A large number of experimenters when building a new receiver like to utilise as many parts as possible from an older set. In the "Radiano" Four this can be done very effectively, and many readers will find they have practically all the parts on hand.

Point No. 11—that the set must be capable of operating entirely from the mains when desired—is completely solved so far as A.C. mains are concerned by the "Stedipower" L.T. and H.T. units which have already been described in our pages.

Incidentally it should be pointed out that the "Stedipower" H.T. Unit is one of the few that it is convenient to use with screened-grid valves, for one can get not only a definite and smooth adjustment of high-tension voltage on the tapping for the screen grid, but can also see on the voltmeter exactly what voltage one is obtaining. The operation of this set from D.C. mains is possible so far as H.T. is concerned, for there is a number of D.C. high-tension units now available.

A D.C. "Stedipower"

On the L.T. side no "Stedipower" unit for D.C. is yet ready, but laboratory experiments are being conducted with such a design, and we hope to publish some results soon. Finally, point No. 12—a handsome appearance combined with low cost has, we think, been satisfactorily effected.

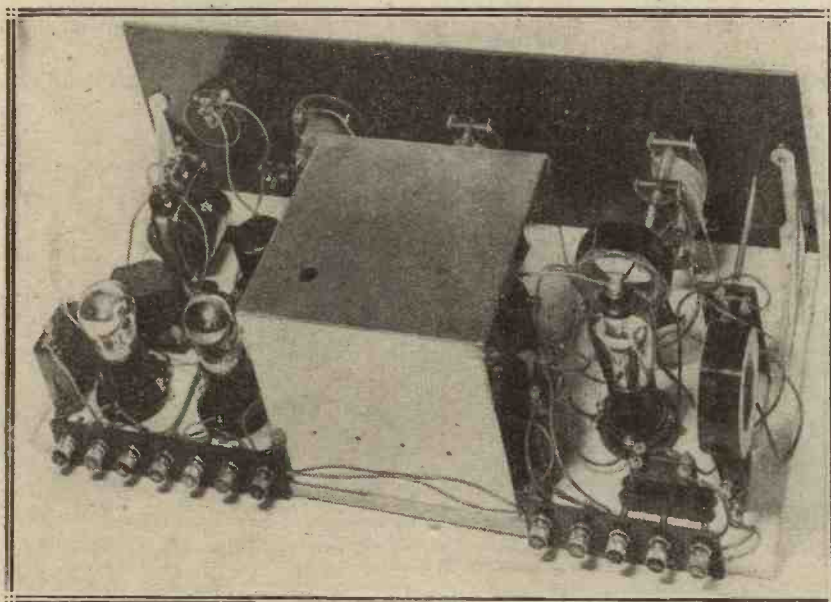

The interior of the set—concealed from general view—is somewhat untidy looking, due to the method of wiring, but this is no real drawback, the simple operation of the set and its extreme ease of construction being very valuable features.

has already been partially explained above, and here it may be said that all experts are agreed that the only really satisfactory form of volume control is one which reduces the

receiver. Every designer worthy of the name can work out a set which will have many advantages provided that special parts are built for it and only these parts used.

BUILDING THE "RADIANO" FOUR

The phenomenal success and popularity of the "Radiano" system of wiring, as illustrated by the famous "Radiano" Three, published last year, has prompted the originator of the scheme, Mr. Percy Harris, to go one better, which he undoubtedly has done in the design of this masterpiece of sets—The "Radiano" Four.

By PERCY W. HARRIS, M.I.R.E.

BUILDING the "Radiano" Four is an easy matter. The wiring method described on another page is so simple and such a wide range of components is now available that it has not been thought necessary to publish a full-size template of the actual wires, as these can be cut as one goes along by a very simple method of measurement which will be described a little later. Incidentally it may be mentioned that the "Radiano" wiring system using rubber-covered wire possesses the following great advantages.

1. Careful bending of wires and loops to exact shape and size is entirely obviated.

2. The change from one make of component to another does not necessitate cutting and making new leads, and while the internal appearance of a set wired under the "Radiano" system is not so pleasing as one wired with stiff wire, "handsome is as handsome does," and those readers who are more skilled in set building will find it very simple to wire up this set with stiff wire if they so desire.

3. There is no need for great accuracy in the length of leads.

Easy to Build

While the constructional work is very simple, it is advisable to follow the lines laid down in this article in order that all of the parts may fit accurately, no matter what make is used.

The first step is to lay out the panel and to drill the holes for the components shown as mounted thereon. The two holes for the plungers of the wave-change switches should be only slightly larger than the rods themselves in order that the panel itself may form a bearing.

Next stand the panel vertically against the front edge of the baseboard and mark out the positions for the two panel brackets. Drill the holes for these and mount the brackets on the panel. You can now stand the panel vertically against the front edge of the baseboard ready for the next step. It is not a

bad plan to secure the two brackets to the baseboard with screws temporarily.

Do not yet mount any of the components on the panel itself, but take the standard screening box and bring it up against the back surface

TWO-HOUR TEST REPORT.

Special Note.—All stations below were received on 2-volt valves throughout. In no case was strength of reception below that which is fully adequate for comfortable reception in a good-sized living-room, and in many cases the volume control had to be used to reduce strength to a comfortable figure. All reception within two hours.

NORMAL WAVE-BAND.

Name of Station.	Reading on second dial.
Stettin	21
Bremen	33
Cologne	35
Belfast	41
*Bournemouth	43
Barcelona	49
*London	54
Union Radio (Madrid)	57
Stuttgart	58
Toulouse	60
Hamburg	61
Frankfurt	68
Rome	71
*Langenberg	75
*Darenty Exp.	79
Budapest	89

LONG WAVE-BAND.

*Hilversum	26
Kalundborg	32
*Zeesen	40
Motala	46
*Darenty	62
*Radio Paris	71
Angora	74
Huizen	77

Readings for first dial will be very similar, but will vary according to which of the six degrees of selectivity is chosen, and the aerial used. Stations marked with a star are receivable in broad daylight in London area.

of the front panel so that the hole in the panel for the second variable condenser comes in the middle of the front of the box. Holding the box firmly in position against the panel take a sharp instrument and scratch through the second switch-hole a circle on the front of the box, so as

to indicate where the box hole is to be drilled.

Now remove the box and drill a large hole in it, using the scratched circle as the centre. A $\frac{3}{8}$ -in. drill will suit quite well. You will find the drilling easier if you stand the box with the surface to be drilled upwards and pack the inside with pieces of wood so that you are pressing on to a block of wood underneath the copper when drilling. This will avoid bending the box. Several firms will supply the boxes with the holes cut if necessary.

The Switch Support

The only other hole it will be necessary for you to drill, and which is not already provided in the standard screening box, is the small hole to take the lead which goes from the plate of the screened-grid valve into the box. This is drilled an inch from the top of the left side of the box and in the middle of that side.

The screening box is provided with a removable interior baseboard, and with this in position you should take a strip of ebonite $1\frac{1}{2}$ in. wide and 3 in. long, and hold it vertically with its lower end pressed against the interior baseboard and its front surface against the inside of the copper box against the large hole which you have already drilled for the switch plunger. Arrange this strip so that the large hole comes on its centre line, and then scratch through the hole in the box with a scriber or other sharp instrument to indicate the position of the hole in the strip which will take the switch itself.

The Extension Rod

When this is marked remove the strip and drill it with a $\frac{3}{8}$ -in. hole for the double-pole double-throw push-pull switch. A similar procedure for marking the position of the hole for the switch for the aerial connections should be adopted, but in this case the ebonite strip will be $1\frac{1}{2}$ in. wide and $3\frac{1}{4}$ in. long. The exact length of these two strips does

Building the "Radiano" Four—continued

not matter provided you get the switch holes in the right places.

Remember that the distance from the bottom of the strip to the centre of the switch hole will be different in the two cases, owing to the fact

copper box, seeing that both holes are level on the panel. Next cut two thin strips of wood about $\frac{3}{8}$ in. or $\frac{1}{4}$ in. thick, and approximately $1\frac{1}{2}$ in. by 2 in., and fasten the two ebonite strips which are to carry the switches

Unscrew the knob of the aerial switch and screw in its place a brass terminal so that the thread on the switch plunger will only go half-way into the terminal. A 2 B.A. terminal is needed, as a 2 B.A. thread is cut

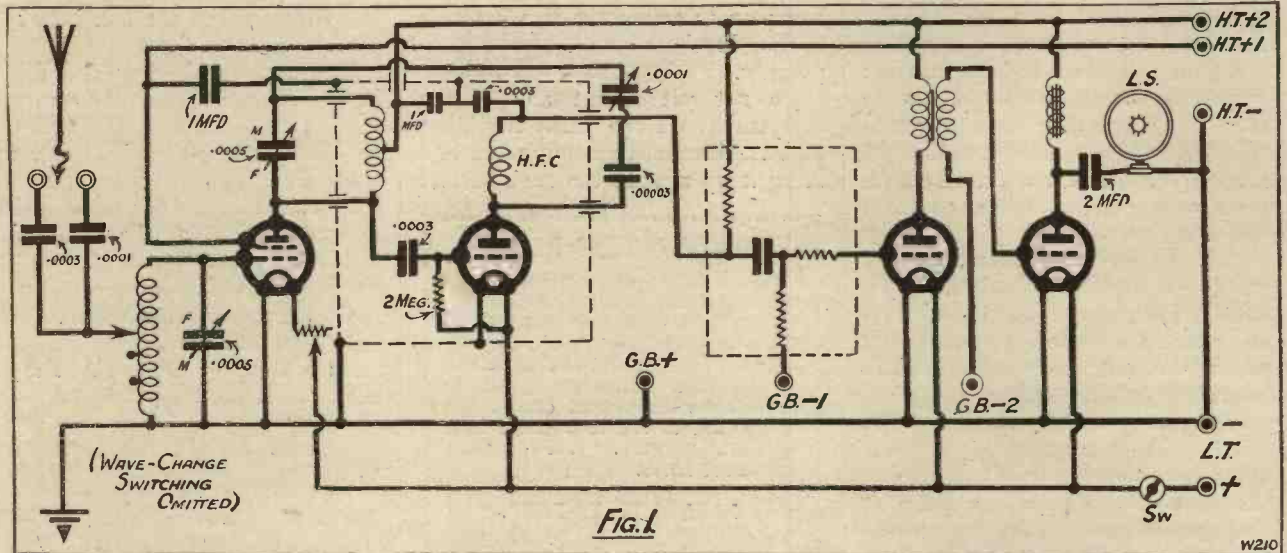

that in the case of the aerial switching the bottom edge of the ebonite strip comes against the main baseboard, whereas with the switch inside the copper box the distance will be shortened by the thickness of the inner baseboard plus that of the

vertically against the front edges of these, and screw them into position, as shown, on the inner baseboard of the copper box and the main baseboard respectively. The correct positions on the baseboards are ascertained as follow.

on the plunger of the switch. Now take a piece of brass rod $4\frac{1}{2}$ in. long and threaded 2 B.A. for a short distance at each end.

Brass rod threaded 2 B.A. for its whole length can be obtained quite easily from any wireless dealer, and

LIST OF COMPONENTS.

NOTE.—Except in the case of the radio-frequency choke (see article), and the special switches, any other high-grade components can be substituted for those used and named. Names in brackets are those illustrated.

Cabinet with 10-in. baseboard (Artcraft). Bond, Raymond, Camco, Caxton, etc.

Ebonite panel, 21 in. \times 7 in. (Resiston, decorated corners). Ebonart, Becol, etc.

2 Vernier dials (Indigraph). Lissen, etc.

2 Variable condensers, .0005 mfd. (Lissen).

1 Reaction condenser, .0001 or .00015 mfd. (Peto-Scott, Cydon, Bowyer-Lowe, etc.)

1 On-and-off switch (Benjamin, Lotus, Lissen, Igranic, etc.).

1 30-ohm panel-mounting rheostat (Lissen). Igranic, Peerless, etc.

2 Double-pole double-throw push-pull switches, with terminals (Lotus).

2 Brass rods, threaded 2 B.A., $4\frac{1}{2}$ in. long.

2 Panel brackets (Magnum). Peto-Scott, Camco.

1 Terminal strip with 5 terminals, 5 in. \times $1\frac{1}{2}$ in.

1 Terminal strip with 7 terminals, 7 in. \times $1\frac{1}{2}$ in.

4 Valve holders (Lotus). Benjamin, Magnum, W. B., Formo, Igranic, Marconiphone, B.T.H., etc.

4 Board-mounting coil holders (Magnum, Lotus, etc.).

2 Fixed condensers, .0001 mfd. (T.C.C.). Lissen, Dubilier, Igranic, Mullard, Atlas, Magnum, etc.

1 Fixed condenser, .0003 mfd. (T.C.C.). (See above.)

1 Fixed condenser, .0003 mfd., with s.p. terminals (T.C.C.). (See above.)

1 Grid leak, 2 megohms (Dubilier). Lissen, Mullard, Igranic, etc.

1 Formodenser, .00003 mfd. max. (Note.—Do not mistake this for .0003 mfd. pattern.)

2 1-mfd. fixed condensers (Dubilier). T.C.C., Lissen, Mullard, Ferranti, Hydra, etc.

1 2-mfd. ditto.

1 Radio-frequency choke (R.I.-Varley). Magnum, Climax, see note in article.

1 Resistance-capacity-coupling unit

(Mullard). R.I.-Varley, Lissen, Dubilier.

1 Grid leak and holder, 250,000 ohms (Not necessary if Mullard R.C. unit is used. See article).

1 Low-frequency transformer (Philips or any of the many high-grade makes now available).

1 Low-frequency output choke (Igranic F., Marconi, Ferranti, R.I.-Varley).

1 Standard screening box, "M.W." pattern (Peto-Scott). Magnum, Camden, Paroussi.

2 Pieces of wood, $1\frac{1}{2}$ in. \times 2 in. \times $\frac{1}{4}$ in.

3 4 B.A. metal screws (cheesehead) and nuts.

About 25 yards rubber-covered, flexible wire (Lewcos). Ward & Goldstone. (Note.—This will allow ample supply for battery leads, etc.)

1 "X" coil, No. 60.

1 "X" coil, No. 250.

1 Centre-tapped coil, No. 60.

1 Centre-tapped coil, No. 250.

1 Screened-grid valve (Cossor, Ediswan, Marconi, Osram, Mullard, Six-Sixty).

1 R.C. type valve.

1 H.F. type valve.

1 Power or super-power valve.

Building the "Radiano" Four—continued

this will do quite well for the purpose. Next, screw the knob which you have removed from the switch tightly on one end, and then insert the rod from the front of the panel through the aerial switch hole, and screw it into the front of the brass terminal which you have fixed on the plunger of the switch itself. A little adjustment will screw both rod into the terminal and terminal on to the switch quite

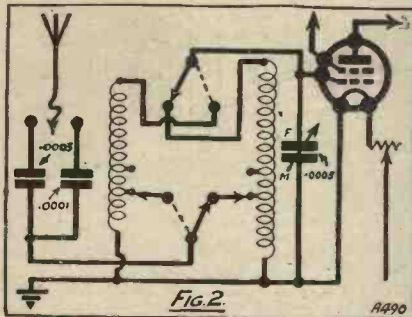

firmly. Push the switch in, and by moving the switch assembly about on the panel you will find the position in which the small baseboard carrying the switch supports can be secured. Screw the small wooden baseboard down to the main wooden baseboard with two small wood screws, and you can remove the rod from the switch until such time as you will permanently mount the panel in position.

Mounting the Switches

To ascertain the position of the switch inside the copper box, place the copper box in position on the baseboard so that its back comes about $\frac{1}{8}$ in. from the back edge, and a line drawn from the second condenser hole to the back of the baseboard runs in the middle of the copper box. The photographs and diagrams will make this clear.

Place the removable baseboard inside the copper box, take another piece of threaded rod, of the same dimensions as before, screw the knob of the switch on one end and pass it as before through the panel, and in this case through the large hole in the copper box. Push the switch plunger in and screw the knob into a brass terminal which has been fitted to the plunger of the switch, and adjust for position as before.

This second switch assembly can now be screwed to the inner baseboard of the copper box in the correct position. Remove the rod, pull it out and remove the inner baseboard

from the copper box, being careful not to move the copper box from its position. The box itself should now be screwed to the baseboard.

Depressions should be made on the underside of the inner baseboard to allow for the heads of the screws which hold the copper box to the main baseboard, otherwise these screw-heads will lift the inner baseboard above the position it should properly occupy.

Further Construction

The various components can now be mounted on the panel and on the baseboard. There are no other critical positions, but you should follow as closely as possible the positions shown in the drawings and photographs. The Mullard resistance-capacity-coupling unit shown has incorporated in it a high-frequency stopping device, and if you use any other make it is advisable to put a grid-leak holder with a $\frac{1}{4}$ -megohm grid leak on the right of the copper box (looking from the front) near to the grid terminal of the first note-magnifying valve.

This $\frac{1}{4}$ -megohm leak should be joined in series between the grid terminal of the R.C.C. unit and the grid of the first note-magnifying valve. The Igranic output choke

used has four terminals, so that the two windings inside can be used in series or in parallel, the parallel arrangement being used in the present set. Other makes of low-frequency chokes or output filters have only two terminals. The wiring up of this set is simplicity itself.

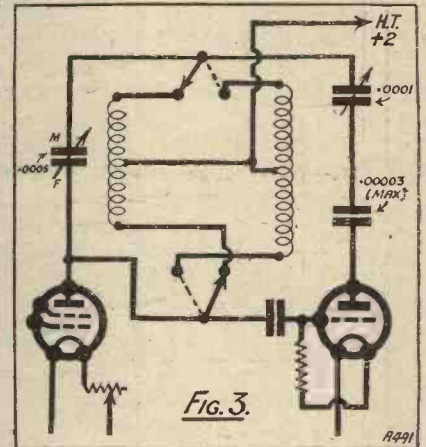

The first valve should be a four-pin screened-grid valve of the 2-volt variety, the detector a 2-volt R.C. valve, the first note-magnifying stage a 2-volt H.F. type, and the output either a 2-volt power valve or the newer 2-volt super-power valve. In the screened-grid valves excellent

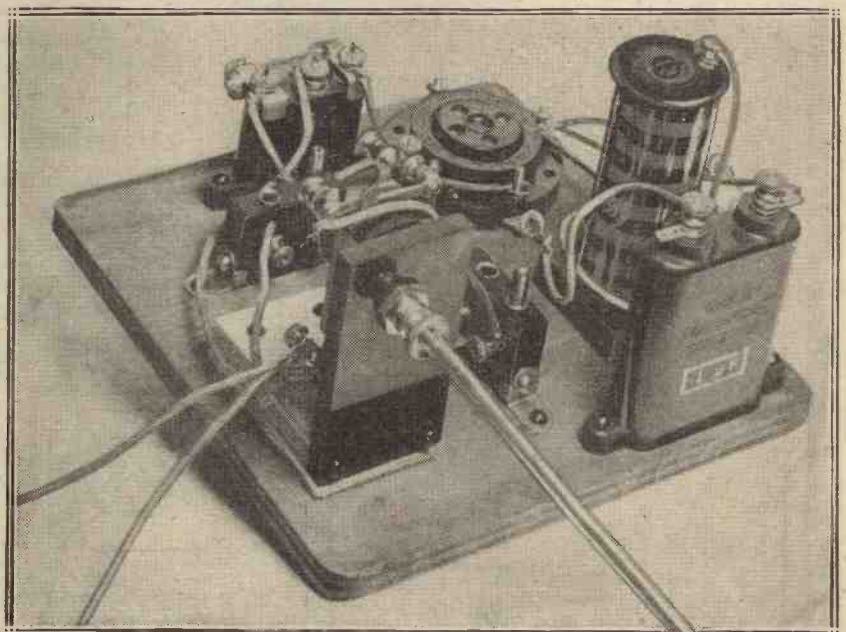

The switch and anode circuit baseboard, which fits into the screening box, must be carefully laid out as shown.

Building the "Radiano" Four—continued

results have been obtained in this set with the Cossor, Ediswan, Six-Sixty and Mullard screened-grid valves.

H.T. positive 1 should have the value given by the makers for the screening grid according to the valve

you use. This tapping only supplies the screened-grid voltage. H.T. positive 2 should have 120 volts. Three volts grid bias will do for G.B.1, and G.B.2 should have the grid bias recommended by the makers

for the particular output valve you use for 120 volts.

As there is no neutralisation to be carried out, one can operate the set directly it is finished. Remember that when the switches are pulled

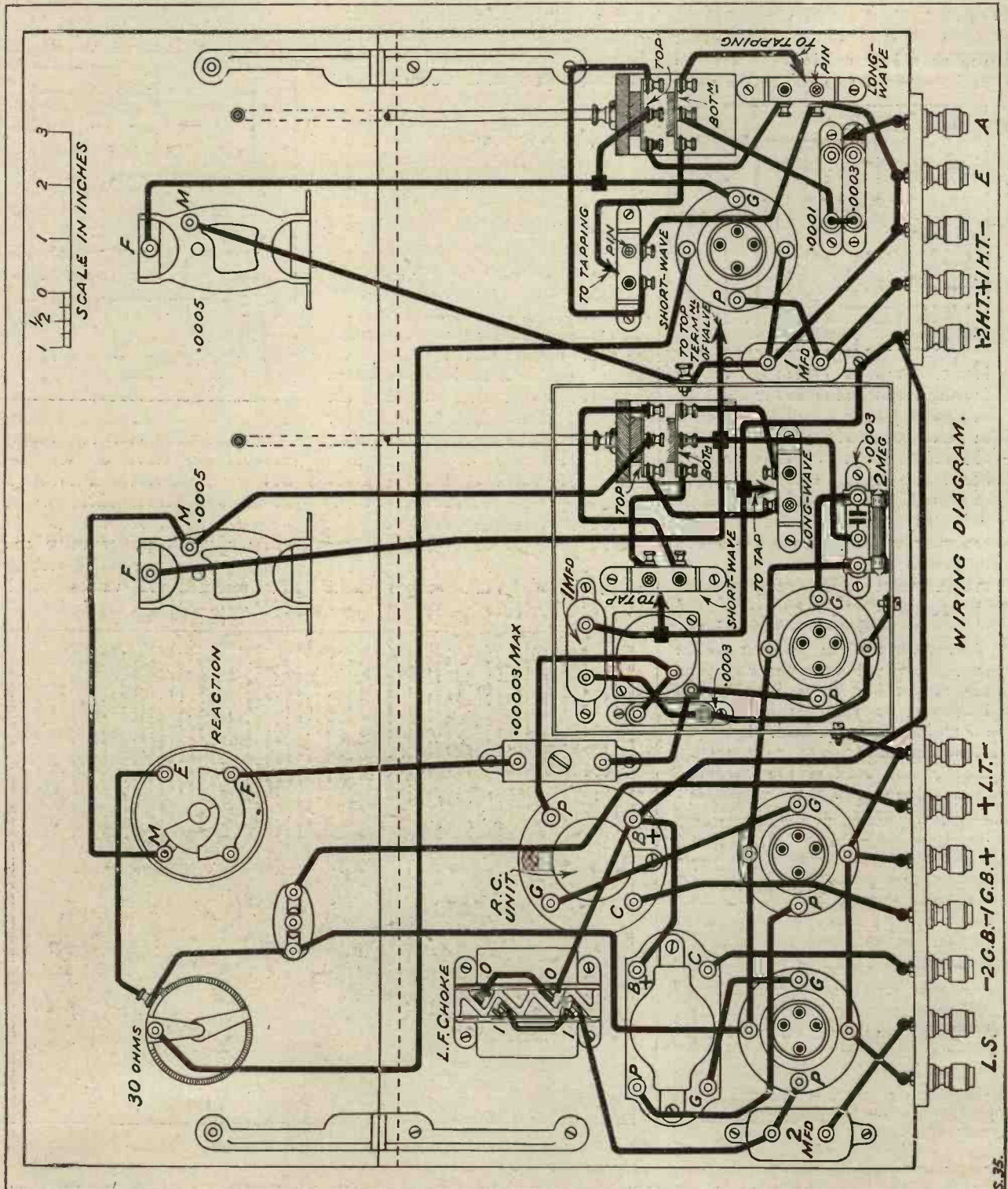

WIRING DIAGRAM.

Building the "Radiano" Four —continued

out you will be on the long wave-band, and when they are in you are on the shorter wave-band. The wavelength ranges are approximately 200

as either tap can be used with any of the condenser arrangements, six degrees of selectivity are obtainable.

high enough use the .0001 condenser instead of the .0003 mfd.

For your first test you should set the reaction condenser at zero and the Formo baseboard condenser about two turns off maximum. Turn the volume control (which is really the filament resistance on the high-frequency valve) to the full on position. You will not find that the two dials will tune exactly the same, as the influence of the copper screening box will slightly alter the tuning of the coils inside that box.

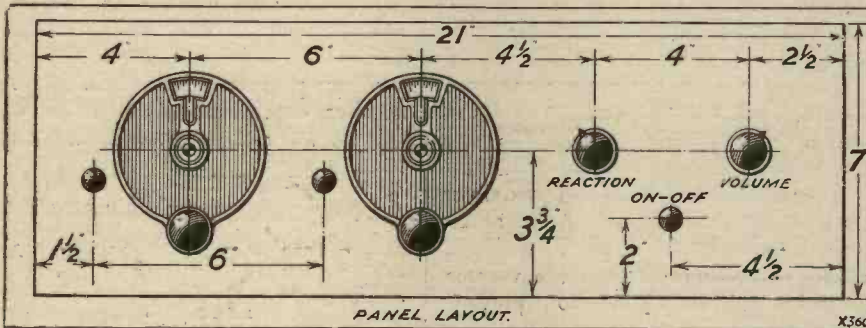

to 580 on the shorter band and from 900 to 2,400 on the longer band.

Selectivity Variations

Six degrees of selectivity are obtainable by taking the lead which goes from the aerial terminal either to the .0001-mfd., the .0003-mfd. condenser, or on to the output side of these two condensers which is connected through the switch to the tap on the "X" coil. Similarly, you have a choice of two tapings on each "X" coil, and

As a start, connect the lead from the aerial terminal to the .0003-mfd. condenser and the lead which goes from the end of this condenser to the higher tapping on each "X" coil. This will give you an excellent degree of selectivity for general work, and if you carry out your preliminary tests in this way you will probably find that the selectivity will be quite good enough for your purpose. If you want it higher, first of all change the tapings of the "X" coils, and if this is not

Volume Control

There is, however, only a few degrees difference, and on some readings they will come approximately the same. Typical readings are given in the test report, and the readings on your own set should be very much the same.

If a station comes in too loud you will find the volume control will give you perfect control of strength without in any way altering the tuning or the quality. In fact, the quality will be improved on using this when a station is nearby, as it will cure any distortion due to overloading your

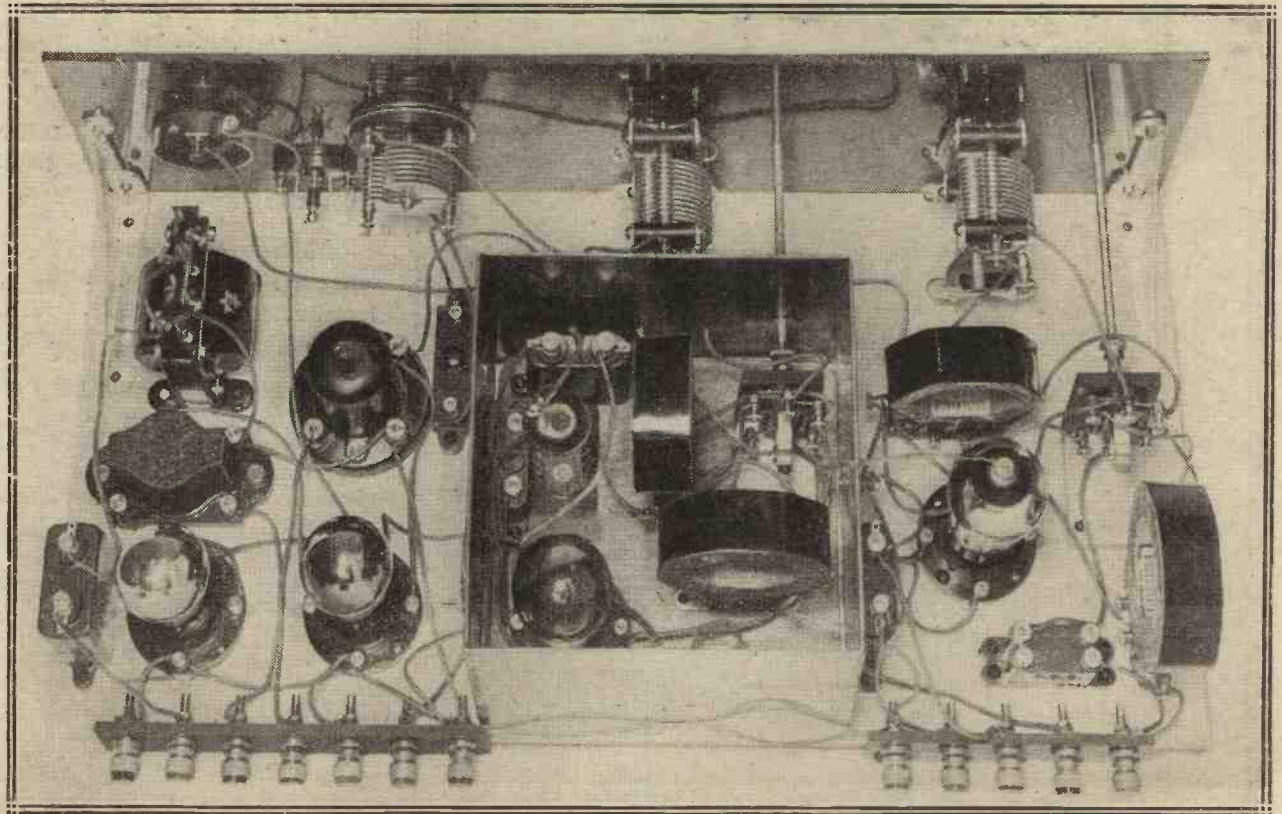

A general view of the "Radiano" Four, showing the screened-grid valve in position and the other valves and coils also ready for work. The lid of the screening box has been removed to show the components inside.

Building the "Radiano" Four—continued

valves. Reaction will only occasionally be used to strengthen signals and slightly to sharpen tuning, but you will get a very large number of stations without any recourse to this.

High Sensitivity

If you wish to use this set with 6-volt valves and the double-ended type of screened-grid valve, the only alteration necessary will be to take a flexible lead from the H.T. positive terminal to a spring clip, and clip this on the screening-grid pin, which will now go on top of the valve. Another clip should be attached to the plate lead. You need not trouble to remove the existing connection which goes to what is normally the plate terminal on the valve holder,

as there will be nothing in this particular socket when the double-ended valve is used.

No other changes of any kind are necessary, so that the set is equally utilisable with the single, or double-ended screened-grid valve. The test report does not indicate all the stations which have been received on this set, but only those received in a relatively short period on one evening. Extremely high sensitivity is obtainable on both short and long waves, and using the outside aerial at Wimbledon, 5 X X, Radio-Paris and Hilversum all need the volume control in daylight to prevent overloading the valves.

One of the most astonishing experiences with the set when it was first put on test was the remarkable

strength of signals received from Angora, Turkey, on the long waves. This was so loud that the volume control had to be used to reduce distortion.

For those who desire to use the ordinary type of H.F. valve and not the screened grid, a special article will be provided next month. A number of further useful notes on this set will also be given in the next issue.

 * THE "RADIANO" *
 * THREE *

SIR,—Having built the "Radiano" Three a few weeks ago, I thought I would let you know some of the results obtained from same.

With London coils, I have tuned in fifteen stations on loud speaker. All German stations, Radio Toulouse, and a Spanish station come in exceptionally loud, but are subject to fading. (I use flat coils on cardboard formers, instead of those stated in book, and find these give greater volume on foreign stations, though not quite so selective.)

Have had splendid results on short waves, down to 15 metres. Stations received are as follow :

With coils stated in book : K D K A (very loud), Nauen (testing), Radio LL (loud speaker).

Melbourne Received

With Igranic coils (No. 2), aerial, 4 turns, and (No. 4) reaction, 9 turns, No. 2 tapped off at 3½ turns, with small flat coil for choke, and variable grid leak set practically at zero, I get 2 X A F, 93° on condenser, at full loud-speaker strength. 3 L O, Melbourne, comes in at 72.5°, with 2 N M, Caterham, at 92°, and I can oscillate down to 70°.

By placing a small neutralising condenser in series with aerial and shorting three turns of reaction, I get 5 S W on loud speaker at 42.5°. By further shorting another turn on reaction, I can oscillate down to zero. Valves used are three Cossor general-purpose, 2 volts.

Yours faithfully,
 SYDNEY W. H.

Kent.

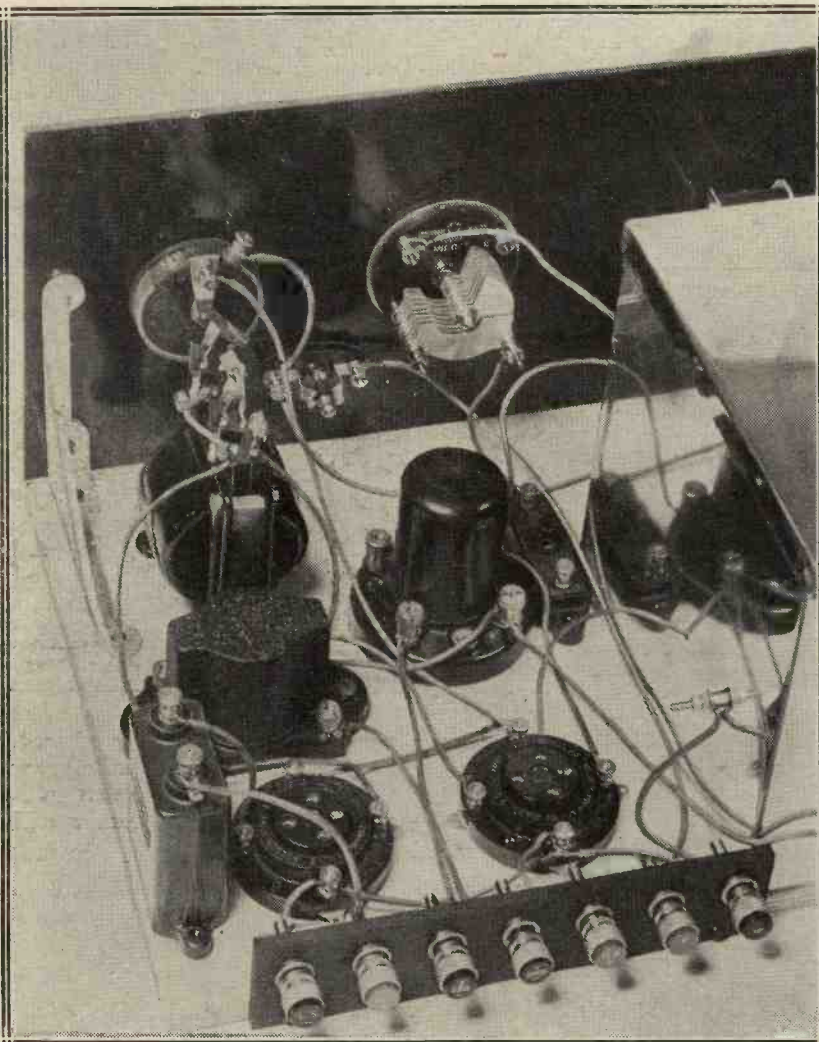

The L.F. end of the set. Note how easy the wiring is to connect up. No soldering is required, the leads just being taken from point to point as required.

TELEPHOTOGRAPHY AND TELEVISION

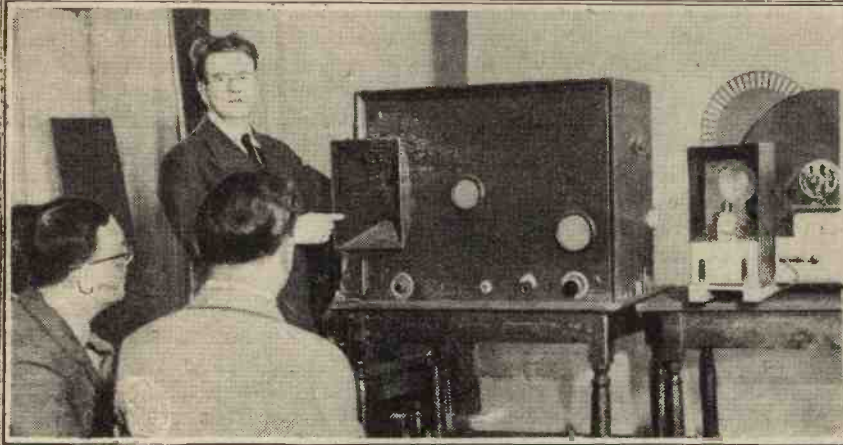

Shall we soon have Telephoto broadcasts, or Television programmes? This question is discussed by

OUR SPECIAL CORRESPONDENT

THE B.B.C. recently stated that it hoped to begin an experimental service of picture transmission early in the autumn. This announcement caused a considerable amount of interest, inasmuch as only a few weeks ago the B.B.C. stated that it had definitely decided not to experiment (in the public sense) with television or telephotography.

But it seems that the engineers of the B.B.C. have had cause to change their minds, and there is no doubt that the progress which has been made in the transmission of still pictures has, during the last twelve months, been very remarkable.

An Experimental Service

Nevertheless, listeners should not count definitely on a regular picture service transmitted from the B.B.C. stations. It is quite likely that some sort of experimental service will be inaugurated in the autumn, but it all depends, of course, how successful the transmissions are, and whether the public responds in the matter of patronising the service by the purchase of the necessary picture-receiving apparatus. In any case, the B.B.C. still seems disinclined to say definitely that their service will be a regular feature.

The B.B.C. has quite rightly pointed out that there is a very great difference between picture transmission and television. Despite the tremendous amount of publicity which has been given to both subjects

of late in the Press, it is still evident that quite a number of people are confused as to the real meaning of picture transmission and television. It may be quite simply expressed thus: that picture transmission is that of still pictures, the process taking several minutes, while television is the transmission and reception of moving pictures instantaneously.

In picture transmission a still picture is transmitted from a station and received on a revolving cylinder,

Mr. J. L. Baird carrying out experiments in shadow-television in his laboratory in Long Acre.

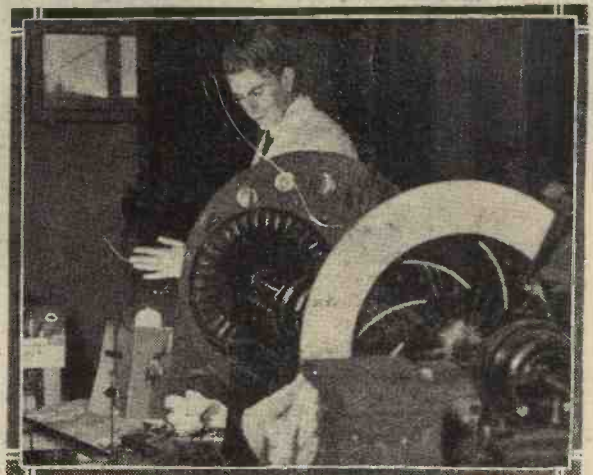

somewhat similar to the early gramophone cylinder. This cylinder is covered with a sheet of sensitised paper, and on it a fairly accurate black-and-white picture can be sent in a few minutes. Listeners possessing such receivers will be able to see the picture gradually coming out at the receiving end and, as the cylinder

revolves, so the picture will be received in more or less detail.

It is quite likely that if the B.B.C. experiments prove successful and adequate receiving instruments are placed upon the market at reasonable cost, listeners will be able to receive in their own homes news photographs, maps, diagrams, dressmaking sketches, picture puzzles, crossword puzzles, and a multitude of other things.

The Fultograph

It is possible that a good many readers, on listening-in to 2 L O and 5 X X after midnight during the past few weeks, have heard peculiar sounds, something like clicks and whistles, etc., and have wondered about them. They have been due to the experimental picture transmissions which have been made by the B.B.C. The B.B.C., of course, will not at the moment say exactly what picture system it is going to adopt. Probably the best known is that of the Fultograph, which is the invention of Captain Otho Fulton, an Englishman who has for some time lived abroad in Vienna, and whose system is the only one in regular use by a broadcasting station, i.e., that of Vienna.

There is a considerable doubt as to whether the average listener is anxious to include in his daily programme the reception of still pictures. Telephotography is, of course, very distinct from television, but it is quite likely that many people will imagine that in due course tele-

photography can be "speeded up" so that regular moving pictures can be received in the home. But the principles of still-picture transmission and moving-picture transmission are very different, and it should not be anticipated that the B.B.C.'s inaugural telephotography experiments are a prelude to a television service.

Telephotography and Television—continued

It has been definitely stated by the B.B.C. that it will have nothing to do with known systems of television because, in the opinion of the B.B.C. experts, television is still in the experimental stage and, consequently, not suitable for public service at the moment. That it will be some day nobody doubts; but it would be as well to get the idea clearly in one's head that television is not for us at the present.

Some Press Correspondence

Regarding television, it has been interesting to note that the "Times" has recently been publishing some correspondence on that much-debated question. Mr. A. A. Campbell Swinton, F.R.S., has contributed two letters to that paper, which have, in themselves, constituted an act of public service, inasmuch as they have considerably cleared up many misapprehensions in connection with television. Although Mr. Campbell Swinton's theories were criticised by Dr. Robinson, Mr. Campbell

say, the head and shoulders of a person from one place to another, the system is exceedingly complicated and, although built up on sound engineering principles, leaves the originators of the scheme very much in doubt as to whether it would offer a hopeful system for broadcasting because of the very great expense it would be necessary to incur.

As the author of the article points out in the "Times," to receive television by the American Telegraph and Telephone Company's method would require apparatus costing hundreds of pounds and, most probably, a staff of skilled engineers to work the set. Consequently, in his opinion—and in the opinion of all those who have taken the trouble technically to study the various systems of television—a home set on these lines is quite out of the question.

Severe Ether Congestion

Why, therefore, asks the author of the "Times" article, are there proposals both in America and this

The author of the "Times" article sums up by saying that, "so far as one can judge from the technical information available, it would appear that the image obtained from a home set would be an exceedingly coarse and horribly distorted affair, and would only be seen at intervals when exact synchronism had been obtained. The service area would be small, and the wave-length channels required very wide."

This latter point is interesting because it is obvious that severe congestion in the ether would be caused.

No Licence Necessary?

A discussion has arisen out of the proposed television service for October which may lead to very interesting developments. An announcement recently appeared in the "Daily Mail" stating that in an interview with the secretary of the company which proposes to start the television service in October, a "Daily Mail" reporter was informed that no licence had been applied for from the Post Office because the company had been informed on high legal authority that television, being a new development, did not come within the scope of the Acts governing the use of wireless in this country.

That view is, of course, a matter of legal opinion; but it is interesting to remember that not so long ago a wireless amateur refused to pay his licence fee on the grounds that listening-in with a modern receiving apparatus was not an offence because he did not purchase a licence. That amateur, of course, as our readers will remember, took his case to Court and lost it!

The Wireless Telegraph Acts

The original Wireless Telegraph Act of 1904 prohibits the establishment of any wireless telegraph station and the installation or working of any apparatus for wireless telegraphy. In 1904, of course, broadcast reception had not been contemplated, and, in the amateur test case above referred to, a doubt arose when the B.B.C. system became established as to whether this original Act of 1904 sufficiently covered the use of broadcast receivers.

This point was settled by the passing of the Wireless Telegraphy (Explanation) Act in 1925, in which

(Continued on page 449).



Capt. O. Fulton (right) with some of his apparatus by means of which still-pictures can be broadcast. (Note that these are "still" pictures—not moving "television.")

Swinton, in reply, very neatly and very conclusively made it quite clear that Dr. Robinson's arguments did not hold water.

Expensive Apparatus

In the "Times" for August 8th, an article also appeared following upon Mr. Campbell Swinton's correspondence, in which it was pointed out that although the American Telegraph and Telephone Company were able to transmit a very faithful picture by television of,

country to sell home sets and to inaugurate a broadcasting service?

Although no full details of the system to be used in Great Britain for the television service promised for October have so far been published, it is fairly clear that in order to make the receiving set simple in construction, all the safeguards that the American Telegraph and Telephone Company found necessary for the reproduction of detail and the maintenance of exact synchronism are likely to be sacrificed.

The Super-Regenerator on Short Waves

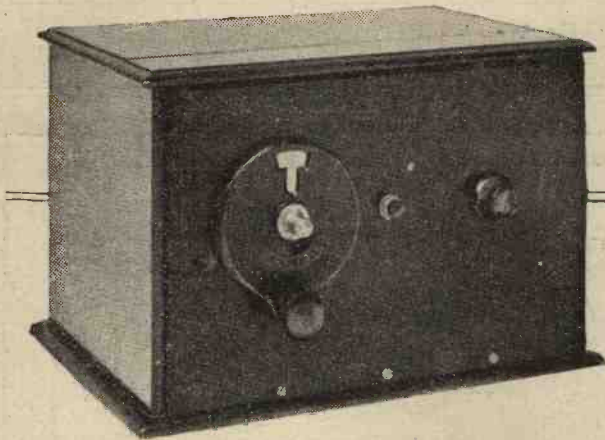

It should be made clear at the outset that the set described in this article is intended rather as a novelty or the opening for a fresh line of experiment by the short-wave enthusiast than as a "first set" for the man who has not,

A remarkably sensitive receiver on which the American stations can be received "almost as loud as they can in the usual way with a detector and two stages of L.F."

By L. H. THOMAS

worrying to those who are not already used to handling a short-wave set of some description or other.

It is mainly a telephony receiver, although Morse may be received quite satisfactorily. The point is

point for receiving C.W. signals. The terms "below" and "above" are somewhat misleading, but express the meaning in a crude sort of way.

Most Sensitive

The point to be brought out is this—that although the very "threshold" of oscillation is the most sensitive condition in which it is possible to operate a receiver, we never do it. This is for the simple reason that it is impossible to make a set stay at this point. The average receiver has quite a smooth control of reaction, as we say, but at the same time there is always a very definite point at which it ceases to be a non-oscillating set and becomes one of the oscillating variety. This is not to be

COMPONENTS USED

- 1 Panel 12 in. × 8 in. × 1/4 in. (Any good branded material).
- 1 Cabinet for above size, with loose baseboard 9 in. deep. (Arterraft, Bond, Cameo, Caxton, Makerimport, Pickett, Raymond, etc.).
- 1 .00025 variable condenser (Marconiphone in set. Any good make).
- 1 "Volume-Control" Clarostat (Louis Holzman).
- 1 On-off switch (Benjamin, Lissen, Lotus, Igranie, etc.).
- 1 Baseboard-mounting rheostat (Lissen or similar type).
- 2 H.F. chokes (Burne-Jones. See text).
- 1 H.F. choke (Metro-Vick or other standard make. Igranie, R.I.-Varley, etc.).
- 2 Valve holders (Redfern or other standard make).
- 2 Baseboard-mounting coil sockets (Lotus or other good make).
- 2 .0003, 2 .0005, and 1 .001 fixed condensers (Clarke, Dubilier, Igranie, Lissen, Mullard, T.C.C., etc.).
- 1 5-megohm and 1 60,000-ohm grid leak (Ediswan).
- 1 Baseboard-mounting neutralising condenser (Igranie or other good make).
- 1 Two-terminal and 1 seven-terminal strip.
- 1 1-mfd. Mansbridge type condenser (Dubilier, Ferranti, Hydra, Lissen, Mullard, T.C.C., etc.).
- Tinned copper wire, wood screws, bolts, etc.

as yet, descended lower in the wavelength scale than the lower of the broadcasting stations.

Quite Different

Although there is nothing freakish about the circuit employed or the operation of the set, it is quite different in its performance from the general run of short-wavers, and is therefore liable to prove rather

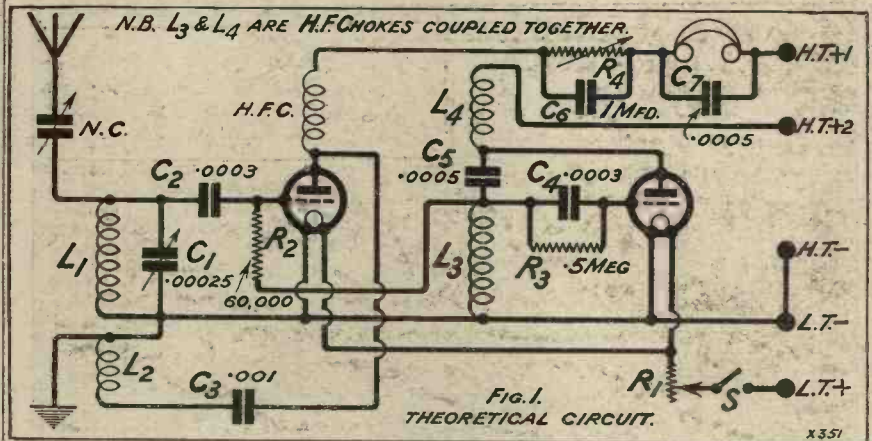

that the benefits of the set show up more on telephony than on anything else.

Many readers will doubtless know by now the principle of super-regeneration. A few words concerning its advantages as applied to short-wave reception will not, however, be out of place.

The ordinary regenerative, short-wave receiver, i.e. the standard detector with reaction, possibly followed by one or two stages of L.F., can be worked in two ways. It is either operating just below the oscillation point for the purpose of receiving telephony, or just above the oscillation

confused with "ploppy" reaction. It is always the case.

Super-Regeneration

If the set is used in the non-oscillating state and we increase the reaction control (whether this is a variable condenser or a swinging coil is immaterial) there is just the merest fraction of a second during which the valve is extraordinarily sensitive; but it is only a fraction of a second, and is gone before we know it is there.

Now, if we slacken off the reaction control again, we encounter another fraction of a second during which the

The Super-Regenerator on Short Waves—continued

valve is super-sensitive, and then we have passed the point and the set is "below" oscillation point again.

I remember reading in an American paper a long time ago a short "popular" article on super-regeneration in which the writer was talking about this super-sensitive point which is not attainable in any ordinary set, and he remarked that if one had the patience and the skill to keep jerking the reaction control across the oscillation point, so as to be continually encountering this spot we have been talking about, he would have produced all the advantages of super-regeneration. But he would have to do it at the rate of something like 10,000 times per second!

An Ingenious Scheme

This gives one a very clear general idea of the principles involved. A super-regenerative receiver embodies some device which keeps it, to all intents and purposes, "standing on the threshold" of oscillation, by causing it to stop oscillating and to start again at a tremendously high

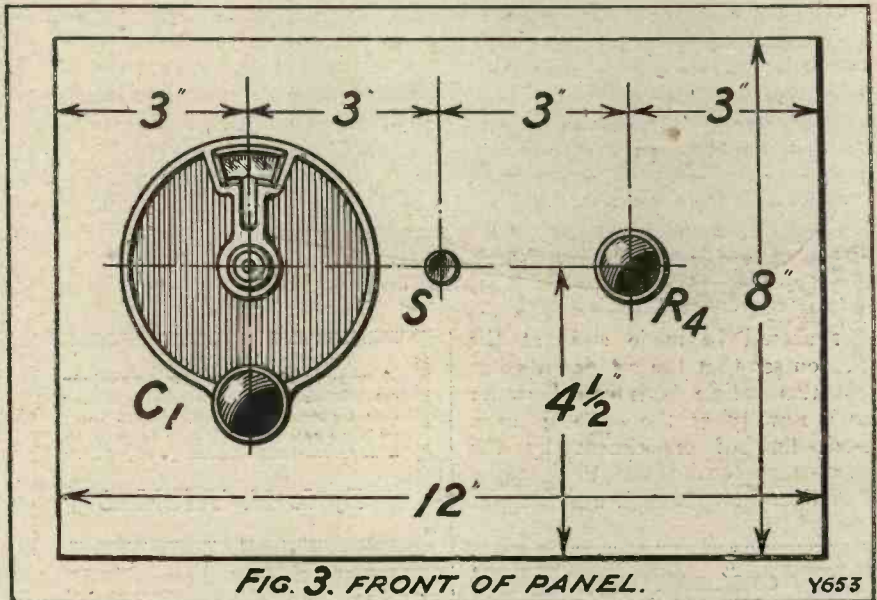

valver, which is controlled by what we may term a "10,000-cycle modulator," which is another valve oscillating on a very long wave-length, corresponding to a frequency of 10,000

it will be seen from the circuit diagram that the short-wave detector circuit is absolutely straight with the exception that the grid leak, instead of being taken down to the filament circuit, is taken to the grid circuit of the long-wave oscillator, thus allowing some of the energy of this latter valve to be fed to the detector.

Thus we are doing the necessary control of the detector by throwing its grid bias backwards and forwards at a sufficiently high rate to draw it in and out of oscillation extremely rapidly. This is a more practical method than a hand- or motor-driven reaction coil revolving at the rate of 10,000 times per second!

The frequency at which this modulator operates affects the sensitivity of the set. The lower the frequency, within limits, the greater is the sensitivity, for if we make it too high the super-regenerative action does not develop at all, or, rather, is cut off before we realise that it is there.

Telephony Specially Good

If, however, we attempt to use a frequency lower than 10,000 cycles it becomes audible (many persons can just hear a note of 12,000 cycles or so as a very high-pitched scream), and we have to arrange all manner of filter circuits and the like to cut out the undesired musical note. Fortunately, for short-wave work 10,000 cycles is quite low enough to be perfectly satisfactory and we do not meet this trouble. If it is audible

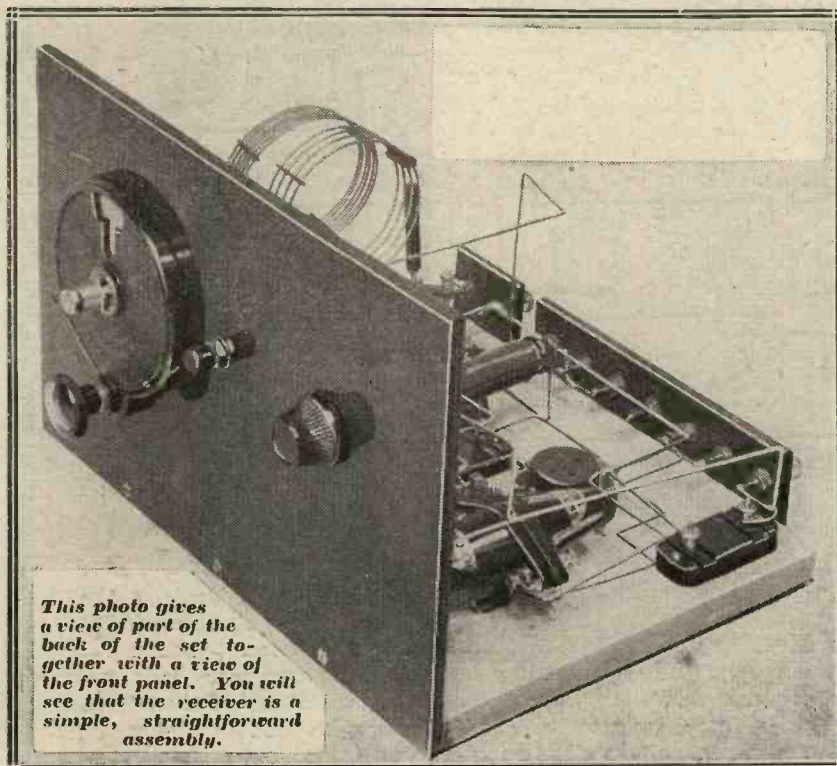

This photo gives a view of part of the back of the set together with a view of the front panel. You will see that the receiver is a simple, straightforward assembly.

frequency. This is probably the very simplest way in which to express a rather complicated principle.

In the receiver described here we have an ordinary short-wave single-

cycles (which gives us 30,000 metres), so coupled to the detector as to cause it to stop oscillating and restart 10,000 times per second.

To come down to practical details,

The Super-Regenerator on Short Waves—*continued*

it is sufficiently high and subdued not to be at all worrying. Probably the actual frequency is somewhat above 10,000 in this set.

With the short-wave detector working under the conditions we have arranged now, it never really oscillates

valve in this case is only to oscillate hard! So great is the sensitivity of the circuit that it makes hardly any difference to the average signal if one removes the aerial altogether and even earths it!

The detector circuit, then, is quite

in this case is a neutralising condenser, which is nearly always worked in the "all out" position.

The grid condenser has a value of .0003, the fixed reaction condenser is .001, and the grid leak (which, it must be remembered, does not operate in the ordinary way) is of 60,000 ohms.

Modulator Arrangements

Turning now to the 10,000-cycle modulator arrangements, it was most happily found that two H.F. chokes could be arranged as the necessary coils for producing the long-wave oscillations. One of the more usual ways is to use a 1,500- and a 1,250-turn coil, but these large coils are bulky as well as expensive, and the neat component produced by bolting two H.F. chokes together is a positive joy to the eye! Magnum chokes were used, and are supported from the baseboard by a small bracket. As a matter of fact, the bracket is supplied with the "Clarostat," which is referred to later, in case one should want to mount it on the baseboard, but as it has been placed on the panel the bracket was used for mounting the "double choke"!

Choke Connections

Note carefully the connections to the two chokes, as shown in the back-of-panel diagram. It should be remembered that the plate and grid of the valve are connected to "opposite

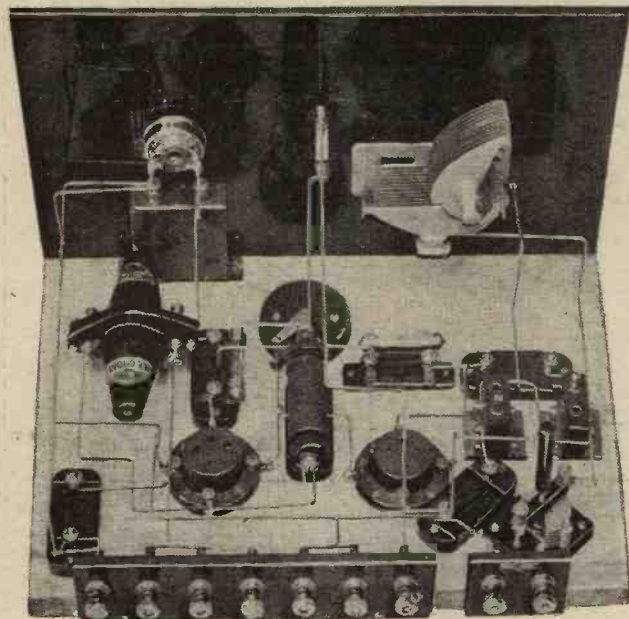

Two H.F. chokes bolted together operate as the low-frequency modulation coupling. They make a neat assembly and are far more compact than the large coils which generally figure in super-regenerative receivers.

lates persistently at all, with the result that we do not obtain the usual beat-notes with C.W. signals and carrier-waves. When the carrier-wave is modulated with speech or music, however, the advantages of the system show up to the full.

For the benefit of the Morse enthusiast it may be stated that there are few C.W. signals which have such a smooth carrier-wave that they may not be read quite comfortably on this set. Any little ripple or noise in the C.W. makes them quite easy to copy, and even the few "dead pure" ones may be read by their clicks, so sensitive is the receiver!

Low-Loss Unnecessary

Turning to the finished receiver, it will be noticed that the short-wave detector has been kept to the right-hand side of the baseboard (looking at one of the rear views), and the modulator valve has been kept separate as far as possible.

Plug-in coils on ordinary bases have been used for the detector. Low-loss coils and condensers are not so desirable as in the ordinary oscillating receiver, since the purpose of the

standard, parallel feed being employed for the high-tension supply, which is conveyed to the anode via a high-frequency choke. The aerial is coupled to the grid circuit through a very small capacity indeed, which

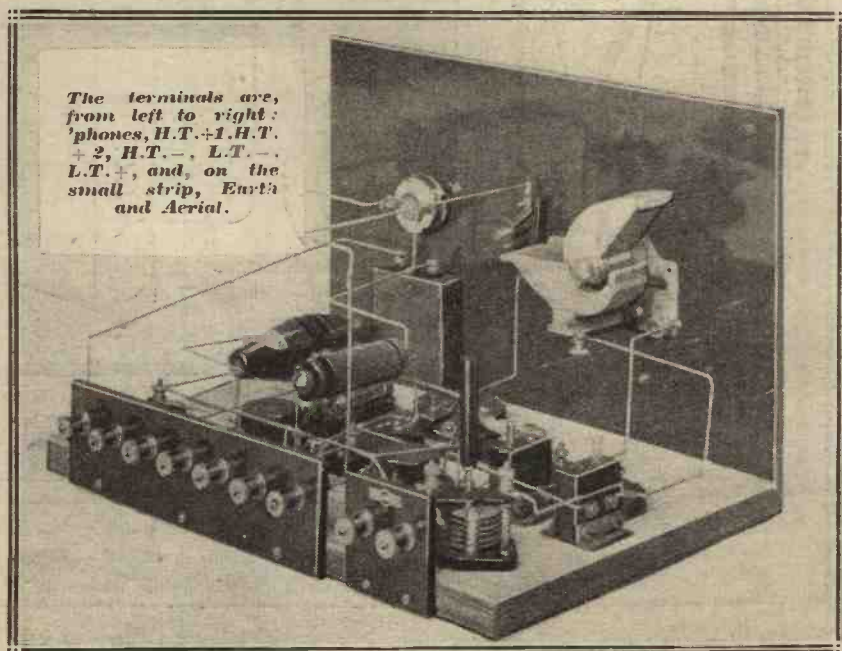

The terminals are, from left to right: phones, H.T. +1, H.T. +2, H.T. -, L.T. -, L.T. +, and, on the small strip, Earth and Aerial.



WIRING DIAGRAM.
FIG. 2.

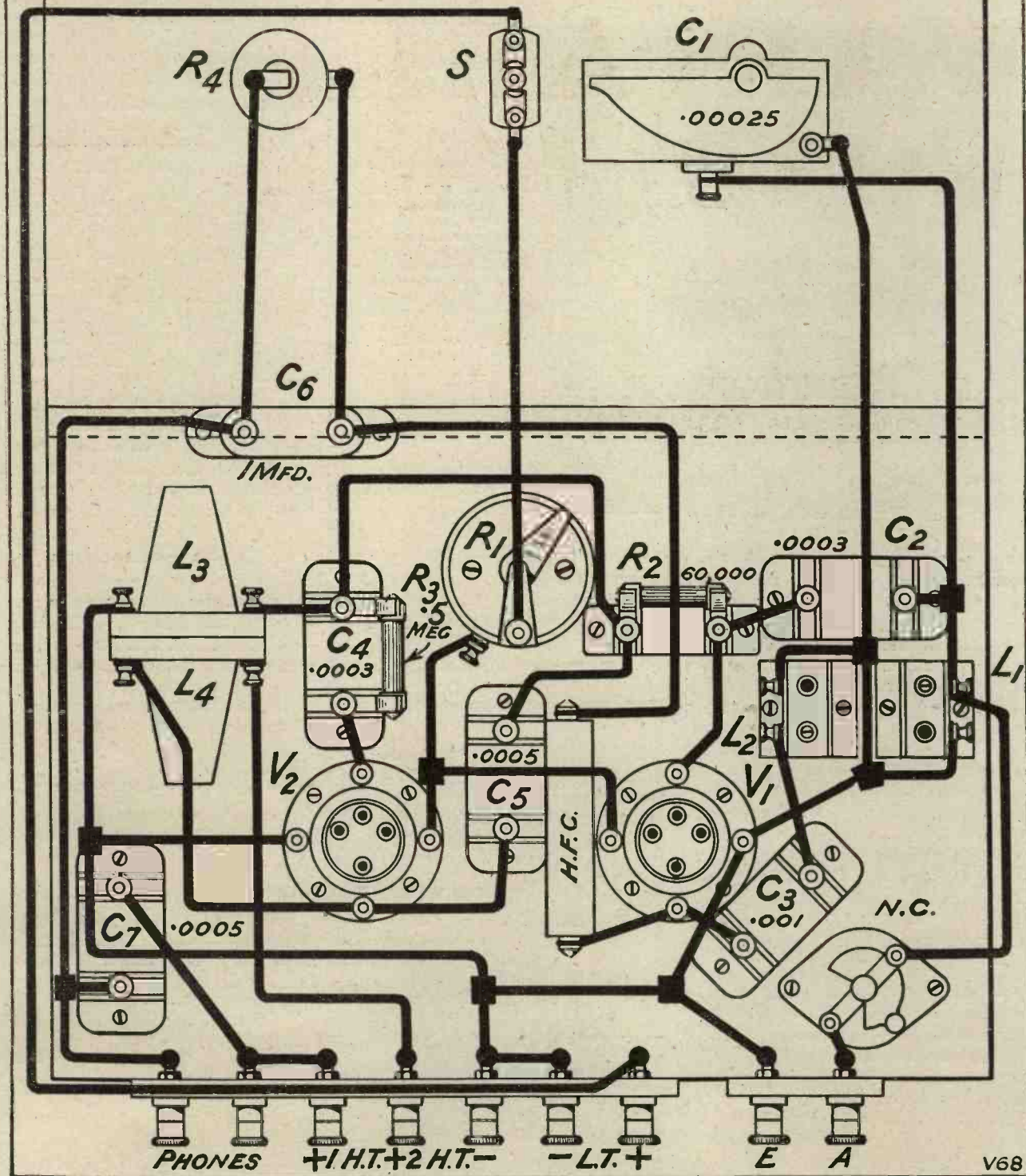

V68

The Long-awaited LISSEN VARIABLE CONDENSER

"The Condenser is one which can be thoroughly recommended."

Mr. Percy W. Harris,
"Wireless Constructor,"
September.

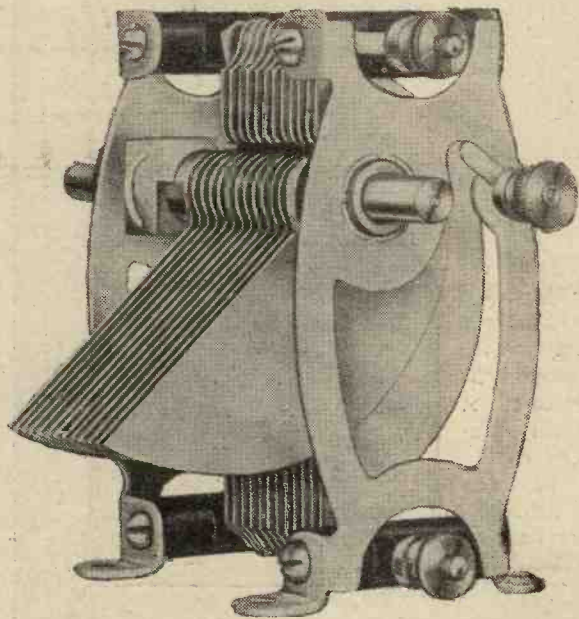

FOR years Lissen have made almost every radio part except an air-spaced variable condenser. Many have wondered why Lissen have so long delayed making a variable condenser of that type. The answer is that Lissen had decided to make only a really low loss condenser which should be without the faults so commonly met with in most condensers and at a price which should be in keeping with the Lissen tradition for fine value. It has taken years for Lissen to make a condenser which at last satisfies every Lissen requirement. But now Lissen has produced a condenser which for fine and facile tuning, for low loss, for universal use, is surely without a rival.

You can use it as a standard condenser in any circuit.

You can gang it—two or three of them together.

You can use a drum control for it instead of a dial.

You can mount it on a panel and it has feet for base-board mounting, too.

·0001 mfd. capacity	- -	5/9
·0002 " "	- -	5/9
·0003 " "	- -	6/-
·00035 " "	- -	6/3
·0005 " "	- -	6/6

You are now able to get a high-grade condenser, offering you advantages you can get in no other condenser, at a price which is so low that users who desire to improve their tuning in existing sets can actually afford to replace their present condensers with this new Lissen. Certainly old condensers will never pay to patch up now that this new Lissen is available. One hole fixing, of course.

And you get exactly the full rated capacity in every condenser

You can get the new Lissen Variable Condenser from most radio dealers. If you have any difficulty, order on a postcard stating capacity required, and condenser will be sent C.O.D. by return of post. Kindly give dealer's name and address if possible.

LISSEN LIMITED,

26-30, FRIARS LANE, RICHMOND, SURREY
(Managing Director : Thomas N. Cole.)

Look for LOTUS at OLYMPIA!

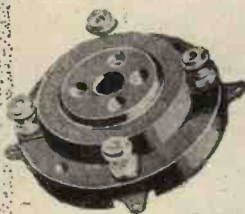
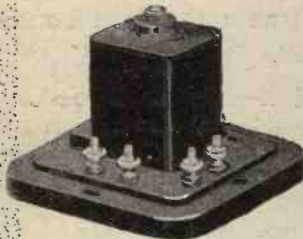
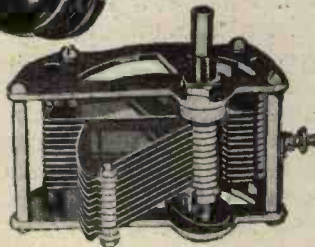

NEW*s at the Lotus Stand!*
Two new components—two new sets being introduced by Lotus!

There is a new Variable Condenser and Vernier Dial, both typical Lotus quality. The condenser is mid-line and logarithmic. It is made with chemically-cleaned special brass vanes and end plates, with ample spacing and ball bearings.

The Lotus Vernier Dial is a slow-motion dial with machine-gear movement giving a ratio of 14 to 1. A closely-marked satin aluminium dial, reading 0-180, fitted to rear, fits flat against panel and a nickel-plated cursor is rotated by small knob round the dial.

The famous Lotus Remote Controls, Buoyancy Valve Holders, Coil Holders, Jacks, Switches and Plugs are also on view.

PRICES:

New Lotus Variable Condenser:		
·0005	5/9
·0003	5/6
·00025	5/3
·00015	5/-
New Lotus Vernier Dial .. 4/9		

COME TO STAND No. 115

LOTUS COMPONENTS

The New
LOTUS
Portable and Transportable Sets

The new Lotus sets are the latest wireless triumph. Using the new Mullard Screened and Pentone valves, the circuit is a combination of latest wireless discoveries and actually makes these three-valve sets capable of five-valve results. Transportable models in oak, 30 gns.; in walnut and mahogany, 31 gns. Portable models in leather case, 30 gns. Instalment terms. Write for booklet.

GARNETT, WHITELEY & CO., LIMITED,
LOTUS WORKS, BROADGREEN ROAD . . . LIVERPOOL.

The Super-Regenerator on Short Waves—*continued*

corners," whatever make of choke is employed, assuming, of course, that both chokes are wound in the same direction.

Note also that the lead from the free end of the detector's 60,000-ohm grid leak is not taken directly on to the grid of the modulator valve but to the other side of its own grid condenser and leak, i.e. to the top of the grid "coil."

The grid condenser on the modulator has a value of .0003, and the grid leak is of .5 megohm. A .0005 coupling condenser is also connected across the two extremes of the coils, i.e. from the anode to the grid end of the grid coil.

Reaction Control

Since it is desirable to have a reaction control on the detector which will not affect the wave-length, this has been arranged by means of a variable high-resistance in the anode circuit, across which a by-pass condenser of 1 mfd. is connected.

Operation is very simple indeed once one has succeeded in making the few original adjustments, which are also perfectly straightforward. A small power valve should be inserted in the modulator socket (V_2), and for the detector almost any general-purpose valve will prove efficient.

Regarding H.T. voltages, about 90 volts on the modulator and 60 on the detector gave best results with the actual set, but other valves and voltages may be used with success, and should, if possible and convenient, be tried.

Having switched on set the variable resistance at a high value, and decrease it slowly until a hiss is heard in the 'phones. Decreasing it farther still below this will probably result in a shrill squeal, and if this occurs it should be re-set to the position that gives the gentle hiss. This adjustment should not be at all critical, and should hardly vary at all with wave-length.

Peculiar Effect

Now rotate the main tuning control slowly, when many stations will be heard. The general effect will not be at all what you expect, most of the C.W. stations merely altering the volume of the "hiss." If this first test is carried out at a time of day when a telephony station is likely

to be working on short waves, try to set the detector roughly to his wave-length, and you should have no trouble in finding him.

Careful adjustment of the variable resistance should show a point at which the telephony is much clearer and more free from "background" than at any other.

The right sizes of coil must, of course, be inserted in the detector-coil sockets or the set probably will not operate at all. For the 40-metre band two 9-turn coils, or a 6-turn as secondary and a 9-turn as reaction, will be suitable. For the 20- and

than is obtainable from a detector and one L.F. stage, and are, in fact, almost as loud as they are in the usual way with a detector and two stages.

Absence of Background

In addition to this, there is an almost complete absence of background and mushy noises when the set is correctly adjusted (the principal adjustment for this purpose being the Clarostat). You should also try the effect of adjusting the neutralising condenser in series with the aerial, since too high a degree of aerial

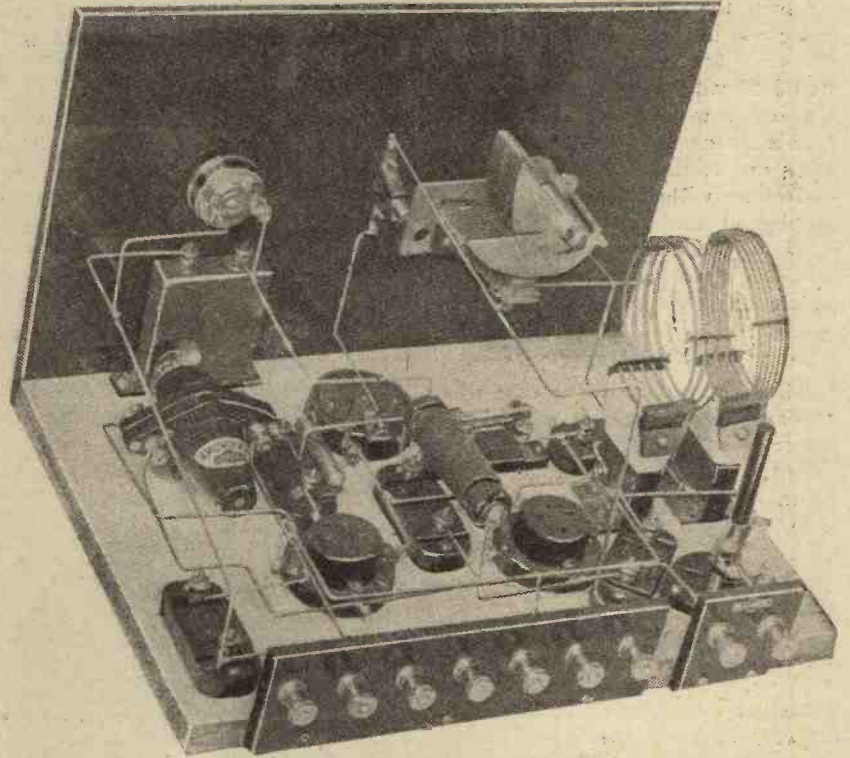

A view of the set which should prove invaluable to you during the mounting of the components, and which, used in conjunction with the wiring diagram on the previous page, should greatly facilitate the wiring.

30-metre bands a 4-turn secondary and a 6-turn reaction coil will be needed.

2 X A D, of course, operates on 21.96 metres, and 2 X A F on 32.77 metres. If neither of them is on, the set can be tested out on 5 S W on 24 metres, who is, by the way, not as strong as 2 X A D in most parts of this country, and therefore makes quite a good test in spite of his proximity. Numerous amateurs may also be heard during the evenings and week-ends.

The American stations are received on this set at rather greater strength

coupling will produce a large amount of background, which can easily be cut down without noticeably affecting signals simply by reducing the coupling.

There should never be any heterodyning or howling when the set is being operated. If there is it probably means that the variable resistance has been reduced to too low a value, in which case it should, of course, be increased again.

It should be mentioned that the "Clarostat" has a left-hand thread, so that the adjustment will be the opposite to what one is used to.

RADIOGRAMPHONICS

A monthly article for the gramophone enthusiast.

Feed-back—Speed Regulation—A New Pick-up—Record Wear.

By A. JOHNSON-RANDALL.

It is surprising how much trouble is caused by running the loud-speaker leads too close to the leads from the set to the pick-up.

There is a tendency to place the loud speaker near the gramophone turntable and the two sets of leads are apt to become intertwined. Thus we have the amplified low-frequency impulses in the output circuit of the amplifier being fed back to the first L.F. valve via the pick-up leads, and in this way low-frequency oscillation is frequently set up. The symptoms are violent howling or chronic distortion without howling. When trouble of this kind is experienced it is advisable to see whether these two sets of wiring are well separated before looking elsewhere for the fault.

A Second Possibility

This is particularly the case when the amplifier is part of a broadcast receiver, and functions quite satisfactorily for the reception of the ordinary radio programmes, bursting into violent oscillation directly the pick-up is plugged in.

Of course, this is not the only possibility.

In the majority of cases, when the pick-up is plugged in an additional L.F. valve is brought into operation (usually the detector which is arranged to work as an L.F. stage) and there is consequently a slightly increased tendency to self-oscillation, and if the remaining stages are not quite up to the mark the amplifier may "spill over" and howl.

Electrical Turntables

Those who have purchased electrical turntables may be having a spot of bother over the speed regulation. There is on most of these turntables a small adjuster and this can be set to give any required speed. The revolutions per minute can be determined as described in last month's article. It must be remembered that these turntables cannot be pre-set owing to the fact that

a slight variation between the voltages of different supply

mains will alter the speed. Therefore, each turntable should be adjusted to suit the mains with which it is to be used.

While on this subject of L.F. oscillation the old bugbear of "motor-boating" must not be forgotten. This form of L.F. trouble has been very difficult to overcome, but I am glad to see that there is a number of anode-feed units and resistances which are being placed on the market with the object of obviating troubles of this nature. These anode-feed resistances are very useful because it is possible to employ one H.T. voltage throughout, applying the maximum to the last valve (or valves,



The Burndept "Electrical Sound-box" described in this article.

if there are two in parallel) and cutting it down with the feed resistances to suit the remaining stages.

This is another step in the right direction towards the simplifying of set design and the prevention of those annoying troubles which so



often cause distortion and general "fedupness" on the part of the home constructor.

We have received one of the new Burndept pick-ups for test. It is an extremely well-made component functioning on the electro-magnetic principle, the permanent magnet being completely protected by a neat black moulding of insulating material.

A Well-Made Device

The two terminals to which are attached the pick-up leads are also mounted on the case.

The device can be obtained complete with volume control, and this is recommended to those who have no means of adjusting signal strength incorporated in the set.

On test the pick-up gave very good results, and there was a marked absence of chatter. The bass comes out very well, provided a suitable amplifier and loud speaker are used, and there is no noticeable loss of the higher frequencies.

The price of the pick-up is 20s., and it can be well recommended.

Record Wear

I receive quite a number of queries concerning record wear, and I am afraid that I can only inform my querists that some pick-ups do tend to produce fairly rapid wear. There is still a lot to be learnt about the design of gramophone pick-ups, and in some cases makers, in their eagerness to ensure high-quality reproduction, seem to have overlooked the important question of wear on the record.

We hope to be in a position to publish details of some experiments on this question, and also that of balancing the tone arm, in the near future.

109876

EVERY DAY

THE PUBLIC
GIVE US
EVIDENCE
THAT



REGD.

EVER READY

BRITAIN'S BEST BATTERIES

GIVE THE PUREST
SWEETEST TONE &
LONGEST SERVICE
AT LEAST COST



*Do you use
Ever Ready Batteries?*

From all Wireless Stores, Elec-
tricians, etc. Complete Battery
Catalogue post free from
THE EVER READY CO. (Gt
Britain), Ltd., Hercules Place,
Holloway, N.7.

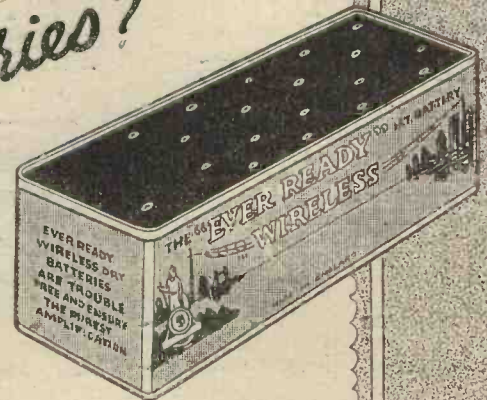

We are exhibiting at the RADIO EXHIBITION, Olympia,
Sept. 22-29, Stand No. 44a. Our representative will be
pleased to be of assistance to you.

Make good results a certainty — by using BURNDEPT Components...

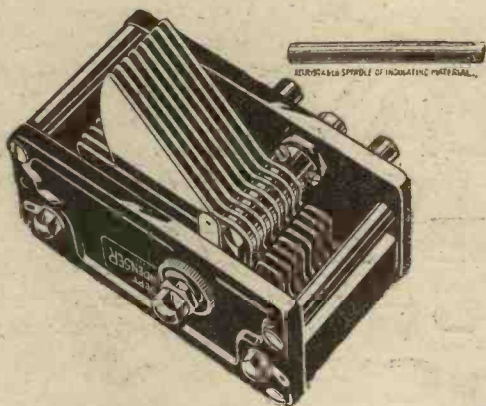

VARIABLE CONDENSERS

give increased signal strength, and absolute freedom from hand-capacity. Their special features are the insulated spindle and metal earth shield, which mean improved results and easier manipulation.

"Square Law."

·00007 or ·0001 mfd. Price 13/6.

"Log Law."

·0003 mfd. Price 15/-, ·0005 mfd. Price 15/6.

Calibrated Scales.

150-3,000 metres (for Log Law type). Price 1/6.



FIXED RESISTORS

Made in all values from 5 to 50 ohms. Cheaper than rheostats. Ensure constant filament current. Obviate danger of burning out valves by applying excess L.T. current. Price 1/6 each.

WIRELESS experts throughout the country have taken this advice—because they know that BURNDEPT is a name that stands for absolute reliability and excellent results. Amateurs, too, swell the army of BURNDEPT users—and if you are going to build a set, you will do well to follow their example. See the BURNDEPT latest range of components and Radio sets on Stands 112-113 at the RADIO EXHIBITION, September 22-29.

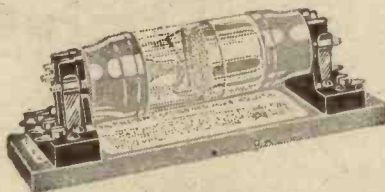

SCREENED GRID VALVE HOLDER

With this holder, the valve can only be inserted in its proper position. Adjustable to varying sizes of same type of valve, and provided with terminals and soldering tags. Price, complete with drilling template, 4/-.

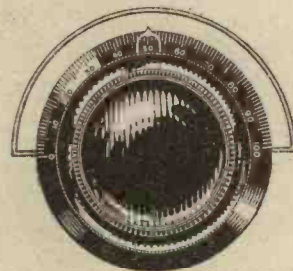

ETHOVERNIER DIAL

Gives easier tuning, fine tuning being a simple matter because of the 18-1 ratio. Noiseless—gearless, and free from backlash. With Etholog and card scales. Price 6/-.



THE NEW H.F. CHOKE

Has high inductance (50,000 mhys.). Suitable for congested wave-lengths and with extremely low capacity of ·000007 mfd. Ideal for shortest wave-lengths. Price, 3/6.

Latest Catalogue
FREE on request



BURNDEPT

Offices

BLACKHEATH, LONDON, S.E.3

London Showrooms

15, BEDFORD STREET, STRAND, W.C.2

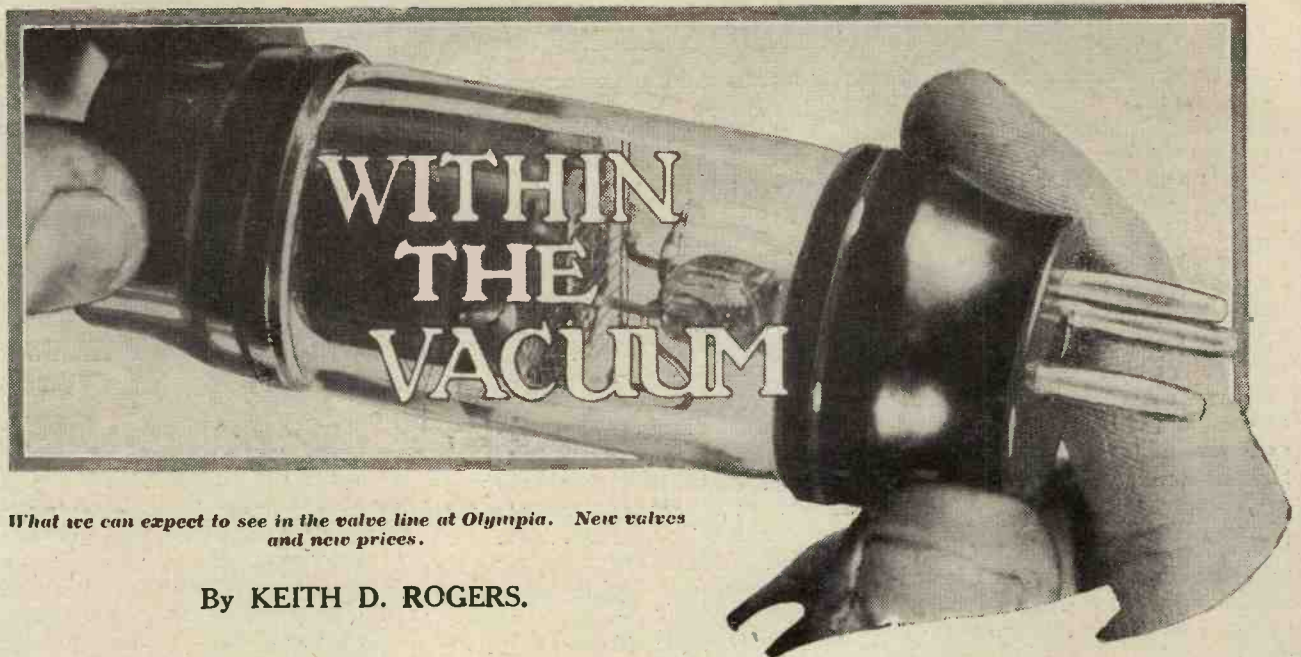

What we can expect to see in the valve line at Olympia. New valves and new prices.

By KEITH D. ROGERS.

NEVER before in the history of radio has there been such a tremendous number of valves of all types and sizes on show under one roof. This year's exhibition at Olympia will surpass anything that has been done either in this country or America, and especially as regards exhibits of the thermionic receiving valve.

During the last two years or so we have not been exactly "hard up" for valves, although we may possibly have lacked some really big super-power valves, especially in the 2-volt classes, but now this is being remedied and we can safely say that we have valves for every requirement and to suit every pocket.

This year at Olympia things have gone further than ever, and we shall see types of "tubes" which will make it even more difficult to make up one's mind which one will use for any particular purpose.

Many More Valves

It will be worth the while of any WIRELESS CONSTRUCTOR visitor to Olympia to spend some considerable time round the valve stalls and to study as well as he can the various types and characteristics of the valves on show. He will find that he can get anything from an ordinary dull-emitter detector of quite a cheap order to the large super-power valve which also can be used for very low-power transmission, and which is employed by a great number of people for public address systems and for working moving-coil loud speakers at really full volume. And what is most

important—prices will be down by a useful amount.

Visitors at the show will find valves of every description and type. H.F. valves for neutralised circuits, screened-grid H.F. valves, resistance-coupling L.F. valves, ordinary L.F. valves, power valves, super-power valves, a complete series in the



This is the new type of Cossor screened-grid H.F. valve, which among other makes is available for various voltages. Note the difference in design between this valve and that of a year ago shown in the heading of this article. The horizontal type of screened-grid valve is now being replaced by the upright 4-pin and cap type such as is shown here. The horizontal Marconi & Osram S.625 will be still available and is not being taken off the market.

ordinary battery L.T. type, then the whole range again for A.C., to run direct off the A.C. mains, and finally we must not forget that valve which has recently come into prominence, the five-electrode valve known as the Pentode.

Certain changes in the lists of valve manufacturers have been made since the last show, some members

have faded away while other new ones have come into prominence, but on the whole you will find the same makes turned out with their usual reliability but greatly reinforced by fresh types added to their ranks, and in many cases redesigned from base to top.

Among the redesigned valves must be mentioned some of the 2-volt screened-grid valves which were first put upon the market with the three-pin mounting at one end and the two-pin mounting at the other, designed to be used in horizontal holders. Except for the S.625, these have been scrapped and redesigned to produce a valve suitable for plugging into the ordinary valve holder, but with the extra connection at the top, so that we have the Mullard, Cossor, Six-Sixty, Ediswan, Marconi and Osram screened-grid valves all arranged for the four-pin base carrying the grid, the screened grid and the two filaments with the plate coming out at the top of the valve to a special terminal.

Wonderfully Efficient

These valves are wonderfully efficient, and I would very strongly advise all my readers who have not yet tested the possibilities of the screened-grid H.F. valve to do so without delay.

A special range of A.C. valves will be making its appearance, known as type Point 8, taking .8 amp. and .8 filament volt. This range is absolutely complete in that it has an ordinary H.F., a screened-grid H.F., L.F. and power valve. The only thing that might be said to

Within the Vacuum—continued

be lacking is the real super-power valve, for the lowest impedance of this range is a little higher than perhaps one might wish for some output purposes.

New super-power valves of 0.15 and 0.25 filament current types from BT-H and Marconi and Osram, and with low impedances of 2,700 ohms will be making their appearance, and these constitute a really definite advance in the design of low-impedance output valves having a low filament consumption.

Pentode Valves

Messrs. Ediswan will be putting on the market several new valves, including some specially designed output valves, while the same firm, together with most of the other firms, will be marketing the five-electrode Pentode, being specially designed for output circuits, and upon which I have commented before in this journal.

Regarding that previous comment on the Pentode, I should like to say here that tests are still being carried out with the valve and that so far I cannot give any further details and can neither criticise nor commend it until it has been given a really thorough test from all points of view.

Readers will appreciate that it is not sufficient to take a valve and plug it into a set, listen to results, check its filament current and its anode current, and then pass an opinion. The valve may work very well, or it may not work at all, but in any case it is not fair to the valve.

Thorough Test Essential

If a valve is to be thoroughly tested, especially a new valve which is really the only one of its type upon the market, it has to be taken very carefully, its characteristics taken with extreme care, and then the valve must be subjected to all sorts of tests in various types of circuits, in an endeavour to find the best circuit to suit the valve, so that it may be given every opportunity of providing its maximum efficiency and the best quality of reproduction.

Thus in the case of an output valve it is essential that it be placed in an output circuit where the impedance of the valve and that of the output circuit are properly suited, having a proper ratio to each other, before one can judge whether the valve is a good one or not.

Now, finally, in regards to the exhibition, I must emphasise the necessity for a careful survey of the valves on show, due attention being given to their characteristics and consideration of the newer classes which may mean a great deal to set design in the near future.

Fresh Set Designs

Already there are, and will be shown at Olympia, a number of receivers on the market specially designed for Pentode valves, a large quantity of sets having three-valve circuits for use with a screened-grid H.F., a detector and then a Pentode as L.F.

The screened-grid H.F. valve has come to stay, the Pentode also cannot be ignored, while the special A.C. valves and the new super-power valves promise to still further advance the progress made in quality reception.

Altogether, this year's "show" demonstrates real advance in the

world of valves, and all readers, not only valve-set owners, should go to Olympia, if possible more than once, and really study things—it will be well worth their while.

 * USING CHEAP VALVES *

SIR,—I have constructed the "Radiano" Three, and have built it in my spare time, and I can honestly say that I cannot find enough appreciation for it as I have no trouble whatever in manipulating it. I have got cheap valves in it, but I am going to purchase three good valves. I have got quite a good number of stations on it. I have constructed different sets at different times, but I can assure you that I do not think that there is any other to come up to it.

E.7.

M. A. SHADRAKE.

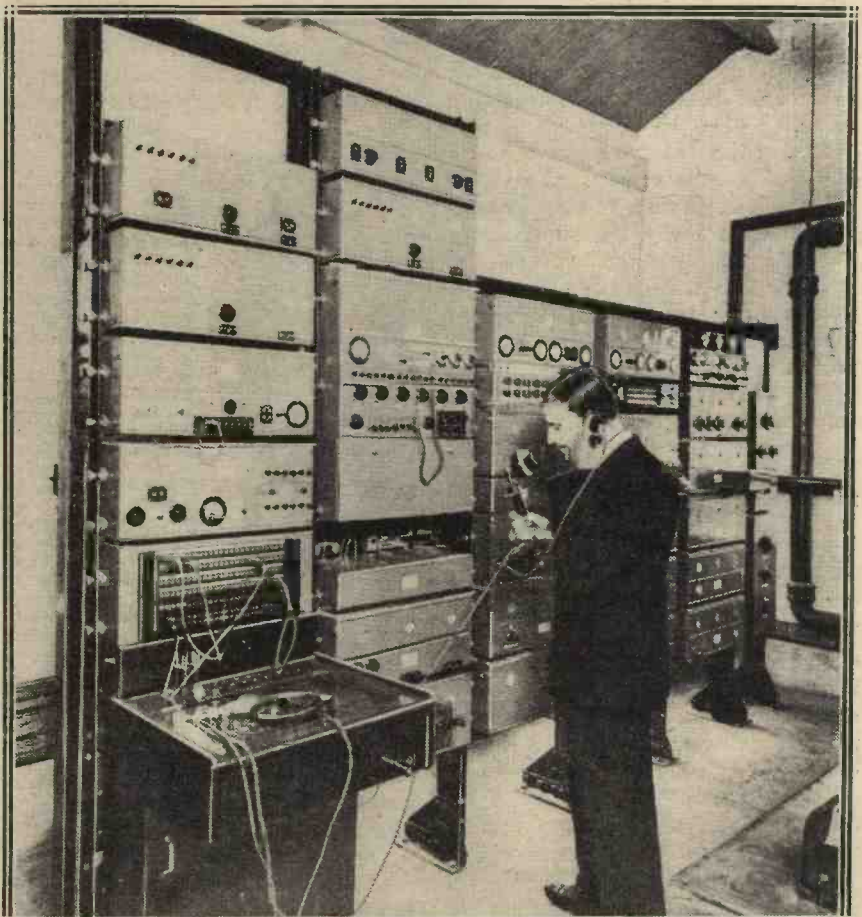

Senatore Marconi and Mr. G. A. Mathieu (who is shown above) have recently developed a multiplex system of radio communication using short waves. Music has been sent from Montreal using the same beam aeriols as those through which two simultaneous Morse telegraph messages were being sent, and was excellently received at Bridgewater.

Choose the right valves for

SCREEN GRID H.F. AMPLIFICATION



S.G. 215

2 V. SCREEN GRID
AMPLIFICATION 140
IMPEDANCE 140,000

S.G. 215

Fil. Volts - 2.0 Amp. Factor 140
Fil. Current 0.15 amp. Impedance 140,000

S.G. 410

Fil. Volts - 4.0 Amp. Factor 140
Fil. Current 0.1 amp. Impedance 115,000

S.G. 610

Fil. Volts 6.0 Amp. Factor 140
Fil. Current 0.1 amp. Impedance 100,000

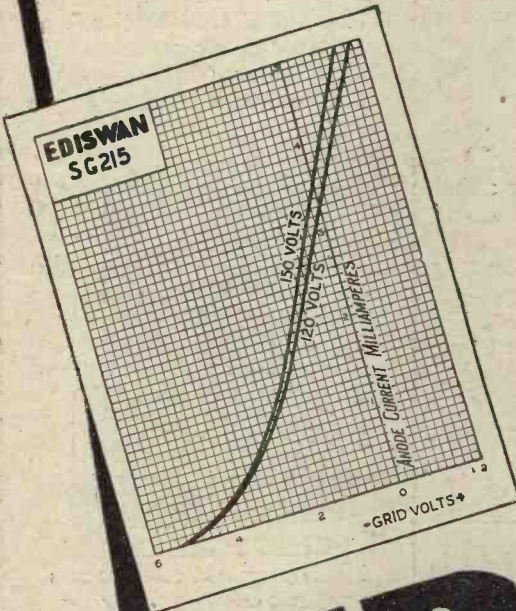

S.G. 215 **22 1/6**

A 4-electrode valve of the screen grid type, specially designed for H.F. amplification. Used in a suitable circuit, it will give enormous amplification with complete stability.

EDISWAN NEW LOW TEMPERATURE VALVES

Make a point of inspecting the range of new Ediswan Low Temperature Valves at Olympia, Stand 43, Main Hall.

Four of the Factors in the Success
of this year's Radio Exhibition
4 of the new
DUBILIER COMPONENTS

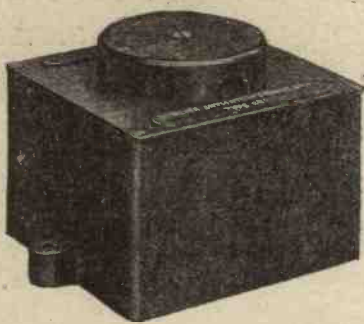

DUBILIER FILTER UNITS
Made in four types 28/6.
47/6, 72/6, 142/6

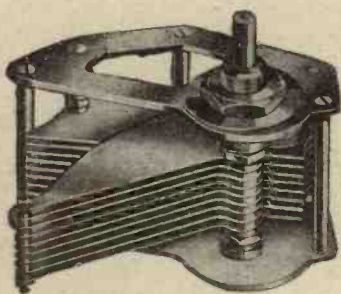

DUBILIER
K.C. CONDENSER
Without Knob, Dial or Slow-
motion device 8/-.
.0003 or .0005

See them and
the other new
Dubilier
Products

at

STANDS
102/103



DUBILIER
CONDENSERS



DUBILIER
MIDGET CONDENSER
Made in two capacities
.0001 or .0002, 5/6.
complete with Knob



DUBILIER H.F. CHOKE
Finely moulded case protects
windings and gives it
a neat appearance. 4/6.

Dubilier built is better built

Advt. of Dubilier Condenser Co. (1925), Ltd., Ducon Works, Victoria Road, North Acton, W.3.

©177

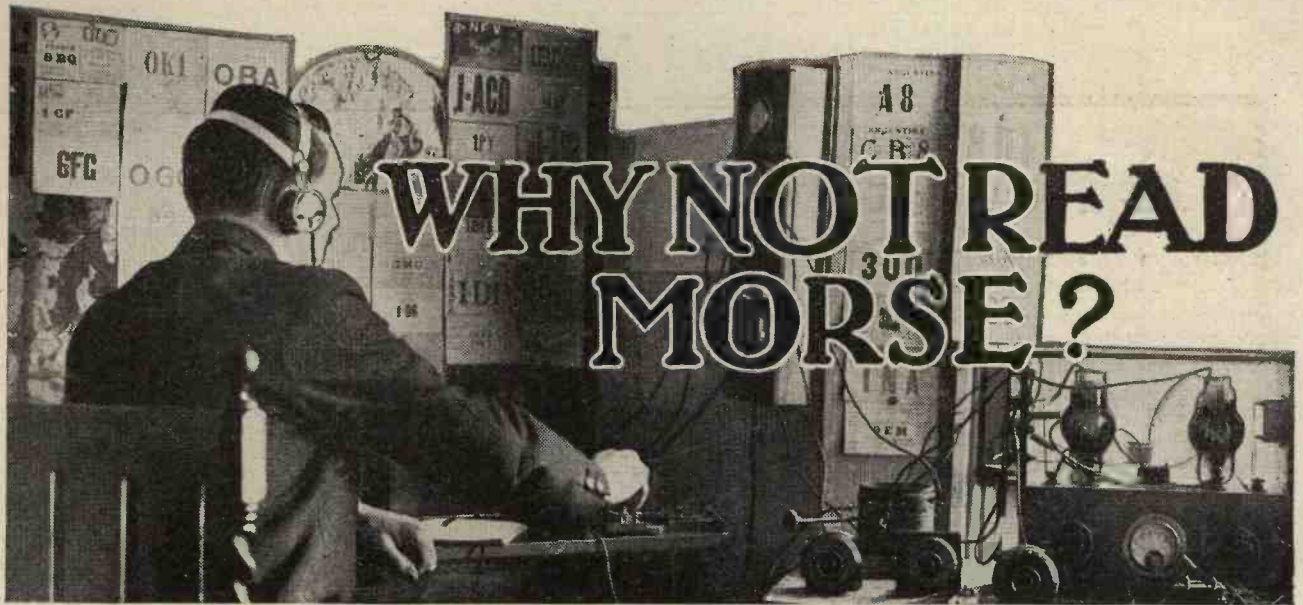

WHY NOT READ MORSE?

You will note that both transmission and reception have been mentioned at intervals in the preceding lines, and it should perhaps be explained that whether or not you will need to learn to send as well as to receive will depend largely upon whether you can get a friend to help you in your task. If you can find a friend who is either willing to learn the alphabet or already knows it so much to the good, because you will then get on much more rapidly. Besides, you will find the whole business very much more interesting if two or more of you can join forces and have regular Morse practice as often as possible.

Avoid Too Much Sending

There is little doubt that the best method of practising is by means of a Morse key and a buzzer, but to use this method successfully, either to memorise the alphabet in the first place, or for practising reading and sending, it is absolutely essential to have an assistant. The practice obtained by a solitary learner from the Morse key is only beneficial up to a point, for as soon as he has memorised the alphabet it becomes actually harmful to go on practising sending interminably. When he comes to learn to read, it will be all the harder for him, in that he has already acquired a one-sided facility in sending. The aim should always be to develop the learner's skill at reading and sending equally with, if anything, a slight preponderance of reading (of course, it is obviously being assumed that it is as well to make a proper job of it while you are about it, and learn both to send and to receive).

The first essential, of course, is

Are you missing half the interest of your short-wave set? Why not learn to read Morse by the special easy methods described in this and the preceding article which appeared last month.

By G. P. KENDALL, B.Sc.

some sort of practice outfit, and this may take the form of one of the complete signalling sets made up in boxes, which are sold by various firms, or it may consist of a couple of dry cells, a buzzer, and a Morse key arranged upon a table.

The key should be of good quality, and it is well worth while to spend ten shillings or so upon one, for a bad key in the early stages may saddle

the learner with a cramped, clumsy style for life. The arm of the key should be of a good length, not less than four inches, and it should be pivoted at a point about one third of its length from one end and not at the end. Further, the tension of the spring should be easily adjustable.

Get a Good Buzzer

The buzzer should preferably be of the variety giving a high musical note, since signals of this sort are much less fatiguing to read than those produced by instruments which merely give a harsh buzzing sound. A good high-note buzzer may cost about 5s. 6d., or, alternatively, one may be improvised by cutting off the hammer

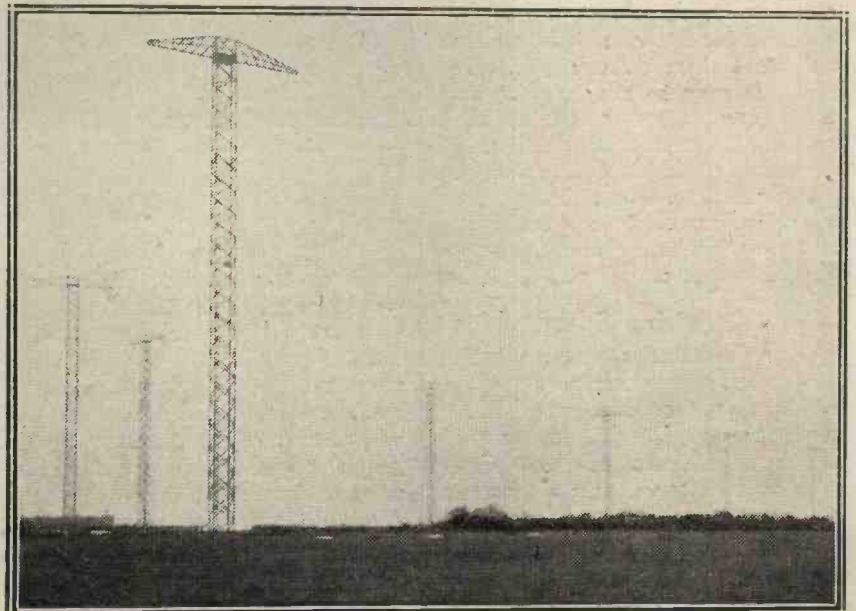

You will not be able to reach the speeds of transmission and reception accomplished by the automatic system employed at the Beam stations, but with practice you should be able to read the messages of many of the hand-operated commercial stations.

Why Not Read Morse?—continued

of an old electric bell and judiciously stuffing a small piece of felt or cotton wool between the armature and the pole-pieces.

The set may be assembled upon a table and the parts wired up in series. The key, by the way, should be firmly screwed or clamped down.

At the outset it is well to spend a little time obtaining command over the key, and learning how to form the letters with precision and accuracy. First note that the proper way to hold the key is with the first two fingers on top of the knob and the thumb at the side, then set to work to learn to handle it easily and certainly.

Remember Your Timing

Practise forming single dots and dashes at first, trying to estimate their correct lengths (remember that a dash is three times as long as a dot), then practise the letters I and M, followed by S and O, and then H. Form the letters very slowly, and take great pains to observe the most accurate spaces between the dots and dashes that you can; speed will come later, and accuracy is the first essential. When these letters can be sent easily, and without hesitation, take letters containing both dots and dashes, starting with A, the simplest, and so proceed until the whole alphabet has been mastered.

Next, practice can be obtained in reading; let one of the learners send very slowly, and the other try to recognise the letters as they are sent and write them down for checking later. It may be necessary at first to send one letter at a time, and then wait for the reader to name it. If this procedure is adopted, sender and reader should exchange duties about every five minutes, to equalise the practice which they obtain and to prevent fatigue on the part of either.

Acquiring Speed

When the letters can be recognised fairly easily the sender may start to send passages of twenty or thirty words at a slow rate, without stopping for the reader to name them, the latter being expected to write them down and mark the omission of any which he has not time to recognise by a dot on his paper. At the close of the transmission the letters written down should be checked, in order that the reader may note his mistakes. The

speed should be such that the reader has just time to recognise about four out of five of the letters sent, and is kept distinctly on the stretch to keep up, since this is the way to acquire speed in reception; very little good is done by practise at a speed which enables the learner to recognise every letter.

It is a great advantage if a good telegraphist can be obtained to do the sending, but quite useful practice can be obtained from the sending of a novice, if he will take the greatest of pains to form his letters correctly and observe the proper spaces, equal to one dash between letters and two dashes between words. A further point of considerable importance concerns the type of matter chosen for



Listening to a loud speaker from a set tuned to a long-wave commercial station is excellent practice for the student of Morse. In this photograph the listener's chair has been occupied by the dog, who seems to be very interested.

practice transmission. Precautions should be taken right from the start to prevent the learner from falling into the pernicious habit of trying to guess what is coming when he is reading. Useful remedies are the use of a foreign language, or the simple expedient of sending each word backwards.

A final word of advice: never either send or read for more than ten minutes at a time in the early stages, for longer periods produce undue fatigue and lead to sloppy sending and inaccurate reading.

The unlucky man who finds it is quite impossible to locate a fellow enthusiast to help him can, unfortunately, make but little use of the buzzer method. It will perhaps be a little helpful to him to fix up a buzzer and key in the manner which has been described and practise forming the various letters so that he can be assured that he has thoroughly memorised the whole alphabet; but beyond that he cannot go, since, as has been explained, to obtain a great deal of practice at sending and none at receiving is worse than useless.

For the Solitary Learner

Probably the simplest solution of the difficulty of the solitary learner will be found in a set of special gramophone records sold by the H.M.V. Company, which in themselves constitute a complete course of instruction in Morse reading. If you possess a gramophone, here is what the writer would suggest. First learn the complete alphabet in the manner which has been explained, and then turn to the gramophone records and proceed to run through them in the correct order and try to become letter perfect. Just a word of warning, however. Do not use these records over and over again until you have actually memorised their contents, since in so doing you are bound to fall into the very bad habit of constantly guessing the next word instead of honestly reading it. This is a great handicap, and will completely ruin your chances of becoming a good reader. It is absolutely essential, if you are ever to become really proficient, to read without guessing; letter by letter, as the message comes through and write it down quite without thinking whether it makes sense or not, at any rate in the early stages of your practice.

The Last Stage

With the aid of one or other of the various methods which we have considered, the reader will be able to learn to recognise the Morse characters when they come in slowly, and after a while to write down correctly complete messages in Morse, and when he can do this with reasonable accuracy he can take the next step in his training as an amateur operator. This is to derive his practice from the receiving set itself, and the messages which he can pick up therewith, and it is then

(Continued on page 449.)

A New Transformer by Igranic

Price
17'6

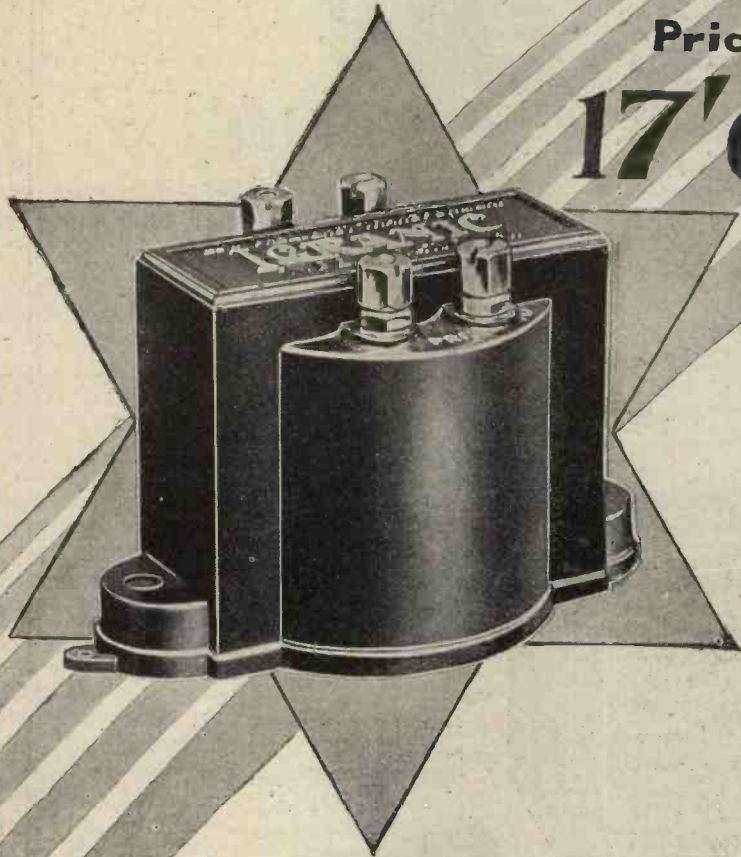

IGRANIC L.F. TRANSFORMER Type "J"

Ratios
3:1 and 6:1

THIS new Igranic Transformer upsets all former ideas of value. The discovery of a super-efficient new iron circuit has enabled the Igranic engineers to design a transformer of less than *one half* the weight and size of other transformers that approach its performance and, consequently, with a much lower price.

The new iron circuit in the Igranic L.F. Transformer, Type "J," has the effect of giving a high primary inductance with a small winding, the interwinding capacity being therefore reduced to the minimum consistent with maximum coupling. The result is that the amplification of all notes between 100 and 9,000 cycles is practically constant, the low notes being reproduced with all their natural mellowness and the high notes with complete freedom from resonances.

For complete particulars of this wonderful new transformer write for List No. J.662. A free copy of "Selected Circuits," by H. J. Barton Chapple, B.Sc., will also be sent you.

WE ARE EXHIBITING AT

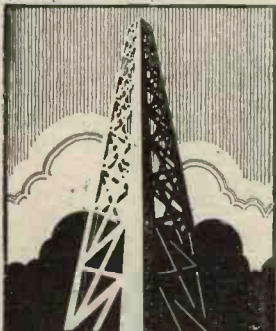

SEPT. 22nd to 29th THE NATIONAL RADIO EXHIBITION OLYMPIA LAMINGTON DANCING

Stands 53, 54 & 75

While at Olympia
Come and hear Igranic apparatus
demonstrated at
28, West Kensington Gardens
(adjoining Olympia)



149, QUEEN VICTORIA STREET, LONDON, E.C.4.

Works: Bedford.

Branches:—

MANCHESTER, NEWCASTLE, BIRMINGHAM, LEEDS, GLASGOW, BRISTOL, CARDIFF



Model A.C.56 for Alternating Current. Incorporating the Westinghouse Patent Metal Rectifier. Price: £8-15-0 Including Royalty.

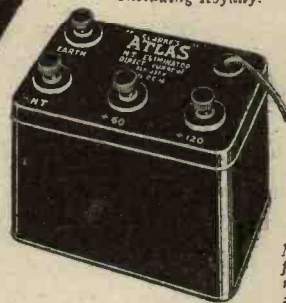

Model D.C.18 for Direct Current. Price: £1-17-6



Model D.C.10 for Direct Current. Price: £3-15-0

GOOD NEWS! Wonderful news! You need not bother any more with expensive short-lived batteries if you install a Clarke's "ATLAS" Battery Eliminator. NO VALVES TO BURN OUT. NO LIQUIDS. NO RENEWALS. Just flick the switch and you'll know the good news is contained in the words:—

CLARKE'S "ATLAS"

BATTERY ELIMINATOR

There's a Model to suit your pocket, and every instrument carries the "Atlas" guarantee. Send now for a copy of the new Eliminator Brochure No. 32 to

H. CLARKE & CO. (M/cr.), LTD.,
Atlas Works, Old Trafford,
MANCHESTER.

See them at the
National Radio
Exhibition, Olympia,
September 22-29
STAND No. 161

you?





Baird's Television Apparatus

SOME RECENT DEVELOPMENTS.

By Our Patent Expert.

A TELEVISION system capable of transmitting moving scenes through the ether on all fours with the present broadcast service is a "consummation devoutly to be wished for" by all good radio enthusiasts. Judging by recent reports in the Daily Press, the prospects of such a service are daily increasing.

It has, in fact, been definitely stated that a television set capable of receiving moving-picture effects will be demonstrated at the forthcoming Radio Exhibition, and is to be sold to the general public at a price in the neighbourhood of £30.

Little Information

Meantime, very little technical information has been given regarding the ways and means by which the latest moving-picture results have been secured. The general theory underlying the original apparatus as used by Mr. Baird has certainly been published, but details of more recent advances are not generally available.

It must be borne in mind that the principle underlying all television systems consists in throwing an image of the scene to be transmitted upon a selenium or photo-electric cell, capable of responding quantitatively to light of varying intensity. In this way, the gradations of light and shade produce electric currents of corresponding value. In photography, for instance, the sensitised surface of the

plate or film is responsive to variations of light and shade in such a way that after certain chemical treatment the complete picture is reproduced in permanent form.

The photo-electric cell used for

such a cell is placed in series with a suitable battery the value of the current flowing through the circuit as a whole fluctuates accordingly, just as the current through a microphone fluctuates in accordance with the varying pressure of sound-waves.

The continually-changing current from the photo-electric cell is first amplified, and is then transmitted either directly over a connecting wire, or as a modulation upon a radiated carrier-wave, to the receiving station. Here it is detected, if necessary, amplified, and then fed to a sensitive glow-lamp, so that the illumination of the latter changes instantaneously with the variations of the incoming signal current.

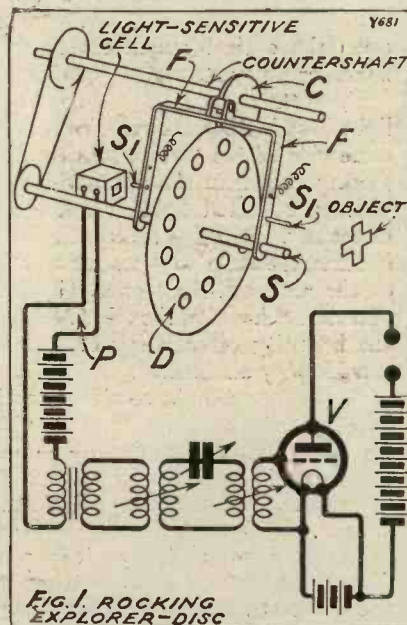

FIG. 1. ROCKING EXPLORER-DISC
A method of exploring patented by Mr. Baird.

television is sensitive to light in something of the same manner, except that it reacts by altering its electric resistance continuously with changes in the intensity (i.e. light and shade) of the ray thrown upon it. If, therefore,

Complicated Problem

So far the whole process is very similar to that used in ordinary telephony, if one imagines the microphone to be replaced by a photo-electric cell, and the incident sound waves by a ray of light of fluctuating intensity. The outstanding difference, however, between telephony and television lies in this fact. In telephony there is no need to arrange the received signals in any definite spatial relation. One note simply follows the next in a sequence of time. In harmony several notes may be superposed, but the trained ear is able to detect and appreciate them simultaneously in time.

In television, on the other hand, it

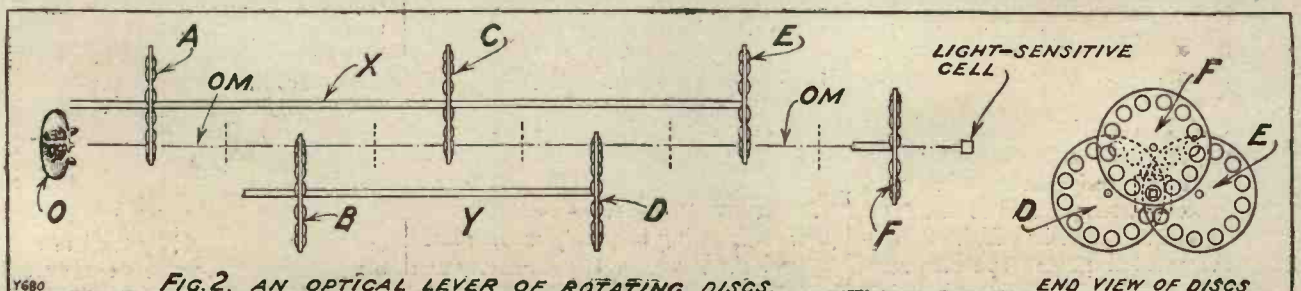

FIG. 2. AN OPTICAL LEVER OF ROTATING DISCS.

An ingenious method of speeding up the passage of the light ray across the selenium cell.

Baird's Television Apparatus—continued

is necessary to send the scene in separate small sections or areas one after the other, so that the forehead, eyes, nose, and mouth, for instance, are transmitted as separate groups of signal elements, one following the other at an enormously rapid rate. At the receiving station each signal impulse is separately received and must be separately projected from the glow-lamp so as to reach the viewing screen (a) in its proper position in space (so that the forehead, nose, and mouth are not blurred into one unrecognisable mass) and (b) so rapidly that the whole picture is repeated not less than twelve to sixteen times per second, as otherwise the kinematographic effect of animation is lost.

The First System

In the original system used by Mr. Baird the picture at the transmitting station is cut up or "explored" into suitable signal elements by a rapidly rotating disc, provided with a series of spirally-arranged lenses or holes, whilst at the receiving end the received signals are reassembled in their

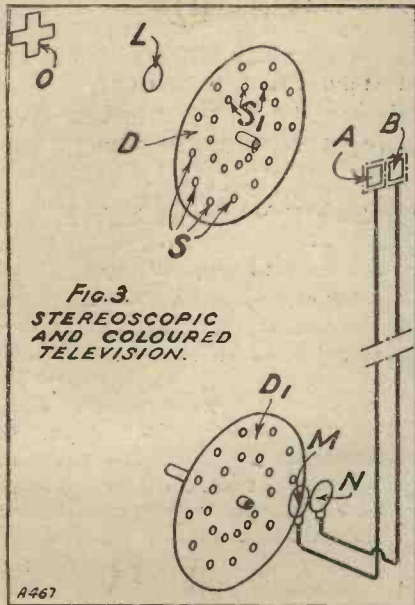

The subject of Patent No. 253,541.

proper order by a similar disc driven at the same speed as the one used for transmission.

Bearing in mind these fundamental points, it may now be of interest to give a short description of some of the television patents granted to Mr. J. L. Baird and to Television, Ltd. Copies of the printed patent specifications can be obtained by those interested from the Patent Office, 25, Southampton

ton Buildings, London, W.C., at a cost of one shilling each.

Patent No. 253,957, granted to Mr. J. L. Baird.

The disc D shown in Fig. 1 is provided with a number of spirally arranged lenses, and is rapidly rotated in front of the object to be televised (shown as a cut-out cross), so that each lens sweeps out a parallel track across the object and projects a corresponding beam of light on to a light-sensitive cell.

Shadow Effects

If the source of light illuminating the object comes from behind, each lens will receive a ray of light that is diminished periodically by the outline of the object. In other words, the shadow of the object will be thrown upon the optical cell in consecutive bands or segments.

If, on the other hand, the source of light illuminating the cell lies on the same side of the "cross" as the exploring disc, then the latter will only pick up reflected light and not the direct ray. By using reflected light it becomes possible to transmit details on the surface of the "cross" instead of a mere silhouette, though, of course, the intensity of each ray of light is considerably diminished.

As the rays of light reach the sensitive cell, fluctuating currents are set up in the circuit P, and these are subsequently amplified by a valve V, ready for transmission to the distant station.

In order to obtain a finer subdivision of the objects to be televised the shaft S supporting the rotating lens disc may be moved to and fro at right angles to its length by means of a frame F, which is rocked about a second shaft S₁ against spring action by an eccentric cam or disc C mounted on an upper countershaft as shown.

The Next Development

Patent No. 265,640, granted to Mr. J. L. Baird.

One obvious criticism to be urged against the use of any purely mechanical exploring device, such as a rotating disc with spiral lenses, is that the necessary speed to ensure a close-grained and clear-cut reproduction of the transmitted scene cannot be obtained, owing to purely mechanical considerations.

Mr. Baird therefore proposes to overcome this objection by utilising

what may be described as an optical lever for increasing the speed at which the ray of light can be made to move across the optically-sensitive cell. To do this he mounts a series of rotating discs A—E, as shown in Fig. 2, in such a way that the image of the object O (shown as a grotesque doll's head) projected by the first disc A is "explored" by the second disc B.

As the lenses of the second disc cross the image in the opposite direction to the movement of the disc A, the effective speed of exploration is

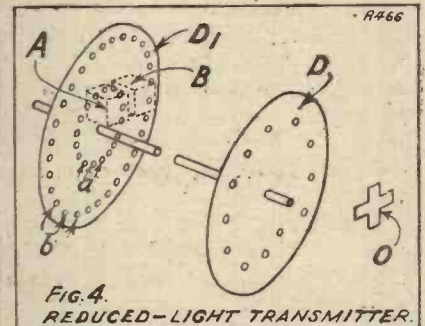

An attempt to reduce the light needed to illuminate the object to be televised.

determined by the relative motion, so that if the two shafts X, Y are rotating at the same rate the speed will be doubled.

The image passing through the disc B is in turn scanned by the disc C, with a corresponding gain in relative motion, and so the speed is doubled at each stage, as the image is projected in turn from one disc to another, moving from left to right.

Loss of Light

As in this arrangement the lenses are mounted on each disc in a perfect circle, and not spirally, it is necessary to introduce a traversing movement across the sensitive cell at the last stage. This can be done either by introducing an oscillating or rotating mirror between the last disc E and the sensitive cell, or by displacing the supporting shaft of an extra disc F so that its lenses move across the optical axis OM in a direction at right angles to those of the discs D or E.

In spite of the highly ingenious character of this arrangement, it would appear that a considerable loss of light intensity must occur at each point where the image projected by one disc is traversed by the lens of the next following disc. In other words, although the speed at which the ray

(Continued on page 450.)

The "ORMOND" CABINET LOUDSPEAKER

THE new "Ormond" Loudspeaker achieves an almost perfect faithfulness of reproduction that gives the speaker or vocalist a personality, that brings the listener into sympathy with the artist.

It reproduces those overtones by which each instrument attains its individual characteristic tone.



No adjustments to be made, the setting being obtained in a most effective manner, ensuring the excellency of reproduction no matter how little or how great the volume. The "Ormond" Loudspeaker is particularly suited to sets using high values of high-tension supply, with "Super-power" as the Loudspeaker Valve.

We would recommend that the maximum values of high-tension voltage be used as given by the valve manufacturers.

Hear the "Ormond" Loudspeaker demonstrated, compare its reproduction on the upper register as well as the lower tones, with any other Loudspeaker whatever its price.

Test it for volume as well as for purity and you must conclude it is the greatest achievement in Loudspeaker construction.

Models
in
Mahogany
and Oak



Price
£4:4:0

THE ORMOND ENGINEERING COMPANY, LTD.,
199-205, PENTONVILLE ROAD, KING'S CROSS, LONDON, N.1.

Telephone: Clerkenwell 9344-5-6

Telegrams: "Ormondengi, Kingcross."

Factories: - - WHISKIN STREET AND HARDWICK STREET, CLERKENWELL, E.C.1

Continental Agents:

Messrs. Pettigrew & Merriman, Ltd., "Phonos House," 2 and 4, Bucknall Street, New Oxford Street, W.C.1

BUILD YOUR "STEDIPOWER"

WITH A

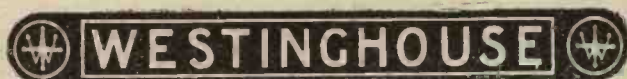

METAL RECTIFIER

TYPE A.3

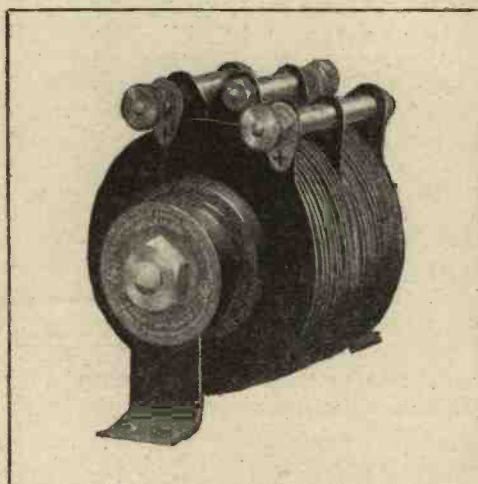

ON VIEW ON
OUR STAND
No. 78
AT THE
NATIONAL
RADIO
EXHIBITION

This rectifier unit has been designed for use in a low-tension battery eliminator, such as the Harris "Stedipower," using chokes and electrolytic condensers. Its output is 1 ampere at 9 volts, and its price is

23/6

WESTINGHOUSE RECTIFIER UNITS ARE CONSTRUCTED THROUGHOUT OF RIGIDLY FIXED METAL. THERE ARE NO WEARING OR MOVING PARTS, NOR VALVES OR ELECTROLYTE REQUIRING PERIODICAL RENEWAL.

When ordering your type A.3 Rectifier, ask your dealer for particulars of other types of Westinghouse Metal Rectifiers, for use in trickle chargers, H.T. battery eliminators and chargers, etc.

MANUFACTURED ENTIRELY IN ENGLAND BY
THE WESTINGHOUSE BRAKE & SAXBY SIGNAL CO., LTD.,
82, YORK ROAD, KING'S CROSS, LONDON, N.1.

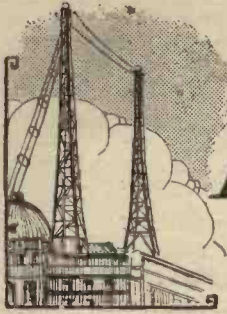

HAPPENINGS AT SAVOY HILL



By OUR SPECIAL COMMISSIONER

Changes of November 1st.

THE changes in relay stations, exclusively announced for the first time in August WIRELESS CONSTRUCTOR, will take effect on November 1st. Ten relay stations will be put on one exclusive national wave (288.5 metres, I believe), will be controlled by a central drive in London, and will radiate the same programme except for rare items that will be given in Regional groups. This change should greatly extend the value of the service in such industrial centres as Leeds, Sheffield and Bradford, where present conditions are about as bad as they could be with the steady increase in foreign station heterodyning and the lamentable failure of the "international common waves."

News Bulletins

I gather there is a good deal of heart-searching at Savoy Hill about the future of the news bulletins. The arrangement with the Agencies comes up for annual reconsideration in November. During the past twelve months the B.B.C. has expanded the scope of its bulletins by adding to the service of information secured from Government departments. This was all very well so long as it gave interesting or useful information; but during recent months there has been a marked tendency to include departmental propaganda and altogether too much "ballast" of the official and semi-official brand.

The reformers at Savoy Hill are all for taking over the collection of news and organising a proper service for listeners. If I were asked what would happen I would say that the present arrangement will prevail for another two years, but after that time the B.B.C. will be forced by its public to collect its own news and to put it out at all times of the day and night.

New Situation in Parliament

I have frequently called attention to the apathy and ignorance of Parliament on all matters connected with broadcasting. Towards the end of last session, however, there was a

sudden outburst of interest when the P.M.G. brought down his estimates. The Liberals were inclined to make a party issue of the criticisms of the programmes, but on second thoughts preferred to begin by "flying a few kites."

The extremely bitter and mostly ill-informed criticism put up by individual Liberal members did not augur well for the effectiveness of a regular party campaign on the same lines. Nevertheless a "Broadcasting Vigilance Committee" did emerge from that debate. This consists of about twenty members, all Liberals except three, the minority being Conservatives. Labour stands aloof because it sees the move developing into a demand for the "dis-establishing" of the B.B.C. as a state concern.

One strange feature of the proceedings of this nucleus Parliamentary committee is that it meets in secret and pledges its members to avoid any Press discussion. There would appear to be some "coup" in pre-

paration for the reassembling of the House in November.

The "Listeners' Committee"

Now that the Wireless League has so contracted its activities as almost to be as quiescent as the Radio Association and the Wireless Association, it will be of interest to see what becomes of Captain Ian Frazer's Advisory Committee which has been meeting monthly for nearly two years at Savoy Hill.

This was originally meant to meet the recommendation of Lord Crawford's Committee that the B.B.C. should rely more upon competent and representative advisory committees. But gradually its whole basis of representation has been undermined.

It would be a pity if the committee simply lapsed. Its members have now acquired valuable knowledge of the working of the B.B.C.—knowledge which enables them to put up constructive criticism and suggestions which really count. It is understood

TOURING TALKERS



Here is the latest broadcasting van in use. It contains all the amplifiers necessary for outside broadcasts while on top is a platform from which events can be viewed and their descriptions broadcast in moderate comfort.

HAPPENINGS AT SAVOY HILL

—continued

that the Governors are really trying to do away with this Committee. If so, their move should be promptly countered by Captain Fraser and Lieutenant-Colonel Moore-Brabazon from their seats in the House of Commons, if necessary.

B.B.C. and the Trade

Relations between the B.B.C. and the wireless trade appear to be established on a firm foundation of amity and mutual help, after an unnecessarily long period of suspicion and recrimination.

The Trade Committee on Broadcasting under Mr. McInstry, of Metro-Vicks, is an active and conscientious body. It stirs up the B.B.C. and keeps it to its pledges; at the

B.B.C. and specially designed for reception when the Regional scheme has been installed. This scheme had its birth in the fertile brain of Mr. W. H. Lynas, when he was still Managing-Director of Messrs. Graham Amplion, Ltd. I imagine Mr. Lynas has stuck to his idea, and I should not be surprised to see him shortly launch a new scheme of his own.

The decision to try out the new stations as single wave-length transmitters in the first instance will give him ample time to get his new enterprise under weigh if he is really contemplating it.

Admiral Carpendale's Future

When the last rumours of Sir John Reith's movements were current, it was accepted that his successor at Savoy Hill would come from outside the Corporation as a patronage appointment to be made by Mr. J. C. C. Davidson. But now the situation has changed a good deal. Admiral

ON BOARD THE "ELETTRA"

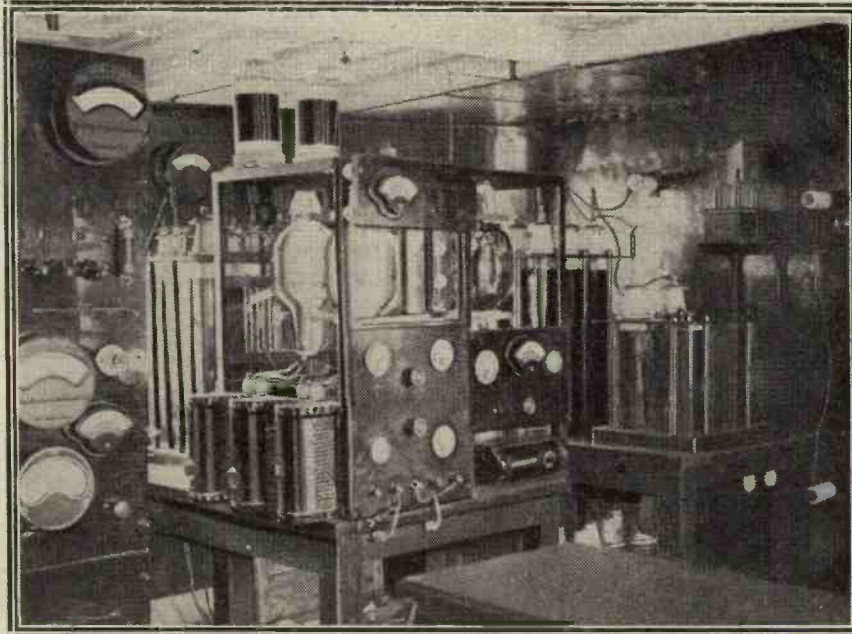

This is a section of the magnificent apparatus on board Senatore Marconi's yacht, "Eletra." Some important experiments have recently been carried out on the vessel in connection with the "Beam."

same time defending it against unfair criticism and accusations. I am told that Captain Gambier Parry deserves very well of the B.B.C. for his share in the new spirit of co-operation with the trade. Messrs. Strachan and Moodie have been the happy ambassadors on the other side.

That Mass-Production Regional Set

Very little has been heard lately of the scheme for a cheap mass-production valve set approved by the

Carpendale, second-in-command and disciplinary chief of the B.B.C., has come to the fore rapidly during the past twelve months.

His remarkable success as Chairman of the International Radio Union has marked him out as possessing qualities of more pre-eminence than was formerly supposed by discerning students of broadcasting. Moreover, it is an open secret that the whole of Sir John Reith's great influence will be directed in securing the succession of his devoted assistant.

"RADIO" THREE SAILS ROUND THE WORLD!

SIR,—It may interest you to know the results I have obtained with the "Radiano" Three. I have been using this set on board a ship for the past ten months, and it has given every satisfaction. I can say that, for power and quality, it is the finest three-valver I have tried, and I have tried a few.

I made two alterations from the original. I use a .0003 condenser in place of the .0005, and aperiodic aerial coupling, as I find these best for short-wave work.

My coils for short-wave are: aerial 4 turns, secondary 6 turns, and reaction 9 turns, home-made to fit Igranic Universal holders. I think that the set is all you claim for it, and in the "Radiano" Three I have an efficient receiver that can tune from 15 metres upwards.

Several B.B.C. and continental stations were received 150 miles west of Ireland, Daventry in the Mediterranean, Bombay at 600 miles, Cape Town was received on two successive nights in South Atlantic at 1,400 miles, W G Y and K D K A were heard in South Cuba at 1,600 miles. All these stations were heard *clear and undistorted* on the loud speaker.

"Morse Simply Floats In"

The set is not quite so stable on short-wave telephony, but the Morse simply floats in. However, with careful tuning I was able to obtain the following stations: 2 X A F was received in South Atlantic at 6,000 miles, and K D K A at 4,000 miles.

Chelmsford was received on three successive evenings at Cienfuegos, Cuba; the last hour's dance music, Big-Ben, and the announcer's voice coming through at sufficient strength to be heard and enjoyed by some of the ship's company at six feet from the loud speaker.

I may add that all tuning was done on the loud speaker, as my 'phones had broken down. I am constructing another "Radiano" for my home in Edinburgh; and next voyage mean to build your "Radiano" short-waver, as the efficiency of this set was demonstrated to me by an enthusiastic constructor in Singapore.

Yours truly,

D. R. M.

London.

(Ch. Engr.).

The WHEEL OF PROGRESS

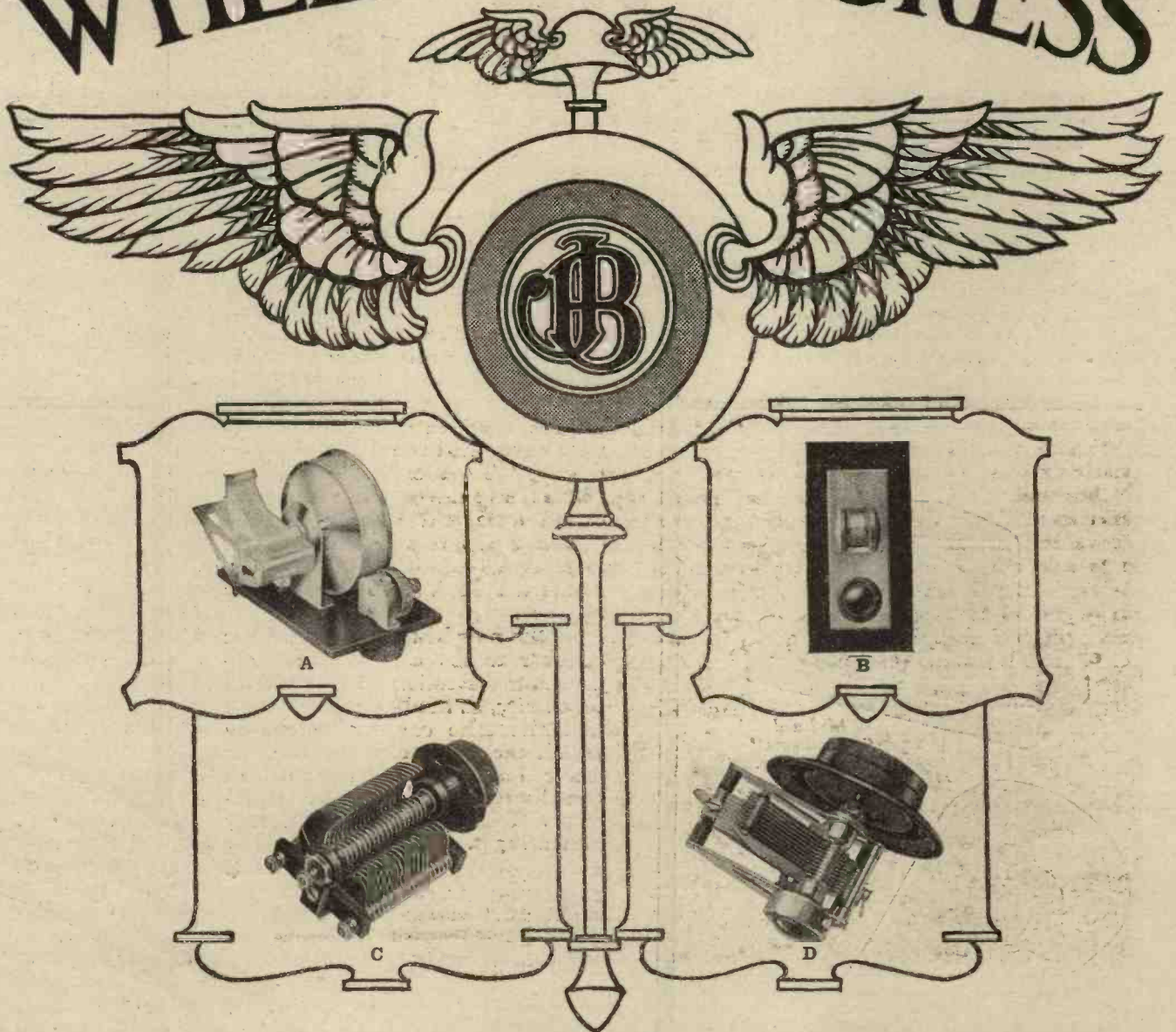

The J.B. policy is, and always has been, to provide discriminating members of the Radio public with precision condensers of unsurpassed excellence and efficiency.

This policy has earned for them a reputation of which they are justly proud, and which is enjoyed by very few manufacturers in the Radio world. It has been said on many occasions that the addition of J.B. precision condensers to a Receiver automatically doubles the number of stations tuned in.

During the summer J.B. experts have devoted the whole of their time to the design of new precision instruments for use with really modern receivers.

The complete J.B. range of condensers now meets every Radio requirement.

Write in to-day for our new illustrated catalogue and watch the editorial announcements of our new lines—and always insist on J.B., the real Precision Condensers.

Brief description of new condensers illustrated:

- A.—J.B. VERNIER DRUM DIAL. Fitted with new and unique devices, and superseding the old and unsatisfactory thumb-control models of other makes.
- B.—ATTRACTIVE PANEL PLATE supplied with Vernier Drum Dial. Neat and artistically designed. Supplied complete with neat pointer knob.
- C.—NEW J.B. MIDGET CONDENSER. The smallest and best yet designed. Supplied complete with neat pointer knob.
Prices: .00025 mfd. 5/9; .0002 mfd. 5/6; .00015 mfd. 4/9; .0001 mfd. 4/6; .0004 mfd. 4/-; .000025 mfd. 3/9
- D.—NEW J. B. SLOW MOTION S.L.F. and Leg. Models.
Prices: .0005 mfd. 16/6; .00035 mfd. S.L.F. 15/6; .0003 mfd. (Log) 15/6 .00025 mfd. 15/-; .00015 mfd. 15/-;

STAND No. 105—OLYMPIA



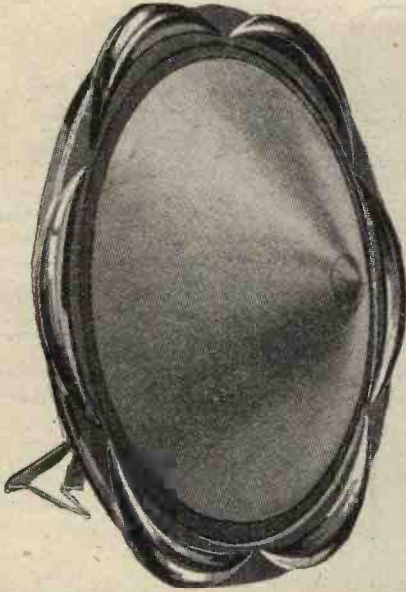

THE LONG VIEW

Take the long view—a set which does not give perfect reproduction need not be all wrong. Examined stage by stage—a better component fitted here, another there, will with each improvement bring you nearer the goal of perfection. Constructors who have fitted the Mullard “Permacore” Transformer in their receivers have discovered what wonderful tone and volume can be obtained with this transformer. It is generally admitted, too, that the Mullard P.M. Valve improves any receiver.

Now the new Mullard Pure Music Speaker marks a still nearer approach to perfection. Its wonderful sensitivity, its life-like reproduction and the tone control switch, by which the pitch can be raised or lowered and shrillness removed, all contribute to your greater enjoyment. Take an early opportunity of hearing it.

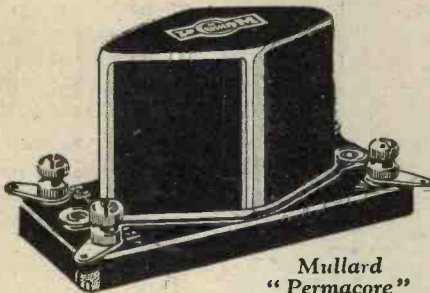

Mullard
“Permacore”
Transformer.
25/-



Use Mullard
Valves—with
the wonderful
Mullard P.M.
Filament.

The Mullard P.M. Speaker,
Model “C,” suitable for
hanging or standing.

PRICE 53/6

OLYMPIA
STANDS 88, 89,
90, 97, 98, 99, 133

Mullard MASTER · RADIO

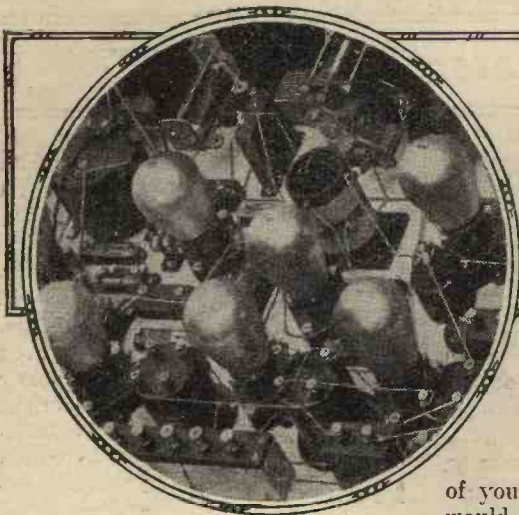

COMMENTS FROM CONSTRUCTORS

Cutting-out Daventry—38 Stations in One Night—Tapping a Hole—Rundrept Wireless, Ltd.—Power Output Devices—The "Roadside" Four.

Cutting-out Daventry

SIR,—Having been a reader of the WIRELESS CONSTRUCTOR for some time, I thought you might perhaps be interested in the enclosed circuit.

As you are no doubt aware, most people in this locality find it difficult

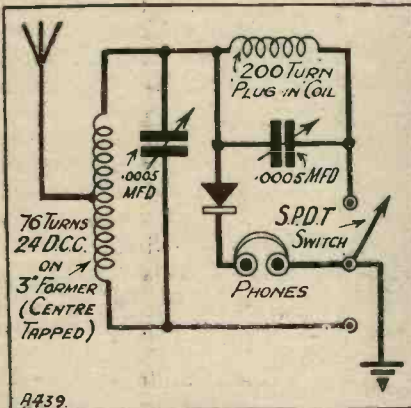

Mr. Betts' selective crystal circuit.

to separate 5 X X from 5 G B on the ordinary crystal set, owing to the proximity to Daventry.

Of course, the simplest way is to insert a .0001-mfd. fixed condenser in series with the aerial, but as this results in a loss of signal strength and does not always cut out 5 G B, the using of a wave-trap is much to be preferred. It was with this idea in mind that I made a set, of which the enclosed is the circuit.

As you will see, the main idea of the set is the using of the same coil for the two stations, in the one case as the inductance coil for 5 G B, and in the other as the wave-trap coil when receiving 5 X X.

I think the idea is quite original, and I have tried the set on several different aerials in the district and found it highly successful.

If you could find space to publish the circuit I am sure there are several

of your readers in this district who would be interested in it, as you see, the only extra cost over that of the ordinary crystal set is that of the extra condenser.

Wishing you and the WIRELESS CONSTRUCTOR every possible success.

I remain,

Yours faithfully,

ARTHUR W. BETTS.

Northampton.

38 Stations in One Night

Sir,—Just another letter in praise of the "Radiano" Three, which I made up as soon as it was published in your magazine. The following is a list of stations received :

- 2 L O (quiet).
- *Daventry (5 X X) (strong).
- *Daventry (5 G B) (strong).
- *Cardiff (strong).
- Oslo (strong).
- *Bournemouth (strong).
- *Hamburg (strong).
- *Dublin (strong, but fading at times).
- *Belfast (strong, but fading at times).
- Cork (strong, but fading at times).
- *Radio Paris (strong).
- Toulouse (strong).
- Graz (quiet).
- Frankfurt (strong).
- *Langenberg (strong).
- *Berlin (strong).
- *Barcelona (strong).
- Copenhagen (strong).
- *Stuttgart (strong).
- Glasgow (faint).
- Aberdeen (faint).
- Manchester (faint).

Also amateur stations. Also several other foreign stations which have not been identified.

(The stations marked with a * can be tuned in practically nightly.)

Also I might mention I do not use phones; neither have I any centre-tapped coils, these results being obtained with ordinary coils.

On one ideal night thirty-eight stations were logged, or shall I say heard, as they were not all identified.

Before I close may I repeat a request you have heard before ?

"When shall we have the 'Radiano' Four?" [In this issue!—Editor.]

I remain, yours truly,

A. E. HERMAN.

Redcliffe, Bristol.

Tapping a Hole

SIR,—In a recent issue of your valuable paper you gave a hint how to tap a hole straight.

There is another way, much used by engineers in marine work, where accurate hand tapping has to be done on occasions. It is as follows :

First a nut is run up the tap to be used, then the tap is inserted into the

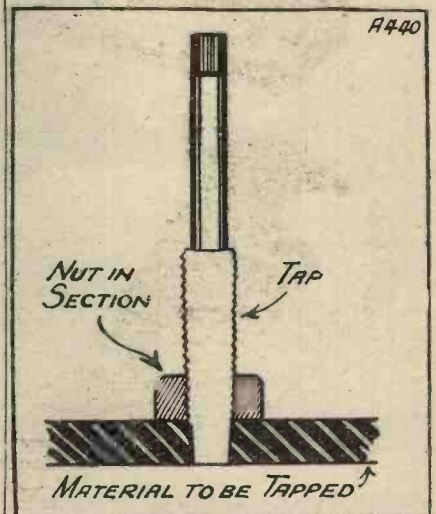

Making sure the hole is tapped dead true is accomplished by Mr. Grafton in this manner.

hole to be tapped, and the nut run down the tap to contact with the job. It is then quite easy to see that the tap is being driven straight—the nut is, of course, held stationary. Perhaps the sketch will show what I mean. The method is also good for small, accurate work. This tip may

Comments from Constructors—continued

be old to you, but perhaps some of your readers may be able to tap straight holes with it.

Yours faithfully,

W. F. GRAFTON.

Kenton, Middx.

Burndept Wireless, Limited

SIR,—The recent appointment by the Court of a Receiver and Manager does not mean that the business is to close down, and any reports to the contrary are entirely unfounded.

The Receiver and Manager is continuing not only the sales side of the business but also the manufacturing sides of the latest types of Receiving Sets and Components. Adequate stocks of all lines are already held and production will continue. Research and development are being maintained, and the Receiver has every intention of preserving the interests of all Burndept customers.

Power Output Devices

SIR,—The following difficulty has repeatedly been brought to our notice and we therefore write to draw your attention to it with a view, if possible, to your mentioning it suitably in your columns.

Experimenters and others when changing over from a single output valve to parallel valves, or to push-pull, frequently tend to overlook the fact that the conditions governing the output obtained are changed quite seriously, and this, unless allowed for, may result in an inferior performance when changing over from the parallel-valve method to the push-pull arrangement, whereas the latter with properly designed components should give, if anything, a superior performance.

An example of what we have in mind will make this clear.

In a particular case, the output

speaker. On the other hand, with these two valves in parallel, using a choke filter or output transformer, the results may be quite satisfactory, and immediately the push-pull system is regarded definitely inferior.

The fact of the matter is, of course, that with the valves in parallel their effective impedance is approximately 1,400 ohms, which is just about right with a speaker of the resistance mentioned, whereas when the valves are in push-pull their impedances are in series and amount to about 5,500 ohms, so that the ratio of the output transformer is quite unsuitable.

An Important Point

In this case, an output transformer having a ratio equal to the square root of the effective valve impedance divided by the speaker impedance, namely, a 2/1 output transformer, should be used, and to deal with cases of this kind we have laid ourselves out to supply transformers of special ratios such as this where necessary.

At the same time, we would point out that when using the push-pull system the same grid bias should be employed as when either of the push-pull valves is used singly. This is an important point, as biasing the valve to a limit of the straight portion of their characteristics usually introduces distortion.

Yours faithfully,

FERRANTI, LIMITED.

Hollinwood, Lancashire.

The "Roadside" Four

SIR,—Permit me to report that the results obtained from the "Roadside" Four are excellent, and this portable set is highly recommended to your readers.

There is, however, a great disappointment to the user to find that the portable set is actually of very little use for the purpose it is intended for, and it is hoped that you will use your best endeavours to persuade the B.B.C. that they are ignoring the requirements of the portable-set user by delaying their afternoon programmes until 4 p.m. upon most days, and providing very unsuitable items in their programmes at this time. Surely light musical items of an entertaining character are the most suitable for summer-time transmissions, and these should be early in the afternoon.

Yours faithfully,

Huddersfield.

S. T.

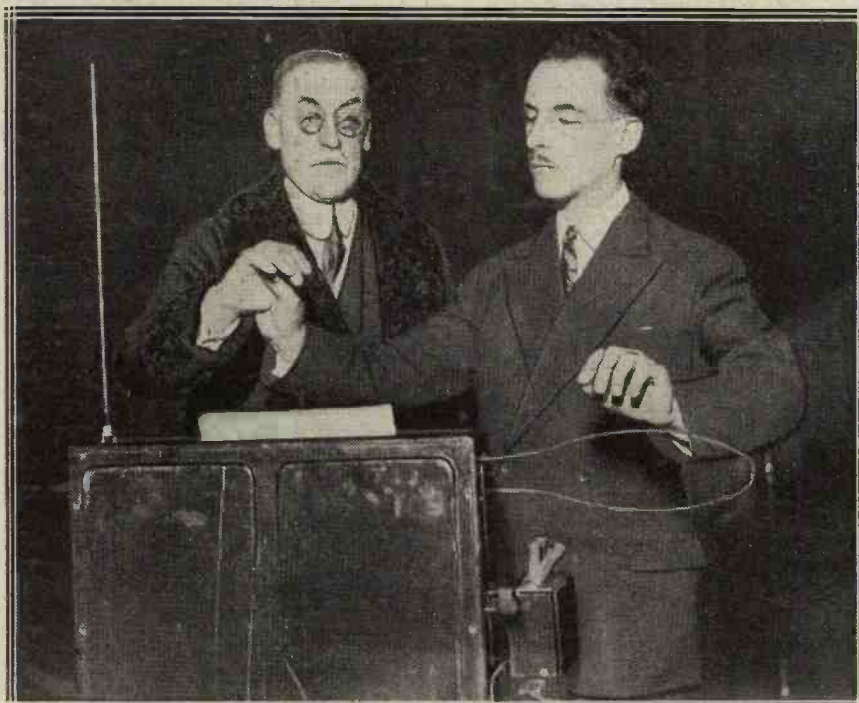

Why is it that we heard such a lot about music from the air and yet this type of broadcast set never makes its appearance at any radio exhibition? By rights we should expect to see Mr. Theremin and his "musical box" at Olympia this month.

In the hope of bringing the above facts to the notice of all interested, perhaps you will kindly give some prominence to this notification in your next issue.

Yours faithfully,

For the Receiver and Manager,
Burndept Wireless Limited,

H. SLATER,
Sales Manager.

valves employed are two L.S.5A valves, and the moving coil has an impedance of about 1,300 ohms.

These valves are connected in push-pull with a 1/1 output transformer and the result is very unsatisfactory in that it may be found that the output valves will be seriously overloaded without obtaining a satisfactory response from the

LOW-PRICE

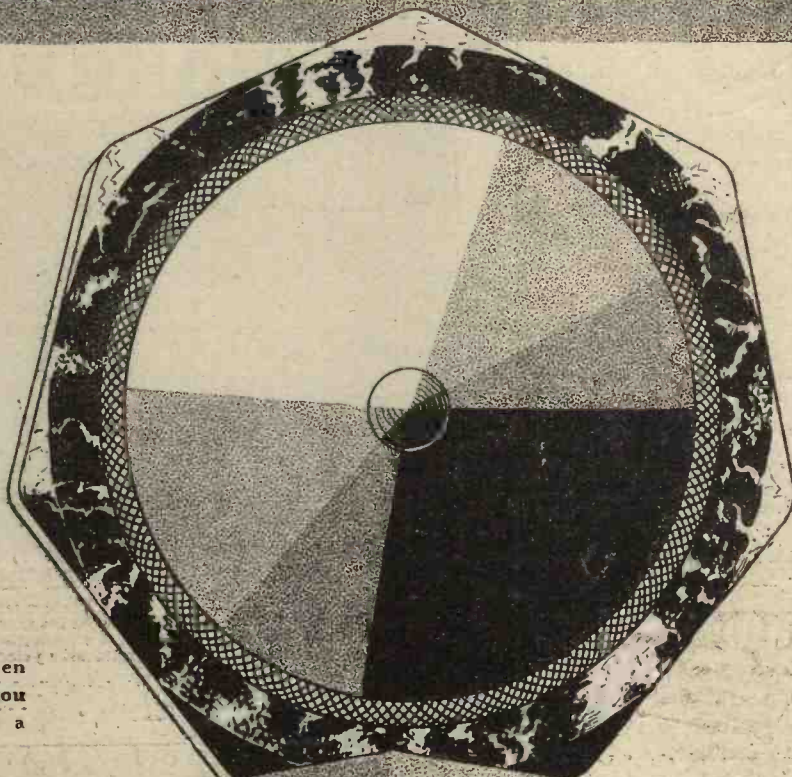

The constructional details of Philips' Seven Cornered Loud Speaker will interest you because they are very unusual in such a low-priced instrument.

The electro-magnetic movement is of the balanced-armature type and is fitted with a cone of ample surface area, which retains its rigidity under all conditions. Consequently Philips' Loud Speaker responds to an unusually wide range of frequencies, and maintains a very natural tone.

There is also a switch controlling a special device which enables you to obtain a suitable impedance.

As you see, Philips' Seven Cornered Loud Speaker is something new in value, a first-class instrument which sets a new low-price standard. Call in at your dealers and ask to hear one, it will be a pleasure worth the asking.

PRICE 50/-

PHILIPS

for Radio

BOWYER-LOWE ANNOUNCE A RANGE OF EPOCH MAKING SETS AND NEW QUALITY COMPONENTS

"LOG MAJOR."

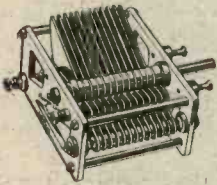

A new full size logarithmic condenser with cast steel spindle $\frac{3}{4}$ " diameter on cone type ball bearings. One piece, pig-tail.

List No.	Mfd.	Panel.	Length Behind	Price
330.	.00025	2 9/16"		12/-
331.	.0003	2 1/2"		12/6
332.	.00035	3"		13/-
333.	.0005	3 1/2"		13/6

End Plate, 3 1/2" x 1 1/2".

"LOG MINOR."

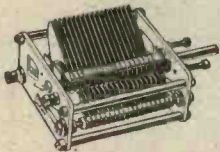

A miniature of the "Log Major" with spindle $\frac{3}{16}$ " diameter.

List No.	Mfd.	Panel.	Length Behind	Price
334.	.0003	2 1/4"		7/6
335.	.004	3 7/16"		8/6
336.	.005	4"		9/6

Supplied with ebonite dielectric for portable sets.

List No.	Mfd.	Panel.	Length Behind	Price
338.	.0005	1 1/2"		11/-

Made in any size for set makers.

ELFIN CONDENSER.

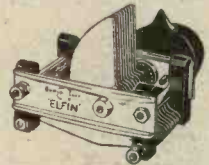

The smallest logarithmic condenser made. A precision instrument especially suited for sets where space is at a premium.

List No.	Mfd.	Price
311.	.0001	5/9
312.	.00015	6/-
313.	.0002	6/3
314.	.00025	6/6

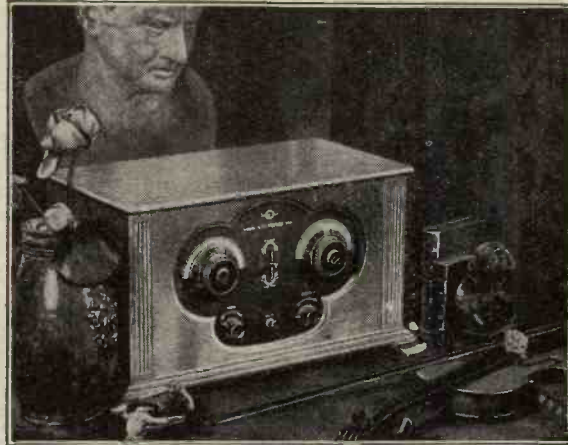

THE SCREENED VOX POPULI THREE.

"The Set of the Year." This Screened Three marks the biggest advance in set design and construction since the industry began. The quality of its reproduction is amazing and its selectivity is no less wonderful, utilising a screened grid H.F. valve and a 5 electrode Pentode for the amplifying stage.

List No. 339. Set in dark polished oak, beautifully finished, complete with grid bias and three special valves tested and matched to set. **£19/-** Marconi Royalty. 37/6

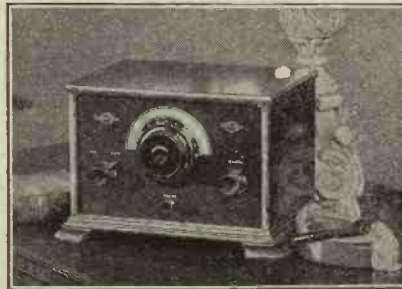

THE PENTOVOX TWO. A Two Station L.S. Set.

The Pentovox will be one of the most popular sets of the coming season. It is a two valve receiver using the new Pentode valve and, despite its luxury equipment and outstanding performance, is one of the cheapest sets on the market—no coil changing, easy and simple control by slow motion dial. List No. 329. Set in dark polished oak. **£4/5/-** Two Special Valves. **£1/15/6** Marconi Royalty. 25/-

Bowyer-Lowe are introducing a Screened Vox Populi Four, a new Short Wave Receiver and a Cone Loud Speaker. Full descriptive details can be had on request.



SETS • COMPONENTS • LOUD SPEAKERS

BOWYER-LOWE CO., LTD., RADIO WORKS, LETCHWORTH, HERTS.

LONG RANGE H.F. CHOKE.



Operates over whole wave-length range from 7 1/2 to 4,000 metres without flat spots. Self capacity of the order of 5 or 6 uuf.

List No. 337. 7/-

"WHITELINE" VALVE HOLDER.



An instrument "mechanically and electrically perfect." Large initial amplitude to shock, but quick and smooth damping.

List No. 282. 1/9

VARIABLE RESISTOR.



For baseboard mounting in two ranges, 0-5 ohms and 0-30 ohms. Resistance wire is wound on non-shrinking former with bakelite base.

List No. 289. 0-5 ohms. 3/-
List No. 290. 0-30 ohms. 3/-



Ferranti Wire-Wound Resistances

A USEFUL addition to the Ferranti range of wireless components is the line of wire-wound resistances now available for use in mains units, in high-tension leads (in conjunction with fixed condensers) as a means of stopping "motor boating," and as resistances for reducing the voltage applied to a valve so that one voltage of battery can be used throughout a receiver. A wide range of values is available from 2,000 ohms to 100,000 ohms, the current-carrying capacity of the 2,000 ohms being 60 milliamps and that of the 100,000 ohms 5 milliamps respectively, the current-carrying capacity falling off, naturally, as the value of the resistance rises.

Used for the purposes for which they are designed, these resistances are most useful. Measurements show that the values are marked with a satisfactory degree of accuracy. No attempt is apparently made to wind these resistances in non-inductive form, although they are sectionised. Measurements showed that the 3,000-ohm resistance had an actual value of 3,220 ohms and an inductance of 4,200 microhenries. The actual make-up of these resistances is in the conventional cartridge form generally associated with wire-wound resistances

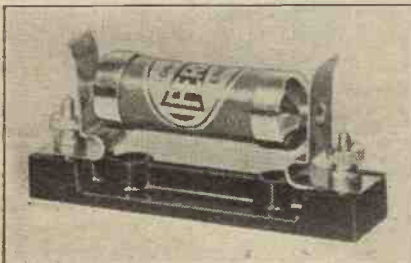

A Ferranti wire-wound resistance.

used for resistance-capacity-coupling. It is not intended that this Ferranti resistance should be used for R.C. coupling, and the Ferranti resistances must not be considered as being interchangeable with the other types. Substantial and well-made moulded

bakelite bases with clips and terminals are provided for these resistances, so that the convenience of rapid interchangeability is obtained.

A MONTHLY REVIEW OF TESTED APPARATUS.

NOTE: All apparatus reviewed in this section each month has been tested in the Editor's private laboratory, under his own personal supervision.

Magnum Valve Holder

The Magnum valve holder illustrated herewith has several interesting features. It is of the "sprung" variety, the central sprung portion carrying the valve sockets being ingeniously constructed so as to remove as much as possible of the solid dielectric from between the sockets.

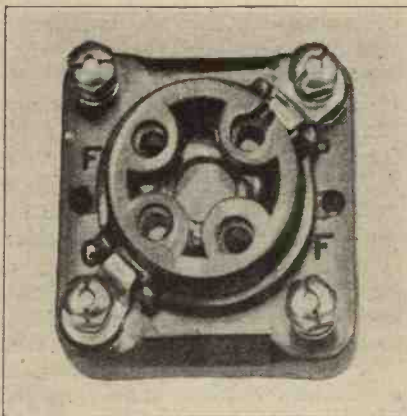

Low-loss construction is a special feature of this Magnum valve holder.

This is effected by the provision of a central hole and cutting away a good deal of the solid material between the sockets themselves, as shown in the illustration.

Four terminals are provided at the corners of the square, and as these terminals do not project the space occupied by the holder is extremely small, which, of course, is a distinct advantage in portable sets. The method of springing is quite sound and good contact is established with the valve pins. High-frequency tests

show that the losses due to the presence of solid dielectric have been reduced to a very low figure, thus making the holder efficient on very short-wave work.

The Philips L.F. Transformer

At one time very small transformers were almost invariably very poor transformers, as the small size generally indicated insufficient iron in the core and insufficient wire on the bobbins, but with the introduction of the newer irons, such as "Permalloy," it is now possible to obtain the effects we require with a very much smaller quantity of iron. The Philips' transformers are a good example of the application of Permalloy in modern low-frequency transformer design. Although the transformer itself is small in physical dimensions, the performance is excellent over the whole musical range, and can be recommended for use in any type of set.

Its small size and light weight make it particularly suitable for portable receivers, and thus it is no longer necessary to sacrifice quality of reproduction in order to obtain light weight. The make-up of the instrument itself is very convenient, substantial terminals and soldering lugs being provided. The base is of moulded bakelite and underneath



A new L.F. transformer due to Philips Lamps, Ltd.

there is a convenient diagram of connections.

The ratio is 3 to 1, and like most high quality modern transformers, the type of valve generally called "high frequency" works excellently in

What's New—continued

front of it. The makers have adopted the practical method of marking G for grid, P for plate, Positive for H.T., and -C for grid bias.

It is rather peculiar to find a European manufacturer adopting the American "C" for grid bias. However, this method is far superior to the I.P., O.P., I.S., and O.S., which some transformer makers still persist in using, though it means nothing to most modern users and is only a source of confusion.

The "Lewcos" H.F. Choke

The latest addition to the line of high-frequency chokes now available to home constructors is the "Lewcos," manufactured by The London Electric Wire Co. In appearance following the conventional lines with a slotted former and sectionised winding, the choke on test showed a remarkably extended range of usefulness, its natural period coming far higher than is usual with such devices.

Our laboratory tests showed that in a normal circuit it can be used up to wave-lengths well above 4,000 metres and down to 50 or lower. We

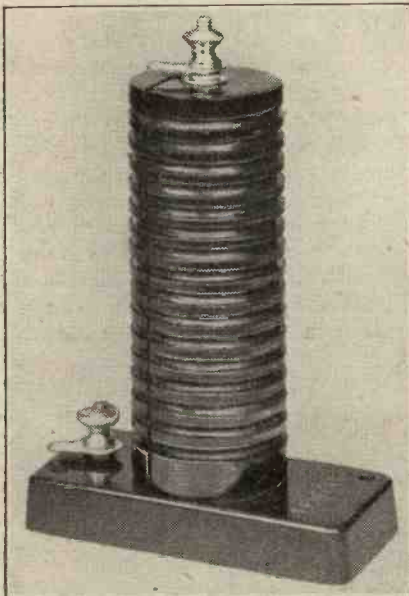

The new "Lewcos" H.F. choke.

understand from the makers that this choke has been brought out in response to a demand for a choke which will be really effective around the Daventry and Radio-Paris range, as many of the existing models cease their choking action well below the 2,000-metre mark.

Readers who have had trouble with their radio-frequency chokes on the

Daventry range should certainly consider this model when making a new choice.

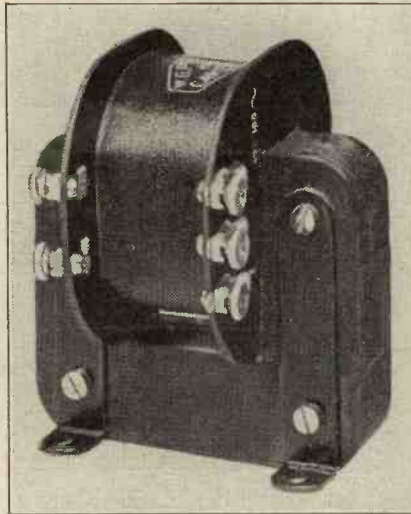

The Pye transformer for Westinghouse rectifiers.

A Transformer for the Westinghouse Dry Rectifier

The increasing use of the Westinghouse dry rectifier has created a demand for a transformer which will function satisfactorily with this useful device. Messrs. Pye's, of Cambridge, who have a well-deserved reputation for transformers, are now producing at the reasonable price of 15s. a useful transformer tapped on its mains side for 200 to 220 and 230 to 250 volts A.C., while on the output side a voltage of 8.5 is obtainable for use with the Westinghouse dry rectifier, types R4-2-1 and R4-2-2. One of these transformers and a Westinghouse R4-2-2 unit make an admirable combination for providing the field current for moving-coil loud speakers of the low voltage variety, as no special smoothing circuit is required; the choking effect of the field windings usually providing all that is necessary. The transformer under review is up to the high standard associated with Messrs. Pye's products and should prove extremely useful for a variety of purposes.

LATEST EXHIBITION NEWS

See "Popular Wireless" for all the latest news from Olympia.
ON SALE THURSDAYS
PRICE 3d.

The Lissen Super Transformer

The new Lissen Super Transformer, illustrated herewith, is a welcome addition to the line of first-rate British low-frequency transformers. Careful tests in the laboratory revealed that the reproduction with this instrument is of very high quality, the low notes being faithfully reproduced as well as the high, reproduction being remarkably uniform over the whole range. A detailed examination of the instrument itself shows that a very substantial iron core is used, the secondary being wound with two bobbins, one inside and one outside the primary bobbin.

Each bobbin is further subdivided so as to obtain a very low distributed capacity. A ratio of 4 to 1 is used and a fixed condenser of .0003 mfd. is placed across the primary terminals inside the casing, which is of moulded bakelite. This super transformer should not be confused with the maker's popular 8s. 6d. model. The latter, while excellent value for the



This is the Lissen super transformer.

money, is not comparable with the new model in performance over the whole frequency range.

In our opinion the advantages gained by using a high-grade low-frequency transformer in a receiver in practically all cases outweigh the difference in cost between the two types. Considering the performance obtained, the price of the new super transformer at 19s. is remarkably low, and we congratulate the makers in producing such a fine component.



SIX-SIXTY

GLOWLESS VALVES



STAND 42a
OLYMPIA

TESTED VALUES OF THE LEWCOS H.F. CHOKE



PRICE 9/- EACH

Minimum self-capacity 1.62 micro-microfarads (N.P.L. test).

Natural Wave-length 5,200 metres (tested with Moullin Voltmeter).

The shaded portion of the diagram indicates the danger zone wherein self-oscillation is liable to occur in a receiver. It will be noticed that the LEWCOS H.F. Choke curve is well above the danger zone throughout the whole range of wavelengths, whereas with the other three makes the opposite is the case.

H.F. CHOKE CURVES
Showing the performance of the Lewcos HF Choke compared with other makes

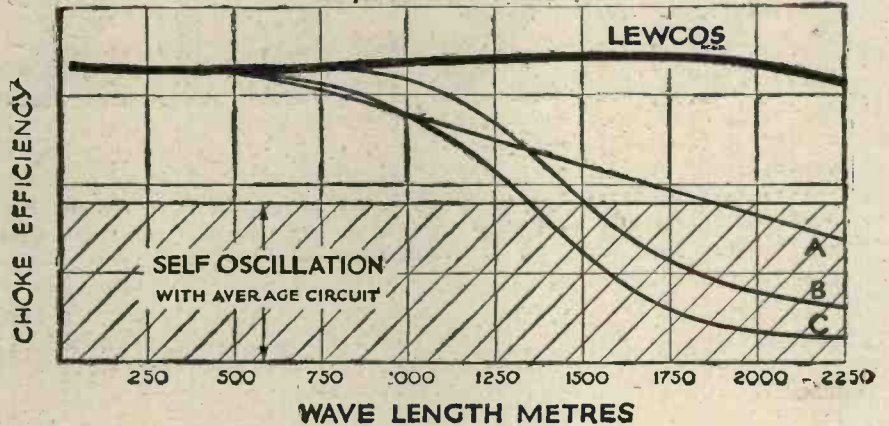

For maximum efficiency from your set on all wave-bands from 20-2,000 metres—use the "LEWCOS" H.F. Choke. Wireless enthusiasts will welcome the design of this new choke because it cuts down H.F. leakage to a minimum. The terminals are arranged one at the top and the other at the base of the coil to eliminate the risk of additional self-capacity in wiring a receiver.

The diagram shows the percentage choking effect of the LEWCOS H.F. Choke on all wave-lengths from 20 to 2,250 metres, as compared with three other popular makes A, B, and C.

Obtainable through any good Radio dealer.

LEWCOS (REGD.) HIGH FREQUENCY CHOKE

The London Electric Wire Company and Smiths Limited

Church Rd.,

Leyton, London, E.10

Phone: Walthamstow 2531

Telegrams: "Lewcos, Phone, London."



MUCH as I respect and admire Professor Goop, who has been justly described as "one of the greatest intellects of all time" (whatever that may mean), I do not think after mature consideration that I am going motoring with him again. Once smitten, twice fly, as the old proverb has it.

Goop's Quaint Habit

I do not really mind his quaint habit of driving at full speed in reverse on arterial roads in dry weather in order to keep the dust out of his eyes; my timbers remained unshivered and my iron nerves unshattered (though I can hardly say



"One simply waits outside King's Cross or Euston."

the same of my gent's natty suiting) when a burst front tyre sustained at ninety miles an hour landed him, his car and his passenger in the gorsiest patch of one of our gorse-covered commons, in order to point out the beauties of which he had removed both hands from the steering-wheel. These little things are all in the day's work, and one takes them as they come. It is more serious matters that have stifled at birth my desire to go motoring with Professor Goop.

Our last—at least, I hope that it is the last—trip together came about as the result of an evening that I had spent with him. In the course of it he told me something of the beauties of a new receiving set that he had just designed. This works on the familiar super-something principle, whose name is so well-known that for the moment I have forgotten it.

Impulses brought in by the aerial take the form, of course, of waves, and these have to be rectified or flattened out by means of a detector. In the

Super-what's-its-name, the first rectification process is done by passing them between rubber-faced rollers operating on the ordinary super-manglodyne principle. They are then stepped-up to umpteen thousand metres, after which they are re-rectified and then, following a considerable amount of further mucking about, they are passed on to the low-frequency side of the apparatus which delivers them to the loud speaker.

Owing to this remarkable invention, it is possible to-day to make a seventeen-valve set that is quite as efficient as the four-valver of yesteryear. The super-whatyoumaycallit has to be heard to be believed. Those who have practical experience of it absolutely rave about it. In fact, asylums throughout the country are now practically full to the doors with people who have tried the circuit and simply can't stop raving.

During our conversation the professor told me that he had just made up a set operating upon this principle whose perfection was such that the distant station came in every whit as well as the local.

Getting the "Granite" City

"Take Aberdeen——" he said. "Impossible," I replied sadly. "With Aberdeen it is a case of put and take; you put and they take. In that brav city every other shop is a dry-cleaner's establishment. They are enabled to pay enormous dividends simply through the business they do in cleaning poppies and roses for use on future occasions."

"Tut, tut," grunted the professor. "What I meant was that Aberdeen provided a notable example. You will hear 2 B D as well here in my house as you would at a point but a mile or two from the centre of what I believe is known as the Igranite City."

"Granite," I corrected, but the professor shushed me into silence and went on with his theme.

I told him that I did not believe a word of it. I mean, of course, I was quite polite about it. I did not put it just like that. I forget exactly

what I said, for after concussion of the brain one's memory is apt to be a little faulty, and concussion is liable to supervene when a fellow swats you over the head with a case-opener. I was not in the least offended with the professor when I had recovered, for, after all, the very fact that one can have concussion proves conclusively that one has a brain, a matter over which I had had quite a heated argument with Gosburton Crump only the week before.

A Practical Demonstration

Shortly after my discharge from hospital, the professor insisted upon me taking part in what he was pleased to call a practical demonstration.

"We will tune in Aberdeen here," he said, "and you shall note the quality. We will then get into my car and we will drive northwards taking the set with us. At suitable intervals we will tune in the Scottish station, and I guarantee that you will agree that the quality originally was every bit as fine as that which we shall obtain when we are within but a mile or so of our destination. How, by the way, does one get to Aberdeen?"



"Where?" stormed the professor. "Wave!" I insisted.

"If," I returned, "one is an Aberdonian one goes to the docks and selects a ship round which no seagulls are hovering. Being thus assured of its port of registry one stows away on board and probably pays one's expenses for the next three months by writing lurid articles on 'How I Caused the S.O.S. to be Sent Out, By A Stowaway.' Of course, if one is liable to seasickness one simply waits outside Euston or King's Cross until some Celtic visitor to the Metropolis drops his return half."

"I meant," snarled the professor,

In Lighter Vein—continued

"what road does one take, for I, of course, invariably motor from place to place?"

I told him that there was practically one-way traffic to the South on all roads leading over the border, but he refused to listen to my words. After consulting maps and things we found that the Great North Road was just the thing.

"Where?" "Why, Ware!"

"Where do we make for first from here?" queried the professor.

"Ware," I said.

"Two questions don't make an answer," cried the professor. "I said where?"

"And I said Ware," quoth I.

"Where?" stormed the professor.

"Ware," I insisted. Seeing him reaching for the poker and remembering that I had already demonstrated that I possessed a brain, I hastily pointed to the place upon the map.

"We will start at nine to-morrow," said the professor.

"Ack or pip-enma?" I inquired.

I am not fond of acks; in fact, if I may so put it, they give me the pip. I mean, I don't think the world is properly aired before midday. All this talk about rising with the lark is really rather rot. Larks find it such a strenuous game that they have to go



"Knotting my necktie as we sped northwards."

to bed just when decent people are getting up. Give me nightingales every time.

The professor, however, was adamant. An early morning start, he said, was essential. I promised with some misgivings to be at the rendezvous at the appointed hour, but I quite forgot that Wilfred, my alarm clock, shares my own feelings and invariably goes off about six hours late. As a matter of fact, though, we did get under way by midday, but I had to pull on my socks and complete the knotting of my necktie as we sped northwards.

The professor's taste in cars is a little queer. He likes something with

some zip about it. That I suppose is why he has a Baby Forcadin body on his 90 h.p. Spaghetti chassis.

"What's our next point?" he queried when the countryside had flashed past for a few minutes.

"Hitchin," I shouted.

"So am I," called the professor, scratching a leg; "but do be careful of your aitches. These mosquitoes——"

A blur of houses and things occurred and we were once more upon the open road.

"You know," remarked the professor suddenly, "I think the trouble with most short-wave enthusiasts is that they can't make fine enough adjustments. If you give just a tiny turn (he did so to the steering wheel and we narrowly missed a haystack) you can tune in 2 X A F to perfection. But if you do like this (and here he gave the thing a yank) you simply don't know where you are."

A Rapid Rotation

We shot down a turning to the left and before I had regained breath enough to point out that we were off the track we found ourselves in Bristol.

It was there that we struck one of those merry-go-round affairs which add so much to the hilarity of modern motoring. Being somewhat unused to this form of traffic-control, the professor, once he had begun to rotate, found himself completely unable to get out of the ring. Like a straw caught up in a whirlpool we circled madly round and round.

At one time a 60 h.p. Moonshine was ahead of us, but in the seventeenth lap we left it absolutely standing still. I have often wondered since whether it mistook that lamp standard for the winning post, or whether the driver was a little disconcerted by the skillful way in which the professor edged him lap by lap nearer the pavement. At length the professor announced that he was feeling giddy and that the only cure was to go round the other way.

A Little Trouble!

He performed a masterly gear change from top to reverse, and after half a dozen more laps saw a way open. We shot down a turning, brushing motor-buses and things aside, and after a merry little turn round Wales found ourselves back on the Great North Road in simply no time at all. The Professor has since written to all local authorities who go

in for merry-go-rounds suggesting that they should have the corners properly banked.

We had a little trouble just north of Berwick owing to a slight puncture sustained by contact with a harrow that somebody had carelessly left lying about. It wasn't actually on the road, for the professor, who is always one for the great open spaces, was trying a short-cut across country.

A "Little Oversight"

Still, I do think that farmers ought to be a little more careful about the way in which they leave their tools about the place. Luckily it was not a tyre that was punctured. The pro-



The professor was trying a short cut across country.

fessor failed to see a stout beam fixed across the gateway between two fields and the car stopped rather suddenly, with the result that he sailed through the air and brought up sitting upon the implement in question. With the help of the jack I was soon able to prise him off it and we resumed our journey, though for some reason the professor elected to drive standing up.

"And now," said the professor, when we had left the border well behind us, "the time has come to give you a convincing demonstration. We will get out the set and tune in Aberdeen. He opened the lid of the glory-hole thing at the back of the car and began to rummage about. "I am afraid," he remarked, glancing up presently, "that by a little oversight I have left the set at home. Jump in and we will go back to fetch it."

I suggested that he should go back alone whilst I remained behind. I promised that I would have a temporary aerial erected by the time that he returned. The professor shot off in a huff and a cloud of dust. When he had gone I set out for the nearest railway station.

"What's the next train for the South?" I asked the booking clerk.

"There's one in half an hour," he replied, "but it's only a slow."

"Thank heaven for that!" I cried.

FIRST ANNOUNCEMENT OF "EKCO" 1929 MODELS

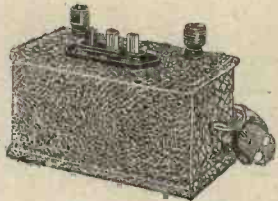

MODEL D.C.2.F.10

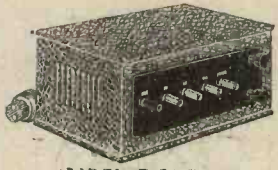

MODEL D.C.4.F.60

New Complete Range in Metal Cabinets

"Ekco," the pioneers and foremost inventors and manufacturers of Mains-Power Radio Devices in Great Britain, have pleasure in announcing their Brand New Range of Models for 1929, and that all "EKCO" Models of the value of £2 10 0 and upwards are obtainable on easy payments through your local dealer.

All models are contained in very attractive metal cabinets of an artistic crystalline dark-brown finish having the appearance of quality leather. The metal case increases efficiency by its "shielding" properties and eliminates any danger of fire. The output sockets are protected and all terminals and leads heavily insulated, ensuring absolute safety conforming to the latest I. E. E. recommendations.

As primarily "EKCO" consumption from the mains is practically negligible—"For Efficiency—Ekconomise!"

The "'EKCO' MAINS-DRIVE" Receiver is one of the outstanding achievements of the new season and is easily the soundest, the simplest and the most economical receiver yet produced.

Write now for the new illustrated "EKCO" Booklet post free, giving full details.

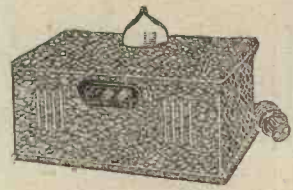

MODEL A.C.2.F.10

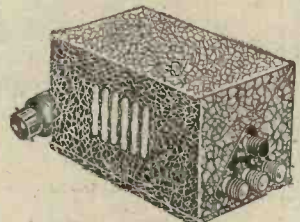

TRICKLE CHARGER

Safe! Silent! Sound!

H.T. UNITS.		Voltage Tappings		A. C. Rectification	PRICE COMPLETE	
Model	Current Output				D.C.	A.C. inclusive of Valve and Royalty
1F.10	10 MILLIAMPS For 1 to 3 valve sets, or those requiring not more than 10 milliamps	60 or 90 or 120		Valve	17 6	£3 13 6
2F.10		60 and 120		Valve	£1 9 6	£4 18 6
3FA.20	20 MILLIAMPS	30 fixed 60 " 120 "		Valve	£2 10 0	£5 8 6
1VA.20	For 1 to 5 valve sets, or those requiring not more than 20 milliamps	0-120 var. 120 fixed		Westinghouse Metal Rectifier	£2 18 6	£6 15 6
3FB.20		30 fixed 60 " 120 "		Valve	—	£7 5 0
1VB.20		0-120 var. 120 fixed		Valve	£3 12 6	£7 2 6
4F.60	60 MILLIAMPS	30 fixed 60 " 120 "		Valve	£3 18 6	£7 13 6
IV.60	For 1 to 10 valve sets or those requiring not more than 60 milliamps	"Power" fixed 0-120 var. 120 fixed "Power" fixed		Valve	£5 0 0	£8 12 6
2V.60		0-120 var. 120 fixed "Power" fixed		Valve	£7 15 0	£15 10 0
FV.120	120 MILLIAMPS Super-Power	0-120 var. 0-120 " 200 fixed		Valve	£9 15 0	—
"ALL-POWER" UNIT. C.1A	60 milliamps. H.T. 0-120 var. 100 fixed power. L.T. up to 6 amp. G.B. up to 21.			Westinghouse Metal Rectifier	—	£2 12 6
TRICKLE-CHARGER. T.500	Charges 2, 4 or 6 volt accumulators from A.C. Mains at 1/2 amp continuously			Valve	—	£3 12 6
RECTIFIER UNITS.				Valve	—	£5 0 0
R.20	For attaching to D.C. Units.	For 10 and 20 milliamp range		Valve	19 Gns.	complete, inclusive of Valves and Royalty
R.60	For use on A.C. mains	For 60 milliamp range		Valve	21 Gns.	complete, inclusive of Valves and Royalty
MAINS-DRIVE 3-VALVE RECEIVER.					15s. 0d.	
ISOLATING TRANSFORMER, for Isolating Loud-Speaker or 'Phones from set where a power supply unit is in use.						

VISIT US AT STANDS 48, 49 & 50, NATIONAL RADIO EXHIBITION, OLYMPIA

E.K. COLE LTD Dept. M, "EKCO" WORKS, LONDON RD., LEIGH-ON-SEA.

NO RADIO WITHOUT DARIO

The latest range of the world-famous
RADIO MICRO VALVES
 AT NEW REDUCED PRICES!

**SUPER
 POWER
 VALVES**
 FOR
 LOUD-SPEAKER
 RECEPTION
 2 and 4
 VOLTS
7/6
 DARK
 EMITTER
 TYPES

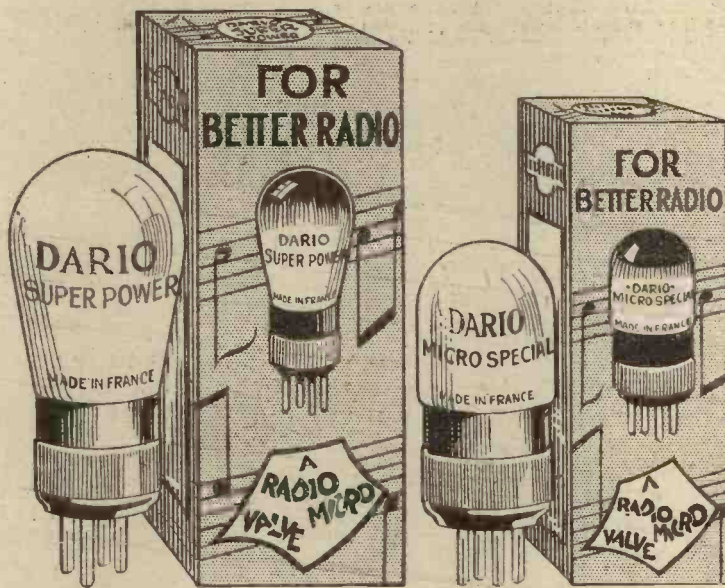

**GENERAL
 PURPOSE**
 and
**R.C.C.
 VALVES**
 2 and 4
 VOLTS
5/6
 DARK
 EMITTER
 TYPES

We claim that with the latest Dario Valves the greatest volume and selectivity can be obtained with the greatest economy of filament current, as the G.P. 2 and 4 volts consume only '05 amps. and the Super Power 4 and 2 volts '1 amp. and '18 amp. respectively.

DARIO VALVES

DARK EMITTER RADIO MICRO

Can be obtained at the new prices from all high-class radio dealers all over the British Isles. If unobtainable locally write to us mentioning name and address of usual dealer.

IMPEX ELECTRICAL LTD.
538, High Road, Leytonstone, London, E.11.

Telephone : Wanstead 2722.

DEALERS' Enquiries are welcome and will be attended to promptly.



Some typical faults and remedies reviewed.

By P. R. BIRD.

FOLLOWING my recent remarks upon the queer things that can happen if contacts are bad, I received a letter from a reader of the WIRELESS CONSTRUCTOR who lives at West End Lane, Hampstead, N.W., London. He instances a case which, although unusual, might have happened to anybody, and I think that I cannot do better than to put it into his own words.

After saying some very nice things about the WIRELESS CONSTRUCTOR, he continues as follows: "My set is a two-valver—Det.-L.F.—and some time ago I had the misfortune to blow a valve, and therefore replaced it with a new one. But on putting this in position, much to my astonishment the set would not work at all! I tested the L.T., H.T., transformer, etc.—all O.K.

The Magic Knock

It then dawned upon me that I may have placed the valve in wrongly, but this did not appear to be the case. I again switched on the set, and in doing so I happened to knock on one of the valves. (Not the new one, the old one.) Suddenly 2 L O came in with a roar, but my joy was short-lived. About five seconds afterwards all was silent again. I again gave the valve a tap and it came through again, but again it vanished. Then I tried pushing the valve down farther in the socket, but it was already down as far as it would go. Next, I began to suspect the valve holder, when examination showed that this was O.K. Apparently the only thing that remained was the valve itself.

To make definitely sure I reversed the valves and gave the new one a

tap. No results. But directly the old one was tapped in came 2 L O again. On placing another valve in the old one's position the set worked as of old. I found out the truth about a week later.

Cause of the Trouble

What had happened was that when I was at business a friend had soldered a lead in place for me. In order to

THE TECHNICAL QUERIES DEPARTMENT

Are you in trouble with your set?

Have you any knotty little Radio problems requiring solution?

The WIRELESS CONSTRUCTOR Technical Queries Department has been thoroughly reorganised and is now in a position to give an unrivalled service. The aim of the department is to furnish really helpful advice in connection with any radio problem, theoretical or practical.

Full details, including the revised and, in cases, considerably reduced scale of charges, can be obtained direct from the Technical Queries Department, WIRELESS CONSTRUCTOR, Fleetway House, Farringdon Street, London, E.C.4.

A postcard will do: on receipt of this all the necessary literature will be sent to you free and post free, immediately. This application will place you under no obligation whatever. Every reader of the WIRELESS CONSTRUCTOR should have these details by him. An application form is included which will enable you to ask your questions, so that we can deal with them expeditiously and with the minimum of delay. Having this form you will know exactly what information we require to have before us in order to solve your problems.

do this he had removed the valve and quite innocently remarked to me that he had had great difficulty in moving one of them, and when it did come out it came out with a jerk and hit the top of the cabinet. I take it that one end of the filament had temporarily come unstuck as a result of that blow and the tapping of the valve replaced it."

I should say that there is no doubt that this is exactly what had happened in this case, though it is certainly not at all a common fault nowadays. Some years ago, however, when valve filaments were so fragile that one was afraid to look at them, it was quite a common habit to carefully tap the valve when the set "packed up," in the hope of restoring the fractured filament, or of unsticking the filament from the grid. Fortunately, the modern valve very seldom gets trouble of this kind, but our Hampstead friend's experience is an interesting one as a good instance of perseverance rewarded.

More Trouble!

Old-timers and those who are skilled at the radio game will not need to be told much about that old trouble reaction overlap. But as this is the time of the year when a good many newcomers to wireless are glad of hints about regulating reaction, I think I ought to tell you about the dreadful trouble of an Essex reader.

Six closely written pages he sent, dealing in detail with the way his set was misbehaving itself, and to judge by the blots and the underlining in his letter he could not have been more worried and distressed if the accumulator had blown up, caught the set on fire, and brought the mast down smack right upon the tenderest spot in the vicinity. And the whole trouble was nothing more nor less than overlap!

Reaction Overlap

For the benefit of those who do not recognise the name, I must explain that overlap is a trouble in getting good reaction results. If, for instance, you have a condenser-controlled reaction, you should be able to increase the reaction effects slowly and steadily; starting at a minimum there should be no reaction effect at all, and then, as the condenser is slowly increased, the feedback should be slowly increased also, until at one point on the scale the set should gently and almost imperceptibly go into oscillation.

Further increase should increase the oscillation until at "maximum" setting the set can be made to oscillate violently. The point is that you should slip in and out of oscillation almost imperceptibly as the reaction control is moved in and out.

Now this reader down on the farm in Essex, like many another good man,

(Continued on page 452.)

OUR NEWS BULLETIN

Some of the More Interesting Happenings in the Radio World this Month.

Call-Signs For Planes

RADIO call-signs have now been fixed for aircraft by the Berne Committee, and it has been decided that each aeroplane is to have a call of five letters, the first representing the nationality—G, in the case of the United Kingdom. The other four letters are the registration mark of the aeroplane. So if an aeroplane bears on its wings the letters GEYOR, that also will be its call for radio purposes. The second letter usually is what may be termed the sub-nationality letter, English aeroplanes using the letter E.

General calls have also been fixed. For example, the general call for all French aeroplanes is FOZ. The general call for all vessels of the Royal Air Force is GEZAA.

Most aeroplanes operate on waves from 600 to 1,550 metres, with 900 metres as a standby wave.

Although there are about twice as many European broadcasting stations as there are available wave-lengths, and many stations have to share a common wave-length, interference between stations is not so chronic as it was a year or so ago.

Still, there is room for improvement; and it is likely that in the near future the Union Internationale de Radiophonie will give its sanction to what is considered to be a good plan for minimising interference between broadcasting stations.

"Synchronised" Transmissions

Captain Eckersley, the chief engineer of the British Broadcasting Corporation, seems to favour this new plan, states the "Daily Telegraph," which, briefly, turns on the question of single wave-length working—that is, the sharing of one wave between several stations exactly synchronised and

broadcasting the same programme. Captain Eckersley has pointed out that if two stations, exactly synchronised, broadcast the same programme, each will give a satisfactory local service in a specified area. Outside this area the two stations would probably create what is known as a "mush" area, where quality of reception would be bad; but a third station, on another wave-length, would serve this "mush" area.

Wide Areas Covered

The main benefits of the plan are that two wave-lengths would be enough to broadcast one programme over a very wide area.

This new plan, if adopted, would probably mean the end of the international common wave, i.e. a wave shared by different stations broadcasting different programmes; and countries now using only one wave would have extra ones at their disposal.

Although the above plan has not yet been officially adopted, it is reasonable to forecast that, in the near future, it will be tried out—possibly with modifications, but essentially as outlined above.

The B.B.C.'s transatlantic broadcasting scheme is, technically, not new,

(Continued on page 430.)



MAGNUM H.F. CHOKES

Recognised as the most efficient of their types. Made in two ranges. STANDARD. 50 to 3,000 metres. Price 7/6. SHORT WAVE. From below 10 metres up to 100 metres. Price 7/6.

MAGNUM VOLUME CONTROL

Supplied in two Resistance values—500,000 ohms and 2 megohms.

Price 7/6

Special Offer Magnum Constructional Receivers

During Exhibition Week, Sept. 22nd-29th, Magnum Envelopes, containing Blue Print and Instructions, will be on sale at 1/- each. The following are available:—
Magnum 1929 Screened Five.
Magnum 1929 Purity Three.
Make a point of seeing Magnum Exhibits at Stand No. 96.
New season's catalogue and lists sent on receipt of 1/4d. stamp.

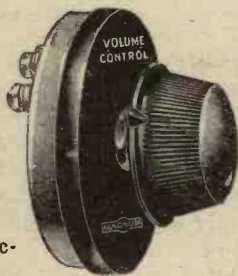

Magnum Screened-Grid Short-Wave Three

A 3-valve set giving 5-valve results. Universal wave-length range from 15 to 2,000 metres by means of Magnum "Twin-tuna" Coils. An entirely new design. Do not fail to see this remarkable Universal Set at our Stand No. 96, Olympia Radio Exhibition.

HARRIS "STEDIPOWER" UNITS



L.T. and H.T. from A.C. MAINS
The "Stedipower" L.T. Unit. Ready wired and tested. Suitable for 2, 4, or 6-Volt valves, the total consumption of which does not exceed 1 ampere. £9 10s. Od.
The "Stedipower" H.T. Unit. Ready wired and tested, and including a U.5 valve. Output 50 M.A. Two continuously variable and one fixed tapping is provided. £13 Os. Od. Royalty extra.

If you wish to build these Units yourself, we supply the complete kits of components, including Cabinets, as follows:
L.T. Unit, complete kit of parts..... £8 17s. Od.
H.T. Unit, complete kit of parts (less valve)..... £10 10s. Od.

Construct the "RADIO" FOUR

as described in this issue by Mr. Percy W. Harris

1 Oak Cabinet, with baseboard	£ 16 0
1 Resistor Ornamental Panel, 21" x 7"	10 9
2 Indigraph Dials	15 0
2 Lissen Variable Condensers, .0005 mfd.	13 0
1 Cydon Reaction Condenser, .0001 mfd.	7 6
1 On-and-Off Switch	1 6
1 Lissen Panel Rheostat, 30 ohms	2 6
2 Lotus Push-Pull D.P.C.O. Switches, with extension rods, knobs, and mountings	11 0
2 Magnum Panel Brackets	2 6
1 Terminal Strip, with 7 indicating terminals	4 6
1 Terminal Strip, with 3 indicating terminals	3 0
4 Magnum Vibro Valve Holders	8 0
4 Magnum Coil Holders	6 0
2 Magnum Fixed Condensers, .0001 mfd.	3 0
1 Magnum Fixed Condenser, .0003 mfd.	1 6
1 T.C.C. Fixed Cond. Strip type, .0005 mfd.	2 4
1 Formodenser, .0003 (type B)	2 0
2 Dubilier Fixed Condensers, 1 mfd.	5 0
1 Dubilier Fixed Condenser, 2 mfd.	3 6
1 Dubilier Grid Leak, 2 meg.	7 6
1 Magnum R.F. Choke	2 6
1 Mullard R.C.C. Unit	17 6
1 Phillips' L.F. Transformer	1 5 0
1 Igranite L.F. Choke, type F	15 0
1 Magnum Copper Screening Box, with all holes suitably drilled	12 6
25 Yards Flex	4 0
1 Lissen X Coil, No. 60	6 4
1 Lissen X Coil, No. 250	9 9
1 Lissen Centre-Tapped Coll., No. 60	6 4
1 Lissen Centre-Tapped Coll., No. 250	9 9
Sundry Screws	3
	£12 15 0

BURNE-JONES & CO. LTD.,
MAGNUM HOUSE
TELEPHONE: HOP 6257-8
288, BOROUGH HIGH ST.
LONDON. S. E. 1

Any of these parts can be supplied separately as required, or THE SET, ready wired and tested, price £14 15 0
Royalties extra ... £2 10 0

Set of 4 Valves for above ... £2 16 0

Components supplied for all sets and apparatus described in this issue.



A NEW IDEA—
“Two Stage” L.F. Unit

One stage RESISTANCE and One stage TRANSFORMER in sealed Bakelite moulding

DELIGHTFULLY CLEAR REPRODUCTION AND VOLUME

30/-
 Terminals very conveniently arranged, making the components extremely simple to wire.



Reproduction of label on top of moulding

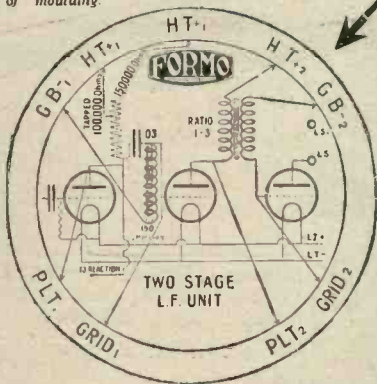

A NEW VALVE HOLDER
 ANTI-MICROPHONIC SHOCK ABSORBING

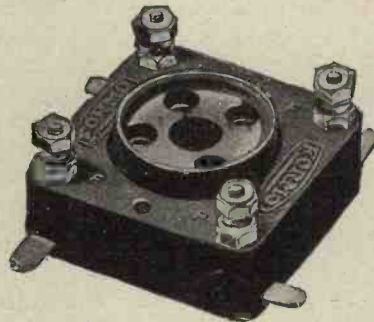

Price 1/3

BAKELITE throughout, including BASE PLATE. Practically DUSTPROOF.

The springing is such that even rough usage will not affect its liveliness.

The “float” is recessed on top, thus making easier the manipulation of valve when plugging into holder.

As will be seen from illustration, Terminals are provided as well as soldering tags.

Send for Full Catalogue and FREE COPY of BOOKLET—“L.F. AMPLIFICATION.” A postcard will do.

A NEW CONDENSER

“DE LUXE” Model Lo3 Condenser

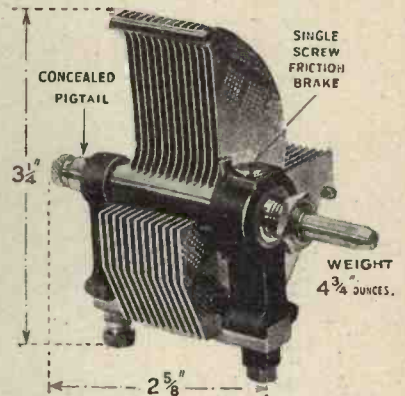

This Condenser has an ingenious NOISELESS “PIGTAIL” incorporated in a manner unobtainable in any other Condenser.

Capacity
 .0005
 .00035
 .00025
 .00015

Price 6/- each

The “Pigtail” passes through a centre boring practically the full length of the spindle, and is securely fastened to the end bearing, which is integral with the Rotor Terminal. The means employed completely overcome the noises associated with the generally used clock spring and similar loose external devices.

SHORT WAVE

DE LUXE .00015 CONDENSER

OUTFIT

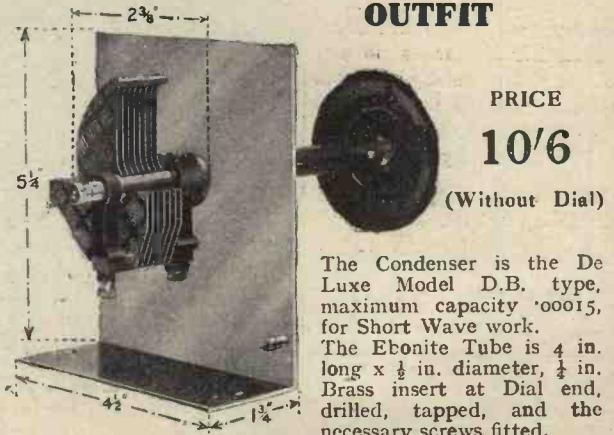

PRICE

10/6

(Without Dial)

The Condenser is the De Luxe Model D.B. type, maximum capacity .00015, for Short Wave work. The Ebonite Tube is 4 in. long x 1/2 in. diameter, 1/4 in. Brass insert at Dial end, drilled, tapped, and the necessary screws fitted.

A NEW TWO-RANGE TUNER

(Reinartz)

PRICE

10/6

Base 2/-



FROM HIGH TO LOW WAVE WITHOUT CHANGE OF COIL

A very neat and efficient Aerial Coupler with 6 pins in standard position, this can be used with any standard 6-pin base.

The change over from High to Low is effected by means of a push-pull switch on panel.

Visit STAND 140, OLYMPIA, Sept. 22-29

CROWN WORKS, CRICKLEWOOD LANE, N.W.2

Telephone: Hampstead 1787

OUR NEWS BULLETIN

—continued from page 428

but it has not yet been put into official use in this country.

The scheme consists of transmitting the same programme from an American station on five different wave-lengths—all between 16 and 50 metres—at once. At Keston five receiving sets will be at work—with the aid of an aerial which can be pointed in any direction at will—and the theory is that what is missed on one wave-length and one receiving set will be picked up on another.

All the signals received will be combined at Keston, and in that strengthened form passed on to British listeners. The idea of receiving at five different points is not, of course, new, but no one has yet sent out the same programme on five transmitters, each with a different wave-length. Captain Eckersley favours the scheme, and it is hoped that before the end of the year it will have been put into practice and have proved satisfactory.

A Search for Talent

For some time the B.B.C. has been looking for new variety artists suit-

able for the microphone, and the dramatic productions' director of the B.B.C. will keep a sharp look-out for novel turns during a Continental holiday. While in Germany and France he will visit cabarets, theatres and music-halls in the hope of finding some fresh "turn" for the many variety lovers among listeners. It is hoped that in return British artists will be heard from foreign stations.

IMPORTANT NOTICE.

The Wireless Constructor "Radlano" Three Envelope which, following a heavy demand, was for a time "out-of-print," has been reprinted. It is now obtainable, price 1/6, at all newsagents and bookstalls, or post free 1/9 from "Wireless Constructor Envelopes," Amalgamated Press Ltd., Bear Alley, Farringdon Street, London, E.C.4.

Talks will be warmly discussed when next the B.B.C. Governors meet. Some of the Governors are against the present talks' policy, and some are for it, and it is anticipated that the arguments will be lively when the Governors "get together."

The Imperial Opera League

It was reported in "Popular Wireless" and the "Daily Telegraph" recently that the Imperial Opera League, which had for some time de-

clined the aid of the B.B.C., had at last accepted the friendly business overtures of Savoy Hill.

Up to a point negotiations went well, and it seemed that Sir Thomas Beecham's dream of permanent opera and a permanent first-class symphony orchestra would become a reality. But, not perhaps unexpectedly, differences have arisen. The B.B.C. has strong views about business, and when it spends money it wants to have a say as to how and where and when it shall be spent. In other words, it likes control.

Sir Thomas will not tolerate dictation on matters concerning the artistic side of his work. In that respect he insists on unfettered liberty.

A slight hitch consequently arose, but listeners will now be glad to hear that the trouble has been cleared away and Sir Thomas is again friendly with the B.B.C.

Music Cliques at Savoy Hill

There are disquieting rumours in musical circles that the music department at Savoy Hill has fallen under the control of two or three little exclusive and faddist cliques, who are making it almost impossible for new talent to get a hearing. The very

(Continued on page 432.)

**THE NEW
10/6
Columbia**

A Columbia battery for 10/6 just consider what this means. Firstly, you are getting a battery that lasts and lasts. Secondly, your battery will maintain the E.M.F. essential to perfect reception. Thirdly, you will purchase your Columbia knowing full well that here is a product which is consistently good.

For you are getting the world's best battery for 10/6.

Just try this new 60-volt Columbia results will do the rest.

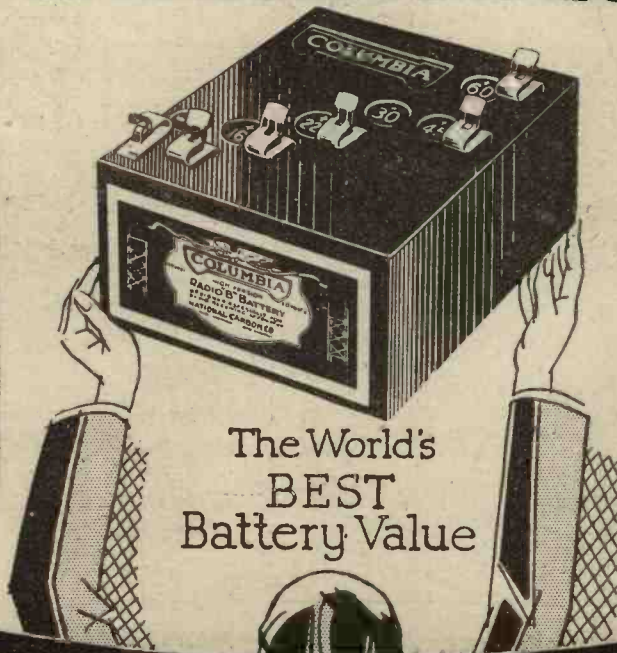

**The World's
BEST
Battery Value**

General reductions in the prices of other Columbia batteries:—

- 60 volts. High (Triple) Capacity (No. 4780) 20/-
- 45 volts. High (Triple) Capacity (No. 4767) 16/6
- 45 volts. Vertical High (Triple) Capacity (No. 4772) 16/6
- 22.5 volts. Power Grid (No. 4766) 9/-
- 4.5 volts. High Capacity Grid (No. 4771) 2/-

AND—The 100% Battery for Multi-Valve Receivers—Columbia "Layerbilt" - - - 25/-

Send for our recently published brochure, "Why Radio is better with Battery Power"—Free.

J. R. MORRIS
Imperial House, Kingsway,
London, W.C.2.

Scotland: J. T. Cartwright, 3, Cadogan Street, Glasgow.

★ HEARING THAT IS ALMOST SEEING! ★

FROM 29'6 UPWARDS

M.P.A.

SPEAKERS ARE
INCOMPARABLE
AT THE PRICE

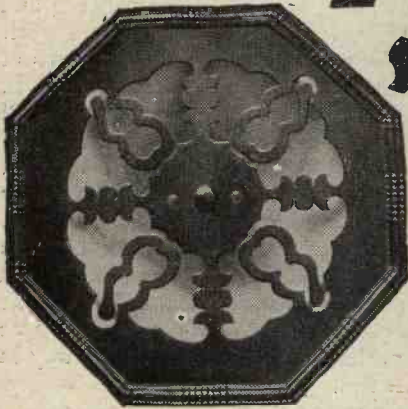

THE POPULAR PLAQUE

This is the cone speaker which has caused an upheaval in the wireless world. Never before has anything like its value been offered. And . . . it has recently been fitted with a new and improved centre adjusting movement. Such volume, such delicacy, such clarity of reproduction you would only expect from a model costing five times as much. Hear it! See it! Both its performance and appearance will make you desire it. Its amazing price, in either dark mahogany or oak, is 29/6.

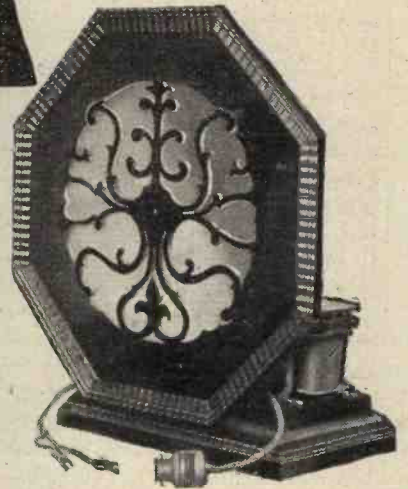

MOVING COIL SPEAKERS

You could search the World over without finding better reproduction than that of the famous M.P.A. Moving Coil Speakers, at whatever price you were prepared to pay. The result of years of painstaking research, they bear striking testimony to the skill of M.P.A. Wireless engineers. Here, indeed, is "Hearing that is almost seeing!" Exquisitely clear! Wonderfully lifelike! All models in beautifully polished mahogany, either mains driven or for use with accumulator, or accumulator combined with trickle charger. Costs 1d. a week or less to operate. Prices 10 to 15 guineas.

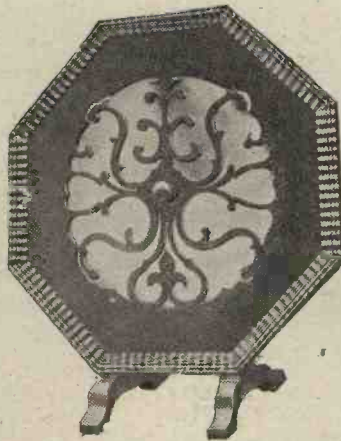

THE DE LUXE MODEL

Two inches larger than the Popular Model, the de Luxe Plaque has a "matched impedance" fret, is fitted with the new patented M.P.A. logarithmic cone, and has a wood base. Finished in either dark mahogany or oak, it not only gives astonishingly excellent results, but is unobtrusively handsome in appearance and will harmonise with any decorative scheme.
Price - - - - - 47/6

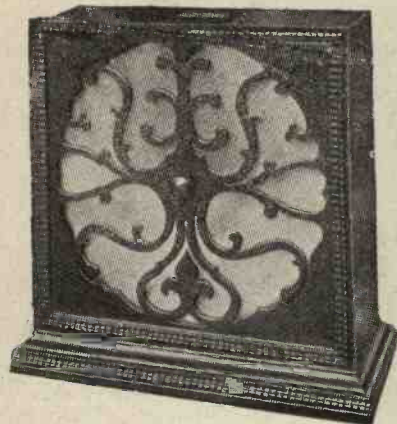

MAHOGANY TABLE CABINET SPEAKER

Another amazing example of M.P.A. quality and value! This Model is fitted with a centre adjusting movement and the renowned M.P.A. Patented Logarithmic Cone. It covers an exceptionally wide range of frequencies and its performance is in every way up to the high standard set by this House. The Cabinet is in handsomely polished mahogany with "matched impedance" fret attractively designed both sides.
Price - - - - - 5 guineas



SEE ME
AT THE
RADIO
EXHIBITION
STANDS
21 & 22

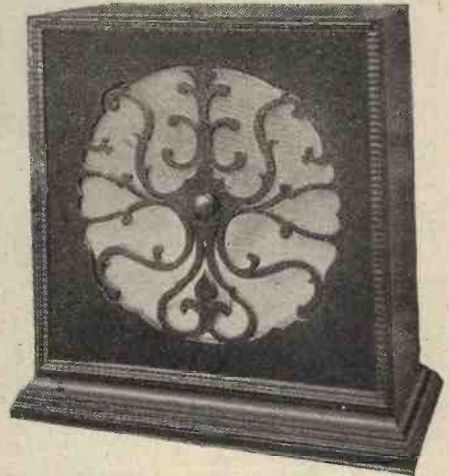

DUAL INDUCTANCE SELF-ENERGISING MOVING COIL SPEAKER

A Model which is miles ahead of anything of its kind. It places moving coil reproduction within the reach of all. Catches the most elusive cadencies of the human voice or instrument, and is startlingly lifelike. Fitted with a vastly improved type of movement exclusive to M.P.A. Speakers, no energising is required from either main or accumulator. The Cabinet is in beautifully polished mahogany fretted both sides. In every way an instrument of which anyone would be proud.
Price 5 guineas.

★ M.P.A. WIRELESS LTD., 62, CONDUIT ST., LONDON, W.1. TEL. GERRARD 6844 ★

OUR NEWS BULLETIN

—continued from page 430

existence of such rumours is reason for an investigation, which should be made to cover auditions and the whole system of searching for new material.

Sunday Programmes

Undaunted by their reverse of last spring, the Freethinkers are launching another attack on the Sunday programmes, again asking for some genuine entertainment, alternative to the religious services. Every time these attacks are made they seem to gain a little in strength, with the result that there is each time just a little more "give" at Savoy Hill. But they will have to return twice more before they get what they want. Why don't they try Parliament, which is now ready and anxious to exploit the difficulties of the B.B.C. ?

Television Solved?

The "Times" recently published a report from Berlin to the effect that Professor Karolus, the physicist, of Leipzig University, has actually solved

the problem of television. "Within a foreseeable time," says the "Vossische Zeitung," which gives the fullest account of his apparatus, "we shall have in the house, alongside the radio receiver, the telephotographic apparatus, so that it will be possible to transmit simultaneously the scene and music of an opera."

An expert in telephotography, who witnessed the working of the Karolus device when it was running far short of full power and transmitting per second only eight pictures of eight thousand light points each, stated that he received "absolutely the illusion of movement, though, indeed, somewhat angular and jerky, as in the case of a slowly running film." The pictures were "clear and recognisable, the face of each separate actor being easy to identify."

That, continues the report, was with eight pictures per second, and it is claimed that the apparatus has now been improved to a point at which it can transmit twelve. Its cheapest constituent will be the "Karolus cell," which, at the same time, is its essential novelty. This electric light relay, from which, it is asserted, the element of inertia has been completely eliminated, is filled with nitro-benzol, and varies its penetrability for light according

to the fluctuations of the current from the transmitter.

The old Karolus apparatus to which it is fitted, operated by the falling of a thin light ray in spiral lines on a rotating drum, whence it was reflected onto a photo-cell which transformed light energy into a fluctuating electrical current.

At the B.A. Meeting

Papers on Broadcasting will be read at the British Association meeting, and Sir William Bragg and Sir Oliver Lodge are to take part. There will also be demonstrations of television and noctovision by Mr. J. L. Baird, the inventor; a meteorological exhibition arranged by the Meteorological Office; a musical display, illustrating the development of music in the schools, by Mr. Hugh S. Robertson, conductor of the Orpheus Choir; and an exhibition of industrial and other instructional films. Sir John Reith will not read his paper at the meeting as he will be away in Berlin.

Another Regional Station

It is reported that a site has been provisionally chosen for the erection of the next high-power twin-wave regional B.B.C. station near Glasgow, (Continued on page 434.)

Round the World with the Brown

The "Brown" Cabinet Loud Speaker. Price £6 6 0

In Spain (Land of the Toreadors)

The "Brown" has a large following in the land where "mañana" is the rule. Good music is fittingly appreciated where life is care free and easy. That is why the faultless reproduction of the "Brown" Loud Speaker is recognised and appreciated by the sensitive Spanish ear. All over the world the "Brown" gives pleasure to discriminating listeners—it is so very true.

They listen to the **Brown**

The Loud Speaker on which the sun never sets!

**The
Week
of
Weeks
for
Radio
Enthusiasts**



**At Olympia this year
you will see the best
in Modern Radio**



Organised by The Radio Manufacturers' Association

78

**Only Weston standards
of Accuracy
are sufficient**



Model 506 Pin Jack Voltmeter with High Range Stand, measures High and Low Tension Voltages. The Weston free booklet "Radio Control" explains the uses of this and other Weston Radio Instruments. Write for your copy.

Price
£2.10.0



Model 506 Mil-Ammeter should be placed in the H.T. circuit of the valve to ensure correct operation and check distortion. Panel Mounting type.

Prices
£1.15.0—£2.15.0

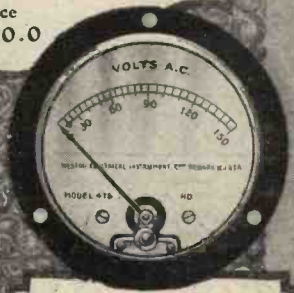

Model 506 Panel Voltmeters ensure permanent accuracy. With a high internal resistance of 125 ohms per volt, they make practically no load on the batteries. Neat and compact.

Prices
£1.15.0—£2.15.0



Model 46 Double-Range D.C. Voltmeter is a necessary portable testing instrument for every radio enthusiast. It is of great use in tracing circuit troubles. Made in various ranges with different sensitivities. Similar instrument for A.C. Model 528.

Prices £4.0.0—£7.15.0

WESTON

STANDARD THE WORLD OVER

Pioneers since 1888

WESTON ELECTRICAL INSTRUMENT CO. LTD.
15, GT. SAFFRON HILL, LONDON, E.C1.

OUR NEWS BULLETIN

—continued from page 432

and that if, as is anticipated, the plans are quickly passed by the Postmaster-General, work will be started on the new station very shortly.

The first regional station is already in course of construction at Brookman's Park, near Potter's Bar, and will probably be operating by next April. Plans for the other regional stations have been ready for some time, but have not been put into operation because of the delay in obtaining permission from the Postmaster-General.

THE WIRELESS SYNCHRONISER

EVER since the advent of wireless telegraphy we have been hearing the question "Why not make use of wireless waves for the automatic synchronisation of our clocks?"

Various suggestions as to the means of effecting the desired object

wirelessly have been made from time to time, but it is pleasing to learn that at Leicester, automatic wireless synchronisation has been in continuous operation for the past eighteen months at the residence of Mr. Alfred E. Ball, F.B.H.I.

Mr. Ball has applied his invention to the well-known "Pul-Syn-Efic" System of Electric Clocks of Gent and Co., Ltd.

The automatic control employs the well-known Daventry six-dot time signal, the last dot of which indicates Greenwich time, and the special apparatus above mentioned utilises this last dot.

The Last Dot

A small aerial is permanently tuned-in for Daventry, and a four-valve receiving set, are installed for the sole purpose of effecting synchronisation, and this set is daily switched in automatically by one of the impulse clocks some seconds before the 10.30 a.m. time signal. The special apparatus is designed to receive the six-dot wireless impulses, but to utilise the last dot only for the operation of a synchronising device known as the See-Saw Synchroniser, which has been designed by Gent and Co., Ltd., and is in use for land-line synchronisation.

This synchroniser controls the pendulum of a standard "Pul-Syn-Etic" Time Transmitter.

The last dot impulse, in addition to effecting synchronisation, automatically switches off the valves with the result that their period of lighting is less than half a minute per day, and the non-sulphating D.F.G. type of accumulator employed only needs re-charging once per annum.

Buy Britain's
Leading Radio Weekly
"POPULAR WIRELESS"
The paper that made
WIRELESS POPULAR
On Sale Everywhere.
Price 3d. Every Thursday.

An electrical switch automatically earths the aerial at all times, except for the brief period the valves are lit, and switches off the valves automatically at 10.31 if the time signal fails.

The time control has been highly successful, and the results exceedingly useful, as Greenwich time has always been given by the eight clocks within one second plus or minus, without any attention whatever.



WRITE OR CALL FOR OUR 1928-1929 CATALOGUE

just published containing particulars and details of all the latest lines exhibited at the Wireless Exhibition. 70 pages of Wireless and Gramophone accessories that are in every day use by all experimenters, constructors, and amateurs. Send 6d. to cover cost of postage for your copy—FREE to callers.

It always "Pays to go to Day's" for all wireless accessories and parts.

STAND 248
Gallery, Wireless Exhibition, Sept. 22-29.

WILL DAY, LTD.,
(The Best in the West)
19, Lisle Street, Leicester Square, W.1.
Phone: Regent 0921 and 0922. Grams: "Titles Westrand London."

Loud & Soft Pedals

for your WIRELESS SET or GRAMOPHONE LOUD SPEAKER with the

CLAROSTAT

VARY THE VOLUME TO THE OCCASION
Loud or soft as your fancy dictates!

A "ClarOstat" enables you to apply Loud or Soft Pedals to your Speaker. Soft when desired just as a "background"; full volume instantly available when a particular item becomes the centre of interest, or for dancing. If you are reproducing Gramophone records you can dictate exactly the volume that pleases you, suiting the volume to the style of the record.

VOLUME CONTROL, TONE CONTROL, and 57 other uses.

Tone Control can also be arranged, lowering and mellowing the quality of your high-pitched Speaker until it reproduces rich, deep notes equal to the most expensive instruments.

All "ClarOstats" are beautifully made, are microscopic in adjustment, and are guaranteed noiseless in operation.

Also available: Standard "ClarOstat" (20 Watts) and POWER "ClarOstat" (40 Watts), for Eliminators. Send for 8-page pamphlet, free, on how to build the most powerful and silent A.C. H.T. Eliminator, yet designed. Ask for pamphlet "POWER."



VOLUME CONTROL CLAROSTAT
(One-hole fixing; bracket for baseboard mounting also included free.)
1928 8/6
Price

TABLE TYPE CLAROSTAT
Place it by your side when dining, reading, resting in bed, etc., etc., thus providing distant control. Cords have generous length.

At all good Dealers: literature FREE from:—

1928 13/6
Price Post free.



CLAUDE LYONS, LIMITED
76, Old Hall Street, Liverpool

FERRANTI

If you have alternating current Supply in your home you can
DISPENSE WITH H.T. BATTERIES
 and build an Eliminator with Ferranti components.

DIAGRAM :—

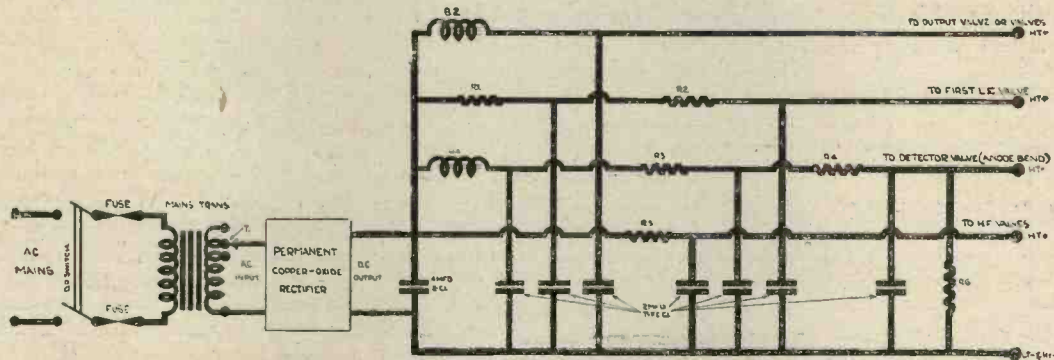

This Eliminator is suitable for a Receiver comprising H.F. Detector and two L.F. stages, but is not suitable for a set employing a screened-grid valve.

PARTS REQUIRED :—

	PRICE.
1 Double Pole Switch - - - - - approx.	£0 5 0
2 Fuses, 1 amp. - - - - - "	0 2 6
1 Ferranti Mains Transformer, type P.1 - - - - -	1 15 0
1 Westinghouse Metal Rectifier, type 4-55-1 - - - - -	4 4 0
1 Choke, type B.2 - - - - -	1 1 0
1 " type B.3 - - - - -	0 14 0
*6 Anode Feed Resistances @ 5/- - - - -	1 10 0
9 Condensers, 2 mfd. each, type C.1 @ 5/6 - - - - -	2 9 6
Baseboard, terminals, wire, etc. - - - - - approx.	0 6 0
	£12 7 0

* Prices of Resistances vary between 5/- and 10/- each, according to value in ohms.

An eliminator built to this specification is free from hum and motor-boating, and when used on a 230 volts A.C. supply will give a maximum output of 160 volts, 60 milliamps. It should be noted that the anode feed resistances and by-pass condensers necessary in a Receiver to overcome interaction and motor-boating form a part of this Eliminator and need not be incorporated in the set. This in reality makes the Eliminator cheaper than it appears to be. If further information is required, such as the values of the resistances, this will be furnished on application, stating the valves used and the mains voltage. Please write to us if you have any difficulty. Descriptive List will be sent on request.

Visit our Stands Nos. 84 & 85 at the Radio Exhibition, Olympia.

FERRANTI LTD., HOLLINWOOD, LANCASHIRE

THIS YEAR AT OLYMPIA

—continued from page 369

less than thirty stations have been logged without aerial or earth on this receiver, and a large number of alternative programmes are always available at loud-speaker strength.

Both the performance and finish are extremely high, and it is interesting to note that the screen-grid valve figures in both these successful sets. Mention must also be made of the popular Orthocyclic condenser which is now a firm favourite with the public. Both the above-mentioned sets are extremely light in weight and are entirely self-contained, other valuable features being the switch-over from short to long waves and the volume control, that with the two dials makes each instrument extremely simple to control.

W. G. Pye & Co., Ltd. Stands Nos. 87 and 100.

Visitors are sure of a goodly array of really first-class components on these stands, all kinds being exhibited. Notable amongst these will be geared condensers, special heavy-duty chokes for output circuits, output transformers, low-frequency chokes of all sizes, push-pull transformers, grid leaks, valve holders, power transformers, H.T. transformers and trickle-charger transformers. As is well-known, this firm is famous for its transformers, and an exceptionally good selection will be found on these stands.

Radi-Arc Electrical Co., Ltd. Stand No. 6.

Kits of parts for superionic sets, suitable for all wave-lengths from ten to three thousand metres, are on view here. With sets built from these parts excellent loud-speaker reception from a number of stations can be obtained in daylight on a small frame aerial, and Bonnemouth, London, Cardiff, Nottingham, etc., can be brought in without any difficulty. In addition to the superionic units, several other interesting lines will be on view, including battery eliminators, the Liberty gramophone pick-up, and a complete Liberty gramophone amplifier.

Rees-Mace Mfg. Co., Ltd. Stand No. 268.

Complete receivers in large variety are displayed here, including one very interesting Pentode three-valve receiver, in portable form, with double-cone loud speaker. Another interesting set is the "Baby Five," and there is also a

"Grand" model five-valve set, employing a very large loud speaker. Various forms of double-cone speakers, etc., also are on view.

Regent Radio Supply Co. Stand No. 82.

This stand will be of interest to the man with electric light in the house, various models (for direct current and alternating current) of high-tension and low-tension battery eliminators being



An interesting moving-coil loud speaker product (Partridge & Mee).

on view. All these instruments conform in every detail with the regulations issued by the Institute of Electrical Engineers.

Ripaults, Ltd. Stand No. 24.

One good exhibit here is the well-known Ripault lateral-action variable condenser. The ingenious construction of this component gave it instant popularity, but it is now available in improved form.

Apart from the improvements in the actual construction, another enormous advantage from the constructor's point of view is the fact that the price of this component has now been considerably reduced, and two models of dials are available for it, one retailing at 2s. 3d., and a slow-motion type which is priced at 4s. 6d. Ebonite of all kinds—tubes, rods, sheets and panels—is also a strong feature of this display.

Another very interesting speciality of this enterprising firm will be a panel with dual finish, that is to say, a highly polished mahogany finish on one side of it, and a highly polished black finish on the other. Can you beat it?

R.L. Varley, Ltd. Stands Nos. 56, 73 and 222.

Have you seen Anti-Mobo? This is not a female relative who has lost herself at the Exhibition, but is the name of a component specially designed for the series-resistance-condenser method of preventing L.F. reaction or "motor-boating," from whence it gets its name.

The R.L. Varley stands are full of good ideas of this kind, and only a few of the outstanding components can be reviewed in the brief space at our disposal. Mention must be made of the new aperiodic tuner covering two bands of wave-lengths by means of a simple change-over switch. It is fitted with a slow-motion dial for reaction control, the whole thing being adaptable for one-hole-fixing.

R.C.C. enthusiasts should make sure of seeing the R.L. R.C. couplers which are fitted with wire-wound resistances, and carefully balanced, the condenser incorporated being tested up to 1,500 volts. N.P.L. curves of these couplers show uniform amplification over the whole range of audible frequencies, from 25 to 10,000 cycles, a fact of which R.L. Varley are justly very proud.

In addition to these there are the new Anti-Mobo R.C. couplers which in order to obviate the possibility of "motor-boating" incorporate the Anti-Mobo device referred to above. Another notable component is the R.L. H.F. choke, the inductance of which is 60,000 micro-henries, the effective choking range claimed for this being from 30 to 4,000 metres without a break or a blind spot.

The famous R.I. multi-ratio transformers will be on view, together with new models, and there is a complete range of Westinghouse rectifier eliminator units for H.T., and L.T., and also for H.T., L.T. and G.B. The new L.F. choke is another specially interesting exhibit, and for the gramophone man there is a new R.L. Varley pick-up. Altogether this is an extraordinarily interesting show, which should on no account be missed.

A. W. Stapleton. Stand No. 211.

The Loristat, Lorientometer and Lorientadaptor will be on view at this stand, the latter being an adaptor for plugging into the lamp-holder, which enables the user to charge his accumulator while getting his light. It is especially intended for charging H.T. accumulators, since it can only be employed on D.C. mains.

(Continued on page 438)

PRICES REDUCED

Splendid models now within the reach of all

That fine "De Luxe" model or "Standard" model which, after hearing, you have always longed to possess, is now obtainable at an undreamt of price—buy now and enhance your evenings with better and more enjoyable reception.

The "De Luxe" model

~~70%~~
50%

The "Standard" model

~~50%~~
40%

Get one on the way home and surprise the wife—they all love a real bargain.

Orphean
LOUD SPEAKERS

are the best possible value on the market to-day for their really fine artistic finish and the purity and volume of their tonal quality. All who hear them are amazed at their low price and high performance.

Prices: "De Luxe" model, 50/-; "Standard" model, 40/-; "Gem" model, 30/-

Your local dealer will demonstrate.

LONDON RADIO MFG. CO., LTD.

Head Office and Works:

Station Road, Merton Abbey, London, S.W.1)

Come and see these models and the ORPHEAN 3-VALVE PORTABLE at OLYMPIA. STANDS Nos. 209 & 210 (Gallery) 18-17.

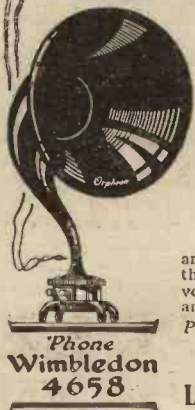

Phone Wimbledon 4658



To EVERYONE who, between Sept. 1st & 22nd inclusive, buys a

Ripaults Self-Regenerative H.T. Dry Battery

(The Battery that gives 50% Longer Life)

we will send Free, and Post Free, a RIPAULTS 9-VOLT. GRID BIAS BATTERY

To the sender of the first coupon opened in our mail each morning from Sept. 3rd to 24th inclusive we will also present Free, and Post Free, a

RIPAULTS 99-VOLT. STANDARD SELF-REGENERATIVE H.T. DRY BATTERY

We know that our Batteries are the most efficient ever made and we want you also to prove to your own satisfaction that they not only give 50% Longer Life but enormously increase the quality of the reception of your receiver.

HOW TO SECURE YOUR BATTERY

Buy one of the "Ripaults" Batteries listed below, fill in the Coupon and post it together with your Dealer's receipt, to reach us not later than first post Monday, September 24th, 1928.

STANDARD CAPACITY	60 volt. 10/6	99 volt. 16/6
(Chocolate Label)		
DOUBLE CAPACITY	45 volt. 11/6	60 volt. 15/6
90 volt. 22/6		
(Blue Label)		
TREBLE CAPACITY	45 volt. 15/-	60 volt. 19/6
90 volt. 29/6		
(Orange Label)		
QUADRUPLE CAPACITY	45 volt. 18/6	60 volt. 23/6
90 volt. 36/6		
(Black Label)		

FILL IN THIS COUPON. I hereby certify that I purchased on the date shown the "Ripaults" Self-Regenerative H.T. Dry Battery as covered by the enclosed receipt from my Local Dealer.

NAME.....

ADDRESS.....

Write in BLOCK letters and POST to:—

RIPAULTS LTD., 1, King's Road, London, N.W.1

RIPAULTS SELF-REGENERATIVE H.T. DRY BATTERIES

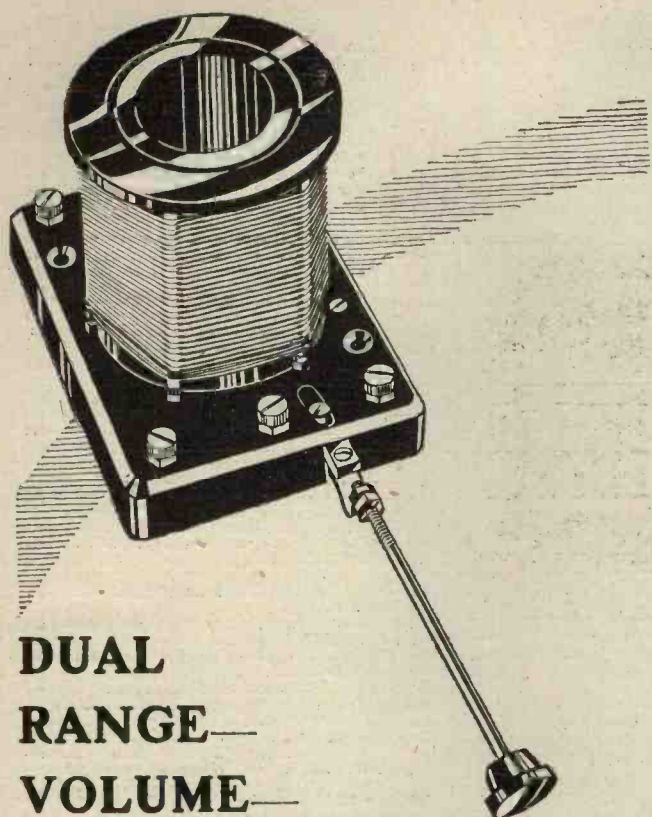

**DUAL
RANGE—
VOLUME—
SELECTIVITY—
CONTROL.**

**Radio Exhibition
OLYMPIA, 1928**

**VISIT
STAND No. 91**

to examine the new Colvern
Dual-Range Coil.

**COLVERN
ACCURATE SPACE WOUND
COILS**

Colvern Ltd., Mawney's Road,
Romford

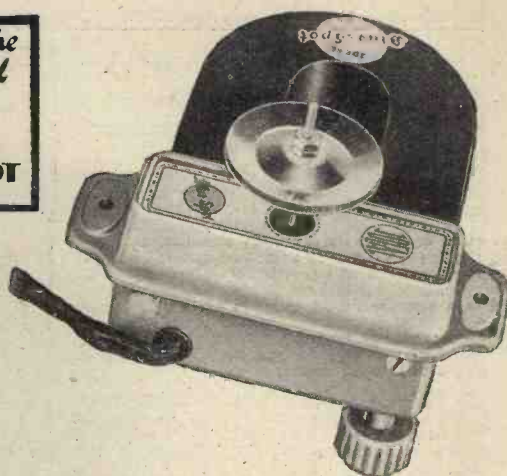

**Introducing
66K —**

*the Adjustable
4 pole unit*

Again and again constructors have told us: "That's a jolly good unit of yours—but why don't you make an adjustable one?" So we put the idea up to the works and the works got busy—and here we are.

The new 66K is just the well-known 66A made still better. It is designed on the same principle—a four-pole magnet unit giving a straight-line movement to the driving spindle, over a very wide range of audio frequencies. The current preserves an evenly balanced flow that gives such exceptional quality to the interpretation of speech and music.

The new adjustor feature enables the butterfly tongue to be kept exactly and constantly positioned between the poles of the magnet. This unit, incorporated in all the latest 'Blue Spot' models, has had repeated commendation under test. It is supplied complete with dust-proof cover and two padded washers to receive **25/-** cone. The price is the old price

The original four-pole armature unit without the adjusting movement is preferred by some constructors, and is now **21/6** obtainable at a specially reduced price

Complete instructions are supplied for building cone speakers—both floating edge and free-edge type—around the four-pole unit. Provided the speaker is built to these specifications and the set is not forced or overloaded, we claim that reception will be virtually as good as if the listener were actually sitting in the transmitting studio.

The **IDEAL 4 POLE
ADJUSTABLE ARMATURE UNIT**

F. A. Hughes & Co., Limited,
204/6, Great Portland Street, London, W.1.

DISTRIBUTORS FOR NORTHERN ENGLAND, SCOTLAND AND
NORTH WALES:

H. C. Rawson (Sheffield and London), Ltd., 100, London Road, Sheffield;
185, Princess Street, Manchester.

THIS YEAR AT OLYMPIA

—continued from page 436

Sylver, Ltd. Stand No. 175.

In addition to the Sylverex and Reactone types of crystal and the Sylverex permanent detector and cone washers which this firm has for a long time had on the market, a new accessory in the form of the Sylverex cone material, made of genuine pertinax and retailed at 1s. 6d. per envelope, will be on show. This material is far stronger and is claimed to be far better than any of the materials for cones now on the market, and is also claimed to respond to every vibration. Those readers who are contemplating building their own cone loud speaker should therefore pay a visit to this stand.

The Telegraph Condenser Co., Ltd. Stand No. 121.

All kinds of fixed condensers for receiving sets will be found at the stand of this well-known firm, which, in accordance with its practice of the last twenty-three years, continues to confine its energies solely to the production of fixed condensers. All types are available in paper and mica dielectric, in capacities from '00005 up to several hundred mfd., and at various voltages.

An interesting new exhibit is the flat mica type condenser with the recently introduced fixing arrangement, which gives one the alternative of mounting the condenser either upright or flat as required. This, by the way, is a great convenience with 1- and 2-mfd. condensers.

Apart from the standard lines for the constructor several special lines will be shown, such as adjustable condensers as supplied to the various cable companies, etc., and transmitting condensers as supplied to the B.B.C. and the Post Office. Of exceptional interest will be the new electrolytic condenser as used in the recently developed "Harris Stedipower L.T. Unit," samples of which will be on view.

Trelleborg Ebonite Co., Ltd. Stand No. 234.

Turned and machined components and accessories, manufactured from Trelleborg's ebonite, and including panels, formers, bobbins, switches, lead-in tubes, will be seen in profusion at this stand.

The Tudor Accumulator Co., Ltd. Stand No. 249.

This firm is a comparatively newcomer to radio,

though one of the best-known suppliers of storage batteries for the heavier branches of electrical engineering. A very comprehensive range of high-tension batteries will be shown here, of any required capacity and voltage. Special unspillable types of low-tension cells of slow discharge will also be on show, and an entirely new type of low-tension battery, primarily intended for filaments of six-volt power valves, and also for supplying current for the field excitation of coil-driven speakers.

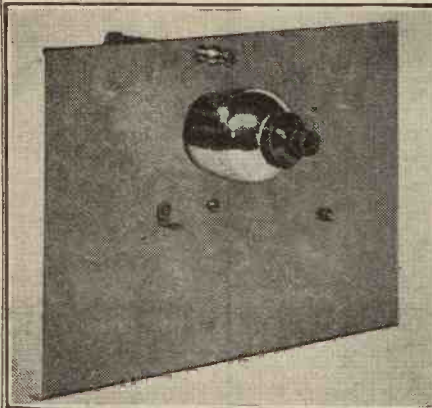

The new valve-holder and screen combination for all types of screened valves. (Peto-Scott, Ltd.)

Many unusual features are incorporated in this battery which is sure to create great interest. The Tudor Accumulator Co. may be newcomers to Olympia, but they are certainly old hands at the battery game.

Turner & Co. Stand No. 234.

An interesting collection of components will be found on stall 234, including a non-dead-end tuner six-pin coils, bases, etc.

C. A. Vandervell & Co., Ltd. Stand No. 114.

Vandervell's have embarked with great enterprise into the making of many radio components and accessories, and all their leading lines will

be on view at this stand. Besides the well-known C.A.V. products, there will be several new additions amongst these being the massed plate L.T. accumulator, type A.G.N.

This type of cell is recommended for low rates of discharge, and special plates are introduced enabling it to be used for comparatively long periods between recharges without injuring the plates.

This battery is supplied in a dry-charged condition, and only requires filling with diluted sulphuric acid to be ready for immediate use. Although originally produced at 5s., the price has already been reduced to 4s. 6d., and the battery is not only reliable in operation, but will last for many years.

Watmel Wireless Co. Stand No. 157.

In addition to the various Watmel components which no doubt will be known to most readers, this firm is showing a complete range of radio receivers, including a mains receiver which is suitable for the home, dance hall, club, etc. This instrument costs less than a farthing an hour to run from the mains, and there are no batteries or other accessories. Of particular interest among the components is the new double-range tuner.

Western Wireless Co. Stand No. 262.

As this is not a manufacturing firm, the Western Wireless Co.'s efforts at the exhibition will be strictly retail. Leading makes of various sets and components will be shown, either for cash or for hire-purchase.

The Westinghouse Brake & Saxby Signal-Co., Ltd. Stand No. 78.

All types of battery chargers and metal rectifiers for radio purposes will be shown on this stand, and also special rectifiers designed for the Harris "Stedipower" L.T. Unit. All readers of the WIRELESS CONSTRUCTOR should make a point of seeing this new component which has been specially brought out in answer to the response for such a unit. All sorts of voltmeters and other instruments suitable for radio purposes will also be seen on the Westinghouse stand.

Wilkins & Wright, Ltd. Stand No. 152.

Most of the "Utility" components will need no introduction to readers, a large proportion of whom have used the Utility switches, or the logarithmic condensers, dials, etc., which are amongst the popular products of this firm.

Several new lines are being released at the exhibition, the chief of these being a new anti-

(Continued on page 440.)

THE BEST VALUE AT THE EXHIBITION WILL BE THIS



**WHITELEY-BONEHAM
LOUD SPEAKER
at 47'6
STAND NO. 120.**

Whiteley, Boneham & Co., Ltd., Nottingham Road, Mansfield, Notts

Positive Control of H.F. and L.F.

To secure that refinement in quality and selectivity you must have a perfect means of controlling both the High and Low Frequency sides of your receiver.

The Gambrell Neurovernia and Voluvernia will each give you positive control with a smoothness and graduation that results in a marked increase in selectivity, quality and volume of reproduction.

The GAMBRELL NEUTROVERNIA

This excellent component can be used as either a Capacity Reaction Control, Balancing Condenser, or Neutralising Condenser. **Price 5/6.**

The GAMBRELL VOLUVERNIA

This control for the L.F. side enables one to obtain the exact volume required and eliminates all the distortion which results from the common practice of detuning. It graduates volume from maximum volume to a mere murmur. It is also exactly suited for use with Gramophone Amplifiers. Resistance 0.1 megohm

Price 6/9.

Obtainable from all Dealers.

SEE OUR FULL RANGE ON STANDS 27 & 108 OLYMPIA

GAMBRELL RADIO LTD.
"Buckingham House," Buckingham Street, Strand, W.C.2.

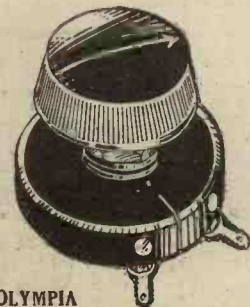

WITHIN THE REACH OF ALL

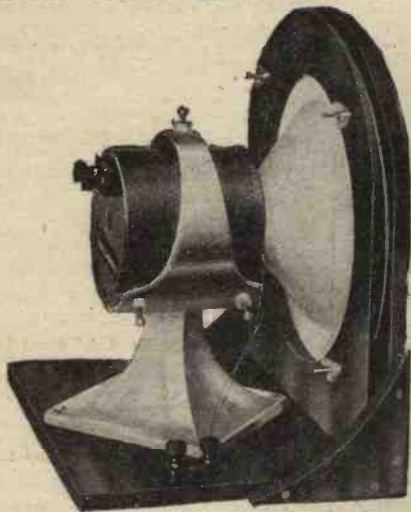

Read.
Design.
Prov.
Pat.

Thousands of wireless enthusiasts have longed for a Moving Coil Speaker, but—well, there was always the question of expense. Now, however, GOODMAN'S have made such remarkable strides in the design and construction of Moving Coil Speakers that it costs little, if anything more, to build your own Moving Coil Speaker than to purchase a good ordinary Loudspeaker.

That wonderful quality of reproduction, that depth of tone in the bass notes, that almost uncanny realism is now within the reach of all.

The GOODMAN "CENTREX" Stand and Frame (shown above) is the last word in Moving Coil Speaker Design—there's nothing else like it on the market. Write for particulars (free) of our complete range for 2-, 4- or 6-volt accumulators, or for D.C. Mains.

GOODMANS
27 FARRINGTON ST. LONDON, E.C.4
Telephone: City 4472.



"I'm going to make more money"

"I am tired of working for a small salary—tired of the strain of endeavouring to keep up appearances—tired of seeing others beat me in the struggle for promotion—tired of the fear of unemployment:

"I've been blind in some ways, but now I see clearly that diligence, integrity, and long service are not enough. To succeed one must have a special vocational training. The men who are going ahead of me have only one advantage—they are trained, while I am not. That makes all the difference, but I am determined to raise myself to their standard without a day's delay. The International Correspondence Schools can help me, just as they have helped tens of thousands of others."

Many a man, at last realising that tremendous handicap of being untrained, has thought along those lines and then become an I.C.S. student, greatly to his advantage and happiness.

In every line of business men and women are holding important positions and receiving splendid salaries—because they became I.C.S. students.

You, too, by studying at home in your own time, can qualify for the position you want in the work you like best—no matter what your age, your occupation, or your means.

The I.C.S. originated spare-time technical training by post 37 years ago, and is by far the largest institution of its kind in the world. It has teaching centres in eleven countries and students in fifty.

Write to-day for full information as to how the I.C.S. can help you in your chosen vocation. There are 360 Standard courses, of which the following are the most important groups:—

- | | | |
|---------------------|---|-----------------------|
| Accountancy | Wireless Telegraphy (Elementary and Advanced) | Salesmanship |
| Advertising | Draughtsmanship | Scientific Management |
| Architecture | Engineering (all branches) | Showcard Writing |
| Building | French and Spanish | Textiles |
| Commercial Art | General Education | Window Dressing |
| Commercial Training | Professional Exams. | Woodworking |

There is a special booklet for each group, which will be sent free on request. Tell us the one you would like to see.

International Correspondence Schools, Ltd.
172, International Buildings, Kingsway, London, W.C.2

THE ONLY BRITISH VALVE WITH A WRITTEN GUARANTEE AS TO PERFORMANCE AND LIFE.

AMATEUR WIRELESS 14/3/28 says: "... The characteristics of this Valve compare favourably with many well-known makes."

WHAT OTHERS SAY of P.R. VALVES

Type	Fil. Volts	Amp.	Imp. Ohms.	Amp. Fac.	
PR 1	2	.095	30,000	14	H.F.
PR 2	2	.095	25,000	13	Det.
PR 3	2	.095	15,000	8	L.F.
PR 4	2	.095	120,000	32	R.C.
PR 8	3.5.4	.063	23,000	15	H.F.
PR 9	3.5.4	.063	18,000	14	Det.
PR10	3.5.4	.063	10,000	8.7	L.F.
PR11	3.5.4	.063	88,000	40	R.C.
PR16	5.6	.1	19,000	12	H.F.
PR17	5.6	.1	18,000	17	Det.
PR18	5.6	.1	8,500	9	L.F.
PR19	5.6	.1	80,000	40	R.C.
PR20	2	.15	7,000	6	6 Power
PR40	4	.15	7,000	6	6 "
PR60	6	.1	5,000	6	6 "

"Unsurpassed for purity of tone and selectivity—the equal of any," is the opinion expressed in hundreds of letters from satisfied users—the originals can be seen at our offices.

Tell us your set—we will send correct Valves.
Matched Valves 1/- extra.

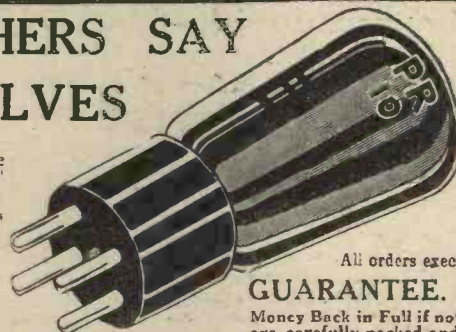

NOW ONLY **3/6** C.O.D.
Phone: City 3783
Post 4d.

- 2 Valves for 6/9 Post 6d.
- 3 Valves for 10/- Post 6d.
- 4 Valves for 13/- Post 9d.

All orders executed by return of post.

GUARANTEE. All valves despatched under guarantee of Money Back in Full if not satisfied. All valves are carefully packed and breakages replaced.
17/3, Paternoster Square, LONDON, E.C.4.

7/6 Each Post 4d **P.R. VALVES**



CASON 1929 COMPONENTS

SIX PIN BASE.

As shown. Size: 2 1/4" by 2 3/8". Moulded throughout including legs. Makes shorting impossible. Recommended for all circuits
Price with terminals **1/6**

ANTI-CAPACITY VALVE HOLDER.

Price **10d.**

ANTI-MICROPHONIC VALVE HOLDER

As shown. Highest grade mouldings throughout. Patent coil spring in each leg. Circular vibration motion guaranteeing perfect valve safety. With terminals and red anode. Price only **1/6**

TOGGLE-SWITCH.

Price **9d.**

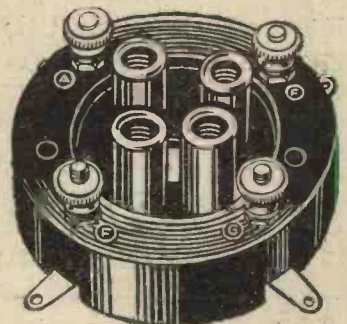

CASON MOULDINGS, CHISWICK ROAD, LOWER EDMONTON, LONDON N.9.

THIS YEAR AT OLYMPIA

—continued from page 438

capacity switch, a thumb-controlled condenser, two thumb-controlled dials (one plain and one vernier), aluminium shielding boxes, and a combined drum control with vernier dial. This latter has a twelve-to-one ratio. There is also a "Mite" condenser of the type now so popular for incorporation in rather crowded sets, where there is only room for a mite to stand.

Williams & Moffat, Ltd. Stand No. 265.

On this stand the makers of the Simplicon radio products will be showing a complete range of components and a long line of new accessories. Among the latter a special condenser with ball-bearing spindle and extremely rigid build should be noted, this condenser being available in the usual capacities and being sold at a very low price. For use with this condenser, or to be used in conjunction with other condensers of the same make, a new vernier dial will make its appearance, and this will be available in two different gear ratios, namely, 100 to 1, and approximately 200 to 1 for special short-wave receivers. Finally, a compact neutralising condenser and a drum-drive ordinary variable condenser, complete with a front panel cover face, must be mentioned as among the more interesting items on this stand.

Wright & Weaire, Ltd. Stand Nos. 251 and 252.

The Standard "P.W." and "M.W." loading coils, which have proved so extremely successful in many popular sets, will be on show at this stand, and the Wearite Company have also a very attractive series of small components, one very ingenious item being the Wearite Flux Gun.

An ordinary tin of flux will fill this gun twelve times, and one guntful of flux will make 2,500 joints! Every drop of flux can be used up by this new method, instead of fifty per cent of it being applied to the fingers, the bench, the components nearby, and to wastage on stray matches, bits of solder or wire. Fitted with a long, fine nozzle, the Wearite flux gun really is a most interesting and ingenious little gadget which can be sure of a big sale.

Another speciality of this firm is a very comprehensive list of copper screens, polished and lacquered, made up for all sorts of popular sets,

and in addition there are the new wire-wound fixed condensers which are sure to create a good deal of interest.

TOO LATE FOR CLASSIFICATION.

M.P.A. Wireless, Ltd. Stands Nos. 21 and 22.

The exhibits here will include the M.P.A. Ethatrope, the all-electric radio gramophone, which is a first-class four-valve radio set, requiring no aerial or earth, and a combined valve-amplified electrically-driven gramophone.

Collinson's Precision Screw Co. Stand No. 91.

Special attention should be paid on this stand to the Colvern dual-range coil, which covers wavebands from 250 to 550 metres and 950 to 2,100 metres. This new coil is in addition to the many types of coils for which Colvern, Ltd., have been famous for some time.



The "Selector" Short-Wave-3 Set.

Falk, Stadelmann & Co., Ltd. Stand No. 127.

All sorts of Eiescaphonic receiving sets and Efesca components will be shown on this stand, which is well worth an inspection by all visitors at Olympia.

The Rothermel Corporation, Ltd.

Owing to the fact that the goods sold by this firm are imported, they are excluded from exhibiting at the Radio Exhibition; but readers should note that they have arranged a special demonstration and show of their products at 24, Maddox Street, during the time of the Olympia Show, and any readers of the WIRELESS CONSTRUCTOR will be welcomed at these showrooms.

Peto & Radford. Stand No. 67.

All sorts of accumulators of L.T. and H.T. types. All accumulators will be of the patent indicating

type, for which this firm is very well known, these cells showing at a glance whether the battery is fully-charged, half-charged, or completely run down.

The J.R. Wireless Company. Stand No. 229.

Following up their slogan of "Buy the coil with the purple winding," this firm are showing all sorts of coils from fixed coils for any circuit, H.F. chokes, plug-in coils, coils for the Corsor "Melody Maker," etc., etc.

The Igranie Electric Co., Ltd. Stands Nos. 53, 54 and 75.

There is such a wealth of components to be seen on these stands that it is impossible to give anything like an idea of their appearance. All sorts of apparatus will be exhibited, from chokes, fixed coil holders, variable condensers, valve holders, pick-ups, transformers, potential dividers, wander plugs, resistors, output chokes, short-wave receivers and portable sets.

Truly a bewildering array of some of the finest apparatus to be found anywhere!

Thos. De La Rue & Co., Ltd. Stand No. 235.

Mainly the exhibit on this stand will be a comprehensive display of Bakelite, fireproof and plastic mouldings. These are produced by a modern multi-production method at the rate of many thousands per week, and as a demonstration of the vast manufacturing capacity of this firm, mouldings from 1/2 in. diameter up to 3 ft. 6 in. are being exhibited.

Special attention should be drawn to the range of 24 types of moulded low-tension battery boxes for accumulators of from 2 to 12 volts.

Wilkins & Wright, Ltd. Stand No. 152.

The new lines on show on the stand of this well-known firm include a new anti-capacity switch, vernier control condensers, aluminium shielding boxes and panels and combined drum control with vernier dials, which have a ratio of 12 to 1.

Runbaken Magneto Co. Stand No. 244.

A new combined H.T. and L.T. model for A.C. mains, which has no valve or complications, and which will deliver 50 to 350 milliamperes, will be on show, together with an assortment of chargers, H.T. units, and polarity fluiders.

Rook Bros., Ltd. Stands Nos. 76 and 77.

Many new lines, including a range of components specially designed for use in battery eliminators and mains sets, are to be seen here. The more important of these mains components

(Continued on page 442.)

Keep plugging away with—



**CLIX
PARALLEL
PLUGS**

These well designed Parallel Plugs embody the "Clix" patent resilient principle which ensures quick yet sure contact with all valve sockets and the "Clix" Parallel Sockets.

PRICE 2^d. EACH

STAND No. 236 OLYMPIA

Look out for this Showcase.

This Parallel Plug is one of the eight positive contact aids in THE "CLIX" SHOWCASE ON YOUR DEALER'S COUNTER

The Showcase includes:—

- | | | | |
|--------------------------|-----|------------------------|---------------|
| CLIX PARALLEL PLUGS | 2d. | CLIX PARALLEL SOCKETS | 1d. & 1 1/2d. |
| CLIX COIL PINS | 2d. | CLIX PIN TERMINALS | 2d. |
| CLIX SPIRAL WANDER PLUGS | 2d. | CLIX LOX WANDER PLUG | 2 1/2d. |
| CLIX SPADE TERMINALS | 2d. | CLIX TERMINAL BRACKETS | 1d. |

Supplies and Illustrated Catalogues obtainable from all Dealers.

LECTRO LINX LTD.

254, Vauxhall Bridge Road, London, S.W.1.

The man who experiments—

cannot afford to be without "ELLIOTT" interchangeable connectors. Any desired terminal, spade, pin or plug, may be instantly fixed without disturbing the leads. The terminal is screwed right down on to the wire of the flex, giving direct contact, and the frayed ends of the flex covering are tucked snugly away out of sight. Supplied in six colours, with or without flexible leads.

Sample trial set of four connector bodies and eight assorted terminals for 1/-, obtainable from all retail wireless depots, or in case of difficulty direct from the manufacturers.

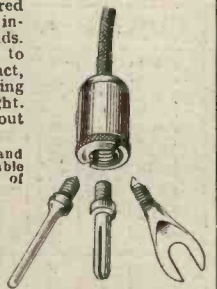

The ELLIOTT (Patent) CONNECTOR

PRICE 2^d. EACH

(Complete Connector Body and one Terminal)

E. ELLIOTT, 126-128, Brearley Street, BIRMINGHAM

WIRELESS CONSTRUCTOR

Advertisement Rates

Single Insertion - - - £60 0 0

per page and pro rata

6 CONSECUTIVE Insertions 55 0 0

per page and pro rata

12 CONSECUTIVE Insertions 50 0 0

per page and pro rata

ONE INCH single col. (2 1/4" wide) 2 5 0

Minimum Space, half-an-inch 1 2 6

IMPORTANT. Copy and Blocks must be in hand by 20th of each month for issue placed on sale 15th day of the following month.

ALL communications respecting advertising must be made to:—

JOHN H. LILE, Ltd., 4, Ludgate Circus, London, E.C.4

Phone: CITY 7261.

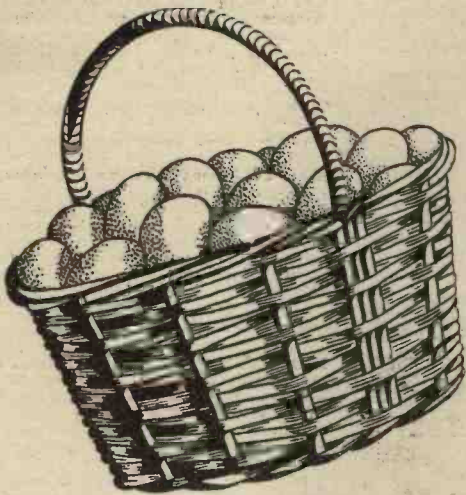

WHICH IS NEW LAID ?

Buying cheap, untried condensers is like buying eggs. You buy on trust. You cannot tell the quality of an egg by its outward appearance. Neither can you judge a condenser by looking at it.

That is why you should insist on seeing "T.C.C." on the condenser you buy. Then you know that you are using a condenser that has behind it a 22-year-old reputation. You know that it has passed rigorous factory tests. It is guaranteed accurate to a minute degree; reliable to a point almost of infallibility.

It will pay you to buy "T.C.C."—the condensers in the green cases.

*Specified for the
Cossor "Melody Maker"*



T.C.C.

Adv. Telegraph Condenser Co., Ltd., Wales-Farm Rd., N. Acton London, W.3.

5531

GREAT REDUCTION IN PRICES of BELLING-LEE TERMINALS

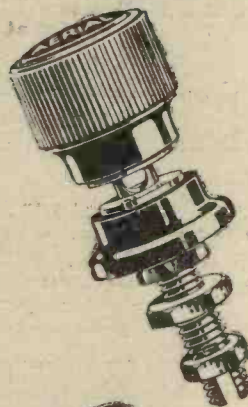

Last year, when Belling-Lee patented terminals enjoyed a popularity reached by no other terminals, we were obliged to extend our Factory premises in order to meet the overwhelming demand.

The result is that we have now increased our output by fifty per cent.

Increased efficiency and output, and the sacrificing of profit to turnover have enabled us to effect the following substantial reductions in price:—

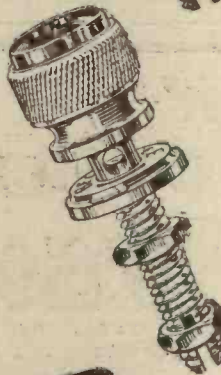

Type "B". Standard large insulated model (Polished black bakelite).

6d. each (formerly 9d.).

Type "M". Popular model, as type "B," but not insulated.

4½d. each (formerly 6d.).

Type "R". Cheap competitive model with rotating name.

3d. each (formerly 3½d. each).



Send to-day for our new Season's illustrated Catalogue.

STANDS 220 and 221
AT OLYMPIA

BELLING-LEE TERMINALS

Belling & Lee, Ltd., Queensway Works, Ponders End, Middlesex.

THIS YEAR AT OLYMPIA

—continued from page 440

form very interesting exhibits. Besides these, a very special feature of the stand will be the new "simpler wireless" mains receiver, of which two models for A.C. or D.C. will be available.

A. J. Dew & Co. Stands Nos. 181 and 182.

The exhibits embrace a representative range of radio receiving sets, accessories and components. All latest designs of receiving sets, including the portable, self-contained and maintenance models, by leading manufacturers, will be shown.

Walker Bros. Stand No. 154.

Many of the standard products of this firm, including a complete range of horn type loud speakers, and special portable cabinets will be on show, while among the new lines the well-known popular model, the Varitone, and the ordinary Walbro models, with loud speakers in cabinet form, will be shown.

A. W. Stapleton. Stand No. 211.

A special D.C. charging adaptor, at the price of 4s. 6d., is one of the main things to be seen here, and high-resistance potentiometers for anode-bend rectification, and the famous Lioristat type resistances will also be on show.

Standard Wet Battery Co. Stand No. 7.

The exhibits on show here mainly consist of Standard Wet Batteries, fitted with the new wooden unblock containers. Each container holds 32 cells, giving a maximum of 48 volts. Separate cell assembly can be supplied, the prices being of a very popular order.

Another exhibit is a new instrument called the Wates "Volt-Amp. Test Meter." This instrument is worked on an entirely new principle, giving three readings on one dial. The readings are Volts 0 to 150, Volts 0 to 6, Milli-amp. 0 to 30.

Catesby, Ltd. Stand No. 25.

Messrs. Catesby are showing the three-valve pedestal type "A" receiver, and the Catesby control model three-valve screened-grid transportable. This latter makes use of the new Mullard screened-grid valve and the 5-electrode valve. In effect, the set is said to be equal to most five-valve portable receivers, and is available at the price of 25 to 28 guineas.

To round off their exhibits, Messrs. Catesby are showing all the latest loud speakers made by reputable makers.

The Eagle Engineering Co. Stand No. 139.

A large series of Chakaphone components, such as battery operated sets, mains equipment and loud speakers, will be shown on this stand.

The Benjamin Electric Co. Stand No. 171.

Well noted for their excellent valve holder, this firm is introducing a new valve holder which is smaller in size but embodies all the essential features of the standard type. A special earthing device and a range of interesting components are also to be seen here.

Be sure to visit the
WIRELESS CONSTRUCTOR
at OLYMPIA.

Stands Nos. 135 and 166.

C. A. Vandervell & Co., Ltd. Stand No. 114.

On this stand there will be a full range of batteries suitable for high and low-tension, and suitable for many other purposes. The batteries shown on this stand are so complete in all their types, designs, and sizes, that it is impossible for us to give a list in the small space at our disposal. We can but say that all readers should visit this stand, and they will find here items of the supreme interest, whether they use a one-valve set or go in for multi-valve receivers with moving-coil loud speakers.

Gambrell Radio, Ltd. Stands Nos. 27 and 108.

Famous for their coils and low loss components, this firm is branching still further into the complete set world, and is exhibiting a large number of mains receivers, suitable for working direct off

the electric light and requiring no batteries or accumulators of any description. This will prove a most fascinating stand, and certainly should be visited by all our readers.

Wingrove & Rogers (Polar), Ltd. Stand No. 111.

Slow-motion condensers, Polar drum-controlled condensers, all sorts of condensers, in fact, will form a formidable array upon Stand No. 111.

High-frequency chokes and other components of the utmost interest will rank scarcely less in importance, and will help to make a most interesting array of goods.

The British Radio Corporation, Ltd. Stand No. 141.

In addition to the popular B.R.C. sets, which are already well known, among the new apparatus will be found a three-valve mains receiver, using A.C. mains, and employing the new type A.C. valve, with a range of wave-lengths of 200 to 2,000 metres and single-control tuning. Also a new portable set using screen valves will make its first appearance. In this latter a gramophone amplifier is incorporated.

Metro-Vick Supplies, Ltd. Stands Nos. 32 and 41.

Perhaps the most prominent feature of this exhibit will be the amount of attention given to the mains-operated sets. In addition to the well-known Metro-Vick five-valve set, three- and four-valve resistance and resistance transformer-coupled sets are being exhibited, and these can either be obtained completely wired-up and tested, or the individual component parts can be purchased, with full details for wiring and assembling.

A considerable array of Cosmops A.C. rectifying and ordinary valves will, of course, take part in the wonderful display of apparatus to be seen on the Metro-Vick stand.

Other interesting components are the new skeleton R.C.C. detector units, moulded anode resistances of guaranteed permanency, and the well-known A.N.P. coil, choke, etc.

A special hospital set in oak cabinet will be exhibited, and this is similar to the recent very successful installation made by this company for the Lodge Moor Hospital at Sheffield. Incidentally, examples of Metro-Vick's new short-wave three-valve receiver, with resistance-coupled L.F. stages, specially designed for the Dominions for the reception of short-wave programmes, will be shown.

(Continued on page 444).

**Solve your
condenser problem
at STAND 159**

(NATIONAL RADIO EXHIBITION)

Cyldon Condensers set the highest standard of design and manufacture. Specified in leading receivers, standardised by leading manufacturers. Ask to see our NEW MODELS.

BEBE CONDENSER

Cyldon "Bebe" Condensers were primarily designed for use as reaction condensers—but the larger capacities are ideal as tuning condensers where space is limited. Specified for the "Radiano Four" and other leading circuits.

Made in five capacities:

*0001 - 7/6 *00015 - 8/- *0002 - 8/6

*00025 - 9/6 *0003 - 11/-

Complete with 2-in. knob and dial.



SYDNEY S. BIRD & SONS, LTD.

Cyldon Works, Enfield Town, Middlesex
Telephone: Enfield 2071-2. Telegrams: "Capacity, Enfield."

"PAREX" PRODUCTS PAR EXCELLENCE

"PAREX" SCREENS

FOR ALL CIRCUITS

SCREEN BOX

WITH LID FOR THE

"RADIO" 4

as specified 12/6

All screens are made of highly polished and mottled copper and are UNTARNISHABLE.

E. PAROUSSI,
10, Featherstone Buildings,
LONDON, W.C.1.

At OLYMPIA visit Stand 272. Phone - Chancery 7010

High-grade

QUEEN ANNE STYLE

FIGURED OAK CABINET

Height 3 ft. 3 ins. Depth 1 ft. 3 ins.
For Panels up to 21 ins. x 7 ins.

£5.5.0

Packing Free.
Carriage Paid.

Prices of other sizes in proportion.
Manufacturer of all types of wireless
cabinets and furniture of every description.

GILBERT,
CABINET MAKER,
SWINDON.

Estimates Free. Estd. 1866.

NOW! ALL STATIONS FROM
250—2000 METRES
WITHOUT CHANGING COILS

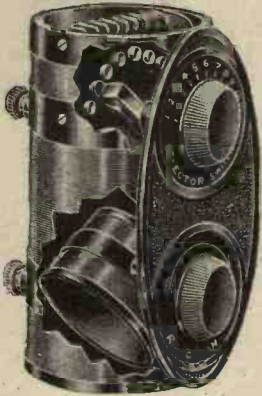

Note these Special Features:

1. Easy two-hole fixing.
2. No friction joints whatever.
3. Improved bakelised former.
4. Reversible dial to allow of upright or horizontal mounting.
5. Knobs fixed by means of grub screw on spindle.

BRITISH GENERAL

AERIAL TUNING UNIT

PRICE **18/6** From all wireless dealers of repute, or direct from **BRITISH GENERAL MANUFACTURING CO., LTD.**, Brockley Works, London, S.E.4.

STAND 10 AT THE RADIO EXHIBITION

STAND 172

OLYMPIA—SEPTEMBER 22-29.

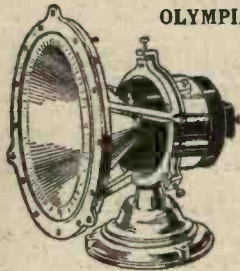

BAKER'S SELHURST RADIO

Moving Coil Loud Speakers give the best possible results.

Write for Illustrated Booklet:—

BAKER'S SELHURST RADIO

42, Cherry Orchard Road, East Croydon. (Telephone: Croydon 1618)

STAND 172

FREE

CABINETS

for **PORTABLE CASES MOVING-COIL AND CONE SPEAKER CABINETS**

A twenty-page catalogue showing our latest range of **CABINETS**. Send for a **FREE** copy.

OLYMPIA: Stand No. 107. Carrington Manufacturing Co., Ltd., Cameo Works, Sanderstead Rd., South Croydon. Tel.: Croydon 0623 (2 lines).



VIBROOLDER

Vibroolder is a better name for a better valve-holder. The new Benjamin Vibroolder will fit every type of British four-pin valve. It ensures perfect results as the point of contact between valve leg and valve socket is self-aligning. It is truly anti-microphonic in character, protecting the delicate filament from every trace of shock and vibration.

1/6

See the Vibroolder, the improved Benjamin battery switch and the whole range of Benjamin components on

STAND 171 at OLYMPIA

Due to its great popularity the original Benjamin anti-microphonic valve-holder is retained.

Price 2/-



1,500,000 **BENJAMIN VALVE HOLDERS** have already been sold.

BENJAMIN

ELECTRIC LIMITED

Brantwood Works
TOTTENHAM, N.17

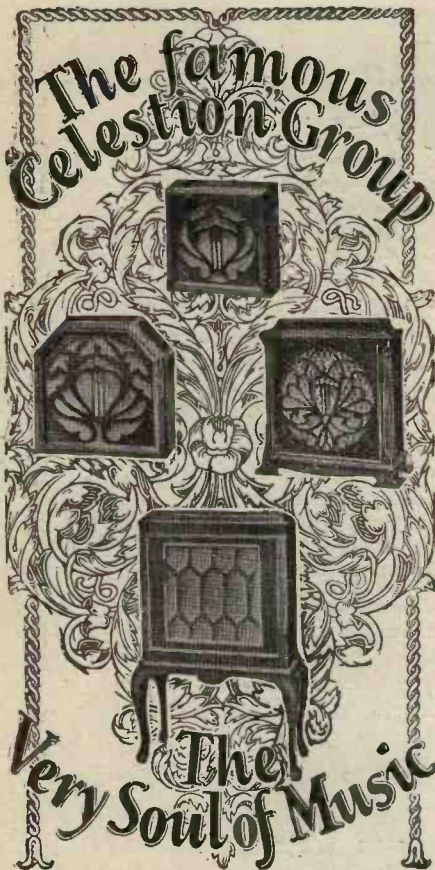

STEP by step the world-famous group of Celestion Loudspeakers has advanced through scientific development to a position of unquestioned supremacy. No greater human effort could have been made to perfect every detail of "Celestion" construction than has been made.

The famous Celestion group consists of four models, in oak or mahogany, as shown above, with prices varying from the C.10 in oak at £5.10.0 to the C.24 in mahogany at £25.

Why not hear a demonstration without obligation at the new Celestion Showrooms, one minute from Victoria Station? Or ask your dealer to demonstrate. Celestion illustrated literature giving full particulars of all models and of the Celestion-Woodroffe Gramophone Pick-up, price £4.4-0, sent free on request.

Made under licence.

VISIT US AT STANDS
Nos. 19 & 20
NATIONAL RADIO EXHIBITION
OLYMPIA

CELESTION

The Very Soul of Music

Write to Dept. L,
THE CELESTION RADIO CO.,
LONDON RD., KINGSTON-ON-THAMES.
Tel.: Kingston 5656 (4 lines).
Showrooms:
106, VICTORIA STREET, S.W.1.

THIS YEAR AT OLYMPIA

—continued from page 442

The Bowyer-Lowe Co., Ltd. Stand No. 51.
Although at the time of going to press no details of the Bowyer-Lowe exhibit had been received from this well-known firm, there is no doubt but that there will be plenty of interest displayed in the goods shown at this stand. Bowyer-Lowe have the happy knack of knowing what the radio public wants, and consequently a great many satisfied purchasers of the past will be interested in seeing the latest products of this famous Letchworth firm.

Anyone in search of a good valve holder will be well advised to pay a visit to Stand 51, as it is an open secret that the new Whiteline valve holder marketed by Bowyer-Lowe Co., Ltd., has already made quite a big hit.

Baird Television Development Co., Ltd. Stands Nos. 11, 13 and 14.

One of the big sensations of the Exhibition is sure to centre round these stands, where the long-looked-for Baird Combined Wireless Receivers and Teleset Sets will be on view. The Company has announced that it proposes as soon as possible to commence broadcasting its own programmes for those of the public who own the new Baird dual sets, for which orders will be taken at the Exhibition. Full particulars can be obtained at Stands 13 and 14.

British Thomson-Houston Co., Ltd. Stands Nos. 88 and 101.

Although the many-sided radio interests of this world-famous concern will be well represented at Olympia, in all probability the chief attraction of the display will be the extraordinarily comprehensive array of valves. All kinds are available. In either the two-, four-, or six-volt range you can have a B.T.H. valve specially designed for resistance-capacity coupling, for H.F. amplification, for "general-purpose" and detector, for low-frequency amplification, or for power and loud-speaker operation.

In addition there are special valves, such as the type R.H.1, which is a half-wave rectifier, for supplying D.C. power from an A.C. source. (This valve was specially produced for use with the R.K. loud speaker.)

Another particularly interesting B.T.H. valve in the special class is the P.X.650, a very efficient super-power valve, designed for the operation of moving-coil loud speakers.

At these stands, also, will be shown the new Mazda Steep Slope Nickel Filament Valves. This new series was invented at Rugby, and comprises a complete range of sixteen valves, covering every requirement of the 2-, 4-, and 6-volt user. The full details of the electrical characteristics of these valves are now available, and are certainly interesting.

Some idea of the wide variations covered by the different types can be gained from the fact that in the 6-volters the impedance of the power valve is only 1,750 ohms, whilst that of the R.C. valve is 90,000 ohms, the respective amplification factors being 3.5 and 40. So be sure to ask the B.T.H. people for the free booklet describing these new nickel-filament valves.

S. G. Brown. Stands Nos. 155 and 156.

The 1928-9 season sees several notable additions to the list of productions of Messrs. S. G. Brown, Ltd., of Acton. The most interesting newcomer is the "Cubist" moving-coil loud speaker, a magnificent example of its type.

Messrs. Brown also introduce a moving-coil unit which merits and will receive a great deal of attention. A miniature edition of the popular "Mascot" loud speaker is another interesting innovation, to which the name of "Duckling" has been given. This model is being marketed at an extremely attractive price.

The Brown L.F. transformer completes the new season's introductions, and since it is the outcome of many months of painstaking research it will doubtless prove a thoroughly efficient instrument, fully living up to the great reputation it will have to uphold in this new field for the activities of Messrs. S. G. Brown.

Burndeft Wireless, Ltd. Stands Nos. 112 and 113.

Up to the time of going to press no information as to the special display arranged for at Olympia has been forwarded to us, but we know that at the Burndeft stands there is a special attraction in the form of a new pick-up. As every owner of a gramophone now knows, the electrical pick-up is a device for plugging into the detector or first L.F. amplifier of a multi-valve set, enabling gramophone music, speech, etc., to be reproduced via the loud speaker (with an enormous gain in clarity, and, if required, in volume). There are several noteworthy features in the Burndeft pick-up, so a visit to these stands should not be omitted, on this account alone.

(Continued on page 445.)

EXTRA POWER ALL THE TIME

PATENT STEEL MAST WIRELESS MAST

A High Aerial is as good as another Valve.

**DAMP PROOF!
ROT PROOF!!
GALE PROOF!!!**

15'-
26 Feet high. In 3 sections of 1 1/2 in. Steel tube tapering to 1 in. Carriage, London 1/6; Midlands, 2/6; elsewhere 3/6. Weight 24 lbs. Two masts for 28/6.

21'6
34 Feet high. In 4 sections of 1 1/2 in. Steel tube tapering to 1 in. Carriage London 2/-; Midlands 3/-; elsewhere 4/- Weight 34 lbs. Two masts for 40/-.

29'6
The "Super" Mast. 42 Feet high. In 5 sections of heavy 1 1/2 in. Steel tube tapering to 1 in. A real bargain. Carriage, London 2/6; Midlands 3/6; elsewhere 4/6. Weight 46 lbs. Two masts for 55/-.

P.R. MASTS
are made of British Steel in 9 ft. lengths, from 1 1/2 in., tapering to 1 in. and are supplied with cast-iron bed plate, steel ground pegs, stay rings, galvanised steel flexible wire stays cut to lengths, pulleys, bolts and fullest erecting instructions. No further outlay necessary. **NO HOLES TO DIG.**

GUARANTEE.
Money refunded without question if not satisfied. Pay C.O.D.

Waterproof Log Line, double length, 2'6 Mast 1/6; 3'4 Mast 2/-; 4'2 Mast 2/6.

P.R. Colloid Coating for protecting the Masts against weather—sets in one hour. 2/6. Sufficient for one Mast.

P. R. MASTS
(Opposite Post Office Tube)
17-3, PATERNOSTER SQ., NEWGATE ST., LONDON, E.C.4

Make The DAILY SKETCH YOUR Picture Paper

11th YEAR—12,000 SUCCESSES ENGINEERS!

The way to rapid advancement to a well-paid executive post in any branch of engineering is through the wonderful home-study courses of The 'Tech.



Write TO-NIGHT to find out how The 'Tech can help YOU: state your age and experience and mark your letter "Confidential Advice." (Moderate Fees—Easy Installments).

FREE BOOK.
"Everything about Engineering how to become A.M.I.Mech.E., A.M.I.E.E., etc."—the greatest book ever published on Opportunities for the practical engineer.

The Technological Institute of Great Britain, 200, Temple Bar House, London, E.C.4.

THIS YEAR AT OLYMPIA

—continued from page 444

Lissen, Ltd. Stands Nos. 71, 72, 57 and 58.

Visitors to last year's Exhibition will remember that the Lissen display was one of the most interesting and informative staged in Olympia, and this year there is every prospect of a repetition of the success scored twelve months ago.

Many new lines will tempt the eye at once, but before attention is paid to these it is worth while pausing to marvel at the success of the already established Lissen lines—the L.F. transformer, the new-process batteries, etc. Not only is there no sign of saturation being reached in the market for the particular Lissen lines which have scored such spectacular triumphs in the past, but as time goes on there seems to be a still keener appreciation of their merits.

Amongst the new lines sure to create a sensation are the new Lissen super-transformer and the Lissenola gramophone.

The new super-transformer retails at 19s., and represents value in high-priced transformers to a remarkable degree. The ratio is 3½ to 1, and the results are really "super"; in fact, the instrument should be heard to be believed. Country and provincial listeners who are not able to get this new transformer from their dealers will be interested in the order-by-postcard scheme which ensures the instrument being sent C.O.D. by return of post.

Other Lissen innovations include the gramophone pick-up (by means of which the set can reproduce gramophone music upon the loud speaker), the new vernier dial, and the already popular Lissen variable condenser which was recently reviewed in the "What's New" columns of this journal. Finally, there is the Lissenola gramophone, which, in view of the increasing liaison between radio and gramophone, will be of interest to practically every listener and constructor.

Mullard Wireless Service Co., Ltd. Stands Nos. 88, 89, 90, 97, 98, 99, 133 and 267.

The fact that the Mullard products now require no less than eight stands in order to be adequately represented to the public at Olympia is in itself a noteworthy tribute to the progressive policy of this famous firm. But however wide the incursions into wireless by Mullards may become, and whatever product they turn their attention to in the future, there is no doubt that they will always leap to the listener's mind in connection first and foremost with valves.

The Mullard P.M. valves, the Mullard P.M. filaments, the Mullard system of matched electrodes—who has not heard of and experienced them? Not content with renewals or with repeating the successes already scored, the Mullard organisation is continually on the look-out for something new and better in the valve line. This year there is sure to be enormous interest in the screened-grid valve, but in addition to this recent revolutionary product there is now another claimant to public interest in the form of the "Pentode." Full details of this, and of the wide range of valves for all ordinary purposes of reception, can be obtained upon application at the stands.

The many other Mullard components represented at Olympia must not be missed, and amongst these the "Permaacore" L.F. transformer is of especial interest. This transformer has a silver winding, and combines big amplification with small bulk in an extraordinary degree. The ratio is 3 to 1, and the price 25s.

Oldham & Son, Ltd. Stands Nos. 125 and 126.

All kinds of batteries for low-tension and high-tension supply will be found at the stands of this old-established and popular firm, whose productions have long been firmly established in the public favour. Those listeners who are thinking of "adding a valve" or of getting a bigger set should not fail to remember that extra valves mean increased consumption, and that they will not be running the filament and anode supplies economically unless the batteries chosen are able to stand up to the demands made upon them.

The Oldham range of batteries has been designed to cover every requirement, and particulars of the various lines will gladly be furnished upon application.

Ormond Engineering Co., Ltd. Stands Nos. 138, 162, 163.

Variable condensers of every type, slow-motion dials for fine tuning, and, in fact, every refinement that the Ormond experience can suggest in the direction of tuning improvements and condenser construction, will be found embodied in the components displayed at these stands.

Peto-Scott, Ltd. Stands Nos. 142 and 143.

Here will be found the Keystone components in great variety, including many new lines sure to be of interest to set-builders and listeners. Whilst

(Continued on page 446.)

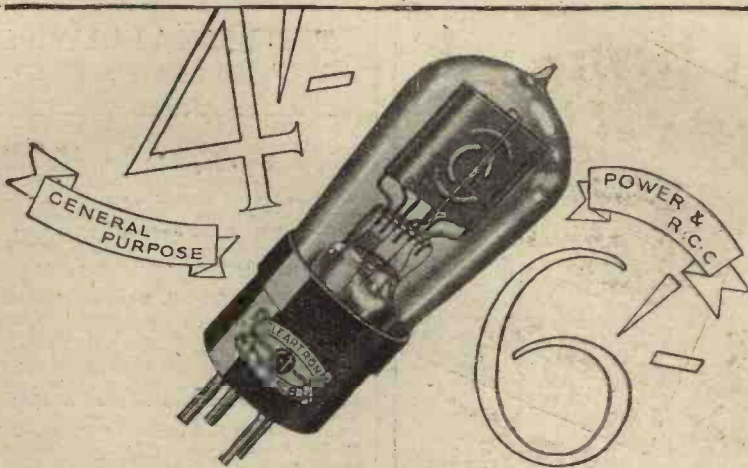

Will any Valve do more?

It's up to you to see that you get full value from the money you spend on valves.

A few days ago a Cleartron user wrote to us to say that he had had three of these valves in regular use for over four years. They had outlasted three accumulators and given excellent reception all the time.

We're not surprised. We know that Cleartrons are made with skill and care on the finest machinery money can buy. Thousands of letters testify to their worth.

They are inexpensive because nowadays there is no good reason for valves to be dear.

Have you discovered that yet? If not, buy your first set of Cleartrons. Two, four and six volt types are made for every purpose in radio. Power types 6/-, General-purpose types 4/-.

If your dealer cannot supply, order direct, or send the coupon for illustrated brochure, and give us your dealer's name.

CLEARTRON

ALL-BRITISH VALVES

FREE POST THIS COUPON
 CLEARTRON (1927), LTD., Sales Dept. 6, 21, Cumberland Street, Birmingham.

Please send me your new brochure describing the characteristics of all types of Cleartron Valves.

Name

Address

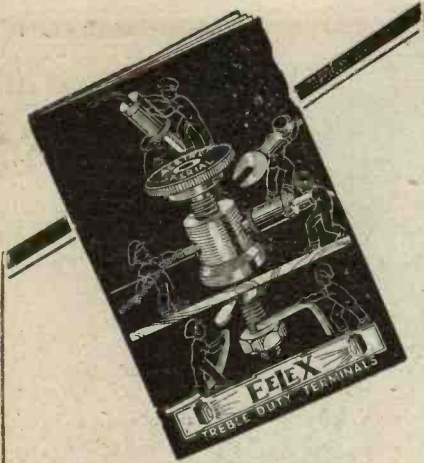

WRITE FOR THIS FREE BOOKLET

and learn all about the EELEX gnomes of efficiency and how by using EELEX TREBLE-DUTY TERMINALS you can make these accessories the centre of industry in your set.

This interesting little booklet also gives you full particulars of other Eelex accessories that will save you pounds. Every constructor should write for a copy—a postcard will bring it to-morrow.

Bad Terminal Connections are often the cause of losses and bad reception. Safeguard yourself by using



TREBLE-DUTY TERMINALS

the terminal with indicating top you can plug into.

DON'T FORGET TO VISIT STANDS 218 AND 219
in the Gallery
Wireless Exhibition, September 22-29

J. J. EASTICK & SONS

EELEX HOUSE,

118, BUNHILL ROW, LONDON, E.C.1

THIS YEAR AT OLYMPIA

—continued from page 445.

It would be difficult to say what is most likely to prove of special interest this year, there is no doubt that the Keystone Midget condenser and the Keystone drum drive will be amongst the favourite features of the display. The drum-drive fits all standard condensers, which can be mounted right or left of the drive. A delightfully smooth slow-motion drive gives a reduction of 9 to 1.

Siemens Bros. & Co., Ltd. Stand Nos. 164 and 165.

Siemens Brothers & Co., Ltd., Woolwich, have quite exceptional experience extending over a period of fifty years in the manufacture of batteries of all kinds, and there is no doubt that knowledge and experience count just as much in battery manufacture as they do in every other walk of life.

In spite of all that has been said and written, it would seem that the dry battery continues to be the most popular and convenient form of H.T. supply, particularly, perhaps, in the hands of those who are not technical enthusiasts. The Siemens display includes:

- H.T. batteries: Small capacity, standard type; small capacity, popular type; large capacity, power type; extra-large capacity, super-radio battery; high-capacity batteries for portable sets.
 - Grid-bias batteries.
 - Special batteries for overseas.
 - Crystacel accumulators.
 - L.T. dry cells and batteries.
 - Radio testing instruments.
- In conclusion, the fact that Siemens Brothers' batteries are of British manufacture throughout is perhaps worth emphasising.

YOU WANT THE BEST and BRIGHTEST Radio Weekly. In other words, IT IS POPULAR WIRELESS THAT YOU WANT

Goodmans, Stand No. 289A.

Goodmans are one of the firms that have come into the limelight with the advent of the moving-coil loud speaker, and already this firm has achieved remarkable popularity with its products. From a standard set of Goodmans parts it is quite a simple matter for the ordinary constructor to make up a moving-coil loud speaker for himself, which may give him the surprise of his life in the matter of reproduction quality, if he has hitherto been content with an old-fashioned type of loud-speaker.

A very noteworthy feature of the Goodmans display is the self-centring device, which enables that exactitude of adjustment to be obtained that gets the very best out of this type of loud speaker.

Graham Amplion, Ltd. Stands Nos. 30 and 31.

The choice of a loud speaker is always a difficult matter. But if figures are any guide to the perplexed purchaser he will find a great attraction in the Graham Amplion boast that well over half-a-million Amplion loud speakers have been sold! On these two stands there are types for every purpose and every pocket. The variety of shapes and styles alone is simply astounding to the uninitiated, and the success of this firm in catering for all styles of appearance is no doubt one of the factors that moved their sales over the half-million mark. The Junior Cone (A.C.2) which is priced at 37s. 6d., the handsome "Chippendale" Mahogany Cabinet (A.C.9) (retailing at £7 0s. 0d.) or any one of the extensive range of models in between, will give you the faithful reproduction expected of the Amplion loud speakers.

Hart Accumulator Co., Ltd. Stand No. 95.

The Hart Accumulator Co. is no newcomer to radio, and this year, as in the past, its stand will bristle with battery bargains. As the firm specialises in this particular branch of radio its whole

(Continued on page 447.)



EVERYTHING FROM THE MAINS

H.T. UNIT TRANSFORMERS, Centre tapped.

volts	m.a.	volts	amps.	
200	20	4	0.8	12/6
400	20	4	1.6	17/6
440	30	3.5	1	20/-
500	50	5	2	28/-
750	60	5	2	40/-
800	120	8	3	55/-
1000	120	8	3	60/-

L.T. TRANSFORMERS for Power Valves, Metal Rectifiers, A.C. Valves, etc.

volts	amps.	volts	amps.	
6	3	12/6	8.5	0.8 10/-
5	3	12/6	8.5	1.6 12/6
7.5	3	12/6	30	2 17/6
4	5	12/6	50	2 22/6
4	3	8/4	250	160 m.a. 17/6

H.T. and L.T. FILTER CHOKES.

50 henrys 25 m.a. 12/6 25 henrys 1 amp. 12/6
30 " 50 m.a. 12/6 50 " 100 m.a. 20/-

Largest and most varied stocks in London of Eliminator and Charger components and Meters. Delivery ex stock. Lists free.

Above components suitable for Harris "Stedipower" Unit.

F. C. HEAYBERD & CO.,
8/9, Talbot Court, Eastcheap, London, E.C.3.

(One minute from Monument Underground Station.)

The Picture Paper with the MOST News

:: SUNDAY GRAPHIC ::

WET H.T. BATTERIES



Solve all H.T. troubles. SELF-CHARGING, SILENT, ECONOMIC JARS (waxed) 2 1/2" x 1 1/2" sq. 1/3 doz. Zincs. New type, 11d. doz. SAOS 1/2 doz. Sample doz. (18 volts), complete with bands and electrolyte, 4/3, post 9d. Sample unit, 6d. Illus. booklet free. Bargain list free.

AMPLIFIERS, 3/- 2-VALVE SET, £4.
C. TAYLOR, 57, Studley Rd., Stockwell, London.

REPAIRS

Any make of L.F. Transformer, Loudspeaker or Headphones repaired and despatched within 48 HOURS—TWELVE MONTHS GUARANTEE with each repair. 4/- Post free. Terms to Trade.

TRANSFORMER REPAIR CO.,

Dept. "C,"
214, High Street, Colliers Wood, London, S.W.19.

The HOME for your WIRELESS SET

OUR STANDARD CABINETS

are DUSTPROOF and house the whole apparatus, leaving no parts to be interfered with. All you do is

UNLOCK AND TUNE IN.

Made on mass production lines, hence the low price. Provision is made to take panel from 16" to 30" wide. Carriage paid and packed free England and Wales. Thousands supplied with full satisfaction.

MAKERIMPORT CO.

Dept. 10,
9, York Street, LIVERPOOL.



From £4 15 0. Write to-day for descriptive pamphlet and suggestions for adapting your receiver or panel in our Standard Cabinets. Immediate Delivery.

PLEASE MENTION "WIRELESS CONSTRUCTOR" WHEN REPLYING TO ADVERTISEMENTS.

A Genuine Spare-time Business

PATENT-PROTECTED ARTICLES YOU CAN MAKE AT HOME.

Good Profits Guaranteed!

If you are interested in any way in Wireless, here is a wonderfully interesting way of making money in your spare time. Simply write for particulars, and by return you will be given full details how to make at home a most marvellously improved article which reduces the upkeep costs of all valve sets, gives splendidly efficient service, contains no harmful ingredients whatever, and which is in enthusiastic demand all over the country.



Is your spare time wasted time? Why not turn it to good account and change the whole of your future life for something better and bigger?

there any inconvenient demand on space. A spare room, an outhouse, or even your kitchen table, can be used as your "factory"—a factory without machinery or plant or electric current. The few simple tools needed you are shown how to make yourself, or buy for a shilling or two.

Output Easily Sold.

Each article you make is protected by Royal Letters Patent, so that your rights cannot be infringed. The market is immense, and only a strictly limited number are allowed to manufacture, thus giving you a huge field for sales at a very big profit. The articles you can produce without any mechanical skill or talent are manifestly superior in quality and value for money to anything on the market, and if you have the least difficulty in disposing of your output to friends, private owners of wireless sets, wireless or electrical dealers in your district, arrangements will be made to take it off your hands, thus guaranteeing your profits!

Think of what you could do with pounds extra per week! Think of the delightful hobby you can pursue instead of finding time hang heavily on your hands! Think of the new and most interesting field opened to you as a responsible "master man"!—and do not delay a single moment in sending the coupon below!

Send this form now for full particulars.

**"MAKE-MONEY-AT-HOME"
COUPON**

To THE ENGLAND-RICHARDS CO., Ltd.,
97, King's Lynn, Norfolk

Sirs,—Please send me at once, and FREE, full details as to how I can Make Money at Home in my spare time. I enclose 2d. stamps for postage.

Print your name and address boldly in capital letters on a plain sheet of paper and pin this coupon to it.

"Wireless Constructor," October, 1928.

THIS YEAR AT OLYMPIA

—continued from page 445

energies are concentrated upon the solution of those problems and difficulties that beset the battery-user, and the various types of wireless accumulator evolved have all had their origin in some real radio need. No matter what class of amperage is required, the Hart accumulators are ready to supply it, so those intent upon the choice of a battery should not fail to visit Stand No. 95.

Jackson Bros. Stand No. 105.

The "J.B." policy is to provide discriminating members of the radio public with precision condensers of unsurpassed quality and efficiency. During the summer this firm's experts have devoted the whole of their time to the design of new instruments for use with really modern and up-to-date receivers. Consequently, there are several new J.B. lines of really outstanding interest, including a vernier drum drive and an attractive panel plate for use with this.

Another very interesting line is the new J.B. Midget condenser, which is supplied complete with neat pointer knob at the following prices: '00025 mfd., 5s. 9d.; '0002 mfd., 5s. 6d.; '00015 mfd., 4s. 9d.; '0001 mfd., 4s. 6d. (Larger capacities are available if required.)

In addition there are the new J.B. slow-motion S.L.F. and log models, attractively priced and giving every evidence of the excellent design and scrupulous workmanship for which this firm is justly famed.

Junit Mfg. Co., Ltd. Stand No. 93.

Tolling, rejoining, soldering—onward through life goes the home constructor. And the fact that many of his soldering troubles have been reduced in the past will always redound to the credit of the Junit Mfg. Co., who are again showing a very attractive range of gadgets for set-builders. The Junit wire and soldering-iron will not need introduction to many of our readers, but the newcomer to radio who is not yet acquainted with their advantages will certainly be well advised to give this stand special attention.

S. A. Lamplugh, Ltd. - Stands No. 81 and 106.

Although we have not received full details of the display to be given at Olympia by this well-known firm of wireless manufacturers, we understand that they will again be featuring the many popular Lamplugh products which in the past have proved so acceptable to the radio public. In addition there will be several improvements to accord with the latest advances in radio technique, such as the epicyclic visor variable condenser, which is illustrated upon another page in this section of the WIRELESS CONSTRUCTOR.

Carrington Mfg. Co., Ltd. Stand No. 107.

Cabinets, more cabinets, and still more cabinets, form the order of the day here. All the popular designs are on show, as well as a number of new designs, worked out in a delightful variety of styles and prices. The Camco cabinets are too well known to need much recommendation, but it may fairly be said that this year this popular firm have fairly surpassed themselves in anticipating and fulfilling the needs of the wireless constructor, whether in the direction of small and compact receivers or in the more ambitious field of multi-valve sets which masquerade as handsome pieces of modern furniture.

Chloride Electrical Storage Co., Ltd. Stands Nos. 33, 40 and 241.

If you have been under the impression that the popularity of mains units has knocked the battery makers out, you should take a look at the Chloride Co.'s stands, where there is ample evidence to the contrary. Batteries of all kinds, from sneaky little fellows that would bias any grid, to huge great batteries that appear to be of unlimited capacity—all are here.

The range will include the new series of Exide patent unspillable cells of special design with a new form of unspillable device. These cells have been designed to give maximum capacity in the small space available in modern portable sets, and at the same time ensure that the plates are completely immersed in electrolyte in two positions, viz., the carrying and operating positions.

In addition to the above-mentioned batteries, a complete new range of Exide trickle chargers for A.C. mains will be on exhibition for the first time.

A selection of loose plates, separators and other component parts will also be exhibited.

A. C. Cossor, Ltd. Stands Nos. 116, 117, 231 and 250.

Cossor valves, of course; but if you think that you already know what that means it will pay you to have a good look at the Cossor stands, just to see how far this firm has penetrated into the

(Continued on page 448.)

Reduced in price

FROM TO-DAY

This is news indeed! The world-famous W.B. Anti-phonic valve holder, as specified by all the leading designers of the day, is reduced in price to

1/6 Complete with terminals

1/3 without terminals.

Why are W.B. valve holders chosen time after time for the premier circuits? Because they do definitely exclude microphonic noises.

Sprung on specially shaped springs, W.B. Anti-phonic valve holders ensure really pure reception.

COME AND SEE US AT OLYMPIA—STAND 120.

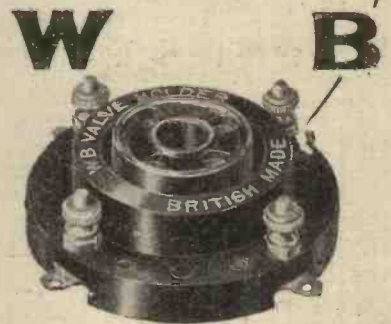

ANTI-PHONIC VALVE HOLDER

WHITELEY, BONEHAM & CO., LIMITED,

Nottingham Road, Mansfield, Notts.

K. RAYMOND

27 & 28a LISLE ST., LONDON, W.C.2
Come to Leicester Square Tube.

This address is at the back of Daly's Theatre.
Phones: Gerrard 4637 and 2821.

WE ARE OPEN

ALL DAY SATURDAY
ALL DAY THURSDAY
ALL DAY EVERY DAY
Hours: 9 a.m. to 8 p.m.
Sat.: 9 a.m. to 9 p.m.
Sunday morning: 11-1.

VALVES

Valves, all latest stocked.
D. L.F., H.F., P., 10/6.
12/6 each; D.U.10, 15/-;
Mullard P.M.4.D., 12/-;
Cossor, Mullard, Ediswan,
Marconi, Osram, Six-sixty.
Screened Grid, 22/6.

SEND CARD FOR PRICE LISTS.

C.O.D.

Orders despatched same day
as received where possible.
Send ORDER with instruc-
(U.K. ONLY.) tions and pay Postman.

Orders for abroad or outside U.K., additional car-
riage and packing, insurance, etc., must be included.

We stock Igranite, Climax, Ever-Ready, Hellesen, Siemens, Formo, Ferranti, Wearite, Ormond, J.B., Benjamin, Lotus, Mullard, Dubilier, Lissen, Lewcos, Utility, Magnum, Peto-Scott, Peerless, Burnsted, Pye, Marconi, McMichael, Cosmos, Carborundum, E.I. Varley, Gambrell, Brown's, Sterling, Ampilons — in fact, everything it is possible to stock.

KITS of parts for all CIRCUITS.
Make out LIST for keen quotation.
DON'T worry, if it's Wireless WE HAVE IT.

LISSEN

Valve Holders, 1/-; Fixed Con., 1/-, 1/6; Leaks, 1/-; Switches, 1/6, 2/8; Latest 2-way Oam Vernier, 4/8; Rheostats, 2/8; B.B. 1/6; Lissenola, 13/8; L.F. Transformers, 8/8; Coils, 60 K., 6/4; 250 V., 9/9; 60 v. H.T., 7/11; 100-v., 12/11; Super 60-v., 13/6; Grid Bias, 1/6; 4-5, 5d.

OCTRON BRITISH

VALVES, 2, 4 & 6 volts.
L.F., R.C., H.F., 5/-
Power, 8/9.

Full Guarantee.
Chart FREE.

EBONITE cut while you wait
Irid square inch, also 1 in.
atjd. Only the best supplied.
No cheap rubbish.

"Dario" Valves

(Genuine Radio Micro)
Best in the World.
R.VOLT 2-v. .05, 5/6;
Loud Speaker Valve,
7/8; R.C. .05 1-8, 5/6;
3-5 .05, 5/8; Loud
Speaker Valve, 7/6;
3-5 R.C. .07, 5/6. Post
6d. each.

ORMOND

No. 2 CONDENSERS.
No. 28, 5/6; .00035, 5/9;
-0005, 6/- (with 4-in. Dial).
Friction Geared, .0005,
15/-; .0005, 14/6; -00025,
13/6. Straight Line
Frequency Friction
Geared, .0005, 20/-;
-00035, 19/6; S.L.F.,
-0005, 12/-; -00035, 11/-;
Log .0005, 13/-; -00035,
12/6; -00025, 12/- S.M.
Dial, 5/-.
ALL COMPONENTS STOCKED

M.W. and P.W. 7/6
Loading Coils,

COSSOR MELODY MAKER £4:10:0 kit. As COSSOR Specification

Leaflet free. (Watmel Choke included)
2 Ormond .0005; 2 Do. S.M. Dials; 6 T.C.C. Condensers; 2 B.F. Clips; B.B. Rheostat; 3 Dubilier Leaks; 3 Lotus V.H.; Ferranti A.F.3; 2 Switches; 1 Cossor Wound Coil; Terminals, Glazite, Grid Bias, Watmel Choke. Handsome Oak Cabinet, 12/6. With baseboard. Carr. 2/-.
Alec Cabinets at 15/11, 18/7; 1 Screen Assembly and Mahogany Polished, at Wood Screws. Carriage 1/-.

FREE with parts

Drilled High-grade 21 x 7
Polished Panel and Strip,
with Wood Screws. Carriage 1/-.

COSSOR VALVES 2, 4, or 6-Volt for above. L.F. D., R.C., or H.F., 10/6 each. Power, 12/6.

LEWCOS PRODUCTS

C.T. Coils, 40, 50, 60, 75, 3/6 each. 100, 150, 200, 5/3 each. Glazite, 10d. 10 ft. Litz Wire, 9/38, 4/- 50 yds.; 9/38, all silk, 5/6 50 yds. Also in 20-yard reels, Litz, 27/42, 11/6 50 yds. Frame Aerial Wire, 3/6 100 ft. Battery Leads, 4-way, 5/6; 5-way, 7/6; 6-way, 7/6; 1 Coil for long waves, 9/-; 1 Coil Base, 1/9.

PETO-SCOTT H.F. UNIT COMPONENTS FOR COSSOR "MELODY MAKER."

1 Ormond S.L.F. Variable Condenser .0005 mfd., 6/-; 1 Ormond Slow-Motion Dial, 5/-; 10-ohm Rheostat, 2/6; 1 Screen Assembly drilled for valve-holder, 3/6; 1 Screened Grid Valve-holder, 3/-; 2 Socket Connectors, with flex and tags, 6d.; 1 T.C.C., 1 mid., 2/10; 1 S.G. Choke, 5/-; 1 Coil (Litz wound) for short waves, 3/6; 1 Coil for long waves, 9/-; 1 Coil Base, 1/9.

C.O.D. (U.K.) post free for 47/6

FREE with above: Drilled panel and strips, 7 engraved terminals, baseboard, wire and screws.

COSSOR Screened Grid VALVES, 22/6

Send your orders, wire, phone or write (plainly please). Personal attention to your requirements.
C.O.D. U.K. ONLY.

RADIO FOUR PARTS. SEND FOR QUOTATION.

THIS YEAR AT OLYMPIA

—continued from page 447

science of valve production. All the old friends are here, of course, but in addition there have been several interesting events in the Cossor valve family. Two newcomers are especially noteworthy — the screened grid and the Pentode valves.

"Melody Makers" will be sure to cluster round the Cossor stands like flies round a honey-pot, but whether or no you have built this famous set you ought to try for a copy of the booklet, "How to get the best from your Cossor Melody Maker." It is fully illustrated, and tells you how to bring in those distant stations, how to get greater volume, how to look after your batteries—in fact, it is full of hints and tips about that ever-engrossing problem of the improvement of radio reception.

Ever-Ready Co. (G.B.), Ltd. Stand No. 44A.

At the stand of the Ever-Ready Co. there is sure to be plenty of interest, though this firm has not—at the moment of writing—advised us of any new lines or departures from their normal range of products for the radio enthusiast. In any case, the construction of primary batteries is a well-settled-down industry, so that many purchasers would sooner rely upon the products of a firm which they have found satisfactory in the past than venture into dealing with novelties. In the past the wide range of Ever-Ready batteries for all wireless purposes has been tested by innumerable listeners, and the high reputation which this firm has won will ensure that anything shown upon this stand is well worth the attention of the keen battery buyer.

The Formo Co. Stand No. 140.

Here will be found a host of good things for the discriminating constructor. Special mention must be given to the new Formo dual-impedance device. This is a special two-stage L.F. unit, incorporating one stage of resistance-impedance coupling, followed by a single stage of ordinary L.F. transformer coupling. This unit is put up in the form of a neat cylinder, with appropriate terminals, and bears a very clear diagram of connections as part of the component, thus assisting in the wiring and in the understanding of the principle upon which the device works.

GOING TO BUILD A SET?

Then you ought to see the September issue of

MODERN WIRELESS,

which, in addition to the usual features, contains full details of

FOUR FINE SETS.

Now on Sale. Price 1/-.

Another new Formo product is a de luxe variable condenser, which is fitted with a bearing at each end, in a very natty style. Another feature of this product which is particularly pleasing is the concealed pigtail which effects contact between the moving plates and the terminal which makes the connection to the circuit.

General Electric Co., Ltd. Stand Nos. 28, 29, 46, 47 and 225.

All the well-known G.E.C. products will be represented at one or another of these stands, and a very fascinating display they make. Probably the largest single attraction will be the Osram valves. An extraordinarily comprehensive range of these will be on show, and besides the old favourites there will be many new departures, including the new Osram S.215 valve. This is a new screened-grid valve for 2-volt users, and it is very interesting to recall that last year the Osram S.625 was the pioneer of the screen-grid type of valve.

Those listeners who possess electric light from alternating current mains will be specially interested in the new Osram series for A.C., full details of which are now available and can be obtained at the stands.

This firm is also announcing the Osram "Pentode"—a wonderful new five-electrode power valve which will shortly be placed upon the market. At the time of writing it is not certain that this will be available for display at the Olympia Exhibition, but it would be an awful pity to miss it if it is, so the only course for the man who wants to be bang up-to-date is to call at the G.E.C. stands to make sure.

PEERLESS Master Switch

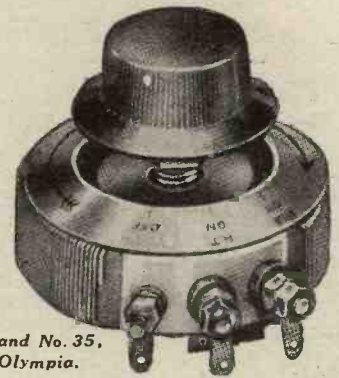

Stand No. 35.
Olympia.

This switch is exactly suited for the control of current where Battery Eliminators are used. Cuts off both High and Low Tension and will carry a very high potential across condenser such as that passing when current is broken suddenly.

A Soundly-constructed British Switch.

PRICE (as illustrated), 2/9.

Obtainable from all Dealers.

THE BEDFORD ELECTRICAL & RADIO CO., LTD.,

22, Campbell Road, Bedford.

LONDON:
21, Bartlett's Bldgs.,
Holborn Circus, E.C.4.

GLASGOW:
113, Vincent St.,
C.2.

HYDRA

Serves you well

There *must* be something unusual in this condenser to win and hold the confidence of the most important Eliminator manufacturers, not only in Britain, but the world over.

CAPACITIES

from 1 MF. upwards.

Tested at 500 volts D.C.,
500 volts A.C., and
upwards to 10,000
volts D.C.



LOUIS HOLZMAN, 34, Kingsway, London, W.C.2.

**TELEPHOTOGRAPHY
AND TELEVISION**

—continued from page 388.

it is stated that the original Act includes "and shall be deemed always to have included the reception as well as the sending of messages."

Television is, of course, another new development not contemplated when the Acts of 1904 and 1925 were passed, but it is the opinion of legal authorities with whom we have discussed this matter that the sending of living or still pictures by wireless is covered by the definition in Sub-section 7 of the 1904 Act: "Any system of communication . . . without the aid of any wire."

Consequently, it follows that any systematic service of television or still-picture transmission must necessitate, as a preliminary, a licence from the Postmaster-General; and, further, it is a widely considered opinion that any such service offered without a licence would be a breach of the experimental licence issued to any experimenter, and also a breach of the exclusive and monopolistic licence already issued by the Postmaster-General to the B.B.C.

Nevertheless, it is quite likely that legal argument may require a more detailed interpretation of the Act, and it is evident that there is already a school of legal opinion which believes that on a technical point radio television, or picture-transmission, as a new development, stands outside the present wording of the Acts. But in the unlikely event of this contention being upheld in the Courts, there is no doubt that Parliament would be asked to pass an amending Act to regularise the position.

WHY NOT READ MORSE?

—continued from page 404

that he begins to discover the real interest of the thing.

The best method is to choose the slowest and clearest sounding transmission you can find, and settle down to try and pick out a few letters here and there, writing them down quickly and listening for others.

When you have practised sufficiently to be able to copy correctly the slower of the amateur transmissions which you hear, the new interest which you will find in your short-wave receiver will amply repay you for all the seeming drudgery of your practice days.



*Don't
Worry*

An ohmite anode resistance isn't superstitious; it's only rated to carry 10 milliamperes, and 13 is reputed to be unlucky, but if it burns out at this we will replace it, but

no Ohmite has ever been burnt out yet!

That's why

**GRAHAM FARISH
OhmitE ANODE RESISTANCES**

*are
Better than
Wire Wound!*

PRICE
ANY SIZE
UP TO
1/2 MEG **2/3**

GRAHAM FARISH of BROMLEY, KENT

■ ■ ■ DON'T WAIT ■ ■ ■
■ For the Winter
■ BUILD YOUR SET NOW!
■ EVERYTHING WIRELESS
ON
■ EASY PAYMENT TERMS
 ■ First Monthly Payment Secures Delivery.
 ■ Call at our showrooms or send list of requirements. Best monthly terms quoted by RETURN.
■ P.D.P. Co., Ltd., Dept. C.,
■ 121, Cheapside, E.C.2. Phone: City 9846. ■

ASTONISHING
BARGAINS
 in our
NEW CATALOGUE
 72 Pages, well illustrated and offering the greatest choice obtainable in radio products.
Get a copy. Post Free 4d.
ELECTRADIX RADIOS,
 218, Upper Thames Street, London, E.C.4.

RED TRIANGLE
GUARANTEED EBONITE PANELS
 CUT TO
 ANY SIZE
SAFETY FIRST
 MAHOGANY
 GRAIN MATT
 OR BLACK
 POLISHED
PETO-SCOTT CO., LTD., 77, CITY ROAD, LONDON, E.C.1



Here is a Panel that will not split or break or crack

HAVE you ever watched the fracture run across the panel just as you think you've finished drilling? It's a common experience unless you choose Resiston.

Resiston Panels, like Radion, are made from nothing but pure rubber. They are tough without being brittle. They can be sawn with ease, they can be drilled without fear of fracture, and when tapped will take a good thread.

With Resiston, the home constructor runs little risk of ruining his panel. Its strength, its perfect insulation, beauty of surface and colour permanence are lastingly assured.

Send for new booklet.

Please send me, free, a copy of your new booklet, "The Panel Makes all the Difference." W.Con. Oct.

NAME.....
ADDRESS.....



5685

American Hard Rubber Co., Ltd., 13a, Fore St., E.C.2

BAIRD'S TELEVISION APPARATUS

—continued from page 408

of light emerging from the optical lever system and impacting upon the sensitive cell is increased, the intensity of that ray, and therefore its power to stimulate or energise the cell, would appear to be proportionally weakened.

"Stereoscopic" Pictures

Patent No. 266,564, granted to Television, Ltd., and Mr. J. L. Baird.

In the case of cinematographic reproduction from a series of film photographs, many attempts have been made to secure what is called the stereoscopic effect. That is to say, instead of the moving picture being thrown upon the screen as a flat or "two-dimensional" reproduction, it appears to have depth as well.

In one known system this result has been attained with a considerable degree of success by throwing two pictures on the screen simultaneously, and providing the audience with spectacles of differently-coloured lenses, so that each picture is seen separately by each eye. The action of the human eye then automatically merges the two separate images into one harmonious whole, in which the various objects stand out from one another in their natural perspective.

Mr. Baird has invented an arrangement whereby the same stereoscopic effect is said to be imparted to pictures or scenes transmitted by television. His method is illustrated in Fig. 3, and consists in using two sensitive light cells A and B placed slightly apart, each cell receiving separate light-impulses from the object O to be televised.

The Receiver

At the receiving end two light sources M and N are similarly displaced, and are respectively energised by the currents derived from the two cells A, B. The resulting variations in light intensity are separately synthesized or reassembled, and are then viewed through an ordinary stereoscope.

In order to keep each image separate from the other a special rotating disc D is used in exploring the object O through a lens L. This disc has two series of spiral holes or lenses marked S and S₁. The spiral lenses S are arranged so as to throw one series of light rays on, say, the cell A, whilst the other lenses S₁ feed the cell B.

(Continued on page 451.)

READY RADIO SUPPLY CO.

41, Newcomen Street, London Bridge, S.E.1

Telephone: HOP 6767.

IMMEDIATE DESPATCH OF ALL THE CORRECT PARTS

as used in the

"RADIO FOUR"

	£	s.	d.
1 Cabinet & Baseboard, 21" x 7" x 10"	1	10	0
1 Ebonite Panel, 21" x 7"	1	16	0
2 Indigraph Vernier Dials	15	0	0
2 Lissen Variable Condensers, .0005	13	0	0
1 Peto-Scott Reaction Cond., .0001	5	6	0
1 Benjamin On-& Off Switch	1	3	0
1 Lissen P.M. Rheostat, 30 ohms	2	6	0
2 Lotus D.P.D.T. Switches, with terminals	8	0	0
2 Brass Rods, 2BA, 4" long	2	6	0
2 Magnum Panel Brackets	2	6	0
2 Terminal Strips, with 5 and 7 terminals	2	6	0
4 Lotus Valve Holders and terminals	7	0	0
4 Peto-Scott E.B. Coil Holders	6	0	0
2 T.C.C. Condensers, .0001	3	8	0
1 T.C.C. Condenser, .0003	1	10	0
1 T.C.C. Condenser, .0003, with S.P. terminals	2	4	0
1 Dubilier Grid Leak 2 megohms	2	6	0
1 Formodenser, .00003 max. Ref. A	5	0	0
2 Dubilier Condensers, 1 mfd.	3	6	0
1 Dubilier Condenser, 2 mfd.	9	6	0
1 R.I.-Varley Radio Frequency Choke	17	6	0
1 Mullard E.C.C. Unit	1	5	0
1 Philips' L.F. Transformer	16	0	0
1 Igranite Output Choke, type F	12	6	0
1 Peto-Scott Screening Box (M.W.)	3	6	0
25 Yards Lewcos Rubber-covered Flex	1	12	2
2 Sets Lissen Coils, med. and high-wave	2	16	0
1 Set Cosmor and Marconi Valves	14	19	1
Wood Blocks and Metal Screws			

Write, wire or 'phone (Hop 6767) your order.

Any of the above parts can be supplied separately. Drilling free. The set can be supplied complete for an extra charge of £6, royalties paid.

INLAND: All orders POST FREE.

OVERSEAS consignments carefully packed and insured.

EVERYTHING WIRELESS

ALEXANDER BLACK, The Wireless Doctor.

will call and cure your set (London and Home Counties). A specialist in quality reproduction. 2a, Woodville Grove, N.16. Sloane 5105. Clissold 3687.

To All Advertisers

PLEASE note that communications concerning advertising in

WIRELESS CONSTRUCTOR
POPULAR WIRELESS
MODERN WIRELESS

must be made to

John H. Lile, Ltd.
4, Ludgate Circus, London, E.C.4.

(Phone: City 7261.)

and NOT to the Editorial or Publishing Offices.

Cabinets of Quality for every Set. Full illustrate particulars from the actual manufacturers. V & Sons & Sons, 61, Hackney Grove, Mare St. London-E.

ARTCRAFT RADIO CABINETS
BEST VALUE
New Catalogue Free
THE ARTCRAFT COMPANY
156, CHERRY ORCHARD R' CROYDON

When replying to advertisers please be sure to mention "Wireless Constructor."

BAIRD'S TELEVISION APPARATUS

—continued from page 450

The two image beams may be prevented from creating mutual interference by providing a partition between the two series of lenses, which partition may either be made rigid with the exploring disc, or else it may be made to rotate relatively to the disc.

The reassembling disc D_1 at the receiving end is also provided with two separate series of spiral lenses in order to project each completed picture separately.

By interposing a stationary orange-red screen between the exploring disc and the light-sensitive cell A, and a stationary green-blue disc between the same disc and the cell B, Mr. Baird states that the object to be televised may be transmitted in natural colours, similar coloured screens being provided for the light sources M, N at the receiving end.

Patent No. 266,591, granted to Mr. J. L. Baird.

In the original experiments carried out by Mr. Baird, the light directed upon the sitter's face was so powerful as to be almost intolerable after a very short time.

In order to avoid this inconvenience, Mr. Baird proposes to reduce the brilliance of illumination by using two light-sensitive cells instead of one, and energising both cells simultaneously with light-beams from the same object. The two series of light signals so produced are sent separately to the receiving station and are there recombined into one picture.

In order to keep each picture separate from the other in the process of transmission, a different interruption frequency is used in each case. As shown in Fig. 4, an exploring disc D is used to traverse the object O, and the resulting light rays are then cut up into two different frequencies by means of a second disc, D_1 , provided with an inner and outer series of interrupting holes a, b.

There are twice as many holes in the circle a as in the circle b, so that light falling on the sensitive cell A is interrupted at a frequency double that at which the rays falling on the cell B are interrupted. In this way each image-signal can be transmitted separately from the others to the distant station. There the two signals are separately rectified and the resultant currents fed in combination to the illuminating glow-lamp.

KEYSTONE

THE HALL MARK OF QUALITY

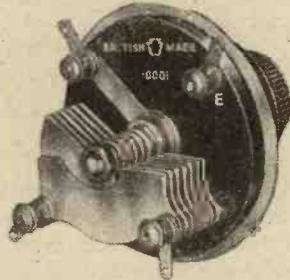

KEYSTONE MIDGET REACTION CONDENSER
PRICE0001 mfd. . . . 5/-
. . . .00005 mfd. . . . 4 6



KEYSTONE ALUMINIUM ANGLE BRACKET
PRICE 2/- per pair

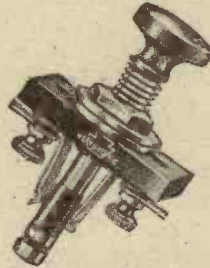

KEYSTONE PUSH-PULL SWITCH
PRICE 1 3

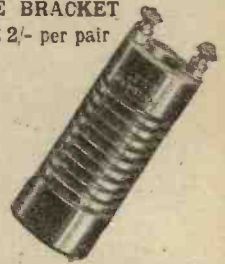

KEYSTONE HIGH-LOW H.F. CHOKE
PRICE 3 6

WRITE FOR LIST No. 25 GIVING PARTICULARS OF FULL RANGE OF KEYSTONE COMPONENTS

PETO-SCOTT CO., LTD.
77, City Road, London, E.C.1

CA 5528

Get Your Copy At Once!

ALL SPORTS FOOTBALL ANNUAL gives all the latest information about the League Teams. Contents include: Laws of Football. Four Pages of Photographs. All English League Fixtures for 1928-29. All last season's results. Full particulars of New Players, etc. Everything to help you with your Football Competitions.

ALL SPORTS FOOTBALL ANNUAL 3d.

MODERNISE YOUR WIRELESS

The "RADIOLA" BUREAU

Costing no more than a Loud Speaker, quickly transforms YOUR SET into a Stately Drawing-Room Receiver

Highest approval, Radio Press, etc. Experts — and over 3000 delighted clients FROM

£5 . 5 . 0

3 ft. high. Solid oak or mahogany. Beautifully polished

Sent ON APPROVAL in sizes for every set. Send for full particulars — FREE.



De Luxe Model

PICKETT'S CABINETS

W.C. WORKS, BEXLEYHEATH, KENT.

"RED DIAMOND" 2-WAY COIL HOLDER



No. R.D.32.

Parallel working. Fine adjustment. Worm driven. Coils cannot fall. Easy movement. Perfect finish. Of all high-class radio dealers or by insured post, 4/- each



R.D. 39.

Pull-and-Push Switch
Robust construction. Definite "on" and "off" positions. No shaking. Perfect contacts. Terminals for easy fitting. Price 1/3



Sole Makers:

JEWEL PEN CO., LTD.

Radio Dept. 41, 21/2, Gt. Sutton St., London, E.C.1

QUEER QUERIES
—continued from page 427

could not get his reaction to work like that at all. When the condenser was adjusted at zero there was no reaction, and adjusting it up to about half-way did not seem to make very much difference. But suddenly there came a point when there was a sort of "pop," and the set started to oscillate violently.

When turning the condenser slowly back again the puzzling part of the performance started. Instead of it plopping out as it had plopped into oscillation, it kept on oscillating even though the reaction condenser was turned several degrees back beyond the point where it began to oscillate.

In this particular instance there were five degrees on the reaction condenser which "overlapped." As our friend was trying hard to get distant stations and knew that smooth reaction was essential to this, you can understand his "terrible trouble."

Curing "Overlap"

Quite a number of factors will cause trouble of this kind. The first thing to suspect where overlap is present is that incorrect voltage is being applied by the L.T. or the H.T. (probably the latter). Another frequent cause of this trouble is a reaction coil which is too big, and if neither of these appear to make much difference, the source of the trouble may be either the grid leak or the grid condenser, or both.

Incorrect values of either leak or condenser can give rise to these symptoms, but generally the H.T. is wrong as well. In any given set, certain valves will be found to be prone to the trouble and others not, so a change of valves, if this is possible, may do the trick.

Big Price Reductions NOW

THE SIFAM

Pocket Model
120 volt, 4,000 ohms Res.
Heavy nickel finish,
now 7/6

POCKET MODEL RADIO METER

THE number of Sifam Radio Meters sold is now approaching the enormous figure of half a million. The absolute dead-beat movement, guaranteed accuracy and robust construction of the Pocket Model Meter have, from the first day of production, won the approval and confidence of listeners everywhere.

This greatly increased production has brought manufacturing economies in its wake. This saving is being handed on to the purchaser by a reduction in price from 9/6 to 7/6. Get your Sifam Meter now, from wireless dealers everywhere, price 7/6.

Write for interesting free leaflet "Detecting Distortion" from Dept. C.

SIFAM ELECTRICAL INSTRUMENTS Co., Ltd.
Radiometer Headquarters,
BUSH HOUSE, ALDWYCH, W.C.2.

THE BATTERY THAT LASTS FOR YEARS!

SAVE MONEY ON H.T. SUPPLY

WHAT a waste Dry battery after dry battery and the ever-present bogey of spoiled programmes. Banish this for ever! Instal the amazing Standard Wet H.T. Battery—the battery that recharges itself overnight. Don't delay. Send for free



booklet describing every detail for installing and maintaining this super-efficient and money-saving battery. Mention Dept. G when replying to this advertisement.

SPECIAL OPPORTUNITY

"UNIBLOC CABINET" 8/1
96-Volt unit complete. Cash Price £2/6/3, or 8/1 down and 5 monthly payments of 8/1. No references. No deposit.
HALFORDS CYCLE STORES, CURRY'S STORES
Call their dealers supply on cash or deferred terms.
Woolworths are now stocking 6d. Units See the name STANDARD on every jar.

RADIO EXHIBITION, OLYMPIA
STAND No. 7 (On right of main entrance.)

The Standard Wet Battery Co.
(Wet H.T. Battery Co.)
Head Offices, Showrooms and Warehouse—
184-188 Shaftesbury Avenue, London, W.C.1
Near New Oxford Street end.

STANDARD
Permanent H.T. Supply

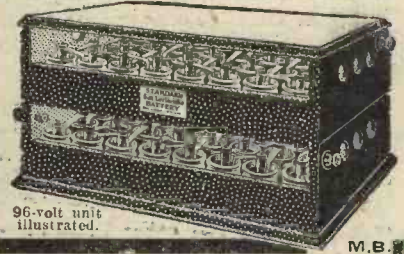

INDEX TO ADVERTISERS

American Hard Rubber Co., Ltd.	450
Artcraft, The Co.	450
Advertisement Rates	440
"All Sports", Football Annual	451
Bedford Electrical & Radio Co., Ltd.	448
Belling & Lee, Ltd.	441
Bird, Sydney S., & Sons, Ltd.	442
Bond, V. C., & Sons	450
Bowyer-Lowe Co., Ltd.	418
British-Thomson Co., Ltd.	354, 355
Brunsept Wireless, Ltd.	398
Burne-Jones & Co., Ltd.	428
Black, Alexander	450
Brown, S. G., Ltd.	432
Baker's Selhurst Radio	443
Benjamin Electric, Ltd.	443
British General Mfg. Co., Ltd.	443
Carrington Manfg. Co., Ltd.	443
Casson Mouldings	439
Celestion Radio Co., The	441
Clarke, H., & Co. (Mer), Ltd.	406
Cole, B. K., Ltd.	425
Cossor, A. C., Ltd.	358
Colvern, Ltd.	437
Clarrton, Ltd.	445
Day, Will, Ltd.	434

Dubilier Condenser Co. (1925), Ltd.	402
Eastick, J. J., & Sons	446
Edison & Swan Electric Co., Ltd.	401
Elliott, E.	440
England-Richards Co.	447
Electron Co., Ltd.	421
Electradix Radios	449
Ever-Ready Co. (Great Britain), Ltd.	397
Ferranti, Ltd.	435
Forno Company	429
Gambrell Radio, Ltd.	438
Garnett, Whiteley & Co., Ltd.	394
Gilbert (Cabinets)	442
Goodmans	439
Graham Parish of Bromley	449
Hayberd, F. C., & Co.	446
Holzman, Louis	448
Hughes, F. A., & Co., Ltd.	437
Impex Electrical, Ltd.	426
International Corr. Schools, Ltd.	439
Igranic Electric Co., Ltd.	405
Jackson Bros.	413
Jewel Pen Co., Ltd.	451
Lectro Linx, Ltd.	440
Lissen, Ltd.	393
London Elec. Wire Co. & Smiths, Ltd.	422
London Radio Mfg. Co., Ltd.	436
Lyons, Claude, Ltd.	434
Marconiphone Co., Ltd.	353
Makerimppot Co.	446
Metro-Vick Supplies, Ltd.	Cover iii
Morris, J. R.	430

M. P. A. Wireless, Ltd.	431
Mullard Wireless Service Co., Ltd. Cover ii &	414
Ormond Engineering Co., Ltd.	409
Paronssi, E.	442
Peto-Scott Co., Ltd.	449, 451
P.D.P. Co., Ltd.	449
Pickett's Cabinet Works	451
Philips Lamps, Ltd.	417
P.R. Masts	444
P.R. Valves	439
Radio Exhibition, The	433
Raymond, K.	448
Ready Radio Supply Co.	450
Ripaults, Limited	436
R.I. & Valey, Ltd.	Cover iv
Rothermel Corp., Ltd.	350, 357
Standard Wet Battery Co., The	452
Sifam Electrical Inst. Co., Ltd.	452
Taylor, C.	446
Technological Institute of Gt. Britain	444
Telegraph Condenser Co., Ltd.	441
Transformer Repair Co.	446
Weston Elect. Inst. Co., Ltd.	433
Westinghouse Brake & Saxby Signal Co., Ltd.	410
Whiteley, Boncham & Co., Ltd.	438, 447

All communications concerning advertising in "Wireless Constructor" must be made to John H. Lile, Ltd., 4, Ludgate Circus, London, E.C.4. Telephone: City 7261.

TWO VOLT VALVES OF CHARACTER

Don't engage a Valve without a good character!

Cosmos-Met-Vick Valves are each supplied with a written character that will bear the closest scrutiny. It tells of the Valve's ability to do the work for which it is designed, its conduct (on test) and its qualification for a situation in your set.

You can have the fullest confidence that the characteristic curves of a Cosmos-Met-Vick "Shortpath" Valve are closely in accord with the inherent character of the Valve.

Here are some of the details of the two-volt family:—

S.P. 16/B BLUE SPOT	S.P. 16/G GREEN SPOT	FILAMENT VOLTS 2	S.P. 16/R RED SPOT	S.P. 18/RR DOUBLE RED SPOT
0.09	0.09	FILAMENT CURRENT (amps)	0.09	0.3
35	16	AMPLIFICATION FACTOR	9	6.5
0.5	0.95	SLOPE (M.A. PER VOLT)	0.9	1.4
70,000	17,000	IMPEDANCE (OHMS)	10,000	4,500
10/6	10/6	PRICE	10 6	12 6

The Booklet 4117/3 (M.S. 4667) gives the complete information showing why Cosmos-Met-Vick Valves give HIGH AMPLIFICATION, PURE TONE, NO DISTORTION!

Ask your dealer for a copy.

METRO-VICK SUPPLIES LTD.
(Proprietors: Metropolitan-Vickers Electrical Co. Ltd.)

155, Charing Cross Road,
LONDON, W.C.2.

**COSMOS
SHORTPATH
MET-VICK
VALVES**

Call and see us at
STANDS
32 & 41,
OLYMPIA,
SEPT. 22 to 29.

These NEW components will improve your Radio Reception

Every year brings us nearer PERFECTION in wireless reception. This season the new R.I. and Varley components are such a marked improvement on existing apparatus that they completely eclipse anything that has been achieved in the past.

Behind all these new improvements is the one big factor, QUALITY. Right from beginning to end QUALITY is always kept in the foreground—that's why R.I. and Varley products are so popular to-day among every section of the radio public.

Come and see Stands 56 and 73 at the National Radio Exhibition—you will then be able to judge for yourself the vast strides we have made during the last year.

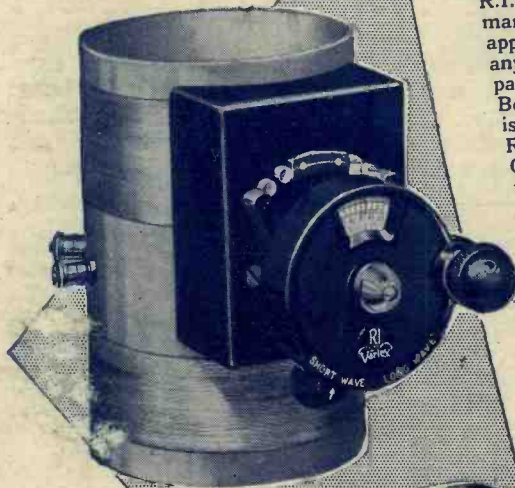

Aperiodic Tuner for both medium and long waves. 25/-

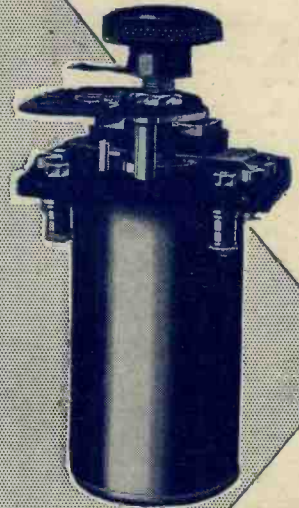

Screened-Grid Reactive Anode Unit for both medium and long waves.



Bi-Duplex L.F. Intervalve Transformer 27/6.



Anti-Mobo Resistance Capacity Coupler
Type Z 25/-
" V 25/-
" X 25/-

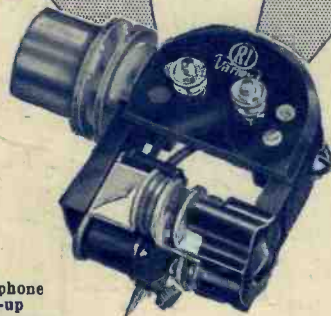

Gramophone Pick-up employing a wonderful new system of suspension £3.3.0

THE MARK OF BETTER RADIO



Kingsway House, 103, Kingsway, London, W.C.2

Telephone: Holborn 5303.