

SPECIAL CHRISTMAS NUMBER

6^D
MONTHLY

Wireless Constructor

EDITED BY
PERCY W. HARRIS M.I.R.E.
VOL. V. DECEMBER No. 14



Presenting
**THE "STRAIGHT
LINE" FOUR**

by *Percy W. Harris*
M.I.R.E.

FOR FULL MEASURE-

THE MULLARD

FULL WAVE



H.T. UNIT

Be sure of these facts when you buy your H.T. Supply Unit—that it is a full wave unit, and that it is made by Mullard. The Mullard Full Wave H.T. Unit makes the most of your mains supply—therefore it is economical.

It is steady. It is silent in action and there is a large output available from four tapings, up to 150 volts—therefore it is efficient.

There are no controls and it requires no attention—therefore it is simple.

Remember — Full Wave for Full Measure—and ask for Mullard.

For A. C. Mains
Price Complete

£7 - 10 - 0

Mullard

MASTER · RADIO

CONTENTS

	Page		Page
The Editor's Chat	89	The Autumn Equinox and Wireless	120
The "Straight Line" Four	91	Happenings at Savoy Hill!	121
Solving the Xmas Gift Problem	100	Amplifier Circuits	125
Providing Your Own Alternative Programme	101	Within the Vacuum	129
In Lighter Vein	105	Helping the Home Constructor	130
The "Wavelet Meter"	107	Chats at the Work Table	133
Cartoon	110	In the Front Line of Research	137
An Amplifier for Your Crystal Set.. . . .	111	A Tapped H.F. Choke	142
Comments from Constructors	115	Simple Formulæ and Rule of Thumb	145
Volts and Valves	117	Notes and Jottings	149
		What's New	150
		Our News Bulletin	156

EDITED BY
PERCY W. HARRIS, M.I.R.E.

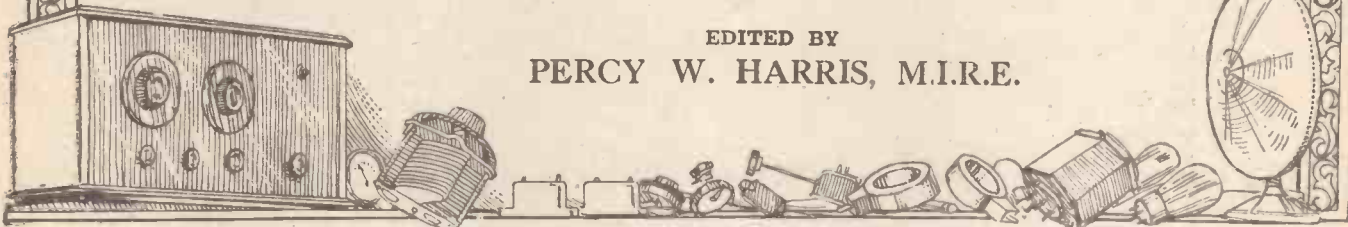

Model A.C.1

Model D.C.1

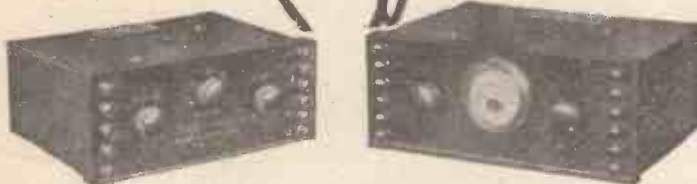

The man who installs a Marconiphone All-Power Unit secures freedom from maintenance worries. His receiver will operate direct from the mains. There will be no accumulator to be charged, no H.T. Batteries to be renewed, H.T. and L.T. are controlled by the turn of a simple switch. Such is the simplicity of a receiver equipped with a Marconiphone All-Power Unit. Economy, too, is another strong point. Running costs are many, many times less than those of an accumulator-battery installation.

ALL-POWER UNIT MODEL A.C.1 for Alternating Current Mains.

For use with receivers employing from 1 to 4 Marconi K.L.1 valves. Provides H.T., L.T. and grid bias. H.T. Current is rectified by Marconi U.5 valve. Output at 100-110 volts, approx. 20 m.a.

Two models are available:

B927 for 100-125 volts. B928 for 200-250 volts.
Price, including U.5 valve and royalty - £9-0-0

ALL-POWER UNIT MODEL D.C.1 for Direct Current Mains.

For use with Marconi 1 amp. valves. Provides all necessary voltages, and provision is made for five values of grid bias. Output at 120 volts, approx. 20 m.a.

Two models are available:

B929 for 100-125 volts. B930 for 200-250 volts.
Price - - - - £6-10-0

Full particulars from your dealer or send for descriptive leaflet.

MARCONIPHONE

ALL-POWER UNITS

THE MARCONIPHONE COMPANY, LIMITED,
AND REDUCED

Head Office: 210-212, Tottenham Court Road, W.1
Registered Office: Marconi House, Strand, W.C.2.

ANOTHER MET-VICK

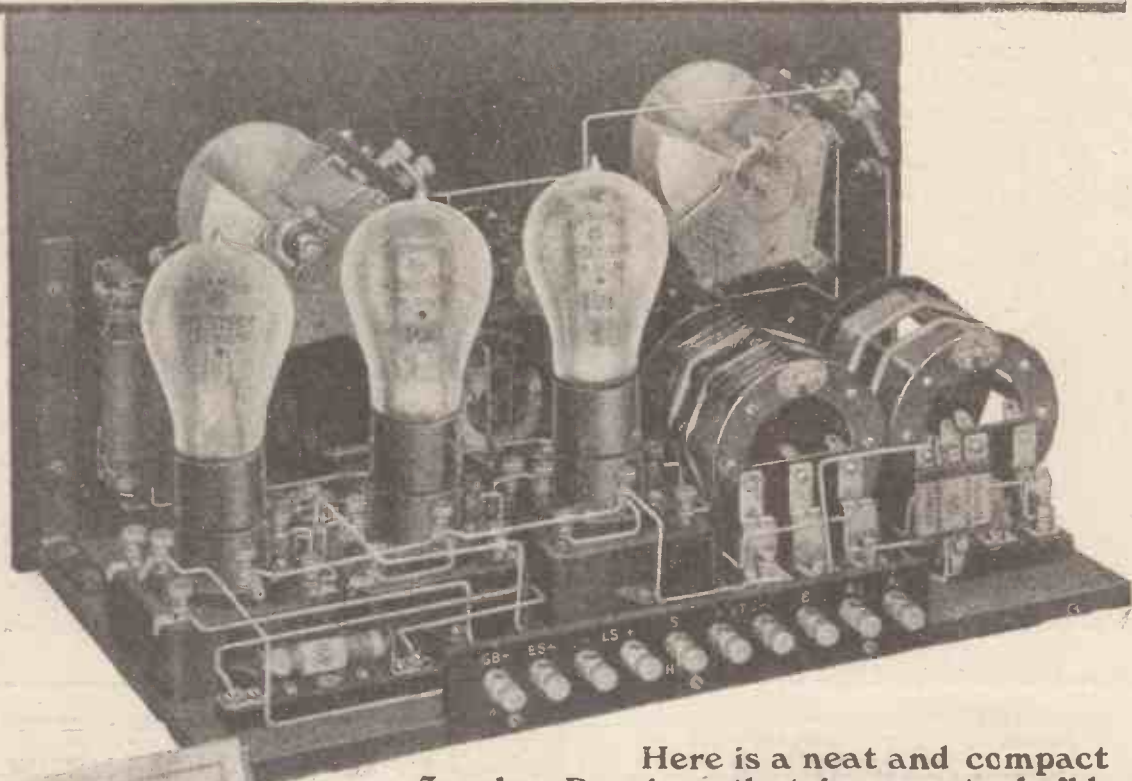

Here is a neat and compact 3-valve Receiver that is easy to build, low in cost, simple to operate, and excellent in performance.

On an average aerial, under good conditions, reliable loud-speaker results are obtained within 50 miles of a main B.B.C. station and 150 miles of either Daventry station.

 Obtain a copy of this Booklet.



METRO-VICK

(Proprietors: Metropolitan
155, Charing Cross

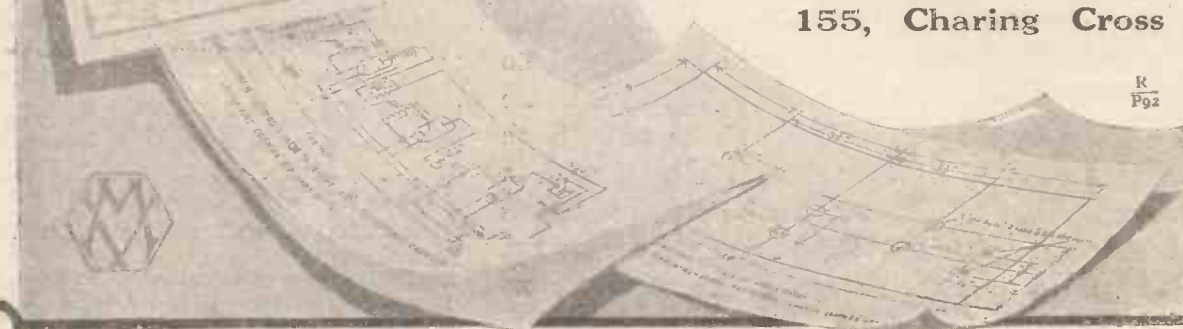

R
Pg2

CONSTRUCTOR SET

COSMOS

(Met-Vick)

3-Valve—Daventry—Local

RESISTANCE CAPACITY COUPLED SET
for home construction

This set is fully illustrated and described in Booklet 7117/3, which contains complete instructions for building a dimensioned drilling template, and wiring diagrams both pictorial and theoretical.

The set embodies the new Met-Vick A.N.P. (Astatic-Non-Parasitic) Coils, which give unusual selectivity in tuning. It also includes the Cosmos Detector Unit and the well known Cosmos Resistance Coupling Units in the Low Frequency stages. The latter components are responsible for the purity of tone and high quality of reproduction obtained with this set. The valves recommended are "Cosmos" Shortpath Valves for 2 volts or 6 volts.

Booklet 7117/2 can also be obtained. This describes similarly a 3-valve set for using the new Cosmos A.C. Valves, and is intended for working off the electric lighting mains.

SUPPLIES LTD.

Vickers Elec. Co., Ltd.)

Road, London. W.C.2

"COSMOS" MET-VICK COMPONENTS USED

2 Variable condensers, slow motion, .0005 each	11/6
1 Minimum reaction condenser, .00002	8d
1 Detector unit, Type "V"	9/0
2 Resis. coupling units, Type "V," each	10/6
1 H.F. choke coil, each	6/6
1 Permacon .001, each	1/8
2 Permacon .0002, each	1/6
1 Resistance	1/6
1 A.N.P. Coil (B.B.C.)	6/6
1 A.N.P. Coil (long wave)	10/6
1 Battery Switch	3/0
1 Filament Rheostat	2/6

'Cosmos' Shortpath Valves

either for 2-volt or 6-volt.

2 Blue Spots, each	10/6
Red Spot	12/6





The Cossor "Melody Maker"

—a stupendous success. Thousands now build this wonderful Set without risk of failure

UP and down the country thousands are building the wonderful Cossor "Melody Maker." Never before has any Wireless Receiver aroused so much enthusiasm. It's a great Set—backed by a great reputation. Into the design of the Cossor "Melody Maker" has gone all the skill and experience gained in the manufacture of the world-famous Cossor Valves. It lives up to its name—it is

a real "Melody Maker". Its tone is superb. It is a Set you'll be proud to own. Its razor-sharp tuning enables you to cut out your local station. Best of all, the wonderful new system of construction enables you to build it in an evening—just like a Meccano. No technical skill—no soldering—failure is impossible. Fill in the coupon and you'll receive the big instruction sheet *free*.

Programmes from six Countries
 Don't be content with programmes from one station only. The Cossor Melody Maker gives you a full range of programmes. Not only most of the B.B.C. Stations, but also Langenberg, Frankfurt, Hamburg Hilversum, Paris, Berlin, Rome, Berne, and Madrid. Easy to build, easy to operate, the Cossor Melody Maker is undoubtedly the Set of the Season.

As easy to build as a Meccano

free

Post the coupon or apply to your Dealer to-day

To A. C. Cossor Ltd., Highbury Grove, London, N.5.
 Please Send me free of cost your constructional system "How to build the Cossor 'Melody Maker'."

Name

Address

W.C. 2.

The WIRELESS CONSTRUCTOR

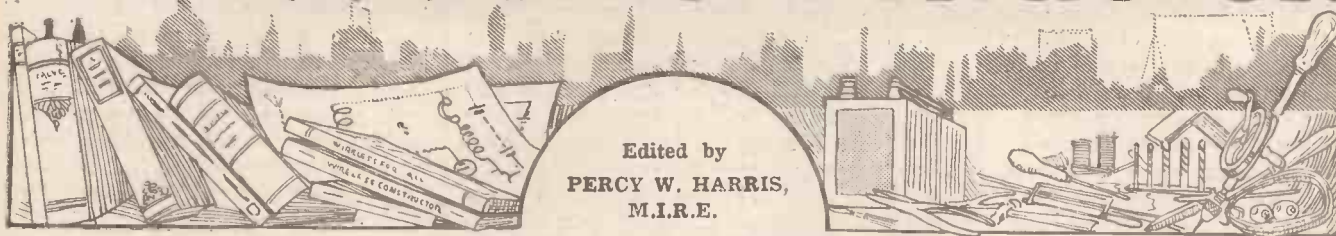

Published by the Amalgamated Press, Fleetway House, Farringdon Street, E.C.4.

THE EDITOR'S CHAT

Percy W. Harris, M.I.R.E., the Editor of the "Wireless Constructor," has something seasonable to say about Christmas radio conditions.

MY letter-bag shows me that many readers of the WIRELESS CONSTRUCTOR are new recruits to the most fascinating of hobbies, and are now approaching their first Christmas in experimental radio.

Most of us, owing to circumstances beyond our control, are compelled to do our listening in the evening hours, and the new experimenter will find, as the year grows older, that reception conditions improve steadily.

Foreign stations which were only just audible, if at all, in August, came in quite loudly in October, while the excellent conditions which prevailed late in the evenings of that month, are now the rule soon after tea.

Natural Conditions

Which all serves to remind us that we cannot ignore natural conditions, which are strangely variable in radio and most fascinating in their inconsistency. It was discovered quite early in the art that so far as the ordinary wave-lengths are concerned, reception conditions are infinitely

better after dark than during daylight and as a rule far better during the winter than in summer.

A knowledge of this fact among broadcast listeners will save a great deal of disappointment, and certainly the difference has not been made sufficiently clear by all who sell ready-made sets.

Variable Reception

The home constructor, who generally passes through a number of phases and tries all kinds of experiments with all kinds of circuits, and who, moreover, likes to know *why* he obtains certain effects, can help a great deal by explaining the differences to those of his friends who prefer to buy ready-made receivers.

While, as pointed out above, conditions are better at night than in daytime, and almost invariably better in winter than in summer, conditions even vary from night to night and from hour to hour. The variation is not noticed in nearby reception, and a set which will give good results on the local station at any distance up to, say, fifty miles, at night, will not

usually give greatly different results during the daytime, while the variations from night to night will not be large. With distant stations, however, conditions are vastly different, and whereas on a good winter night Rome will frequently give loud-speaker results on a set consisting of a detector with reaction and a note magnifier, the most expensive and elaborate super-heterodyne will give not even a whisper from that station until after nightfall.

Short Wave Work

The reception of American stations operating on short waves is now a comparatively simple matter. Hundreds of readers have written to say how easily they have received Schenectady or Pittsburgh on the Radiano Short-wave Set, or the other short-wave receivers described from time to time in this journal, while quite a number have been successful in receiving these two stations on the "Radiano Three," using short-wave coils.

Two or three years ago, before the short-wave stations began to operate; and before, indeed, we were aware

*A Happy
Christmas
to all our
Readers*



The Editor's Chat—continued

of the remarkable distance-penetrating properties of these wave-lengths, the reception of American broadcasting direct on the normal wave-lengths between 300 and 500 metres was by no means unusual. For some reason or other the ether conditions three and four winters ago were exceptionally good for long-distance listening, and the powerful Schenectady station of the General Electric Co., working on a wave-length of about 380 metres, and about a dozen others working on powers of half a kilowatt or so, were "safe bets" if one cared to sit up with any ordinary fairly sensitive receiver till about three o'clock in the morning.

Regular Reception

So regular did this reception of American broadcasting stations become that it was the custom of designers of sets for the wireless journals to test out even single-valve sets on American reception. Within a month or so of the publication of the "All Concert-de-Luxe," I received dozens of letters containing well authenticated cases of the reception of American broadcasting on this set, yet in the last year or two conditions have been so different that very few cases of direct reception have been recorded, notwithstanding the fact that wireless receivers, as a whole, have greatly improved in their distance-getting qualities.

What will conditions for American reception be like this winter? As there seems to be fairly regular cycles of good and bad conditions I shall not be at all surprised if, this season, conditions are good once more. If they are the readers of this journal will have a remarkably good opportunity of receiving America,

particularly on the sets described within the last month or two.

The special four-valve receiver utilising the new screened-grid valves, published for the first time in this issue, is by far the most sensitive set ever described in this journal, greatly exceeding in its efficiency the "Anglo-American Six," which has a long list of direct receptions from America to its credit.

Because of the variability of reception conditions from night to night it is particularly difficult to give a really comprehensive test report of any receiver, and it should be the aim of every designer to produce a set

near the oscillating point, and by skilfully working the set in such a condition a very large number of stations can be recorded.

So long as the reception of distant stations was in itself a novelty, and high quality was not looked for, such lists might appear very attractive, but personally I much prefer to have a set which will give a dozen stations with a quality of reproduction comparable to that of the local, rather than a set capable of receiving three times that number in a more or less distorted fashion.

Free from Distortion

The purity of reception of distant stations made available by the "Straight Line" Four is positively startling and will come as a revelation to even the advanced experimenter. In a phrase, the set must be heard to be believed. If it were possible I should like to give every reader an opportunity of hearing this set, but as this is out of the question I shall be pleased to demonstrate the set in my laboratory by appointment to twenty secretaries of duly constituted wireless societies.

It is not proposed that these representatives should all attend on the same evening, for individual tests are impossible in such conditions, and consequently arrangements will be made for not more than two or three to attend at the same time. As far as practicable the time will be suited to the convenience of the secretaries themselves.

Application for the demonstration should be made by secretaries on their society's printed letter-paper. In order to avoid unnecessary correspondence it must be made perfectly clear that it is impossible to extend this invitation to individual readers.



Captain J. Plugge making adjustments to his anti-vibratory frame aerial fitted to a car during a recent radio communication test held between two travelling cars.

with such a reserve of power that a very large number of stations can be received in average conditions and without the need of recouring to excessive reaction in order to get strength. In any receiver with variable reaction control there is an enormous increase of sensitiveness in the last few degrees of adjustment

"Don't wait—we want to hear the Carols!"



The "Straight Line" Four

A "TWO H.F." SET FOR THE SCREENED GRID VALVES

By Percy W. Harris M.I.R.E.



"By far the most sensitive set ever described in the 'Wireless Constructor' . . . any night the number of stations that can be brought in on the loud speaker seems unlimited . . . a sheer joy to operate."

The above remarks give a slight idea of the amazing sensitivity of this set—the latest thing in radio receivers.

LAST month, when describing the "Three for the New Valves," it was indicated that I had in course of construction a four-valve receiver using two stages of high-frequency with screened-grid valves, a detector and one note-magnifier. That the "Three" is a remarkably good receiver many readers will have already found for themselves. It will be remembered that one of the new screened-grid valves, in a suitable circuit, has a practical magnification equal to that of about two ordinary H.F. valves, and has the further advantage that, provided adequate precautions are taken to prevent external feedback, no neutralising is required. A further very important point is that the H.T. consumption is low.

As soon as I had made a few preliminary experiments with the new type of valve, I pictured in my mind

AN UNBIASED OPINION.
The Editor, "Wireless Constructor."
Sir,—Regarding the demonstration and visit last evening which we enjoyed, I should like to give you our considered opinion :

The "Straight Line" Four is a receiver that is simple in construction and surprisingly efficient. The absence of any reaction makes control easy, although there are three tuning condensers. To tune on one and improve results with the other two is the impression one receives at a demonstration. Quality is all that can be desired, and the power of selectivity is such that one's choice of programmes is so varied that the only difficulty is to decide which to enjoy.

Only an indoor aerial is necessary, as many European stations were brought in with good strength on the loud speaker.

Wishing you continued success,
I remain,

Yours faithfully,
Hon. Sec. W. F. NEAL,
Luton Wireless Society.

what a remarkable receiver could be built with two such stages of high-frequency, a suitable detector and one stage of note magnification. The distance piercing powers of such a receiver, when used with an outside aerial, should be distinctly better than that of a super-heterodyne using a frame, and as the high-frequency amplification is so high, one stage of note magnification should be sufficient to give full loud speaker volume.

No Reaction

It may therefore be of interest to follow out the line of reasoning taken in designing this set, and the various difficulties which had to be overcome. The main idea was to make a receiver with two stages of stable high-frequency, a suitable detector which would not overload, and one stage of resistance magnification so as to obtain the highest quality.

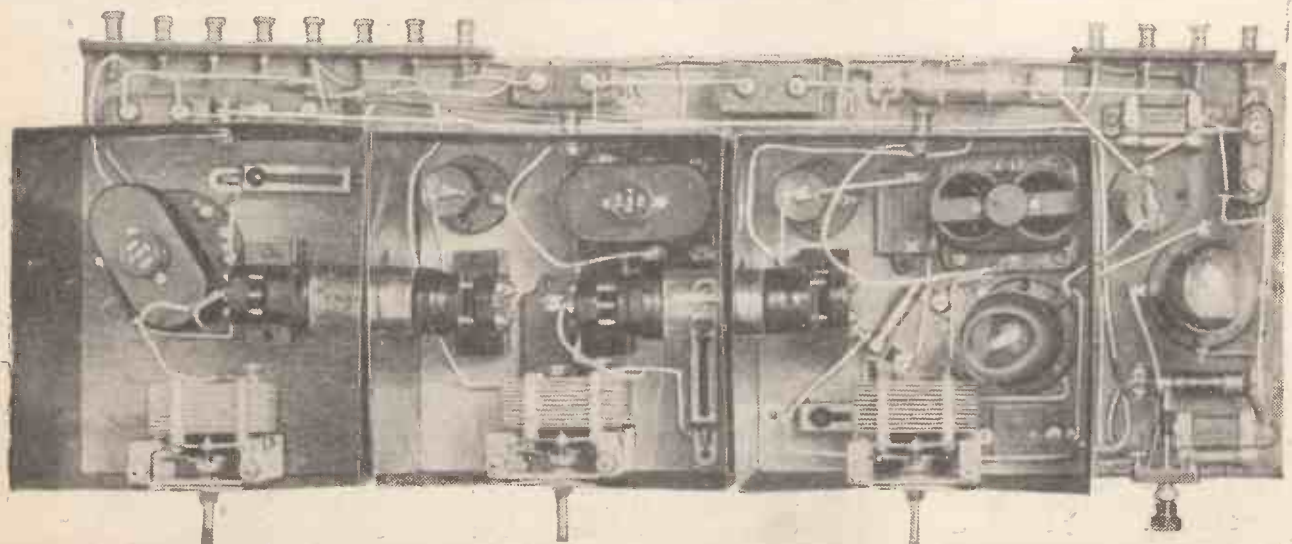

The "Straight Line" Four before its panel was affixed. The screened valves are shown in position in the screening boxes.

The "Straight Line" Four—continued

other hand will handle a strong signal much better than the usual grid leak and condenser method, but is relatively insensitive and moreover needs a very careful adjustment to get the best results. The best plan, when faced with a problem of this kind, is to try out various methods experimentally until the best is found. The method finally adopted had the advantage of requiring no separate battery, no critical adjustment of anode voltage, and works equally well with a wide variety of valves. Provision, however, is made for the experimenter to try other methods.

Design of H.F. Stages

The real problems, as might be expected, centred around the proper design of the radio-frequency stages. Those readers who have handled multi-valve sets using two really efficient stages of high-frequency will know that there are two kinds of feedback against which we have to guard. The first is the feedback in the valve itself—usually overcome by one of the many neutralising schemes—and the second is that due to interaction either between magnetic fields—largely reducible by "fieldless" coils, coil screening or case screening—or to capacity effects between various parts of the circuit, wiring, etc.

Now unless a receiver is designed and built on what be termed "laboratory" lines, with specially constructed high-efficiency coils, careful screening—with the screens not too near the coils—and a most careful selection of valves to suit the coupling methods adopted, it is most difficult to get a high-frequency magnification of more than six per stage. Let us consider for a moment that our incoming signal has a strength of one.

High Magnification

At the output side of the first stage, the signal strength will be six, and there may be some amount of feedback, which, however, is not sufficient to produce oscillation, the only effect being a slight reaction magnification which is sometimes helpful. If there is a second stage, however, the strength of the radio-frequency output will rise to thirty-six. Then a feedback effect which is only sufficient to produce a mild reaction amplification with one stage will be more than sufficient to pro-

duce violent oscillation with complete instability when two stages are used.

In most cases where sets "will not neutralise" the trouble is due, not to lack of neutralisation in the valve itself, but to external feedback not balanced out in any way. Two stages of high-frequency magnification with the ordinary type of valve can be made quite stable by a combination of valve neutralisation and careful

between coils and condensers, the set becomes unmanageable even with two efficient stages of high-frequency magnification. Screening of the separate stages is a distinct advantage, and now that really efficient screening boxes have been made available for the home constructor considerable general improvements will be effected.

Let us now see what happens when

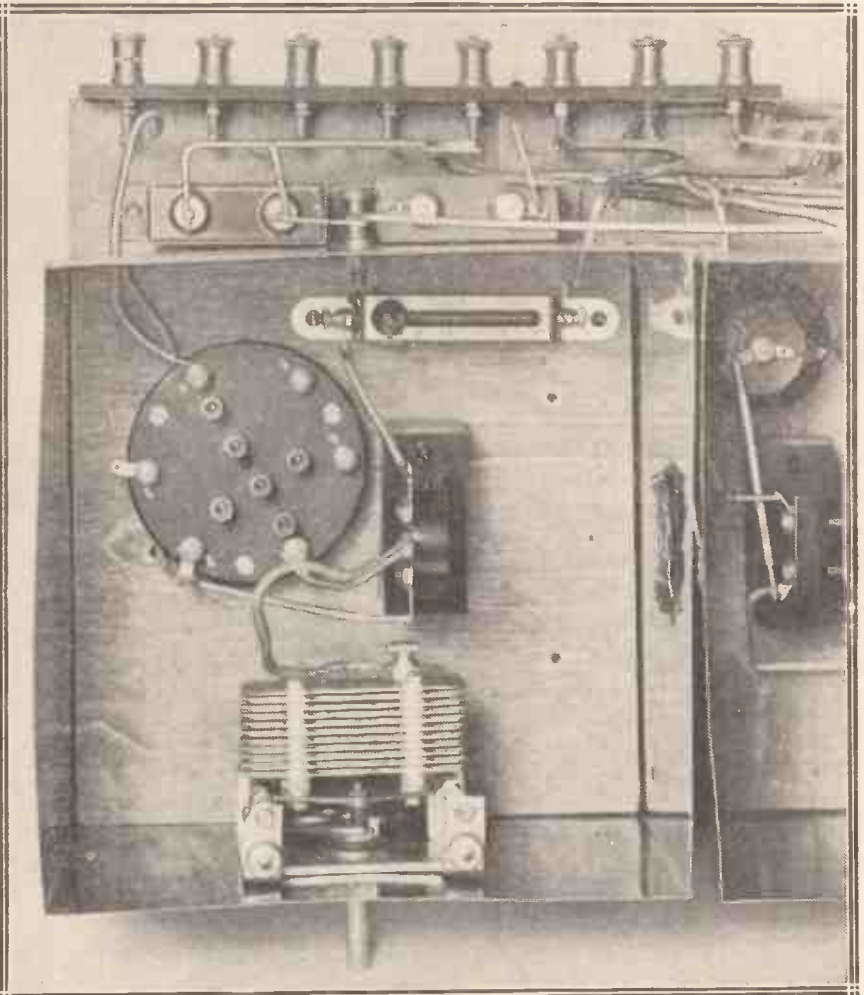

The first H.F. unit, as seen from immediately above it.

arrangement of coils, condensers and other components. A departure from the standard layout of such a receiver may completely upset the whole design, and this has been emphasised many times in these pages.

Let us add a third stage, and the magnification will now rise to 216! We can still neutralise the valve capacity, but unless we embark upon complete screening of the stages, or failing this a very wide separation

using two screened-grid valves, the effective magnification of which in practice can easily be thirty per stage. An initial figure of one becomes thirty after the first stage and 900 after the second! Obviously total screening of stages must be effected and other precautions taken.

In designing sets for readers of the WIRELESS CONSTRUCTOR, the endeavour is always made, firstly, to keep the total cost within a reason-

The "Straight Line" Four—continued

able limit, secondly, to use as far as possible standard components, readily available, and, thirdly, to make the various components as far as possible interchangeable between the good makes. It is most irritating if a design is worked out to be suitable for one particular make of component and no other.

Inter-Lead Coupling

Preliminary experiments showed at once that not only should the coil fields be restricted, but that each stage of high-frequency should be completely screened, including the condensers. The new standard screening boxes designed by Mr. G. P. Kendall are now generally available and after careful test it was found possible to include the whole stage within one of these standard boxes. In achieving this, it has been necessary to confine oneself to only one or two makes of some of the components, owing to variations in size, as the

only alternative would have been to have special screening boxes made much larger, which in turn would increase the total size of the receiver and considerably increase the cost of the cabinet work.

The only disadvantage in using the smaller standard screened boxes is that the home constructor is rather restricted in the choice of his components, but those used are readily available at reasonable prices and where possible a choice is given.

Now, in spite of stage screening, the first experimental set was found to oscillate violently. Wherein lay the trouble? Magnetic and electrostatic feedback between stages had been cut out and the valve, of course, has no effective feedback in itself. An investigation showed that the unwanted coupling effect was being produced by coupling in the H.T. battery, the L.T. battery and the leads going to these. Such coupling was expected, and I should have been



The valve-holder permits the use of screening boxes with holes for the valves instead of slots.

very surprised if it had not occurred, but it was desired to find all these coupling effects first, and then to eliminate them one by one.

The next step was to find some means by which the high-frequency currents could be isolated from the battery and its leads. Captain Round has recommended the tuned-anode circuit for use with the screened-grid valves, and indeed a consideration of the valve itself (see Mr. James's excellent article in the previous issue) shows that tuned-anode coupling is very suitable. To isolate the radio-frequency component from the direct-current component in the circuit, we can place a resistance or radio-frequency choke in the H.T. battery leads, and provide an alternative path for radio-frequency currents. It then occurred to me to try out the "parallel feed" method. In this method the D.C. supply for the high-frequency valve comes through a radio-frequency choke, while the radio-frequency component has an entirely separate path.

Complete Screening

By placing the radio-frequency choke and the radio-frequency portions of the circuit within metal screens the valve itself can carry the inter-stage currents and the leads passing out of the screen or box need no radio-frequency current whatever, or such an infinitesimally small amount as to be negligible even in a receiver such as this. Of course, a really effective radio-frequency choke is necessary, but fortunately there are several good makes available. This then gets rid of our coupling trouble in the H.T. battery.

Both screened-grid valves have their screening grids connected to an

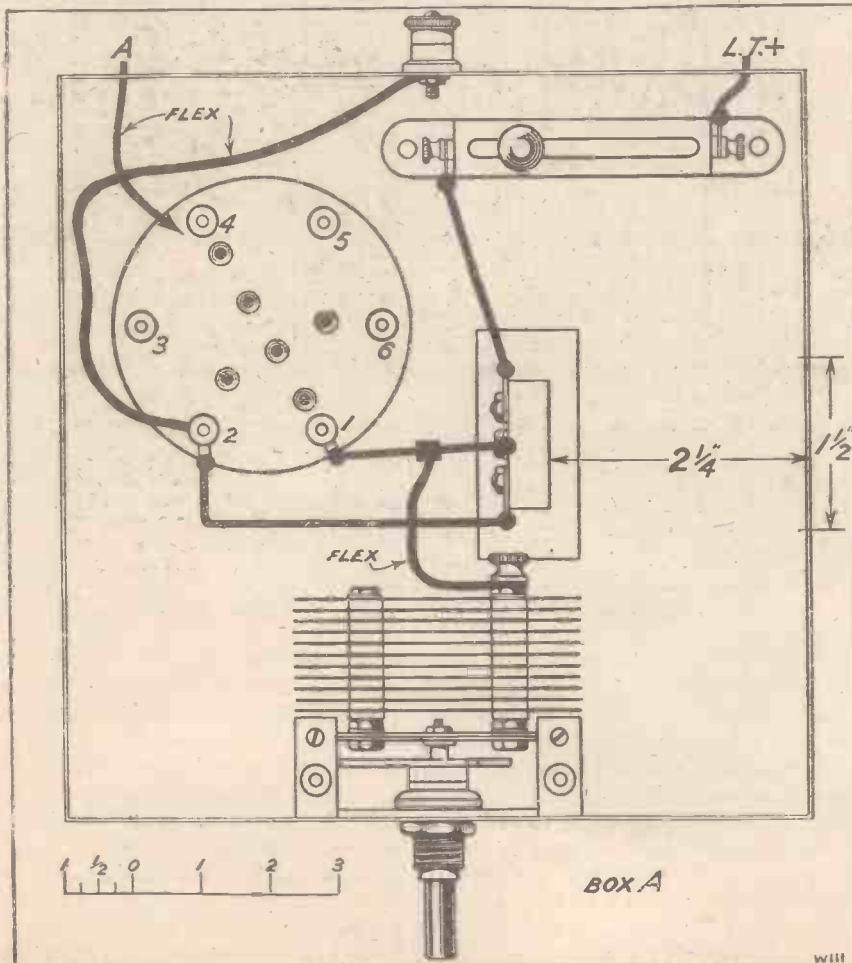

The "Straight Line" Four—continued

80-volt tapping on the H.T. battery, but very little trouble was experienced in this regard and a shunting mans-bridge condenser was found to be sufficient protection here. It should be remembered that this screening grid is kept at a steady potential whereas the plate of the screened-grid

"STATION AFTER STATION."

Sir,—Kindly invited by Mr. Percy W. Harris, I paid a visit to his laboratory to witness a demonstration of the "Straight Line" Four. First, Mr. Harris found station after station all round the dials, and then in the course of less than fifteen minutes we, who were not at all acquainted with the set, obtained eleven stations at full loud speaker strength. What impressed me particularly was the quality of reception accompanied by considerable volume. The circuit is certainly such as the average person can handle with facility. It is certainly selective enough, as Daventry and Radio Paris were easily separated on the long waves, and Hamburg was quite clear of London on the short waves.

Without flattering Mr. Harris, I can say that he has evolved a set which will give many alternative programmes with purity and of good volume, which should be a delight to any listener.

With a little practice twenty or thirty stations could be received with ease at good loud-speaker strength in the course of an evening.

Yours faithfully,

C. H. PIPER,

Hon. Secretary, Thornton Heath Radio Society.

P.S.—Before departing, a change was made to a frame aerial. With the absence of mush, fifteen stations, including Dublin, were received on the set in considerably fewer minutes.

C. H. P.

valve is at a varying high-frequency potential.

Shielded H.T. Wiring

It was next decided that the leads passing out of the screening boxes should be lead covered, the lead coverings being connected to earth and together at various points and, of course, making contact with the screening boxes where they pass through. This in effect prolongs the screening over the leads and is an additional help in safeguarding the set from unwanted pick-up. After all these precautions had been taken it was found necessary to shunt the

L.T. battery terminals with a mans-bridge condenser.

A big difficulty in a receiver such as this is to prevent the radio-frequency component getting into the note-magnifying stage which is quite capable of giving a further "boost" to the radio-frequency potentials and to hand them back to the aerial, thus producing a reaction chain effect. In the detector stage, the isolation of the low frequency from the high was effected by a radio-frequency choke and a .0001-mfd. by-pass condenser to

proved in conjunction with these binocular coils, that the set is quite stable when the screen lids are off, save when a frame aerial is used.

Parallel H.T. Feed

Incidentally, it is a very good test for the stability of a receiver using a considerable amount of radio-frequency magnification that it can be used successfully with a frame aerial. In this particular case the frame aerial can stand on top of the cabinet and not the slightest unwanted interaction effect is noticeable.

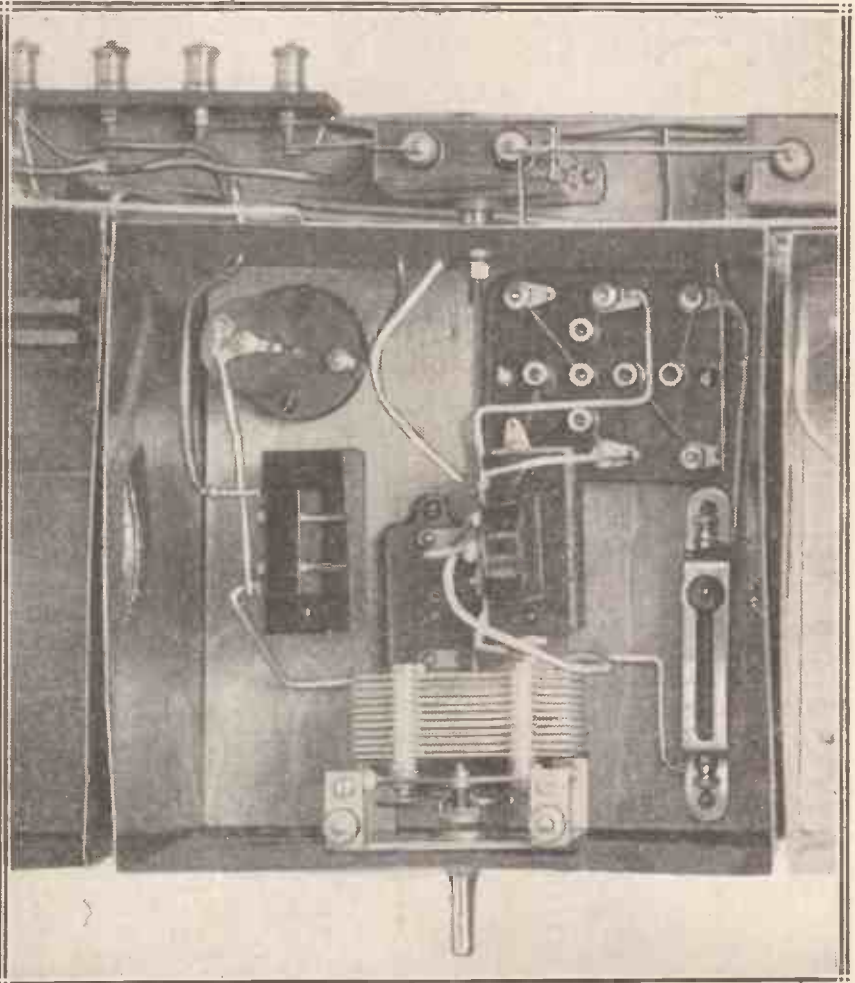

The second high-frequency stage, as seen when looking down into box B.

earth. Binocular coils were chosen for all three circuits, not only as a further safeguard for interaction effects, but because being inside metallic screens and close to them, eddy current losses would be reduced by their adoption.

So effective has the screening

A particular advantage in the parallel feed system is that the moving plates of all three condensers are connected to negative L.T. and to earth. The screened-grid valves themselves are double-ended, having three pins at one end and two at the other. At the three-pin end we have

The "Straight Line" Four—continued

the grid and the two filament pins, while at the other end we have the plate and the screening grid pin. Circular holes are cut in the standard screening boxes, and the valves are so arranged that one part is in one box and one part in the other. Negative L.T. is connected to the screening box.

Components Required

The only leads passing into the

of components. The screening boxes can be of any good make—they are the standard screening boxes designed by Mr. G. P. Kendall and previously described in this journal—and it does not matter whether they are copper or aluminium. Box A will need to have a circular hole $1\frac{1}{2}$ in. in diameter on its right-hand side. The centre of this hole is $3\frac{1}{4}$ in. from either side and 2 in. from the top. If you have no facilities for cutting these holes

If you are cutting your own holes in these boxes, you need not worry if they are rather jagged. Perhaps the simplest way is to scratch a circle 2 in. in diameter in the required position, and drill a number of holes round the scratched line so that the piece of metal drops out. A file will then remove any irregularities. The job is not so difficult as you may think.

The First Stage

In box A we have a standard six-pin base (and as there is plenty of room here, you have a wide choice of bases), a baseboard-mounting adjustable filament resistance (10 ohms is satisfactory), a special holder for the three-pin end of the first high-frequency valve, and a variable condenser .0005 mfd. At the time of writing there is only one holder that fills the bill suitably for this receiver, and that is the Parex, but others will soon be available. This is in two halves, one going in one box and one in the other. The holder for the two-pin end has a demountable piece, which is so arranged that the three-pin end of the valve can be pushed through the hole in the screen into the three-hole socket. When it is in position the demountable end can then be pushed on, making contact with the two pins and with the other half of the base.

Variable Condensers

So far as the variable condensers are concerned, owing to the small space available you have rather a limited choice. The Ripault, which is shown in the set, fits in the space adequately; and another condenser which will suit excellently is the Igranic Patent. Many otherwise excellent variable condensers are too large for this arrangement, but a careful examination of the space available will soon show you whether the condensers you have on hand can be made to fit or not.

Box B contains a radio-frequency choke. Those by R.I.-Varley, Mc-Michael, Lissen, Climax, etc., are all good, in fact, any good radio-frequency choke which will function on both the short and the long wavebands is suitable. You will also find the second half of the first Parex holder and the first half of the second holder, a standard six-pin base, a .001-mfd. fixed condenser, baseboard-

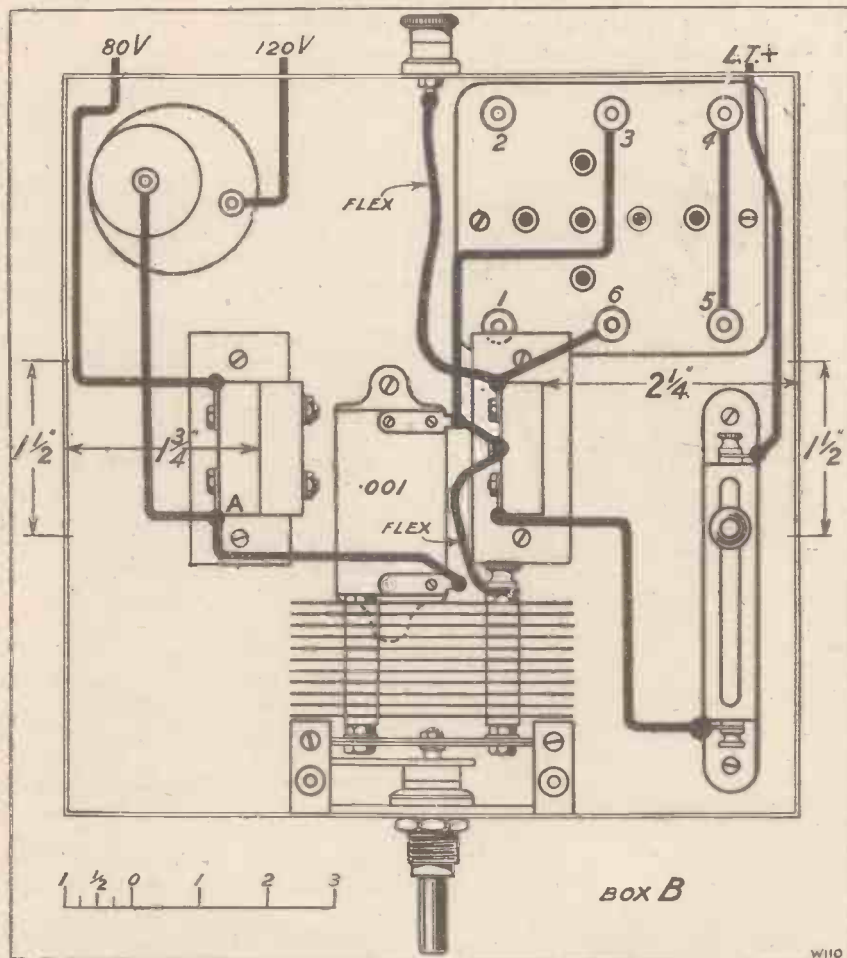

first box (marked box A) are the aerial lead (a flexible wire) and the L.T. positive, which is lead-covered. Box B has three entering leads only, all lead-covered—L.T. positive, 120 volts H.T. and 80 volts H.T. Box C has four lead-covered entering leads, three being as in box B, and the fourth the lead to the plate of the detector valve. It will thus be seen that the radio-frequency parts of the circuit are very effectively isolated.

And now a word about the choice

yourself, the makers will cut them for a very small (if any) additional charge.

Box B will have two such holes, one on each side, the positions being as before, viz., $3\frac{1}{4}$ in. from each side and 2 in. from the top. Box C will have one hole on the left, matching in height the hole on the right-hand side of box B. It is not necessary to cut any other special holes, as the leads which pass into the boxes go through the standard holes already cut.

The "Straight Line" Four—continued

mounting filament resistance, and a variable condenser. You will naturally have all three variable condensers of the same make, so that the same

.0001-mfd. fixed condenser. Again you have a wide choice.

So far as the resistance magnifying stage is concerned, any good makes of

resistance and for the grid leak, but there are several excellent complete R.C. Units which can be substituted for the parts shown without any loss of efficiency, providing one is prepared to accept the values given by the makers.

Binocular Coils

Owing to the small space available it is essential that the binocular coils should be of very small size. Those I have used in this set are the new Lewcos, of which you will require one binocular aerial coil, B.A.C.5, and two split secondary coils, B.S.S.4 or B.T.A.4. For the Daventry range you will require one B.A.C.20 and two B.S.S.15 or B.T.A.15. In addition a 120-volt H.T. battery is required, with tappings round about the 80-volt figure to get an accurate adjustment of the 80-volt potential on the screening grid. A grid bias battery of the type suitable for the note-magnifying valves will also be required. The accumulator should not have a smaller actual capacity than 30 ampere hours.

Constructional Details

The ample supply of photographs with the article will enable you to carry out the constructional work in the easiest possible fashion, but the front panel can be left until last, and the first step should be to cut the 1½-in. holes in the screening boxes in the manner indicated; ⅜-in. holes should then be cut in the middle of the front of each screening box, three and a half inches from the bottom. Through the three holes the condenser spindles have to be passed, the lock nut holding the condensers firmly against the inside of the boxes, at the same time making good electrical contact

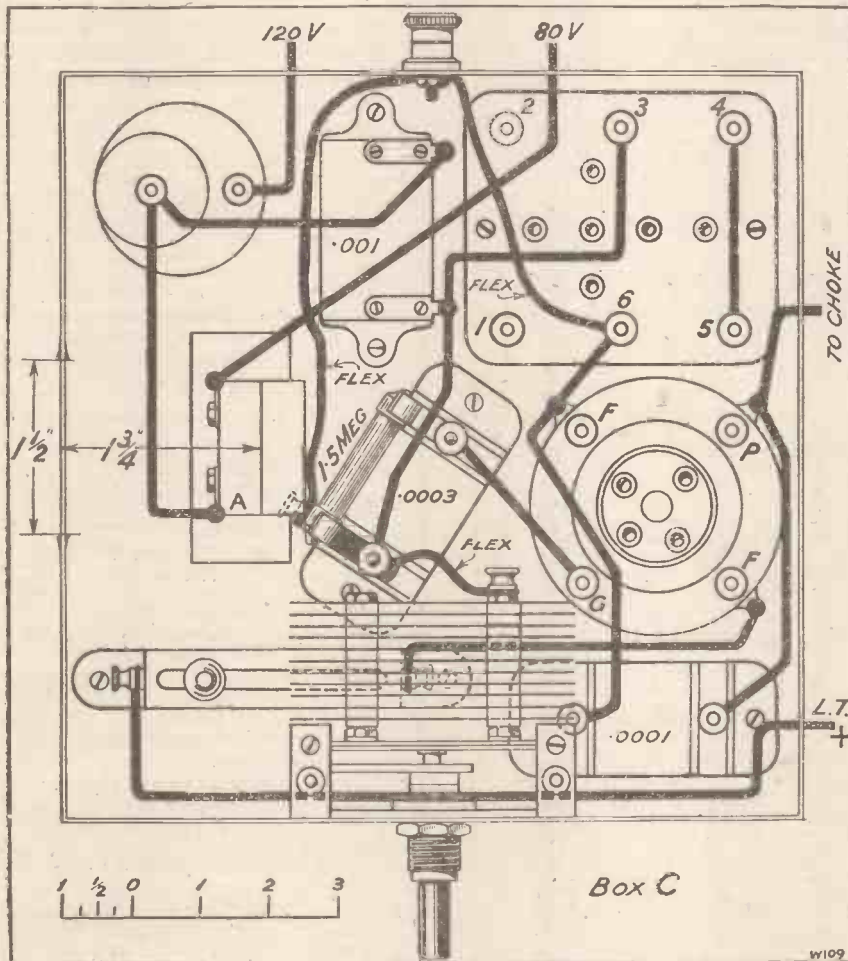

remark about size applies to this as the previous case.

Any good baseboard-mounting 10-ohm filament resistance will do, and any good .001-mfd. fixed condenser. Owing to the restricted space here it is advisable to use a Lewcos six-pin base, as this is square and fits in the space available to a nicety.

The Detector Section

It is just possible, however, to get one or two of the smaller circular bases into this box, but care must be exercised to see that nothing fouls.

Box C contains, in addition to the components already named, an ordinary anti-vibratory valve socket, a .0003 fixed condenser with clips for series arrangement of leak, and a

components can be substituted for those shown here. As many readers will like to experiment in values, I have provided separate clips for anode

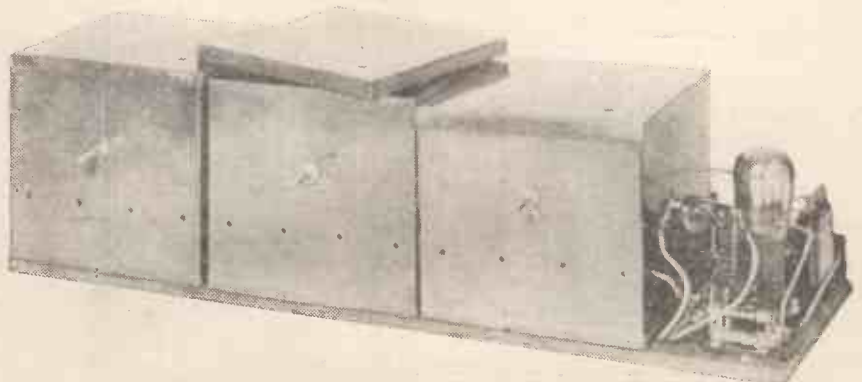

Most of the wiring is enclosed in the screening boxes, and when construction is at the stage shown the panel can be screwed on and the condenser dials fixed.

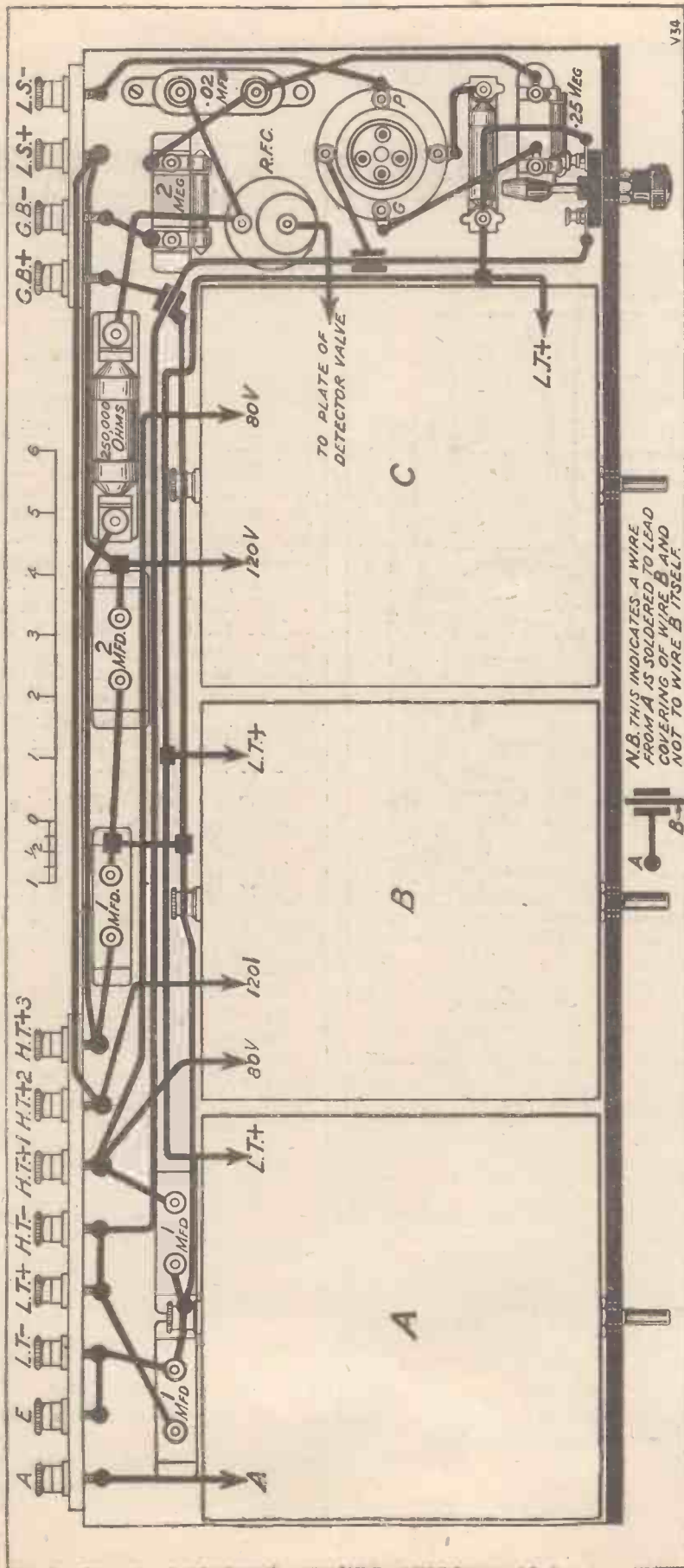

THE "STRAIGHT LINE" FOUR

—continued

with them. You will not, however, insert these condensers yet.

When the holes through the sides of the boxes and the $\frac{3}{8}$ -in. holes in the front of them have been cut, you can mount the components on the three separate baseboards as shown. Of the two electrical connections to the variable condensers, one is automatically made on to the screening box itself, and the other is made to the terminal of the fixed plates. In

REPORT FROM WEMBLEY WIRELESS SOCIETY.

October 19th, 1927.

Dear Mr. Harris,—Many thanks for a very interesting evening; your new set is certainly a great advance. It is a pity the atmospherics were so bad last night.

NOTES ON TESTS.

1. Set on indoor aerial and standard aerial. A good number of foreign stations heard at full strength and excellent quality, but tests rather spoiled by atmospherics.

2. Set working on normal frame aerial. Later in evening, atmospherics not so bad. Stations heard: Langenberg, Frankfurt, Rome, Milan, Toulouse, Lyons, Breslau, Brussels, Ecole Sup., Bruenn, Hamburg and Radio-Madrid. All at good loud-speaker strength and all except the last free from interference.

GENERAL IMPRESSIONS.

1. Quality on local and foreign stations equivalent to good broadcast receiver.

2. No reaction "chirps" or edge distortion.

3. Set easy to handle; free from hand-capacity or other outside effects.

4. Simple in construction and design.

Wishing you every success.

Yours sincerely,

H. E. COMBEN.

H. POTTER.

Wembley Wireless Society.

order that the condenser may be inserted last a flexible lead is used for the connection to the fixed plates.

There is no difficulty in assembling the components of box A. It will be necessary to cut a block of wood to raise the three-pin holder to the correct height. This piece of wood will measure approximately $1\frac{3}{8}$ in. high, but it is best to cut it exactly to size after you have cut the holes in your screens, for these may not be exactly at the height originally intended, and it is easy to cut the pieces of wood to suit.

A flexible lead is taken from the soldering lug connected to the grid

The "Straight Line" Four—continued

pin, and this is finished with a spade terminal so that it can be screwed under the terminal of the fixed plates of the condenser later on.

The Aerial Lead

The aerial lead is made of flexible wire and is threaded through a hole in the first screen box and joined to terminal 3 on the standard six-pin base. Terminals 5 and 6 are left blank, but the others are wired up as shown. A further flexible lead is taken from terminal 2 and finished in a spade tag, so that this later on can be screwed underneath a lock nut passing through the box. This is for making the common negative and earth connection to the box.

As soon as wiring of this baseboard is finished, it should be placed in the first screening box, which can now be screwed down in position. The spindle of the variable condenser is last inserted through the $\frac{3}{8}$ -in. hole in the box from the inside, so as to secure it in position by a lock nut outside. Notice that the position of the screening boxes is such that there is a space a little wider than the lock nut between the box and the front panel which is placed in position later.

There is still one lead to insert into this first box—positive L.T.—and the manner of doing this will be explained later.

Remaining Two Boxes

Boxes B and C are assembled in a similar way. In box C flexible leads are used for a lead from the grid condenser to the fixed plates on the variable condenser, from terminal 6 of the six-pin base and from the insulated terminal of the grid-leak holder. This last flexible wire is joined either to the box or, when desired, to the negative terminal of a single cell, the positive terminal of which is joined to the box. In general practice, however, it will be found quite sufficient to join this flexible lead straight to the box.

Four lead-covered wires enter this box and are inserted later.

The fixing of the components for the resistance amplifier and the various mansbridge condensers will present no difficulty. The only further point requiring special mention is the lead-covered wire.

Obviously we must be very careful in every case to prevent contact between the wire and the lead

covering. To bare the ends of the wire take a sharp knife and make a very light cut round the lead covering at a suitable distance from the end of the wire, say 1 in. You will find the thin lead will cut very easily and it is easy to cut through it without damaging the insulation inside. Once you have made this circular cut, the lead covering will slide off and you will

boxes. Be very careful how you place these lead-covered wires and most carefully guard against contact between the bare wires and the lead covering. When tappings are taken off be very careful they are clear of the lead coverings. When these precautions have been taken, group the lead wires as closely as possible. In many cases you can run the actual

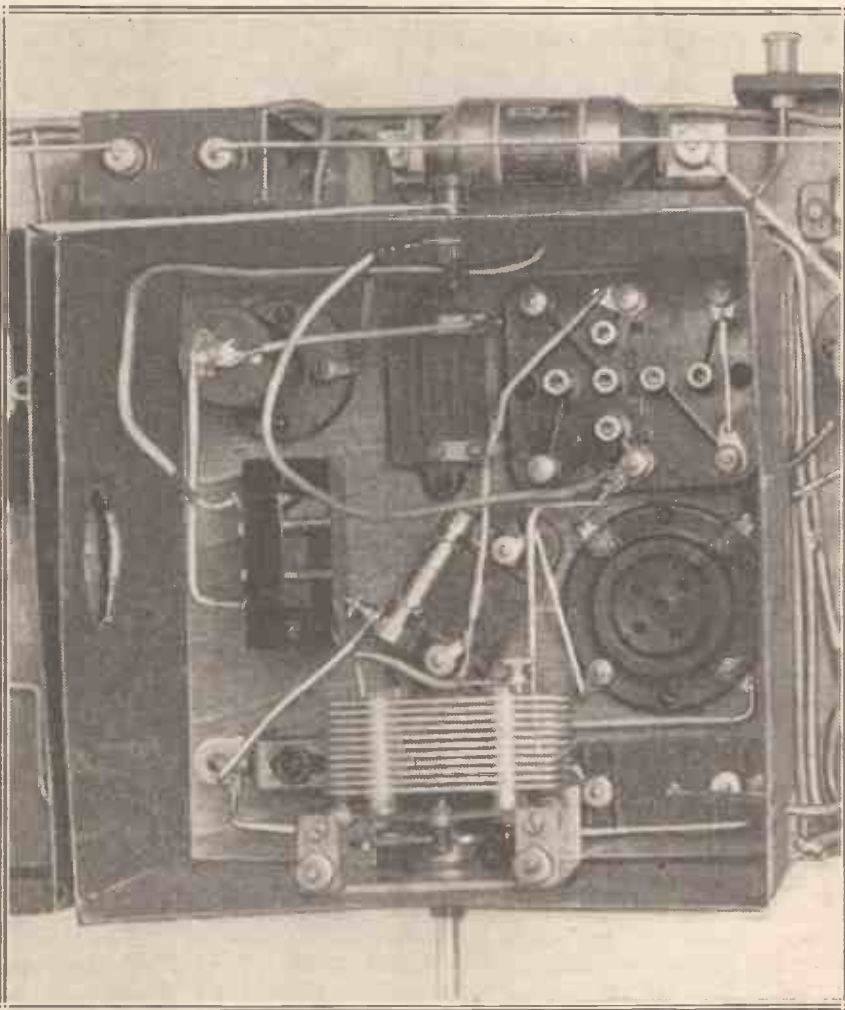

The detector unit. Notice the bunching of the lead-covered wires to the right of the box. The coverings are soldered together every few inches.

then have the insulation of the wire revealed. About half an inch from the end remove this insulation and you will then have a bare wire with no possibility of contact between the wire itself and the lead covering.

Bonding the Lead Casings

The longest lead-covered lead is from the L.T. positive terminal on to the on-and-off switch (mounted on the panel) and from there back to the

coverings in contact. Using a very hot iron and flux carefully solder the casing together here and there. This will serve the double purpose of holding them securely in position and earthing all the casing.

The three terminals of the back of the screened boxes are joined by a wire, and a wire should be taken from any one of these terminals to some suitable point on the lead casing. To

(Continued on page 160.)

SOLVING THE CHRISTMAS GIFT PROBLEM

By a Correspondent.

"I SUPPOSE you are worried to death with the Christmas gift problem, just as we are, Mrs. Brown!" remarked a good lady, dropping in with her husband one evening.

"No!" replied her friend, with a smile. "Thank goodness that problem is over this year. Jack has decided we will give 'wireless' all round."

"But surely that is a very expensive thing to do? Even the simplest wireless set costs a good deal of money, and in any case so many people have sets already!"

At this point Mr. Brown joined in.

"Don't run away with the idea that we have come into a fortune and can afford to give super-heterodynes to every one!" he exclaimed. "Myra and I talked over the matter, and we soon found that by spending no more than we generally do we could solve the problem in ten minutes and give satisfaction and pleasure to everyone. If you would like to see how it works out, I will read you our list."

A Justifiable Purchase

"Do!" exclaimed the visitors, in chorus, "and perhaps it will help us to solve our own problem."

Mr. Brown went to the bureau drawer and produced a neatly-written foolscap list. Filling his pipe and settling down in a chair he started off.

"Item No. 1—a present for ourselves (in fact, the most deserving case we know of), one up-to-date five-valve receiver. This old thing here has done very well for the last four years. The amount of amusement

and interest, and even instruction we have had out of the programmes during that time quite justifies the purchase of a really good receiver. However, you are not interested in what we buy for ourselves.

When Brown Smiled

"Item No. 2—Myra's old nurse. We always give her something every Christmas. She is a dear old dame, and for the life of us we could not think what we could give her this year. She has all the blankets and cushions and other such comforts one usually buys for such people. Then we found out that her great joy in the evenings is her crystal set. As she is getting a little deaf she no longer hears as well as she did, particularly since they have built a big factory nearby and partially screened her aerial. Solution: one sovereign to the local builder, who will put a nice, straight, tall mast at the bottom of her garden so that her aerial can be more than twice the present height. Result: more than double the strength of reception.

Item No. 3, and indeed items Nos. 4, 5, 6 and 7—Nice new high-tension batteries, neatly packed and ticketed. Have you ever known anyone who wouldn't welcome a new high-tension battery even when the present one is not worn out?" he asked, fixing his eyes on the visitors.

The male visitor coughed self-consciously.

"All right, old man, you've got me there," he answered. "You needn't remind me of that time when you came to our rescue by lending us one. Most people put off buying a

new high-tension battery until their reception is horribly distorted."

Brown smiled.

"Then," he went on, looking at the list once more, "I have a collection of young nephews who are all keen home constructors. They are very easily catered for, as a few discreet questions will always find just what they are wanting. If you have any doubts, a pair of variable condensers, one of .0003 mfd. and one of .0005 mfd., is a safe bet."

"That's all very well," said the visitor's wife, "but what about us down-trodden women?"

"Aha!" broke in Mrs. Brown. "You haven't seen my list. Three of my friends are to have special headphones which are supported by the hand and do not disarrange the hair, even in these days of the shingle and bob. But what is wrong with a new high-tension battery as a gift to a girl friend who has a wireless set? True, it may not be so conventional as handkerchiefs, gloves or silk stockings.

Real Pleasure

"There was one person we puzzled about for a long time. George has an aunt who is very well blessed with this world's goods and who has one of the best wireless sets money can buy. Also, she is particularly proud of the Chinese decoration scheme in her drawing-room. Looking through the catalogues the other day we came across a charming little loud speaker in black and gold lacquer, which will fit in admirably. So you see that even here radio was able to answer our difficulty."

"You certainly seem to have solved your own problems, and I think we can follow the same line in several cases," said the visitor. "After all, the radio set is in daily use and it is nice to think that one's gift is giving real pleasure so often."

And so the conversation drifted away to other subjects.



Providing your own ALTERNATIVE PROGRAMME

by
L.H. THOMAS



This interesting contribution follows on the article in our August issue, entitled "Electrify your Gramophone." It explains how music can be obtained from either the gramophone or the local station.

ALTHOUGH there is, and probably always will be, a class of listener to whom the sense of achievement, on tuning in a foreign station, means considerably more than the actual programme received, there are undoubtedly quite a number who have tired of attempting to receive really enjoyable music from abroad, and have been discouraged by the

their "musical library," and now, with the introduction of 5 G B, they have only three programmes, and

They certainly have many consolations, not least among which is the fact that a set of the simplest charac-

COMPONENTS USED.

- 1 ebonite panel, 12 in. × 8 in. × ¼ in.
- 1 baseboard, 9 in. deep, and cabinet of same depth.
- 1 .0005 variable condenser. (Ormond.)
- 2 .1-mfd. mica condensers, large type (Dubilier, T.C.C., etc.)
- 1 250,000-ohm wire-wound resistance (Dubilier, Mullard, etc.)
- 1 100,000-ohm wire-wound resistance (Dubilier, Mullard, etc.)
- 1 .0001-mfd. condenser. (Dubilier, Lissen, Mullard, T.C.C., etc.)
- 2 1-megohm grid-leaks. (Dubilier, Lissen, Mullard, etc.)
- 3 non-microphonic valve-holders. (Benjamin, Bowyer-Lowe, Lotus, etc.)
- 1 baseboard-mounting single-coil holder.
- 1 push-pull switch. (Igranic, etc.)
- 12 terminals.
- Strip of ebonite, 8 in. × 2 in., to take eight terminals.
- Wood-screws, bolts, etc., and tinned copper wire or Junlt for wiring.

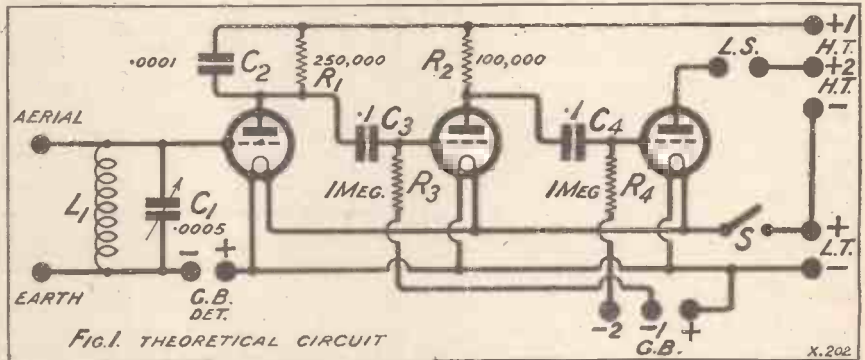

often only two, upon which they can rely, for 5 X X often duplicates the programmes of other main stations.

ter, comprising a detector followed by one or two stages of audio amplification, is all that they need. To them

persistent interference from Morse stations and other sources from searching seriously for DX.

To them the programme received matters more than the distance from which it is coming, and their point of view is perfectly sound and understandable. Their chief grievance up to the present has been that two programmes, at the most, represented

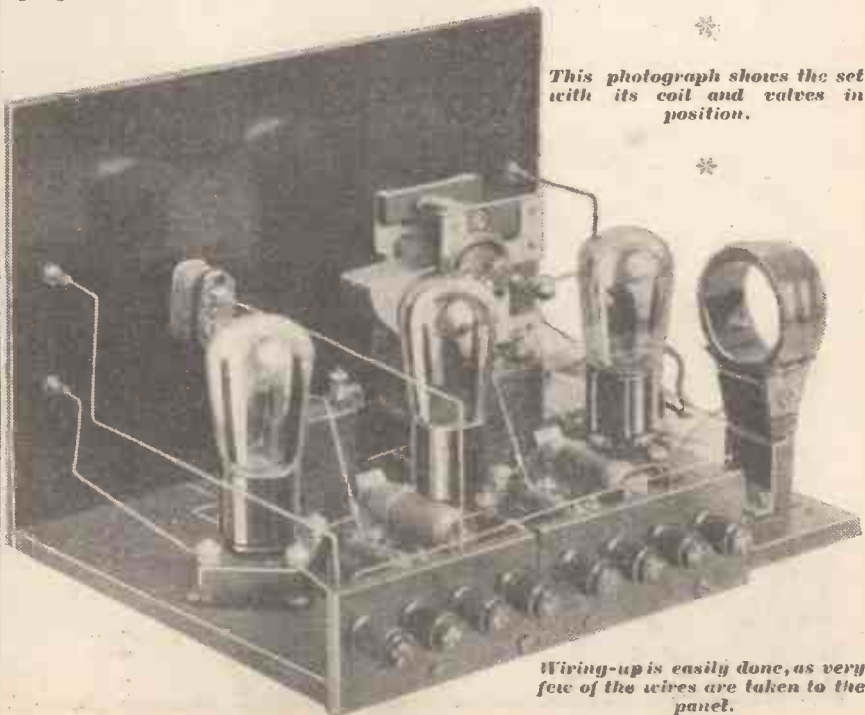

This photograph shows the set with its coil and valves in position.

Wiring-up is easily done, as very few of the wires are taken to the panel.

Providing your own Alternative Programme—continued

the words "neutrodyne," "parasitics," etc., mean nothing whatever.

Generally they are lovers of music, of whatever class it may be, and have "favourite" items which they would like to hear more frequently from the station to which they listen.

It is mainly to meet the needs of this class that the set shown in the accompanying photographs has been built. Its chief characteristic is that music at full loud-speaker strength may be obtained either from the local station or the gramophone, the change over from one to the other being of the simplest character. Distortionless reception is another feature.

Pure Reproduction

With respect to the "gramophone section" of the set, many probably wonder whether there is any real advantage gained by employing a "pick-up" such as is necessary, and an amplifier, simply for the sake of hearing the music emanate from the loud speaker instead of the horn of the gramophone. The answer to this is that there is much more in it than meets the eye. Using the "pick-up" which may be seen in the photograph showing the gramophone, the only part of the gramophone mechanism brought into use is the turntable! The sound-box is removed, the tone-arm and horn out of use.

Thus all the parts of the gramophone likely to cause distortion and bad reproduction have been completely removed. It is, therefore,

quite immaterial how ancient a gramophone is used, and, indeed, the quality of reproduction obtained on the loud speaker, in the writer's opinion, excels that obtainable from

"on-off" switch. Eight terminals at the rear make provision for all the battery connections, except those to the small grid battery used in conjunction with the anode rectifier.

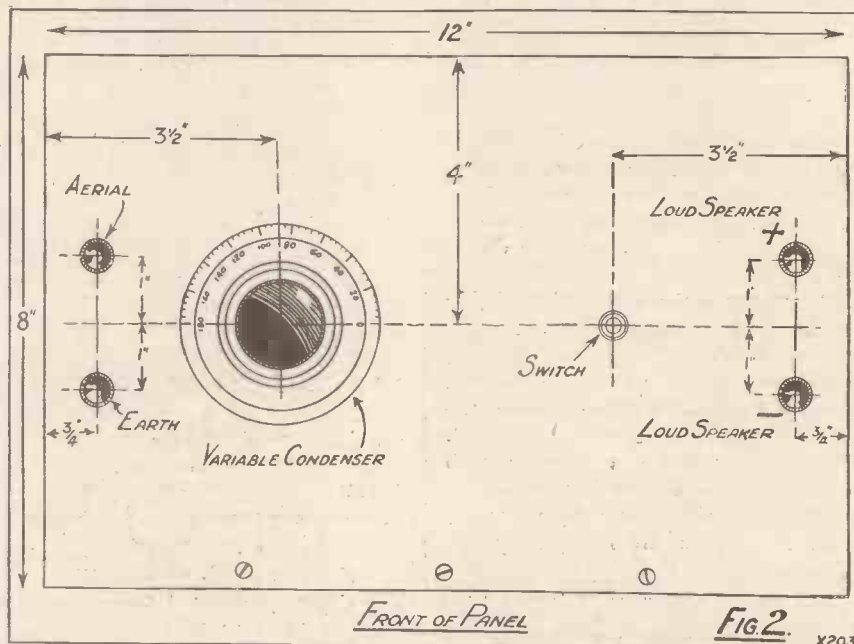

some of the highest priced gramophones available.

The set is extremely compact and quite inexpensive to construct. Although three valves are employed, the size of the panel is only 12 in. by 8 in., and the baseboard 12 in. by 9 ins. The only components mounted on the front of the panel are four terminals, a variable condenser, and an

The circuit, as will be seen from Fig. 1, consists simply of an anode-bend rectifier without reaction, and two resistance-coupled low-frequency amplifiers. It is generally agreed that this is a combination which will give reasonably pure production, and it was accordingly decided upon for use in this set. The aerial and earth are normally applied directly across the grid and filament of the anode rectifier, a No. 50 coil being used as A.T.I. when it is desired to receive 2 L O or 5 G B. When the gramophone is to be used, the only adjustments necessary are the removal of this coil, and the substitution of the flex leads from the pick-up for the aerial and earth leads. An alteration in the biasing of the first valve is also sometimes necessary and condenser C₁ should be placed at the zero position.

Constructional Details

The wiring should be perfectly clear from the photographs and the back-of-panel diagram, but a few hints will probably enable the constructor to economise in time and patience. Since very few connections are made to the components on the panel it is quite a good plan to mount

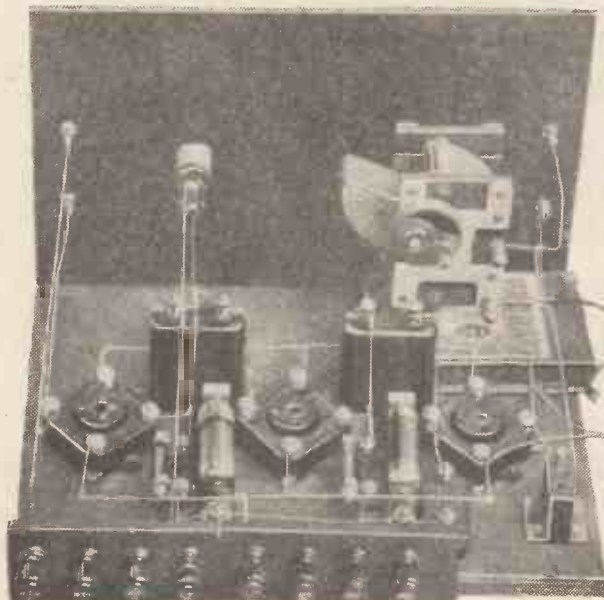

This view should be compared with the wiring diagram during construction. The terminals on the strip are H.T. +2, H.T. +1, H.T. -, L.T. +, L.T. -, G.B. +, G.B. -1, and G.B. -2.

Providing your own Alternative Programme—continued

the baseboard components in their appropriate positions first, and to complete the wiring on the baseboard. This is, of course, rather more easily

use of non-microphonic valve holders in an amplifier of this type is highly advisable.

No filament resistances have been incorporated, since a super-power valve is necessary in the last stage; and as no valve of this type exists in the 3-volt class, it is necessary to use either 2-, 4-, or 6-volt valves, all of which may be run direct from an accumulator of suitable voltage without coming to any harm.

It is as well to conduct the first test of the set on a broadcasting

size of coil depends on the wavelength of the station you wish to receive. For waves from 300 to 450 metres a 30 or 35 will generally suit. Above this to 500 metres a 40 or 50 is needed. For Daventry, about 150 will suit.

Valves and Voltages

Insert two "R.C." valves with high magnification factors in the first two sockets, and a super-power valve in the last socket. Connect up batteries as follows: accumulator of suitable voltage direct across L.T. terminals; negative end of H.T. battery to H.T. — terminal; about 100 volts positive to H.T. + 1, and 120-200 volts to H.T. + 2. Considerably better results will probably be obtained if 200 volts are employed, although it is not essential to use so high a voltage. The grid-bias battery is connected externally, about 1½-3 volts negative being applied to the G.B. — 1 terminal, and a value indicated by the makers, according to the voltage of H.T. used, to the G.B. — 2 terminal.

The other grid battery, which supplies the negative potential to the grid of the anode rectifier, may be slipped between the first valve holder and the panel, and may be clearly seen in this position in some of the photographs. When the set is being used on outside broadcast, as in the present instance, about 1½

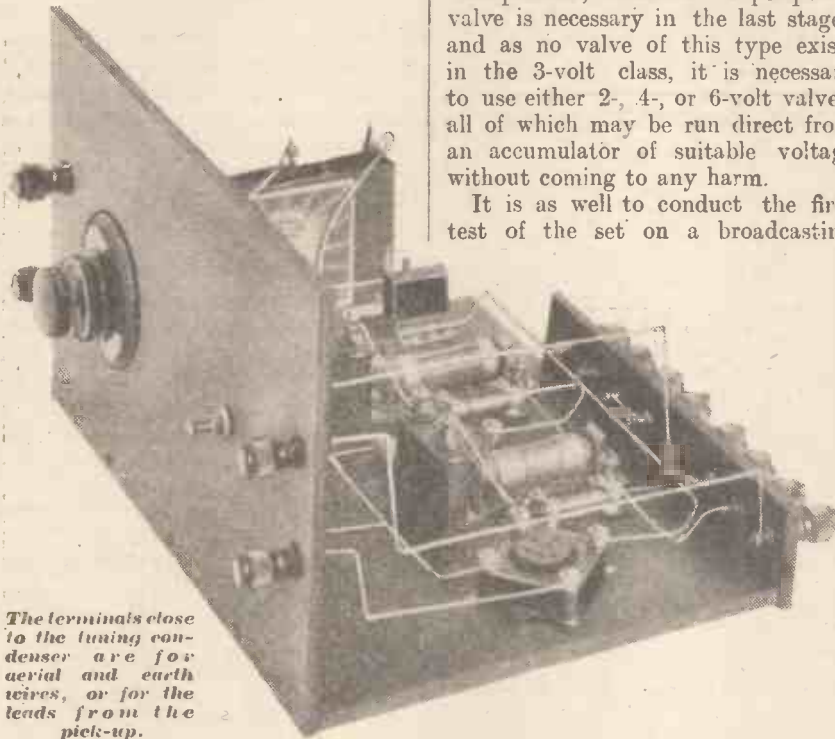

The terminals close to the tuning condenser are for aerial and earth wires, or for the leads from the pick-up.

done before the panel is fixed in position. Most of the leads are very short indeed, but the somewhat longer filament wiring should be completed first of all. The leads from the H.T. terminals may then be tackled, and lastly the grid and anode wiring. The panel components may then be mounted and the panel affixed to the baseboard by three or four screws. Brackets are really unnecessary for a panel of this small size.

Wire-Wound Resistances

It is not, of course, essential to use the actual components employed by the writer, but it is most important that the fixed condensers especially should be of irreproachable quality. The slightest trace of leakage on the part of the grid condensers will impose a positive potential on the grids of the note magnifiers, and ruin the working of the whole amplifier.

The anode resistances should preferably be wire-wound, and if grid leaks of doubtful manufacture or great age are used it is advisable to have them tested to make sure that their resistances are as stated. The

station, so that the following procedure should be followed:

Insert a suitable coil in the socket, and connect the aerial and earth to their allotted terminals. The actual

This view, showing the set with coil and valves removed, will be of great assistance when deciding baseboard layout.

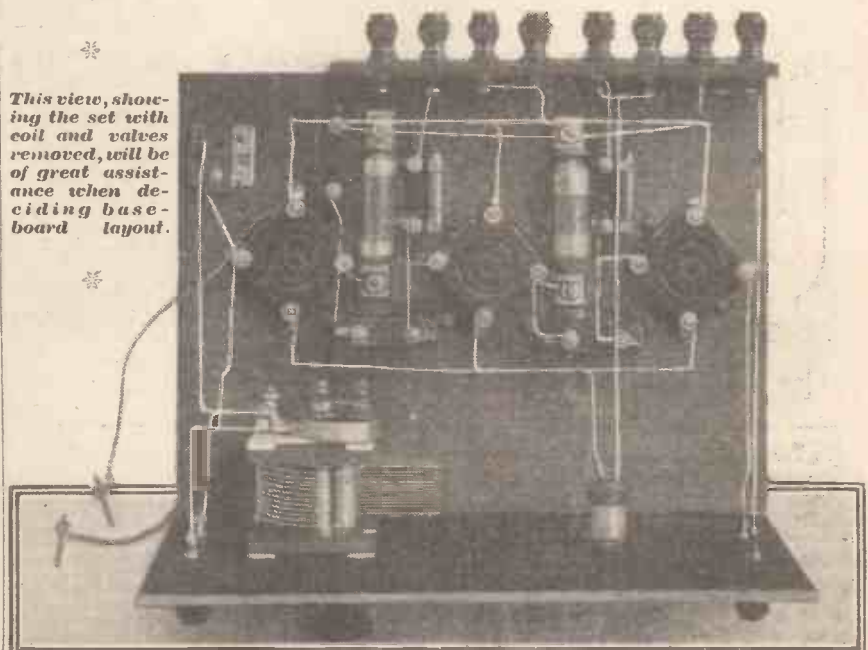

Providing your own Alternative Programme—continued

or 3 volts negative bias will be necessary on this grid.

The loud speaker should now be connected, and, on rotating the condenser C_1 (which is, of course, the only tuning control), the local station should be heard at good strength, if it is within 30 miles or so.

of the last valve, i.e. between the set and the loud speaker. When the local station is being received free of distortion, the needle should be practically steady. If it does "kick" at all, the variation should not be more than about half a milliamp., assuming that the steady current

set is tuned and de-tuned from the local, larger kicks on the milliammeter will be noticed; but this is, of course, quite normal.

With the gramophone in use, as has been previously stated, apart from the removal of the A.T.I. and the connection of the "pick-up" across the aerial and earth terminals, the only adjustment necessary is a slight alteration in the grid bias of the first valve, which is now functioning, of course, not as an anode-bend rectifier, but as a first-stage amplifier.

A Peculiar Effect

Generally speaking, if 3 volts are used when this valve is rectifying, the same value will serve when it is used as an amplifier. A rather peculiar effect, however, sometimes seems to render it necessary to increase the value when it is amplifying to about $4\frac{1}{2}$ volts. In any case, the best value will soon be found, and the adjustment of this grid battery forms a convenient volume control when the gramophone is in use! The setting of the condenser C_1 also has a slight effect.

The writer would emphasise the fact that if any trouble arises from distortion, it may nearly always be cured by careful adjustment of the values of H.T. and grid bias. It should *not* be necessary to vary the values of resistances and condensers, which have been carefully chosen and seem to be correct.

It will be noticed that the first resistance is "by-passed" by a condenser of .0001 capacity. A larger value than this should not be used.

Results Obtained

With regard to actual results, these were found, on test, to be so satisfactory that the writer's normal broadcast receiver has been supplanted by this "alternative programmes" set. 2 L O and the gramophone are "received" at about equal strength, which is quite sufficient to fill the whole house if necessary. 5GB is also received, but not very loudly, owing to the absence of reaction.

From the point of view of quality, 2 L O and the gramophone (with the new electrical records in use) are quite indistinguishable. There appears to be no need for a "needle-scratch filter," since the scratch received is so very slight as to be practically inaudible.

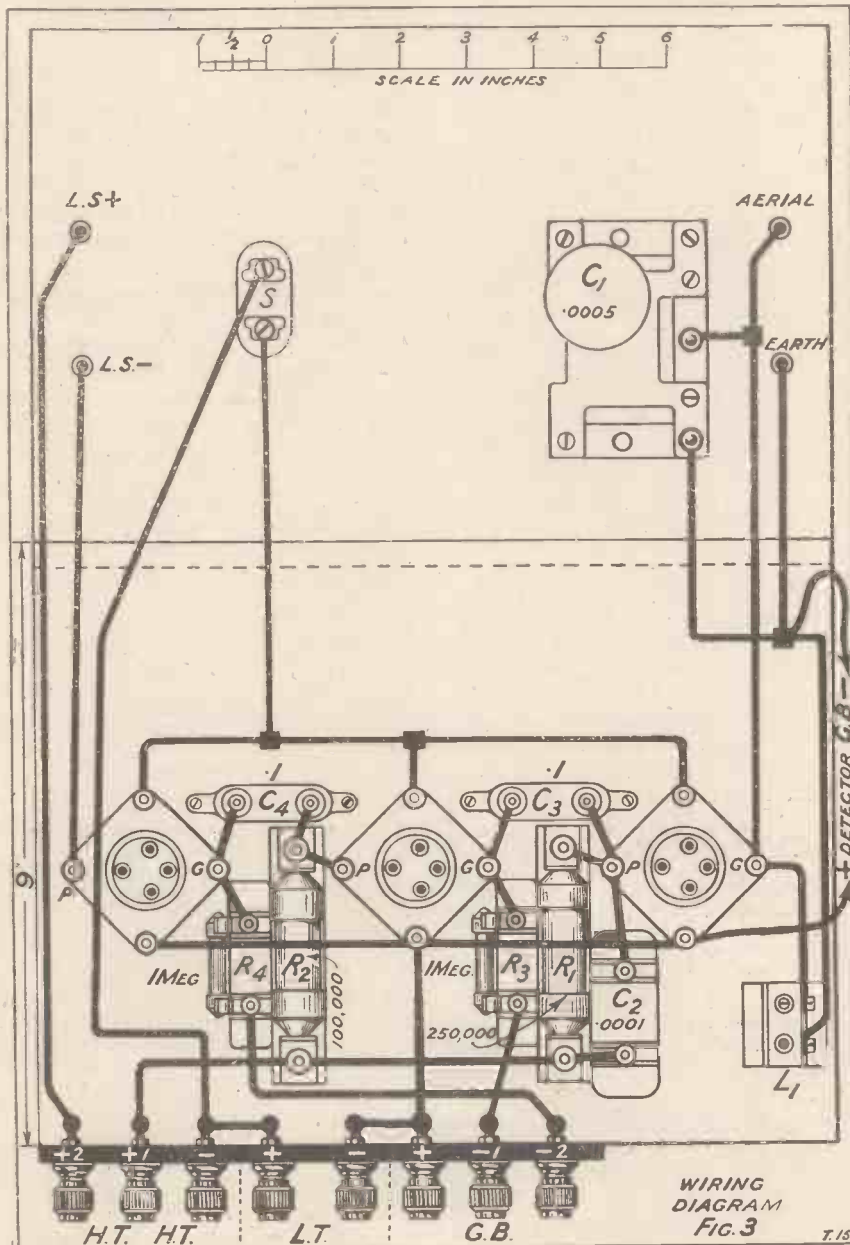

Once the local station has been found, a quarter of an hour or so spent on making small adjustments of the H.T. and grid voltages will soon enable the reader to decide on the correct settings.

It is always a good plan to connect a milliammeter in the anode circuit

is between 10 and 15 milliamps. Any greater "kick" than this will indicate the presence of distortion, but it is a comparatively easy matter to obtain a steady reading by making small adjustments of anode voltage and grid potential. When the condenser is swung round, i.e. as the



MISS WORPLE, Captain Buckett and I all shook our heads sadly in chorus as we stood chatting at the corner of the High Street. Our reason for doing so was that we had just agreed how grievous it was that Professor Goop should have got left in the matter of inventing new valves. So cut up about it was Miss Worple that her head shakings dislodged her hat, which was promptly



"... promptly took him in charge."

trundled off down the pavement by a frolicsome gust of wind.

Like the perfect gentlemen that we are, Captain Buckett and I immediately set off in pursuit of the confection, in the manner of greyhounds after a stuffed hare. I don't mean to say that Captain Buckett's figure is particularly greyhound-like, though my own is, of course, beyond any criticisms, as careful students of the illustrations will no doubt have perceived. In a moment the whole High Street was agog with excitement.

As I dashed past his shop, I heard Mr. Spoooper, who has sporting proclivities, offering to lay six to four on the hat. P.-c. Mugglewump woke up from his trance at the cross-roads and, seeing flying figures, promptly blew his whistle before himself joining in the chase. Primpleson, coming out of a side street, grasped the situation in a moment and joined the pursuers with a will. Tootle, who is rather short-sighted, failed to recognise any of us or to see the hat.

A Case of "Stop Thief."

Hearing the policeman's whistle and the shouting, he imagined that it was a case of stop thief. For this reason he hastily tried to remember his early Rugby education and proceeded

to execute upon the person of Captain Buckett his own version of collaring low. Luckily he missed the sea-dog entirely, alighted upon his ear and shot across the pavement between the legs of P.-c. Mugglewump who, when he had sufficiently recovered from his spill, promptly took him in charge for obstructing the police in the execution of their duty.

Along the pavement raced the dauntless three, the hat ever leading by a short feather. At one moment it was almost within Captain Buckett's grasp. He bent forward to pick it up, got his flying feet all mixed up, and took no further part in the chase. At this stage we were joined by Goshburton-Crump, who panted out the fullest instructions for dealing with wind-blown hats.

Owing to the fact that he was quite fresh he took the lead for a little while. "All that you have got to (gasp) do," he said, "is when (puff) the hat (wheeze) stops (gurgle) to pull up short (gasp) and seize it (puff) with your hand (wheeze)." Just at that moment the hat stopped and Goshburton-Crump, whose head was still turned over his shoulder, fell over it.

Soaring into the air, it continued its way as gaily as ever. By this time we were leaving the town behind us. Far ahead of us, returning from a country walk, we saw the portly figure of Sir K. N. Pepper striding manfully homeward. I waved my arms; Primpleson yelled "Stop it!" I kept on waving. He kept on yelling. Both of us kept on running. The hat kept on spinning. Sir K. N. Pepper kept on neither seeing nor hearing.

At last he observed that something was happening. "Stop it!" yelled Primpleson. I waved my arms more meaningfully than ever. The distance between us lessened. We were a hundred, fifty, twenty-five, ten yards apart, with the hat between us. Sir K. N. Pepper flung himself forward, tripped over something and sat on the hat. Primpleson tripped over Sir

K. N. Pepper and sat on him. I tripped over Primpleson and sat on both.

Perhaps you have seen a stuffed hare when the greyhounds have caught it by some misadventure? If so, you have quite a good idea of what the hat looked like as we bore it back to the sorrowing Miss Worple. Perhaps, too, after breaking your best valve, or when you have snapped the twenty-seventh strand of Litz after successfully baring twenty-six, you have longed for words to express what you really thought about things in general; if so, you really ought to have heard Sir K. N. Pepper's remarks as Primpleson and I picked him up.

The Latest in Hats.

We had just returned the chapeau when Professor Goop arrived upon the scene. When I pointed out tactfully that he was wearing his coat inside-out he answered with a charming smile that he was always going to wear them that way in future, since it made the pockets so much easier to get at.

Fastening the coat, he admitted, was somewhat of a difficulty, but he got over this rather neatly by attaching a piece of No. 18 D.C.C. to the shank of each button. This was passed through the buttonhole and the ends twisted together. It just shows you, does it not, how a great mind can deal with the knottiest of problems.

Taking the wrecked hat from Miss Worple's hands he placed it gently



"... tripped over something and sat on the hat..."

upon her head and stepped back in an ecstasy of admiration. "Allow me to congratulate you, dear lady," he said, "upon the very latest thing in

In Lighter Vein—continued

vagabond hats." Miss Worple surveyed for some moments her reflection in a shop-window. Turning round she rushed to fling her arms about the Professor's neck, but as he ducked rather neatly she fell into a totally unintentional clinch with Primpleson.

Tears of joy streamed down her cheeks. "The smartest, the most original, and the most *chic* hat ever seen in Mudbury Wallow!" she cried. "All the other women will be positively green with envy!" It appears that she was right, for before the week was out all the ladies in Mudbury Wallow were proudly sporting similar head-gear. It was reported that Madame Moggs, the local milliner, had offered Sir K. N. Pepper a princely salary to spend his time in sitting upon hats in her workrooms.

Something Up His Sleeve

But to return to the professor. We told him the reason why we had stood sadly shaking our heads at the corner of the High Street.

"Surely," remarked the rather battered Captain Buckett to the still more battered Tootle, "surely the professor is not going to let himself and the Mudbury Wallow Wireless Club down in the matter of valves."

Professor Goop smiled knowingly. "I should have thought," he said, "that you might have known that I had something up my sleeve."

I had been watching the professor's right sleeve for some minutes, for there appeared to be queer movements beneath its surface that could



"... he stepped back in an ecstasy of admiration..."

hardly be due to the rippling of his muscles. I called his attention to the phenomenon. The professor shook himself. A bat flew out.

"Hibernating, I suppose," said the professor. "Now I come to think of it, I have noticed something queer about that sleeve for the last fortnight. Poor little thing. What a shame to disturb its winter sleep."

"Speaking of valves," continued Professor Goop, "I have been fully

alive to the developments that have been taking place in recent times. A while ago we had valves with two and in some cases three filaments. Then came the valve with two grids. An enterprising Dutchman produced one with three grids. Not to be outdone, one of our own countrymen fitted his special valve with two grids and two plates. I should also mention that yet another type of valve was produced provided with two bulbs for the purpose of reducing microphonic tendencies. You may possibly think that since every part of the valve has been duplicated or triplicated no further complicate—I should say improvement is possible.

"It ought to occur to you that valves will in future develop more along the lines of simplicity indicated by a well-known Continental inventor who, instead of giving one valve two bulbs, has placed two and in some cases three valves within one bulb. With this, however, I do not agree. My own view is that the function of the plate has never yet been properly grasped by Captain Square and other dabblers in valve development."

By this time we were all positively hanging upon the professor's lips.

"You have a surprise in store for us," breathed Miss Worple.

"I have," rebreathed the professor. "If you will accompany me to The Megohms—that, by the way, is the pretty name that I have just given to your late villa, dear lady—you will be able to judge for yourselves whether Professor Goop has been left-or whether he has been right."

The New Valve

We reached the front door.

"One moment," said the professor, "the doorbell is out of order. Allow me." He opened the door, passed into the hall, rang a handbell standing upon the oak chest, and then came out again, closing the door behind him. Next minute the door was opened by the maid, and we passed in. "I wonder," remarked Professor Goop to Primpleson, "whether you would have known what to do if your door bell had broken down?"

In the professor's laboratory, standing upon the table all by itself was what might easily have been mistaken for a jampot, particularly as it sported a label bearing a picture

of luscious fruits and the words "Plum and Apple." It was, however, nothing of the kind. It was an experimental model of the new valve. Bidding us be seated, the professor proceeded to explain just what it was and why. The screened-grid valve was, he told us, admittedly a great advance upon the earlier four-electrode affairs.

Infinite Impedance

In the same way his valve, containing but four electrodes, went far beyond the screened-grid contrivance.

"It is curious," he said, "that Captain Square had the great idea within his grasp, yet just missed it.

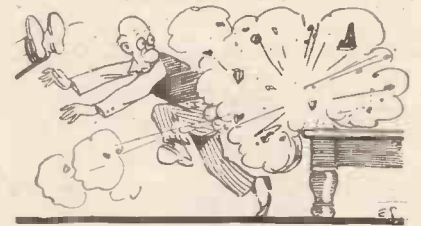

"... earthed the bulb of the new valve which flew into a thousand fragments..."

He himself discovered that as the impedance increased so the magnification increased. He himself pointed out that if the impedance were infinite practically infinite magnification could be obtained.

"But it never seems to have occurred to him to *make* the impedance infinite. That is what I have done in the new Goop screened-plate valve. The theory is perfectly simple. Why is the impedance of the average valve low? Simply because electrons are allowed to reach the plate. Why do high-tension batteries give so much trouble? Simply because they are constantly being called upon to whack up electrons from filament to plate. Very well, then.

"All that we have to do is to introduce between the filament and the plate proper a screen plate, completely covering the first, to which is applied a strong negative potential. What is the result? The plate proper is entirely shielded from the flow of electrons. The impedance is infinite. The magnification is therefore what you like. All wireless problems are, in fact, solved." At this moment, unfortunately, the professor flung out his hand, and quite unintentionally earthed the bulb of the new valve, which flew into a thousand fragments.

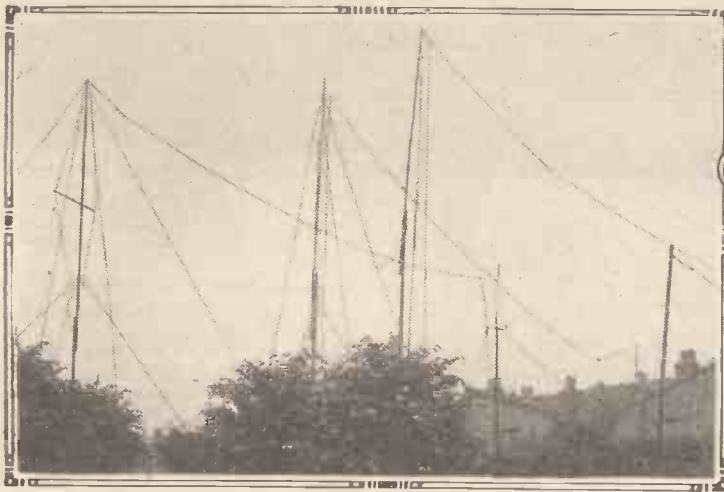

The Wavelet Meter

A simple method of "finding your way about" among the short waves.

By R. W. HALLOWS, M.A.

ONE of the difficulties experienced by beginners at short-wave reception is that when they come to search for transmissions on the prolific band that lies between 20 and 27 metres they have, as a rule, no means of obtaining even the roughest idea of the wave-length to which the set is tuned, until a known

station is picked up and definitely identified. To purchase a wave-meter that will go down to 25 metres, or a little less, is rather an expensive business, for most of these instruments are of the precision type used in laboratories. The average amateur does not need anything of this kind; all that he wants is an instrument that will enable him to know where he is within a metre or so. If one has something of this kind at hand, the business of searching for KDKA, WLW, WIZ, 2XAF, 2XAD, PCJJ, or any of the numerous other stations which broadcast on the short waves, is immensely facilitated.

always knows exactly where one is. Many of my friends, however, who have constructed short-wave sets have not been able to deal with them in the same way, and find matters rather difficult. They used to bring them round to my den, where we would spend interesting, though somewhat laborious, hours in calibrating them from my own apparatus. Sometimes matters were comparatively easy, for it might happen that the grid tuning condenser was of the kind which gave a straight-line graph in either wave-lengths or frequencies; but often we found that the graph was anything but a straight line, so that it had to be most carefully plotted by means of a large number of resonance-points. Not all S.L.W. or S.L.F. condensers produce straight-line graphs when they are used in short-wave circuits. The reason is that the designers of each condenser,

in taking into consideration the stray capacities that must always occur, work as a rule upon the assumption that the instrument will be used mainly for reception upon the broadcast band, that is upon wave-lengths

COMPONENTS REQUIRED.

- Panel, 4½ in. × 7 in. (hard wood).
- Baseboard, 4½ in. × 7 in.
- 1½-in. length of six-flinned coil former (Becl).
- 2 valve pins.
- 2 valve legs.
- 1 piece of ebonite, ¼-in. thick, 2 in. × 1½ in.
- 0003-mfd. variable condenser (Ormond Square Law).
- Slow-motion dial or plain 4-in. dial reading 0-100.

between 200 and 600 metres, or frequencies between 150 and 500 kilocycles. In a short-wave set, specially designed to avoid stray capacities, matters may be very different, with the result that a large portion, at any rate, of the calibration curve of the condenser is no longer a straight line.

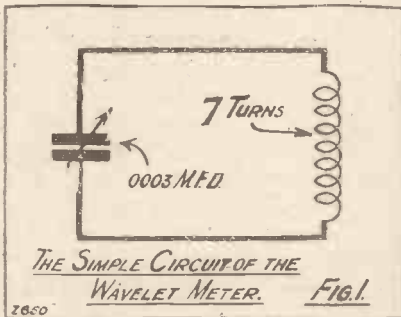

station is picked up and definitely identified. To purchase a wave-meter that will go down to 25 metres, or a little less, is rather an expensive business, for most of these instruments are of the precision type used in laboratories. The average amateur does not need anything of this kind; all that he wants is an instrument that will enable him to know where he is within a metre or so. If one has something of this kind at hand, the business of searching for KDKA, WLW, WIZ, 2XAF, 2XAD, PCJJ, or any of the numerous other stations which broadcast on the short waves, is immensely facilitated.

Calibrating a Receiver

My own short-wave set has been carefully calibrated in both wave-lengths and frequencies, with the help of the transmissions made for the purpose by certain of the short-wave stations; searching with it is, therefore, comparatively easy, since one



Testing the strength of 5 GB by means of a microammeter and a sensitive crystal set.

The "Wavelet Meter"—continued

The difficulty of drawing calibration charts for a variety of receiving sets in this way set me wondering whether a simple form of wave-meter could not be devised whose accuracy would be sufficient to lighten the labours of inexperienced searchers.

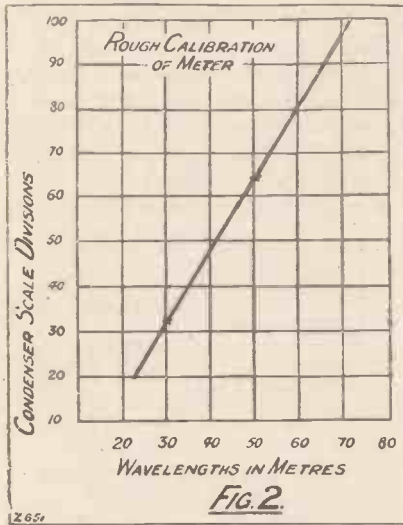

If it could be done, it would obviously be a great boon, for with its help the settings required for any station of known wave-length could be discovered within a division or two of the condenser scale, and searching would thus be immensely simplified. Once such stations had been identified, their settings would form a basis for a precise calibration. After a good deal of experimenting, I evolved a

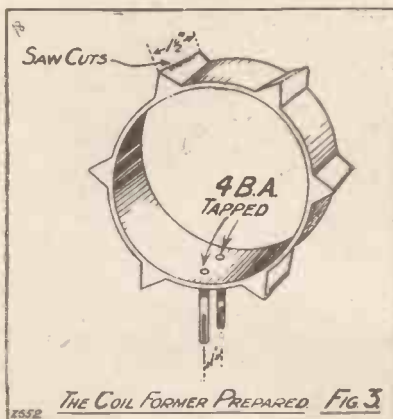

wavemeter so surprisingly simple and so easy and cheap to construct that it seems at first almost too good to be true. For all its lack of complications this little "Wavelet Meter" does its job most effectively, and it has been found of the very greatest

use. Though the circuit (Fig. 1) contains only two components it gives, if properly used, knife-sharp tuning and enables the approximate settings required for any short-wave receiving set to be ascertained with the greatest possible ease.

The "Absorption" Principle

The meter is of what is known as the absorption type. The principle is this. When a tuned circuit is oscillating it radiates a certain amount of energy. If a second circuit, tuned to the same frequency, is placed near the first so that coupling exists between the two inductances, a transfer of energy will take place. Now, for energy to be transferred work must be done. By making the first circuit transfer energy to the second and set up oscillating currents therein, we are causing it to do work. In other words, we make it more difficult for oscillating currents to circulate in the first circuit; the effect is, in fact, almost exactly the same as that produced by introducing resistance into this circuit. If sufficient resistance is introduced into an oscillatory circuit, it stops oscillating. A similar result is produced by bringing close to it a second circuit tuned to the same frequency, so coupled to it that the transfer of energy is considerable. The absorption wavemeter consists of the simplest form of oscillatory circuit, containing only an inductance and a condenser. When the coil of the meter is placed close to the short-wave set, energy is absorbed, and oscillation made to cease as soon as the two circuits are brought into resonance.

Nothing To Go Wrong

Such a meter is exceedingly easy to use, since there is no buzzer to get out of adjustment and no valve to "play up," as even the best of valves must if plate or filament batteries are run down. There is, in fact, absolutely nothing to go wrong, and the instrument requires no attention whatever, except that it must naturally be kept clean and free from dust. The method of using an absorption wavemeter is as follows:

The receiving set is brought into a condition of gentle oscillation and the meter is placed close to it so that coupling exists between its inductance and the grid coil of the set. The dial of

the meter is now turned slowly, whilst the operator listens carefully. At one definite point it will be found that the rustling noises due to oscillation cease. If the set is oscillating strongly there is

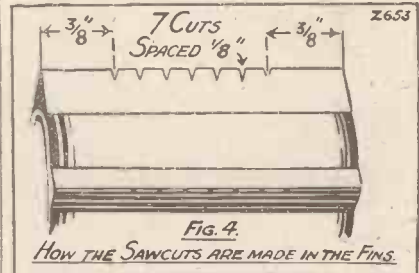

usually a click as the resonance-point is reached. When a telephonic transmission has been tuned in the set should be just below the oscillation-point for the best results. To use the meter when the set is in this condition, turn the condenser of the meter until speech or music fade out.

The "Resonance-Point"

The meter is in resonance with the receiving set when a telephonic signal is rejected. Experiment will show the position in which the meter must be placed so that the tuning is as sharp

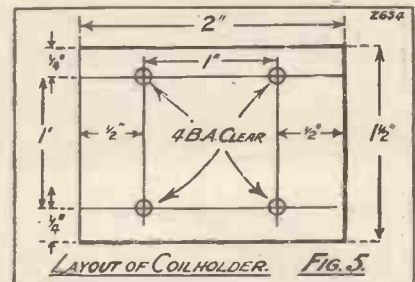

as possible, that is so that a tiny movement of the meter condenser, when it is near the resonance-point, suffices to make the set cease to oscillate or to cause a telephonic transmission to become inaudible. It is clear that if the wavemeter is calibrated the wave-length of the receiving set, as determined by the resonance-point, can be discovered at once.

If the layout of the components is carefully followed, and if the coil is constructed exactly on the prescribed lines, an absorption wavemeter can be constructed whose calibration will give very little trouble. The chart seen in Fig. 3 shows the graph obtained from my own meter, and in copies of the instrument made by

The "Wavelet Meter"—continued

friends the differences are slight. In any case, if the design is carefully followed, the first graph drawn will not be very far out. With its help, KDKA, 2XAF, 2XAD or PCJJ will be found readily. Be careful, by the way, to make sure that you try for particular stations on

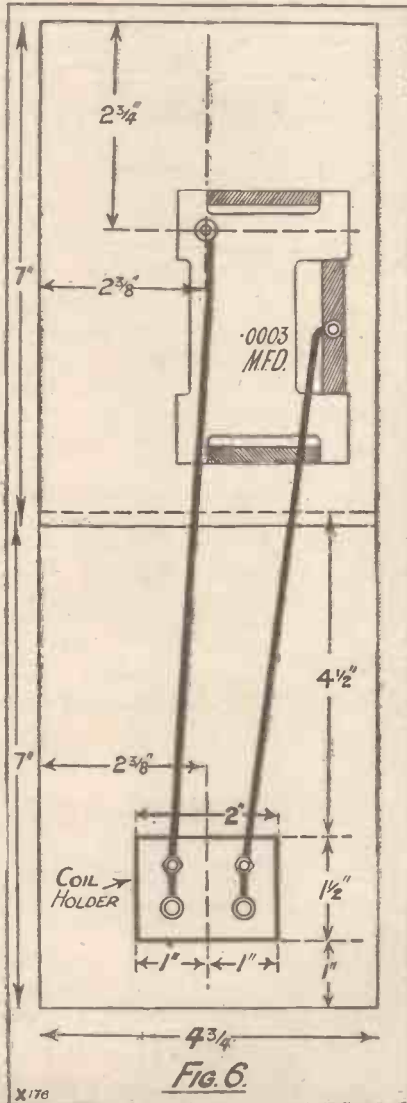

nights when they are transmitting, and any necessary corrections can be made without trouble.

Another exceedingly useful station for calibration purposes is the Eiffel Tower, which transmits in Morse on 32 metres at 7.55 and 8 a.m., and at 7.55, 8, and 10.50 p.m. G.M.T. The 32-metre transmissions from the Eiffel Tower at 8 a.m. and 8 p.m. are the easily recognised International time-signals.

The method of constructing the coil is indicated in Fig. 3. The 1 1/2-in. length of former required may be cut from a standard 3-in. piece, or may be obtained ready cut by ordering specially. A good deal of trouble is saved by ordering the former ready cut from the makers, for many constructors find it rather difficult to make a neat, clean job of cutting mouldings of this kind. In one of the panels between the fins drill and tap two 4 B.A. holes 1 in. apart, as shown in Fig. 3. These are for the valve pins which will serve to mount the coil. Be careful, by the way, before drilling and tapping, to see that the pins are 4 B.A.; many makes are 5 B.A. In each of the fins make seven small cuts 1/8-in. apart in the way indicated in Fig. 4.

An easy way of doing this job is to deal with one fin at a time, marking out with a hard, sharply-pointed pencil or a scribe, and afterwards making the cuts with the edge of a warding file. They need not be more than 1/2-in. deep—just deep enough, that is, to hold the windings firmly in position.

Winding The Coil

The valve pins used should be of the type made with shoulders. With round-nosed pliers make a loop in the bared end of a reel of No. 18 enamelled copper wire, place a washer on one of the valve pins, pass the shank through the loop in the wire, insert it into one of the holes in the former, and screw up tightly. If necessary a clamping nut may be placed on the tapped portion of the valve pin which protrudes into the interior of the coil former.

Now get a friend to hold the reel of wire for you. It should be provided with an axle of some kind, such as a stout pencil or a skewer. The reel holder must keep the wire stretched really tight by holding his thumbs firmly against the flanges of the reel. Wind the wire on carefully, seeing that each turn lies properly in the notches provided for it in the fins. At the end of the seventh turn place your left thumb on the wire at the point where it crosses the last fin, measure off enough to reach the second valve pin, make a loop as before, and clamp down.

Fig. 5 shows how the coil holder is made from the piece of ebonite measuring 2 in. by 1 1/2 in. Four

4 B.A. clearance holes are drilled as shown, valve legs being inserted into one pair and terminals into the other. Each leg is connected to a terminal by means of a short piece of wire. Holes are also required for the fixing screws. To enable the nuts below the valve legs and the terminals to clear the baseboard, either mount the coil holder on small battens or drill recesses in the baseboard in the proper positions. The components may now be mounted upon the baseboard and panel as indicated in Fig. 6;

The Wiring

Be careful that you place the condenser upon the panel and the coil holder upon the baseboard exactly in the positions indicated. Use No. 18 enamelled wire for connecting the condenser to the coil. The instrument seen in the diagrams is not provided with a cabinet, for it is just as well to keep the coils and condensers of short-wave apparatus away from the close neighbourhood of even

(Continued on page 104.)

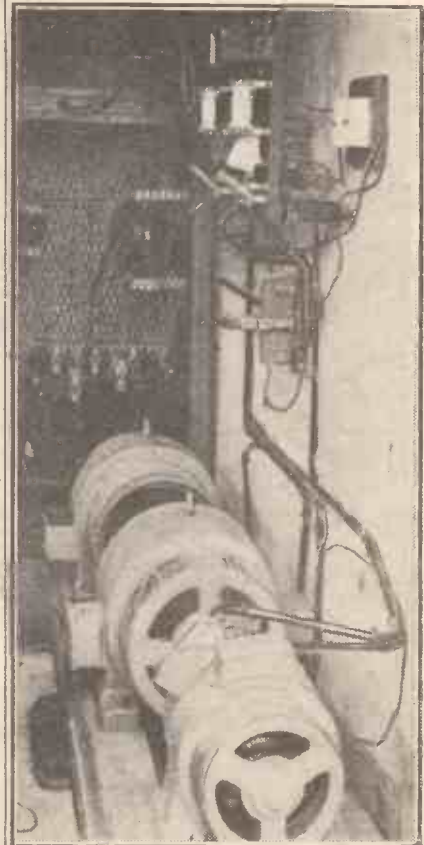

The new generators recently installed by Mr. Gerald Marcuse for his Empire broadcasting experiments from 2 N M, Caterham.

An AMPLIFIER for your CRYSTAL SET

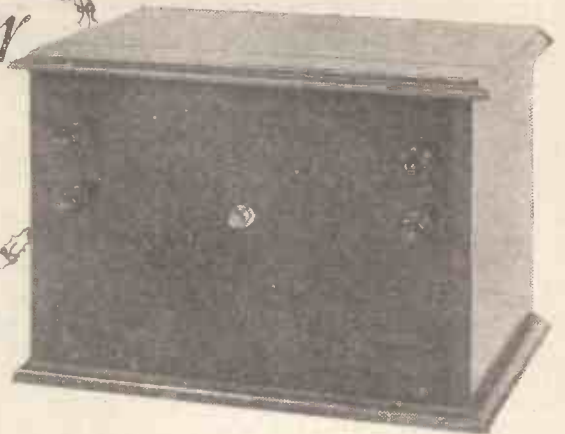

"That is exactly the kind of loud-speaking I have been waiting for!" said a visitor who heard this easily made amplifier in operation. It was designed for use in conjunction with any crystal set.

By HARRY P. WOOTTON.

LIST OF COMPONENTS.

- 1 panel, 10 in. × 7 in. (Ebonart, Pilot, Radion, Resiston, Trelleborg, etc.)
- Baseboard, 7 in. deep.
- Cabinet to take same. (Cameco, Caxton, Pickett, or other good make.) The baseboards are supplied with the cabinets.
- 1 good L.F. transformer. Any of the leading makes will suit, but if you choose a make which has several ratios the highest should be used.
- 2 anti-phonous valve sockets. The new Bowyer-Lowe White Line have been used, but any of the standard makes such as Benjamin, Burndep, Lotus, W.B., etc., are suitable.
- 1 on-and-off switch. (Benjamin, Igranic, L. & P., etc.)
- 4 indicating terminals—Input negative, Input positive, L.S. negative, L.S. positive. (Belling Lee.) Plain terminals can be used, but the indicating terminals match the "Localong."
- 2 baseboard-mounting adjustable resistances. (Igranic, Lissen, etc.) Ten ohms is a suitable value for most valves.
- 1 anode resistance with holder. (Mullard, R.I.-Varley, Dubilier, etc.) If you do not want to buy special R.C. valves have an "H.F." valve, 100,000 ohms. If you are going to use a special R.C. valve the value should be 250,000 to 500,000. The exact value between these figures is not important.
- 1 grid-leak holder. (Lissen Combinator, Dumetohm, etc.)
- 1 grid leak (half a megohm with the 100,000 resistance or two megohms with the higher resistance).
- 1 fixed condenser, .015 or .02 mfd. (Dubilier, Igranic, Lissen, Watmel, etc.)
- Terminal strip measuring 5 in. × 1½ in., with four terminals for L.T.—, L.T.+, H.T.—, and H.T.+.
- 1 grid bias battery. (Unless you intend to use a super-power valve in the last stage, the maximum value of this battery need not exceed 9 volts.)

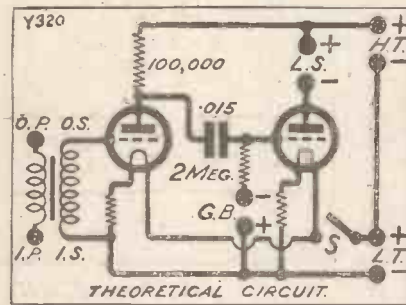

THE quality of loud-speaker reproduction given by a crystal set followed by a good amplifier is unbeaten by any other arrange-

ment. Looking through the columns of the WIRELESS CONSTRUCTOR for last year the writer has found that no description has been given of the type of amplifier which he himself has found particularly useful for a crystal set. Accordingly, the present amplifier has been built as a companion instrument to "The Localong," described in the issue for October, 1927. It is extremely simple to build, many experimenters will already have all of the components available, and even if they have to be bought specially, the total cost of the instrument is extremely low for the pleasure it will give.

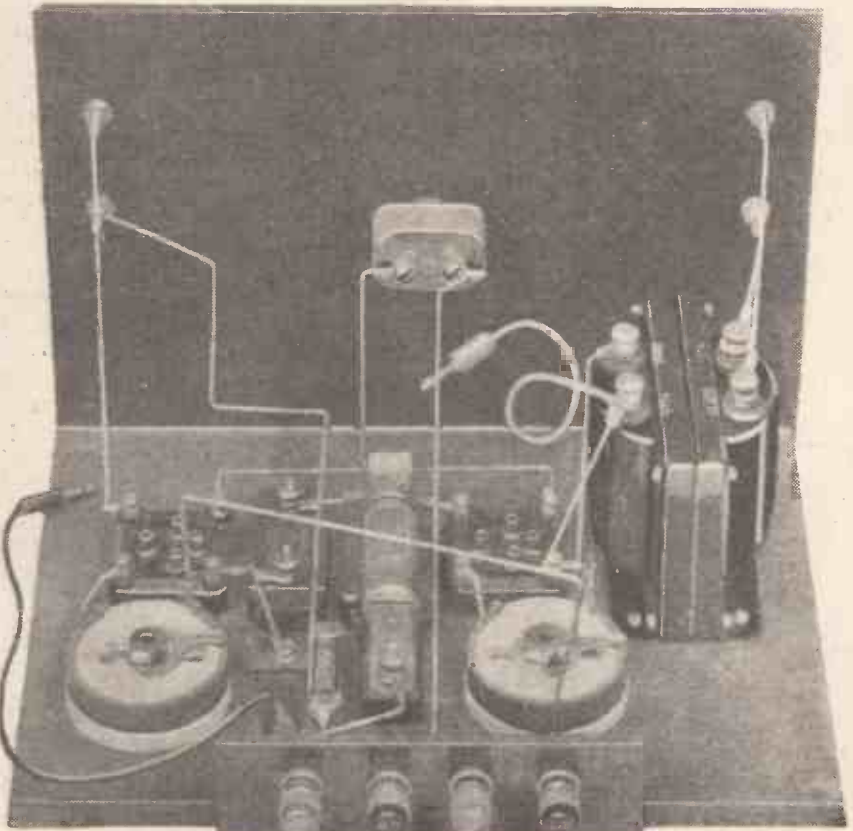

The wiring is quite simple and straightforward, as this photograph shows.

An Amplifier for your Crystal Set—*continued*

Every home should have a receiver available at any time for first quality reproduction of the local station. Provided this station is not more than ten or fifteen miles away—and I am sure the majority of the WIRELESS CONSTRUCTOR readers live within that distance of a station—the amplifier described, together with the “Localong,” will give really first-class reproduction. Indeed, the remark was made by a visitor who heard this combination: “That is exactly the kind of loud-speaking I have been waiting for, but, of course, you have obviously a very expensive set to give such results!”

Concerning Grid Bias

The amplifier itself consists, first of all, of a transformer which is connected direct to the crystal set, the secondary feeding the first note-magnifying valve. This valve is connected to the next by resistance coupling, the values of which are interchangeable to suit the experimenter's taste. As only two valves are required, the H.T. consumption is not above that which can reasonably be taken from

the ordinary size of H.T. battery while the drain on the accumulator is extremely small. In fact, both

here. There is a definite reason for this, as the grid bias required for a valve in the plate circuit of

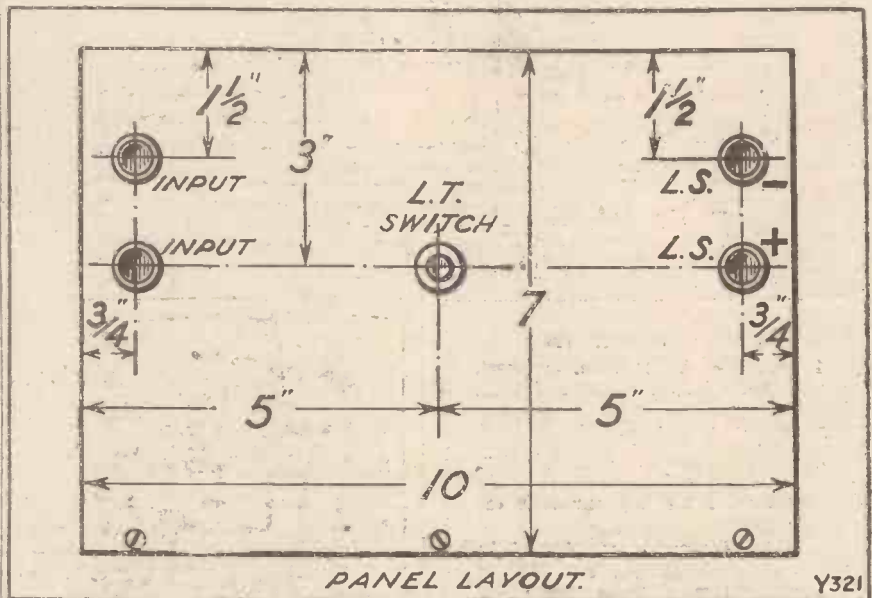

first cost and maintenance are very low. The circuit is shown in the preceding page.

Notice particularly that the I.S. terminal of the transformer is connected direct to low-tension negative and a filament resistance is inserted in the negative leg of the valve. In this way a slight grid bias—equal to the voltage drop in the filament resistance—is put on the first valve, no grid-bias battery or tapping being provided

which a high resistance is placed is very small and in practice only the most experienced ear can notice any difference if I.S. is connected straight to the negative filament terminal of the valve holder.

An Unnecessary Complication

This is particularly the case when a high resistance of 250,000 or 500,000 ohms is used in conjunction with the modern high-magnification valves. The writer has been rather amused by the instructions issued with such valves. Here, for example, is an instance. A certain well-known and excellent valve designed for resistance-capacity coupling is sold with a leaflet in which the grid bias required for 75 volts on the anode is given as 75 volt; for 100 volts, 1 volt; for 125 volts, 1.25 volt; and for 150 volts (which is a voltage very rarely used by experimenters), 1.5 volt. In the accompanying diagram a tapped grid-bias battery is shown.

Now everyone knows that grid-bias batteries are made in 1 1/2-volt tapings, and it is quite impossible with the arrangement shown to get any voltage less than one and a half, which is that indicated for 150-volts H.T. The only way to obtain a fraction of a volt is by a potentiometer arrangement which, in the writer's experience, is entirely unnecessary in such an amplifier.

This back-of-panel view shows the wiring at the output end of the receiver.

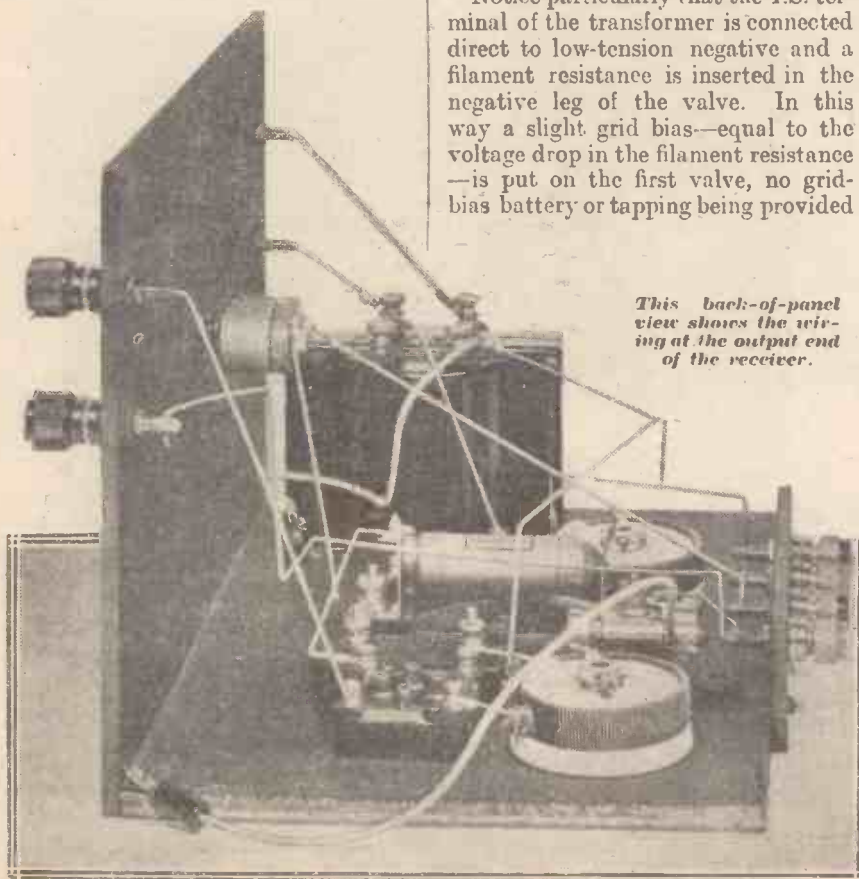

An Amplifier for your Crystal Set—continued

Another maker of another excellent R.C. valve plainly states "Nil" as the grid bias at all values of H.T., while

The first valve can be a standard high-frequency valve if you have one, or, better still, an R.C. valve. Either

2-, 4-, or 6-volt valves can be used but better results are given by the 6-volt type than by the 4-, and better with the 4-volt than with the 2-volt. The second valve can be a power valve of the same filament voltage as the first.

The constructional work is of the simplest. There is plenty of room on the baseboard, and the layout of parts is clearly shown in the photographs and diagrams.

Wiring up has been carried out with Junit wire (self-soldering), which is certainly very easy to use as the wire carries its own solder and joints are most easily made. Two flexible leads are used terminating in wander plugs.

Operating The Amplifier

To operate the set it is only necessary to connect up the batteries, join the input terminals to the output terminals on the crystal set, and the loud speaker to the terminals on the right of the panel. The plugs are inserted in the grid-bias battery according to the instructions given by the maker of the power valve, the positive of this battery being joined to the flex connected to L.T. negative. A 100-volt or 120-volt H.T. battery should be used. It is usually advantageous to join the negative L.T. terminal to earth when using the amplifier with crystal sets.

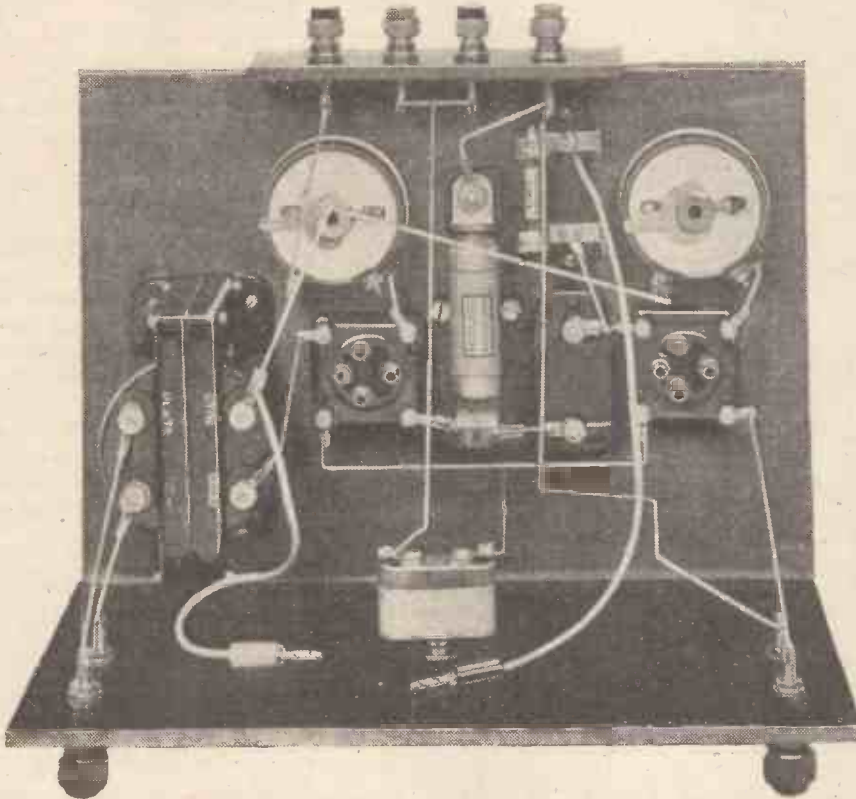

a third ignores the point altogether. While these different valves have slightly different characteristics, practical tests with all of them (2-, 4-, and 6-volt) show that they work perfectly satisfactory and without any noticeable distortion with the arrangement shown, which gives a slight negative bias in all cases.

The Valves To Use

The value of 100,000 ohms anode resistance and half a megohm grid leak shown in the diagram are the values for the reader who has the ordinary high-frequency type of valve and does not desire to purchase a special resistance-capacity valve. If, however, this latter type of valve is used (and the increased amplification obtained is well worth while) the value of the anode resistance should be 250,000 to 500,000 ohms, and the grid leak two megohms. The filament resistance should be set first of all to the full on position, and then pushed back towards the off position as far as possible without weakening or distorting signals.

The spacing of the components on the baseboard will be clear from the photograph above. Note that the grid sockets of the valve holders are facing towards the low-frequency transformer.

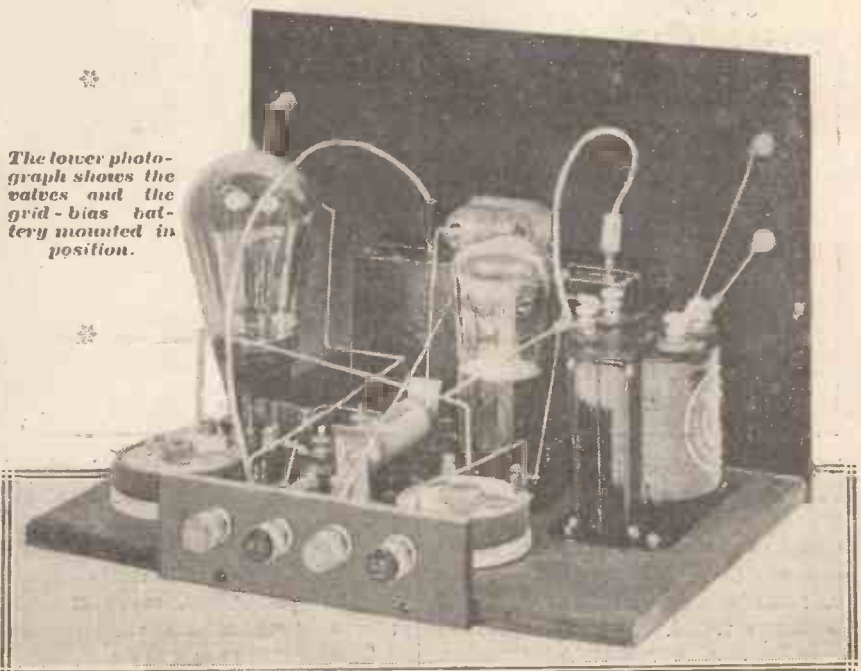

The lower photograph shows the valves and the grid-bias battery mounted in position.

An Amplifier for your Crystal Set—continued

A special point in regard to all amplifiers should be mentioned here. There are two methods of connecting the H.T. negative inside an amplifier. One is to join a H.T. negative to L.T. negative, and the other is to join it to L.T. positive. There are advantages and disadvantages in each scheme. The general rule in the WIRELESS CONSTRUCTOR sets is to

the internal connections of H.T. negative to L.T. positive are made is used with a receiver in which the H.T. negative is connected to L.T. negative and a common accumulator is used for both sets, the accumulator will immediately be shorted. Before using a separate amplifier with any valve receiver make perfectly certain that the H.T. negative connection is the

between H.T. negative and L.T. positive terminals and the wire is taken from this bridge to the on-and-off switch. To change these connections, remove the bridging wire from H.T. negative to L.T. positive, and take a lead from H.T. negative to L.T. negative. The on-and-off switch lead then goes straight to the L.T. positive only.

Using the Same Batteries

If it is desired to use this amplifier with an ordinary single-valve set it is only necessary, after the examination just indicated has been made, to connect the two input terminals of the amplifier to the telephone terminals of the single-valve set. The same accumulator and H.T. battery can be used for both sets. It is often an advantage to try reversing the leads going from the telephone terminals of the valve set to the amplifier.

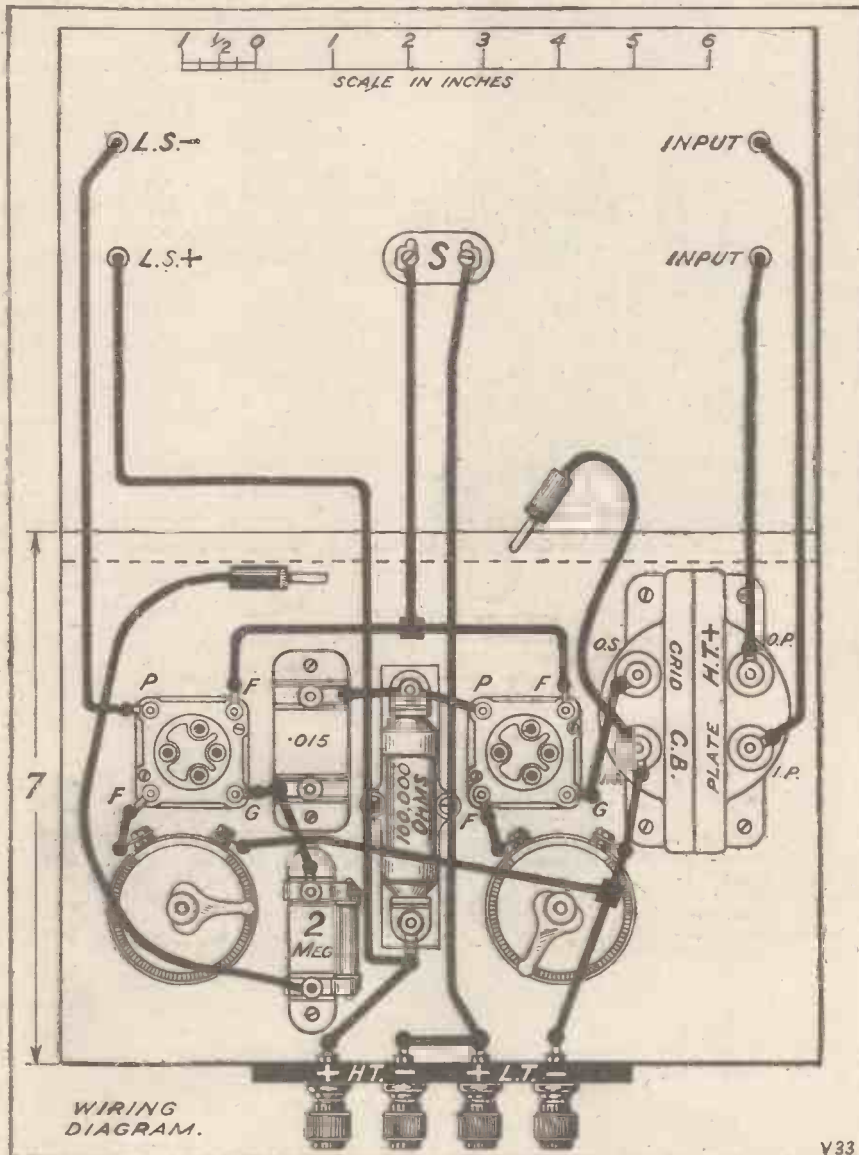

THE "RADIANO" SILENCER

SIR.—Possibly you will be interested to know the results, not to say benefit gained, by the "Radiano" Silencer. (I must say I am a pure novice in wireless.)

Results previous to fixing wave-trap: Daventry, with very bad interference from Birmingham not quite so bad on two valves as three; whilst Birmingham was transmitting I was unable to get anyone else.

Results since fixing wave-trap, and this is whilst Birmingham is transmitting: Manchester, London, Bournemouth, Stoke, Nottingham, and several others, and foreign stations I do not know, and this with no interference from Birmingham whatever.

I used an Ormond vernier condenser and a Tunewell 60 C.T. coil. The coil holder I had to make up.

I live four miles from Birmingham, in the open country, and reception from Birmingham is very powerful, which makes the wave-trap to be even more to be congratulated for its efficiency.

I trust I have not bored you. Thanking you very much for Silencer. Wishing you and your book (WIRELESS CONSTRUCTOR) every success,

I am, sir,
Yours faithfully,
Birmingham. D. CLULOW.

join H.T. negative to L.T. positive. The advantage of this scheme is that the voltage of the L.T. battery is added to that of the H.T., and in the case of a 6-volt accumulator, one gets an additional six volts of H.T., which is always useful.

It is most important to remember, however, that if an amplifier in which

same in both amplifier and set. If the set has H.T. connected to L.T. positive, then it can be used with this amplifier as it stands. If, however, the H.T. negative is joined to the L.T. negative you should make an alteration to the connections in this amplifier.

The alteration is quite simple. At present a small bridging wire goes

COMMENTS FROM CONSTRUCTORS

Some interesting experiences with "The Radiano Three," "The Signal Box," and other well-known WIRELESS CONSTRUCTOR Sets.

"The Radiano Three" Gets Australia

SIR,—I have been experimenting with wireless since the days of the old Writtle concerts and have built a large number of sets, but for power and purity none of the three-valve class have rivalled "The Radiano Three." I would point out that I have made two small changes from the original set, viz., the grid and reaction windings are wound upon a six-pin former, also the aerial condenser is removed from the face of the panel to a position several inches removed, connection to the dial being made by a length of ebonite rod.

I enclose a list of my "catches" so far, which I hope to increase soon, having completed your high-frequency unit of last month's issue. The chief compliment to the set is yet to be told. On short waves the set behaves remarkably well, as my list shows; but recently, together with four friends, I tuned in the new Sydney station, 2 F C, direct.

This transmission we held until the close down at eight o'clock. The strength was about R.8, though it was prone to fading, while at some times it was loud enough to be heard at a distance of six feet from a small "Brown" loud speaker (as 2 L O stopped their relay at 6.57 it is quite evident that we were not upon one of his harmonics of the fundamental).

I think this is one of the greatest tributes I can pay your set.

Wishing you would continue to evolve more of these splendid sets,

I am, yours very truly,

J. R. F.

Middlesex.

List of Stations Received

London	Rome
Daventry 5 X X	Hamburg
Daventry, 5 G B	Prague
Hilversum	Berne
Radio Paris	Barcelona
Motala	Madrid
Langenberg	Aberdeen
Bournemouth	Breslau
Newcastle	Helsingfors
Dublin	Bratisland
Dundee	(Station unknown)

Petit Parisien	Croydon
Leipzig	Le Bourget
Sheffield	Philip's experimen-
Stuttgart	tal, P C J J,
Toulouse	2 X A F, W G Y,
Frankfurt	2 X A D
Berlin	New Sydney Sta-
Brussels	tion, 2 F C

Also many amateurs from the Continent and the British Isles.

Radiano Results

SIR,—It is with pleasure I enclose report of your "Radiano Three."

The set is all you claim for it. Stations come in great from all parts. I have not taken much special point, but up to the present (after 10 days' use) I have logged 28 different stations, all at good L.S. strength,

Sydney Direct on "Wireless Constructor" Set

SIR,—I am pleased to write to you of my results I have had on the short-wave receiver you published in the August number of the WIRELESS CONSTRUCTOR, 1926.

Although I have not used components you advised, I have got wonderful results. I finished building it one Saturday and tried it Sunday morning. At 12.30 I picked up W G Y on 38 metres on loud speaker. I then added another valve, and at times it was too loud (the weather was good but I was troubled with fading).

Later, when the B.B.C. was relaying Sydney, Australia, I put on my short-wave set and put dial to W G Y reading, and with a slight touch of dial I heard a man announce



A loud speaker of unconventional appearance. The magnets are hidden in the base and the open mouth of the lion acts as the trumpet.

and numerous others on the 'phones; at present we are listening to Leipzig at good strength. I had to build the Radiano Silencer, as I could not cut out the local station seven miles away, but now all is O.K. I don't know 2 Z Y is working except by tuning same; it never troubles. Wishing the CONSTRUCTOR every success. Yours sincerely,

H. W. WHEELDEN.

P.S.—My aerial is a 40-foot L-type, 20 ft. high, so you see how I am placed.

Lancashire.

2 F C, Sydney, Australia! We could all hear in the room and I could hardly believe my ears. I think it was loud enough to relay. The detector short-wave set cost me £2 5s. Od., and it has not got a high-frequency choke. I wound a coil of about 700-800 turns, and laid it on baseboard.

The valve I used was a "Cosmos."

I used loud speaker because my 'phones are broken.

My aerial is a twin 50 ft. and 45 ft. high. Yours truly,

W. C. THORNEYCROFT.

Staffordshire.

Comments From Constructors—continued

“Signal Box” Results

SIR,—In your May issue you gave the circuit for the “Signal Box” Receiver, which you claimed to be the equal of five valves, although only a three-valve machine.

I built this as per instructions, with the exception of one or two minor alterations, and after being in constant daily use from 6 to 11, have every reason for tendering you my best thanks for the circuit.

It is everything, if not more, you claim it to be. I am only using 2-volt valves (P.M., detector; S.P., 2nd; and S.P. 3rd), using 60 volts on 1st valve and 100 volts on 2nd and 3rd valves, and with this reasonable voltage have an enormous volume and have gathered in over a dozen stations at loud speaker strength, and no doubt could get more if I had the patience to try.

I can thoroughly recommend the set as the last word in simplicity of handling, clear reception and stability.

The coils I use are also home-made, standard wiring.

Again thanking you, Sir,

Yours faithfully,

G. NEWMAN.

Gloucestershire.

The “Signal Box” in Switzerland

SIR,—I have constructed the “Signal Box” designed by you and described in the May issue of the WIRELESS CONSTRUCTOR. I took care to use the components recommended in said article, as former experience has taught me that this is the safest course to satisfactory results.

The “Signal Box” is certainly everything you promised it would be. Sensitivity and purity are first-class, while the selectivity of the receiver surpasses my wildest hopes, as may be judged by the fact that I am able now to receive London free from Leipzig. None of my other sets, including the “Elstree Six,” can do this. The handling of the set is simplicity itself, and so was the neutralising operation, even employing 4-volt valves.

I am using the “Signal Box” for the shorter waves only, as it brings in all the stations worth listening to on that wave-band. For the Daventry range I am building the “Long-Wave

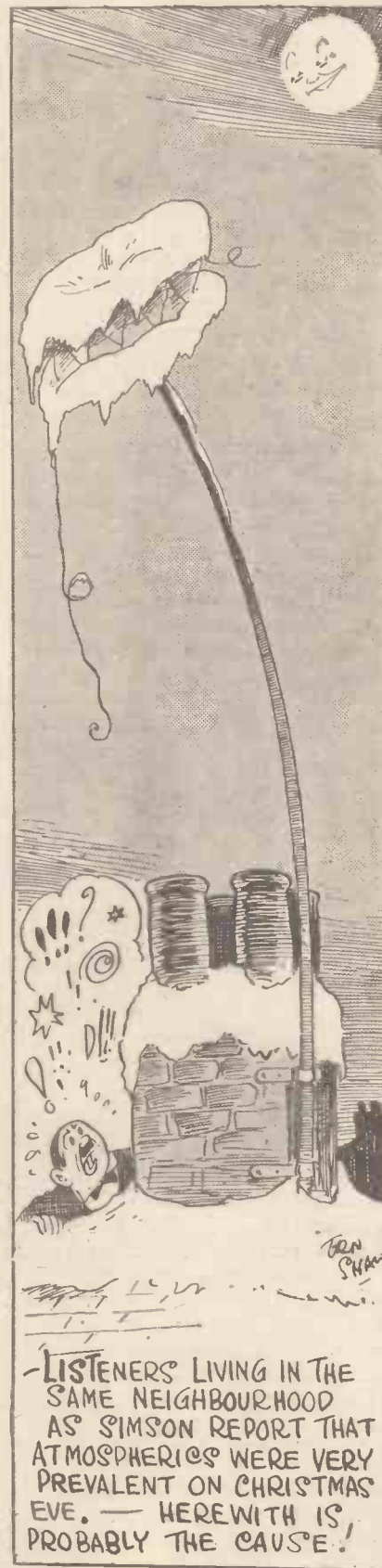

—LISTENERS LIVING IN THE SAME NEIGHBOURHOOD AS SIMSON REPORT THAT ATMOSPHERICS WERE VERY PREVALENT ON CHRISTMAS EVE. — HEREWITH IS, PROBABLY THE CAUSE!

Special” described in the July issue of your paper and which, being a design of yours, is sure to be a success.

Yours faithfully,

Zurich.

M. A. ZUEST.

Radiano Again

SIR,—I am writing after some time to let you know that the “Radiano Three” is absolutely the goods.

I am situated rather badly, and am unable to put up a good aerial; in fact, with screening it is all losses. The earth system is worse still, about 6 yards of wire trailing to a gas-pipe.

However, with all these drawbacks I can rely (conditions permitting) on at least five stations on the L.S., i.e. London, 5 G B, Langenberg, Daventry and Stuttgart at strength which can be heard all over the house. On the telephones I have received all the B.B.C. stations and most of the Continentals which are rated at 4 kilowatts or more.

I have received W G Y on the short-waves, but the set is not stable enough to go in for serious work on the higher frequencies.

I have made some alterations as regards the components, i.e. Ferranti A.F.3 in the first stage, R.I. multi-riate in the second.

A fixed H.F. choke (McMichael), which I find very stable on all frequencies.

A Watmel variable leak, and I have shunted the H.T. supply with two 2-mfd. Mansbridge condensers.

The quality is excellent for transformer coupling.

Yours, etc.,

S.W.

C. RUSSELL.

* OVERLOOKING JACKS *

SOME constructors look on jacks as complicated components to be avoided in a set. This is probably brought about by ignorance of their usefulness. If you study the illustrations in the maker’s catalogue, and compare the contacts with the circuit diagram, before ordering, you will have no difficulty in getting the right sort.

As well as being more convenient than two telephone terminals and an on-and-off switch, they will also be found cheaper, which is a definite point in their favour.

VOLTS AND VALVES

By W. JAMES



An article of interest to the practical amateur.

WHEN considering the subject of amplification we have always found it advisable to work backwards, as it were, from the last valve, for we know that good loud-speaker reproduction demands that signals of a certain average voltage be applied to it. The precise voltage of the average signal which it is necessary to apply to the last valve will, of course, depend on a number of factors, such as the characteristics of the power valve, the anode voltage available, and the type of loud speaker. A large loud speaker, say of the cone type, will naturally deal with more power than a more moderately priced instrument of the horn type.

The Output Question

We have therefore to provide a power valve, sufficient current for the anode circuit, and dry cells for the grid bias, so that our loud speaker can be worked at a satisfactory level of strength. Thus, if the loud speaker is of the small horn type and we are limited to an anode supply of 120 volts, we can say at once that the valve used in the output stage can be of the ordinary power type. Valves of this class, such as the Cossor Stentor 2, P.M.2, D.E.P.215, etc., in the 2-volt range, or the D.E.5a, Cossor Stentor 6, P.M.256, etc., in the 6-volt range, will all work well with an anode voltage of 120 and a grid bias of from -9 to -15 volts, according to the particular valve.

When, however, the loud speaker is a high-class instrument capable of handling a fair amount of power, it is always necessary to employ higher voltages and in many instances to

use large power valves. Under certain conditions it may even be necessary to employ power valves in parallel in the power stage, but before resorting to this it is necessary to consider whether the extra output will be worth while, or whether it would not be more economical to use a single valve of favourable anode A.C. resistance with augmented anode voltage and grid bias.

The function of the last or power stage, it should be noted, is to supply speech-frequency currents to the loud speaker, and to obtain maximum efficiency in this stage it is necessary properly to proportion the load, with reference to the A.C. resistance of the valve. It is true that the load is a

maximum power output from a valve is obtained when the impedance of the load is twice the A.C. resistance of the power valve.

It is therefore necessary to bear this in mind when setting up the power stage, for an increase in output may be obtained by adapting the impedances through the medium of an output transformer. Alternatively, a simple choke-condenser filter circuit may be preferred, but then it is necessary to consider the advisability of putting valves in parallel in the last stage in order to obtain the desired value of anode A.C. resistance.

When Large Power is Used

Fortunately, average loud speakers have characteristics such that it is not vitally necessary to employ an output transformer or to use valves in parallel—except when the anode voltage which can be used is strictly limited.

We can therefore leave it at this,

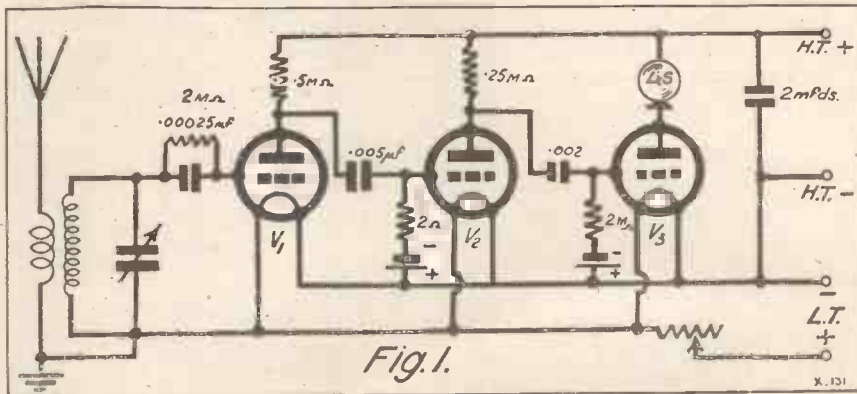

loud speaker having capacity, inductance, and resistance, and that its characteristics vary according to the frequency of the currents passed through it, but we must consider its characteristics at the lowest frequency of importance in the signal.

Authorities are agreed that the

that so far as the last stage is concerned we do not need to worry over much about output transformers, or the use of valves in parallel, for among the power valves available can be found specimens which are quite capable of handling without overloading all the power required by

Volts and Valves—continued

the average loud speaker for domestic purposes.

We are, of course, aware of the man who uses a "luxury" type of loud speaker—we can specify for him three L.S.5a valves in the power stage with an anode voltage of 300 and a grid bias of 50 or 60 volts, and leave him with the problem of how best to adapt the output impedance of the valves with that of his loud speaker.

Necessary Grid Volts

Having decided that a normal type of loud speaker will give tolerably satisfactory results with a single power valve and a grid input of up to 15 peak volts, we have to consider the method to be adopted to raise the level of the incoming signals to this value. Obviously the power stage will require a grid bias of at least -15 , and we can assume that a detector and one low-frequency stage will be used before the power stage.

First of all, let us suppose that both stages are resistance-condenser coupled and we will further assume that both valves V_1 and V_2 (Fig. 1), are of the type expressly designed for resistance-condenser amplifiers.

of valve V_2 at a little over negative 0.6 volt, but to provide a reasonable factor of safety, as resistance couplings are used, it will be advisable to provide -1.5 volts, which is the voltage given by a single dry cell. But will the valve V_2 stand this negative bias? That is, has the valve a sufficiently lengthy straight part of working characteristic, or shall we by using a grid bias of -1.5 be causing rectification of the incoming signals?

Most valves of the type having a voltage factor of 40 will fortunately stand this bias when, and *only* when, an anode-battery voltage of at least 120 is used. But the factor of safety is relatively small, and in most instances it would be advisable to decide on a different type of valve for use in stage V_2 . One which is much more suitable is of the class having a voltage factor of about 20, and if this is resistance coupled to the power stage with a coupling of suitable size, we may expect an amplification of 15.

The voltage of the signal applied to valve V_2 to produce 15 volts on V_3 will therefore be exactly 1 volt, and we can safely bias valve V_2 -1.5 or even -3 volts for an anode-battery

twenty-fifth or 0.04 volt. But it has to be remembered that modulated high-frequency currents are applied to the detector and that the depth of modulation for normal broadcast signals is about 20 per cent. We shall therefore have to apply a high-frequency signal of 0.2 volt to the detector.

We may therefore represent the detector-amplifier of Fig. 1 as in Fig. 2, which gives details of the voltages and the magnification at each stage. Thus, speaking generally, we may say that to provide a signal of 15 volts on the grid of the power valve we must apply a signal of 0.2 volt to the detector when the amplifier is resistance coupled and has an R.C. type of valve at V_1 , and a valve of the H.F. class (of voltage factor about 20) in position V_2 . The amplifier would give more amplification, and therefore would provide the required output from a smaller input, when an R.C. type valve is used at V_2 , but for the reasons given it is not advisable to use such a valve in this stage.

Many readers of this paper will probably not have a very clear idea as to what a signal of 0.2 volt means. We may therefore point out that it is by no means unusual for a signal of 3 to 5 volts to be received across a tuned circuit connected to a normal outdoor aerial within about three miles of a main broadcast station. By using a really good coil and tuning condenser this voltage may be considerably increased, and even at distance of 15 to 20 miles no difficulty at all should be experienced in providing a signal of 0.2 volt across the ends of the aerial coil.

Adding H.F.

Such an amplifier as we have been describing will therefore give sufficient power for the average loud speaker up to distances of at least 20 miles, and in many instances it will be necessary to reduce the high-frequency voltage applied to the detector by detuning, or some other means, in order to prevent overloading the power stage.

If we wish to receive 0.2 volt at the detector from a distant station, we must obviously use some form of amplification to strengthen the received signal. It may be good policy to apply reaction to the aerial circuit from the detector valve. This, admittedly, has the effect of magnifying

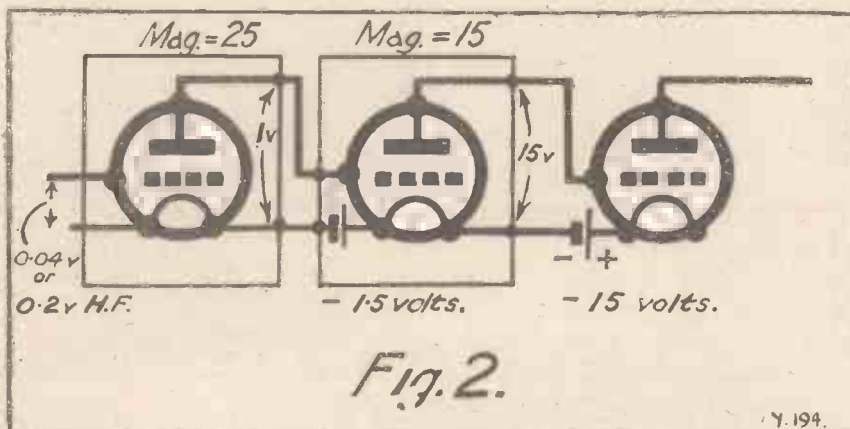

Typical valves have a voltage factor of 35-40, and with couplings proportioned to give more or less uniform amplification we may say that a voltage amplification on about 25 per stage will be obtained. We may therefore work out the voltage of the signal which has to be applied to the grid of valve V_2 in order to produce 15 volts' peak value on the grid of the power-stage V_3 . Obviously this will amount to fifteen twenty-fifths of a volt, or 0.6 volt.

We must therefore fix the grid bias

voltage of 120. This allows a satisfactory margin of safety.

It is now necessary to consider the detector stage. We decided originally to employ a valve having a high voltage factor in this stage, and there is nothing to prevent us so doing, particularly when the leaky-grid method of detection is used.

As this stage may be expected to provide a low-frequency amplification of 25 times, it is clear that the voltage applied to the grid of valve V_1 , to give one volt at V_2 will be one

Volts and Valves—continued

weak signals enormously, but only when the operator skilfully uses the controls and when conditions as to the components used, the steadiness of all batteries used, etc., are very favourable.

It is usually to be preferred to connect a stage of high-frequency amplification before the detector. A good high-frequency stage will give an amplification of 35 to 40 for the broadcast band of 200 to 600 metres without any trouble, and this may be increased by a regenerative contribution to 100 or more without signs of instability or distortion.

Arranging the Stages

Further, it follows that so far as the high-frequency amplifying valve is concerned we do not have to bother about its ability to handle the applied grid voltages, for these are so small that any valve at present on the market will easily deal with them, provided normal battery voltages are used.

We do have to consider another point, however, and that is the advisability of providing a negative bias to the H.F. valve. In practice it has been found almost essential to give this valve a small bias, usually of -1.5 volts, so that here again we must take care that the valve used will take this bias without the risk of distorting the incoming signals.

Considerations of stability and the amplification obtainable are likely to make us decide, in many instances, to employ a valve having a moderate A.C. resistance with a voltage factor of about 20. The point we wish to emphasise is this, that a valve of the R.C. type will handle the signal, provided it has a suitable anode voltage; this must be of the order of 100 to 120.

We can unreservedly recommend the receiver of Fig. 3. Here one stage of high-frequency amplification is used, and this is followed by a valve detector V_2 working as an anode-bend rectifier with a resistance coupling to valve V_3 . This valve is transformer-coupled to the power stage. Quality can be made quite good by suitably proportioning the components, and we will assume this has been done, and will now examine the circuit as we did that of Fig. 1.

We require 15 volts for the grid of the last valve, and good quality demands that the low notes and high

notes shall be present in sufficient proportions. Thus, if valve V_3 is of about 20,000 ohms and the transformer has a primary inductance of 50 to 80 henries, such as the Ferranti A.F.3, or the Marconi Ideal 2.7 to 1, the low notes are sufficiently well amplified for the majority of purposes.

As a rule, a valve having an A.C. resistance of 20,000 ohms will have a voltage-factor of 20, if of the 6-volt class, and about 10 if of the 2-volt class. Taking as an example the Ferranti A.F.3, the stage will therefore amplify 70 times for the 6-volt valve and 35-times for the 2-volt valve. With the 2.7 to 1 transformer the amplification obtained is 54 and 27 respectively.

We can therefore say that the input to the valve V_3 will have to be 15/70 or 0.21 volt when the valve is of the 6-volt type, or 15/35 (0.43) volt when the valve is of the 2-volt class. Obviously the 20,000-ohms valve chosen

an anode rectifier its A.C. resistance is more nearly 300,000 to 400,000 ohms; this will depend, of course, on the precise value of the negative grid bias and anode voltages used, but it is always very much more than the value of A.C. resistance when the valve is used as an amplifier.

In order to preserve the high notes it is necessary to keep down the effective resistance in the anode circuit. This is particularly true in the case of a valve rectifier, because not only have we the shunting capacities due to the wiring, valve, and components, but for efficient rectification we have to provide a by-pass condenser which usually must have, as a minimum, a value of .0001 mfd. It is therefore necessary to use such a value of anode resistance that good quality is obtained, and unfortunately the value of resistance is usually rather low, so that the voltage amplification is also low.

By using a coupling resistance of

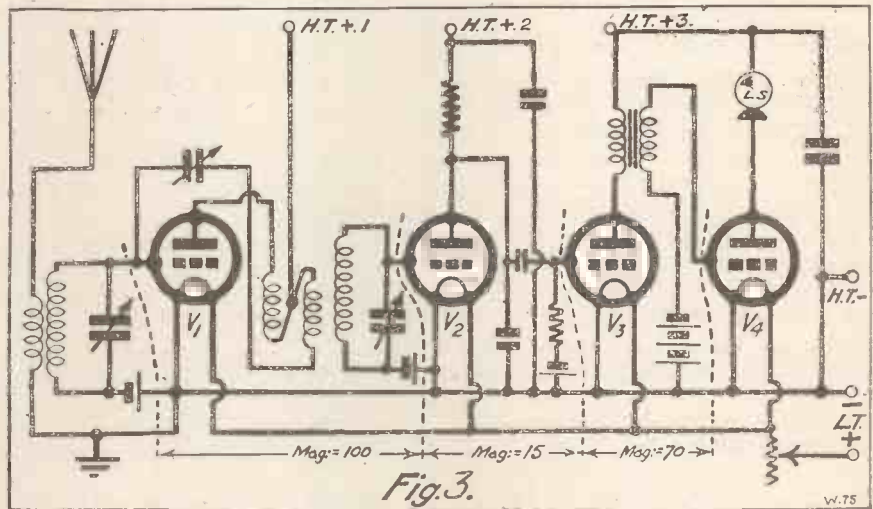

for V_3 will take a grid bias of 1.5 volts for an anode voltage of 90-120, so that here we need not concern ourselves as to the ability of the valve to handle the signal.

Now, as we are using the detector valve as an anode rectifier, the A.C. resistance of the valve under working conditions will exceed very considerably the figure given by the makers.

Final Considerations

Thus the makers may say that an R.C. valve having a voltage factor of 40 has an A.C. resistance of 80,000 ohms, but when this valve is used as

250,000 ohms and a by-pass condenser of .001 mfd., which is a satisfactory combination from the point of view of good quality, we find that when the amplifying valve has a voltage factor of 40, the step up for the stage is about 15. It is therefore necessary to apply to the detector a signal having a voltage of about 0.07 when 6-volt valves are used, and 0.14 with 2-volt valves. If now we reckon that the H.F. stage amplifies 100 times, which is quite reasonable, we see that the receiver will give loud-speaker results from many distant stations, particularly when 6-volt valves are used.

 *
 *
 *
THE AUTUMN EQUINOX
 *
 *
AND WIRELESS
 *
 *
 *

 By a Correspondent.

MANY amateurs have noted the coincidence between the poor long-distance reception conditions during October and the arrival of the autumnal equinox.

The connection cannot be given any definite scientific explanation by the writer—that must be left to a meteorological expert—and, perhaps, from the scientific point of view there is no definite explanation. But the coincidence cannot be denied—that with the start of the autumnal equinox, the conditions for distant reception became poor.

The writer, using a six-valve neutrodyne receiver of marked sensitivity and selectivity, has had, in common with other amateurs, ample opportunities during the month of October of demonstrating the bad conditions prevailing for DX reception.

Wave-length Crowding

Quite apart from the adverse affects of weather conditions, the weak spots in the Geneva wave-length scheme have become glaringly apparent—and, by the way, without reference to the discourteous Spanish stations, which have not made the necessary alterations.

One of the best of foreign stations, Langenberg, although still a dominant voice in the ether, is obviously being "worried" by smaller power stations working too close to his wave-length. A powerful set is, perhaps, a critical instrument for such a test, but even with a four-valve neutrodyne set, there is ample evidence that the Langenberg wave-length is being

dangerously pressed, both from above and below, by more unimportant stations whose absence would not be unduly lamented.

Bournemouth is another station which is finding it difficult to obtain adequate "room to move in," while Vienna and Rome (two stations I once received with ease) are murdered by a number of parasites too close in wave-length and thus badly addicted to the heterodyne vice.

Hilversum, Paris, and the other few European long-wave stations do not seem greatly troubled, although bursts of Morse interference are not infrequent—but on the 200-500 metre band things seem considerably worse than this time last year—not only because of crowded wave-lengths, but because of adverse atmospheric conditions.

The exact influence exercised by weather conditions on wireless work is by no means clearly known, and although a good deal of data has been collected—especially with regard to the effect of the atmosphere on the way wireless waves travel—there is still a good deal of mystery about the whole business.

It is known that storm centres will create atmospherics which will interfere with reception at very great distances—and in a recent paper read before the Royal Meteorological Society it was shown that reception in many parts of Europe was spoilt by a storm having its origin in the Dol-drums—more than two thousand miles away.

Amateurs have probably noticed that atmospherical interference is

often more pronounced on 5 X X's wave-length than 2 L O's.

This is because atmospherics consist of heavily damped wave tracks, and these cause the aerial to oscillate at the particular frequency to which it is tuned. The higher the wave-length the more emphatic the interference by atmospherics.

A correspondent to "The Times" pointed out a few weeks ago that: "Speaking generally, atmospheric interference in disturbed weather is in the majority of cases worse upon high wave-lengths than upon medium or low. There are, however, times when it is more noticeable upon the low waves than upon the high. In these curious circumstances the interference may be caused by discharges of a particular kind with frequencies much higher than those of normal atmospherics.

Radio and the Barometer

"Most of those who indulge in long-distance reception expect good results when the barometer is rising or is high and steady, but are far from optimistic when it is falling. When the glass is rising at a moderate rate conditions are often at their best; a very rapid rise, however, frequently betokens the coming of atmospherics, and the writer has noticed that such a rise may be accompanied by fading of a very marked kind. His own records kept over a number of years seem to show that some of the greatest ranges are achieved when the barometer reading is low but steady, and when the weather is thoroughly bad. In these conditions the refracting effect of the Heaviside layer is sometimes very pronounced, with the result that stations may be heard at almost incredible distances. It would appear that so far as wireless reception is concerned steadiness is the most desirable state of the barometer. Rapid fluctuations nearly always

(Continued on page 162).

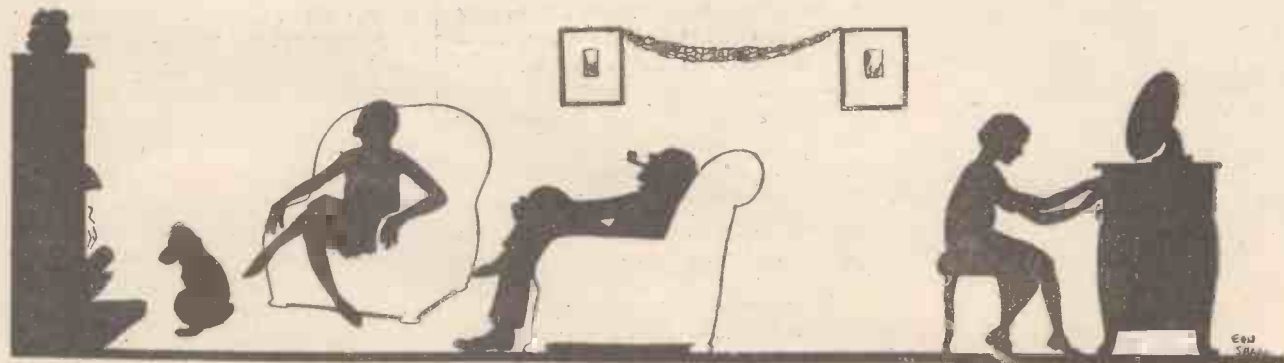

HAPPENINGS AT SAVOY HILL

By
OUR SPECIAL COMMISSIONER.

A Notable Birthday

THE fifth birthday of the B.B.C., celebrated during the third week of November, is the first event of the kind in the history of the Corporation. With the passing of 1927 the Corporation will celebrate its first actual birthday on January 1st, 1928. The balance of critical judgment on the testing period of the Corporation should certainly be in its favour. The prognostications of those who saw the dead hand of State control have not been fulfilled. From the standpoint of the average listener the only apparent change is the improvement of programmes, and this is probably due to plans and activity in the preceding year. Thus, to all intents and purposes, British Broadcasting has gone on undisturbed by the nominal change from a company to a corporation. Definite gains are as follows: less Post Office interference, running commentaries, better news, more controversy and therefore more interest in the talks, and a general addition of varied interest to the programmes generally.

Looking Ahead

More controversy and acuter debates should be developed on the talks side. A new agreement should be made with the Press, so that the news bulletins may be freshened and brightened, and put out at less prolonged intervals. There should be a return to "stunt" programmes now and then. These have great value. Their decline in 1927 was supposed to be due to a desire to lift the general average of programmes so that outstanding occasions would not be necessary. This is wrong psychologically, and it is to be hoped that Savoy Hill realises the mistake by now. Of course, the experiments both in technical distribution and in programme-making under the regional plan must be evolved continuously and patiently.

New Regional Transmitter

Work on the first regional station—that for London—has made excellent progress. The B.B.C. should be ready to transmit from the new 2 LO by about the beginning of July, but there will not be regular programmes under service conditions until the August anniversary of the opening of 5 G B. It is a good plan to place some kind of big pivotal event in August each year. For one

station, leaving Scotland and Northern Ireland for a third and subsequent instalment. It is just possible, however, that they may be able to start all four together. There is much to be said for the latter course, because once we are committed to the new system of distribution, the sooner we have it all round, the better. A half-measure will be most difficult for the trade to handle. Anyway, for the present, what wo

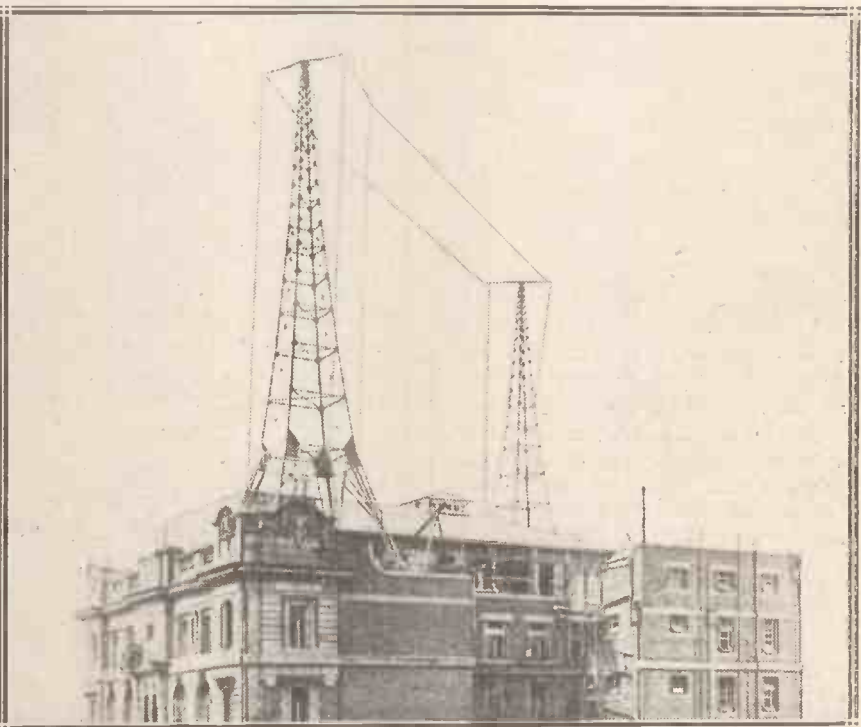

The aerial of the Brisbane broadcasting station, 4 Q G, is situated on the roof of the highest building in the city.

thing, there is a better chance to get going before the new season is under way. For another thing, listeners are much more tolerant in August than in any other month. I presume that after a month or two of the London twin station, the B.B.C. will put in hand simultaneously the West-country station and the Pennines

have to look forward to is the inauguration of the London contrast programmes some time about the middle of 1928. This will represent the first real sample of alternative programmes. The 5 G-B experiment has had so many irregularities and exceptions on the programme side that it could hardly be considered

Happenings at Savoy Hill—continued

typical of probable results when two high-power medium-wave transmitters were working over the same area. With the London regional station in operation many new problems will be presented. The lot of the reacher-out in the Central London area will not be enviable for a while, at least.

The Menace to Daventry

Although no official statement one way or the other has, so far, been made about the future of 5 X X, it is understood in well-informed wireless circles that the now famous long-wave high-power British station is in peril of extinction; or, at least, of relegation to an obscure background under the regional scheme. Apparently long-wave Daventry hardly figures in the new scheme of things, and there is a suggestion that, if retained, it should take only certain dull, specialised talks. If the B.B.C. decide lightly to abandon 5 X X, they will encounter a storm of protest from all over Britain, as well as a host of sorrowful complaints from the Continent. The truth is that Daventry is regarded with something akin to affection by millions. It has transformed the lives of thousands of lonely villagers; it has brought countless thrills to Britishers abroad. Internationally, it has established clear-cut pre-eminence. Daventry went on just the same, paying no heed to the challenges of Hilversum, Langenberg, or any other of the Continental giants of the broadcast wave-band. Unless there are very strong reasons for de-throning Daventry—unless, indeed, the service generally will suffer by its retention—the B.B.C.

will make a serious mistake if they weaken or withdraw it.

The Washington Conference

The World Wireless Conference at Washington has come and gone, and Captain Eckersley has returned full of enthusiasm for the results. Apparently his unofficial status at Washington was soon overcome by his irresistible geniality. Thenceforward there was no one else exercising a greater say in the more important deliberations. Long reports have been issued, and much capital is being made of the new agreements and understandings. The delegates at Washington approved the "Plan de Genève," with certain minor reservations. So far so good. It now remains for the Governments to take prompt action. If the experience of the League of Nations is any criterion, there will be no prompt action. Indeed, there need be no anticipation of all the Governments acting within two years. Meanwhile, we must go on trying to run things on the "gentleman's agreement" plan, and the first practical step is to prevail upon the French to leave the 491-metre channel clear of Morse. Other nations have already agreed to this, but certain French ship and shore stations have gone on pumping Morse on this frequency, thereby completely spoiling 5 G B transmission for the whole of the South Coast. This is really a most serious snag, and the B.B.C. should take a firmer line about it.

Wireless at Westminster

The reopening of Parliament has uncovered a new interest in broadcasting on the part of a few more

members. Lord Birkenhead's advocacy of a certain amount of political controversy in the broadcasting programmes has stirred up unparalleled interest. The executives of all three parties have been searching for the elusive formula to embody a challenging policy. So far nothing has emerged except rumbles of distant trouble. It is believed, however, that the 1928 Budget speech, together with the speech in reply from the Labour opposition, will be broadcast from the House of Commons.

Concerning Criticism

Some of my observations on this page seem to have created a turmoil at Savoy Hill. Great efforts have been made to discover my identity—I neither know nor care whether these efforts have succeeded—but, anyway, I have not so far encountered any sudden misfortune! Seriously, however, perhaps I should say that I am actuated by only the friendliest motives in my discussion of the affairs of the B.B.C. I lose no opportunity of complimenting the B.B.C. when, in my opinion, it does well. I share with other wireless enthusiasts a natural pride in the pre-eminence of our Broadcasting service, but I am not one of those who see nothing wrong with Savoy Hill and, when I criticise, it is solely with the view to helping forward the cause of broadcasting, which is a great deal more important than either the present organisation of the B.B.C. or any of the people concerned in it. About twice a year, Savoy Hill seems to yield to the temptation to become annoyed because of certain criticisms in the Press. Nothing is more likely to stimulate malicious criticisms than this kind of irrational annoyance.

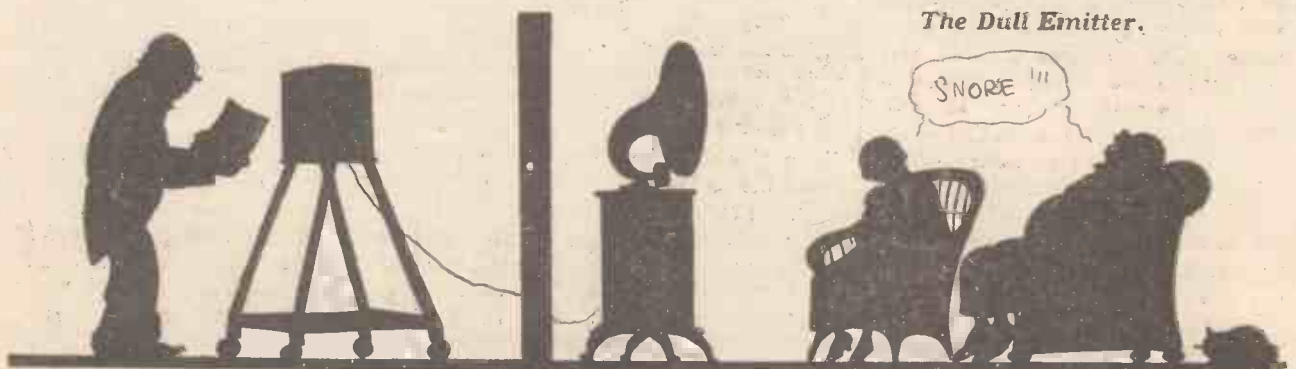

WHAT IS THE SECRET

Your loud speaker, fresh voiced, natural, clear-toned, powerful—right from the beginning to the end of every programme, no matter how long. This is evident to you so soon as you put the **LISSEN New Process Battery** into use.

But the formula and manner of making the battery which render this improved loud speaker reproduction possible are the closely guarded secret which some other battery makers would willingly sacrifice thousands of pounds to learn.

You pay shillings only for a battery so fine because **LISSEN** have pursued a policy in price and distribution never before attempted by any battery maker.

Obtainable at 10,000 dealers throughout the country.

Ask for it in a way that shows you will take no other, say "**LISSEN New Process Battery.**"

—A DYNAMO WITHIN YOUR SET.



60 volts (reads 66)	7/11
100 volts (reads 108)	12/11
9 volts (grid bias)	1/6

LISSEN LIMITED, 26-30 Friars Lane, Richmond, Surrey.
Managing Director: Thos. N. Cole.

LISSEN NEW PROCESS BATTERY

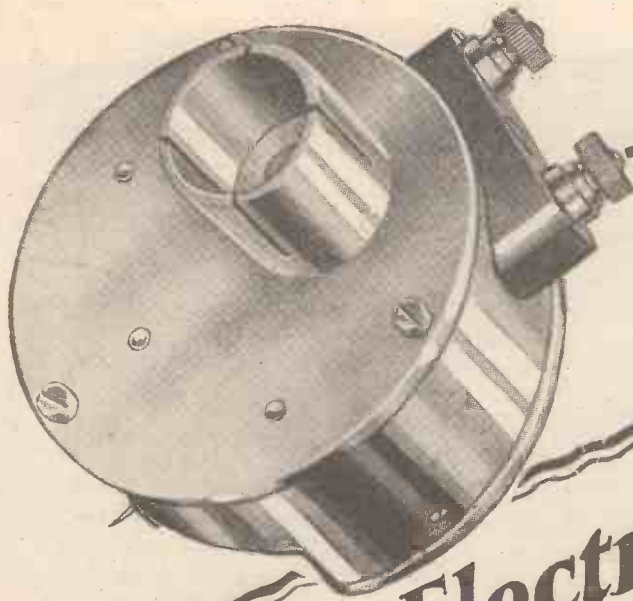

Let Electricity improve your gramophone

BE your Gramophone old or new, electricity can improve it. The **Brown Electrical Pick-up**, when fitted in place of the ordinary sound box and connected to an amplifier and loud speaker, will give you four much-sought gramophone improvements. It will give purer, more mellow, more life-like tone. It will give far greater, more majestic volume. It will give that much-needed effective control of volume. It will almost completely eliminate the bug-bear of needle scratch. In short, the **Brown Electrical Pick-up** brings gramophone performance streets nearer the ideal. Ask your Dealer to prove this to you by showing you how the Pick-up can improve your gramophone. Price **£4**

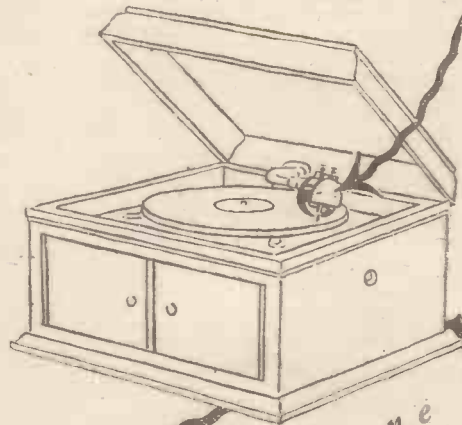

The Brown

ELECTRICAL PICK-UP

Purify its tone
Increase its volume
Reduce its needle scratch
Control its volume

will

Adv. S. G. Brown. Ltd., Western Ave., North Acton, London, W.3.

9694 

AMPLIFIER CIRCUITS

Four typical L.F. Amplifier Circuits with practical notes and values.

By SIMPSON MANN

MANY experimenters desire to assemble a two-valve amplifier from existing apparatus but are unable to choose between the various arrangements available. In this article four two-valve amplifier circuits are given with practical notes and values, so that the reader may choose one to suit his own purposes. There are, of course, others, but these are typical.

crystal set, a high-ratio transformer should be chosen for the first stage. For the second stage, a medium ratio should be chosen. Care should be taken in choosing the output transformer from among the various makes available, as some of the cheaper patterns have quite a high-resistance primary winding.

Some makers sell transformers with only one ratio. The impedance of

of this kind, reversing the primary connections of the second transformer will often effect a cure. A quarter-megohm grid leak across the secondary winding of the second transformer improves the quality in some cases with only a slight reduction of signal strength.

Resistance Coupling

Fig. 2 shows a two-valve amplifier in which resistance coupling is provided to join the detector valve to the first audio-frequency valve, and a transformer for the second coupling. In the output a filter choke and condensers are used in place of an output transformer. Output filter chokes are sold by a number of makers. Condensers C_2 and C_3 should be of good quality Mansbridge type, and should not have a smaller value than one mfd. each. The loud speaker is connected to the two terminals on the right of C_2 and C_3 .

Such an amplifier is not recommended to follow a crystal set, and should be used with a valve receiver to get the best results. The terminal A should be connected to the plate of the detector valve, and terminal B to the H.T. supply for the detector. If the detector is using Reinartz re-

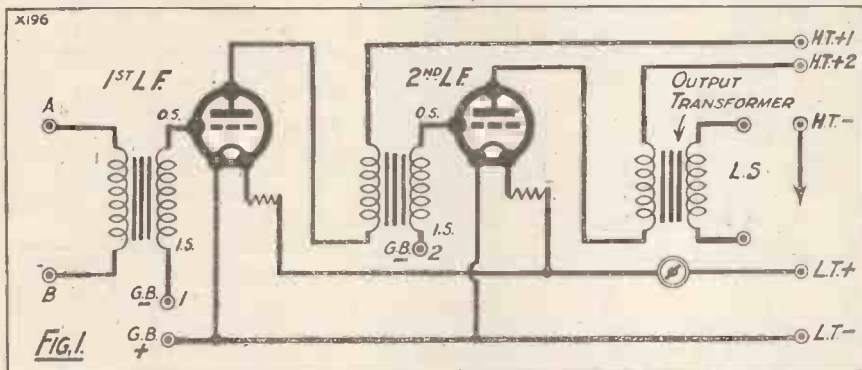

Fig. 1. A two-stage transformer-coupled amplifier with an output transformer.

Fig. 1 shows a two-valve transformer-coupled amplifier with an output transformer so that when a super-power valve is being used in the second stage (which is always advisable if high quality reproduction is desired) the loud speaker windings are isolated from the direct current supply, and the last valve can have its H.T. current delivered through a low-resistance winding.

Output Transformers

It is not always realised that with the modern super-power valve having an internal resistance of, say, two or three thousand ohms, the direct-current resistance of a loud-speaker winding may be as high as that of the valve itself, and thus a good deal of voltage drop will occur in these windings, restricting the voltage available to the valve. The use of a suitably designed output transformer or output choke will make the available voltage on the last valve higher than would be the case if it were fed through the loud-speaker windings.

Low-frequency transformers can be obtained in different ratios. If this amplifier is intended to follow a

such a primary winding is suitable for the average detector valve in use to-day. Such transformers will work quite well with crystal sets, but generally they work better with the perikon or two-crystal combination than with

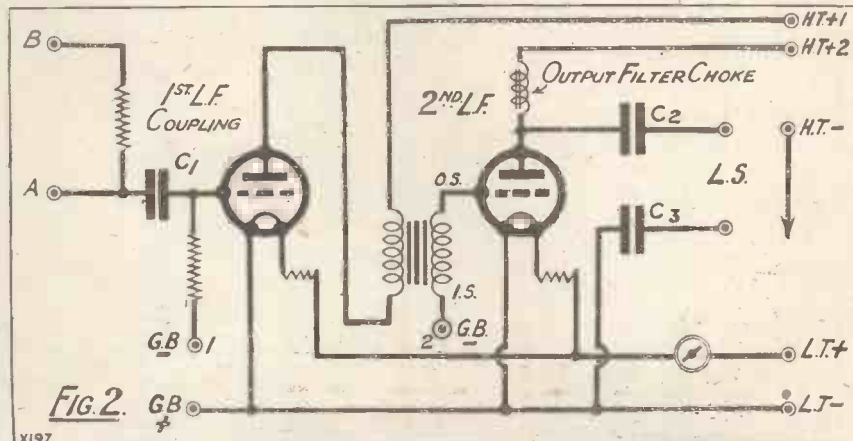

Fig. 2. A system of amplification which has attained great popularity.

the "galena and cat-whisker" type. In all cases where the amplifier is designed to work with a crystal set the negative terminal of the accumulator should be connected to earth.

If howling occurs in an amplifier

action no shunting condenser is required, but if magnetic reaction of the swinging coil types is used, and there is no shunting condenser across the output terminals of the detector set, a .0001 mfd. should be connected

Amplifier Circuits—continued

between A and L.T. negative. The value of the coupling condenser C_1 can be .005 to .02 mfd.

The output filter arrangement is interchangeable with the output transformer arrangement of Fig. 1. Either circuit can have either form of output. The resistance between A and B, the condenser C_1 and the grid leak associated with it, can be replaced by one of the now popular resistance-capacity units if desired. If, however, such an amplifier is following a detector with reaction, the value of the resistance and grid leak is better chosen in the neighbourhood of 100,000 ohms for the anode resistance and half to one megohm for the grid leak. If the detector is used without reaction, and is one of the high-magnification type, then the resistance can be 250,000 or 300,000 ohms, and even 500,000 ohms, the grid leak value being about four times the value of the anode resistance.

H.T. to L.T. Connections

In all circuits the connection of H.T. negative to L.T. is shown as a flexible wire with an arrow. If the amplifier in Fig. 1 is used with a crystal set the H.T. negative can be connected to either L.T. negative or L.T. positive as desired. If, however, any of the amplifiers in Figs. 1, 2, 3 and 4 is used with a valve detector, then the H.T. connection must be the same

valve. In this circuit special arrangements are shown to prevent radio-frequency getting through to the audio-frequency side. For example, a radio-frequency choke is shown following A, and additional resistances R_1 and R_3 in series with the grids of the valves. The condenser C_4 should have a value not exceed-

and the grid leak R_2 , should be chosen as mentioned for the previous circuit. The value of the condenser C_1 in all resistance amplifiers can quite well be .01 mfd.

In practice it is generally found better not to use special resistance-capacity valves for the first valve in the amplifier if reaction is being used,

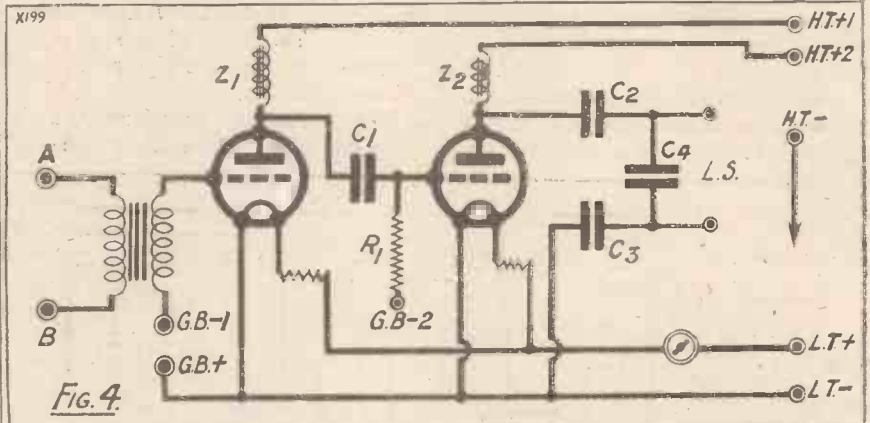

Fig. 4

Two choke-coupled stages of L.F. amplification with output filter choke.

ing .0001 mfd., and the radio-frequency choke can be of any of the standard types. If, of course, the condenser C_4 and radio-frequency choke is included in the detector unit then it will not be needed here.

The values R_1 and R_3 can be a quarter of a megohm each, and grid leaks will suit excellently for this purpose. They do not offer any

and one of the H.F. type is very suitable here. R_6 can have a value of, say, 100,000 ohms, and R_1 half a megohm. The condenser C_3 shown dotted should have a value not exceeding about .0005 mfd., and will often be found helpful if, in spite of all precautions taken, radio-frequency still gets through into the audio-frequency side. The radio-frequency "stoppers" can be omitted if found unnecessary.

Choke Coupled Amplifiers

Fig. 4 shows a circuit with transformer coupling for the input, choke coupling between the two amplifier valves and choke output. The remarks regarding the choice of the input transformer apply here as in the case of Fig. 1. Either transformer or choke output can be used in all of these circuits. Condenser C_4 is helpful in improving the tone of some makes of loud speaker, and the value is best found experimentally.

The value of the grid leak R_1 can well be one megohm and the condenser C_1 about .01 mfd. Different chokes are used for Z_1 and Z_2 . Z_2 is an output choke, and should have a value of about 30 to 50 henries with modern types of loud speaker. It must be a comparatively low D.C. resistance. Z_1 , however, should have a much higher inductance value.

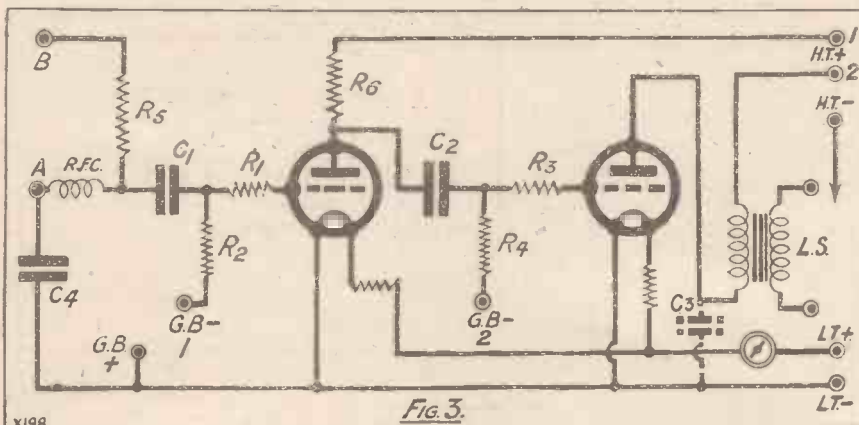

Fig. 3

Where extreme purity is required resistance-capacity coupling is often employed.

as that made in the detector unit it is following. That is, if the detector unit has H.T. negative connected to L.T. negative, then the same arrangement must be made in the amplifier.

Fig. 3 shows a resistance amplifier of two stages made to follow a detector

opposition to the passage of the audio-frequency potentials, but are very helpful in preventing radio-frequency current getting through to the audio-frequency side and being amplified there. The values of R_2 and R_4 can be chosen as usual. Resistance R_5 ,

*the perfect Cone Unit
in the acoustically perfect
cabinet—*

The performance of this Brandes Cone type loudspeaker is as near perfection as possible, and unequalled by instruments at double the price. It removes the last objection to an external loudspeaker. There is no horn, and the cone itself is effectively concealed in a handsome cabinet which is finely finished in either oak or mahogany. The tones are luxuriant and natural. Very low tones—the kind that were once muffled and lost—respond with accuracy and clarity. High soprano notes, once thin and metallic, are beautifully rounded and mellow. This faithful reproduction is due not only to the large vibrating area of the cone itself, but also to the driving unit of special Brandes design. This unit is of the balanced armature type which, whilst giving great volume, is extremely sensitive, and reacts to the faintest impulse. A special magnetic circuit is incorporated in the unit, increasing sensitivity. Very large magnets are employed, and the pole pieces are laminated.

The ELLIPTICON
(Registered Trade Mark)

£4 : 15 : 0

A Junior Model, the Table Cone, is also supplied
£1 : 19 : 6

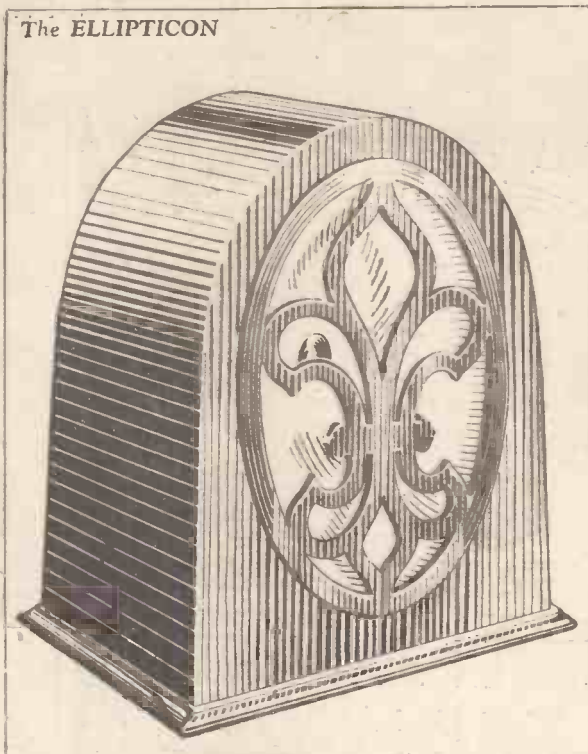

The ELLIPTICON

**BRANDES
HEADPHONES**

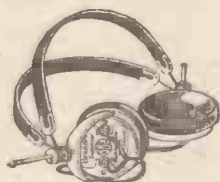

*the
world's greatest
headphones value* **13'6**

★Post the coupon (below) for free information concerning the full Brandes range at the NEW prices.

Brandes

Brandes Limited 2 & 3 Norfolk Street, Strand, W.C.2

**7 OTHER FINE
BRANDES PRODUCTS**

Brandola Loudspeaker	57/6
Table-Talker	30/-
Table Cone	39/6
L.F. Transformer	15/- & 15/6
Variable Condenser	15/- & 15/6
Accumulator R.B.10	5/6
Accumulator R.B.20	9/-

**The BRANDESET IIIA
the set the public chose**

This is "the set the public chose." Proved by private tests to be the ideal loudspeaker receiver, it is guaranteed to give excellent loudspeaker reception anywhere in the British Isles. A competent set, tractable and ingeniously contrived, simple to operate and beautifully finished.

£6 : 15 : 0

(excluding Royal'y and Accessories)



COUPON

Brandes
AUTHORISED
RADIO DEALER



Brandes Ltd.,
2/3, Norfolk St., Strand, W.C.2

Please send me your free illustrated catalogue.

Name

Address

W.C.

Brandes products are only obtainable where you see this sign.



EFESCA JUNIOR HIGH TENSION BATTERY ELIMINATORS

The convenience of obtaining HIGH TENSION SUPPLY STRAIGHT OFF THE MAINS, where electric light is available, has created a wide demand for High Tension Battery Eliminators.

The Efesca Junior (illustrated), for direct current, incorporates a feature not usually found in low-priced instruments in the provision of Grid Bias, which not only clarifies reception, but suppresses the commutator noises from the generating station usually experienced. It is guaranteed to give satisfactory results when used with sets employing up to **35/-** three valves.

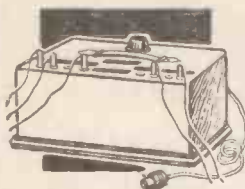

MODEL NO. 1

Dimensions, 12 by 7 by 4 1/2 in. Direct Current, suitable for up to five valves.

Contained in polished oak case, with three positive tapings— one variable 40 to 75 volts, for H.F. and detector valves, and

two fixed at 90 and 120 volts, for L.F. and power valves, incorporating negative grid bias tapings at 2, 4, 6, and 8 volts.

Price £4 10s.

EFESCA
ALL WAVE
REGENERATIVE
AERIAL
TUNER
25/- EACH

EFESCA
VARIFORM L.F.
TRANSFORMER
WITH FOUR
INTERCHANGEABLE
PRIMARY
BOBBINS - **25/-** EACH

Write for complete Catalogue of Efesca Components.

FALK, STADELMANN & CO., LTD.,
Efesca Electrical Works,
83/83, Farringdon Road, London, E.C.1.

And at
Glasgow, Manchester, Birmingham, Dublin, Newcastle, Cardiff.

Lewcos Coils for all modern circuits



Patent No.
277876.

Supplied in
the following
types :

Split Primary
Transformer.

Split Secondary
Transformers.

Reinartz
Transformer.

Split Secondary
Tapped
Primary.

Aerial Coil.

Binocular Coils are the latest Lewcos development in six-pin Coils. They are interchangeable with the popular types and can be used in a standard Lewcos Screen, although for use in multi-stage receivers they are sufficiently fieldless without screening. All dealers can obtain them for you. Full particulars and prices gladly sent on request.

THE LONDON ELECTRIC WIRE CO. & SMITHS, LTD.,
Playhouse Yard, Golden Lane, London, E.C.1.

LEWCOS

Binocular Coils

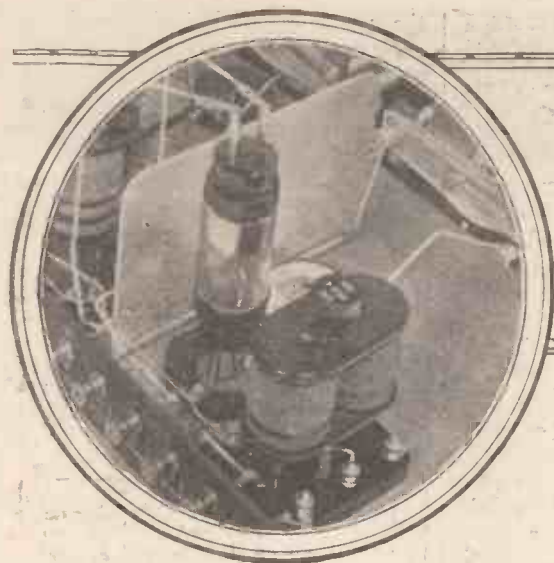

WITHIN THE VACUUM

Why not give valves this Christmas?—How to choose suitable types—New valve "releases."

By KEITH D. ROGERS.

CHRISTMAS is once more approaching, and though that festival is still some weeks distant I daresay a number of my readers have already been discussing what they shall give So-and-so for Christmas. Something in the radio line is sure to be acceptable if he is a keen constructor, and of all components or accessories the valve is usually most gratefully received.

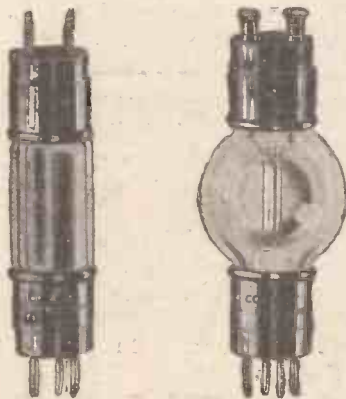

The Cossor screened valve and the new Cossor A.C. valve. This latter has two terminals on the top for connection to the mains supply unit.

H.T. batteries form useful gifts, but I think the average valve-set constructor would prefer one or two valves as his quota from Father Christmas's sack.

Careful Choice Required

But before you decide upon the actual type of valve or valves you will give your friend or relation, you should get a good idea of the set he is using, or the new one he is commencing to build. The reason for this will be obvious after a little consideration, for *any* valve will not do for *any* set. If the best is to be obtained from a receiver, the valves must be

suited to the positions they are to occupy, and so your friend will not be pleased if you give him an R.C. valve and he is using a Det. and L.F. receiver employing transformer coupling. Similarly, a super-power valve would be useless—or nearly so—to the man making an H.F. and Det. receiver.

So whatever you do, get some idea of his taste in receivers, if possible of the circuit he is using or is about to use, and choose the present accordingly. Incidentally, do not forget the L.T. voltage part of the question; he won't like a 6-volt valve if he is using 2-volters, and similarly, though it could be used, a 2-volt valve will not please him to the fullest extent if he favours a 6-volt L.T. supply—or he may be using mains, and in that case the indirectly heated cathode type of A.C. valve will be required.

So it will, therefore, be seen that with a little care you may be quite sure that your present will be exactly what is required.

So far so good. The next, and most difficult, point to decide is the actual choice of the valve or valves. This is not so easy, for so many new ones are constantly coming out that the task is becoming more difficult each month.

In order to get a fair idea of what is likely to "go down" best, let us take a few concrete examples. In the first place, suppose we consider the man who is building a four-valve set, having one H.F. (neutralised) stage and a detector resistance-coupled to the first L.F., this latter being transformer-coupled to the last valve—such a set as the "New Family Four," recently described by Mr. Percy Harris.

Now, although an R.C. valve would *work* in the H.F. position, it would not give very good results, and here we require something of the order of the P.M.5 X, Cossor 610 H.F., Ediswan E.S.5 H.F., etc. The new screened-grid valves just brought out would not be suitable, of course, and we must confine ourselves to three-electrode valves, either 2-, 4-, or 6-volt types, having impedances from 13,000-30,000 ohms with amplification factors of 15-25 or so.

Det. and L.F. Stages

The detector valve, being resistance-coupled, could be an R.C. valve, but in that case I am inclined to believe the reaction control might leave a little to be desired, and personally I prefer the H.F. type again—that is the same class of valve as is used in the H.F. stage. This would give better reproduction of the high notes probably, and would obviate over-



The new Cosmos AC/R (red spot) A.C. mains valve. It employs the well-known short-path construction and a special adaptor is supplied to enable it to be used in any circuit.

loading of the next valve should strong signals be dealt with.

The L.F. valve will have to be a compromise, I am afraid. For best

(Continued on page 172.)

Helping The Home-Constructor

A simple system for assisting set builders.

READERS of the WIRELESS CONSTRUCTOR will be interested to learn that it has been decided to incorporate a small dimensional scale with all diagrams to which such a scale can be usefully applied, such as panel and baseboard "layouts."

The scale will, in all cases, correspond to the scale actually used by the draughtsman in making his drawing, and can be applied by the constructor to ascertain any dimension or dimensions which may not be indicated clearly on the diagram.

The scale will, in most cases, be only 3 in. long, but where possible $\frac{1}{4}$ in. and $\frac{1}{2}$ in. dimensions will be shown.

The easiest way to employ the scale is, of course, to use a pair of "dividers" for the smaller measurements.

If necessary, however, the scale may be cut out and mounted with paste on a piece of stiff cardboard, but if for any reason the mutilation of the paper is not desired, the scale can be traced by placing a piece of tracing or

transparent paper over it and carefully tracing the dimensions. An alternative method is that shown in the illustration.

Take a strip of "Bristol" board, or thick white paper—12 in. long by 1 in. wide will be ample for the purpose—and place this against the scale. Mark off the dimensions as indicated, then move the strip 3 in. to the left, and mark off three more inches. Repeat this until the scale is complete, when a 12-in. scale rule applicable to the drawing will result.

Using the Scale

To give a simple example. We will presume that it is necessary to find a certain drilling point on a panel, the position of which has not been clearly defined on the diagram. The scale rule is applied to the diagram, and the point is found to be 3 in. from one side of the panel and $2\frac{1}{2}$ in. down from the top, as illustrated.

The scale rule is then placed aside, and these dimensions are marked on

the panel in *actual* inches with an ordinary rule.

Measure 3 in. in from the side of the panel along its length, then rule a line (A) down the panel parallel with the side edge. Measure $2\frac{1}{2}$ in. down the side edge of the panel and draw a line (B) parallel with the length of the panel. Where these two lines cross each other is the required drilling point.

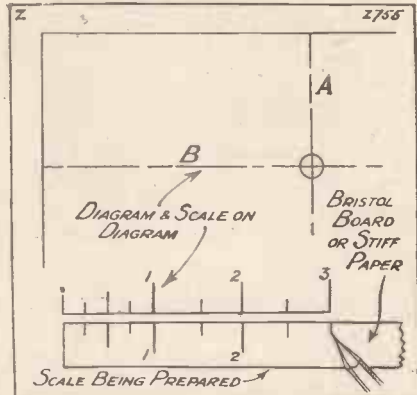

The use of the scale in actual practice is quite simple provided it is remembered that the scale only applies to the diagram, and the dimensions shown in inches by such application must be converted into actual inches when scribing a panel or making a baseboard.

"FATHER WILLIAM"

WIRELESS VERSION.

With sincerest apologies to Robert Southey and Lewis Carroll.

"You are old, Father William," the young man said;

"You belong to the days of the Ark,
So wouldn't you like a nice new
Crystal Set.

Since you can't stir abroad in the
dark?"

"In the days of my youth," Father
William replied,

"These earphones were not yet
invented;

And that is the reason why, quite
unlike yours,

My brain-pan was never indented."

"You are old," said his son, "and
your voice is so weak,

I could hardly imagine it weaker,
So wouldn't it give a new int'rest to
life

To have in the house a loud
speaker?"

"In the days of my youth," Father
William replied,

"I took to myself a young wife;

And the very loud speaking she did
for some years

Will last me the rest of my life!"

"You are old, and you're foolish," re-
plied the young man,

"And your answers are very ill-
bred;

But think what a blessing in old age
'twould be

To hear chamber-music-in bed."

"In my youth," Father William re-
plied, with a groan,

"I slept with a fellow who snored,
And now I'm not anxious to hear once
again

That eternal nocturnal 'Lost
Chord!'"

"You are old," said the lad, "but I
think that you must

Admit that you're awfully silly
To miss listening-in to a good Cabaret
Or the Jazz Band from gay Picca-
dilly."

"In my boyhood," replied Father
William, with tears,

"I lived with a Scotchman, who
blew

'The Cawn'ells are comin'' so oft on
his pipes,

That a rest seems too good to be
true!"

"You are old," said the boy, "and
you're subject to flu',

And you send for the doctor with
sorrow;

And yet you might listen to people
who know

What the weather will be on the
morrow."

"In my youth, when I caught a bad
cold," said his sire,

"My nose often came in for blows;
And if you'd escape one, just leave
me the fire,

And I don't care a hang if it
snows!"

A. B. COOPER.

SUCCESS DESERVED AND SUCCESS WON

For over four years LISSEN parts have gained in speed and volume of sales until at last they have won their way through to first place.

This is due to the growing recognition on the part of an appreciative public, which in turn is due to the remarkable value offered in everything bearing the LISSEN name. As radio knowledge has spread, people have begun to realise that when other makers' parts are specified in published circuits, the corresponding LISSEN

parts can in almost every case be used, often with an improvement in the volume and clarity of signals, and so to-day LISSEN by sheer merit has won such wide appreciation from the public that they now occupy the foremost place in the making of fine parts for radio.

LISSEN'S NEW PRICE REDUCTIONS



**LISSEN
L.F.
CHOKE**

Previously 10/-
Now 5/6



**LISSEN
Mansbridge Type
CONDENSERS**

Capacity Mfd.	PRICE.	
.01 to .05	Previously 2/4	NOW 1/9
.1	.. 2/6	NOW 1/9
.25	.. 3/-	NOW 2/-
.5	.. 3/4	NOW 2/3
1	.. 3/10	NOW 2/6
2	.. 4/8	NOW 3/6

LISSENSTAT MINOR

12 Months' Guarantee.

Suitable for baseboard or panel mounting.

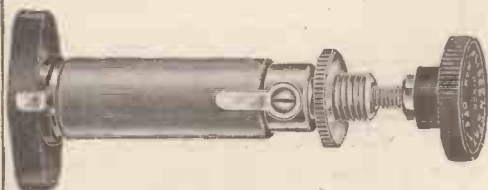

Previously 3/6
NOW 2/-

LISSEN COMBINATOR

Convenient holder for fixed condensers and fixed grid leaks.

Previously 1/-



NOW 6d.

You get all the advantages of power, performance, prestige and price when you buy

LISSEN

—the parts that pull together!

LISSEN LTD., 26-30, FRIARS LANE, RICHMOND, SURREY

**As correct as
the plumb line**

"THE shortest distance between two points" our old friend Euclid tells us, "is a straight line." The plumb line always registers the shortest distance between two points. It is correct—to a minute degree.

So is the T.C.C. Condenser. The strenuous tests through which every T.C.C. passes, ensure that. When you buy a T.C.C. you know that its capacity is identical with that stamped on the side of its green case. In its insulation, too, you can have the same complete faith. Remember: you get a square deal when you buy T.C.C. Mansbridge Condensers. All capacities from .005 mfd. price 1/8d.

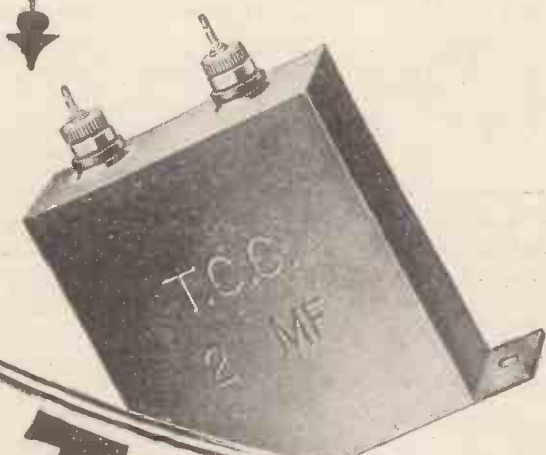

**T.C.C.
Condensers**

3d.
and Coupon
brings copy of
"How to build
your own H.T.
Eliminator."

To the Telegraph Condenser Co. Ltd., Wales Farm Road., N. Acton, W. 3.
I enclose 3d. in stamps. Please send me a copy of "How to build your own H.T.
Eliminator for A.C. or D.C." W.C. Dec.

Name.....
Address.....

9706



*The
Latest Radio
Development*

MAGNUM

**GRAMOPHONE
ELECTRICAL PICK-UP**

THE Magnum is the latest and easily the lowest priced Pick-up. One of its unique features is its volume control. You can regulate its amazingly pure reproduction from a faint whisper to the maximum volume your wireless amplifier can give. Adapted to any gramophone instantly. You have merely to fit the Magnum Pick-up on to the tone-arm and connect to the amplifying side of your wireless set. Uses all types of needles.

35/-

Send stamp for particulars.

**BURNE-JONES
& CO. LTD.,
MAGNUM HOUSE
TELEPHONE: HOP 6257
288, BOROUGH HIGH ST.
LONDON. S. E. 1**

CHATS AT THE WORK-TABLE

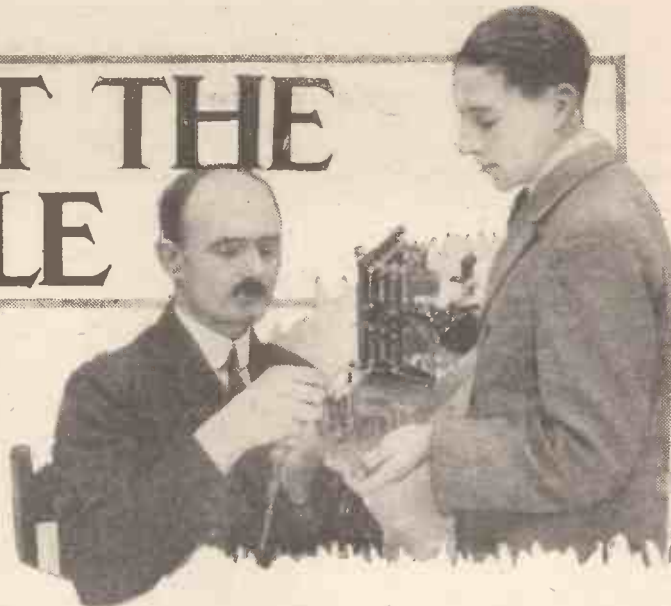

A Template Difficulty—Accurate Drilling—Home-made Valve Holders—Improving Switches—A Handy Pattern—Converting a Jack.

By R. W. HALLOWS, M.A.

A Template Difficulty

There are many condensers of first-rate quality that are not provided with a one-hole fixing and with these the makers generally send a template made of cardboard or stiff paper. Such templates are

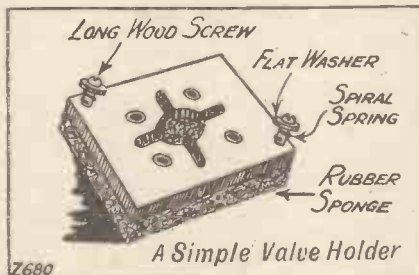

by no means easy to use, though it is essential that the holes for the fixing screws should be exactly spaced, for if they are not the spindle may bind in the hole made for it, and it may be difficult, without resorting to the sort of botching that displeases the neat worker, to get the fixing screws in at all.

It seems to me that if makers insist on turning out condensers whose fixing screws are spaced in small odd fractions of an inch, they should let us have metal jigs with them.

Accurate Drilling

The cost of these in tin or thin zinc would be trifling in comparison with the price of first-grade components, but nobody so far seems to have adopted this idea. What reaches us is a cardboard template showing simply the centres and the sizes of the holes that are to be made. Unless considerable care is exercised in the use of these templates it is quite possible to make an unholy mess of

drilling the holes for the fixing screws. The best method that I have found is as follows: Prick through the centres indicated with the point of the scriber. Then place a fine drill in the chuck of your hand-drill or bench drill, and with it drill through the panel at the place marked out for the centre of the spindle. Take the drill out of the chuck, thrust it through hole pricked in the panel and leave it there. Turn the template until it is in the right position; then drill through one of the centres indicated for the fixing screws with the next finest drill that you have.

Final Operation

Leave this drill in position also, and with another small drill make holes corresponding to the centres of the remaining fixing screws. The template may now be removed and holes of the proper size drilled, using the small ones ready-made as centres. This process may seem

Home-made Valve Holders

Not a few of the so-called anti-microphonic valve holders fail to be really useful owing to the fact that the mounting for the valve is too springy.

The figure shows a home-made valve holder which I have found very effective indeed, especially for short-wave work, where it is essential that the detector should be mounted in such a way that it is insulated as far as possible from the effects of vibration. The valve holder itself consists of a piece of $\frac{1}{4}$ -in. ebonite, about 2 in. square, with holes drilled to take the valve legs. Superfluous ebonite between these holes may be cut away, as shown in the drawing, by drilling a $\frac{3}{8}$ -in. hole in the centre and making hacksaw or file cuts between the valve-leg holes. Near two of the corners fairly large holes are drilled; their diameters must be sufficient to allow the wood screws used for fixing the holder to the

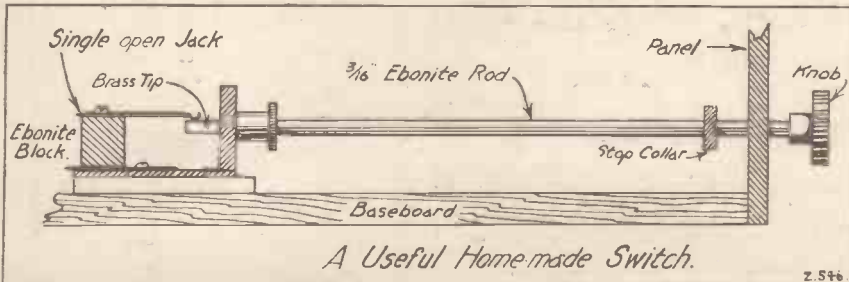

rather complicated, but unless something of the sort is done it is difficult to produce accurate work, owing to the practical impossibility of preventing the template from moving slightly whilst drilling is in progress.

baseboard to pass quite easily. Under the holder is a piece of rubber sponge about $\frac{1}{2}$ in. in thickness. Each of the two fixing screws has below its head a flat washer, and below that a spiral spring made from

Chats at the Work-Table—continued

steel wire. With this type of holder we have much the same effect as is seen in the shock absorbers fitted to motor cars. There is plenty of resilience, but the rebound of the springs is damped by the rubber sponge, and that of the rubber sponge by the springs. All shocks are, so to speak, mopped up by the rubber sponge, and the valve holder is prevented from vibrating too freely by the mutual damping action. Connections to such a valve holder should be made preferably by means of flex wire. If stiff wire is used the last inch or two of each lead should be formed into a small coil spring by winding it tightly round a pencil. If you have any difficulty in obtaining suitable spiral springs to go between the flat washers and the valve holder proper, these can very easily be made at home by winding wire of any kind of about No. 18 gauge tightly round a piece of $\frac{3}{16}$ -in. rod and cutting off lengths required. Steel wire is, of course, best, but even hard copper wire will make quite respectable springs.

Improving Switches

One often sees it stated that as few switches as possible should be used in the wireless receiving set; particularly on the high-frequency side. Actually the main objection to the use of switches is not so much that they produce bad or chancy contacts as that they lead to considerable increases in the amount of

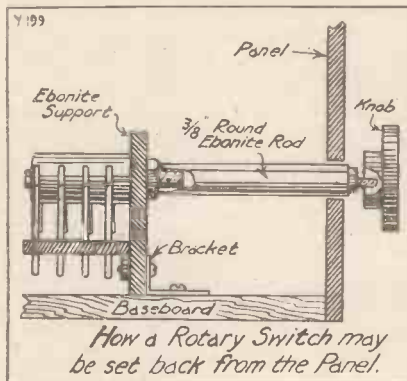

wire needed. To be of any real use the knob controlling a switch must be on the panel of the receiving set, and if the switch itself is mounted immediately behind one has to bring several wires right over from distant parts of the baseboard. The more wire there is the more likely are unwanted couplings to occur.

There is only one way of shortening the wires: instead of bringing leads to the switch, take the switch, so to speak, to the leads. The knob must, of course, remain on the panel, but there is no reason why, in many cases, the actual switch should not be at the back of the baseboard or in a position which allows all leads to it to be of the shortest. If you already possess switches of the double-pole kind there is no reason why they should not be mounted on small vertical pieces of ebonite in such positions. The figure shows how this may be done. The knob is removed and replaced by a suitable length of round ebonite rod, which is brought through a hole in the panel.

Barrel switches can be used in just the same way, but since there is a torque instead of a straight push-and-pull by the actuating rod, it is necessary to use thicker ebonite. The sketch shows how a tumbler switch, or any kind of rotary switch, may be set back. The switch itself is mounted on a small piece of ebonite fixed at right angles to the baseboard by means of small brackets. The connecting rod is a piece of $\frac{3}{8}$ -in. round ebonite, drilled and tapped 2 B.A. at both ends. One end is screwed on to the spindle of the switch in place of the knob. Into the other is screwed a short piece of 2 B.A. studding, with a locknut upon it. The knob is then screwed tightly on to the studding.

A Handy Pattern

Another diagram shows an exceedingly useful type of switch which may be turned out very quickly in the workshop. It was actually made for use in a short-wave receiving set, where it is always necessary to be able to throw the aerial series condenser into or out of action to avoid resonance with the natural frequency of the aerial or one of its harmonics. It is a nuisance to have to change the lead-in from one terminal to another when searching is in progress, and most shorting devices for condensers have the drawback that one has to open the cabinet in order to get at them.

The simple arrangement seen enables the condenser to be placed in series or shorted out in the easiest possible way by merely pulling or pushing the knob. In the short-

wave set one encounters high-frequencies with a vengeance, and it becomes doubly necessary to keep all leads short. The switch works perfectly satisfactorily in the position for which it was designed, and the idea has many other applications. A similar switch may, for example, be used for making and breaking either high- or low-tension circuits, and with rather more elaborate jacks it is possible to make change-over and other switches in this simple way.

Many constructors probably have jacks of the single-open, single-closed, and double-closed patterns

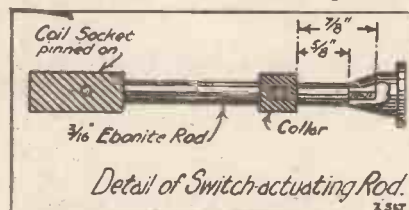

in their junk boxes, having discarded them for those of the filament-control pattern. A little thought will show that quite a number of useful switching devices can be made from these.

Converting a Jack

I will describe the method of making an on-and-off switch from a single-open jack; the construction of other switches from jacks of different kinds follows exactly the same lines, and will present little difficulty. The jack actually used is one of the Edison Bell pattern, and the dimensions are given for this type. They will not vary very greatly from other patterns.

Begin by mounting the jack upon a small block of $\frac{1}{4}$ -in. ebonite. This is best done by making two deeply countersunk 4 B.A. clearance holes in the piece of ebonite and two corresponding tapped holes in the horizontal part of the frame of the jack. Short screws are then driven in. In the ebonite block make also two holes for the wood-screws, which will fix the contrivance to the baseboard. Now determine the position that the switch is going to occupy; you can calculate the length of $\frac{3}{16}$ -in. ebonite rod required. The length of the rod will be equal to the distance from the contact arm of the jack to the panel plus the thickness of the panel plus $\frac{1}{4}$ inch.

Details of the rod and its fitting are seen above. The sliding metal

(Continued on page 170.)

The Set Manufacturer chooses Six-Sixty —



"Valves are by far the most important part of any Receiver, and my reputation as a set manufacturer depends upon the correct choice of these important components." This statement comes from the Set Manufacturer, who continues, "The most careful tests under all conditions convinced me that Six-Sixty Valves could not be beaten, and so Six-Sixty were standardised and proved an immediate and lasting success. That my choice was correct is proved by the fact that practically all the Set Manufacturers in the country have followed my lead and standardised Six-Sixty Valves in their Receivers."

Some of the well-known Manufacturers standardising Six-Sixty Valves in their Receivers.

- Beard & Fitch.*
- Campbell & Addison.*
- Dunham C. S.*
- General Radio Co.*
- Langham Radio.*
- Lever, Eric.*

Send for illustrated brochure describing the full range of 2, 4, and 6-volt valves from 10/6.

Some of the well-known Manufacturers standardising Six-Sixty Valves in their Receivers.

- McMichael Ltd.*
- Runnymede Eng. & Elec.*
- Stevens A. J. & Co.*
- Tru-phonic Wireless.*
- Waverley Wireless.*
- Whittingham, Smith & Co.*

Send for illustrated brochure describing the full range of 2, 4, and 6-volt valves from 10/6.

**SIX-SIXTY
GLOWLESS VALVES**

THE ELECTRON CO., LTD., 122-124, CHARING CROSS RD., LONDON, W.C.2.

Components of Distinction & Quality



Constructor's Kit containing principal components for building a Seven Valve Set, £10. Three Transformers, one Filter, and fixed Condenser, £4. Interchangeable Oscillator Couplers: 250-550 metres, £1. 550-2000 metres, £1. Base for same, 4/-.

Pioneers in Super-Het Components

The world-wide success of BOWYER-LOWE Super-Het Components and Receivers has not been due to chance. BOWYER-LOWE were Super-Het pioneers. Long before other manufacturers had begun to think of Super-het production, BOWYER-LOWE designers were at work. Laboratory research was followed by elaborate and exhaustive testing and no component was introduced until it had satisfied the high standards of BOWYER-LOWE performance.



THE "WHITE-LINE" VALVE HOLDER, 2/3.

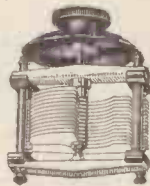

"POPULAR" CONDENSER
 '0003 .. 10/-
 '0005 .. 10/6

WRITE TO-DAY FOR A COMPLETE LIST OF OUR PRODUCTIONS



BOWYER-LOWE CO. LTD., LETCHWORTH

A BOOK THAT EVERY EXPERIMENTER SHOULD HAVE:
 "The Bowyer-Lowe Standard 7 and 8-valve Super-Heterodyne"
 How to Build and Operate. By A. E. BOWYER-LOWE.

PRICE - - 2/-

Send your remittance for a copy to-day.



For R·C Circuits

THE fixed Mica Condenser (Type B775) shown here is designed for use in Resistance Capacity amplifiers and in other circuits where condensers of large capacity are required to withstand potentials of several hundred volts.

They are tested during manufacture at a potential of 500 volts D.C. and are hermetically sealed in handsome black bakelite cases carrying screw terminals and solder tags.

Standard capacities and prices are as follows:—

Capacities	Prices	Capacities	Prices
0.02 mfd.	5/6	0.09 mfd.	8/-
0.03 "	5/6	0.1 "	8/6
0.04 "	5/6	0.125 "	10/-
0.05 "	5/6	0.15 "	12/-
0.06 "	6/6	0.2 "	15/6
0.07 "	7/-	0.25 "	19/-
0.08 "	7/6	0.3 "	22/6



Advt. of the Dubilier Condenser Co. (1925), Ltd.,
 Ducon Works, Victoria Road, North Acton, W.3

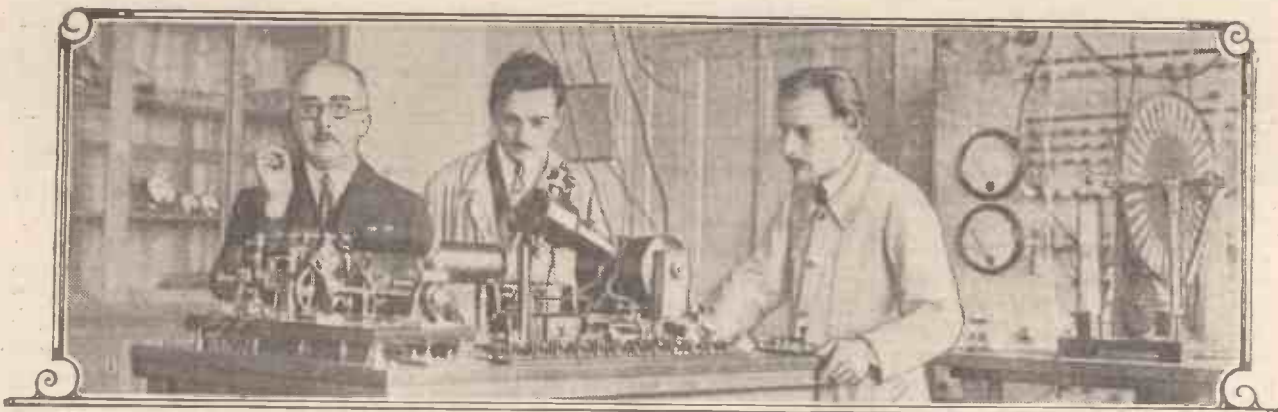

In the Front Line of Research

REVIEWING recent developments in wireless technique, it is surprising to find how frequently one can identify this or that advance as a mere re-discovery of some more or less obscure "dug-out" from the physics laboratory, or else as a happy revival of some theory which has previously been tried out and abandoned.

For instance, the modern practice of using low-powered short-wave energy for long-range transmission, and the use of reflectors for concentrating short-wave radiation along a definite path or beam, are both

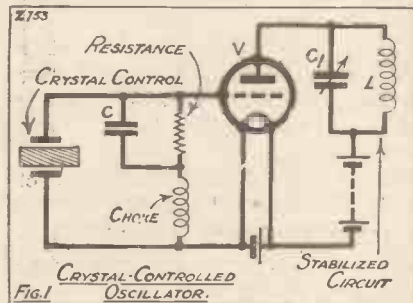

One of the most important uses for piezo crystals.

revivals of short-wave experiments originally carried out by Hertz and other early pioneers, but subsequently abandoned in favour of high-powered working on the longer wave-lengths.

Stabilising Frequency

Again, the discovery that quartz crystals could be used to stabilise the carrier frequency in broadcast transmission, and the application of obscure optical effects to produce sensitive cells for use in television or picture signalling, may be cited as examples where radio development has imparted a new and practical importance to scientific "curiosities"

The New and the Old—Laboratory "Dug-outs"—Modern Radio applications.

By **SEXTON O'CONNOR.**

that had previously found no useful application outside the research laboratory.

Piezo Crystals. The fact that quartz and certain other crystals would develop an electrical charge or reaction to an applied mechanical pressure was discovered as far back as 1880 by the brothers Curie. They called the effect piezo-electricity, from the Greek piezo, meaning "to press." Apart from some attempts to utilise this phenomenon in microphones and sound-recording instruments, it was regarded more or less as a laboratory curiosity.

Natural Vibration Period

In 1922, Professor W. G. Cady, of the Connecticut University, discovered that the piezo effect was associated with—or, rather, was the symptom of—a bodily or mechanical vibration of the crystalline mass of the quartz. Each piece of crystal had, in fact, a natural or inherent vibration frequency which depended mainly upon its size, and varied in practice between 50,000 and 15,000,000 cycles per-second. A slab of quartz approximately 2 millimetres thick will oscillate at a frequency corresponding to a wave-length of 200 metres. By doubling the thickness the frequency is halved (or the wave-length doubled), and vice versa.

No other substance is capable of vibrating bodily at frequencies sufficiently high to be utilised as a direct

master-control or stabiliser for a wireless transmitter. There are other means for standardising frequency, but none so simple or direct in operation as the quartz crystal.

Crystal-control

Fig. 1 shows a typical crystal-controlled oscillator. The crystal is inserted in the grid circuit of the valve V, and is shunted by a leak resistance and choke, the resistance being paralleled by a discharge condenser. A tuned anode, L, C₁, provides the stabilised oscillatory circuit, which is usually coupled to further stages of amplification.

The crystal oscillator will undoubtedly find other applications in the near future, apart from transmission. For instance, it can be applied to anchor the frequency of the local oscillator in certain classes of heterodyne receiver, and also to provide a super-selective coupling between two stages of high-frequency amplification, in the manner shown in Fig. 2, thus serving to cut out undesired signals or other disturbances.

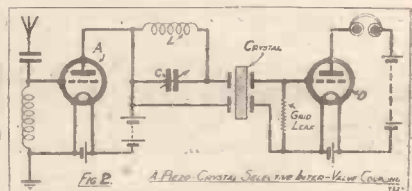

An interesting receiving circuit.

A high-frequency amplifier A is coupled to a detector D by inserting the quartz crystal across the condenser C of the tuned-anode circuit L, C. Only those signal voltages which correspond to the inherent frequency of the crystal are thus

In the Front Line of Research—continued

transferred to the grid of the detector, all other frequencies being filtered out or made ineffective.

A Clue to Gravitation. In connection with the peculiar optical and crystalline properties of quartz, it is interesting to note that recent investigations carried out by Kowsky and Frost in Poland appear to show that a quartz crystal loses weight when subjected to high-frequency potentials. If these experiments can be verified, they will throw a new and highly interesting sidelight upon the nature of gravitation and its relation to electro-magnetic forces.

Television. Some fifty years ago, Dr. Kerr, of Glasgow, pointed out that when glass and certain other dielectrics, such as carbon bisulphide, are placed in an electric field, they acquire the property of rotating the plane of polarisation of a ray of light. The extent of the "twist" so imparted to the light ray is proportional to the strength of the applied field.

This curious fact is now being exploited in the form of the Karolus cell by the well-known Telefunken Co., of Berlin, in their new system of television.

The Karolus Cell. The cell consists of a thin glass vessel filled with carbon bisulphide. It is connected across the output circuit of an amplifying set so that it is subjected to the varying voltages of the received signals representing the elements of the transmitted picture. A ray of light which has previously been polarised by passing through a Nicols tube is then focussed on the cell.

The transmitted light rays are then "twisted" through varying angles corresponding to the voltage changes of the incoming picture signal. The twisted ray is subsequently passed through a second Nicols tube so that its intensity, as it emerges, gives an accurate reproduction of the light and shade effects of the signal picture at the transmitting end.

The Faraday Effect

The Faraday Effect. In 1845, Faraday discovered that glass acquired the power of rotating the plane of a polarised beam of light when placed in a magnetic field of force. This can, of course, be utilised in television systems in the same

way as the Kerr effect by placing the sensitive glass in the field of an inductance coil, instead of across the condenser, as described above.

It has also been known for many years that the action of glass upon polarised light varies with the mechanical stress applied to the glass, and attempts are now being made to utilise this phenomenon in connection with the transmission of visual effects by wireless and line telegraphy.

The Hall Effect. Taking a thin metal strip of some width through which an electric current is passing, one can imagine the flow of electrons to take place in lines parallel to the sides of the strip, as shown in Fig. 3. If now a magnetic field be applied to the conductor across the thickness of the metal, by two pole-pieces, of which only the lower is shown in the figure, it is found that a transverse electro-motive force will be set up in the direction of the arrows a, b, c.

This peculiar effect, which was discovered by Dr. Hall in 1879, has quite recently been suggested as a means for receiving wireless signals in a manner somewhat similar to

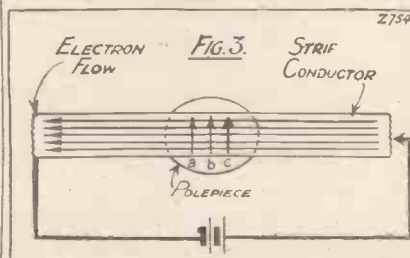

A diagram illustrating the Hall effect.

that originally used by Marconi in his well-known magnetic detector.

The inventor, however, goes considerably further than this. He also proposes to use it as a means for amplifying high-frequency currents. As shown in Fig. 4, his arrangement consists of a number of strips, A, B, C, connected up in series for the Hall effect between the points P and Q, and fed in parallel with current from a common battery D.

Origin of Screening

Incoming signals from the aerial are passed through a tuned circuit L, C_1 , and an associated loop winding L_1 , surrounding the strips A, B, C, and the resulting magnetic field creates a "Hall" electro-motive force across the points P, Q. The output current from the points P, Q is then

back-coupled through a winding L_2 to the aerial in the same way as with a valve amplifier.

Screened-grid valves. The new type of valve in which inter-electrode capacity coupling is prevented by using a second grid or shielding member to screen the control grid from the electric lines of force coming from the plate is another interesting innovation based upon a very old experiment of Faraday's.

Polarised Radiation

He constructed a cubical box measuring 12 ft. each way, covered it externally with copper wire and tinfoil, and insulated it from earth. Although the box was charged up on the outside to a pressure of many thousand volts from a powerful electric machine, no trace of an electrical field inside could be discovered by the most sensitive measuring instrument.

He says: "I went into the cube and lived in it, using lighted candles, electrometers, and all other tests of electrical states. I could not find the least influence upon them, though all the time the outside of the cube was powerfully charged and large sparks were darting off from every part of its outside surface."

The same screening action of a conducting surface is also to be seen in the modern practice of enclosing all high-frequency transformers and similar windings in separate metal cases in order to prevent the fields of force from spreading from one stage of amplification to the next, and so giving rise to undesirable interaction between the different circuits.

Polarised Radiation. Among his earliest experiments Hertz showed by means of a grid-iron frame of wires that electro-magnetic waves could be polarised. Up till quite recently no particular use was made of this aspect of radiation, apart from some later experiments by Artom, who devised a system of directional and secret signalling based upon the use of circularly polarised waves.

Within the last two or three years, however, various investigators, amongst whom may be mentioned Alexanderson and Pickard, have discovered that fading effects can be largely eliminated, particularly in the case of short-wave signalling (where fading is usually most troublesome) by using horizontally polarised radiation.

FERRANTI RADIO PRODUCTS

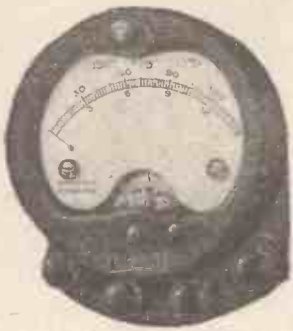

PORTABLE TYPE PR_{3a}
PRICE (as illustrated) £2 7s. 6d.



PROJECTING TYPE RI_{Pa}
PRICE (as illustrated) £1 10s. 0d.

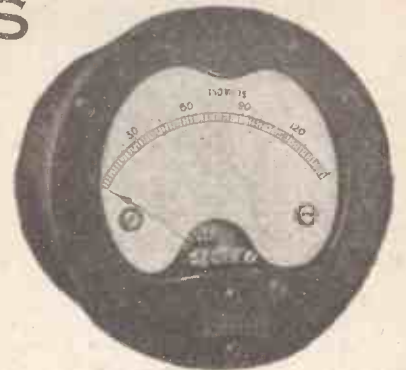

FLUSH TYPE RI_{Fa}
PRICE (as illustrated) £1 10s. 0d.

RADIO METERS



THE SPEAKER
with
The Exponential Horn
PRICE £3 3s. 0d.



TRANSFORMERS
for
1. Audio Frequency
2. Push Pull
3. Output (Telephone)
and
4. Chokes
Price according to type.



FIXED CONDENSERS
Type C₁. PRICE 8/-
" C₂. " 4/-

Ask your dealer
for
Lists
Wa 406.
Wa 406/2.
Wa 408.
Wa 409.

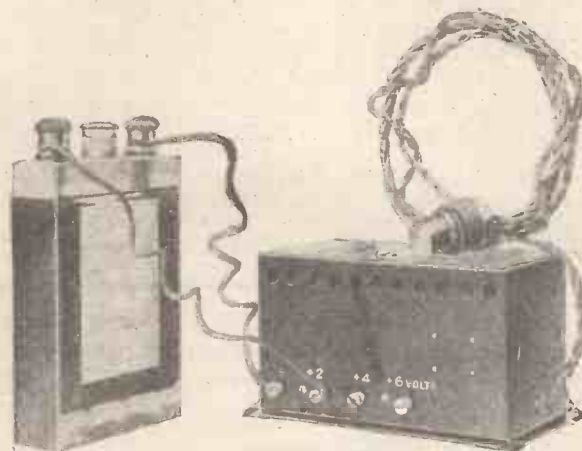

THE TRICKLE CHARGER
PRICE 55/-

For charging L.T. accumulators at home.
Consumes only 1 unit in 80 hours. Charges at the rate of 0.5 amperes.

Ask your dealer
for
Lists
Wa 405.
Wa 410.
Wa 411/1.
Wa 411/2.
Wa 412.

FERRANTI LTD.
HOLLINWOOD
LANCASHIRE



"ROYAL SUPER"

Made by Thordarson

Realistic tone quality—that elusive but much talked-of characteristic of radio reception—can be obtained only through the use of apparatus of the finest materials and workmanship. For years Thordarson Transformers have been the choice of many discriminating manufacturers of quality receiving sets. Follow their lead. If you enjoy good music fit Thordarson's! Made in one Ratio only—for all stages. Housed in handsome metal casing. Size $2\frac{1}{2} \times 2\frac{1}{2} \times 3$ ". Weight 2 lb. Type R.200. Audio-Frequency Transformer **21/-** Price, post free.

Thordarson Choke. For Filter Circuits and as an Output Choke. Has the same outward appearance and size as R.200 and is similarly housed. Current carrying capacity 20 m/a. Inductance 30 henries. Type R.196. 30-henry Output Choke. Price, post free, **12/-**

Hamleys
Estd 1760
HAMLEY BROS. LTD.

Telephone: 200/2, REGENT STREET, LONDON, W.1. Telegrams: Regent 3160 (6 lines). "Pleasingly Piccy."

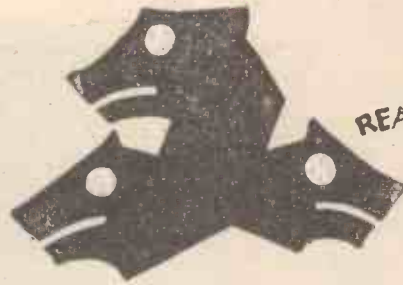

EXTRAVAGANT
QUALITY
REASONABLE PRICES

No money and no pains have been spared to make Hydra Condensers "the Zenith of Quality" yet owing to modern methods of manufacture and a great demand the prices are exceedingly reasonable. Aren't they?—

Prices: Tested on 500 volts D.C.
1 mfd., 2/6 2 mfd., 3/6 4 mfd., 5/3

Prices: Tested on 750 volts D.C.
equal to 500 volts A.C.

1 mfd., 3/- 2 mfd., 4/- 4 mfd., 6/9

Inquire for prices of Condensers tested at 1,000, 2,000, 4,000 and 6,000 volts D.C.

From all good dealers or direct from

LOUIS HOLZMAN

34, Kingsway, London, W.C.2.

Telephone: Holborn 6209.



HYDRA

A FREE BLUE PRINT

with the SPECIAL XMAS NUMBER of

"MODERN WIRELESS"

On Sale December 1st

PRICE 1/6

Do not fail to get your copy of the Christmas Number of "MODERN WIRELESS," which will be on sale at all bookstalls and newsagents on December 1st. It will contain many specially attractive technical features, including the first published details of

THE VIKING IV

A fine blue print of this receiver will be given away with every copy. As this Xmas issue of "MODERN WIRELESS" will also be considerably enlarged, it will be the most magnificent wireless magazine value ever offered for 1/6.

ORDER YOUR COPY OF THE CHRISTMAS DOUBLE
NUMBER OF "MODERN WIRELESS" NOW

IN THE FRONT LINE OF RESEARCH

—continued from page 138.

In the ordinary elevated type of aerial the waves are radiated with the electrical field vibrating vertically, whilst the magnetic field is horizontal or parallel to the earth's surface. This type of wave is vertically polarised, and it suffers large absorption losses when it is reflected from the Heaviside Layer. These absorption losses, in turn, cause serious fluctuations in signal strength at the receiving end.

Solution of Fading?

By using a large loop aerial mounted some distance above, and having its plane parallel to the ground, Alexander succeeded in radiating waves in which the electrical component is in the horizontal plane instead of in the vertical as before. Such horizontally polarised radiation suffers little loss on reflection from the Heaviside Layer, and signals are accordingly remarkably free from "fading," particularly on long-distance working.

interfering in the least with their normal function.

He proposed, in fact, to feed several different carrier-waves into the same lines, and by modulating each carrier-wave separately, to distribute several distinct signals or conversations at the same time. The separate signals were, of course, separated out at the receiving end by using a number of filter circuits, each tuned to a particular carrier frequency.

Alternative Programmes

This discovery is the origin of the so-called wired-wireless method of broadcast transmission. Although the principle is now nearly fourteen years old, very little practical use has been made of it until the last year or so.

Increasing congestion in the ether, and the consequent difficulty in securing a reasonable selection amongst the various broadcast programmes, is now forcing attention to the possibility of using "wired wireless" as a substitute for radiated programmes. This is particularly so in the case of large towns where the bulk of listeners are swamped by the local broadcasting station.

By making use of the existing electric supply network it is quite

amplification, as compared with the usual two- or three-valve set necessary for feeding a loud speaker from an outside aerial.

Wired-wireless distribution has already been successfully tried out both on the Continent and in America, and it is by no means improbable that in the near future it will prove a formidable competitor to the present system of radiated broadcast.

 * A TIME-SAVING *
 * DEVICE *

OFTEN the experimenter finds that there are pairs of terminals that he has to connect and disconnect frequently, e.g., L.T., H.T., telephones, loud speaker. This device was thought out with a view to saving time and also to prevent the free ends, in the case of batteries, from "shorting."

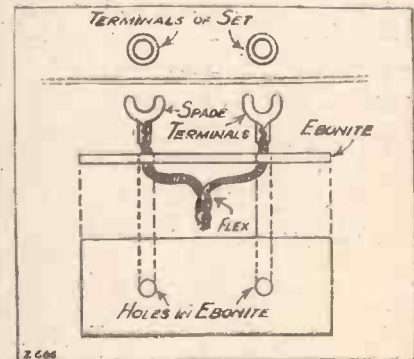

The figure shows a plan of it. It consists of an odd piece of ebonite $\frac{3}{8}$ in. to $\frac{1}{2}$ in. in thickness by $\frac{3}{4}$ in. approx., and about $\frac{1}{2}$ in. longer than the distance between the terminals on the panel. This is bored with two holes, as shown, to take the flex, which is pushed through, fastened, and soldered to an ordinary spade terminal which is then pushed firmly into the hole.

The ebonite may be extended to take 3, 4 or even more wires.

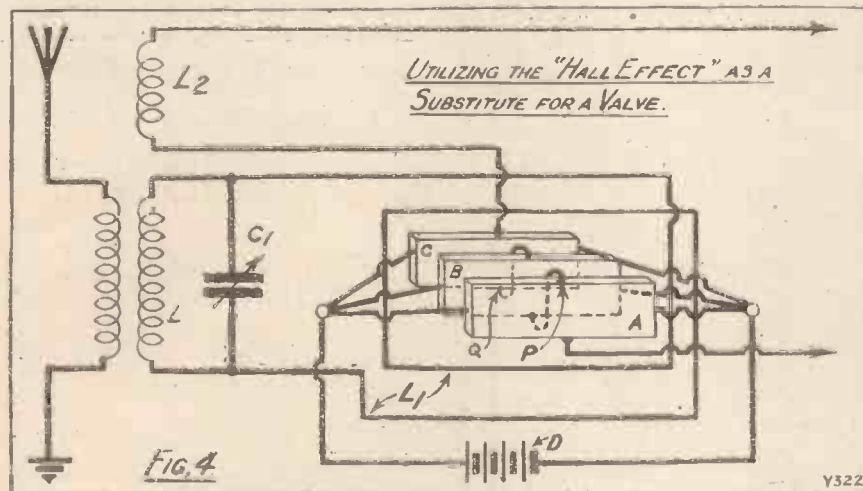

An interesting circuit where the Hall effect is utilised as a substitute for a three-electrode valve.

Although this particular development is still in its initial stages the results secured have proved very promising, and it appears likely that the use of plane or circularly polarised radiation will in the course of time result in freeing short-wave transmission from the bugbear of fade-out.

Wired Wireless. As early as 1914 Major-General Squier discovered that it was possible to superpose modulated high-frequency oscillations upon ordinary electric-light mains, or existing telephone wires, without

possible to distribute from four to six alternative "wired-wireless" programmes, any one of which can be selected at will simply by plugging in a suitable filter unit.

An Efficient Scheme

Wired wireless has an additional advantage because the strength of the currents as fed over the supply wires is sufficient to give ample loud-speaker strength upon an inexpensive outfit comprising a crystal detector and only one stage of low-frequency

Do You Read
 the brightest and best of all radio weeklies
POPULAR WIRELESS
 which keeps you up-to-date with all the latest developments in wireless science.
Order A Copy NOW!
 On Sale Everywhere. Price 3d.

A TAPPED H.F. CHOKE

Though easily made at home, this little component is very efficient in use.

By G. E. DYER

THE tapped H.F. choke described in this article was made by the writer at the cost of a few pence, and is quite satisfactory in his four-valve set.

The components required are one piece of round hardwood $4\frac{1}{2}$ in. long and 1 in. diameter, two pieces of ebonite, one 2 in. by $1\frac{1}{2}$ in. by $\frac{1}{4}$ in., and one round piece 2 in. in diameter, two valve legs each with two nuts, three tapping studs, one terminal, one piece of thin brass $1\frac{1}{2}$ in. by $\frac{1}{2}$ in., four round-head brass wood-screws $\frac{3}{4}$ in. long, and 2 ozs. of No. 42 S.W.G. S.S.C. wire (the wire off a Ford secondary coil was used by the writer).

First prepare the hardwood column by making five grooves $\frac{1}{4}$ in. wide and

Now prepare the top piece of ebonite by drilling six holes, as shown in Fig. 2, three for the tapping studs $\frac{1}{8}$ in. from the centre, one in the centre for the terminal, and two for the screws

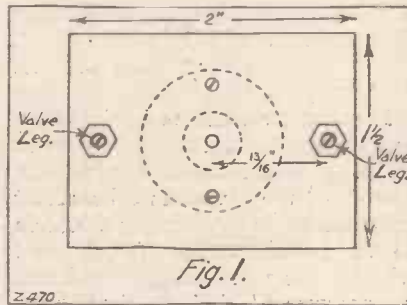

$\frac{3}{8}$ in. from the centre. Put the studs and terminal in, leaving nuts free. The terminal should have locking nuts on the bottom end, and a spring washer on the top, under which the piece of brass which forms the switch, and is shaped as in Fig. 3, revolves.

The Three Tappings

The bottom piece of ebonite 2 in. by $1\frac{1}{2}$ in. by $\frac{1}{4}$ in. can now be prepared. Two holes $\frac{1}{8}$ in. from the centre for the valve pins, and two holes $\frac{3}{8}$ in. from the centre for the wood-screws, and a centre hole $\frac{1}{8}$ in. diameter in the centre must be drilled. Screw this bottom plate on to one end of the column, and commence winding on the wire after having fixed one end to one of the valve pins. Wind on 200 turns in each slot, laying the wire in the shallow cuts (c) when passing from one slot to the next.

After the third slot is wound pass the wire, doubled, through the hole at (x) into the centre boring and up to the top of the column, allow 2 in. for connections, and then continue winding the next slot, doing the same at the other two holes after each 200 turns.

When the windings have been completed join the other valve leg to the terminal switch at the top by passing a piece of flex about 6 ins. long through the centre bore and the centre hole in the bottom plate, thus connecting the switch with the second

pin, the flex being fastened at the top between the lock nuts.

Screw the top plate on to the column with the three doubled ends passing out between the wood and the top plate, connect these ends to the studs, and the choke is complete with tapings at 600, 800, and 1,000 turns.

More tapings could be taken, but these three are found to be quite sufficient.

The choke holder is simply two single valve sockets screwed into a piece of ebonite or the panel of the set, $1\frac{1}{2}$ ins. apart.

 * AN AERIAL *
 * HINT *

THE first part of the summer was very wet, and our aerials, which were quite taut during the wet weather, may now have sagged very considerably. This sagging generally means that the lead-in, which would previously clear the house, is now dangerously near it and a slight wind may swing it against metal

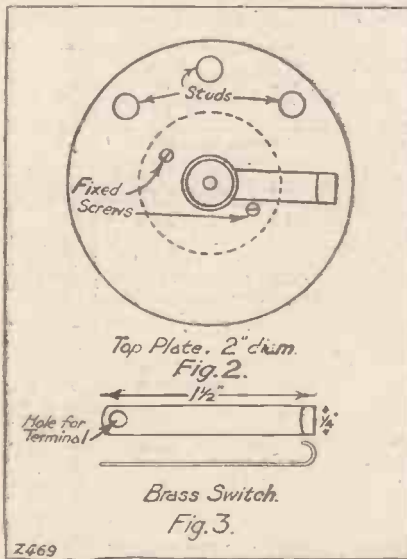

$\frac{1}{8}$ in. deep round the column, as shown in Fig. 4—this can be done with the square edge of a file if a lathe is not available. Then bore or burn a hole $\frac{3}{8}$ in. diameter through the whole length of the centre as at (a) in Fig. 4.

Shallow Cuts for the Wire

At (x) Fig. 4 drill three small holes from the circumference to the centre for the wire to pass through, and join the five grooves with some shallow cuts made with a penknife, one in each spacing, as at (c) Fig. 4. These cuts are for the wire to lie in when passed from one groove to the next.

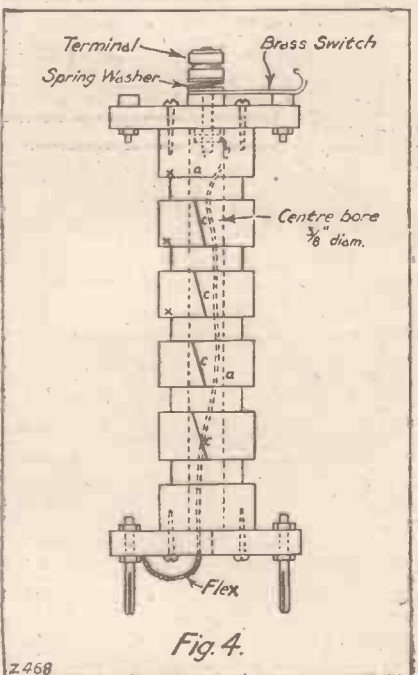

gutterings, causing loss of signals, or more often a series of irritating noises which are frequently put down to atmospheric trouble. Whenever there is a long spell of dry weather have a look at your aerial to see whether the leads are loose.

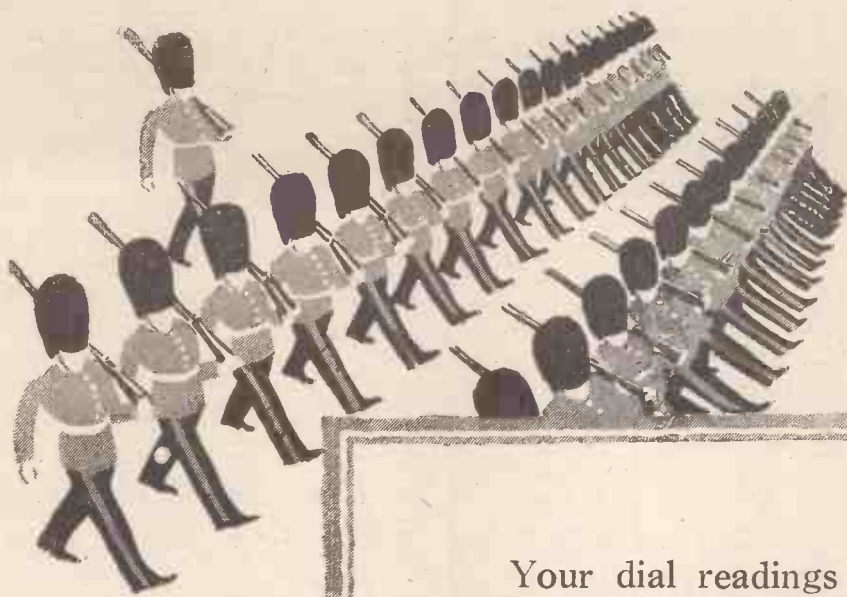

**All
in step!**

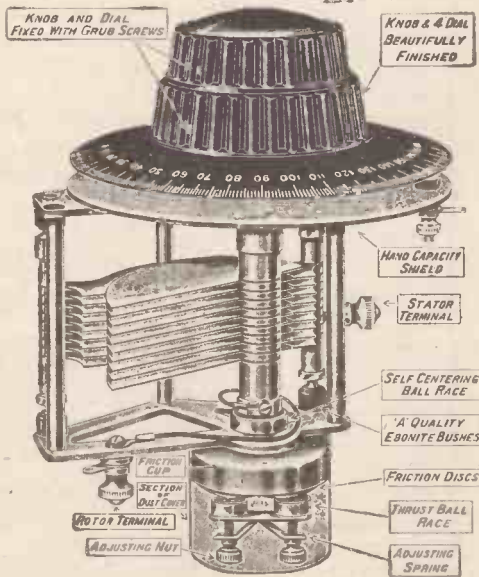

Your dial readings will keep all in step throughout the entire tuning scale if you instal Ormond Logarithmic Condensers in your set. And for ease in searching, when multi-tuned circuits are used, these condensers are indispensable.

Similar in construction to the Ormond S.L.F. Condenser, the Ormond Logarithmic Condenser's efficiency at radio frequency potentials is of the same highest standard.

Complete with 4 in. Bakelite Knob and Dial and Earthing Shield.

PRICES :		
With Friction Control		
·0005	- -	20/-
·00035	- -	19/6
·00025	- -	19/-
Without Friction Control		
·0005	- -	13/-
·00035	- -	12/6
·00025	- -	12/-



Write for our descriptive leaflet.

199-205, PENTONVILLE ROAD, KING'S CROSS, LONDON, N.1.

Tel. phone : Clerkenwell 9344-5-6.

Telegrams : "Ormondengi, Kincross."

FACTORIES : WHISKIN STREET AND HARDWICK STREET, CLERKENWELL, E.C.1

Continental Agents : Messrs. Pettigrew & Merriman Ltd., "Phonos House," 2 & 4 Bucknall St., New Oxford St., London, W.C.1.

Uniform change of Reading

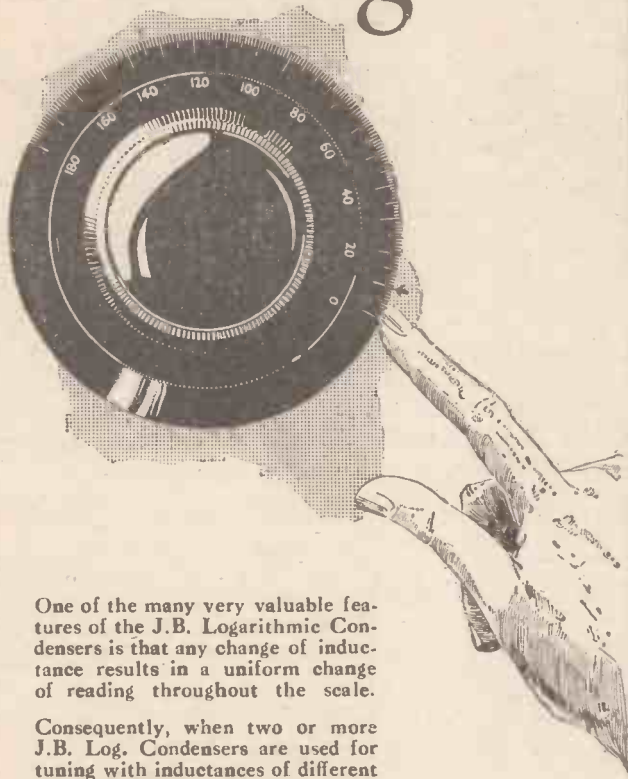

One of the many very valuable features of the J.B. Logarithmic Condensers is that any change of inductance results in a uniform change of reading throughout the scale.

Consequently, when two or more J.B. Log. Condensers are used for tuning with inductances of different values, they keep "in step" over the whole scale.

A unique feature of the J.B. Log. Condensers is that they are provided with rigid ball bearings for rotor—these bearings will never wear out, or give trouble of any kind.

J.B. Log. Condensers are proving the popular models of a popular condenser.

Prices: J.B. Log. Plain. .0005 mfd. 11/6; .0003 mfd. 10/6; .00025 mfd. 10/-; .00015 mfd. 10/-

J.B. Log. Slow Motion. Double Reduction Friction Drive, Ratio 60-1. Complete with 2" Bakelite Knob for vernier control and 4" Bakelite Dial for main control. .0005 mfd. 16/6; .0003 mfd. 15/6; .00025 mfd. 15/-; .00015 mfd. 15/-

Send for full particulars of our S.L.F. and Neutralising models.

JACKSON BROS.
8, POLAND ST—OXFORD ST Telephone:—
LONDON—W.1. GERRARD 7414

You can't burn off the tinning!



Impossible, you say! Well, take your "Peerpoint" Soldering Iron and place it in the gas flame or fire, and then leave it as long as you like! When you take it out red hot the tinning will be intact. Why? The tinned portion of this wonderful iron is not inserted in the flame at all. The Junit "Peerpoint" Soldering Iron is fitted with a sheath which is well-tinned, and which is removed when the bit is placed in the flame, and then replaced for the actual soldering operation, the heat travelling from the copper bit to the tinned sheath instantaneously. Thus you have the Fool-proof soldering iron which is always clean and well-tinned, and which makes all types of soldering the easiest thing in the world.

Price 3/6
(Patented).

Junit Self-Soldering Wire is specified in every circuit in the famous P.M. publication, "Radio for the Million." Is your set wired with it? If not, you have wasted unnecessary energy, time and temper in the wiring of your set.

Sold in attractive packets each containing five 2-foot straight lengths:

1/- PER PACKET

Ask your dealer for these Junit Products, and if he is unwise enough not to stock them, write direct to us.

The Junit Manufacturing Co., Ltd.
NAPIER HOUSE, 24-27, HIGH HOLBORN, LONDON, W.C.1.

The Home For Your Wireless Set

This HANDSOME PIECE OF FURNITURE will keep your wireless set free from dust and locked up to prevent meddling. Think of the comfort to have no more wires across the room, no batteries on tables or carpets; you just unlock and tune in!

Our Standard WIRELESS CABINETS are made in three sizes, on mass production lines, hence the low prices, and can accommodate any receiver or panel up to 30" x 18". SOLID OAK or MAHOGANY throughout (no Plywood used) and perfect workmanship guaranteed.

From £4. 15. 0.

Write to-day for free descriptive pamphlet and suggestions for adapting your receiver or panel in our Standard Cabinets. DELIVERY from stock ON APPROVAL. Thousand Cabinets already supplied to the utmost satisfaction of our clients. MAKERIMPORT CO. (Dept. 20), 50a, Lord Street, Liverpool.



Model "D"

CENTRE-TAPPED COILS and HOLDER



Universal Coils—use not being limited to centre-tapped circuits, fit any standard socket, easily interchangeable, and occupy minimum baseboard space.

Size.	Price.	Approx. No. of Turns.
a2	4/10	18
a	4/10	25
A	5/-	30
B1	5/3	40
B	5/6	60
D	5/9	75
D	6/3	100
E1	6/9	150
E	7/9	200
P	8/6	300
G	10/-	600

Prices quoted Standard Coil Centre tapped 6d. extra.

There is no neutrodyne condenser with as many good points as the NEUTRO-VERNIA. Cap. Range, approx. 2/38 m/mfds. Will not Short. Dust and Damp proof. Price 5/6

Coil Holder, specially designed for Gambrell Centre-Tapped Coils, does away with flexible leads. 1/9

Write for Booklet (G.F. 12) Free!



GAMBRELL BROS. LTD.
76, Victoria Street, London, S.W.1

SIMPLE FORMULAE AND RULES OF THUMB

From a Correspondent.

*

In this article some of the vital calculations of radio are so simplified that any amateur should be able to use them.

*

THERE are numbers of simple little formulae which can be of the very greatest assistance to the constructor and the experimenter. What may almost be called the fundamental formula of electricity is that known as Ohm's law, which is expressed as: $C = \frac{E}{R}$. Here C stands for the current in amperes, E for the potential in volts, and R for the resistance in ohms.

Knowing any two of these factors you can always find the third in a very simple way. Fig. 1 shows you how to do it. Cover up with your finger the factor that you wish to find, and what is left indicates the method of finding it. Thus, supposing that you wish to find the voltage you cover up E and you are left with $C \times R$, or current multiplied by resistance. To find resistance divide volts by amperes; to find amperes divide volts by ohms.

Working in Milliampères

When working in milliampères with this formula the volts are always multiplied by 1,000. Suppose, for example, that you wish to find the voltage when 10 milliampères are passed through a resistance of 10,000 ohms. Then $\text{volts} \times 1,000 = 10 \text{ milliampères} \times 10,000 \text{ ohms}$. This comes to 100,000, so that the volts are 100. Knowing the volts and the resistance and wishing to find the current we have: $\frac{100,000}{10,000} = 10 \text{ milliampères}$.

Again, if we know the volts and the current and wish to find the resistance the calculation is:

$$\frac{100,000}{10} = 10,000 \text{ ohms.}$$

A most useful formula is that which enables us to convert wave-lengths into frequencies and vice-versa. To find the frequency corresponding to a given wave-length divide that wave-length into 300,000,000; if you know the frequency and want to discover the wave-length divide the frequency

into 300,000,000. This is not an absolutely accurate formula, since it is based on the assumption that the speed of light is 300,000,000 metres a second, a figure which is not quite correct. The formula is, however, good enough for all ordinary working, and it was that actually used in preparing the present scheme of broadcast wave-lengths on a 10-kilo-cycle separation basis.

A Basic Radio Formula

If Ohm's law may be regarded as the basic formula of electricity, that of wireless is:

$$\text{Wave-length} = 1,885 \times \sqrt{L \times C}$$

This means that to find the wave-length to which a circuit is tuned you have only to multiply the square root of the capacity in microfarads by that of the inductance in

Armed with these figures the calculations are easily made. Suppose, for example, that we have a coil whose inductance is 300 microhenries tuned by a variable condenser whose maximum capacity is .001 and minimum capacity .0001 mfd.; what is the tuning range of the combination? For rough-and-ready calculations we can afford to neglect the self-capacity of the coil and stray capacities in the wiring. We have then simply: Maximum wave-length = $1,885 \times 17.3 \times .03162$, which comes to approximately 1,031 metres. The calculation for the minimum wave-length is: $1,885 \times 17.3 \times .01$, which works out to 326.1 metres.

An Interesting Fact

If either the inductance or the capacity in a circuit is doubled there is not a two-fold increase in the wave-length; actually it is multiplied not by 2 but by the square root of 2. The reason for this is clear from the preceding formula, in which the factors are the square roots of the inductance and the capacity. Similarly, in the example given above, the maximum capacity of the condenser is ten times the minimum and the maximum wave-length is the square root of ten times the minimum. The square root of 10 is 3.162 and if 326.1, the minimum wave-length, is multiplied by this the result is 1,031 metres.

But though doubling the inductance value does not double the wave-length, doubling the number of turns does do so. The reason for this is interesting. Supposing that on a former three inches in diameter 75 turns are wound so that there are 25 turns to the inch, the inductance of the coil so produced is approximately 300 microhenries. If, however, we double the number of turns, winding 50 to the inch, the inductance is four times as great.

Trebling the number of turns increases the inductance nine-fold, quadrupling the number increases it sixteen-fold, and so on. In other

FIG. 1.



microhenries and to multiply the result again by 1,885. Since not everyone will care to tackle the problem of finding the square roots of decimals the following table of commonly used capacities with their square roots will be found of great assistance.

Capacity.	Square Root.	Capacity.	Square Root.
.0001	.01	.001	.03162
.0002	.01415	.002	.04472
.0003	.0173	.003	.05476
.0004	.02	.004	.06324
.0005	.02231	.005	.07078
.0006	.02444	.006	.07761
.0007	.02645	.007	.08366
.0008	.02828	.008	.08943
.0009	.03	.009	.09486

Simple Formulae and Rules of Thumb—continued

words, the inductance goes up as the square of the increase in the turns and the wave-length is therefore double when twice the number of turns are put on.

There is an exceedingly useful formula for finding the inductance in microhenries of a given solenoid coil. Though they are not absolutely accurate, the results found by it are sufficiently precise for all ordinary purposes. Here it is :

$$L = \frac{(5 \times D \times T)^2}{B + \frac{1}{3}} \times \frac{1}{1,000}$$

L=inductance in microhenries.
D=diameter of coil in inches.
T=total number of turns.
B=breadth of windings.

Let us see how the 75-turn coil mentioned a moment ago works out by this formula. We have :

$$L = \frac{(5 \times 3 \times 75)^2}{5 + \frac{1}{3}} \times \frac{1}{1,000}$$

$$= \frac{1265 \cdot 625}{4}$$

= 316.4 microhenries.

Fixed Condensers

The formula for finding the capacity of fixed condensers is this :

$$C = \frac{.0885 \times K \times N \times a}{d \times 1,000,000}$$

C = capacity in microfarads.
K = dielectric constant.
N = number of dielectrics.

a = area of plates in square centimetres.

As an aid to making fixed condensers of given capacity there is, however, an exceedingly handy rule of thumb which works out very well indeed. This is simply $C = N \times a \times .0001$. This rule of thumb, which applies only when the best ruby mica .002 inch thick is used, means, in other

words, that if the overlapping area of the plates is 1 square centimetre the capacity will be .0001 mfd., if there is one dielectric, .0002 if there are two, and so on.

To find the total capacity of any number of condensers placed in parallel to one another, all that one has to do is to add the individual capacities together. If the condensers are in series the formula is :

$$\frac{1}{C} = \frac{1}{C_1} + \frac{1}{C_2} + \frac{1}{C_3}, \text{ etc.}$$

Formulae for Resistances

Here C is the total capacity in microfarads, and C1, C2, C3 the capacities of the individual condensers. Where two or more of equal capacity are in series the total capacity is that of any of them divided by their number. Thus, if we wire two equal condensers in series the resulting capacity is half that of either of them; if there are three it is one-third that of any of them, and so on.

For resistances the above formulae are exactly reversed. When resistances are in series the total resistance is the sum of all, when they are in parallel :

$$\frac{1}{R} = \frac{1}{R_1} + \frac{1}{R_2} + \frac{1}{R_3}, \text{ etc.}$$

When resistances of equal value are wired in parallel the total resistance is that of any of them divided by their number.

To find the correct value of the resistance in a rheostat or fixed resistor to be used in connection with a given valve, make use of the simple formula :

$$R = \frac{\text{Volts to be dropped}}{\text{Filament current.}}$$

Let us take an example. We desire to construct a fixed resistor for use with a valve whose filament requires 5 volts and passes .25 ampere. The

accumulator in this case will be a 6-volt one, and we therefore require to drop 1 volt. Dividing 1 by .25 we obtain the answer 4 ohms.

There is one exceedingly useful formula and one handy rule of thumb in connection with low-frequency amplifiers. The formula shows us the amplification obtainable in a resistance-coupled amplifier. All amplification must be done within the valve, since there can be no voltage step-up in the coupling; what we desire, therefore, is to find the value of anode resistance that will allow us to obtain a reasonable proportion of the valve's possible magnifying powers as shown by its amplification factor. The formula is :

$$M = \frac{R}{R + Z} \times \mu$$

M = actual amplification.
R = anode resistance in ohms.
Z = valve impedance in ohms.
 μ = amplification factor.

What amplification will be obtained from a valve with an amplification factor of 40 and an impedance of 80,000 ohms if a 500,000-ohm anode resistance is used ?

$$M = \frac{500,000}{500,000 + 80,000} \times 40$$

$$= \frac{1,000}{29}$$

= approximately 34.5.

It must, however, be remembered that so far as oscillating currents are concerned the grid condenser and the grid leak of the following valve are in parallel with the anode resistance.

The full amplification given by the formula will not therefore be obtained in actual working; the amplification will, in fact, be considerably less unless the grid leak has a value many times greater than that of the anode resistance.

A Positive Success

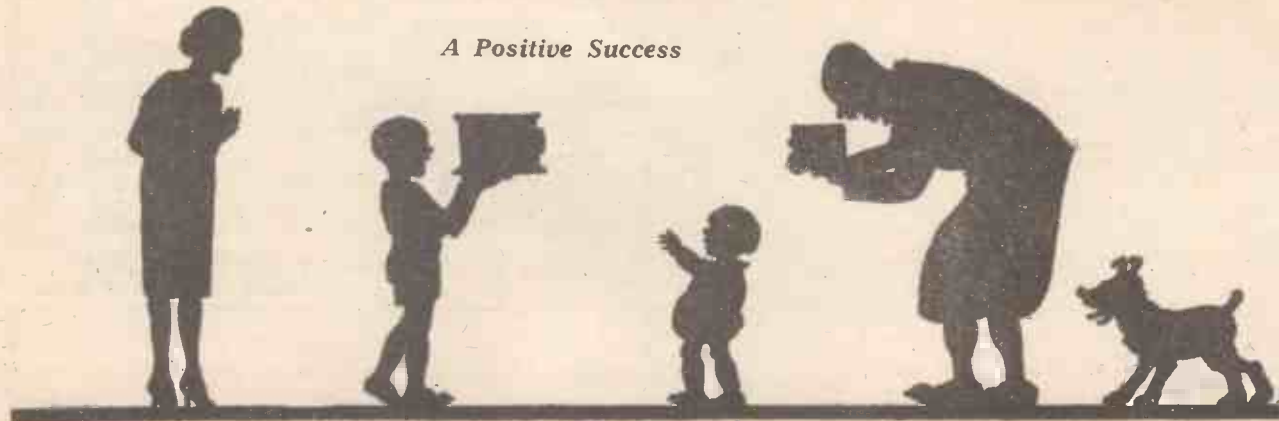

**THERE IS
NO FILAMENT
LIKE THE
WONDERFUL
MULLARD P.M.
FILAMENT**

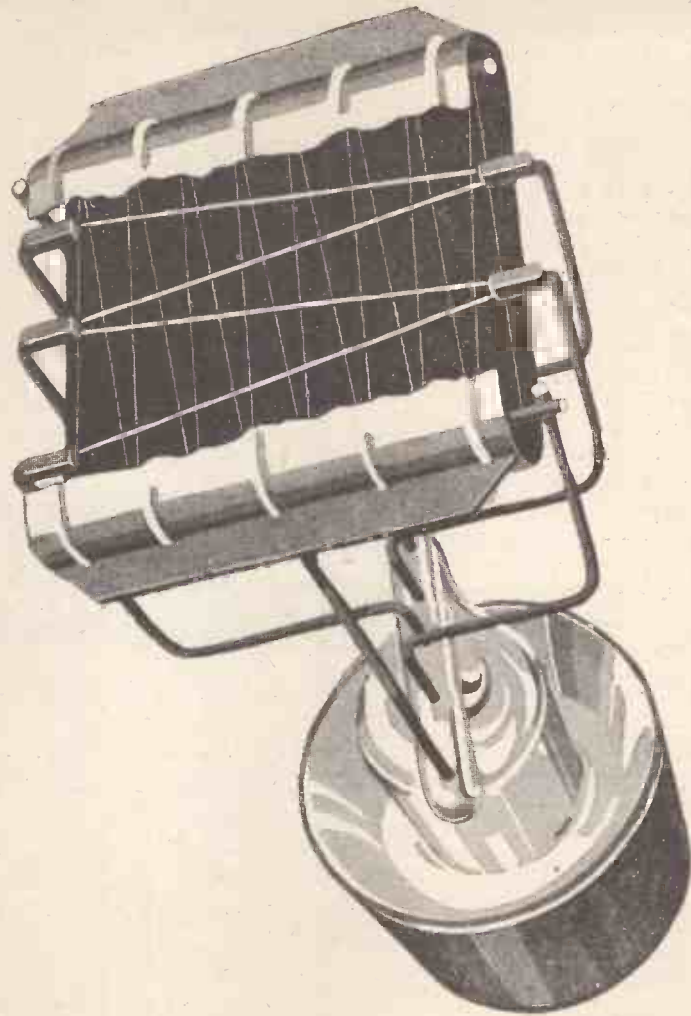

The filament that holds world preference because it improves any radio receiver . . . because it gives more value for lowest maintenance . . . because it is tough and lasts longest. The filament with huge proportions and enormous emission. A British filament found only in Mullard P.M. Radio Valves.

Mullard
THE · MASTER · VALVE

Advert. MULLARD WIRELESS SERVICE CO., LTD., MULLARD HOUSE, DENMARK STREET, LONDON, W.C.2.

THE BEST TERMINALS IN THE WORLD

THE NAME DOES NOT ROTATE
THE HEAD DOES NOT COME OFF

SOLDERING NOT NECESSARY
STEM WILL NOT TWIST LOOSE

WRITTEN GUARANTEE AND
CARTON FOR EACH TERMINAL



The names cannot be put on the wrong stems.

Highly polished black Bakelite Insulation.

Patent

Electric shocks prevented, and burnt-out valves minimised.

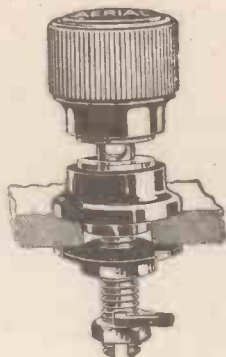

Soldering can be dispensed with by using the slot and extra nut. The smooth stem at the clamping gap prevents fine wire binding up in the thread. The collar has an insulation bush for wood or metal panels, and a wedge to prevent working loose.



30 different useful letterings.
Price 9d. each
(Type B)

Type "M". Non-rotating names as Type "B", but not insulated.

Price 6d. each.

Obtainable from all Dealers, but in case of difficulty send your order to us, enclosing your dealer's name and address.



BELLING & LEE, LIMITED, Queensway Works, Ponders End, Middlesex.

ARTCRAFT RADIO CABINETS BRITAIN'S BEST VALUE. NEW 1928 MODELS.

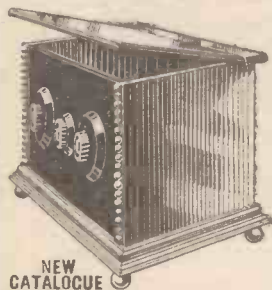

NEW CATALOGUE FREE

AMERICAN POPULAR TYPE (as illus.)

Panel Size	Baseboard Depth	Price in	
		Oak	Mahogany
9 x 6 x 6	6	8 0	12 0
10 x 8 x 6	6	10 0	14 0
12 x 8 x 8	8	14 0	18 0
16 x 8 x 8	8	17 6	22 6

Baseboards Free. Hinged Lids 1/8 extra. Add 1/- for crate. All Cabinets sent Carriage Paid.

PANELS FITTED AT STANDARD PRICES.

Obtainable from all dealers or direct from
The Artcraft Company,
158, Cherry Orchard Rd., Croydon

PRICE PER SET,
3/6
HIGHLY POLISHED,
4/6

THE "PAREX" HOLDER VALVE

(Patent applied for. Registered Design.)

THE ONLY PRACTICAL HOLDER

for the

NEW SCREENED VALVES.

AS USED IN

THE STRAIGHT FOUR

described in THIS issue.

As supplied to the valve manufacturers.

ORDER A SET NOW!

E. PAROUSSI,

10, Featherstone Bgs., High Holborn, LONDON, W.C.1. 'Phone: Chancery 7010

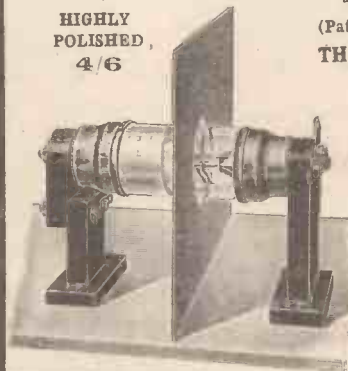

THE BEST TIP FOR 1928 USE FORMO COMPONENTS

1/-

FORMO - DENSOR

A sound variable condenser which fills a long-felt want.

Specially designed to take the place of the hitherto generally used Fixed Condenser. For use as:

- Neutralising Condenser
- Aerial Condenser
- Grid Condenser
- Reaction Condenser
- Phasing Condenser
- Tone Control Condenser

A fully illustrated, well-compiled work on the construction and uses of Radio components, including

BLUE PRINTS OF
THREE-VALVE "TRUE SCALE" SET

(Proportional L.F. Amplification.)

This gives reception with a fidelity unobtainable by any other known method, and a

TWO-VALVE SET



Full Catalogue free on request.

The FORMO Company, Crown Works, 22, Cricklewood Lane, London, N.W.2.

NOTES AND JOTTINGS

Two Filter Circuits—A Special Switch—Mounting Meters.

By A. V. D. HORT, B.A.

Two Filter Circuits

THE use of a filter circuit between the receiver and the loud-speaker is nowadays common enough, the arrangement depicted in Fig. 1 being usually employed. Here a fixed condenser of large capacity is inserted in one of the loud-speaker leads, the iron-cored choke Z providing a path for the steady anode current.

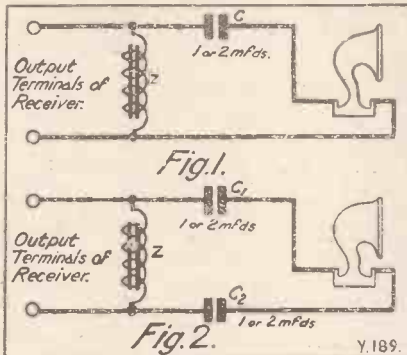

When the mains are used to supply H.T. to the receiver, some sort of filter circuit has still greater advantages. When long leads are used to connect up the loud speaker to rooms at a distance from the receiver, it is possible that a worn loud-speaker flex may at some time come into contact with a similarly worn lamp flex, with a consequent short-circuit of the supply mains. This risk can be obviated by adopting the filter circuit shown in Fig. 2. Fixed condensers are placed in both of the loud-speaker leads, the choke serving the same purpose as before. This isolates the loud speaker altogether from the mains. The condensers should be of 1 or 2 mfd. capacity, in order to pass efficiently the wide range of speech and music frequencies.

A Special Switch

THE receiver which I keep for local station work is equipped with a single switch to bring it into operation, both L.T. and H.T. being cut off when the receiver is not in use. The L.T. supply is drawn from accumulator, and the A.C. mains furnish H.T. through a home-constructed rectifier, with chokes and large smoothing condensers to get rid

of the ripple. The switch lights up the valve filaments first, putting on the mains immediately afterwards. On switching off, the mains supply is cut off first, after which the L.T. battery is disconnected from the filaments.

The effect of this is that the large capacity smoothing condensers are discharged via the ordinary anode circuit paths before the receiver is left. This precaution, not perhaps of such importance when the H.T. voltage is low, is worth taking in cases where the condensers are charged to a potential of several hundred volts, as they may be, for example, in a transmitting circuit. In any case it obviates the risk of a shock on touching the condenser terminals when the apparatus is not actually in use, since a good condenser will hold its charge for a considerable period.

The switch consists of two porcelain-mounted D.P.D.T. switches, fixed side by side on a baseboard and coupled together. The handles of the switches are removed, and in their place a strip of ebonite is bolted to the ebonite strips which join the pairs of blades. A single handle is secured to the centre of this strip for operating

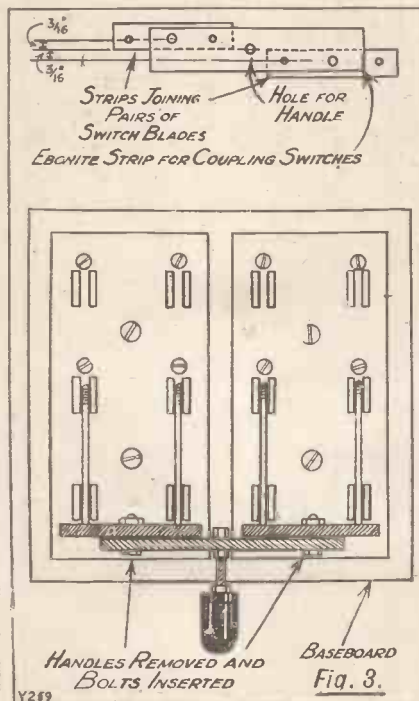

the switch. The drilling of the strip is carried out as shown in Fig. 3, so that one switch always closes before and opens after the other. To this switch the L.T. supply is connected. The blades of the other switch will not, of course, close right down into the contact clips, but they should be able to make firm contact with them when the blades of the first switch are right home.

The contacts on the other side of

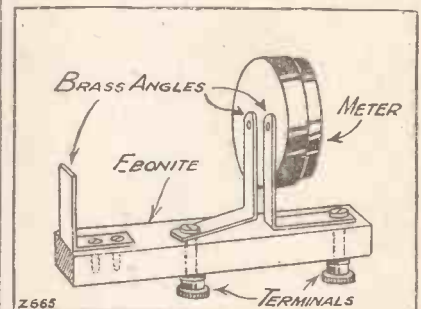

the switch are used for leading the L.T. and H.T. supplies to other receivers when required.

Mounting Meters

IT is usual to mount voltmeters and ammeters on the panel of the receiver, when they are to be used for one purpose only, but it is sometimes convenient to keep a meter outside the receiver for general service in experimental work.

Meters with terminals at the side may be fixed to the bench or to a vertical board at the back of it by means of screws through the flange. Meters of the flush-fitting type, with terminals behind, are not so simple to mount. It is unnecessary labour to cut a hole in a square of ebonite and mount this on the bench. An attachment for the meter may be made on the lines indicated in the accompanying sketch.

Thick ebonite is best for the main support, and the two brass brackets are secured direct to the meter terminals. Their other ends are bolted to the ebonite, the bolts serving as terminals for the connecting leads. A brass angle bracket at one end of the ebonite support allows the meter to be fixed on the bench in any convenient position.

WHAT'S NEW

A Choke Former

MESSRS. REDFERN'S have submitted for test specimens of their Ebonart high-frequency choke former, made of slotted ebonite and mounted on a suitable ebonite base

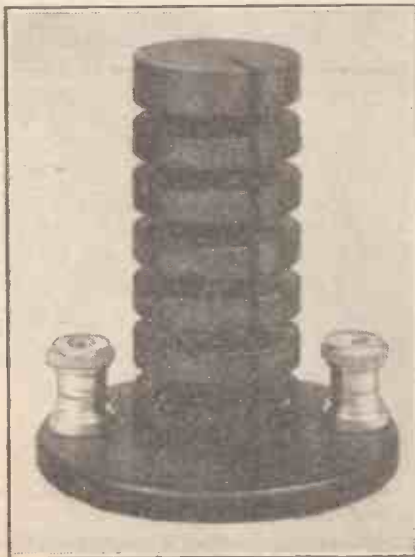

An "Ebonart" R.F. choke former.

with terminals. The idea is that the home constructor should wind his own choke on this former, thus giving himself the opportunity of much experimental work. The price is very reasonable and the former is very suitable for the purpose for which it is designed.

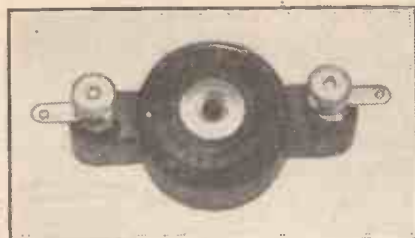

A well-made fixed condenser—"C.D.M."

Test Report on French Transformer

We have received from Messrs. Wholesale Wireless, Ltd., for test and report, a specimen of the Croix eliminator transformer. This is a compact

and well-finished component intended for use in H.T. eliminators working from alternating current mains. The transformer submitted was rated for 220-volt mains and was provided with two secondary windings, one to supply the H.T. voltage, and one the L.T. current for the filament of the rectifying valve. Both of these windings were provided with centre tapings, the L.T. winding being rated to give 3 volts on either side of this centre tap, and to supply a current of 1.5 amp. The H.T. secondary was rated to give 200 volts on either side of the centre tap, with a maximum current of 30 milliamps. On test with a rectifying valve of the U.5 type it was found that a current of 1.6 amp. was supplied at a voltage of 5.8 for the filament, indicating a creditably close conformity with the rating of the transformer. Upon passing the rectified

capacity is well within the limits of accuracy prescribed for such components. The job is well-finished and of pleasing appearance, and high-frequency tests proved satisfactory.

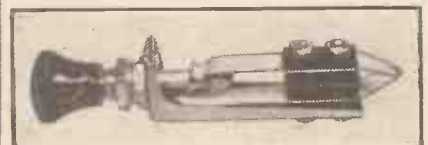

This on-off switch is a Bowyer-Lowe product.

A Jack Switch

The Bowyer-Lowe Co., Ltd., of Letchworth, have submitted their new Jack switch made on very similar lines to the well-known and excellent jacks and mounted in the same way. A plunger instead of the usual plug is, however, provided, and this gives a

A MONTHLY REVIEW OF TESTED APPARATUS.

(NOTE: All apparatus reviewed in this section each month has been tested in the Editor's private laboratory, under his own personal supervision.)

H.T. current through a low-resistance filter circuit, it was found that a supply of D.C. was available after smoothing at a voltage of 180 when 30 milliamps were being drawn. Prolonged running under these conditions of slight overload produced only a very slight rise of temperature in the transformer, and this component should be found to give perfectly satisfactory operation.

A Well-Made Fixed Condenser

The C.D.M. fixed condenser, submitted for test, is a very well-made component in bakelite moulding, fitted with adequate terminals and soldering lugs. The general appearance will be seen from the illustration. The central hole gives the advantage that the condenser can be fixed to the baseboard or to the panel with one fixing screw, while the measured

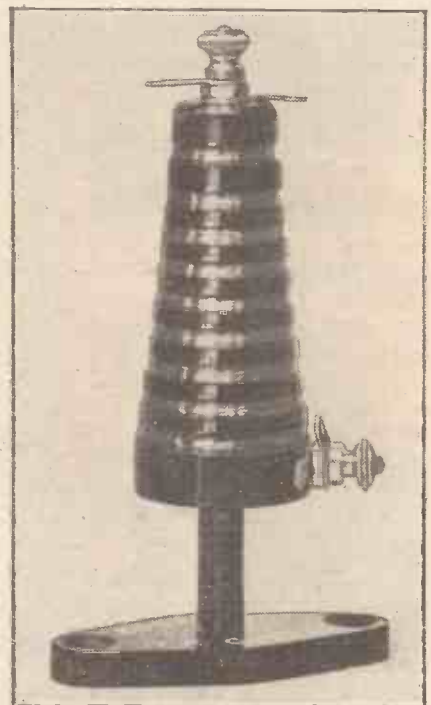

The "Eddystone" R.F. choke.

very definite on-and-off movement and a thoroughly sound low-resistance self-cleaning contact. The switch will satisfactorily carry far more

Being

honest



Mother and her cherub! Implicit confidence in each other always. And so with "ADICO" and the public. "ADICO's" aim is to keep the public's confidence.

No "secret process" has been responsible for the phenomenal increase in "ADICO" sales since 1925. The secret of "ADICO's" success is identical with that of nine out of ten other successful commercial propositions:

- (1) Long practical experience in manufacture.
- (2) Highest standards in raw materials consistently.
- (3) Capable workmanship carefully superintended.
- (4) Thorough testing before leaving factory.
- (5) Selling at a fair price.

Extract from test report in the "Broadcaster," Wireless Trade Paper, dated July, 1926.

"After six weeks' shelf life, with temperature varying from 55° to 70°, there was not the slightest drop in voltage. Our tests show the "ADICO" H.T. Battery to be excellent in every respect. Will meet the exacting demands made upon H.T. Batteries by present-day receivers. The price is very moderate."

Positively the finest value in the world

ADICO
BATTERIES

Prices:

H.T. 100 v. . . 12/6
 H.T. 60 v. . . 7/6
 H.T. 30 v. . . 4/-
 Grid Bias 9 v. . . 1/8
 Flashlamp 4.5 v. 4½d.

Large Capacity.

Torch 4.5 v. . . 1/1
 " 3 v. . . 9d.
 " 1.5 v. . . 4½d.

ADIE & CO., LTD., Dept. W., 2, Aldermanbury Avenue, E.C.2.

Telephone: London Wall 2474.

*If your dealer cannot supply you we will deliver, post free, on receipt of cash with
 :: :: order :: ::*

Dry Cells.

Spring terminals 1/10
 Screw " 2/3



Tungstone High Tension 96 Volt De Luxe

Special Ebonite and Rubber Insulation. No Current Leakages. 3 Amp. Hour Actual Capacity. Patented 12-16 Volt Low Tension Removable Charging shown on the Front of Illustration removed.

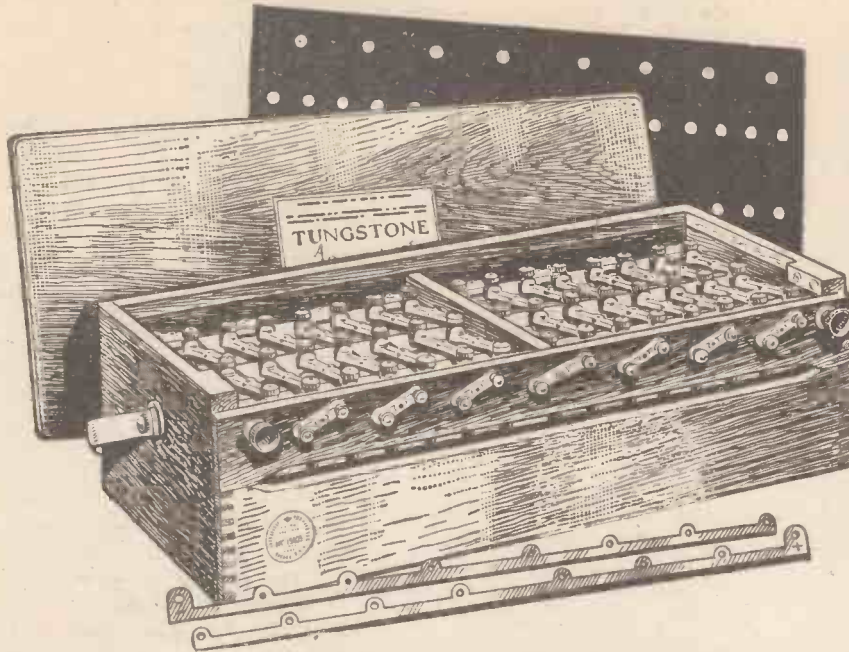

Showing Low Tension Charging Equipment removed.

Thick ebonite panel is fixed between each 48 volt section. All terminal bridge pieces are firmly mounted on an ebonite panel which forms the front of the cabinet. Rubber bands round each 2 volt unit secures independent separation and perfect insulation. Additional insulation is provided as all units stand on Rubber mat, and cabinet is fitted with rubber feet. The Cabinet is solid teak highly polished, with the new enamel, giving a glass hard surface that cannot be soiled or scratched. Twelve volt Sections can be taken out separately.

Price :

60 Volt - £5 15s. 0d.

96 Volt - £10 10s. 0d.

**Sold U.K. on Extended
Monthly Payments.**

Apply for Details.

TUNGSTONE DE LUXE HIGH TENSION Fitted with Patented Equipment for Charging on 12-16 Volt Low Tension Plant.

First Charge completed in the Short Period of 12 Continuous Hours. Re-Charges in Seven Hours.

The practical advantage of Tungstone's exclusive feature of **BALANCED PLATES**, in combination with Low Tension Charging Equipment, guarantees that the First Charge and all Re-charges are fully completed, consistently and reliably, which the present-day long period charging cannot guarantee and never secures, the basic fault necessitating heavy costs for repeated re-charges at short intervals.

HIGH TENSION PLATES. EXCLUSIVE FEATURES Never Before Achieved by any other Maker.

All Tungstone High Tension Plates are **SCIENTIFICALLY BALANCED** in correct weight proportions of the Grid and Pure Lead Paste, so that the Ampere Hour Capacity is evenly used up by an automatic proportional discharge of current from Positive and Negative Plates securing steady voltage. No abrupt changes in the potential. The drop slow and imperceptible. No Wood Separators prevent Voltage fluctuations due to polarization and internal resistance which is negligible. No frothing or foaming. No Sulphation. No Parasitical Noises in Phones or Loud Speaker. No sudden Plate failure at a critical moment demanding Voltage adjustments. The respective Plates are Certain to get their required proportionate charge of current. If correctly First Charged is a guarantee against uneven strain and irregular drain on Plates on Charge and Discharge, and there is no chance of a separate Cell discharging and reversing long before the others. The loss of charge on standing is low and the local action small.

The open Circuit Voltage will give due warning of the approach of the Battery to a discharged state. As H.T. Cells are small it is difficult to test the Specific Gravity. Balanced Plates allow greater dependability to be placed on voltage readings. Cells are not permanently ruined by being left standing for months.

For Post Free Copy of Free Booklet on **MODERN BATTERY FAILURES** containing Special Illustrated Articles, send name on Postcard to:—

TUNGSTONE ACCUMULATOR CO., LTD., The Independent Battery of the British Empire,
3, St. Bride's House, Salisbury Square, Fleet Street, London, E.C.4.

What's New—continued

current than the most extravagant valve sets can ever utilise, and it can be thoroughly recommended as a sound job.

The Eddystone Choke

A radio-frequency choke which has satisfactorily passed laboratory tests has been submitted by Messrs. Stratton & Co., Ltd. This takes the place of an earlier model which covered the lower broadcast band only, and is designed to cover both the ordinary and Daventry ranges. It consists, as will be seen, of a conical former with a number of slots, adequate terminals being fitted, together with soldering lugs. The choke itself is supported away from the base on a small pillar, the base being secured by two screws. This choke can be used quite satisfactorily in all ordinary circuits which call for such a device.

A Good Radio-Frequency Choke

From Bowyer-Lowe we have received a new radio-frequency choke, a particularly well-finished component of conical shape and a multitude of slots, giving a subdivision into far more sections than is often the case in radio-frequency chokes. This, of



The Bowyer-Lowe H.F. choke.

course, reduces the self-capacity appreciably. The choke has been submitted to the standard tests for radio-frequency chokes in this laboratory,

and has passed them all quite satisfactorily. The only criticism we would make is that the terminals are on the small side, but as soldering lugs are provided this is not a very important point. A thoroughly good and well-made component, it can be recommended to all readers.



A neat on-off switch (Wright & Weaire).

Neat On-and-Off Switch

From Messrs. Wright & Weaire, Ltd., we have received specimens of their new on-and-off switch, a very neat and small component which gives a sound and thoroughly satisfactory contact at the "on" position and a good break at the "off." The special points to look for in a laboratory test with regard to on-and-off switches are, firstly, that good positive contact should be made at the "on" position; secondly, that the "off" position shall be clearly defined when the switch is mounted on the panel, and, thirdly, that the insulation and mechanical make-up are good. The switch satisfactorily fulfils all these requirements.

A New General-Purpose Transformer

A new transformer in a brilliant orange casing is now being supplied by R.I.-Varley, Ltd., as an inexpensive general-purpose transformer for those cases where the constructor does not care to fit one of the more expensive types. At 15s. it is very good value, and while not giving quite so high a standard of reproduction as the larger "Straight Line" already reviewed, it is really excellent value for money, and is very much better than many transformers sold at higher prices.

Lissen H.T. Battery

Some months ago Messrs. Lissen, Ltd., submitted for test two specimens of their 60-volt H.T. battery. It is not the custom of this journal to issue immediate test report upon batteries,

for obviously the only satisfactory test is of performance under normal conditions. The batteries were immediately put on test in different fashions, one being given a regular and steady day-to-day use in conjunction with a normal receiving set, the set being used for two or three hours daily; while the other battery was used for general experimental work, sometimes for running powerful sets for two or three hours on end, the discharge taken in many of the tests being much in excess of that which one would normally, or reasonably, take from such a battery. At the end of four months both batteries were as lively as ever, showing a very small drop in voltage and being completely free from noise. The performance of these batteries is



The R.I.-Varley L.F. transformer.

considerably in excess of that which we expected for the low price charged, and they have proved considerably more reliable than several other higher-priced makes which have been tested in the laboratory.

We have one comment to make regarding the label of this battery and its use for grid-bias purposes. In examination of the battery shows that the negative end is tapped at each one-and-a-half volts up to seven and a half on the 100-volt size and up to four and a half on the 60-volt size. Instructions are given to plug the grid bias connection of the receiver into the negative socket and the H.T. negative lead to one and a

WHAT'S NEW

—continued from page 153

half, three, four and a half, etc., which will give the required value of grid potential. Now this scheme is quite excellent in receivers where H.T. negative is connected to L.T. negative, but is not satisfactory where H.T. negative is connected to L.T. positive, as is the case with a very large number of receivers, in fact practically all published in this journal. The advantage of connecting H.T. negative to the L.T. positive is that the voltage of the accumulator is added to that of the H.T. battery, and, as we usually desire to get all the H.T. voltage we can, this is a distinct advantage. If the scheme marked on the Lissen battery is used in a set where H.T. negative is connected to L.T. positive, the voltage of the accumulator is working against the voltage of the grid bias, so that with a six-volt accumulator if the grid bias negative is placed in the negative terminal of the battery and the H.T. negative in one of the tappings, say, six volts, the grid bias is exactly zero!

There is nothing whatever against the scheme in a set with H.T. negative connected to L.T. negative, but we would suggest that a note is made on the label that the scheme indicated only applies when a set is so connected.



The "Colvern" binocular former.

Headphones

From Messrs. Lissen we have received specimens of their new headphones—an inexpensive line of quite satisfactory instruments. They are marked 4,000 ohms and the

measurement shows that the resistance is sufficiently close to this figure, while the quality of reproduction and sensitivity shows them to be perfectly satisfactory. The headbands of the telephones are reasonably comfortable, but the earcaps are on the small side and are made much more comfortable by attaching a pair of the soft rubber cushions sold by Sorbo and other firms for use with telephones.

A Good Binocular Former

The Collinson Precision Screw Co., Ltd., of Walthamstow, well-known makers of the "Colvern" components, have produced an excellent binocular former on which home constructors can wind their own coils. The former is a particularly clever moulding in bakelite with a minimum of solid dielectric material and fits, of course, the standard six-pin base, the pins being numbered clearly and holes being provided for threading the connection wires through the base. The individual cylindrical formers are easily detachable for separate winding and a noteworthy point is that provision is made for withdrawing the completely wound former from the base without touching the windings.



which incorporates a Vibro valve holder.

This instrument has been designed to meet the modern demand for true reproduction now made possible by the recent introduction of valves specially designed for Resistance Capacity Coupling, the inherent virtues of which are now fully recognised, the principal one of which, however, is faithful and pure reproduction over a wide scale of frequencies.

This Unit contains a correctly proportioned Condenser, Anode Resistance, and Leak of a special design to eliminate all possibility of variation due to climatic conditions. These elements are sealed in a Bakelite Moulding, which, as will be seen in the illustration, embodies a Magnum Vibro Valve-Holder. Nickel-plated terminals and also solder tags are provided.

The Unit is supplied in neat carton, including fixing screws and circuit diagram, the general finish of the instrument being of the high standard associated with Magnum Products.



PRICE 10/6

Size: Height 1 1/2 in. Overall dia., 3 in.
A highly efficient 3-valve Receiver can be simply and cheaply constructed by the use of two of these Units. Full particulars and constructional details will be supplied free on application. BLUE PRINTS 1/6 EACH.

BURNE-JONES & CO. LTD.,
MAGNUM HOUSE
TELEPHONE: HOP 6257
288, BOROUGH HIGH ST.
LONDON. S.E.1

CONSTRUCT THE STRAIGHT LINE FOUR

as described herein by Mr. PERCY W. HARRIS.

	£	s.	d.
1 Mahogany Cabinet with baseboard ..	2	0	0
1 Ebonite Panel, 24 x 8 x 1/4 ins., ready drilled ..	0	14	0
3 Magnum Copper Screening Boxes with bases (as used in the original set described herein) ..	1	17	6
1 Magnum Terminal Panel with 8 terminals drilled and engraved ..	0	3	0
1 Magnum Terminal Panel with 4 terminals drilled and engraved ..	0	1	6
1 Magnum 6-pin Base ..	0	2	0
4 Magnum Calibrated Rheostats ..	0	12	0
2 Magnum Vibro Valve Holders ..	0	5	6
3 T.C.C. Condensers, 1 mfd. ..	0	3	10
1 T.C.C. Condenser, 2 mfd. ..	0	4	0
1 T.C.C. Binocular Condenser, .02 mfd. ..	0	10	0
1 Lewcos Binocular Aerial coil, B.A.C.5 ..	0	10	0
2 Lewcos Binocular Split Secondary Coils, B.S.S.4 ..	1	0	0
2 Lewcos 6-pin bases ..	0	5	6
1 R.I. Anode Resistance with clips as described ..	0	11	0
3 Ripaults .0005 Var. Condensers with Slow-Motion Dials ..	2	15	6
3 Wearite H.F. Chokes ..	0	19	6
2 Parex holders for Screened Grid Valves ..	0	7	0
2 Dubilier Condensers, .001 ..	0	6	0
1 Dubilier Condenser, .0001 ..	0	2	6
1 Dubilier Condenser, .0003 with clips for Series Leak ..	0	3	0
2 Dumetohm holders ..	0	2	0
3 Lissen Grid Leaks as specified ..	0	3	0
1 On & Off Switch ..	0	1	0
2 10-ft. lengths Lead Covered Wire ..	0	1	6
6 ft. Rubber Covered Wire ..	0	0	4
Glazite ..	0	0	10
	£14	0	0

If required:
3 Extra Coils for high wave-length range .. £ 1 18 0
2 Screened Grid Valves, S.625 .. 2 5 0
1 Cossor 6-volt R.C. valve .. 0 10 6
1 Cossor Stentor Six .. 1 0 0
Any of the above components supplied separately as desired.
NOTE.—Where a complete set of components is purchased together, Marconi Royalties at the rate of 12s. 6d. per valve holder are payable.

**PUT THESE COMPONENTS
IN YOUR SET - AND GET IT RIGHT
FIRST TIME**

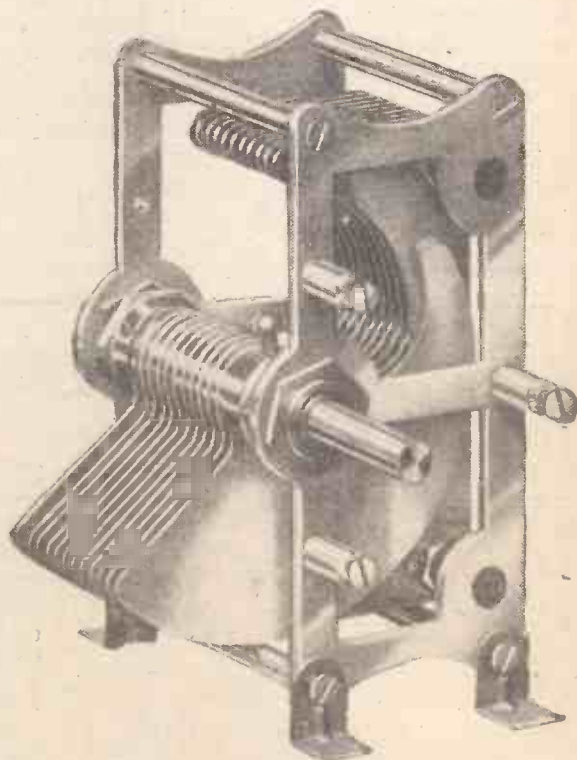

DON'T buy your Components blindly. A little thought beforehand may save you endless trouble and expense afterwards. Buy parts that are proved by experience to be the height of instrument efficiency. Buy Eureka Radio Instruments, and know that they will give you faithful and long-lasting service.

Each Eureka Instrument—the world-famous Transformers, the Ortho-cyclic Condenser and the new Loga-cyclic Condenser—is an instrument of precision. Long years of experience and experiment have made it so. Say "Eureka" to your Dealer—and get your Set right first time.

GET THEM FROM YOUR DEALER

REDUCED PRICES

Ortho-cyclic Condenser.	·0003	:	12/9
	·0005	:	13/6
New Loga Cyclic Condenser.	·0003	:	12/9
	·0005	:	13/6
Eureka Transformers.			
Concert Grand No. 1	· 21/-	Baby Grand No. 1	· 13/6
Concert Grand No. 2	· 21/-	Baby Grand No. 2	· 13/-
Reflex Model	· 13/6		

EUREKA

INSTRUMENTS
of
PRECISION

PORTABLE UTILITIES CO., LTD., FISHER ST. W.C.1.

OUR NEWS BULLETIN

*Some of the More Interesting Happenings
 in the Radio World this Month*

Empire Broadcasting

At last the B.B.C. has come up to the scratch in the matter of Empire Broadcasting. Just after we had gone to Press last month it was announced that an experimental short-wave transmitter was being erected at the Marconi Works at Chelmsford. The test transmissions will be carried out on a wave-length of 24 metres under the call sign 5 S W. The Chelmsford masts are nearly five hundred feet in height, and as the new station will use a power up to 25 kilowatts, it is probable that when the B.B.C. does start Empire Broadcasting, it will start in style!

Sydney on One Valve!

The B.B.C.'s second relay of broadcasting from Australia was not nearly so successful as the first. But it must not be inferred that the first success

was a freak that cannot be repeated, for Sydney has been coming over with tremendous punch. One Irish listener who tuned in Sydney direct on two valves reports: "The volume at times was too loud for earphones, so I cut out the Mullard P.M.6 valve and got most of the programme on the P.M.5X only."

Germany's Super Station

Langenberg will soon have to look to its laurels, for the great new German super station at Zeesen is now straining at the leash. This super transmitter is soon due to start pushing out a programme on 40 kilowatts, or thereabouts, and it is reported that the tests from this station will begin during November.

Washington Conference

What has been happening at the Washington Conference? Up to the

time of writing, nothing startling has been officially announced, although some almost incredible rumours have crossed the Atlantic. One thing is certain. If the Conference can stop some of this jamming, heterodyning, wave-length pinching, frequency wobbling, and similar trials that John Listener has to put up with, it will have been well worth while.

New York's Disappointment

New York's listeners are horribly peeved about the great new station just built at Bellmore, Long Island. It is the new home of W E A F, and was to be built "absolutely regardless." Apparently the site is unsuitable, or somebody has been regardless of something fundamentally necessary, for instead of making all the New York loud speakers rattle their diaphragms simultaneously, W E A F has simply whispered like a ghost with a cold. Whatever the cause, Long Island's big noise has had to be taken off the air before the shine had gone off its aerial wires.

National Wireless Week

This year National Wireless Week is being celebrated from November 14th to the 19th inclusive. All-star
 (Continued on page 158.)

Don't treat your Valves like an Ass!

THE overburdening of Valves is so common, that the Ashley Resistor method of prevention when adopted, not only takes the extra load from the battery but relieves the burden of anxiety on the minds of those who may have to foot the bill for replacements.

And similarly, each of the other Ashley components perform their various functions reliably in the Home Set, so that nothing will go amiss in the absence of the person whose pet it may happen to be.

Various Capacities

Best your own Radio should be built

Ashley Radio

Two fully descriptive leaflets will be sent on request.

ASHLEY WIRELESS TELEPHONE Co. (1925) Ltd.
 Finch Place, London Road, LIVERPOOL

If your dealer cannot supply we send post free.

RESISTOR AND BASE
 2/6

State particulars of valve for which Resistor is required when ordering.

MULTIPLE FIXED CONDENSER
 5/6

15 various capacities from the one unit.

R.C.C. UNIT
 5/6

Neatest and most reliable at lowest price obtainable.

GUARANTEED COMPONENTS

*You must have a
precision instrument*



Modern radio circuits call for critical tuning—critical tuning demands precision condensers—precision condensers means Pye condensers for accuracy and reliability. Pye precision condensers are scientific instruments made one at a time with great care. You need them to get the best from your set.

PRICES—'0001, '0002, '0003 Mfd. 17/6 each.
'0005 Mfd. 18/6 "
'00075 Mfd. 22/6 "



W. G. PYE & Co.,
"Granta Works," Montague Rd.,
CAMBRIDGE.

**PREPARE FOR THE NEW
B.B.C. S.W. STATION.
AERO COIL SUPER-SENSITIVE
INDUCTANCE UNITS.**

The Perfect Inductances for all S.W. Work.
(FULLY COVERED BY BRITISH PATENTS.)

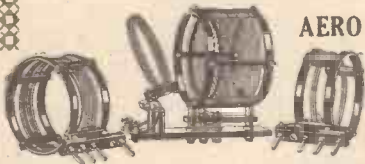

AERO S.W. RECEIVING KIT
Completely interchangeable.
Range from 15 to 130 metres.
The kit includes 3 coils and
mounting covering U.S. Bands
of 20, 40 and 80 metres. You
can increase the range of the
Aero S.W. Receiver to cover
wavelengths up to 750 metres
with coils Nos. I.N.T.4. and I.N.T.5.

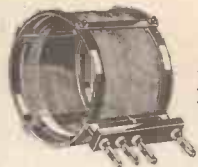

	Each.	
Aero S.W. Kit 15-130 M.	List Price	52/6
Extra coil, No. I.N.T.4.	" "	16/6
" " " I.N.T.5.	" "	16/6

AERO SHORT-WAVE SET.

Its performance makes it the leading short-wave set for distance getting, selectivity, volume, and easy control. Used by the United States Government, Broadcasting Stations, University Laboratories, the MacMillan Expedition, University of Michigan Greenland Expedition, and adopted by leading experts and amateurs throughout the world.

Send for details To-day and get to know
the marvellous results of S.W. reception.

**THE ROTHERMEL RADIO
CORPORATION OF GREAT BRITAIN, LTD.,
24-26, MADDOX STREET, LONDON, W.1.**

Tele. Nos.: Mayfair 578 and 579. Rothermel, Wesdo, London.

WESTON



Regulation
of voltage
by means of
WESTON
Instruments
gives improved
reception

To obtain maximum results from your receiver you must be sure that the H.T., L.T. and G.B. voltages are regulated correctly. For an exact measurement of these variable voltages use a Weston Pin-Jack Voltmeter with high-range stand. Only the Weston standard of accuracy and reliability is sufficiently fine to be of any use for such measurements.

The Weston free booklet "Radio Control" explains the necessity for accurate electrical control of your radio receiver and gives much helpful advice. Let us have your name and address.

MODEL 506 Pin-Jack Voltmeter complete with high range stand and testing cables £2:10:0

WESTON

STANDARD THE WORLD OVER
Pioneers since 1888

Weston Electrical Instrument Co. Ltd.
15, Gt. Saffron Hill,
London, E.C. 1

OUR NEWS BULLETIN

—continued from page 156

programmes have been arranged by the B.B.C. and the quality of the turns is such that even if you can't cut out the local station there will be something well worth hearing all the while.

The Trans-Ocean 'Phone

The trans-ocean telephone, broadcasting's big brother, has been making good progress of late. Not only the U.S.A., but Canada also can now be called up by any telephone subscriber in this country. The hours of service are from 12.30 a.m. to 11 p.m., and the charge is not a nominal but a "phenominal" one. Kipling said, "A nation spoke to a nation," and the P.M.G. said, "Yes! Fifteen pounds for three minutes, please!"

Remote Control

Surely one of the most remote of all remote controls is that fitted to the five-metre transmitter of W G Y, Schenectady. To avoid body capacity, the tuning is done at a distance of one hundred yards away from the transmitter by means of a rope-driven vernier!

A Timely Tip

If you have not yet bothered to do so, it would not be a bad idea to give a fatherly eye to your aerial, in preparation for the winter weather. Masts and guys that look groggy, and insulators that won't insulate properly, are liable to give any amount of trouble when the winter gales get going. So when you hear the announcer talking about winds that will reach gale force, remember that tall masts are all right provided they are masts, but they make uncommonly poor skittles.

The Promenade Concerts

From a musical point of view, the B.B.C. has been striking the right note recently. The promenade concerts were a huge success, opera seemed more popular than ever before, and in general the musical side of the B.B.C.'s activities seems to be forging ahead favourably. 2 Z Y, the Manchester station, is living up to its reputation as a centre of harmony, and at least eight of the famous Hallé concerts will be broadcast during the coming winter.

Is 5 G B Falling Away?

Is 5 G B falling from grace? New aerials and more power are all

very well in their way but, after all, the fundamental fact about a station is what sort of programmes can it produce? Several readers have written to say that 5 G B seems to be falling off, and it will be a thousand pities if the B.B.C. allows the cheery character of this station to fall under the spell of the killjoys and uplift merchants, who want to make Daventry Junior a station fit only for heroes to listen to.

2-ASL

Mr. G. Hume has drawn attention to an error which appeared in last month's WIRELESS CONSTRUCTOR, under the photograph of his station 2-ASL. This station has not been heard in Australia when using low power, but signals were received at 2-ASL when the Australian station was using only five watts.

Langenberg's "Ghost"

Listeners who were troubled recently by the jamming on Langenberg's wave-length will be interested to learn that the culprit has now been traced. It appears that the ghostly transmissions emanated from Paris, P T T, which station was temporarily trying out a longer wave-length.

SAVOYARD.

Use **REDFERN'S**
REG. NO. 469456.
Ebonart
NON-METALLIC SURFACE EBONITE
RADIO PANELS

Entirely free from surface leakage, Ebonart is strong yet easily worked. Artistically finished in mahogany grain, and black.

Made in all the standard sizes.

Obtainable from all dealers.

Send for *The Book of Ebonart*, a useful guide for the wireless amateur.

REDFERN'S RUBBER WORKS LIMITED, HYDE, CHESHIRE.



C. E. PRECISION SECTIONALLY-WOUND FIXED RESISTOR. THE LAST WORD IN FIXED RESISTOR DESIGN. Its accuracy is guaranteed to within 1 per cent of its stated value. Made in all values from 0 to 60 ohms. Price 1/6 each. Clips and Base 1/-

C. E. PRECISION FLOATING VALVE HOLDER
Anti-capacity and non-microphonic. Price 2/- each

C. EDE & CO., LTD., BYFLEET, SURREY

Manufacturers of
C. E. PRECISION RADIO COMPONENTS AND BROADCAST RECEIVERS

WRITE FOR LIST OF COMPONENTS AND CIRCUIT DIAGRAM OF THE

"ORCHESTRAL THREE"

The Receiver that sets the Standard of Perfection

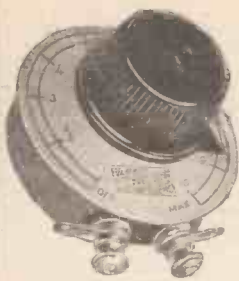

C. E. PRECISION RHEOSTAT

The resistance remains constant always and the smoothness of control is a noteworthy feature

2/9 to 3/9



C. E. PRECISION WIRE-WOUND ANODE RESISTANCE.

The wire used is specially made and costs £15 a pound. Each value is absolutely constant.
20,000 to 50,000 ohms 3/9. 60,000 to 100,000 ohms 4/9. 150,000 to 200,000 ohms 7/-. 250,000 ohms 8/-. 500,000 ohms 15/-. Clips and Base 1/3 extra. Other values to order.

Best Quality at Cheapest Prices.

Valves, Batteries, 'Phones, Rheostats, Transformers, etc.

"Radio Micro."	Fil. Volts.	Anode Volts.	Amps.	Price.	
"Special"	3.5-4	40-50	.05	7 6	All
New Bivolt	2		.05	7 6	
New Bivolt Power	2		1.3	10 9	
New Power	3.5-4	40-250	0.1	10 9	
"Triotron."					Free.
T. 10	1.6-2	50-120	0.2	5/- each.	
Z.D.2 Power	2			8 6	
T.S.4	4		.06	6 3	
Z.E.4 Power	3.4-4	50-150	0.2	7 6	
"Polo" Batteries.	60 volt 7 6.	100-volt 10 6.		(Carriage 1/- extra.)	

Write for Illustrated List FREE. (Traders please send card.)

BISHOPSGATE ELECTRIC SUPPLY (1924) CO.,
180, Bishopsgate, London, E.C.2.

CUT THIS OUT FOR CABINETS

and post to us for new FREE list illustrating Cabinets as shown in "Wireless Constructor," etc., etc.

NAME

ADDRESS



(Write in block letters, please.)
CARRINGTON Mfg. Co. Ltd.,
Camco Works,
Sanderstead Road, South Croydon
Telephone: Croydon 0623 (2 lines).

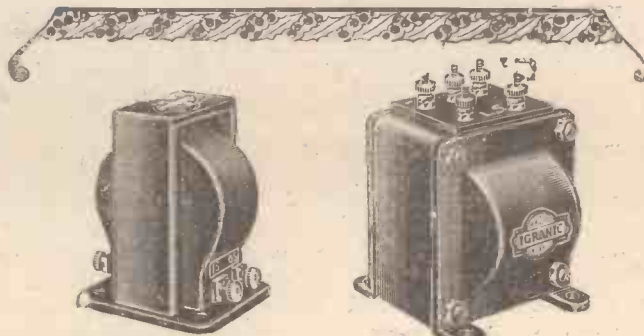

L.F. Transformer, Type "G."

"C.C." (Choke Capacity) Output Unit.



The Gifts

he will appreciate most

Of all the multitude of gifts there are to give at CHRISTMAS few will please the radio enthusiast as much as components for his constructional work. Choose IGRANIC and you'll give latest design and perfect workmanship.

The IGRANIC range is the most complete in the world—from a complete receiver to a terminal. Here are a few suggestions:

L.F. Transformer, Type "G."

Sets a new standard in Transformer design. Substituted for an old transformer, it will give new life and unequalled tone range to a wireless set.

Two ratios: 3:6:1 for first stage and single stages.
7:2:1 for second stage and with valves of very low impedance.

Price 30/-

Absorption Wavemeter.

Enables all stations received to be quickly identified. It also makes an efficient wave-trap.

An invaluable accessory to any wireless set.

Price £2 13s. 6d., without coil.

Coil A.	15- 55 metres	10 8
" B.	50- 157 "	10 8
" C.	160- 600 "	14 -
" D.	550-2000 "	£1 1s.

Short-Wave Inductance.

The standard plug enables many existing receivers to be used for the reception of short wave-lengths. Rigid and highly efficient they contain all the properties essential for successful short-wave reception. A set of four covers 15 to 130 metres.

Price 11/6 per set.

Write for the new Igranic Publication No. J.339 which illustrates and describes the entire range.

IGRANIC ELECTRIC CO., LTD.
149, Queen Victoria Street, London, E.C.4

WORKS:

Branches: BIRMINGHAM.
BRISTOL, CARDIFF.



BEDFORD

GLASGOW, LEEDS, MANCHESTER, NEWCASTLE.

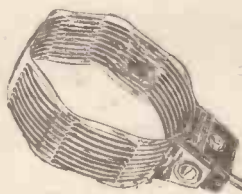

Short-Wave Inductance Coil.



Absorption Wavemeter.

THE "STRAIGHT LINE" FOUR

—continued from page 99

make the connections which pass through the various holes in the boxes, bare the ends of the wire, as previously explained, thread them through the holes and carefully bend them until they come to the right positions, and then solder securely. Be careful not to rub the lead casing too much against the sharp edging of the hole in case you cut through both lead and insulation.

Careful Insulation

You must also be careful that the lead covering does not touch any wires inside the box. Where there is a fairly long lead from the outside of the box, to a component inside, as in the case of the screening box C, it is not a bad plan to take an insulated wire, such as Glazite, from the component inside the box to within, say, half an inch of the hole through which the lead-covered wire is to come. The lead-covered wire can then be threaded through and soldered to the bared end of the insulated wire. This is

a safety precaution I have found useful.

Notice that the negative connection of the last valve is taken to the lead casing of the wires, as is also the grid bias positive. As the lead casing is connected to earth and negative L.T., this saves additional wires.

So far as the panel is concerned, it is only necessary to hold it up against the baseboard in its correct position and note where holes are required for the spindles. These holes can be quite large and it does not matter whether they are cut uniformly as they will be covered by the dials.

The on-and-off switch is mounted by the single-hole-fixing method, and when the last of the three holes for the spindle has been cut, the panel can be secured to the baseboard by screws along the bottom edge. The three dials are then clipped over the spindles and positions of their locking screws marked. The dials are then secured in place in the usual way. You can, however, carry out all tests with the receiver by temporarily securing dials to the spindles before the panel is put in position. Even the on-and-off switch can be joined to its lead-covered lead and supported in "mid-air" without the panel, as shown.

Before putting any valves in posi-

tion it is essential to test to see that all the connections are soundly made and that none of your wires are shorting anywhere. When this has been done there is nothing to do but to insert the valves, connect up your batteries, aerial and earth, and tune in the stations. There is no adjustment and no neutralising to be done, and if you have followed the instructions carefully the set should work properly right away.

Good Quality

The quality of reproduction will astound you for distant stations come in exactly as do the local. First of all, the tuning may seem flat, but this is due to the great radio-frequency amplification given by the set. Actually, any one dial can be turned through several degrees without losing the station, but when a station is tuned-in at full strength on all three dials, the set will prove to be as selective as you can desire.

For example, at Wimbledon, when 2 L O is going at full blast, using a large outside aerial, I can tune in Stuttgart on 379 metres without any trace of 2 L O; while Union-Radio, Madrid, can also be received while London is working. This station is

(Continued on page 162.)

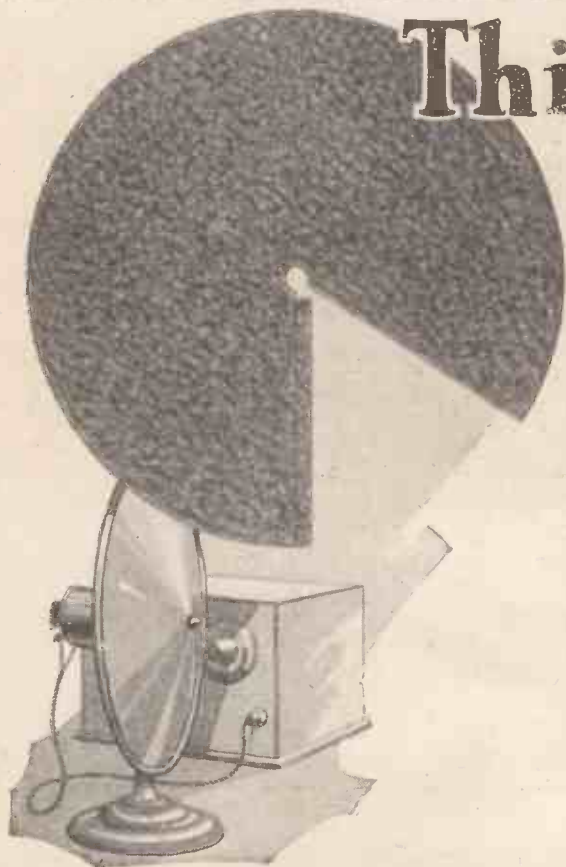

This Winter's most pleasant hobby

Why pay a high price for a Cone Loud Speaker when you can make one just as efficient and attractive yourself, and for a quarter the outlay? A few hours spent on the fascinating and easy task of constructing your own Cone Speaker, and you have an instrument which is equal in performance to any that can be purchased. But one important point must be borne in mind. Six-Sixty Cone Speaker Paper is the only Cone material which will guarantee you that perfect reproduction which is so desirable. A very special material, the processes in its manufacture ensure tonal qualities and purity unobtainable with any other material.

The quality of Six-Sixty Cone Speaker paper may be judged from the fact that it is used in most of the well-known American Cone Speakers. America is the country which originated the Cone.

Made in two sizes, 12 in. diameter and 19 in. diameter, Six-Sixty Cone Speaker paper is obtainable from all Radio dealers, but in case of difficulty write direct to us.

Prices 2/6 and 3/6.

Brass Washers 3d. extra.

THE ELECTRON CO., LTD., Dept. W.C., 122-124,
Charing Cross Road, London, W.C.2.

£300 A YEAR FOR YOUR SPARE TIME!

Wonderful New Invention YOU can Make and Sell under My Patent!

REALLY, genuinely, you can make at home and in your spare time a sum of extra money up to £300 per year. The work is of fascinating interest. It will open up to you new ideas, new vistas of money-making; provide many of those luxuries and necessities which you have so long wished for, and give you occupation just at those hours when time is apt to hang heavily on the hands.

to manufacture under my Royal Letters Patent, in order to ensure unrestricted marketing. Let me hear from you NOW before somebody else is granted the licence and the extra income that can so easily become yours.

Simply forward the coupon and, by return of post, I will send you every par-



IN THE COMFORT OF YOUR OWN HOME YOU CAN DOUBLE YOUR INCOME. The work is a delight. You can keep at it just as long as you like each day or week. No "plant" or machinery is needed. A spare-room or even the kitchen table can serve as your profit-making "factory"—and the children can help too!

particular with which you may wish to be acquainted. It is those who

Others are doing this by working my enormously successful patents. Why not you? It costs you nothing to write for full particulars, and you can then see for yourself exactly what you can do.

My patents are in very great demand in the field of wireless and electricity—so much so that

I GUARANTEE

your profits, and further guarantee to protect you against any infringement or interference with your market. Only one person in 50,000 of the population is allowed

seize opportunities who succeed. Take this opportunity NOW.

MAKE-MONEY-AT-HOME COUPON.
 To THE ENGLAND-RICHARDS CO.,
 94, King's Lynn, Norfolk.
 Sirs.—Please send me at once, and FREE, full details as to how I can Make Money at Home in my spare time. I enclose 2d. stamps for postage.
 Print your name and address boldly in capital letters on a plain sheet of paper and pin this coupon to it.
 The Wireless Constructor, Dec., 1927.

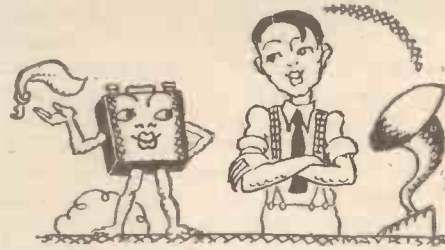

Never mind the knot in your hanky

No need for you to remember when your L.T. Batteries ought to be re-charged if you use Peto & Radford Indicating Accumulators. Just glance at the Ball-floats and you can see how the juice stands—charged, half-charged, or nearly run-out.

That isn't all about this battery, either. It has all the features a P. & R. Battery always has. Paste keyed-in to plates; lugs burned-on; tested separators; extra heavy grids; sludge ducts; it's guaranteed for six months; in brief, it's a P. & R. Battery. Which leaves no more to be said.

If you would like all the details, send a post-card for our leaflet to Peto & Radford, 50, Grosvenor Gardens, London, S.W.1.

P AND R PETO & RADFORD ACCUMULATORS

The beginning and the end in POWER

Indicator-Ball Battery
 PCF5, 20 amp. hours actual
 2 volts
 Price 13/-

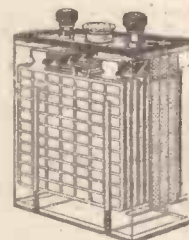

Also made in non-spill type to fit all well-known portable sets.



A Wonderful HOW-TO-MAKE Book!

A practical "How-to-Make" book that deals with all the hobbies that interest Boys. If you want to know how things work and how things can be made at home without a great outlay you must have the HOBBY ANNUAL. There are hundreds of illustrations—photographs specially taken—sketches and drawings that SHOW you EXACTLY what to do. There are two fine photogravure plates and THREE LOOSE-LEAF SUPPLEMENTS.

Every Boy's HOBBY ANNUAL

On Sale at All Newsagents and Booksellers. 6/- NET.

**THE "STRAIGHT LINE"
FOUR.**

—continued from page 160

operating on a wave-length of 375 metres. In this case there is a slight background of London, but it is not noticeable when Madrid is transmitting.

By way of a change, I am not going to give you a detailed test report. I prefer to leave it to others to give you a description. Suffice is to say that it is by far the most sensitive and most easily handled set ever described in the WIRELESS CONSTRUCTOR, and is a sheer joy to operate. Any night the number of stations that can be brought in on the loud speaker seems unlimited, and as reproduction is entirely free from reaction distortion, and as, moreover, resistance amplification is included, you can realise for the first time what excellent quality reproduction is being given by many of the foreign stations.

The set is equally satisfactory on the long-wave range; Motala, Daventry, Hilversum, Koenigswusterhausen, Radio-Paris and a number of others can be really enjoyed for their pro-

grammes, and not merely for the novelty of receiving them. Frame-aerial reception is extremely easy, for it is only necessary to disconnect the ordinary aerial and earth and to connect the frame to the aerial and earth terminals, removing the flexible lead which goes from the aerial terminal to terminal 3 on the base in box A, and joining it to terminal 1.

The frame does not cause instability and, in fact, the stability of the receiver is so excellent that a frame can be stood right on top of the cabinet without causing the slightest reaction effect. As an indication of its sensitivity on a frame, loud-speaker results are obtainable from Langenberg in daylight on a frame measuring only 3 ft. across.

Not the least useful feature of this set is the economy of its H.T. consumption.

[NOTE.—More about the "Straight Line" Four next month.]

**THE AUTUMN EQUINOX
AND WIRELESS**

—continued from page 120

mean poor conditions, frequently with a great deal of atmospheric interference.

"The temperature is also an important factor. Whenever considerable fluctuations are observed the atmosphere is thrown into a disturbed condition. Charged layers of air rise or fall, coming into contact as they do so with other layers carrying different charges and producing atmospheres of a more or less violent nature."

"The Times" correspondent also points out that there can be little doubt that the moon exercises no small influence upon wireless reception, especially on short waves below 100 metres. The first quarter of the moon coincides often with a period of poor reception, while ranges are often at their longest at about the time of a full moon.

Conditions Improving

The autumnal equinox then may well be responsible for the very poor reception conditions during the last month, and readers who may note (by the time this issue is on sale) that conditions have improved as the period of the autumnal equinox draws to an end.

Amateurs who have kept a record of long-distance reception results throughout October are invited to write to this journal, giving any available information.

SENSATIONAL

IMPROVEMENTS IN AERIALS

AMAZING SUCCESS OF GÖLTONE "NEGROLAC" REGD

Extracts from Technical Reports:

"WIRELESS CONSTRUCTOR" (November).
The "NEGROLAC" Aerial gave better results than had been obtained with any aerial previously tested. Test of the insulating properties of the wire covering showed it to be of high order.

"RADIDEA" (Radio Expert to the Manchester Evening Chronicle).
"The one found to give the best reception was the "NEGROLAC," with a gain of 25 per cent. over ordinary aerials. An aerial that should last indefinitely. The tuning will remain constant, and the energy picked up will be the maximum."

Features of the "NEGROLAC" (Regd.) Aerial. 49 strands, each enamelled and specially stranded. Fabric outer covering "NEGROLAC" varnished, ensuring high insulation, minimum surface leakage, long life, and maximum efficiency. Will withstand severest climatic conditions.

GÖLTONE "NEGROLAC" (Regd.) Aerial is light in weight, will not tangle, amply weather-protected to last for years.

Price, per length of 50 ft. 9/0 Price, per length of 80 ft. 15/0 Price, per length of 100 ft. 18/0

Obtainable from leading Stores. (Refuse substitutes.) Write for descriptive leaflet, with full particulars and results of tests

Mr. A. C., Stanley Park Lane, Wallington, writes:

"5 GB came in 25 per cent. stronger on 'NEGROLAC' Aerial. On a three-valve set, effect of new aerial was extraordinary, detuning being necessary to avoid overloading power valve. Distant reception improved beyond measure."

Mr. W. R. G., Kippax Street, Hulme, writes:

"Improved results after replacing the old aerial with GÖLTONE 'NEGROLAC' (Regd.) were simply amazing."

CARBORUNDUM IN RADIO

CARBORUNDUM STABILISING DETECTOR UNIT.



This Unit is an electrically controlled Carborundum Detector and is adaptable to all detector circuits. This is because of the resistance controlling feature whereby the Detector may be made to match the impedance of any circuit. The unit control is exceptionally fine and smooth, accurate to about 1/1000th of a volt. The Unit consists of a fixed detector high-resistance potentiometer, built-

in mica condenser and clips for the dry cell, all mounted on a low-loss base. Single hole mounting.

No. 32. Price - each 12/6

Dry Cell (price extra), each 5d.

No. 30. Carborundum Detector (without Stabilising Device). Price - each 5/-

CARBORUNDUM RESISTANCE CAPACITY COUPLING UNIT.

This Unit is quite different from any other at present on the market, presenting as it does many distinct advantages over Units employing ordinary Grid Leaks and Anode Resistances. The Resistances used in the Carborundum Resistance Capacity Coupling Unit are solid rods of unbreakable Carborundum, which is created in the largest electric furnaces in the world, at the terrific temperature of 4060° F. They cannot burn out, present no capacity effects, and are absolutely non-microphonic. The Unit takes up far less room than the smallest L.F. transformer, and the complete absence of background noise enhances the already great possibilities of R.C. Coupling. Not being dependent on a metallic film, the resistances will not disintegrate and are unaffected by atmospheric changes. No. 73: Price 8/6.

CARBORUNDUM ANODE RESISTANCES AND GRID
LEAKS in all standard values. Price - each 2/6.



*
All Carborundum Radio Products are sold under our complete guarantee that they will operate satisfactorily in properly designed circuits
*

Send for new 24-page Book containing Circuits and much useful information.

THE CARBORUNDUM Co., Ltd.,
TRAFFORD PARK, MANCHESTER.

Anti-microphonic at last!

The REDFERN

Pneumatic Action
VALVE HOLDER

Patent No. 269,388

This new invention positively eliminates microphonic noises. Constructed without springs, it has no natural frequencies, therefore completely solves the problem of the proximity of loud speaker to valves.



Sold everywhere

PRICE

2/6

EACH

Recognise them by
the Yellow Carton

Send for The Book of Ebonart,
a useful guide for the wireless amateur

REDFERN'S RUBBER WORKS LTD., HYDE, CHESHIRE

A RADIO BOOK EVERY ENTHUSIAST SHOULD HAVE



SET BUILDERS. THE WORLD'S
GREATEST RADIO PUBLICATION
IS HERE!

EUROPEAN EDITION OF CITIZENS
RADIO CALL BOOK.

Contains full details of very latest American Circuits and Receivers. Graphic illustrations and diagrams, constructional data and other information enabling the novice to construct the World's finest sets.

Full list of Broadcasting Stations, helpful hints and tips. Unquestionably the finest value and most useful book of the day. Over 200 pages, size 9" by 12", crammed full of information and hundreds of illustrations. September issue is now Ready—Secure your copy at once and get to know about the most up-to-date developments in Radio.

The European Edition of the Citizens Radio Call Book is on sale at all W. H. Smith and Son's Bookstalls and can be obtained also from THE ROTHERMEL RADIO CORPORATION OF GREAT BRITAIN, LTD., OF 24, MADDOX ST., W.1. In France, Brentanos Ltd. Price 3/- per copy. Send P.O. to-day.

The component parts for making these sets are distributed throughout Great Britain by the Rothermel Radio Corporation, of 24, Maddox St., W.1, and may be obtained from all high-class dealers.

Published by
THE CITIZENS' RADIO
SERVICE BUREAU,
Chicago, Illinois, United States of America.

THE "WAVELET METER"

—continued from page 169

a wood case. It can be kept in good condition if it is covered when out of use with a piece of American cloth, which is both dust and damp-proof.

Rough Calibration

It may be found that the moving plates of the Ormond square-law condenser travel through rather more than a complete semi-circle in moving from the maximum to the minimum position. It is thus impossible to fix the dial so that it reads 0 when the plates are right out of mesh and 100 when they are fully meshed. Adjust it so that the reading is exactly 100 when the moving plates are turned right home. On a piece of graph paper make a chart on the lines of that seen in Fig. 2. The vertical sides of each large square represent ten condenser scale divisions, so that the upright sides of each small square correspond to one division. Similarly the horizontal sides of the large squares are made to correspond to 10 metres of wave-length, and

those of the small squares to 1 metre. Only the large squares are shown in Fig. 2.

At a point where the 50-metre vertical line crosses the horizontal line corresponding to a condenser reading of 65 make a dot. A similar dot is made at the crossing of the vertical line, representing 30 metres, and the horizontal line representing 32 divisions of the condenser scale. Lay the edge of a ruler on these two dots, draw a fine line joining them and produce it downwards a little and upwards until it meets the top edge of the frame. You have now a rough calibration of the meter for wave-lengths between 30 and 70 metres.

Close Calibration

With the aid of the meter adjust your set to 62 metres, allowing it to oscillate gently. Move the meter well away from the set and search carefully. A small movement of the controls in one direction or the other should bring in the carrier-wave of K D K A, provided, of course, that the work is done at a time when this station is transmitting. Once the American station has been tuned in, place the meter near the set, and turn its condenser until speech or music

becomes inaudible. Note the condenser reading of the meter. Next tune in either 2 X A F (32.77 metres) or P C J J (30.2 metres), both of whom transmit on Tuesdays and Thursdays. The first rough graph prepared for the meter shows that the reading for the American station should be slightly over 36 divisions, and that for the Dutch a little over 32. Note carefully the exact readings obtained. Now plot these readings on a fresh chart and draw a straight line joining them. You have thus a calibration curve for your wavemeter, which will differ probably a little from that shown in Fig. 2. If the work is carefully done the meter will give very close readings for all wave-lengths within its scope. The American station 2 X A D, on 22.02 metres, may possibly lie a little off the straight line, for the lower part of the graph below 30 degrees will very likely show a bend. In any case, you will find that the meter enables you, even after its first rough calibration, to adjust your set so that searching for a particular station is confined to very small movements of the tuning controls. When the final calibration has been completed by plotting in a number of stations of

(Continued on page 168.)

EKCO "H.T. UNITS—Models for every purse"

Model	Voltage Tappings	Sets Suitable for	Price	
			D.C.	A.C.*
			£ s. d.	£ s. d.
M.1.	60 or 90 or 120	1- to 3-valve sets only	0 17 6	3 7 6
M.2.	60 and 120		1 9 6	6 2 6
1.F	90 and "Power"	Majority of sets of not more than 5 or 6 valves	2 12 6	6 15 0
2.F	60, 120 and "Power"		3 5 0	7 7 6
3.F	60, 90, 120 and "Power"		3 17 6	7 12 6
1.V	0-100 variable and "Power"	(A) Multi-Valve (B) Super-Het (C) Sets depending on a critical voltage adjustment (D) Fada, Burndept, Elstree Six, etc.	4 2 6	8 17 6
2.V	0-100 variable and "Power"		5 7 6	9 10 0
3.V	0-100 variable and "Power"		6 0 0	
C.2	100-150 var. and "Power"			
Provides: (a) H.T. 60, 120 and "Power." (b) L.T. Current for 3, 4, or 5 1 amp. valves or for any combination of valves of the same filament voltage, provided the sum total of current consumed by the filaments is not less than 3 amp. and not more than 5 amp. (c) G.B. Tappings at 1½, 3, 4½, 6, 9			Complete £6 7s. 6d.	
*Extras payable on A.C. Models only			F. & V. TYPE. Mullard D.U.10 Valve 15/- Royalty 12/6	M. TYPE. Marconi D.E.5 Valve 12/6 Royalty 12/6

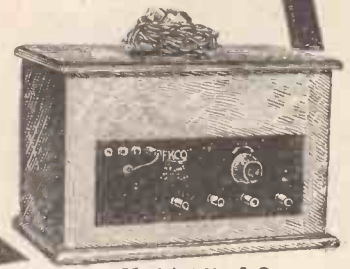

Model 1.V., A.C.

Write for new Illustrated "EKCO" Folders.
E.K. COLE LTD (Dept. D) "EKCO" Works, London Road, Leigh-on-Sea.

**CYLDON
LOG MID-LINE MODEL**

Prices :

·001 ..	19/-
·0005 ..	15/6
·0003 ..	14/8
·00025 ..	14/-
·0002 ..	13/8

With 4-inch Knob Dial, 2/- each. In the case of condensers, Log Mid-Line are a necessity, not a luxury.

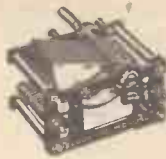

**CYLDON
THUMB CONTROL CONDENSER**

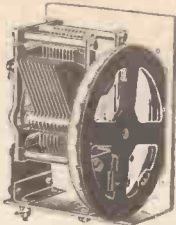

Semi-Shielded Models (as illus.).

Single :

Prices :

·0005 ..	£1 2 0
·0003 ..	£1 1 0
·00025 ..	£1 0 6
·0002 ..	£1 0 0

**CYLDON STRAIGHT LINE
WAVELENGTH SQUARE-LAW
VARIABLE CONDENSER**

Prices :

·001 ..	19/-
·0005 ..	15/6
·0003 ..	14/6
·00025 ..	14/-
·0002 ..	13/8

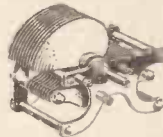

CYLDON BEBE CONDENSER



Prices :

·0001 ..	7/6
·00015 ..	8/-
·0002 ..	8/8
·00025 ..	9/8
·0003 ..	11/-

**CYLDON
STRAIGHT LINE
FREQUENCY
CONDENSER**

Prices :

·0005 ..	15/6
·00035 ..	15/-
·00025 ..	14/6

With large 4-inch Dial, 2/- extra.

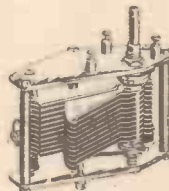

CYLDON TEMPRYTES



Prices :

Temprytes ..	1/8
Mounts ..	1/-
Shorting plugs ..	9d.

Write for the "Tempryte" Chart.

**Write For This
FREE BOOKLET**

Every keen constructor should send for this Free Booklet "Concerning Variable Condensers." Post free on request.

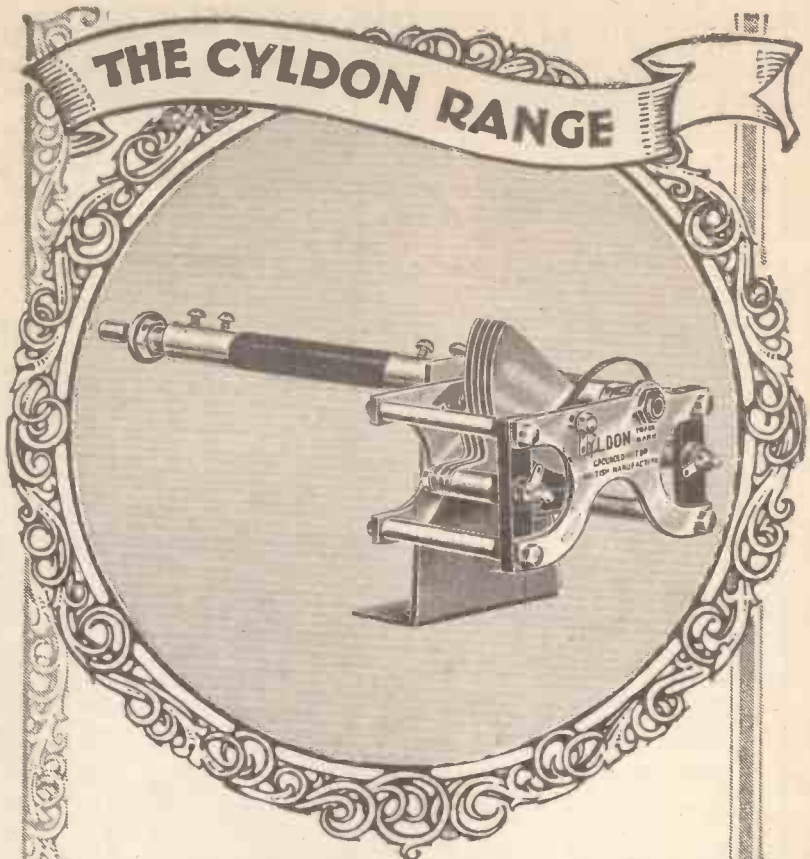

**PREPARE NOW FOR
SHORT-WAVE RECEPTION**

Wireless Constructors will enjoy a unique opportunity of Short-Wave Experiment with the advent of the Short-Wave Transmission from Chelmsford. The first essential to successful results is the new "Cyldon" Short-Wave Condenser.

**PRICES OF "CYLDON"
SHORT-WAVE CONDENSERS**

(Complete equipment as illustrated).

·0001 ..	14/6	·0002 ..	15/6
·00015 ..	15/-	·00025 ..	16/-

Extension rod, bracket, panel bush and nut with spindle 3/6 per set, for use with either "Cyldon" Square-Law, or Log Mid-Line condensers.



SYDNEY S. BIRD & SONS, LTD.

**CYLDON WORKS,
SARNESFIELD RD., ENFIELD TOWN, MIDDLESEX**
Contractors to the B.B.C., H.M.R.A.F., H.M.O.W., and all the leading manufacturers of quality receivers.
Sole Australian Agent: E. V. Hudson, 55-7, Charlotte Street, Brisbane, Queensland.
Telephone: Enfield 2071, 2072. Telegrams: "Capacity, Enfield."

CALLERS' LINES (No Post)

TERMINALS. Nickel W.O. Pillar, 'Phone, 1/- doz. (3 for 4d. with N. and W.); Brass do., 10d. doz. (1d. each with N. and W.), all high quality. Valve-Pins, with nuts, 2 a 1d. Ormond Screws, 6 or 4 B.A., 6d. dozen, with nuts; washers 12 a 1d. Red and Black Spacers, screws at sides, 3/4d. pr. Plug and Sockets, 6d. or Black, 3/4d. Wandler Plugs, Red or Black, 3/4d. pr. (large, good). 'Phone Connectors, 1d. Finish panel sockets and nuts, 4 for 4d., 10d. dozen. Brass Spade Tags, 6 a 1d. Large ditto, 3 a 1d. Nickel Soldering Tags, 4 a 1d. Valvo Pins and Nuts, 2 for 1/4d. Full set of Circular Discs for Panel, 9d.

SOLDER, with Resin, 2d. foot. 1/16 sq. Bus Bar, 2 ft. 1d. Tinned Copper, 16 and 18 gauge, round, 9d. per lb. D.C.C., 1 lb. 20 gauge, 8d.; 22 gauge, 9d.; 24 gauge, 10d.; 26 gauge, 11d.; 28 gauge, 1/-. 30 gauge, 1/4. D.S.C. 1/16, 1/8, 1/4, 1/2, 3/4, 1, 1 1/2, 2, 3, 4, 5, 6, 7, 8, 9, 10, 11, 12, 13, 14, 15, 16, 17, 18, 19, 20, 21, 22, 23, 24, 25, 26, 27, 28, 29, 30, 31, 32, 33, 34, 35, 36, 37, 38, 39, 40, 41, 42, 43, 44, 45, 46, 47, 48, 49, 50, 51, 52, 53, 54, 55, 56, 57, 58, 59, 60, 61, 62, 63, 64, 65, 66, 67, 68, 69, 70, 71, 72, 73, 74, 75, 76, 77, 78, 79, 80, 81, 82, 83, 84, 85, 86, 87, 88, 89, 90, 91, 92, 93, 94, 95, 96, 97, 98, 99, 100.

GRAND VALUE IN GRID BIAS. 43-v. tapped 1 1/2-v., 101d. & 1/-; 9-v., tapped 1 1/2-v., 1/3, 1/6, 1/9, 2/-.

AERIALS.—100 ft. 7/22. Hard drawn, 1/11. Extra heavy 2/2. Phosphor 49 strands, 1/16. Electro 49 strands, Special INDOOR Aerials, phosphor, with ebomite separators and rubber rings (12 ft. x 8 strands) total 100 ft., 4/6. O.V., 2/6. Rubber-insulated, highest quality, 10 yds. 1/-; 10 yds. 1/3; 10 yds. 1/6. Extra heavy, 2d. and 3d. yd. 1/- & B. 10d. Flex (best), 6 yds., 10d. 12 yds., 1/6; 36 yds., 4/-; Ins. Hooks, 2 for 1 1/2d. Egg Insulators, 2 for 1 1/2d. Ins. Staples, 4 a 1d. Earth Tubes, Copper, extra value, 1/11 and 2/3. Climax, 5/- (also at 2/6).

HEADPHONE CORDS. Good quality, 1/3, 1/6. Loud Speaker Cords, 1/9. 4-way Battery Leads, 2/-; 7-way, 3/6. GEARED COIL STANDS. 2-way, 2/3, 2/6, 2/11 up. 3-way, grand value, 4/6. Back of panel from 3/11. All ebomite and best quality. Only needs scoring. Newey, G.E.O., Lotus, Polar stocked.

VALVE HOLDERS. Anti-Microphone, 1/2, 1/3, 1/6. W.B., Lotus, Benjamin, Burndeft and all good makes stocked. Cheap R.B. V.H., 6d. SWITCHES on Porcelain, D.P.D.T., 1/3; S.P.D.T., 8/4d. and 10/4d. Sound quality. Panel switches, with Ebomite handle, worth 6 P.D.T., 1 P.D.T., 1 D.P.D.T., 1/6. Insulating Tape, 4 1/2d. Copperfoil, 4d. foot (6 in. wide). Grid Bias Clips, 6d. Panel Brackets, 3/4d. 1/- pair. Shorting Plug, 3/-.

HEADPHONES. 4,000 ohms. Dr. Nesper (non-adjustable), 5/11; Dr. Nesper pattern, adjustable, with double headbands, 6/11; very good line at 5/3; N. and K. Fatierni, double leather headbands, 5/11. Don't let the price prejudice you.

PERMANENT DETECTORS. Red Diamond (a topper), 2/-. Lion Micro (latest, cannot be equalled), 2/6. Brownie, 2/6. Enclosed, 2/6. Detectors, 1/-. 1/3. Micrometer, 2/-; Service do., 2/6 (both with crystal). Cat's whiskers, 2d., 3d. Set of 6, 4d. B.A. COIL STANDS stocked in standard sizes.

SETS OF COMPONENT PARTS. RADIANO "THREE" (March '27, Wireless Constructor). All parts as specified with Terminals. 2 Ormond S.L. Variables, with friction gear; 3 Coil Sockets; T.C.O. '0003 and Clips and 2-meg. Leak; 3 Benjamin Valve Holders; 3 Mixed Resistors and Bases; On and Off Switch; Geophone 1st Stage L.F.; B.T.H. 2nd Stage L.F. (Black Band); 2 H.F. Terminals and Nuts; 2 H.L. Terminals for Front Panel; 3 Gross Pinch-off Spades; Rubber Flex. £3/10/0 lot, post free U.K. EDISWAN R.C. THREESOME. Set of Parts: 2 Ediswan R.C. units; Ediswan P. 2 Valve; 2 Ediswan R.C. ditto; Lotus H.L. 3/4; R.C. 3/4; R.C. 9-v. Grid Bias; Lotus 2-way L.H.; '0005 Tuning Condenser. £3/5/0 the lot, post free U.K.

SIGNAL BOX (P. Harris, May '27, W. Cons.) 1 Ormond S.L.F. '0005 and 2 '0003, with friction gear; 2 6-pin bases; 1 Nut; 1 Nut; 1 Nut; 1 Nut; 4 V.H.; 4 Resistors; '0001 and stand; R.F. Choke; 100,000 Ohm and Base, 3 o/o Switches; Carborundum Unit; R.I. Multi; Ferranti do.; 4 Strips and Terminals; '015 Dubilier, Glazito; 6-pin H.F. Trans., 8.5. type; Do. S.P. for Broadcast Range; Components as specified. The lot, post free net, £7/10/0 U.K.

FAMILY FOUR PARTS (Percy Harris, Aug. '27). 14 Belling-Lee Terminals; 4 Anti-Micro V.H.; 4 Burndeft Res. & Bases; 1 30-ohm B.B. Rheostat; 2 six-pin Bases; 1 Fordensider; Dubilier '0003, with clips; 4 meg. and 4-meg. Leaks; '015 Fixed, 610 type with Series Clip; 100,000 ohm Wire Wound; 300,000 ohm ditto Resistances (Dubilier or R.I. Varley); Nut. Condenser, B.B.; R.F. Choke; Geophone L.F.; 2 "J.B." '0005 and 2 S.M. Dials; 2 Ferranti '0003; 1 Ferranti o/o Switch; 2 Lotus D.O. Jacks and Plugs; Binocular Coils 250/550; S.P. H.F. Transformers, 250/550 and 1,000/2,000 metres; S. Secondary dillo for Davenport. THE COMPONENTS, ALL AS SPECIFIED, SENT POST FREE. NETS £8/8/0 U.K. PANELS, CABINETS, VALVES, PHONES, LOUD SPEAKERS, TO YOUR REQUIREMENTS.

SHORT - WAVE RADIANO. "Wireless Constructor," June, 1927. 2 Variable Condensers '0003; 1 Potentiometer o/o Switch; 2 Valve Holders; 2 Resistors (state valves); Dimic S.W.1 and S.W.2; Unimic No. 5; 2 Bases; '0003 with Leak; '002 Fixed; Coil Socket; E.A.V. L.F.; Strip and Terminals; Rubber Flex. All parts with Terminals. List Price, £5. Also good quality kit for £4.

FOR PANELS AND CABINETS S E ELSEWHERE. DARIO VALVES. BIVOLT 2-v. '05, 7/6; Loud Speaker Valve, 10/9; R.G. '05, 7/8; R.G. '05, 7/6; Loud Speaker Valve, 10/9; 3-5 R.C. '07, 7/6.

AMPLION BENJAMIN COLVERN DUBILIER EDISWAN ORMOND FERRANTI IFRANIC LISSEN MARCONI MULLARD OLDHAM POLAR W. & B. MEMICHAEL HELLESEN SIEMENS EVER-READY LEWOS BELLING-LEE and all proprietary lines stocked

COIL STANDS. 2-way Polar, with dial, formerly 10/-, new price 5/-. Lotus, 7/-; L. Handle, 8/- (also left hand). "Kay-Ray," geared (P. or B.), 2/11; extra value, 3/6. Geophone, back of panel (one-hole fixing); also for B.B., new price, 5/-. Grand value in B. of P., 3/11. Three-way, various makes. Special offer ebomite, 3-way, geared, 6/6. Post extra.

H.T. BATTERIES (carriage extra). Siemens's, 60-v., 2/6; 100-v., 3/6; Grid Bias, 2/-; 60-v. Double Capacity Power, 17/6; 100-v. ditto, 29/6.

J.B. CONDENSERS. T.T. Friction Ver. '0005, 166 '00035, 15/9 '0015, 16/- S.L.F. '0005, 11/6 '00035, 10/6 '00025, 10/- '00015, 10/6 Sq. Law '001 . 9.6 '0005 . 8/- '0003 . 7/- Neutralising . . . 3/6

LOW LOSS SQUARE LAW. '0003 4/11 This variable Condenser is each simply marvellous value. By Post 5/11 equalled in price per kv. Wm VERNIER 1/- extra.

LOG-MID-LINE. Try our NEW VARIABLE CONDENSERS, made on the Log-Mid-Line principle. '0005 or '0003, with a 4-in. Tridite Dial, the best you can buy, for the moderate price of 5/11 each. post free.

R.C. UNITS.—Ediswan, 7/-; Dubilier, 7/-; Cosmos, 8/6 (with V.H. 10/-); Magnum, 10/-; R.I. Coupler, 20/-; Graham Farish, 3/6. FERRANTI.—A.F.3, 25/-; A.F.4, 17/6; Output, 20/- and 22/6. HELLESEN (post free), 66-v., 12/6; 99-v., 21/-; Grid Bias, 9-v., 2/-; 41-v., tapped 1 1/2, 2.

PANELS. Grade A, cut to size, 1/4 sq. inch, 3/16 or 1/4 for 1/4. Reduction Large Sizes. L.O.T.S. REMOTE CONTROL.—Complete Outfit for Wiring two rooms: 1 "Lotus" Radi-Relay, 2 "Lotus" Relay Filament, Control Wall Jacks, 2 "Lotus" Jack Plugs, 21 yards of Special 4-strand Wire, 30/-. Each additional room, 7/6.

DX COILS. Used on "P.W." 14-valve Super-het. 25 1/1, 35 1/2, 40 1/3, 50 1/4, 60 1/5, 75 1/6, 100 1/8, 150 2/1, 175 2/2, 200 2/4, 250 2/6, 300 2/9. CENTRE TAPPED, 6d. EXTRA. The most efficient winding. The only multi-layer coil wound under a former. Min. capacity & H.F. losses. DX Coils made under Burndeft Licence Patent No. 168243.

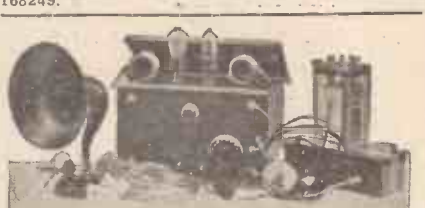

THREE-VALVE LOUD-SPEAKER SET. NOTE THE WONDERFUL VALUE. TRY ONE OF THESE! (The set shown is two-valve.) Gets Local Davenport and many continental stations. THIS MAGNIFICENT 3-VALVE SET (D. & L.F.), includes Handsome Polished American-Type Cabinet (all parts enclosed), 3 Dull Emitter Valves, Tuning Coils, H.T. & L.T. Batteries, Aerial Equipment, Leads, Loud Speaker or Phones. Tax paid. JUST THINK OF A 3-Valve Set at £5/19/6! —It sounds unbelievable, doesn't it?

TWO-VALVE SET. EXACT TO ABOVE SPECIFICATION. £4 19 6 Nett. NO POST ORDERS ON ABOVE SETS.

OUR NOTED 1-VALVE (L.F.) & CRYSTAL SET. In Solid Polished Cabinet. COMPLETE WITH LION MICRO DETECTOR. SET only 22/6 Carr. 1.6. Or complete with valves, phones, H.T. and L.T. Units, Aerial Equipment. Extraordinary 45/11 Post 2/-

TESTIMONIAL. G. A. Ross, Esq., 21, Wharfedale Rd., N.1., March, 1927. Messrs. Raymond,—I am sending this letter to tell you how pleased I am with the three sets purchased from you. They are working in Billerica, Chiswick, and Wandsworth, and I must say the results are simply wonderful, loud-speaker reception being impossible to beat. You may rest assured that I shall heartily recommend them to anyone whom I know is in need of a set, as there is no better value obtainable anywhere. (The above entirely unsolicited.)

COSSOR VALVES. In 4 types and 3 voltages. 2-volt: 210 H.F. (Red Band), for H.F. use, 10/6; 210 Det. or L.F. (Black Band), for Detector or L.F. use, 10/6; 210 R.C. (Blue Band), Resistance or Choke Coupling, 10/6; 215 P. Stentor Two-Power Valve, 12/6. 4-volt: 410 H.F. or Det. (Red Band), for H.F. or Detector use, 10/6; 410 R.C. (Blue Band), for Resistance or Choke Coupling, 10/6; 410 L.F. (Black Band) First L.F. Stage, 10/6; 410 P. (Stentor Four) Super Power Valve, 12/6. 6-volt: 610 H.F. or Det. (Red Band), for H.F. or Detector use, 10/6; 610 R.C. (Blue Band), for Resistance or Choke Coupling, 10/6; 610 L.F. (Black Band) First L.F. Stage, 10/6; 610 P. (Stentor Six) Super Power Valve, 20/-.

MULLARD P.M. VALVES. For 2-volt accumulator. P.M.1 H.F. . . . 10/6 P.M.1 L.F. . . . 10/6 *P.M.1A (Resist Capacity) . . . 10/6 P.M.2 (Power) . . . 12/6 For 4-volt accumulator or 3 dry cells. P.M.3 (General Purpose) . . . 10/6 *P.M.3A (Resist Capacity) . . . 10/6 P.M.4 (Power) . . . 12/6 For 6-volt accumulator or 4 dry cells. P.M.5X (General Purpose) . . . 10/6 *P.M.5B (Resist Capacity) . . . 10/6 P.M.6 (Power) . . . 12/6 Super-power valves for last L.F. Stage. *P.M.254 (4 volts) . . . 20/- *P.M.256 (6 volts) . . . 20/-

COSSOR MELODY KIT OF PARTS £4.10 Nett (as specified). Cabinet, panel, valves extra. CHEAPER KITS SUPPLIED

K. RAYMOND 27 & 28a, LISLE St., LONDON, W.C.2. 'Phone: Gerrard 4637.

EDISON BELL COILS. 25 . . . 2/6 100 . . . 3/6 35 . . . 2/6 150 . . . 3/6 50 . . . 2/6 200 . . . 4/6 75 . . . 2/6 250 . . . 4/6 300 . . . 4/6

FIXED CONDENSERS. Dubilier, '0001, 2, 3, 4, 5, each 2/6. '001, 2, 3, 4, 5, 6, each 3/-. Grid Leak, 2/6. Edison Bell, '001, '0001, 1, 2, 3, 4, 5, 6, 1/-; '002, 3, 4, 5, 6, 1/6. McMichael and grid leak, 2/-. McMichael with clips, '0001 to '0005, 2/6 each. '001 to '006, 3/- each.

LITZEN WIRE is the best for Tuning Coils, Valves, meters, and H.F. Transformers. Each individual strand is silk-covered with an overall covering of silk. 20 yds., 5/6; 25 yds., 6/6; 50 yds., 12/-; 60 yds., 14/6.

GALLERS PLEASE MAKE OUT YOUR LIST FOR ORDERS OVER 20/- IF REQUIRING COMPONENT PARTS FOR ANY SET AND WE WILL GIVE YOU A FIXED INCLUSIVE PRICE.

PARTS IN STOCK FOR THE ELSTREE SIX, SOLODYNE MEWFLX, ELSTREFFLEX, 1927 FIVE, AND ALL THE CHIEF CIRCUITS.

PARTS FOR NELSON P.M. (as specified by Author). Transformer, 2 Coil Holders, Variable Condensers, 2 '0005, 1 '0003 S.L.F., with 4 Dial, Gambrell Neurovenera, Mullard 10,000-ohm Anode and Clips, all Fixed Condensers and Leaks, Mullard Everest 100,000 and Stand, R.I. or Varley Choke, B.T.H. Transformer, & P. Switch, Fil. Rho., Split Primary H.F. Transformers (long and short wave, 6-pin base), 2 Aerial Coils, and Gambrell B. & E. (secondary) centre tapped Coils.

Inclusive Price £6 10 0 Carriage 2/- With slow motion Dials

RODNEY P.M. 12 Terminals, 3 Valve-Holders, 5 Coil Stands, Two part Binocular Coils, 15/-, Rotary o/o Switch, 2/6. M.C.3 Aerial and Transformer Coils, wound on Paxolin formers, ready for use, 3/- pr. Post. £8.0.4 Ditto B.B.O., 10/6 set, 5XN 12/6 set. H.F. Choke, 6/6.

HYDRA CONDENSERS (Tested to 500 volts D.C.), 1, 1/9; 25, 2/1; 5, 2/3; 1 mfd., 2/6; 2 mfd., 3/6; 4 mfd., 5/3.

WEARITE, 2-way geared, 5/-; B. of Panel, 7/6. Grand value Four-set of Binocular Coils, 15/-; Rotary o/o Switch, 2/6. M.C.3 Aerial and Transformer Coils, wound on Paxolin formers, ready for use, 3/- pr. Post. £8.0.4 Ditto B.B.O., 10/6 set, 5XN 12/6 set. H.F. Choke, 6/6.

LEWCOX.—Frame Aerial Wire, 100 ft., 3/6. Multi-way Battery Leads, 4-way, 5/6; 5-way, 6/6; 7-way, 8/6. Glazito stocked. Lewcox Det. Screens, Coil Units, 32/6, 67/6, and £2 Screens and 6-pin base, 9/6. H.F. Transformers, 6-pin, 10/-. All kinds stocked.

COME TO LEICESTER SQ. TUBE (Important) Ask for back of Daly's Theatre This address is opposite.

IGRANIC TRIPLE-HONEYCOMB INDUCTION COILS. 30, 2/9; 40, 2/9; 50, 2/9; 60, 3/4; 75, 3/3; 100, 3/6; 150, 3/9; 200, 4/2; 250, 4/6; 300, 4/9; 400, 5/6; 500, 7/1; 750, 9/6; 1,250, 14/1; 1,500, 16/1.

R.I. VARIETY STOCKED.
R.I. VARLEY Latest L.F. Transformer, 15/-; Multi, 25/-; Straight Line, 25/-; Choke, 9/6. Anodes, all capacities, R.C. Coupler, 20/- (Red, 22/6). Tuner, Model "A," 47/6; "B," 37/6; Standard, 39/6.

CRYSTALS. — Shaw's Genuine Sealed Herzite, 1/4; 1/6; Myray, 1/6; Superite, Long Range, 1/6. Crystal Detectors, Micrometer, fitted Crystal, 2/6. No post.

TRANSFORMERS (L.F.) Geophone, 2-1, 17/8; 4-1, 22/6. Formic, 5/-; 10/6 each. Igranico, 3-1, 15/-; 5-1, 16/1. Tolson Radiogram, 12/6. "Ace," 8/6. Marconi Ideal, 2-7/1, 4-1, 6-1, 25/- each. Flye, 2-5-1 and 4-1, 17/6; 6-1, 20/-.

PETO-SCOTT BAL. CONDENSER, 7/6. Neutralising, 5/- (Panel, 6/9). Screen and Base, 1/6. Binoocular, screened, and usual lines stocked.

BOWYER-LOWE VALVE HOLDERS. White Line, 2/-; 2/6. 2/-; Popular, '0003 and '0005, 10/6. Screening Boxes, 6/-.

DUBILIER K.C. variable. 12/1, S.M. 200-1. Wire-wound resistances, Leaks, Condensers, Manbridge Condensers, R.C.C. units, all in stock.

LISSEN Valve-holders, 1/-; Fixed Con., 1/-, 1/6; Leaks, 1/-; Switches, 1/6, 2/6; Latest 2-way Cam Vernier, 4/6; Rheostats, 2/6; B.B., 1/6; Bistola, 13/6; L.F. Transformers, 10/6; 100-v. H.T., 12/11; 60-v. 7/11; Coils, 60X, 6/4; 250X, 9/9. Stats, minor, major.

MANSBRIDGE CONDENSERS, 2 mfd., 3/6; 1 mfd., 2/6. Other sizes, L.F. Chokes, 5/6. Phones, 8/6.

CARBORUNDUM. Detector only (No. 30), 5/-; Stabilising Detector Unit, with No. 30 Detector, 12/6. R.C.C. Unit, 8/6.

LEWIS COILS. 50, 7/5; 150, 20/0, 25/0, 5/3 each. Binoocular Coils, Split Primary Aerials, H.F.T. S.S. list prices. List wire stocked.

BENJAMIN, 1/16; 1/8; 1/4; 1/2; 3/4; 1/-. Valve Holder, 2/-, with Grid Leak, 5/3. With Condenser and Leak, 7/1. Rheostat, 2/9. Grid Leak de Luxe, 3/6; with condenser, 4/6. Anode, 3/6.

BURNDIPT ETHOVERNIER DIAL (with Midge Station Indicator, 18/1, 8/1). J.B. Condensers, T.T. Friction Ver., '0005, 16/6; '00055, 15/6; '0015, 15/5; S.L.F., '0005, 10/6; '00055, 8/10; '00025, 10/-; '00015, 10/-; Sg. Law, '001, 9/6; '0005, 8/-; '0003, 7/-; Neutralising, 3/6.

ACCUMULATORS, 2-v. 40, 7/11, 8/6, 8/11; 4-v. 40, 15/-, 15/11, 16/6; 2-v. 60, 10/-, 11/6; 4-v. 60, 12/11, 13/11; 2-v. 80, 12/6, 13/6, 14/6; 4-v. 80, 23/6, 25/-; 6-v. 60, 26/11, 30/-, all best quality Carriage, 1/- and 1/6 each. Exide, 3 star stocked.

JACKS & PLUGS. — Lotus S.C.O., 2/-; S.C.C., 2/3; D.C., 2/6; F.S.C., 2/6; F.S.D., 3/-; Break Plug, 2/-; P.P.S.J., S.P.D.T., 3/3; D.P.D.T., 4/-.

IGRANIC FACENT 61, 2/-; 62, 2/3; 63, 2/6; 64, 2/6; 65, 2/6; 66, 3/-, etc. Univ. Plug, 1/6.

ASHLEY S.C.O., 1/3; S.C.C., 1/6; D.C., 1/9; F.S.C., 1/9; F.D.C., 2/3. Phone Plug, 1/6.

H.F. CHOKES. — Watmel, 5/-; J.S., 4/6; McMichael, 9/-; R.I. Varley, 9/-; Split Coil type, 12/6; Success, 8/6; Cosmos, 6/6; Bowyer-Lowe, 8/-; Lissen, 5/6; Olfmax, 8/6; Special for Eliminators, 10/6; Wearite, 6/6.



This illustration shows you a set made in one of our American Cabinets. (Prices elsewhere.)

**SET OF THE SEASON
COSSOR MELODY MAKER
COMPONENTS FOR SAME**

2 Ormond '0005 S.L.F. at 6/-; 2 Do. Slow Motion Dials at 5/-; T.C.G. Condensers, '0001, '001, '0003, '002, 2/4 each; 2 mid., 3/10; 2 Grid Leak Clips, B.B., 9/-; Dubilier, 3, 4 and 25 mcg. 2/6 each; 3 W.B. V.H. at 1/9; 1 Ferranti A.F. 3, 25/-; 2 Eclair P.S. at 1/6; Paxolin, 7/4; 3/-; Terminals, Glazite, Systoflex, 3/-; Variable Resistance, B.B., 3/-; 9-v. Grid Bias, 2/-, 20 and 32 D.S.C. Wire stocked. Handsome American Type Cabinets, baseboard, hinged lid, solid oak, for 21 x 7 panel, 27/6. Ebonart, Boston, Purflat Panels, Mahogany or Black Polished, Grade A from 5/-.

COSSOR VALVES FOR ABOVE:

210 D	410 HF	610 HF	10/6 each.
210 RC	410 RC	610 RC	10/6 each.
210 P	410 P	610 P	12/6 each.

LOUD SPEAKERS (All makes stocked)
Amplion, A.R. 33, 38/-; A.R. 65, 65/-; Oak Flare, 13/6 extra; Cobo A.C. 3, 75/-; A.C. 1, 52/6; Jacobean Oak A.C. 7, 25/6. Celestion, £5 10s. to £25. B.T.H. 02, 60/-; Sterling Mellox, 45/-; Geophone, all metal, 35/-.

UNITS AND PICK-UPS, all makes.



OAK CABINETS
American type, opens at back, compartment underneath for batteries, etc. 12 by 8 by 9 in. deep 18/11 16 by 8 by 9 in. ... 25 11
Case and Carriage 2/6
Solid Oak, glass finish, beautifully made.

WESTOCK IGRANIC CLIMAX EVERREADY BELLESEN, SIEMENS' FORMO FERRANTI WEARITE ORMOND, J.B. BENJAMIN, LOTUS, MULLARD, DUBILIER, LISSEN LEWIS, UTILITY, MAGNUM, PETO-SCOTT, PEARLESS, BURNDIPT, P.YE, MARCONI, McMICHAEL, COSMOS, CARBORUNDUM, R.I. VARLEY, GAMBRELL, BROWN'S, STERLING, AMPLIONS IN FACT EVERYTHING IT IS POSSIBLE TO STOCK

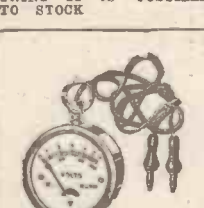

WATE'S UNIVERSAL TEST METER, L.T. & H.T. Also READ'S, from 1 to 36 milliamps. A really wonderful instrument.
Post Free 8/8 U.K.

**THE NEW No. 3
ORMOND
S.L.F. CONDENSER**

'00025, 5/6; '00035, 5/9; '0005, 6/-; With 4-in. Dial. With Friction 5.5-4-in. Dial, 6/- each extra. **ORMOND Square Law Low-Loss.** '0005, 9/6; '0003, 8/6 (1/6 each less no vernier); Friction Geared, '0005, 15/-; '0003, 14/6; '00025, 13/6. Straight Line Frequency Friction Geared, '0005, 20/-; '00035, 19/6. S.L.F. '0005, 12/-; '00035, 11/-.

PILAMENT EBEOSTATS, Dual, 2/6; 6 ohms or 30 ohms, 2/-; Potentiometer, 400 ohms, 2/6; '0001, Reaction, 4/-; Air Dielectric, 2/-; Neutralising, 4/-; Neutrodyne, 2/-; Twin Gang, '0005, 32/-; Triple, 40/-; H.F. Choke, 7/6. Geared Dial, 5/-.



2-way Geared COIL STANDS 3/6, 3/11, 4/3 All Ebonite

USE BRITISH VALVES
Now reduced prices.
MULLARD 10/6 COSSOR MARCONI 12/6 P. B.T.H. EDISWAM 20/- S.P. COSMOS

L.F. CHOKES
R.I., 10 Henries, 11/-; R.I., 20 Henries, 12/6; Success Super, 18/-; P.Ye (20 or 32 H.), 12/6; R.I. Filter Choke, 9/6.
RESISTOR PANELS.
10 x 8, 5/-; 12 x 8, 6/-; 16 x 8, 8/-; 14 x 7, 6/3; 21 x 7, 9/3; 24 x 7, 10/6.

VALVE HOLDERS. Non-microphonic, — Benjamin, 2/9; Lotus, 2/6, 2/3; W.B., 2/-; Magnum, 2/6; Raymond, 1/9; Harlie, 1/4; Standard, 9d., 1/-.

BENJAMIN. — Battery Switch, 1/-; Valve Holder, 2/-; with Grid Leak, 5/3. With Condenser and Leak, 7/1. Rheostat, 2/9.

BRETWOOD. — Grid Leak de Luxe, 3/6; with condenser, 4/6. Anode, 3/6.

CLIMAX. — Potential Divider, 5/-. Special Choke, 10/6. Shock Absorbers, 3/- pr. Earth Tubes, 5/-. L.L. Insulators, 1/- pair.

GOLVERN SCREENED COILS, &c. Former & Base, 5/-. 6-pin Base, 1/6. Former only, 4/-. Screen and Base, 8/6. S.P.H.F.T., 9/6. S.S. do., 5/6. 2 Monodial, 13/6.

DUBILIER. Dustproof Wire-wound, 20,000 to 100,000 ohm resistances, 5/- each; Base, 1/6; 200,000 ohms, 8/-. Vol Control Unit, 7/6. Invariable, 1/6. Dumctohn Holder, 1/6.

DUNHAM "ALL-WAVE" TUNER covers all wavelengths from 150 to 2,000 metres, and is complete with reaction. "All-wave" Tuner, 9/6.

EVER-READY H.T. Popular 66-v., 9/6; Do. 108-v., 15/6. Standard, 66-v., 12/6; 108-v., 21/-; L.T. 3, 7/6 (44-v.). Flash Lamp, 4-5, 6/- dozen. Grid Bias 9 Tapped 15-v., 2/-.

FORMO Individual-Gang Control Condenser. Twin-Gang, 4/12s. 6d.; Triple-Gang, 4/3s.

GANG Dual. '0005. Ormond, with dial, 32/-; Gylidon, no dial, ... 50/-; Ormond, '0005, ... 40/-; Gylidon, no dial, ... 70/-; Igranico, no dial, ... 75/-; Bowyer-Lowe, no dial, 70/-.

GRAHAM FARISH Hakelite Mica Condensers have S.P.H.F.T. clip. '0001 to '002, 1/-; '003 to '006, 1/6; '007 to '01, 2/6; Grid Leaks, 1/3; '0003 and Leak, 2/-.

AMAZING VALUE

BROWNIE CRYSTAL SET (2001,700 metres). Latest Model No. 3, 12/6. Pair 4,000-ohm Headphones, 7/8. Aerial and Lead-in, 2/11. **18/11**
The above lot, 1/6.

BRITISH HEADPHONES. Ericsson (English) now reduced to 12/6 pair, 4,000 ohms. Post 6d.

BRITISH HEADPHONES. B.T.H. (English) now reduced to 15/- pair, 4,000 ohms. Post 6d.

TELEFUNKEN HEADPHONES. Genuine 'BEE' adjustable, very sensitive, extremely light. Our price, 12/11 pair nett. (List 20/-). Post 6d.

LISSEN

Valve-Holders, 1/-; Fixed Con., 1/-, 1/6; Leaks, 1/-; Switches, 1/6, 2/6; Latest 2-way Cam Vernier, 4/6; Rheostats, 2/6; B.B., 1/6; Lissenoh, 13/6; L.F. Transformers, 8/6; 100 v. H.T., 12/11; 60 v. H.T., 7/11; Coils, 60X, 6/4; 250 X, 9/9.

THIS IS THE ADVT. OF

RAYMOND'S
27 & 28 LISLE ST., LEICESTER SQUARE,

WE HAVE THE GOODS WE ADVERTISE AND MANY MORE



Large stocks of really useful cabinets kept or made to order. Solid oak glass finish. American type, hinged lid, baseboard.

10 x 8 x 8 ... 8/11
12 x 8 x 9 ... 11/6
14 x 7 x 9 ... 13/11
16 x 8 x 9 ... 16/11
18 x 8 x 9 ... 19/11
20 x 8 x 9 ... 22/6
21 x 7 x 9 ... 25/6
24 x 7 x 9 ... 27/6

PERSONAL SHOPPERS

WE ARE OPEN ALL DAY SATURDAY ALL DAY THURSDAY ALL DAY EVERY DAY

TWO SHOPS Hours 9 a.m. to 8 p.m. if one is closed Sat. 9 a.m. to 9 p.m. the other is open. Sunday morning 11-1

NOTE WONDERFUL OFFER BELOW! STUPENDOUS BARGAINS

BE SURE YOU ARE AT RAYMOND'S! THESE SPECIAL LINES ARE SOLD TO CALLERS ONLY who are purchasing their regular wireless supplies at the same time.

ALL BRAND NEW.

YOU CAN ONLY BUY THESE AT RAYMOND'S WHEN BUYING OTHER GOODS. NOT SOLD AT THESE PRICES ALONE OR BY POST.

MANSBRIDGE CONDENSERS. Brand new, 1 mfd., 1/6; 2 mfd., 1/11; 4 mfd., 3/11 (List prices double).

BATTERY CASES, complete with Ollips, 1/- (List 2/6 each). All brand new.

4" EBONITE DIALS, extra quality, 10d. (List 18/-).

250 CT. COILS, 1/3 (List 3/-).

AMERICAN CABINETS, various sizes, 6/11, 8/11, 10/11, 12/11. Oak polished, (List double).

ACCUMULATORS, 2-v. 40-v., 4/11 (List 8/6).

HEADPHONES (4,000 ohms), brand new, 12/11, 2/6; 2/11. (List prices treble).

LOUD SPEAKERS, brand new, 4/11, 6/11, 2/6, 15/-, 21/-. **SEEKING IS BELIEVING.** (List prices double and treble).

LOUD SPEAKER UNITS, 4,000 ohms, 6/11. Brand new. (List 11/6).

H.F. TRANSFORMERS (6 pin), S.P., 3/6; S.S., 3/11. Brand new. (List 8/6).



Large stocks of really useful cabinets kept or made to order. Solid oak glass finish. American type, hinged lid, baseboard.

10 x 8 x 8 ... 8/11
12 x 8 x 9 ... 11/6
14 x 7 x 9 ... 13/11
16 x 8 x 9 ... 16/11
18 x 8 x 9 ... 19/11
20 x 8 x 9 ... 22/6
21 x 7 x 9 ... 25/6
24 x 7 x 9 ... 27/6

PERSONAL SHOPPERS

WE ARE OPEN ALL DAY SATURDAY ALL DAY THURSDAY ALL DAY EVERY DAY

TWO SHOPS Hours 9 a.m. to 8 p.m. if one is closed Sat. 9 a.m. to 9 p.m. the other is open. Sunday morning 11-1

NOTE WONDERFUL OFFER BELOW! STUPENDOUS BARGAINS

BE SURE YOU ARE AT RAYMOND'S! THESE SPECIAL LINES ARE SOLD TO CALLERS ONLY who are purchasing their regular wireless supplies at the same time.

ALL BRAND NEW.

YOU CAN ONLY BUY THESE AT RAYMOND'S WHEN BUYING OTHER GOODS. NOT SOLD AT THESE PRICES ALONE OR BY POST.

MANSBRIDGE CONDENSERS. Brand new, 1 mfd., 1/6; 2 mfd., 1/11; 4 mfd., 3/11 (List prices double).

BATTERY CASES, complete with Ollips, 1/- (List 2/6 each). All brand new.

4" EBONITE DIALS, extra quality, 10d. (List 18/-).

250 CT. COILS, 1/3 (List 3/-).

AMERICAN CABINETS, various sizes, 6/11, 8/11, 10/11, 12/11. Oak polished, (List double).

ACCUMULATORS, 2-v. 40-v., 4/11 (List 8/6).

HEADPHONES (4,000 ohms), brand new, 12/11, 2/6; 2/11. (List prices treble).

LOUD SPEAKERS, brand new, 4/11, 6/11, 2/6, 15/-, 21/-. **SEEKING IS BELIEVING.** (List prices double and treble).

LOUD SPEAKER UNITS, 4,000 ohms, 6/11. Brand new. (List 11/6).

H.F. TRANSFORMERS (6 pin), S.P., 3/6; S.S., 3/11. Brand new. (List 8/6).

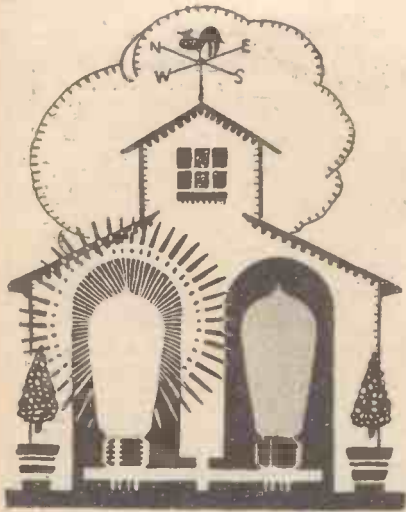

BRIGHT OR DULL—
The **PEERLESS**
DUAL RHEOSTAT
AFFORDS
PERFECT
CONTROL!

The Peerless Dual Rheostat is specially made to meet the demand for a Rheostat covering needs of both bright and dull emitter valves. Has two windings, a resistance of 6 ohms, with a continuation on to a 30-ohm strip winding. Resistance wire wound on hard fibre strip under great tension and immune from damage. One-hole fixing, terminals conveniently placed. Contact arm has smooth, silky action. All metal parts nickel-plated. Complete with ebonite combined knob and dial.

PRICE 3/-



THE BEDFORD ELECTRICAL AND RADIO CO., LTD.,
22 Campbell Rd., Bedford.

LONDON: 21, Bartlett's Buildings, Holborn Circus, E.C.4. GLASGOW: 113, St. Vincent Street, C.2.

THE "WAVELET METER"

—continued from page 164

known wave-length, readings accurate to a fraction of a metre are readily obtainable.

One last hint. It may be found that when the resonance-point is reached the receiving set, if oscillating, goes out of oscillation with a click and does not oscillate again until the dial has been moved through perhaps as much as a complete scale division. Similarly, if a telephonic transmission has been tuned in it may be rejected over a whole division of the scale.

This generally means that the meter is too tightly coupled to the set; if, however, loosening the coupling leaves the tuning still on the broad side, always begin at a lowish reading of the meter-dial and turn *clockwise* (i.e. so as to increase the capacity) until the resonance-point is reached. Take your reading from the exact point at which the set goes out of oscillation or telephonic signals fade out. Very fine readings may be obtained by the use of a slow-motion dial, but for most ordinary work above about 30 metres such a thing is not absolutely necessary. The instrument makes no pretensions to a laboratory standard of precision. What it claims to do and what it actually does is to be an aid to the quick finding of stations and to the identification of those that have been tuned in.

 * A USE FOR OLD H.T. *
 * BATTERIES *

SOMETIMES quite a good H.T. battery may be spoilt by overloading, especially when several tappings are taken from it and when the bulk of the battery has to carry the full load. For example, a 72-volt battery may be used in such a way that three valves are run at 60 volts and the fourth valve at 72. When this is done there will be a four-valve load on 60 volts and only a one-valve load on 60 to 72. This part may be quite good when you decide to discard the battery, and if it is so, do not forget that the last section, if tapped, can often be used as a satisfactory grid bias battery.

 "POPULAR WIRELESS"
 is the
 LEADING RADIO WEEKLY



Plantations and Panels.

2. The Sap from the tree is now taken by the oxen-carts to the tanks.

'W AY back in a Malay rubber plantation our tree is giving forth its latex. This latex, or sap, is now collected in pails by the native and transferred to an oxen-drawn cart. This takes it to the factory where is begun the long process of transformation from a milky fluid into a Resiston Panel.

Only the pick of the rubber is used to make Resiston Panels. The slightest flaw which has crept in during the many stages of manufacture bars a piece of rubber from ever becoming a Resiston Panel. Utter purity is the Resiston Standard.

That is one of the reasons why the Resiston Panel is famed for its sheer beauty. Why Resiston has such amazing strength. Why Resiston's insulation is 100% efficient. Why Resiston's dielectric constant is so low. Why Resiston's colour is permanent. Why, in short, Resiston will give you that satisfaction which comes from knowing that the panel in your set is efficient. Ask your Dealer for Resiston.

Resiston Panels come in 13 stock sizes in black and Mahogany-grained. From 6 in. x 9 in. in black, 3/5, to 8 in. x 30 in. Mahogany-grained 19/.



"24 hours Cut Panel Service"

A vt. American Hard Rubber Co., Ltd., 13a, Fore St. E.C.

A NEW Music Work edited by SIR HENRY J. WOOD

MUSIC OF ALL NATIONS

To be published in Fortnightly Parts **1/3** A Collection of the World's Best Music
Per Part

Full Music Size—Full Words 'of all Songs

Part 1, Now On Sale, contains

- LES MILLIONS D'ARLEQUIN**
Italian Drigo
- SWING LOW, SWEET CHARIOT**
Negro Spiritual Arranged by Burleigh
- MINUET IN G**
German Beethoven
- SHENANDOAH**
Sea Shanty Arranged by Sir Richard Terry
- COME, ALL YE ROVING BACHELORS**
- SEVENTEEN COME SUNDAY**
Two English Folk Songs
- BLUE DANUBE WALTZ**
Austrian Strauss
- LA PALOMA**
Spanish Yradier
- HYMN TO THE SUN**
Russian Rimsky-Korsakov
- National Anthems of the World**
(1) *God Save the King* John Bull

Part 2, Now On Sale, contains

- LE REGIMENT DE SAMBRE-ET-MEUSE**
French Planquette
- THE LONDONDERRY AIR**
Irish
- REFRAIN DE BERCEAU**
Finnish Palmgren
- BARBARA ALLEN**
English
- GREEN BUSHES**
English
- NOBODY KNOWS DE TROUBLE I'VE SEEN**
Negro Spiritual Arranged by Burleigh
- WHAT SHALL WE DO WITH THE DRUNKEN SAILOR?**
Sea Shanty Arranged by Sir R. Terry
- GRENADA**
Spanish Albeniz
- National Anthems of the World**
(2) *The Marseillaise (French)* de Lisle

Parts 1 and 2 are now on sale at all Newsagents, Book-stalls, and Music dealers everywhere. If you have any difficulty in obtaining them, send 1/6 for each part required direct to the Publishers, The Amalgamated Press.

Ltd., Fleetway House, Farringdon Street, London, E.C.4. This work may only be exported to the British Dominions (excluding Canada) and possessions overseas, including Egypt and mandated territories.

LES MILLIONS D'ARLEQUIN

SÉRÉNADE

R. DRIGO

Allegretto cantabile (♩ = 144)

This piece alone is worth more than the cost of an entire part. It appears in Part 1. You probably know it well. Try it over on the piano now.

3 ways of Fixing - 1 only is sound -

and that is the
RAWLPLUG
WAY

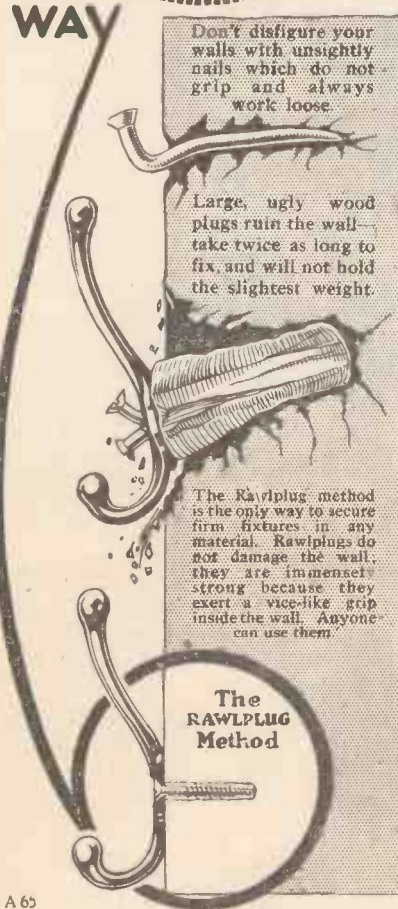

Don't disfigure your walls with unsightly nails which do not grip and always work loose.

Large, ugly wood plugs ruin the wall - take twice as long to fix, and will not hold the slightest weight.

The Rawlplug method is the only way to secure firm fixtures in any material. Rawlplugs do not damage the wall, they are immensely strong because they exert a vice-like grip inside the wall. Anyone can use them.

The
RAWLPLUG
Method

A 65

RAWLPLUG OUTFITS

Popular Outfit - - 1/6

Household Outfit - - 3/6 | Handyman Outfit - - 5/6

£500 IN PRIZES

Have you seen details of the great Rawlplug Competition which offers £500 in prizes? If not, ask your local Rawlplug stockist to tell you about it, or write direct to the Rawlplug Company.

The Rawlplug Co. Ltd, Cromwell Rd, London, SW.7

CHATS AT THE WORK-TABLE

-continued from page 134

portion of the switch, which forms the contact between the body and the arm of the jack, is formed in the easiest possible way from a standard coil socket, which can be purchased at almost any wireless shop. Luckily the bore of these sockets is just $\frac{3}{16}$ inch, and their outside diameter is $\frac{1}{4}$ inch, which fits most standard patterns of jack. Thrust the end of the rod into the sockets and then pin the two together in the following way.

Take a small brass nail of the kind used by shoemakers and discover by means of the drill plate which drill will produce a hole for which it is a good fit. With a drill of this size make a hole right through both brass and ebonite, and push in the pin. Cut it off fairly short and rivet over the end by tapping gently with a small round-ended hammer. When this job has been roughly done turn over and file the head of the nail almost away. Next flatten it out with the hammer. Trim off the burred-over portions of the pin on both sides with a small file and hammer again.

The Stop-Collar

An examination of Fig. 5 will show the purpose of the stop-collar. It prevents the metal contact from being pulled too far out of the jack. When the knob is pulled the collar butts against the back of the panel and stops further movement. The collar is made from a second socket. A piece of the hollow portion of this about $\frac{1}{4}$ inch in length is cut off with a hacksaw and pinned to it in the way previously described, so that its forward edge is $\frac{7}{8}$ inch from the end of the rod. The end of the rod is now threaded 2 B.A. by means of a die.

The knob can be made quite well from one of those of a wander plug. The hole in this is usually 4 B.A. tapped. Drill out with a No. 15 Morse drill and tap 2 B.A. The threaded portion of the rod should be just $\frac{1}{4}$ inch long, so that when the knob is screwed home the distance between its inner face and the outer face of the collar is exactly $\frac{5}{8}$ inch. This will allow exactly the travel needed. If you do not care about the job of threading the end of the rod and tapping the knob you can avoid this part of the job in the following way. Drill out the knob with a No. 12 Morse drill to a depth of slightly over $\frac{1}{4}$ inch. Lay it on the bench with the

(Continued on page 171.)



So we labelled it
BLUE SPOT

F. A. HUGHES & Co., Ltd.,
204-206, Great Portland Street, W.1.

Telephone : Museum 8630 (3 lines).
Telegrams : Distancing, Wesdo, London.

Manchester Office :

185, Princess Street, Manchester.

Telephone : City 3369.

CHATS AT THE WORK-TABLE

—continued from page 170

hole upwards, melt a little Chatterton's compound and put one drop into the hole. Now push the rod firmly in. When the compound has set the knob will be securely fixed.

Mounting the Switch

To mount the switch remove the knob and push the metal-cased end of the rod into the jack. In the panel drill a $\frac{3}{16}$ -inch hole in the proper position, and put the end of the rod which is to carry the knob through this. Before doing so it may be as well to give the portion of the rod between the collar and the threads a trim up with fine emery paper to make it perfectly smooth and to bring the diameter down to slightly under $\frac{3}{16}$ inch.

Put on the knob and move the switch about until when the knob is right against the panel the metal sleeve is making contact between the frame of the jack and the arm. Fix the switch down with *one* screw. Now move the knob in and out, turning the switch slightly if necessary, until a perfectly straight push and thrust is obtained. When you have found this position fix the switch with a second screw driven through the hole provided in the ebonite block upon which it is mounted. Solder up the leads to the contact points of the jack, and the job is done.

Accurate Marking Out

Where accurate marking out is necessary it is not entirely satisfactory merely to scribe cross lines and then to make punch-marks by means of the centre-punch and the hammer. Even if a fine-pointed punch is used—and this is not by any means always the case—it is not too easy to make the little depression in exactly the right spot.

A much better method is to make further use of the scriber after the cross-lines have been drawn. Place its point at each intersection which marks a centre, press it firmly down and turn it a little in the process. It is quite easy with a fine-pointed scriber to feel one's way to the exact point of intersection and so to make a prick in the place required. Once this has been done the punching becomes easy, for the point of the centre-punch can be inserted without difficulty into the small hole made with that of the scriber. Tap now with a hammer, and you may be sure that your centre is just where it ought to be.



The Benjamin Standard

The Benjamin Standard is known throughout the Radio trade. It stands for a greater efficiency, a far higher degree of excellence and an unequalled value. Every component that is stamped with the name of "Benjamin" is the very best of its class.

THE BENJAMIN RHEOSTAT
has its windings protected inside the dial. Three windings—6, 15 and 30 ohms. Price 2/9.

THE BENJAMIN IMPROVED EARTHING DEVICE.

Twelve feet of one inch copper in $11\frac{1}{2}'' \times 1\frac{1}{2}''$ giving 288 sq. in. of surface area. The inclined plane of the plates ensures perfect contact. Price 5/9.

THE BENJAMIN BATTERY SWITCH.

Simplest and most efficient switch. It's OFF when it's IN. Single contact, one hole fixing. Price 1/-.

THE BENJAMIN BATTERY ELIMINATOR

for Alternating Current 200-240 v. 50 cycles. Delivers current for loads up to twelve valves, giving 180 volts for power valve. A really dry eliminator. No acids, no liquids, no hum. £7 15 0.

THE BENJAMIN VALVE-HOLDER.

No other valve-holder so efficiently disperses microphonic noises and absorbs shocks so thoroughly. Valves free to float in any direction. Price 2/-.

BENJAMIN
THE BENJAMIN ELECTRIC LTD.

Brantwood Works, Tariff Road,
Tottenham, N.17.

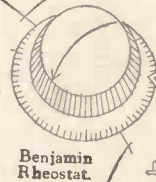

Benjamin Rheostat.

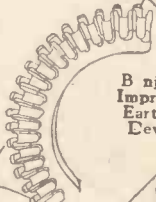

Benjamin Improved Earthing Device.



Benjamin Battery Switch.



Benjamin Battery Eliminator.

Benjamin Valve-holder.



MADE FOR THEIR JOB!

THESE HOLES

Patent No. 246977

Enable the Rapid Building-up, with Tappings each 4.5 volts, of any size H.T. Unit. No connection to solder, no danger of a weak connection and no container required



THESE POINTS

Patent No. 240314.

Protect every "Cordesia" Battery against usage before sale thereby securing you "100% value of your purchase." Protecting a Battery containing "the Maximum of Capacity" they enable a guarantee of complete satisfaction.

Specify "CORDESIA" but always see the seals are unbroken.



MAINTAINED PRICES.

4.5 Pocket Lamp Battery—
5d. each, 4/6 dozen.

HIGH TENSION.

Grid Bias	1/3	each
S.T. 60 volt	7/3	"
S.T. 100 volt	12/-	"
T.C. 60 volt	7/6	"
C.S. 60 volt	8/6	"
C.S. 90 volt	12/-	"
C.S. 100 volt	13/6	"
S.C. 60 volt	14/6	"
S.C. 72 volt	17/-	"

BUY BEST BATTERIES CORDESIA



WITHIN THE VACUUM

—continued from page 129

results as regards purity, I should like a valve of the order of 8,000 ohms impedance—not higher, especially if it is to be used for the local station. In the set actually mentioned, this valve is sometimes used as the last valve, and so 8,000 ohms would be ample. Probably 6,000 would be better, though this would tend to overload the L.F. transformer with the plate current it would require. Many transformers saturate at between 3 and 4.5 milliamps, and this 6,000-ohm valve would in all probability require about 5 milliamps. As an average, we can take the 8,000-ohm valve, with an amplification factor of 6-8, as a reliable valve for this position.

The last valve should, preferably, be of the super-power variety if it is to carry any large input voltage, or if only moderate signals will be dealt with a "power" valve of the 6,000-ohm impedance class would be quite suitable.

But you will see by the foregoing that the choice of a suitable valve is of paramount importance, so that before you purchase those little wonders—radio valves, make sure where and how they are to be used. A "general purpose" valve may be useful, but there's a risk that it will not, and its best to find out more about the valve's home before you choose.

New Valves

And, talking about choice, was there ever such a galaxy of types and makes from which you may pick your fancy? During the last month the numbers have been added to in no small degree, and the details of new valves given below will be of interest to many of my readers.

Among the new valves I must mention the Mullard and Cossor screened valves. The former make I have had an opportunity to try out, though I have been unable to give them a thorough test. They are quite unlike the S.625 (Marconi and Osram) valve, for the shield, instead of being

(Continued on page 173.)

QUALITY AT ZENITH

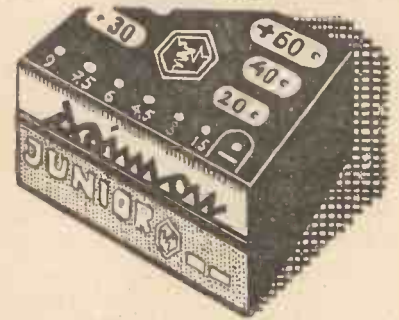

Never has Daimon quality been higher than it is in the new 60 and 100 volt batteries, and never has price been lower. Priced the same as other makes of equal voltage, Daimon are cheaper because they have better performance.

They work in a background of silence, and until you use Daimon your reception is not at its best.

The prices are:

60 volts	7/11
100 "	12/1

H.T. Batteries 60 volts 9/6; 100 volt 15/6.

Ask your dealer or send direct—

LOUIS HOLZMAN,
34, Kingsway, London, W.C.,
or S.D.H. Manufacturing Co., Colindale Avenue,
Hendon, N.W.9.

PRICE AT ZERO

—THE TAYLEX—
WET H.T. BATTERIES
Solve all H.T. troubles. Self-charging, silent, economical. JARS (Waxed) ZINCS SACS 1 1/2 x 1 1/4 sq. 1/3 doz. new type 1/- doz. 1/6 doz. Sample dozen (13 volts) 3/6, post 9d.. sample 6d.
BARGAIN LIST FREE.
Amplifiers: 1-valve, 19/-; 2-valve, 30/-; 2-valve all-station set, £4. Approval willingly.
C. TAYLOR, 57, Studley Rd., Stockwell, London.

DIGBY'S CABINETS
WRITE FOR NEW 16 PAGE CATALOGUE
F. DIGBY, 9, BANBURY ROAD, SOUTH HACKNEY, LONDON E.9.
PHONE: CLISSOLD 5458

LONDON LISTENERS!
—improved reception ensured
If you have your accumulators correctly charged by our skilled maintenance service. We collect weekly, fortnightly or monthly within 12 miles of Charing Cross and exchange your accumulator (H.T. or L.T.) for one fully charged. If yours are not serviceable, you can hire ours. Both trouble-free money-saving services. Terms—weekly, fortnightly or monthly—no deposit required. And you can depend on our service for a solution in every wireless trouble.
Our service—the speciality of experts. Write for full details and terms: RADIO SERVICE (London) Ltd., 105, Torrington Avenue, Camden Rd., N.W. 5. Phone: North 0623 (3 lines)

Pay for that set bit by bit!

PERHAPS you want a set, perhaps only accessories. Whatever your purchase, price need be no worry. Our instalment system—the first ever tried in Radio, is safe and generous. Send enquiries to desk 'C.'

New Times Sales Co., 77, City Rd., London, E.C.1

Use
KEYSTONE
COMPONENTS

in
"Constructor" Sets

KEYSTONE "MIDGET"
CONDENSER



Ideal for the many positions where a small capacity condenser is required. An aluminium shield prevents hand-capacity effects, and a special taper bearing gives a beautifully smooth movement. Accurately designed and rigidly constructed, this Keystone condenser is backed by the usual Keystone guarantee of efficiency. Capacity .0001 mfd. Price **5/6**

Keystone Neutralising
Condenser

Used in all the popular circuits this season. These condensers have been designed by experts, and they are suitable for neutralising the electrode capacities for all types of valves. Very low minimum capacity. The wide spacing of the vanes renders accidental "shorting" impossible. Very well made from best quality material and beautifully finished.

Board mounting 5/-
Panel mounting 6/3

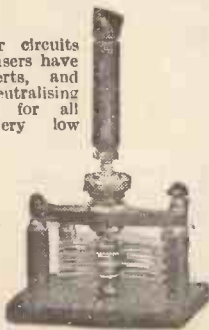

KEYSTONE FIXED RESISTOR



No. 4 for .25 amp. valves with 6-volt accumulator
No. 17 for .06 amp. valves with 4-volt accumulator. And in many other values.
Price **2/6**
Resistor only 1/9.
Base, 9d.

Kits for the
COSSOR
"Melody Maker"

Red Triangle Panel, Polished and Mat s. d.
back, 21 x 7 x 1/2. Drilled free - 9 6
Red Triangle Terminal Strip, 21 x 1 1/2 x 1/2.
Drilled Free. Engraved 2/1 extra 2 3
4in. x 7in. Pertinax Tube - 2 9
2 Reels wire for winding Green Silk - 3 6
Complete Coils ready wound - 7 6
Polished Oak Cabinet as specified - 30 0
Base-board - 2 0

We supply all the parts
from stock.

Write for Illustrated Catalogue ('W.S.') of
Components.

PETO-SCOTT Co., Ltd.,
77, City Road, E.C.1.

Branches:—62, High Holborn, London, W.C.1.
4, Manchester St., Liverpool.

P.S. 9704

WITHIN THE VACUUM

—continued from page 172

brought out to a pin at the opposite end of the valve to the main grid, is brought to a pin corresponding to the anode pin of the ordinary three-electrode valve. The valve base is the same to look at as the ordinary three-electrode, the grid and filament pins are the same, with the "anode" pin making connection with the screening grid. The actual anode is taken to a terminal at the top of the valve.

The characteristics of the Mullard screened valve are different from those of the S.625. The filament consumption is .075 amp. and the impedance is 275,000 ohms, or thereabouts. The magnification factor is given as 200.

Why a different mounting from other makes has been adopted I can't say, it certainly complicates experimental work, for it renders other makes of valves non-interchangeable with the Mullard valve.

Two-Volt "Super"

The Cossor screened valve follows a similar design (externally) to that of the Marconi and Osram valve. Its characteristics are different and the shield has a different design, while it employs the kalenised filament, having a consumption of .1 amp. Both 2- and 6-volt models are to be produced, having amplification factors of 60 and 100 respectively, with impedances of 120,000 ohms in each case. Both the Mullard and the Cossor valves are to sell at 22s. 6d.

By the way, I hear a rumour that the B.T.H. screened valve will not be ready yet awhile.

* * *

A good super-power 2-volter is the Marconi and the Osram D.E.P.240. This is a good little valve (price 20s.), and is a really useful super-power. It will handle about 10-12 volts grid swing either way, quite a useful voltage. The characteristics are:

Fil. volts 2
Fil. amp. 0.4
Anode volts 120 (max.)
Amp. fac. 3.5
Impedance 3,000

The valve is a very useful addition to the "stable" of 2-volters. While it is claimed that the "W" filament employed has the largest emission surface of any 2-volt valve. It should solve the problem of quality with 2-volters for a great many radio "fans."

There's
ALL
the Difference

There is all the difference in the world between ordinary brass terminals, which are almost things of the "stone age" in these advanced days of wireless construction, and

EEX
TREBLE-DUTY
TERMINALS

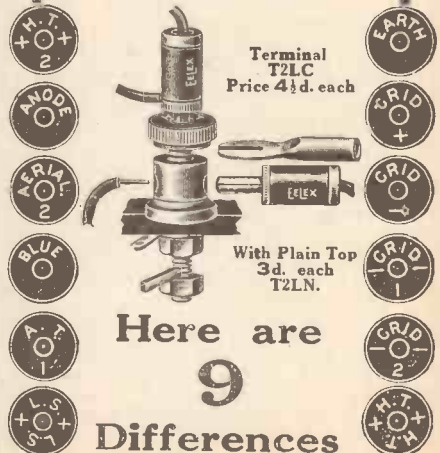

Terminal T2LC
Price 4 1/2 each

With Plain Top
3d. each
T2LN.

Here are
9

Differences

1. Designed to secure as firmly as held in a vice, spade, pin or tag, plug or just bare loose wires.
2. Plugs can be secured at top or side of terminal.
3. 36 varieties of indicating tops, + Red - Black and also in White, Black, Blue, Green, Red and Yellow.
4. Slotted stem to save soldering internal joints.
5. Nickel-plated terminal.
6. Soldering tab.
7. Standard Eex fittings, interchangeable.
8. Cost no more than any other nickel-plated terminal with indicating top.
9. Chosen by leading designers and manufacturers, and millions being used by amateurs.

Have you had details of these other EEX Accessories?

Standardised plug and socket system. Multiple connector and combined on-and-off switch.
Lightning switch
Moisture retaining earth.
Twin plug and socket. Frame aeriels.
Switches (all kinds).
H.T. battery boxes.
Electric soldering irons.
Anti-capacity valve holders.
Voltmeters, ammeters & galvanometers.
Morse tapping keys, etc., etc.

Every discriminating wireless constructor should have List No. V22. Drop a post-card to-day, of course without obligation, to—

J. J. EASTICK & SONS,

Eex Works,

118, BUNHILL ROW,
LONDON, E.C.1.

Telephone: Clerkenwell 9282-3.

TROLITE

BECAUSE

- (1) Trolite is ideal for panels and stub panels.
- (2) Trolite is easily drilled, sawn, and machined, and being soluble in acetone, a perfect and permanent joint can be made in a few minutes without the labour and disfigurement of screws.
- (3) Trolite does not fade or discolour.
- (4) Trolite panels are distinctive and can be obtained in the following varieties of beautiful finishes :
- (1) Black Polished, (2) Mahogany Polished, (3) Walnut Polished, (4) Wavy Design, (5) Cube Design.
- (5) Mirror-like polish, but no surface leakage.
- (6) The price of Trolite is within the reach of all constructors, but you do not sacrifice efficiency for effect by using Trolite ; you have both in the Panel de Luxe.

RETAIL PRICES, per square inch:

Polished Black	Mahogany Cube	Walnut Wavy
$\frac{1}{8}$ in. . . 1d.	$\frac{1}{8}$ in. . . 1d.	$\frac{1}{8}$ in. . . 1d.
$\frac{1}{4}$ in. . . 1d.	$\frac{1}{4}$ in. . . 1d.	$\frac{1}{4}$ in. . . 1d.

Ask your dealer to show you samples of Trolite. If you have any difficulty in obtaining, write direct to the makers and send the name of your nearest Radio Store.

F. A. HUGHES & Co., Ltd.,
 204-206, Great Portland St., W.1.
 Telephone: Museum 8630 (3 lines).
 Telegrams: "Distancing, Wesdo, London."
 Manchester Office: 185, Princess St.
 Telephone: City 3369.



TROLITE

THE RADIO PANEL DE LUXE
 COMBINES
 EFFICIENCY with EFFECT

SLOW-MOTION DIAL TROUBLES

SLOW-MOTION dials of good make are so well designed that in the ordinary course of events they give little or no trouble. There are, however, times, particularly when the dials have seen a considerable amount of service, when their working may become not quite so smooth as it should be owing to some cause that may be rather difficult to trace if one does not know just what to look for. A section diagram of the action of a typical slow-motion dial is shown in the drawing. The actuating knob is secured by means of a setscrew to a hollow brass sleeve.

Reduction Ratio

Through this sleeve passes a bolt, locked at its outer end by a nut, which secures the split pulley and

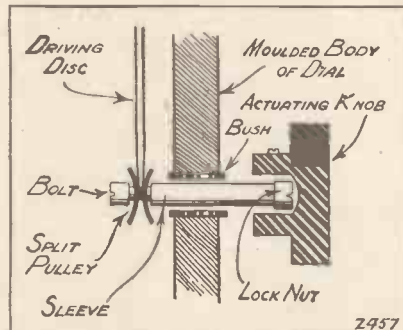

also serves to adjust its grip upon the driving disc. The driving disc itself is fixed to the central moving boss of the dial, which is firmly attached to the spindle of the condenser by means of either a setscrew or a split tapered bush. When the actuating knob is turned the pulley imparts motion to the driving disc, which turns the spindle carrying the moving vanes of the condenser. The reduction ratio obtainable in the drive depends upon the relation between the diameter of the pulley to that of the driving disc.

The Three Causes

A fault that the writer has experienced more than once with slow-motion dials is a gradual development of a tendency to stick at certain points, and then to move forward with a jump. There are three possible causes of this very unpleasant quality. The first is to be found in an accumulation of dust or dirt between the driving disc and the inside of the moulded frame. The second consists in a slight warping of the frame which makes the rim of the driving disc

(Continued on page 175)

Free! ENGINEERS Here is a Wonderful Opportunity

A book that—free for the asking—throws a new and startling light on the possibilities within your grasp, and shows how you can prepare for the A.M.I.E.E. A.M.I.Mech.E., A.M.I. Struct.E. A.M.Inst.C.E. A.M.I.A.E. and any other engineering qualification quickly, and in the privacy of your own home. 60 engineering Diploma (A.M. Tech. I.) courses are described—51 pages of vitally interesting matter to the ambitious engineer. The book is FREE. Write for your copy now, stating branch of Eng. or Exam. which interests you. The Technological Institute of Great Britain 200, Thanet House Strand London W.C.2.

EBONITE BUSHES FOR MOUNTING ON METAL OR WOOD PERFECT INSULATION Two required for each hole

NUMBER	0	1	2	3	4	5	6
Hole in Bush	3/8"	1/2"	5/8"	3/4"	7/8"	1"	1 1/8"
Price each:	1d.	1d.	1d.	1 1/2d.	2d.	2d.	2d.

(Complete List of sizes free on application)
DAREX RADIO CO.
 Waldram Rd., Forest Hill, London, S.E.
 TRADE SUPPLIED

READY SUPPLY CO.

41, NEWCOMEN STREET, LONDON BRIDGE, S.E.1.

PROMPT AND RELIABLE.

Write to-day for price lists of components for circuits described in this issue.

- (1) The "Straight Line" Four.
- (2) Providing your own Alternative Programme.
- (3) An Amplifier for your Crystal Set.

A BOON TO INVALIDS
THE RADIO CONTROL CLOCK
 Price 10/6 post free.

PICKETT'S CABINETS

For Your HOME Radiola! Wireless Furniture 3 ft. high-taking your Set, Batteries, etc., complete.

BUREAU Models from	23	3	0
"Radiola" Jacobean from	25	5	0
"Radiola" Queen Anne from	26	15	0

High Grade Work and finish GUARANTEED and Sent ON APPROVAL
 Lists of Cabinet Designs No. 21 FREE
 Pickett's Cabinet (W.C.) Works, Bexleyheath.

"EMACO" SEND TO-DAY "EMACO"
 List No. 93. "EMACO" CRAFTSMANSHIP CABINETS READY
 MELODY MAKER 32/- EVERYMAN FOUR 55/8
 NELSON - - - 36/- THRESOME - 16/8
 SOLODYNE - - 98/- 1927 FIVE - - 58/-
 Cabinets for all sets made.
 ENTERPRISE, 11, GRAPE STREET, LONDON, W.C.2.
EMACO

EVERYTHING RADIO ON EASY TERMS
WOOLDRIDGE RADIO CO. LTD.
 26 LISLE ST, LEICESTER SQUARE LONDON, W.C.2.



LAKER STEEL MASTS
are 100 per cent. efficient
They are made by engineers and supplied to H.M. Government, the B.B.C., and to Colonial and foreign stations throughout the world. There are 50,000 "Laker" Masts in daily use. By mass production we are able to offer a wonderfully efficient and handsome Steel mast at the extraordinarily low price of 22/6 complete, as illustrated. Send 1/6 extra for part carriage. We pay the rest. Buy a Laker Mast for good reception.
LAKER & Co., Engineers
BECKENHAM, KENT
30 ft. STEEL MAST 22/6

A Quality Cabinet for your Set.
Full illustrated particulars from the Actual Manufacturers, V. C. Bond & Sons, 61, Hochner Grove, Mare St., London, E.8. Phone: Clissold 0883

TRADE MARK "RED DIAMOND"
RED DIAMOND
REGD
THE RECOGNISED DETECTOR FOR ALL CIRCUITS USING CRYSTAL RECTIFICATION.



RD40 2/-
Shield for same, 6d.

By Insured Post 2/3 or 2/9 with shield. Can be mounted on brackets or through panel. Once set always ready. Not affected by vibration. Each one is tested on broadcast before despatch, and is perfect. Of all high-class Radio Dealers or Sole Makers:—

JEWEL PEN CO., LTD.

(Radio Dept. 41), 21-22, Gt. Sutton St., LONDON, E.C.1

AGENTS

Large German Factory of Wireless Sets and Accessories requires Agents in various districts of Great Britain and Ireland. Offers with references to

A. GÜNTHER,

FURTWANGEN, BADEN, GERMANY

DAREX
"Safety First"
Accidental Damage avoided
TERMINALS Descriptive List free on request.
DAREX RADIO CO.,
Waldram Rd., Forest Hill, London, S.E.23.
TRADE SUPPLIED

REPAIRS

to HEADPHONES, LOUVER SPEAKERS, TRANSFORMERS, COILS.

First-class workmanship only. This is just the vital difference. We are specialists with almost 30 years' experience in every form of intricate and accurate coil winding, and we guarantee that work entrusted to us will be returned to you as good as new, if not better. This is no idle claim, but the unsolicited opinion of scores of satisfied clients.

THE VARLEY MAGNET COMPANY
(Proprietors: Oliver Pell Control, Ltd.)
BLONPITRE, A. WOY WIOR, E.18.

Telephone: Woolwich 0888



SLOW-MOTION DIAL TROUBLES

—continued from page 174

touch the edge of the frame at certain points. The third—and this is by far the commonest—is due to the formation of small notches or burrs upon the edge of the driving disc.

The cure in the first case is obvious; the dial should be dismantled and thoroughly cleaned out. Before doing this, however, see that the second possible cause is not present. Remove the dial from the receiving set, turn its back towards you and move the actuating knob until one of the "sticky" places is reached. Now look very carefully to see whether the driving disc is not touching the rim of the moulding at some point. If it is, remove the disc and thin down the rim of the frame a little.

A Good Tip

Burrs or notches on the edge of the driving disc are difficult to deal with, though sometimes careful work with an emery cloth will effect a cure. A very good tip when the rim is found to be imperfect is to take out the driving disc and to turn it right over before replacing it. This is sometimes very effective.

A great deal of the "sweetness" of the motion depends upon the adjustment of the split pulley. If it is too tight the dial will be unduly stiff, whilst if it is over-slack slipping may occur.

The most curious fault in a dial that the writer has experienced occurred recently. The action became slowly stiffer and stiffer when the dial was moved in a clockwise direction, though it eased off when the movement was reversed. At length the dial seized up altogether, whilst being turned clockwise. The cause of the trouble took some time to locate, but it was found at length to be due to the sleeve being a little too tight for the bush.

Two Trade Announcements

In connection with the "Kuprox" and "Raytheon" units referred to last month in the article "Rectifier Developments," it should have been stated that the agents in this country are the Rothermel Radio Corporation of Great Britain, Ltd.

The London and Provincial Radio Co., Ltd., inform us that their on-off switch reviewed recently in "What's New" is now reduced in price to 1s. 3d.

"Quarts" and "Pint Pots"

There is an adage which has for its theme the futility of endeavouring to "drain a quart from a pint pot." Ancient wisdom—but it is disproved by Columbia Batteries.

Small H.T. Batteries are "pint" Batteries, and from them you cannot extract more than "pint" service—but—

BY DOUBLING THE SIZE OF A BATTERY ITS CAPACITY IS AT LEAST TREBLED!

Thus although a battery twice the size costs twice as much—it will give three or four times as much service—That is economy.



Here is an illustration of the COLUMBIA No. 4780—60-volt High-capacity Type—a "quart" Battery—It costs 22/6, but it lasts so long that you forget you have an H.T. Battery at all. Don't waste any more money on cheap, indifferent Batteries—

Buy

Columbia

High Capacity Batteries

They last longer.

Ask your dealer for them, or drop us a card for lists, etc.

J. R. MORRIS,
15, Kingsway, London, W.C.

Scotland: J. T. Cartwright,
3, Cadogan Street, Glasgow.

Your new 075 Valves! Heat the filaments with the famous Columbia Radio "A" Cells.

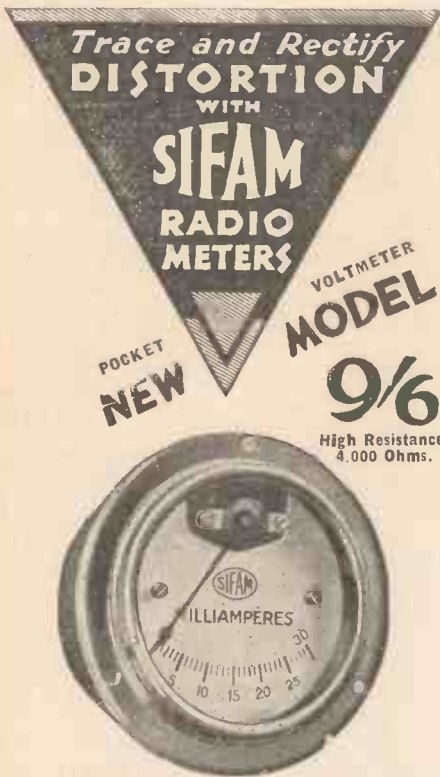

NO listener can avoid knowing when distortion is spoiling his reception, but hours of laborious overhauling may never reveal the source of trouble.

The Milliammeter illustrated above, price 25s., is one of the highly sensitive Sifam Radio Instruments which tells you at once if distortion is due to L.F. Transformers, inaccurate H.P. or L.T. current, or incorrect grid bias. Without Sifam Radio Meters you are always liable to sudden failure at the critical time of an interesting programme.

Ask your dealer to show you complete range, or write to (Dept. C)

SIFAM ELECTRICAL INSTRUMENT CO., LTD.
10a, PAGE STREET, WESTMINSTER, LONDON, S.W.1.

Get your copy of the
SIFAM
Descriptive
List

Remember!

TEST YOUR SET TO-NIGHT
WITH A **SIFAM** METER
and it won't let you down to-morrow.

M. B. 34

* A WIRELESS *
* ENCYCLOPEDIA *

FROM Fredk. J. Drake & Company, of Chicago, we have received a copy of "Drake's Radio Cyclopedia," by Harold C. Manly. The book is designed to provide non-technical men with a ready reference work in solving their radio problems, and a careful examination of the book shows that it is not only an ambitious effort, but a remarkably good effort in the bargain.

Some four hundred pages and near a thousand illustrations—these latter excellently drawn—seem to cover almost every aspect of the art, but unlike many so-called reference books on radio, it is essentially a practical work and of great usefulness to the home constructor. It is right up-to-date, and includes full details of such matters as the electrical reproduction of gramophone records by modern pick-up devices.

Under "Amplifier—Phonograph type," six pages are given to the description of the use of various pick-up devices and their operation. Six pages are also given to radio-frequency amplifiers, and some pains are taken to explain the general principles of radio-frequency transformer design. A very interesting curve is included in this section showing the effect of primary turns on radio frequency amplification in a given transformer.

An explanation is also given as to why we do not get a voltage step-up comparable to the turn ratio. The difference between capacitive and inductive coupling in radio-frequency transformers is also explained.

Under "Balancing" a great deal of useful and up-to-date information on neutralised circuits is given, although in some cases, perhaps, the

credit is not always given in the right quarter for the arrangement described. A particular arrangement called the "Roberts method" while used in a receiver of that name is really the method we generally call "split primary," with tight coupling between the two windings as used in the more recent Hazeltine receivers.

In the "Battery Section," a very interesting table is given showing the months of life which may be expected from three different sizes of high-tension batteries; for various plate currents and milliamperes when the set is used on an average of two hours a day. Under "Grid Bias, Methods of Obtaining," the reader will find much assistance in experimental work.

Throughout the book is every evidence of the information being thoroughly up-to-date, and that it has been compiled by a practical man for practical men.

Spend 4^d and save £4

1000 BARGAINS
Are listed and hundreds illustrated in our
NEW 72-PAGE CATALOGUE
Now Ready
SEND 4d. IN STAMPS TO
ELECTRADIX RADIOS
218, Upper Thames St., London, E.C.4.

The WHITELINE VALVE HOLDER

Adapted by the most critical of set designers.

Bowyer-Lowe  2/3

W & M WIRELESS CO. LTD.

Antiphonic Valve Holders, 1/-; LOG-MID-LINE Variables, 0003, 4/1, 0005, 4/3. Two-way Bag of Panel Coil Holder, 3/3. Variable Dial, Ratio 260 to 1, 5/9. L.F. Transformers, 1 to 5 or 1 to 3, 4/-. VALVES from 4/6.

Orders 5/-, and over Post Free. Under 5/-, add 1d. per 1/- for packing and postage. Cash with order.

LOWEST PRICES FOR EVERYTHING WIRELESS.

Send stamped addressed envelope for Free List.

531, FOREST RD., WALTHAMSTOW, LONDON, E.17

INDEX TO ADVERTISERS	
American Hard Rubber Co., Ltd.	168
Adil & Co., Ltd.	151
Artemit Company, The	143
Ashley Wireless Telephone Co., Ltd.	156
Bedford Electrical & Radio Co., Ltd.	168
Belling & Lee, Ltd.	148
Benjamin Electric, Ltd.	171
Bird, Sydney S., & Sons, Ltd.	165
Bishopsgate Electric Supply (1924) Co.	159
Bowyer-Lowe Co., Ltd.	136 & 176
Bond, V. C., & Sons	175
Brandes, Ltd.	127
Brown, S. G., Ltd.	124
Burne-Jones & Co., Ltd.	132 & 154
Carrington Mfg. Co., Ltd.	159
Citizen's Radio Service Bureau	163
Cole, E. K., Ltd.	164
Cordelia Batteries	172
Cosser, A. C., Ltd.	88
Carborundum Co., Ltd.	163
Digby, F.	172
Dubilier Condenser Co. (1925) Ltd.	136
Darex Radio Co.	174 & 175
Eastick, J. J., & Sons	173

Ede, C. & Co., Ltd.	159
Electron Co., Ltd.	135 & 160
Enterprise Mfg. Co.	174
England-Richards Co., The	161
Electrodix Radios	176
Falk Stadelmann & Co., Ltd.	128
Ferranti, Ltd.	139
Formo Co., The	148
Gambrell Bros., Ltd.	144
Garbutt, Whiteley & Co., Ltd.	Cover iii
Gunther, A. (Germany)	175
Hamley Brothers, Ltd.	140
Hobby	161
Holzman, Louis	140 & 172
Hughes F. A. & Co., Ltd.	170 & 174
Igantie Electric Co., Ltd.	159
Jackson Bros.	144
Jewel Pen Co., Ltd.	175
Junit Mfg. Co., Ltd.	144
Laker, J. & J. Co.	175
Lissen, Ltd.	123 & 131
London Electric Wire Co. & Smiths, Ltd.	128
Makerimpport Co.	144
Marconiophone Co., Ltd.	85
"Modern Wireless"	140
Morris, J. R.	175
Metro-Vick Supplies, Ltd.	86 & 87
Mullard Wireless Service Co., Ltd.	Cover ii and 147
"Music of All Nats" ns	169
New Times Sales Co.	172

Ormond Engineering Co., Ltd.	143
Paroussi, E.	148
Peto & Radford	161
Peto Scott Co., Ltd.	173
Pickett's Cabinet Works	174
Portable Utilities Co., Ltd.	155
Pye, W. G. & Co.	157
Radio Service, Ltd.	172
Ravilpug Co., Ltd., The	170
Raymond, K.	166 & 167
Ready Radio Supply Co.	174
Redfern's Rubber Works, Ltd.	158 & 163
Rothermel Radio Corp. (of Gt. Britain), Ltd.	157
R. I. & Varley, Ltd.	Cover iv
Sifam Electrical Instruments Co., Ltd.	176
Taylor, C.	172
Technological Institute of Gt. Britain	174
Telegraph Condenser Co., Ltd.	132
Tungstone Accumulator Co., Ltd.	152
Varley Magnet Co.	175
Ward & Goldstone, Ltd.	162
Weston Electric Instrument Co., Ltd.	157
Woodbridge Radio Co., Ltd.	174
W. & M. Wireless Co., Ltd.	176

All communications concerning advertising in "Wireless Constructor" must be made to John H. Lile Ltd., 4, Ludgate Circus, London, E.C.4. Telephone: City 7261.

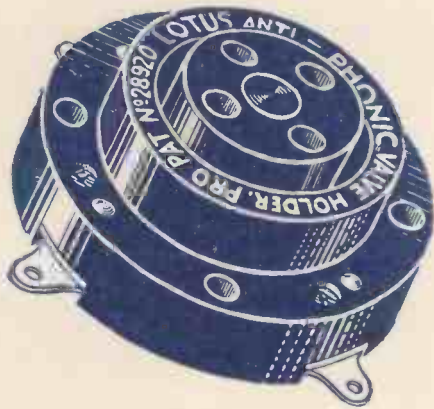
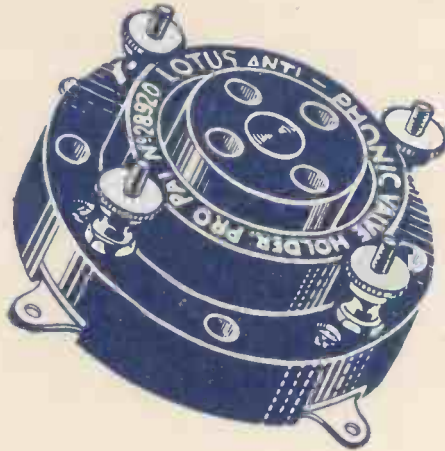

Used and recommended by the important set-makers of Great Britain, and for the famous Mullard "Radio for the Million" Circuits.

Prices :

- Without Terminals 2/3
- With Terminals 2/6
- Combined Grid Leak and Terminal Valve Holder 3/9

Look to your Valve Holders !

IF your reception is unsatisfactory or weak, if it is spoiled by constant irritating noises, look to your Valve Holders.

See that they are guaranteed to absorb shock and eliminate all microphonic noises, because that IS where the fault lies.

The Lotus Valve Holder is constructed to give immediate and lasting connection when the valve pins enter the valve sockets. The leg sockets expand and automatically lock, and the floating platform in which they are fixed is suspended by four phosphor bronze springs, which have great mechanical strength and at the same time are sufficiently resilient to absorb any external shock that would cause damage to the valve,

Carefully made from the finest bakelite mouldings, with phosphor bronze leg sockets, every Lotus Valve Holder undergoes strict tests before leaving the factory, and can be relied on to withstand a great deal of rough usage.



Made by the makers of the famous Lotus Remote Control, Vernier Coil Holders, Jacks, Switches and Plugs.

GARNETT, WHITELEY & CO., LTD.
"Lotus Works" - Broadgreen Road, Liverpool

ABSORBS SHOCK—ELIMINATES MICROPHONIC NOISES

CAUSTON

NEW — and BETTER PRODUCTS



Retroactive Tuner,
Model 'B' ... £1/17/6



Bi-duplex Wire-wound
Multi-cellular H.F.
Choke 9/6

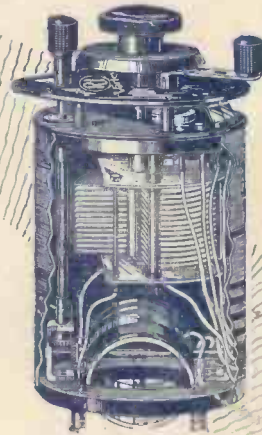

Retroactive Tuner,
Model 'A' ... £2/7/6



Straight Line
Super Trans-
former ... 25/-



Bi-duplex Wire-wound
Anode Resistances.
Complete range up
to 500,000 ohms.
Prices 5/6 to 17/6

The combining of the resources of R.I. Ltd. and the Varley Magnet Company has been a tremendous success. Literally, treasures have been unearthed, and our new products are everywhere acclaimed a big advance in radio design.

Our specialised experience in every form of L.F. Intervale coupling has resulted in a Straight Line Super Transformer and Resistance Capacity Coupler, whose remarkable efficiencies can be seen from the National Physical Laboratory Curves.

Our components have been chosen with remarkable consistency for sets described in all the leading Journals of the Wireless Press, and for the popular circuits in "Radio for the Million."

The famous Bi-duplex winding has further increased its reputation as a result of the real degree of efficiency and reliability achieved in the case of our Resistance Capacity Couplers, Anode Resistances, and Multi-cellular H.F. Choke. The new Retroactive Tuners enjoy an ever-growing degree of popularity, which after all is the best proof of their reliability, utility and efficiency.



TYPE A—Suitable for use after Valves with A.C. Resistance (Impedance) of 15,000-40,000 ohms, 20/-.
TYPE B—Suitable for use after Valves with A.C. Resistance (Impedance) of 30,000-100,000 ohms, 22/6.

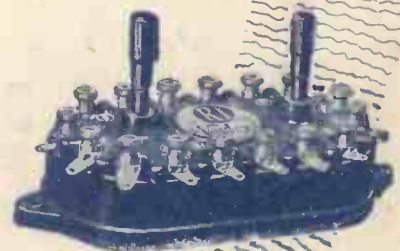

Multi-
Balancer,
11/6.

THE MARK OF

Kingsway House, 103, Kingsway, W.C.2.



BETTER RADIO

Telephone - HOLBORN 5303.