

1923

"America's Foremost
Radiophone Review"

October
25 Cents

The WIRELESS AGE

VOL. II No. 1



Flaeger

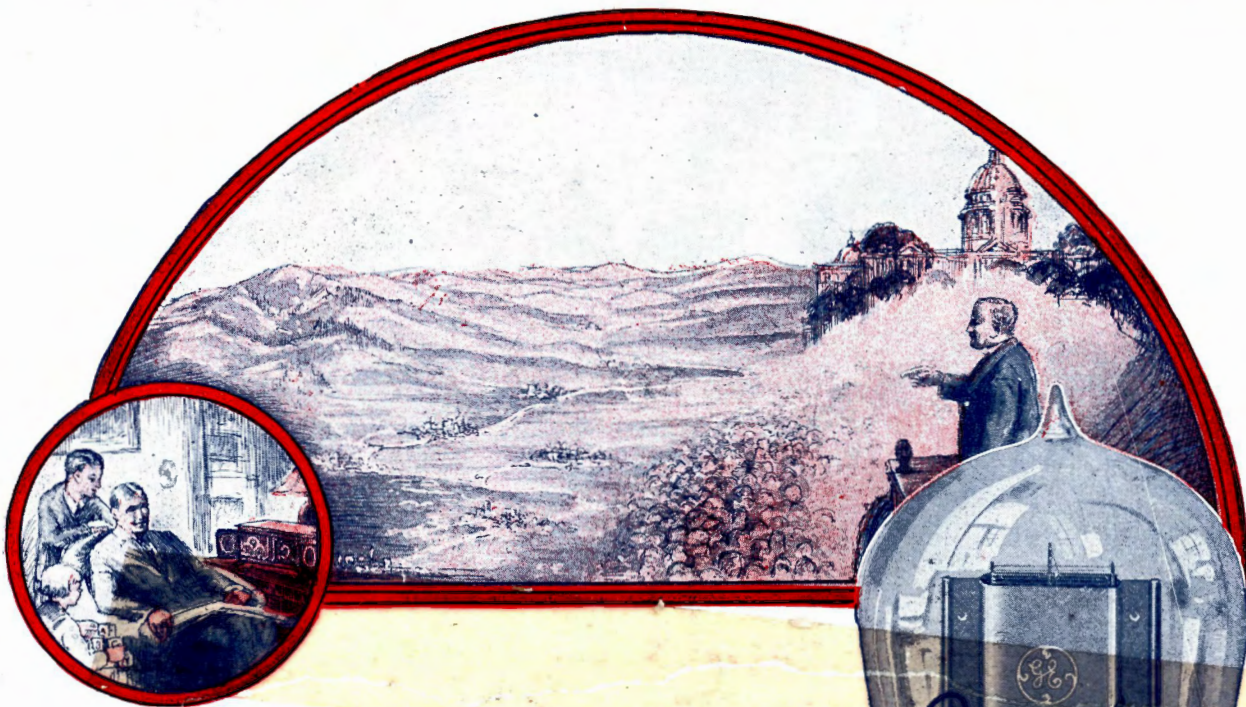

Carries Great Messages Around the World

THAT statement adequately expresses what is perhaps the greatest influence of radio in developing and bettering human fraternal interest, not only between the people of one community, of one country, of one state, or even a single nation, but between all nations and all peoples of the world.

Be these messages from government leaders—from the heads of the world's greatest educational institutions or from those who stand foremost in the arts of the world—they will serve to bring the human race into closer contact.

In the past ages great orators and writers, famous poets and musicians have swayed the destinies of nations, and have been instrumental in the rise and downfall of mighty empires.

In the future these same influences of similar great minds will, through radio, create a better understanding and a greater fraternal spirit between the people of the nations.

It is the vacuum tube that has made possible this broad and far reaching application of radio telephony, and that plays the most important part in the operation of your receiving set.

Cunningham Vacuum Tubes, standard for all makes of receiving sets—built by one of the world's largest manufacturers with unlimited resources—are the product of years of manufacturing experience and the creative genius of the engineers of that great scientific organization, the Research Laboratory of the General Electric Company.

Cunningham Radio Tubes

C-301A—6 Volts ¼ amp. Amplifier.....	\$6.50
C-299—3 Volts .06 amp. Dry Battery Det. & Amp.....	6.50
C-300—6 Volts Gas Con- tent Detector.....	5.00
C-11—1.1 Volts .25 amp. Dry Battery Det. and Amp. Special Base.....	6.50
C-12—Similar to C-11 with standard base.....	6.50

Patent Notice: *Cunningham tubes are covered by patents dated 11-7-05, 1-15-07, 2-18-08, and others issued and pending. Licensed for amateur, experimental and entertainment use in radio communication. Any other use will be an infringement.*

E. J. Cunningham Inc.

Home Office
248 First Street
San Francisco, Calif.

154 West Lake Street
Chicago, Illinois

30 Church Street
New York City, N. Y.



CUNNINGHAM
National
Tube Week

**September 24 to
October 1, 1923**

**\$5000 in Cash Prizes
to Radio Dealers**



PRODUCTS

Moulded from

BAKELITE

Condensite

REDMANOL

"Shawlac"

FOR UNITED STATES GOVERNMENT

Thomas A. Edison, Inc.
General Electric
Russell-Stoll

DeForest Radio Tel. & Tel.
American Transformer
Lanston Monotype

Benjamin Electric
International Time Record'g Co.
U. S. Cloth Cutting

Henry Hyman

Wireless Specialty Apparatus

Klosner Wireless Improvement
Post Electric Adams-Morgan
Eby U. S. Tool

Wallace & Tiernan

Ludwig & Ludwig Western Electric
Western Union Postal Telegraph

Union Switch & Signal

National Electrical Supply

Tabulating Machine

Thomas & Betts

Ward Motor Vehicle

Hanovia Chemical Callaphone
F. A. D. Andrea Sleeper

American Radio & Research

Eiseman Magneto Pacent

Cardwell Thresher

Bacarach O. T. Knode

Who Are Nationally Known Manufacturers of
ELECTRICAL — MECHANICAL — OPTICAL —
CHEMICAL — DENTAL — HARDWARE — MUSI-
CAL — AUTOMOBILE — STATIONERS — ART
— TOY — LABORATORIES — UTILITY SUP-
PLIES AND EQUIPMENT

We Manufacture from Customers' Moulds and
Specifications Exclusively.

We do not wholesale or retail

SHAW INSULATOR COMPANY

Founded 1892

HENRY M. SHAW, President

FRANK H. SHAW,

Vice-Pres. and General Mgr.

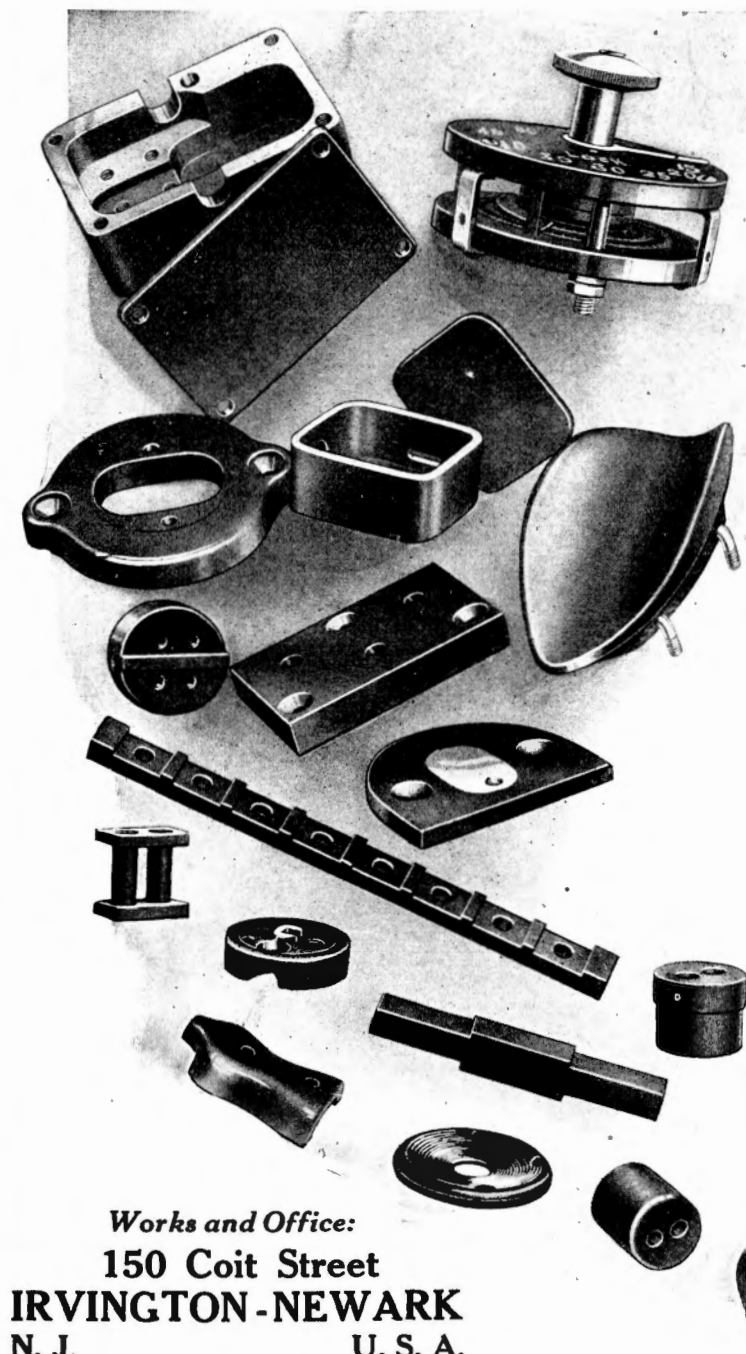

Works and Office:
150 Coit Street
IRVINGTON-NEWARK
N. J. U. S. A.

THE WIRELESS AGE

Volume 11

Edited by J. ANDREW WHITE

Number 1

October, 1923—Contents

Cover Design, <i>By Chas. F. Jaeger</i>		Improving the Operation of Receivers, <i>By A. Reisner</i>	51
Editorials	17	How I Built My Neutrodyne Receiver, <i>By K. S. Houton</i>	52
Pictorial Section	18	Tests for Determining the Genuineness of UV-199 Radiotrons	54
The Thrill That Left Millions Breathless	22	Radio Antenna Design, <i>By Frank Conrad</i>	54
When Japan Called for Help! <i>By J. O. Smith</i>	26	C.W. Work of Station 6EA, <i>By Thomas J. Knapp</i>	56
Wireless Warnings of Iceberg Danger	28	Enlarged Appropriations Required for Radio Inspection Service	56
Blame It on Radio! <i>By Carl Dreher</i>	30	Oberlin College Radio Station 8YAE	57
Impressions From Paris	32	Radiophone Aids Alaskan Lighthouse Service	57
How Atlanta Prisoners Listen In	33	Ionization in Vacuum Tubes, <i>By W. A. Dickson</i>	58
Different Schooldays, <i>By Helen Beckett</i>	34	A Revised Reflex Circuit, <i>By J. McCartney</i>	58
Discrimination in Listening Homes, <i>By John Tasker Howard</i>	35	Notes on Insulation Phenomena, <i>By A. Reisner</i>	59
Finding and Keeping War Secrets, <i>By Robert Lenier</i>	36	Factors of Wavemeter Design and Operation, <i>By L. R. Felder</i>	60
Answering "How's Business?" by Radio	38	Popular Misconceptions of Radio, <i>By G. H. Clark</i>	62
"Radiotherapy" in Many Hospitals, <i>By Albert S. Hyman, M.D.</i>	39	What Is the Range of My Receiver?	62
World Wide Wireless	42	Fundamentals of Wireless, <i>By C. Dwight Briggs, B.S., E.E.</i>	63
Listening to the Broadcasting of Three Con- tinents, <i>By Howard Adams, Jr.</i>	44	Broadcast Station Directory	64
Radio Activities in Australia	45	New Appliances and Devices	66
Adapting Dry Cell Tubes to the Radiola RC <i>By Vincent Morley</i>	46	Industrial Inklings	68
Radio Beacons and Their Operation, <i>By O. C. Roos</i>	47	Stations Worked and Heard	69
Lighthouse Department Extending Radio Compass Service	48	National Amateur Wireless Association	70
Radio Equipment of the ZR-1, <i>By S. R. Winters</i>	49	Queries Answered	71
Directive Radio Transmission, <i>By Jerome Snyder</i>	50	Amateur Radio Stations of the United States	95

PUBLISHED MONTHLY AT WIRELESS PRESS, INC., 326 BROADWAY, NEW YORK
GREAT BRITAIN, 12-13 Henrietta St., London. AUSTRALIA, 97 Clarence St., Sydney, N. S. W.

CHICAGO, ILL., Marquette Bldg.
Wheeler & Northrup

LOS ANGELES, CALIF., 156 So. Spring St.
Coast Publishers Co.

Yearly subscription in U. S. A., \$2.50—Outside U. S. A., \$3.00; Single Copies, 25 cents. Entered as second class matter Oct. 9, 1913, Post Office, New York, N. Y., under the Act of March 3, 1879. Copyright, 1923, Wireless Press, Inc. When subscription expires you will find a renewal blank enclosed. Return with remittance promptly. Notify us of any change in your address, giving both the old and new location. James G. Harbord, Pres. J. Andrew White, Vice Pres. L. MacConnach, Secy. George S. DeSousa, Treas. J. O. Smith, Business Mgr.

Because certain statements and expressions of opinion from correspondents and others appearing in these columns from time to time may be found to be the subject of controversy in scientific circles and in the courts, either now or in the future and to sometimes involve questions of priority of invention and the comparative merits of apparatus employed in wireless signaling, the owners and publishers of this magazine positively and emphatically disclaim any privity or responsibility for any statements of opinion or partisan expressions if such should at any time appear herein. Printed in U. S. A.

"America's Foremost Radiophone Review"

THE WIRELESS AGE is a member of the Audit Bureau of Circulations. During the last six months of 1922 there were printed 204,650 copies of THE WIRELESS AGE.

This issue 45,000 copies

AMPLION



England

Canada

Scotland

Australia

Wales

New Zealand

Ireland

So. Africa

Norway

India

Sweden

France

Denmark

Italy

Holland

Spain

Belgium

Japan

WITH the Amplion Loud Speaker the infinite clearness and softness of tone achieves an unsurpassed reproduction welcomed and admired everywhere. The human voice or musical sounds come to you in their true richness, without the slightest distortion, unalloyed — just as they are rendered.

It is hard to believe you are listening to reproduction. Originality is so unmistakably registered in every tone.

The Amplion is made by the world's oldest manufacturer of loud speaking instruments. It is not a head set receiver used as a loud speaker, but a development for radio purposes of a loud speaking device, used exclusively on every ship of the British and other leading navies.

The Amplion requires no battery. You simply attach it in place of head phones. The Amplion is being extensively used in every country mentioned in the border of this announcement.

That it has been adopted as standard by the leading countries of the world is the tribute it has achieved through its brilliant performance.

All models on view at the New York Radio Exposition, Booth 5, at the New York Show — Oct. 6th to 13th.

SIGNAL ELECTRIC MFG. CO.

Sole United States Distributors Menominee, Michigan

BURNDEPT OF CANADA, LTD.

Canadian Distributors 172 King St., West, Toronto

*The Supremacy of the AMPLION
is the Supremacy
of Actual Performance*

The Royalty  of Radio

New Additions to

Beautiful New Furniture Models— Simplified Tuning—Self-contained

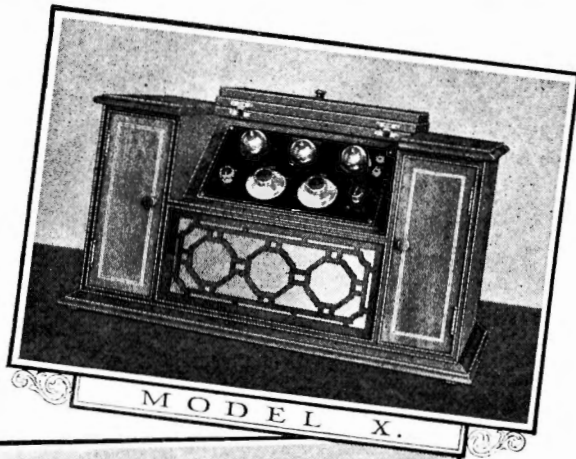

MODEL X.

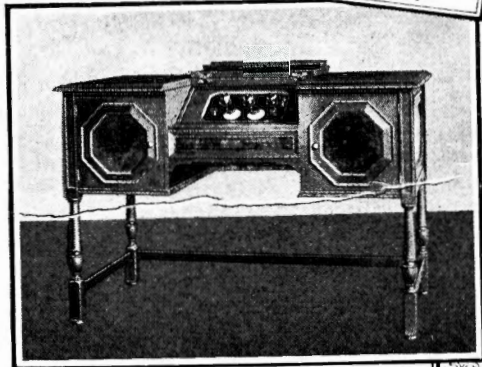

JACOBEOAN CONSOLE MODEL



SPANISH DESK MODEL

The three new Kennedy Furniture Models illustrated on this page are the very last word in radio receiving sets. Even if attention were drawn no further than their exterior beauty, their purity and harmony of design alone would be instantly appreciated.

The receiver in each is a new achievement of the Kennedy Engineering Staff. Extreme simplicity of tuning is attained with the same selectivity and long-distance reception that have made Kennedy sets so well and favorably known. Only two dials are used—one for "tuning in" or selecting the desired station, the other to control sound volume. Adjustment is provided for very fine tuning.

These models are complete and self-contained. They operate on dry battery tubes for which internal space is provided, although any standard tubes—including storage battery type—may be used. Two stages of audio amplification—built-in loud speaker with unusually clear and distortionless qualities of reproduction. Highly polished Formica control panels. Gold-plated metal trimmings on front—including dials. Respond to all broadcasting wave-lengths. Each complete with three dry-battery tubes, all dry batteries and Kennedy 3000-ohm phones with plug, for individual reception.

Kennedy Model X. Beautiful hand rubbed Mahogany cabinet with inlay of Satin Wood and Ebony. The tracery, in delicate contrast with background, is suggestive of the marquetry workers of King William's time. Price, complete.....\$285.00

Kennedy Jacobean Console Model. Exemplifies the late Jacobean design. Built of American Walnut with artistically matched paneling, which contributes the rich subdued effect almost always associated with true elegance. Price, complete.....\$775.00

Kennedy Spanish Desk Model. An adaptation of the Spanish with a free intermingling of the effects of the Moorish influence. This is particularly in evidence in the panel. Cabinet finished either in Mahogany or American Walnut. Interior lined completely with Golden Bird's-eye Maple. Price, complete....\$825.00

KENNEDY

The Royalty of Radio



the Kennedy Line

A New Popular-Priced Model, Head Phones and Loud Speaker

The apparatus shown on this page is of the same high character as the more elaborate Furniture Models. The sets were designed to fill the demand for high quality at a popular price, and, with the wonderfully improved head phones and separate loud speaker unit, they provide Kennedy apparatus for every home.

Kennedy Model V. Incorporates the new Kennedy receiver and two-stage amplifier at moderate cost. Same type of radio unit as higher priced Furniture Models, but without loud speaker. Highly polished Formica control panel. German silver dials. Space for batteries. All dry batteries, three dry-battery tubes and Kennedy phones with plug, complete...\$125.00
Receiver only, without phones, tubes or batteries...\$ 86.50

Kennedy Type-281. One of the sets that has won recognition for the Kennedy line. An extremely selective three-circuit receiver. Solid Mahogany cabinet. Brilliantly polished Formica control panel, black etched dials, heavily nickel-plated metal parts. Wave-length range 175 to 900 meters. Designed for 6-volt tubes but can be used with dry-battery tubes as well. Receiver only...\$ 90.00
Receiver and two-stage audio amplifier...\$145.00

Kennedy Type-311, 522 Portable. Neat, compact, portable. Easily tuned—highly selective and efficient. Designed for all standard tubes, including dry-battery type. Detector and two stages of audio amplification. Wave-length range 150 to 600 meters. Complete with three dry-battery tubes, all dry batteries and Kennedy phones, with plug...\$137.50

Kennedy Loud Speaker. The same as used in the new Kennedy Furniture Models. Remarkable fidelity of reproduction with total absence of unpleasant distortion. No separate batteries required. Price, complete with 6 ft. cord...\$30.00

Kennedy Head Phones. Perfection in mechanical and electrical design results in unusual volume with rich tonal purity. No rattle or blare. Extremely sensitive on weak and distant signals. Light and snug fitting. Resistance 3000 ohms. Price per set, with 6 ft. cord...\$9.00

See the new sets and parts at the nearest Kennedy dealer or write us direct for literature. State type of set in which you are interested.

DEALERS Write or wire for exclusive Kennedy proposition.

THE COLIN F. KENNEDY COMPANY
SAINT LOUIS

SAN FRANCISCO

All Kennedy receiving sets are regenerative—Licensed under Armstrong U. S. Patent No. 1,113,149.

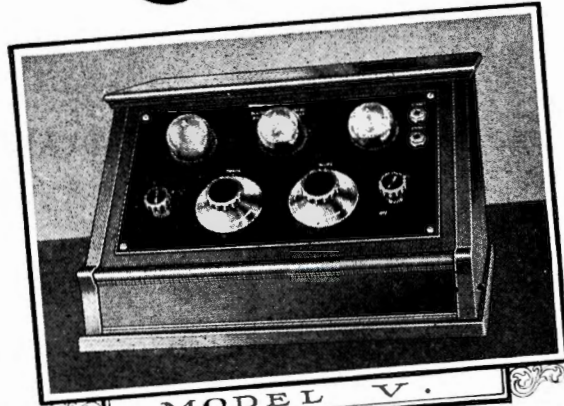

MODEL V.

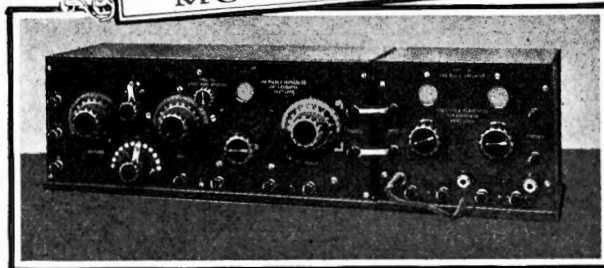

TYPE 281.



PORTABLE COMBINATION SET

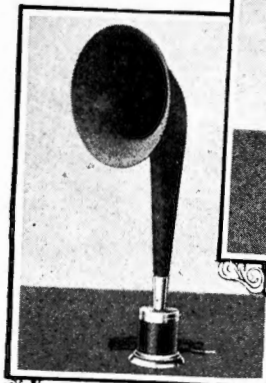

LOUD SPEAKER



PHONES

KENNEDY



"What panel shall I use?"

ONE of the first questions you probably will ask yourself when you get ready to build your radio set will be about the choice of a good panel. Your answer will determine, to a large extent, the efficiency of your set.

Of course you want a panel that has superior insulating properties. Celoron Radio Panels are used by fans who appreciate the value of a good radio panel. They have high dielectric strength and great volume and surface resistivity. Celoron panels are uniform in quality, and do not warp or crack.

You will find Celoron panels easy to saw, drill, and tap. They engrave evenly without feathering, and enable you to build a set that is neat and attractive as well as efficient.

Approved by Uncle Sam

Celoron Radio Panels are approved by the U. S. Navy Department Bureau of Engineering and the U. S. Signal Corps. Many of the leading manufacturers of

radio equipment use Celoron in their standard parts.

Each panel is wrapped separately in glassine paper and carries complete instructions for working and finishing. Ask your dealer for one of the following sizes:

1—6 x 7 x $\frac{1}{8}$	5—7 x 18 x $\frac{3}{8}$
2—7 x 9 x $\frac{1}{8}$	6—9 x 14 x $\frac{3}{8}$
3—7 x 12 x $\frac{1}{8}$	7—7 x 21 x $\frac{3}{8}$
4—7 x 14 x $\frac{3}{8}$	8—7 x 24 x $\frac{3}{8}$
	9—12 x 14 x $\frac{3}{8}$

We also furnish Celoron in full-sized sheets and can cut special sizes if desired. If your dealer has not yet stocked Celoron panels, ask him to order for you, or write direct to us. Indicate by number the size you want.

Send for free booklet

Our booklet, "Tuning in on a New World," contains a list of the leading broadcasting stations in the United States and Canada, several efficient radio hook-ups, and an explanation of the symbols used in radio diagrams. Write at once and be sure of getting yours before the supply is exhausted.

To radio dealers: Send for special dealer price list showing standard assortments

Diamond State Fibre Company

BRIDGEPORT (near Philadelphia) PENNSYLVANIA

BRANCH FACTORIES AND WAREHOUSES
BOSTON CHICAGO SAN FRANCISCO

Offices in Principal Cities

In Canada: Diamond State Fibre Company of Canada, Limited, 245 Carlaw Ave., Toronto

CONDENSITE
CELORON
STANDARD RADIO PANEL

A New Thrill!

Listen-In Tonight with a Kellogg Head Set

Clear reception with plenty of volume is necessary to satisfactorily listen to distant stations.

Kellogg head sets should not be classed as ordinary radio receivers. Today Kellogg stands foremost in the manufacture of a high-grade head set that actually surprises listeners in comparative tests.

Maximum volume, unusual clearness, extreme lightness in weight, are a few of the many outstanding advantages. The head band is unusually light, though durably built. The receivers are easily adjusted to fit the head, and can be detached from the holders when desired.

The magnets are of special tested steel and hardened by our own special method which controls the heat and time electrically and mechanically, eliminating any possible variation as when manually controlled.

The magnet windings are of great accuracy, the mountings, end plates, wire, insulation, etc. are of the highest grade and of the best material suited for the purpose.

Our twenty-five years experience in building receivers for telephone work has proven invaluable in turning out a real radio receiver of merit.

Hundreds of voluntary testimonial letters tell us of the superiority of Kellogg head sets in actual comparative tests, barring none.

Listen-in tonight with a pair of Kellogg receivers and get a new thrill from your radio set. Kellogg radio products are all in a class by themselves from a quality, service and appearance standpoint. With Kellogg radio equipment, USE IS THE TEST.

KELLOGG SWITCHBOARD & SUPPLY COMPANY
CHICAGO

COLUMBUS

KANSAS CITY

SAN FRANCISCO

PORTLAND

Kellogg apparatus exclusively is used in building The Symphony Receiver

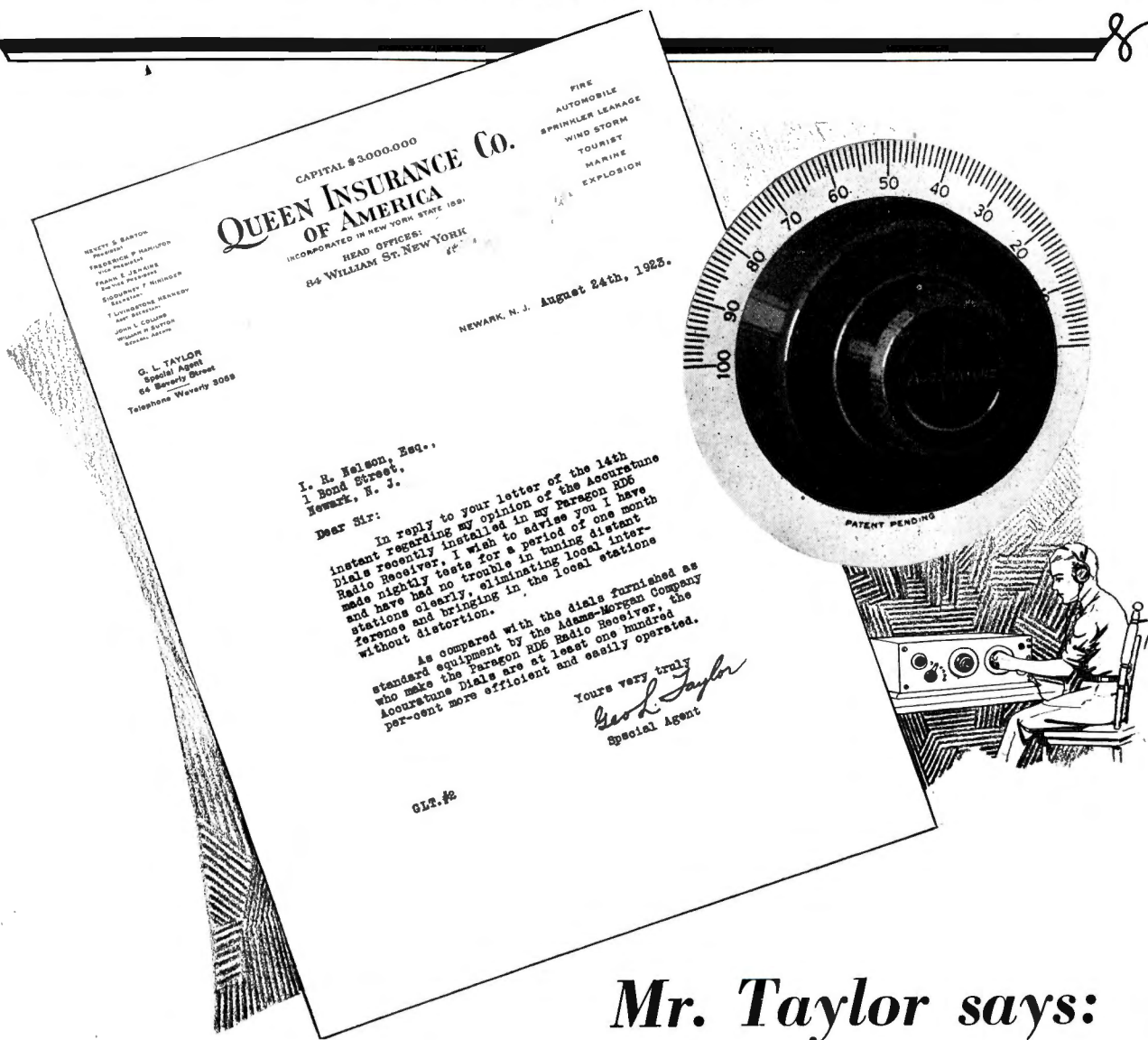

Mr. Taylor says:
“No trouble tuning distant stations”

Universal micrometer action and easily fingered knobs are the outstanding features of the Accuratune Control. The larger knob is used for coarse adjustments, the smaller knob operates the micrometer mechanism. Either action will swing the dial through the full 360 degrees. Your dealer will supply you with Micrometer Controls for your present set, or if you buy a new set, choose one equipped with Accuratunes.

Manufacturers of Popular Sets: Equip your apparatus with Accuratune products. Increased efficiency and beauty will advance your sales.

HE is pleased not only in this capacity, but he adds that he has no trouble tuning CLEARLY.

It is no little stunt to bring in a distant station, with all local and other disturbances in the air. But with an Accuratune fine adjustments are easy, and the slightest turn of the micrometer knob will throw interferences out of the way, and bring in the station you want CLEARLY. The Accuratune is not a mere dial, but an actual Micrometer Control ten times more efficient than any tuning device.

For such satisfactory reception the Accuratune was created, and though the price be slightly higher than ordinary dials, it will prove its worth the first time you use it.

MYDAR RADIO COMPANY
 9-A Campbell Street, Newark, N. J.

ACCURATUNE
MICROMETER CONTROLS

EVERY ACCURATUNE PRODUCT IS A GOOD PRODUCT

Sharpen Your Tuning

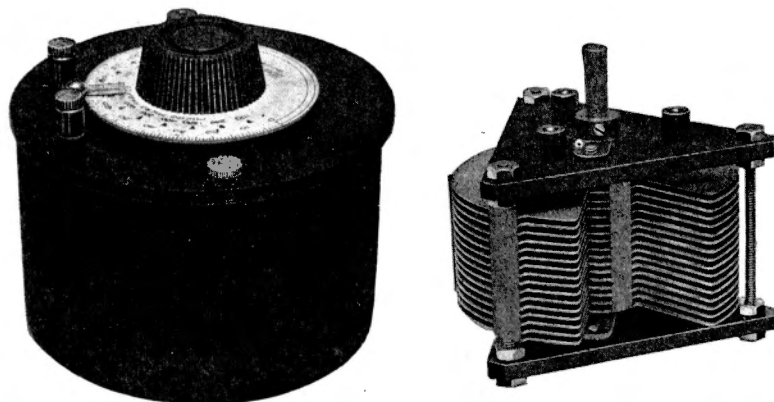

NO operator of a radio receiving set need be told of the advantage of sharp, precise tuning. It is not always clear, however, how this may be obtained. After a good tuning coil has been chosen look to the CONDENSER for the answer.

Years before radio became a popular pastime, the General Radio Co. was manufacturing low-loss, scientifically designed condensers for use in such discriminating laboratories as those of the Bureau of Standards, Naval Radio, General Electric, Westinghouse, Western Electric and the leading educational institutions of the country. The results of these years of research work in our own laboratory have resulted in the design of a condenser incorporating the best features in design and at the same time available at a price substantially lower than other good quality condensers.

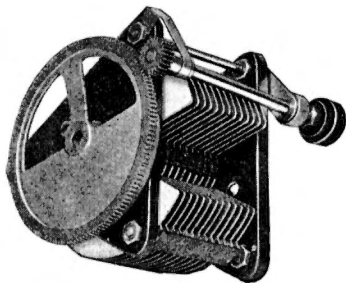

**General Radio Co.
Type 247
Variable Air Condenser**

Here are some of the important features: Sharp tuning through low-loss design, using hard rubber properly placed; heavy brass plates soldered together, keeping capacity constant and greatly reducing danger of short-circuiting; low zero capacity, giving wide wavelength range; a CONTINUOUS VERNIER formed by a gear and pinion combination. Only one setting required.

Made in three sizes—250, 500 and 1000 m. m.f.—to fit every circuit. Mounted condensers are fitted with calibrated, direct reading capacity dial.

Prices \$3.00 to \$8.50. Send for Educational Pamphlet, "Quality Condensers," and new RADIO BULLETIN 916W.

5738

GENERAL RADIO COMPANY

Manufacturers of Electrical and Radio Laboratory Apparatus

Massachusetts Avenue and Windsor Street,

-

Cambridge, Massachusetts

No wireless receiving set complete without

Magnavox Radio

The Reproducer Supreme

IT has been the dream of every Radio user to own in one unit a Power Amplifier and electro-dynamic Reproducer, thus insuring perfect Radio reproduction.

After exhaustive study and tests by our engineers, this has been successfully accomplished, and the new instruments of the unit type here illustrated in one and two stages of amplification may now be had through Magnavox dealers everywhere.

There is now a Magnavox for every receiving set. The full line embraces:

Magnavox Reproducers

- R2 with 18-inch curvex horn . \$60.00
 R3 with 14-inch curvex horn . 35.00
 M1 with 14-inch curvex horn.
 Equipped with binding posts
 and a five foot flexible cord;
 requires no battery for the field. 35.00

Magnavox Combination Sets

- A1-R consisting of electro-dynamic
 Reproducer with 14-inch curvex
 horn and 1-stage of amplification 59.00
 A2-R consisting of electro-dynamic
 Reproducer with 18-inch curvex
 horn and 2 stages of amplification 95.00
 Special: with 14-inch curvex
 horn as illustrated . 85.00

Magnavox Power Amplifiers

- A1—new 1-stage Power Amplifier 27.50
 AC-2-C—2-stage Power Amplifier 55.00
 AC-3-C—3-stage Power Amplifier 75.00

Magnavox Products can be had of
 good dealers everywhere. Ask for
 a demonstration.

THE MAGNAVOX CO.
 OAKLAND, CALIFORNIA

370 Seventh Ave., New York

*World pioneers in the development and manufacture of
 sound amplifying apparatus*



*New Magnavox
 Combination Set*

A2-R insures convenient and perfect Radio reproduction. Designed especially to meet the requirements of receiving sets used in the home.

Magnavox Reproducers and Amplifiers

When writing to advertisers please mention THE WIRELESS AGE

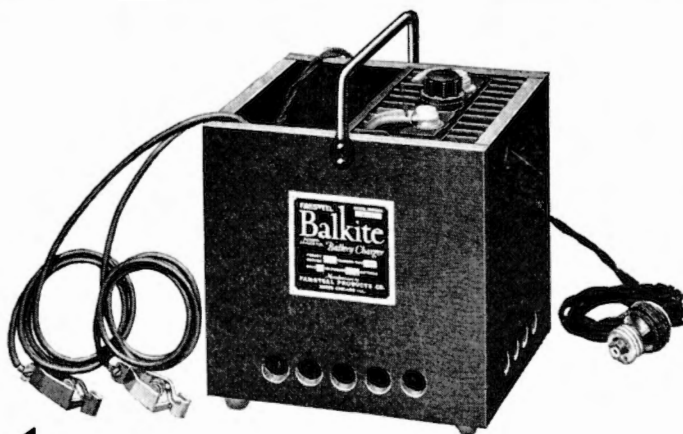

The **FANSTEEL**
Balkite
 PATENTS APPLIED FOR **battery charger**

*has no vibrators, bulbs,
 or moving parts*

**FANSTEEL
 BALKITE**

is a new metal developed for this charger. It acts as a valve, allowing alternating current to flow into the battery but not out of it. It is the most efficient charger valve made, is practically indestructible, and does away with noisy, delicate vibrators and fragile bulbs.

The Gould Battery Company is also marketing, under the Fansteel Balkite Patents, a complete battery and recharging unit known as the Gould Unipower, into which this charger, under the name, "The Fansteel Balkite Rectifier," has been incorporated.

The Fansteel Balkite Battery Charger for Radio "A" Batteries [6 volt] is an entirely new type of rectifier, based on the use of Fansteel Balkite, a new and rare metal developed for this purpose. It is entirely noiseless. *It can be used while the set is in operation.* It cannot deteriorate through use or disuse. It has nothing to replace, adjust, or get out of order. It cannot discharge or short circuit the battery, and requires no attention other than an occasional filling with distilled water. It will not overcharge, and cannot fail to operate when connected to the battery and line current. It is unaffected by temperature or fluctuations in line current. It is simple, efficient, and indestructible except through abuse.

The Fansteel Balkite Battery Charger will charge the ordinary 6 volt radio "A" battery at 3 amperes, and a 12 volt at 1½ amperes, from 110-115 AC, 60 cycle current. It comes complete and ready for use. Get it from your dealer, or use the coupon below.

Price, \$18

(\$18.50 West of the Rockies)

FANSTEEL PRODUCTS CO., Inc.

DEPT. 5-B

North Chicago, Illinois

Dealers and Jobbers: The Fansteel Balkite Battery Charger does away with complaints and replacement troubles. Write for literature and discounts.

Dept. 5-B
FANSTEEL PRODUCTS CO., Inc.

North Chicago, Ill.

Enclosed please find \$18. [\$18.50 West of the Rockies.] Send me the Fansteel Balkite Battery Charger for Radio "A" Batteries. If I am not entirely satisfied I will return it and you will refund my money.

Name

Street

City..... State.....



Abroad at Home with a CROSLY MODEL X-J

PRICE \$65

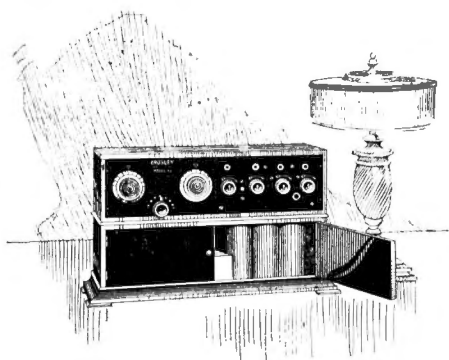

CROSLY MODEL XJ

A 4 tube radio frequency set, incorporating one stage of Tuned Radio Frequency Amplification, Detector and two stages of Audio Frequency Amplification, with jack to plug in on three tubes for head phones; new Crosley multistats, universal rheostats for all makes of tubes; new condenser with molded plates; filament switch and other refinements of details. A mahogany battery cabinet which makes the set completely self containing may also be had to fit the Model XJ at a cost of only \$16. See illustration above.

See this beautiful receiver at your dealers.

New York Office, C. B. Cooper, 1803 Tribune Building, 154 Nassau Street, Beekman 2061.

Boston Office, B. H. Smith, 755 Boylston Street, Room 316.

Chicago Office, 1311 Steger Building, 28 E. Jackson Blvd., R. A. Stemm, Mgr.

Philadelphia Office, J. H. Lyte, 65 North 63rd Street.

St. Louis Office, Robert W. Bennett Co., 1326 Syndicate Trust Building.

Wonderful opera from New York, love songs from the tropics, dance music from Chicago; stock quotations, stirring speeches, amusing stories from where you will—all these pleasures and utilities are brought truly, clearly, right to your fireside if you own a Crosley Model XJ Radio Receiver.

This beautiful new Crosley 4 tube Model contains the same units as the famous Crosley Model X, with added refinements of detail which make it even better. At bringing in distant stations, the Model X established many records during the past year. Sebring, Fla., continually heard Honolulu. A man writes from Nassau, British West Indies, "First of all on Friday night, June 29, 1923, I heard Honolulu." He goes on to relate that practically all stations in the United States were brought in clear as a bell.

With the Crosley Model XJ even better receptions are assured. We unhesitatingly claim that it is the best radio receiver ever offered, regardless of price.

For Sale by Good Dealers Everywhere

Write for free catalog which shows the complete Crosley line of instruments and parts. In it you will find just the receiver to suit your needs and pocket-book. Crosley Receivers without batteries, tubes and head phones range in price from the efficient 2 TUBE MODEL VI AT \$28 to the beautiful CONSOLE MODEL AT \$150.

CROSLY MANUFACTURING CO.

1028 Alfred Street

Cincinnati, O.

CROSLY
Better - Cost Less
Radio Products

\$20

**Clear Reception
at Lowest cost**

*Armstrong
Regenerative
Receiver*

*Licensed under
Armstrong
U. S. Patent
No. 1,113,149*

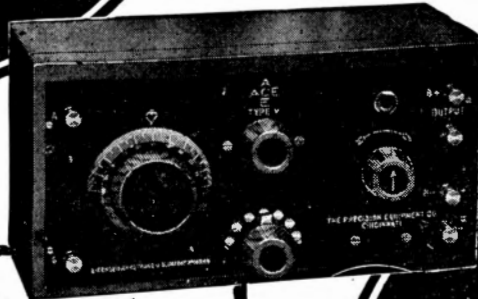

**ACE
TYPE V**

FORMERLY
CALLED
CROSLY
MODEL V

THE ACE Type V is a long range regenerative radio receiver. Signals received on it are clear and distinct.

Stations from coast to coast are heard under ordinary conditions by owners of this set. Wonderful efficiency, simplicity of operation and low cost are the chief factors in the growing success of this receiver. They are the things that have made it the most popular on the market. Thousands of the Ace Type V have been sold—hundreds of letters from owners are proof of their success. Can be used with dry cell or storage battery tubes.

Those who desire to operate a loud speaker in connection with the Ace Type V, later can add an Ace Type 2 B, a new two-stage audio frequency amplifier, to the set. Then music or voice being received from a far-away station will be heard throughout the room or house. The price of the Ace Type 2 B amplifier is \$20.00.

If your dealer cannot supply you, order direct, mentioning his name. Ask for "Simplicity of Radio." Your copy is FREE.

DEALERS—Write on your letterhead for attractive sales proposition.

THE PRECISION EQUIPMENT COMPANY

Russell Crosley Jr. PRES.

1028 Vandalia Ave.

Cincinnati, Ohio

The New Ace Type 3 B

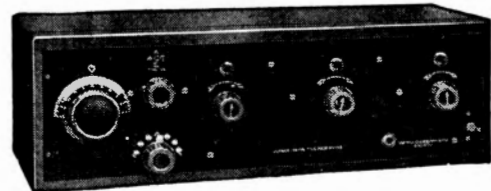

A new member of the Ace family selling for \$50, which is equal to a combination of the Ace Type V and the Ace two-stage amplifier. Like the Ace Type V it is manufactured under Armstrong U. S. Patent No. 1,113,149. This set is new, but months of research work have brought it to a high degree of perfection. Out-performs receiving sets costing great deal more. A filament switch eliminates necessity of turning out rheostats when set is not in use. A person hearing a broadcasting station may turn off the set by throwing switch and come back later without retuning. A telephone jack is between first and second stage of amplification. This is for use of persons who desire to use head phones instead of loud speaker. Crosley Multistats, universal filament control rheostats for all makes of tubes, Price \$50

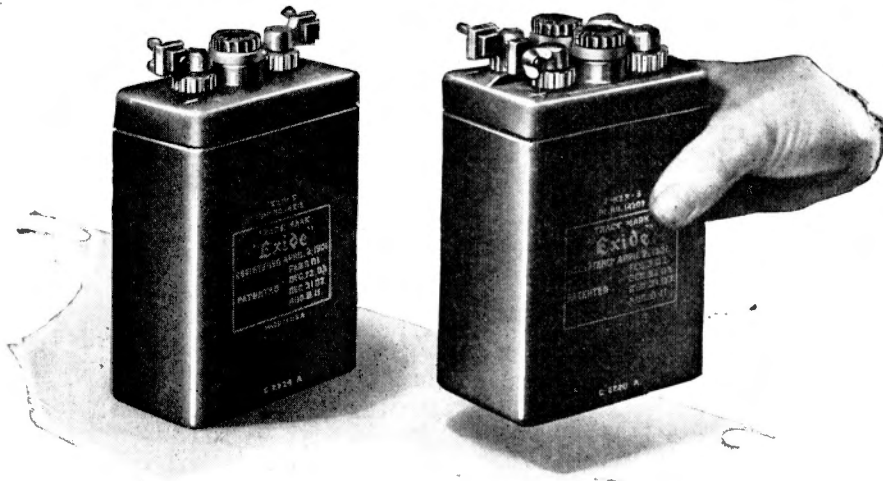

Midgets in size—but giants in power

IMAGINE a radio storage battery so light that you can lift it on the palm of your hand, but powerful enough to supply all the current you need for long-distance receiving—and then some!

The new two- and four-volt Exide A Batteries for low-voltage tubes weigh only five and six pounds each. And they are wizards of efficiency—right in step with the latest developments in radio receiving.

These sturdy little batteries are neat and compact. They were specially designed for WD-11 and UV-199 vacuum tubes, but can be used with any low-voltage tube. The two-volt Exide A Battery consists of a single cell. It will heat the filament of a quarter-ampere tube for approximately 96 hours. The four-volt A Battery, having two cells, will light the filament of a 60 milli-ampere tube for 200 hours.

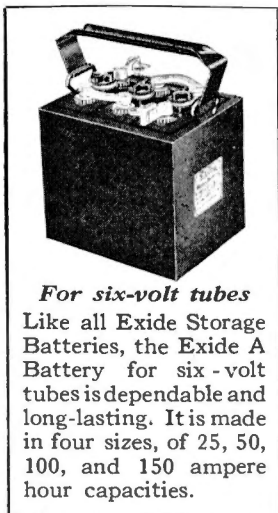

For six-volt tubes

Like all Exide Storage Batteries, the Exide A Battery for six-volt tubes is dependable and long-lasting. It is made in four sizes, of 25, 50, 100, and 150 ampere hour capacities.

Service you will appreciate

Exide Radio Batteries are carefully constructed on sound engineering principles. They give the kind of service every radio fan would like to get from his storage battery.

As you know, any variation of current in the plate circuit produces weird sounds in your phones. With an Exide B Battery

hooked up to your set, static is the only interference you will have to contend with. The

Exide B Battery supplies steady, noiseless current. It permits the niceties of adjustment that make radio receiving an unalloyed pleasure.

The Exide A Battery for six-volt tubes has extra-heavy plates, assuring constant potential and uniform current over a long period of discharge. Like all Exide Batteries, it embodies the finest materials available.

In marine and commercial wireless

On sea and on land the Exide plays an important role in the industrial life of the nation. In marine wireless Exide Batteries provide an indispensable store of emergency current. A majority of all government and commercial wireless plants are equipped with Exides.

Exide Radio Batteries are sold by radio dealers and Exide Service Stations everywhere. Ask your dealer for booklets describing in detail the complete line of Exide Radio Batteries. Or write direct to us.

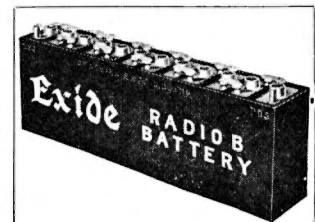

Exide B Batteries

give noiseless, full-powered service over a long period of discharge. Designed throughout to prevent electrical leakage. Capacity, 3 ampere hours.

Exide

RADIO BATTERIES

THE ELECTRIC STORAGE BATTERY COMPANY, PHILADELPHIA

Oldest and largest manufacturers in the world of storage batteries for every purpose

Service Stations Everywhere

Branches in Seventeen Cities

When writing to advertisers please mention THE WIRELESS AGE

Get your money's worth!

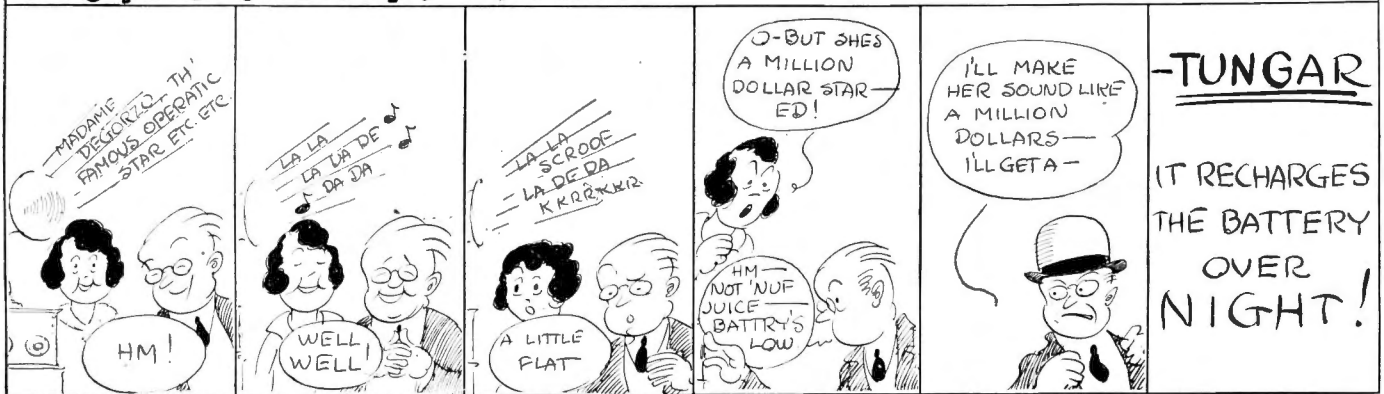

Music's charms cease when batteries fail

Your radio set works best on near and far stations, only when your batteries are delivering ample current.

Storage batteries, tuned up with Tungar, give the fine results which the owner of a high class radio set is justified in expecting from his instrument.

With Tungar—the go-between from house lighting circuit to storage battery—you do not need to move the battery, or buy a new one. Just attach to a lamp socket or a convenience outlet, turn on the current and leave it, any time, day or night.

Tungar is certain, clean and quiet. There are no moving parts to get out of order or to make noise. Its cost of operation is low.

For years motor car owners have used Tungar for charging their automobile batteries.

See one at any good electrical shop, or write for literature. Address Section W. A. 10.

Merchandise Department
General Electric Company
 Bridgeport, Connecticut

Tungar Battery Charger. Operates on Alternating Current.

(Prices east of the Rockies)

2 Ampere Outfits Complete—\$18.00

5 Ampere Complete—\$28.00

Special attachment for charging 12 or 24 cell "B" Storage Battery—\$3.00

Special attachment for charging 2 or 4 volt "A" Storage Battery—\$1.25

Both attachments fit either Tungar

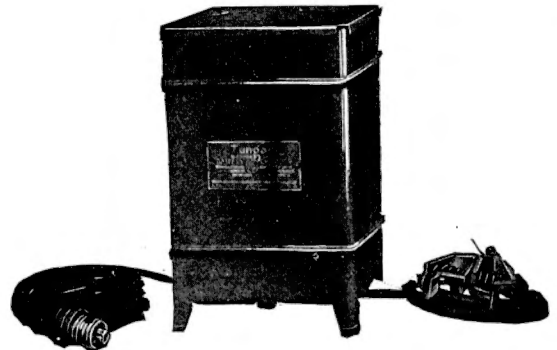

Charge 'em at Home, with

Tungar

BATTERY CHARGER

35A-103

A GENERAL ELECTRIC PRODUCT

When writing to advertisers please mention THE WIRELESS AGE

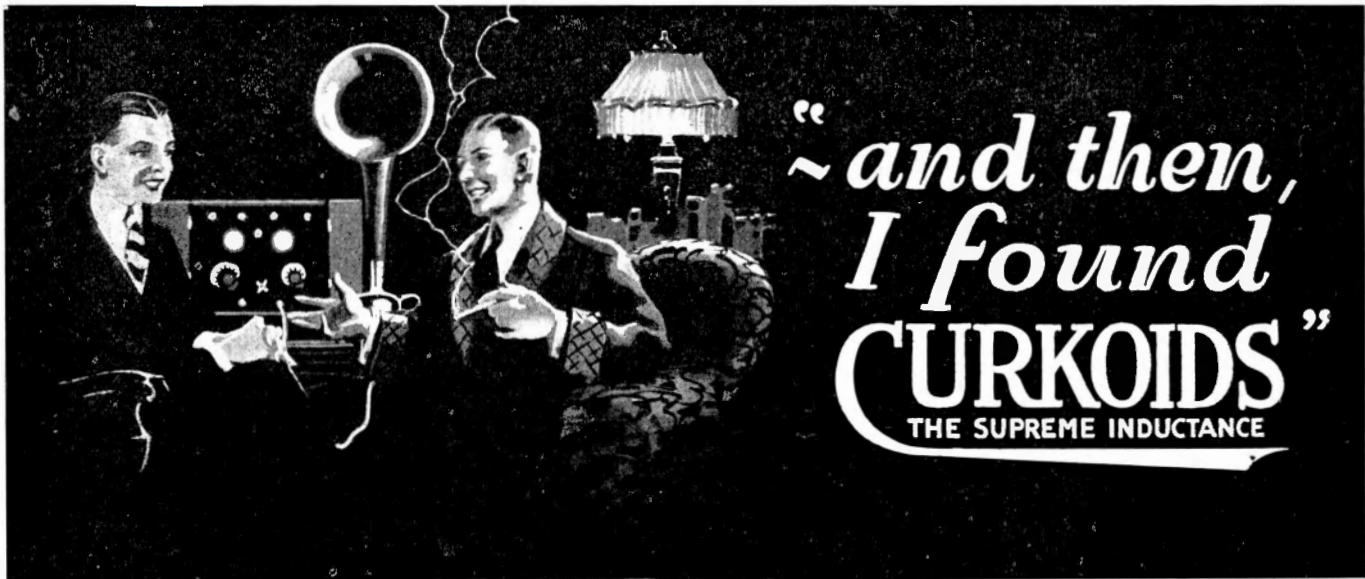

*“and then,
I found
CURKOIDS”*
THE SUPREME INDUCTANCE

REMEMBER, when you were on the coast, Gene, I wrote you that I was off Radio for good? I had bought and built about a dozen different sets and the only stations I could get at all satisfactorily were local ones. Well, right after you left I made my final effort to build a set that would bring in the programs right.

I junked a lot of stuff and went out and bought new transformers, condensers, and everything else. Had a new circuit that was supposed to be all that a radio fan could want.

Same old story. The set worked as good as any I had had but it had the same fundamental weaknesses in the tuning elements.

You know—body capacity effects, energy losses through high frequency resistance and the rest of it.

—And then I found **CURKOIDS**
THE SUPREME INDUCTANCE

They were so different in design and the claims made for them were so unique that I decided to try them out.

They're in that set. You hear what's coming through now. That's what I get all the time—quality.

And you saw what they can do in bringing in the distant stations. The other night I picked up five broadcasting stations just on variations of the primary circuit. Yes—that left hand knob.

And I've learned the code so I could listen in on the amateur DX work. I'll show you my log in a minute so you can see the number of distant stations I have heard. Some list.

What makes this set so good? Simply this—in addition to all the advantages Curkoids have over ordinary inductances, the Curkoid mounting is so accurate in its adjustment that one degree on the dial gives a variation of 1/400th of an inch in coupling and holds it. On distant stations that means that you are bound to get the ones that you otherwise would miss entirely.

I'll say it's a real set. I'm satisfied that all in all it's the best thing in radio and that if any improvement is possible it will come only from the Curkoid laboratory.

If you are really going to put in a set, now that you're home for good, be sure that it's built around Curkoids.

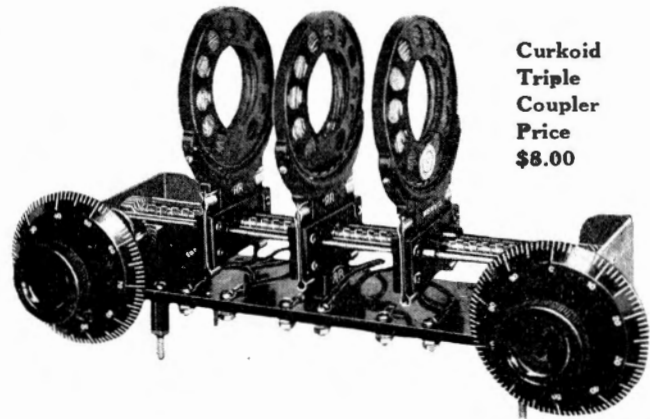

Curkoid
Triple
Coupler
Price
\$8.00

CURKOIDS THE SUPREME INDUCTANCE	
No. 20K	\$1.40
No. 25K	1.50
No. 35K	1.50
No. 50K	1.60
No. 75K	1.65
No. 100K	1.70
No. 150K	1.75
No. 200K	1.85
No. 250K	2.00
No. 300K	\$2.10
No. 400K	2.25
No. 500K	2.25
No. 600K	2.40
No. 750K	2.75
No. 1000K	3.45
No. 1250K	3.85
No. 1500K	4.45

OUR "FAN" BOOKLET
CURKOIDS
THE SUPREME INDUCTANCE
Tells you how will help you get better quality—clearer signals and greater distance with your set.
Packed with tried and approved hook-ups, real information and specific data. PRICE 10c.

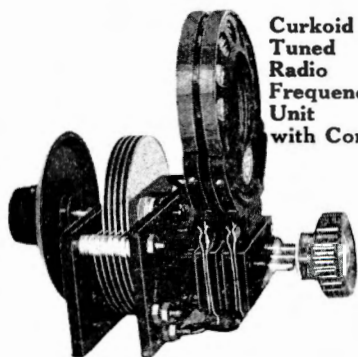

Curkoid
Tuned
Radio
Frequency
Unit
with Condenser

Manufacturers, Jobbers, Dealers

Write for details of
CURKOIDS License and
THE SUPREME INDUCTANCE Sales Plan

**RIEGER RESEARCH
CORPORATION**

112 West 44th Street, New York

When writing to advertisers please mention THE WIRELESS AGE

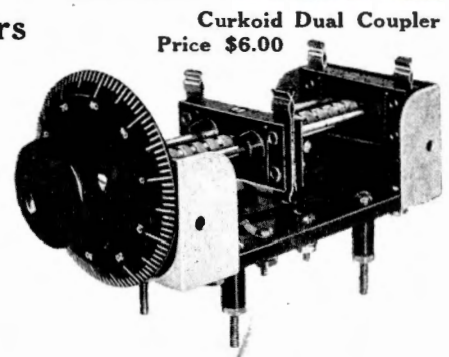

Curkoid Dual Coupler
Price \$6.00

In Our Opinion

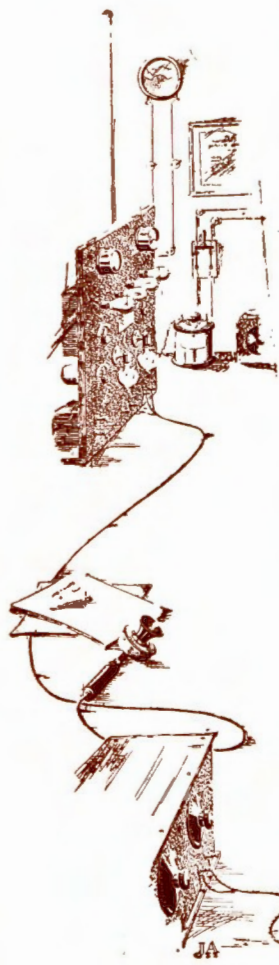

IT is not nice to scold. Particularly in an editorial, which is a constructive form of writing. But the function of this page of opinion is to make readers thoughtful about the happenings in radio. And sometimes the public has to be jolted into realization of its place in the scheme of things.

Taking the Listener to Task

So it has become a duty to say a few words about the woeful slump in writing letters of appreciation to those who entertain through the ether.

An amazingly small percentage of the listeners are writing, these days. Two years ago, an impressive program brought a response from one person in four; today, right now, the ratio is one letter for every 20,000 listeners. These are facts, ascertained through careful recording and study by the staff of this magazine.

Now these figures apply to specially interesting programs. It is not difficult to understand, therefore, that an ordinary performer would not receive a single letter. Many who are not of mediocre calibre, however, hear nothing from the audience; and this lack of appreciation of real talent is discouraging.

Those who have not faced the microphone can never understand the difficulties of doing oneself justice; the unresponsive disc is very disconcerting to the ablest and most

experienced entertainers. They conclude their performance with the uncomfortable feeling that they have tried their utmost, but have not given their best. Which is because there are no human faces before them to express approval or disapproval, no sound to register approbation or lethargy. It is as inspiring as talking to yourself in a dark closet.

But the station manager assures the performer that hundreds of thousands of persons are listening; they will write, and the "applause" will be very gratifying. And then . . . silence. Or a stray letter or two.

The artist has spoken, or played or sung into a metal disc with the stimulating thought or vision of a vast audience, some of whom will be indifferent, but there will be others who will really enjoy the entertainment. But the reward is expression in infinitesimal proportions, or no expression whatever. The sensation is comparable only to playing in a theatre filled with people with masked faces and forbidden to applaud or even make a sound.

It can't go on. No artist can be expected to continue broadcasting without the stimulus of appreciation. Even censure would be better than silence.

The difficulties of letter-writing in adequate proportions are obvious, for there are too many stations broadcasting and a multiplicity of performers and programs. In an evening, a half-dozen stations may be listened to,

for a few minutes each. Some give enjoyment, some do not. But where there is enjoyment, certainly a note of thanks has been earned. The entertainment is free, so the few minutes required to jot down an appreciative phrase or two is not much to expect of the listener.

If it isn't done—this is fair warning—the most talented performers will quit. Several have said so, plainly. And it happens that those who have served notice are the biggest radio stars of all!

That is why this editorial was written.

The situation is serious. Continued carelessness will cost the public dearly.

PROBABLY the peak has been reached in the installation of broadcasting transmitters. Not a single application for a license was made in the first week of September, and four stations discontinued.

Reaching the Saturation Point More than 500 stations remain, however, and as every listener knows, this number is about ten times more than is required to cover the whole United States.

For the past eighteen months, persons and firms in every conceivable business have been falling over themselves to get their individual ideas on the air. But delivering broadcast service is an expensive proposition and it is certain that many will discontinue and others who contemplated entering the field will hesitate about taking on the requisite heavy financial obligations. Gradually, the field will clear up, and it appears that the day is not far distant when the owner of a tube set will be able to "hold" a particular station throughout its program without the annoyance of overlapping carrier waves.

Which, of course, will give stability to broadcasting; for, after all, the unskilled outnumber the scientific hobby converts, and radio's real function is to deliver an entertaining program with fidelity to the arts represented.

WHILE Japan's cry for help is still ringing throughout the world, a thought should be given to the marvel of radio as an unfailing aid to humanity. Once more the invisible electromagnetic waves have done the job when all other means of communication were rendered inarticulate.

The Savior of Humanity

Cities and villages crumbled, buildings burst into flame and homes toppled into rising waters when the great earthquake brought disaster to the Island Empire; a hundred thousand persons died and millions faced death from hunger, disease and exposure. The tragedy of it all would have wrung the heart of the world had it been that weeks elapsed before sister nations heard the call for succor. The awful consequences of delay sicken the imagination. But radio came through. The frenzied appeal was heard across the ocean, and the greater catastrophe was averted.

The tradition still lives: The operator faithful at his post and the electrical impulses dedicated from birth to the mission of life-saving unflinchingly obeying his command.

Man's greatest gift to humanity—that is radio.

—THE EDITOR.



Fans Are Here, There and Everywhere



Manipulating levers equally well to jazz or stately measures is the achievement of Edward Joackin, yard signalman on New York's elevated railway

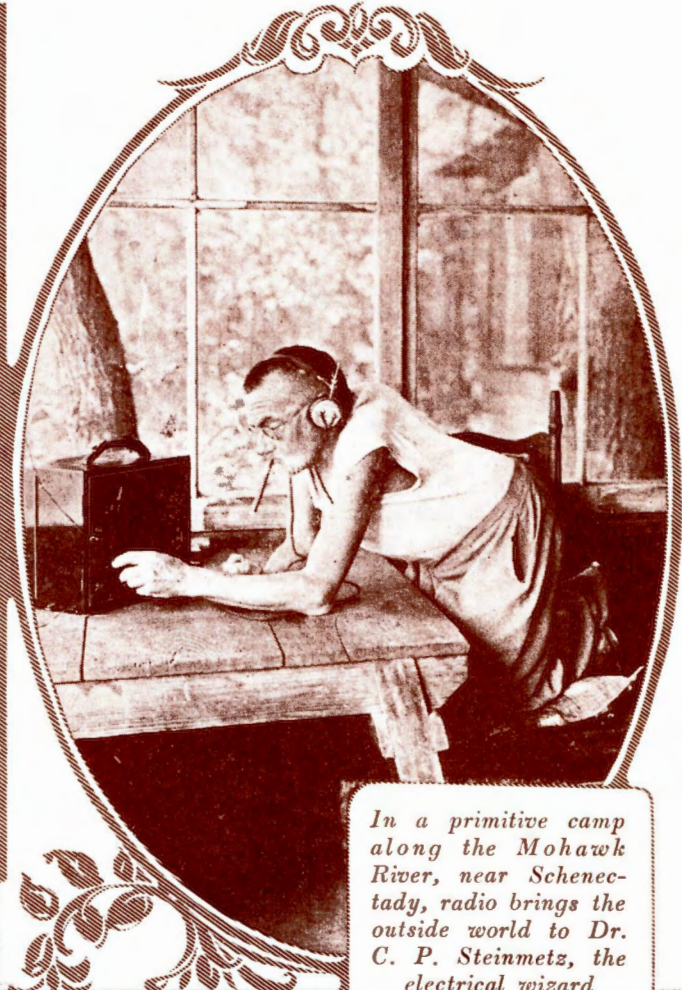

In a primitive camp along the Mohawk River, near Schenectady, radio brings the outside world to Dr. C. P. Steinmetz, the electrical wizard



From their facial expressions this group of Indians can hardly be classified as radio enthusiasts, but it is their first experience and strains of syncopation from the loud speaker may yet modernize the night dances at Wind River Reservation, Wyoming

It May Be Construction—or Contest



Mitzie, famous musical comedy star, wields a potent screw-driver in support of the claim that she made this five-tube receiver



Monkeying with the radio is a familiar pastime even to Ritzy, whose training embraces impersonations of all activities of up-to-date humans



All square and four to play is the situation in this game of radio golf, the winner of which—his back is turned here—logged his eighteen stations in less than an hour

Indoors and Out, They Listen



Cornelius Vanderbilt, Jr., and his bride occupy chairs outdoors in a Los Angeles garden when enjoying the broadcast concerts from Pacific Coast radio stations



More insulation than antenna spread makes this mobile receiver a typical small boy installation and evidently calls for some concentration and evidently calls for some concentration from Johnny Jones, the juvenile film star



Jean Tolley's boudoir bandeau of orchid and purple velvet is in reality a head-phone set which at once serves the ear and pleases the eye



The gipsy caravan has adopted an accessory to modern civilization and broadcasting entertains the roving radio-ists, although Romany Rye and his family still cling to the customs of their ancestors



Although his business is pictures, Marcus Loew hasn't been photographed in many years—that is, until he broadcast at the opening of Station WHN on top of one of his New York theatres

This Diversity Is Radio's Charm



Col. King Stanley faces WOR's microphone when making his marriage vows to Grace A. Raymond, the bride



Jack Dempsey, whose fistic achievements have been heralded through space on two exciting occasions, tries out his voice at N. Y. Police Games



Radio rehearsing in the Venetian Garden of Miss Fowler's Long Island estate plays its part in the perfection of the swaying grace of Addison and Fowler, widely known to the American public as whirlwind dancers, who are giving the Valentinos a close run for fame and fortune



Big Bill Edwards, onetime football star and former Collector of Internal Revenue, is worshipfully watched by four honor Boy Scouts as he broadcasts the organization's activities

The Thrill That Left

When Dempsey Went Through the Ropes
And Came Back to Knock Out Firpo the
Greatest Radio Audience "Saw" It All

By Capt. Robert



J. Andrew White, Editor of "The Wireless Age" in action. To the right, at the ringside (see arrow); and above, close-up as he gave his listeners moments dramatic, humorous, personal, appealing and exciting

"SIX - seven - eight - nine - TEN!
Firpo's out!"

The voice whose message was heard half way around the world and which brought despair to all Argentina, fairly shrieked the closing words of another memorable broadcast from the ringside at the Polo Grounds.

Everyone knows, of course, what happened—how Jack Dempsey, the world's premier heavy-weight title holder, met Luis Firpo, pride of the South American continent, and when it was all over our representative still held the championship.

Prize fighting never before has been so glorified—so dignified—radio has removed the stigma of other days, when it was not "good form" in polite society to be numbered among those so reduced to the level of the beast as to desire to witness a bout. In little more than two years radio has changed all this.

When the first championship fight was broadcast, in July, 1921, there were some misgivings. But the way it was done put it over. Then there were lesser fights, several in rather close succession, and immediately the radio public approved. Probably a large percentage of the listeners to the description of jabs and feints and counters and swings could not have been persuaded to go to the ringside. But in the privacy of their homes they could listen, and the thrill was as great, the combat as good—if not better in some respects—than actually seeing it.

The primeval instinct revived as J. Andrew White skilfully told each move, with a running fire of comment which made the scene vivid; the prize fight became a boxing contest, and as such was countenanced.

So it was that not only were there

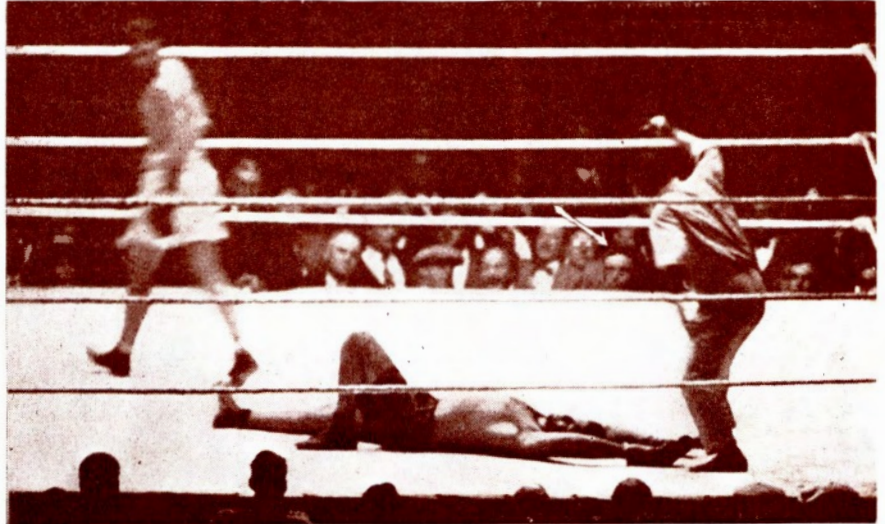

distinguished citizens among the 85,000 spectators at the Polo Grounds for the Dempsey-Firpo bout, but there were millions who sat with receivers clamped to their ears, or who faced the loud speaker and cheered themselves hoarse as the stirring details came in. Many of the clerical profession and others to whom fights are not exactly the thing, could with good grace listen to a radio account with no more harm than having their emotions thrilled as never before.

THERE were clerics, too, in many rows at the Polo Grounds. What more natural than that young fellows, recently from college, where athletics—including boxing—is in the curriculum, should want to see this interesting affair? So they went. Possibly their sermons were tinged by the "good fight" as were St. Paul's epistles by the sporting events of his day; but that matters not.

New York is used to excitement—lives on it; but it was hardly prepared for the succession of shocks which the Dempsey-Firpo affair produced. When a cool, collected broadcaster like J. Andrew White, famed for his mental poise, gets worked up there is something doing in radio. It was a night of excitement and from the first knock-down until the last count events transpired at such a reckless pace, including the champion's tumble into the lap of Grantland Rice outside the ring, that no one could resist the onward rush of events.

Those breath-taking descriptions of

previous ring encounters amazed us by their delivery in low, incisive tones. But this time precedent was thrown aside, and listeners got a mental picture of the observer rising to his feet with each word shrilling the intensity of the drama unfolded—whew! it must have been some shindig!

All the radio world went awry; listeners howled and shrieked and went wild.

MILLIONS there were who "saw" the battle only with the eyes of the radio announcer, for the ringside microphone was hooked up with three stations and every word and sound was transmitted simultaneously from WJZ, New York; WMAF, South Dartmouth, Mass., and WCAP, Washington, D. C. The interest was not confined to the cities. The country districts are as much wrought up over radio as the metropolis and when a star event like this was to be put "on the ether" they became doubly enthusiastic. Scarce a hamlet in the Eastern half of the United States but had one or more loud speakers set up to the street with a crowd listening and cheering and going wild as at the ringside.

In New York City it seemed as if every single person wanted to listen. Most of the radio shops outside of the strictly downtown business districts gave a "party," having a loud speaker either rigged up for a street audience or for all who could crowd inside.

For several days the fight was the chief topic of the radio bugs. One

Millions Breathless

Argentina Heard and the Whole United States Listened At Home, In the Streets and In Theatres for Five Epochal Minutes

Scofield Wood

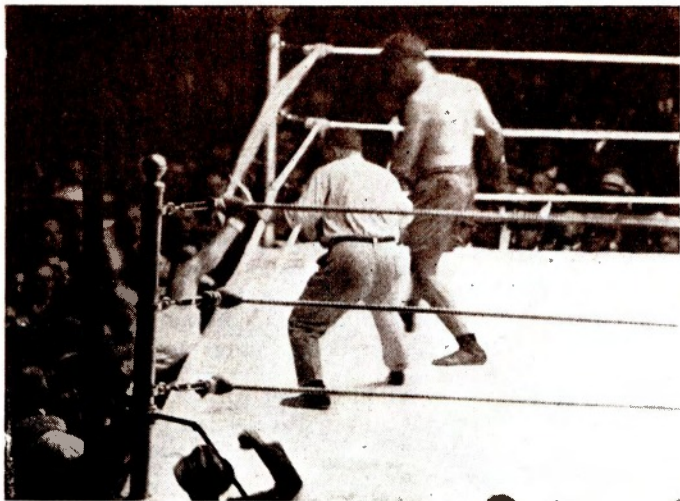

Above, a typical group of home listeners, snapshotted by Arthur Page, of Nutley, N. J. Below, the sensational knocking of the champion through the ropes

would hear such conversations as these: "Say, Bill, what do you say if I drop over tonight and listen in on the fight?"

Or, "Oh, Jack, I'm giving a little party for the fight tonight—by radio—and you're in on it."

FOR the same period of time the radio dealers were hard put to supply their patrons with parts. One can only guess how many new sets were sold, but it's no guess how much they sold of parts, such as batteries, tubes, phones and loud speakers. They sold out! It was exactly the quantity of each article they had in stock. On the day of the fight dealers and their clerks were scurrying around town trying to beg, borrow or steal these commodities, and price became a matter of no consideration. Ten dollars for a "B" battery is going some, but one buyer paid it, right before my eyes, saying he just had to have it. Dealers could get what they asked for tubes, also; with none obtainable that last afternoon. Radio sales had a boom such as it never had known before.

Several of the theatres capitalized the fight. There was the Circle, in New York City, for instance. To test the popularity of the thing, the management installed the best set they could get hold of, inadequate and inefficient, but, as it proved, capable of producing a thrill when the fight came. The plan was that the regular musical and movie program was not to be interrupted by the radio news from the ringside. When the main bout came

a movie thriller was being shown, but it might just as well have been stopped. No one watched the picture, no one cared a thing about what their eyes saw. Through their ears they were "seeing" things of much more interest. And when the final count came they were all on their feet with a shout that disconcerted even the case-hardened traffic cops on duty at Columbus Circle.

Sitting next to me in the theatre was a large blond lady. She had been getting more and more nervous as the situation grew tense. When that "TEN" came thundering in she simply went completely daffy. With a loud whoop and a grand swoop she grabbed me around the neck—and no more can I profess that I have never been kissed! That was all—except my blushes, for she fled precipitately, leaving me in confusion, and wondering.

Was the show a success from the manager's standpoint? I'll say it was. Every one of the 1,500 seats was filled.

THIS theatre has announced that it will install a real receiver and loud speaker before the next event of the kind is broadcast and expects it will prove as much of an attraction as it did for the Dempsey-Firpo affair. Other theatres which tried it out, make much the same kind of a report and it is safe to say that many other installations will be made and radio become a regular feature of the performances, of course, when anything big is on the air.

The *Staten Island Advance* invited folks to come to the square in front

of that office to hear the returns of the fight. Haste in installing the receiver and loud speaker marred the early part of the show. The announcement of the preliminary bouts was chiefly noise. Electrical difficulties puzzled the ones in charge and they did not get it all straightened out when the big bout was put on. But this came through fairly well and as the crowd had stood by in spite of the trouble, there was a large, uproarious time had by all.

Now all this happened, not solely because of two men pitting their skill against each other within a ring, though they were essential, but because there was a third man beside the ring who was able to make vivid to the listening millions the things which were occurring with lightninglike rapidity before him—J. Andrew White, the father of sporting entertainment by radio. He is the pioneer, and still the peer of broadcasters.

THERE is one particularly distinctive thing about these boxing descriptions: It doesn't seem at all brutal by radio. One does not see the blood, if there happens to be any. There is nothing at all of physical distress by radio and there is all the thrill left.

Why is it that the radio has so transformed folks that a prize fight is now the proper thing for society, banker, merchant, lawyer, or preacher; that it is considered proper for the home; that the ladies have been charmed by the contest and have become ardent fight fans, so that many of them even go to the ringside? Probably to thousands the sight of a boxing contest even now would be objectionable; they could not stand the thing, for there would be memories of brutal fights outside the ring, and a stigma which attached to it from which they could not rid their minds. But by radio this is missing, and a clear-cut, snappy account of what is transpiring in the ring sets the blood tingling, without producing a revulsion of feeling.

What surprises us all is the way the ladies take to it. Of course, they had been prepared for it in part by

war-time activities, which changed their viewpoint of many things. But no one dreamed that they would "fall" for boxing and go as absolutely crazy as the men folk over a championship bout as they have. There is but one explanation, and that doesn't explain: The Radio Bug bit 'em and they took whatever came through the air as a matter of course.

But why did the maiden lady talk about the beastly, brutal, sinful affair and then hug the loud speaker and shout with the loudest when Major White's account came through? We leave it to the reader. Perhaps that's the reason—Major White.

Incidentally, the *New York Evening World* used the radio for reception and put it through an amplifier for the crowd in front of the Pulitzer Building, and it beat the ticker service by five minutes all the evening.

An interesting feature of the broadcasting was the manner in which the announcements were sent to Argentina. Far from the scene of the battle, more than six thousand miles from the ringside in New York, some of the most eager fight fans listened tensely to a blow by blow description of the supreme fistic engagement of the year. And this invisible audience was Fir-

po's own, those who inspired him to enter the ring against Dempsey, confident in the belief that their giant brother would trot back to the pampas with the world's heavyweight championship title. Disappointed, but with the satisfaction of knowing that the challenger fought bravely in defeat, they caught the result made known to them by radio over their receiving sets through the intermediary of the most powerful radio station in the world, Radio Central, located at Rocky Point, Long Island.

The manner in which the transmission of this precious information was carried out during the many stages of its progress over telephone wires, telegraph circuits, and the many transformations of voice and telegraph signals is represented schematically in the chart.

The Audience Pictured in Paragraphs

Arthur S. Page, of Nutley, N. J., eloquently expressed his appreciation by sending a souvenir to Major White, in the form of a photograph of the listeners at his home, a flashlight developed at midnight and the print made before breakfast, so it could accompany the warm note of thanks.

The Chesleigh brothers, who operate station 2AEE, in Brooklyn, had fifteen guests and neighbors listening for a block in each direction and all reported perfect reception. They thought: "It certainly topped everything we have heard, and that includes going back to the Dempsey-Carpentier contest."

The N. Y. Edison Company fans executed a testimonial of appreciation of the "hair-raising description rendered," with fourteen signatures attached.

Louis Elkins, of the Bronx, N. Y., who had fifty guests at his home, proclaims Mr. White the peer of radio announcers, adding: "It is beyond imagination for those who did not listen in, to understand just how good his description was, embracing as it did, moments dramatic, humorous, personal, appealing and exciting."

Henry Hoyt Moore, a Brooklynite, got all tangled up in a conflict of emotions. He wrote a letter stating that fistic combats were brutal, but, at that, much less revolting than the bull fights of Firpo's mother country, to which he added the admission, "we are all interested and absorbed despite our-

How the Fight Results Were Flashed to Argentina

Dempsey and Firpo clash in the ring shown at "A." While the battle rages, J. Andrew White, the announcer stationed at the ringside at "B" describes the mighty left and right blows exchanged between the champion and the challenger. Each movement within the ring is translated into a word picture by White which is transmitted over the line through the microphone at "B." This land line connects with the Radio Corporation station WJZ located several miles from the scene of the engagement within the Polo Grounds. From the antenna of WJZ shown

at "C" radio waves laden with the precious information given by White are hurled outward with the speed of light to be intercepted by thousands of receiving antennas scattered throughout the United States. A few miles from WJZ, the antenna shown at "D" receives a minute portion of the energy from "C" which is received by the broadcast receiving apparatus "E." After sufficient amplification at this point the blow by blow description of the bout is projected into the transmitting room of the Radio Corporation Central Radio office by means of

the loud speaker "F." An operator intercepts White's word messages and transcribes the words received into dot-dash language which is recorded upon a tape by means of the perforating machine "G." The tape is then instantly fed into an automatic high speed transmitting machine connected directly in the control line extending to the giant radio telegraph transmitting station at Rocky Point, Long Island. This line, represented at "I" links New York City with the three mile multiple-tuned antenna and two Alexanderson alternators which deliver 700 amperes to the antenna "K." Thus White's voice message is converted into telegraph characters and the waves radiating from "K" on 17,500 meters are an amplified telegraphic repetition of the short wavelength energy broadcast from the antenna "C" at WJZ.

The system made up of the waves the radio generators at "J," and the antenna at "K," elevated 750 feet above the earth on twelve steel towers, forms one New York terminal of the RCA trans-Atlantic radio system. During the period of the bout, however, its signals were intended for the high power receiving station at Buenos Aires. Thus, 6000 miles away, the powerful wave energy flung from the antenna "R" registers at the receiving set "N" through the Monte Grande antenna represented at "L." Over great expanses of water and long stretches of land the progress of the big bout described by White journeys to the native land of Firpo. But the circuit is not yet complete. The telegraph signals issuing from the loud speaker at "O" must be converted back from that staccato language into the very words which White delivered to his microphone. This is carried out by a telegraph operator-announcer. He is stationed in the studio of the RCA broadcasting station shown at "P" where he translates dots and dashes into a word description. The antenna at "Q" flashes his announcements to eager listeners sitting beside their short wave receiving sets.

The range of this station is sufficient to carry the news of the battle at New York not only to radio fans in the Argentine, but to Chile, Paraguay and Uruguay.

From the moment the referee reached his tenth count while Firpo lay upon the canvas after a blow delivered by his opponent, only 15 seconds were consumed in transferring the news from New York City to the countries in South America first mentioned.

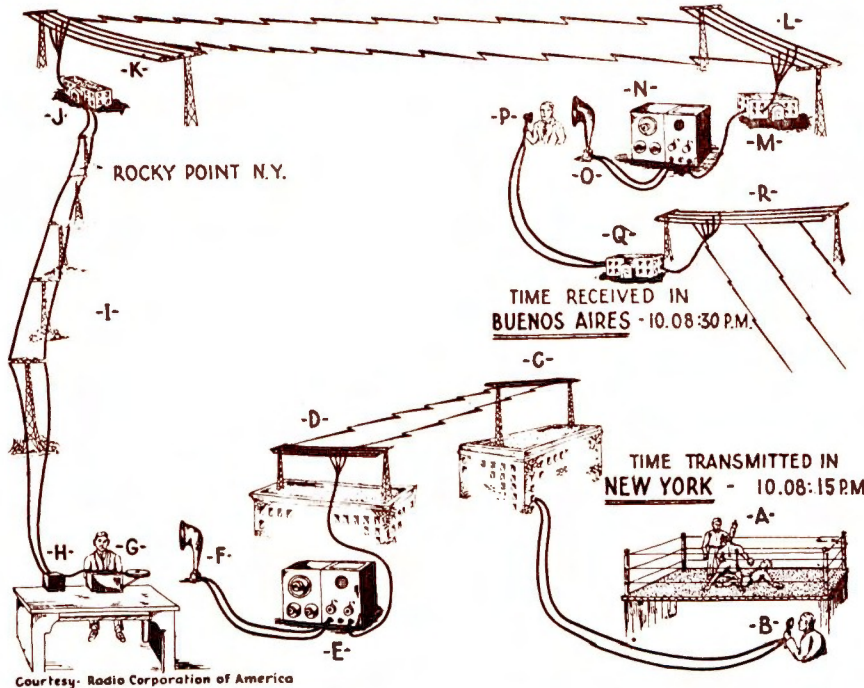

Courtesy: Radio Corporation of America

selves. If such brutal things must be broadcast, then by all means get a good man like White to do it." Before the letter was mailed, Mrs. Moore apparently was consulted, and the following postscript appended: "On reading the above to the wife, she says: 'Don't send that. Your ears were glued to the head-set, and you know you wouldn't have missed it for anything. Mr. White's description was masterly.'"

Harold Hillis, of Jefferson, N. Y., embroidered his written thanks with the gift of a box of smokes—calling them "life savers" for the strained nerves of the radio observer.

At Fort Humphreys, Va., the Signal Corps installation was placed in the Liberty Theatre. The post has a command of 500 officers and men, but 900 persons crowded into the theatre, civilians coming from the inlands for fifty miles around.

The bout brought a vision to E. Young, of Highland Mills, N. Y., that the hundreds of thousands who "saw" the fight through radio had to depend upon a single pair of eyes, which, "never for a fraction of a second wavered!"

A. Engles, who listened-in with his family at Chicago, comfortably seated in his room, said: "This one reception has more than repaid me for the expense incurred for my set."

Albert T. O'Connor, of Taunton, Mass., who had twelve guests, observed to Major White: "I was glad that you got excited yourself; you never have been excited before in any of the bouts. I nearly fell out of bed myself, and I have been in it for eight years."

John Collins, of Millville, Mass., thought: "It seemed strange that you could be so calm while we could hear so many excited remarks from the ringside. I think I heard you strike that trick match you brought from Atlantic City when you lit your cigar; it put me in mind that my own pipe was out. Tim McNamara, of the Boston Braves, who is home with an injury and who was listening with me, said he never saw a ball game in his life that gave him one-half the thrill that he got in the few minutes the fight lasted."

F. W. Warriner, writing from Tyronne, Pa., feels well acquainted. "Andrew was wonderful," he remarks. "Checking up his words with the later reports, he was like a flash and absolutely accurate. He gave me as good a time as he had himself."



The skilled observer for the great heavyweight boxing contest made a close study of both contestants at their training camps and in advance of the big event itself told the radio audience many interesting and intimate things about the personalities and lives of both champion and contender. At the left, Mr. White instructs Jack Dempsey on the operations of a radiotron and Radiola Senior, and at the right, he bids Firpo farewell at the conclusion of his visit to the Argentine's camp.

Among the unfortunates was Louise F. Smith, of Brooklyn, who dictated her note of appreciation with the opening sentence: "I cannot see the light of day, but I saw the whole fight as you described it over the radio. Your controlled excitement at the last made a splendid climax." She pleads then: "Please don't ever translate any bull-fights or cannibal feasts over the radio because I am afraid I would get wildly interested." After which comes the request: "But if you ever do, let me know."

Out in Missouri, at Washington, Powell Ross let a large crowd listen at his store, getting the returns through WJZ "fully a half hour before the other stations gave any details."

Helpless, an invalid for 13 years, James de Voe Wilkins, of Port Chester, N. Y., dictated a warm note of thanks on behalf of himself and twenty-two friends, saying that they almost "smelled" Mr. White's cigar.

Ruth Burton's appreciation took the form of commendation for the ringside observer because, "He was intelligent, refined and dignified and did not indulge in any vulgar 'gallery play,' which many people would have deemed necessary on such an occasion."

George M. Newcomer, of New York, heard the description with "in-

expressible amazement at ability so accurately to describe the occurrences of probably the most exciting five minutes ever experienced."

Harry J. Shine thought that no one could match Mr. White's description, whom he refers to as "the Jack Dempsey of the broadcasters."

One hundred patients gathered in Surgical Ward 2 of the N. Y. Post Graduate Hospital, heard the fight description through the receiving set of Jack Hajim, a fellow patient, and expressed their gratitude by saying, "without the radio we could not forget our pains."

At Albany, N. Y., a radio party was given by Martin F. Grumbly, who termed the fight broadcast "the most interesting program ever sent out" because all the guests "were laughing at Mr. White's funny remarks" during the preliminaries and then during the big bout there was pandemonium, for as Mr. Grumbly expressed it: "Never could an announcer get one so excited as he did!"

Laurence J. Hutchinson, of Malden, Mass., doffs his hat with the observation that "the humor of Mr. White in describing the preliminary bouts was original and witty, but the description of the big bout was the finest piece of work I have ever heard over the radio."

When Japan Called for Help!

With Disaster Overtaking the Nipponese All Other Means of Communication Were Silenced But Radio Reached Round the World

By J. O. Smith

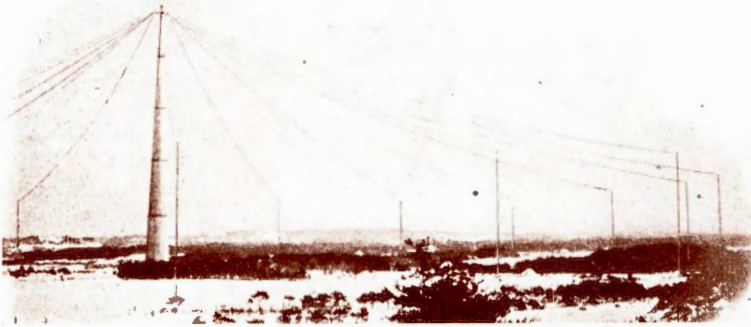

The transmitting section of the Iwaki plant at Haranomachi which supplied the world with details of the great catastrophe. It is ordinarily controlled from Tokio, but owing to the destruction of the connecting land wires, its operation was carried on from Tomioka, the receiving unit of the station

CQ—CQ—CQ—de JAA JAA
JAA—

The frenzied voice of Japan calling. There was desperation in the tone of the radio flash to the wide world early on the morning of September 2. Never in history has a twelve-hour period of silence, such as preceded the call, been broken with a more startling and stunning message than immediately followed.

It told a story of earthquakes, fires, floods and general disaster that has had no parallel in a decade. And through the days of anxiety and anguish that followed radio remained the only reliable connecting link between the stricken land and the outside world.

The first word of the great Japanese disaster came in a short message from the Japanese Iwaki trans-oceanic station JAA, 144 miles northwest of Tokio. It was transmitted to the Koko Head, Honolulu, station of the Radio Corporation of America, the first of the high-power Pacific stations to hear the call from stricken Japan. The message was brief, but of great portent:

CONFLAGRATION SUBSEQUENT TO SEVERE EARTHQUAKE AT YOKOHAMA AT NOON TODAY WHOLE CITY PRACTICALLY ABLAZE WITH NUMEROUS CASUALTIES ALL TRAFFIC STOPPED.

Immediately upon receipt of this message, the operator at Koko Head retransmitted it to KET, the Radio Corporation's station at Marshall, Calif., 44 miles from San Francisco, and it was instantly received over "tone" land wires, without retransmission, at the main office there.

The importance of the message, after twelve hours of silence on the

part of the Japanese station, with which continuous commercial traffic is ordinarily exchanged by KET, was instantly recognized. The manager of the station, George Baxter, and the entire operating personnel were hurriedly summoned, for it was quickly realized that a deluge of messages and press dispatches would follow.

The brief message was given to the San Francisco newspapers and to the press associations; and soon the entire United States, and the rest of the world, was informed of the great catastrophe which had fallen upon the Land of the Rising Sun.

As the hours went by it developed that radio was the sole means of communication with the stricken land, the Pacific cables having failed at a point about 80 miles from Yokohama.

The demand for more information became acute. The hours went by, and hundreds, then thousands of messages, from everywhere, began to pour into the offices of the Radio Corporation. Repeated calls by KET, however, brought no reply from JAA, and it was feared that disaster had also fallen upon the only connecting link with the stricken land.

Details are lacking at this time, but it is not hard to imagine that such severe earth disturbances as were ex-

perienced short distances away might easily have caused trouble at the big Japanese station. Possibly those intervening hours between the receipt of the first message, 6:10 A. M. Pacific time and 4 P. M., when JAA again answered the continuous calls of KET, were hours of feverish hard labor for Superintendent K. Yonemura and his staff in getting the big plant back into operating condition. Once communication had been re-established, Mr. Baxter sent the following brief message:

WE WANT DETAILS GIVE US FACTS.

Yonemura replied that all possible information would be given as quickly as possible and from that time on, after the whole world had anxiously waited almost a full day, the story of the disaster began to come haltingly through. Japanese was slowly translated into English, with the horror of the picture painted in the cryptic expressions of the unfamiliar translator, shocking and stunning an entire globe.

Traffic was all in one direction, east-bound, as Yonemura had stated in a very short, concise message there was no use sending traffic for Japanese delivery—"Delivery here hopeless." All land wires were down and JAA was unable to get replies to repeated calls to other Japanese radio stations in the region of the disaster.

For many days Yonemura, through JAA, continued to be the only connecting link between Japan and the outside world, being the only man on the station's staff who could translate Japanese into English for transmission. As the time went on he continued to supply the rest of the world with details of the great disaster as

Trans-oceanic operating room of the Radio Corporation of America, Honolulu, where the first news of the great Japanese disaster was received



refugees and couriers began to arrive from the stricken area.

But for the services rendered by radio during the great emergency the rest of the world would have been without knowledge of it, or, certainly, without details for a week or more.

In addition to supplying a constant stream of information to San Francisco, Yonemura frequently sent a lot of reports to Pekin. The latter station, XYZ, as well as JAA, were both plainly audible at the offices of the Radio Corporation in San Francisco.

Yonemura also performed another special service which earned him the gratitude and praise of thousands of relatives and friends of the passengers on the great Pacific steamship *Taiyo Maru*.

The vessel, with a large American passenger list, sailed from San Francisco on August 21 for Yokohama, which should have brought her in the vicinity of the earthquake at the time of its occurrence. Shortly after the details of the disaster had become available the steamship was heard to broadcast an SOS signal. Nothing further was heard of her.

The consequent fears of the relatives and friends of those on board resulted in a deluge of demands for information and to satisfy them the San Francisco office of the Radio Corporation, through KET station, sent insistent demands for further information to Yonemura at Tomioka. The latter, although sleepless for days and worn out with incessant effort to give the world details of the great disaster, succeeded in getting in touch with the Japanese Government station at Choshi. The latter station finally, after many long, weary hours, finally got into communication with the *Taiyo Maru*, which reported that she was safe.

The information was forwarded to Yonemura, who, in turn, relayed it to San Francisco, relieving the fears of those who had relatives and friends aboard.

The reason for the SOS from the *Taiyo Maru* is not known at this writing.

The Iwaki radio installation, which was virtually the sole link between devastated Japan and the remainder of the world, is a new and highly modern establishment. Its sending station at Haranomachi has a concrete mast 660 feet high, which, strangely enough, seemed undamaged by the earthquake.

The receiving station is at Tomioka. This is 155 miles from Tokio and twenty-four miles from the Haranomachi station, which is farther north. Both Tomioka and Haranomachi are small towns near the eastern coast of Hongo, principal island of Japan.

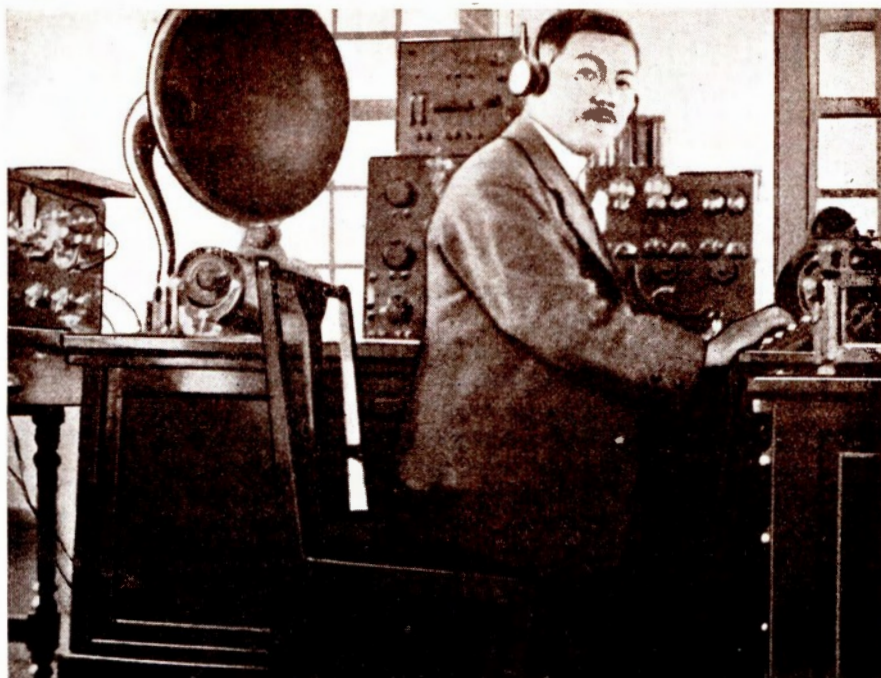

T. Yonemura, superintendent of the Iwaki trans-oceanic station at Tomioka, Japan, who supplied the world with details of the great disaster and worked continuously without rest or sleep for four days

The Haranomachi station's mast is hollow, fifty-five feet in diameter at the base and four feet in diameter at the top. The walls at the base are four feet thick, tapering upward with a decrease in the mast's outside size.

From this giant mast, which dominates the flat rice lands of the countryside for miles around, sixteen wires, the basis of an "umbrella type" aerial, radiate to smaller towers, 200 feet in height and 1,320 feet distant. The



The 600-foot concrete mast of the transmitting section of the Iwaki plant at Haranomachi, which was not damaged. It is 55 feet in diameter at the base and four feet at the top

Japanese government owns the station and operates it, so far as its connection with this country is concerned, under a traffic arrangement with the Radio Corporation of America.

Normally the station erected in 1921 communicates with America through the Radio Corporation's station at Honolulu which, in turn, relays the traffic to that company's station at Marshall, across the Golden Gate from San Francisco. In the recent emergency, however, practically all communication was carried on direct between Iwaki and Marshall.

Reception at Tomioka is over a standard Radio Corporation set, connected to a Beverage wave-type aerial. This set was built in America and picks up and retransmits the incoming wireless signals over land lines to Tokio, so that no manual relay is necessary.

The trans-oceanic station of the Radio Corporation of America, which handled practically all of the great amount of traffic to and from Japan following the emergency, is composed of two parts. The transmitting section is located at Bolinas, Calif., and the receiving section at Marshall, both about 50 miles from San Francisco. All incoming signals are automatically transferred to "tone" wires at Marshall, the actual receiving being done at the San Francisco offices of the Radio Corporation. The transmitting unit at Bolinas, consisting of two 100 k.w. Alexanderson high-frequency alternators, is also controlled from the San Francisco offices.

Wireless Warnings of Iceberg Danger

United States Coast Guard Ice Patrol Functions Exclusively By Radio—Changes Course of Steamers to Avoid Floating Ice

By Ortherus Gordon

YEARLY, when the sluggish Labrador Current shakes off the frozen grip of the north and "seems to feel the thrill of life along her keel," it brings down to our latitudes huge detached portions of the polar cap, each one of them an iceberg large enough to send the largest ship to the bottom. Every Spring two vessels of our Coast Guard fleet sally forth to meet these unwelcome visitors, to number them, watch their every movement, warn shipping by radio of their unexpected pranks and thereby make life at sea safe from their chilling and deadly embrace. Radio is the most important single element in protecting commerce from the iceberg danger. In fact, radio's service in transmitting ice warnings is exceeded in importance only by the aid it gives when a ship is in actual distress. Radio ice warnings have undoubtedly saved thousands of lives, all unknown to the passengers who so gaily sail the Atlantic.

Each of the two vessels charged with the duties of the Ice Patrol in the north Atlantic is on patrol for 15 days at a time, not counting the day or so spent in going to and from the temporary base at Halifax, and during the

three months of the iceberg menace, each vessel sees sixty-three days of cruising. Last year the *Seneca* and the *Yamacraw* were assigned to the work, which began on April 2 and ended on June 30. At that date, the danger was pronounced negligible, and the trans-Atlantic shipping lanes, moved south as an additional precaution, were shifted back to their original latitude, sixty miles to the north. It has been discovered that every June the weak Labrador Current, after a losing struggle with the swift Gulf Stream, beats a slow retreat, and the bergs that formerly moved south with the current, share the retreat and turn north, which takes them far above the ordinary lanes for steamship traffic. The need for the Ice Patrol then disappears, and the particular vessels on the beat join the remainder of the Coast Guard fleet on the Atlantic seaboard.

While it lasts however, the need is an urgent one. We were taught so to our sorrow in 1912, when the proud steamship *Titanic* crashed into an iceberg and went to the bottom with many of the leading men of England and America. Whatever additional lessons that disaster carried in its

wake, it brought home to an appalled world the sinister and newly realized danger of the Polar ice in the Spring. A demand for protection against the bergs immediately arose on both sides of the Atlantic. Hitherto considered by navigators as but one of the hazards of the sea and disregarded by ship-owners, the iceberg in 1912 became known as an international menace, and at a conference held in London in 1913 the maritime nations represented concluded that something must be done. The United States was there—and told the conference that for two years she had patrolled the ice region on her own account, and had been taught one thing about the job. That was that one ship equipped with radio was as efficient a patrol as the North Atlantic fleet not equipped—provided that all other ships were fitted with radio as well! The problem of the Ice Patrol, it was stated, was solely one of communication. The conference listened to the story and then passed the whole responsibility into the hands of our country, so that the patrol for 1914 was conducted by our ships and our men, but was paid for by the thirteen powers interested in trans-Atlantic navigation. This arrangement has

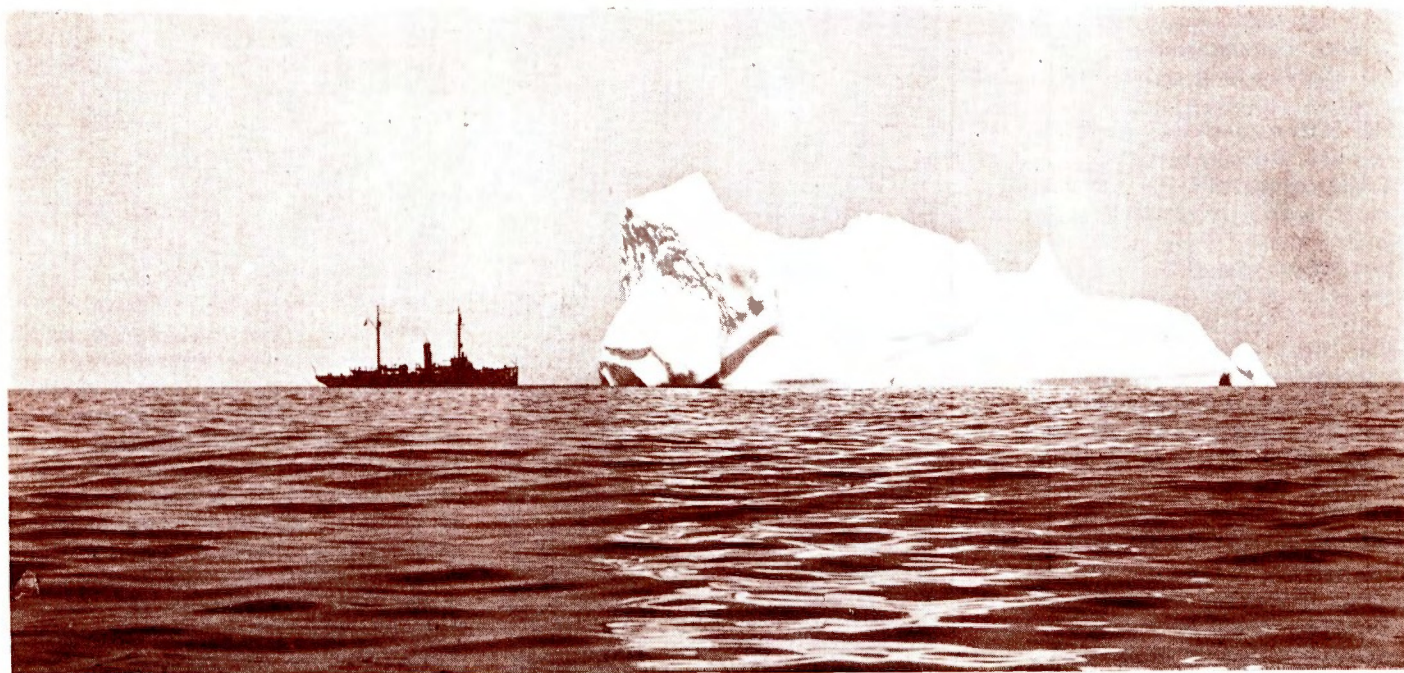

Radio is the most important single element in protecting commerce from the iceberg danger and the Coast Guard vessel seen in the photo, the "Seneca," cruises for sixty-three days among these unwelcome visitors, to number them, to watch their every movement and warn shipping of their presence by radio

held for every year since then, although the issues of the Great War have altered the number of nations sharing the expense.

The work must all be done by radio. Think of Boston and New York being entered from the East by scores of steamers daily, and think of dozens of itinerant and irresponsible icebergs floating downward across their path. The problem is not only for the ice patrol to know the position and drifting habits of each and every berg, but to transmit that information to each and every ship entering the danger zone. Right away there appears the "makin's" of a mighty job—and every single bit of it, aside from the actual sighting of the bergs and determining of their drift, is accomplished by radio. That's the important part—getting the words of caution, the warnings, the commands, to the ships that are running straight into danger.

"Will all ships within call and entering the ice region communicate their position, course and speed, together with temperature of water, to the U. S. C. G. S. *Seneca*, doing duty as Ice Patrol, now in lat. 42° 12' N., long. 51° 20' W.?" Every four hours, while on duty, the *Seneca* or the *Yamacraw* broadcasts this request, and in response all the ships within range, perhaps thirty of them, send in the information required. Immediately the various ships, according to their latitude and longitude are plotted on a large chart of the waters south of Newfoundland and east of Nova Scotia. The Ice Patrol then has a graphic picture of the commerce plying the ice-infested waters and in need of protection.

When Mr. Iceberg is sighted, he too is spotted on the chart, and from that time forward, his movements are watched with the greatest concern. If the chart shows that the iceberg and a ship are due to meet, a warning is flashed directly to that ship and a collision averted. As more and more ships appear on the chart, and more and more icebergs come down from the north, the job of keeping the one clear of the other becomes a bit complicated. To say that it requires constant vigilance and untiring endeavor is to give downright hard toil a fancy name. The amount of radio work entailed is nothing short of stupendous.

Aside from the great volume of traffic with steamers, there are reports that must be sent to Headquarters. Every morning at 4 a. m. a message leaves the *Seneca* or the *Yamacraw* addressed to the Branch Hydrographic Office in New York. It is routed via the naval radio station at Otter Cliffs, Maine, and is transmitted on a wave length of 952 meters—either that or

975. This report is a diagnosis of the ice situation at that moment—taken from the chart, which is always up to the minute—with the areas that will be affected during the coming day by drifting bergs. That such information is appreciated in New York is evidenced by the lengthy list of shippers, merchants, and others who want it mailed or delivered to them by special carrier. That its importance is not disregarded by the Government is shown by its ultimate end, which is a broadcast over a considerable portion of the earth's surface from the huge station at Arlington, Va.

Throughout the day, the ship on patrol collects and disseminates information on the floating menace. In this she is aided by the many hundreds of vessels which use the steamer lanes each month. If the *American*, for example, narrowly misses an unreported iceberg in lat. 42° 50' N., long. 47° 12' W., she doesn't merely thank God and double her lookout. She determines the latitude and longitude of the "critter," makes up a more or less scary report on its characteristics, and sends it by radio to the coast guard cutter on duty. At the same time, by way of showing that she isn't the least bit tremulous, she asks for the position of every "growler" or iceberg ahead of her! Of course, the information is forthcoming, and a fresh berg plotted on the chart. A broadcast is sent out immediately, and everyone within range is warned of the latest arrival from the Polar regions. Those ships whose courses show that they will pass close to the reported location of the berg are favored with a special warning, which they must acknowledge and report their action. As soon as practicable, the ice patrol ship verifies the existence of the iceberg, determines its drift, and places it permanently on record until it has melted to nothing, or has returned to the north whence it came.

Farmers' Night at WGY

SOMETHING different in radio programs was offered Thursday evening, September 6 by WGY, the Schenectady station of the General Electric Company. It was "Farmers' Night" and the program consisted of the entertainment, musical and otherwise, which might be expected at the home of a prosperous farmer and his faithful wife on the observance of their fiftieth wedding anniversary. Josh Quinby and his wife Samantha received their friends and the radio program consisted of the singing of old time songs by the Cowbell Four, orchestral numbers by the Cornhuskers orchestra, and a speech by Josh himself. The program was continuous.

Receiving Sets for Icebound Arctic Posts

THOUGH icebound and in darkness through the long winter months of the Arctic regions, trading posts there will not be entirely isolated from civilization and life. According to plans made by the Hudson Bay Company lonely posts will be provided with radio receiving sets so as to secure entertainment at any time. Two north-bound ships, the S. S. *Bayeskimo* and the S. S. *Nascopie*, are carrying Westinghouse radio receiving sets to six of the posts above the Arctic circle.

In order to determine whether or not these posts will be able to hear the concerts from the United States next winter the ships are listening in on their way North to the broadcasts as they steam to the frigid zone. Several nights ago the Westinghouse station WBZ in Springfield, Mass., gave a special concert at 11 o'clock, and radiograms received from the steamship *Bayeskimo* state that the music has been heard with great success.

There are hundreds of posts spread throughout Canada and North America from above the Arctic Circle into James Bay. The ships have left for these trading posts, and the factors will have their sets for next winter. Although the reports received so far from the ships are very encouraging complete information on the results will be obtained upon their return. The posts are so far removed from civilization that this will be the last news from the outposts until spring. The lanes of travel to these posts are entirely blocked on account of the heavy ice and snow.

Correcting Longitudes by Radio

THE position of Bordeaux on the map has been pushed 360 yards westward as a result of new calculations of its longitude made at the observatory there on the basis of wireless time signals transmitted by the Eiffel Tower in Paris. Previous calculations of the longitude of Bordeaux had placed the city on a meridian 2 minutes 5.51 seconds west of Greenwich, but correction by wireless proves the correct longitude to be 2 minutes 6.554 seconds west, an increase of fifteen seconds of arc. The length of a second of arc varies from zero at the poles to 101 feet at the equator, and at the latitude of Bordeaux is seventy-two feet. Fifteen seconds thus means a change of 360 yards or approximately a fifth of a mile.

Astronomers say that wireless time signals are being used to correct longitudes all over the world, with the result that boundary lines are being altered in many cases.

Blame It On Radio!

By Carl Dreher



That radio waves may have any physiological effect is disproven by the fact that the laugh of Miss Louise Lorraine pictured above uses up several hundred times more energy than is contained in any ordinary unamplified radio wave

At one time men blamed everything on the stars. It was assumed that the stars in their courses determined the issues of battles, the state of the potato market, and whether grandfather would sink or swim when thrown into the castle moat with all his armor on. This belief was a good thing for the astrologers and they made quite a little money out of it in their day. In fact, some of them are still making a living out of it, though on a reduced scale. People can be found to believe almost anything, and, after all, no one can prove conclusively that the heavenly bodies do not influence human affairs, Sirius and the Pleiades being too far away to venture an opinion.

In our day, however, the stars have lost much of their prestige, while radio has captured the public imagination and become the repository of many hopes, as well as the cause of many fears. Both, I dare say, are much exaggerated.

A good example of the latter is contained in a dispatch from the Paris Bureau of an American newspaper. The article is headed, "French Believe Germans Have Way to Force Down Their Airplanes," and hints darkly at a "mysterious magnetic area which renders control practically impossible," and the conclusion is drawn that perhaps "German science has made another great discovery, the details of

which are being kept secret, but which is being used against French planes."

Airplane motors run in the neighborhood of 400 horsepower apiece, which is about one and one-half times the power of an Alexanderson alternator, such as is used in telegraphing across the ocean by radio, on full load. Prob-

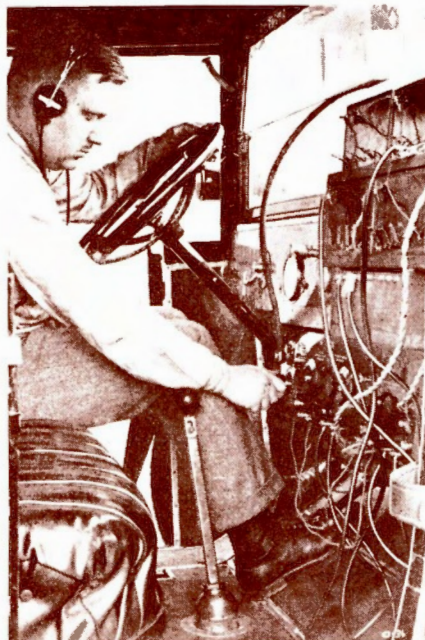

Experiments have demonstrated that the metal frame of an automobile will accumulate a high-frequency charge if placed directly under the antenna of a high-power trans-oceanic station, but if placed 100 feet either side of the antenna no effect whatever can be detected

ably in noise alone the output of an airplane motor greatly exceeds the full radiating power of a large broadcasting station. Elementary physical sense tells one that the Germans could not charge any considerable area to this extent, even if energy transmission by radio were a reality. If they had means of doing that the German mark would speedily rise to its pre-war level. It is clear that any direct opposition of the energy supplied to the propellers of the planes, by radio transmitted power, is out of the question.

The planes might be forced down, however, by power transmitted on a somewhat smaller scale, by interference with the ignition system of the motors. At one time a report came from the German high-power station at Nauen that difficulty was experienced in operating automobiles in the neighborhood of the antennas, owing to inductive sparks which exploded the gasoline vapor at the wrong points in the cycle. At American stations of equal power I have not observed this phenomenon, but it is true that sparks may be drawn from the metal framework of a car directly under the antenna, by a person standing on the ground. The chassis, being insulated from the earth by the tires, receives a considerable radio frequency charge. It is practically impossible to work on a car in this location, as one gets a moderately severe shock every time a metal part is touched. The same thing has happened when a small aerial was erected for broadcast reception at one of these super-stations. But these effects are in evidence only directly under the main antenna. If the car is rolled only a matter of one hundred feet to one side, there is no evidence of any charge, the field at this point being already too weak to manifest itself in this way. We may safely conclude that there was no interference at all with the French airplanes, but that a few of them happened to come down in this area, giving rise to the report cited. Flying is still a very hazardous business, as evidenced by the fact that practically every pilot, however prominent and skilful, must make forced landings at times, and almost all the aces developed by the war, who continued to fly after the armistice, have since been killed. In fact, flying

may be compared to DX work in radio; sometimes it is as easy as hearing the locals, while at other times it simply cannot be done; but in flying the corresponding occasions spell tragedy.

Power transmission by radio is in about the same class as the exertion of magnetic force at a distance. With a reasonable amount of power it is easy to design an electro-magnet capable of picking up great weights—but the object picked up must be in contact with the magnet. Such magnets are built and used commercially in this way. Attracting an iron object from across a room is another story entirely, for the force decreases inversely as the square of the distance. This operation, though often portrayed in humorous cartoons, is a fable. Workmen walk quite close to the enormously powerful magnets in the dynamos of power plants without having iron tools pulled out of their hands, or feeling any attraction. All that these giant magnets are capable of doing at this distance is to magnetize the work of a watch. The old Arabian Nights fable about the ship which sank when it sailed a few miles from a magnetic mountain, owing to the nails pulling out of the planks and flying over to the mountain, is a very good story, but perhaps it was just as well for the charming Scheherazade that the sultan had not taken a course in electrical engineering. About the same reasoning applies to power transmission by radio. While it may some day be realized, it should be understood that radio as we know it today does not afford any evidence to make one glow with optimism. Messrs. Nichols and Espenschied calculate in a recent engineering paper that over a distance of only a few hundred miles we can count on picking up not more than the one ten-thousand-millionth part of the energy radiated ($1/10^{10}$). Let it be noted also, that the progress which has made broadcasting and radio telephony a commercial proposition in our time, has been in substance simply the development of faithfully reproducing amplifiers for transmitting and receiving. The intervening medium has not changed in these two decades, and there is no reason to suppose that it will change, any more than the tides and the seasons and the other great natural forces of the earth. The modern radio circuit loses nearly as great a proportion of its initial energy in the space between the transmitter and the receiver as when Marconi made his first experiments. When it comes to power transmission, which means getting at the receiving end an appreciable amount of the power put into the transmitter, we are still forced to fall back on media more solid than the electrons of space—copper and iron.

However, the notion of power transference by radio has at least some rational basis, which can only be disproved by analysis and citing of figures. Some of the accusations brought against the art cannot be taken even as seriously as this. Recently an English lady of title delivered a denunciation against the broadcasting stations of her



Transmitting enough power by radio to disable an airplane at considerable height would probably destroy nearby human beings and objects before having any effect on the plane

country, maintaining that the waves killed song birds in flight. A bird would be flying along, according to her description, busy with his domestic arrangements, such as collecting material for his nest or feeding his offspring, and, meeting a wave from one of the nefarious broadcasting stations, would drop to the earth, quite dead. Why it had to be a wave from a broadcasting station, and not one from the far more powerful radio telegraph transmitters, was not stated. The incident reminds one of the shouts of alarm which rose when it was predicted that railroad trains would run at the appalling speed of twenty miles an hour, and the fact that an ordinance conceived on hygienic grounds, prohibiting bathing from November 1st to March 15th, failed to pass the Philadelphia Common Council by only two votes, not so many decades before the Civil War. The bird-lovers need not be unduly alarmed, for the birds themselves fly around and through the aerials of even high-power stations entirely unharmed, and, according to a recent report, a

flock of them even alighted on the antenna of WCAP and actually changed the wavelength of the station without seeming to know they were there.

The days are past when radio was a mysterious force to the general public; now everybody thinks he knows all about it, and it has become so common that even a brand of mustard plaster has been named after it. At one time, however, radio was in about the same class as spiritualism, telepathy, and other wonders, and many insane people in the paranoiac class, or with paranoid tendencies, blamed "wireless" for their hallucinations and troubles. Their imaginary persecutors, they were sure, were shooting wireless waves through them, and that made them nervous. Although these fears have become less common since radio became a public utility, there was a case only recently of a young man walking into a large New York radio store with the complaint that radio messages kept coming into his ears, and what could be done about it? One of the salesmen advised him to put a little fine steel wool into his ears, explaining that this would absorb the waves. The unbalanced one was much relieved to hear of this cure, and went out to look for a hardware store.

Leaving the field of lunacy, many people are concerned about whether radio waves may be expected to have any physiological effect. The answer is negative, with very little room for doubt, for the reason that the energy of the waves is insignificant compared to the energy normally involved in physiological processes. An ordinary cough or laugh uses up more energy than is contained in any ordinary, unamplified radio wave—several hundred times as much, at least. If radio waves had any deleterious effect the operators and engineers of high-power stations should all be physical wrecks, inasmuch as they live constantly in far more intense electric fields than other people, but one has only to eat at the operators' mess for a few meals to be relieved on this score. It is only a question of time, however, when one of the indirect effects of radio on health will come into public notice. Some enterprising physician will discover a new disease, "DX fiends' sleepless sickness." While this is somewhat far-fetched, admittedly, it is a fact that appreciably more power is being sold for electric light in the United States, as reported by the National Electric Light Association, through broadcast listeners refusing to go to bed at hours formerly considered seasonable. It is not reported as yet that any broadcast listeners have disposed of their beds entirely, but there is no doubt that the manufacturers of beds and mattresses have reason to be alarmed.

Impressions from Paris

PARISIANS are being more and more enamored of their radio concerts and particularly of what are known as "Concerts Radiola," according to the French radio paper *Radio-électricité*. While the Radiola broadcasting station near Paris is not by any means the only one that is heard on the air in France, it is, according to the French publication the one that has transmitted the voices of the most celebrated artists and speakers.

A clever writer in a recent issue of *Radio-électricité* said some amusing things in a whimsical vein, which perhaps may be translated as follows:

"Oh! Well, my dear Radiolo, there it is—the fire is out and my coffee is cold, writes us a friend ravished of admiration. But at once I myself interrogate: a such enthusiasm has he really as to make to forget the fire and the coffee of all the listeners to the concerts, as soon as Radiolo speaks?"

"For myself, I confide in you—such a grave error in domesticity merits being considered as a social cataclysm. It would be necessary to be a proud partisan of universal overturning to undertake each evening such responsibilities as the listening via radio, if we had not the certitude that the concerts radiophoniques far from throwing the disorder in the heart of the home, constitute the most inoffensive of diversions, in the same time as a useful distraction.

"The public familiarizes itself with some works celebrated, and a happy innovation makes to precede each bit by a short summary of history and art, permitting the listener to sharpen his memory, and, often, to increase his knowledge.

"One has quickly taken the habit of tasting at home a pleasure that one used to go to search for at a distance and which would be strongly onerous if one did not find it at the domicile. . . .

"Ah! in what emotion would our fathers find themselves at the sight of this phenomenon if they could return! Just between us, I strongly suspect that after having tasted, with refinement mixed with stupefaction, the daily delights of the radiophone, they would demand suddenly of the Eternal Father the authority to regain the Elysian Fields if one should speak to them of the problem of reparations or the increasing of taxes. I swear that they would not be wrong! Without contesting, moreover, the power of the Hertzian waves, it pleases me to hope that an emotion of that sort is not reserved solely to the peaceful lovers of radiophone transmissions."

Another writer, in a later issue of the same publication, takes a more serious tone and analyzes the current performances and the trend of the times, as follows:

"The radio concerts are interesting, and are captivating the public more and more. That is due to the adroit manner in which the programs are arranged, so all the amateurs find it possible to satisfy their personal tastes. Little by little the performances are acquiring that character of unity that many of the listeners desire; little by little all the types of entertainment are being represented, the most serious as well as the most frivolous.

"At the same time the great anniversaries of musical history are celebrated in the most complete and dignified manner. After they mark the anniversary of the death of Saint-Saëns, we had the centenary of César Franck. While the Opéra Comique celebrated in a pompous manner the centenary of Edouard Lalo, Radiolo consecrated an evening to the works of that great French musician, with the assistance of Mme. Ducuing. A rather short but very compact recital, given over to a short biography and the performance of some of the works of Lalo, completed this artistic celebration.

"Programs of this type aid materially in comprehending the musical works that are performed. They not only give a resumé of the life of the composer, in which the outstanding facts of his history are made plain, but they cite interesting anecdotes connected with him or his works, and also

include an analysis and commentary of the particular composition that is to be performed.

"When the orchestra played Beethoven's Pastoral Symphony, Radiolo explained to us in concise terms how this work had been conceived in the composer's mind, how it had ripened there, and had come to full flower in the work which we frequently enjoy, and never more than in our homes, by radio.

"The evening that was reserved for the celebration of the 23rd anniversary of the first performance of 'Louise' was particularly noteworthy. The musical program was exclusively devoted to the works of Charpentier. The master himself, who was at Bayonne, no doubt heard with emotion the radio transmission of this work that is so overflowing with life, and in which his youth is represented so triumphantly. But no one could have felt a more strong emotion than Mme. Riota, who, twenty-three years before, had created the rôle of Louise, when, installed before the microphone, the honor fell to her of singing once more the famous aria, 'Depuis le Jour.'"

The Radiola concerts are broadcast from the Neuilly plant of the Société Française Radio-Électrique, located in one of the suburbs of Paris. The studio, however, is located in the office of the SFR in the center of Paris. A wave length of 1,565 meters is used and a power of 2 kilowatts. The concerts are usually given nightly between the hours of 8:45 and 10 p. m., Greenwich Mean Time.



Miss Nina Payne, American dancer, in her Paris home listening to the radio concerts broadcast from the Eiffel Tower

How Atlanta Prisoners Listen In

Radio Equipment in Federal Penitentiary, Atlanta, Ga., Does Its Share in Making Good Citizens—Symbolizes New Era in Prison Work

THE Federal Penitentiary at Atlanta, Ga., has a radio receiving set, with which it is able to hear not only the local stations, but many of the high powered transmitters located east of the Rockies. The apparatus was presented to the prison by several manufacturers, following the great success of the initial experiments performed last Summer. At that time the radio truck of the *Atlanta Journal* made regular visits to the prison yard, providing radio concerts through its loud speaker equipment. When winter came and the yard was closed, Chaplain (Father) Hayden was able to secure gifts of radio equipment for permanent installation indoors.

The effect of this is described as follows by one of the prisoners:

"From time immemorial men and women have devoted their lives to prison reforms, have striven to bring about the purpose of the law, which is not vengeance, and less of punishment than of reform. But throughout all the ages nearly all movements for the betterment of prison conditions have been aimed at lessening the physical punishment and giving little thought to or care for the mental punishment of imprisonment, which is by far the greater. If, when we enter a prison house, by the turning of a key, we could lock the door to the brain cells of memories, bitter and sweet, to the brain cells in which are hoarded the myriads of pictures of the past, and keep the doors locked till we pass out again, then, verily, the prison of today would hold but few terrors. But the haunting memories of the past, the bitter dreams of what might have been, rising like fireflies in the dusk, fastening themselves like leeches upon us throughout the long evening hours when no toil claims our thoughts, and throughout the silent watches of the night, constitute the real hell of prisons, the scorching flames of the furnace of vain longings and regrets that mar all men and benefit none.

"Not by brooding over a past irrevocably gone can a man shape the course of the oncoming years with even the glimmer of hope of success. Ashes and smouldering embers are poor foundations for the house of the future. And, hence, anything tending to break



The effect of radio in the penitentiary is described in this article by a prisoner, who terms it epoch making, because its entertainment brings smiles to lips that have forgotten how to smile and awakens aspirations for better and nobler ideals

the chains that shackle a man to the skeletons of his past, that stirs within him new thoughts, new hopes, new illusions and, through them, new resolutions, is a movement that will carry in its wave a moral uplifting beyond the power of man to estimate.

"THE installation of a radio receiving station in each of the four vast cell houses in this institution is an innovation which should prove epoch making in the annals of prison reform. Music has tamed wild beasts of the jungle where the whip failed utterly. And music will bring smiles to lips that that have forgotten how to smile, will soften the hardening tendencies of the heart, will call forth ambition slumbering in the stupor of indifference, will awaken aspirations for better and nobler ideals. Too much credit cannot be given the sponsors of this movement for the moral uplift of the prisoners.

"The old prison methods were to crush the spirit in man, to strip him of his last shred of manhood, to rob him of every remnant of self-respect and self-confidence, and to turn him into a sneaking, skulking, shifty-eyed creature who, when released, would seek the dusky byways of the slums, shunning the light of God's sun. But the old prison system proved a boomerang that struck back at society. Now, in most of the penal institutions—though not yet in all—the methods are to trust men, to put them on their

honor, to inspire self-confidence in them and thus fit them to face the future. And, verily, it is better to trust all humanity, even though we be deceived ten thousand times, than to distrust one of our fellow men. The aim of the present administration has been to trust a man till he proves unworthy of such trust. And let it be said in all truth that few and far between are those who have proven themselves unworthy of the trust placed in them.

"This policy of trusting has been evidenced in many ways—the latest being in permitting inmates to give a concert once a month at the *Atlanta Journal's* broadcasting station. The first concert was given on May 7th, 1922, when WSB was still a babe in swaddling clothes. Few, aside from its immediate neighbors, heard it. The second concert was given on September 30th at midnight. It had been widely heralded in the newspapers and from broadcasting stations all over the country and, when Lambdin Kay, the whiskerless announcer and favorite of all the broadcasting stations in U. S. tapped his gong and announced the program, a nation stood by and listened in.

"ACROSS the portals of the prisons of the past was written, invisibly, yet visible: 'All ye who enter, let hope depart.' Across the portals of the prisons of today is written: 'To ye, who are worthy of trust, trust shall be given.'"

Different Schooldays

A Radio Period Has Been Added to All the Readin' and Writin' and 'Rithmetic In a Newark School Whose Principal Recognizes Unrealized Educational Possibilities

By Helen Beckett

DON'T you wish you were a child again, back in your "golden school days, dear old broken rule days?" For now, added to all the readin', writin' and 'rithmetic, they are having a radio period. Of course, not every school is so advanced as to adopt this wonderful new thing as part of the curriculum. In fact, so far as is known, there is only one school that makes regular use of a Radiola Grand and that is the Robert Treat School in Newark, N. J.

Martin L. Cox, principal of the Robert Treat School, has imagination and vision and foresees the immense possibilities of radio as an instrument of education. The first graphophone to be used in any public school in New Jersey was installed in Mr. Cox's school and now the Radiola Grand stands beside it, a new proof of the progressiveness of the man.

His thirty-two hundred pupils, like children the world over, have a great interest in the many things that are not found in the pages of their school books, but which can only be discovered by turning the dials of a radio set. That is how it happens that the students themselves really secured the Radiola Grand for the school. When the Newark Ledger offered to the person or persons bringing in the greatest number of coupons one of these receivers, the Robert Treat pupils turned in no less than fifty-four millions, two millions of which were gathered by one lad alone.

One must be really inspired to want something so much and to work so hard to get it. Having earned it, the thirty-two hundred little radio fans feel a sense of ownership in it.

The Robert Treat School is organized on the Gary System, one feature of which gives every child a forty-five-minute auditorium period in each school day. That now may be called the radio period because, as the children file into the hall, the teachers who conduct the auditorium assemblies search the air by radio for some suitable entertainment or instruction, and they proceed with the regular schedule only if there is nothing appropriate on the air at the time.

"Often nothing suitable is being broadcast," Mr. Cox was regretful.

"The great educational possibilities of the radio have just been recognized and the opportunity for influencing the child through public school radio programs has not been seized, certainly not through programs arranged for school children during school hours."

However, radio has been used during four different Commencement Day exercises held at the school. "I hope the time will come," said Mr. Cox, "when every graduate can hear the Superintendent of Schools of his city deliver an address on Commencement Day. This can be made possible only by means of the radio. Some day every child in the land will hear the voice of the President of the United States, the Mayor of his city and the Governor of his state deliver addresses, a privilege which we never had when we were children. When the leaders of our country realize that a half-million children are hearing what they say, what an inspiration that will be!

"Radio will also raise the standard of teaching, because if an instructor somewhere has a special talent for teaching a certain subject, thousands of children and teachers, too, in schools everywhere would be glad to listen in while this teacher conducted her class. Not only teachers would broadcast their class lectures, but the services of many great men and women, worthy of leading America's child population, could then be afforded as part of the public school training. The cost of such an educational service would be small to each school.

"We have motion picture programs every two weeks, arranged by the Board of Education," continued Mr. Cox. "Now the twin to this is a radio program, broadcast during school hours so that children may hear lectures on science, civics, economics, art, music, drama, literature and health, not at home in the evening, where there are a hundred distractions, but in school, under the direction of teachers who have prepared themselves for the radio offering of the day and who are capable of discussing the subject when it is over.

"In preparation for this, I am teaching the children good radio habits—the habit of selecting only what is worth listening to and the habit of



Martin L. Cox, the progressive principal, and two of the fortunate pupils

listening to the entire number, by radio as on any other occasion."

This is especially valuable in schools like the Robert Treat, where there are about fifteen nationalities, including children who, if they lived in the European countries whence their parents came, would grow up with the idea that each one had the individual right to get up in a concert hall and yell if he did not like the program, regardless of whether the other persons who purchased a ticket liked it or not.

"The children are very generous," Mr. Cox reported with pride, as we entered the manual training room, where two hundred radio sets have been made by the children. "They have made a great many sets for shut-ins, who now have renewed their contact with the outside world."

The movies have given great enjoyment to the four deaf pupils at Robert Treat School, and now radio is bringing unspeakable joy to the eight blind children who are under special care. One can comprehend how tremendously the humdrum existence of the physically handicapped child has been changed by radio when one hears Arthur Vorhees, thirteen and blind, say that he likes educational lectures best and after that he enjoys hearing a good concert.

"The radio is a marvelous instrument in developing good taste," the progressive principal thinks. "It is surprising how quickly these children recognize something good when they hear it and how quickly they reject something that is not well rendered. Young critics like these will demand better artists. The radio will improve constantly, giving us better reading, better speaking, better music and better lectures."

Discrimination in Listening Homes

By John Tasker Howard

BROADCASTING has sufficiently established itself as a public utility to allow of some intelligent speculation as to its future course. The usefulness of radio in providing late news service—weather reports, storm warnings, market fluctuations, election returns and the outcome of boxing matches—is quite obvious. Many and diverse are the opinions on radio music as an entertainment medium, however.

The year and a half of radio broadcasting has given those in charge of the stations some opportunity to judge as to what the public wants in the way of entertainment. The radio audience never hesitates to express its opinion and the radio stations receive vast quantities of daily mail in which praise or dissatisfaction is freely indulged. Frequently some enthusiastic, or it may be disgusted, auditor phones the station to express an immediate opinion.

One gentleman called to request that a certain singer be led out and treated to an application of the fire hose.

All of which shows that the public is vitally interested in its radio menu, and as long as it praises, or blames, in such unmistakable terms, it is quite evident that this interest is increasing rather than diminishing.

In my experience as director of the Ampico Series of Distinguished Artists' Concerts, held each week at WJZ, I have had some interesting sidelights, not only as to the artists' viewpoint, but also on the public reaction to these concerts.

I have found that it is by no means the artist with the greatest reputation who receives the largest amount of mail after a radio concert, and I feel perfectly safe in saying that the radio audience is more interested in how the singer sings, than in who he is.

A certain violinist, almost unknown to the general public, played his first concert at a broadcasting station, and he played beautifully. Two days later the station received large quantities of mail from all parts of the country praising the performance.

A short while afterward an artist of far greater reputation performed at the same station but being somewhat indisposed he did not play as well as usual. He received a mere handful of letters.

That the public is more interested in the performance than in the performer, is readily proved by the immediate response of the invisible audience to anything novel, or out of the

Mr. John Tasker Howard at the piano

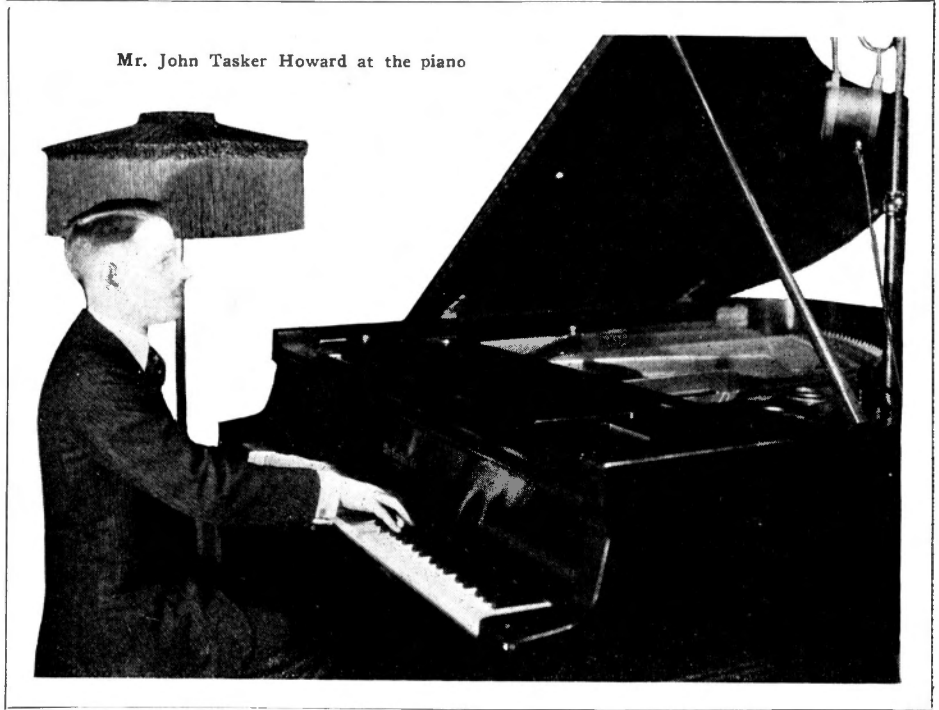

beaten path. The radio fan never hesitates to remark on anything in which he is especially interested, or which makes a particularly individual appeal to him.

At one of the Ampico series of concerts a soprano rendered a brief program devoted largely to seldom-heard French songs. The affair had been announced merely as a song recital and none of the newspapers carried announcements as to what the individual program numbers would be.

The singer received letters from

French people, not alone in this country, but from a large number of French Canadians.

These people had heard the songs they loved, sung in their own language, and each had felt an individual message in the performance. Each one of these individuals is eagerly awaiting this soprano's appearance in his own city or town, and if she should later tour among the localities from which she received these commendatory letters, she will surely find several enthusiastic advance agents among the French people of each place.

Another case is that of a Hungarian soprano who rendered a miscellaneous program which contained one Hungarian folk song given in her native language.

This song was rewarded with hundreds of letters from Hungarians, who said that they had not heard it since they left Hungary, and begged her to give a radio recital devoted entirely to Hungarian folk songs.

This request performance, which was given, brought an equally large number of letters thanking the singer for her ready response.

It is evident, therefore, that the public interest in radio is becoming highly discriminating. Those who listen in do so critically, and, denied the opportunity of expressing their approval by hand clapping, or disapproval by silence, they resort to letter writing.

Radio, by bringing about a new contact between artist and audience, is performing a valuable service for both.

JOHN TASKER HOWARD

Thousands have heard radio programs presented by talented artists under the direction of Mr. Howard, who has not only persuaded scores of musicians to perform for the radio audience, but has also lectured and spoken himself. He is still a young man, but his reputation as a musician, composer, and lecturer is firmly established. For some years he was managing editor of a musical publication; his songs and piano compositions are to be found in the catalogs of the leading publishers; and he himself has held the eager attention of audiences in all parts of the country with his lectures. What he has to say here is based on his broadcasting experience, which has revealed to him that radio has reversed the usual attitude of the public, which judges the radio performance by itself, instead of by the fame of the performer. This, he considers, is one of radio's great services to the musical art.

Finding and Keeping War Secrets

How Clandestine Radio Work by French Army Helped Outwit the Germans

By Robert Lenier



The ship left me alone on the shore with my tons of contraband apparatus

THE 20th of January, 1916, the submarine chaser X—, then cruising in the North Sea, received by radio the following message in cipher:

"Extremely urgent. Please transport Monsieur Y— to Paris for Government orders. Destination allows no delay."

The same night, at 3 o'clock in the morning, the chaser set me on shore at Dunkerque and resumed its interrupted cruise. The 21st of January, at 2 o'clock in the afternoon, I stood before the Minister of the Marine, in Paris, who told me, in general terms:

"In two hours you must be out of your uniform, and in civilian clothes, with linen and all effects necessary for a year's residence as a civilian. You will leave tonight for the port of Z—, where a boat flying a foreign flag is waiting for you and will sail immediately. Here are your secret instructions, which you will unseal in 48 hours, when at sea, and from which you will give sailing orders to the ship. I have no need to recommend to you the most careful discretion, for your life will depend on yourself alone. Good-by and bon voyage."

On February 2 I landed in a country where the temperature of Spring, the azure sky, and the balmy air contrasted agreeably with the sad horizons of the North Sea, on which I had cruised for 18 months. I had come to this lovely spot on an ingrate mission of evasion and deception.

If I debarked with a light heart, after a week of rough sailing, my baggage was not landed with the same celerity. True, for myself there was but a small valise, but for the work I had come to do there were six complete radio telegraph stations. Each one, besides the sending and receiving apparatus, included a dynamo driven by a gasoline engine, and supplied with 300 litres (80 gallons) of gasoline. In addition,

there were six cases of tools and spare parts and equipment, to facilitate my clandestine work without having recourse to local resources.

PROBABLY the most thrilling, and certainly one of the most dangerous of the tasks performed by radio during the war was that of clandestine collaboration with the Secret Service in neutral and enemy countries. This chapter of radio history still has to be written; possibly it never will be more completely set before the public than it is herewith, lest secrets touching the very lives of nations be robbed of their usefulness. The present account is guarded, but loses none of its exciting quality because of the necessity for caution. It is, in fact, the most moving and authoritative account of secret radio work that has been made public. The writer is Robert Lenier, a French radio telegraph officer of wide experience, who, during the course of the war, was placed in charge of an important secret mission, part of whose work he describes. His article appeared recently in the "Radio-Revue" of Paris, from which this translation has been made by THE WIRELESS AGE.

In all, there were 50 cases, each weighing 400 kilogrammes (880 pounds). It was in the midst of all that equipment that I landed furtively in a strange country, of whose language and customs I knew nothing.

The ship hastened to steam away, leaving me alone on the shore, where, pensive and not a little worried, I watched its silhouette move across the setting sun.

A month later, March 1, 1916, the waves of a clandestine radio telegraph station, established in the very heart of the capital, traveled through the ether, making the first tests, during which direct communications were made with an Allied warship moored 200 miles away. For a year and a half this station communicated with Allied ships cruising within this range, which was 200 miles by day and 500 by night. The matter transmitted consisted of information, supplied by the Intelligence Service, of the departure of small sailing vessels, laden with gasoline and food for enemy submarines.

I should add, as an impartial historian, that many of these ships never returned to port, and that the radio station, whose antenna concealed itself in the eucalyptus tree of a fairyland garden, was a matter of life and death to many.

A second station was established under my direction on the hardly hospitable coast of a neutral country. This, with two other stations, calculated and transmitted the positions of enemy submarines as determined by radio goniometry.

It is common knowledge that each night the enemy U-boats communicated with their secret bases by wireless, receiving information as to the departure and courses of our merchant vessels, this data having been previously reported to Nauen by the German Intelligence Service.

Independently of the chief object for which the various stations under my care were established, they also copied certain enemy and neutral stations. These texts were retransmitted to Paris, where they were deciphered and made to reveal their information, which was often vital to the national defense.

Today, due to the progress realized in amplification, the establishment of a

clandestine radio station is child's play. A simple loop in a room permits reception over thousands of miles. Transmission still presents certain inconveniences if it is to be secret, but by reason of the great progress made in it also, one now would not have to surmount the great difficulties of the first years of the war.

The stations were ordinary groups of 2.5-kilowatt power, producing damped waves. Reception was by crystal, without amplification. The rapidity of my departure from France had prevented me from choosing the apparatus, which was not at all qualified for its task.

I will not expand upon the difficulties, in point of view of secrecy, that had to be surmounted in transporting and maintaining in a strange and hostile country 50 cases of prohibited material, the total weight of which was about 20 tons. Such a story, interesting though it is, is outside of the scope of this article, for I will discuss only the strictly technical side of the establishment of secret stations.

A VEILED INSTALLATION

Let us take a typical case. The station, transmitter and receiver, was established in the cellar of a house, which had been bought for the purpose, in the center of an opulent city. In spite of the pressing population, the house was surrounded by a sizable garden, which was no less necessary to the enterprise than was the house itself.

In order to muffle the noise of the damped sparks, I had had constructed a small compartment with heavy double wooden walls, the spaces between the walls being filled with sand. In addition, three woollen hangings were used, separated 10 centimeters (4 inches) one from the other. In that country, where the nights are particularly beautiful and silent, it was necessary that the sounds of transmission be absolutely silenced, so that they could not be perceived by passers-by in the neighboring streets. The dynamo-gasoline engine group, whose noise was absolutely silenced by this arrangement, however, generated an insupportable temperature in the hermetically inclosed room.

This inconvenience led me to consider the possibility of utilizing the city lighting current for transmission, but it took me a fairly long time to realize my hope. The German Embassy and its office of the Intelligence Service were both in the vicinity and were supplied from the same electric mains as our house. It could be presumed, therefore, that should this current be used for sending, all the lamps in that section of the city would flicker in time with the operation of the key, and we

would, in effect, cast our messages right upon the enemy's desks. This contingency finally was avoided by confining transmission to the early morning hours, when the lighting circuit had but little drain upon it, and therefore delivered to us sufficient power for transmission without noticeable effect upon such few lamps as might be lit in the neighborhood.

A discreet receiving antenna was installed permanently. It consisted of two telephone wires, separated about two feet, which clung amorously to the house, swept grandly through the garden, meandered capriciously here and there, and finally ended in insulated darkness in a barn. This antenna was carried upon insulators of the type in current use in the city, and had every appearance of a telephone circuit. In

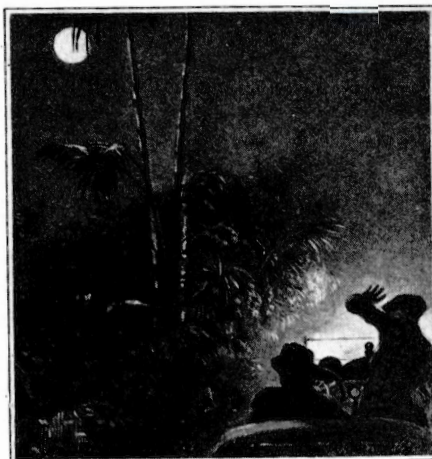

Intrigue, ambush and sudden death surrounded us

spite of the fact that it had a rather long stretch, its wave length was only 800 meters. Reception over it was excellent, and orders from the Eiffel Tower, on 2,000 meters, were received with a crystal detector. Transmission also was a possibility with this antenna, but its resistance was such as to cut the efficiency of the transmitter in half.

In order to secure reliable communication, and ranges in proportion to the power used, an antenna was hoisted each night in the garden. This was an inverted L, of three wires, 40 meters (130 feet) long and the vertical leg 15 meters (49 feet) in height. It was very difficult to handle, and six men were required to hoist it and stretch it through and over the trees in the darkness.

As promenaders and spies walked the nearby streets, complete silence had to be observed during the hoisting operation, which certainly did not facilitate it. As soon as transmission was ended for the night, the antenna was lowered, for during the day the garden was host to numerous visitors.

In spite of the presence of an official

station only 2 kilometers (1.2 miles) from this clandestine set, it went for a long time without being discovered. If our enemies finally learned of its existence, it was from their Intelligence Service, which well knew how to profit by the slightest indiscretion, and had its agents everywhere. Technically, however, the position of this station was never exactly located.

For my work in locating secret enemy stations, I then had nothing but a simple loop and an elementary crystal receiver. Placing this in an automobile, I would ride through the country at night. Always I took the precaution of adding to the party one or two of the women of our spy service; thus the expedition had the appearance of a gallant excursion.

Thus equipped, I frequented the points where I had reason to suspect the existence of a clandestine radio station. These searches were very difficult and most deceptive, for each day the Secret Service brought me reports of the existence of such stations, reports emanating from agents more zealous than technical, whose baseless radio suspicions often led me into futile peril.

During the entire night a watch was kept for nearby transmitters, and if loud signals were heard, I would estimate the distance and direction, and then make a minute scrutiny of the suspected district. During these visits I was often obliged to employ the most diverse disguises.

Operating in this most elementary fashion, I succeeded in locating a German transmitter in the buildings of a mine formerly worked by a German company. Unfortunately, the Germans got wind of my discovery, for the following night several shots were fired from the bushes at my automobile, one of whose occupants was seriously wounded in the neck. Moreover, the station had been promptly moved. However, I found a piece of paper bearing in pencil part of a German cipher, and in the garden I discovered several trees bearing bits of antenna wire of the type characteristic to the Germans.

CONSTANT INTRIGUE

All these things happened in a country whose official neutrality (???) obliged us to keep secret the nature of our activities.

It was a veritable war, as murderous and bloody as the other one that was waged in our own territory, that existed between the French and German Intelligence Services.

The least carelessness, and the moment of forgetfulness often was a death-warrant. The struggle was secret and mysterious, without mercy, without rest.

Answering "How's Business?" by Radio

Banks Use Broadcasting Stations to Transmit Market Information of All Kinds — Many Industries Finding Radio Essential for Timely Dissemination of Data

BROADCASTING usually is thought of in terms of entertainment and instruction of the general public, but that is by no means its only use. Many business houses in all parts of the country are using broadcast matter daily in a business way, and are profiting from it directly and indirectly.

The business use of broadcasting is important, and growing steadily in volume, so that it bids fair to place the radiophone on a par with the other means of communication, advertising and publicity that are taken as a matter of course.

The most obvious use of broadcasting in business is seen in the establishment of a transmitting station by firms wishing to reach the people in their locality. The Westinghouse Electric & Mfg. Co., of course, was the pioneer in this at its Pittsburgh station, and since its first performance in November, 1920, many other companies, some of them not directly connected with the radio industry, have followed suit. Department stores form the most numerous group in this class, establishments from coast to coast having installed radio telephone transmitters. Also prominent in the operation of transmitters are various daily newspapers.

Other operators of broadcasting stations, besides radio manufacturers and dealers, include automobile dealers, music houses, schools and universities, the Y. M. C. A., oil companies, and even a church.

In nearly every case the operator of these stations expects to profit indirectly by the resulting publicity, though a store in Toronto, Canada, is quite direct, giving its call—9BA—and stating that it is ready to receive orders by radio and will send goods collect. Some of the stations co-operate with local weather bureaus and crop reporting departments of the Government in distributing their daily reports.

By far the greatest business use of the radiophone, if number of installations be considered, is through receiving instruments. Naturally, every radio apparatus store has a demonstrating set in operation, but many firms in totally foreign businesses find it profitable to listen-in daily. This is particularly true of banks in the Middle West, who need to receive crop and

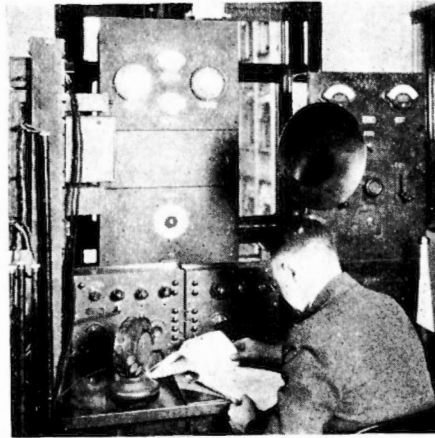

Ohio farmers listen eagerly to crop reports, securities prices and weather forecasts sent through the station of the Union Trust Co., Cleveland

market reports for their own information and the benefit of their depositors. The State Bank of New Athens, New Athens, Ill., was a pioneer in this work, having installed its receiving equipment in June, 1921, in time to catch the report of the Carpentier-Dempsey fight. This attracted much attention, crowded the street in front of the bank, and aroused comment all over the State. Since then, the bank has been posting on its bulletin board the crop reports and weather bulletins received from St. Louis University. This board is consulted continually by farmers, who also telephone daily to have the news read to them.

The First National Bank, Norris City, Ill., defrayed the cost of installing a set by selling 30 "memberships" at \$10 each, offering members special privileges in listening. In Indianapolis, Ind., the Bankers' Trust Co. stuck the horn of a loud speaker out of a window, and drew such crowds that the police interfered.

Other concerns that have installed receiving sets include tea rooms, restaurants, and department stores that do not care to go to the expense of installing broadcasting transmitting equipment. As has been told in these columns, a real estate operator in Philadelphia, Pa., has used the radiophone as a selling argument for his houses, advertising that each one is to be "wired for radio telephone service," so that receiving sets can be installed with the minimum of bother.

By far the most important commercial use of the radiophone is one that is increasing daily, and that is its utili-

zation by farmers. The banks that feature their radio receiving equipment do it on the basis of the crop and weather reports they receive, and feel that in many cases the promptness of these reports as transmitted by radio has saved the cost of the instruments many times over. By saving money by radio for their depositors—and debtors—the banks strengthen their own positions as they increase the wealth of their communities by radio.

In just one case, so far as is known, was a radio receiving set tried and subsequently discarded. That was in a tea room that was of the quiet, secluded type. It installed a loud—very loud—speaker, but found it so out of keeping with the restrained atmosphere of the place that it drove away the exact type of person that it had been hoped it would attract. In radio, as in everything else, fitness counts.

Where it fits—and it seems to belong almost everywhere—radio is a surprising asset, as more and more hard-headed business men are discovering, to their sometimes great astonishment and always more or less considerable profit.

One of the most complete of the bank installations is that of the Union Trust Co., Cleveland, O., which has a radio telephone broadcasting station of 500-watt power and is transmitting financial, weather and crop reports daily. The decision to install the transmitting set was taken when it was seen that receiving sets were of great utility to banks, and in the belief that only a banking institution is equipped to gather and transmit the type of matter desired by financial organizations.

The new station transmits for two periods of 45 minutes each in the morning and afternoon, from 9 to 9.45 and 10 to 10.45 a. m., and from 2 to 2.45 and 3 to 3.45 p. m. Voice reports of major movements in the prices of stocks and bonds, latest prices on farm and dairy products, and important financial news received over the Trust Company's private wires are put on the air. In general, the new bank station supplies the entire Fourth Federal Reserve District with up-to-the-minute commercial and financial news. Once a week, from 7 to 8 in the evening, a general entertainment program is broadcast. The main purpose of the installation, however, is to serve the interests of banks and of their customers.

"Radiotherapy" in Many Hospitals

Broadcasting Offers Splendid Opportunity to Practically Every Institution—Important Use in Mount Sinai Hospital, Philadelphia

By Albert S. Hyman, M. D.

Superintendent, Mount Sinai Hospital of Philadelphia, Philadelphia, Pa.

IT has often been said that the medical profession as a whole has responded more slowly to the innovations and inventions of modern progress than any other profession; and by the same token, hospitals tend to lag behind in the adoption of the newer advancements of science. It is just as well, perhaps, that this should be so in some degree, for many hospitals can ill afford to risk hard obtained moneys upon untried ventures. Between the rejection of all things because they are new and the blind adoption of every new project, there lies a middle course which every hospital should follow if it desires to remain in the van of institutional progress.

With this in mind, it is the humble effort of this paper to discuss the place of radio equipment in hospitals; particularly those dedicated to the relief and convalescence of chronically ill patients and to those hospitals situated afar from the large centers of population. The problem of keeping such patients interested in other things besides themselves is one which hospital administrators and others have pondered for many years. Occupational therapy, systematic exercises, physiotherapy, and allied fields are essentially devices for removing the patient from himself. To these has now been added that wonder invention of the ages—the radio-telephone—the voice that speaks for a thousand miles, and the music that travels with the speed of light far over every hill and dale. The possibilities of the radio are yet too colossal for mortal comprehension. It is as though the great Architect of the Universe has revealed to us a little of the Unknown Beyond, where space shrinks before His will.

The radio has now reached a stage of standardization which will permit hospitals to purchase equipment without fear of radical changes and depreciation, within the next few years. Not that wireless telephony has reached its perfection, but the changes in the future will be small compared to the gigantic advances of the last five years. Similar, indeed, to the story of the gasoline motor; the great advances and changes in the construction of the internal combustion engine occurred subsequent to the first four years of the invention. The past twenty years have seen nothing but refinements of the original period of development.

During the past year, wireless tele-



Originally, radio was installed for the children's pavilion, but it is now a necessity for the entire hospital

phony has rapidly standardized itself. Lending readily to popular imagination it has easily become the study of more persons, perhaps, than any other one product of pure science. The result has been a continual simplification and perfection of equipment, making it possible for a child to build for himself a receiving set capable of "listening-in" on concerts given many hundreds of miles away.

SIMPLE TO OPERATE

Standardized equipment is so simply operated that it can be intrusted to the care of the patients themselves. In expense, a radio suitable for hospital purposes costs no more than a high grade phonograph, varying in price from \$150 to \$225, depending on the site of the hospital buildings, the size of the antenna, and the number of accessories purchased. A two-stage amplifier set, detector, and loud-speaker are the essential parts of the equipment. If the hospital is situated within 500 miles of broadcasting stations, a single stage amplification may be sufficient.

On December 1, 1922, the government announced that there were over 600 broadcasting stations licensed in the United States. As might be anticipated, about 85 per cent were located near large cities; 63 per cent were situated on the Atlantic and Pacific seaboards. The Middle West has 21 per cent of the total number of broadcasting stations. A study of this report would seem to indicate that there were but few places in the entire country located further than 650 miles from some

broadcasting station. The significance of this statement should not be lost to hospital administrators, many of whom believe that they are situated too far from any broadcasting station to make use of a radio.

Many are the ways in which the radio can actually be used in a hospital. If there are several places where the radio is desired to be heard, the entire equipment can be mounted upon a wheel carriage and connected to the antenna and ground by two leads which can be brought in through a window.

A much simpler method is to have a central control station and a mobile loud speaker. In this way it is only necessary to carry the loud speaker from room to room instead of moving the entire apparatus. In some ways this is a better method of utilizing a radio in the hospital wards as the receiving set is somewhat delicate and should not be unduly exposed to the dangers of transportation from building to building. Furthermore, it is not at the mercy of the curious and destructive. In using this method, leads are brought into the various rooms from the central control station and the loud speaker attached to these leads. At the Mount Sinai Hospital of Philadelphia, this plan has given most gratifying results. In recent experiments, we have been able to hook up the loud speaker on a single wire circuit from the control station, using a convenient nearby water pipe for a ground lead.

CAN BE USED WITH TELEPHONE

A third method is applicable to hospitals with far separated buildings or with isolated small cottages, such as, for example, are in use at tubercular or psychiatric institutions. The cottages must be equipped with telephone service. In the control room a loud speaker is held before the transmitter of a telephone; the switch board operator then opens keys on the lines of those wishing to listen-in. A very simple procedure, yet one which will give patients immeasurable happiness. Not far from Boston is a tubercular hospital which allows 27 cottages to listen-in at one time to concerts relayed by the control station.

Private room patients in city hospitals can also listen-in at the telephone. This can usually be done at night, as the open keys would tie up the switch board for hospital business. After 9 p. m. we have allowed certain private

patients to listen-in on their own telephones.

The field of usefulness of the radio increases daily. Originally, installed at the Mount Sinai Hospital to delight the kiddies of the children's pavilion with bed-time stories and afternoon concerts, it has gradually assumed proportions of a necessity at the hospital. Indeed, when it was silent for a few days because of storage battery difficulties, patients, staff, and visitors all expressed feelings of loss.

Radio programs have changed for the better during the past year; formerly anything musical or even tuneful was considered suitable for broadcasting, says the author, in "Hospital Management." Today, radio programs are compiled with the utmost diligence and study, for it can be truly said that "a broadcasting station can be known by the program that it sends." The best types of music, lectures, readings and reports are now the rule. It is not unusual to be able to listen-in to an entire opera rendered by the world's stars. Great men have not overlooked the vast radio audience. Harding, before his death, Coolidge and others have been heard by unbelievable numbers of persons. Only recently at the occasion of the national Pasteur centenary celebration held at Philadelphia, the speakers at a local theatre addressed nearly a half million persons.

CARRIES RELIGIOUS SERVICES

In addition to delighting and educating thousands, the radio has still another function which should endear it to hospital patients, and that is the carrying of religious and sacred services. From nearly every large city, church services are broadcast in their entirety; from the roll of the organ to the admonition of the preacher. The pastor must now number an unseen flock of thousands, compared to the few he actually sees. Words of consolation and of cheer do much to inspire the convalescent patient. A picture, never to be forgotten, was seen last summer when on a Sunday morn with beautiful sunshine and a gentle, fragrant breeze there knelt 159 souls who prayed in unison with a voice that came over 300 miles away; an impressive sight and surely a marvelous thing, this radio, well fitted to carry the Divine message.

There is no limit, of course, to what can be broadcast—weather reports, time signals, market and news reports, readings from good books, operas, symphonies, children's stories; all in profusion. Jazz music, too, has its way. At one isolated psychopathic hospital, far from any large city, the regular Saturday night dance is now done by radio music. No more the scratchy and antiquated dance records upon the overworked phonograph; nothing but

the latest music from the jazziest band will do!

The radio has proven to be a heaven-sent blessing to the hundreds of "shut-ins" who are now able to leave their crippled and diseased bodies and fly away from their long endured imprisonment. Wireless telephony is rapidly becoming one of the essential parts of our highly complex modern civilization. Hospitals should not lag behind in the adoption of this marvelous invention, especially those situated afar and inaccessible to the regular channels of intellectual intercourse. To these hospitals the radio comes with great possibilities.

Canada Hears Fire Talks

WHAT is called the "most powerful radio receiving set in Canada" has been installed by the Canadian Marconi Company in the Forest Exhibits Car of the Canadian Forestry Association. This railroad car has just started on its 1923 tour of 15,000 miles. During this trip talks on various fire preventions and allied topics will be broadcast from the nearest Canadian broadcasting station, received by the apparatus in the car and made available to the crowds around the car by means of powerful loud speakers.

Desert Radio Saves Life

ANGUS BUCHANAN, explorer for the British Museum, thanks wireless for rendering him medical assistance while he was in the midst of the Sahara Desert. He fell while climbing the hills in the desert and was badly injured. Natives carried him fifty miles to the wireless station operated by a detachment of French soldiers. Medical advice was secured by wireless from Algiers and Buchanan responded so well to the treatment that he was able to proceed in a few days.

Ship-to-Shore Phone Service

PASSENGERS on the Admiral Liners, sailing out of San Francisco, now are able to use the ship to ship and ship to shore radio telephone. Already three of the Admiral ships have been equipped by the Radio Corporation of America with complete combination wireless telephone and telegraph sets, these being the *H. F. Alexander*, *Dorothy Alexander* and *Mattsonia*. On May 16th, the captains and passengers of the *H. F. Alexander* and the *Dorothy Alexander* used the radio telephone to exchange messages while the two ships were at sea in the Pacific. So successful was the test that all the Admiral passenger liners are to be equipped with this apparatus and contracts for the work have been placed with the Radio Corporation. It is expected that the operators of the important passenger lines on the Pacific will follow suit.

'Change Censors Radio

IN order to guarantee that all quotations and announcements sent out by radio by members of the New York Stock Exchange shall be authentic, the Board of Governors of the Exchange has recently taken steps to regulate such use of radio. The resolution adopted by the Board is as follows:

"Resolved, That no member of the Stock Exchange or firm registered thereon shall make use of wireless or radio to transmit or broadcast market information, or forecasts of business, or financial conditions or any other matter intended to advertise such member or firm or to stimulate interest in particular securities or in the market; provided, however, that members may supply quotations to broadcasting stations which have been approved by the Committee on Quotations and Commissions at such intervals and under such regulations as are prescribed by said Committee."



Dr. Carlos Sampaio, former Mayor of Rio de Janeiro and his two daughters, Sylvia and Rosita enjoying the broadcasting of grand opera

Canada's First Radio Wedding

CANADA'S first radio wedding was consummated recently when Morris V. Chesnut, secretary-treasurer of the W. W. Grant Radio, Ltd., at Calgary, Alberta, Canada, was united in marriage to Miss Dale M. Snebley, also of Calgary, the proceedings being broadcast over CFCN from Grace Presbyterian Church, where the service was conducted by the Rev. Robert Johnston, D.D.

Bells on German Sets

MEANS for connecting a bell to a wireless telephone receiving set are reported as having been developed in Germany. When the set is properly tuned to a transmitting station, as soon as broadcasting commences a bell rings, notifying the owner that there is something to hear. He then can turn on his vacuum tubes and listen or not, as he pleases.

Mystery Radio Music

THIS is a story that can't be illustrated, because what makes it a story is the fact that there is nothing to be seen. In Jules Verne's "Twenty Thousand Leagues Under the Sea," the music room of the submarine *Nautilus* is described as being at times flooded with music from a source unseen. As the submarine is now a reality, so a room may now be mysteriously flooded with melody.

In every four-sided room each corner forms the small end of an enormous megaphone, and a person standing in the center of such a room is really standing inside the mouths of eight monster horns formed by walls, floor, and ceiling.

An ideal method of supplying music to the small ends of these horns would be by tubes of suitable size put through from other rooms, the tubes having at their outer ends radio loud-speakers connected together electrically. This, however, entails boring through the walls.

A substitute method which works beautifully is to take off the horn of the loud-speaker and attach a tube two or three inches long. This outfit is placed in a corner, the end of the tube touching both walls and floor, and inclined equally to all three surfaces; there will be plenty of air space at the tube end. The whole may be hidden from view in such a way as not to cut off the sound, as by a chair or wastebasket.

A room may thus be flooded with music, mysterious as to source, and rounded out by the balanced reflection of the sound from walls and floor.

Stop Thief!

RECOVERY of stolen automobiles by radio, once so successful, now is in dire straits. Indications are that broadcasting of descriptions of missing cars will stop. The trouble is that after the description is poured into the ears of the eager world, it is almost impossible to find the car because of the crowd of radio fans who surround it, each claiming the reward.

Station WLAG is the guilty one. It transmitted an offer of a reward of \$25 for a stolen Ford; Mr. and Mrs. Evarts of St. Paul, Minn., said, simultaneously, "Why, that's the car that's been parked in front of our house for the last two hours." And all their neighbors said, also simultaneously, "Why, that's the car that's been standing in front of the Evarts' for the last two hours."



Marconi (center) listens in to the Ongar station from his motor car, on the way to Chelmsford while conducting a visiting party of a hundred members of England's Parliament

Seven called the police, and seventy, maybe more, hastened to stand guard over the machine—and the reward. When the policeman arrived it looked more like a riot than a Ford, with "I heard it first," and "I saw it first," and "I got here first," filling the air.

The question of the reward is still unsettled.

So Much an Evening

A NEW note in the radio industry appeared a short time ago with the announcement by a Washington, D. C., radio concern that it will supply "radio entertainment by the evening" if so desired.

The firm will put a receiver in your home, supplying entertainment suit-

able for a "social evening," with the guarantee of success or it will not charge anything.

Next!

Radio to Aid Westward Flight of ZR-3

EARLY in November the German built Zeppelin ZR-3 will start on the long aerial journey from Germany to her American home at Lakehurst, N. J., a distance of approximately 4,200 miles. This new airship will be equipped with radio apparatus of latest German design and during the trip will be kept informed of the weather conditions she will be expected to encounter. Meteorological reports will be compiled through the cooperation of the Weather Bureau, Navy Department Shipping Board vessels and other agencies and this information will be transmitted by NAA, Arlington, Va., to a station ship in mid-Atlantic. The station ship will in turn retransmit the reports to the ZR-3 and so keep her navigators informed of the weather conditions to be expected a long distance ahead.

Toll Radio Receiving

REAL estate men in Dundee, Mich., are licking their chops in anticipation of a great boom in real estate values. The flood of settlers has not started as yet, and the town still has only about one thousand people, but they hope to make it at least 100,000 soon. The reason is that the Dundee Farmers' Telephone Co., is offering radio programs at \$1.50 a month. Frank W. Graudolph, president of the company, has devised a system whereby subscribers only have to throw a switch in order to hear radio programs as picked up by a special receiving set at the central office of the telephone company. Special equipment is supplied to each home that subscribes to the radio service.

Languages by Radio

THE schools in Sheffield, England, have begun to teach foreign languages with the aid of the radio telephone. Special programs have been broadcast from a French radio station for the benefit of the Sheffield educators, the matter transmitted consisting of French prose and poetry. The students listened to the program in their school rooms. So successful was the experiment that it is hoped to secure similar co-operation with radio broadcasters in Germany, Italy and Spain, as soon as broadcasting has been sufficiently well developed in those countries. European educators now view radio as a tremendous force in the teaching of languages.

WORLD WIDE WIRELESS

Radio Soon to Link America with the Argentine and China

JAMES G. HARBORD, President of the Radio Corporation of America, has recently returned from a trip to Europe, where he attended a meeting of representatives of international radio companies.

The countries represented at this conference which convened in London were the United States, Great Britain, France and Germany, and the chief object of the sessions was to complete plans for a projected radio communication service connecting both the United States and Europe directly with South America.

"These plans," said General Harbord, "previously conceived to link the United States and European countries directly with Brazil and the Argentine were enlarged upon at the recent conference. Circuits will extend from the high power station at St. Assise, France; Nauen, Germany; and Carnarvon, Wales — direct to Buenos Aires while the other will bridge the gap between New York City and Buenos Aires through the intermediary of Radio Central, the Radio Corporation of America's station on Long Island.

"Reception in Argentina from France and the United States has already been established and the receiving apparatus has been in test operation at Buenos Aires for a number of months. A notable test of this 6,000-mile circuit occurred when the returns of the recent Firpo-Dempsey boxing contest were transmitted from the giant station at Rocky Point, Long Island, direct to the receiving station at Buenos Aires from which they were subsequently broadcast by radio telephone. Having thus accomplished reception in the Argentine," continued General Harbord, "we are now finishing the erection of a high power transmitting station at that point, which when completed, will enable us to carry on two-way communication. It is expected that the new service will be ready for commercial use some time this Fall.

"I feel that Americans generally do not appreciate the great strides we have made in radio broadcasting in this country. Certainly the initiative and enterprise which American manu-

facturers have shown so far have placed this country far in advance of others in this new art. And the great privilege of free broadcasting exists nowhere as we know it in the United States."

Referring to the linking of America and China by radio General Harbord said:

"This undertaking calls for the erection of five powerful stations in China, the principal one to be located at Shanghai. This station will engage in direct communication with the RCA stations at Hawaii and even San



The increased efficiency in handling foreign mails is largely due to this radio equipment aboard the U. S. mail boat "President"

Francisco, over five thousand miles distant. Shanghai will also operate a station of lesser power for communication with similar smaller stations to be located at Peking, Canton and Harbin, each of which cities are separated by approximately 800 miles. In this way the central station of Shanghai will have 'feeder' stations in the principal provinces, through which traffic from these several territories will be routed to the giant station at Shanghai, for transmission to the western hemisphere. Conversely, Shanghai will be the gateway through which communications from points East will pass to the Chinese interior. These stations will be operated jointly by the Federal Telegraph Company of Delaware and the Chinese Government, thus placing the project under Chinese-American administration.

"American business men will be quick to appreciate the commercial

significance of this comprehensive plan; inasmuch as there is today only one cable crossing the Pacific to China. And this new, strong link of friendship cannot help but play its own important part in the cause of better understanding between these two countries, and indirectly the peoples of the world."

Work on the stations will begin this Fall, and the inauguration of service is expected during the latter part of 1925, although the plan may reach maturity before that time. Test signals will, however, span the Pacific from China well in advance of the official opening.

New Station in Madagascar

PENDING the establishment of a permanent radio station at Tulleur Bav, Madagascar, a temporary receiving station with the call FTL has been established. This station receives on a wave length of 600 meters from 9 to 11 A. M. and 7.30 to 9.30 P. M. daily.

Government Aid for Canadian Radio

GOVERNMENT aid to the extent of \$55,000 has been extended in Canada for the purpose of establishing radio stations at McMurray, at the end of the railroad in Northern Alberta, Fort Simpson, on the Mackenzie River, and Dawson, in the Yukon, according to reports just received at the Department of Commerce. The new stations will displace the land lines at present in use from McMurray northward, for which the Canadian Government has appropriated from \$275,000 to \$300,000 annually for the past twenty-three years.

6,550-Mile Two-Way Ship-to-Shore Work

AT 5:10 A. M., Aug. 24 last, two-way communication was maintained between KPH, the Bolinas, Cal., station of the Radio Corporation of America and the S.S. *Tahiti*, while the steamship was 6,550 miles out of San Francisco in the Pacific. A 1 k.w. I. C. W. set was used by KPH. The *Tahiti* is equipped with a 1½ k.w. spark set.

Direct Service with Holland and Italy

DIRECT radio telegraphic service between the United States and The Hague, Holland, and between the United States and Caltano, Italy, was recently established by the Radio Corporation of America. The opening of these services raises the total number of direct radio circuits radiating to European countries from New York City from six to eight and affects not only Holland and Italy, but provides more direct routes between the adjoining countries and the United States.

High Power Station in Mexico

THE General Electric Company has representatives at Caracas, Mexico, preparing for the construction of a large radio transmitting station.



The U. S. Government radio station at Pago Pago, on the American-owned island of Tutuila in the Samoan group

Sweden Authorizes Broadcasting

THE Government of Sweden after much deliberation, has finally decided to permit radiophone broadcasting in that country. The transmitting stations will be built by the Government, and leased to commercial companies for operation. Receiving stations may be operated by private individuals, but Government licenses must be secured for them.

Large Radio Station in the Balkans

WORK has been started on a new 100-kilowatt radio station at Rakovica, about four kilometers from Belgrade and on a receiving station at Laudon Trench, a suburb of that city.

The station is being built by the French Wireless Telegraph Company and the total expense is estimated at 38,000,000 dinars (\$402,800). On its completion the entire installation will be taken over by the state and the operating personnel will become employees of the Department of Posts and Telegraphs, the company maintaining one engineer as a technical adviser. This particular station will be the first high-power radio installation in the Balkans and will afford greatly increased facilities for the dissemination of news and the rapid dispatch of information, with the rest of the world.

Japanese Ship-to-Shore Radiophone Service

JAPANESE efforts to operate a radio-telephone service out of Kobe may have to wait until operators who

24, Secretary of Commerce Hoover announced recently.

The new vessel will have the first radio fog signal, an automatic apparatus sending during fog a group of four dashes every thirty seconds, enabling vessels with radio direction finders or compasses to obtain accurate bearings from a distance of 30 miles or more in any weather, and to steer for and "make" the lightship. The light vessel will also have two other fog signals, a powerful steam whistle, and a submarine bell. A little later a submarine oscillator will be substituted for the bell. The vessel is also equipped with radio for communication purposes.

Broadcasting in Italy

RADIOPHONE broadcasting will soon be under way in Italy. An agreement has been reached between a number of Italian radio manufacturers whereby a broadcasting station is to be constructed and jointly operated. Up to the present time there has been no regular broadcasting done in Italy.

Three Broadcast Stations in Italy

THREE big broadcasting stations are to be set going in Italy in the course of a week or so—one at Turin for North Italy, one in Rome for the center and south, and a third at Palermo for Sicily and the Calabrias. Concerts, meteorological information and general news will be broadcast.

The wireless habit is only just now beginning to catch on here and moderate-priced sets are being offered for sale in some of the Rome shops.

RCA Cuts Deferred Rate to Honolulu

THE Radio Corporation of America has announced that the rate on deferred messages to Honolulu from Seattle has been cut in half. Messages filed in Seattle for Honolulu and Japan with the Western Union marked RCA are transmitted to San Francisco by wire, then turned over to the radio circuit there.

Rio de Janeiro to Have Broadcasting

A RADIO organization, known as the Radio Sociedade do Rio de Janeiro has been formed in Rio de Janeiro, and already has more than 100 members. Several influential men of the city are among the officers and directors. It is also announced that a daily broadcasting service will be inaugurated by the Praia Vermelha station.

can speak English as well as Japanese are secured. The service of the Japan Sea Port Radio Telephone Company has been tested thoroughly by the Columbia Pacific Shipping Company, which reports that the service was satisfactory. On account of the inability of the radio telephone company to get operators who could speak English, however, it was necessary for them to put interpreters aboard ships when officers were wanted on the air. It is expected, however, that this difficulty will be overcome when efficient English speaking Japanese operators are secured.

Radio Fog Signal on Nantucket Lightship

THE new lightship, equipped with a radio fog signal, was put into service on Nantucket Shoals, on August

Listening to the Broadcasting of Three Continents

By Howard Adams, Jr.

ONE afternoon in 1916 I was listening in when all of a sudden I received the thrill of my life. A man's voice was there in the receivers and as loud as a regular line telephone! At first I thought some one had played a joke on me by connecting the telephone to my set, but after listening for a few seconds I was sure it was coming from the air, because it said, "This is voice number one speaking at the Washington Navy Yard. We would like to receive reports on this radio test." I immediately flew to the telephone and called the Navy Yard up to tell them I had received the phone test on my little crystal set. I reckon the man thought I was crazy because I was so excited I couldn't talk straight. Anyway he thanked me and I went out to tell the school that I had heard a voice come through the air the great distance of five miles! Little did I think then that in the year 1923 I was to hear Rio de Janeiro, Brazil, which is one thousand times that far.

The next year I bought a vacuum tube and hooked it up in an ultraudion circuit as a detector. This was a large improvement over my other detector because it didn't need adjusting all the time and as it was not regenerative the signals were practically the same as before in regard to volume.

With this single tube set I could hear the experimental radiophone at Annapolis, Md. (NSS.) At this time he was transmitting phonograph music about two or three times a week and it was with great interest that I looked forward to the days when he was on the air.

The following summer Dempsey and Carpenter were to fight for the heavyweight championship of the world and it was to be broadcast by WJY. I was then living in Baltimore, as school had stopped. Well, as soon as I knew that the fight was to be broadcast I counted my money and found I had enough to make myself a single stage of audio-frequency amplification. I wanted to be as sure as possible that I would be able to pick up the fight, so I bought the necessary apparatus for a one-step and hooked it up. It worked great and when the fight was finally broadcast I received the whole of it through heavy static.

I thought I now had the best set obtainable, just imagine hearing all the way from the upper part of New Jersey to Baltimore! Why it had my first five miles beaten by a long shot.

That fall I met a friend of mine who had just purchased a Paragon RA-10 with detector and two-step. I was so pleased with the performance of this regenerative set that I decided to junk my old one and order a Paragon. I have been getting excellent results with it as the list of stations heard clearly shows and I attribute it all to the Paragon which has proven to be a highly sensitive as well as a selective receiver. Last fall I bought a Paragon detector and two-step unit to go with my RA-10.

About the first of this year I moved to

my present location in West Virginia. At first I was very busy unpacking and getting settled so I didn't have a chance to get my set in operation for about four days. Finally I did manage to hook it up, but I just could not find the time to put up a good antenna.

My room is on the third floor so I thought that I might be high enough to use an indoor antenna, even though I had no radio frequency amplification. I had brought some bell wire with me and I decided I might use this by stringing it around the top of the room. I suppose it was about seventy-five feet in all. I next made a temporary ground

Receiving equipment of Howard Adams, Jr., consisting of one step of tuned radio frequency amplification, Paragon tuner, detector and two steps of audio frequency amplification. With this equipment Mr. Adams has listened to the broadcasting of three continents

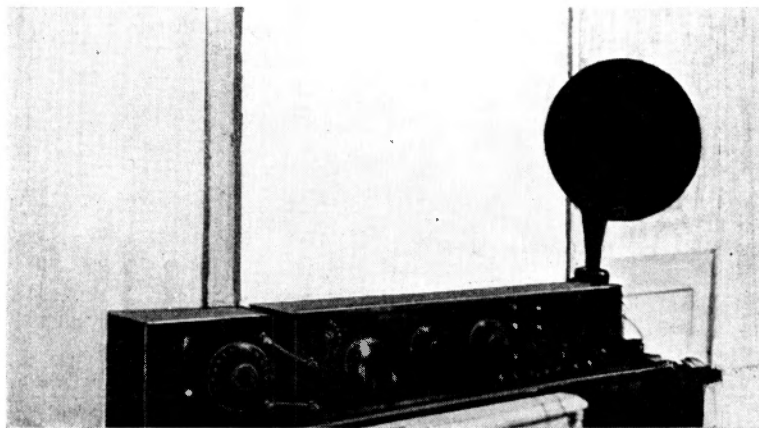

by clamping a wire to the gas pipe in my room. The first station I tuned in was WOC at Davenport, "Where the West begins." I considered this very good as the aerial wire was insulated only by the cotton insulation on the wire itself. I received in all about fifty stations with this aerial which ranged from PWX at Havana, Cuba, to CFCA in Toronto, Canada, and as far west as KZN, Salt Lake City, Utah. I soon began to want to try a good aerial so I decided to put one up the first chance I got.

When I did put the antenna up I ran a single wire from one corner of the roof of the house to the opposite corner on a barn. This made it point northwest by southeast, and my lead-in had to come from the highest end and run down the edge of the roof.

My next thought was my ground connection. Up to this time I had been using, with very good results, the gas pipe because no water pipe was available. I decided to continue to use this pipe and also the tin roof, so after soldering all the connections I tried it out and the stations just hummed in. I was so pleased with the results I got in the next few weeks that I finally decided to send my list to THE WIRELESS AGE so that it might be published in the list of stations heard and this list is also included in this article.

I have since added the Paragon one-step of tuned radio-frequency amplification to my set. With this radio-frequency I am able to do nearly as well in the summer as I could in the winter when I had no radio-frequency.

My Paragon is like all other Paragons and I believe that anyone with such a set, well installed, can do just as well as I have. Of course, it is necessary to be careful when tuning in distant stations. You can't expect to hear California or Honolulu just by swinging the dials around, you have to move them slowly and get all the circuits well balanced and in resonance before such distant stations are audible, but after a little practice in tuning there will be no trouble at all in bringing in distant stations.

As nearly everyone knows, some localities are so situated that it is practically impossible to receive stations over fifteen hundred

miles no matter how good a receiver you may own. One of these so-called "dead spots" surrounds Baltimore (Md.) and that is why the stations in that city are never heard at any distance. It is true that there are no powerful stations there, but the ones which are there should be able to send much farther than they do. Reception is also hampered by this peculiar condition and I never knew what long distance reception really was until I came out here to West Virginia.

The following broadcasting stations have been heard by Mr. Adams on his Paragon equipment.

Station Call	Location	Distance in Miles
WHAS	Louisville, Ky.	300
KYW	Chicago, Ill.	425
WMC	Memphis, Tenn.	600
WSB	Atlanta, Ga.	450
WWJ	Detroit, Mich.	250
WGM	Atlanta, Ga.	600
WDPA	Chicago, Ill.	425
WJZ	Newark, N. J.	350
WTZ	New York, N. Y.	350
WOR	Newark, N. J.	350
WIP	Philadelphia, Pa.	300
KSD	St. Louis, Mo.	550
WOC	Davenport, Ia.	575
WDAF	Kansas City, Mo.	775
WEAF	New York, N. Y.	350
WGR	Buffalo, N. Y.	275
WLW	Cincinnati, O.	225
WLK	Indianapolis, Ind.	300
NAA	Arlington, Va.	175
WGY	Schenectady, N. Y.	425
WHAZ	Troy, N. Y.	425
WHA	Madison, Wis.	550
WBZ	Springfield, Mass.	450
CKAC	Montreal, Canada	575
KOA	Denver, Colo.	1,325
WKY	Oklahoma City, Okla.	1,025
WGI	Medford Hillside, Mass.	550
CFCN	Calgary, Canada	2,000
WDAL	Jacksonville, Fla.	625

WGAL Lancaster, Pa.	225	WLB Minneapolis, Minn.	775	KZN Salt Lake City, Utah.....	1,675
WEAV Rushville, Neb.	1,200	WIAO Milwaukee, Wis.	485	SPC RIO DE JANEIRO, BRAZIL.....	5,000
WCAL Northfield, Minn.	775	2XB New York, N. Y.	350	CHCF Winnipeg, Canada	1,150
KFAF Denver, Colo.	1,325	WHAM Rochester, N. Y.	300	WBAN Paterson, N. J.	325
KDYX HONOLULU, T. H.	4,600	WDAJ College Park, Ga.	475	WEAS Washington, D. C.	175
WGF Des Moines, Ia.	725	WSY Birmingham, Ala.	550	PWX Havana, Cuba	1,400
WHAH Joplin, Mo.	700	CHYC Montreal, Canada	575	5KW Tuinucu, Cuba	1,400
CHXC Ottawa, Canada	500	WSM Norfolk, Va.	275	WEAD Atwood, Kansas	1,150
KOP Detroit, Mich.	250	WIAR Paducah, Ky.	500	WFAA Dallas, Tex.	1,050
WAAC New Orleans, La.	875	WBAV Columbus, Ohio	150	WAAP Wichita, Kansas	950
WDAK Hartford, Conn.	425	WOAT Wilmington, Del.	250	CFCA Toronto, Canada	310
WCAY Milwaukee, Wis.	485	WMU Washington, D. C.	175	2LO LONDON, ENGLAND	3,100
WDAR Philadelphia, Pa.	300	WWX Washington, D. C.	175	WLAZ Warren, O.	150
KGG Portland, Ore.	2,250	WJH Washington, D. C.	175	WFI Philadelphia, Pa.	300
WJY New York, N. Y.	350	KGU HONOLULU, T. H.	4,600	WBT Charlotte, N. C.	300
WMAC Cazenovia, N. Y.	350	WJAN Peoria, Ill.	510	WOO Philadelphia, Pa.	300
KGW Portland, Ore.	2,250	WIIX Des Moines, Ia.	725	WOAI San Antonio, Tex.	1,275
KPO San Francisco, Cal.	2,350	WMAF Dartmouth, Mass.	500	WAAH St. Paul, Minn.	775
WLAY FAIRBANKS, ALASKA	3,500	WHAL Lansing, Mich.	325	WCX Detroit, Mich.	250
KLB Pasadena, Cal.	2,175	WRAO St. Louis, Mo.	550	KWH Los Angeles, Cal.	2,200
KFBV Colorado Springs, Colo.	1,325	WCK St. Louis, Mo.	550	KFI Los Angeles, Cal.	2,200
WWI Dearborn, Mich.	275	KDYS Great Falls, Mont.	1,675	WOAN Lawrenceburg, Tenn.	400
WNAC Boston, Mass.	525	WOAW Omaha, Neb.	850	WLAK Bellows Falls, Vt.	500
WBAP Fort Worth, Tex.	1,075	WHK Cleveland, Ohio	175	CFCF Montreal, Canada	575
WMAQ Chicago, Ill.	425	WOH Indianapolis, Ind.	310	WKAO San Juan, Porto Rico	1,400
WIAX Cleveland, Ohio	175	WHN Ridgewood, N. Y.	350	WJAZ Chicago, Ill.	425
WEAR Baltimore, Md.	200	WEO Columbus, Ohio	150	WAAM Newark, N. J.	350
WEAM North Plainfield, N. J.	275	WGL Philadelphia, Pa.	300	WOI Ames, Ia.	750
WBAD Minneapolis, Minn.	775	WWAD Philadelphia, Pa.	300	CHBC Calgary, Canada	2,000
WLAG Minneapolis, Minn.	775	WEAN Providence, R. I.	510	WCAU Philadelphia, Pa.	300
WHB Kansas City, Mo.	775	WIAR Providence, R. I.	510	KFEC Portland, Ore.	2,250
WOS Jefferson City, Mo.	650	WCAR San Antonio, Tex.	1,275		

Radio Activities in Australia

DURING the last twelve months radio in Australia has progressed considerably in many ways. First, the restrictions placed upon amateur experimenters have been modified. The license fee has been reduced to 10 shillings per annum for each separate license (transmitting and receiving). Each applicant for a transmitting and receiving license has now to pass a satisfactory examination covering technical knowledge and operating at a speed of 12 words per minute. This examination will be waived if the applicant can satisfy the authorities as to his ability to handle his apparatus in a sensible way.

The following are the conditions upon which the amateur licenses are granted: Transmitters will be restricted to two bands of wave-lengths, one from 150 to 250 meters for all classes of transmitting stations and the other from 410 to 440 meters to be reserved for radiophones and C.W. transmitters. All stations within a radius of five miles from any commercial or defense station will be limited to 10 watts and only C.W., I.C.W. and radiophone transmitters will be permitted within this area. Outside of this area and within 50 miles from a commercial station all types of transmitters except those of the plain aerial type will be permitted, but the power will be limited to 20 watts. Any station outside this area will be licensed to use upwards to 250 watts power.

Special regulations have been made to apply to transmitting stations as follows:

No transmission is to commence without previously listening in on the wave-length which is to be used in order to ascertain whether the proposed transmission is likely to interfere with any other station which may be working.

No single transmission shall last more than ten consecutive minutes and each transmission shall be followed by a period of not less than three minutes listening in on a wave-length used for transmission. Transmission is to be confined to communications relating to the experiments in hand and intended solely for the stations actually co-operating in those experiments. General calls, news, advertisements or matter similar to that which will be transmitted from a

broadcasting station are expressly forbidden.

Many applications have been received for transmitting licenses, C.W. and radiophones predominating, therefore the world will soon be hearing of the results obtained by the amateurs of this country in an untried sphere of operations. Splendid results should be obtained as demonstrated by one of our leading amateurs signaling 600 miles on 3.2 watts during daylight. Such results would indicate that the Southern Hemisphere is especially favorably located for long range signaling on low power.

Arrangements are in hand for the formation of an organization to be called the Australian Radio Relay League. The main object of the league will be to relay messages on low power and so link up Australia and perhaps the British Empire. By carrying out this work in a proper manner the amateur will not only be useful should communication by the regular telegraph lines be destroyed in any part of the continent, but as a unit of defence the services of the amateurs can be utilized. The formation of this league comes at the right time as in the future the amateur experimenter will have to turn his activities into other channels besides that of transmitting speech and music. As the results of the recent Broadcasting Conferences held in Melbourne goes to show, he will soon have to take second place as far as the transmitting of entertainment is concerned.

At the time of writing the amateurs are providing excellent entertainment every night which is enjoyed by thousands of listeners-in. Since December the growth of the number of amateur transmitters has been remarkable, for where there were only two or three there are hundreds now. Applications for receiving licenses are coming in at the rate of 1,000 to 2,000 a month with every anticipation of a big increase when official broadcasting commences in the very near future.

Recently during the month of June a series of conferences were held in Melbourne by the representatives of the various parties interested in broadcasting on a commercial basis. Various schemes were discussed and that of E. T. Fisk, Managing Director of the Amalgamated Wireless, Australia, Ltd.,

was deemed to be most suitable to Australian conditions. After slight amendments the proposals were forwarded to the Postmaster General, who stated that regulations would be drafted from them as recommended by the conference. Hereunder are Mr. Fisk's proposals as submitted by the conference to the minister administering the Wireless Telegraph Act, The Hon. W. G. Gibson, M.H.R.:

A—A number of wavelengths to be allotted for broadcasting purposes. Such wavelengths to be selected in respect of their suitability for station of various powers, and their suitability for standardization of receiving apparatus, and subject to their not being required for public wireless telegraph or wireless telephone services.

B—Licenses or concessions for broadcasting stations to be granted for all available wavelengths within a given area.

C—Each broadcasting station to be licensed for transmission on one wavelength only, but transfer may be approved by statutory authority.

D—Licenses to be issued under the wireless act to the public for receivers of design approved by statutory authority and capable of receiving signals of two or more services and incapable of variation without intentional tampering.

E—Licenses on nominal fee to sell or hire receiving apparatus to be issued to bonafide manufacturers or other traders.

F—All licenses to be renewed annually excepting in the case of broadcasting stations and trading concerns which are to be for five years.

G—Concessionaries and licensed dealers to be authorized to issue licenses to all their customers who have paid their subscription to the concessionaire.

H—Receiving licenses and renewals thereof to be withheld from all persons who do not pay the annual subscription to the broadcasting stations.

I—The Government to take effective measures to protect the industry.

J—Dealers and traders only to supply receiving equipment or parts thereof to holders of licenses.

K—Dealers and traders must collect the first year's broadcasting subscription on all receivers sold.

L—Since there will be ample room for competitive broadcasting services it is unnecessary to place any limitations on

the nature of the services provided. Each concessionaire may decide for himself the class of service that will bring him the greatest number of subscribers. That after the publication of these regulations time be allowed in which to receive applications for broadcasting licenses; such applications to be treated on their merits.

- M—Retailers to keep a record of all equipment sold, together with the name, address, and license number of purchaser, and to notify the concessionaires of any particular wavelength accordingly.
- N—Any person, company or manufacturer dealing in or using wireless equipment without a license from the Government shall be subject to an adequate penalty.
- O—The administration of regulations governing broadcasting to be in the hands

of a board having thereon representatives of the Government, of broadcasting stations of manufacturers, of traders and the press.

The following motions were adopted by the Conference Committee:

That this conference affirms the principle of preference to Australian, British and foreign manufactured apparatus in that order on such terms as will encourage use of Australian and British manufactured apparatus and that this be the recommendation from the conference to the Minister.

That this committee realizes the necessity for protecting the principle of property in news, and we forward herewith a memorandum drawn up and submitted to us by representatives of the press.

That this committee recognizes the right

of fully-qualified persons indulging in bona-fide experimental work to be without any hindrance, except as prescribed in Statutory Declaration No. 169 of 1922, such right to be kept in mind in the allotment of wavelengths subject to the experimenter giving an undertaking that he will not poach on broadcasting services.

These regulations should ensure a broadcasting service that will be of maximum efficiency and usefulness to the community.

Recently tests have been successfully carried out with American amateur stations. The American signals being received in (Brisbane, Queensland), (Sydney, N. S. W.), (Melbourne, Victoria). They have also been received in New Zealand, one station reporting the logging of 89 American stations on 36 consecutive nights.

Adapting Dry Cell Tubes to the

Radiola RC

By Vincent Morley

THE Radiola R.C. is a regenerative type of receiver which combines with it in the same cabinet a two-stage audio-frequency amplifier. It was designed before dry cell tubes had been developed and were commercially available. The constants of the receiver were naturally chosen for operation with the vacuum tubes then available. Even though the WD-12 tubes which are supplied with the set at present have slightly different characteristics, it is possible to use them to advantage in the R.C. set.

As the WD-12 operates on but 1.10 volts on the filament it will be necessary to substitute the 1.5-volt battery for the 6-volt storage battery which would be ordinarily used with the old type of tube. Three dry cells connected in parallel will supply the energy necessary to light the filaments of the three WD-12 tubes.

It will be found that this arrangement will give very good results provided not more than 45 volts are used on the amplifier circuit. If higher amplification is desired and more voltage applied to the plates, distortion will be experienced. This effect can be remedied by the use of a "biasing battery." The introduction of a biasing battery in the circuit is not difficult and will produce improved results. In fact the method outlined herein is applicable to any type of amplifier and will give better results with increased amplification.

As the alteration will be made in the amplifier unit, it will be necessary to remove it from the cabinet. This can be done very easily by disconnecting the bars of the binding posts on the rear of the cabinet between the two units. Then remove the four oval head nickel plated screws nearest each corner of the right hand panel. All of the battery connections must be taken off and it should then be possible to take the entire unit out of the cabinet without disturbing the other half of the apparatus.

The two rheostats which are used to control the filament current can be readily located. They will be found on the lower part of the panel, the right hand one being the detector control and the left hand one for the two amplifier tubes. This last one is the one in which we are interested. If this rheostat is carefully examined there will be found a wire which has been soldered to one of the turns in the rheostat and also to

one of the terminals of the amplifying transformer. It will be necessary to remove this wire and if a soldering iron is handy, it is an easy matter to soften the solder, and remove the wire. If no soldering iron is at hand the wire should be cut off as close to the rheostat as possible with a pair of pliers.

A length of insulated wire is connected to the end of the lead which is connected to the transformer, this wire being long enough to make connections outside of the cabinet. A neat job can be made by drilling a small hole in the back of the cabinet and pushing the wire through it, leaving it long enough so that it will extend through the hole when the amplifier unit is taken out of the cabinet.

This wire which has just been added has been shown by the heavy dotted line in figure 1. It is connected to the negative end of a small battery of dry cells. This battery may be a flash light battery of three cells, or the proper number of ordinary dry cells. The essential thing is that all connections to this battery should be soldered and otherwise tight. The other end of this battery is connected to the binding post marked "A" battery, or to its equivalent, the negative side of the filament battery as shown by the heavy line in the diagram.

As the values for the "C" battery—as it is called—vary with the number of "B" batteries used, the right one can be determined from the following table.



Dry cell batteries, for filament lighting, are now used extensively with the Radiola RC receiving set

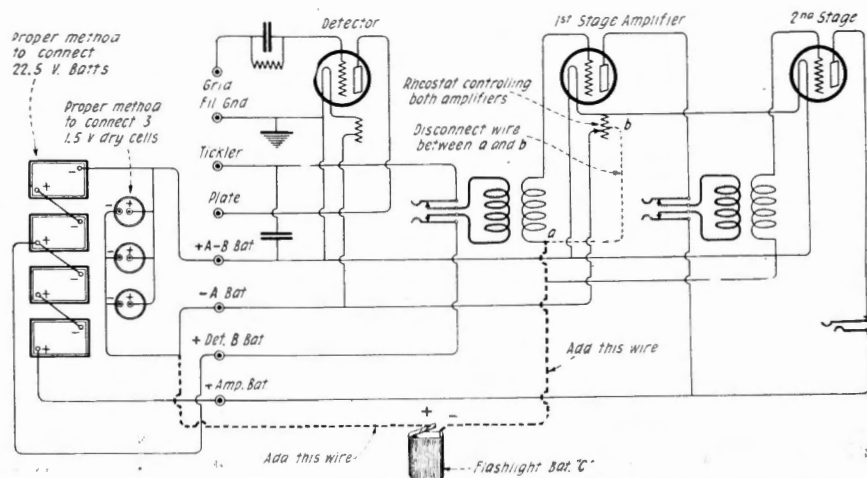

Diagram of connections of R C amplifier showing how to place biasing battery "C" so as to secure better amplification

No. 22½ Volt B Batteries	Bias Voltage	No. Cells in Series
1 (22.5 V.)	0	0
2 (45 V.)	1½	1
3 (67.5 V.)	3	2
4 (100 V.)	4½	3
5 (122.5 V.)	6	4

An examination of this biasing table would show that there is always one cell less in the bias battery than there are blocks of 22½-volt B battery. It is not advisable to use more than five blocks of 22½ volts B battery for the amplifier when WD-12 tubes are in this circuit. Although it would be possible

to use a greater voltage than this there is danger of damaging the tube under such conditions. One hundred and twenty volts will be found ample enough for all amplifying purposes, including the operation of loud speaker units.

For the detector tube either 22.5 or 45 volts can be applied, some tubes working better with one voltage than with the other.

Particular care must be taken when the filament battery is connected to the set. The WD-12 tubes are designed for use with a battery giving approximately 1.5 volts. It should never be used with a battery giving

more than two volts as there is great danger of burning out the filaments of the tubes.

Since there are three tubes in each set three dry cells connected in parallel should be used. This combination will give 1.5 volts and will supply about one quarter of an ampere, which has been found to be the greatest current that can be taken from a dry cell for any length of time without running it down too rapidly. If desired more cells can be connected in parallel and greater service can be had from them. In no case however should less than one cell be used with each tube.

Radio Beacons and Their Operation

By O. C. Roos

THERE are two systems in successful use today, through which a fog-bound ship, if provided with charts, can locate her position by radio signals. They are both based on the fact that a loop aerial can be made very sharply directional and responds best to signals in its own plane and least to those normal to this plane.

The navy department uses the Radio Com-

pass system—or just one, if economy is an object—which receives signals continuously from at least three radio beacons on shore. A radio beacon is a station which radiates a continuous stream of electric waves and its direction can be quickly ascertained by a

several loop radio compasses on one vertical shaft or else by arranging these compasses as near as possible horizontally, without producing mutual disturbances.

An interesting innovation, first discovered by the writer as far as he is aware will be described below which permits the ship's observers to ignore the magnetic north or even the ship's direction, by taking all beacon

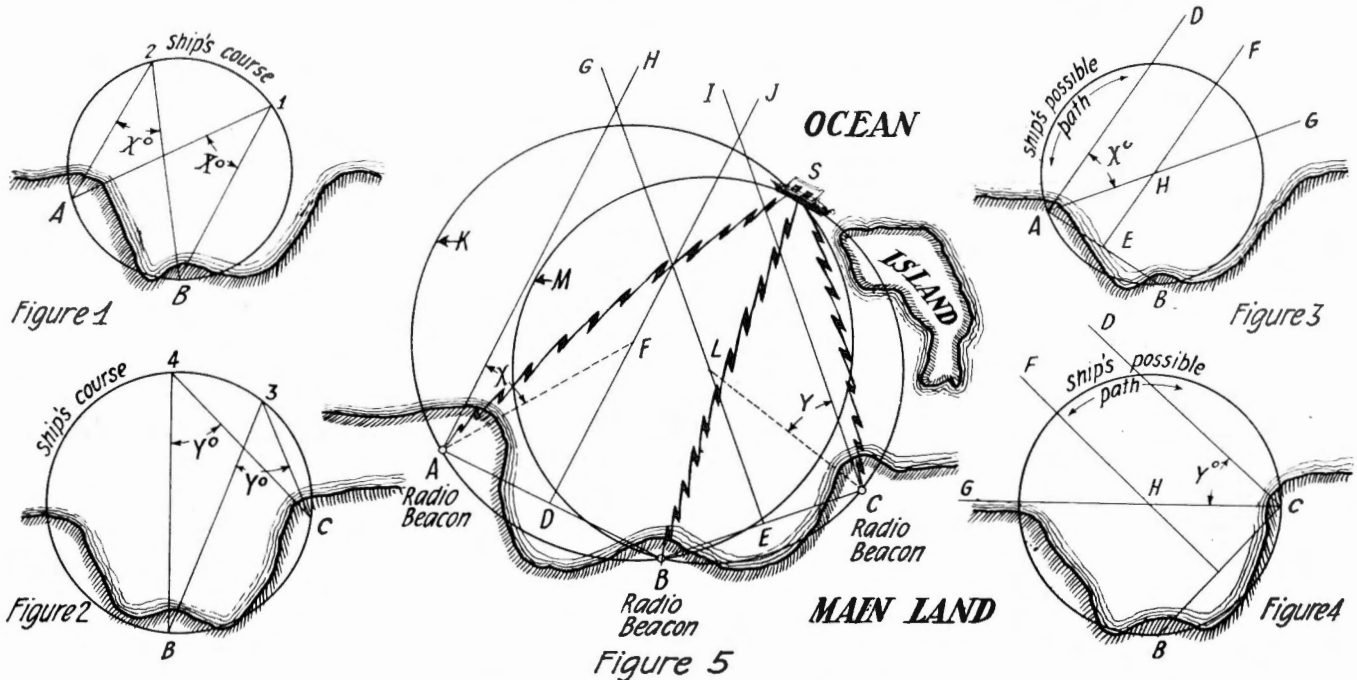

Method of locating fog-bound ships by radio beacons

pass system which presupposes a transmitting set on the ship. The Bureau of Commerce has developed the Radio Beacon system which does not require this. The latter system is rapidly coming into vogue on the Great Lakes and the Pacific Coast, while navy wireless stations use the former near N. Y. City and other Atlantic ports.

The Radio Compass System is operated by means of from 3 to 5 radio compass stations on shore which find the ships' directions from the stations and where these "directions" cross is located the position of the ship on a chart. The navigator does no work except to send out a code signal on 800 meters asking for bearings. These are broadcast to him in code by the principal compass station. The only trouble with this system is that it takes longer to use than the Radio Beacon system.

single loop aerial on a ship if it has a characteristic signal or frequency. When the loop is at right angles to this direction, the signals are weakest and this fact is more sharply indicated in turning the loop than is the condition of greatest intensity. Hence the minimum value of signal is the means used for getting the radio beacon's direction.

There are certain difficulties in using the radio beacon system when a storm rapidly changes the "course" or direction of the ship's head. It is obvious that no direction of a beacon means anything in the above system unless referred to an invariable direction—say the magnetic north. Now a storm changes this bearing of the radio beacon several times in the course of a few minutes and hence we are faced by the necessity of making all our measurements very quickly. This can best be done by using

bearings relative to the instantaneous (relatively) direction of the ship's head, even though this may be unknown, owing to unmanagability of the ship's compass in a storm. If all radio compass loops are on one shaft, even this is unnecessary, as will be now shown in detail.

To understand this, one must master the principles underlying the method which will now be explained step-by-step.

Let us imagine that in a fog a vessel is sailing in a circle without knowing it, as in figure 1, where the above circle 1-2-A-B passes through the radio beacons A and B. Now from the elementary geometry of such a circular course, it follows that at all points on the circular arc 1-2, the angle between the directions of A and B, or in other words the difference in their bearings is constant.

Calling this angle X there would be a constant difference between the directions of radio signals from A and B and it would be impossible for the ship's crew to determine its position. Wherever they were on the circular course—so long as it would pass through A and B—the base angle X would be constant. The name, "base angle" is justified by the fact that it is the angle subtended by the "base-line" A-B between the radio beacons A and B—as "viewed" from the ship—by radio waves!

In figure 2 we have a third radio beacon C whose direction may be compared with that of B by means of radio signals received on radio compasses on the same ship. The same laws apply here to a ship steering, a circular course, which would pass through B and C. All observations on the ship give the same base angle Y between A and B, as observed from any point whatever on the course. Hence the ship could not determine its position.

We have now derived an important law, which is the basis of the quickest method of locating fog-bound ships by radio signals; as follows: All circular courses passing through two radio beacons have a constant base angle.

The next problem is this. Knowing the base angle can we draw the particular circular course which will give it for all points on itself? The solution is very simple and elegant and is shown in figure 3.

To find the course giving a constant angle X, proceed as follows: Take a chart of the part with the radio beacons located accurately and joint them by the base line A-B. Erect a perpendicular E-F at the mid-point of A and B. Erect another perpendicular A-D at the point A and measure the angle X from A-B towards E-F. Next draw the line A-G at an angle of X degrees from A-D. Where this line cuts E-F is the center of the circle whose arc, if followed by a ship, will give a constant "base angle" of X degrees.

A similar construction to get an unchanging angle of Y degrees between B-C from the ship is shown in figure 4 with the working lines lettered as in figure 3 for clearness.

We now are in a position to understand the law underlying the finding of a ship's position. It is as follows: A ship which observes a base angle between A-B of X degrees and one of Y degrees between B-C must be at the one point which is on both circular courses giving these angles respectively. In no other way could it possibly observe such angles simultaneously.

Hence by combining the methods of figure 3 and figure 4 we can ascertain the ship's position graphically in a few minutes. This is worked out in figure 5 where the ship S is supposed fog bound and dangerously close to an island toward which it is headed. Without going over the work again, it is readily seen that F is the center of the circular course which would always show X degrees between A-B from the ship, and L is the center of the circular course which would always show Y degrees from the ship, between B-C. Hence it is only at S which lies on both these courses that we can possibly find the ship.

In working out the method, there are certain refinements in the graphical process that speed up the work a great deal. For instance, the chart of the port should be mounted on a translucent or transparent base, used as a drawing board to support it. Diffused artificial light from underneath is employed to bring out the features of the chart.

Over the chart is placed thin tracing paper or cloth on which the working lines are drawn in lead, so as to be easily erased without destroying the surface, even after several graphical calculations have been made.

A further refinement consists in having two protractors which can be accurately and quickly fastened to the translucent base by suction produced through the use of cup shaped "feet."

It will be evident—if more than three radio beacons are used—that the ship will have more than one possible position indicated, through unavoidable errors. For instance, when using four radio beacons we could have three different ship's positions; using 5 we might have four different ship's positions, etc. In such cases the center of the figure is the most probable location of the ship.

The above method is evidently entirely free from any consideration of the direction of "true north" or similar considerations. All that is necessary is quick observations of the differences in the directions of radio signals of three stations taken two-by-two consecutively, using the second station for a comparison to both the first and third.

If the ship holds its course steady, as on a calm but foggy day, a single operator can read "base angles." The method only requires him to note the angles between the compass loops when signals are simultaneously a minimum as he turns the radio compass loops.

This account of the method has taken a great deal more time than is necessary in practically applying it. A skilled operator can determine the minimum signal position of a radio compass in a few seconds. If all compasses are on one shaft he has both angles X and Y in plain sight at all times. If they are placed in line horizontally over the ship's keel—their directions are all referred to the ship's fore and aft center line.

In conclusion it may be stated that by using the Radio Beacon system as developed by the Bureau of Commerce and the Federal Telegraph Co. of San Francisco—mercantile ships have been steered with blindfolded navigators through the "Golden Gate." The observations of position were taken practically continuously.

In spite of obstacles and red tape the pioneer in practical compass work—Fred A. Kolster—has finally interested important business concerns in the problem of protecting their shipping by this method for rather the usual one of referring bearings to the "north." The results are the same, however, by the use of either method, and as a matter of fact the Bureau of Navigation is heartily in approval of the method which it has installed in a score of locations.

In another five years we may reasonably expect to find hundreds of radio beacons scattered in groups of three to five among all the important harbor approaches in the U. S. The great terror of navigation has been vanquished. Fog—the wreckers' friend and the mariners' enemy, has at least been pretty well conquered.

Lighthouse Department Extending Radio Compass Service

INCLUDING light vessels already equipped with radio fog signals and those in contemplation, eleven light vessels and two light stations are to have facilities for lessening the dangers of navigation during the continuation of fog or thick weather. By means of apparatus for the sending of wireless signals of simple and well defined characteristics, the navigator of any vessel provided with a radio compass may take bearings in guiding and locating his ship, in the absence of any visible object.

A radio fog-signaling system has been recently introduced on the Blunts Reef Light Vessel, in California located at a point where the steamship *Alaska* was sunk on the reefs some time ago. The radio-transmitting apparatus on this light vessel will send a series

of simple dashes for thirty seconds, after which there will be a silent interval of thirty-five seconds, during foggy or thick weather. A radio fog-signaling system is soon to be installed on the Columbia River Light Vessel, in Oregon, the wireless transmitting characteristics of this aid to navigation being a series of triple dashes for a duration of twenty seconds, with a silent interval of an equal period of time. This installation will probably be made this year.

The most outlying aid to the seafaring voyager on the Eastern Coast, the Nantucket Shoals Light Vessel, in Massachusetts, will be equipped with means by which the navigator may determine the location of a ship when foggy conditions becloud the beacon of the lighthouse or other

objects visible in fair weather. This new light vessel is nearing completion and will probably be in service during the present year. Two complete fog-signaling transmitting sets will be installed on this floating aid to navigation. The fog signals will have the characteristics of four dashes of a duration of thirty seconds with twenty-five seconds of silence. The Nantucket Shoals, 40 miles off the mainland is the extreme eastern part where aid is available to passenger and cargo-laden vessels. The Lighthouse Service of the United States Department of Commerce is in receipt of numerous requests for the installation of a radio fog-signaling system on the light vessel stationed at this point.

The Boston Light Vessel stationed in

Massachusetts, and the Swiftsure Bank Light Vessel, in service in the State of Washington, are to be equipped with wireless apparatus for determining the bearings of ships. The installation on the Swiftsure Bank Light Vessel, located off the shore of Juan de Fuca, will probably be made during the latter part of 1923.

The Five Fathom Bank Light Vessel, at the entrance of the Delaware Bay, and Cape Charles Light Vessel, Virginia, will also be provided with equipment for the transmission of radio signals, the installation to be made at some time not determined as yet. The Cape Henry Light Station, Virginia, was thus equipped and placed into commission on June 1. The radio fog signals or electrical characteristics of this floating aid to navigation are two dots and a dash, according to the Morse International Code, transmitted for a period of fifteen seconds, followed by an interval of fifteen seconds of silence.

The application of the principles of radio toward the end of increasing the safety of mariners in thick weather when lights and landmarks are invisible has been practiced for some time at the following places: Ambrose Channel Light Vessel, Fire Island Light Vessel, Sea Girt (New Jersey) Light Station, Diamond Shoal Light Vessel (North Carolina), and San Francisco Light Vessel (California).

The three stations in proximity to New York City enable vessels approaching or departing from that port to locate their positions by cross bearings and to furnish con-

venient leading marks to approach the harbor. Each station is identified by the definite characteristics of the radio signals it transmits. Ambrose Channel sends one dash, Fire Island a group of two dashes, and Sea Girt a group of three dashes, at specified brief time intervals.

A commercial panel-type transmitting apparatus, of one kilowatt electric power, is employed for the present in sending radio fog signals from these various light vessels. An automatic motor-driven timing switch for producing the desired signal at regular intervals was designed and placed into service supplementing the transmitting apparatus. The antenna at the transmitting station does not differ from conventional types. A wavelength of 1,000 meters has been assigned for the transmission of radio fog signals. The distance covered in sending these electric characteristics varies from 30 to 100, depending to some extent on the sensitiveness of the receiving equipment.

Radio fog signals or the method of radio direction finding, developed by the Bureau of Standards and the Lighthouse Service of the United States Department of Commerce, is based on the peculiar behavior of the coil antenna, when employed for the reception of wireless signals. This particular coil is comprised of ten turns of insulated copper wire wound about a wooden frame four feet square, which may be rotated. When the plane of the coil is parallel to the direction from which wireless signals are transmitted, the strength of the signals is greatest. By revolving the coil, the intensity of the signals is reduced until a minimum is

obtained. The latter condition is reached when the plane of the coil antenna arrives at a position at right angles to the line of direction from the wireless signals. This minimum point is used for navigational purposes for taking radio bearings.

The coil antenna mounted upon a vertical spindle provided with a pointer, and a graduated circle below the pointer for determining the position of the coil, resolves itself into a radio compass or radio direction finder. The latter and essential radio-receiving apparatus are installed on light vessels as aids to navigation in thick weather. If the installation is made on lighthouse tenders, the coil is usually mounted on the roof of the pilot house. The spindle penetrates through the roof and is equipped with a wheel which is turned by hand when rotating the coil.

The installation on some large foreign vessels involves the mounting of two loop antennas in a fixed position above the upper deck, one lying in the plane of the axis of the ship, and the other perpendicular to it. The lead wires are conducted to the radio-receiving panels, where each loop is identified with a fixed coil. Two small coils are so arranged as to rotate within the fixed coils, and radio bearings are taken by rotating these until the incoming wireless signals are at a minimum strength. The reading of the direction on a fixed scale simultaneously with that of reading the ship's head by the magnetic compass enables the mariner to determine "Where am I at?" The radio-telegraph receiving apparatus on board usually consists of several stages of amplification.

Radio Equipment of the ZR-1

By S. R. Winters

THE ZR-1, the powerful airship of the United States Navy Department, at Lakehurst, New Jersey, is the first lighter-than-air craft to include a radio compass on board. This direction-finding equipment, spherical in shape, and comprised of two sets of coils, is capable of taking bearings on the range of frequencies between 500 and 30,000 meters. By use of this radio compass, this big dirigible can plot its position in the upper atmosphere and determine its course in the contemplated, but problematical, flight to the North Pole.

The radio installation on the ZR-1, for the present, is confined to apparatus for the transmission and reception of wireless telegraph signals. Later, however, radio-telephone equipment will be included for the transmission of voice communication by the captain of this Goliath of aircraft when giving instructions to persons handling the lines for the bringing of the dirigible to the ground. A standard radio-telegraph transmitter of the United States Navy Department is included on the ZR-1. This transmitting equipment may be used for sending continuous and interrupted continuous electric waves by use of a rotat-

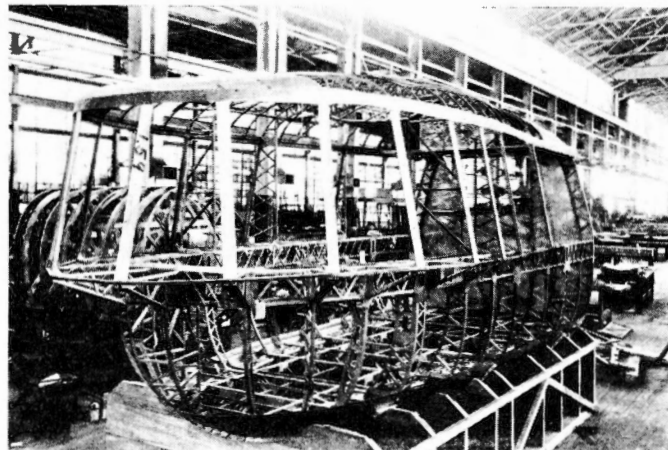

Navigation and control car, on the forward position of which is installed the radio apparatus of the Navy's new rigid airship ZR-1 now completed

ing segment wheel. Six 50-watt electron tubes are employed, these supplying an input energy of 300 watts and an average output of 150 watts of power. The operating wavelengths are 507, 600, 800, and 975 meters.

The antenna on this dirigible conforms to the type ordinarily used on aircraft. It consists of a trailing wire 300 feet in length and may be reeled up as the airship approaches the ground. The transmitter has been tested on the bench with a phantom type having characteristics similar to the

trailing-wire antenna actually to be used. The results of these tests indicated: Fundamental wave-length, 315 meters; capacity, 300 micro-microfarads; inductance, 93 microhenries. The resistance ranges through the variable wave-lengths used from 9 to 13 ohms, giving a radiation constant of 5 amperes. A loop antenna will be accessible in the control car of the dirigible for use when the airship makes a landing.

The wireless receiving instruments for signaling on short wave-lengths are of a two-circuit type, employing six stages of amplification—three of radio-frequency, two of audio-frequency, and a detector. The six tubes are of the SE 1444 Navy type. The long-distance radio-telegraph receiver is capable of operating over a band of frequencies ranging from 500 to 30,000 meters. A universal amplifier of six stages with telephone jacks for employing either radio or audio alone in one or two stages is available.

A gasoline-driven generator, differing from the usual aircraft installation of a fan-driven generator, is the source of electric energy. A storage battery, somewhat like
(Continued on page 63)

Directive Radio Transmission

By Jerome Snyder

IN the July, 1923, issue of THE WIRELESS AGE the writer pointed out the importance of the question of directive radio communication and discussed the general requirements of directional transmission and reception. In this article it is proposed to consider one of the practical methods whereby directional communication is accomplished.

THE HORIZONTAL ANTENNA

One of the very first practical solutions to this problem was given by Marconi himself as far back as 1905 when he patented the idea of the horizontal antenna. He found, during the course of numerous experiments, that an antenna which had a long horizontal portion radiated more in one particular direction than in any other. Thus, figure 1 represents such an antenna, in which OA is the short vertical portion and AB the horizontal portion. Measurements made at a

towards the receiving antenna, while the receiving antenna receives best those waves coming from the direction shown by the dotted arrow, namely from the transmitter A.

The reason for this very peculiar behavior of the horizontal antenna has been pointed out by Zenneck to be due to the poor conductivity of the earth ground. The transmitting aerial radiates waves as shown in figure 4. These waves travel through the air, the feet of the waves gliding along the ground, while the tops of the waves travel through the atmosphere. Now if the earth and atmosphere offered exactly the same resistance to the passage of the radio waves it would follow that the top and bottom of the waves would travel along at the same speed and would arrive at the receiving

there will be practically no directional effect, for the antenna is now practically a vertical antenna and a vertical antenna radiates equally well in all directions (for directional characteristics see July, 1923, issue of THE WIRELESS AGE). The greater the horizontal portion the more directional the antenna becomes.

This explains to a considerable extent why some broadcast stations seem to transmit better in certain directions than in others, and why some broadcast listeners receive some broadcast stations better than others. In general, the horizontal antenna as usually built by novices receives in all directions, but receives best in one particular direction due to the directional properties of the horizontal portion of the antenna. For this reason it is a good plan to install the antenna so that its best directional effect will be secured from the broadcasting sta-

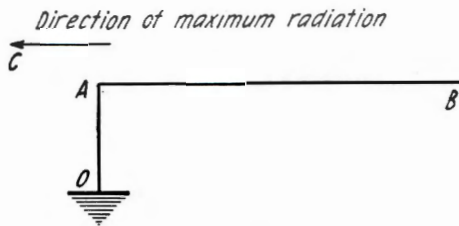

Figure 1

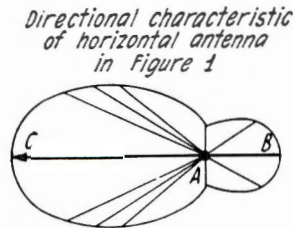

Figure 2

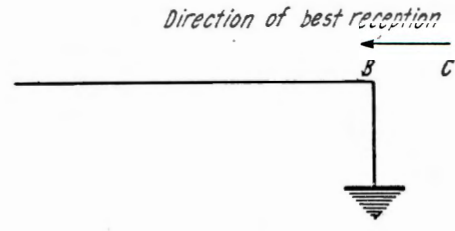

Figure 3

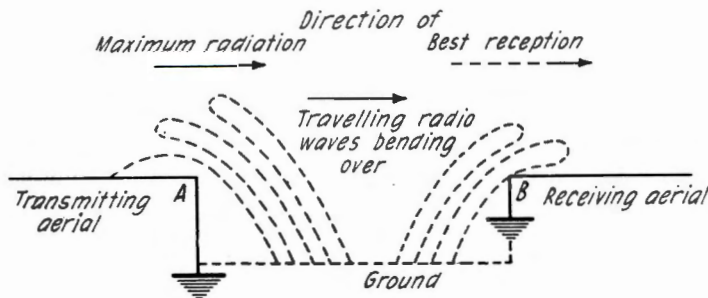

Figure 4

Direction of receiving antenna with respect to broadcast station for best reception from it.

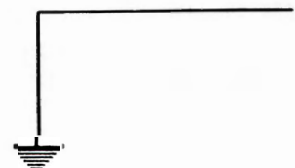

Figure 5

Some elements of directive radio telegraphy

given distance from the antenna and in all directions of the compass around the station showed that such an antenna had a directional characteristic of the form shown in figure 2. It is seen from this that the antenna radiates most in the direction AC shown by the arrow of figure 1, while it radiates least in directions at right angles to the antenna. Thus such a transmitting antenna would radiate best in the direction directly opposite to the horizontal portion of the antenna.

In the same way he has found that if a horizontal antenna is used for reception as in figure 3, it will receive best those waves coming in the direction from C to B, while it will not receive so well in other directions. Thus if two antennas, one transmitting and one receiving, are placed back to back as it were, as in figure 4, maximum efficiency in communication will be secured. For the transmitter A radiates best in the direction of the full line arrow, namely

aerial in the same relative position as that in which they are radiated or thrown out by the transmitting antenna. However, due to the poorer conductivity of the ground the resistance offered by the ground to the passage of the radio waves is greater than that offered by the atmosphere. Hence the feet of the waves are slowed up and the tops of the waves move forward faster than the bottom. As a result, by the time the waves reach the receiving station antenna the tops of the waves are bent forward and are almost horizontal, and therefore affect a horizontal antenna which is in the same direction as the tops of the waves, more than they affect any other antenna in any other direction. For this reason the combination of two horizontal antennas produces a very marked directional effect.

The directional effect is essentially produced by the horizontal portion of the antenna only. If the horizontal portion is very small compared to the vertical portion,

tion which it is desired to hear most. That is, install the antenna so that it is pointing directly away from the broadcasting station it is desired to hear most, figure 5. In this way the signals from this station will be the loudest, while the signals from other stations will also be good, but not so loud. In this connection it should be pointed out that a horizontal antenna of the "T" type is not as directional as one of the "L" type, for in the "T" type antenna the horizontal parts on either side of the lead-in neutralize each other's directional characteristics. Hence, if the constructor desires to obtain this directional effect, avoid the "T" aerial and build the more simple "L" antenna.

One of the very great advantages of the directional type of antenna is its inherent anti-static properties. It does not eliminate static—no antenna does at present—but it does improve the ratio of signal strength to static, which is one way of overcoming the bad effects of static. For due to the direc-

tional characteristics of the antenna much louder signals are secured, than otherwise, and likewise due to the directional characteristics the static from all directions other than the best receiving direction is reduced in intensity due to the poorer reception in these directions. Hence the net effect is that the ratio of signal strength to static strength is increased and the effect of static is reduced.

The directional effect of a long horizontal antenna is utilized in practice by the so-called "Beverage antenna," the invention of H. Beverage and other engineers of the Radio Corporation of America. This antenna consists of a very long horizontal wire, equal to the wavelength or half the wavelength to be received. It is closed at one end by the receiver and at the other end by a resistance to ground, this resistance being specially chosen to match the constants of the long antenna wire. This antenna has a very marked directional effect and reduces the static to signal ratio considerably. This was the antenna employed by Godley when he received the American amateurs' signals

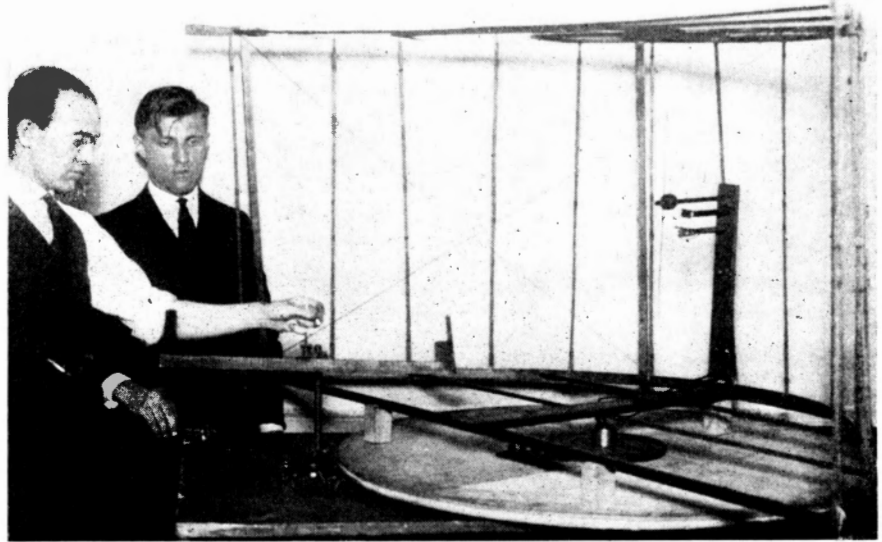

The most directional antenna, invented by Marconi, ever developed. All the energy is transmitted and received in the plane of the shield surrounding the transmitter or receiver

in England. It is fast coming into commercial use because of its great utility and effectiveness in reducing the harmful effects of static.

Improving the Operation of Receivers

By A. Reisner

THE big problems of the installation and operation of the receiving set of the broadcast listener generally occupy his attention to the exclusion of all other things. As a result he is apt to lose sight of the fact that many small precautions properly taken will frequently result in an improvement of reception not to be disregarded. For example, the advantage of an excellent antenna installation is to a considerable extent obliterated by using the headphones in such a manner as to demagnetize the magnets and hence receive much weaker signals than the set is capable of giving. Yet this is done day after day by novices who do not yet know that there is a right way and a wrong way to connect the headset to the receiver. A number of small precautions which will go a long way towards increasing the efficiency of reception will be given here. They are admittedly

with definite polarity. Hence it is to be expected that this polarity will be affected by the flow of current through the magnet windings. When the direct current flows in one direction through the magnet coils it produces a magnetic field which assists the permanent magnet, and when it flows through the magnet coils in the opposite direction it opposes the permanent magnet. When the current flow is such as to assist the permanent magnet, the magnets are increased in strength and the signals are thereby increased. Furthermore there is no tendency on the part of the receiver magnets to lose their magnetism and so decrease the sensitivity of the headset, for the flow of current through the magnet coils is such as to increase the magnetism of the magnets. On the other hand if the receivers are con-

demagnetization has gone so far as to make the headset worthless. It is therefore of the utmost importance to connect the phones to the set in the proper manner. The best way is, of course, to follow the directions of the manufacturers. Reliable manufacturers issue instructions as to how to connect them. Generally the telephone cords have colored stripes, such as red and green, the red indicating it is to be connected to the positive side of the circuit, the other to the negative side. A very simple test is to connect the receivers one way and note what signal strength is obtained. Then reverse the phone connections and observe again the signal strength. The connection which gives maximum signal strength is the correct one for then the flow of direct current is such as to strengthen magnets and increase the signal intensity. The above precautions apply in equal measure to the connection of loud speakers to amplifiers.

Working at points A and B on amplifiers produces distortion. Point C is the best operating point for no distortion

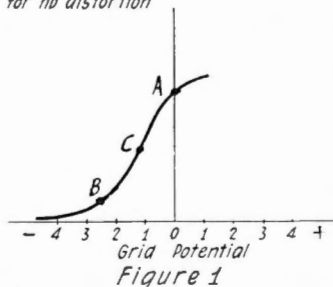

Diagrams showing best point for operating amplifiers and improved connection of antenna lead-in

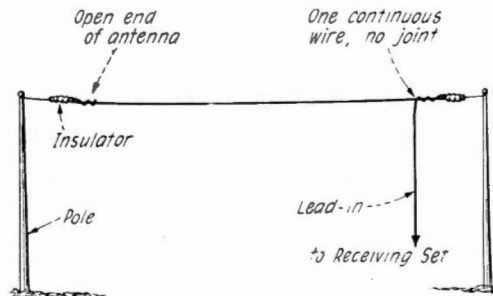

Figure 2

small precautions, but then small bricks are also an integral part of modern skyscrapers.

PROPER USE OF HEADSETS

Headphones are generally connected in the plate circuit of vacuum tubes, and in this plate circuit there flows direct current. This direct current therefore also flows through the magnet windings of the receivers. Now receivers are built with permanent magnets

nected so that the plate current flows through the magnets so as to oppose the magnetism of the magnets, the strength of the receiver magnets decreases and the incoming signal strength is thereby weakened. Furthermore, if the current flows steadily through the magnet coils in the wrong direction the opposition results in decreasing the strength of the permanent magnets until the

DISTORTION AND REGENERATION

When music which is being broadcast is received very much distorted all of the pleasure of listening-in is lost. Distortion and poor quality is due to many causes, some of them being due directly to the broadcasting stations. The larger broadcasting stations, such as WJZ, WEA, WOR and others send out very high grade quality, so that in such cases the distortion may generally be traced to the receiver. Too much regeneration can be easily checked by reducing it until the signal is weak and then gradually increasing regeneration. With weak regeneration the speech or music is very good, although low in intensity. As regeneration is increased signal strength increases, but a point is reached where distortion very obviously sets in, although the signal becomes very loud. High regeneration is incompatible with good quality of reception. It is for this reason that many amateurs prefer radio frequency amplification to regeneration. With regenerative receivers it is worth while sacrificing some regenerative amplification to gain in quality.

DISTORTION AND GRID BIAS

Distortion of received speech and music is very often due to improper grid bias on the amplifier tubes. Either too much or too little grid bias may produce distortion. This will be apparent from figure 1, in which is shown the characteristic curve of a standard type of amplifier tube. If no grid bias is used the tube is being operated around the point A on the curve which is not straight at that portion of the characteristic. As a result for a given rise and fall in grid voltage due to the signal the plate current varies more in one direction than in the other, thus in this case it falls more than it rises. But for true and distortionless amplification the plate current should rise and fall an equal amount for a given rise and fall of grid voltage. Since it does not do this distortion results. The same effect is produced when too much negative potential is used on the grid, in which case the amplifier is being worked at the curved portion of the characteristic marked B. For distortionless amplification the grid bias must be so adjusted that the tube is worked on the straight portion of the curve, namely at C, where a given rise and fall of grid voltage will produce an equal rise and fall of current in the plate circuit. The best way to obtain this correct bias is simply to vary the grid bias voltage until proper results are secured. Frequently this information can be secured from the manufacturers of vacuum tubes, in fact some companies like the Radio Corporation issue instructions as to how much bias should be used.

TUNING OUT INTERFERENCE

Many novices and at times even regular operators experience interference between broadcasting stations. Some of this interference cannot be easily overcome. On the other hand there is some that can very easily be entirely eliminated by the following simple little stunt. Connect a 0.0005 to 0.001 microfarad variable condenser across the antenna and ground post and vary it until you find a value at which one of the interfering stations disappears. After this value has been found the variable condenser may be replaced by a small fixed condenser

of the same value. This plan is simple and will be found to be successful in many instances.

INCREASING WAVE LENGTH OF RECEIVER

The writer's receiver was capable of tuning up to about 450 meters. WJZ was just barely received on the maximum setting of the tuning condenser. Having a small condenser of 0.0005 microfarad capacity I tried to make use of it. I finally found that placing it directly across the antenna and ground posts of the receiver gave just the results desired. WJZ was now received about two-thirds of the way up on the tuning condenser and WEAF, which I could not get at all before, came in clearly and sharply near the end of the tuning condenser scale. At the same time this shunt condenser helped discriminate a little more sharply between various broadcasting stations, so that practically no interference at all is experienced between stations.

ELIMINATING ANTENNA JOINTS

It is an old story that has been repeated over and over again that in installing antennas all joints should be soldered. But since this rule is not always followed, sometimes because it is very difficult to do so, it is still a better policy to avoid the making of joints. One of the most frequent places where a joint is made is at the junction between aerial wire and lead in. To avoid a joint at this point do not cut the aerial wire when it is stretched between your two supporting points. Continue the aerial wire intact through the insulator screw eye, bring it back along itself a short way, twisting the free wire around the stretched antenna wire and then bring it down to the house, as shown in figure 2. Thus the antenna wire is continuous from the open end down to the receiver without any joints.

SAVING ON VACUUM TUBES

The vacuum tube in your receiver is a pretty expensive item and it is desirable to make it last as long as possible. Beginners often jack up the filament current to excessive values in order to get slightly louder signals. This means that the tube is being burned brighter than is consistent with long life. Of course if the filament current is

turned down slightly the signal intensity decreases, if nothing else is done. However, the novice should try this stunt. Burn the filament as brightly as is generally done. Now turn the filament rheostat down a notch or two, decreasing the brilliancy of the filament. The signal intensity drops. Now increase the amount of regeneration either by increasing the tickler coupling or the plate variometer, or whatever other means possible, and it will be observed that your signal intensity will rise practically to the same level as before. Decrease the filament current again, and again increase tickler coupling until the signal comes up. Do this until the filament is at the lowest value consistent with reasonable signal strength. The reason it is possible to burn the filament at lower values and get just as great signal strength is this: With high filament brilliancy it is not possible to use much regeneration, because howling sets in at a very early stage, whereas with lower filament brilliancy it is possible to use greater regeneration before howling sets in. This increased regeneration increases signal strength and compensates for the lower filament brilliancy. Thus with low filament currents it is possible to secure just as great signal intensity as with high, and at the same time have the important added advantage of longer life of the tubes.

ELIMINATING GRATING NOISES IN PHONES

Mixed up with the incoming concert there are quite frequently grinding and grating noises which are often wrongly attributed to static. These noises will often be found to be due to poor contacts between the vacuum tube prongs and the springs of the vacuum tube sockets. Press the tube down into the socket tightly and it will be observed that the noises disappear. The remedy is to bend the socket springs up a little more so that the tube prongs press down hard on them, making perfect contact.

These are all small precautions which every listener ought to carefully observe. They will improve broadcast reception enormously and do away with the dissatisfaction which many broadcast listeners now experience.

How I Built My Neutrodyne Receiver

By K. S. Houton

MY radio education had advanced to the point where I could pronounce heterodyne, decrement, oscillion, and regenerative and keep company with the rest of the neighbors on my street. I really thought that there would be nights in the near future when 10 o'clock and bed-time would mean deep, peaceful sleep for me—nights when radio would be taken for granted as a settled part of our evening entertainment—and forget. I felt that my struggles to master the technical intricacies of a radio receiver so that concerts from nearby stations could soothe the fretting of three-year-old Marjorie had not been in vain. Actually, I really felt I was on the road back to normalcy—and then Professor Hazeltine came along with another tongue-twister "neutrodyne."

"Neutrodyne," I would have you know,

is the name of a radio receiver circuit that is supposed to extend the sphere of

the radio universe—and does, pretty well, when you get the thing to "neute."

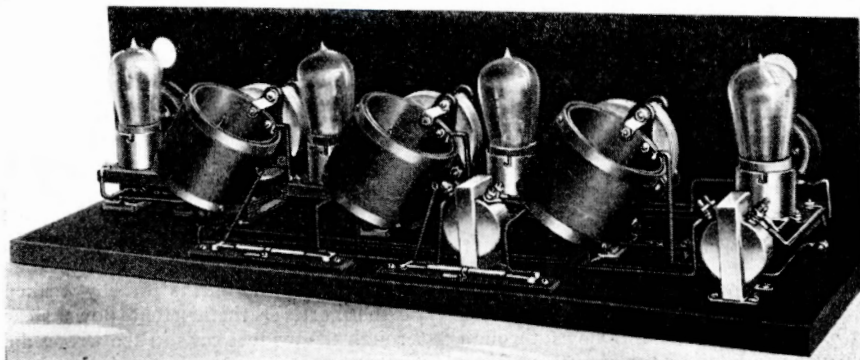

The assembled four-tube neutrodyne receiver

Last month I had the greatest thrill in my placid life when I succeeded in picking up WIP in Philadelphia from New Rochelle on a cigar-box crystal set that cost me about \$2.68 to build. Believe me, young twelve-year-old Jim Harris, the radio expert on our street, had nothing on me that night and I was ready to "tell the world."

A couple of days after that came my introduction to Mr. "Neutrodyne."

I was over to friend Harvey's house to borrow his storage battery charger—for I had graduated to the "tube" class long ago—and the moment I opened the door to his private junk-shop I was greeted by a new look of elation on George's brow and by

a book, in which was a full-sized paper template that I pasted down on my bakelite panel for drilling the holes. When I was ready for assembly I went all over the dope that had been published about the "Neutrodyne" and found that one of the most important things to be careful about was the mounting angle of the neutroformers. Some say about 60 degrees from the base line, some 54 degrees, and some 56 degrees. The real dope is 54.7 degrees. In adjusting the set for neutralization, however, the coils can be moved slightly from this angle until a good "no-signal" is obtained.

Another point usually in dispute is the wiring diagram. All sorts of diagrams have

ondary between the first two vacuum tubes should have a capacity of .0002 microfarads. The other two fixed condensers act as by-pass condensers and should have a capacity of at least .006 microfarads. The capacity of the by-pass condensers can be varied from the .006 point up to one or two microfarads, but .006 will usually be found O.K.

A suggestion about adjusting the neutrodyne circuit. Use a buzzer hook-up such as is shown in the adjusting diagram, figure 2. Be sure to re-tune all dials on the receiver when shifting from the adjustment of the first to the second tube. Always balance-out on a short wave-length—around 250 meters is good—or, 15 to 20 degrees on the condenser dials.

The neutrodon condensers, as will be noted, have three terminals. Ordinarily the connections are made to the two terminals on each end. Sometimes, however, one cannot seem to obtain a good minimum signal balance in this way. Then I recommend that one of the connections to the neutroformer be made to the centre terminal of the neutrodon. This gives a greater capacity range to the neutrodon and will allow added capacity adjustment to give a good minimum or inaudible signal balance.

A good test for balance is to rotate the dials as is usual in regenerative sets and attempt to pick up beat notes. If this can be done the receiver is not properly adjusted for capacity neutralization and should be carefully re-adjusted until signals come in clear and without parasitic regeneration.

Another very important point that I discovered about neutrodyne circuit receivers is the method of tuning, namely the second and third dials must be adjusted to practically the same points to receive signals from a given broadcasting station. Many people condemn the circuit after trying to tune it as they used to tune regenerative receivers. I did this very thing when I first finished my home-made set, and was ready to throw the whole thing out of the window, for results were N.G. at first. After getting the hang of things and rotating the dials very slowly and in step I began to learn anew what long distance reception really meant.

I'm using regular UV201A amplifying

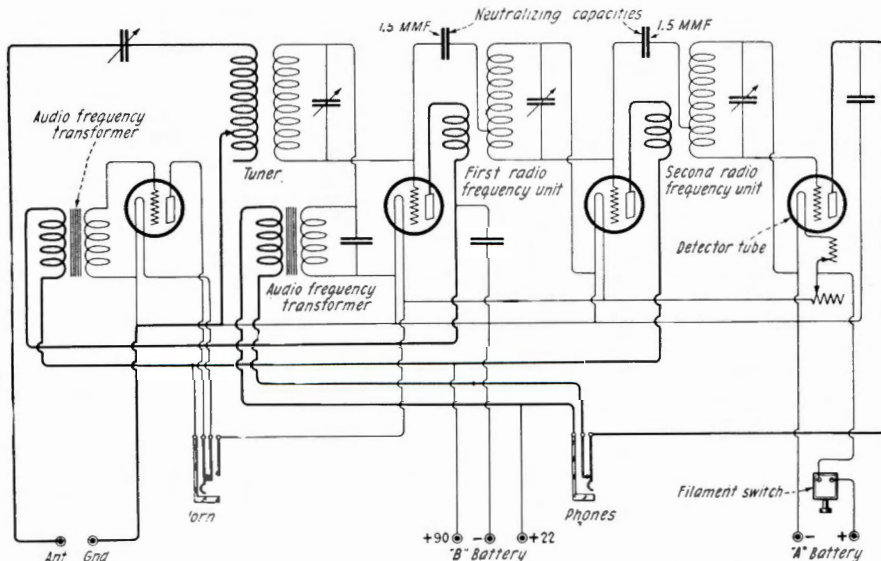

Figure 1—Schematic wiring diagram of the four-tube Neutrodyne receiver

cautions and gestures to "keep quiet while the operator is receiving."

The upshot of it all was that the new black box and his table was a neutrodyne circuit receiver, and having sat up all the past night to get Fort Worth, Texas, the malady of "long distance" had overtaken another safe and sane right good "old scout."

Of course I had to get in the swim. I let Harvey spend his perfectly good money for a factory-made instrument as I'm one of those bugs who like to realize that "grand and glorious feeling" of hearing the home-made set work after hours of sawing, drilling, mounting, soldering, wiring, testing—and Lord knows what not.

My idea was to spend about half as much and build my own—and I did. One of the worst salesmen I ever encountered succeeded in separating me from twenty-five golden dollars for which I got in return a box full of neutrodyne parts and a young encyclopedia of "How-to-Build-It" dope.

Life commenced all over again and for the next few nights the good wife had to handcuff me to my chair long enough to partake of bodily nourishment.

I was building a four-tube neutrodyne set. For the benefit of other afflicted radio bugs I'm telling my troubles, and particularly my discovered remedies.

I found among the box of purchased parts

appeared in various publications. The four-tube diagram, accompanying this article as figure 1, is the correct one. Note particularly that the secondaries of the first and second radio frequency units have a tap in the winding. In mounting the neutroformers they should be placed on the panel to conform exactly with the wiring diagram. Connections are made from the tap of the first

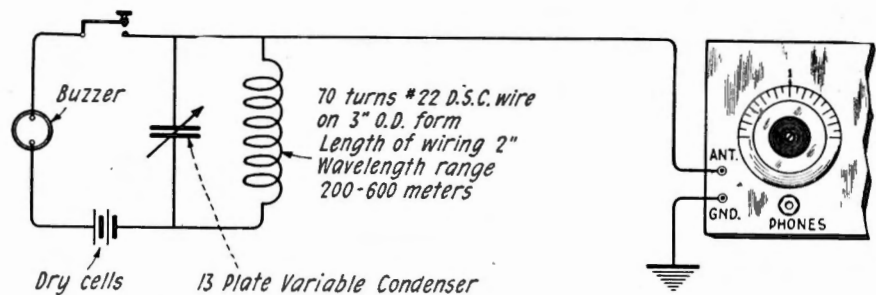

Circuit diagram for Neutrodyne receiver adjustment

and second neutroformers direct to the first and second neutrodon condensers. No connection is made to the tap, however, of the first radio frequency unit or neutroformer.

The capacity values of the fixed condensers shown in the diagram are of importance. The condenser which is connected in parallel with the audio-frequency transformer sec-

tubes and a UV200 detector tube in my set. These tubes work the best, but the experimenter can try other tubes, even including the various dry-cell tubes that are on the market. Be careful to check one tube against another, as much trouble has been caused by the tubes going wrong, even though the filaments remain lighted.

Tests for Determining Genuineness of UV-199 Radiotrons

THE wide use and great popularity of the UV-199 Radiotron have led to numerous attempts on the part of unscrupulous manufacturers to counterfeit this tube. In external appearance some of the imitations bear such a close resemblance to the genuine tube that it is very difficult to detect the difference. Even the carton markings, the instruction sheets and the trade marks etched on the tube itself have been copied very closely.

However, in spite of the resemblance in appearance, the electrical characteristics of the counterfeit tubes are very different from those of the genuine UV-199. So far, none of the manufacturers of illegal tubes has been able to duplicate the 60 milliamper filament of the UV-199 and most of the counterfeits require as much as one-fourth of an ampere. Since this filament operates on 3.0 volts or less, the user of such a tube is often misled by the apparently satisfactory operation when the tube is first lighted, but he soon finds that his dry battery is quickly exhausted and often the tube itself fails in a few hours.

The easiest way of determining the current required by the filament is to use a milliammeter and a voltmeter, but since such instruments are not in common use

among radio experimenters the following method may be used which gives a rough approximation of the filament current.

Connect three new six-inch dry cells in series with the tube to be tested and an ordinary 50-watt, 110-120 volt Mazda

will not light at all. In making the test, the tube should be left in the socket for at least 30 seconds to allow the Mazda lamp filament to heat up to constant temperature.

When the proper electrical instruments are available, an even better test is to use a

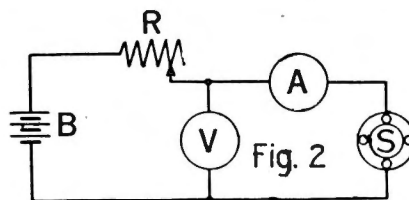
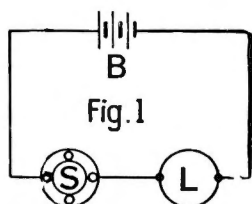

Method for determining proper filament current. B—Three new 6-inch dry cells connected in series. S—UV-199 socket. L—50-watt 110-120 volt Mazda lamp. R—30-ohm rheostat. A—Milliammeter. V—Voltmeter.

vacuum lamp. Figure 1 shows the proper connections. If the filament of the tube being tested does not take more than 60 milliamperes, it will light up almost to normal brilliancy, which is yellow. If the tube is not a genuine UV-199 and the filament requires appreciably more than 60 milliamperes, however, the resistance of the Mazda lamp will rise, due to the higher current flowing through it, and the voltage on the tube will be so low that its filament

voltmeter and milliammeter connected exactly as shown in figure 2.

At three volts the current through the filament of a genuine UV-199 Radiotron is between 55 and 65 milliamperes. For this test high quality instruments must be used as otherwise the test is worthless. A voltmeter having a full scale reading of 5 is recommended. The milliammeter should have a full scale reading between 100 and 250 milliamperes.

Radio Antenna Design

By Frank Conrad

Assistant Chief Engineer, Westinghouse Electric and Manufacturing Company

THIS paper describes some features of antenna design, particularly when used for transmitting purposes.

The principal requirement for the transmitting antenna is that it shall transmit maximum signals with a minimum internal loss, which simply means that it shall be as efficient as possible. The ability of the transmitting antenna to radiate energy is determined by its characteristic known as "antenna resistance." Thus, in the case of some given antenna, if we determine the losses due to the conductor resistance and the dielectric losses in the capacity element of the antenna, we would find that the actual loss would be a value greater than the sum of the two losses just mentioned. This difference would consist largely of the element known as "radiation resistance," and would represent the actual proportion of the power delivered to the antenna which would be available for transmitting purposes.

Investigation has shown that the antenna resistance varies as the square of the effective height of the antenna. By the effective height we mean the actual distance between the centers of the upper and the lower capacity elements. It also varies as the square of the frequency impressed on the antenna. Of the two elements which determine the antenna radiation resistance, that of frequency, or wavelength, is easily determined.

The effective height is usually more readily obtained from measurements of the an-

tenna resistance or signal strength a short distance away than from the physical dimensions of the antenna, unless of very simple outlines. Except as it varies with the effective height, the radiation resistance is not in any way influenced by any other characteristics of the antenna, such as its fundamental wavelength, form of conductors, or extent of upper or lower capacity elements.

We may take as an illustration a simple antenna of the inverted "L" shape connected to a conducting ground. This antenna will have a certain fundamental wavelength and certain resistances at given wavelengths. Should we add another top structure to this antenna, converting it into a "T" type, rather than the inverted "L," we will have increased the capacity element, so that the fundamental wavelength will be considerably lower. The effective height, however, will be very slightly changed and, except for this slight change of effective height, the radiation resistance at a given wavelength will be unchanged. Of course, the radiation resistance at the fundamental wavelength will be altered, due to the fact that this wavelength itself is altered. But for any given wave, in each case the radiation resistance will be unchanged except so far as the additional top structure has slightly increased the effective height.

It is usually thought that the fundamental wavelength of the antenna has some bearing on the question of the most efficient operat-

ing wave. However, investigation will show that there is no connection between the most efficient operating wave and the fundamental wave of an antenna, and that the most efficient wave is the shortest wave. omitting, of course, any consideration of the relative transmission efficiency. The efficiency of the antenna, in common with that of any other piece of apparatus, may be stated in terms of the useful output divided by the input. In general, the ratio of output to input increases with a decrease of wavelength, for the reason that in a properly-designed structure the losses will remain approximately constant with change of wavelength, while the radiation component will increase with a decrease of wavelength. Therefore, if it were merely a question of antenna efficiency, we should operate with the shortest possible wave. On the same assumption, in considering the proportions of the antenna, the losses will be very slightly changed by increased height, but the radiation element will vary as the square of the height, and, on the basis of efficiency, the antenna height should be the maximum.

I have stated before that the antenna resistance is not in any way influenced by the shape of the antenna, so long as the effective height remains unchanged, and from this it follows that it will be immaterial as to whether our antenna is of the fan shape, inverted "L," or "T" shape, as to whether its top structure is of the cage form, flat

top, umbrella shape, or what not, the radiation resistance for a given effective height will remain unchanged. However, when we consider the maximum height of any part of the antenna, the effective height, and therefore the radiation resistance, can vary widely with changes in structural shape. Thus, with an antenna consisting of a vertical wire, the effective height would be only about two-thirds of the height to the top of this wire, whereas in an antenna with a flat top of a very great extent compared with the area of the down-lead, the effective height would very nearly correspond to the actual height, and for an equal total height would, of course, show a considerably higher radiation resistance than in the case of the vertical wire.

From the viewpoint of cost, the ratio of effective height to actual height is an important one, as the elements of an antenna structure which determine its height are usually those which determine its cost. In fact, the cost will probably vary somewhat as the square of the actual height. From this, we can infer that, except under some exceptional circumstances, the plain vertical wire would not be a suitable structure for an antenna, but we should attempt to approach the ideal condition of effective height, equal to actual height, by using as large a structure as possible for our elevated capacity element, and on the same line of reasoning, we will reduce as much as possible the capacity of the vertical element of the antenna, or down-lead.

This consideration rules out the fan antenna, which has an effective height but little better than that of a single vertical wire; the amount by which it is better being determined, of course, by the relative top spread of the fan as compared with the base. Conductors of large diameters or cages for down-leads are similarly disadvantageous; and it also follows that the top structure should be of as large an area as possible and all of it maintained at the greatest possible height.

In the actual antenna, it is, however, necessary to depart more or less from these ideal conditions. Thus, there may be available one high support, such as a chimney, and to support a single flat-top element it may not be economical to erect the supporting structure for the other end of this top of the same height as the existing chimney. The question of whether the down-lead should be attached to the high or the low end of the antenna is usually determined by the local conditions surrounding the antenna, but from the consideration of effective height only, the greatest value will be obtained by attaching the down-lead to the high end.

What form the flat-top structure shall take is open to considerable variation. In general, it will be found that a rectangular shape will be the most economical form to give the desired capacity. In the case of an antenna intended for operation with long wavelengths, the problem of insulation will largely determine the capacity element; but for an antenna operated on wave lengths in the broadcasting of amateur zone, it is seldom that the question of voltage insulation will enter. The capacity element will therefore be largely determined by the value necessary to attain a reasonable effective height. The number of wires necessary for the rectangular flat-top element will be determined

by its actual width, or the distance between the outside wires, and also the carrying capacity required.

With a comparatively narrow flat-top element, there is very little advantage in using more than the wires forming the outside boundary, as the increase of capacity due to additional inside wires will not be very appreciable. Thus, for a flat-top consisting of two wires spaced ten feet apart, the capacity would be about 65 per cent. of that obtained by entirely filling up the space between these wires with conducting material. With a separation of twenty feet, the capacity would be about 55 per cent. of that of a solidly-filled space. Therefore, for this spacing the number of wires might be increased with advantage. The necessary carrying capacity can, of course, be taken care of by the use of wire of sufficient size.

When considering the design of an actual antenna, it will be found necessary to make compromised departures from the ideal proportions, and a survey of existing structures would indicate that the latitude in this respect is very wide. I would say that if the antenna could be constructed on the surface of a large body of water almost any sort of design would be satisfactory, and only accurate measurements would distinguish between designs of largely different proportions. It will usually be found that the greatest source of losses is not in the antenna structure itself but in surrounding features. These losses may be due to a poorly conducting ground, dielectric losses on the surface of the ground, and induced currents in nearby conducting objects. If the location of the antenna is fixed, the designer will have very little control of these elements of losses, with the possible exception of those due to ground resistance or dielectric losses on the surface of the ground. The use of an insulated counterpoise will very largely reduce the losses from this source, as a counterpoise of the proper proportions will practically eliminate any conduction currents in the ground or any electrostatic field on the surface of the ground. The use of a counterpoise also permits of an antenna mounted on an elevated structure which can be efficiently operated at comparatively short wavelengths. Under this last condition, in which an antenna is erected on an elevated structure such as the roof of a building, it is desirable that the capacity between the antenna top and the building be practically the same as that between the counterpoise and the building; otherwise, a charge may be induced on this roof surface, which would give a circulating current between the roof surface and the ground and entail additional losses. This condition is improved by having considerable separation between the counterpoise and the roof and by using a counterpoise structure of somewhat less capacity area than that of the antenna top.

Having determined on the possible dimensions of our antenna capacity structure, we may consider the down-lead connection. There are two main possibilities here, one in which the down-lead is connected to the center of the top, forming the "T" antenna, and the other in which the down-lead is connected at one end of the top, forming the inverted "L" antenna. In the first arrangement, that of the "T" antenna, we have the equivalent of greater carrying capacity, or lower resistance, in the top structure, as the cur-

rent will divide between the two halves of the "T" top. In addition, for the same capacity, the "T" top will have lower inductance and therefore permit of operation at shorter wave lengths. The disadvantage of this form is the considerable reduction of effective height due to the deflection of the top from the weight of the down-lead, for unless this deflection is allowed to be of considerable value, very heavy strain will be imposed on the end supporting the structure and insulators. For this reason, the "T" structure in general is not to be recommended.

With the inverted "L" antenna, the capacity elements can be stretched up practically flat, and the deflection due to the down-lead at one end will be very slight. However, owing to the proximity of this down-lead to the supporting structure, its capacity is more liable to be varied by swaying, and it is necessary to insure that this capacity will not be varied sufficiently to affect the wave length.

In order to obtain sufficient conductivity in the down-lead, it may be advisable to make it up of a number of parallel conductors spaced sufficiently to insure equal distribution of current. This constitutes the usual cage form. In order to reduce the capacity to a minimum, the diagram of this cage should be restricted, and it should not be necessary under any conditions to make it more than one or two inches in diameter. In general, it will be found that the actual conductor losses in an antenna are a very small part of the total. This may be readily appreciated by the fact that the resistance of a No. 14 copper wire at 300 ohms is about .02 ohm per foot. Therefore, assuming an antenna of only a single No. 14 wire and having equal current throughout its whole length, the copper resistance would be only 2 ohms, so that in an actual antenna operated at different wavelengths the equivalent of two or three wires of this size would reduce the copper resistance to a negligible value. But, of course, for the high-power, long-wave stations, such as used in trans-Atlantic service, the radiation resistance with any practical antenna height is comparatively low. Therefore, in order to obtain any reasonable efficiency, it is necessary to go to extremes in the way of reducing the conductor resistances. Fortunately, in this case the low resistance can be readily obtained by increased conductor dimensions, while in the case of our 300-meter antenna, a great decrease of resistance would be obtained only by a very disproportionate increase in conductor material, owing to the difficulty of maintaining equal distribution of current in the various sections of the conductor.

In the foregoing, no mention has been made of the question of tuning the antenna to the desired operating wave. It is not assumed that the tuning arrangement will have any effect on the radiation resistance, but, of course, in the case of operating an antenna at a wavelength below its fundamental it will be necessary to use a capacity in series with the antenna, and when operating above its fundamental wave, it will be necessary to use an inductance in series with the antenna. However, in considering the efficiency of the antenna as a whole, the losses in this capacity, or inductance, will be added to the antenna losses. But in a properly-designed apparatus, these losses should not be a con-

(Continued on page 63)

C.W. Work of Station 6EA

By Thomas J. Knapp

IT is not the object of this article to claim the best transmission among amateurs—others may be in a position to use a more powerful set—but many a young fellow has had trouble to acquire even a 5-watt set and may have ambitions for one of greater capacity and want to know the possibilities of its range before making further sacrifices.

The C. W. station illustrated is owned and operated by Howard C. Seefred, located at 343 South Fremont Avenue, in Los Angeles, California, call 6EA, and the results accomplished have been very gratifying to the owner.

The transmitter is of 50-watt power using about 1,300 volts on the plate supplied by a home-made transformer, which has a winding over the primary for the filament of the power tube. The plate voltage is rectified by a synchronous rectifier. No radio and audio-frequency choke coils or filter and by-pass condensers are used. The antenna plate and grid-tickler inductances are used in conjunction with variable condensers, grid leak, grid condenser, tube socket, power tube, rheostat and meters for thermo-coupler, milliamperes, and volt readings, all mounted on a bakelite panel, also a radio key, using a modified reverse feed-back circuit. The antenna current is 4 to 4½ amperes, with 170 milliamperes of plate current, and 10½ volts on the filament.

The receiver is of the single circuit type and consists of three spiral wound inductances—antenna, tickler, and tickler loader—antenna variable condenser, detector with two-stage amplifier, variable condenser to load up to six hundred meters, and Baldwin phones. The complete equipment is home-made except the necessary parts that could not be readily manufactured.

The antenna is 52 and 45 feet in height, with four wires on 16-foot spreaders, 45 feet long, with 55-foot cage lead-in.

The counterpoise system has nine wires 60 feet long, 23 feet wide at the far end, 14 feet at the lead-in and at a height of 11 feet above the earth. Both antenna and counterpoise consists of seven stranded No. 22 copper wire.



Antenna system of 6EA Station, Los Angeles, Calif., an efficient radiator as determined by actual results

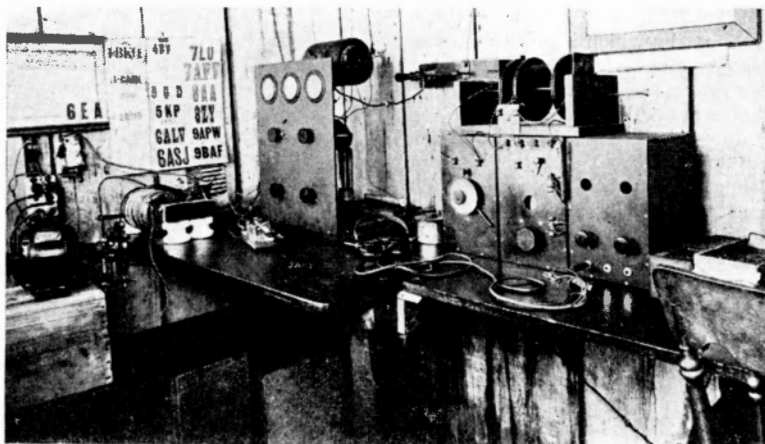

C. W. transmitter of station 6EA. the novel feature of which is a synchronous rectifier for plate current supply

During the past winter of 1922-1923 this station has communicated directly with station 2FP, Brooklyn, New York, the distance being close to 3,000 miles from Los Angeles. It has been reported several times by VLB at Radio Awarua, Invercargill, New Zealand, at a distance of nearly 7,000 miles. The *S. S. Easterner* reported hearing this station when 3,060 miles west of here. Best distance to the north was a report from 7DG at Cordova, Alaska; To the east—1CIK at Concord, New Hampshire; to the south—"BX" at Guamajuato, Mexico. Best Canadian report was from 9AL at Toronto, Ontario.

The station has been heard in five Canadian districts, all United States districts and thirty-eight states, Alaska, Canada, Hawaii, Mexico and New Zealand.

When using five watts, A.C., C.W., 6EA has communicated directly with 6ZAC at Hawaii (2100 miles) and 9DR at Minneapolis, Minn. (1535 miles). The best reception reported to the east was from 8IB and 8CZN, both in Ohio and about 2100 miles distant.

Enlarged Appropriations Required for Radio Inspection Service

A GREATLY increased appropriation will be asked of the next Congress for the operation of the Radio Division of the Department of Commerce, which to-day is struggling along on funds but little greater than those available three and four years ago when broadcasting, as we know it to-day, was non-existent.

If the Radio Division is to perform its functions efficiently, at least \$100,000 more than is now appropriated will be necessary, it is believed. A greatly increased force of inspectors is needed if the broadcasting and amateur stations are to be checked up prop-

erly. At present, practically all of the time of inspectors, on the coast particularly, is required for the inspection of ship stations and similar Government work, and they are hard pressed for the time in which to make these necessary inspections of other stations. The recent re-allocation of wavelengths, however, requires that every station be operated exactly on its assigned wavelength, if there is to be no interference, and careful checking up of the wavelengths used is therefore very essential.

Few persons not connected with the work of the Department of Commerce realize what

the district inspectors are doing. Many of them are out of bed and ready for their day's work before the last "ham" has signed off for the night. All sorts of work come to the radio inspectors; the checking of broadcasting stations and the inspection of ship plants is but a part of their labor. Many complaints are received, some well founded and some imaginary; but all must be investigated, with the general result that practically every inspector is heavily overworked, with many essential things left undone, owing to lack of time and funds.

Oberlin College Radio Station 8 YAE

RADIO Station 8YAE is located in the laboratory of physics at Oberlin College, Oberlin, Ohio. It is operated by a staff of four operators, and very consistent relay work over long distances was accomplished with the 10-watt transmitter in the center of the illustration appearing in this article.

The antenna at 8YAE consists of a six-wire flat top, 55 feet high and 75 feet long, hung between two of the college buildings. Directly beneath it at a height of 15 feet is an eight-wire counterpoise which covers an area of over 2000 square feet. It is 100 feet in length and 23 feet in width. For earth connection, the water pipes and the college heating system steam pipes are used.

The station is well equipped in the receiving line for both amateur 200-meter work and broadcast listening on the higher wavelengths. The station includes a separate receiver for each. On the left in the illustration is the single circuit receiver used for relay work. The circuit employed is similar to the Grebe CR-5. Only one stage of audio frequency amplification is used as this is found amply sufficient for all DX work, even when using the small indoor antenna for working through heavy QRN. This set is homemade and has a range of from 150 to 400 meters.

On the table to the right is the broadcast receiver. This was built in the laboratory, and is very efficient over its band of wavelengths. Either a three-circuit regenerative or a non-regenerative unit may be employed

with this set. The latter in conjunction with two stages of radio frequency amplification. The last unit on the right is a Western Electric power amplifier and loud speaker.

Radio Station 8YAE, Oberlin College, Oberlin, Ohio
—E. W. Thatcher, chief operator

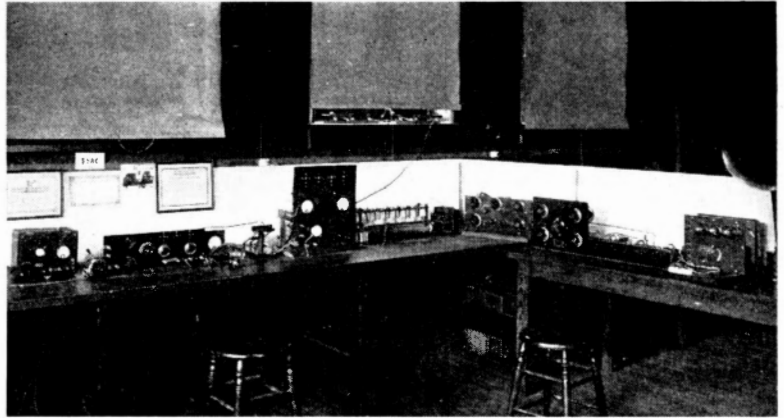

On this equipment musical programs have been heard with remarkable clearness several hundred feet from the loud speaker.

The C.W. transmitter consists of two five-watt tubes in a Colpitts circuit. An electrolytic rectifier of twelve lead-aluminum cells delivers 500 volts to the plates. A saturated solution of borax serves as the electrolyte. A filter system consisting of two 2 mfd. condensers and a 1.5 henry choke smooths out the ripples and gives the transmitter a very pleasing note. The circuit is quite flexible, good radiation being obtained on wavelengths from 180 meters up. The set is

usually operated on 220 meters with an antenna current of 1.8 to 2.0 amperes. The plate current is 105 milliamperes, and the filaments are kept at a constant voltage of

7.8. The potential for both the plates and filaments is supplied by an Acme 200-watt transformer.

This set has been in operation since the first of the year, and a great deal of traffic has been handled. Remarkable distances have been covered by this low power transmitter. Stations in all districts of the United States and Canada have been effectively worked. The best working records established were with 6XAD in Avalon, Calif., and 7SC in Aberdeen, Wash., and on many other occasions the signals were reported from the Pacific Coast.

Radiophone Aids Alaskan Lighthouse Service

IF anyone is prone to scoff at the adaptation and value of the radio telephone and telegraph in isolated territory—in regions removed from civilization, as it were—the contents of a letter recently received by the Lighthouse Service of the United States Department of Commerce should serve to dismiss this misapprehension.

Tucked away in the recesses of Alaska, the Lighthouse Service maintains light stations at points designated at Scotch Cap and Cape Sarichef as aids to mariners navigating in these waters. The keepers of these stations readily converse with each other by means of radio telephone. Since, however, vessels navigating in Alaskan waters are not ordinarily equipped with radio telephones, communication is restricted to radio telegraphy. Hence, these enterprising guardians of life and property on water began to study the Morse International Telegraph Code, attempting to master this intricate system of dots, dashes and spaces by applied practice in the absence of instruction or outside assistance.

These keepers, not unlike the student in land-line telegraphy who keeps books for the station-master while studying the Morse telegraph code, have by slow and painstaking effort acquired knowledge sufficient to

manipulate the telegraph key and send code messages, slowly, of course. This incident, as well as others, in the application of radio telephony and telegraphy to the aids of navigation in Alaska, are interestingly told about in a letter recently written by W. C. Dibrell, superintendent of lighthouses of the sixteenth district, to the Washington office of the Lighthouse Service. This communication, inspiring as it is with relation to the uses of radio in remote areas, is quoted in entirety:

"The two stations converse with each other by 'phone without difficulty. Owing to lack of radiophones in that part of Alaska other business is handled mainly with key. One keeper at each station has taken up the study of the code and the manipulation of the key, and they are now able to handle key messages each way without difficulty, although they are still somewhat slow. They have no difficulty at all in exchanging messages with the mail steamer *Star* by means of the key, the vessel not being equipped with phone. Messages can be exchanged by this means when the steamer is west of Unga, or distant not more than 165 miles. When the *Star* reaches the vicinity of False Pass, distant about 65 miles, in a straight line and on the opposite side of high mountains the voice from Sarichef can be heard

by the *Star*. It is reported that when the *Star* is off the stations, the voice can be heard in the radio room of the vessel without wearing the head phones. The use of this means of communication with the mail boat has been of great service both to the vessel and to the stations. Whenever the boat is approaching Unimak Pass information can be obtained direct from both stations as to landing conditions and no time is lost if landing cannot be effected. Instructions can also be issued from the station in regard to landing of mail for that station at Scotch Cap, if possible, and it is then carried overland by keepers.

"Both stations can readily converse with the radio station at Dutch Harbor by key, which means that the stations are in touch with the outside world by radio at all times which is of great value in case of emergency. The Coast Guard Cutters when in Bering Sea and vicinity converse with the stations by radio. Some of the cutters are provided with radio telephones.

"The *Cedar* has recently been provided with radio telephone and conversation can therefore be readily carried on with the Light Station when the vessel visits that location. This will undoubtedly prove of great assistance in connection with landing of supplies at the station."

Ionization in Vacuum Tubes

By W. A. Dickson

IT is a well known fact that some vacuum tubes are termed "hard," and others "soft," according to the extent to which they are evacuated; in other words, according to the amount of gas remaining in the tube. An ideal tube would contain no gas at all, i. e., would be evacuated to a perfect degree; this is impossible of course, and we find a varied quantity of gas in all present-day tubes.

The most deleterious effect on the presence of gas in a vacuum tube is ionization, which may be defined as the breaking-up of the normal gas atoms when subjected to too high a potential gradient; this corresponds to the "breaking-down" of any insulator. Gas is ordinarily a good insulator, but when ionized can be made to carry a large current. We will endeavor to give only an elementary idea of what happens when a tube becomes ionized.

Studying the curve in the accompanying diagram, consider the solid line curve showing the relations between the plate potential and plate current for a constant filament temperature. The higher the plate potential, the greater the velocity of the electrons flowing from the filament to the plate, especially after the saturation value of plate current has been reached. Now if the tube contains no gas, a certain potential, E_1 will be reached, for which the velocity of the electrons is great enough to break up the normal atoms of gas into two parts, namely, free electrons and positively charged ions. The positive ions travel toward the filament and

the free electrons toward the plate thus producing an increased plate current. This is shown in the diagram by the dotted line curve.

If the plate of a vacuum tube is made negative with respect to the filament no current will be registered, for this would necessitate an emission of electrons from the cold

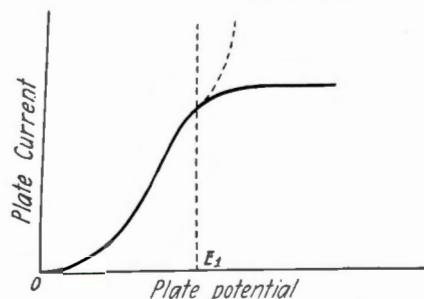

Graph showing relation of plate potential and plate current for a constant filament temperature

plate. However, if the tube contains a sufficient amount of ionized gas, this would serve as a conductor for the current. Usually the filament must reach a certain temperature before ionization starts.

Ionization in a vacuum tube can readily be distinguished by the familiar blue glow which is accompanied by an immediate increase in plate current which owing to the great change in the characteristics of the tube, will generally stop it from functioning. This blue glow may be noticed in

highly evacuated tubes when operated at potentials much greater than for which the tube was designed. It is due not so much to the ionization of the gas left in the tube, as to the ionization of the gases resulting from the volatilization of the plate under the effect of the impact of the electrons against it at such a great velocity.

In the case of detecting and amplifying tubes, ionization is quite common and can be stopped by decreasing the plate voltage or filament current. However, in the case of power tubes, ionization, unless stopped immediately will leave the tube useless for further operation. In vacuum tubes with oxide-coated filaments, ionization will usually result in their burning out; this action can be explained in a few words. There is always a large amount of gas in the metal parts of this type of tube, and when ionization occurs the positive ions are attracted by the filament, causing a bombardment; this results in an extra heating of the filament generally in one spot. When the filament burns out, considerable more gas is released, which becoming ionized, may result in an explosion. Usually a vacuum tube with oxide-coated filament has more gas in it after becoming ionized than before.

Due to the effects of the presence of gas in a vacuum tube great care has to be taken during the process of evacuation.

The tubes used today for detecting purposes are usually allowed a small gas content, as it has been found that at certain points they are more sensitive.

A Revised Reflex Circuit

By J. McCartney

THE very interesting article in the May, 1923, issue of THE WIRELESS AGE, headed—"A New Reflex Circuit," by Stanley Russell, led me to give it a tryout, and I beg to advise that the results were particularly satisfactory. Lacking some of the parts necessary for a trial of figure 2, of that article I experimented with figure 1, at first with a single tube, with the result that the addition of another stage worked out very satisfactorily, and gave excellent increase in volume, and was no more difficult to operate than the one-tube circuit. The variometer between the primary of the R. F. T. and the plate of the first tube actually increased the output; the only peculiarity noted being that the positive lead from the "B" battery had to go to the P-2 post of the A. F. T. to get results. The circuit as revised is as follows:

The variocoupler used was of the "Simplex" variety. Some other type might need a different adjustment of values. Note that the plate circuit of the first tube passes through the rotor of the variocoupler which no doubt increases by inductive regeneration the potential of the grid.

The small three-plate or vernier type of condenser (three plate) shown as C, as I

figure it, gives the radio frequency an opportunity to operate at its full value instead of being wasted by resistance in the phones, the primary of the audio frequency trans-

condenser and the rotor of the variocoupler, dependent upon the amount of induction in the primary of the variocoupler, which is more in evidence when the greater number

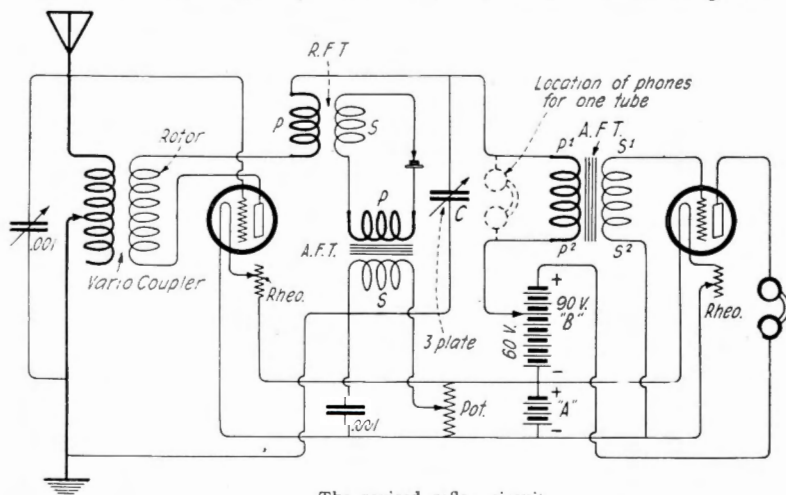

The revised reflex circuit

former of the second tube, or the batteries, in order to complete the circuit to the filament of the first tube.

There is also an adjustment relation between the position of the small three-plate

of turns are being used. This, of course, can be determined by the experimenter.

I should like to have Mr. Russell's comments on the modifications of his original circuit as outlined in this article.

Notes on Insulation Phenomena

By A. Reisner

THE writer has found that many electrical experimenters have some peculiar notions about the subject of insulation. These notions pertain especially to the value of using more than one dielectric or insulating medium for insulation purposes. Many of them feel that if they have air as the insulating medium between two terminals and partially fill this air space with some other insulator, for example glass, the insulation will be able to withstand a greater voltage because glass is a stronger dielectric than air. This theory is absolutely wrong as will be more evident from what follows.

Suppose we have two electrodes between which we are applying a high voltage, as in figure 1. Let us say we are applying 3,000 volts and the electrodes are spaced 10 centimeters apart. Now the figure which determines how the insulation will stand up is the potential gradient, namely the voltage per unit length of the insulating medium.

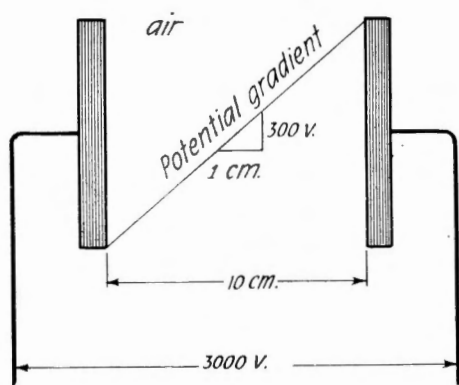

Fig. 1

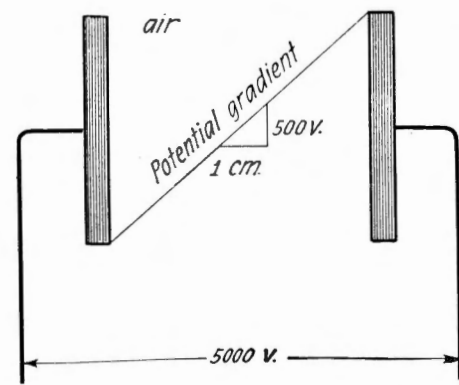

Fig. 2

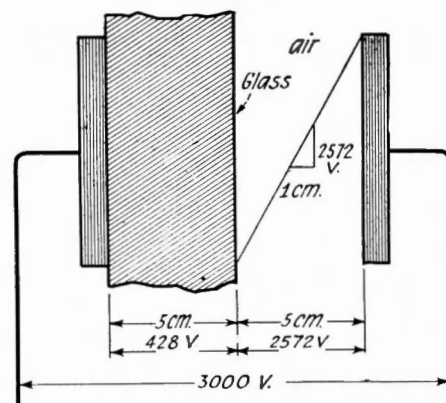

Fig. 3

Various insulating mediums and their potential gradients

The potential gradient simply tells how the voltage is distributed throughout the insulator. Thus if we have as in figure 1, 3,000 volts applied through 10 centimeters of air the voltage is distributed uniformly so that there are 300 volts across each centimeter of air. If, on the other hand, we had 5,000 volts applied across the same distance the voltage gradient would be 500 volts per centimeter of air, and there would be greater possibility of breaking down the insulation. Now this voltage distribution or gradient throughout an insulator may be designated by a straight line as in figure 1. Since the positive terminal is at the highest voltage and the negative at the lowest, the straight line slopes as shown. But the important point is that the slope of the line is such that it falls down 300 units or volts for each centimeter distance, hence this line shows how the voltage is distributed throughout the insulator. The greater this slope is the greater is the strain on the insulator. Thus in figure 2 we have the same spacing between the two terminals but the line slopes more, in fact it slopes so much that it falls 500 units or volts for each centimeter. This means that the potential gradient is 500 volts per centimeter, hence the strain on the insulating medium is greater. In other words a steep slope for the potential gradient means greater strain on the insulator.

trical facts. When a voltage is applied between two electrodes as in figure 1 with air between, these electrodes become charged with a certain amount of electricity depending upon the voltage and the insulating medium and the space between them. If another material is used as insulator instead of air, say glass, then the same voltage will put a greater charge on the electrodes, because glass has a greater capacity for storing electricity than air. Actually it has about six times the capacity. If we have two similar appliances, one having air as the dielectric or insulating medium, the other having glass, then if both have the same charge in them, the glass will require one-sixth the voltage, because its capacity is six times as great as air. It is as though glass had one-sixth the resistive power and therefore required one-sixth the voltage that air does.

Now let us go back to figure 3 where we have equal amounts of glass insulation and air insulation, five centimeters of each, and 3,000 volts between them. The total voltage is divided between the equal amount of glass and air insulation, but it is not divided equally between them, that is there are not 1,500 volts across the air and 1,500 volts across the glass. The reason for this is explained above. The two plates in figure 3 have the same charge, one is charged to plus

3,000 volts the other is charged to minus 3,000 volts, and since they are part of the very same apparatus the electric charges on each of them are identical. But as glass has six times the capacity of air it will take just one-sixth the voltage air will take to give it the same charge as air has. This means that of the entire 3,000 volts the air will require six parts, while the glass will require only one part (1/6th of air), to give the same charges of electricity. In other words there will be 2,572 volts across the air insulation, and only 428 volts across the glass insulation, this being one-sixth of 2,572.

Thus by inserting some glass insulation we have changed the voltage distribution as follows: Formerly in figure 1 when we had only air insulation the entire 3,000 volts were distributed across 10 centimeters of air, giving us a voltage gradient of 300 volts per centimeter: When we inserted an equal amount of glass insulation, namely

five centimeters thick, as in figure 3, the voltage distribution was altered so that 2,572 volts were distributed across the five centimeters of air, giving a voltage gradient of 514 volts per centimeter, while only 428 volts were distributed across the glass, giving a voltage gradient of about 85 volts per centimeter of glass. Thus the insertion of glass resulted in increasing the voltage gradient across air from 300 volts per centimeter as in figure 1, to 514 volts per centimeter as in figure 3.

This occurs whenever two different types of insulators are used in series. The addition of another good dielectric does not improve insulation, it always throws an extra burden on the weaker insulating material, as was seen in the above numerical illustration. Although glass is a stronger insulator, still its presence simply increased the strain on the weaker insulating medium of air. If any change in the insulating qualities of the dielectric must be made the change must be a complete one. In the case of figure 3, instead of using part glass and part air, use all glass.

The above figures should show experimenters conclusively that nothing is gained by using two insulating materials in series. This applies whether direct or alternating currents are used.

Factors of Wavemeter Design and Operation

By L. R. Felder

IN the design of any radio unit or complete set there are certain prime conditions that the designer seeks to fulfill, which conditions are characteristic of the item being designed. Thus in designing inductances the goal aimed at is to get the required inductance with a minimum of resistance, in other words to make the L/R ratio as great as possible. In the case of a transmitter the goal aimed at is to secure the necessary power radiation at maximum efficiency. In the design of wavemeters, the subject of this article, the problem boiled down is to secure highly selective tuning and a low damping factor. Let us see why and how these conditions have to be met.

As its name implies the wavemeter is used essentially to measure wave length. However this is not the only use to which this instrument can be put. It is used to measure capacities, inductances, decrements, coupling coefficients. It can be used to secure res-

has twice the decrement of curve B, and about four times the decrement of curve A. The low decrement produces the sharp resonance curve. Wavemeter design, then, aims to secure a wavemeter to cover a definite range of wave lengths which shall have a minimum damping factor.

The wavemeter is essentially a coil and condenser combination, one of these elements—usually the condenser—being variable, which combination is so calibrated that the condenser instead of reading capacities will read wave length. Thus if the condenser at any setting has a capacity of C microfarads, and the inductance is L microhenries, the combination will have a definite wave length given by the formula.

The effective resistance of the circuit is mainly made up of the coil resistance and resistance of connections and resonance indicator. The resistance of the capacity may be neglected as this is always an air condenser and hence loss-free. The resistance of connections will always be quite low and negligible if care is taken to so dispose of the wavemeter elements as to make the connections very short. If the resonance indicator is placed in series with the coil and condenser, as for example, an ammeter, its resistance should be low. In the case of indicators which are placed in shunt connection, as is the case when a vacuum tube is used, its resistance should be extremely high, otherwise it will introduce high effective resistance in the wavemeter circuit. In general, however, the chief resistance is that due to the wavemeter inductance.

The wavemeter inductance L affects the decrement in two opposite ways: (1) From

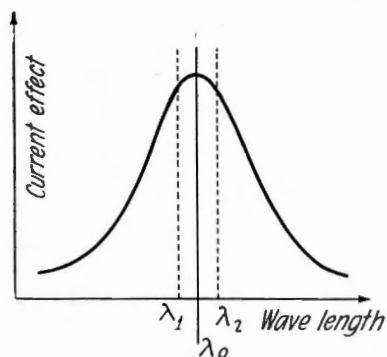

Figure 1

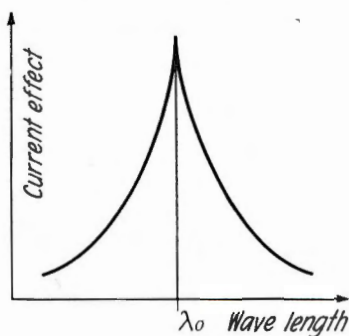

Figure 2

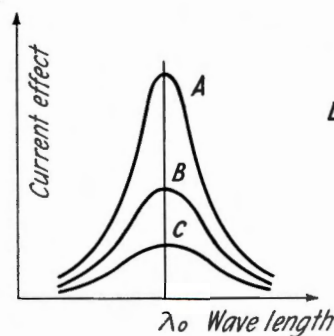

Figure 3



Figure 4

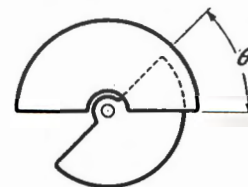

Figure 5

Diagrammatic details of wavemeter design and operation

onance curves and other data as to the nature of radiated waves, to calibrate receivers and transmitters and so on. Obviously all these measurements which are made with the wavemeter depend for their accuracy upon the ability of the wavemeter to tune sharply to the wave at which measurements are made. Thus suppose we have a wavemeter whose resonance curve has the shape of figure 1, a broad resonance curve, and suppose that measurements are to be made at the wave length λ_0 . It will be observed that the current effect over a wide band of wave lengths between λ_1 and λ_2 is about the same and that on either side of this band the current effect is still very considerable. In other words, due to this broad tuning of the wavemeter it would be very difficult to tune it to exactly the wave length required, as a result of which considerable inaccuracies will be made. The broader the tuning of the meter the larger will the inaccuracies be. If on the other hand the resonance curve of the wavemeter were as shown in figure 2, tuning to any given wave length could be accomplished with considerable accuracy and measurements would then be more reliable.

What is required then in the wavemeter is a design so that a sharp resonance curve is secured. This is primarily dependent upon the decrement of the wavemeter circuit. To illustrate this figure 3 shows three resonance curves of the same circuit, each curve having been secured with different resistance, thus varying the decrement. Thus curve C

This wave length may be calculated for each setting of the condenser, and a curve plotted of wave length against condenser setting, in this way securing a calibration of the wavemeter. However there must be used in conjunction with the coil and condenser some indicating device to show when the condition of resonance is secured, as for example a radio frequency ammeter, or thermo-couple and galvanometer, or crystal detector and telephones. Then there are also the connecting wires. Both of these factors have to be taken into consideration for they may possess sufficient inductance and capacity to destroy, if their effect is neglected, completely the accuracy of the calculation. Hence the wavemeter is generally calibrated against a standard, and all the accessories of the wavemeter are in circuit as actually used, so that their effect is thus accounted for.

In the wavemeter circuit of figure 4 the decrement is dependent upon the total inductance, capacity and effective resistance of the circuit, and is given by the equation

$$\delta = \pi R \sqrt{\frac{C}{L}}$$

From this equation it is seen that the higher the effective resistance of the circuit the greater will be the damping and hence the broader the tuning, which is undesirable.

the equation we see that the larger we make the inductance the lower will the decrement be, which is what is desired. However we cannot increase this inductance to too high values for (2) the larger the inductance the higher will the resistance of the coil be, and from the equation above this results in increased decrement. In other words it is disadvantageous to increase the inductance beyond a certain value as otherwise harmful effects of resistance enter. In a similar manner a reduction of the inductance to too low values would be harmful also, for although the reduction in coil resistance affected thereby would result in lowering the decrement this would be more than counterbalanced by the diminished inductance, as seen from the equation for damping. Thus the choice of inductance must be a compromise between two extreme values, and in general is based upon the values of capacity which are employed in the wavemeter.

In the case of capacity, too high values are not desirable for the simple reason that allowance must be made for sufficient inductance to act as the coupling coil of the wavemeter. Furthermore, high values of capacity mean high decrements and hence broad tuning. In practice the best designs are such that the wave length range of the wavemeter for a given coil is about 3 to 1. This means that the condenser should have a maximum to minimum capacity ratio of about 9 to 1. Most commercial condensers are built to have a ratio of about 10 to 1,

which is therefore quite satisfactory. The commercial wavemeters are built to have maximum capacities of about 0.0005 and 0.001 microfarad. These will be found to be suitable values on which to base calculations for the inductance coils. Which value to use depends upon the maximum wave length it is desired to cover. If in the low wave length band, say up to 1000 meters, the 0.0005 microfarad condenser will be found the better. Above this it is best to use the 0.001 condenser, as otherwise the inductance coil will be found to be too great.

With a given condenser it is possible to cover a wave length range much greater than the 3 to 1 range given above. Thus suppose we desire to build a wavemeter to cover the range of wave lengths from 200 to 3000 meters. We would use a 0.001 microfarad condenser and design one coil for this to tune to 600 meters. In this way with this one coil we would secure a wave length range of 3 to 1, namely from 200 to 600 meters. We would then design another coil which would tune with the condenser to a maximum wave length of say about 1500

1 in figure 6. The other curves, namely 2 and 3 in that figure show how C varies with the angle of displacement and how the wave length varies with capacity and angle of displacement. It will be seen from the wave length curve that at the lower values of capacity the wave lengths, for small changes in capacity, make large changes. Therefore at the lower end of the capacity scale the wave length scale will be very crowded while at the upper end of the scale the wave length scale will be wide open. This non-uniform scale is very undesirable for it makes the reading of wave length at the lower end extremely difficult and due to the crowded scale inaccuracies are very liable to arise.

What is desired is a uniform wave length scale so that equal increases in wave length are secured by equal movements of the rotating condenser plates. This can be accomplished only by means of specially formed plates as shown in figure 7. The fixed plates are semicircular, but the rotating plates are specially shaped, and the shaft is eccentrically located as seen in the figure. Figure 8 gives the various curves which

is considerable energy withdrawn from each circuit and transferred to the other. This is equivalent to increasing the effective resistance of each circuit. Hence the damping will increase and broad tuning will result, which destroys the accuracy of the measurements as stated above.

In order to be able to couple the wavemeter very loosely to the source of oscillations it is necessary to employ sensitive resonance indicators. In the case of measurements being taken on a transmitting set the best type of indicator to use is a radio frequency ammeter of some sort. In the case of measurements being taken on receiving equipment where the oscillating currents are very small, more sensitive indicators must be employed. In some cases of laboratory measurements thermocouples and galvanometers are employed. For station work such meters are not generally employed, but a crystal detector and telephones are used instead.

The use of a crystal detector and telephones on a wavemeter as in figure 9 introduces certain corrections to the wavemeter calibration which must be taken care

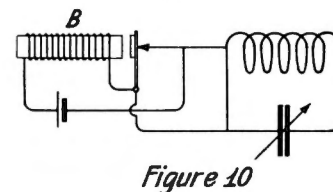
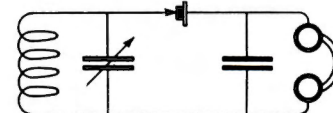
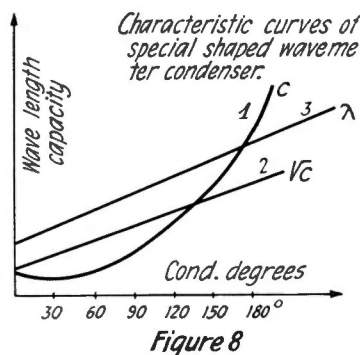
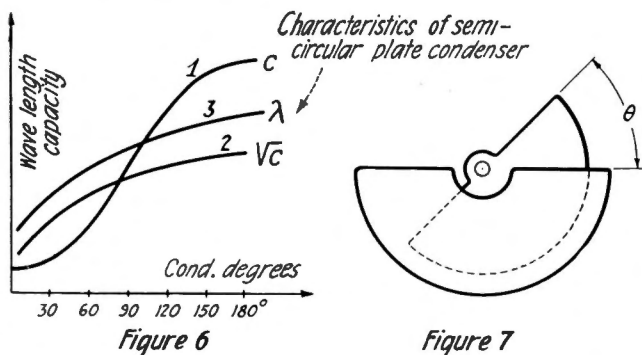

Figure 6

Figure 7

Figure 8

Figure 9

Figure 10

Details of wavemeter design and operation

meters. With this coil, then, we could cover the range between 500 and 1500 meters. A third coil could then be designed to give a maximum wave length of about 3600 meters, thus covering a wave length range with this coil of 1200 to 3600 meters. This is the method generally followed in the practical design of wavemeters where a wide band of wave lengths is to be covered. An important point to observe in this connection is the so-called "overlap." Coil A covers the range between 200 and 600 meters, coil B covers the range between 500 and 1500 meters. The second range overlaps the first range between 500 and 600 meters. This "overlap" would, in commercial practice be made a little larger, say from 450 meters to 600 meters. The smaller the overlap, of course, the fewer coils will be required to cover a given wave length range. It is thus possible to check the accuracy of wave length measurements which occur at the extreme ends of the condenser scale by measuring with two different coils.

THE WAVEMETER CONDENSER

The ordinary semicircular plate condenser has some disadvantages when used in a wavemeter. Figure 5 shows diagrammatically the semicircular plate condenser moved through an angle of θ degrees. This particular type of condenser gives a capacity which is approximately proportional to the angle through which the movable plates are moved, and this fact is shown in curve

characterize this particular form of condenser. It will be seen that the capacity of this condenser is no longer directly proportional to the angle through which the rotating plates move. In spite of this, however, the wave length scale is uniform, for the wave length is proportional to the square root of capacity, and from curve 2 it is seen that the C curve is a straight line curve. Thus the wavemeter scale with this type of condenser is not crowded but uniform and hence more accurate results are obtainable. This type of condenser is marketed by some firms and is to be strongly recommended to amateurs considering the construction of a wavemeter.

COUPLING OF WAVEMETER

In the use of the wavemeter the most important rule to observe pertains to the coupling of the wavemeter, and is: Always use very loose coupling. No results will be reliable unless this rule is strictly adhered to. There are two reasons for this. In the first place, coupling a wavemeter closely to a circuit effects a reaction between the two circuits. In a wavemeter measurement the wavemeter must react to the other circuit, but there must be no reaction in the direction of wavemeter to the other circuit, otherwise this double reaction will produce coupling waves, which detract from the accuracy of the measurement. Secondly, with very loose coupling there is no change produced in the constants of wavemeter and the other circuit. At close couplings there

of. The combination of crystal and phones has a capacity effect which may be of the order of 0.000005 microfarad, and this may alter the wave length calibration of the meter by as much as 4 or 5 per cent. Consequently the wavemeter should be calibrated with the indicator in circuit or the effect of the indicator should be taken account of by calculation. Of course the greater the wavemeter capacity, relative to the capacity of the resonance indicator, the less effect will the indicator have on the calibration.

A wavemeter cannot only be used as a receiving wavemeter, but may also be a transmitting wavemeter. In a great many measurements, as inductance and capacity measurements of coils and condensers it is necessary to provide an external source of oscillations to excite the circuit in which the measured element is connected. This is most easily accomplished by means of a transmitting wavemeter as in figure 10. A vibrating buzzer B is used as the means of exciting oscillations in the wavemeter circuit which oscillations are then transmitted to the circuit under test. The incorporation of a buzzer in a wavemeter enables many measurements to be made which would otherwise not be convenient to make. When the wavemeter is used as a transmitter it should be recalibrated with the buzzer in circuit, as the capacity effect of the buzzer may alter the calibration to a marked extent.

Popular Misconceptions of Radio

By G. H. Clark

I had an intense interest in medical matters during one of the boyish crazes that I went through in common with all other youngsters. Whenever I had a chance, I asked questions of my physician friends, and I read every book I could find on physiology and materia medica. I thought of course, that I knew a lot about the matter, but I remember now how my ostentatious use of technical terms brought a smile to the lips of those who really knew the subject. I remember that smile of my doctor friends. It comes in very handy these days to remember it, when eager beginners in radio ask me the same kind of questions that I used to ask.

Now it is an obvious fact that the body can be used fairly well without the knowledge that the physician has. You and I walk quite naturally without appreciating or knowing the wonderful series of muscles and controls that we are using. The same is true of radio. The beginners—both amateurs and novices—who operate receivers and get wonderful results out of them are often totally ignorant of what they are doing. Many of them know little more than that there are several dials to adjust, but what these dials do is a complete mystery. Sometimes it seems as if the less one knows about radio the better results one can get.

There are a few popular misconceptions about radio, however, which actually do harm. The first, and most common one, is that the receiving antenna has to point in a certain direction to receive a given station best. This is not true at all of the antennas used in broadcast reception. To have the quality of "directivity" referred to, an antenna must have very great length compared to the height, such as the antenna used by

the Radio Corporation of America at Riverhead, L. I., which is thirty feet high and nine miles long. But the ordinary broadcast antenna, with its length of a hundred feet or so, will receive your favorite broadcast stations equally well, whether the wire be pointing north, south, east, or west.

Others, misled doubtless by the analogy of a violin string, think that an antenna will not receive unless it is stretched tight. I recall a classic case where an old-time Naval officer refused permission to tune up a set on board ship because the antenna wires were not stretched taut. Others go still farther, and think that if one were to tie an insulator to some point along the middle of the horizontal wire—as might be done to keep it away from a tree near its path—this would stop the antenna from vibrating and prevent signals from being received. There is no truth in these beliefs at all. They are due to confusion of mechanical vibration and electrical vibration, which are two entirely different things. The former means actual physical movement of the wire; the latter means that electric currents are set up in it from a distant station. One action has no relation to the other. The antenna may be humming away like a telegraph wire on a cold night, or it may be guyed at twenty different places, and it will receive equally well in both cases.

People have funny ideas about ground connections, too. One man complained about poor reception from his receiver, and when the wiring was examined it was found that he had run his ground wire down to a tack driven through the carpet.

A very common and incorrect idea is that

the larger the physical size of a coil the greater distances can be covered. A customer in a store the other day brought in a honeycomb coil, size 50, saying that she wanted instead one of the big size 1500 coils, so she could pick up Chicago on her broadcast receiver. Now such a large coil as she desired could only be used for long waves, such as the 15,000-meter wave used between Radio Central and Europe, and had she used it for broadcast reception, she would have received nothing at all, rather than an increased signal.

Another customer, a man this time, asked me to advise him on the way to connect up a set he was building. He carefully explained that he was using honeycomb coils and a forty-three-plate condenser and a variocoupler, and he wanted to connect up a radio frequency amplifier. I handed him a little circuit diagram that was at hand, and he replied, "Oh, I have that already, but it won't do. It shows cylindrical coils whereas I am using honeycombs." Undoubtedly there are many beginners who think that there is some especial kind of inductance in a honeycomb coil or a spider web compared with an ordinary cylindrical one! There isn't. A coil is a coil. What counts most is its inductance, and this depends greatly on how many feet of wire there are in the coil. The method of winding is a minor matter.

Incorrect ideas such as these greatly hinder the progress of radio. The whole trend is toward the idea that radio is complicated and mysterious, whereas if the few elementary circuits and laws are studied, it is simple and quite ordinary. Too much stress cannot be laid on clearing up the confusing ideas that are so prevalent and so undesirable.

What Is the Range of My Receiver?

PROBABLY the hardest question to answer in radio is the one most commonly asked, what is the range of the different types of receivers? The reason the answer is so hard to give is because there is no answer, at least no definite one.

It would be hard indeed to give an intelligent reply to anyone asking, "How far can one go in a day by automobile?" Obviously, it depends on the condition of the roads; on the make of car; and finally on the expertness of the driver. But the answer to the radio question depends on many more factors than three. First, and most important, is the location of the receiving station. If it happens to be in a locality where the ground conditions are good, that is one very important factor in its favor. If again there are no metal buildings, or trees, in the immediate vicinity, that also helps greatly. Then comes the matter of an antenna, a rather minor factor at that, but it enters in. The condition of the atmosphere between you and the station you want to receive is an enormously important matter, and one that is entirely out of your control. Lastly, of course, you want a reliably built set, and you need to know how to handle it.

From the standpoint of the antenna and

ground conditions, we can say that if you live in the country you are likely to have a very great receiving range; if you live in the suburbs of a city you will have a good range, and if you live in the heart of a city itself you will find that your receiving distance is cut down considerably. For this reason, the only fair way to estimate the range of a receiving set, without knowing the location of its use, is to give the range that can conservatively be expected under the worst conditions. Then, if the questioner has conditions better than these, he will be gratified by getting distances greater than he anticipated. Much harm is done to radio by irresponsible salesmen blithely guaranteeing reception of Cuba or Los Angeles when perhaps the prospective purchaser lives in the city in the shadow of a number of steel apartment buildings.

We know little of the question of ground conditions, meaning by this not the local ground for your set, but the "density" of radio energy in your particular locality. As the waves sweep over the surface of the earth, any particularly good conducting stretch will cause the waves to crowd over and take advantage of this, leaving the land nearby comparatively free. Thus a lake or

river improves local conditions and robs the adjacent territory. An important test was made some time ago at Oil City, Pa., where signals from KDKA were very weak indeed, whereas many miles farther away signals were picked up very loud. Investigation showed that the city was entirely surrounded by ore deposits, which diverted practically all the waves so that they actually passed the town by on their way. In much the same way, one of the German high power stations has never been able to get its anticipated distance of transmission, because, although its local ground is excellent, it has been found that the region as a whole is set in a huge stone "bowl," which prevents good contact with the surface of the earth in general. The fact that certain stations work excellently in one direction and poorly in others may be due to particularly good ground conditions which stretch out in one particular direction. This may explain why owners of crystal sets in Pittsburgh report common reception from Schenectady, station WGY, a truly remarkable record.

As to your own ground conditions, a water pipe ground is ideal. If this cannot be obtained, approach it as nearly as you can by driving galvanized iron rods in the earth.

The antenna that you should use for long distance work should be a single wire, well-insulated, as high as you can get it at both ends, and with a total length (both vertical and horizontal) of about one hundred and fifty feet. The direction of the antenna makes no difference at all, except that if you cross electric light wires you would do well to cross them at right angles.

It will be found excellent to install two antennas, one the long distance type described above, and another short one, say twenty feet or so in length, for local work. The latter may be an indoor antenna if you so desire. On this small antenna you will get plenty of signals from your nearby broadcasting stations and you will find the occasional interference problem greatly helped by this simple device. A switch for throw-

ing to either antenna at will completes your installation. Do not forget to have a reliable and approved lightning arrester on both antennas, if both are out of doors.

Keeping in mind that the ranges given are those which almost every set can attain, no matter how poor its location, the following general principles can be given. If your home is situated in the suburbs, you will do much better than the figures given, in all probability, and if you are a country dweller your chances are still better.

A crystal set, that is, a receiver with crystal detector, will cover a range of twenty-five to fifty miles.

A receiver with a vacuum tube detector and with the regenerative or tickler circuit will be good for two hundred miles. This is partly due to the better action of the vacuum

tube as detector compared with the crystal detector, but the greater increase in the range is due to the regenerative circuit. This acts to increase the sensitiveness of the detector, and also serves another useful purpose, namely, to reduce the antenna resistance and make the set sharply tuned.

A receiver with a vacuum tube detector and two stages of audio amplification will bring the range of your set up to about eight hundred miles. Where the conditions are favorable, such a set will bring in stations almost over the entire American continent, but the conservative range of eight hundred miles gives the lower limit which is almost certain to be obtained by anyone. Another advantage of the amplifier is that with it loud speaker operation is possible, a factor greatly desired by most listeners.

Fundamentals of Wireless

By C. Dwight Briggs, B. S., E. E.

SOUND in its common meaning refers to the sensation received by the ear. In scientific work the cause of that which produces this sensation is studied. This cause has been found to be the result of vibrations—these vibrations giving rise to impulses or waves.

When a table is struck or a musical note "sounded," there radiates from the source of energy vibrations which are transmitted in all directions through the air by sound waves. The simple fundamental process is then, an acting force causing elastic vibrations which set up a wave motion in the air, the transmitting medium, until the ear drum receives them causing the sensation of sound.

Man communicates with man by conversation. Party number one acts upon his vocal organs causing the air to vibrate, the air transmits the sound waves to the ear drum of number two.

Conclusion number one: There can be no sound, no transmission of the sound waves,

without vibration. A laboratory experiment used by physicists to demonstrate the characteristics of the transmission of sound utilizes an electric bell in a bell jar; so long as air is in the jar the bell can be heard, but as the air is exhausted the sound becomes less and less and finally as the vacuum is established the sound ceases. Why? Nothing to vibrate.

Wireless communication is then the primitive form, but its limits depended upon the muscular force of the sender's vocal organs. The Indians would place their heads upon the ground to hear the approach of beasts or foe. The ground was the medium to vibrate. Very early man noticed that if some medium could be made to vibrate, distance transmission would be increased.

No great steps were made until the telephone was invented. The old principle is used, but its adaptation is brought about electrically. The transmitter changes sound waves to electric impulses; the wire transmits these electric impulses;

the receiver transforms these electric impulses to sound waves. Distance is practically nil. The efficiency of electric transmission defines the limits.

Distance communication is divided into four steps. First—Changing sound waves into some waves or impulses that are easily transmitted. Second—Transmitting these waves through some medium. Third—Receiving these impulses. Fourth—Changing these impulses back to sound waves.

Present-day wireless does these things, but the transmitting medium is a dielectric acted upon by high frequency electro-magnetic waves. The sending or broadcasting stations come under item one. The thousands of receiving sets under three and four. Rather than confuse ourselves with the technical ways and means of accomplishing these just remember that this fundamental principle cannot be changed. Regardless of bulbs, rheostats, condensers, etc., etc., the whole scheme is to get something to vibrate.

Radio Antenna Design

(Continued from page 55)

siderable part of the total necessary losses.

The scope of this paper does not permit me to go into the possible methods of supplying energy to the antenna, but is merely intended to bring out the fact that the properties of the antenna as a radiator can be stated simply in terms of its effective height, and that its efficiency does not very materially depend on its particular form, but is more dependent on the conditions local to the antenna in question.

The statements, in general, refer to an antenna as used for transmitting purposes, and when used for receiving purposes, the operating conditions are different in that the antenna, in addition to being capable of radiation, is energized by an incoming wave. The energy which can be delivered to our receiving apparatus is determined by the relation of the received energy to the losses in the antenna and the energy which it radiates. As the same property which makes

the antenna a receiver of energy also makes it a radiator of energy, the ability of the antenna to receive will be determined mainly by its losses, and when used with a vacuum tube regenerative receiver, these losses can be canceled by regeneration, so that the signals received by the antenna can reach a value such that it radiates the same signal, or, in other words, the current in the receiving antenna can reach a maximum value, which is such that it radiates a signal of the same intensity of that received. Consideration will show that this would make the receiving antenna independent of height, and experience shows that this is practically so within a certain limitation, due mainly to the fact that the very low antenna near the ground is usually in a position of reduced field, owing to absorption by ground and surrounding objects. There is also certain difficulty in adjusting a regenerative set to such a point as to just neutralize antenna resistance but when accomplished the receiver operates at its best efficiency for quality as well as range.

Radio Equipment of the ZR-1

(Continued from page 49)

the electrical power equipment of an automobile, is carried aloft on the ZR-1 in the event of a breakdown of the gasoline-driven generator. This would supply power for about two hours. The electric energy derived from the generator not only operates the radio instruments but furnishes electricity for lighting the airship.

The wireless instruments are installed on the forward position of the control car, shown in the photograph reproduced with this article. The call letters assigned are "ZR-1," bearing the designation of this dirigible. The comparatively great height of the 300-foot trailing wire antenna will, it is anticipated, make for effective long-distance communication. Therefore, with both adequate sending and receiving wireless instruments, together with a radio compass, the ZR-1, in the event of a voyage to the North Pole, should be able to maintain communication with the outside world.

BROADCASTING STATION DIRECTORY

(Revised to September 20th, 1923)

KAO	Young Men's Christian Association, Denver, Colo.	360	KFDY	South Dakota State College of Agri. & Mech.	360	WIP	Gimbel Bros. Philadelphia, Pa.	509
KFI	E. C. Anthony. Los Angeles, Calif.	469	KFDZ	Arts, Brookings, S. D.	360	WIZ	Cino Radio Mfg. Co. Cincinnati, Ohio	360
KFZ	Doerr Mitchell Electric Co. Spokane, Wash.	253	KFEJ	Harry O. Iverson. Minneapolis, Minn.	360	WJD	Richard Harris Howe. Granville, Ohio	229
KGB	Tacoma Daily Ledger. Tacoma, Wash.	252	KFEF	Guy Greason. Tacoma, Wash.	360	WJH	White & Boyer Co. Washington, D. C.	273
KGG	Hallack & Watson Radio Service, Portland, Ore.	360	KFEK	Winner Radio Corporation. Denver, Colo.	360	WJK	Service Radio Equipment Co. Toledo, Ohio	360
KGU	Northwestern Radio Mfg. Co. Portland, Ore.	360	KFEL	Radio Equipment Co. Denver, Colo.	360	WJX	DeForest Radio Tel. & Tel. Co., New York, N. Y.	360
KGV	M. A. Mulrony. Honolulu, Hawaii	360	KFEP	J. L. Scroggin. Oak, Nebr.	360	WJY	Radio Corp. of America—Aeolian Hall, N. Y. C.	405
KGW	Oregonian Pub. Co. Portland, Ore.	492	KFER	Auto Electric Service Co. Ft. Dodge, Iowa	231	WJZ	Radio Corp. of America—Aeolian Hall, N. Y. C.	455
KGY	St. Martins College. Lacey, Wash.	258	KFEV	Radio Electric Shop. Douglas, Wyo.	263	WKA	Landau Music & Jewelry Co., Wilkes-Barre, Pa.	360
KHJ	Times Mirror Co. Los Angeles, Calif.	395	KFEW	Augsburg Seminary. Minneapolis, Minn.	261	WKC	Joseph M. Zamoski Co. Baltimore, Md.	360
KHQ	Louis Wasmor. Seattle, Wash.	360	KFEY	Bunker Hill & Sullivan Mining & Const. Co., Kellogg, Idaho	360	WKY	Oklahoma Radio Shop. Oklahoma City, Okla.	360
KJG	C. O. Gould. Stockton, Calif.	360	KFEZ	American Society of Mech. Engrs., St. Louis, Mo.	360	WLB	University of Minnesota. Minneapolis, Minn.	360
KJR	Northwest Radio Service Co. Seattle, Wash.	270	KFFA	Dr. R. O. Shelton. San Diego, Calif.	242	WLC	Hamilton Mfg. Co. Indianapolis, Ind.	360
KJS	Bible Institute of Los Angeles, Inc., Los Angeles, Calif.	360	KFFB	Jenkins Furniture Co. Boise, Idaho	240	WLD	Arrow Radio Laboratories. Anderson, Ind.	360
KLN	Monterey Electric Shop. Monterey, Calif.	261	KFFC	Eastern Oregon Radio Co. Pendleton, Ore.	360	WLE	Commercial. Memphis, Tenn.	500
KLS	Warner Brothers. Oakland, Calif.	360	KFFD	Jenkins Furniture Co. Boise, Idaho	360	WLF	Precision Equipment Co. Cincinnati, Ohio	248
KLX	Tribune Publishing Co. Oakland, Calif.	360	KFFE	Dr. P. H. Smith. Hillsboro, Oregon	229	WLN	Doubleday-Hill Elec. Co. Pittsburgh, Pa.	261
KLZ	Reynolds Radio Co. Denver, Colo.	360	KFFG	Markschoffel Motor Co., Colorado Springs, Colo.	360	WLO	Shotton Radio Mfg. Co. Albany, N. Y.	400
KMC	San Joaquin Light & Power Co., Fresno, Calif.	360	KFFH	Jim Kirk. Sparks, Nev.	226	WLP	Wireless Telephone Co. of Hudson County, N. J.	460
KMD	Low Electric Co. Tacoma, Wash.	360	KFFI	Graceland College. Lamoni, Iowa	275	WLR	Palmer School of Chiropractic. Davenport, Iowa	360
KMJ	Roswell Public Service Co. Roswell, N. M.	250	KFFJ	McGraw Co. Omaha, Nebr.	278	WLS	Iowa State College. Ames, Iowa	360
KMK	Grays Harbor Radio Co. Aberdeen, Wash.	263	KFFK	Pineus & Murphy, Inc., Alexandria, La.	275	WLT	Arkansas Light & Power Co., Pine Bluff, Iowa	360
KML	Radio Supply Co. Los Angeles, Calif.	256	KFFL	Al. G. Barnes Amusement Co., Dallas, Tex.	226	WLU	John Wanamaker. Philadelphia, Pa.	509
KMN	Electric Lighting Supply Co., Los Angeles, Calif.	360	KFFM	Louisiana State University. Baton Rouge, La.	254	WLV	Western Radio Co. Kansas City, Mo.	360
KMO	New Mexico College of Agriculture and Mechanical Arts, State College, N. Mex.	360	KFFN	Chickasha Radio & Elec. Co., Chickasha, Okla.	248	WLV	W. L. Bamberger Co., Newark, N. J.	405
KMP	Detroit Police Dept. Detroit, Mich.	286	KFFO	Buchanan Stevens & Co., Mt. Vernon, Wash.	360	WLT	Missouri State Marketing Bureau, Jefferson City, Mo.	441
KMQ	Modesto Evening News. Modesto, Calif.	360	KFFP	Leland Stanford Jr., Univ. Stanford Univ., Calif.	360	WLU	Fort Worth Record. Fort Worth, Tex.	360
KMR	Hale Bros. San Francisco, Calif.	423	KFFQ	National Guards Mo., 138th Inf., St. Louis, Mo.	266	WLV	Nushawg Poultry Farm. New Lebanon, Ohio	234
KMS	University of California. Berkeley, Calif.	360	KFFR	Arlington Garage. Arlington, Ore.	234	WLV	Electric Supply Co. Clearfield, Pa.	360
KMT	Apple City Radio Club. Hood River, Ore.	360	KFFS	Cheney Radio Co. Cheney, Kans.	229	WLV	Walter A. Kuschl. Chicago, Ill.	360
KMV	Doubleday-Hill Electric Co., Pittsburgh, Pa.	360	KFFG	Crany Hdq. Co. Boone, Iowa	226	WLV	Radio Corporation of America. Washington, D. C.	469
KMW	Charles D. Herold. Berkeley, Calif.	278	KFFH	First Baptist Church. Utica, Nebr.	224	WLV	Doron Brothers Electric Co., Hamilton, Ohio	360
KMX	Berkeley Daily Gazette. Berkeley, Calif.	278	KFFI	First Presbyterian Church. Orange, Tex.	224	WLV	Union College. Schenectady, N. Y.	360
KMY	Post-Dispatch. St. Louis, Mo.	546	KFFJ	Gjelbaug's Radio Shop. Baudette, Minn.	224	WLV	University of Illinois. Urbana, Ill.	360
KMZ	Prest & Dean Radio Lab., Long Beach, Calif.	360	KFFK	Emmanuel Missionary Co., Berrien Spgs., Mich.	268	WLV	City of Dallas (Police and Fire Signal Department), Dallas, Tex.	360
KNA	First Presbyterian Church. Seattle, Wash.	360	KFFL	Colorado State Normal School. Gunnison, Colo.	360	WLV	Tarrytown Radio Research Lab. Tarrytown, N. Y.	273
KNB	The Examiner Printing Co., San Francisco, Calif.	360	KFFM	The Rialto Theatre. Hood River, Oregon	226	WLV	Atlanta Journal. Atlanta, Ga.	429
KNC	City Dye Works & Laundry Co., Los Angeles, Calif.	360	KFFN	Utz Electric Co. St. Joseph, Mo.	226	WLV	J. & M. Electric Co. Utica, N. Y.	273
KND	Coast Radio Co. El Monte, Calif.	256	KFFO	Central Christian Church. Shreveport, La.	266	WLV	Alabama Power Co. Birmingham, Ala.	360
KNE	Portable Wireless Telephone Co., Stockton, Calif.	360	KFFP	Ambrose A. McE. Near Bay, Wash.	283	WLV	Marshall Gerken Co. Toledo, Ohio	360
KNF	Los Angeles Examiner. Los Angeles, Calif.	360	KFFQ	Charles V. Dixon. Wichita, Kans.	224	WLV	Kansas State Agr. College. Manhattan, Kans.	360
KNG	Herald Publishing Co., Modesto, Calif.	252	KFFR	Fallon Co. Santa Barbara, Calif.	360	WLV	George M. McBride. Bay City, Mich.	360
KNH	Electric Shop. Honolulu, T. H.	360	KFFS	Penn College. Oskaloosa, Iowa	227	WLV	Daily News Printing Co. Canton, Ohio	360
KNI	Westinghouse Elec. & Mfg. Co., Chicago, Ill.	536	KFFG	Radio Bulb Products Co., Kearney, Nebr.	246	WLV	Ford Motor Co. Dearborn, Mich.	273
KNJ	Preston, D. Allen. Oakland, Calif.	360	KFFH	Cartis Brothers Hardware Store, Los Gatos, Calif.	242	WLV	The Detroit News. Detroit, Mich.	517
KNK	The Desert News. Salt Lake City, Utah	360	KFFI	Star Elec. and Radio Co. Seattle, Wash.	270	WLV	Loyola University. New Orleans, La.	280
KNL	Wenatchee Battery & Motor Co., Wenatchee, Wash.	360	KFFJ	Robert Washington Nelson. Hutchinson, Kans.	229	WLV	John Wanamaker. New York, N. Y.	360
KNM	Westinghouse Elec. & Mfg. Co., Pittsburgh, Pa.	326	KFFK	R. S. McEwan. Trinidad, Colo.	242	WLV	Valdemar Jensen. New Orleans, La.	280
KNO	Westinghouse Elec. & Mfg. Co., Cleveland, Ohio	270	KFFL	Franklin W. Jenkins. St. Louis, Mo.	244	WLV	Tulane University. New Orleans, La.	360
KNP	Southern Electric Co., San Diego, Calif.	244	KFFM	Phillip Laskowitz. Denver, Colo.	244	WLV	Ohio Mechanics Institute. Cincinnati, Ohio	360
KNQ	Telegram Publishing Co., Salt Lake City, Utah	360	KFFN	Ross Arbuclies Garage. Jola, Kans.	226	WLV	Chicago Daily Drivers Journal. Chicago, Ill.	286
KNR	Savoy Theatre. San Diego, Calif.	252	KFFO	Benson Tech. Student Body. Portland, Ore.	360	WLV	Commonwealth Electric Co., St. Paul, Minn.	360
KNS	Oregon Institute of Technology, Portland, Ore.	360	KFFP	Gladbrook Electric Co., Gladbrook, Iowa	234	WLV	Gimbel Bros. Milwaukee, Wisc.	280
KNT	The Tribune, Inc., Great Falls, Mont.	360	KFFQ	Windisch Elec. Farm Equipment Co., Louisville, Kans.	234	WLV	W. L. Nelson Co. Newark, N. J.	263
KNU	Smith & Hughes. Phoenix, Ariz.	360	KFFR	North Central High School. Spokane, Wash.	252	WLV	University of Missouri. Columbia, Mo.	254
KNV	Star Bulletin Publishing Co., Honolulu, T. H.	360	KFFS	Yakima Valley Radio Broadcasting Association, Yakima, Wash.	224	WLV	O. W. Taylor. Wichita, Kans.	360
KNW	Frank E. Siefert. Bakersfield, Calif.	240	KFFG	Alaska Elec. Light & Power Co., Juneau, Alaska	226	WLV	W. A. A. New England Motor Sales Co., Greenwich, Conn.	360
KNX	Rhodes Company. Seattle, Wash.	455	KFFH	V. H. Broyles. Pittsburgh, Kans.	240	WLV	Georgia Radio Co. Decatur, Ga.	360
KNY	Automobile Club of So. Calif., Los Angeles, Calif.	278	KFFI	Reorganized Church of Jesus Christ, Latter Day Saints, Independence, Kans.	240	WLV	Omaha Grain Exchange. Omaha, Nebr.	360
KNZ	Electric Supply Co., Wenatchee, Wash.	360	KFFJ	Dr. John B. Lawrence. Harrisburg, Pa.	266	WLV	Hollister-Miller Motor Co., Emporia, Kans.	360
KOA	Nevada Machinery & Electric Co., Reno, Nev.	360	KFFK	Broil Laboratories. Seattle, Wash.	236	WLV	Lake Forest College. Lake Forest, Ill.	266
KOB	Pyle & Nichols. Denver, Colo.	360	KFFL	Drott Laboratories. Seattle, Wash.	236	WLV	Dr. John B. Lawrence. Harrisburg, Pa.	266
KOC	Bellingham Publishing Co., Bellingham, Wash.	261	KFFM	Dr. John B. Lawrence. Harrisburg, Pa.	266	WLV	Fuldeiter Grimes Battery Co., Anderson, Ind.	229
KOD	Seattle Radio Association. Seattle, Wash.	360	KFFN	Broil Laboratories. Seattle, Wash.	236	WLV	Parker High School. Dayton, Ohio	286
KOE	Western Radio Corporation. Denver, Colo.	360	KFFO	Dr. John B. Lawrence. Harrisburg, Pa.	266	WLV	Y. M. C. A. Washington, D. C.	283
KOF	Cope & Cornwall Co., Salt Lake City, Utah	360	KFFP	Dr. John B. Lawrence. Harrisburg, Pa.	266	WLV	Mt. Vernon Register-News Co., Mt. Vernon, Ill.	234
KOG	McArthur Brothers Mercantile Co., Phoenix, Ariz.	360	KFFQ	Dr. John B. Lawrence. Harrisburg, Pa.	266	WLV	Arnold Edwards Piano Co., Jacksonville, Fla.	240
KOH	State College of Washington. Pullman, Wash.	360	KFFR	Dr. John B. Lawrence. Harrisburg, Pa.	266	WLV	Lake Shore Tire Co. Sandusky, Ohio	248
KOI	Western Radio Corporation. Denver, Colo.	360	KFFS	Dr. John B. Lawrence. Harrisburg, Pa.	266	WLV	Bangor Railway and Electric Co., Bangor, Me.	240
KOJ	Cope & Cornwall Co., Salt Lake City, Utah	360	KFFG	Dr. John B. Lawrence. Harrisburg, Pa.	266	WLV	Radio Laboratories. South Bend, Ind.	240
KOK	McArthur Brothers Mercantile Co., Phoenix, Ariz.	360	KFFH	Dr. John B. Lawrence. Harrisburg, Pa.	266	WLV	First Baptist Church. Worcester, Mass.	252
KOL	State College of Washington. Pullman, Wash.	360	KFFI	Dr. John B. Lawrence. Harrisburg, Pa.	266	WLV	Connecticut Agri. College. Storrs, Conn.	283
KOM	Western Radio Corporation. Denver, Colo.	360	KFFJ	Dr. John B. Lawrence. Harrisburg, Pa.	266	WLV	F. E. Doherty. Saginaw, Mich.	254
KON	Cope & Cornwall Co., Salt Lake City, Utah	360	KFFK	Dr. John B. Lawrence. Harrisburg, Pa.	266	WLV	Waldo C. Grover. La Crosse, Wisc.	234
KOO	McArthur Brothers Mercantile Co., Phoenix, Ariz.	360	KFFL	Dr. John B. Lawrence. Harrisburg, Pa.	266	WLV	Lake Avenue Baptist Church, Rochester, N. Y.	252
KOP	State College of Washington. Pullman, Wash.	360	KFFM	Dr. John B. Lawrence. Harrisburg, Pa.	266	WLV	Indian Pipe Line Corp., Princeton, Ind.	360
KOQ	Western Radio Corporation. Denver, Colo.	360	KFFN	Dr. John B. Lawrence. Harrisburg, Pa.	266	WLV	Purdue University. West Lafayette, Ind.	360
KOY	Cope & Cornwall Co., Salt Lake City, Utah	360	KFFO	Dr. John B. Lawrence. Harrisburg, Pa.	266	WLV	Sterling Electric Co. and Journal Printing Co., Minneapolis, Minn.	360
KOA	McArthur Brothers Mercantile Co., Phoenix, Ariz.	360	KFFP	Dr. John B. Lawrence. Harrisburg, Pa.	266	WLV	The Dayton Co. Minneapolis, Minn.	360
KOB	State College of Washington. Pullman, Wash.	360	KFFQ	Dr. John B. Lawrence. Harrisburg, Pa.	266	WLV	Wireless Phon Corporation. Paterson, N. J.	244
KOC	Western Radio Corporation. Denver, Colo.	360	KFFR	Dr. John B. Lawrence. Harrisburg, Pa.	266	WLV	James Millikin University. Decatur, Ill.	360
KOD	Cope & Cornwall Co., Salt Lake City, Utah	360	KFFS	Dr. John B. Lawrence. Harrisburg, Pa.	266	WLV	Worham-Carter Pub. Co., The Star Telegram, Ft. Worth, Tex.	476
KOE	McArthur Brothers Mercantile Co., Phoenix, Ariz.	360	KFFG	Dr. John B. Lawrence. Harrisburg, Pa.	266	WLV	WBAU Republican Publishing Co., Hamilton, Ohio	258
KOF	State College of Washington. Pullman, Wash.	360	KFFH	Dr. John B. Lawrence. Harrisburg, Pa.	266	WLV	Erner & Hopkins Co., Columbus, Ohio	286
KOG	Western Radio Corporation. Denver, Colo.	360	KFFI	Dr. John B. Lawrence. Harrisburg, Pa.	266	WLV	Marietta College. Marietta, Ohio	248
KOH	Cope & Cornwall Co., Salt Lake City, Utah	360	KFFJ	Dr. John B. Lawrence. Harrisburg, Pa.	266	WLV	John H. Stenzer, Jr., Wilkes-Barre, Pa.	360
KOI	McArthur Brothers Mercantile Co., Phoenix, Ariz.	360	KFFK	Dr. John B. Lawrence. Harrisburg, Pa.	266	WLV	Western Electric Co. New York, N. Y.	492
KOJ	State College of Washington. Pullman, Wash.	360	KFFL	Dr. John B. Lawrence. Harrisburg, Pa.	266	WLV	Newark Radio Laboratory. Newark, Ohio	240
KOK	Western Radio Corporation. Denver, Colo.	360	KFFM	Dr. John B. Lawrence. Harrisburg, Pa.	266	WLV	BBBC Sterling Radio Equipment Co., Sterling, Ill.	229
KOL	Cope & Cornwall Co., Salt Lake City, Utah	360	KFFN	Dr. John B. Lawrence. Harrisburg, Pa.	266	WLV	Barbey Battery Service. Reading, Pa.	224
KOM	McArthur Brothers Mercantile Co., Phoenix, Ariz.	360	KFFO	Dr. John B. Lawrence. Harrisburg, Pa.	266	WLV	St. Lawrence University. Canton, N. Y.	280
KON	State College of Washington. Pullman, Wash.	360	KFFP	Dr. John B. Lawrence. Harrisburg, Pa.	266	WLV	WCAE Kaufman & Baer Co., Pittsburgh, Pa.	462
KOO	Western Radio Corporation. Denver, Colo.	360	KFFQ	Dr. John B. Lawrence. Harrisburg, Pa.	266	WLV	Michigan Limestone & Chemical Co., Rodgers, Mich.	360
KOY	Cope & Cornwall Co., Salt Lake City, Utah	360	KFFR	Dr. John B. Lawrence. Harrisburg, Pa.	266	WLV	Clyde R. Randall. New Orleans, La.	286
KOA	McArthur Brothers Mercantile Co., Phoenix, Ariz.	360	KFFS	Dr. John B. Lawrence. Harrisburg, Pa.	266	WLV	Entrekin Electric Co. Columbus, Ohio	266
KOB	State College of Washington. Pullman, Wash.	360	KFFG	Dr. John B. Lawrence. Harrisburg, Pa.	266	WLV	WCAJ Nebraska Wesleyan University, University Pl., Nebr.	360
KOC	Western Radio Corporation. Denver, Colo.	360	KFFH	Dr. John B. Lawrence. Harrisburg, Pa.	266	WLV	WCAK Alfred P. Daniel. Houston, Tex.	360
KOD	Cope & Cornwall Co., Salt Lake City, Utah	360	KFFI	Dr. John B. Lawrence. Harrisburg, Pa.	266	WLV	WCAL St. Olaf College. Northfield, Minn.	360
KOE	McArthur Brothers Mercantile Co., Phoenix, Ariz.	360	KFFJ	Dr. John B. Lawrence. Harrisburg, Pa.	266	WLV	WCAM Villanova College. Villanova, Pa.	360
KOF	State College of Washington. Pullman, Wash.	360	KFFK	Dr. John B. Lawrence. Harrisburg, Pa.	266	WLV	WCAO Sanders & Stayman Co., Baltimore, Md.	360
KOG	Western Radio Corporation. Denver, Colo.	360	KFFL	Dr. John B. Lawrence. Harrisburg, Pa.	266	WLV	WCAP Chesapeake & Potomac Tel. Co., Washington, D. C.	469
KOH	Cope & Cornwall Co., Salt Lake City, Utah	360	KFFM	Dr. John B. Lawrence. Harrisburg, Pa.	266	WLV	WCAW Alamo Radio Electric Co., San Antonio, Tex.	360
KOI	McArthur Brothers Mercantile Co., Phoenix, Ariz.	360	KFFN	Dr. John B. Lawrence. Harrisburg, Pa.	266	WLV	WCAD Dunwoody Industrial Institute, Minneapolis, Minn.	246
KOJ	State College of Washington. Pullman, Wash.	360	KFFO	Dr. John B. Lawrence. Harrisburg, Pa.	266	WLV	WCAT South Dakota School of Mines. Rapid City, S. D.	240
KOK	Western Radio Corporation. Denver, Colo.	360	KFFP	Dr. John B. Lawrence. Harrisburg, Pa.	266	WLV	WCAX Durham & Co. Philadelphia, Pa.	286
KOL	Cope & Cornwall Co., Salt Lake City, Utah	360	KFFQ	Dr. John B. Lawrence. Harrisburg, Pa.	266	WLV	WCAV J. C. Dice Electric Co., Little Rock, Ark.	360
KOM	McArthur Brothers Mercantile Co., Phoenix, Ariz.	360	KFFR	Dr. John B. Lawrence. Harrisburg, Pa.	266	WLV	WCAX University of Vermont. Burlington, Vt.	360
KON	State College of Washington. Pullman, Wash.	360	KFFS	Dr. John B. Lawrence. Harrisburg, Pa.	266	WLV	WCAY Kesselman O'Driscoll Music House, Milwaukee, Wisc.	261
KOO	Western Radio Corporation. Denver, Colo.	360	KFFG	Dr. John B. Lawrence. Harrisburg, Pa.	266	WLV	WCBA Charles W. Haimbach. Allentown, Pa.	280
KOY	Cope & Cornwall Co., Salt Lake City, Utah	360	KFFH	Dr. John B. Lawrence. Harrisburg, Pa.	266	WLV	WCBB K. & K. Radio Supply Co., Greenville, Ohio	240
KOA	McArthur Brothers Mercantile Co., Phoenix, Ariz.	360	KFFI	Dr. John B. Lawrence. Harrisburg, Pa.	266	WLV		
KOB	State College of Washington. Pullman, Wash.	360	KFFJ	Dr. John B. Lawrence. Harrisburg, Pa.	266	WLV		
KOC	Western Radio Corporation. Denver, Colo.	360	KFFK	Dr. John B. Lawrence. Harrisburg, Pa.	266	WLV		
KOD	Cope & Cornwall Co., Salt Lake City, Utah	360	KFFL	Dr. John B. Lawrence. Harrisburg, Pa.	266	WLV		
KOE	McArthur Brothers Mercantile Co., Phoenix, Ariz.	360	KFFM	Dr. John B. Lawrence. Harrisburg, Pa.	266	WLV		
KOF	State College of Washington. Pullman, Wash.	360	KFFN	Dr. John B. Lawrence. Harrisburg, Pa.	266	WLV		
KOG	Western Radio Corporation. Denver, Colo.	360	KFFO	Dr. John B. Lawrence. Harrisburg, Pa.	266	WLV		
KOH	Cope & Cornwall Co., Salt Lake City, Utah	360	KFFP	Dr. John B. Lawrence. Harrisburg, Pa.	266	WLV		
KOI	McArthur Brothers Mercantile Co., Phoenix, Ariz.	360	KFFQ	Dr. John B. Lawrence. Harrisburg, Pa.	266	WLV		
KOJ	State College of Washington. Pullman, Wash.	360	KFFR	Dr. John B. Lawrence. Harrisburg, Pa.	266	WLV		
KOK	Western Radio Corporation. Denver, Colo.	360	KFFS	Dr. John B. Lawrence. Harrisburg, Pa.	266	WLV		
KOL	Cope & Cornwall Co., Salt Lake City, Utah	360	KFFG	Dr. John B. Lawrence. Harrisburg, Pa.	266	WLV		

Table listing various radio stations and their locations, including call letters like WCBD, WDAE, WDFW, etc., and their respective cities and states.

Canadian Broadcasting Stations

Table listing Canadian broadcasting stations, including call letters like CKY, CFAC, CFCA, etc., and their respective locations in Canada.

NEW APPLIANCES AND DEVICES

Proudfoot Vernier Condenser

IN the Proudfoot one knob vernier condenser, manufactured by the Cruver Manufacturing Company, the vernier plate lines up with the rotor plate as the knob is turned to the right so that the position of the vernier is always known when setting the position of the main plates and this is indicated by the large scale. The fine adjustment is obtained by turning the knob to the left which allows only the vernier plate to move and the position is indicated on



Vernier condenser

the inner scale, therefore by the two readings an accurate log can be obtained.

When using some circuits the movement of the vernier indicator one division will tune in or out a station so it will readily be seen how indispensable this very simple improvement of the condenser will be to the Radio Industry as a means of facilitating the reception of distant stations.

Post Metallic Soldering Iron

THE Post Electric Company now has ready for the trade a new product, known as the Metaelectric Soldering Iron.

The Metaelectric Soldering Iron is about one-half again the size of the Post soldering iron, but of somewhat different construction. It is constructed entirely of metal, thoroughly insulated and operates on any electric circuit in series with a regular light



Soldering iron

bulb, similar to the Post soldering iron. It is finished in a bright nickel and supplied with eight feet of cord wire including series current tap and attachment plug complete. The heating element is located in the point, which is fitted with an interchangeable tip, both point and tip being composed of German silver, insuring minimum oxidation and long life. The point itself is connected to the handle by a spring coil, allowing the operator to literally "get around corners" in intricate soldering both in radio and general assembly work.

The heating element is composed of

nickel chromium, is large and durable. It has been subjected to exhaustive tests.

The Magnavox Company Announces New Models

AN announcement has been made by the Magnavox Company regarding the introduction of important additions to their line of reproducers and power amplifiers. Among these new models are the Magnavox combination sets A1-R and A2-R; a new Magnavox reproducer M1 and a new one-stage Magnavox power amplifier A1. The combination sets A1-R and A2-R (as illustrated) consist of the electro-dynamic Magnavox reproducer with 14-inch curvex horn and a Magnavox audio-frequency power amplifier (one or two stage) incorporated



Magnavox A1-R

in a new type of radio unit which might be termed an "Amplifying Reproducer."

The rheostats (maximum resistance thirty ohms) and circuits are so arranged in Magnavox combination sets that five-watt transmitting tubes or any type of amplifying tube



Power amplifier

may be successfully used, thus covering the widest possible range of operating conditions from the smallest home to the concert hall. These instruments are equipped with a modulating device for controlling the volume.

Another interesting and important Magnavox product is the M1 reproducer with 14-inch curvex horn. This instrument is of semi-dynamic type and has been developed



Magnavox A2-R

by Magnavox engineers along the original principle to meet the requirements of dry battery receiving sets, as it consumes no current from battery.

New York Coil Co. R. F. Transformers

THE new radio frequency transformers of the New York Coil Co. resemble nothing heretofore on the market, and are a complete departure from conventional practice. No "trick" circuit, delicate grid leaks or special capacity condensers are required

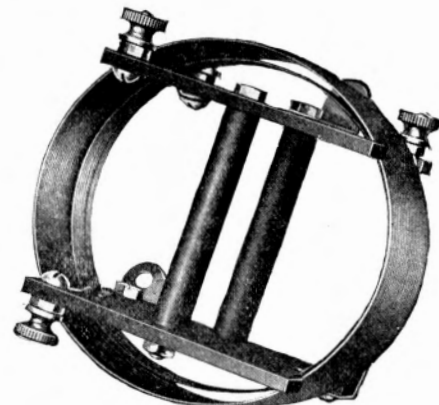

Radio frequency transformer

with these transformers and 201, 201A, or the 199 dry cell tubes may be used.

It is claimed that these transformers eliminate the heretofore experienced difficulties of radio frequency reception by originality of construction in electrical and mechanical principles. They are effective on wave lengths up to 550 meters.

Heath Radio and Electric Mfg. Co. Condensers

THE Heath Radio and Electric Mfg. Co. has incorporated several new ideas in variable condenser construction in their Radiant Condensers. The most vital feature of these condensers are the plates which the manufacturers claim cannot warp or buckle and are therefore permanently flat. To the ordinary processes of producing condenser plates they have added a special process of stamping the plates in extremely heavy presses which temper them to a degree of steel hardness. The Heath Radio and

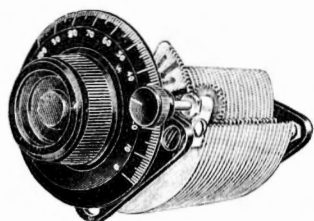

Heath condenser

Electric Mfg. Co. say that this protects their plates from temperature changes and the accidents which bend ordinary condenser plates. The advantage of this feature, of course, is that as long as the adjustment of the plates is undisturbed the condenser will remain aligned almost indefinitely, thus solving one of the most aggravating problems associated with variable condensers.

Another feature is a vernier adjustment that operates on a reducing gear. Teeth on the outer edge of the vernier plates engage directly with the reducing gear. This enables ordinary vernier adjustment to be made infinitely finer. This adjustment has a separate tension take-up screw so that action can be maintained always positive and accurate.

New Crosley Model XJ

DURING the summer of 1923, the experimental department of the Crosley Manufacturing Company conducted a series of practical tests with radio apparatus and from these tests there was created the new Model XJ that is now an important factor in the new Crosley line of radio receiving sets.

This new Model XJ utilizes the famous Crosley tuned radio-frequency circuit. This is the same circuit which was used in the



Crosley Model XJ radio receiver

Model X, the famous receiving set which made possible the hundreds of letters and telegrams from radio fans all over the country and especially from the static zones near Florida, where some of the owners of this model heard Honolulu several times. Except under the most adverse conditions, the owners of this model have heard stations from coast to coast. Now, however, comes the new Model XJ with its many refinements

that will enable the owner to get even greater service.

Incorporated in the new Model XJ, is the Crosley multistat, with its molded shell rendering a smooth ball-bearing contact and graduated resistance wire to accommodate any type of tube, adding to the appearance and efficiency of the set. The new molded sockets of a composition approved by the best radio engineers and the new radio-frequency tuned amplifier coil with its unique low resistance winding makes it possible to tune out local interference, a thing the Model X has been noted for.

The new Model XJ is equipped with a phone jack, so that it is now possible to plug-in on one-stage of radio frequency, detector and one-stage of audio frequency for head phones. Removing the phone plug, automatically switches to the loud speaker binding posts, which is always connected from the rear.

A filament switch has been provided, so that the tubes can be turned off.



Interior view

New knobs and dials have been provided and the large tuning knob is so grooved and designed, that vernier adjustment may be made with ease. These large dials and knobs are placed on the tuning condensers.

This new Model XJ is a four-tube set, consisting of one-stage of tuned radio frequency detector and two-stages of audio-frequency amplification. It is suitable for use with storage battery or dry-cell tubes.

Allen-Bradley "Bradleyleak"

THE Allen-Bradley Co., manufacturers of the Universal Bradleystat and Bradleystat, have added another item to their line of graphite disc radio products.

The new device is an adjustable grid leak known as the "Bradleyleak," which was developed to meet the insistent demand for a high-grade, dependable grid leak.

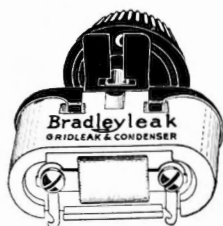

The Bradleyleak can be adjusted between the limits of 250,000 ohms and 10,000,000 ohms or, as usually stated, between 1/4 megohm and 10 megohms. The entire range of grid leak resistance between these limits is instantly obtainable without noises, steps or jumps by simply turning the adjusting knob.

The Bradleyleak is claimed to be very accurate and a desirable addition to any radio set and makes possible the accurate adjustment of grid leak resistance for any tube used on a detector circuit.

The base of the Bradleyleak is recessed to receive a small fixed condenser which is furnished as an extra attachment, if desired. The grid condenser is accurately adjusted to a capacity of 0.00025 microfarad.

New "Red Seal" Headset

A HEADSET designed to produce maximum results is the new "Red Seal" headset of the Manhattan Electrical Supply Company, Inc. Ohms were entirely neglected, but the impedance, matching that of the vacuum tube, is approximately 25,000 ohms at 1,000 cycles.



"Red Seal" headset

In addition to responding unusually well to weak signals, the Red Seal gives clear distinct response to strong ones. No "chattering" is possible, while the diaphragm is practically free from "periods."

Case and caps are of red bakelite. The headbands are covered with red moulded rubber, making the instrument very comfortable and easy to adjust.

U. S. Tool Co. Condensers

THE U. S. Tool Company has put on the market a line of variable condensers. It includes table mounting types as well as the plain and vernier types of all sizes and capacities.

The main shaft bearings are carefully machined, so that there is very little, or no wear despite years of use. Consequently there is no need of re-adjustment. The oxidizing of plates and spacers which ordinarily destroys the efficiency of most condensers is provided against by means of a special chemical treatment to which these parts are subjected. Even exposure to all kinds of weather has no effect upon these plates and spacers. This, alone, is a big step ahead in condenser manufacture. The insulating ends are of Condensite-Celeron. Although there has been endless discussion

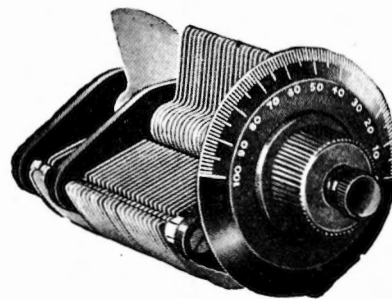

U. S. Tool Co. condenser

of the special claims of the various materials used for condenser end plates, there is no doubt that Condensite-Celeron has the virtues of non-retention of moistures and extreme dielectric and tensile strength.

INDUSTRIAL INKLINGS

Holland as a Radio Market

ACCORDING to best estimates there are at present no less than 4,000 amateur receiving stations in Holland; following the war there were only a score or more receiving stations. The Management of Posts and Telegraphs advises that there are about 477 other receiving and transmitting wireless stations in the country.

Permits for receiving stations are readily granted in Holland. Dealers in radio materials are now negotiating with the Government for authority to erect a general broadcasting station. The plan is to broadcast concerts and news on a much larger and better scale than is done at present by any Netherlands broadcasting service to amateurs.

Germany has been getting the bulk of Holland's import business, but the greater portion of German goods coming into the country are old war stocks. These goods cost usually anywhere from 40 to 50 per cent. below American and other competitors in price. Germany, of course, has advantages in the Netherlands on account of proximity of market.

The United States is gaining a better foothold in this market, however, and imports of radio material are increasing. Whereas in the full year 1919 the United States sent only \$1,600 worth of radio material to this market, during the first half of the year 1923 there were \$12,800 (normal) worth entered.

American goods will probably continue to enter the country on an improved scale, and competent members of the business express the opinion that if American parts and systems were made to conform more to local needs a much larger business would be done. American instruments in this market are as a rule designed for wave lengths averaging around 360 meters. In Holland most radio owners desire around 1,050 meters average, and, in a good many cases, up to 2,000 meters is required.

Ready entry of radio material is provided for in Holland, since there are no Governmental regulations or restrictions governing imports. The import duty on parts and whole sets is 5 per cent. ad valorem.

Benjamin J. Cohen with Rova Radio Products Corp.

ON August 22, The Rova Radio Products Corporation formally introduced its new vice-president, Benjamin J. Cohen, in charge of sales, to the radio press at a dinner at the Hotel Pennsylvania, New York.

Mr. Cohen has been with the United Cigar Stores for twenty-one years, and his promise to the representatives of the radio press was, that his efforts would be directed toward the establishment of confidence between the public and his organization—service to the consumer, and assurance that his

company would stand back of every dollar's worth of goods sold.

So far as entertainment at the dinner was concerned, Frank Tinney of the Music Box Revue, and Mrs. Tinney provided enough to satisfy the most exacting. No one had a better time than this fine team of entertainers, and they gave the crowd their best, and that is treat enough for one evening.

Broadcasting Helps Gas Sales

WHILE filling automobile tanks with gasoline this enterprising garage owner of New Haven, Conn., fills the air with speech and music by means of a loud speaker mounted outside the building. The innovation has proved to be very popular and has considerably increased the business of the filling station.



Radio loud-speaker used to stimulate gasoline service station business

THE interesting prize contest for windows trimmed to display to best advantage Cunningham vacuum tubes brought forth some notable displays for the week of September 24 to October 1.

The awards will consist of \$5,000 in prizes to be distributed among 45 dealers having the best windows. The contest was limited to radio retail dealers who had Cunningham tubes in stock or who had ordered them at the time of the first announcement of the contest.

THE building in Tokio in which was located the headquarters of Takato & Co., also the main office of the Westinghouse Electric International Co., in Japan, was destroyed in the September earthquake. The building, of five stories, was a beautiful example of the architect's art and was one of the most modern business buildings in the city.

THE Eisemann Magneto Corporation has a new 24-page catalogue, "Radio Products," ready for distribution. It is of letterhead size, 8½x11, which makes it convenient for filing and contains a complete description of all Eisemann radio products which, as William N. Shaw, president, says

in the foreword of the new booklet, "carry the full guarantee as to workmanship and quality."

New Sales Plan of Magnavox Co.

AN extension of the sales and advertising co-operation of the Magnavox Company has recently been announced and the new Magnavox selling plan has features which will prove of interest to all who are following the steady progress of radio.

In general the new plan consists in the appointment of Magnavox registered distributors whose combined influence covers the country; and also the appointing of registered Magnavox jobbers who supply the trade not directly reached by the Magnavox distributors' salesmen. The distributors are appointed directly by the Magnavox Company who in turn appoint the jobbers.

In addition registered Magnavox dealers are also being appointed, their selection being in the hands of the Magnavox distributors and jobbers.

The Magnavox promotion service is intended to link up the Magnavox wholesale and retail dealers with the extensive national advertising of the Magnavox Company and consists in supplying without charge a considerable quantity of efficient selling helps.

These selling helps include booklets, folders, leaflets, display cards, newspaper electros or mats, moving picture slides, giant reproductions of the Magnavox advertisements in the *Saturday Evening Post* and finally an extremely attractive Magnavox cutout lithographed in eight colors.

Each registered Magnavox dealer is furnished by the Magnavox Company with a registered dealer certificate in the form of a decalcomania for use on his window. Within a short time it is planned to register dealers in practically every community throughout the country where radio products are sold.

More efficient service to the radio consumer is the real objective in this selling plan and only such dealers are registered by the Magnavox Company as are qualified not only to carry the line in stock, but also to assist the purchaser in the selection and installation of radio equipment.

An important feature of this sales plan consists in reaching the wholesale and retail registered dealer at regular intervals by means of the Magnavox house organ which is devoted to assisting dealers in the efficient selection of display advertising and selling of Magnavox radio products, as well as to publish notices of interest to the radio trade.

THE H. H. Eby Manufacturing Company has ready for distribution their latest catalogue No. 15. This catalogue illustrates their complete lines of metal and insulated binding posts as well as other electrical specialties they manufacture. Copies of the catalogue will be sent free upon request.

Modern sales methods employed by live radio dealers include more than a mere display of apparatus

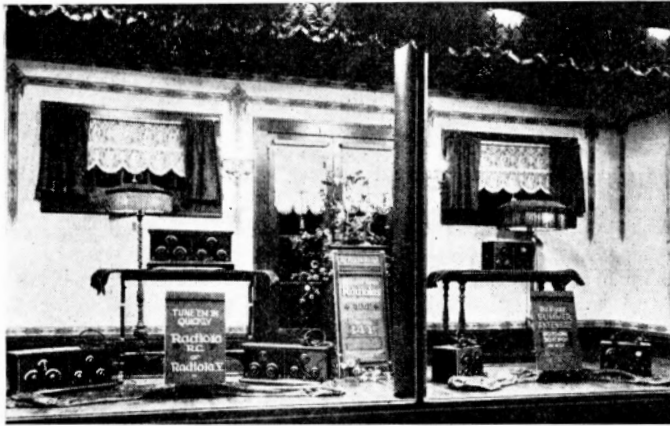

RCA window display of the McGraw Company, Sioux City, Iowa. "Tune 'em in quickly with a Radiola," is their slogan



RCA window display of the Shepard Stores, Boston, Mass. The Radiola enriches the home surroundings

Zenith Radio Corporation

THE Zenith Radio Corporation with a \$500,000 capitalization all common stock with a par value of \$10.00 has been incorporated and has the contract to act as the exclusive selling agents for Zenith radio receiving and sending apparatus, manufactured by the Chicago Radio Laboratory.

The officers and directors of the corporation are: E. F. McDonald, Jr., president and treasurer; Thomas M. Pletcher, vice-president; J. R. Cardwell, director; U. J. Herrmann, director; Irving R. Allen, director; N. A. Fegen, secretary, General Sales Manager; and S. I. Marks, assistant treasurer.

The Chicago Radio Laboratory is now enlarging its factory and manufacturing facilities to enable it to take care of an output of 300 sets per day. R. H. G. Mathews and K. E. Hassel of the Chicago Radio Laboratory are already busy with production of Zenith radio apparatus in period designs.

THROUGH the co-operation of the Wisconsin Radio Club there will be exhibited at the Fifth Annual Food, Household & Electrical Exposition, to be conducted by *The Milwaukee Journal* at the Milwaukee Auditorium, October 15 to 21, a complete radio broadcasting station for public inspection, and a series of educational exhibits, detailing the benefits of the use of radio in the home and on the farm.

The exhibits will occupy some 3,000 square feet of floor space and will be under the direction of the Wisconsin Radio Club which is composed of Milwaukee County radio dealers.

P. C. Kullman & Co., New York City, are sending out the fifth of a series of circulars designed to create a world-wide interest in radio. This latest circular has been mailed to officials-in-charge of wireless telegraphy and radio telephony in 112 foreign countries. It gives interesting in-

formation of radio development in the United States, including the following statistics:—

Trans-Oceanic Stations	12
Experimental Stations	292
Broadcasting Stations	591
Point-to-Point Commercial Stations	128
General Public Service Stations...	41
Aeroplane Stations	2
Technical Training School Stations	128
Amateur (Licensed) Stations	18,357
Limited Public Point-to-Point Stations	40
Ship Stations (Estimated)	3,000
Receiving (Unlicensed) Stations (Estimated)	3,500,000

Readers of THE WIRELESS AGE can obtain copies of this and other interesting circulars on radio development by addressing Kullman and Co., 116 Nassau Street, New York.

Bureau of Standards Tests Receiving Sets

THE results of tests of radio receiving sets by the Bureau of Standards are given in a series of letter circulars of which the first (No. 90) was mentioned in item 9 of Technical News Bulletin No. 73. This paper dealt with tests of electron tube sets. The second circular of this series (No. 93) is now ready for distribution and gives the results of tests on crystal detector sets.

It is believed that the methods followed and the examples given in these reports will be of assistance to manufacturers in the development of methods of testing besides aiding them to properly describe and improve their products. The particular receiving sets are referred to by arbitrary reference numbers rather than by manufacturer's name and type and model numbers. As these circulars are only available in mimeographed form, the supply is limited, but copies can be obtained by those directly concerned with the testing of receiving sets by addressing the Bureau of Standards.

STATIONS WORKED AND HEARD

Stations worked should be enclosed in brackets. All monthly lists of distant stations worked and heard which are received by the 10th of each month will be published in the next month's issue. For example, lists received by November 10th will be published in the December issue. Spark and C. W. stations should be arranged in separate groups.

8AEB, Don I. Barringer, Kalamazoo, Mich. (Sept.)

1aur, 1gv, 1acu, 1bes, 1bji, 1ckp, 1cpi, 1cmp, 1cw, 1ckp.

2fp, 2sm, 2wb, 2agx, 2agb, 2amr, 2apd, 2aqq, 2bji, 2bnz, 2bsc, 2cfb, 2cqv, 2cqz.

3bp, 3ds, 3mk, 3mo, 3ni, 3th, 3tj, 3su, 3uj, 3tw, 3th, 3vh, 3vd, 3wf, 3xn, 3ys, 3zt, 3afs, 3atg, 3bdo, 3bmo, 3bof, 3buy, 3bpm, 3cdn.

4ag, 4do, 4os, 4mb, 4gx, 4cs, 4kc, 4kf, 4er, 4om, 4ft, 4eb, 4rx (4uk ? qrm), 4my, 4ku, 4lj, 4ni, 4na, 4mi, 4gw.

5nj, 5pv, 5qh, 5ma, 5hl, 5ek, 5lr, 5ga, 5ny, 5za, 5kw, 5sg, 5uk, 5kc, 5am, 5fc, 5je, 5gi, 5sf, 5abt, 5aby, 5acm, 5akn, 5agg, 5amb.

Canadian 3bp, 3kg, 3ni, (9al?) (3wi?)

Also a large number of 8's and 9's were logged.

9ZT, D. C. WALLACE, Minneapolis, Minnesota. (Two weeks August over 1000 miles.)

CW. 1er, 1bbo, (1bcg), 1bes, 1bsj, (1bwj), (1crw), 2bnz, 2brc, 3ab, 3bv, 3iw, 3sg, 3brf, (3bva), (3chg), 4eb, 4gl, 5gj, 5gn, (5gp), 5nj, (5ns), (5sk), 5uc, 5uo, (5aba), (5acq), 5ajj, (5akn), 5amh, 5xab, (6hp), (6km), 6tv, 6arb, (6aru), (6awt), (6bjq), (6bvg), (6cbu), 7zn, (7agv).

Canada—2bn, mex, jh.

The Monthly Service Bulletin of the NATIONAL AMATEUR WIRELESS ASSOCIATION

Guglielmo Marconi
President

J. Andrew White
Acting President

H. J. Welker
Secretary

Founded to promote the best interest of radio communication among wireless amateurs in America

NATIONAL ADVISORY BOARD OF VICE-PRESIDENTS

Maj. Gen. George O. Squier
Chief Signal Officer, U. S. Army
Prof. A. E. Kennelly
Harvard University

Prof. Alfred N. Goldsmith
College of the City of New York
E. E. Bucher
Instructing Engineer

HEADQUARTERS: 326 BROADWAY, NEW YORK

ACCORDING to final reports from Australia, the following American amateur stations were heard there during the recent 8,000-mile trans-Pacific tests.

3ail, 3ard.
5me, 5no, 5aec, 5ado, 5bch.
6bp, 6bv, 6jd, 6ku, 6pd, 6avn, 6bic, 6bum, 6cbi, 6cdq, 6cgw, 6xad.
7au, 7la.
9gg, 9za, 9arl, 9auc.

In the case of some of these stations assigned code words were transmitted and the reception accordingly verified, but there is considerable doubt regarding the reported reception of a number of others.

Of the stations heard 6PD, San Francisco, Calif., was reported as being the strongest, the signals being consistently loud and clear.

A complete message was received from station 6JD, Los Angeles, and the signals of that station were reported as being audible at times twenty-five feet from the phones. The message received from 6JD is the first confirmed message ever received in Australia from an American amateur station. This same station is also reported as having been heard in Adelaide on a single tube receiver.

Conditions during the tests, especially at the receiving end, were poor. The whole country had suffered from a prolonged drought previous to the tests which was finally broken by heavy rainstorms which brought heavy static along with them. Other tests will probably be conducted this Fall.

THE first meeting of the Milwaukee Radio Amateurs' Club, Inc., following the annual Summer recess was held on Thursday evening, September 20th, at 8:00 P. M. in the Trustees' Room of the Milwaukee Public Museum. One week later the society, which is over six and a half years old and is now a non-stock corporation, held its annual corporate meeting at which there was an election of the members of the Board of Directors. The newly selected directors will appoint the five general officers and the committee chairmen.

At the several mid-summer meetings of the present directors extensive plans were formulated for a Fall membership campaign. Not only radio amateurs living in the City of Milwaukee will be invited to join the club, but all those residing in the city's suburbs and surrounding county. The club is primarily one for amateurs, but membership is open to others interested in radio,

particularly to technically inclined broadcast listeners.

A lecture program is being arranged for. The committee in charge promises to present to the club during the course of the season some of the best known amateurs in the country as well as several men high in the commercial side of the radio field who have a known reputation as designers and manufacturers. Traffic discussions and means to reduce any local interference that there may be, will receive the attention of some gatherings of the members.

General co-operation with all other interests in the radio field will constitute the policy of the Milwaukee club. No great financial obligations are assumed by joining, and with a 100 per cent. representation of amateurs the association can act for all amateurs in any question involving their rights. The club's correspondence address is, 601 Enterprise Bldg., Milwaukee, Wis.

THE famous "zero," or unknown transmitting station of Paris, which has given the French authorities something to worry about for a long time, has at last been identified as one belonging to an American resident of the French capital, Reginald Gouraud.

The thrilling story of the mysterious "zero station" of Paris came to light when the young American, his experimental work completed, surrendered to the military authorities. His ingenuity and sense of humor, broadcast from his station, had amused France for months while the authorities were searching frantically to locate him.

Gouraud went to France to join the American ambulance unit during the war and remained after peace was declared. He began experimenting in radio with a spark set and a crystal detector. The set for both sending and receiving was developed by him more than a year ago. French law prohibits aliens from owning and operating radio sets, but that didn't bother Gouraud.

The trouble started one night when Gouraud determined to talk to the world despite the law. He tuned to the wavelength of Eiffel Tower broadcasting station, and after listening to a concert, suddenly broke in with, "Hello! Hello!" All listeners-in then heard some perfectly good English language. Then he started his phonograph and served out a program of lively jazz.

Military stations throughout France heard the first greeting with astonishment. The operators could not understand English, but

understood the jazz. Gouraud signed off in French by saying, "We will have another concert tomorrow. Good night, ladies and gentlemen."

The next night it was the same. In a few days all the operators in France were listening while the American "kidded" them with his slang French and English and snappy jazz records. The police began a search and French newspapers took up the story of the mysterious station, which continued its illegal operation unhindered for a long time. Finally Gouraud surrendered to the French authorities, but was released upon promising that he would never again violate French radio laws.

THE signals of station 2BIR, D. A. Troy, Nutley, N. J., were recently heard by 6RR, Los Angeles, Calif. One five-watt tube is used at 2BIR.

AMATEURS and broadcast listeners throughout New Jersey reported a very welcome absence of odd noises while the trolley cars there were idle, owing to the strike.

E. R. BATEMAN, 418 Norman Avenue, Baltimore, Md., Call 3APT, reports the reception of signals and messages from the *Bowdoin*, call WNP, the ship of Explorer MacMillan, now in the Arctic on a long exploration of the polar regions. WNP has also been heard by George H. Pinney, South Manchester, Conn., 1CKP; Irving Vermilya, Marion, Mass., 1ZE; James A. Trainor of Dorchester, Mass., and R. B. Bourne of Chatham, Mass., since the ship left on its trip to the Far North.

Recent messages said that the *Bowdoin* was located at Etah, Northwest Greenland.

CONSTANCE LEE SHARP, 16 years old, of Alhambra, Calif., who has just been granted a first-class commercial radio license, is said to be the youngest member of the female sex to obtain a license of that grade.

JOHN LENOX, of 581 Perry Street, Trenton, N. J., while endeavoring to pick up WGY, ran across radiophone speech which proved to be a magazine article being read by an aviator into a transmitting set in an aeroplane high above the ground. The reader gave the call letters of the plane as DG-4, but neglected to say where it hailed from or where it was going and it has not as yet been identified.

L EON DELOY, of Nice, France, owner and operator of French Amateur station 8AB, the only French station to be heard in America during the tests of last winter, arrived unexpectedly in New York early in September for a visit with American amateurs.

Soon after reaching America, M. Deloy went to Hartford, Conn., and visited the offices of the American Radio Relay League.

M. Deloy is known to American amateurs because of his persistent efforts during the last year to establish two-way direct traffic with amateur stations in this country. He stated that he was confident of final success in the coming December amateur tests.

While in Hartford he visited the home of Hiram Percy Maxim, president of the league, and operated the latter's station 1AW, the first time that he has touched a key of an American transmitter.

Besides his interest in amateur radio, which he regards distinctly as a hobby, he is a sportsman of international reputation, being the champion live-pigeon shot of Europe. * * *

T HE Central High School Radio Club has been organized at Newark, N. J. Any boy student may become a junior member, but the requirements for senior membership embrace such things as ownership of a vacuum tube set, ability to read and draw diagrammatical hookups, and a satisfactory grade in examination on radio theory.

The faculty advisor of the club is David Skolnick, who is also vice president of the Faculty Radio Club. The recently elected officers are: Joseph Medresch, president; Herbert I. Diamond, vice president, and Hyman Marcus, secretary.

The vice president is chairman of the program committee, the other members of which are Robert DeCamp and Joseph Scilla. This committee has arranged many interesting talks to be given to the club, including talks by members of the faculty, members of the club and experienced amateurs.

Queries Answered

Answers will be given in this department to questions of subscribers, covering the full range of wireless subjects, but only those which relate to the technical phases of the art and which are of general interest to readers will be published here. The subscriber's name and address must be given in all letters and only one side of the paper written on; where diagrams are necessary they must be on a separate sheet and drawn with India ink. Not more than five questions of one reader can be answered in the same issue. To receive attention these rules must be rigidly observed.
Positively no questions answered by mail.

B. A. Smith, Watertown, N. Y.

Q. I would appreciate a little information in regard to the article of negative potential on vacuum tubes by Bernard Steinmetz, as written in the June issue of THE WIRELESS AGE. In the circuit employing the potentiometer across the "C" battery of grid circuit, would it not be necessary to use one of a certain resistance? If so, let me know just what I should use. I use a Reinartz. How would this work in it, or can you give me a hook-up which would be more selective for radiophone reception?

A. A Radio Corporation potentiometer, PR-536, of 200 ohms resistance is satisfactory. Here is a hook-up using three honeycomb coils which will be much more selective.

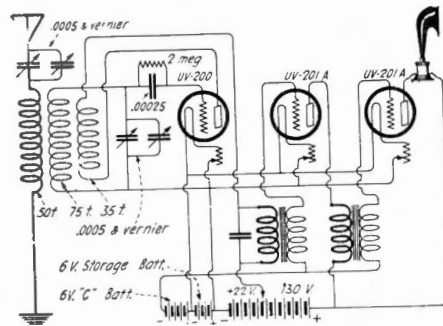

Carlo Janson, New York City.

Q. I have a single tube WD-11 set and I want to get a one-step amplifier. Therefore I bought another WD-11 tube, a socket, a rheostat, an amplifying transformer and

a radio frequency transformer, but I do not know how to wire it.

A. The accompanying diagram is a good workable circuit for your purpose, and includes one step of reflex.

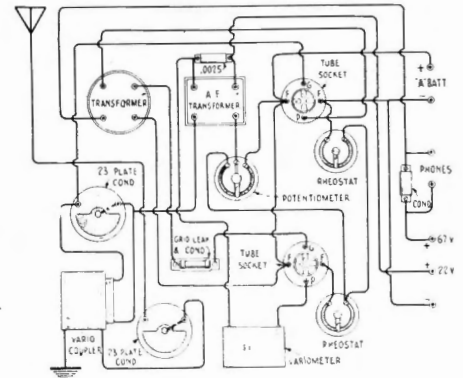

"3,000 mile"

RADIO "B" BATTERY

DIRECT FROM FACTORY TO YOU

Greatest radio B battery on market. Absolutely fresh, full voltage, seamless cells, noiseless—will bring in Concerts **LOUDER** and **STRONGER!** Built correctly—full number of voltage taps—will work any tube or on 1 speaker. Real service **GUARANTEED.** Sold direct from our factories to you at lowest prices. Shipped prepaid to your door. **ORDER TODAY.** Send money order, check or pay C. O. D. Order By Number

No. 5 22B—22½ volt variable—regularly \$2.25—our price **\$1.98**
 No. 5 22A 22½ volt variable—regularly \$3.00—our price **\$2.65**
 No. 5 45A—45 vol.—8 taps—regularly \$6.00—our price **\$3.98**

AYRES BATTERY CORPORATION. Cincinnati, Ohio

Pall Mall Products

Hook Up and Description of the famous **ESSEX ONE TUBE COAST TO COAST CIRCUIT**

FREE to the first 1,000 fans who send in a 2c. stamp and the names and addresses of five friends who are interested in Radio.

ESSEX MFG. CO., 119 Mulberry St. Newark, N. J.

Jones' "Fiddlestick" Vernier

Drill one hole on side of each dial and make all fine adjustments with your hand away from set. Nicely finished in black enamel. Mounted 24 on a card for counter display.

JONES' CONDENSER CLEANER

Pat. Applied For

HERE IT IS

Clean those dusty, dirty condensers. Stop that noise every time you come to a certain spot. You will notice the difference at once. Mounted 24 on a card. Samples by mail 12c each. Samples free to recognized dealers and jobbers.

HOWARD B. JONES, 612 S. Canal St., Chicago

ATWATER KENT

RECEIVING SETS AND PARTS

If you are now working with a one-tube set, the 2-stage amplifier shown here will give you the necessary volume of sound to make a loud speaker possible.

It is a compact unit—transformers are sealed in the base so that no dampness can affect the working quality of the instrument. To demonstrate the damp-proof qualities, one of these instruments was soaked in a tub of water for several hours, then put into a circuit and tested for reception with perfect results.

Send for an illustrated folder showing all parts and complete sets.

ATWATER KENT MANUFACTURING COMPANY
 4946 STENTON AVE. Radio Dept. PHILADELPHIA, PA.



LOUD SPEAKER

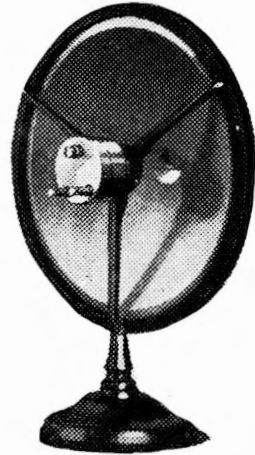

Price
\$22.00

A Combination of Efficiency and Beauty

The Pathé Loud Speaker is unexcelled for its clarity and faithfulness of reproduction. In the large sized diaphragm lies the secret. The music is thrown directly from the diaphragm into the air in all directions. That choked and distorted sound is eliminated. Only a beautiful pleasing tone is heard.

The beauty of the Pathé Loud Speaker has called for untold praise. Its design shows excellent taste. Its elegant finish of delicate Pompeian Green blends with the surroundings of any room. Not big, not ugly, just as sweet as the music it faithfully reproduces.

Jobbers and Dealers write for Special Proposition.

Pathe Phonograph and Radio Corp.

20 Grand Avenue, Brooklyn, N. Y.
533 South Wabash Avenue, Chicago, Ill.

Get on the Subscription List and you will be sure to get your copy of THE WIRELESS AGE

SAVE YOUR TUBES

NEW—INDISPENSABLE NEON VACUUM TUBE PROTECTORS

Prevents accidental burning out of your tubes.

This is not a fuse—nothing to burn out. Only one is needed for your entire radio outfit. Get one now and save yourself considerable expense and inconvenience.

SIMPLE SAFE SATISFACTORY

PRICE 50c



PRICE 50c

Ask your dealer, or send direct to us.

Complete illustrated catalog of the NEON RADIO LINE sent on request.

NEON LAMP WORKS, Inc., - - - 64-70 West 14th Street, New York City

Lorin Mayhorn, Sebastopol, Calif.

Q. Can a Tesla high-frequency coil, mentioned in Vol. III of "Homemade Electrical Apparatus" be operated on a toy 1102-volt step-down transformer? If so, how many volts should it take?

A. A Tesla coil cannot be operated from a step-down transformer.

* * *

Albert Montgomery, Greenleaf, Kans.

Q. 1. Would the hook-up of the reflex circuit, shown in figure 1 on page 61 in the May, 1923, issue of THE WIRELESS AGE, work more successfully coupled to an aerial and ground than a variocoupler? If so, will you please publish diagram?

A. 1. Below is circuit you request.

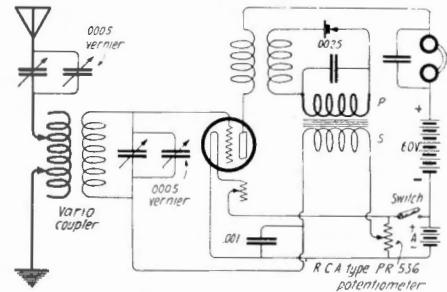

Q. 2. Please explain how the potentiometer is connected across the terminals of the "A" battery without drawing current from the battery all the time and overheating the potentiometer.

A. 2. The potentiometer has a resistance of 200 ohms and in the case of a 6-volt battery draws only 6/200 or 0.03 ampere. This current is insufficient to heat the potentiometer. In case dry cells are used for the "A" battery, it is best to connect a switch as shown, so that the batteries will not run down.

* * *

Edwin J. Israel, New York City.

Q. 1. Will you please be good enough to give me a circuit diagram of the Radiocraft Company's type D-6 outfit (Armstrong patent) showing also the capacity, etc., of the various condensers, coils, etc?

A. 1. Below is a circuit similar to the Radiocraft, using two stages of audio frequency.

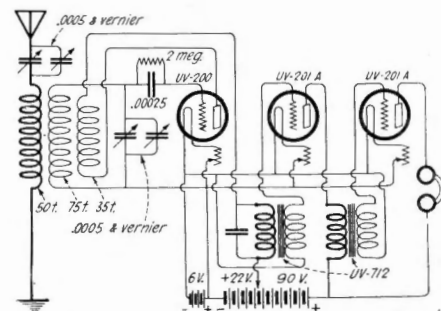

Q. 2. I have been contemplating getting a Grebe RORN tuned R.F. amplifier to be used in conjunction with this set. Would this make a good combination insofar as better results in bringing in DX is concerned? Or would you recommend a radio

frequency amplifier of different make for better results with the D-6 mentioned?

A. 2. A Grebe type RORN radio frequency amplifier will give better results when used with the above circuit.

Q. 3. What tubes do you recommend using on the radio frequency amplifier?

A. 3. UV-201-A or C-301-A tubes are probably the best for radio frequency. UV-199's are the best dry battery tubes for radio frequency amplification.

Q. 4. If a radio frequency were used could the D-6 be used on an indoor loop aerial?

A. 4. An indoor antenna about 15 or 20 feet long, or a loop antenna may be used.

* * *

H. H. Ashbrook, Mitchell, Nebr.

Q. 1. Please publish the wiring diagram of the Colin B. Kennedy regenerative set, detector and two-step amplifier. Also diagram for two-stage radio frequency to work with same, using 201-A or 301-A tubes.

A. 1. Herewith is the circuit desired.

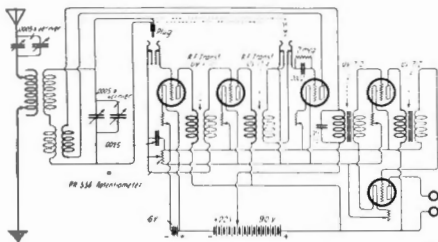

Q. 2. Which is the more efficient, tuned or untuned radio frequency?

A. 2. Tuned radio frequency is the more efficient.

Q. 3. Which is the simpler to handle?

A. 3. Untuned radio frequency is easier to handle.

* * *

F. M. Adsit, Syracuse, N. Y.

Q. Please give me a hook-up of a two-stage amplifier to be used with the new Flewelling circuit.

A. The diagram is as follows:

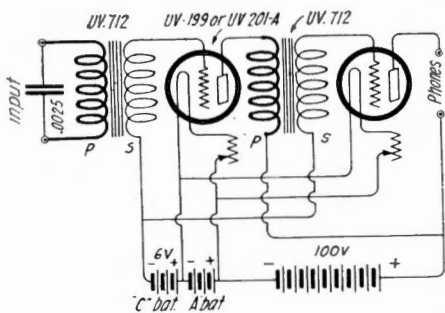

Charles W. Lewis, Pawtucket, R. I.

Q. Above is my hook-up which I would like to improve with your help. When I built the detector I got KDKA about 600 miles and could not get any other station. I added one stage of amplification and got local stations with excellent results. Is it possible to make this a reflex? If so, what do I need? How do you wind a D.C. 50 coil?

A. You will find it hard to get distant stations in the Summertime. In the Fall and Winter your range will be very much greater. See other "Questions and Answers" in this issue for reflex hook-ups.



Have An Established Reputation for Honest Value, Maximum Results And Ease of Installing

New York Skeleton Type Tune Radio Frequency Transformers have so simplified Radio Frequency that you can enjoy the thrill of long distance reception, the satisfactory operation of a loop, or the tuning in of just the one desired station—these actual results (not idle claims) are due to our original design and advanced Radio engineering found in no other transformer. Any one can construct, at small expense, a highly efficient two stage set with positive certainty of results, price \$4.00 each.

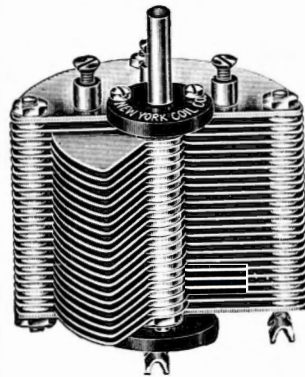
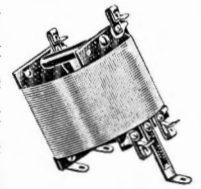

New York Condensers bring in the broadcasting loud, and clear with the true tone, because the construction eliminates all leakage and electrical losses—the standard by which others are judged.

11 Plate	\$1.50
23 "	2.00
43 "	3.00
3 "	1.25

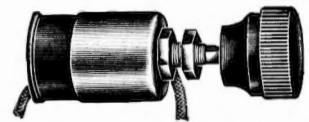

Supplementary Vernier Condenser \$1.00

Insist on New York Amplifying Transformers. Do not be satisfied with something claimed to be "just as good." They are universally recognized for their marvelous amplification, purity of tone and ability to produce uniformly perfect results with any style of standard tube. Price \$4.00 and worth it.

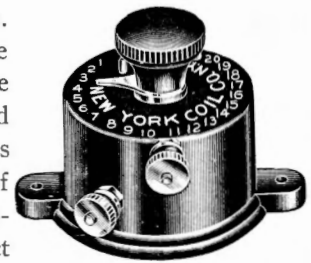
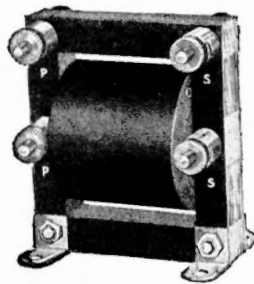

New York Variable Grid Leak \$1.50

Get literature on

Variometers, Couplers, Mica Condensers, Inductance Tap Switches

NEW YORK COIL COMPANY
338 Pearl Street New York City

William Schreiber, Jr., New York City.

Q. I would like to have some information regarding an article "A Supersensitive Receiving Set," by Charles R. Doty, published on page 84 of "Practical Amateur Wireless Stations." The information wanted is: Can a long range bank wound variocoupler be used in place of the loose coupler? Can the coils marked L and L-1 be bank wound so that a small length of tube could be used in place of the 30-inch tube?

A. A bank wound variocoupler can be satisfactorily used in place of the loose coupler. The coils L and L-1 may also be bank wound. * * *

W. R. Van Dyck, West Philadelphia, Pa.

Q. Referring to "A New Reflex Circuit" on page 61 of the May issue, show the aerial and ground if used with outside aerial; or is loop absolutely best? Have WD-11 tube, also 199 tube.

A. Either a loop or a 2-circuit tuner should be used with this reflex set.

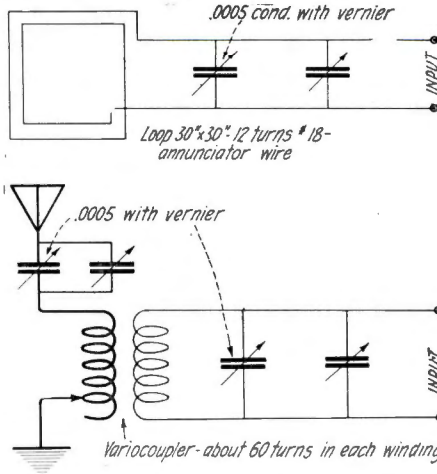

R. K. Temple, Lynchburg, Va.

Q. Kindly give a formula in THE WIRELESS AGE for the inductance of a choke coil having a core of Norway or Swedish iron wire or any iron wire of good quality.

A. Empiric formula for inductance of open iron core choke coil:

$$L = \frac{T^2}{3140} (0.00042 l + 0.00012S)$$

Where L=inductance in henries
T=number of turns
l=length of iron core in inches
S=area of cross section of iron core in square inches

This formula is the result of many experimental observations.

* * *

Wm. C. Frindell, Pangman, Sask., Canada.

Q. 1. Will you please publish in THE WIRELESS AGE a hook-up of a Reinartz receiving set, showing details of the winding of the spider web coils?

A. 1. Below is diagram:

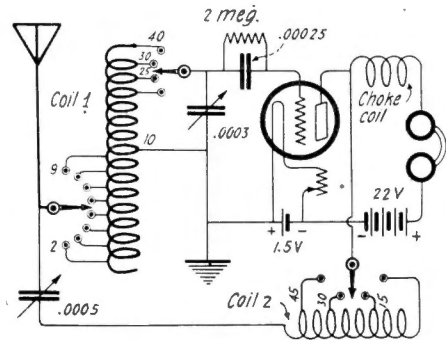

Either a spider web or a cylindrical coil may be used. The latter is to be preferred because of the simplicity of winding. Coils 1 and 2 are both wound in the same form. A spider web of 2½ inches inside diameter is used, with 9 spokes radiating; No. 26 S.C.C. wire is used. The plate winding, coil 2, is first started—45 turns are wound with taps at 0, 15, 30 and 45 turns. Coil 2 is then wound in the same direction, with taps at 2, 4, 5, 6, 7, 8, 9 turns—a ground tap at the tenth turn. Continuing, taps are taken at 25, 30, and 40 turns. The radio frequency choke coil in the plate circuit consists of about 300 turns of No. 29 or No. 26 S.C.C. wire wound on a tube 2½ or 3 inches in diameter—about 4 layers of 75 turns per layer. A 250-turn honeycomb or other machine wound coil is also satisfactory. A very thorough-going description of the Reinartz receiver is given in "Radio Telephony for Amateurs" by Ballentine, a Wireless Press book.

Q. 2. Will you also state if a wet primary battery could be used for lighting the filament of a peanut tube (Northern Electric R-125)?

A. 2. A wet primary battery is very good for such purpose.

* * *

Mr. W. T. Cobb, Jeanerette, La.

Q. I want to charge my 6-volt A battery from our lighting plant and just don't know how much resistance to use. We have a 110-volt direct current generator with sixty 2-volt cells for use when generator is not running. Can I use lamps in reducing the voltage? I wish to charge at about 5 amperes.

A. To charge your battery from 110-volt D.C. you will require a resistance of 22

"COPPERWELD"

(Made by the Molten Welding Process)

ANTENNA WIRE

**STRONGEST
MOST EFFICIENT — BEST**

The permanently welded copper exterior makes it ideal because of "skin effect" phenomena of radio currents. Standardized by the largest manufacturers of radio equipments.

Sold everywhere
100, 150 and 200 feet per carton

BUY IT IN CARTONS



"COPPERWELD"
THE IDEAL RADIO ANTENNA

COPPERWELD IS 30% STRONGER than Copper, can be strung taut, stays up when other wires stretch and break, and gives 100% electrical efficiency.

COPPER CLAD STEEL COMPANY
BRADDOCK P. O., RANKIN, PA.
Directions for Antenna construction on reverse side of carton

COPPER CLAD STEEL COMPANY

NEW YORK SALES OFFICE: 30 CHURCH STREET, NEW YORK
CHICAGO SALES OFFICE: 129 S. JEFFERSON ST., CHICAGO
MAIN OFFICE AND WORKS: BRADDOCK P.O. RANKIN, PA.
403 RIALTO BLDG., SAN FRANCISCO



UNITED Y. M. C. A. RADIO SCHOOLS

The largest radio school chain in the country

Interesting Work Good Pay See the World

Each year we enroll hundreds of radio students.
Our graduates sail the seven seas.
Radio will give you a millionaire cruise to almost any port in the world.

If you are red-blooded and like adventure, study radio.
Complete laboratories fitted with the very latest apparatus.
All instructors experienced radio men.
Dormitories, Restaurants and Swimming Pool for use of students.
Complete radio training in the shortest possible time.

Send today to the nearest school for full information.

149 East 86th St.
New York City

Central Y. M. C. A.
Seattle, Wash.

715 So. Hope St.
Los Angeles, Cal.

ohms which must be capable of safely carrying 5 amperes. If you wish to use lamps, you will require any one of the following combinations:

1. Six 100-watt lamps in parallel.
2. Twelve 50-watt lamps in parallel.
3. Ten 60-watt lamps in parallel.
4. Fifteen 40-watt lamps in parallel.

These may be carbon lamps since you do not care about the illumination. If you have a 500-watt electric iron you may use that as a series resistance instead of lamps. Be sure to allow for sufficient cooling in either case, whether you use lamps, resistances, or electric iron.

* * *

Arnold W. Miller, Laurium, Mich.

Q. Would you kindly furnish in THE WIRELESS AGE a suitable hook-up for charging a 70-volt B battery, using a 6-ampere Tungar bulb? What is the proper filament

current of these tubes? Please note my hook-up and formula. Would the bulb stand that amount of current from filament to plate?

A. The filament of a 6-ampere Tungar bulb requires about 15 amperes at 3 volts. You will require approximately 25 turns for the filament. Because of the high filament current, this winding should be of low resistance. You should use two strands of No. 12 S.C.C. wire connected in parallel, or else use copper ribbon $\frac{3}{8}$ inch wide x $\frac{1}{32}$ inch thick.

* * *

Sam H. Wilson, Liberty, Mo.

Q. 1. Is, in your opinion, the "100-Mile Crystal Receiver" as described on page 76 of the December issue of THE WIRELESS AGE, a better, longer range and louder tone set than one made up of a Signal Jr. 600-meter loose coupler, condensers and crys-

tal detector? I have one of the loose coupler sets on which I have heard Detroit, Chicago, Atlanta and Ft. Worth all on the same night and received them direct as no V.T. receiver is within five miles of here.

A. 1. We doubt whether you will be able to improve on your present reception with any other crystal receiver.

Q. 2. Of the one-tube circuits, Flewelling, Reinartz and super-regenerative, which gives the loudest amplification; which is the most selective; which is the easiest to tune; which, in your opinion, is the best for the concerts as will be broadcasted under the new rulings, and how do they compare in strength of tone with the three or four tube reflex receivers that are on the market now?

A. 2. Loudest amplification is obtained with the super-regenerative receiver. The Flewelling is not a super-regenerative cir-

FERBEND
TRADE MARK
Wave Trap
PATENT APPLIED FOR
The Original Wave Filter
Stops Interference!
Eliminates interfering stations.
Improves the selectivity of the set.
Eliminates local broadcasting.
Selects between conflicting stations.
Simplifies tuning.
Often increases signal strength.
Reduces howling and squealing.
The WAVE TRAP is mounted on a Formica panel in a beautiful mahogany finished cabinet 6x5x6, and is a high grade instrument throughout enhancing the appearance of the most expensive sets.
**18 E. SOUTH WATER ST.
CHICAGO**

The Saturn
Above The Ordinary "Radio Products"
Automatic Plug
AUTOMATICALLY perfect electrical connection. Made or broken with one swift, simple movement. Terminal tips, held in a vise-like grip that tightens the harder you pull on the cords. Lever instantly releases the tips. Each Saturn Plug fully guaranteed.
LIST PRICE, \$1.00
Perfect Jack
CROWFOOT Offset (illustrated in circle below) reduces soldering to utter simplicity. Solder and flux already on blades. Nickel-plated brass bracket, with rounded corners. Spring German-silver blades, sterling silver contact point.
LIST PRICES
No. 1 Single Circuit Open 50c.
No. 2 Single Circuit Closed 55c.
No. 3 Double Circuit Closed 75c.
No. 4 Single Filament Control 75c.
No. 5 Double Filament Control 80c.
The Saturn Mfg. & Sales Co., Inc.
48 Beekman Street
New York, N. Y.

Build Your Own
HAZELTINE
NEUTRODYNE
with
FREED-EISEMANN
Licensed Essential Parts
Complete wiring diagram, instructions, etc. sent in special container with patented essential parts. Three NEUTROFORMER COILS mounted on variable condensers, and DOUBLE NEUTRODON (as illustrated), sent for \$24.00. Ask your dealer to show you these parts, as well as complete assembled five-tube Neutrodyne Set in mahogany cabinet, Model NR-5, \$150.
Or send 25c for Neutrodyne Constructor which shows "How to Make the Neutrodyne"
FREED-EISEMANN RADIO CORPORATION
255 Fourth Avenue New York
Licensed by I. R. M. Inc. Under Hazeltine Patents

PROTECT
THE HEART OF YOUR RADIO SET
Vacuum Tubes are costly and extremely delicate. B battery or any other excessive current applied for only the fraction of a second to the filament leads will burn out your tubes. You have probably already had this experience and it is apt to happen again at any time. A burnt out tube means money lost—the set out of commission—inconvenience to you.
WHY TAKE THESE CHANCES WHEN RADECO SAFETY FUSES
will absolutely protect your tubes. Applied in an instant to the filament terminals. Will fit any standard tube or go in any standard socket. Fully guaranteed. 50 cts. each. Sent Postpaid. Delay may be costly. Write now. Specify type of tube used.
Dept. 8
RADIO EQUIPMENT COMPANY
630 Washington Street Boston, Mass.
New England's Oldest Exclusive Radio House
Distributors of many other successful Radio Specialties. Dealers:—Write for our proposition and full details.

cuit. If it were a true super-regenerator, you should be able to obtain loud speaker operation from a single tube. The Reinhartz is the most selective, but the single-circuit receiver is sufficiently selective now that new wave lengths have been assigned to broadcast stations. The single circuit receiver, with two stages of audio amplification, will give satisfactory all around operation, both as regards selectivity, ease of tuning and loudness.

Q. 3. Is it possible to use the WD-11 or De Forest 3-volt dry cell tube (hard) in either of the three circuits mentioned above?

A. 3. You will find the new radiotron UV-199 much superior to either the De Forest or WD-12. The UV-199 takes 60 milliamperes filament current at 3 volts. It requires 90 volts on the plate with a 4.5 volt negative bias on the grid for best amplification.

Paul Thomson, Elmwood, Conn.

Q. 1. Which gives the best regeneration, a variometer or tickler when connected between the plate and phones?

A. 1. A tickler is better since it is more effective over a wide wavelength range. The variometer will not give satisfactory regeneration above 450 meters.

Q. 2. Please give a regenerative hook-up, with data, for the following instruments: load coil, variometer, 23-plate condenser, 11-plate condenser, three fixed condensers, grid leak and grid condenser, WD-11 tube, rheostat, phones and batteries. I would like to be able to tune between 175 and 3,000 meters, if possible.

A. 2. We recommend using honeycomb or duolateral coils; using larger coils for the longer wavelengths. At the longer wavelengths it is advisable to shunt the tuning condensers with .0005 mfd. mica condensers.

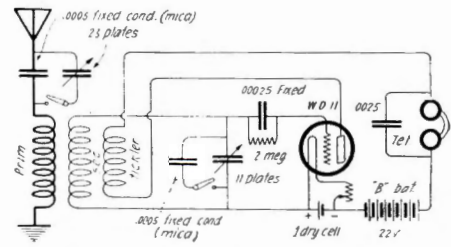

The following coils are to be used at the various wavelength ranges:

Wavelength	Primary	Secondary	Tickler
150-350	35	35	35
300-700	75	75	35
600-1,600	100	150	75
800-1,900	200	200	100
1,300-3,000	300	300	150



HOWARD

No. 1001
6 1/2 Ohm Rheostat \$1.10
25 Ohm Rheostat . 1.10
40 Ohm Rheostat. 1.10
Patd. 870,042

HOWARD

Ask the man to show you the Howard line of quality Radio Merchandise. Every piece is sold with the guarantee of satisfactory performance.

Discounts to the Jobbing and Electrical Trade.



HOWARD

No. 1002
6 3/4 Ohm Micrometer Rheostat\$1.50
25 Ohm Micrometer Rheostat 1.50
40 Ohm Micrometer Rheostat 1.50
Patd. July 10, 1923



HOWARD

No. 1003
200 Ohm Potentiometer\$1.50
400 Ohm Potentiometer 2.00
Patd. 870,042



HOWARD

No. 1004
Multi Terminal Receiver Plug, instantaneous connection for as many as six pairs of standard receiver tips.....\$2.00
Patd. Aug. 28, 1923

HOWARD RADIO CO., Inc.
4248 North Western Ave.,
Chicago, U. S. A.



WALNUT
Trouble Proof
RADIO
Apparatus.

DECORATE—
Don't Mar Your Panel

No longer is it necessary to drill holes for switch points—by no means an easy job and hard to make attractive-looking.

Walnut's engineers have given the radio public the "Walnut" ten-point induction switch. Just one hole to drill. Saves time, does not destroy the panel, and can easily and quickly be fitted. The contact is smooth and positive. The knob is genuine Bakelite. The results will delight you.

"WALNUT"
Trouble Proof
Variable Condensers

insure quick, accurate tuning. Plates are pressed and locked into supporting posts. Positive spring contact.

Plates	Plain	Vernier
3	\$1.50	
5	1.65	
13	2.25	\$4.25
23	3.00	5.00
43	3.50	6.00

All above will be sent postpaid on receipt of price, but ask your dealer first.

This is one of the many Walnut specialties. Send for catalog of "Walnut" Trouble-proof Radio Products.

WALNUT ELECTRIC MFG. CO.
Dept. 501-1249 W. Van Buren St.,
Chicago, Ill.

PACENT ADAPTER

For UV-199 Tubes

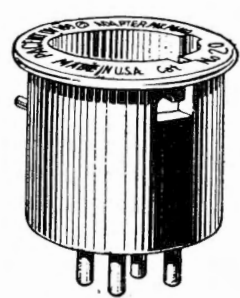

50c

NOW \$1.00

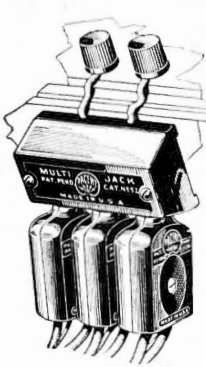

Ask your dealer to demonstrate new No. 5240 Pacent Jackset—\$1.50

This new price on Pacent Multi-jack, Twin-adapter and Duo-jack will permit the convenience of these standard devices for combination connections to many more radio users.

PACENT ELECTRIC CO., Inc.
22 Park Place, New York, N. Y.

Pacent

RADIO ESSENTIALS

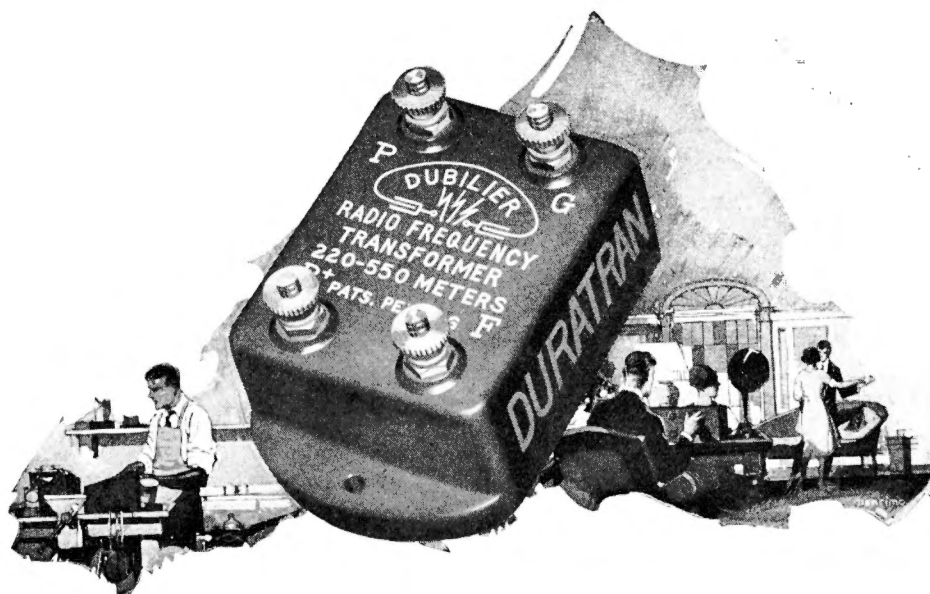

The Dubilier Duratran

Amplification on all wave lengths

THE Dubilier Duratran is the supreme radio-frequency transformer. It amplifies powerfully and uniformly *over all the wave-lengths* now used by broadcasting stations.

Price \$5.00

At all good dealers

DUBILIER CONDENSER & RADIO CORPORATION
48-50 WEST FOURTH STREET
NEW YORK

DUBILIER DEVICES

Micarta Is Good Insulation

and good insulation is conducive to the clearness and sensitivity of the transmission and reception of wireless messages.

Micarta is a substance developed by the research engineers of Westinghouse for insulation purposes.

Micarta has high dielectric and mechanical strength. It is a hard, compact material which will not warp, expand, nor shrink with age or exposure. Its sleek, silky black, smooth surface will take a high polish and it can be readily drilled and worked, without cracking—drilled holes will not lose their shape.

Micarta is insoluble in practically all the ordinary solvents, such as alcohol, benzine, turpentine, weak solutions of acid or alkali, hot water and oils. It is unaffected by ozone, which makes it exceptionally suitable for electrical purposes.

Micarta, then, is the ideal insulating material for radio use.

Westinghouse Electric & Mfg. Co.
East Pittsburgh Pennsylvania

Buy Micarta
plates and tubes
for your radio
insulation ~ ~

~ purposes

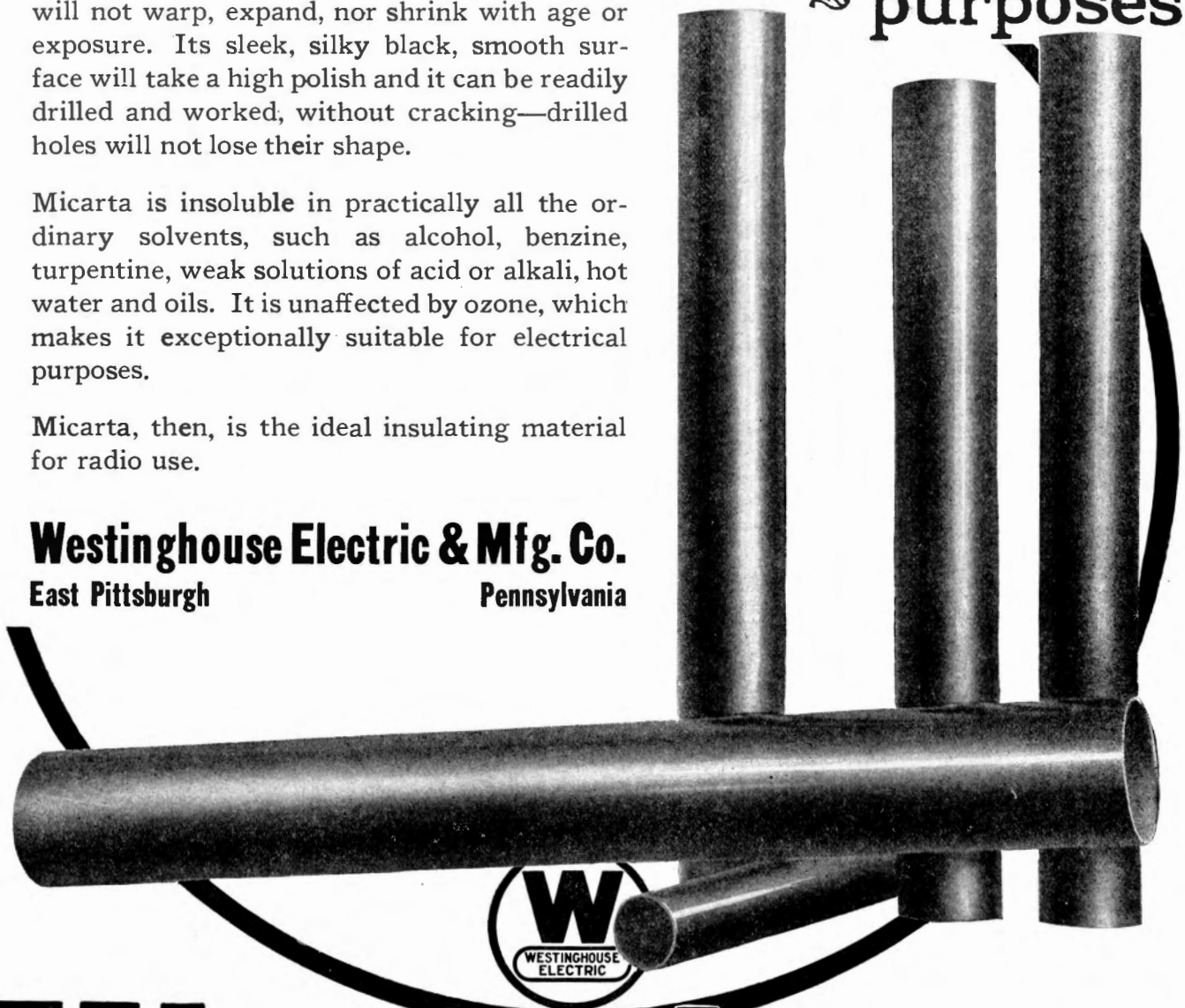

Westinghouse

Brandes



NEW PRICES

Superior
\$6.00

Navy Type
\$8.00

Grandpa joins the fans!

WHEN Grandpa first "listened in" it was through a noisy, uncomfortable headset, and he wouldn't try it again till some one called him old fashioned. Then he heard a concert through a Brandes *Matched Tone* Radio Headset. Now his dinner grows cold when there is something good coming over!

He says the Brandes makes all the difference. It fits so comfortably and he gets real music or a clear message every time.

Grandpa may not appreciate what *Matched Tone* means, but he likes the result.

C. BRANDES, Inc. 237 Lafayette Street, New York City

Matched Tone

TRADE MARK REG. U.S. PAT. OFF.

Radio Headsets

© C. Brandes, Inc., 1923



Radio Engineers KNOW and buy these features

Teleradio

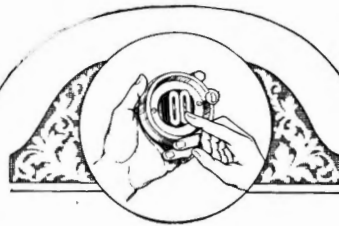

SUPER-SENSITIVE

1. A guarantee that less than five percent variation in resistance ever exists between the coils of Teleradio head sets. The secret of accurate reproduction of faintest signals.
2. Positive adjustment of diaphragm—insures best tonal qualities.
3. Improved self adjustable friction-sleeve—positive position grip.
4. Drawn aluminum case—all metal parts highly nickel polished. Light and durable for the hardest usage.
5. Fabricated head band for unusual comfort and ease.
6. Latest engineering principles and best of materials employed in every detail of construction and manufacture.

If your dealer cannot supply you, write for catalogue and prices.

Jobbers and dealers write for trade prices.

TELERADIO ENGINEERING CORP.

488 Broome St. New York City

\$5.50

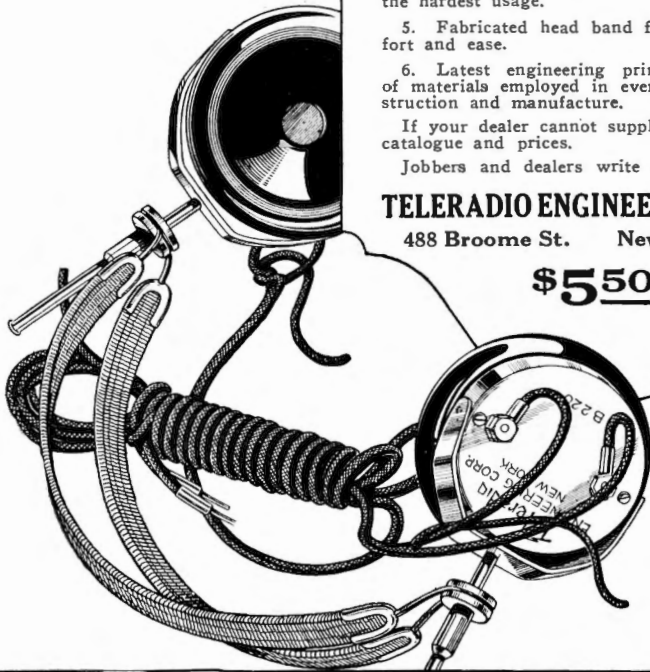

VERNIER CONDENSERS	
23 plate	\$4.50
43 plate	\$5.50
VARIABLE CONDENSERS	
3 plate	\$2.00
23 plate	\$3.00
11 plate	\$2.50
43 plate	\$4.00
RHEOSTATS	
(6 & 30 ohm)....	\$1.00
LIGHTNING ARRESTER	
	\$1.00
HEAD PHONE	
(2,000 ohm)....	\$5.50
(2,200 ohm)....	\$6.00
(3,000 ohm)....	\$7.00

Sound Method of Learning the Code, 50c
Wireless Press, 326 Broadway, New York.

CARTER JACK SWITCH



\$1.00

For closing battery circuits, etc.
Mounts like a Carter jack—without spacer washers.
Furnished with "ON & OFF" Name plate.
Also made in other spring combinations.

Write for free Carter Automatic Control Rheostat hook-ups.
No Jobber or Dealer stock complete without Carter products.

CARTER RADIO CO., 1802 Republic Bldg., Chicago

CARTER "TU-WAY" PLUG



\$1.00

Takes 1 to 4 head sets at same time.
Takes all types of cord tips.
Fits all standard jacks.

Does more for a dollar than any other plug and does it better.

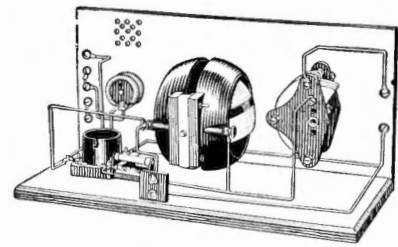

You Can BUILD YOUR OWN Radio

with the Overland Circuit and the easy non-technical instructions ANYONE can assemble their own Radio Receiver.

The Overland Circuit has proven this and has proven that it will

Cover a Radius of 2000 MILES

which assures abundant radio entertainment regardless of where set is located.

Instruction Booklet and complete parts for building the Overland Circuit Receiver as **\$11.50** illustrated

Instruction Book only; containing hook-up and wiring directions sent postpaid for 25c.

Address **Mr. Sumner**

OVERLAND RADIO

& EQUIPMENT CORPORATION
108 WEST 40TH ST., NEW YORK, N.Y.

SPARE TIME MONEY

Turn some of your spare time into money by securing subscriptions to

The America's Foremost Radiophone Review
WIRELESS AGE

Many radio enthusiasts find this an easy way to get the money to pay for their new apparatus and books. For particulars write

SUBSCRIPTION MANAGER

THE WIRELESS AGE

326 Broadway New York

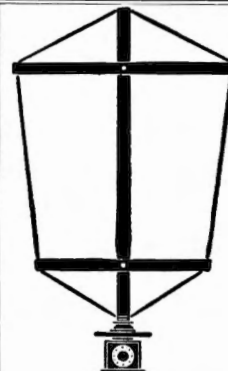

STATIC and Interference is reduced to a minimum
Better Reception with the NASSAU

Pat. Pend.
Price **\$35.00**
Jobbers and Dealers write for Proposition

LOOP TUNER
TRADE MARK

Eliminates Aerial and Ground
The Secret is in the Patented Winding 1500 MILES ON LOUD SPEAKER

With 2 stages radio and 2 stages audio frequency amplification
Write for Circular "W"

Manufactured by
NASSAU RADIO CO., Inc.
60 Court St. Brooklyn, N. Y.

YOUR PHONE PLUS A FIBERTONE MAKES A BEAUTIFUL MUSICAL INSTRUMENT

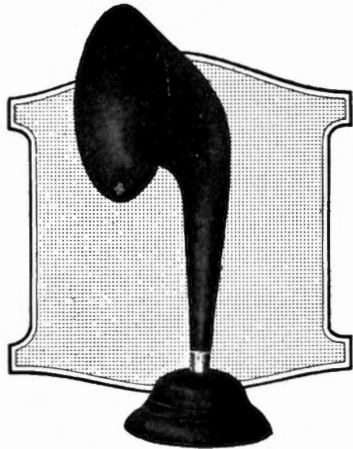

You will be pleased at its appearance
Yet wait until you HEAR it

Without a doubt, the greatest joy in buying a Fibertone is demonstrated the first time you place it upon your library table and "tune-in."

And after its purchase, your enthusiasm lives because there's always that feeling of assurance you possess an instrument of superior tonal qualities.

The Fibertone is scientifically constructed of fiber throughout and amplifies the true tones without vibrative or metallic noises. The outer surface is finished in an attractive black crystalline that rivals its inward beauty of tonal perfection. Operates on one stage of amplification.

No. 2 Fibertone (14 in.)...\$12.50

FIBER PRODUCTS CO.
240-A North 10th St. Newark N. J.

\$8

FIBERTONE
RADIO HORN

Jobbers and dealers write for trade prices.



The World's Most Popular Battery Charger

Nothing speaks so eloquently of HOMCHARGER satisfaction as the fact that thru sheer merit alone it has become the *standard* by which all other battery chargers are judged. Over 125,000 HOMCHARGERS already in use offer the most convincing proof that it is the most efficient, economical and fool-proof battery charger at any price.

A NEW TRADE-MARK FOR A TRIED AND PROVEN PRODUCT

Its phenomenal success has led to the introduction of many inferior and make-shift imitations. To insure our reputation and protect the buying public against substitution, the Radio De Luxe HOMCHARGER henceforth will be sold under a new Trade-Mark, viz.:

**GOLD SEAL
HOMCHARGER**

Retaining the same fundamentally correct operating principle and beautiful appearance of our Radio De Luxe model, it is a step nearer ultimate perfection through adoption of several construction refinements dictated by the policy of Progress.

HOMCHARGER'S 10 POINTS OF SUPERIORITY

1. Simple—Only one moving and wearing part, replaceable after thousands of hours use for \$1.00. Will last a lifetime.
2. Efficient—Uses less than one-half the current of any bulb or liquid type rectifier. Will charge any radio or automobile battery for a nickel.

3. Quick—Its high charging rate of 7 amperes eliminates long waiting for battery to become charged. Will charge any "A" or "B" battery over night, or three times as fast as a 2-ampere machine.
4. Clean—No expensive bulbs to break or acids to spill or replace. No acid fumes. Charges without muss, fuss or bother.
5. Dependable—Tungsten contacts insure continuous operation—prevent sticking and stopping.
6. Fool-Proof—Can be operated by anyone. Attach to lamp socket and connect battery either way, it will always charge. High-grade ammeter eliminates guess work.
7. Safe—No danger of shock or fire. Tested and approved by Fire Insurance Underwriters everywhere. Gives tapering charge—will not overheat or injure battery.
8. Beautiful—Mahogany and Gold Finish.
9. Unqualifiedly Guaranteed.
10. Popularly Priced—Retail at \$18.50 complete (\$22.00 Canada). No extras to buy. Sold by all dealers.

FREE BROADCASTING LIST. Send today for Free List of Broadcasting Stations, and Circular Describing the Gold Seal Homcharger.

DEALERS!

JOBBERS!

GOLD SEAL HOMCHARGERS will outsell any other radio device this season. "GOLD SEAL Business Builders" illustrates many attractive sales helps and explains how we are prepared to cooperate with the Trade in making this a "HOMCHARGER Year." Send for your copy and Trade Discounts, TODAY.

Insist **LOOK FOR IT**
on the **GOLD SEAL**



It is your protection against substitution. When buying order by name and verify by the GOLD SEAL, which appears on the carton as well as the nameplate.

The Automatic Electrical Devices Co., 119 West Third St., Cincinnati, O.

Largest Manufacturers of Vibrating Rectifiers in the World

EMPIRE OILED TUBING

For perfect insulation in wiring radio sets use Empire Oiled Tubing, sometimes called "Spaghetti."

Made By:

MICA INSULATOR CO.

68 Church St. New York
542 So. Dearborn St. Chicago
Works: Schenectady, N. Y. 2030-F

Learn the Code at Home with the Omnigraph

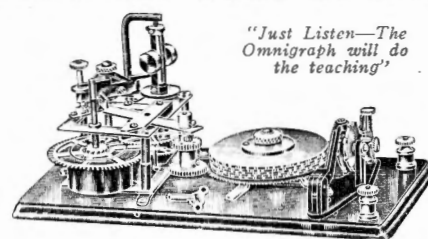

"Just Listen—The Omnigraph will do the teaching!"

THE OMNIGRAPH Automatic Transmitter will teach you both the Wireless and Morse Codes—right in your own home—quickly, easily and inexpensively. Connected with Buzzer, Buzzer and Phone or Sounder, it will send you unlimited messages, at any speed, from 5 to 50 words a minute. For more than 15 years THE OMNIGRAPH has been sold all over the world with a money back guarantee. THE OMNIGRAPH is used by the Dept. of Commerce to test all applicants applying for a Radio license. THE OMNIGRAPH has been successfully adopted by the leading Universities, Colleges and Radio Schools.

Send for FREE Catalog describing three models, \$14 to \$30. DO IT TODAY

THE OMNIGRAPH MFG. COMPANY, 16B Hudson Street, New York City
If you own a Radio Phone set and don't know the Code—you are missing most of the fun

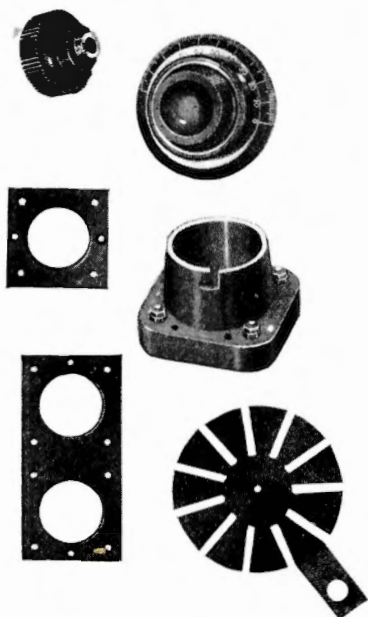
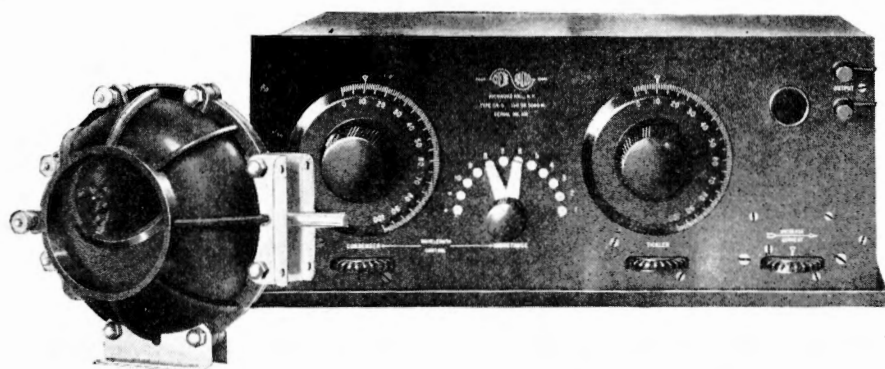

Dielectric Strength that is constant under varying climatic temperatures is the property of phenol resin insulation.

Combined with this dielectric strength are the additional advantages of mechanical strength, freedom from moisture absorption, lasting beauty of finish and color.

The leading manufacturers of radio parts and panels have adopted phenol resin insulating materials because they give uniformly satisfactory service under practically all working conditions.

BAKELITE CORPORATION

Address the Divisions

General Bakelite Company 8 West 40th St., New York
 Condensite Company of America Bloomfield, New Jersey
 Redmanol Chemical Products Co. 636 W. 22nd St., Chicago

3235-B

BAKELITE
Condensite
REDMANOL

are the registered Trade Marks for the Phenol Resin Products manufactured under patents owned by **BAKELITE CORPORATION**

THE MATERIAL OF A THOUSAND USES

LEARN THE CODE

Get all the fun there is to be had from your wireless set. Learn to read the dots and dashes and double your pleasure.

The Marconi-Victor Records

Provide the ideal instruction

SIX DOUBLE FACED RECORDS—TWELVE LESSONS

From the alphabet to press and code work. Actual operating conditions reproduced. Satisfaction guaranteed.

Price: \$5.00 per set

WIRELESS PRESS, Inc., 326 Broadway, New York

A Twist of the Wrist **IT'S SET**

YELLOW TIP
 MICROMETER ADJUSTING
CRYSTAL DETECTOR

Any adjustment made in a moment—fixed instantly! Held indefinitely, until you wish a change, then—“A Twist of the Wrist—It's Set.” Ideal for reflex and other circuits. **\$2**

Write for folder and name of your nearest dealer.

WHOLESALE RADIO EQUIPMENT CO.
Exclusive Factory Representatives
 39 William Street, Newark, N. J.
 Dealers and Jobbers—Write for Attractive Proposition

Get on the subscription list of

The Wireless Age

and you'll be sure of getting your copy.

The latest and most essential part of an efficient tube set

Variable Resistance Leaks FOR PANEL MOUNTING

Mounted on any panel in a few seconds—2 screws serving as connections behind panel. When mounted only the knob shows on the panel.

Get stations you never heard before
 No pencil markings. Assure unbroken range of 180 degrees. Clarify signals—eliminate hissing.

Complete with either .00025 or .0005 mfd. Mica Cond. **\$1.00**
 Without Condenser 75c

At your dealers—otherwise send purchase price and you will be supplied without further charge.
 106 Seventh Ave. New York

Chas. Freshman Co. Inc.
Radio Condenser Products

The choice of foremost Engineers for over 17 years.

Sold by all dealers



BRACH
VACUUM
RADIO PROTECTOR

Approved by the National Board of Fire Underwriters
Ask YOUR Insurance Agent

L. S. BRACH MFG. CO.,
Newark - New Jersey

SOLDERALL
Metal in Paste Form



Handy Tubes 25¢
Every Electrical Connection Needs
Solderall for Perfect Reception
The Only Convenient Metal Solder

Radio Fans
High Carbon Tool Steel Forceps
Only \$1.00

Clamp these self-locking, nickel plated forceps on each tap you take in winding inductances of any kind. Pliers won't stay clamped—these forceps grip tight. Hundred uses in building any set. An extra hand wherever needed. Send for it today. We'll send it postpaid on receipt of \$1.00. Satisfaction guaranteed or money back.

Dept. 310
C. E. CARSON 1001 Washington Blvd. Chicago

Approved!



The Champ—VARIOMETER No. 53
Approved as a Record Breaker

Approved because it makes 600 Meters
Approved because it has a genuine mahogany stator and a kiln dried rotor
Approved because of Fahnestock spring clip connections and non-conductive adhesive
Approved because—you'll know why when you

GET ONE FOR \$3.50
20 Diagrams FREE With Each

For sale at your dealer's—otherwise send the \$3.50 directly to the manufacturer and you will be supplied postpaid.

G. H. Fischer & Co.
123 Liberty St. New York City



On the Wings of the Air

NORTH, South, East, West, over mountain ranges, across rivers and ravines, through storms and clear weather fly the magic voices of radio. Throughout the country a multitude of eager listeners, old and young, settle down to enjoy the entertainments. Hundreds of stations are broadcasting every evening. There is always something going on to please every listener.

PARAGON

Reg. U.S. Pat. Off.

RADIO PRODUCTS

With the Paragon Three-Circuit Receiver you can pick the program you want to hear, tune in on the station that is broadcasting it, and you will get it. The messages will be understandable, the music clear and harmonious. In fact, you will first realize the full enjoyments of radio the first time you listen in with a Paragon set.

An illustrated Catalog of Paragon Radio Products Is Yours For the Asking

DEALERS—The Adams-Morgan Company has an interesting proposition to make to reputable radio dealers who believe in quality merchandise. Details on request.

ADAMS-MORGAN COMPANY
8 Alvin Avenue, Upper Montclair, N. J.

Illustration shows Type RD-5 Regenerative Receiver and Detector —\$75.00
Type A-2 Two-Stage Amplifier—\$50.00 (Licensed under Armstrong Patents)



Federal Radio Receiving Sets Bring Real Entertainment to Your Home



THEY embody the experience of twenty-five years in building high-class telephone equipment and fifteen years in producing radio parts and sets. They are built by radio engineers—not by experimenters. Each part and each set is guaranteed by the entire resources of the Federal Telephone and Telegraph Company.

Ask your dealer for a demonstration of the Federal 58 D. X. Receiver. If he doesn't stock them, a post card will bring a complete catalog of the 130 complete Federal units and the name and address of the nearest Federal dealer.

Federal Telephone and Telegraph Company

BUFFALO, N. Y.

Pittsburgh
San Francisco

Boston

New York
Bridgeburg, Canada

Philadelphia

Chicago

London, England



THE SYMBOL OF SERVICE

CONTINENTAL

"New York's Leading Radio House"

THE GREBE CR-12



SEVEN REASONS

1. No outdoor antenna—or loop.
2. Uses all kinds of tubes (4 of them) in any combination.
3. Employs the perfect combination of Regeneration and Tuned Radio Frequency Amplification with only 2 tuning adjustments.
4. Receives all broadcasting.
5. Tuning Dial graduated in wavelengths.
6. May be set up immediately, and successfully operated—anywhere—by anyone.
7. Complete, self-contained Receiver, in attractively finished walnut cabinet, with compartments for A and B batteries.

Something new! . . . Something which will satisfy the desires of every radio user. No outdoor antenna or loop. It employs a perfect combination of Regeneration and Tuned Radio Frequency with only two tuning adjustments. Immediately and successfully operated anywhere by anyone.

The Grebe CR-12 is ruggedly built, yet the handsomely finished case adds a touch of refinement and quality.

Send for Descriptive folders and literature on the Grebe CR-12 and—

HOW SIMPLE IT ALL IS!

2055-Q

CONTINENTAL RADIO & ELECTRIC CORPN.

6 and 15 Warren Street

New York, U. S. A.

"RED-HEAD"

—a triumph in radio receiver design

We guarantee that "Red-Heads" have every one of these desirable features:

- Extreme Sensitiveness
- Beautiful Tone
- Fine Appearance
- Mechanical Strength

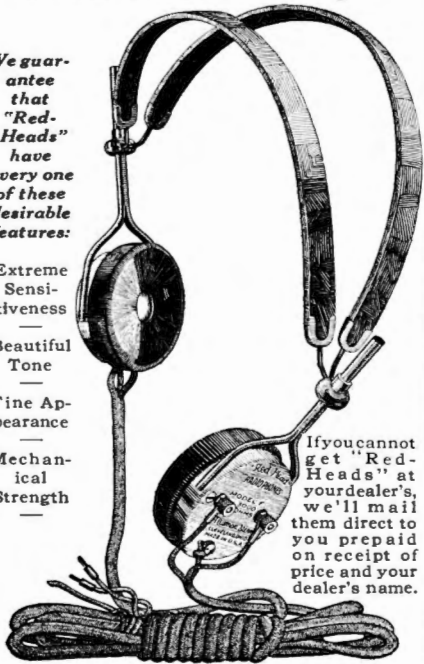

If you cannot get "Red-Heads" at your dealer's, we'll mail them direct to you prepaid on receipt of price and your dealer's name.

HERE'S what we say about "Red-Heads"—they're extraordinary radio receivers. We believe they're the best receivers on the market today. Superlatives are easy to say and hard to back up. Here's how we back up ours. We guarantee that you'll like "Red-Heads." You take no risk in buying them. We'll refund your money plus postage if you don't agree with us after trial. "Red-Heads" are the lowest priced, high-grade, aluminum-backed receivers on the market. Nine years of receiver experience are behind their quality.

What One User Says

Waupun, Wis., July 26, 1923

The Newman-Stern Co.,

Gentlemen: In 1915 I purchased a pair of your "Red-Head" phones. This pair of phones was one of the first you put out. They are still in good condition and, I believe, beat most of the other phones on the market.

Very truly yours,
D. J. SAXTON,
And "Red-Heads" are better today than they ever were.

- 1923
- 1922
- 1921
- 1920
- 1919
- 1918
- 1917
- 1916
- 1915

READY NOW! The New 1924 Model F—3000 Ohms

The new standard "Red-Heads" have ELEVEN improved features—new this year. Beautiful and graceful in appearance; light in weight; aluminum case; the famous brown-red ear caps; military headband; high-grade cord; exquisitely sensitive and fine toned. 3000 OHMS PER PAIR.

At your dealer's or prepaid on receipt of price. **\$6.50** PAIR Complete

THE NEW "RED-HEAD" JR. 2000 Ohms

Makes its bow to the public this year in response to a demand for an extra fine 2000 Ohm phone. A remarkable production with the same workmanship and guarantee as on our standard Model F. Complete with headband and cord.

At your dealer's or prepaid on receipt of price. **\$5.00** PAIR Complete

Since 1915 Pioneers in Radio—year after year striving to achieve one purpose—better radio receivers.

THE GUARANTEE Money back if after 7 days trial you're not satisfied that "Red-Heads" are the BEST receivers on the market at the price. **The NEWMAN-STERN Co.** Dept. W.A.E. 12th St., Cleveland, O.

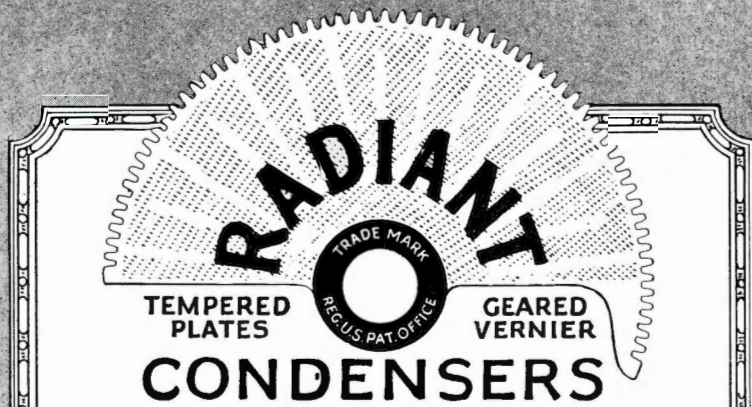

THE greatest condenser trouble—warped plates—is made IMPOSSIBLE in Radiant Condensers. No more re-adjusting, bending and makeshift supports. Both the rotating and stationary plates are PERMANENTLY FLAT as a straight edge. Flattened under powerful presses, and tempered by a new process, the plates of Radiant Condensers are unaffected by temperature changes. You can identify Radiant Condensers by the radiating rays design on rotary plates. Permanent alignment is "the best condenser buy."

Geared Vernier

Infinitely fine control of this delicate adjustment. Micrometer accuracy without special effort. Neat, smooth-working, trouble-proof gear. Another advantage for the price of just an ordinary condenser.

Write for illustrated booklet and the name of the nearest Radiant dealer.

PRICES

Vernier Type

- 13 Plate including 2 1/2 in. dial and knob.. \$5.00
- 25 Plate including 2 1/2 in. dial and knob.. \$5.50
- 45 Plate including 2 1/2 in. dial and knob.. \$6.50

Jobbers and Dealers

Write Immediately for Proposition

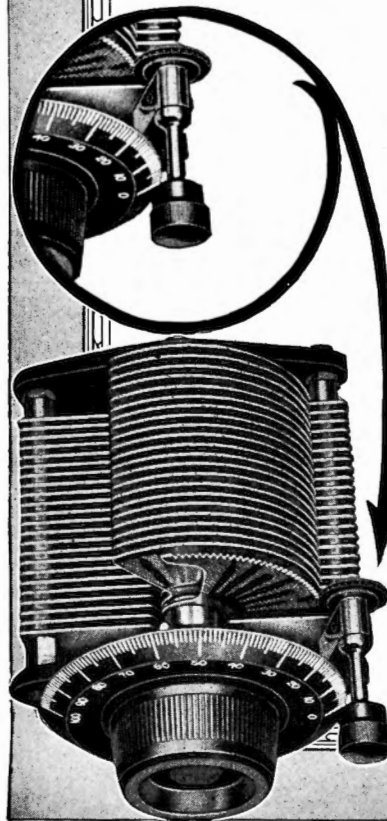

HEATH RADIO & Elec. Mfg. Co.
203 First Street
Newark, N. J. U. S. A.

WOC-TRESCO
Licensed Under Armstrong U. S. Patent No. 1,113,149

A long distance 1,000 mile 600 meter range regenerative tuner for \$10.00—add parcel post on 6 lbs. New circuit, startling results. Cheaper than crystal set. Uses any aerial. Amplifiers to match set for Circulars free—full

your loud speakers. instructions.

TRESCO Davenport, Iowa

NOVO "B" BATTERIES
with insulated binding posts and 7-inch Copper Wire Connectors

NOVO M'F'G. CO.
424 W. 33rd St., 531 So. Dearborn St.
NEW YORK CHICAGO

U.S. TOOL CONDENSERS



*Plates and Spacers
Chemically Treated
to Prevent Oxidizing*

THE greatest enemy of condenser efficiency—oxidizing of plates and spacers—is conquered in *U. S. Tool Condensers*, as described in the adjoining panel. Years of continual use and exposure leave these condensers unharmed—as perfect as the day they were purchased. Built to maintain a reputation, gained thru years of honest manufacture. Every other feature of these condensers is as thoughtfully evolved. Write for illustrated booklet and the name of the nearest U. S. Tool dealer—TODAY!

Climatic changes eventually spread a film of oxidization over the surface of plates and spacers. A high resistance is set up to the radio frequency currents. U. S. Tool Condensers are protected against oxidization by a patented chemical process, developed after tireless research and experiment.

U.S. TOOL COMPANY INC.
113 Mechanic St.
Newark, N.J.

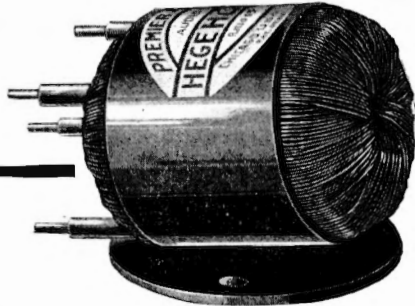
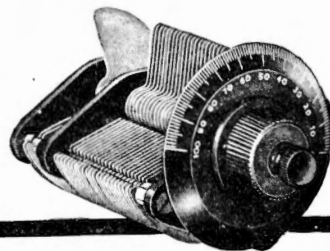

EXACT SIZE

\$3.50

PAT. PEND.

\$3.50

PREMIER "HEGEHOG" (Trademark) Audio Frequency Transformer

This little wonder is the talk and surprise of Radio Engineers everywhere. Fix in your mind's eye an AUDIO Transformer about the size of an English Walnut and you have the "HEGEHOG" for size. Then recall the best radio amplification you ever heard and you have the "HEGEHOG" for volume and tone quality. Our new patented design and construction (100% shielded) makes this possible. It's a real bit of engineering.

RATIOS—1 TO 3—1 TO 4 AND 1 TO 5... \$3.50
1 TO 10..... \$4.50

Ask your dealer for "HEGEHOG"

Premier Electric Company

3809 RAVENSWOOD AVE.

CHICAGO, U. S. A.

Smart!

Handsomely finished a sleek, everlasting black, Bakelite-Dilecto (XX grade) makes the smartest, most "Professional"-looking radio panels.

bakelite|| -dilecto..

(A Laminated Phenolic Condensation Material)

It has NO disadvantages for radio! And EVERY advantage.

Strong, tough, durable; yet machinable. Warpless! Used in the U. S. Navy and Signal Corps nine years!

Get Bakelite - Dilecto cut to size. Your electrical dealer knows how.

The Continental Fibre Co.
Factory: Newark, Delaware

Dealer Service From:

New York, 233 Broadway
Pittsburgh, 301 Fifth Ave.
Chicago, 332 S. Michigan Ave.
San Francisco, 75 Fremont St.
Los Angeles,
411 S. Main St.
Seattle, 1041
Sixth Ave., So.

The Radiovox Company

Distributors of Radio Corporation and Western Electric Radio Apparatus

Operating Cleveland Broadcasting Station "WHK"

5005 Euclid Avenue
CLEVELAND OHIO



Na-ald Special Socket
No. 499



De Luxe Contact



Na-ald De Luxe
No. 400

It's the contact that counts

A careful examination will show that each contact in Na-ald sockets and adapters is of a wiping nature on a broad surface, and of sufficient tension, and so designed that tension is permanent, no matter how often the bulbs may be removed and how much the connecting prongs in the tubes vary.

Na-ald sockets are moulded of Bakelite with uniform cross-section, cure and other engineering features incorporated, avoiding plate to grid losses and insuring each tube to develop its fullest efficiency.

NA-ALD SOCKETS

- No. 499 Socket, 199 tubes... \$0.50
- No. 429, Adapter, 199 tubes... .75
- No. 400, De Luxe, 200 tubes... .75
- No. 401, Small Space, 200 tubes... .35
- No. 411, W. D. 11 Tubes... .75
- No. 450, Two in One, W. D. 11 or 200 tubes... .50

Na-ald Circuit Booklet packed with each Na-ald product.

Write for "Why a Bakelite Socket," and other descriptive literature.

ALDEN MFG. CO.
Manufacturers of Sockets and Dials for every radio requirement.

Dept. A 52 Willow St.
Springfield, Mass.
Cable Address: Aldenco



RADIO CATALOGUE

Dealers, write for our Catalog showing Crosley, Grebe, Precision, Federal, Fada, Atwater Kent, Western Electric, Magnavox, Brandes, Frost, Burgess, Carter, Murdock, Dubilier, Remler, Workrite, Eby, Acme, Roller Smith, Victory and other standard lines.

THE SUTCLIFFE CO.
INCORPORATED
Louisville, Ky.

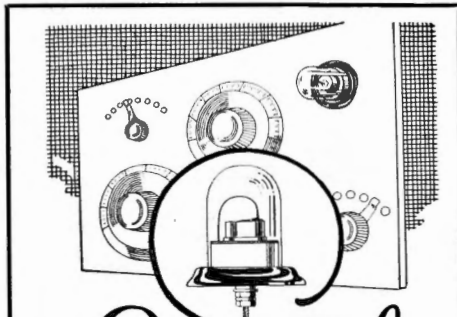

Grewol
THE PERMANENT DETECTOR

The only crystal detector that has won such universal approval. Eliminates usual crystal detector difficulties. Adjusted to maximum efficiency and held there by vibration-proof base. Crystal protected from dust and moisture by glass enclosure. No complicated adjustments to get out of order. Needs no attention. Simplifies and improves the operation of your set. Fully patented. Unconditionally guaranteed. Write for Booklet. **\$2**

RANDEL WIRELESS COMPANY
3 Central Ave. Newark, N. J.

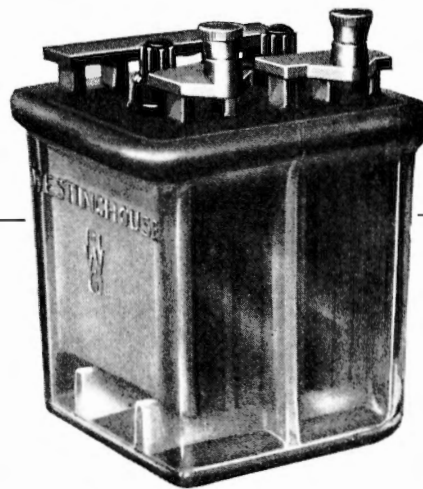

One-piece glass case, including solid glass cell partitions and plate rests. Visible interior; liquid level easily watched. Rechargeable; lasts indefinitely.

New!

Westinghouse CRYSTAL CASE Radio Batteries

The Complete Line

Thousands of radio fans already know and enjoy the advantages of the glass-case Westinghouse "B" Batteries. Now the same advantages may also be had in Westinghouse CRYSTAL CASE "A" Batteries, in voltages and amperages to meet various filament requirements. See your radio dealer, or the nearest Westinghouse Battery Service Station, at once. You're probably going to improve your set for this winter's big radio treats, and Westinghouse CRYSTAL CASE Batteries are a logical first step.

Westinghouse
CRYSTAL CASE

"B" Batteries

The 22-MG-2 (22 volts) is a marvel for steady, noiseless, full-powered service. Can be easily and repeatedly recharged. Larger types, too. Also single 2-volt "C" cells.

WESTINGHOUSE UNION BATTERY CO.
Swissvale, Pa.

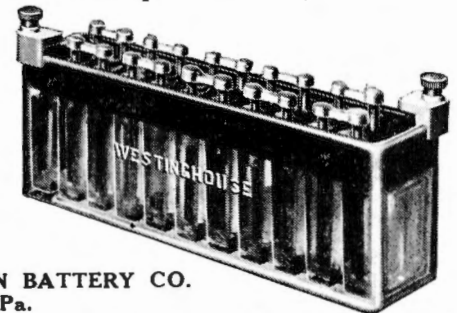

WESTINGHOUSE
Radio "A," "B" and "C"
BATTERIES

A Booklet You Will Want

By W. J. Merritt Garvey, of New York World's Radio Section, Handbook of Helpful Hints for Radio Set Builders, includes tables, charts, legends, statistics and carefully selected hookups with diagrams and full descriptions. Reading this interesting book we discovered Mr. Garvey recommended the FIL-KO-STAT. We bought an edition of the books and will gladly send a copy anywhere at handling cost 10c. postpaid.

RADIO STORES CORPORATION, Inc.
Sole International Distributors for

FIL-KO-STAT

Filament Control of Infinite Adjustment
Dept. WA 10-218 West 34th St. New York

PARAGON DISTRIBUTORS

— for —

Colorado, New Mexico, Idaho, Montana, Wyoming, Arizona, Western Kansas, Utah and Nevada

Complete Lines of Standard Apparatus.

Write for our Price Bulletin.
Wholesale Only.

The Rocky Mountain Radio Corporation
1512-1516 Broadway, Denver, Colo.

TRADE **"ESCO"** MARK

Quality always has been, and always will be
The World's Safest Investment

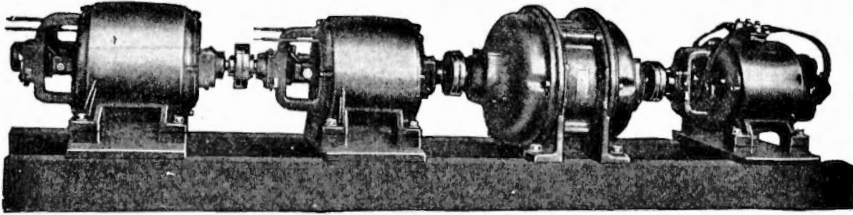

This is a Special 4-Unit set for Wis. Dept. of Markets—the largest broadcasting station in existence. A 10-H.P., 220-V., 60-cyc., 3-phase Motor. Two 1600-V., 2000-W. Generators to operate in series, producing 2000 V., 4000 W., and one 12-V., 2000-W. Filament Current Generator.

These two, and many other types, used by most prominent educational institutions, various U. S. Government Departments, Research Laboratories, Newspapers, Department Stores.

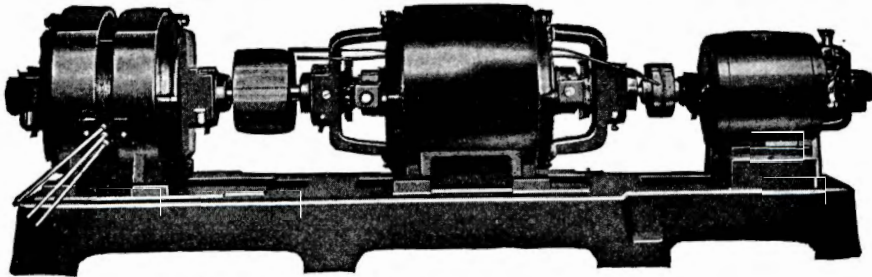

Sold by Principal Dealers in United States and Abroad.
Ask for Bulletin 248.

ELECTRIC SPECIALTY CO.

225 South Street

Stamford, Conn., U. S. A.

PIONEERS IN DEVELOPING QUALITY WIRELESS APPARATUS

Here It Is!

DISTRIBUTORS FOR

- Radio Corporation of America
- Westinghouse
- General Electric
- Murdock
- Fada
- Remler
- Front
- Brandes
- Pacant
- Burgess
- Hipco
- Baldwin
- Signal
- Acme
- Rhamsone
- Kellogg
- Holtzer-Cabot
- Connecticut
- General Radio
- Radio Service
- Homecharger
- Brach
- Chelera
- Arkey
- Clapp-Eastham
- and other top manufacturers

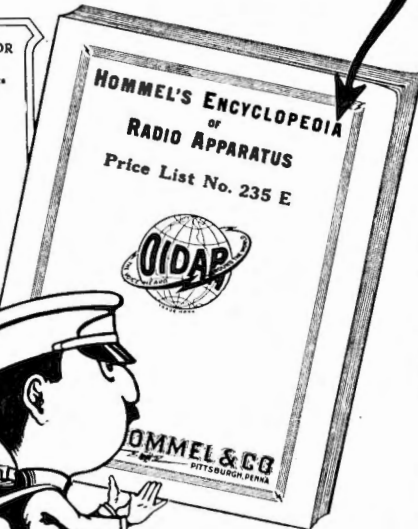

Send for it
NOW

LUDWIG HOMMEL & CO
530-534 FERNANDO ST. PITTSBURGH, PENNA.

Retail Price

\$1.85

P. P. 10c extra



The
Universal Bradleystat
gives perfect control for all radio tubes.

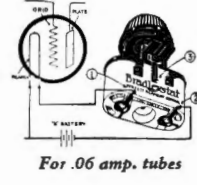
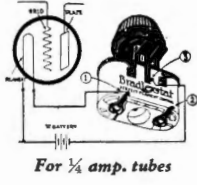
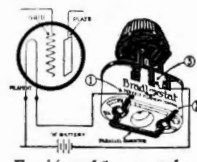

The Universal Bradleystat solves the perplexing problem of finding one rheostat for all tubes.

Perfect filament control is guaranteed for any new, old or foreign tube. The entire range of control is stepless and noiseless.

The Universal Bradleystat is a graphite disc rheostat. Beware of carbon dust imitations. The name Bradleystat is embossed on the porcelain container.

Buy a Bradleystat, today

Allen-Bradley Co.

Electric Controlling Apparatus
283 Greenfield Ave. Milwaukee, Wis.
Mfrs. of Graphite Rheostats for 20 years

Bradleystat
REGISTERED U. S. PAT. OFF.
PERFECT FILAMENT CONTROL

**STYLE W
RADIO KEY**

A speed key designed for radio transmission and with which cramp is unknown.

Other types carried in stock.

Sample by mail \$4.00. Send Stamp for Catalog No. 45-W.

J. H. BUNNELL & CO.
32 Park Pl., N. Y. C.

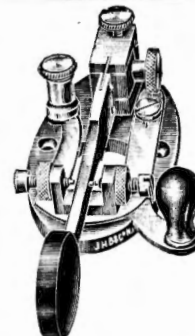

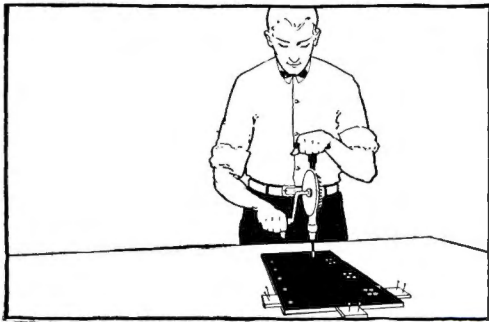

The Supreme Insulation
RADION
Panels
 are easiest
 to drill, saw
 or engrave
 with simple
 tools at
 home

18 Stock Size
 Panels

6 x 7	7 x 21
6 x 10 1/2	7 x 24
6 x 14	7 x 48
6 x 21	9 x 14
7 x 9	10 x 12
7 x 10	12 x 14
7 x 12	12 x 21
7 x 14	14 x 18
7 x 18	20 x 24

Radion, being an insulation material especially made for wireless use, has the lowest phase angle difference, lowest dielectric constant, highest resistivity and supreme moisture, gas and acid repelling properties.

American Hard Rubber Co.
 11 Mercer St., New York

RADION

Panels - Dials - Knobs - Sockets - Insulators



Pioneer

Distance
 —unusual distance—has been gotten by using a Pioneer Variocoupler and a plate and grid variometer.

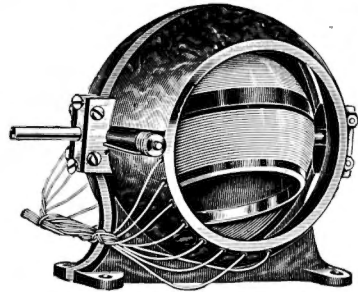

Pioneer Variocoupler \$7.00

Selectivity. 16 taps on the variocoupler gives exceptional close tuning and selectivity. Stations can be cut out and brought in at will. Interference is entirely eliminated.

The instruments have been awarded the highest award by all the testing laboratories.

Made of moulded Bakelite, moulded in our own factory under our own personal supervision.

The hardware is the best obtainable; the contacts are positive and will not become disconnected through use or wear. Instruments are made for table or panel mounting.

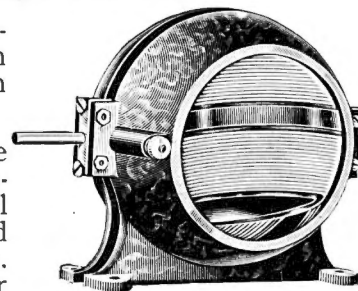

Pioneer Variometer \$6.50

Binding posts on each instrument for ready and quick connections.

PIONEER RADIO CORPORATION

105 Pioneer Avenue Galesburg, Illinois

Branch Offices:

European Branch Office—London, Eng., 27 28 Anning Street
 Gaston E. Marbaix, European Manager

New York City 220 Fulton Street
 Chicago, Ill. 33 South Clinton Street
 Kansas City, Mo. 208 Baltimore Building
 Minneapolis, Minn. 705 Plymouth Building
 San Francisco, Cal. 623 Larkin Street

METALECTRIC SOLDERING IRON

(The All-Metal Instrument)

"A solution to the small soldering problems of the discriminating assembler"



Interchangeable tip

ONE-HALF ACTUAL SIZE \$5.50

Unbreakable Construction—Economical Operation on any Electric Circuit
 from your dealer or write

POST ELECTRIC CO., MFRS. (Radio Division), 30 East 42nd St., N. Y. C.



DISTRIBUTORS
FOR THE
Radio Corporation
of America
WOLWORTH BUILDING - NEW YORK CITY



ILLINOIS

Complete Radio Supplies
LYON & HEALY

Visit Our Model Store
245 So. Wabash Ave. Chicago

NEW JERSEY

NATIONAL LIGHT AND
ELECTRIC COMPANY

Co-operative Merchandisers
289-291 MARKET STREET
NEWARK, N. J.

NEW YORK

JAMES F. BURNS
ELECTRICAL WORKS

Dealers and Jobbers in All Kinds
of Radio Supplies
442 STATE STREET
SCHENECTADY, N. Y.

TUSCOLA RADIO SUPPLY
STATION

Dependable Radio Apparatus
TUSCOLA ILLINOIS

RADIO DISTRIBUTING
COMPANY

Guaranteed Radio for Every Purpose
8 WEST PARK STREET
NEWARK, NEW JERSEY

NORTH CAROLINA

SOUTHERN RADIO CORP'N

The South's Largest Exclusive
Radio Company
Located in
"The Radio Center of the South"
CHARLOTTE, N. C.

MAINE

ATLANTIC RADIO CO., Inc.

Complete  Service

21 TEMPLE ST., PORTLAND, ME.

TRI-CITY ELECTRIC CO.

52-56 Lafayette Street
NEWARK, N. J.

OHIO

THE MILNOR ELECTRIC
COMPANY

Large Stocks—Quick Service
129 GOVERNMENT SQUARE
CINCINNATI, OHIO

MARYLAND

JOS. M. ZAMOISKI CO.

19 NORTH LIBERTY STREET
BALTIMORE, MARYLAND

NEW YORK

CONTINENTAL RADIO
AND ELECTRIC CORP'N

New York's Leading Radio House
15 WARREN STREET
NEW YORK

PENNSYLVANIA

General Radio
Corporation

10th and Cherry Sts.
Philadelphia
806 Penn Ave.
Pittsburgh

Special Service to
Dealers on Radio Cor-
poration of America
Products, in Pennsylv-
ania New Jersey,
Delaware, Maryland,
District of Columbia,
Virginia and West
Virginia.

MASSACHUSETTS

ATLANTIC RADIO CO., Inc.

Complete  Service

727 Boylston St. Boston, Mass.

TIMES APPLIANCE CO., Inc.

Approved Radio Merchandise
Wholesale Only

145 WEST 45th ST. NEW YORK

LUDWIG HOMMEL & CO
130-534 FERNANDO ST. PITTSBURGH, PENNA.

WHOLESALE EXCLUSIVELY

Hommel's Illustrated Encyclopedia of Radio
Apparatus 235 E will be sent free to dealers.
We sell to no others.

MINNESOTA

STERLING ELECTRIC
COMPANY

MINNEAPOLIS, MINN.

LANDAY BROS.

A Complete Stock of R. C. A. Merchandise
Always on Hand
311 Sixth Avenue, New York
Retailled at the 7 Landay Stores

PENN ELECTRICAL
ENGINEERING CO.

Westinghouse Agent Jobbers
SCRANTON, PA.

MISSOURI

WESTERN RADIO CO.

Dependable Merchandise
from
America's Greatest Manufacturers
BALTIMORE AT FOURTEENTH
KANSAS CITY, MO.



ALBANY, N. Y. SCRANTON, PA.
ELMIRA, N. Y. READING, PA.
BUFFALO, N. Y. WILKESBARRE, PA.
Wholesale Distributors Only

THE PHILADELPHIA ELECTRIC
COMPANY SUPPLY DEPT.

130-32 So. Eleventh St.
Philadelphia



Three Aces! BURGESS RADIO BATTERIES

IN the experience of radio engineers, amateurs and experimenters there is a suggestion which clearly points the way to the battery buyer who desires the most fitting and practical combination of electrical energy, low cost per hour of service, long shelf life and uniformity of discharge.

"ASK ANY RADIO ENGINEER"

More than a mere phrase these words express the preference of radio engineers who have learned the limitations of ordinary batteries and who have found in Burgess products the built-in efficiency which Burgess has achieved to an unequalled degree.

These "Three Aces," the famous Burgess "B"—the new *double strength* Radio "A," and our latest product, the Vertical "B" Battery are playing an important part in correct and dependable reception of radio broadcast. Each is

"A Laboratory Product"

Good dealers everywhere recommend and sell Burgess Batteries

BURGESS BATTERY COMPANY

Engineers—DRY BATTERIES—Manufacturers
Flashlight—Radio—Ignition—Telephone

General Sales Office:
Harris Trust Building, Chicago
Laboratories and Works: Madison, Wisconsin

Branches:
New York Boston Washington St. Paul
Kansas City New Orleans

In Canada:
General Offices and Works: Niagara Falls, Ontario
Branches: Toronto, Montreal, Winnipeg, St. John



Just
off the
Press



Upon request, our latest radio catalogue will be sent to those interested in the construction of receiving sets—without charge.

Each part we manufacture is illustrated and described in detail.

Write for it today.

EISEMANN MAGNETO CORPORATION

William N. Shaw, President

BROOKLYN, N. Y.

DETROIT

CHICAGO

SAN FRANCISCO

NEW COPIES FOR OLD

For each copy of the following issues of THE WIRELESS AGE, that you send us we will extend your subscription one month:

JANUARY, 1922 FEBRUARY, 1922 MARCH, 1922 MAY, 1922
SEPTEMBER, 1921 DECEMBER, 1921 DECEMBER, 1920

THE WIRELESS AGE

Room 315

326 Broadway

New York City, N. Y.

MU-RAD ★ RECEIVERS



The Ultimate in Radio Reception

*By this signal from afar off,
Bending like a wind of willow,
Cuche Manito, the mighty,
Calls the tribes of men together.*

—THE SONG OF HIAMATOS, Long fellow



The New Star in the Radio World

GIFTS FROM THE GREAT SPIRIT" said Iron Hawk, the famous Sioux chief, of the Indians' means of communication. The final perfection of this great gift to mankind is radio. The new science attains its *ultimate* in MU-RAD RECEIVERS. The MU-RAD owner lives in close touch with a vast radius of 4300 miles and more. Time is eliminated. Distance is only geographical. Reception conservatively guaranteed—*1000 miles, using only a 2 foot loop aerial.*

WRITE FOR LITERATURE

MU-RAD LABORATORIES, INC.
808 FIFTH AVE. ASBURY PARK, NEW JERSEY



SMALL ADS OF BIG INTEREST

Space in this department costs only 65 cents a line. Minimum space seven lines. Payable in advance.

RADIO GENERATORS—500 Volt, 100 Watt \$28.50 each. Battery Chargers \$12.50—High Speed Motors—Motor-Generator Sets. All Sizes. **MOTOR SPECIALTIES CO.**, Crafton, Penna.

LIGHTNING STRANGE BATTERY COMPOUND—Charges discharged batteries instantly. Eliminates old methods entirely. Gallon free to agents. **Lightning Co.**, St. Paul, Minn.

AMPLIFIER TUBES—First-class, Dutch mfg.; different sizes, with 8, 20-24, 20-30 and 30-60 volts plate. Samples against prepayment of \$11; postage paid everywhere. **Oosterhuis Brothers**, Arnhem (Holland).

SALES REPRESENTATIVE WANTED—By well established company manufacturing radio apparatus. Commission basis. Box 141, **Wireless Age**.

IMITATED BUT NEVER DUPLICATED



This Symbol — a guarantee

Everlastingly pounding away on a quality basis has established the Shamrock trade mark as a symbol of supreme quality.

Every radio fan silently envies his friend whose critical judgment leads to the selection of Shamrock Variocouplers and Variometers.

The particular workmanship and excellent grade of materials placed in every Shamrock product are brilliantly reflected in the superior results obtained. And results are what count.

All Shamrock instruments are made of genuine grade XX BAKELITE, are designed to positively take in all new wave lengths and incorporate all the latest features.

Dealers write for trade prices.

Shamrock Manufacturing Co.
314-316 Market St. Newark, N. J.

SHAMROCK
(FOR SELECTIVE TUNING)

180° VARIO-COUPLER
VARIOMETER

CATALOG E19-112 PAGES FREE

EVERYTHING IN RADIO
One of the largest complete stocks in the world. 40 diagrams of latest Hookups.
DEALERS ALL OVER THE U. S.
Making big profits handling our supplies, 24-hour service. Goods shipped same day order received.

QUALITY AND SERVICE
American RADIO Mfg. Co.

WHOLESALE RADIO DISTRIBUTORS
Dept. U 107 E. 13th St. Kansas City, Mo.

Learn Radio

\$50 to \$200 a Week

No other business offers you such amazing opportunities as this new uncrowded field of Radio. Thousands of trained men are needed. Wonderful salaries are paid for easy, fascinating work.

Become a Radio Expert

We train you at home to design, construct, install, operate, repair and maintain radio equipment, and, on completion of your course, to help you to the highest paid positions in Radio. **FREE**—Special offer of wonderful vacuum tube receiving set free. Mail postcard or letter for full information.

RADIO TRAINING ASSOCIATION OF AMERICA
D. 457-1223 Connecticut Av., N. W. Washington, D. C.



Warren Radio Loop, cut away to show construction

A Better Set with a Better Aerial

Those who get the most out of their sets use a Warren Radio Loop. Eliminates interference; simplifies tuning. Wider range of frequencies on single coil. Fits inside cabinet or any small space. Many other advantages. Choice of experts. Buy a Warren Radio Loop for expert results.



- Sharper Tuning**
One tuning adjustment — no others needed.
- Directional**
Receives signals strongest.
- Selective**
Picks out just the station you want to hear.
- Portable**
Small, light, compact. Ideal for portable or mobile sets.
- Wider Range of Frequencies**
on single coil.
- Small re-radiative effect.** Fine for regenerative circuit.

A Type for Every Set at the Best Dealers

- Type A-737 (300-700 meters) 6 inches square—non-directional. \$10.00
- Type A-7236 (175-1,000 meters) 6 inches square—non-directional. 12.00
- Type B-2537 (300-700 meters) 18 inches square—directional. 20.00
- Type BL-2520 (200-18,000 meters) with honeycomb coil mounting. 18 inches square—directional. 25.00

Write for Bulletin M-102.

V-DE-CO RADIO MFG. CO.
ASBURY PARK, N. J.
Dept. W



Natural
Re-PRODUCTION
Atlas
AMPLITONE
LOUD SPEAKER

\$25



Write for the booklet C that proves. Contains helpful information.

MIRRORS the naturalness of the original production. Actually re-PRODUCES. New principles of acoustics introduced in the marvelous "double diaphragm." Sold by all up-to-the-minute dealers.

Letters from Users Requested

"Far superior in tone." "Surprisingly good results." "The best loud speaker before the radio public." "This most wonderful instrument"—these are typical phrases from letters written us unsolicited by enthusiastic users. What have you accomplished with your *Atlas Amplitone*? Tell us about it!

Multiple Electric Products Co. Inc.

ORANGE ST. RADIO DIVISION NEWARK, N. J.

RUSONITE
CRYSTAL RECTIFIER

Patent Pending
THE PERFECT SYNTHETIC CRYSTAL DETECTOR
SENSITIVE OVER ENTIRE SURFACE
No Hunting for "Spots." Loud and Clear.
Endorsed by Thousands of Satisfied Users.
SENSITIVENESS Price Mounted..... 50c
GUARANTEED

14 K. Gold Supersensitive
RUSONITE CATWHISKER, Price.. 25c
Permanent. Will Not Oxidize.

RUSONITE REFLEX CRYSTAL
Manufactured Expressly for Reflex Circuits.
Will Stand Up Under Heavy Plate Voltage
Price Mounted..... \$1.00
GUARANTEED

Order From Your Dealer or Direct From
RUSONITE PRODUCTS CORP.
115 PARK ROW, NEW YORK, N. Y.

Standard Special Crystals



The Warranted Crystal in the "Little Red Box" Satisfies All
We make Special Crystals for new reflex circuits, 75 Cents
STANDARD CRYSTAL CO.
274-W Halsey Street Newark, N. J.
Canadian Agents: Sterling Specialties
213 Somerset Bldg., Winnipeg, Man., Canada
We also sell standard phones adaptable for tube sets, \$5.75
Liberal discounts to jobbers and dealers

Advertisers' Index

—o—

Adams-Morgan Co.	83
Alden Mfg. Co.	87
Allen-Bradley Co.	88
American Hard Rubber Co.	89
American Radio Mfg. Co.	92
American Transformer Co.	3d Cover
Anchor Co., The	94
Atwater Kent Manufacturing Company	71
Automatic Electrical Devices Co., The	81
Ayres Battery Corp.	71
Bakelite Corporation	82
Brach Mfg. Co., L. S.	83
Brandes, C., Inc.	79
Bristol Company, The	94
Bunnell & Co., J. H.	88
Burgess Battery Company	91
Carson, C. E.	83
Carter Radio Co.	80
Continental Fibre Co., The	86
Continental Radio & Elec. Corp.	81
Copper Clad Steel Co.	74
Crosley Manufacturing Co.	12
Cunningham, E. T.	Second Cover
Diamond State Fibre	6
Dubilier Condenser Co.	77
Eisemann Magneto Corp.	91
Electric Specialty Co.	88
Electric Storage Battery	14
Essex Mfg. Co.	71
Fansteel Products Co., Inc.	11
Federal Telephone & Telegraph Co.	84
Ferbend Electric Co.	75
Fiber Products Co.	81
Fischer & Co., G. H.	83
Freed-Eisemann Radio Corp.	75
Freshman Co., Inc., Chas.	82
General Electric Company	15
General Radio Co.	9
Heath Radio & Electric Mfg. Co.	85
Hommel & Co., Ludwig	88
Howard Radio Co., Inc.	76
Jones, Howard B.	71
Kellogg Switch and Supply Co.	7
Kennedy Co., The Colin B.	4, 5
Magnavox Co., The	10
Mica Insulator Co.	81
Multiple Electric Products Co.	93
Mu-Rad Laboratories	92
Nylar Radio Co.	8
Nassau Radio Co., Inc.	80
Neon Lamp Works, Inc.	72
Newman-Stern Co., The	85
New York Coil Co., Inc.	73
Novo Mfg. Co.	85
Omnigraph Mfg. Co., The	81
Overland Radio & Equip. Corp.	80
Pacent Electric Co., Inc.	76
Pathe Phonograph and Radio Corp.	72
Pioneer Radio Corporation	89
Post Electric Co.	89
Precision Equipment Co.	13
Premier Electric Co.	86
Radio Corporation of America	1
Radio Corporation of America Distributors	90
Radio Equipment Co.	75
Radio Stores Corporation	87
Radlovox Company, The	86
Randel Wireless Co.	87
Rieger Research Corporation	16
Rocky Mt. Radio Corp.	87
Rusonite Products Corporation	93
Saturn Mfg. & Sales Co., Inc.	75
Shamrock Mfg. Co.	92
Signal Electric Mfg. Co.	93
Standard Crystal Co.	93
Sutcliffe Co., Inc., The	87
Teleradio Engineering Corp.	80
Tresco Tri-City Radio Elect. Supply Co.	85
U. S. Tool Company, Inc.	86
V-DE-CO Radio Mfg. Co.	93
Walmart Electric Co.	76
Westinghouse Electric & Mfg. Co.	78
Westinghouse Union Battery Co.	87
Wholesale Radio Equipment	82
Y. M. C. A. School	74
SMALL ADS OF BIG INTEREST	92

RADIO ON THE FARM

THE DAILY MARKET REPORTS

**WITHOUT THE
AUDIOPHONE**

**IT LINKS
THE CITY
WITH
THE FARM**

**WITH THE
AUDIOPHONE**

TRADE MARK
AUDIOPHONE
REG. U. S. PAT. OFFICE

Market reports through the AUDIOPHONE can be depended upon because nothing is lost from the original broadcasting.

Not only is it easily possible to distinguish the words of a speaker, but also the minute graduations in pitch, timbre and quality of overtones, which distinguish individual voices.

The same qualities that make the AUDIOPHONE a source of profit by day, gives pleasure in the evening to the entire household, furnishing entertainment and education of a varied nature because it is equally efficient in reproducing the speaking voice, singing voice and all musical instruments.

The AUDIOPHONE is complete and self-contained—needs no separate battery or other accessories—goes to you ready for use in connecting to your receiving set. It will prove a source of lasting pride and pleasure.

Audiophone Sr.	\$32.50
Audiophone Jr.	22.50
Bristol One Stage Power Amplifier	25.00

Send your name and address to receive copy of
Bulletin No. 3006-V

THE BRISTOL COMPANY,
WATERBURY, CONN.

Branch Offices:

Boston	New York	Philadelphia	Pittsburgh
Detroit	Chicago	St. Louis	San Francisco

Sound Method of Learning the Code. 50c
Wireless Press, 326 Broadway, New York.

THE CRYSTAL THAT MADE GOOD OVER NIGHT

Just 1 month ago Anchorite was an unknown crystal—today Anchorite is being shipped in nearly every state in the Union and Canada.

THERE'S A REASON

Anchorite is the best crystal in America for crystal sets—for reflex circuits and for any other radio work where a 100% crystal is necessary. It is the only crystal in the world that will pick up outside stations on a crystal set distinctly without distortion and static noises.

ANCHORITE SELLS FOR 25c.

And there is no crystal sold at even 4 times the price than is its equal.

OUR IRON CLAD GUARANTEE—Anchorite is sold to you on a money back guarantee—if it does not do everything we say—return the crystal and your money will be refunded.

Address All Correspondence to
THE ANCHOR CO.
420 Wood St. Pittsburgh, Pa.

Send 25c in silver and a crystal will be sent you postpaid. DEALERS Write for exclusive sale rights.

When writing to advertisers please mention THE WIRELESS AGE

Amateur Radio Stations of the United States

Supplementary List brought up-to-date from August WIRELESS AGE

First District

- 1 BCII Warren T. Slown, Orange Ave., R. F. D. No. 5, W. Haven, Conn. 10CW
- 1 BCM Edwin S. Worden, Jr., R. F. D. No. 1, East Poultney, Vt. 151CW
- 1 BCP Kineo Camps, Inc., Harrison, Me. 151CW
- 1 BCR Charles N. Kraus, 11 Downing St., Worcester, Mass. 10CW
- 1 BCT John Hereford, 14 Irving Ave., Providence, R. I. 2008
- 1 BCU Charles F. Stevens, 106 Cedar Street, Clinton, Mass. 40CW
- 1 BCY William J. Lee, Box 417, Camden, Me. 10CW
- 1 BRQ Frederick H. Pierce, 35 Wood Street, Lewiston, Me. 75CW
- 1 CTL Harry E. Willis, 7 N. Franklin Street, Hilo, Mass. 151CW
- 1 GD John F. Walsh, 7 Longfellow Street, Dorchester, Mass. 440
- 1 WD Fred J. Parent, 14 Congress St., Lynn, Mass. 10CW

CHANGE OF ADDRESS

- 1 ANJ George H. Allen, 237 School St., Waltham, Mass.
- 1 ANV Harold H. Swain, 120 Winthrop St., Medford Hills, Mass.
- 1 AOP Jack H. Johnson, 537 Pleasant St., Malden, Mass.
- 1 ASA Henry E. Metcalf, 3 Whitman St., Somerville, Mass.
- 1 BCX Edward N. Dingley, Jr., 104 Charles River Road, Cambridge, Mass.
- 1 CDT Herbert Drew, 65 Rutledge Road, Hyde Park, Mass.
- 1 CFU Lawrence K. Keenan, 117 Otis St., Medford, Mass.
- 1 CIC L. Gilford Frank, Kilsyth Road, Brookline, Mass.
- 1 CS Fred B. Sweet, 81 Essex St., Cliftondale, Mass.
- 1 FS H. F. Southwick, 103 Green St., Fall River, Mass.
- 1 GY Lee A. Bates, 274 Main St., Worcester, Mass.
- 1 PT Edward C. Tompson, 35 Ivy St., Boston, Mass.
- 1 RG Everett L. Bowman, 102 Prescott St., Clinton, Mass.
- 1 SR Orin F. Davis, 1 Hillside Ave., Somerville, Mass.
- 1 ARU Richmond H. Blake, 106 Hewitt St., Roslindale, Mass.
- 1 BBI Richard P. Shirinian, 71 Arnold St., Providence, R. I.
- 1 BBX Fredk. J. McLane, Jr., 32 Underwood St., Fall River, Mass.
- 1 BCZ Raymond F. Kimball, Denmark, Maine
- 1 BEZ Leonard Marshall, 319 Greenwich Ave., Stamford, Conn.
- 1 BGB Louis Greenblatt, 8 Burton St., Waterbury, Conn.
- 1 BGG Donald H. Hathorn, 497 French St., Bangor, Maine
- 1 BGI Creston F. Laager, 282 Ohio Ave., Providence, R. I.
- 1 BGJ Francis H. Flagge, 718 Bedford St., Elmwood, Mass.
- 1 BGL Robert B. Conaughy, 28 McAllister St., Newport, E. I.
- 1 BGN Walter E. Spicer, 90 Queen St., Bristol, Conn.
- 1 BGO Lee J. Bell, 139 Military St., Houlton, Maine
- 1 BGP Henry Field, White Lodge, Manchester, Mass.
- 1 BQQ William Thompson, 525 Pacific St., Stamford, Conn.
- 1 BGS Charles H. Stout, Penfield Hill, Portland, Conn.
- 1 BGT George F. Wilson, 52 Harvard St., Everett, Mass.
- 1 BGU Wallace E. Dildbury, 58 Prospect St., Winsted, Conn.
- 1 BGW Louis C. Brown, 9 Richardson Ave., Lymeore Falls, Me.
- 1 BGX George E. Wiggins, 3 Gregory Hill Ave., Princeton, Mass.
- 1 BGY Andrew Brink, 235 Washington St., Braintree, Mass.
- 1 BII Charles W. Dionne, 758 East 5th St., S. Boston, Mass.
- 1 BIJ Eli Crumb, 8 Ward Street, Norwich, Conn.
- 1 BIM Jas. E. Carpenter, 25 Commonwealth Ave., Worcester, Mass.
- 1 BIP Hartwell M. T. Hughes, 5 Underwood Street, Worcester, Mass.
- 1 EU Albert G. Hutchins, Jr., 8 1/2 Prospect Street, Attleboro, Mass.

CHANGES OF ADDRESS

- 1 AHM Henry B. Joy, Kidd's Way, Watch Hill, R. I.
- 1 AJD Albert Correa, 78 S. Sixth St., New Bedford, Mass.
- 1 AKB Peter T. Cucuvalias, 431 Essex St., Lynn, Mass.
- 1 AO William C. Kohl, 118 Ashland Street, Melrose Highlands, Mass.
- 1 AQR Walter F. Walsh, Box 108, Lincoln Street, Waltham, Mass.
- 1 ASA Henry E. Metcalf, 3 Whitman St., Somerville, Mass.
- 1 AVK Louis A. Richmond, 65 Middle Turnpike, Manchester, Conn.
- 1 BCX Edward N. Dingley, 104 Charles River Road, Cambridge, Mass.
- 1 BI Geo. D. Darling, 30 Swains Pond Ave., Melrose, Mass.
- 1 BUX Orville T. Wood, 17 Grenada Terrace, Springfield, Mass.
- 1 BVL Richard S. Briggs, 393 Ashmont Street, Dorchester, Mass.
- 1 BWW Sherman M. Hall, 211 Wilbraham Road, Springfield, Mass.
- 1 CCV Geo. S. Kelemen, 37 Fairmont St., Arlington, Mass.
- 1 CEI Angus J. Walker, 150 Quincy St., Dorchester, Mass.
- 1 CFO Frank C. Eisner, 107 Jacques St., Somerville, Mass.
- 1 CEV Arthur E. Clough, 35 Lincoln St., Somersworth, N. H.
- 1 CFT Kenneth F. Carlon, 185 Oakland Street, Springfield, Mass.
- 1 CGO Vahe Johnson, 166 Eastwood Ave., Providence, R. I.
- 1 CQJ Neal Dow, New London, N. H.
- 1 CUP Herbert Newman, 29 Fountain St., Worcester, Mass.
- 1 DN Harrie E. Duncan, 26 Berkshire Road, Newtonville, Mass.
- 1 GY Lee A. Bates, 274 Main Street, Worcester, Mass.
- 1 HJ Matthew Camillo, 940 Grand St., Bridgeport, Conn.
- 1 OC Stanley J. Prusark, 43 Ringgold Street, Springfield, Mass.
- 1 SE Earl G. Holbrook, 58 Pearl St., Attleboro, Mass.
- 1 TM Arthur B. Gibbs, Edgartown Road, Vineyard Haven, Mass.
- 1 WO John W. Whitmore, 196 Calla St., Providence, R. I.

Third District

- 3 CHS Frank J. Blasewick, Jr., 1330 S. 3rd St., Phila., Pa.
- 3 CHT Albert E. Newcomb, 2727 S. 12th St., Phila., Pa.
- 3 CHU Howard D. Ogden, 735 N. 38th St., Phila., Pa.
- 3 CHV Robert George, Jr., 60th St., Phila., Pa.
- 3 CHW Chas. Loops, Jr., 2117 Penn. Ave., Wash., D. C.
- 3 CHX Karl M. Wiegandt, 65 E. Broad St., Bethlehem, Pa.
- 3 CHY Wm. J. Zaun, Box 78a, Dumbarton, Va.
- 3 CHZ James M. Krumm, 1604 E. 32nd St., Baltimore, Md.
- 3 CLA Russell A. Dennis, North West Ave., Vineland, N. J.
- 3 CIB Raymond P. Glemser, 1022 Indiana Ave., Phila., Pa.
- 3 CIC Lawrence A. Laser, 1517 Kenilworth Ave., Kenilworth, D. C.

- 3 CID Henry Cooper, 2602 Woodland Ave., Baltimore, Md.
- 3 CIE L. S. Panfily, 1013 20th St., N.W., Wash., D. C.
- 3 CIF Douglas H. Friedman, 1710 N. Franklin St., Philadelphia, Pa.
- 3 CIG Franklin W. Smith, 407 Scott Ave., Glenolde, Pa.
- 3 CIH George T. Logan, 14 Bala St., Sparta, N. J.
- 3 CIJ Junior High School No. 89, Bala, Pa.
- 3 CIK Beverly B. Bond, Federal and Eden Sts., Baltimore, Md.
- 3 CIL Elmer J. Cummins, 71 Seymour St., Germantown, Pa.
- 3 CIM David R. Wingate, 3130 14th St., N.W., Wash., D. C.
- 3 CIN Henry K. Kappel, 2826 Warnock St., Phila., Pa.
- 3 CIO Albert L. Melching, 3639 Lancaster Ave., Phila., Pa.
- 3 CIU George W. Huff, 1430 Rhode Island Ave., N.W., Washington, D. C.
- 3 CIQ W. E. Siddall, 401 Sixth St., N.W., Wash., D. C.
- 3 CIR John Hereford, 1440 Rhode Island Ave., N.W., Washington, D. C.
- 3 CIS Samuel J. Hutchinson, Jr., 216 Harrison Ave., Glenside, Pa.
- 3 CIT Thomas L. Dorsey, 1122 Bolton St., Baltimore, Md.
- 3 CIU LeRoy Ritter, 2413 S. Sartin St., Phila., Pa.
- 3 CIV Berthold Carmosh, 1654 N. Marshall St., Phila., Pa.
- 3 CIW Lester Campbell, 1299 Potomac St., Georgeown, Wash., D. C.
- 3 IUX Stephen P. Dalrymple, 31 1/2 Grant St., Dover, N. J.
- 3 IY S. L. Hastings, Preston, Md.
- 3 IZA Walter Brunn, R. F. D. No. 1, Jackson St., North Plainfield, N. J.
- 3 IJB Clyde N. Seigle, Finesville, N. J.
- 3 IJC Jesse H. Jones, 720 W. Market St., Pottsville, Pa.
- 3 IJD Edward B. Duvall & William H. Lehr, 3912 Main Ave., Forest Park, Baltimore, Md.
- 3 IJE Frank L. Deitcher, Jr., 221 State Road, Highland Park, Phila., Pa.
- 3 IJF John H. Eppinger, 1520 N. 60th St., Phila., Pa.
- 3 IJG Adalie P. Love, 221 Florida Ave., Washington, D. C.
- 3 IJH Fredk. T. Van Beuran, Leantaka Terrace, Morristown, N. Y.
- 3 IJI Richard Dittman, 209 S. Main St., Chambersburg, Pa.
- 3 IJJ Wm. E. Savelle, 14 Collins St., Piesantville, N. J.
- 3 IJK Lynn L. Steiner, 233 Elm Terrace, York, Pa.
- 3 IJL Richard E. Schaffstall, 1123 Vernon St., Harrisburg, Pa.
- 3 IJM Chas. L. Sientz, 22 S. 17th St., Harrisburg, Pa.
- 3 IJN Herbert E. Snyder, 822 St. John St., Allentown, Pa.
- 3 IJO John M. Altender, 109 Stokes St., Havre de Grace, Md.
- 3 IJP Gregory D. Campbell, 700 Webster Ave., Portsmouth, Va.

Sixth District

- 6 AAO Walter L. Martindale, 1229 W. 24th St., Los Angeles, Calif.

Eighth District

- 8 AJ Edmund B. Redington, 411 Waverly St., Waverly, N. Y.
- 8 AG Noel J. Gooch, 151 Bradley St., Buffalo, N. Y.
- 8 AO J. F. Atwood, Jr., 155 Brighton Road, Columbus, O.
- 8 AP Warren Walker, Marietta, Mich.
- 8 AQ Walter J. Brown, Red Rock, Pa.
- 8 AR Charles Ross, 3016 Montgomery St., Detroit, Mich.
- 8 AS Earl Anderson, Douglas, Mich.
- 8 AT F. Dawson Billey, 350 W. 9th St., Erie, Pa.
- 8 AU City of Cleveland Water Department, Cleveland, Ohio
- 8 AV Crib No. 3 (in Lake Erie), Cleveland, Ohio
- 8 AW Maynard J. Colombo, 26 River St., Plattsburg, N. Y.
- 8 AX Joseph L. Smith, N. Y. State Armory, Syracuse, N. Y.
- 8 AY William F. Belter, 18 Winter St., Rochester, N. Y.
- 8 AZ Theodore Suman, R. F. D. No. 13, Dayton, Ohio
- 8 BA Clyde E. Darr, 137 Hill Ave., Highland Park, Mich.
- 8 BB J. Clayton Nicholson, 815 N. 12th St., Cambridge, Ohio
- 8 BC Randolph Wm. Gutshall, 417 Ross Ave., Wilkinsburg, Pa.
- 8 BD John J. McConnell, 114 W. Main St., Carrollton, Ohio
- 8 BE Willard Koble Francis, W. Main St., Shawnee, Ohio
- 8 BF Albert E. Coatsworth, 969 Niagara St., Buffalo, N. Y.
- 8 BG Harold Hoess, 421 Elm St., Wilkinsburg, Pa.
- 8 BH George W. Murphy, 20 Walnut St. (Portable), Salem, Ohio
- 8 BI William Graff, 43 Nichols St., Rochester, N. Y.
- 8 BJ Glenn R. Rosenbauer, 606 Bay St., Rochester, N. Y.
- 8 BK Robert A. Burrows, 2934 Glenmawr St., Pittsburgh, Pa.
- 8 BL Rufus G. Snyder, 528 Robb Ave., Johnstown, Pa.
- 8 BM Howard S. Kibbe, 165 Parrish St., Canandaigua, N. Y.
- 8 BN Harry L. Wadsworth, 501 Eighth St., Charleroi, Pa.
- 8 BO Alban A. Michael, Amity Road, Reading, Ohio
- 8 BP Bartel J. Geib, W. South St., Shreve, Ohio
- 8 BQ Lee Davis, 240 Carr Ave., Clarksburg, W. Va.
- 8 BR Harold K. Wilder, 119 Garrison Ave., Battle Creek, Mich.
- 8 BS Kenneth L. Burnmann, 53 Main St., Owego, N. Y.
- 8 BT Daniel R. Axford, 69 Mechanic St., Oxford, Mich.
- 8 BU W. B. Jerome, 32 Wandle Ave., Bedford, Ohio
- 8 BV Howard T. Barker, 33 Coe Place, Buffalo, N. Y.
- 8 BW Anderson G. Wertz, 1007 Jacoby St., Johnstown, Pa.
- 8 BX Harry A. Voorhes, 82 Oswego St., Baldwinville, N. Y.
- 8 BY Benjamin Bartzoff, 249 William St., Buffalo, N. Y.
- 8 BZ Milton Wilson, 615 North Cory St., Findlay, Ohio
- 8 CA Herman J. Zepp, Jr., Lisbon St., Waynesburg, Ohio
- 8 CB Harry J. Mitchell, 253 Perry St., Alliance, Ohio
- 8 CC David J. Conlon, 22 Hereford St., Cincinnati, Ohio
- 8 CD John L. Morgan, 1 Watson Entrance, Pittsburgh, Pa.
- 8 CE Gordon Turnbull, 179 Rock Island St., Gouverneur, N. Y.
- 8 CF Elmer H. Schubert, 122 McMicken Ave., Cincinnati, Ohio
- 8 CG Robert H. Shenk, 232 W. 21st St., Erie, Pa.
- 8 CH Rexford Stark, 313 Wood St., Painesville, Ohio
- 8 CI Ray D. Jones, 975 N. Goodman St., Rochester, N. Y.
- 8 CJ Claude A. Moore, 248 S. Bala St., Akron, Ohio
- 8 CK William B. Scott, 543 Greenfield Ave., Pittsburgh, Pa.
- 8 CL John J. Simovic, Cleveland Ave., Stevensville, Mich.
- 8 CM Honer E. Zimmerman, 187 Dodge Ave. (Portable), Akron, Ohio
- 8 CN Francis Gibb, 212 N. 20th St., Columbus, Ohio
- 8 CO William S. Andrews, 743 Thornhill Dr., Cleveland, Ohio
- 8 CP Jerry V. Brouser, 3402 W. 50th St., Cleveland, Ohio
- 8 CQ W. Guy Watson, 457 Florence St., Royal Oak, Mich.
- 8 CR Cleveland City Water Department, W. 45th and Division Sts., Cleveland, Ohio

- 8 BBP L. Selye Whitmore, 40 Alexander St., Rochester, N. Y.
- 8 BBB M. C. Taggart, 1771 E. University St., Wooster, Ohio
- 8 BBS Edward Goss, 24 Hoffman Place, Buffalo, N. Y.
- 8 BBT Edw. Alan Heffner, 930 S. Ohio Ave., Columbus, Ohio
- 8 BBW William C. George, 3178 Scranton St., Cleveland, Ohio
- 8 BCC Ross Armstrong, R. F. D. No. 7, Penn Yan, N. Y.
- 8 BCF Charles R. Allison, Jr., 968 W. Wayne St., Lima, Ohio
- 8 BCG Gerald W. Fox, Rapid City, Mich.
- 8 BCJ Frank Paul Friesa, 2309 May St., Cincinnati, Ohio
- 8 BCM Francis E. Handy, 400 Hampton St., Wilkinsburg, Pa.
- 8 BCN Francis E. Shewmon, N. Main St., Eldorado, Ohio
- 8 BCD Clarence F. Hartman, 2237 Park Ave., Norwood, Ohio
- 8 BDE Stephen R. Phean, Alderson, W. Va.
- 8 BDF Millard W. Baldwin, Jr., America Farm, Marey, N. Y.
- 8 BDG Pierce Thos. Adams, E. Third St., Ottawa, Ohio
- 8 BEG Earl Hanson, 688 Canysie St. (Portable), Akron, Ohio
- 8 BEL Fred Wetterer, 1727 Westwood Ave., Cincinnati, Ohio
- 8 BES R. G. Eils, Lincoln Way, Lisbon, Ohio
- 8 BEF Darcy F. Thurmes, 320 Cottage Place, Akron, Ohio
- 8 BEG E. Albert O'Connell, 34 S. Portage St., Westfield, N. Y.
- 8 BGI Wellington Goodrich, 910 Union St., Scranton, Pa.
- 8 BGJ Louis A. Bery, 985 Arington St., Akron, Ohio
- 8 BGK Burton Gragg, 363 Wyoming St., Dayton, Ohio
- 8 BGL John K. Harper, 1240 Prospect Ave., Toledo, Ohio
- 8 BHM Johnstown Radio Co., 324 Market St., Johnstown, Pa.
- 8 BHN Robert Ellis Winn, South 7th St., Onaway, Mich.
- 8 BHG Earl Dickes Burnett, 327 W. Main St., Greenville, Ohio
- 8 BHN Don Canady, 3439 W. 119th St., Cleveland, Ohio
- 8 BHJ Charles O. Goulding, Jr., 239 Shady Ave., Pittsburgh, Pa.
- 8 BIA Robert S. Betten, 3 The Circle, Ithaca, N. Y.
- 8 BIC William C. Lafferty, 77 Rich St., Buffalo, N. Y.
- 8 BIE Raymond J. Anderson, 1120 Franklin St., Fremont, Ohio
- 8 BIF Rollin A. Buck, R. F. D. No. 5, Warsaw, N. Y.
- 8 BIG John McWatters, R. F. D. No. 19, Dryden, N. Y.

CHANGE OF ADDRESS

- 8 BE Jesse J. Francis, 414 Eddy Road, Cleveland, Ohio
- 8 BJ Albert Thren, 1561 Tremont St., Cincinnati, Ohio
- 8 BK Alexis W. Russin, Oak Hill Road, Endicott, N. Y.
- 8 BL Abe Irving Frankel, 900 E. Main St., Rochester, N. Y.
- 8 BM Thomas A. King, 106 Brown St., Dayton, Ohio
- 8 BN Paul M. Eicks, 14 Brockway Ave., Morgantown, W. Va.
- 8 BO Edward R. Wendell, Bancroft Drive, Greece, N. Y.
- 8 BT Ray M. Lacey, 1998 Euclid Ave., Detroit, Mich.
- 8 BU Lucian D. Coman, Jr., 1611 Lakefront Ave., East Cleveland, Ohio
- 8 BV Lloyd N. Chatterton, 12409 Woodside St., Cleveland, Ohio
- 8 BQ Lot & Wilbur Alexander, 2711 Espy Ave., Dormont, Pittsburgh, Pa.
- 8 BR Paul M. Johnston, 4700 Apollon, Pa.
- 8 BS Marvin C. Hollowell, 344 W. Columbus St., Kenton, Ohio
- 8 BT Robert G. Burns, 802 Blaine Ave., Detroit, Mich.
- 8 BU William K. Thomas, 2 Dakota St., Crafton, Pa.
- 8 BV Willis Stafford, 559 St. St., Worthington, Ohio
- 8 BW Kenneth Neubrecht, 1316 Utah St., Toledo, Ohio
- 8 BX Robert A. Wilkinson, 920 Elm St., Van Wert, Ohio
- 8 BY George W. Parker, R. F. D. No. 7, Mt. Clemens, Mich.
- 8 BZ James F. Barton, 245 East St., Bloomsburg, Pa.
- 8 CA B. C. Eades, 241 Mill St., Conneaut, Ohio
- 8 CB D. W. Pinkerton, 819 W. Delaware St., Toledo, Ohio
- 8 CC John A. Wells, 37 Garrison Ave., Battle Creek, Mich.
- 8 CD A. Romeyn Bitter, 517 Euclid Ave., Toledo, Ohio
- 8 CE Richard H. Howe, Granville, Ohio (Portable)
- 8 CF Ralph M. Brown, 81 S. Vaughn St., Kingston, Pa.
- 8 CG Clark E. Mawby, 1018 Sawyer Ave., Akron, Ohio
- 8 CH Merrill C. Kent, 517 10th St., Monessen, Pa.
- 8 CI Howard F. Hansell, Elmo Place, Middletown, Ohio
- 8 CJ William G. Biddle, 912 Lorain Ave., Dayton, Ohio
- 8 CK Raunond E. Deemer, 3295 W. 44th St., Cleveland, Ohio
- 8 CL C. J. Jenks, 72 Clinton Ave., North East, Pa.
- 8 CM Roland G. Peart, 715 Magnolia St., Toledo, Ohio
- 8 CN C. M. Chorpenting, 401 Cedar Ave., Connellsville, Pa.
- 8 CO George A. Cooke, 308 Montgomery St., Marietta, Ohio
- 8 CP Orson S. Finch, 3 Riverview Road, Port Dickinson, N. Y.
- 8 CQ William S. Patton, 539 Brownville Road, Pittsburgh, Pa.
- 8 CR James F. Hamilton, 842 Jefferson Ave., Buffalo, N. Y.
- 8 CS Richard M. Hoe, 17422 Shaw Ave., Lakewood, Ohio
- 8 CT Benjamin T. Wehner, Hites Road, Harwick, Pa.
- 8 CU Russell A. McBride, 608 S. Woodward Ave., Birmingham, Mich.
- 8 CV John P. McGoldrick, 1055 Blair Ave., Scranton, Pa.
- 8 CW Philip Schwartz, 1460 E. 90th St., Cleveland, Ohio
- 8 CX J. M. Chambers, 33 Park Ave., Delaware, Ohio
- 8 CY William D. Myers, 417 Hancock Ave., Vandergriff, Pa.
- 8 CZ Wade McL. Miller, 305 Alice St., Pittsburgh, Pa.
- 8 DA Richard Voight, 1314 Clinton St., Sandusky, Ohio
- 8 DB Henry T. Miller, 2494 N. High St., Columbus, Ohio
- 8 DC Theodore Weiss, 1694 Hazelwood Ave., Detroit, Mich.
- 8 DD E. Fomhl, 3817 McDouall Ave., Detroit, Mich.
- 8 DE Harold D. Osgood, 3557 Calvert Ave., Detroit, Mich.
- 8 DF Vernon C. Kier, 302 Wood St., Wilmington, Ohio
- 8 DG Percival J. Smith, 1506 Stockbridge St., Kalamazoo, Mich.
- 8 DH Harry Kinney, 2857 Lincoln Rd., Shaker Hgts., Ohio
- 8 DI Frank Walker, 2612 Marsh Ave., S. Norwood, Cincinnati, Ohio
- 8 DJ Lloyd Fishbeck, 5416 24th St., Detroit, Mich.
- 8 DK Robert E. Perry, 116 Charleston St., Charleston, W. Va.
- 8 DL Lloyd F. Kridler, 854 Clairmount St., Detroit, Mich.
- 8 DM Chester Jawa, 270 Magnolia Ave., Mt. Lebanon, Pa.
- 8 DN Stephen Lichtblaw, 10612 Woodland Ave., Cleveland, Ohio
- 8 DO George Fagerholm, 2085 Brown Road, Lakewood, Ohio
- 8 DP Charles M. Jacobs, 481 E. Perry St., Tiffin, Ohio
- 8 DQ Theo. M. Dickinson, 320 N. George St., Rome, N. Y.
- 8 DR James L. Russell, 994 E. 130th St., Cleveland, Ohio
- 8 DS Robert A. Trago, 40 Pohl St., Williamsburg, N. Y.
- 8 DT Fred A. Long, 1904 Division Ave., Grand Rapids, Mich.
- 8 DU George M. Clasper, 601 Pittsburgh St., Connellsville, Pa.
- 8 DV Gilbert E. Mears, 11535 Byron Ave., Detroit, Mich.
- 8 DW Paul Marco, 728 Lawrence Ave., Detroit, Mich.

8 BZD Carl A. Moline, 24 St. John St., Wyandotte, Mich.
8 CDY Ivon Paul, 135 Poplar St., Wyandotte, Mich.
8 CDD Fred E. Castenholz, 863 Calvin St., Grand Rapids, Mich.
8 CES Melvin L. Leppert, Third and S. Main St., Sharpsburg, Pa.
8 CEZ Thos. D. Schumacher, 5853 Forbes St., Pittsburgh, Pa.
8 CFD William K. Hawk, Greensburg, Pa.
8 CFX Don I. Dayton, 234 Main St., Hinton, W. Va.
8 CGI Cecil Funk, 2434 Pennsylvania Ave., Detroit, Mich.
8 CLY Richard H. Hutchings, Jr., State Hospital, Carey, N. Y.
8 CPQ Harold E. Hart, 1020 Adams St., Owosso, Mich.
8 CRH Loren Macomber, Quaker Road, Orchard Park, N. Y.

9 BWL Irvin D. Linehan, 4534 Dover St., Chicago, Ill.
9 BWT Charles D. Burgess, Franks St., Pipestone, Minn.
9 BYS Melvin Yeager, 4131 Pleasant St., St. Louis, Mo.
9 CAE John S. Guilborg, Jr., 4628 Beacon St., Chicago, Ill.
9 CAI A. G. Garrett, 131 Eighth St., Newport, Ky.
9 CAJ Kenneth Wolfe and Forrest P. Nason, 322 1/2 S. Ralph H. Osborne, 1100 N. Oak St., Creston, Iowa
9 CAN Ferdinand Nagel, 221 Vine St., Paris, Ky.
9 CDQ Floyd E. Saint, 200 N. Pioneer Ave., Lyons, Kans.
9 CEA William C. Forrest, R. F. D., Arlington Township, Poynette, Wisc.
9 CME Darrell E. Holt, 1345 E. Penna St., Lawrence, Kans.
9 CML Albert J. Leckeny, Franks St., Pipestone, Minn.
9 DBQ Donald Freeman, 1000 S. Oak St., Oden, Ill.
9 DBT Morris Fritz, 47 Andrew St., Jerseyville, Ill.
9 DDD Jack Hamilton, 973 Strong St., Kenosha, Wisc.
9 DDD Harold Moe, 1555 17th St., Milwaukee, Wisc.
9 ELD Aldrich C. Krones, 1176 Superior St., Milwaukee, Wisc.

9 BRW Ottumwa High School Radio Club, E. Second St., Ottumwa, Iowa
9 BSO Robert G. Turner, 719 Sixth St., Ottumwa, Wisc.
9 BWV Alfred L. McCauley, 207 N. 23d St., Omaha, Nebr.
9 BXG Frank N. Reidhecker, 958 Tenney St., Kansas City, Kans.
9 BXV John E. Hynes, 3349 University Ave., S.E., Minneapolis, Minn.
9 BYU Wharton Hoch, 412 Seventh St., St. Louis, Mo.
9 BZA Charles R. Woods, 801 N. Birch St., Creston, Iowa
9 BZJ Sam'l W. Kendrick, 2919 Choteau Ave., St. Louis, Mo.
9 BZZ Ralph L. Hanson, 2919 Choteau Ave., Stockton, Ill.
9 CAQ Eiden E. Dultand, Jr., 1336 Castlewood Ave., Louisville, Ky.
9 CAS Herbert F. Berg, 751 39th St., Milwaukee, Wisc.
9 CBD Phillip R. Kennedy, 5818 Oak Ave., Indianapolis, Ind.
9 CBE Robert D. Hart, 302 Erie St., Valparaiso, Ind.
9 CBF Geo. E. Ekblad, 604 W. Myrtle St., Stillwater, Minn.
9 CGD Frank R. Denney, 412 Seventh St., St. Louis, Mo.
9 CNT LeRoy A. Dey, N. 1st St., Osborn, Kans.
9 COW Lawrence Kessel, 1215 S. Fourth Ave., Maywood, Ill.
9 CSG Chas. S. Hickman, 41 Gilbert Ave., Terre Haute, Ind.
9 CWX Jesse H. Lofton, 328 N. Missouri Ave., Mexico, Mo.
9 CZY Wilmer P. Frazier, 702 Lyon Ave., Carthage, Ill.
9 DAT Frank W. Wodrich, Jr., 1829 Foster Ave., Chicago, Ill.

Ninth District

9 AUP Eli Swaringen, 960 Grove St., Virden, Ill.
9 AWX Lindblom Tech. High School, 62d and Lincoln Sts., Chicago, Ill.
9 BHH Robert C. Reid, 341 W. Lafayette Ave., Jacksonville, Ill.
9 BWX Martin L. Edwards, 4820 Charlotte St., Kansas City, Mo.
9 BWY Harry E. Moore, 1000 S. Oak St., Oden, Ill.
9 BWZ Leo Westerman, 1000 S. Oak St., Oden, Ill.
9 BXE Leslie E. Jaekke, R. F. D. No. 41, Chapman, Wisc.
9 BXF R. J. Callen, 302 Morrison St., Collinsville, Ill.
9 BKK Jesse D. Harms, 811 N. Boone St., Olney, Ill.
9 BXO LeRoy F. George, 912 Monroe Ave., S. Milwaukee, Wisc.
9 BXX Gerald K. Dabler, 116 E. Buchanan St., Kankakee, Ill.
9 BYQ Clarence J. Windisch, 116 E. Buchanan St., Kankakee, Ill.
9 BZB Merrill W. Price, 4626 E. Washington St., Indianapolis, Ind.
9 BZT Herbert W. Einzel, 685 Fifty-first Ave., West Allis, Wisc.
9 CAD Albert Lauck, 418 Jefferson Ave., Allon, Ill.
9 CAT Robert Marshall, Marshall Radio Co., Richmond, Mo.
9 CAU Frederick E. Howdle, 408 N. College St., Montfort, Wisc.
9 CAW Edward T. Rippey, Jr., 408 N. College St., Richmond, Mo.
9 CMY James W. Morris, 1128 Neosho St., Emporia, Kans.
9 DAO Clarence A. Moe, 4137 Elliott Ave., Minneapolis, Minn.
9 DBJ William Lechner, 4120 S. Wayne Ave., Ft. Wayne, Ind.
9 DCK Alfred T. Mitchell, L. B. 608, Rockford, Iowa
9 DCU Howard Myers, 4746 N. Fortieth Ave., Omaha, Nebr.
9 DFE Robert Burk, R. R. 1, Box 3, Ogdun, Ill.
9 DIC Emmett C. Miller, R. F. D. No. 3, Nappanee, Ind.
9 DIK Robert F. Hilyard, R. F. D., Mason City, Ill.
9 DMI Sherman O. Myers, R. 3, Box 37, Nappanee, Ind.
9 DMN Robert Merrill, 305 W. Main St., Marshalltown, Iowa
9 DOD Camp Checaugau, 330 Westminister Ave., Palatine, Ill.
9 DVM Lyman J. Haviland, 330 Westminister Ave., Lake Forest, Ill.
9 NY Eben R. Dennis, 2401 S. Chicago Ave., Hutchinson, Minn.
9 NW Herbert F. Wareing, 2401 S. Chicago Ave., Hutchinson, Wisc.
9 AUX Herman F. Hediger, 778 University Ave., St. Paul, Minn.
9 BNS Loyde T. Barker, 300 S. Oakland Ave., Parkville, Mo.
9 BWU Berthold A. Halfpap, 300 S. Oakland Ave., Green Bay, Wisc.
9 BYV Carl L. Fisher, 719 E. Fourth St., Maryville, Mo.
9 CAX John D. Barrett, 931 N. Kesler, Chicago, Ill.
9 DBS Bert J. Barnes, 289 First St., N. E., Linton, Ind.
9 DFR Clarence M. Morgan, 1010 "A" St., N. E., Linton, Ind.
9 XAS M. G. Sateren, 18 Franklin Ave., Minneapolis, Minn.
9 XAT Cutting & Washington Radio Corporation, 18 Franklin Ave., Minneapolis, Minn.

9 ELE George S. Porter, N. St. Vincent Road, LaSalle, Ill.
9 ELF Thomas W. Tizard, Jr., 352 Prairie Ave., Downers Grove, Ill.
9 ELG G. Frederic Pfoutz, R. F. D. No. 9, Rockford, Ill.
9 ELH Harold Layton, 1017 Pleasant Place, Oak Park, Ill.
9 ELI Kermit F. Tracy, 2429 Banks Ave., Superior, Wisc.
9 ELJ Charles I. Olson, 129 Melbourne Ave., S. E., Minneapolis, Minn.
9 ELK Alonzo L. Bates, 936 Kimbrough St., Springfield, Mo.
9 ELL William R. R. LaVielle, Jr., Audubon Park, R. D. 120 B, Louisville, Ky.
9 ELM Joseph A. Vivian, 516 1/2 Broadway, Logansport, Ind.
9 ELN Kenneth Everhart, 116 E. Buchanan St., Kankakee, Ill.
9 ELO William K. Cole, 242 Mansfield St., Ironwood, Mich.
9 ELP Lawrence D. Smith, P. O. Box 403, Crete, Nebr.
9 ELQ Leonard H. Rudd, 621 N. Penn Ave., Burlington, Wisc.
9 ELR Myron T. Steffy, 93 Forest Ave., Downers Grove, Ill.
9 ELS Lawrence A. Bernert, 381 Perkins Blvd., Burlington, Wisc.
9 ELT Leland N. Gibson, Box 8, White Water, Kans.
9 ELU Allen Woodridge, Main St., Osage, Iowa
9 ELV Justin W. Blauert, 498 13th St., Milwaukee, Wisc.
9 ELW William K. Schlegel, 1641 Washington St., Lincoln, Nebr.
9 ELX Howard W. Lange, 2243 Addison St., Chicago, Ill.
9 ELY Donald R. Dixon, 5821 Page Ave., St. Louis, Mo.
9 ELZ Herbert Hanrion, 2912 Prospect Ave., Kansas City, Mo.
9 EZ A. B. McCall, 631 W. Edwards St., Springfield, Ill.
9 GE A. B. McCall, 631 W. Edwards St., Springfield, Ill.
9 ME William H. Smith, Y. M. C. A., 16th and Lincoln Sts., Denver, Colo.
9 MH Adolph H. Haupt, 5409 Indiana Ave., Chicago, Ill.
9 ML Wilbur F. Hull, 301 Prairie St., Stevens Pt., Wisc.
9 MP Sigmund Kazrowski, 5234 W. 31st St., Cicero, Ill.
9 QP Powhattan Breeden, 3rd, 1441 Penn St., Denver, Colo.
9 SE Culver Military Academy, Culver, Ind.
9 AGB Eugene Young, 2290 Commonwealth Ave., St. Paul, Minn.
9 ASZ Casimer A. Jurkiewicz, 2739 N. Drake Ave., Chicago, Ill.
9 BDV Culver Military Academy, Culver, Ind.
9 BZU Kansas City Council (Boy Scouts of America), Noel, Mo.
9 CBI Leon DeLichter, 3435 Franklin Blvd., Chicago, Ill.
9 CGW Lorin K. Hill, 112 Main St., Ottumwa, Iowa
9 CCK Hardsoeg Mfg. Company, 112 Main St., Ottumwa, Iowa
9 CDR William W. Harper, Hotel Ottumwa, Ottumwa, Iowa
9 DKD Earle D. Miller, 3717 Burnham St., Darlington, Wisc.
9 DB James T. Gregerson, Jr., 3717 Burnham St., Milwaukee, Wisc.
9 GH Arnold C. Doman, Beaver Island, Clinton, Iowa
9 GK Kenneth M. Hance, 813 Third Ave., Fargo, N. Dak.
9 HB Frank L. Riggs, 505 S. Green St., Polo, Ill.
9 IA Russell C. Thompson, 1010 Mount Curve St., Minneapolis, Minn.
9 JN Gilbert Meredith, 860 Fifth St., N.W., Linton, Ind.
9 JD Herbert Richter, 1563 University Ave., St. Paul, Minn.
9 JQ Wm. Schroeder, 1825 Spaulding Ave., Chicago, Ill.
9 JI Frederick A. Bailey, Perry, Mo.
9 KD Fredk. & Wilbur Braig (Braig), 413 Spruce St., Rockford, Ill.
9 KJ Clarence E. Folkers, 123 Main St., Frankfort, Ill.
9 LA Leroy Thayer, 757 Eighteenth St., Des Moines, Iowa
9 LB Frank J. Warth, 637 New York Ave., Milwaukee, Wisc.
9 LE Leonard T. Carlson, 820 E. Prospect St., Kewanee, Ill.
9 LJ Howard H. Taylor, 2001 Mitchell Ave., St. Joseph, Mo.
9 LK John P. Matthews, 527 E. First Ave., Newton, Iowa
9 LT Marshall Electric Co., 1603 W. Main St., Marshalltown, Iowa
9 NB Raymond C. Sellers, R. F. D. No. 1, Sycamore, Ill.
9 NG Raymond G. Sellers, 1414 First Ave., Evansville, Ind.
9 NI Robert B. Dome, 406 E. Columbia St., Evansville, Ind.
9 OA Leland D. Whitecock, 408 Ninth St., Petersburg, Ind.
9 OB Lewis R. Miller, 905 Avenue "A", Dodge City, Kans.
9 OM Clarence A. Brockert, 911 W. Main St., Plattville, Wisc.
9 PJ James A. Martino, 2148 N. Kostner Ave., Chicago, Ill.
9 PR Stanislaus B. Mateske, 1101 St. Andrew St., Leicheston, Ind.
9 PU Merle L. Hobson, 401 W. Nat'l Rd., Owensville, Ind.
9 PV Arvid N. Montgomery, Main St., Owensville, Ind.
9 QH W. Alva Hill, 817 Market St., Emporia, Kans.
9 QI George J. Wagner, 1319 S. Eighth St., Lincoln, Nebr.
9 QJ Rev. Clifford L. White, E. Main St., Greentown, Ind.
9 QK Gurden F. Gould, 217 E. Seventh St., Concordia, Kans.
9 TR Harold I. Tarr, 2517 Capitol Ave., Des Moines, Iowa
9 TS Albert Johnsen, 2203 W. 11th St., Lincoln, Ill.
9 TW Carl W. Yarech, 232 Sixth St., Omaha, Nebr.
9 UD Orval W. Phebus, 2336 S. 19th St., Omaha, Nebr.
9 UG Charles C. Schuder, W. South St., Sumner, Ill.
9 UI Junior Bishop, 616 W. 6th St., Sedalia, Mo.
9 UT Walker Knotts, 847 W. 27th St., Indianapolis, Ind.
9 VA Edward A. Ramsey, 108 H. College Ave., Assumption, Ill.
9 VL Gordon W. Volkenant, 1242 N. Knox Ave., Minneapolis, Minn.
9 VP John M. Olson, 716 N. Sixth St., Manitowoc, Wisc.
9 AKT W. A. Weiboldt & Co., 3235 Lincoln Ave., Chicago, Ill.
9 AKV Edgar C. Penny, 714 Garfield Ave., Belvidere, Ill.
9 AMM James Gwynn, 118 Clarinda Ave., Shenandoah, Iowa
9 AWJ Orlando E. Nichols, 732 N. Drake Ave., Chicago, Ill.
9 AXF John Hemingway, 4331 N. Hermitage Ave., Chicago, Ill.
9 AZL Garnett Bryan, 420 E. 11th St., Sedalia, Mo.
9 BCX Kirebner & Wedel, 1326 Main St., Keokuk, Iowa
9 BLN Edgar A. Triplett, 525 Lincoln Ave., Osawatimie, Kans.
9 BME Bartlett Van Dolsen, 103 Miller St., Shelbyville, Ind.
9 BMZ Wilfred Hoaglin, 1220 Tenth Ave., N. Ft. Dodge, Ia.
9 BOX Roy C. Mullen, 500 Twelfth St., Osawatimie, Kans.

9 BRV Paul C. Mletke, Jr., 519 N. Main St., Crookston, Minn.
9 VY William S. Schultz, 1004 N. Locust St., Valparaiso, Ind.
9 AOK Cecil P. Meek, 4536 Woodlawn Ave., Chicago, Ill.
9 ARE Conrad O. Lunde, 227 Second Ave., N., Crookston, Minn.
9 BAU John A. Hutcheson, 320 Ashton St., Grand Forks, N. Dak.
9 BQK John Pelnar, 5609 S. Nineteenth St., S. Omaha, Nebr.
9 BRU Wallace E. St. Vrain, 315 N. Missouri St., Mexico, Mo.
9 DRU Melvin Johnson, 305 Guthrie St., Ottumwa, Ill.
9 DWB Raymond Prewitz, 402 Congress St., Emporia, Kans.
9 ECC James A. Yates, 439 E. Main St., Richmond, Mo.
9 EEF Anson L. Carr, 1500 Main St., Leon, Iowa
9 EFY Claiborne C. Van Zandt, 338 Euclid Ave., Oak Park, Ill.
9 ZG Maurice G. Goldberg, 711 Dayton Ave., St. Paul, Minn.
9 ZN Ralph H. G. Matthews, 5525 Sheridan Rd., Chicago, Ill.
9 ZV Robert L. Coe, 207 Linden Ave., Clayton, Mo.
9 AX Clarence W. Leininger, 3825 Lawrence Ave., Chicago, Ill.
9 AGT Wm. H. Hebal, 328 McCulloch St., Stevens Pt., Wisc.
9 AVT G. Edward Allebach, 3440 W. 40th Ave., Denver, Colo.
9 BOA Theodore Graffunder, Marshall, Minn.
9 BOB Louis C. Stroh, 1314 Lawrence Ave., Emporia, Kans.
9 BOZ John K. Lowe, 2927 Kensington St., Kansas City, Mo.
9 BSV Ralph R. Fowler, 219 Central Ave., Kearney, Nebr.
9 CWC Lincoln J. Simms, 218 S. Sedgwick St., Wichita, Kans.
9 CZS Indiana Radio Engineering Co., 370 W. 30th St., Indianapolis, Ind.
9 DEL George C. Bowen, 538 Greenwood St., Fond-du-Lac, Wisc.
9 DMU G. Luther Anderson, 200 N. Chicago Ave., Lincoln, Ill.
9 FM Sidney J. Blum, 6320 Main St., Kansas City, Mo.
9 RR Lawellin B. Laizure, 5544 Highland Ave., Kansas City, Mo.
9 VG John L. Greene, 615 Weissinger St., Louisville, Ky.
9 ALB French H. Willis, Cherry St., Carlisle, Ind.
9 AZO William C. Rosenberger, 6946 N. Michigan Ave., Chicago, Ill.
9 CIT Harry S. Carr, 260 Main St., Dundee, Ill.
9 CVK Edwin J. DeCosta, 6738 Gradon Ave., Chicago, Ill.
9 CZA Arthur N. Gunderson, 4833 Newport Ave., Chicago, Ill.
9 DPD Marson H. French, R. F. D. No. 1, Partridge, Kans.
9 EAX Thos. M. Breen, 3649 Stevens Ave., Minneapolis, Minn.
9 AQ Mervyn Street, 807 S. Third St., Champaign, Ill.
9 BI Waldo E. Lisle, 9625 Vandepool Ave., Chicago, Ill.
9 BU Edward J. Selenka, 3348 N. Avers Ave., Chicago, Ill.
9 DX Jay F. Carpenter, 1109 17th Ave., S.E., Minneapolis, Minn.
9 FT George A. Plank, 101 N. Pleasant St., Independence, Mo.
9 JU Reynold Worgitzky, 1831 Hammond St., Chicago, Ill.
9 NS Joseph P. Snorke, 5115 S. Ada St., Chicago, Ill.
9 AFN Donald H. Stover, 1007 S. First St., Champaign, Ill.
9 AIF Charles T. Norton, 321 N. Spring St., Sioux Falls, S. Dak.
9 ALX Stanley Tollman, 3927 Beachwood Ave., Pineo Lawn, Mo.
9 BBD Walter E. Bryner, 838 N. Eighth St., Springfield, Ill.
9 BHL Lawrence Topp, 3018 Keating Ave., Chicago, Ill.
9 BIQ Frank Romacka, 1021 Monticello Ave., Chicago, Ill.
9 BQO Clarence R. Sienberger, Forest St., Marengo, Ill.
9 CBP Maurice MacLeod, 642 Elgin Ave., Forest Park, Ill.
9 GD Harold D. Jones, P. O. Box No. 5, St. Croix Falls, Wisc.
9 KB Walter C. Evans, 6637 Kimbark Ave., Chicago, Ill.
9 PW Harold J. Becker, 4419-a Michigan Ave., St. Louis, Mo.
9 RE Wilber E. Monigan, 1142 N. Johnson St., South Bend, Ind.
9 IT Adolph J. Zeithammel, 2503 S. 61st Ave., Cicero, Ill.
9 VZ Bert L. Brown, 26 Alexandria Pike., Clifton, Ky.
9 AGL Howard M. Crosby, 708 Eighth St., Brookings, S. Dak.
9 AXX Russell and Donald Callender, 1669 Princeton Ave., St. Paul, Minn.
9 BMF W. Monfort Barr, Men's Hall., Greencastle, Ind.
9 BZZ Dean Wesley Imel, 502 S. 16th St., Independence, Kan.
9 CBF Alf Morris Myhre, 721 4th St., N. E., Watertown, S. Dak.
9 CCX Raymond Pfisterer, 1411 Second Ave., Evansville, Ind.
9 CDW Gustav G. Rehm, 4324 Itasca St., St. Louis, Mo.
9 CFF Rudolph W. Bucke, 1045 S. Second St., Springfield, Ill.
9 CGF Warren P. Adams, 310 First Ave., N. Fairbank, Minn.
9 CHQ Theodore Kennedy, 2613 Stevens St., Madison, Wisc.
9 CIT Harry S. Carr, 260 Main St., Dickinson, N. Dak.
9 CIZ Harry S. Carr, 260 Main St., Dundee, Ill.
9 CPY Elmer A. Scheer, 4452 Farlin Ave., St. Louis, Mo.
9 CSS Henry H. Gutmann, 2919 Cottage Grove Ave., Chicago, Ill.
9 CUD Fred W. DeZonia, 1835 Spruce St., Murphysboro, Ill.
9 CZI Glenn Keller., Sikeston, Mo.
9 CZW Henry Bester, Jr., 620 Moro St., Manhattan, Kans.
9 DDP Carl A. Jacobson, Main St., Kenneth, Minn.
9 DHQ C. Frederick Wolcott, 2817 Thayer St., Evanston, Ill.
9 DLQ Noble C. Lippincott., Milton, Wisc.
9 DME William A. Pringle, 224 N. Sixth St., Lyons Station, Clinton, Iowa.
9 DRO Roy J., & Clarence Kuester, 370 Naynut St., Menasha, Wisc.
9 EAD Dudley Andrews, R. R. B-1, Box 287-L, Indianapolis, Ind.

CHANGES

9 ATD Norman R. Bowen, 3246 High St., Denver, Colo.
9 BOY Robert Heuberger, 535 Forest Ave., Oak Park, Ill.
9 CJE Charles A. Pine, 818 W. Sixth St., Coffeyville, Kans.
9 CLN Arthur E. Thompson, 812 Spencer Ave., Marion, Ind.
9 CXR Elmer C. Madson, Wagner Bldg., Walnut St., Chicago, Ill.
9 DFV Warren D. Birkenhead, 410 Addison Ave., Elmhurst, Ill.
9 EBG Maurice Locker, 1114 W. 25th St., Minneapolis, Minn.
9 KE Edwin A. Beane, 4900 N. Whipple St., Chicago, Ill.
9 UP Adolph J. Zeithammel, 2503 S. 61st Ave., Cicero, Ill.
9 UW William Symons, 821 N. Penn Ave., S. Indianapolis, Ind.
9 WE Noble E. Watson, 233 Iowa St., Indianapolis, Ind.
9 WM Daniel F. Hesley, 219 Mescham Ave., Park Ridge, Ill.
9 AIB Joe E. Smay, Nevada, Iowa
9 DWX William F. Marquardt, 2624 Potwysne Place, Chicago, Ill.
9 EDO Howard M. Howell, 819 N. 25th St., Vincennes, Ind.
9 ASZ Theodore Kropushek, Livingston, Ill.
9 AWA Willard Hagn, 2082 Greenleaf Ave., Chicago, Ill.
9 AWU Ralph V. Bradley, 809 N. Main St., Princeton, Ill.
9 ABY John O. Weaver, 119 E. 10th St., Mt. Carmel, Ill.
9 AZD Paul Beck, 170 E. Sanborn St., Winona, Minn.
9 BIF Henry D. Tyssen, 10555 Wallace St., Chicago, Ill.
9 BKL Everette M. Foster, 1242 S. 6th St., Cedar Rapids, Iowa
9 BLX Lynford E. Reynolds, Cedar Rapids, Iowa
9 BQE H. I. Gibbs, 1053 W. 19th St., Des Moines, Iowa
9 BRB Risser Williams, 1328 1/2 Broad St., Newcastle, Ind.
9 BRH Jack R. Mohler, 2214 S. 15th St., St. Joseph, Mo.
9 BRZ Anthony J. Wember, 10511 S. Racine Ave., Chicago, Ill.
9 BTG Leroy Lankford, 603 Pfeiffer Ave., Ft. Wayne, Ind.
9 BTM Dale L. Smith., Bowen, Ill.
9 BTP Arthur T. Bailey., Winnebago, Minn.
9 BTR Lyle C. Nelson., Sheffield, Ill.
9 BTV Russell Anderson, 609 Case St., St. Paul, Minn.
9 BUA Aloysius J. Grobarel, 2446 N. Artesian Ave., Chicago, Ill.
9 BUB Andrew Fischer, Jr., 811 Cass St., Chicago, Ill.
9 BUU Raymond C. Rogers, 4435 Washington Blvd., Chicago, Ill.
9 BUL Charles O. Gosch, 105 S. Oronogo St., Wabash City, Mo.
9 BUS Fredk J. Stephens, Grove St., Livingston, Wisc.
9 BUZ Clark H. Gore., Rock Port, Mo.
9 BVE Jack C. Newburn, 2824 Galena St., Milwaukee, Wisc.
9 BVJ George McHarg, R. F. D. No. 4, Box 91, Brooklyn, Iowa
9 BVN Joseph A. Flaherty, 278 N. Fifth St., Kansas City, Kans.
9 BVS Marshall E. Whitecomb, 225 S. East St., Redwood Falls, Minn.
9 BVT Graydon E. Burnett, 321 Josephine Ave., Madison, S. Dak.
9 BVU Robert P. Freeman., Adon, Iowa
9 BVQ William S. Duncan, 712 Jordan St., Mt. Vernon, Ill.
9 BWC Roy A. Mosher, 2530 Artesian Ave., Chicago, Ill.
9 BVB Francis E. Nelson, 216 Linn St., Boone, Iowa
9 BWH Arnold P. Brastad, 1814 13th St., Minneapolis, Minn.

9 CBI Leon DeLichter, 3435 Franklin Blvd., Chicago, Ill.
9 CGW Lorin K. Hill, 112 Main St., Ottumwa, Iowa
9 CCK Hardsoeg Mfg. Company, 112 Main St., Ottumwa, Iowa
9 CDR William W. Harper, Hotel Ottumwa, Ottumwa, Iowa
9 DKD Earle D. Miller, 3717 Burnham St., Darlington, Wisc.
9 DB James T. Gregerson, Jr., 3717 Burnham St., Milwaukee, Wisc.
9 GH Arnold C. Doman, Beaver Island, Clinton, Iowa
9 GK Kenneth M. Hance, 813 Third Ave., Fargo, N. Dak.
9 HB Frank L. Riggs, 505 S. Green St., Polo, Ill.
9 IA Russell C. Thompson, 1010 Mount Curve St., Minneapolis, Minn.
9 JN Gilbert Meredith, 860 Fifth St., N.W., Linton, Ind.
9 JD Herbert Richter, 1563 University Ave., St. Paul, Minn.
9 JQ Wm. Schroeder, 1825 Spaulding Ave., Chicago, Ill.
9 JI Frederick A. Bailey, Perry, Mo.
9 KD Fredk. & Wilbur Braig (Braig), 413 Spruce St., Rockford, Ill.
9 KJ Clarence E. Folkers, 123 Main St., Frankfort, Ill.
9 LA Leroy Thayer, 757 Eighteenth St., Des Moines, Iowa
9 LB Frank J. Warth, 637 New York Ave., Milwaukee, Wisc.
9 LE Leonard T. Carlson, 820 E. Prospect St., Kewanee, Ill.
9 LJ Howard H. Taylor, 2001 Mitchell Ave., St. Joseph, Mo.
9 LK John P. Matthews, 527 E. First Ave., Newton, Iowa
9 LT Marshall Electric Co., 1603 W. Main St., Marshalltown, Iowa
9 NB Raymond C. Sellers, R. F. D. No. 1, Sycamore, Ill.
9 NG Raymond G. Sellers, 1414 First Ave., Evansville, Ind.
9 NI Robert B. Dome, 406 E. Columbia St., Evansville, Ind.
9 OA Leland D. Whitecock, 408 Ninth St., Petersburg, Ind.
9 OB Lewis R. Miller, 905 Avenue "A", Dodge City, Kans.
9 OM Clarence A. Brockert, 911 W. Main St., Plattville, Wisc.
9 PJ James A. Martino, 2148 N. Kostner Ave., Chicago, Ill.
9 PR Stanislaus B. Mateske, 1101 St. Andrew St., Leicheston, Ind.
9 PU Merle L. Hobson, 401 W. Nat'l Rd., Owensville, Ind.
9 PV Arvid N. Montgomery, Main St., Owensville, Ind.
9 QH W. Alva Hill, 817 Market St., Emporia, Kans.
9 QI George J. Wagner, 1319 S. Eighth St., Lincoln, Nebr.
9 QJ Rev. Clifford L. White, E. Main St., Greentown, Ind.
9 QK Gurden F. Gould, 217 E. Seventh St., Concordia, Kans.
9 TR Harold I. Tarr, 2517 Capitol Ave., Des Moines, Iowa
9 TS Albert Johnsen, 2203 W. 11th St., Lincoln, Ill.
9 TW Carl W. Yarech, 232 Sixth St., Omaha, Nebr.
9 UD Orval W. Phebus, 2336 S. 19th St., Omaha, Nebr.
9 UG Charles C. Schuder, W. South St., Sumner, Ill.
9 UI Junior Bishop, 616 W. 6th St., Sedalia, Mo.
9 UT Walker Knotts, 847 W. 27th St., Indianapolis, Ind.
9 VA Edward A. Ramsey, 108 H. College Ave., Assumption, Ill.
9 VL Gordon W. Volkenant, 1242 N. Knox Ave., Minneapolis, Minn.
9 VP John M. Olson, 716 N. Sixth St., Manitowoc, Wisc.
9 AKT W. A. Weiboldt & Co., 3235 Lincoln Ave., Chicago, Ill.
9 AKV Edgar C. Penny, 714 Garfield Ave., Belvidere, Ill.
9 AMM James Gwynn, 118 Clarinda Ave., Shenandoah, Iowa
9 AWJ Orlando E. Nichols, 732 N. Drake Ave., Chicago, Ill.
9 AXF John Hemingway, 4331 N. Hermitage Ave., Chicago, Ill.
9 AZL Garnett Bryan, 420 E. 11th St., Sedalia, Mo.
9 BCX Kirebner & Wedel, 1326 Main St., Keokuk, Iowa
9 BLN Edgar A. Triplett, 525 Lincoln Ave., Osawatimie, Kans.
9 BME Bartlett Van Dolsen, 103 Miller St., Shelbyville, Ind.
9 BMZ Wilfred Hoaglin, 1220 Tenth Ave., N. Ft. Dodge, Ia.
9 BOX Roy C. Mullen, 500 Twelfth St., Osawatimie, Kans.

9 BRV Paul C. Mletke, Jr., 519 N. Main St., Crookston, Minn.
9 VY William S. Schultz, 1004 N. Locust St., Valparaiso, Ind.
9 AOK Cecil P. Meek, 4536 Woodlawn Ave., Chicago, Ill.
9 ARE Conrad O. Lunde, 227 Second Ave., N., Crookston, Minn.
9 BAU John A. Hutcheson, 320 Ashton St., Grand Forks, N. Dak.
9 BQK John Pelnar, 5609 S. Nineteenth St., S. Omaha, Nebr.
9 BRU Wallace E. St. Vrain, 315 N. Missouri St., Mexico, Mo.
9 DRU Melvin Johnson, 305 Guthrie St., Ottumwa, Ill.
9 DWB Raymond Prewitz, 402 Congress St., Emporia, Kans.
9 ECC James A. Yates, 439 E. Main St., Richmond, Mo.
9 EEF Anson L. Carr, 1500 Main St., Leon, Iowa
9 EFY Claiborne C. Van Zandt, 338 Euclid Ave., Oak Park, Ill.
9 ZG Maurice G. Goldberg, 711 Dayton Ave., St. Paul, Minn.
9 ZN Ralph H. G. Matthews, 5525 Sheridan Rd., Chicago, Ill.
9 ZV Robert L. Coe, 207 Linden Ave., Clayton, Mo.
9 AX Clarence W. Leininger, 3825 Lawrence Ave., Chicago, Ill.
9 AGT Wm. H. Hebal, 328 McCulloch St., Stevens Pt., Wisc.
9 AVT G. Edward Allebach, 3440 W. 40th Ave., Denver, Colo.
9 BOA Theodore Graffunder, Marshall, Minn.
9 BOB Louis C. Stroh, 1314 Lawrence Ave., Emporia, Kans.
9 BOZ John K. Lowe, 2927 Kensington St., Kansas City, Mo.
9 BSV Ralph R. Fowler, 219 Central Ave., Kearney, Nebr.
9 CWC Lincoln J. Simms, 218 S. Sedgwick St., Wichita, Kans.
9 CZS Indiana Radio Engineering Co., 370 W. 30th St., Indianapolis, Ind.
9 DEL George C. Bowen, 538 Greenwood St., Fond-du-Lac, Wisc.
9 DMU G. Luther Anderson, 200 N. Chicago Ave., Lincoln, Ill.
9 FM Sidney J. Blum, 6320 Main St., Kansas City, Mo.
9 RR Lawellin B. Laizure, 5544 Highland Ave., Kansas City, Mo.
9 VG John L. Greene, 615 Weissinger St., Louisville, Ky.
9 ALB French H. Willis, Cherry St., Carlisle, Ind.
9 AZO William C. Rosenberger, 6946 N. Michigan Ave., Chicago, Ill.
9 CIT Harry S. Carr, 260 Main St., Dundee, Ill.
9 CVK Edwin J. DeCosta, 6738 Gradon Ave., Chicago, Ill.
9 CZA Arthur N. Gunderson, 4833 Newport Ave., Chicago, Ill.
9 DPD Marson H. French, R. F. D. No. 1, Partridge, Kans.
9 EAX Thos. M. Breen, 3649 Stevens Ave., Minneapolis, Minn.
9 AQ Mervyn Street, 807 S. Third St., Champaign, Ill.
9 BI Waldo E. Lisle, 9625 Vandepool Ave., Chicago, Ill.
9 BU Edward J. Selenka, 3348 N. Avers Ave., Chicago, Ill.
9 DX Jay F. Carpenter, 1109 17th Ave., S.E., Minneapolis, Minn.
9 FT George A. Plank, 101 N. Pleasant St., Independence, Mo.
9 JU Reynold Worgitzky, 1831 Hammond St., Chicago, Ill.
9 NS Joseph P. Snorke, 5115 S. Ada St., Chicago, Ill.
9 AFN Donald H. Stover, 1007 S. First St., Champaign, Ill.
9 AIF Charles T. Norton, 321 N. Spring St., Sioux Falls, S. Dak.
9 ALX Stanley Tollman, 3927 Beachwood Ave., Pineo Lawn, Mo.
9 BBD Walter E. Bryner, 838 N. Eighth St., Springfield, Ill.
9 BHL Lawrence Topp, 3018 Keating Ave., Chicago, Ill.
9 BIQ Frank Romacka, 1021 Monticello Ave., Chicago, Ill.
9 BQO Clarence R. Sienberger, Forest St., Marengo, Ill.
9 CBP Maurice MacLeod, 642 Elgin Ave., Forest Park, Ill.
9 GD Harold D. Jones, P. O. Box No. 5, St. Croix Falls, Wisc.
9 KB Walter C. Evans, 6637 Kimbark Ave., Chicago, Ill.
9 PW Harold J. Becker, 4419-a Michigan Ave., St. Louis, Mo.
9 RE Wilber E. Monigan, 1142 N. Johnson St., South Bend, Ind.
9 IT Adolph J. Zeithammel, 2503 S. 61st Ave., Cicero, Ill.
9 VZ Bert L. Brown, 26 Alexandria Pike., Clifton, Ky.
9 AGL Howard M. Crosby, 708 Eighth St., Brookings, S. Dak.
9 AXX Russell and Donald Callender, 1669 Princeton Ave., St. Paul, Minn.
9 BMF W. Monfort Barr, Men's Hall., Greencastle, Ind.
9 BZZ Dean Wesley Imel, 502 S. 16th St., Independence, Kan.
9 CBF Alf Morris Myhre, 721 4th St., N. E., Watertown, S. Dak.
9 CCX Raymond Pfisterer, 1411 Second Ave., Evansville, Ind.
9 CDW Gustav G. Rehm, 4324 Itasca St., St. Louis, Mo.
9 CFF Rudolph W. Bucke, 1045 S. Second St., Springfield, Ill.
9 CGF Warren P. Adams, 310 First Ave., N. Fairbank, Minn.
9 CHQ Theodore Kennedy, 2613 Stevens St., Madison, Wisc.
9 CIT Harry S. Carr, 260 Main St., Dickinson, N. Dak.
9 CIZ Harry S. Carr, 260 Main St., Dundee, Ill.
9 CPY Elmer A. Scheer, 4452 Farlin Ave., St. Louis, Mo.
9 CSS Henry H. Gutmann, 2919 Cottage Grove Ave., Chicago, Ill.
9 CUD Fred W. DeZonia, 1835 Spruce St., Murphysboro, Ill.
9 CZI Glenn Keller., Sikeston, Mo.
9 CZW Henry Bester, Jr., 620 Moro St., Manhattan, Kans.
9 DDP Carl A. Jacobson, Main St., Kenneth, Minn.
9 DHQ C. Frederick Wolcott, 2817 Thayer St., Evanston, Ill.
9 DLQ Noble C. Lippincott., Milton, Wisc.
9 DME William A. Pringle, 224 N. Sixth St., Lyons Station, Clinton, Iowa.
9 DRO Roy J., & Clarence Kuester, 370 Naynut St., Menasha, Wisc.
9 EAD Dudley Andrews, R. R. B-1, Box 287-L, Indianapolis, Ind.

Amplification Perfection

with an audio transformer means

PURE TONE QUALITY
with **MAXIMUM VOLUME**

The AMERTRAN

- REG. U. S. PAT. OFF. -

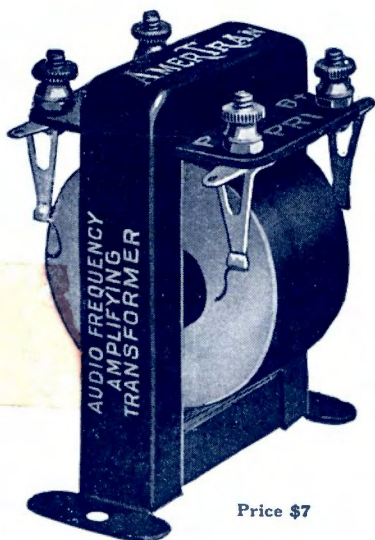

Ask your
Electrical
Dealer

or, sent car-
riage charges
collect (Wt. 1 lb.)

Price \$7

is acknowledged by professional radio engineers to be the STANDARD OF EXCELLENCE for audio amplification.

It amplifies in their proper proportion all the notes of a full orchestra—the full, rich bass notes as well as the high scale. It reproduces speech articulation with a faithfulness unsurpassed.

The plotted curve of its amplification shows a flat-top and absence of distortion, making it possible to use The AmerTran in any or all stages.

Circular 1005 contains a great deal of useful data regarding amplification, and will be sent upon request.

Turn ratio, 5:1. Amplification
ratio, 30-40 times audibility in
the flat part of the curve.

American Transformer Company

Designers and builders of radio transformers for over 22 years

179 Emmet Street

Newark, N. J.

Radiotron WD-12
The standard
base dry cell tube
\$6.50

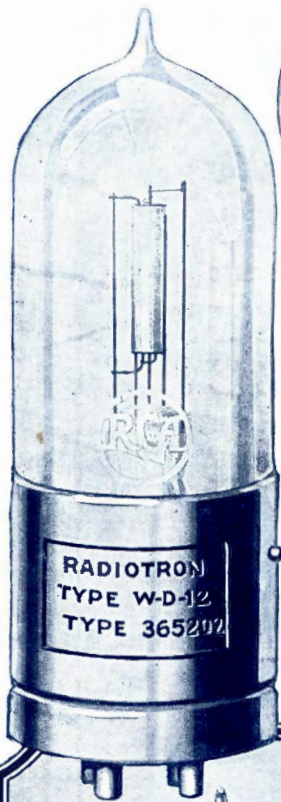

Radiotron UV-201-A
The super-amplifier tube \$6.50



Radiotron UV-199
The little tube of big performance \$6.50



Radiotron UV-200
The long distance detector \$5.00



Radiotron WD-11
The ideal dry battery detector and amplifier \$6.50

3,600,000 Radiotrons/ already made and sold!

This one fact reveals at a glance the growth of radio! 3,600,000 RADIOTRONS already sold! It was the perfection of the RADIOTRON that made popularization of radio possible—and every vacuum tube set needs RADIOTRONS for clear reception and amplification—for sensitivity—and long distance reception.

RADIOTRONS were developed in the world's largest radio laboratories, where hundreds of modern radio achievements had their beginnings. There, they have been steadily perfected to give ever greater service. And now RADIOTRONS have been developed to meet new needs of both transmission and reception. When you ask for a RADIOTRON, take a good look to be sure the name is on it—and the trade mark!

This symbol of quality is your protection



Radio Corporation of America

Sales Dept., Suite 2064; 233 Broadway, New York

District Sales Offices:

10 South LaSalle Street, Chicago, Ill.

433 California Street, San Francisco, Cal.

Radiotrons