

Radio Aire

362

It's all on Aire on 362

Radio Annual

LL (12/1)
ent Annual Edition

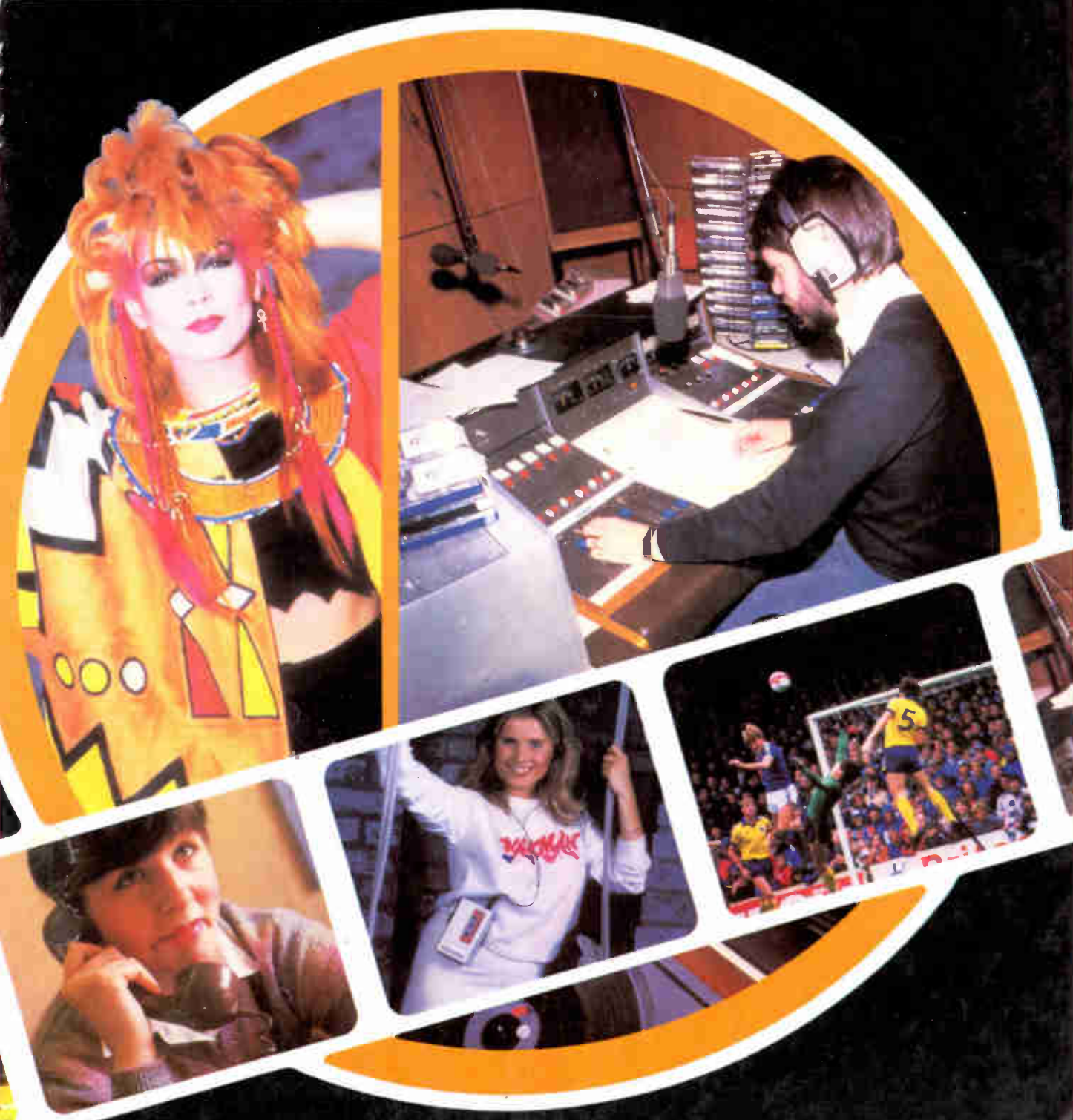



RACE GAME

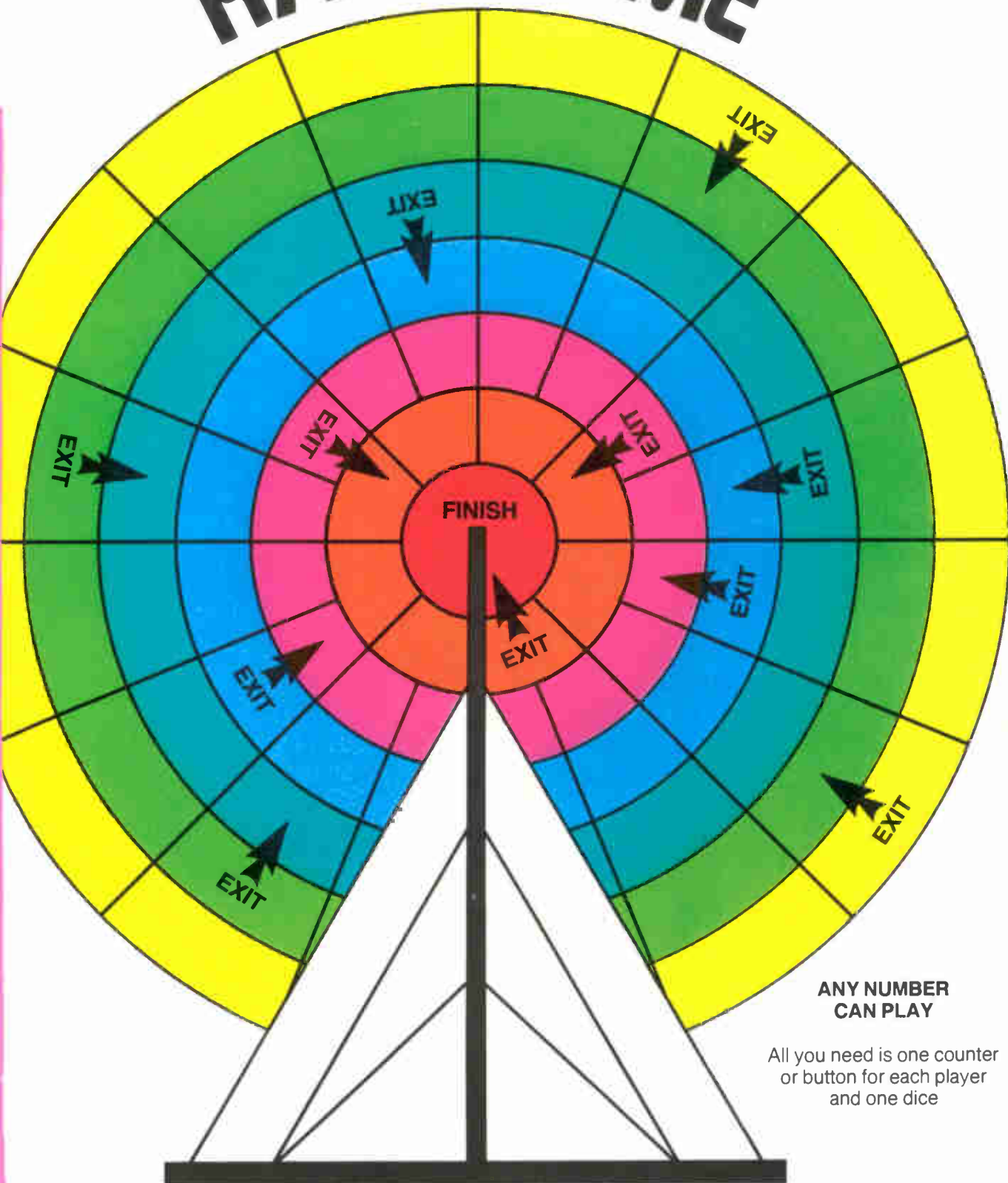

**ANY NUMBER
CAN PLAY**

All you need is one counter
or button for each player
and one dice

the exact number to land on an EXIT square at the end of your move. On your next turn you move into the adjoining waveband.

If you land on someone else's counter, you knock it sideways into the previous waveband. The winner is the first one to reach the FINISH circle.



Radio Aire
362
It's all on Air on 362

**Radio
Annual**

ISBN 0-946315-50-7



9 780946 315505

Your Independent Radio Annual

A fun annual for all ages

SP

ACKNOWLEDGEMENTS

Published by Stamford Publishing, The Grey House, 3 Broad Street, Stamford, Lincoln PE9 1PR

Distributed by World International Publishing Limited, PO Box 111, Great Dixie Street, Manchester M50 3BL

Printed and bound in Great Britain by Collins of Glasgow

Design and graphics, ADP, Yeovil, Somerset

Contents

Page 6	Madness . . . the story so far
Page 8	The History of Radio
Page 11	Puzzle Page
Page 12	Laugh-in
Page 14	Animals in Action
Page 16	Paul McCartney . . . the legend that lasted
Page 18	Here is the News from IRN
Page 20	CB Radio
Page 22	Radio Treasure Trail
Page 25	Radio Waves across the Universe
Page 28	Duran Duran
Page 30	Getting a Start in Radio
Page 32	Puzzle Page
Page 33	Your favourite Radio Station
Page 44	Toyah
Page 46	Sports Round-up
Page 50	Fame
Page 52	Human League
Page 54	An Unusual Holiday
Page 56	Shaky
Page 58	How to make your own radio
Page 60	Bucks Fizz
Page 61	Profile of a Superstar — Kenny Dalglish
Page 62	Name The Radio Stations
Page 64	Ultravox
Page 66	Laugh-in
Page 68	Quiz
Page 70	Altered Images
Page 72	Answers
Page 74	Tim Rice's 100 All-time Greats
Page 78	Radio Masts Race Game

Hi there!

*W*elcome to our first ever annual. We've tried to pack in as much as we possibly could and we hope you have as much fun reading it as we did putting it together.

We've included pop pictures and articles on your favourite artists from TOYAH and DURAN DURAN to PAUL McCARTNEY and HUMAN LEAGUE.

In the centre you will find a whole section on your favourite Radio Station which gives you an inside view on what goes on and the people involved.

There are puzzles and quizzes, jokes and cartoons plus some exciting features on Dance and your favourite Sports personalities.

There's an article on how to build your own radio plus a special four-page feature where TIM RICE picks his top 100 records of all time and tells you why he thinks they're the best.

Without our listeners there would be no Radio Station, so let me say a big Thank-you and have fun reading this annual . . .

MAD

Madness are:

Woody — Daniel Woodgate

Suggs — Graham McPherson

Barso — Mike Barson

Kix — Lee Thompson

Chrissy Boy — Chris Foreman

Chas — Carl Smith

Bedders — Mark Bedford



Photo courtesy Stiff Records

MADNESS

...THE STORY SO FAR

Madness is what usually ensues when seven young North London loonies meet up with the aim of making fun music. But the looning that goes on doesn't mean that Madness don't take their music seriously. They do, it's just that they like to have fun as well. As Kix says: "The original idea of our nutty sound was to keep the music fun and humorous."

It was back in 1979 that things started to happen for the band. They changed their name from The North London Invaders to Madness, after a Prince Buster song they were playing, and put down a few studio tracks.

One of the tracks, *The Prince*, was released on Two-Tone, the Specials' label, and it got into the charts, staying there for ten weeks and peaking at number 16.

Up until then Madness had found gigs hard to come by, but the success of the single meant that they were suddenly in great demand, and in September they signed to Stiff.

A whole string of single and album hits followed, including *One Step Beyond*, *My Girl*, *Baggy Trousers*, *Embarrassment*, *Grey Day*, *Shut Up*, *It Must Be Love*, *Cardiac Arrest* . . . The list seems endless.

It wasn't until May 1982, though, that they got their first number 1 single. It was *House of Fun*, and shortly after the album *Complete Madness* topped the charts, too. In just a couple of years Madness have established themselves as one of the top bands, not only in Britain, but

in Europe, America, Australasia and the Far East. They proved natural stage performers, and love every minute of live gigging.

Add to that a great feature film *Take It Or Leave It* and a number 1 video cassette and you'll start to get some idea of the scale of their success and popularity.

Yet for all that success they're still North London nutters at heart. They don't much like the image-building and posing of the pop world. "I think the best you can do is to stay the same as you started out," says Suggs. He hates the idea of pop stars being put on a pedestal, and he and the band are always approachable, always ready to talk to young fans.

It's these young fans who have found it easy to identify with the songs: songs about being on the dole, going down the pub, riding in a beat-up car. But, as Suggs says: "It gets harder to write songs. I used to write about anything that came into my head. Now I feel the lyrics should be more subtle. The trouble is, the more you know about what happens in the world, the more difficult it is."

This more thoughtful mood is reflected on the *Rise and Fall* album, where the lyrics especially show new maturity — but it's still just as much sheer fun as typical Madness records.

Madness are still ordinary, unspoilt guys just buzzing with talent. Madness music makes people feel good — and that makes Madness feel good, too.

The history of radio



Mention the name Marconi and most people will tell you that he discovered radio waves. This, however, is not quite true because many years prior to Marconi conducting any experiments, James Clerk Maxwell theorised that radio waves existed. It was, however, Heinrich Hertz who first produced and transmitted radio waves. Despite this earlier work, Marconi is known as the Father of Radio for he managed to refine and improve the process of sending Radio messages.

Guglielmo Marconi was born in Bologna on 25th April 1874. His father was Italian and his mother Irish. Educated first in Bologna and Florence, Marconi then went to technical school in Leghorn, where he studied physics. During this time he began conducting experiments using electromagnetic wave techniques and it was at this time that he managed to recreate the experiments of Heinrich Hertz.

Marconi was only 20 when he left Leghorn and went back to his father's estate in Bologna, where he continued his experiments, using comparatively crude apparatus.

Despite this and his lack of any real scientific background, Marconi began making progress. One of Marconi's early breakthroughs came when he succeeded in ringing a bell, via the use of radio waves, over a distance of 20 metres. After these preliminary experiments over a short distance, he improved his equipment by introducing a vertical aerial with a metal plate or cylinder attached to each end. This simple yet significant modification increased the range of his radio.

Marconi tested the aerial by sending his brother out into the countryside around Bologna armed with a receiver and a gun. Marconi's brother was to fire the gun every time a signal was received. During these tests Marconi succeeded in sending signals over a distance of 1 1/2 miles. This was enough to convince him of the potentialities of the 'new' system of communications.

Fired with enthusiasm for his new communication system, Marconi approached the Italian government for sponsorship to continue his

experiments. The Italian government, however, was sceptical about Marconi's claims and gave him no encouragement or financial help at all.

In 1896, Marconi moved to London. In June of that year he met Sir William Preece, the Chief Engineer of the Post Office and, following a series of successful demonstrations during which he used balloons and kites to give greater height to his aerials, he succeeded in sending messages over distances of 9 miles. These experiments together with Preece's lectures, attracted considerable interest both in England and abroad.

Despite the success of Marconi's experiments, there remained much scepticism as to the useful application of this means of communication. However, help was at hand, Jameson Davis, Marconi's cousin and a practising engineer, financed a patent in America and helped to form the Wireless Telegraph and Signal Company Limited. (Changed in 1900 to the Marconi Wireless Telegraph Company Limited.)

This company's efforts were chiefly devoted to showing the world the full potential of the Radio Telegraph. To this end in 1899 Marconi equipped two American ships to report to newspapers on the progress of the yacht race for the America's Cup. The success of this demonstration led to the formation of the Marconi International Marine Company.

Despite all of these major triumphs, Marconi still had not convinced everyone. Mathematicians were sceptical as to whether messages could be transmitted further than 200 km. The mathematicians claimed that as radio waves travel in straight lines then the range of any radio would be limited by the curvature of the earth. In 1901 Marconi answered his critics by sending a message from Cornwall to Newfoundland across the Atlantic.

This feat was achieved by bouncing or reflecting the radio waves off the ionosphere which is a layer of electrically charged particles to be found in the atmosphere. The radio waves reflected off the ionosphere in much the same way light is reflected from a mirror.

From this date onwards great strides were made on the science of radio communications. By the time World War 1 started, most armies and navies of the world were equipped with radio apparatus. A problem with this radio apparatus was that anybody could listen as long as they possessed a receiver. This meant that military secrets could not be discussed 'on the air' and so this was a great limitation on the use of radio. Ways were found around this by using code but this was time consuming and unreliable.

Marconi recognised this problem and set to work solving it. He thought that if short wave radio signals were used then reflectors could be positioned around the aerial, and so produce a narrow beam of radio signals, minimising the possibilities of the signals being intercepted by the enemy.

Until the beginning of the 20th century the use of radio was limited to sending off messages. By 1904 the production of small radio receiving sets for the home had begun, and by 1906 R A Fessenden had opened up the first commercial radio station in California. This station had an operating range of only 24 km.

Today's radio stations can be found all around the world. In some countries such as Australia, where people live great distances from towns, special radio stations broadcast school lessons for children.

So it is thanks to Marconi's efforts that we have today many thousands of radio stations and such an efficient communication system.

Lecture & Practical Demonstration
OF
MARCONI'S
WONDERFUL SYSTEM OF
WIRELESS TELEGRAPHY
BY MR.
WILLIAM LYND.



The
Instruments
used are
supplied by the
**WIRELESS
TELEGRAPH
SIGNAL CO.**

And prepared
especially for
Mr. LYND by
Signor
MARCONI.

MARCONI AND HIS MARVELLOUS APPARATUS.
How to Send Telegrams through Space and Apparent Obstacles will be demonstrated during the course of the Lecture. Mr. LYND will be assisted by Mr. W. W. BRAINFIELD, one of Signor Marconi's Experimental Assistants.

Marconi Company Ltd.

How radio works

Radio waves belong to a larger group of electromagnetic waves. Included within this group are light waves, ultra violet and infra red. The only difference between all these different groups of waves is their **WAVELENGTH**, radio waves having the longest **WAVELENGTH** of all. The wavelength of any of these wave forms is the distance from one wave peak to another. (dia 1)

If a sound is to be transmitted by radio it must first be converted into radio waves. The initial stage in this process is to convert sound wave (vibrations in the air) into electrical impulses. This is done using a microphone.

As a sound wave enters a microphone, it causes a metal coil — which has a small electrical current passing through it — to vibrate. These extremely small vibrations cause the electrical current to fluctuate. This fluctuation of the electrical current is known as the **AUDIO FREQUENCY**. The AF is extremely weak and so it is fed into an **AUDIO FREQUENCY AMPLIFIER**, which increases the strength of the signal. However, the signal is still not ready to be transmitted; before this can happen, the signal must be combined with a carrier signal.

Once these two signals are combined, the new signal is ready to

be converted into radio waves. This is done by feeding the combined signal into an **AERIAL** which emits radio waves in all directions.

These radio waves travel in straight lines at the speed of light. The fact that the radio waves travel in straight lines and that the earth is a sphere led many scientists to believe that radio would be limited to a range of 150 to 200 km. (dia 2)

This, however, is not the case because of the existence of a layer or layers of charged particles around the earth known as the **IONOSPHERE**. The **IONOSPHERE** acts as a mirror and so reflects the radio waves back to earth. The earth, in turn, acts as a mirror and reflects the radio waves back towards the sky. (dia 3)

In this way signals can be transmitted all the way around the world.

Marconi Company Ltd.



Marconi with friends aboard his yacht "Elettra" in the early 1900's.

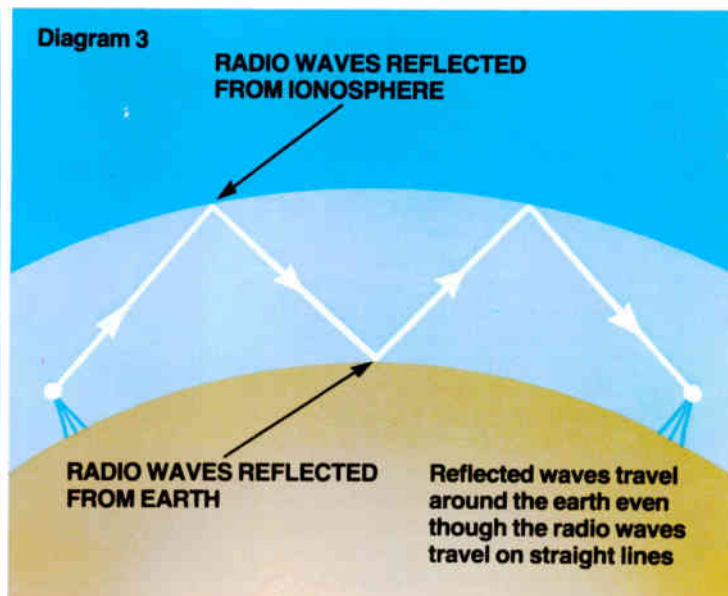
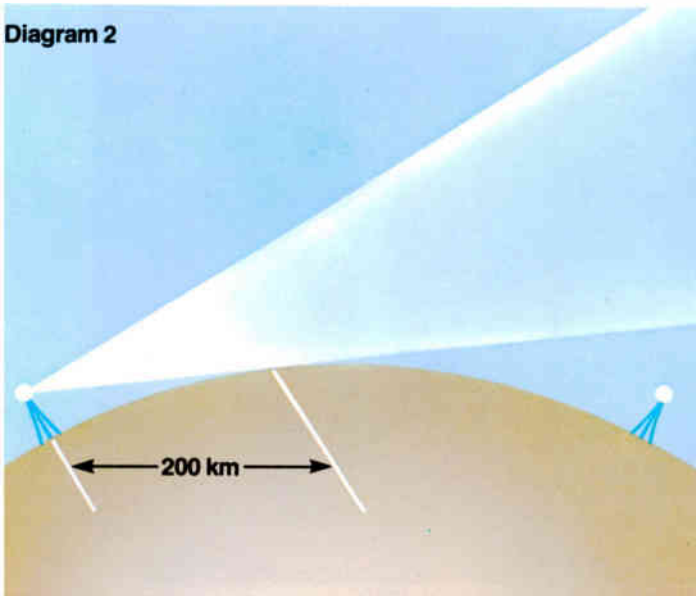
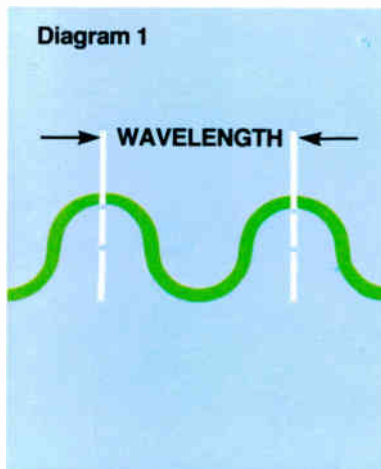

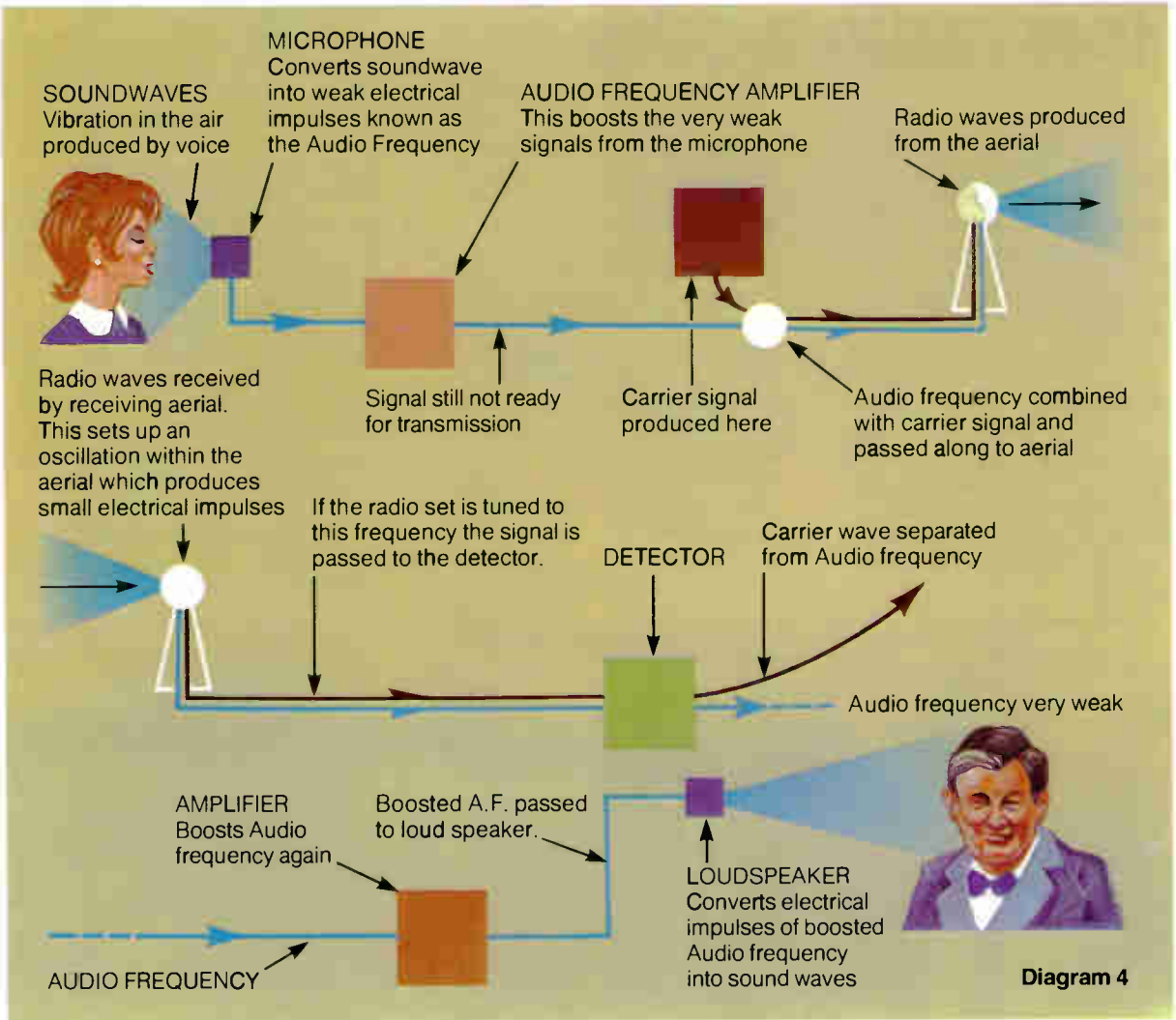

Receiving a Radio Wave signal and converting it into sound is much the same as the process for sending a signal, only the process is reversed.

Once a radio wave hits a receiving aerial, it sets up oscillations within the aerial. This produces a small electromagnetic current which then passes through the aerial down to the radio set. All radios are tuned to a particular frequency, and if this corresponds to the frequency of the Radio Waves being received then the signal is passed from the aerial to a detector which separates the carrier signal from the Audio Frequency. This AF is again very weak and so must be amplified before it can be converted into sound. Once the AF has been amplified it passes into a loud speaker and causes a cardboard or plastic cone to vibrate, thus producing sound waves very similar to the original sound that entered the microphone. (dia 4)

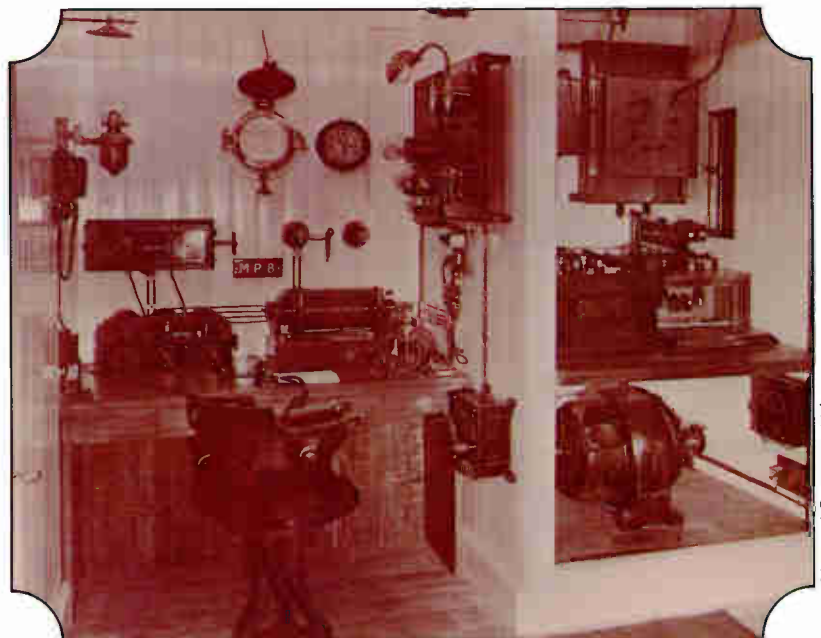

A Marconi Marine radio room aboard ship, 1910.

PUZZLEPAGE

Link-up

The answers to these clues are all 5-letter words. Start at No. 1 and fill in the answers, one letter to a square, in a clockwise direction. The last two letters of each word are the first two letters of the next word.

- | | | |
|--------------------------|------------------|---------------------|
| 1 Large birds | 9 Arm joint | 17 Wait at table |
| 2 Number | 10 Possessor | 18 Annoyed |
| 3 Foe | 11 Mistake | 19 Allan Poe |
| 4 Frankincense and | 12 Make a speech | 20 Scottish isle |
| 5 Horned animal | 13 Instruct | 21 Part of triangle |
| 6 Wanderer | 14 Inexpensive | 22 Smallest |
| 7 Worship | 15 Fruit | 23 Postage |
| 8 Nonconformist | 16 Rent | |

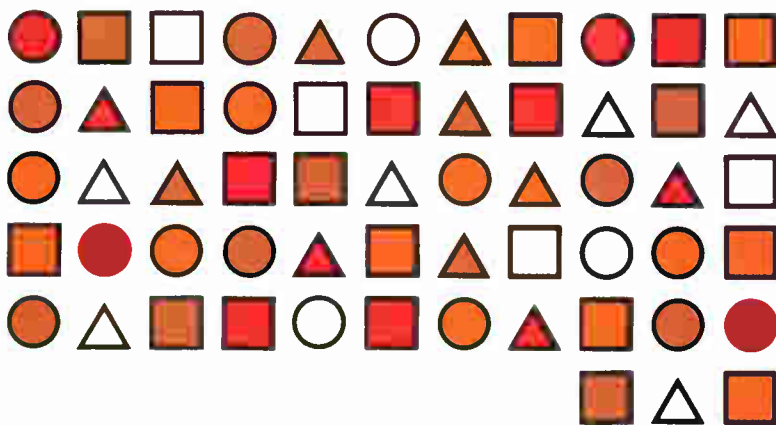

Pathway

Trace a pathway from Start to Finish by moving from one tile to the next, up, down, sideways or diagonally, but only from the same colour to the same colour, or the same shape to the same shape.

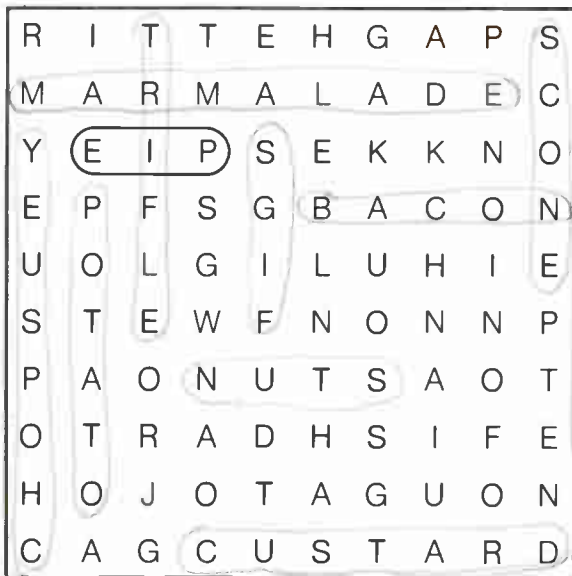

Word search — food for thought

25 things to eat are hidden in the diagram. Each word is in a straight line, across (forwards or backwards), up or down, or diagonally. Put a ring round each word as you find it. The first word has been done for you.

Jumbled

What's the word?
Clue: Forerunner

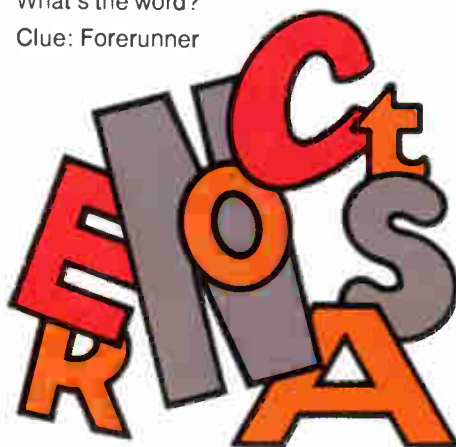

Answers on page 72/73



What time is it when an elephant sits on a fence?

Time to get a new one

Willie: 'It's raining cats and dogs today.'

Bob: 'I know. I've just stepped in a poodle.'

'Daddy, there's a black cat in the dining room.'

'But son, black cats are lucky.'

'This one is — he's eaten your dinner.'

What's the difference between a lemon and a white elephant?

A lemon is yellow

What's the difference between a biscuit and an elephant?

You can't dip an elephant in your tea

Why do elephants have big ears?

Noddy wouldn't pay the ransom

Why don't elephants eat penguins?

They can't get the wrappers off

What's worse than raining cats and dogs?

Hailing taxis

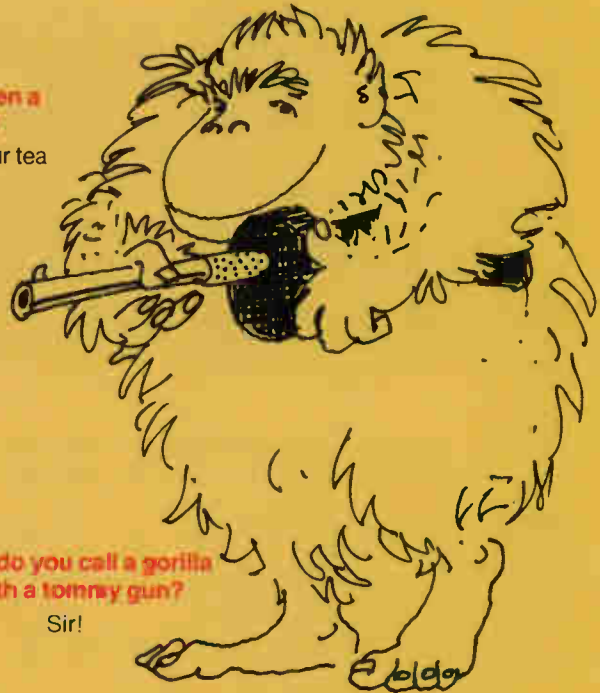

What do you call a gorilla with a tommy gun?

Sir!

What is a caterpillar?

A worm in a fur coat

What do you give an elephant with big feet?

Plenty of room

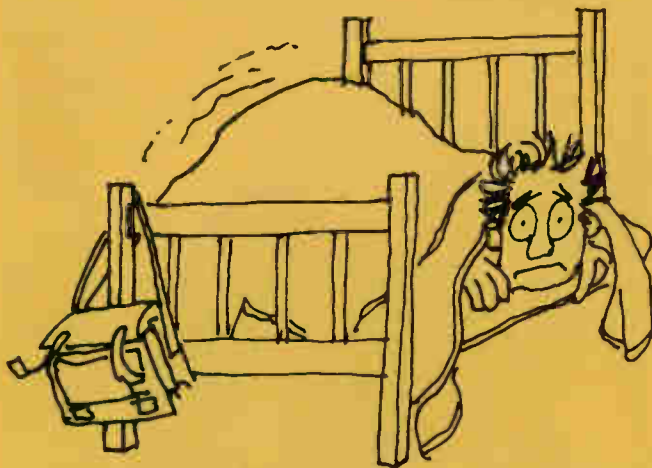

Mother to son: 'Come on you'll be late for school.'

'Shan't,' came the reply from the bedroom.

'Why, what's wrong?'

'The teachers hate me and the kids despise me.'

'I'll give you two reasons why you should go.'

'What are they?'

'One — you're forty six, and two — you're the headmaster.'

'I've lost my dog.'

'Why don't you put an advertisement in the paper?'

'Don't be silly — he can't read.'

What's black and white and noisy?

A zebra with a set of drums

What are the best steps to take when you meet an escaped lion?

Very long ones

When is it bad luck to have a black cat follow you?

When you are a mouse

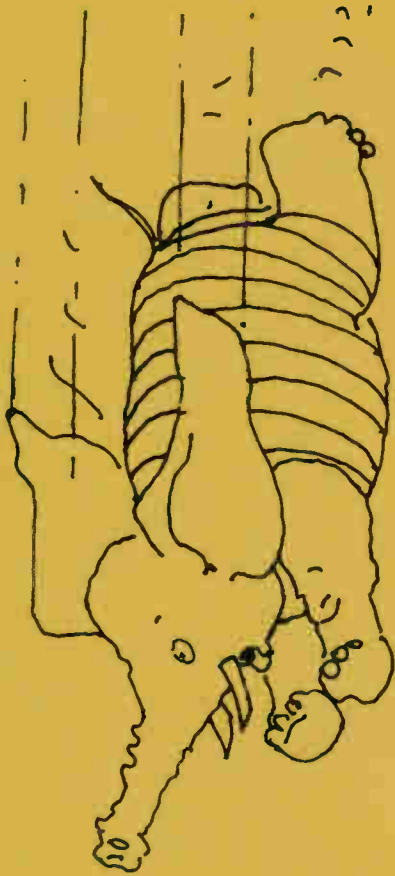

Why did the elephant cross the road?

It was the chicken's day off

What's green and highly dangerous?

A caterpillar with a hand grenade

What do you get if you cross a crocodile with a rose?

I don't know, but I wouldn't try smelling it

What is a certain way to get a wild duck?

Buy a tame one and annoy it

What comes out of a wardrobe at 100 mph?

Stirling Moth

Can an elephant jump higher than a lamp-post?

Yes. Lamp-posts can't jump

Why do birds fly south in winter?

It's too far to walk

How do elephants dive into swimming pools?

Head first

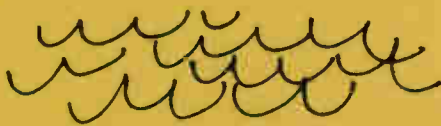

On which side does a chicken have most feathers?

On the outside

Why is it silly to hold a party for chickens?

Because these days it's difficult to make hens meet

What animal has two humps and is found at the North Pole?

A lost camel



1st Man: 'Every day my dog and I go for a tramp in the woods.'

2nd Man: 'Does the dog enjoy it?'

1st Man: 'Yes, but the tramp's getting a bit fed up.'

ANIMALS IN ACTION

The Kouprey - a Living Legend



WORLD WILDLIFE FUND

Blurred and out of focus though this may be, the picture you're looking at is the only known photograph of a living legend — the Kouprey, or wild, grey, forest ox of South East Asia . . . which made the headlines in the summer of 1982. Although chosen by Prince Sihanouk as the national animal of Cambodia and featured frequently in the prehistoric paintings and temple carvings of the area, everyone believed that the Kouprey had become extinct — until, that is, July 1982, when the scientific world was set alight by reliable news that a small herd of two calves, two cows and a bull had been sighted in a remote forest area near the borders of Laos and Cambodia. Immediately a rescue team was despatched under the leadership of Thailand's famous conservationist Dr Boonsong Lekagul. Hopes ran high that they would be able to capture the herd and take it to Chokchai Ranch near Bangkok where plans are afoot not only to increase the herd in numbers but also to cross the Kouprey with domestic cattle to produce a new disease-resistant strain before reintroducing the herd back into the wild. But a particularly twentieth century hazard was to prove a danger to both rescuers and Kouprey alike. The whole remote terrain through which the herd were wandering turned out to be studded with landmines left over from the recent Indochina War and it was not long before disaster struck. On August

7th, one of the team's guides was injured when he inadvertently stepped on a landmine and the mission had to be abandoned. Now once more the Kouprey's fate hangs in the balance. Not only are expeditions expensive to mount, but the added hazards of the landmines could prove an insuperable problem. What a tragedy if this photograph remained the only witness to the existence of a vanished species.

Wally the Walrus

Every child gets lost once in a while, but for Wally, a two year old walrus found crying on a beach in the Ouse Washes near Skegness, it was a question of being literally thousands of miles away from his native home in the Arctic. He was also extremely hungry. The seas around Britain just don't house the specialist diet of shellfish and crustaceans that he needed to survive and it was obvious from his weakened condition that he had already been living off his reserves of fat for several months.



MARK CARWARDINE

Earlier in the year, a 1500lb female walrus had been captured off the coast of Holland and transported back to the safety and security of the waters around Greenland. Could this possibly have been Wally's mother? Wally's rescuers, Mark Carwardine (World Wildlife Fund), Tim Thomas (RSPCA), and Kath Parry (a veterinary surgeon) decided that that just might be the case, so set about trying to get Wally to Greenland as soon as possible. Forty-eight hours of frantic telephone calls to governments, embassies, airlines and conservation organisations finally produced a solution. Icelandair and the Icelandic Government agreed to fly him in a specially strengthened crate in front of the passenger section



of a Boeing 727 from London's Heathrow airport to Keflavik in Iceland. There an Icelandic gunboat would be ready to carry him on a further thirty hour voyage to the Greenland coast, a hundred miles inside the Arctic circle. For the three conservationists who had worked so hard for his release, not to mention the photographers, journalists, television viewers and radio listeners who had followed his story worldwide, it was an anxious moment as Wally crawled slowly out of his crate which had been lowered onto an ice floe. For a while he just lay there, obviously dazed and very stiff after spending nearly five days in very cramped conditions and having refused all food offered to him by his worried captors. Then, gradually, he began to limber up. A moment's hesitation, and then to everyone's relief he gently splashed into the water. For ten long minutes he disappeared from view. Everyone held their breath. And then, suddenly, he resurfaced a couple of hundred yards from the ship. But what was that? Suddenly surfacing beyond him? Another walrus, swimming towards him in greeting. Wally was home at last!

Why Chimps Don't Like Cameras

This young chimp is lucky. He's free to roam the forests of West Africa where he was born. But for some of his friends 1983 will hold a much more tragic future. And all because thoughtless tourists on the coasts of Spain, the Canaries and Balearics are prepared to pay to have their photographs taken holding a live cuddly chimpanzee. Behind these apparently innocent snapshots there's a gruesome tale of needless suffering. To capture the baby chimps the poachers first have to kill their mothers as well as any other member of the group who may resist them. The youngsters are then



JCJ VAN ZON

shipped to Spain, but in such cramped conditions that for every baby chimpanzee who reached his destination alive at least seven of his young companions will have died in transit. Once at the seaside resorts the youngsters are then drugged by the photographers before they are taken around the bars, night clubs, restaurants and beaches. And it's not as if their new owners treat them well. Even those who do survive have a very short life expectancy. By the time they reach the age of six they will have become young adolescents, both dangerous and unpredictable: at which stage, no longer of use to their captors, they are either killed or abandoned. In 1982 a survey showed that there were around 200 chimps being used by photographers throughout the Spanish resorts, which means that at least 2,000 others had been killed. Only public pressure, urging the Spanish Authorities to clamp down on this cruel trade in chimpanzees, will prevent another thousand chimps dying unnecessarily this year. If you and other Radio Annual readers want to join the campaign to save these chimps, all you have to do is to write to the World Wildlife Fund, Panda House, 11-13 Oxford Road, Godalming, Surrey, GU7 1QU and they'll send you a selection of leaflets and posters which you can distribute to the local travel agents in your area so that visitors to Spain are encouraged to refuse to have their photographs taken with young chimpanzees. And they'll also tell you the address of the Spanish Authorities to write to, protesting about this cruelty. If enough people voice their anger, sooner or later they will have to listen.

Bothy - 'Pet of the Year'

This is no ordinary long-haired Jack Russell terrier, but 'Bothy', 1982 winner of the PRO-DOGS Gold Medal Award for Pet of the Year, and one of the country's most well-travelled pets. For Bothy belongs to Sir Ranulph and Lady Fiennes and was the couple's constant companion throughout the Transglobe Expedition, travelling with them to both North and South polar regions. The citation on the medal reads, "for comfort and companionship", and that's just what Bothy unstintingly provided. When the expedition were forced to live in a small cardboard hut in permanent darkness through long months of the arctic winter, it was Bothy's antics which kept the team amused and boosted their morale. To cope with the severe cold, he grew himself an extra warm coat so that he could brave the elements, but it wasn't just the elements that he battled against — on one occasion he fearlessly tackled a pair of marauding wolves, an escapade which nearly ended in disaster — while one of his favourite sports turned out to be chasing penguins across the slippery ice. For Lady Fiennes there has never been a dog like him. One of the worst parts of the expedition, as far as she was concerned, was when she was left behind for two months whilst Sir Ranulph set off to try and reach the South Pole. It was then that Bothy really came into his own, comforting Lady Virginia when she was anxious and worried, distracting her with his antics when she needed taking out of herself and proving an ever-cheerful little friend. At the PRO-DOGS dinner, when he was presented with the medal, it was as if Bothy understood that this was his special reward. He posed carefully for the cameraman, modestly acknowledged the applause, and seemed to be



saying to the assembled crowd, "Yes, perhaps you're right, I am some thing of a superdog".

GARWOOD 'DOG WORLD'

The Plight of the Panda

No prizes for identifying this cuddly fellow... he's one of the fifty or so Giant Pandas kept in captivity at various zoos throughout the world.



WORLD WILDLIFE FUND

In 1982, however, it is his fellow pandas living in the wild in protected reservations in the mountainous areas of Szechuan Province, China, who are likely to be hitting the news. Currently estimated to number between 400 and 1,000, this wild population faces a very real threat of starvation unless a recently-formed team of western and Chinese scientists can come up with a way of either changing, or supplementing, the panda's basic diet of bamboo. Key to the problem lies not in the panda, but rather in the strange hundred-year cycle of the bamboo plant itself. There are many different species of bamboo, but all have one thing in common... whether found in a London Botanical Garden or on a mountain top in China, each plant within a given species of bamboo flowers, spreads its seeds and dies at about the same time. The last time this happened on a large scale was in the 1880's and naturalists are only too well aware that the cycle is just about to repeat itself. As the bamboo dies it can take years for the seeds to grow into new plants. In the meantime, the pandas, who need to eat up to 40lbs of the plant per day to survive, have no mature plants to live off. Unless they can move, or be moved, to fresh tracts of forest where a different species of bamboo grows there is little hope for them. Already the local villagers have reported 150 panda deaths. If pandas moved in groups or herds the job of rescue would not be such a complicated one, but they are solitary animals who wander alone through their individual territories only meeting up at mating time. For the conservationists it is going to prove a mammoth task just to track and trace each individual animal, capturing and moving them one at a time. Unless they succeed, however, the panda looks as though it is doomed to join that ever-growing list of endangered species.

On October 5th 1962 *Love Me Do*, the Beatles' first single, was released, the start of a phenomenal success story. Sadly, John Lennon is now dead, and George Harrison and Ringo Starr work in comparative obscurity, but Paul McCartney is still at the top, one of the legends of the pop music business.

When the Beatles split, Paul played solo, then formed Wings and hit followed hit with amazing regularity. He undeniably has a way with a catch melody and hook-line; who else could have made *Mull of Kintyre* such a big-seller, bagpipes and all?

Locked into a good marriage with his wife Linda, and with a close family around him, Paul doesn't *have* to work, but he has never lost his enthusiasm for music, and is a prolific writer and performer.

When he planned the *Tug Of War* album, he decided to record on the tropical island of Montserrat. It was his twelfth album since he started to record solo, and he chose George Martin as producer, the first time they'd worked together since the days of the Beatles (apart from the *Live And Let Die* single).

It wasn't going to be a Wings type album: "We decided we wouldn't stick any limits on ourselves, and that if it took a long time, then it was going to take a long time."

Together they decided to use different musicians for different tracks. "We cast each track as if it was a film or something. We'd just try to get who we thought would be the best people for it."

This is how Stevie Wonder

came to record with Paul: "My ambition always, one of the things we didn't get to do a lot with the Beatles, was working with black musicians. We admired them very much, but outside of Billy Preston, who played on *Get Back*, we never really worked much with black artists.

"How Stevie's thing came about was that I'd written a song a couple of years ago called *Ebony and Ivory* that was about racial harmony, and I thought what I'd like to do is sing it with a black guy and we'll show physically that there ought to be some harmony by the two of us singing together. So I gave him a call and said, 'Come to Montserrat, it's great here.'"

Carl Perkins is another artist Paul wanted to work with. He invited him to Montserrat, "and while he was here I wrote the track *Get It*, and we had a bit of fun recording that, getting that together."

The result of Paul's working holiday was another ultra-successful album, plus the single smash *Ebony and Ivory*. So what of the future? More music, definitely, and there are plans for Paul to make a musical film starring Rupert Bear. More than twenty years on, Paul's still right on top . . .

Paul McCartney the legend that lasted

What does the world's most successful writer of popular music like to listen to himself? When he appeared on radio's *Desert Island Discs* these are the eight tracks he said he'd like to take with him:

- 1 *Heartbreak Hotel*, Elvis Presley
- 2 *Sweet Little Sixteen*, Chuck Berry
- 3 *The Courtly Dance*, Julian Bream
- 4 *Be-Bop-a-Lula*, Gene Vincent
- 5 *Beautiful Boy*, John Lennon
- 6 *Searching*, The Coasters
- 7 *Tutti-Frutti*, Little Richard
- 8 *Walking in the Park with Eloise*, James McCartney (Paul's father)

PHOTOGRAPH BY LINDA MCCARTNEY COURTESY EMI RECORDS





IRN news staff collecting information for broadcasts.

Here is the News from IRN

"Here is the news from IRN" is a familiar introduction to news items heard daily on ILR stations throughout the country.

Independent Radio News is one of the most important and highly regarded of the national news services which keep the British public up to date with world and home events.

IRN was established in 1973 when the first independent local radio stations came on the air to provide the then new broadcasting service with a professional and independent news service.

From the outset, it has been integrally linked with LBC, (London Broadcasting Company), the first all-news radio station serving London.

Speed, Accuracy

IRN has established a well deserved reputation for the speed and accuracy of its reporting. It can claim many 'first with the news' successes in competition against other major national news gathering organisations.

A major world and home news service for ILR listeners...

Probably the biggest challenge faced by the IRN news team was the coverage of the Falklands crisis and the progress of the war. IRN received many official and public tributes for the speed and accuracy of its reporting.

Wherever news is being made in the UK or throughout the world, there is an IRN reporter or correspondent 'on the spot', to relay the story instantly back to the IRN newsroom in London.

From there it is transmitted by telex to all the independent local radio stations or a voice report can be taken and relayed 'on-air' immediately.

A major statement in the United Nations Assembly or perhaps made by the American President in the White House in Washington can be heard by ILR listeners in their local radio station within minutes.

Where major events happen, such as the launching of a space shuttle from Cape Canaveral, ILR reporters can be heard describing the event as it takes place.

The IRN newsroom in the LBC studios is based close to Fleet Street, the centre of British news reporting, not far from where Dr Johnson wrote the first English dictionary.

The news is gathered for use 'on-air' by more than 40 local radio stations in several ways and a great deal of daily planning and organisation goes into giving ILR listeners the best news service possible.

The news editor has to ensure coverage of all major events that are pre-planned such as significant court cases, the opening of Parliament, Royal visits, or, overseas, sessions of the United Nations, meetings of the oil producing countries to decide world oil prices, and the European Parliament . . . the list is endless.

A news diary is kept for this purpose and updated each day.

Instant News

But, in addition, the newsroom has to be geared up to cope with the instant news that occurs without warning, and a special team of reporters is always on stand-by.

The Argentine invasion of the Falklands, the start of the Polish crisis, the Russian invasion of Afghanistan, the day that the American embassy staff were taken hostage in Iran, and the siege of the Iranian embassy in London are all classic examples of unexpected daily events that keep a radio news team on its toes, 24 hours a day.

IRN's own reporters, together with reporters from the local radio stations themselves, gather the news from around Britain and overseas and relay it to the central news desk, where it is assessed by news editors according to news value and priority before it is processed by sub-editors for immediate telex transmission to all the independent local radio stations.

In addition, regular 'on-air' voice reports are supplied to local radio stations where they can be used instantly or recorded for inclusion in the next station news programme.

Some local radio stations use the IRN bulletin 'live' at the top of every hour. Other stations slot the material into their own world, home and extensive local news bulletins.

The service from IRN of world and home news enables the newsroom and reporters to give more time to providing and developing the most comprehensive local radio news coverage possible.

News and information about the local community served by independent local radio and provided throughout the day has become one of the outstanding innovative features of ILR. Local news plus local traffic and weather reports is recognised as one of the most important community services provided by ILR stations.

Foreign Correspondents

As well as their reporters in this country, IRN has freelance correspondents throughout the world and two permanent foreign correspondents.

Andrew Manderstam is based in Washington and keeps IRN listeners up to date with all that happens throughout America, in the White House and The United Nations headquarters.

In Brussels, Nick Peters reports daily on news and events throughout the countries of the European Economic Community, and covers meetings of the EEC parliament and committees.

To ensure that newsworthy events in provincial towns and villages throughout the British Isles are not missed, IRN employs professional freelance 'stringers' who are paid for each item of news they provide.



A member of the news team getting more details on an earlier story.

These freelance journalists are frequently responsible for providing the offbeat, sometimes humorous, stories from out of the way places. It may be whales stranded in the Wash on the East coast, a wild animal that escapes from a small town zoo, or a protest by a village opposing a decision to build a motorway nearby.

Often, a first brief paragraph from a distant 'Stringer', say, in the Outer Hebrides, may be the start of a major story. The first sightings of a small off shore oil slick may be just a paragraph in an early morning news bulletin. By mid-morning, IRN reporters may be on their way to cover a disastrous oil pollution story.

To ensure that virtually nothing that occurs each day is missed, IRN newsdesk also takes reports from other news agencies such as Reuters, the world's oldest and largest independent news agency. Reuters is subscribed by the majority of daily newspapers, TV and radio stations throughout the world. Its telex

machines transmit a continuous stream of world news items, 24 hours a day.

IRN Specialist Reporters

The IRN news team includes reporters who specialise in specific news subjects, such as Defence, the City and Finance, Royalty, Industry and Labour Relations, and Sport.

One of the most important subjects covered by an experienced and specialist team is Parliamentary News.

IRN has its own studio at the House of Commons. A team of six reporters, three radio engineers and two assistants are permanently based at Westminster to provide regular news reports, including urgent 'flashes' telephoned through to the IRN newsdesk, and voice reports both live and recorded. Major Commons debates or announcements such as the Chancellor of the Exchequer's budget speech are introduced by IRN reporters and transmitted live via the IRN newsroom to all independent local radio stations or recorded for use in later news bulletins or programmes.

The news gathered by the IRN newsteam is broadcast 24 hours a day by LBC to its 2¾ million listeners in the London area.

Some 17 million people throughout the rest of the country, regular listeners to the independent radio stations, are kept up to date with world events by the news service provided by IRN.



A technician at the console transmitting a news item to a local station.

C.B. RADIO

Citizen's Band Radio

It means you're never alone, it means you're never bored, it's a way of making a whole new batch of friends . . . above all it's FUN. It's Citizen's Band Radio, known as CB to the million or so *breakers*, or CB users, who have turned CB into a cult craze in this country over the past couple of years.

Major plus point for a beginner is that the basic CB set, or *rig*, is so easy to operate. As long as you already know how to twiddle the knob on your TV set in order to change channels, and if you can use the simple ON/OFF switch on a microphone, then that's all the technical knowledge you need to know in order to operate the rig. Then it's just a question of raising the necessary cash to get started . . . £10



Al Gross, often named the father of CB, who was flown into Britain from America on November 2nd 1981 to obtain the first British CB licence ever issued. He was also the first person to speak on American CB many years ago.

PICTURE CREDIT:- CB RADIO MAGAZINE

for the CB licence which allows you to use up to three rigs, around £30 for a basic CB set, £11 for a power pack to reduce the mains voltage, and a further £10 or so for your radio antenna.

Welcome to breaker's world! The rig is basically a type of two-way radio which lets you talk and listen to all the other breakers who are transmitting in your area. But, unlike with a telephone, you don't need to have your rig always based at home . . . on foot, in a car, in a holiday caravan, or even bobbing around in a small boat at sea . . . the freedom of the airwaves is yours. No telephone numbers to remember, no complicated STD codes to master, all you do is flick a switch and see who else is out there ready to talk, or *ratchet* in CB jargon. You can start up a conversation of your own, or you can join in a ratchet that's already in progress, or you can simply listen in to other people's conversations; whatever takes your fancy.

It all began with the truckers in America. In Britain, long distance lorry drivers may travel the same mileage as their American counterparts, but they're never very far from a friendly transport cafe or their essential breakdown services. In America it's a completely different story.

The truckers often have to drive for long stretches of several hundred miles between towns and settlements with no-one to talk to and no help at hand in case of an emergency. It's a lonely life and a breakdown could mean a delay of several hours before another vehicle comes past to fetch help. No wonder then that as soon as CB became available in the States

many truckers had them installed in their cabs . . . not only the luxury of being able to break the driving monotony by chatting to other truckers, but, more important, being able to keep each other informed about weather conditions ahead and traffic delays, as well as having the security of knowing that they could summon immediate aid in the event of accident or breakdown.

In those days, had you been able to listen in to the conversations, you would probably have been able to understand what everyone was saying. But in 1973, things suddenly changed.



Stephen Pratt (handle Stickinsect), a young breaker from Bloxham, Oxfordshire, who has used his rig to help stranded motorists by relaying their emergency calls on his CB set.

PICTURE CREDIT:- CB RADIO MAGAZINE

That was the year when the international fuel shortage meant that America was running out of petrol. In order to bring fuel consumption down, a speed limit of 55 mph was introduced.

This spelt disaster for the truckers, who relied on speedy deliveries of goods to keep their businesses afloat and they began to use CB as a means of avoiding speed traps. But there was nothing to stop the police from listening in to the CB conversations and monitoring what was going on.

The truckers began developing their own jargon so that messages were coded, and stopped using their own names, adopting *handles*, or nicknames, for themselves and the towns and cafes they used. They created a whole new language.

Like Cockney rhyming slang,

there was a definite lyrical quality to many of these trucking expressions and it wasn't long before a song writer, in the shape of Country and Western singer C W McCall, put the jargon to music and created 'Convoy'. It rocketed to the charts virtually as soon as it was released . . . a mammoth blockbuster of a hit not only in the States, but in Britain and right across Europe.

Suddenly everyone was trying to learn this intriguing new jargon, anxious to join that small but select group of CB users, and crying out to get hold of rigs which would make them part of the growing fellowship of breakers.

First to cross the Atlantic may have been the Top Ten hit, but it was the crateloads of rigs which followed which really marked the widespread start of CB in this country. But there was one extremely serious snag for those so anxious to get their hands on a rig of their own . . . the American rigs operated on a 27 MHz AM frequency which the British Government, in the shape of the Home Office, had already allocated to other licensed users . . . it was against the law for British breakers to use the CB rigs which they had bought. Left and right the police suddenly began to swoop down on offenders, confiscating and imposing fines.

It was all aimed at stamping CB out, but it had the very opposite effect . . . the fact that breakers were operating outside the law only fuelled their enthusiasm. When 'Convoy' first topped the chart there were a

mere 500 breakers in the UK, but by early 1980 that number had swelled to almost a quarter of a million. "Make CB legal" was the chant from all sides.

As the numbers continued to climb to almost the half million mark, the Government was forced to give in and promise to legalise CB. But they still insisted that they couldn't allow breakers to use the American AM frequency which was strong enough to allow breakers to speak to each other around the world from London to Los Angeles or Hong Kong.

Instead the Home Office (*Uncle Charlie*) insisted that the breakers be given an FM frequency which limited people to chatting within a mere thirty miles or so radius of their rig. The breakers tried as hard as they could to fight against it, taking to the streets on marches and demonstrations but to no avail. In 1981 when the first CB licences were issued it was only the FM frequency which was legal.

So how does a CB set now operate? Each FM rig has a total of 40 channels which breakers can use for their conversations and a channel selector which allows the breaker to move up and down the channels to find a clear channel where they can talk.

To find if there is anyone out there wanting a chat, the first step is to use the *breaking channel* . . . usually either channel 14 or 19, but NEVER channel 9 which is reserved for emergency messages. Having found someone on the breaking channel, it's then just a question of moving up and

down the forty channels to find a free space for the conversation to continue.

Breakers still use a large proportion of the jargon developed in the early trucking and illegal days of CB. Below you'll find the format for your first ever chat on CB. Once you've got the conversation started, just what you end up ratcheting about with your new-found friends is entirely up to you.

"Breaker one-four for a copy . . . breaker one-four for a copy . . ."

(Using the 14 channel as your breaking channel you're asking if anyone fancies a natter)

"Got a copy there Good Buddy" (Someone is there and ready to talk to you)

"Smash a window" (You're asking them to choose a channel to talk on)

"Try three-five" (They're suggesting channel 35 might be free)

"Roger, Gone" (You're agreeing and saying OK see you up there)

YOU NOW BOTH ADJUST YOUR SETS FROM CHANNEL 14 TO 35

"Are you on channel?" (They've arrived, have you?)

"Yes, Roger" (You reply yes you are)

The rest is up to you. But just remember one thing. CB users never reveal their actual names or addresses on channel. There are shady characters around in CB just as there are everywhere else. So one of your first tasks as a newcomer to breaking is to think up a suitable handle for yourself. How about Spiderman, Cough Drop . . . Bionic Bunny? Already the fun has started.

The 10-10 code

An important rule for all CB users is "Don't hog the airwaves for too long". Give other users a chance. Which is why, over the years, breakers have developed the 10-10 code which uses numbers to denote certain phrases. It goes from 10-1 to 10-100, but here are some of the more familiar ones.

- 10-1 I can't hear you clearly
- 10-3 Stop transmitting
- 10-5 Relay your message
- 10-9 Repeat your message
- 10-12 I've got visitors present/
I'm not alone
- 10-33 EMERGENCY
- 10-34 I'm in URGENT need of HELP



Troubled times: Breakers on the march which took place in the summer of 1981 from Speaker's Corner, Hyde Park, to the Houses of Parliament, to protest against the Government's decision to legalise 27 MHz FM instead of 27 MHz AM.

PICTURE CREDIT:- CB RADIO MAGAZINE

RADIO TREASURE TRAIL

ANDY SMITH, RADIO BISHAM'S POPULAR D.J. IS TELLING HIS FANS ABOUT A BURIED TREASURE HUNT COMPETITION IN THE AREA. HE'S READING OUT THE CLUES THAT WILL LEAD SOME LUCKY LISTENER TO WHERE THE BURIED TREASURE HAS BEEN HIDDEN!

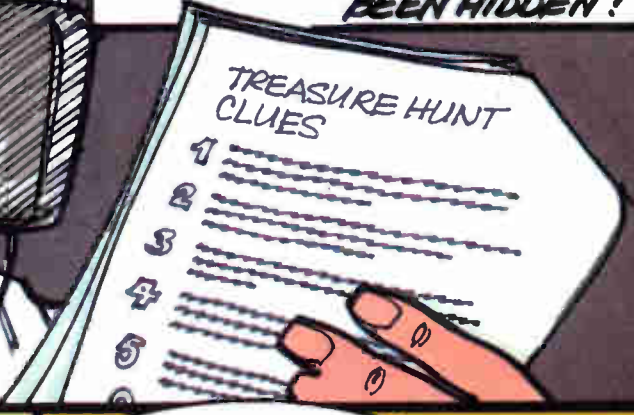

PAUL AND ROBERT ARE LISTENING CAREFULLY TO THE CLUES...
... SUDDENLY ROBERT'S FACE LIGHTS UP WITH GLEE!

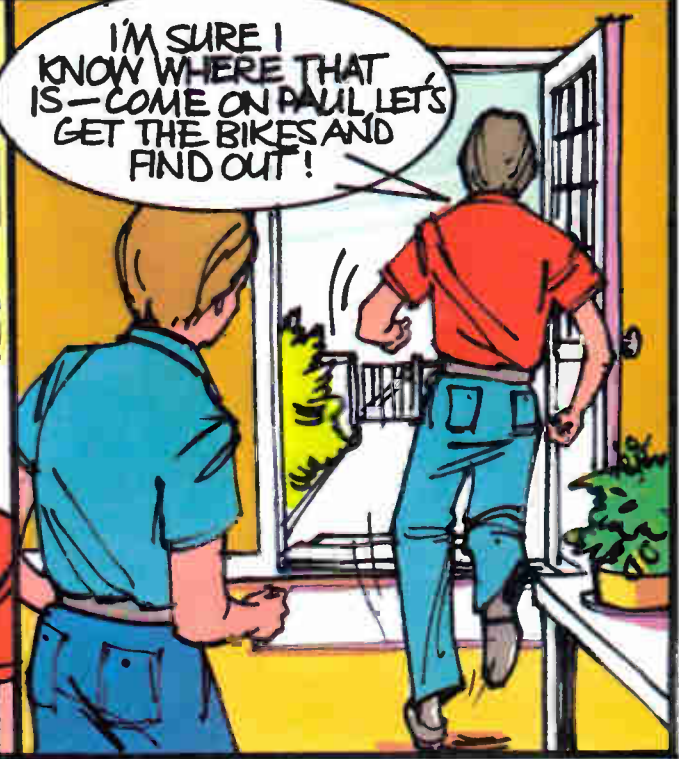
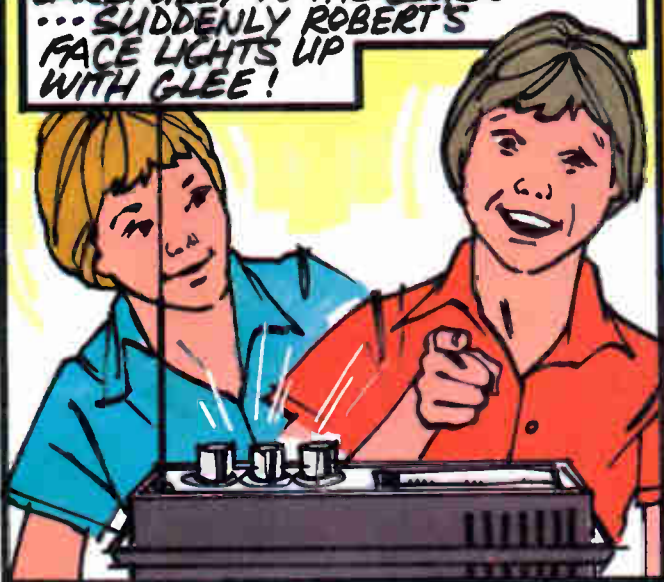

THE BOYS GET TO THE FIELD WHERE ROBERT THINKS THE TREASURE MIGHT BE HIDDEN... ONLY TO FIND TWO STRANGE MEN - ONE CARRYING A BAG - HEADING FOR BINGHAM WOODS!

DO YOU THINK THEY'VE FOUND IT?

DON'T KNOW PAUL - LET'S WAIT AND SEE!

AFTER WAITING FOR WHAT SEEMED AGES AND THE MEN NOT HAVING REAPPEARED FROM THE WOODS, OUR TWO TREASURE HUNTERS WERE READY FOR HOME.

LET'S COME BACK THIS AFTERNOON, PAUL!

AS THEY START BACK THEY MEET THEIR FRIEND, AMANDA...

HI AMANDA! WE'RE LOOKING FOR THE RADIO BINGHAM BURIED TREASURE!

...THEY TELL HER ABOUT THE TWO MEN

NEVER MIND - I CAN BORROW MY DAD'S METAL DETECTOR SO IT'LL BE MUCH EASIER SEARCHING - ESPECIALLY IF WE LOOK TOGETHER. LET'S COME BACK LATER AND TRY AGAIN.

SO LATER THAT DAY THEY ALL SET OFF AGAIN ON THE RADIO BINGHAM TREASURE TRAIL!



IT LOOKS AS IF THOSE TWO MEN HAVE GONE - LET'S GET CRACKING!

WITH PAUL LISTENING TO THE RADIO AND ROBERT USING THE DETECTOR THEY ALL START SEARCHING THE AREA



IT'LL HELP IF WE SPREAD OUT A BIT - I'LL GO AND LOOK IN THE WOOD!



HELP!

ONLY A FEW MINUTES AFTER AMANDA DISAPPEARED INTO THE TREES THE TWO BOYS WERE SUDDENLY STARTLED BY HER FRIGHTENED CRIES!



CONTINUED ON PAGE 41 ...

Radio waves across the universe

Our ancestors knew little about the stars or planets. Indeed, most believed that the earth was flat and that the heavens revolved around the earth.

Early astronomers, such as Galileo and Copernicus, theorized that the earth was a sphere orbiting around the Sun, which was the centre of our solar system. The invention of the optical telescope gave the astronomers plenty of information to support their new theories.

Today, not only can we view our Solar System through very powerful optical telescopes, but also by using a relatively new technique, the radio telescope.

Just as optical telescopes rely on light wave emissions from distant stars and heavenly bodies, so the radio telescope relies on radio wave emissions from these bodies.

Radio waves were not discovered until the late 19th century and it was not until 1931 that radio waves were traced to outer space by a radio engineer named Karl Jansky. By 1940 special telescopes had been built to receive and analyse these mysterious radio signals to find out just where they came from.

Radio telescopes are really just large dish shaped aerials. One reason for the shape is that radio waves from space are very weak and so must be collected and focused upon one point in order to make them powerful enough for scientists to use. Another reason is to enable astronomers to detect which region of the sky the radio waves are coming from.

Using their new telescopes the radio astronomers were able to draw up a whole new picture of the universe — a radio picture. The radio telescope has allowed astronomers to probe more deeply into space than ever before, picking up radio signals that have been travelling through space for thousands, perhaps even millions, of years.



Some of the sources of radio waves in space are merely stars such as our own sun, but some other sources are whole galaxies whose radio emissions are so strong that they have been given the name *radio galaxies*. Other, even more powerful, sources of radio waves have been discovered.

Quasars

Despite all the research that scientists have carried out, they are still not sure what Quasars are. On a radio screen, Quasars look far more like stars than galaxies but they give off tremendous amounts of radio waves. Another strange fact about Quasars is that they are retreating away from us at great speed.

Pulsars

Some star-like objects give off radio waves, light or X-rays in very short regular pulses. These are known as Pulsars. Some Pulsars do this once every 4 seconds or so, but most 'pulse' at a more rapid rate.

When Pulsars were first discovered, some people believed them to be proof that intelligent life existed in outer space, and that the Pulsars were radio beacons of some sort. However, the most likely answer has been provided by astronomers trying to work out what happens in a giant star explosion of Supernova. They suspect that what can happen is the formation of a tiny but immensely heavy star called a neutron star. Such a star is composed entirely of neutrons and would spin very fast and so give off pulses of radiation.

Black Holes

These, too, were discovered through the use of radio telescopes. They are dense black regions of space, thought to be the result of a giant Supernova, or exploding star. After the explosion it is thought that the matter remaining may be drawn inwards into itself and so form a super-dense neutron star. The process of inward collapsing may not stop here.

Eventually, all the matter will disappear, leaving nothing but gravity behind. This enormous concentration of gravity will drag more and more matter toward it from the space around and so more and more radiation will be given off. Some scientists believe that Super Giant Black Holes could be the distant Quasars.



A radio telescope need not be a single dish-shaped aerial: it can be a whole set of aerials which together make a single receiver of radio waves from outer space. At the Mullard Radio Astronomy Observatory at Cambridge, this set of

eight radio aerials is mounted on a railtrack so that they can be moved closer together or further apart. Set at their furthest distance apart the aerials make up a giant telescope 5 kilometres long.

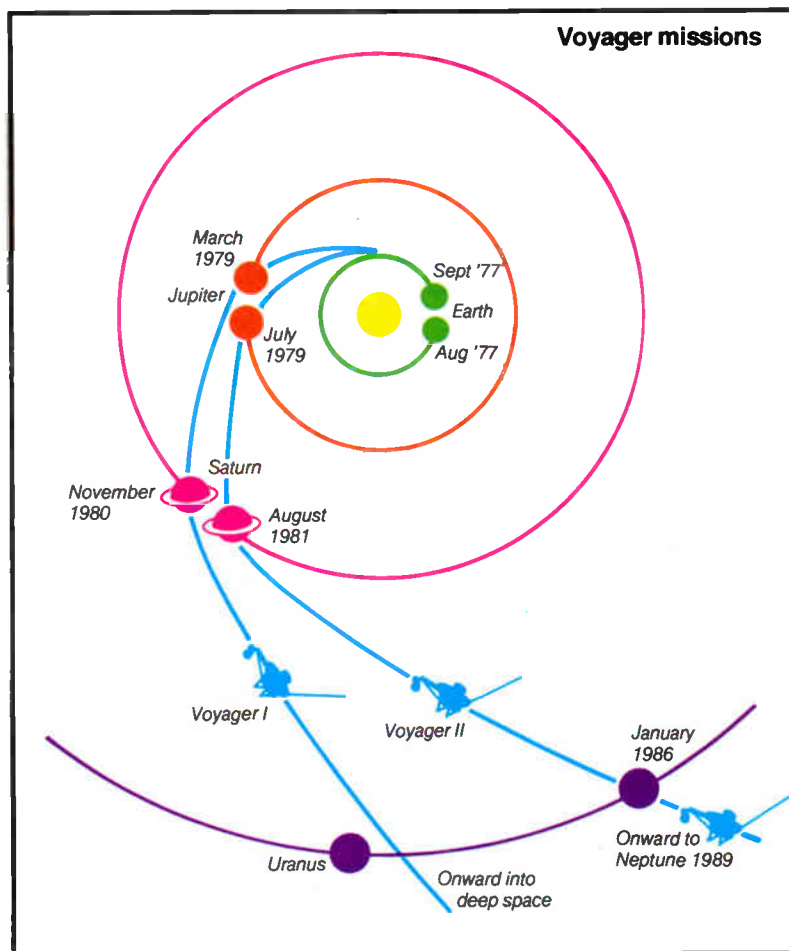

Radio waves have proved to be a great asset to man in his exploration of space, not only through the use of the radio telescope, but also for controlling unmanned satellites, such as the Pioneer and Mariner Probes.

In the short 20 year history of space travel, human beings have reached out to the moon but unmanned probes have reached further still.

Pioneer 10 was one of the first of these outer planet probes and it flew past Jupiter as early as 1973. At this time Pioneer 10 was travelling at 170,000 km/p/h. By now Pioneer 10 will have passed our outer most planet, Pluto, and out of our solar system. Pioneer 10's task was to photograph and map Jupiter and then carry on to be lost in the depths of space. But why should contact be lost while all the instruments remain intact? The answer to this question is all about *signalling*.

When Pioneer 10 was photographing Jupiter, its cameras and other instruments were being

controlled by radio signals broadcast from earth. As the probe was so far away from earth it took the controlling signals three quarters of an hour to reach the probe, and the pictures taken by the probe and relayed back to earth took three quarters of an hour to return. So you can see that it was 1½ hours before controllers on earth knew whether or not the commands had been carried out. To control a space craft in the orbit of Pluto, the controllers would have to wait over 10 hours before they could be sure their commands had been carried out.

The time factor is not the only problem encountered when controlling a probe from a great distance. As a probe recedes further and further from earth the signals returning from the probe become fainter and fainter. Eventually the signals will become so weak that they will no longer be detected back on earth and so all contact with the probe will be lost.

In 1977 two more spacecraft were launched by the USA. Voyagers

I and II were aimed at Jupiter and Saturn. By the summer of 1979, both Voyagers had flown past Jupiter and they sent back detailed pictures of Jupiter and its inner moons.

After flying by Jupiter the two voyager craft were 'thrown' out deeper into space by the gravitational pull of Jupiter on towards Saturn. It took the voyagers another 1½ years to reach Saturn, arriving in November 1980 and August 1981. As the two craft passed through Saturn's rings several new moons were discovered. The Voyager craft also showed us that Saturn had many more rings than previously thought and at least one ring was coiled like the strands of a rope.

After surveying Saturn's rings and surface, Voyager I was catapulted onwards by Saturn's gravity into a deep space. Voyager II on the other hand was guided toward the next planet Uranus. Voyager II should reach Uranus early in 1986 and then it will journey on towards Neptune, which it should reach in 1989.

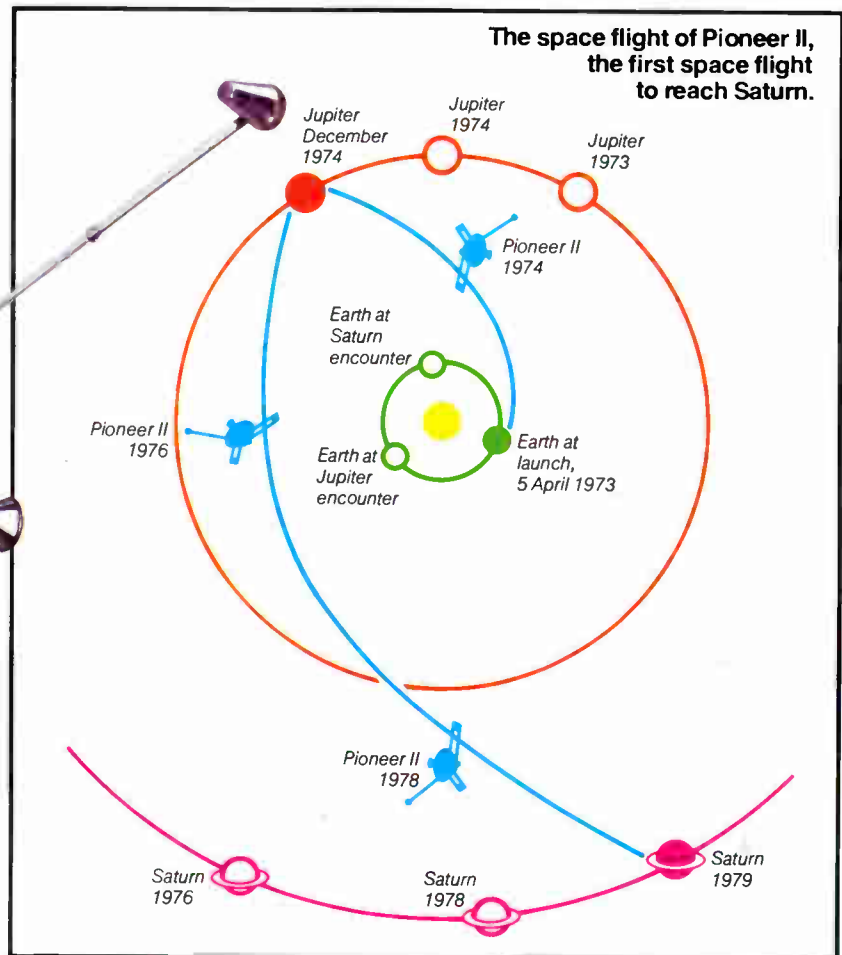
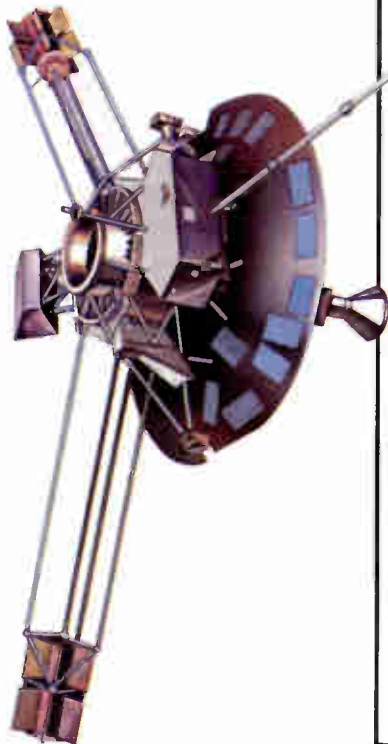

DURAN



PHOTOGRAPH COURTESY EMI RECORDS

Nicknames

Simon is sometimes known as Charley, because his middle name's Charles, John's known as JT (for obvious reasons) and Roger's called The Frog because he loves snorkels and flippers. Nick is named Ringo — because he hates it, and Andy's known as Sniffer...

Duran Duran take videos very seriously, regarding them as an art form, as the 'talking pictures' of the music industry. The *Flo* video was shot on an island Simon calls 'the closest I've been to paradise' — Sri Lanka, formerly Ceylon.

DURAN

DURAN

Duran Duran...choosing their own direction

"We don't really feel it's necessary to mouth off about how good this is going to be. It's not necessary. We'd rather just wait and let the people hear the music."

The music that Nick Rhodes referred to back in March 1981 was Duran Duran's debut single *Planet Earth*, and the people thought it was very good. It raced up the charts, peaking at number 12, and was the start of a classic success story.

Nick Rhodes and John Taylor formed Duran Duran in their native Birmingham in 1978. They recruited Roger Taylor (no relation) from a local punk band, and Geordie Andy Taylor (again no relation) via a music trade paper ad. The Duran Duran line-up was completed by singer Simon Le Bon, childhood actor and art school drop-out, who was recommended by a barmaid!

The group gained lots of valuable experience — and equally valuable exposure — as support to Hazel O'Conner on a British tour, and they were signed up by EMI soon after.

Planet Earth was followed by many more single hits like *Careless Memories*, *Girls on Film*, *My Own Way*, *Hungry Like the Wolf* and *Rio*, and their uniquely melodic brand of 'night music' won them a fanatical following all over the world.

But Duran Duran have a cool-headed approach to the music world, and the adulation that goes with it. "Of course we're excited

about it all," says Simon. "But we are also very relaxed people. We're not going to start sitting around in night clubs every night getting old, fat and broke."

Roger echoes those feelings: "I'm sure some people think it's fun to throw champagne parties all the time and go wild. But when you live like that, you don't actually get much work done."

And work is what Duran Duran enjoy most. They're by no means a studio band, but enjoy hard gigging in front of live audiences. Punishing tour schedules have taken them all over the world, and their energy, elegance, professionalism and sheer hard work have won them a reputation as one of the very best live groups.

Backed by an elaborate stage set, Roger's drums provide the firm backing for Nick's polished keyboards and Andy and John's well structured guitar and bass lines. The excellent musicianship and harmonies are fronted by Simon Le Bon's impressive and increasingly highly rated vocals. They look good, too!

All in all Duran Duran have enjoyed a classic success story, and it's a success that's well deserved. We'll leave the last word to Simon: "I'm doing something that I want to do. I always wanted to be a pop singer. I wouldn't want to change a thing. It's everybody's dream."

DURAN

There are more opportunities today than ever before if you want to make a career in broadcasting and it is worth giving a thought to the possibility of working for Local Independent Radio.

ILR is still developing and it is doing so away from the traditional broadcasting centres which means new opportunities for people with personal aptitude or relevant experience.

With over 40 ILR stations on the air at the moment, and a proposed five to seven new stations opening each year, there are real prospects for people with enthusiasm and a keen interest in radio.

Already, some 2,000 people are employed by ILR stations; many of them doing work not immediately associated with radio.

As well as the more glamorous jobs, such as presenting and reporting, a radio station would not be able to function efficiently without good back-up personnel, for example, secretaries, receptionists, accounts staff and computer operators. The glamorous jobs get all the publicity, but entry requirements are such that few of the many thousands of applicants each year actually make it.

If you find the idea of a job as a presenter attractive, the first

GETTING A START IN RADIO

requirement is obviously a good microphone voice. If you have ever heard your own voice played back on a tape recorder, you will know that there is a difference between how you think you sound and how your voice actually sounds to others.

Gone are the days when broadcasters had to sound as though they'd graduated from Oxbridge. Regional accents are now accepted and can add colour and interest. But, your voice must be clear, possess character and be interesting.

Few ILR stations employ disc jockeys these days. They have presenters, people who can do not only the voice links between records and other items, but who also have a high level of technical expertise to operate the increasingly complex equipment used in radio broadcasting.

A presenter needs to do his own timings for records, work to a music format laid down by the station, and does his own paperwork — copyright returns and so on. In ILR you rarely get producers, researchers, technical operators and programme assistants — as a presenter you do it all yourself.

A presenter needs an extraordinary mixture of personality, warmth and friendship, plus the memory of a 'Brain of Britain'. You must keep up with all the latest information, records in the charts, musical preferences of the people in one's broadcasting area and events in the area. You need to be able to talk to people on their level, not talk down to them. You must have that high technical skill and superfast reflexes to cope with the inevitable unexpected occurrence. You must have common sense, and be capable of hours on end of sustained concentration.



Students of the National Broadcasting School recording a drama production in the school's 16-track studio.

How can you train for all that? What course can teach you what to do? The honest answer is, there isn't one. Hospital radio is one source of experience, operating a disco is another. Or you might start elsewhere in radio and move over to presenting. Whatever your route, study carefully how your local presenters work. Don't imitate them, but learn their technique.

Send demo tapes to your target radio station with an explanation of why you think they should give you a trial. One of the major responsibilities of the Programme Controller at each ILR station is to spot that very special talent among all those tapes and letters which arrive every day.

Radio journalists must have a good voice, too. You can be the finest newshound in the business, but if you don't sound authoritative, if your speech is not clear, all your hard work will be for nothing.

Next, you need an enquiring mind. Reporters are, by definition, nosy. Almost everything interests them.

You must also be the sort of person who enjoys hard work. A clock watcher is of no use in a newsroom, as news doesn't only happen between nine and five.

Some budding journalists wanting to get into radio go through induction training. There are graduates from the Cardiff School of Journalism, City University, the London College of Printing and others, while at least good 'A' levels are required at the National School of Broadcasting and some polytechnics.

More commonly, journalists entering ILR have already completed a number of years in journalism, probably in local press. These journalists go through a conversion course to turn them into radio journalists without having to go through the basics.

Technical requirements at ILR stations are high. You will find ILR stations where all the technical staff have degrees in one or other of the physical sciences, having received their final training for radio work at the station.

At other stations the requirements are less rigorous but Chief Engineers will look for products of radio courses at

polytechnics and specialist schools. The National Broadcasting School runs a foundation course in Radio Engineering. As with all their courses, the minimum age of entry is eighteen. You will need an 'A' level pass in a science and, not unnaturally, good health.



A traffic clerk using a VDU to monitor recent developments.

Apart from the very large stations, a technical staff of more than three or four is unusual, but opportunities for trainees do exist. Get yourself known to the engineering staff at your local station. They'll see what talent and potential you've got, and when an opening occurs, they'll tip you off.

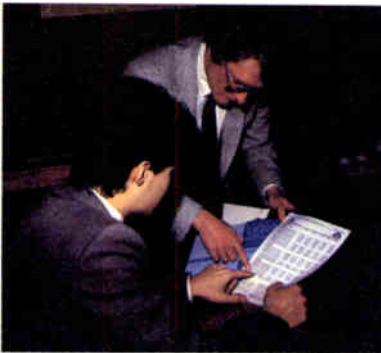

A salesman presenting the case for radio to a potential advertiser.

There's no-one in ILR more important than the time sales executive, a job increasingly done by women. Without his or her successful work, no radio station would survive because nobody would get paid. Time salesmen need no formal prior qualifications.

There are formal training programmes for ILR sales staff, but the task of spotting the right recruit is one of the many jobs done by the station's sales manager. Sales reps' salaries are usually related to the money he or she brings in every week. And, like the journalist, you'll need a clean driving licence.

The qualifications for secretaries, accounts clerks, receptionists and so on are little different in radio than they are for other areas but there are opportunities for many of these staff to go on and do other things. Somebody taken on as a librarian — an essential job in independent radio — may find themselves doing a programme on air once or twice a week, and a new career path has opened up.

Increasingly, skill at operating computers is a basic requirement, as radio stations strive for more efficiency and for better business control methods. The visual display panel and keyboard, attached to a mini or microcomputer is now commonplace in ILR.

As far as working in ILR is concerned, it is not just qualifications or experience that count. Attitude is just as important. If you're happy, enthusiastic, constructive and a team worker, okay. But if you watch the clock or other people's pay packets, forget it.

We can't deal with every job there is, so try and find out what's possible from your local station. You can get information on training facilities through them or from the Training Advisor, Association of Independent Radio Contractors, Regina house, 259/269 Old Marylebone Road, London NW1.

The National Broadcasting School offers three foundation courses. The standard of these is quite high and anything from 'O' levels to a degree is asked for. Areas covered are Programming, which involves presentation, production and writing techniques; Journalism and Engineering.

The NBS has only recently been set up and enjoys the many advantages of four fully equipped studios, a radio newsroom and an engineering workshop.

Courses are short and, unfortunately, expensive, but are seen to be an excellent starting point to a career in radio.

For further information write to The National Broadcasting School, 14 Greek Street, London W1.

If after all this you still think that independent radio is for you, then you are in with a chance, because you have the right attitude of mind. Go to it, and good luck!

PUZZLEPAGE

Link-up

The answers to these clues are all 5-letter words. Start at No. 1 and fill in the answers, one letter to a square, in a clockwise direction. The last two letters of each word are the first two letters of the next word.

- | | | |
|--------------------|----------------------|--------------------|
| 1 Arise (2 words) | 9 Show again | 17 'War and |
| 2 Top of shoe | 10 Father's brother | 18 Tree |
| 3 Wipe out | 11 Carroll | 19 Smell |
| 4 Part of calyx | 12 Abraham's son | 20 Purple colour |
| 5 Texas battle | 13 Stage performer | 21 Opera composer |
| 6 Found in cracker | 14 Barrel | 22 Roadside hollow |
| 7 Burned bread | 15 Celestial being | 23 Ape |
| 8 Large shop | 16 Run away together | |

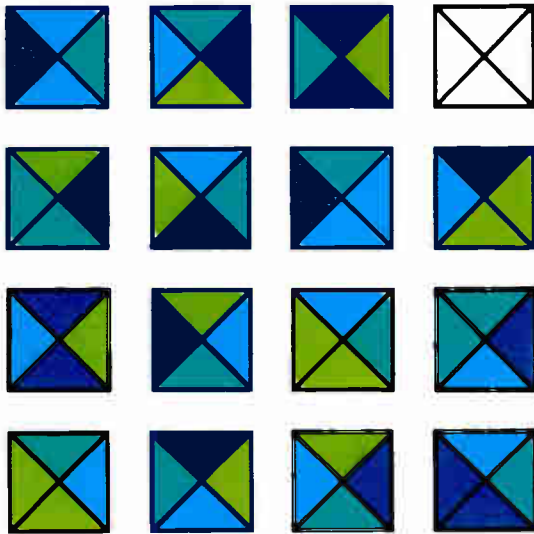

Colour Match

Colour in the white square to complete the sequence

Hexagonal

How many words of three letters or more can you find by moving from one hexagon to the next?

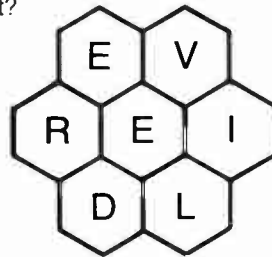

A-maze-ing

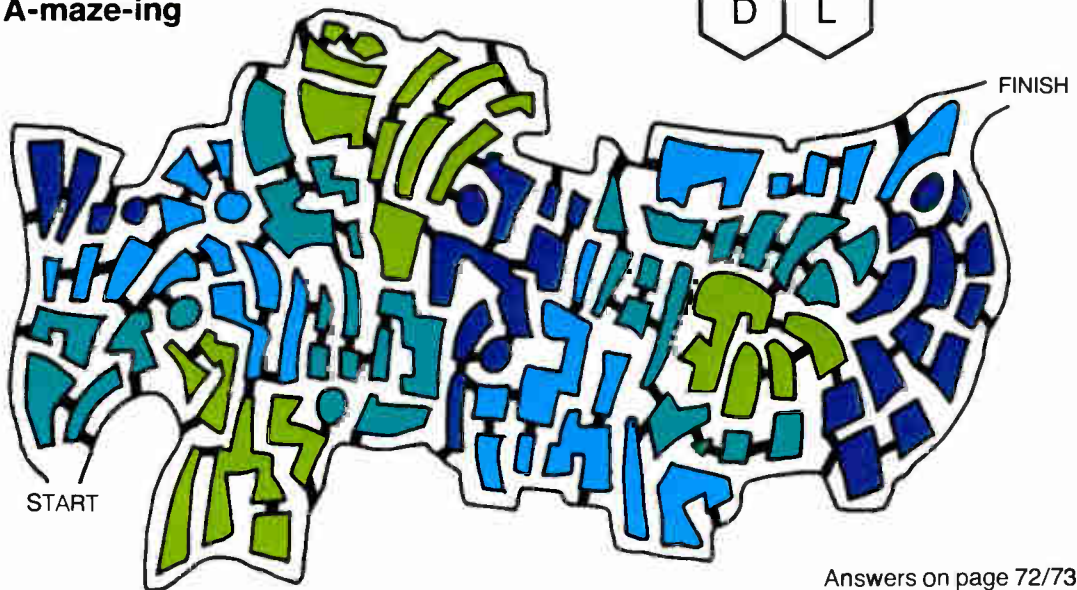

Answers on page 72/73

23
22
21
20
19
18
17
16

3
4
5
6
7
8
9
10

15 14 13 12 11 10

Radio Aire

362

It's all on Aire on 362

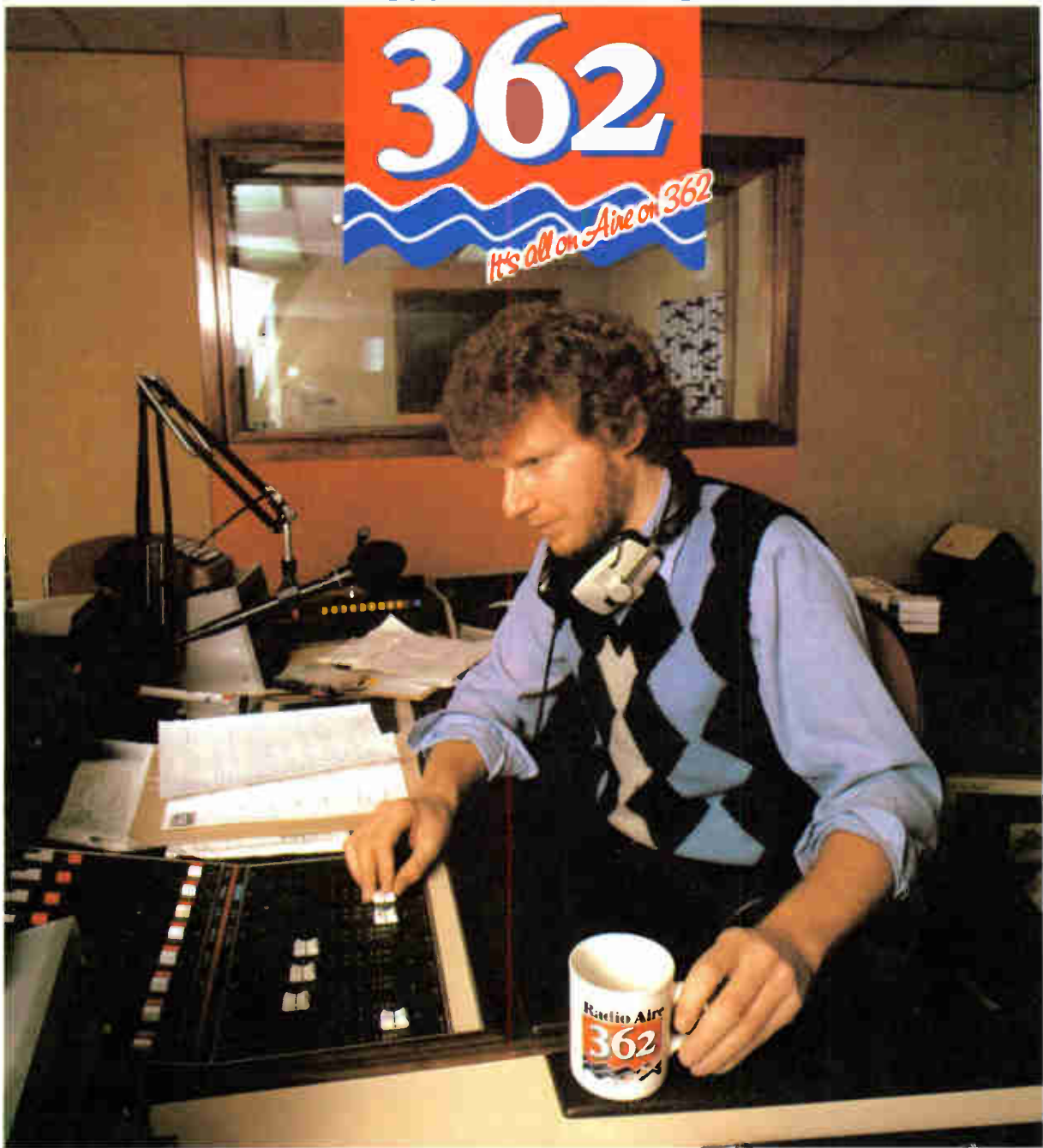

Radio Aire first hit the airwaves on September 1st, 1981, and immediately established itself as a firm favourite with the people of West Yorkshire.

From its studios in Leeds (incidentally, the first purpose-built commercial radio station in the country), Radio Aire broadcasts to a potential listening audience of one and a quarter million people of all ages and walks of life.

Apart from Leeds itself, the

transmission area includes the industrial towns of Wakefield, Pontefract, Dewsbury, Huddersfield and Castleford and the greener pastures north of Leeds towards Wetherby and east as far as Selby.

The station's daytime output comprises a lively and varied programme of music, conversation, news, sport, features and traffic and weather information. Specialist music programmes can be heard every

weekday evening and whether you have a taste for blues, folk, jazz, country, heavy metal or reggae (or perhaps all of them) there will be something for you on 362.

If you are already a dedicated Radio Aire listener, or if you are just getting to know us, you will find this book gives you a behind-the-scenes look at the personalities and machinery of your favourite local radio station.

The Story of Radio Aire

At 6 a.m. on Tuesday September 1st, 1981, West Yorkshire awoke to the first ever broadcast by Radio Aire.

Christa Ackroyd was the first voice on air, reading the news as though Radio Aire had always been there.

Amazingly, the station was built and in business less than six months after the franchise had been granted to West Yorkshire Broadcasting Corporation by the Independent Broadcasting Authority.

The name, Radio Aire, was chosen in a local newspaper competition from over 300

suggestions. As the new station serves the cities of Leeds and Wakefield, both standing on the River Aire, the name is symbolic of the link between the areas.

(The most bewildering suggestion for the station's name was 'Radio Pixie's Grotto'!).

Originally Radio Aire broadcast for 16 hours per day, but this has since been extended to 20 hours.

Sitting on Aire's Board of Directors is Colin Welland, the well-known actor, playwright and Oscar-winning screenplay writer of 'Chariots of Fire'.

A new Chairman of the Board has just been announced. He is Rock and Rolling Rodney Walker, a local businessman and Jerry Lee Lewis fan!

RADIO AIRE'S PROGRAMMES

Radio Aire's daytime output comprises a lively and varied programme of music, conversation, news, sport traffic information, competitions and local features.

Specialist music programmes can be heard most weekday evenings and Radio Aire caters for all tastes across the musical spectrum with Blues, Folk, Jazz, Country, Heavy Metal and Reggae shows.

In certain programmes, emphasis is given to up and coming acts and local talent.

Monday - Friday

5 a.m. - 7 a.m. *Ross Dickinson* wakes up West Yorkshire

7 a.m. - 10 a.m. *Eric Smith* with the Breakfast Show including the Mystery Voice Competition

10 a.m. - 1 p.m. *Peter Levy* — three hours of music and news features including 'Peter's Pontoon'.

1 p.m. - 4 p.m. *Alex Lester* — the wit and wisdom of the Pudgy Purveyor of Pop sliced with good music. Fast and Furious Quiz, Tradio Bargains, and TV reviews and previews

4 p.m. - 7 p.m. *Martin Kelner* — 'Mad Max Kettle' with his highly individual melange of music and mirth. Naff jokes, Kazoo accompaniments to records and 'Headbangers Heaven'.

10 p.m. - 1 a.m. *James Whale* — compulsive phone-in show with professional egotist James Whale

Evening Schedule

Monday

8 p.m. - 10 p.m. *Third World Music* — mainly reggae music, sprinkled with the occasional Asian selections

Tuesday

7 p.m. - 8 p.m. *Alex Lester* playing blues, r'n'b, gospel and soul

8 p.m. - 10 p.m. *Dave Burland* with The Folk Music Show

Wednesday

7 p.m. - 10 p.m. *Midweek Sport*

Thursday

7 p.m. - 8 p.m. *Andy Kershaw* — across the spectrum quality music from Sinatra to Siouxsie and the Banshees. Emphasis on new releases, independent singles, the off-beat, punk, reggae, blues, country and western, local bands

Friday

8 p.m. - 10 p.m. Jazz with *John Brown*. Mainly contemporary jazz, local acts, interviews and news from the Leeds Jazz scene

Saturday

6 a.m. - 9 a.m. *Alex Lester*

9 a.m. - noon *Mike Hurley*

noon - 2 p.m. *Dave Silver* with the West Yorkshire Top 40 compiled from local record shop sales

2 p.m. - 6 p.m. *Saturday Sports* with *Bill Naylor*. Sports coverage of the day's big matches interspersed with good music

6 p.m. - 7 p.m. *First Timers* — an opportunity for budding presenters to try their skills on the radio

7 p.m. - 10 p.m. *Juke Box Saturday Night* with *Ross Dickinson*. Back to back music. Chart records and oldies.

10 p.m. - 1 a.m. *Andy Kershaw* — a mixture of oldies, chart records and new releases. Plus 'Kershaw's Musical Mastermind'.

Sunday

6 a.m. - 9 a.m. *James Whale*

9 a.m. - noon *Eric Smith*

noon - 2 p.m. *Solid Gold Silver* with *Dave Silver*. A two hour oldies show

2 p.m. - 2.30 p.m. *Radio Aire Reports* — current affairs

2.30 p.m. - 6 p.m. *Rugby League Special*. Chart records between exhaustive rugby coverage.

6 p.m. - 8 p.m. *Peter Levy* with two hours of easy listening for Sunday evening

8 p.m. - 10 p.m. *The Lively Arts* with *Maggie Mash* and *Alison Joseph*

10 p.m. - 1 a.m. *The Late Martin Kelner Show*

Where to find us on your dial . . .

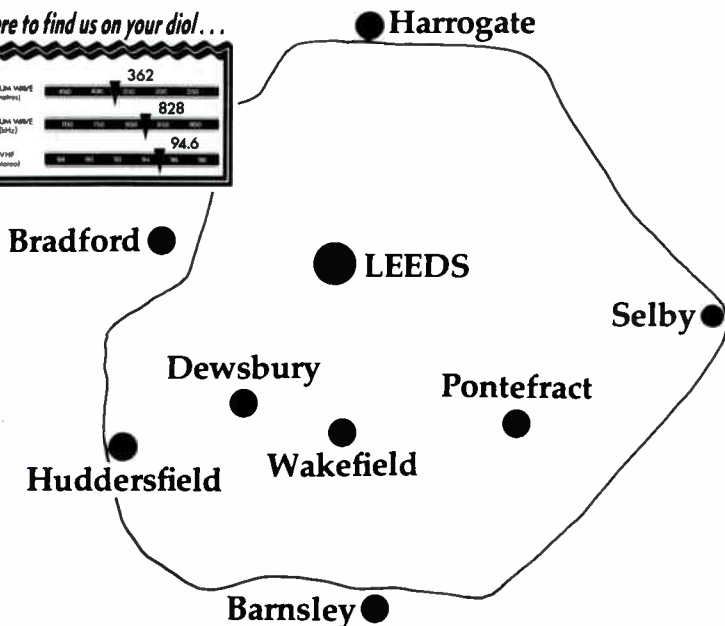
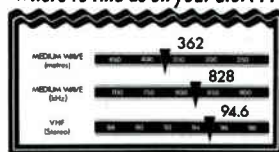

THE BROADCASTING AREA

Under the terms of the franchise granted by the Independent Broadcasting Authority (I.B.A.), Radio Aire's official broadcasting area covers a region of West Yorkshire from Harrogate in the North to Barnsley in the South, Huddersfield in the West to Selby in the East, containing a population of one and a quarter million.

With studios in central Leeds, all the major towns within their region are served by Radio Aire and the transmitter is located at Tingley between Leeds and Dewsbury.

Although the station's output is

geared solely to the needs of the area of West Yorkshire, the signal can be heard further afield. Reception reports are frequently received from radio enthusiasts and exiled Yorkshiremen and women around the country.

Under freak atmospheric conditions, however, the signal may be carried across continents! Correspondence from Scandinavia has ceased to raise an eyebrow among the Radio Aire staff, but everyone was shocked to receive a recent phone call from a listener in New Zealand!

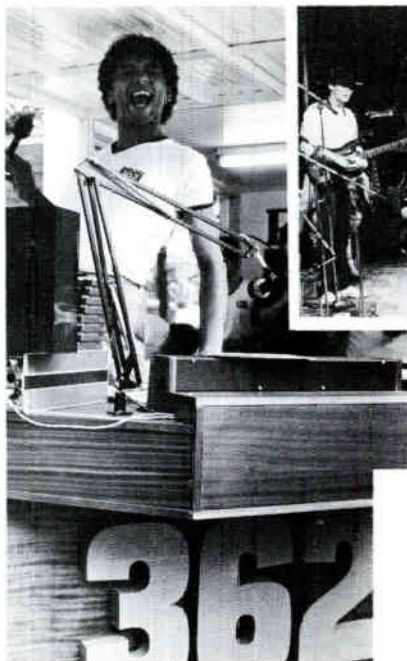

Dave Silvers' exuberant style always collects a large crowd at any outside event



Maddy Prior on stage at the Radio Aire Folk Festival

The guests having fun at Radio Aire's 1st birthday party



The winner of the Leeds Marathon collects his trophy

Out and about with Radio Aire

Radio Aire's activities are not confined just to the airwaves. Getting to know the voices and personalities of the presenters is one thing, but face to face contact is crucial for a friendly relationship between the listeners and their local station. That's why Radio Aire is constantly out and about, around the region meeting the people.

Particularly during the summer months, the Roadshow is rarely off the road, appearing at all manner of events around West Yorkshire, from huge public gatherings to village fetes, often broadcasting live on the air. In July 1982 the Roadshow entertained its largest ever audience at Roundhay Park, Leeds, where 120,000 people gathered to see the Rolling Stones.

Personal appearances by the boys are a daily event, and whether they are opening a shop, judging a beauty contest or presenting the disco roadshow at a nightclub, organisers are always guaranteed a large crowd of people eager to 'see the face behind the voice'.

The fun and frolics of Martin Kelner are ever popular with

younger listeners, so he frequently broadcasts his tea time show from a local school or college. Somehow assembly is never the same again!

Radio Aire not only attends events but promotes them too. The Radio Aire Jazz Festival and Folk Festival have become established annual events in the cultural calendar of West Yorkshire. Encouraging local musical talents, Radio Aire sponsors the City of Leeds Youth Orchestra, and its performances are featured regularly on Sunday's 'Lively Arts'.

The station's more off-beat stunts have always proved popular. Our first birthday party on September 1st 1982 was attended by 500 listeners of all ages sharing the same birthday. And the sight of crowds of people in silly hats, eating cake and dancing in front of the studios in the middle of the afternoon attracted the disbelieving stares (and the cameras!) of next door neighbours Yorkshire Television.

Over 3,000 people ran in the Leeds Marathon in October 1982 which Radio Aire organised in conjunction with Leeds Leisure Services Department. Most

entrants were local hopefuls of all abilities, but some competitors came from the Continent to tackle the toughest Marathon course in Europe around the perimeter of Leeds.

The distinct local identity of the assortment of cities, town and villages in the listening area is something Radio Aire tries to reflect. To emphasise this variety, the station recently embarked upon its spring campaign of Aire-Raids, featuring a particular area for two days per week, gradually covering every district in the region.

The most popular stunt in this feature was the commando style raids on houses displaying a Radio Aire sticker. On spotting a sticker, a presenter in the outside broadcast car would knock on the door, microphone in hand and invite himself in for a cup of tea! The reaction of the stunned householder was often hysterical, especially as it was going out live on air.

The Radio Aire-Raids will be taking to the skies again, so put that sticker in your window and see what happens! When Radio Aire is out and about you never know where it will turn up next.

The Presenters



Ross Dickinson

By the time most of the Radio Aire staff are tumbling out of bed and making their way to the Burley Road Studios, Ross Dickinson's working day is finished. It's Ross's job to wake up West Yorkshire, presenting the Early Show between 5 a.m. and 7 a.m.

Twenty-two year old Ross gave up a degree course at Leicester University to join Radio Aire. During his stay in Leicester, Ross developed an interest in broadcasting through work for hospital radio. He's earned a reputation as a wizard of the recording studio, spending hours at the mixing desk creating new jingles.

Work commitments leave Ross with little time for hobbies, but when the opportunities arise he enjoys a game of rugby or squash... followed by a pint.

There's no rest for Ross at the weekend either. On Saturday night he presents Radio Aire's Saturday Night Juke Box Show between 7 p.m. and 10 p.m.

On spare evenings Ross amuses himself with DJ work around the clubs of West Yorkshire, usually falling into bed at around 1 a.m. By 3.30 a.m. he's up and off to work again.

Ross's ambition is to have a good sleep.

Eric Smith

Barnsley born Eric Smith, Radio Aire's Breakfast Show presenter, seemed destined for a career in law, until he spotted an advertisement in a newspaper for a record librarian assistant at BBC Radio Sheffield.

On leaving school, Eric found himself toiling in a dingy solicitor's office in Barnsley whilst attending a part-time college course in law. When Radio Sheffield offered him the job he took their hand off and cheerily embarked on a life in radio. With some experience of hospital broadcasting, and mobile disco work already under his belt, Eric soon found himself on the air presenting several shows for Radio Sheffield.



The chance of a producer's job necessitated a move to Radio Stoke, which Eric combined with TV presentation and continuity work at BBC North East. He returned briefly to Radio Sheffield as producer and mid-morning presenter, before defecting to commercial radio, joining Radio Aire on its inception in September 1981.

Particularly during the summer months, Eric never stops working, and is always a firm favourite with the crowds at Radio Aire Roadshow appearances. Dubbed 'The Diminutive Dynamo' by his buddies at Aire, Eric's nickname is justifiably earned.



Peter Levy

Peter Levy, or Petee as the housewives call him, is almost a Yorkshireman now... he's lived here for nearly six years.

Peter started acting on television when he was 16 and was in many top television series and numerous commercials. In 1975 he joined Pennine Radio in Bradford and was runner up in the best daytime radio show in both the presenter and producer categories in 1978.

In December 1979 he moved to Liverpool and joined Radio City where he presented an afternoon show which was a mixture of interview and chat.

Peter has been presenting the Morning Show since Radio Aire first went on air and says, "I have never enjoyed a programme more than this one — the station and the listeners are the best".

Asked what he liked about his job most, Peter admits "having a laugh with a listener on the air".

He has no great ambitions except to succeed with gliding which is a new hobby and Peter hopes to have his pilot licence by the end of 1984... so if you're in Doncaster anytime you might look upwards and move if something comes towards you that looks suspiciously like an aeroplane.

Martin Kelner

Pin-up Darling of the Airwaves and Forces Sweetheart 'scrummy' Martin Kelner fills the late afternoon slot on Radio Aire between 4 p.m. and 7 p.m. with his own blend of lively music and terrible jokes.

Martin is 24 and an habitual liar! Born at an early age in Manchester, 'Max Kettle' (as he calls himself) claims he would never have been born at all if it hadn't been for Manchester United winning the FA Cup and several bottles of brown ale.

Before working for Radio Aire, Martin had a late night show at Radio Hallam in Sheffield: He gained further radio experience at Piccadilly in Manchester and LBC in London. With a show like Martin's you've got to keep moving.

After leaving school Martin tried his hand at a number of professions (milkman, poodle clipper, fairground operative), before embarking upon a short-lived and spectacularly unsuccessful university course.

Attracting listeners as daft as himself, Martin regularly throws parties for his dedicated correspondents and juvenile jokesmiths. The most recent scriptwriters convention boasted such celebrities as Captain Fruitbat, Eduardo Von Foodmixer and the Reverend Milo Nostradamus.

Martin is interested in camping and one day hopes to visit Northampton.



Alex Lester

There's hardly a radio station in the land that hasn't, at some time, enjoyed the dubious distinction of employing Alex 'Cuddles' Lester.

Before arriving at Radio Aire to present the weekday Afternoon Show 'Cuddles' left his indelible mark on local BBC stations in Birmingham, Humberside, Leicester, London, Carlisle, Stoke, Cleveland, Derby and Blackburn.

Renowned for his healthy cynicism, The Pudgy Purveyor of Pop claims to be happy only when he's miserable. He likes nothing, least of all himself.

Alex was born in Walsall 26 years ago, and is the product of Public School. ("The school motto was 'Keep Your Bowels Open and Your Mind Closed' ", he recalls).

After a spell at charm school, the young Lester found himself on a journalism course at Birmingham Polytechnic. Unlike most of his colleagues, he 'went the distance' in Higher Education, but his first job after graduating was The Green Man at Dudley Zoo — he had to dress as a green monster responsible for lighting the volcano in the Land of Dinosaurs.

Alex's long-standing ambition was to be a child star. "I managed the child bit", he reflects wistfully, "but now my priorities have changed. I'd like to live alone on a canal boat with a private income". Anything else? "Oh, yes, I would always like to have a seat to myself on the bus".

James Whale

Born "somewhere in Wales" in 1951, James became an actor on leaving school and appeared in several episodes of Z Cars. He fell accidentally into broadcasting in 1972 after making a commercial for Metro Radio in Newcastle. Impressed by his style of presentation, Metro hired him as a freelance DJ.

James's reputation eventually carried him to jobs at BBC Radio Derby and Radio Tees in Stockton, sandwiching the occasional acting role in between. (He was turned down for a part in 'The Professionals'!)

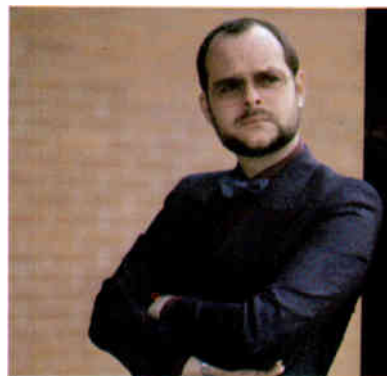

James Whale was already a legend in local radio before he arrived at Radio Aire in August 1982, and his notoriety has spread like a bush fire through the late night listeners of West Yorkshire.

Pompous, arrogant, self-opinionated, bombastic, egotistical, dogmatic stubborn . . . and bald, are all adjectives regularly applied to James by his listeners. His phone-in chat show between 10 p.m. and 1 a.m. every weekday evening is compulsive listening, deliciously infuriating and controversial.

A country boy at heart, James fulfilled an ambition recently when he and his family made their home on a farm in North Yorkshire. The rural life provides James with the ideal opportunity to pursue his hobbies of archery and horse riding.

News action with Radio Aire

West Yorkshire is well known as one of the busiest news areas in the country with a high crime rate producing such notorious criminals as Christie, Peter Sutcliffe, Donald Neillson — the Black Panther, Barry Prudom and John Poulson.

With a wide range of industry including wool, carpets, clothing and electronics, and such well known M.P.'s as Denis Healey, Sir Keith Joseph and Merlyn Rees, this all adds up to a busy life for the news team.

Reporters man the station from five o'clock in the morning until midnight, collecting news stories from one end of the large county to the other.

Among the stories to come out in the last twelve months, was the



hunt for triple killer Barry Prudom, the Helen Smith Inquest and the letter bomb from the Angry Brigade sent to the Tory offices on the day Mrs. Thatcher arrived in Leeds.

We've also had visits from the Queen, the Prince and Princess of Wales and the Duchess of Kent who's the Chancellor of Leeds University.

THE NEWS TEAM

Christa Ackroyd

At 26 not only is Christa Ackroyd one of the youngest news editors in the country but the first woman to be appointed to run a Newsroom for an Independent Radio Station.

Combining a busy job and running a house, husband, two children and a dog and a cat, produces more than a few grey hairs — as well as an extremely busy life.

She entered journalism straight from school working for local evening newspapers before joining Pennine Radio where she covered the Yorkshire Ripper trial.

As a senior journalist at Radio Aire, she read the first news when the station went on air . . . and was appointed News Editor in November 1982.



Mark Mardell

Swashbuckling Mark Mardell arrived at Radio Aire after escaping from the Newsroom of Radio Tees in Stockton. He decided to go into journalism after serving concurrent sentences at Kent University and the London College of Printing.

Mardell's Milestones in Journalism include legendary and colourful encounters with the rich and famous. "I was once beaten up backstage by Jean-Jaques Bernel of the Stranglers and earlier this year I stood very close to Princess Diana!" quipped the vivacious blonde bombshell.

Surrey-born Mark likes to relax by listening to his favourite band the Clash whilst eating a chinese takeaway, preferably in New York, his favourite city.



Dee Marshall

Unlike the other southern jessies in the Radio Aire Newsroom, Dee Marshall is Yorkshire born and bred . . . Wakefield 25.11.59.

She spent a year in London to obtain a Diploma in Radio Journalism and came back up north to freelance for the other lot (the BBC), turned traitor and joined Radio Aire just before the station went on air.

She has reported on all sorts of events . . . the most frightening one involved standing next to the young policeman in Malton who was shot in the face during the hunt for gunman Barry Prudom . . . and then having to run for cover.



Helen Boaden

A converted Northerner, addicted to the beer, Helen Boaden made her way to Woodhouse in Leeds via a training course in the London College of Printing, a year in New York, and a stretch in the Radio Tees Newsroom.

Now known for her chilblains — a regular feature on the Martin Kelner Show — and her love of a sappy story, she has become a vital and vivacious part of Radio Aire's Newsroom. (It's alleged. Ed.)

Favourite Band: Fun Boy Three; Favourite Food: any; Favourite colour: red; Favourite sport: digging the garden; Favoutie Boy: the one next door. Ambition: to have a car which works.

Jill Hopkins

Jill Hopkins joined Radio Aire, before the carpets were laid, originally as a producer but now she is working in the newsroom.

Although born and bred in Yorkshire, Jill has worked at radio stations in Norwich, Bristol, Stoke and Oxford before joining Radio Aire.

Jill's first job was as an art teacher in a comprehensive school but after twelve months she abandoned teaching for an interviewer's job with a National Coal Board TV unit!

Jill used to enjoy travelling but now prefers to stay in front of the fire at home . . . ironical, as her husband is an airline pilot.

After a hectic day in the newsroom Jill likes to hide away with her husband at their Pennine farmstead, in the company of their pigs, hens, horses and dogs.



Chris Kiddey

Genial, pipe-smoking Chris Kiddey was born in Nottingham 28 years ago, and made his way to Radio Aire via newspaper journalism.

On graduating from Hull University with a degree in Economics, Chris talked his way into a job on a weekly newspaper in Lincoln, and then onto the staff of the Shropshire Star. His introduction to radio journalism came with a two year spell at Beacon Radio in Wolverhampton.

When duffle coat clad Chris is not scouring the streets looking for news stories, he enjoys reading the Guardian, rebuilding his house in North Leeds, and sailing in Cornwall.

Sports action with Radio Aire



Leeds United in action

The sports team at Radio Aire produces three programmes every week, spanning ten hours.

John Boyd, Sports Editor, has

developed a close working relationship with the local personalities and attributes the success of the department largely to

this everyday contact.

John leads a squad of nine commentators and reporters. Come the weekend it's all hands on deck as the Radio Aire sports machine slips into gear and the team go scurrying all over the county to report on the performances of local sportsmen and teams.

Saturday is essentially Leeds United's day, although a top Rugby Union game is also featured in the four hour Saturday Sport show, presented by Bill Naylor. Rugby League Special occupies the Sunday afternoon slot and the show includes plenty of exciting commentary from the top matches of the day.

Midweek Sport on Wednesday evening is a colourful magazine programme, a general round-up of the local sporting activity. The forthcoming weekend fixtures are previewed and star names call into the studios to talk and pick their own choice of music.

Making a commercial

You may not realise it, but producing a radio commercial is a complicated and quite often lengthy process.

Every commercial starts life in the sales department. Radio Aire has a local sales team of nine. When the sales person brings back a brief (comprehensive details of what the client wants to promote in the commercial) Radio Aire's team of expert producers set about the details and produce a commercial script. All the details of the finished



commercial are included in the script: the number of voices, sound effects, music details, etc.

Once approved, the commercial goes into a voicing session.

A commercial may require a hard-sell sound, a relaxed soft-sell, or a variety of different accents. Voicing sessions often use three or four different voices at a time and take place in Radio Aire's 8-Track Commercial Production Suite: Studio 4.

Studio 4 is a maze of electronic wizardry, all connected to a 12 channel mixing desk, from which the Commercial Producer can alter the quality or sound of a voice, music bed or sound effect.

As well as the main mixing desk, Studio 4 has two Studer Reel-to-Reel tape recorders, a special record turntable and two cartridge machines, which record the finished commercial onto special cartridges



before they go to the 'On-Air' studio for transmission.

Studio 4 is also one of the few Commercial Production Studios in the country to have an 8-Track facility.

The 8-Track is similar to an ordinary tape recorder, but has the facility to play and record up to eight different sounds at the same time on one piece of tape.

Radio Aire can produce up to 80 commercials a week in this way, and although is often a lengthy process, a simple commercial can be written, voiced, mixed and carted within only 15 minutes!!!!

Write a Commercial

All you have to do is write a commercial that promotes your Radio Station. It must last approximately 30 seconds (about 75 words) and can be in the form of a conversation, a play, humorous or serious, etc.

The winner will receive a specially stylised radio and a day with your Radio Station. The five runners up will receive special gift packs.

Send your entry to
Stamford Publishing
Limited, The Grey House,
3 Broad Street, Stamford,
Lincs, PE9 1PLR.

Abridged rules

- 1 Entry open to all residents of the UK excepting employees of Stamford Publishing Ltd, any ILR station or anyone connected with the organisation of the competition and their families.
- 2 The judge's decision shall be final and binding on all entrants and no correspondence will be entered into.
- 3 The final closing date for entries is 2nd February 1984.
- 4 All entrants must be aged under 18 years on the closing date for entries.
- 5 Winners will be notified by post before 30th March 1984. A list of major prizewinners or a full set of rules can be obtained by sending a s.a.e. to the competition address marked 'Winners' or 'Rules' in the top left hand corner.

ENGINEERING



The front line of Radio Aire presenters may be the best on the waveband, but without the backroom boys in the engineering department, you'd never know about it.

Under the captaincy of Chief Engineer, John Orson, a team of four technical wizards are on hand to make sure everything that the presenters say or play reaches the listeners. In a manner bewildering to the non-technically minded, they dart around the studio complex, clutching the assorted accoutrements of their trade, flicking switches, pressing buttons with mesmerising know-how.

The bulk of the engineers' time is occupied with maintenance — servicing the studio equipment to avoid breakdowns. In the event of a breakdown, nothing is sent back to the manufacturers for repair. In fact, the sight of a mixing desk in a million pieces on the engineering workshop bench is commonplace. The engineers also apply their skills to modifications to existing gear.

John Orson designed the studios himself, drawing on lifelong experience in radio engineering. They are quite simply the best designed studios and consoles in the country.

Whenever the Roadshow leaves the Radio Aire car park, the engineers are at the helm ensuring that the equipment is properly set up to provide the best possible show and outside broadcast. Similarly, it's the lads from engineering who man the mixing desks and tape recorders at live concerts recorded by Radio Aire.

If you like the idea of a career in radio engineering, John Orson describes the necessary qualifications for the job: "You have to be prepared to work any time, day or night, and a degree in electronics helps, too!"

THEY DASH INTO THE WOOD TO FIND AMANDA ON THE GROUND WITH HER FOOT WEDGED INTO WHAT APPEARS TO BE A RABBIT HOLE!

HOLD ON, AMANDA— WE'RE COMING!

THE BOYS RUSH TO HELP AMANDA OUT OF THE HOLE

OW!

YOU'RE O.K. NOW AMANDA

WITHOUT REALISING IT ROBERT HAD PUT THE METAL DETECTOR DOWN NEAR THE HOLE ... SUDDENLY IT STARTED BLEEPING LIKE MAD!

HEY LISTEN! — THE DETECTOR MUST HAVE FOUND SOMETHING!

COR!

PAUL REACHES INTO THE HOLE AND PULLS OUT SOME VALUABLE LOOKING THINGS!

CRUIKEY! WE'VE FOUND THE RADIO BINGHAM BURIED TREASURE!

YOU TWO STAY HERE — I'LL GO AND TELEPHONE RADIO BINGHAM!

WE'VE FOUND IT—WE'VE FOUND THE RADIO BINGHAM TREASURE ! IT WAS IN A RABBIT HOLE IN BINGHAM WOODS !

ANDY SMITH—KNOWING THAT THE TREASURE HADN'T BEEN BURIED IN BINGHAM WOODS—REALISED THAT SOMETHING WAS WRONG ...

OK, ROBERT, GO BACK TO THE TREASURE AND WAIT FOR ME — I'LL BE THERE AS QUICKLY AS I CAN !

...HE THEN CALLED THE POLICE !

ROBERT RACES BACK TO BINGHAM WOODS

IN HIS HASTE ROBERT LEAVES HIS BIKE ON THE GROUND IN FRONT OF A PARKED CAR— WHICH HADN'T BEEN THERE EARLIER !

HE DASHED BACK TO WHERE HE HAD LEFT HIS FRIENDS — TO FIND THE SITUATION VERY DIFFERENT—AND VERY ALARMING !!

GOOD GRIEF— WHAT'S HAPPENED ?

QUICK, THEY'VE TAKEN THE TREASURE !

ROBERT QUICKLY RELEASES AMANDA AND PAUL ...

HURRY UP, BOB - THEY'RE GETTING AWAY!

THEY RACE AFTER THE TWO MEN JUST IN TIME TO SEE THEM GETTING INTO THE CAR!

OH NO! THEY'RE BOUND TO GET AWAY NOW!

BUT THE DRIVER HADN'T SEEN ROBERT'S BIKE UNDER THE FRONT WHEELS - THE CAR SUDDENLY SLEWED ROUND AND HIT A TREE!!

CRUNCH!!

JUST THEN A POLICE CAR APPEARED AND THE POLICEMEN LEAPT OUT AND GRABBED THE TWO CROOKS!

ANDY SMITH - WHO HAD ARRIVED WITH THE POLICE - WENT ACROSS TO CONGRATULATE THE THREE TREASURE HUNTERS ...

LATER... LORD BINGHAM WAS SO GLAD AT GETTING HIS VALLUABLES BACK THAT HE BOUGHT ROBERT A NEW BIKE - AND GAVE ALL THREE A £10 RECORD TOKEN AS A REWARD!

WELL DONE KIDS - THAT WASN'T OUR TREASURE - THOSE WERE THINGS STOLEN FROM BINGHAM HALL LAST NIGHT!

AND I'M INVITING YOU ALL TO SPEND A DAY WITH US AT RADIO BINGHAM!

... SO THEY DID FIND THEIR "TREASURE" AFTER ALL!!



Be Loud, Be Proud (Be Heard) is not just a successful Toyah single; it's something of a personal anthem, too, the lyrics pretty well summing up her attitude to life. It's about having a confident, positive attitude; about having motivation; about not being manipulated. And it's an attitude she's keen to get over to her fans: "A lot of unemployed kids are fans of mine, and when they come to see me, I tell them to be proud and to take life in both hands."

Toyah is certainly very much in charge of her own life. Some time ago she dispensed with her manager, and now looks after her own affairs. "I'm managing myself, and it's hell. I never realised how much managers do, but I'm happy because now I can organise everything. I am *terribly* organised, but it's me who does that, nobody else." When Toyah found that her knowledge of law and accountancy was lacking, she set about learning, with the help of teach-yourself tapes.

She has great confidence in her own abilities, and likes to pack as many things as possible into her schedule. She'll happily go without sleep if she's enjoying working on a project, and that could be any one of a number of things: writing songs, writing music, recording, planning her stage shows, making videos and doing promotional work. She's also keen to design makeup, jewellery and clothes that mirror her great sense of style: "I want to sell outrageous day clothes of good quality."

And then, of course, there's her acting career. Toyah Willcox left school with just a music O level, and went to Birmingham Old Rep Drama School. After only a few months she got a

part opposite Noel Edmonds in a TV play, *Glitter*, then went on to act with the National Theatre and to appear in films like *Jubilee* and *Quadrophenia*.

In 1978 she formed a band, and in just a couple of years had collected single and album hits and had been voted top female singer in numerous pop polls. She'd also acted as a chat-show hostess, and had headlined tours in Britain and Europe.

Toyah really comes alive on stage. Her gigs are nothing short of real events, combining her powerful songs, dancing and stage sets. "I listen to my fans," she says. "That's where my heart is. It's great getting feedback off an audience."

When she recorded her live album *Warrior Rock* at the climax of her 1982 summer tour, Toyah had microphones in the audience to capture the atmosphere: "What's the point of doing a live album if you don't get the atmosphere created by the fans?"

So what of the future? Toyah has plans for more writing, singing, recording, acting — oh, and she plans to conquer America, too. "I think I'll write down my life story when I'm sixty, when I've done a lot more and I'm more fulfilled. I think I'm definitely one of those people who improves with age." That life story should make interesting reading, for under that mop of colour-of-the-week hair there's one talented lady . . .

Did you know that Toyah once formed a band with Adam Ant and his ex-wife Eve Goddard? The band was called the Man Eaters, and Adam and Toyah planned to write the music, but they split after a row: "Our egos just went bang."

Is Toyah your real name?

"Yes it is. There's a town in Texas called Toyah (it means 'water' in Indian). The neighbouring town is Willcox, so that must be where my mum got it from — it was definitely her who named me."

Sports Roundup

COEVETT!

Yet another summer has gone by with athletics again being dominated by the Coe-Ovett road show! Both of these amazing athletes have been travelling the world entertaining millions of spectators with the electrifying pace that they both possess. However, this year the entertainments will 'cease when they arrive at the Los Angeles Olympics. Both men have stated that victory there is their largest remaining ambition. The stage is set then for possibly the most exciting race ever seen!



COPYRIGHT, THE BRITISH OLYMPIC ASSOCIATION



OLYMPICS '84

The symbol on the left is the one to be worn by our leading sportswomen and sportsmen when they compete in the 1984 Games.

The Winter Olympics will be staged in Sarajevo Yugoslavia, and the rest of the games in Los Angeles, California, U.S.A.

Throughout the country, schools and sports clubs are busy helping to raise the much needed funds to equip and send our team to compete on our behalf.

If you would like to know more, write to:

*The British Olympic Association,
1 Church Row,
Wandsworth Plain,
London SW18 1EH*

KATHY COOK

Kathy Cook (née Smallwood) is undoubtedly the best woman athlete that Britain has produced for many years and is one of the few Western girls with the ability to challenge the East Europeans. And to show how much she loves athletics she married Britain's highly ranked 800m runner Garry Cook at the end of last year!

DALEY THOMPSON

Great Britain is fortunate to have so many athletes who are at or near the top of their own particular disciplines but there is one man to whom the Los Angeles Olympics means more than being just this year's World's best. A decathlon gold medal will mean that DALEY THOMPSON will be hailed as the best all-round athlete in the history of the world! In the past six years he has won nearly all the major Decathlon championships . . . TWICE!

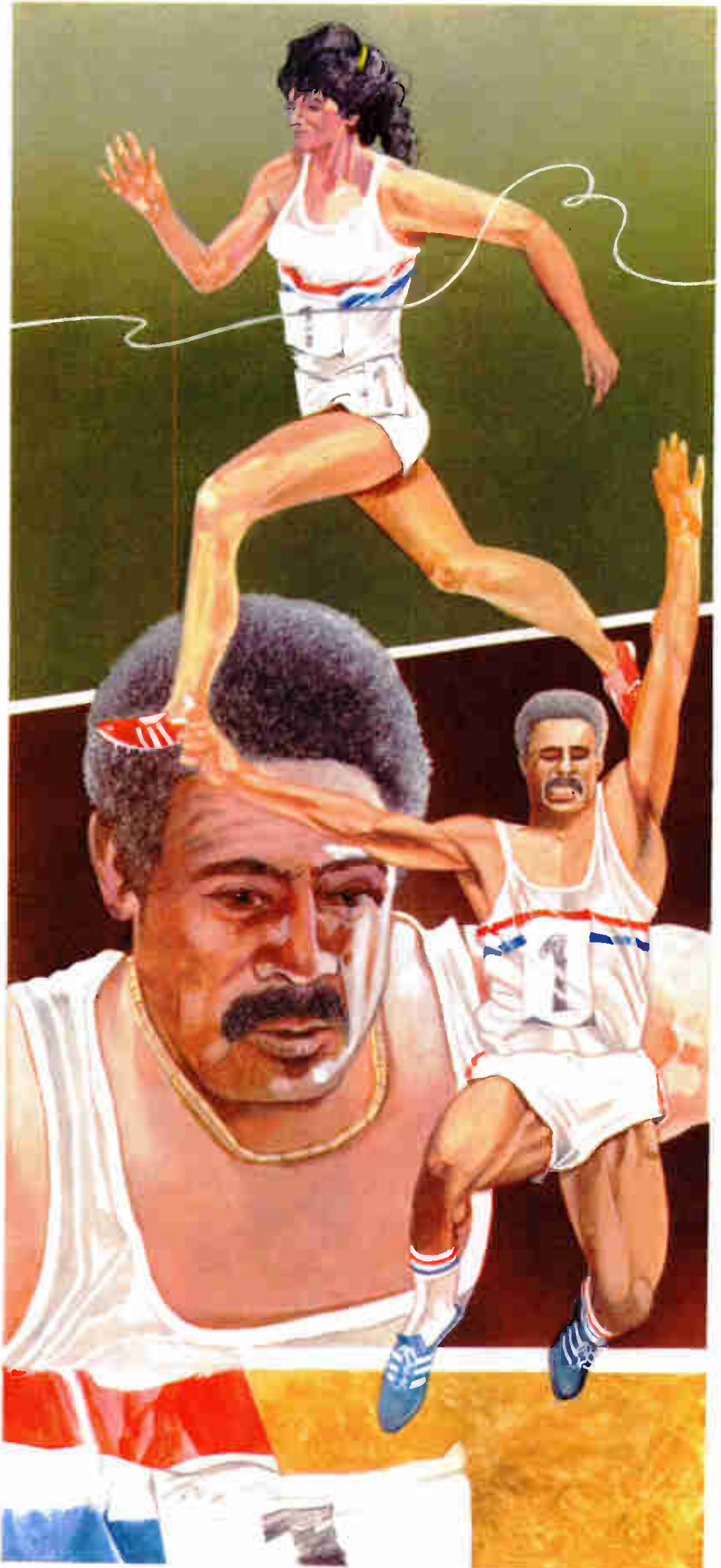

IN A RUSH FOR GOAL!

Hunt, Toshack, Keegan, Dalglish and now Rush! In keeping with Liverpool's amazing tradition of deadly strikers, Ian Rush has made a name for himself that must rank him amongst Liverpool's greatest, and he's still only 22! His club are hoping that he will stay at the sharp end of what is yet another great Liverpool team for a long time to come. And the fact that he has been an ever-present member of the Welsh team for nearly three seasons means that his country are hoping he'll be around for some time as well!



PHOTOGRAPH: MATCH WEEKLY



ACTION MAN ROBSON!

'Perpetual motion' is a phrase often used to describe England's dynamic young captain Bryan Robson. Whether it be for his club, Manchester United, or for his country, Bryan can be seen giving a 100% effort, week in and week out. It is not an uncommon sight to see him clear his team's lines at one end of the pitch and, a few moments later, see him scoring one of his many spectacular goals at the other! Definitely a man of action on whom England are pinning a lot of hopes for the future!



NORMAN COWANS

Following a very traumatic tour of Australia last winter, Norman Cowans has survived that baptism of fire and put in another summer of blisteringly fast bowling for his county team, Middlesex. Still only 22, Barbadian-born Norman has had a particularly tough apprenticeship and is still learning fast! England's bowling strength should be greatly enhanced for many years to come by this genuinely fast young man!



LUCINDA GREEN

The last six years has seen the rise of Lucinda as Britain's premier 3 day eventer and the best woman competitor in the world, winning the world 3 day event championship in 1982. As far back as 1974 she won the European Junior title and followed this up with success in the 1976 Badminton horse trials. The following year she achieved the rare double of again winning Badminton and also Burghley. All of this was achieved on that great horse Be Fair and their success hasn't stopped there! Unfortunately Be Fair suffered a leg injury and has appeared only occasionally over the past few years but Lucinda has a fine string of horses and this, combined with the mere mention of her name strikes fear into the hearts of all of her competitors!

JUNE CROFT

For a number of years June Croft had been one of Britain's brightest young swimming prospects, but was always overshadowed by the country's most popular female sportswoman Sharron Davies. However, Sharron's premature retirement from competitive swimming and June's three gold medals at the Melbourne Commonwealth Games in 1982 has changed all that!! Yet another British sportswoman with high hopes for this year's Olympics!



PHOTOGRAPH: SWIMMING TIMES LIMITED

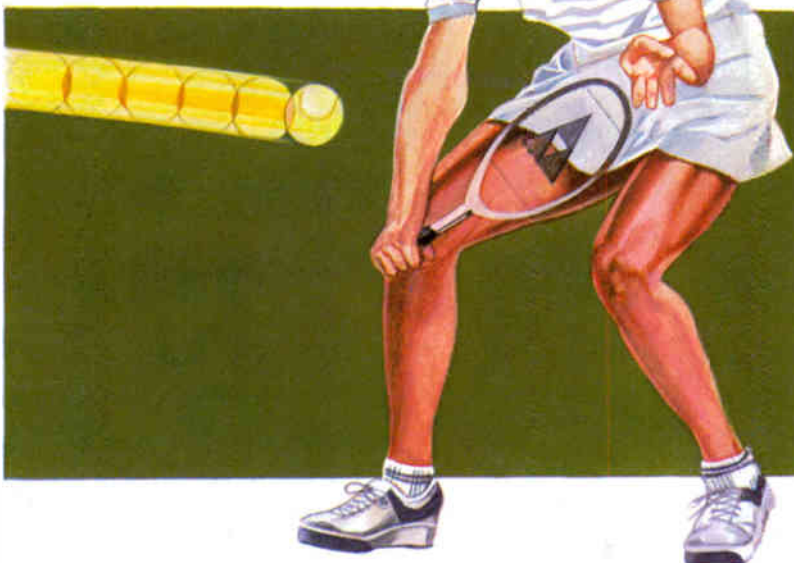

JO DURIE

Jo Durie is slowly establishing herself as Britain's premier lady tennis player. The last few years have seen a titanic struggle between Jo, Virginia Wade and Sue Barker for the prized No 1 spot. Virginia, long time holder of that honour and ex Wimbledon Champion, 'retired' 3 years ago, but keeps popping up at the occasional tournament and continues to pull off the odd surprise! The effervescent but equally erratic Sue Barker is a brilliant performer on her day and was a beaten semi-finalist at Wimbledon in the same year as Miss Wade won her crown. But it is Jo's consistency, week in, week out, that gives her the edge over her native rivals!

FAME

Just a film, a television series and five young people. . . Lee Curreri (Bruno), Erica Gimpel (Coco), Lori Singer (Julie), Carlo Imperato (Danny) and Gene Anthony Ray (Leroy) . . . that's all it's taken to create a mini-boom in the number of young people clamouring to get into Dance and Drama schools, or queuing up to attend evening and weekend dancing classes.

Suddenly everyone wants to get in on the Fame Game. Dancing Fame-style is alive, it's electric, it's pure rhythm and music: exciting to watch, but even more exhilarating when you're actually taking part in it yourself.

So unique is the kind of dancing featured by the Fame team that it's been christened with its own name . . . jazz-style. Not that the creators of Fame invented it themselves, it was there all the time waiting to be discovered, a unique style developed by black youths from the poorer areas of New York who used to meet and jam together on street corners to discover new steps and movements.

As a result jazz-style is a mixture of a whole host of separate styles. It's part reggae, part funk, part tap dancing, part classical jazz. To date it has defied definition. The basic rule, however, couldn't be simpler . . . dance the way you feel

inside: whatever you feel, dance it.

But don't go running away with the idea that in jazz-style anything goes. Far from it. Despite that free-and-easy look it has its feet far more firmly planted in ballet than in disco dancing.

For the Fame fan those pirouetting prima ballerinas at Covent Garden may seem a far cry from the styles of Bruno and Leroy but in fact most teachers prefer you to have had ballet training (anything up to five years) before you are ready to tackle jazz-style in your early teens.

Why should this be? Basically because the movements and gestures which you learn to master

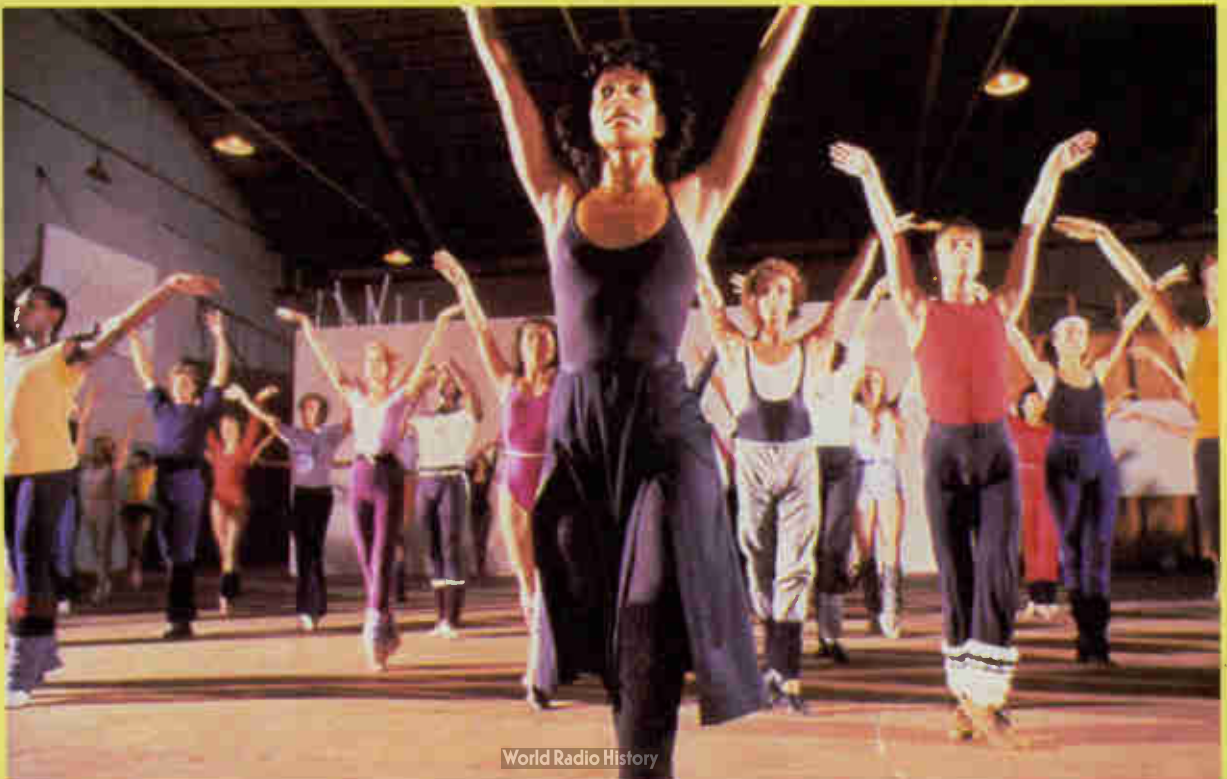

PHOTO: YORAMI KAHANA



PHOTO: YORAM KAHANA

in conventional ballet provide an excellent grounding for the strength and body discipline needed to master jazz-style. There are two types of ballet, classical and contemporary, and each provides a separate form of training.

From classical ballet comes the control, elegance and poise which is the hallmark of the Royal Ballet Company. Every step, every movement, every gesture has been written down, named and described to form that essential store of steps from which all classical ballets are choreographed. No variations from these strict basic rules are allowed.

From contemporary ballet, as performed by the Ballet Rambert and the London Contemporary Dance Theatre, comes a much more supple, flowing style. It was created about thirty years ago by leading figures like Martha Graham and although the dance-steps have not yet been so carefully outlined and written down as in classical ballet still all are based around the simple movements of either expanding or contracting the torso. In learning contemporary ballet you learn to make your movements loose-limbed and flexible.

And so to jazz-style. At times it requires the total control of classical ballet and sometimes its movements are as liquid as contemporary ballet. But, above all else, the important element of jazz-style is speed. If you like it's the racing car of dance, the body kept low to the floor and the dancer moving swiftly around the stage.

To find out more about exactly

what learning the new jazz-style involves, Radio Annual contacted Helen Robbins who teaches contemporary dance at the Northern Youth Dance Theatre, the Leeds Dance Centre and at a variety of youth clubs and schools throughout the area.

Certainly she finds that since Fame hit the television screens there has been no shortage of teenagers anxious to follow in the footsteps of the celebrities in Fame. So what does a typical one and a half hour Fame-style work-out involve? "Usually for the first twenty minutes or so the class do sitting exercises, stretching and elongating to strengthen their bodies and build up the endurance essential to jazz-style routines".

"Next comes another half hour or so of standing exercises done to music . . . anything from funk to guitar or Beethoven . . . and then the class practise certain step patterns, moving across the floor in groups of three or four. It's only in the last quarter of an hour or so that they can bring together all the new factors which they have learned and develop them into individual routines."

Sounds relatively tame? It's not. Helen Robbins again, "It does mean blood, sweat and tears — I have to work the youngsters hard — and often even the tough guys have to admit that they can't keep up."

But that, after all, is what the Fame film and television series portrayed. The world of dance and drama really is just as tough and competitive as they made out. To succeed you have to develop your body to the peak of fitness and beyond. You have to keep exercising and doing work-outs when the rest of your mates are out enjoying themselves. And if you do finally make it you'll find that your professional life as a dancer is just as exacting.

To quote principal dancer Patricia Ruanne, "Your body doesn't want to move in the daytime and it shrieks even louder when you go home at night. It's a battle, and it never stops being a battle — it gets worse."

But that, after all, is the price you have to pay if you want fame.



PHOTO: YORAM KAHANA

Human League



PHOTO: VIRGIN RECORDS

The Human League story started back in 1977, in Sheffield, when Ian Marsh and Martyn Ware formed Dead Daughters. They added Addy Newton, called themselves Future, then Addy left and was replaced by Phil Oakey. They took the name Human League (from the board game Star Force) and in 1978 Adrian Wright joined to give slide shows during gigs. A single, *Being Boiled*, earned the band the support spot on a Siouxsie and the Banshees tour.

In 1979 they released the EP *The Dignity of Labour*, signed to Virgin, and toured with Iggy Pop. They opened a recording studio in Sheffield, Monumental Pictures, and scored a minor hit with *Empire State Human*.

By 1980 The Human League was a well-known cult band, and the *Travelogue* album crept into the top 20. But in October Ian and Martyn left, and Phil had to find new members so that a planned European tour could happen. Adrian took over on synthesiser, Ian Burden joined, and Susanne Sully and Joanne Catherall were recruited. The girls hadn't planned a pop career, but Phil spotted them dancing in a disco, and asked them to join. The girls had tickets for a Human League gig, but sold them, for by the time the gig happened they were in the band!

Magically, the gamble worked. The new lineup's first single, *Boys and Girls*, reached number 48 in the charts; *Sound of the Crowd* rose to 12; *Love Action* hit the top 3. Ex-Rezillo

Joe Callis joined, boosting the band's song-writing strength, Martin Rushent took over as producer — and *Open Your Heart* topped the singles chart soon after.

1981 became The Year of the Human League, their biggest single being *Don't You Want Me*, which dominated the charts for five weeks at number 1. It also topped the US charts, which until then had proved highly resistant to synthesiser music.

On the home front the band were relatively quiet in 1982, but perhaps they needed that quiet period after their rise to stardom. As Susanne said later in 1982: "A year ago it was all happening for us. We could easily have gone on appearing on *Top of the Pops* every two weeks, but we didn't want to give everyone an overdose of Human League. It's easy to glut the market."

Phil Oakey certainly didn't think their time out of the limelight was detrimental: "If you're doing something of quality you'll always sell, regardless of the time you take doing it."

He was proved right when *Mirror Man* was released in late 1982. It had taken three weeks of work in the studio, but that's nothing by League standards — they spent 2½ weeks recording a 45-second advertising jingle for a Norwegian magazine!

Despite their chic looks, the band take their music very seriously. "Music is important," says Phil Oakey. "It colours every person's attitude and life. Our mission

is to stop it ever becoming mediocre."

The touchstone of their individual sound is the synthesiser, used sparingly but very effectively. At the time of writing they are thinking about buying a Synclavier synth for a cool £35,000. "It's no use investing in cheap equipment," says Oakey. "We don't want a sound that comes over like pebbles rattling in a tin can."

So what of the future, after their phenomenal rise to stardom? Phil Oakey again: "I'd like to do an album that will sell and be remembered, something like Pink Floyd's *Dark Side of the Moon*. I would like it to be a real classic."

And that shouldn't be a problem for the Human League, knowing the time and care they take in getting things just right. The only problem they have — if problem's the word — is maintaining the ultra-high standards they themselves have set.

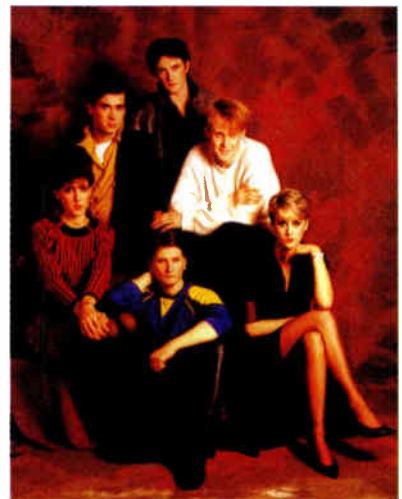

Human League



Lisa Pryce of Rising Brook High School in Stafford wants to write for a living and says that writing is her full time hobby.

The Beacon Radio Kid's Stuff competition is the first that Lisa has won but somehow I think it won't be the last. Lisa's story, 'An Unusual Holiday', was judged to be the best from the many hundreds received by the Beacon Radio Studios.

AN UNUSUAL HOLIDAY

Duggie was a mechanical digger. You can see his brothers working at the roadside. With their long, yellow noses and sharp, powerful teeth, they take great bites out of the earth so much more easily than any number of men with spades.

He was six months old and his engine was still very young and powerful. He had a driver called Sid, a burly man with broad shoulders and a thick, ginger beard. He liked working overtime and made Duggie work very hard often after all the other drivers had gone home.

"It's too bad," Duggie complained unhappily to his friend, Derek the Dumper. Derek listened sympathetically.

"Why don't you take a holiday?" he suggested, his headlamps twinkling mischievously in the moonlight.

"A holiday! But where?" Duggie spluttered.

"Well, how about Blackpool? It's quiet there now the illuminations have finished."

Duggie shook his neck which made a sad, clattering noise.

"Sid went there last year. He said it was rather cold."

"Then how about a complete change like—Australia? It's lovely and warm, soft clean sand to dig and plenty of my friends live there," Derek explained enthusiastically.

"But how could I get there? I can't swim and I know I'd get sea-sick if I went on a boat."

"You won't have to do anything of the sort, silly."

"Yes, but how?" Duggie was getting impatient.

"Listen. Australia is just underneath us. You could dig your way down there."

"Is it far?"

"Not for such a strong young chap like you."

Duggie blushed.

So the next night, when Sid had gone home, Duggie started his adventure. Luckily Sid had filled him with petrol ready for the next day's work and after several attempts Duggie managed to reach the starter button by twisting his neck.

"I wonder what Sid will say when he finds me gone?" Duggie chuckled. "I'll send him a postcard from Australia."

Several motorists who passed seemed rather surprised to see a digger working at night without a driver but no-one stopped.

"It's working automatically," they said to their passengers. "Computers, you know."

Duggie smiled as he dug deeper and deeper into the heavy red clay beneath his caterpillar tracks. What a surprise those people would have if they knew where he was going!

"Ugh! What was that?" His mouth had bitten something very hard and a strange, unpleasant smell rose from the hole.

"Gas," said Duggie to himself, "still, there won't be anything as nasty as that in Australia."

He went on digging furiously although the smell made him feel rather sick.

The next thing that he knew was that he was all cold and soaking wet. He managed to switch on his wipers and clean the windows of his cabin but the ice-cold water made him gasp and sneeze. He now realized that he had broken a water-main.



"Maybe I would rather stay in England after all," he said, feeling rather sorry for himself. "No, I won't, I'm going to get to Australia or bust."

The earth was now much softer and Duggie felt certain that he was nearly there. Suddenly there was a vivid blue flash and Duggie experienced a tremendous shock which ran up his long, yellow neck and jolted him as if he had been struck with a sledge-hammer. He had bitten through an electric cable buried deeply in the ground.

That did it! All thoughts of a holiday evaporated. It was far too dangerous. He sadly lifted his neck out of the hole and he couldn't prevent a little tear trickling down his cabin windows, a trickle which became a flood.

"Hey you up there! Can't a worm get some peace and quiet?"

"Sorry," mumbled Duggie, "it's just that I've had a nasty shock and I'm so unhappy."

It was Wilbur the Worm who was getting drenched with Duggie's tears.

"You weren't trying to dig to Australia were you?" Wilbur enquired.

Duggie hung his head and giggled.

"Matter of fact, I was." And he laughed. Then Wilbur started laughing. They made such a noise that they woke Derek the Dumper who was sleeping nearby.

"Now look, you pair, shut up and go to sleep. It's way past midnight!" Derek shouted angrily.

"Wilbur," Duggie said quietly, "can you get to Australia down there?"

"I'm not so stupid as all that, Duggie, but I'm very glad to see you. You've moved a big stone that's been stopping my getting to market. Much obliged." And with a wriggle, Wilbur was gone.

"Well, I've done someone a good turn," thought Duggie, "but I wonder what Sid will say in the morning when he sees this mess I've made?"

As a matter of fact, Sid was not very pleased. But it all turned out happily because he decided that because Duggie was so tired with overwork he had been sleep-walking. So he never worked him so hard again.

Lisa Pryce (16 years)

SHAKY

One of the most interested observers of the Shakin' Stevens success story would surely be the rock 'n' roll star's old music teacher.

For even in his schooldays Shaky, as he is known to his friends, was immersed in rock 'n' roll. As a youngster he practised wriggling his hips as he bopped his way through the rock classics. All of which greatly distressed his music teacher at school in Cardiff, who hated all the songs which the young Shakin' Stevens insisted on performing.

Now years later the dark haired, handsome singer can smile at those memories. Particularly since he is now undoubtedly cushioned by the realisation that he has at last achieved the stardom that was once no more than a teenage dream. That fantasy is now reality.

1981 saw Shaky notch up an impressive clutch of chart successes — including a total of seven weeks at No 1 with 'This Ole House' and 'Green Door' — and the success of these revitalised oldies is in some way a tribute to his intuitive feeling that the time was right for a new version of two pop greats.

"The very first time I ever heard 'This Ole House' was just before Christmas. I was visiting a friend who had this collection of old records. He pulled it out and played it for me. I was amazed that no-one had released a cover version since 1954 and I just knew that I had to record this song."

His intuition was bang on. Now this unassuming, slightly built singer must consider that decision to be one of the best, and most significant, he has made in his rock career. For as the song crashed its way straight to the top of the hit parade, Shaky was suddenly what the television people describe as 'a hot property'. The country's top TV companies were all desperate for him to make guest appearances. And to many viewers, unaware of the workings of the fickle world of pop, it must have seemed that in Shakin' Stevens they were witnessing yet another story of overnight success.

Nothing, however, could have been further from reality. Although the 'overnight success' tag is a publicist's dream, Shakin' Stevens, like so many of his rock contemporaries had, as they say, paid his dues.

A lifetime of sheer hard work had been endured before he gained star status. After those days of rock in the playground, Shaky left school and worked the remorseless grind of the local club circuit in Wales. But in 1969 it must have appeared to the 18 year old singer that his luck had changed. That was when he was asked to be the support act to the Rolling Stones at the Saville Theatre.

It must have seemed to him that the elusive big time was within his eager grasp. Shaky was certainly confident that he was ready for success, because just a year later he plunged himself into a full-time professional singing career. And almost immediately he discovered just what an uphill struggle the rock business can be. It took years of bashing up and down the country's

motorways and performing all sorts of obscure venues before things began to click into place.

Ironically, when it all did start to happen, Shaky owed a great debt to the King of Rock 'n' Roll . . . Elvis Presley. For the turning point in his career came when the snake hipped Welshman was asked to play Elvis in an award winning West End musical which was simply titled 'Elvis'. It's an illustration of the genuine affection that he has for Elvis and his music that Shaky turned down this plum role when he was initially offered it.

"I look upon Elvis as a great entertainer and I respect him for what he did for music. That is why I turned the part down at first. It was only when convinced that the musical wasn't going to be a send-up but a tribute that I agreed to appear in it", explained Shaky. His performance as Elvis won great critical acclaim and also persuaded the legendary rock entrepreneur, Jack Good, to star Shaky on his revamped 'Oh Boy' television series.

And once Shakin' Stevens was on the rollercoaster of success there was no stopping him. Especially after December 1979, when he signed a management deal with Freya Miller. When Shaky and Freya formed their partnership it was like introducing the final and vital magic spark, the catalyst to bring out the best of his undoubted talent.

The combination started to work within only two months when Shakin' Stevens made his chart debut with a rocking little number called 'Hot Dog'. A few months later he followed that with another hit, 'Marie Marie' . . . which brings us straight back to 'Green Door', 'This Ole House' and 'You Drive Me Crazy'.

But all that is just the tip of his success story. While Shaky was enjoying this success in Britain he was also wooing record buyers all over Europe as his discs leapt into the continental lists of best sellers. His impact is also being felt by our Transatlantic cousins. In the States he has practically become a fixture on their TV screens by starring in 36 programmes of rock 'n' roll TV series called 'Let's Rock', a series that has been seen coast to coast in the USA.

Shaky has definite ideas about developing his career. One important direction, as far as he is concerned, is in writing more of his own material. Already he has shown that he has the ability to sculpt songs. On his album, 'This Ole House', a couple of songs, 'Baby If We Touch' and 'Make It Right Tonight' were composed by the man himself, and on his album 'Shaky' he has no fewer than five credits. "I'm writing more and more of my own songs," he admitted. "Like any other writer, I hope that one of my songs will live on after I'm gone."

Born on March 4, 1951, Shaky comes under the star sign of Pisces and an astrological reading for him says that in many ways he is fortune's favourite who will probably succeed in whatever he turns his hand to.

So it was all written in the stars after all . . .



S
H
A
A
K
W

How to make your own radio...

it's easy!



Have you seen the inside of your radio at home? It is crammed full of wires, transistors, resistors and many other complicated components. All of these are necessary to receive a high quality sound from your radio but, with a few cheap and simple components, you can make a radio which picks up your favourite local radio station.

All the components that you will need can be obtained easily, usually from your local radio or electrical dealer.

A crystal set is the basis on which most radios are made, but can operate entirely on its own. It is this that we will now make.

The first 'circuit' that we need to make is a TUNED CIRCUIT and the picture below shows it in its completed state.

The TUNING CAPACITOR can be bought from your radio dealer and you should ask for a $0.0005\mu\text{F}$ solid dielectric type. It is moving this capacitor that determines which radio station we will pick up.

The coil will have to be made and these are the materials you'll require: 36 swg (standard wire gauge) enamelled copper wire, sticky tape and a 3" piece of ferrite rod.



1 Wind the sticky tape in slightly overlapping parallel bands



2 Leaving about 3" of wire, secure one end of the wire with sticky tape



3 Wind 5 turns, side by side, onto the rod. Pull out a 3" loop and twist it until it's tight up to the rod



4 Wind another 45 turns and stick the end piece down

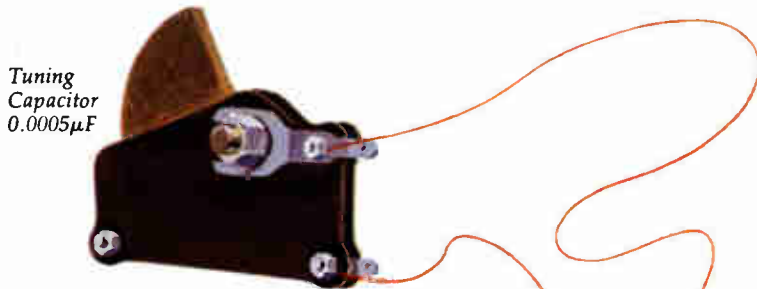

Tuning Capacitor
 $0.0005\mu\text{F}$

A TUNED CIRCUIT

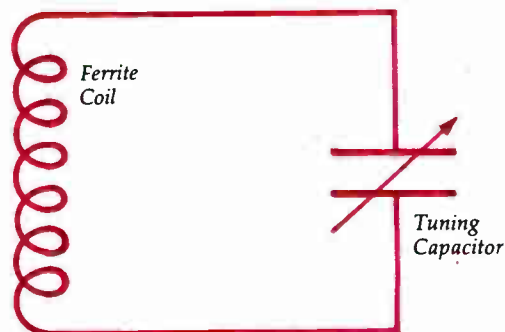

Coil

Tuning Capacitor

The final components that we will need are a crystal diode and a crystal earpiece, both of which should be asked for by name.

CRYSTAL SET CIRCUIT DIAGRAM

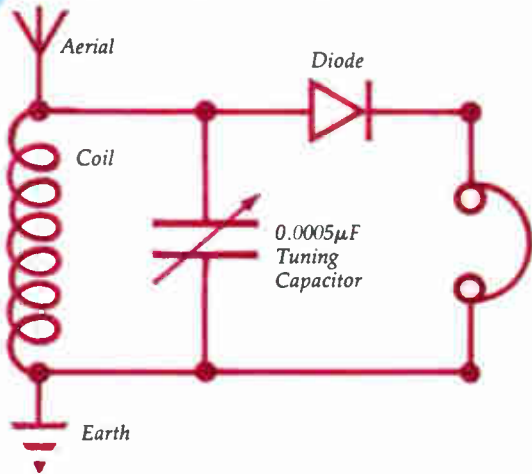

Along with some pieces of PVC covered copper wire for making our connections, we now have all the materials we need to build our radio! However, we need something on which to build our circuits and connect the wires. In electronics the pieces are usually connected with SOLDER but for beginners a simple method using wood screws and washers is advisable. The diagram below shows how this is done on our 1/2" piece of softwood that we are going to mount our radio on.

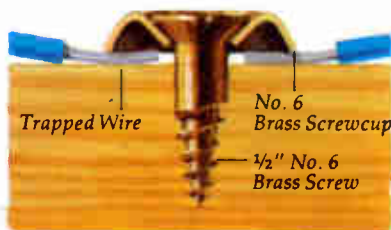

The picture right shows the complete crystal set. Notice that the tuning capacitor is upside down on the board. This is because the shaft needs to go through the wood in order for you to change radio stations. The picture shows how this is done. It is probably best to get an adult to help you with making the hole!

It is very important to remember to scrape the enamel from the points where the coil is connected to the tuning capacitor. It is also as well to scrape clean all the ends of the connection wires before screwing them down.

Now you've made your first radio set, all that remains is to consider the aerial and the earth.

The aerial needs to be as long as possible (inexpensive PVC covered copper wire is ideal) and as high as possible. Running the aerial wire from your bedroom to the top of a tree or a friendly neighbour's eaves is the best way but remember, this

MOUNTING THE CAPACITOR

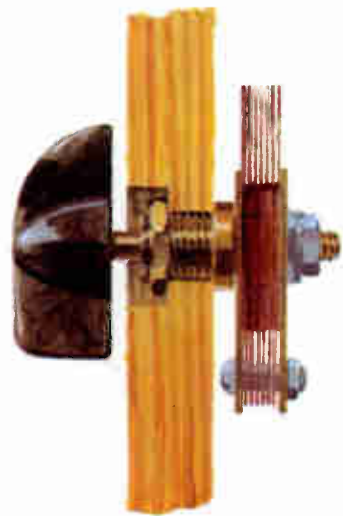

can be dangerous and should be done by an adult.

All of this clambering about, however, will have been wasted if the other end of the tuned circuit is not well earthed! This is easily achieved by connecting it to the nearest household water pipe. If there isn't one available, or they are made of plastic, you can make your own by driving about 1 metre of copper pipe into soft earth. You can then connect your earth wire to the top of it using a hose-clip, making sure that the point of contact is clean.

THE COMPLETED CRYSTAL SET

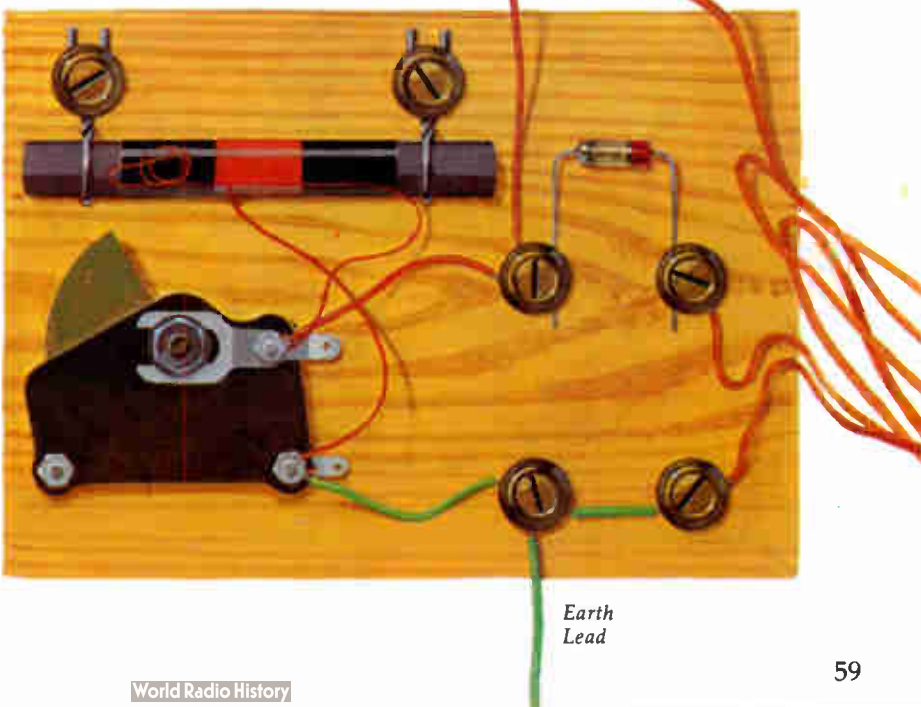



Photograph courtesy of RCA

Bucks Fizz

Cheryl, Jay, Bobby and Mike — as with all of the world's top groups the names are enough to identify them — are Bucks Fizz.

Since the Eurovision Song Contest which they won spectacularly with 'Making Your Mind Up' in 1981 the four members of Bucks Fizz have become the most successful group to have an association with the show since Abba.

World tours have accompanied their success on record with singles like 'Piece of the Action', 'One of Those Nights', 'Land of Make Believe' and 'My Camera Never Lies' hitting the charts in a dozen or more countries around the globe and their three albums have helped establish the group as one of Britain's leading attractions both at home and abroad.

America, Australia, the Phillipines, Europe and Japan are just some of the territories that have fallen under the charms of these talented four youngsters, and 1982 was topped for them when they were chosen to appear before Her Majesty Queen Elizabeth the Queen Mother in the Royal Variety Performance.

Bucks Fizz were originally the brainchild of Jill Shirley and Nichola Martin whose idea it was to put together a group for A Song For Europe 1981. They found four vocalists following a string of auditions and it is to their credit that these complementing personalities have formed one of the strongest visual and vocal units to hit the entertainment scene in more than a decade.

Individually:

JAY ASTON

Born on May 4 1961, Jay started her career as a photographic model at the age of three. While at school she studied acting and dancing and eventually went to a stage school. At 16 she already had two years professional dancing experience working around London in floor shows and cabarets. Jay's whole family is theatrical. Her father is a comedian and her mother, an ex-dancer, works with him as 'straight man'. Her brother Lance is a singer, actor, dancer and fashion designer. Jay is often responsible for the Bucks Fizz look, designing and advising on the clothes for the group's stage and television appearances.

She is in the process of furnishing and decorating her recently-purchased house. Jay is animal mad, particularly over dogs, horses and rabbits and is also an avid keep-fit fanatic. It is a rare day when she is not up at 6.30 a.m. to jog, exercise or swim.

CHERYL BAKER

Born on March 8 1955, Cheryl started singing professionally eight years ago. Since then she has been heavily involved in the Song For Europe contest, culminating with her association with Bucks Fizz. In between competitions she was involved in lots of cabaret and backing sessions for radio, TV and recording. Her reputation as an excellent session singer won her a place in Bucks Fizz.

Cheryl is the scatterbrain of the group. If she turns up on time, it's usually in the wrong place on the wrong day. She says: "I enjoy meeting people and seeing new countries, but as I don't like travelling I would prefer everyone and everything to come to my front door!"

BOBBY GEE

Born on August 23 1954, Bobby was a self-employed builder until four years ago when he decided to give show business one more try. He had had a youthful fling with the industry and started his own building company when he was 18.

He started playing guitar in clubs and progressed to cabaret. He joined the stage version of "Jesus Christ Superstar" to understudy Pilate during the show's last six months in London, and went back into cabaret when the show closed in August 1980. All set to join the touring company, he answered an ad in The Stage which led him to successfully audition for Bucks Fizz.

Bobby lives in Surrey with his wife Jackie and sons James and Matthew, who were born in January 1982. In his rare moments of spare time he likes to play golf and goes scuba diving.

MIKE NOLAN

Born on December 7 1954, Mike came to England from Dublin with his parents as a small child. He always wanted to be a singer and with schooldays over he started gigging in London pubs with his guitar. He joined various vocal groups and had eight unsuccessful singles released.

Mike has appeared on many TV shows and at the London Palladium where, in 1974, he thought he would get his 'big break', but nothing came of it.

Five years ago he auditioned for a vocal group, one of the members of which was Nichola Martin who turned him down because she felt his voice was unsuitable, but she remembered his good looks and distinctive voice when searching for someone to record "Making Your Mind Up", which she and Andy Hill entered for the 1981 Song for Europe.

Mike has a white Persian cat called Beethoven, runs up large telephone bills and collects plants.



Photograph courtesy of RCA

Kenny Dalglish

Profile of a superstar

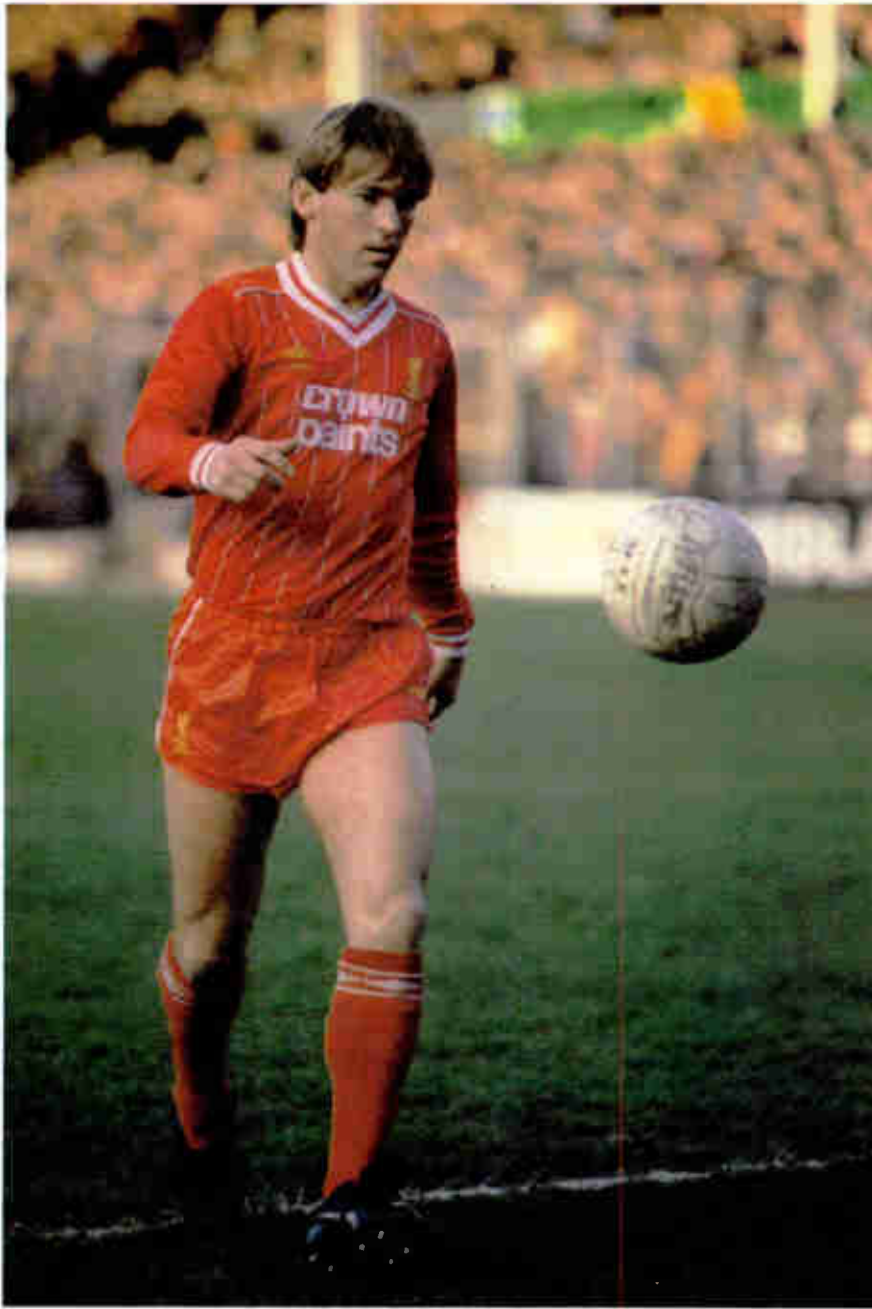

The fans of Liverpool Football Club are not easily impressed; they have come to expect nothing less than excellence. When their idol, Kevin Keegan, left for Hamburg in 1977, they thought he was going to be a very hard act to follow.

The player signed to replace him (from Celtic for a fee of £400,000) was Scottish international Kenny Dalglish, and such was his impact that Keegan was forgotten, and the Kop had a new idol. He topped the scoring tables in his first two seasons at the club, and it was his superb goal that took the European Cup to Anfield in 1978.

He is the ideal professional: dedicated, hard-working, enthusiastic and always super-fit. He relishes his striking role, and loves being in the thick of the action in front of goal. He is quick, nimble, skilful, and always alert, even for the half chance. He's brave, never afraid to go in when the boots are flying, shrugging off the heavy challenges that inevitably come his way.

Kenny hasn't reproduced his club form at international level, and after his poor performance in the 1982 World Cup finals, many people were ready to write him off. But he bounced back again in season 1982-83, and was among the League's top scorers alongside his team mate Ian Rush.

So don't write off Kenny Dalglish — he's still a world class striker who scores world class goals, and he intends to keep it that way.

PICTURE : MATCH WEEKLY

NAME THE RADIO STATIONS

On this page, all you have to do is match the independent radio station with its location. The first letters of each station name are given to you and the number shows the location on the map. Have fun!

Station names

Hereward Radio
 Cardiff Broadcasting Company
 Radio Forth
 Red Rose Radio
 Plymouth Sound
 Radio City
 Moray Firth Radio
 Centre Radio
 Radio West
 Radio Orwell
 Marcher Sound
 Radio Trent
 West Sound
 Radio Tees
 Essex Radio
 Radio 210 Thames Valley
 Radio Victory
 BRMB Radio
 Pennine Radio
 North Sound
 Metro Radio
 Two Counties Radio
 Saxon Radio
 Mercia Sound
 Devon Air Radio
 Northside Sound
 Radio Clyde
 Capital Radio
 Wiltshire Radio
 Radio Wyvern
 Piccadilly Radio
 Radio Tay
 Radio Aire
 Downtown Radio
 Severn Radio
 Chiltern Radio
 Beacon Radio
 Radio Hallam
 Swansea Sound

- 1 M..... F..... R..... (5,5,5)
- 2 N..... S..... (5,5)
- 3 R..... T..... (5,3)
- 4 R..... C..... (5,5)
- 5 R..... F..... (5,5)
- 6 W..... S..... (4,5)
- 7 N..... S..... (9,5)
- 8 D..... R..... (8,5)
- 9 M..... R..... (5,5)
- 10 R..... T..... (5,4)
- 11 R..... R..... R..... (3,4,5)
- 12 P..... R..... (7,5)
- 13 R..... A..... (5,4)
- 14 P..... R..... (10,5)
- 15 R..... C..... (5,4)
- 16 R..... H..... (5,6)
- 17 M..... S..... (7,5)
- 18 R..... T..... (5,5)
- 19 B..... R..... (6,5)
- 20 C..... R..... (6,5)
- 21 H..... R..... (8,5)
- 22 B..... R..... (4,5)
- 23 M..... S..... (6,5)
- 24 R..... W..... (5,6)
- 25 C..... R..... (8,5)
- 26 S..... R..... (5,5)
- 27 S..... S..... (7,5)
- 28 R..... O..... (5,6)
- 29 S..... S..... (7,5)
- 30 C..... B..... C..... (7,12,7)
- 31 E..... R..... (5,5)
- 32 R..... W..... (5,4)
- 33 W..... R..... (9,5)
- 34 R..... 2..... T..... V..... (5,3,6,6)
- 35 C..... R..... (7,5)
- 36 P..... S..... (8,5)
- 37 D..... A..... R..... (5,3,5)
- 38 T..... C..... R..... (3,8,5)
- 39 R..... V..... (5,7)



Answers on pages 72/73

U I L T R

They didn't start using synthesisers until they got their first recording contract "but once we started using them we went past the classic rock song format and began scratching the surface of what we are now".

The band's first album appeared in '76, at the start of the punk era — a musical revolution that Ultravox welcomed, at least for a while. "There had been elements of that in our music and we pre-dated it. We had a few familiar ideals shared in common with the punks, but they became too regimented, both in their clothes and music".

"We were young men but didn't want to play at 100 mph all night. We wanted to be thought-provoking, or have the ability to make you melancholy, as well".

1982 was a busy year for Ultravox. They may not have been very visible to their audience back home, especially after the massive success of 'Vienna' and 'Rage in Eden' in 1981, culminating in 'Vienna' winning Britain's Rock & Pop Awards as Best Selling Single Of The Year.

The band were working pretty hard however, they spent half the year travelling round the world, and the rest of the time preparing for a new album, and you're just about to see and hear the fruits of their labour.

THE TRAVELS

"We took our 'Rage in Eden' tour round the other side of the world to see if anyone liked it. They did, everywhere we went".

"New Zealand — We played the Sweetwater Festival, the biggest annual event in the New Zealand rock calendar, which was crammed full of people. The rest of the country was crammed full of sheep".

"Australia — Wonderful. Just like America without the Americans! It was the tail end of their summer so we managed to get ourselves a sun tan in February (which can't be bad) and came away with armfuls of gold and silver records".

"Japan — A different barrel of sake altogether. The audiences and everyone we met were incredibly polite, but it was great fun listening to them arguing among themselves. We had broken through Japan by accident! We had never gone to woo them, then a whisky company used 'New Europeans' in a TV commercial. After three concerts in Tokyo, we travelled to Kyoto, to shake off the travellers' dust at a traditional Japanese inn for a few days, and to absorb the Japanese culture at Japanese speed. They would keep trying to make us have mud baths though".

"After that brief respite it was back to Britain

for . . . THE REALLY BORING BIT".

"Otherwise known as preparing for a new album. We'd already decided that we didn't want to write the songs in the studio like we did with 'Rage in Eden', so we developed a pattern whereby we'd go into a rehearsal studio for three weeks and put down ideas. Then we'd take a week off and listen to the cassettes and pull out the best bits and think about lyrics".

"We did that for three months and found that we had no shortage of ideas, although fitting them together was a problem sometimes, as we kept having to chop out bits we liked".

"But at the end of that time there were eight complete songs so there was no excuse for not recording . . . THE ALBUM".

"While we were rehearsing we'd already decided we didn't want to go back to Connie Plank's studio in Germany where we had recorded our last albums — one of the basic philosophies of the band has been that constant change and development is important to our music. So we started thinking about a new producer. When George Martin's name came up it sounded a more strange and bizarre combination than the big names who'd been suggested to us, and, as we'd been looking for something more off-the-wall for this album, we all agreed that he was the man for the job".

"He turned out to be a cross between a father and a school-teacher to us. He'd let us get on with it, but he'd come down and work on harmonies and arrangements with us if we were having trouble. The only thing we'd agreed was that we wanted it to sound harder than the previous albums and that's what George helped us achieve".

"The only song that came together in the studio was 'The Song (We Go)' which arose out of a drum rhythm 'jam' we used to do at the end of our set during our last tour. Most of the songs we write in the studio tend to be slow, but this one was fast which was something different for us".

"So now we've finished the album it's time for . . . THE TOUR".

"Peter Saville, who designed the sleeve for 'Quartet', has been working on the stage set for the tour which will be an extension of the theme he's used on the album. We want a continuity from the release of the first single to the last gig of the tour, and we make a point of being involved down to the tour poster."

The Ultravox quartet are: Warren Cann (drums, electronic percussion and backing vocals), Chris Cross (bass guitar, synthesisers and backing vocals), Billy Currie (keyboards and violin) and Midge Ure (guitar, keyboards and vocals).

AVOX



JOKES

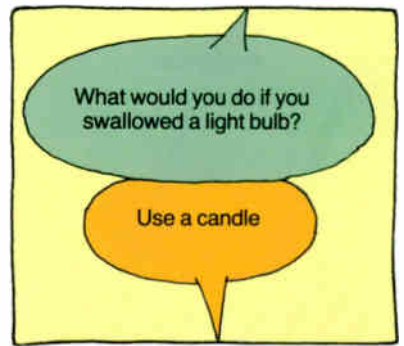

Hickory Dickory dock
Three mice ran up the clock
The clock struck one . . .
and the other two got away with
minor injuries!

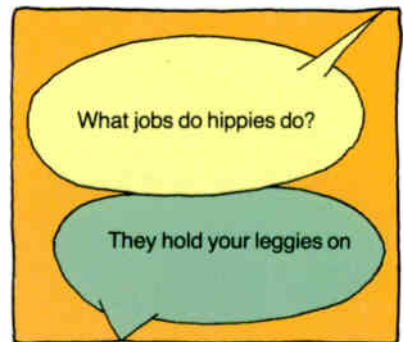
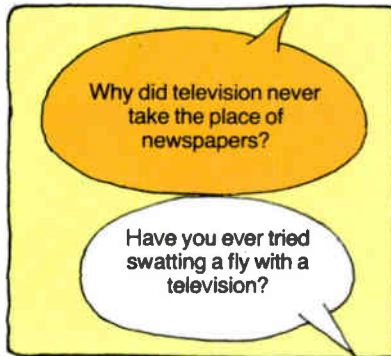

Teacher: 'If I had forty apples in one hand and fifty in the other, what would I have?'

Tommy: 'Big hands.'

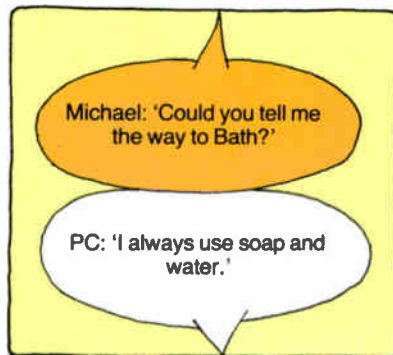

Man: 'I say, What's that bad cut doing on your forehead?'

Nut: 'I bit myself.'

Man: 'But how did you get up there?'

Nut: 'I stood on a chair.'

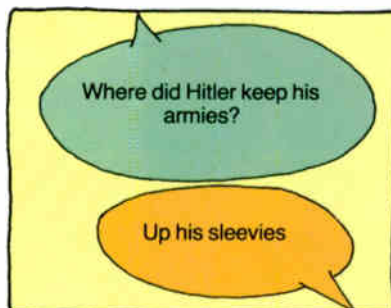
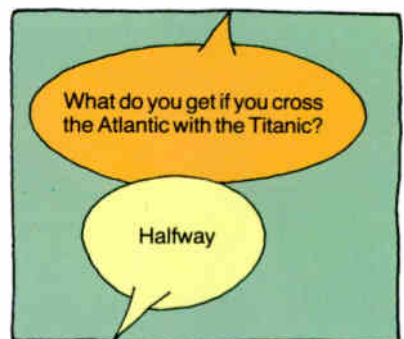
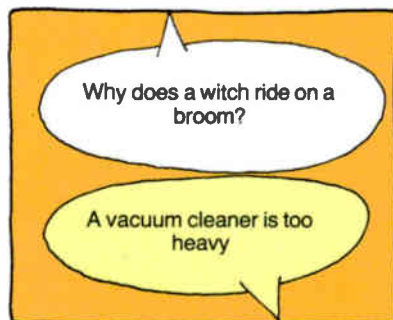
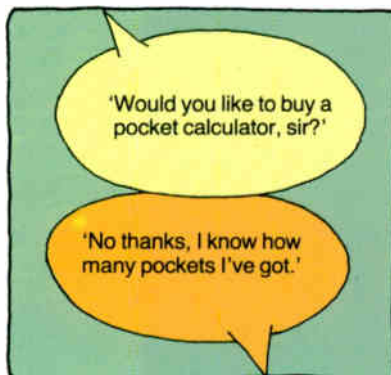

Customer: 'I'd like to try on that suit in the window, please.'

Assistant: 'I'm sorry, sir, you'll have to try it on in the changing rooms like everyone else.'

There was a young bard from Japan
Whose limericks never would scan

When they said it was so

He replied, 'Yes, I know,

But I make a rule of always trying to

A woman was driving down a one-way street the wrong way and was stopped by a policeman.
 'Didn't you see the arrows?' asked the policeman.
 'Arrows?' replied the woman, 'I didn't even see the Indians.'

get just as many words into the last line as I possibly can.'

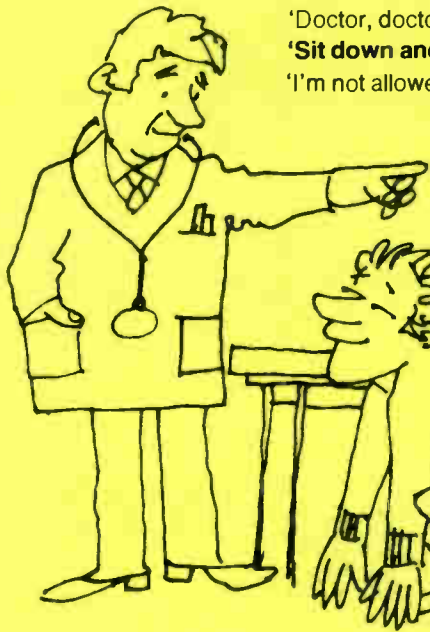

'Doctor, doctor, I feel like a dog.'
'Sit down and tell me about it.'
 'I'm not allowed on the furniture.'

'Doctor, doctor, I feel like a cricket ball.'
'How's that?'
 'Don't you start.'

Man: 'Ouch! A crab just bit my toe.'
Doc: 'Which one?'
 Man: 'I don't know, all crabs look alike to me.'

'Doctor, doctor, I keep seeing striped camels.'
'Have you ever seen a psychiatrist?'
 'No, only striped camels.'

What do you call a Scottish cloakroom attendant?
 Angus McCoatup



Sam: 'One of my ancestors died at Waterloo.'
 Philip: 'Really? Which platform?'

Two ears of corn ran up a hill. What were they when they got to the top?
 Puffed wheat.

Should you stir your tea with your left hand or right?
 Neither. You should stir it with a spoon.

What happened to the man who couldn't tell putty from porridge?
 His windows fell out.

Diner: 'What's wrong with these eggs?'
 Waiter: 'Don't ask me, sir, I only laid the table.'

Why did the cookie cry?
 Because its mother has been a wafer so long.

Salesman: 'Would you like to try our new oatmeal soap?'
 Man: 'No thanks, I never wash my oatmeal.'

What's red, runs on wheels, and eats grass?
 A bus.
 PS I lied about the grass.

'Waiter, what soup is this?'
'It's bean soup, sir.'
 'I don't care what it was, I want to know what it is now.'

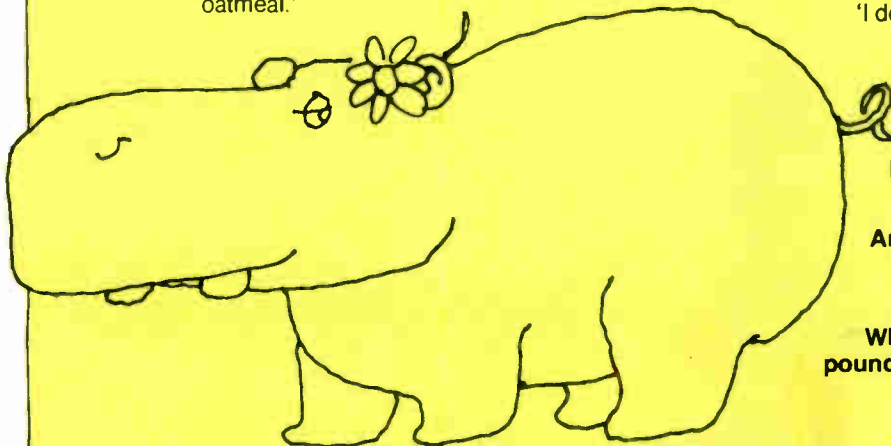

Man: 'A return ticket, please.'
Railway clerk: 'Where to?'
 Man: 'Why, back here of course.'

Are my car indicators working?
 Yes, no, yes, no, yes . . .

What weighs two thousand pounds and wears a flower behind its ear?
 A hippy potomus

QUIZ QUIZ

Photo: Match Weekly

Sport

- a) Who is the only person to score a hat trick in a World Cup final?
- b) Which famous English Test cricketer is nicknamed Guy the Gorilla?
- c) Which British athlete has won European, Olympic and Commonwealth gold medals for the Decathlon?



- d) In which sport are the Ryder Cup and the Walker Cup contested?
- e) Which is the only horse to have won the Grand National three times?

music

- a) What was Abba's first U.K. chart success?
- b) With which band did Gary Newman first achieve chart success?
- c) What was the No. 1 single, in 1982, which featured Paul McCartney and Stevie Wonder?
- d) Which band achieved No. 1 chart hits with 'Gino' and 'Come on Eileen'?
- e) 'House of Fun' was a No. 1 hit for which famous band?



space

- a) When was the Columbia space shuttle launched and why is the craft unique?



- b) Who was the first man to set foot on the moon and what was the date?
- c) Which country put the first man into space and what was his name?
- d) Which planet is commonly known as the Red Planet?
- e) Which planet takes the longest time to complete an orbit of the sun?

locations

Photo: Guildhall Library, City of London



- a) Which bridge is this and where does it stand?
- b) Which city is famous for its gondolas?
- c) Where is Cleopatra's Needle?
 - i) Paris
 - ii) Cairo
 - iii) London

Photo: Anthony Finch



- d) In which country would you find this famous land mark?
- e) In which city would you expect to find the "Dreaming Spires"?

capital cities



A British Airways Photograph



- a) What is the capital city of:
 i) The United States of America?
 ii) Australia
 iii) Venezuela
- b) In which capital cities would you find the following:
 i) Eiffel Tower
 ii) Parthenon
 iii) Colosseum

science

Match the names with the discoveries.



- | | |
|--------------------------|---------------|
| a) Pasteur | Television |
| b) Curie | Gramophone |
| c) Newton | Telephone |
| d) Edison | Gravity |
| e) Marconi | Radioactivity |
| f) Logi Baird | Penicillin |
| g) Alexander Graham Bell | Radio |

authors

Who wrote:

- | | |
|---|---------------------------------|
| a) Alice in Wonderland | e) The Day of the Triffids |
| b) David Copperfield | f) Jungle Book |
| c) The Lion, the Witch and the Wardrobe | g) Murder on the Orient Express |
| d) Wuthering Heights | |

exploration

- a) Who was the first person to reach the South Pole?
 b) Who was the first man to sail around the world single handed?
 c) Who discovered the source of the river Nile?
 d) Who discovered Australia?
 e) Where was Christopher Columbus born?



biggest, smallest

- a) What is the largest living mammal?
 b) What is the largest living bird?
 c) What is the largest animal that has ever lived?
 d) What is the smallest living bird?
 e) What is the tallest species of tree in the world?



aviation

- a) Who made the first cross channel flight?
 b) Who made the first non-stop transatlantic flight?
 c) What do the letters VSTOL stand for?
 d) Which well known commercial aircraft can travel at twice the speed of sound?
 e) What was the largest rigid airship ever built?



Answers on pages 72/73



PHOTOGRAPHY COURTESY: CBS RECORDS

altered images

altered images

show a refreshing lack of respect for the music business.

altered images

are Clare on vocals, Johnny and Steven on guitars, Tony on bass and a mystery drummer (as yet unnamed) who will play with the band on a semi-permanent basis.

altered images

were helped along the path from obscurity to pop fame by DJ John Peel. He became a devotee of their music early on, and played regular sessions recorded by the band on his radio show.

altered images

are individuals with a very individual sound. Catch it!

altered images

came to the notice of the public and the record companies thanks to very successful club tours, and soon became a headline band instead of a minority-interest one.

altered images

were formed in their native Glasgow in March 1979 and played their first live gig in August that year in a local pub called The Countdown.

altered images

music can best be described as happy, vibrant, playful almost, the sometimes strange backup fronted by Clare's pretty, pitter-patter, little-girl voice.

altered images

write all their own songs, and won't rely on flash clothes and outlandish appearance as an excuse for lack of creativity.

altered images

were signed by CBS Records, and released their first album, *Happy Birthday*, in September 1981.

altered images

had their first hit single soon after, when the title track from the album bounded up the charts, peaking at number 2.

altered images

are fronted by tiny, young Clare, who performs with a confidence, composure and personality that bely her age.

altered images

released their second album, *Pinky Blue*, in May 1982. It was produced by Martin Rushent, and recorded at his Genetic Studios in Berkshire. Rushent is a much-respected producer, and the band give a lot of credit for their success to him.

Name the stations

- 1 Moray Firth Radio
- 2 North Sound
- 3 Radio Tay
- 4 Radio Clyde
- 5 Radio Forth
- 6 West Sound
- 7 Northside Sound
- 8 Downtown Radio
- 9 Metro Radio
- 10 Radio Tees
- 11 Red Rose Radio
- 12 Pennine Radio
- 13 Radio Aire
- 14 Piccadilly Radio
- 15 Radio City
- 16 Radio Hallam
- 17 Marcher Sound
- 18 Radio Trent
- 19 Beacon Radio
- 20 Centre Radio
- 21 Hereward Radio
- 22 BRMB Radio
- 23 Mercia Sound
- 24 Radio Wyvern
- 25 Chiltern Radio
- 26 Saxon Radio
- 27 Severn Sound
- 28 Radio Orwell
- 29 Swansea Sound
- 30 Cardiff Broadcasting Co.
- 31 Essex Radio
- 32 Radio West
- 33 Wiltshire Radio
- 34 Radio 210 Thames Valley
- 35 Capital Radio
- 36 Plymouth Sound
- 37 Devon Air Radio
- 38 Two Counties Radio
- 39 Radio Victory

Colour match

In each row or column, each colour appears once in each position in the square.

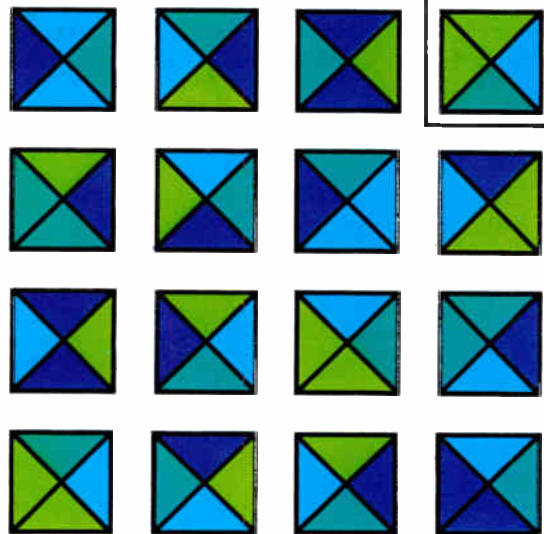

A-maze-ing



Quiz pages 68 and 69

Sport

- a Geoff Hurst for England against West Germany in 1966
- b Ian Botham of Somerset
- c Daley Thompson
- d Golf
- e Red Rum who won in 1973, 1974 and 1977

Music

- a Waterloo
- b Tubeway Army
- c Ebony and Ivory
- d Dexy's Midnight Runners
- e Madness

Space

- a It is the first re-usable space craft and was first launched on 12 April 1981
- b Neil Alden Armstrong on 21 July 1969

- c Cosmonaut Flight Major Yuriy Gagarin for the USSR on 12 April 1961
- d Mars
- e Pluto

Locations

- a It is London Bridge which was dismantled and shipped to America in the 1960s and now stands at Lake Havasu City, Arizona
- b Venice
- c London
- d Italy
- e Oxford

Capital cities

- a (i) Washington DC
(ii) Canberra
(iii) Caracas
- b (i) Eiffel Tower in Paris
(ii) Parthenon in Athens
(iii) Colosseum in Rome

Science

- a Penicillin
- b Radioactivity
- c Gravity
- d Gramophone
- e Radio
- f Television
- g Telephone

Authors

- a Lewis Carroll
- b Charles Dickens
- c C S Lewis
- d Emily Brontë
- e John Wyndham
- f Rudyard Kipling
- g Agatha Christie

Exploration

- a Raold Amundsen on 14th December 1911
- b Sir Francis Chichester in Gipsy Moth IV

- c David Livingstone
- d Captain James Cook, who landed on Possession Island on 23 August 1770
- e Genoa, Italy

Biggest, smallest

- a The Blue Whale
- b Ostrich
- c Brontosaurus
- d Hummingbird
- e Redwood

Aviation

- a Louis Blériot, 25 July 1909
- b Captain John Alcock and Lieutenant Arthur Brown on 14 June 1918
- c Vertical Short Take Off and Landing
- d Concorde
- e Graf Zeppelin II

Tim Rice's 100 All-time Greats



When I was asked to compile a list of my 100 All-Time greats, I was stumped. There have been literally hundreds and thousands of great records since Edison invented the phonogram. So to make things a bit easier for myself, I decided to choose my favourite 100 number ones out of the 500+ that have made it to the top of the chart since it began in those far off days of 1952 . . .

Al Martino – Here In My Heart
As a pop historian I'm probably biased but this was the first number one and so deserves a place in my list.

Lita Roza – (How Much Is) That Doggie in The Window?
One of twenty questions asked by number one records. Possibly the most ridiculous but a timeless novelty record nevertheless.

Johnnie Ray – Such a Night
The Prince of Wails with a song that even Elvis couldn't add much to when he recorded it ten years later.

Rosemary Clooney – This Ole House
Shaky took it to the top again almost twenty years later but I haven't forgotten this version.

Perez Prado – Cherry Pink and Apple Blossom White
'Cerisier Rouge et Pommier Blanc' was its original French title. Not surprisingly, as an instrumental, it lost absolutely nothing in translation.

Jimmy Young – Unchained Melody
This has hit the charts with versions by six different people. Only the radio DJ could make the top with it.

Bill Haley and his Comets – Rock Around the Clock
The song that shook the world. Rock 'n' Roll had arrived.

Tennessee Ernie Ford – Sixteen Tons
Marle Travis' father had a saying, "Another day older and deeper in debt". Travis wrote a song around this and Mr Ford had his biggest hit with it.

Kay Starr – Rock and Roll Waltz
Miss Starr (real name Starks) ended her British chart career on a high note. This was it.

Frankie Lymon and the Teenagers – Why Do Fools Fall In Love?
Musical Youth don't seem quite as young when compared to Frankie who was just thirteen when he recorded this.

Tommy Steele – Singing The Blues
A rare example of the British cover version being better than the original American recording (by Guy Mitchell). This was the first record I ever purchased.



Elvis Presley

Elvis Presley – All Shook Up
Out of Elvis' seventeen chart-toppers I had to choose one.

Paul Anka – Diana

The only one for the youngster who put the English lyrics to My Way. It was widely expected to be number one again at the Royal Wedding two years ago, but after re-release, wasn't.

Crickets – That'll Be The Day

John Wayne, (the big leggy one), said "That'll be the day" in the film The Searchers. Buddy Holly and the Crickets wrote a song around the phrase. This was the result.

Jerry Lee Lewis – Great Balls of Fire

The piano pumping rocker at his best.

Marvin Rainwater – Whole Lotta Woman

Mr Rainwater is a full-blooded Cherokee indian. However, this was not a rain dance but a full-blooded Rock 'n' Roll song.

Connie Francis – Who's Sorry Now

A ballad that is still frequently played at older people's parties. It probably still will be when I attend such parties.

Everly Brothers –

All I Have To Do Is Dream

The Everlys were a major influence for Simon and Garfunkel. The song became a standard for many a duet.

Lord Rockingham's XI – Hoots Mon

As part of the 'Benny Green Trio' I potted up the River Thames last year. As part of Lord Rockingham's XI Benny Green potted to the top of the charts.

Conway Twitty –

It's Only Make Believe

The sort of stuff Rock 'n' Roll ballads were made of.

Bobby Darin – Dream Lover

One of two number ones for the singer plagued with heart disease.

Jerry Keller – Here Comes Summer

This song was a hit in the month of October. There's something wrong there but that doesn't stop it being a great record.

Adam Faith – What Do You Want?

Just to prove you really can sing through your nose and still produce a classic.

Johnny Preston – Running Bear

I predicted this man would have three number ones; I was only two out!

Eddie Cochran –

Three Steps to Heaven

Another tragic loss for Rock 'n' Roll on April 17th 1960. This hit the top shortly after his death. Never to be forgotten.

Cliff Richard and the Shadows –

Please Don't Tease

This was produced by my one-time boss, Norrie Paramor, who produced more number ones than anybody else.

Johnny Kidd and the Pirates –

Shakin' All Over

Probably the most exciting British Rock 'n' Roll record. Kidd's first hit single, Please Don't Touch, was recorded by heavy metal merchants Motorhead and Girlschool fifteen years after his death.

Roy Orbison – Only The Lonely

It was often mistakenly thought that Orbison was blind because he always wore dark glasses. In fact, it was just an image for the great balladeer.

Marcel's – Blue Moon

A Rodgers and Hart song given the full Doo-Wap treatment. Probably the best remembered version of this widely covered song.

Del Shannon – Runaway

Without a shadow of doubt this is my all-time favourite. His trousers must have been two sizes too small.

Johnny Leyton –

Johnny Remember Me

Johnny may have remembered him but the public didn't. A few hits later he stopped singing and started acting.



The Shadows

Shadows – Wonderful Land

Written by Jerry Lordan, the most successful instrumental writer in the British Charts. Apart from Apache this is the most instantly recognisable Shadows track.

Ray Charles –

I Can't Stop Loving You

The blind pianist, who was an inspiration to Stevie Wonder, with a Don Gibson ballad; an inspired combination.

Tornados – Telstar

Billy Fury's backing band were taken by writer/producer Joe Meek and recorded this wonderful instrumental named after an American satellite.

Searchers – Sweets For My Sweet

The Searchers are still recording thus proving the staying power of this "other" Mersey group. The song is not so well remembered but it's great all the same.

Gerry and the Pacemakers –

You'll Never Walk Alone

When Sunderland get to Wembley both me and the other Sunderland supporter will be singing this one.

Dave Clark Five – Glad All Over

Along with the Spurs FA Cup squads of 1981 & 1982, DC5 were the 'Tottenham Sound'. Spurs didn't make number one but then Dave Clark's lads didn't win the FA Cup two years running.

Cilla Black –

Anyone Who Had A Heart

The chirpy Liverpool lass with the big voice presents "Another George Martin Production".



Cilla Black

Peter and Gordon –

A World Without Love

A Lennon-McCartney composition that they gave to Paul's girlfriend's brother, Peter Asher, and his mate Gordon Waller.

Tim Rice

In his career Tim Rice has written his name into musical history with those memorable lyrics for the world famous musical shows, "Joseph and the Amazing Technicolour Dreamcoat", "Jesus Christ Superstar" and "Evita". Andrew Lloyd Webber created the always to be remembered melodies for these blockbusting shows. Perhaps the most famous of all the lyrics and melodies which Tim and Andrew put together is "Don't Cry For Me Argentina".

He is co-author of the Guinness Book titles covering "British Hit Singles", "Hits of the Seventies", "500 Number One Hits" and "British Hit Albums".

Now he is quietly beavering away on ideas for yet another musical stage spectacular.

Animals –

House Of The Rising Sun

A song they heard a version of on a Dylan album. Their version swept to number one and producer Mickie Most was on his way to fame and New Faces.

Rolling Stones – It's All Over Now

This must be the most incorrect 'prophecy' ever. It had only just begun for 'Mother's Little Helpers'.

Manfred Man – Doo Wah Diddy

The multi-talented Paul Jones on maracas and doo wah diddies, South African Manfred Man on keyboards. Their first number one.

Sandie Shaw – (There's) Always Something There To Remind Me

Future Eurovision winner Sandra Goodrich with a Bacharach & David song.

Tim Rice's 100 All-time Greats

Georgie Fame – *Yeh Yeh*

Famous for his duetting with ex-Animal Alan Price, this was the first of a dozen solo hits.

Righteous Brothers – *You've Lost That Loving Feeling*

Like the Walkers, the Righteous Bros weren't brothers and nor were they Righteous, but it didn't stop Bobby Hatfield and Bill Medley hitting the top.



The Beatles

Beatles – *Ticket To Ride*

It's difficult to choose a favourite Beatle's number one; My pin chose this one from the film 'Help'.

Hollies – *I'm Alive*

The Hollies only managed one chart-topper but they had plenty of other hits.

Byrds – *Mr Tambourine Man*

A Bob Dylan song, a jangly twelve-string guitar, a great song and a big hit.

Sonny and Cher – *I Got You Babe*

Once you'd sorted out just who was Sonny and who was Cher you could sit back and enjoy this hippy anthem.

Seekers – *The Carnival Is Over*

An adapted Russian folk song was the second number one for vocal group, the Seekers.

Walker Brothers – *The Sun Ain't Gonna Shine Anymore*

Teardrop Explodes mainman, Julian Cope, is a great Scott Walker fan. Scott was 33.3% of the Walker Brothers.

Dusty Springfield – *You Don't Have To Say You Love Me*

The middle hit of Dusty's chart career was her best, and her only number one.

Frank Sinatra – *Strangers In The Night*

A career spanning some forty years but only two number ones – so far. The other was 'Three Coins In A Fountain'.

Troggs – *With A Girl Like You*

Their 'Wild Thing' was adopted as a stage anthem for Jimi Hendrix and also saw the charts through the Goodies. This was the one that reached the top though.

Small Faces – *All Or Nothing*

Midge Ure's favourite single also deserves a place in my top 100.

Jim Reeves – *Distant Drums*

This was number one two years after his death in a plane crash and sold on the strength of the song not on sympathy sales.



The Beachboys

Beachboys – *Good Vibrations*

When the Oxfordshire skies above my home are grey, this record conjures up sun, sand and sea.

Monkees – *I'm A Believer*

Nick 'Haircut 100' Heyward's idols are frequently being re-run on TV fifteen years after their number one.

Procol Harum – *Whiter Shade Of Pale*

The summer of '67. Peace, love and flower power and a tune nicked from Bach was number one for six weeks.

Scott McKenzie – *San Francisco (Be Sure To Wear Some Flowers In Your Hair)*

This record has more letters in its title than any other number one. Fascinating, eh!!

Long John Baldry – *Let The Heartaches Begin*

Chris Farlowe recognised the value of this song when he recorded it last year.

Dave Dee, Dozy, Beaky, Mick and Tich – *Legend of Xanadu*

Only two hit songs have had Xanadu in the title; they both made the top spot. The other was by ELO and Olivia Newton-John.

Union Gap featuring Gary Puckett – *Young Girl*

Just the right sort of song for the spring of 1968.

Equals – *Baby Come Back*

Lead singer Eddy Grant came back to the top spot in 1982 with 'I Don't Wanna Dance'. The second time around his hair wasn't dyed blond.

Joe Cocker – *With A Little Help From My Friends*

Originally sung by Ringo Starr on Sergeant Pepper, Joe Cocker grated his rough vocals around the song and came up with a classic.

Hugo Montenegro – *The Good, The Bad & The Ugly*

Possibly the most 'whistleable' song of all times. Enough said?

Scaffold – *Lily The Pink*

I sang back up vocals on this novelty song when I worked for the late great Norrie Paramor.

Fleetwood Mac – *Albatross*

A favourite instrumental number one of Peter Green's group. Very atmospheric.

Amen Corner – *(If Paradise Is) Half As Nice*

If Paradise is half as nice as this record I wouldn't mind a day trip there.

Peter Sarstedt – *Where Do You Go To My Lovely?*

His brother, Richard, had a number one in 1961 under the pseudonym of Eden Kane. This was the better of the two.

Marvin Gaye – *I Heard It Through The Grapevine*

Geoff Hurst, Everett Moreton of the Beat and Dick Taylor of the Pretty Things, all rate this their all-time favourite record. I understand why.

Desmond Dekker and the Aces – *The Israelites*

The first, and as yet the best, reggae chart-topper.

Zager and Evans – *In The Year 2525 (Exordium And Terminus)*

One thing is certain; they'll still be playing this unusual song in 542 years' time.

**Creedence Clearwater Revival –
Bad Moon Rising**

Their early albums featured old blues standards but the singles were more obviously 'pop' as this song proves.

**Simon and Garfunkel –
Bridge Over Troubled Water**

From the best selling album of the same name, this was their only number one hit single and what a classic.

Christie – Yellow River

This song could have been the Tremeloes second number one but they turned it down: Jeff Christie must have been laughing all the way to the top.

**Smokey Robinson and the Miracles –
Tears Of A Clown**

"If there's a smile on my face," it's only there because I'm listening to this Motown record.

Diana Ross – I'm Still Waiting

Ex-Supreme Ross was determined to keep on having hits after the demise of the group. With a song like this she couldn't miss.

Rod Stewart – Maggie May

After a long track record with various blues groups, Rod Stewart embarked on a solo career that is still going strong today.

Nilsson – Without You

Still one of the most played slow records at teenage parties (so I'm told)!

Don McLean – Vincent

Van Gogh and Lowry have two things in common. They were both artists and they both had number one hit songs written about them. This was about the former and should really have been recorded in mono, bearing in mind Van Gogh had only one ear.

**Lieutenant Pigeon –
Mouldy Old Dough**

The penultimate instrumental in the first five hundred number ones. Eye Level by Simon Park Orchestra is the last.

Slade –

Merry Christmas Everybody
Almost certainly the ultimate in Christmas records.



David Essex

**David Essex –
Gonna Make You A Star**

He was obviously singing this to himself on this occasion. The pinnacle of his career came a few years later when he starred in Evita.

**Steve Harley and Cockney Rebel –
Make Smile (Come Up And See Me)**

The smooth voice of Steve Harley. Who remembers that Frank Sinatra hat he wore on Top Of The Pops?

10cc – I'm Not In Love

Just who wouldn't feature this in their all-time top 100?

Queen – Bohemian Rhapsody

Nine Weeks at number one for Freddie's boys. Queen will not be touring with the 'If I Had You' hitmakers, the Korgies.

**Elton John and Kiki Dee –
Don't Go Breaking My Heart**

The Watford chairman and his rocket stablemate had to team up to reach the summit of the charts. Neither has done it on their own.

**Julie Covington –
Don't Cry For Me Argentina**

This is my only number one as a co-writer and co-producer so far, but I'm still trying.



Hot Chocolate

Hot Chocolate – So You Win Again

The man who played lead guitar on Unit 4+2's number one, Russ Ballard also wrote this song for Errol Brown's group.

Wings – Mull Of Kintyre

This was the first record to sell more than two million copies in the UK.

Art Garfunkel – Bright Eyes

Mike Batt threw off his Womble costume and wrote and produced this song for Art Garfunkel. It was for the film Watership Down.

Boomtown Rats – I Don't Like Mondays

This song was written around the story of the American school-girl who gunned down her fellow students on the playground. When asked why she did it, she replied, "I don't like Mondays".



Police

Police – Message In A Bottle

A strong songwriter, talented musicians and perennial good looks made the Police the first true supergroup of the eighties.

Pretenders – Brass In Pocket

The co-writer of this song and guitarist with the group, James Honeyman-Scott became another casualty of the rock and roll lifestyle last year. This song remains an epitaph.

Abba – The Winner Takes It All

1974 Eurovision winners, Abba, had nine number ones. This was one of the best and Bjorn's favourite.

Barbara Streisand – Woman In Love

Written by two thirds of the Bee Gees this was Bab's first number one nearly fifteen years after she first made the charts.

John Lennon – Imagine

It took the senseless murder of the one-time Beatle to bring this classic back into the charts and all the way to the top.



Bucks Fizz

Bucks Fizz – Land Of Make Believe

Another bunch of Euro winners, Bucks Fizz and a song with appeal for youngsters which is why I like it.

**Paul McCartney and Stevie Wonder –
Ebony And Ivory**

Motown's Stevie Wonder and ex-Beatle Paul McCartney teamed up to get Wonder's first taste of number one and McCartney's nineteenth.

RADIO MASTS

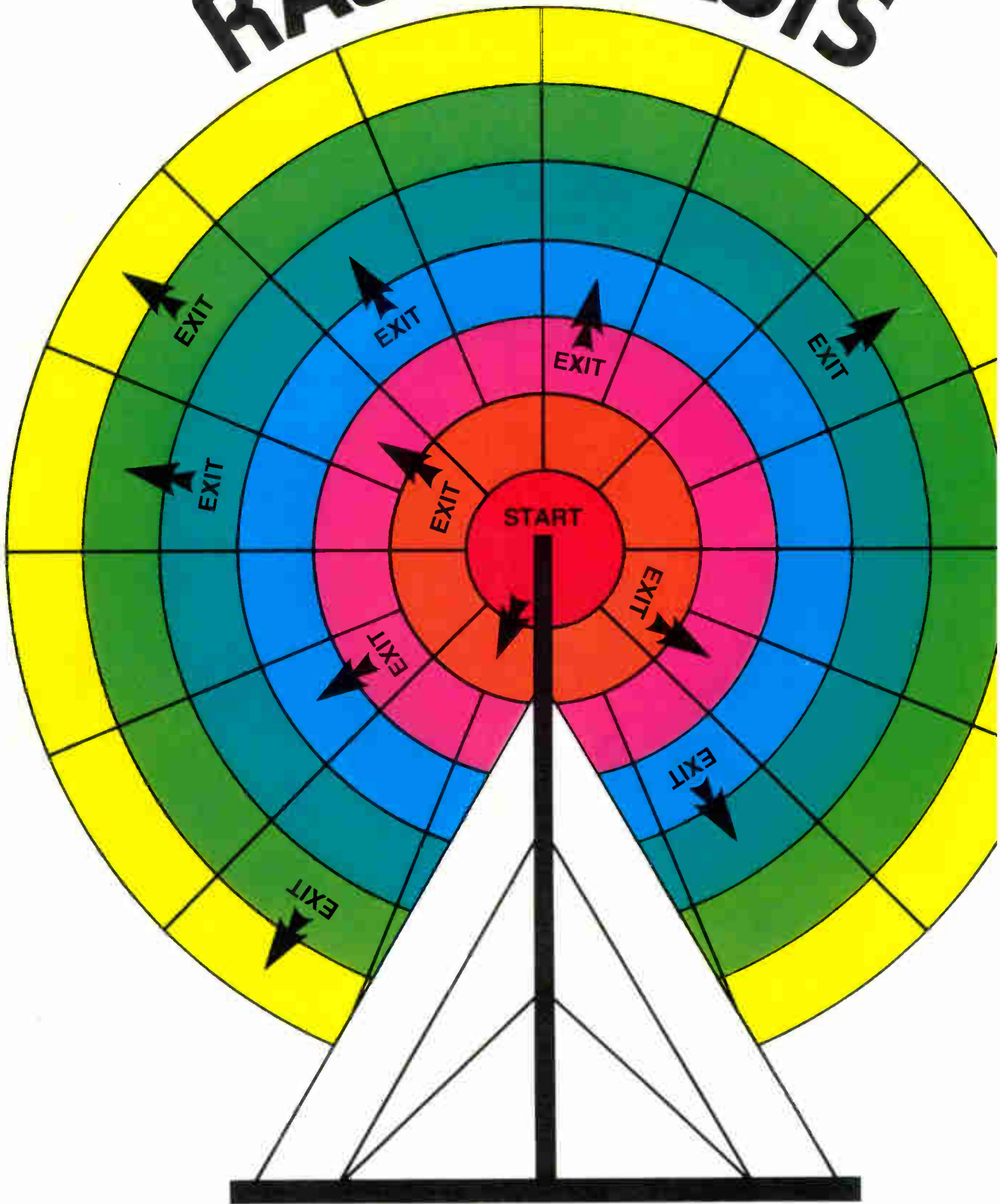

Throw the dice in turn, moving your counter the correct number of squares round each coloured waveband. You cannot cross the mast: you may move in either direction

round the band, if there are enough squares, but may not change direction in the middle of a move. To get out of one waveband into the next, you must throw