

electronic engineering

December 1976



Semiconductor lasers provide carrier and optical confinement

The
T&B/Ansley
BLUE MACS™
'D'
Connector....

Our new 'D' connector is designed to lower your installed cost through exclusive T&B/Ansley mass termination techniques.

Utilising our proven insulation-displacing TULIP[®] contacts in a spread pitch design, enables this 'D' connector to be terminated at any point, to standard 0.050" pitch flat cable, while at the same time being intermatable with existing 'D' type connectors.

Termination reliability, as with all other BLUE MACS™ connectors, is assured by self aligning cable grooves which automatically position the cable over the TULIP[®] contacts.

The one-piece connector design with mechanical side latches, maintains the integrity of the connector before, during and after the termination cycle, eliminating the need for complicated assembly operations.

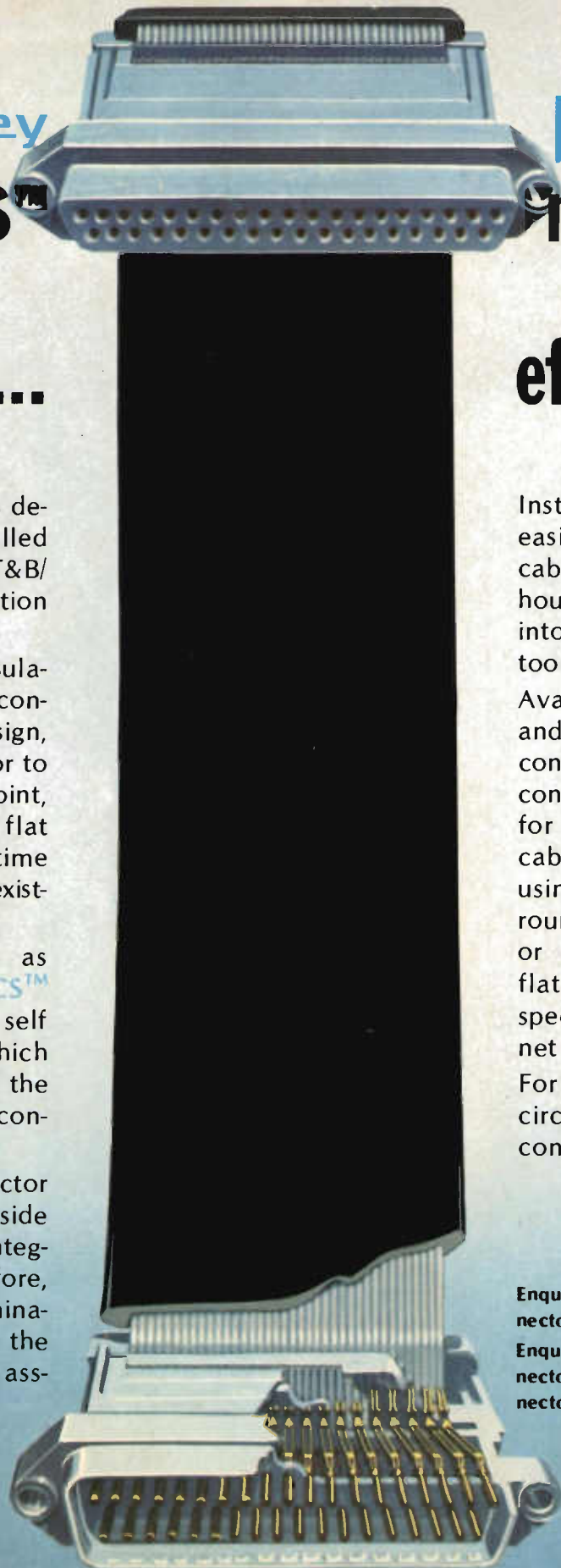

....a
brand new
meaning to
cost
effectiveness

Installation couldn't be easier; simply insert the cable into the connector housing, locate assembly into standard BLUE MACS™ tooling, then terminate.

Available at present in 25 and 37 way plug and socket connector versions, our 'D' connector is ideally suited for both internal and external cabinet interconnections by using our standard U.L. listed round-conductor flat cable or our U.L. listed jacketed flat cable — engineered specifically for external cabinet use.

For further information, circle the enquiry number or contact us direct.

Enquiry no. 171 for the 'D' connector only.

Enquiry no. 172 for the 'D' connector and BLUE MACS™ Cable/Connector System.



T&B / Thomas & Betts Limited
Sedgwick Road, Luton LU4 9DT. Tel: Luton (0582) 597271

Editor

Brian J. Jennings

Technical Editors

Peter Gebler BA

Elaine Williams BSc

Group Editorial**Consultant**

Lord Avebury BA CEng

MIMechE MIMC

Art Editor

Adrian C. Day

Circulation Manager

H. S. Gibbs

Reader Service Manager

Grace Wall

Advertisement Manager

Patrick Flynn

Northern Area Manager

Peter T. Westhead

061-928 9801

Publisher

Peter Jago

Electronic Engineering is published monthly and is distributed free of charge in the United Kingdom to designers, engineers, researchers, technical management, and approved authorities, in industrial and scientific establishments manufacturing and using electronic components and equipment. It is also available to others in the U.K. and overseas at an annual subscription rate of £12.50 (or \$37.50 in North and South America). Single copy price is £1.50.

Notice to overseas readers

A number of advertisers, at their own request, do not appear in the world-wide edition. This unavoidably interrupts the page sequence, but does not affect the editorial content.

 © 1976

Morgan-Grampian (Publishers) Limited

Morgan-Grampian House

30 Calderwood Street

London SE18 6QH

Telephone 01-855 7777

Telex 896238 (Industpres Ldn)



This month's cover depicts the Amphenol range of Merlin connectors which are used for military, Aerospace and other areas where weight is an especially important consideration in design.

electronic engineering

Vol 48, no 586

December 1976

-
- 4** **Comment and Readout:** *Common Market?; low cost design aid; Marconi opens pcb plant; fibre optic monitoring; cable plant set up; waveguide trials; development aid for 6800; add on memory; Scopex hails successor; support for cosmac; oscilloscope launch; industry predictions.*
-
- 17** **Applied Ideas:** *Steam engine whistle simulator circuit; low power cmos switch debouncer; reduction of amplifier offset and drift; current to frequency converter without insulation; complement adders give unambiguous zero output; flip flops help in multiplexing control bits; ram storage adaptor for oscilloscope; hex inverter and or gates for frequency doubler; low power cassette data recorder; constant speed for a permanent magnet motor; automotive battery voltage indicator for 12 V; programme generates n phase oscillations.*
-
- 41** **Narrowbeam five layer heterostructure lasers:** *A variety of (GaAl)As/GaAs devices have been fabricated using two pairs of heterojunctions. G H B Thompson et al, explain the characteristics and research undertaken for these devices.*
-
- 49** **The software challenge for microprocessor engineers:** *Microprocessors are likely to become an essential tool for the electronics engineer. Alan Potton explains how to understand and use them.*
-
- 59** **Design considerations for optically coupled isolators:** *In this article Chris Williams describes the opto-isolator families and ways of obtaining optimum performance.*
-
- 65** **Failure mechanisms in cos/mos integrated circuits:** *This article discusses the reasons for failure in these circuits. Gallace and Pujol explain how some of these may be avoided.*
-
- 73** **Digital logic board design with test needs in mind:** *As digital logic ic's become more complex the requirement for testing digital systems becomes more critical, writes David Tose.*
-
- 77** **Advances in medical electronics:** *There are several interesting developments in the medical electronics field. The use of lasers and ultrasonics provides both powerful diagnosis and treatment facilities writes Elaine Williams.*
-
- 89** **Product Focus:** *This month Brian Jennings looks at the connectors market.*
-
- 106** **New Products**
-
- 120** **New Data**
-
- 126** **Classified Advertisements**
-
- 128** **Advertisers Index**

Throw some light on your frequency response

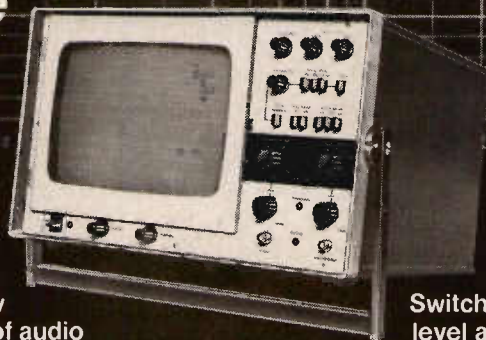

The RA200 Test Set quickly gives you accurate traces of audio system frequency responses. In just a few seconds, this self-contained instrument clearly displays response as a gain/frequency plot on a long-persistence CRT. Outputs are provided for operating an X-Y plotter. Whether you use the internal sweep oscillator, or an external signal, the RA200 requires no synchronisation and adjusts automatically to the incoming frequency. It covers 20Hz to 200kHz, with resolution down to 0.1dB over a very wide dynamic range.

Switched attenuators for output level and input sensitivity ensure fast and precise evaluation of all audio devices, whether having nominally flat response or a steep-cut characteristic. You can adjust the sweep rate, set upper and lower limits independently, and use one-shot or repetitive sweeps triggered electrically or manually.

The Wayne Kerr RA200

Fast. Accurate. And easy to use. Send for full information today.

WAYNE KERR RA200.



Wilmot Breeden Electronics
Ferrograph Rendar Wayne Kerr

Please send me information about the Wayne Kerr RA200

Name _____

Position _____

Company _____

Address _____

Telephone _____

Wilmot Breeden Electronics Limited, Durban Road, South Bersted, Bognor Regis, West Sussex. England. Telephone: Bognor Regis 25811 (STD Code 02433).

EE 12/76

Type 94 cermet - a really exclusive trimmer

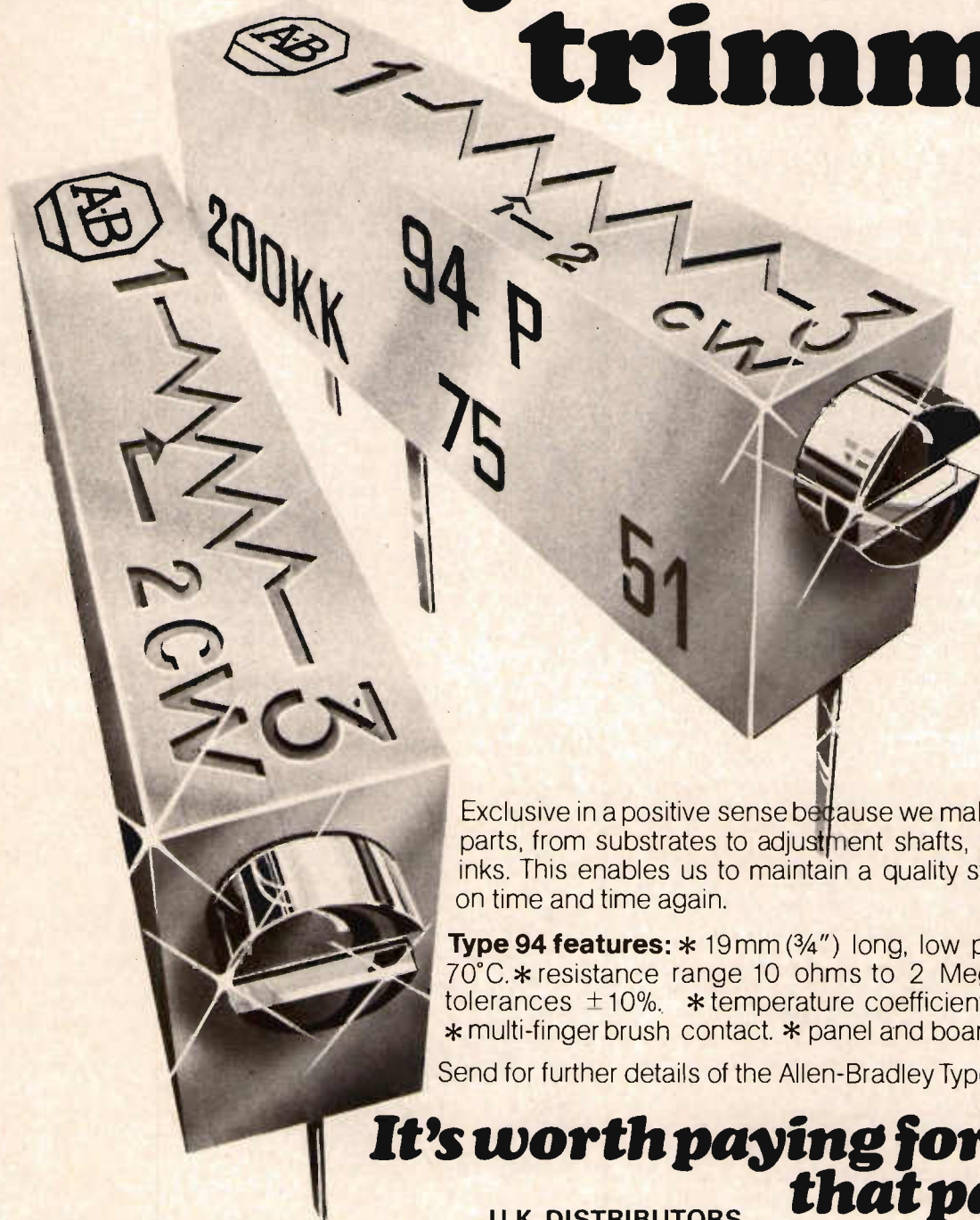

Exclusive in a positive sense because we make all the component parts, from substrates to adjustment shafts, contacts to cermet inks. This enables us to maintain a quality standard you can rely on time and time again.

Type 94 features: * 19mm (3/4") long, low profile. * 0.5 watts at 70°C. * resistance range 10 ohms to 2 Megohms. * selection tolerances $\pm 10\%$. * temperature coefficients ± 100 PPM/°C. * multi-finger brush contact. * panel and board mounting versions.

Send for further details of the Allen-Bradley Type 94 now.

**It's worth paying for quality
that pays you.**

U.K. DISTRIBUTORS

I.T.T. Electronic Services
Edinburgh Way, Harlow, Essex CM20 2DF
Tel: 027-96 26777

Woolley Components Ltd.,
214A Manchester Road, Broadheath,
Altrincham, Cheshire W14 5LU. Tel: 061-928 2289.

Jermyn Distribution,
Vestry Estate, Offord Road,
Sevenoaks, Kent. Tel: 0732 51174

Spenco Electronics (Phoenix) Ltd.,
79 Carron Place, Kelvin Industrial Estate,
East Kilbride G75 0SD. Tel: 035-52 36311/2/3

J. Gledson & Company Ltd., Newbiggin Lane,
Westerhope, Newcastle-upon-Tyne NE5 1PH
Tel: 0632 860955.

Electronic Component Supplies (Windsor) Ltd.,
Thames Avenue, Windsor, Berkshire SL4 1QP
Tel: 075-35 68101

or apply direct to:



ALLEN-BRADLEY ELECTRONICS LIMITED

Bede Industrial Estate, Jarrow, Tyne and Wear NE32 3EN
Tel: Jarrow (0632) 897771 Telex: 53353

Common Market?

It seems that after a painful recognition that the purely domestic market is simply incapable of sustaining the UK components industry, the European market place, six times greater than our own, beckons invitingly.

But this invitation is a deceptive one. The obvious benefits of sheer size and location are dissipated by the individual national preferences which disfigure the face of co-operation within the EEC itself. This manifests itself particularly in the field of specifications. Britain has failed to impress Europe with domestically inspired specifications which were drafted without reference to the needs of Europe. We are now belatedly searching for that elusive ideal—a framework within which to produce specifications catering for European rather than national requirements. With the continuing delay in producing this framework more and more manufacturers are turning towards US Mil specs, a tendency which can only hinder the growth of the European components industry.

Success here should determine the future of our components industry, or indeed dictate whether or not it has a future to enjoy. France, Germany and the rest are equally guilty of vacillation in order to force their own national standards on the rest of Europe. The appearance of the Industrial Electro-Technical Commission (IEC) and the Committee of European Association of Manufacturers of Passive Components (CEPEC) is perhaps a sign that they are now recognising the need for united action.

But debates on specifications are protracted within the IEC, and some critics claim that, as a forum for negotiations at international level it is deficient in muscle power. For our part, we must remember that Europe is no more enamoured of BS9000 than it was in the beginning, a lack of enthusiasm unfortunately echoed by many of Britain's own manufacturers.

We must be prepared to abandon BS9000 in the cause of European harmony. Only by co-operation can we ensure the health of the European components industry and shake off our dependence on US technology.

Our domestic electronic components industry has suffered much at the hands of interventionist governments, though some of its wounds have been unconsciously self-inflicted. It does appear, however, that the situation which has arisen is because of a Government inspired parochialism characterised by a failure to become a world leader in any one major product area.

READOUT

Low cost design aid

Intel has developed a new 8080 design aid known as Prompt 80. It is offered as a low-cost alternative to the MDS but can also be used as an MDS peripheral. Prompt 80 contains an 8080 cpu, 1 k of ram and a monitor program contained in a 3 k rom. It also contains several seven-segment displays, a keyboard and a bank of switches.

Two ports are provided at the front panel, the output ports driving led indicators and the bank of switches providing input data. The monitor program will support peripherals such as a paper tape reader or a teletypewriter, although neither are required for operation.

An internal prom programmer can be used to program an entire prom or 16-byte segments of the prom. The system can be expanded up to the full capacity of the 8080 using cards from the SBC family. As an MDS peripheral, Prompt 80 can be used as an intelligent prom programmer or as a means of allowing several programmers to share the same MDS.

Simultaneously with the announcement of the Prompt 80, Intel has announced details of its 8085 family, Intel's immediate answer to the Z-80 and Motorola's improved depletion-mode 6800. The 8085 is essentially a faster 8080 with the addition of an on-chip clock generator, serial I/O and increased interrupt capability.

From the software point of

view, the 8080 and the 8085 are almost identical, the 8080 having only two new instructions. The pin functions are different, however, the 8085 having three levels of priority interrupt and a trap (non-maskable) interrupt in addition to the 8080's interrupt request pin. It also has a serial I/O facility built in and the 8085's two additional instructions are concerned with the serial I/O and interrupt masking.

Three additional devices complete the family; two roms and a ram. The 8355 is a mask-programmable rom and the 8755 is a uv-erasable. Each provides 2 k bytes of storage as well as two 8-bit I/O ports. The 400 ns access time ensures that no wait states are required during access. Both devices contain address latches to interface directly with the 8085's multiplexed bus. The 8155 ram provides 256 bytes of data memory and three I/O ports. The ram chip also contains a 14-bit interval timer so that the 8085, 8155 and either the 8355 or 8755 together provide a complete system with all the commonly required facilities.

The 8085 is about 50% faster than the 8080 and all of the devices operate from a single 5 V supply. Like the 8048 and 8748, Intel's other new microprocessors, the 8085 is used with 8080's MDS development system so that users of the 8080 can change to the 8085 without having to buy a new development aid.

Marconi opens pcb plant



Marconi Space and Defence Systems has opened a new, purpose-built printed circuit board plant in Scotland. The plant is the latest addition to Marconi's Hillend establishment which, since its opening in 1967, has grown to occupy an area of 170,000 square feet and employs some 2000 people.

The £1m pcb plant has been set up primarily to produce plated through hole (pth) boards,

and with the facility to produce print and etch boards. It is designed to produce boards to BS9760, with high density, tight tolerance, fine geometric tracks of the order of ten thousandths of an inch and narrower, along with track spacings and holes subject to equally demanding specifications.

The plant is highly automated and provides a total in-house capability to produce boards to full commercial or military specifications and to provide a fast prototype service with a one-week turnround to meet the needs of Marconi's development engineers.

Many advanced techniques are used in the plant. All pth boards have the plating pattern delineated by photomechanical means using dry film resist.

Fibre optic monitoring

The growth of off-shore oil and the hydrospace industries has generated a growing requirement for sophisticated equipment to monitor the effects of deep water environments on divers. Hitherto, medical monitoring of divers has been restricted to dry simulated conditions but there was a requirement as depths increased to monitor an operational diver. This is particularly so, since the diver may be unaware of any deterioration in his physical condition. An operational diver is connected to his support system by an umbilical cable and data monitoring must be routed through this link. The bulk and weight of individual electrical conductors, together with their susceptance to electromagnetic interference precludes their use.

ITT and J & S Marine, in conjunction with the Admiralty's Experimental Diving Unit, have developed a completely new system employing a four-core

fibre optic link, replacing the conventional cable. By using a fibre optic cable, connectors, transmitters, receivers and other interface units, the multiplex system enables a diver's physiological and life support functions, such as body temperature, eeg, pulse rate, gas temperature, etc to be remotely monitored.

The system enables 16 functions to be monitored, each of the input channels being multiplexed and encoded to digital data for transmission through the single fibre optic data link to the surface control vessel. The data is then decoded and reconstructed to its original 16 functions. The receiver unit offers facilities for computer storage, outputs for 'scopes, chart recorders and other display devices and if required, a fibre optic two way voice link can be supplied which has been made possible by extending the voice channel bandwidth.

Cable plant set up

The first commercial factory to be committed solely to the manu-

facture of optical fibre work has been carried out.



facture and marketing of optic fibre has been set up by STC. It is claimed to be the first unit of its kind, operating on a commercial scale, which will bring together all the aspects of optical communications under one roof. Until now optic cable has either been imported from the United States or produced under laboratory conditions.

Inside the 4000 sq ft factory is all the equipment required to prepare the silica and pull it into fibres which are then coated and fabricated into complete optical fibre cables. Since the unit is situated in Harlow it will be easy to transfer any developments in the technology from the research labs at STL where most of the

STC has already found that the optical communications market is a substantial one. With the increasing cost of copper and the fact that it is a diminishing resource, optical cable appears to be an interesting alternative apart from its inherent advantages such as electrical noise immunity and increased capacity, since it is made from some of the most common raw materials.

The company sees the cable being exploited not only for private and public communications links and networks but also, for use in aircraft systems, manufacturing plants and other areas where the size, weight and safety factors are critical.

Waveguide trials

Millimetric waveguides are the latest developments in the communications field. Following field trials by the Post Office, the companies involved with the PO, BICC and Marconi, in its development are preparing to form a marketing team to sell the system to other countries.

The 14 km of waveguide under test at Martlesham can provide a capacity for half a million telephone calls or a mixture of data television pictures and facsimile directed through the waveguide along with the speech circuits.

At present conventional cables can carry 16 000 telephone calls and even the supercable link between planned London and the Midlands will only have a capacity of nearly 100 000 calls which is about a fifth of the waveguides present capability.

The waveguide only requires repeaters at a distance of the order of 20 km compared with cables which need signal amplification every 2 km. It uses pulse code modulation as its system of transmission and hence its suitability for digital information as well as conforming to the PO's plan aiming for a complete digital transmission network.

The next step for the development of the waveguide is the installation of a 123 km run between Bristol and Reading but this still awaits final PO approval.



The cable itself consists of a close wound helix, 50 mm in diameter, of superfine enamelled copper wire surrounded by an outer wall of glass fibres impregnated with a loaded epoxy resin. A layer of aluminium foil provides a barrier against oxygen and water and is covered with an outer layer of resin and synthetic fabric tape for robustness.

The waveguide is housed in a steel pipe which is buried at a depth of four feet and is capable of following bends quite sharply without any appreciable loss of performance.

BICC who manufacture the cable for the waveguide are confident of the success of the systems and have plans to increase the manufacturing capacity of its present production unit at Alperston if the PO approves the Reading to Bristol system.

Development aid for 6800

Motorola has officially unveiled its new "Polyvalent" design system, a flexible 6800 development aid that can be used in a variety of configurations. Flexibility is a key feature of the pds, which can be adapted to serve the changing needs of the user as he progresses from evaluation through hardware and software development to final production. PDS comprises a master board, a video card and a number of options.

The master board is a single card microcomputer with sufficient memory, I/O and interrupt lines to satisfy the requirements of most applications. The card contains the 6800 cpu, 6871A clock generator, two 6820 pias (providing 32 I/O lines), sockets for 4 k bytes of rom/prom, 384 bytes of ram and both RS232C and current loop interfaces. Buffered busses allow memory or I/O expansion using the EXORciser's optional cards. The master board can be converted into an evaluation board by inserting a monitor program into one of the rom sockets. The monitor program, known as MINIBUG II, provides all the standard monitor facilities and allows the board to be used for developing small programs in hexadecimal code. Editing and assembly facilities can be added if the ram capacity is extended to 8 k bytes.

The video card can be used to convert the master card and monitor firmware into a self-contained development system that does not require a teletypewriter. The video card is used to interface the master card with a crt monitor or domestic tv set. In addition to the keyboard and display supplied with such a system, Motorola offers a 30 cps printer and a cassette interface.

NEW AP Range of

REED RELAYS

TO FIT 14 PIN DIL SPACINGS

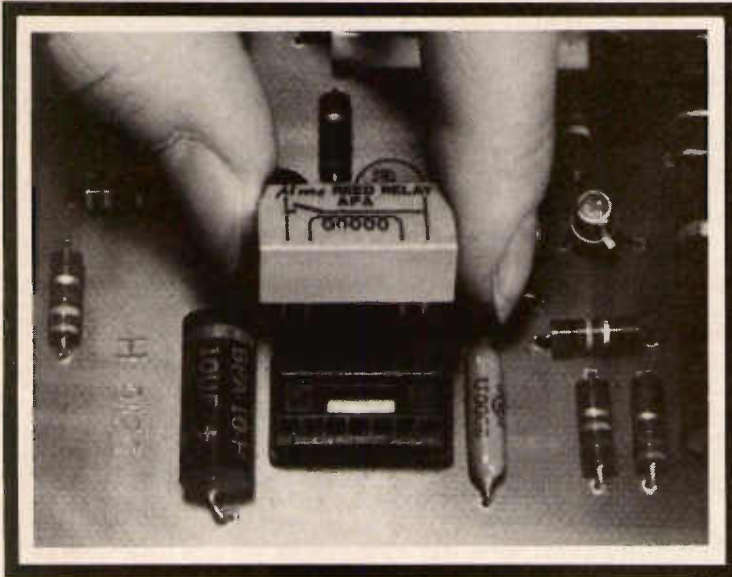

This new range of reed relays has pin spacings identical to 14-pin dual-in-line sockets. Less expensive than the conventional dual-in-line types, the range comprises initially 28 types including Form A (normally open) and Form C (changeover) with or without built-in diodes.

CONTACT DATA	Standard capsule	High voltage capsule	Changeover capsule		
Max. Power	10W	10W	3W		
Max. Volts D.C.	100V	500V	28V		
Max. Volts A.C.	100V	240V	28V		
Max. Current	0.5A	0.5A	0.24A		
COIL DATA	Standard capsule	High voltage capsule	Changeover capsule	Coil Volts	Coil Resistance
	APA/A	APA/E	APC/E	18 to 30	3k Ω
	APA/B	APA/F	APC/F	12 to 18	1.7k Ω
	APA/C	APA/G	APC/G	9 to 12	1k Ω
	APA/D	APA/H	APC/H	6 to 9	700 Ω
	APA/J	APA/T	—	5	700 Ω
	—	—	APC/J	5	320 Ω

Please send for further details of this new range



ALMA COMPONENTS LIMITED

Park Road · Diss · Norfolk · Telephone: DISS 2287 · Telex: 98162

M.O.D. and C.A.A. Approved Inspection.

Add on memory

Plessey Memories has introduced a range of add-on memory systems designed for use with the ICL 1900 series central processing units. The memories, designated the Memory Miser, allows 1900 users to expand the capacity of their present installations by adding additional blocks of memory, in 16 k increments, up to 65 k words of 25 bits in a single free-standing cabinet.

The Memory Miser is based on the "P" series of memories which Plessey originally introduced for application in the Japanese market over three years ago. More than 2000 of these units have now been installed.

According to Plessey, the system is designed for ease of diagnosis, maintenance and repair. The cabinet contains the memory, logic and interface modules, power supply and cooling as well as user test facilities and an on-line spare memory module.

In the event of a fault, the built-in user-test facility allows diagnosis by an led display.

Scopex hails successor

Scopex believes that its new 'scope, the 4D10A, offers the best specification anywhere in the low cost oscilloscope market. The instrument has dual trace operation, a claimed accuracy of 3% and is 25% lighter in weight.

This 10 MHz version supercedes the 4D10 'scope which the company has produced for about four years, but the layout of the internal circuitry has undergone some considerable change.

The 4D10A costs £150 and has stabilised power supplies throughout unlike many low cost 'scopes which use unstabilised supplies because of the expense involved. The company claims that a 10% variation in the mains supply will not affect the trace.

The attenuator for the instrument has been adopted from the 25 MHz 'scope the company makes, and allows measurements up to 50 V/cm. Also, use is made of Glarecheq non-reflective filters which overcome display reflections.

Support for COSMAC



RCA Service Division has joined forces with RCA Solid State Europe to form RCA Microprocessor System Services. The new service provides a consultancy and support service for microprocessors users.

RCA entered the microprocessor market early in 1975 with the original two-chip COSMAC, now superseded by the CDP-1802 single-chip cpu. Since then, the company has maintained a relatively low profile while most of its competitors have intensified their microprocessor marketing efforts.

The new service covers all aspects from the initial design concept to manufacture and installation, according to the requirements of the customer. It also includes maintenance of existing hardware, a service few existing consultants undertake.

Two microprocessor service

bases have been established; one at the company's Sunbury-on-Thames headquarters, the other in Yorkshire.

In the computer field, the RCA Service Division uses computers made by most of the major manufacturers and employs about 50 hardware and software engineering staff, backed up by several hundred technicians. The divisions activities range from the operation and maintenance of complete satellite control systems and the Ballistic Missile Early Warning System at Fylingdales, Yorkshire, to the custom design of microprocessor systems.

RCA believes that the new service will result in a much greater share of the market for the CDP1802 which is still the only 8-bit cmos microprocessor available in the British market place.

Oscilloscope launch



The latest range of oscilloscopes from Tektronix, the T900 range, is claimed to fill a so far unexploited market area. The T900 range in fact has been in the US and Europe for over a year but Britain was the last international market place for it to be introduced.

This was mainly due to the fact that the company has a strong foothold in the oscilloscope market with its low cost range of Telequipment 'scopes

and its rather more sophisticated equipment at the upper end of the market which caters for a specialist field in research and development.

The company manufactures about 100 'scopes in the T900 range per week at its manufacturing facility in Guernsey but is looking to increase that to at least 200 per week when the market finally established itself, and trends can be assessed.

The company sees two types of users in the oscilloscopes market, those involved in research and development and those in production, maintenance and education. The latter are more in need of portable instrumentation such as the T900 for which the range was principally designed.

Industry predictions

The latest survey of the West European electronics industry reveals that total production is expected to reach \$39 536 million in 1977 compared with \$35 015 million this year. The survey carried out by Mackintosh also shows that during the difficult period in 1975 output increased by only 4% over the previous year, which was 10% below its historical mean growth rate of 13 to 14% per annum, at current values.

In money terms this means that total production in Europe rose from \$31 239 million in 1974 to \$34 068 million in 1975. This figure is of course inflated by an overall 5% devaluation of European currencies against the US dollar, and the 1974 figure compares with values of \$39 billion and \$16.4 billion in the USA and Japan.

Europe's trading position revealed it as a net importer of electronics products with the rest of the world. Also large trade gaps exist in the areas of computer systems, video/audio consumer goods and in components—active, passive and audio.

However, in other sectors of the industry West Europe is a strong net importer with total exports of communication, telecommunications and control and instrumentation equipment reaching \$6350 million while imports lagged at \$4115 million.

France with its heavy government support has showed itself as a net exporter for the first time in 1975 with totals of \$2555 million and \$2523 million of exports and imports.

The only other European country with a positive trade balance was West Germany. It has had one since 1973.

Britain unfortunately did not fare so well. The only electronic product areas to make a positive trade balance was communications and telecommunications with exports of \$311 and \$153 million and imports of \$131 and \$89 million respectively. Total UK exports amounted to \$2370 million compared with an import figure of \$2507 million.

Forecasts which have been made for the electronics industry in West Europe for 1980 predict that computer systems which show the fastest expansion will be 74% up on 1976.



Build your visual display terminals with low-cost deflection packages from Plessey

Designers of visual display terminals for data readout and point-of-sale applications will welcome the efficient, low-cost deflection packages available from Plessey.

These comprise deflection coils, flyback transformers, linearity and width controls, providing high quality resolution for 90° and 110° displays. And at a very competitive cost. They are available as individual components too.

Plessey has a long and extensive experience in the development and quantity production of CRT deflection components. Ask us for further information and find out why Plessey wound products are contributing to the prosperity of more and more manufacturers of professional equipment.



PLESSEY **WINDINGS**

Plessey Windings International Headquarters, Fareham, Hampshire, England PO14 4QA
Telephone: Titchfield (032 94) 43031 Telex: 86214

612 PO44

Take away the accessories and what have you got?

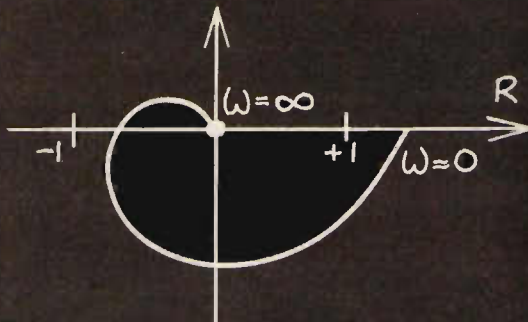

The most complete third generation F.R.A.

SM 2001 A has complete harmonic analysis capability, so it's a frequency response analyser in the fullest sense.

Digital techniques ensure high stability, resolution and accuracy.

It's easy to operate – a fine example of ergonomic design – a pleasure to service – and portable.

Yet SM 2001 A costs far, far less than its competitors. And a range of custom-built ancillaries provides unique flexibility with cost effectiveness.

They include facilities for frequency extension, two channel operation, plotter and computer interfaces. There are also modulator/demodulator and reference synchroniser units.

Frequency range is 0.00001 Hz to 999 Hz (up to 999 kHz with frequency extension).

How's that for an easy to operate, easy to service and cost effective dynamic analysis system.

Let us send you further details.

EMI SE Labs

SE LABS (EMI) LIMITED,
Spur Road, Feltham, Middlesex TW14 0TD, England.
Telephone: 01-890 1477. Telex: 23995.

A member of the EMI Group of companies. International leaders in music, electronics and leisure.

BARR & STROUD

MODULAR FILTERING

EF3-04 Low Pass

Cut-off frequency variable from 0.1Hz to 100kHz

EF3-03 High Pass

Cut-off frequency variable from 0.1Hz to 100kHz

EF3-02 Low Pass

Cut-off frequency variable from 0.01Hz to 10kHz

EF3-01 High Pass

Cut-off frequency variable from 0.01Hz to 10kHz



EF3 Basic Main Frame

Now FOUR Modules—and more to come!

The introduction of our EF3 Electronic Filter System was a breakthrough in electronic filtering, a System with options and interchangeability.

Now we introduce two additional modules to extend the scope and versatility of the EF3. To appreciate fully the technical and economic merits of the EF3 System you ought to have our detailed literature which we will be pleased to send. Continuing development of the EF3 System means that we will be announcing yet more modules in the near future.

Send now for full details to:



Glasgow and London

Barr & Stroud Limited,
1 Pall Mall East, London SW1Y 5AU.
Tel: 01-930 1541 Telex: 261877

It's not just another XY recorder.

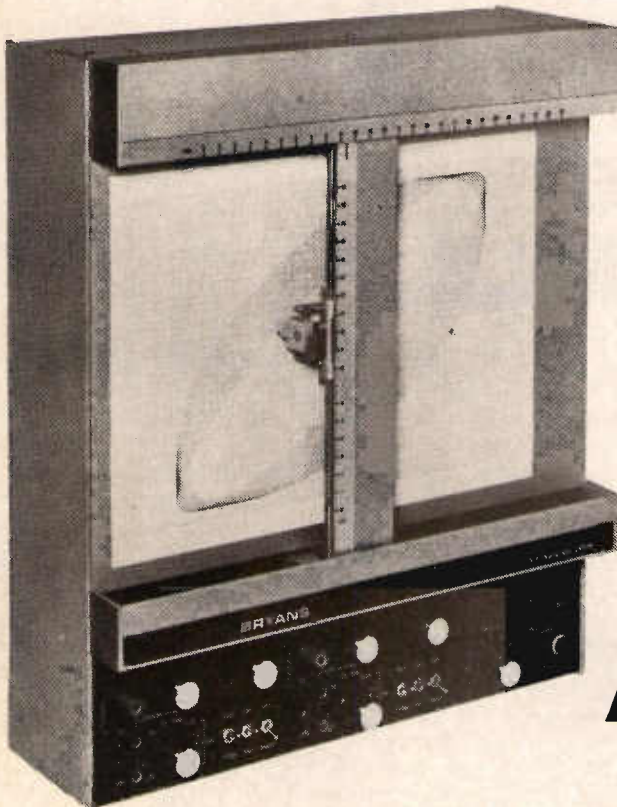

It's from Bryans Southern, and one of a line-up of XY recorders with an extra margin of value.

So if you're looking for greater performance, precision, features and versatility, you'll find the 29000 series offers more than similar priced recorders.

The 29000 is designed and built to the high standards people have come to expect from Bryans, guaranteeing you outstanding accuracy and a long reliable life.

You get a choice of A3 or A4 plotting size, with or without built-in timebase for the X axis. You also get a specification designed to cope with the widest possible range of recording problems.

It all adds up to the smoothest operation this side of perpetual motion. Write now for full data. We promise not to send you just another leaflet.



Bryans Southern Instruments

Bryans Southern Instruments Limited,
Willow Lane, Mitcham, Surrey CR4 4UL, England.
Tel: 01-648 5134. Telex: 946097. Grams: Bryans Croydon

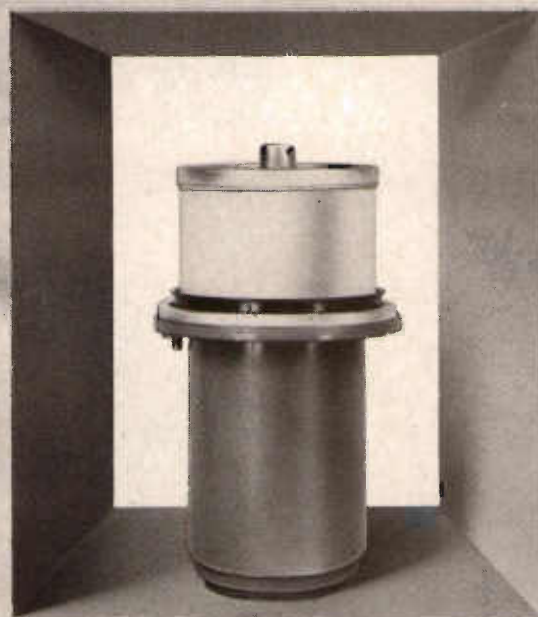

A brighter day for radio broadcasting, with our new high-power tetrode line

From 50 to 500 kW of carrier power from a single-tube RF final stage.
Pyrobloc® grids plus Hypervapotron® cooling, for an eye-opening combination of power,
compact size, overload safety, light weight, performance and operating reliability!
Five different tubes for any high-power short-wave radio broadcasting application,
all with the latest and best in power-grid tube technology from a world leader: THOMSON-CSF.



THOMSON-CSF

THOMSON-CSF ELECTRONIC TUBES LTD / RINGWAY HOUSE / BELL ROAD / DANESHILL / BASINGSTOKE RG24 OQG
TEL. : (0256) 29155 / TELEX : 858865

**Burr-Brown's 8-bit ADC82 gives you
a 2.8 μ sec conversion speed,
adjustment free operation, low cost,
and much more...**

Our new ADC82 successive-approximation A/D converter offers both parallel and serial data outputs, output-status signals, and conversion speeds of 2.8 μ sec maximum. It's self-contained, with internal clock, comparator and reference. No gain or offset adjustments are needed for 0 to +10V or \pm 10V signal range accuracies of better than \pm 0.2%, \pm 1 LSB.

All this means money saved in production and testing. And the ADC82 is packaged in a metal (ADC82AM) or ceramic (ADC82AG) 24-pin DIP that measures only 36mm by 20mm and is less than 7mm high.

ADC82

For details on this or other conversion products, contact
Burr-Brown
International, Ltd.,
Permanent House,
17 Exchange Road,
Watford WD17 9EB,
Telephone
(0923) 33837



BURR-BROWN
BB

**Fifty-four
conversion choices**

Electrical Tapes are our business

Woven Glass Cloth
Polyester
Woven Acetate
Teflon



We've got the range

A whole family of polyesters, Teflons... filmic, paper and cloth substrates... silicone and thermosetting adhesives... to meet the requirements of electrical specifications.

We've got the stock

Most tapes listed in the Tuck Range are 'ex stock'. In fact we claim to have one of the widest selections available immediately.

We've got the technical resources

As part of an international organisation our manufacturing knowhow and technical research is second to no-one. That is why we say that our self-adhesive tape products are all engineered for a specific purpose to meet given standards of performance.

... why not make it your business now?

Find out more about this interesting complex of tapes for your industry. Write off to:

Technical Tape Limited

Robley House Orwell Road Kirkdale Liverpool L4 4AB
Tel: 051-922 1901 Telex: 627406 Telegrams: Tuckbrands Liverpool
London Office: 14 The Broadway Stanmore Middlesex
Tel: 01-954 0018 Telex: 934208 *Teflon is a trademark of Dupont*



**ENGINEERED TAPES
FOR INDUSTRY**

Our six-sided box will reshape your ideas on FFT spectrum analysis

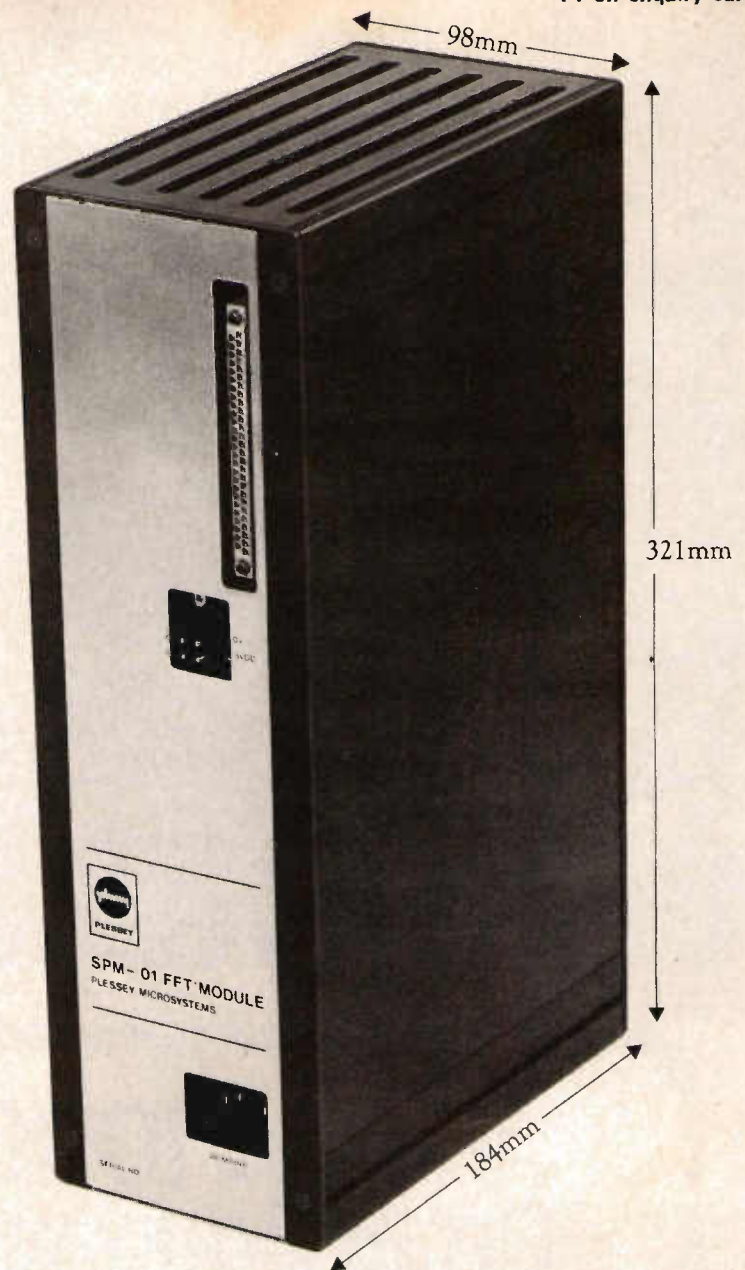

At remarkably low cost, Plessey SPM fast Fourier transform spectrum analysers provide the spectral content of analogue or digital input signals of up to 1024 complex points in 237 milliseconds.

To an RMS accuracy better than 0.1%.

These modular, compact self-contained units offer instant plug-in, black-box simplicity with excellent processing performance. SPM-01 transforms 1024 complex points in 610 milliseconds; the higher performance SPM-02 achieves this in only 237 milliseconds.

If you think FFT is way out of your reach, think again. OEM quantities of 100 SPM-01 in the UK cost £1,700 apiece, depending on specification and design options. One-offs £2,300 each.

Neat. Small. Controlled by a simple TTL interface. SPMs can be added-on to mini- or microcomputers, or used as stand-alone modules. Ideal for production of instrumentation, scientific applications, volume OEM products. They could transform your ideas, your products and their performance—in such fields as speech analysis, engine health monitoring, geophysics, spectrometry,

bio-medical analysis, optical transfer function measurement, signal processing, oceanography, education and ECG analysis.

Something special for you?

These SPMs are standard products of our highly specialised engineering group based at Towcester, developing high performance signal processing equipment to meet customer specifications. Can we discuss *your* special needs?



PLESSEY MICROSYSTEMS

Plessey Microsystems
Water Lane, Towcester
Northants NN12 7JN
Telephone: Towcester (0327) 50312
Telex: 31628

 654 P018

Transducer and Recorder

amplifiers and systems



differential dc amplifiers · transducer amplifiers · sample & hold amplifiers · operational amplifiers · charge amplifiers · bridge amplifiers galvanometer drivers · bridge conditioning units · thermocouple references · filter amplifiers · V-F & F-V converters · shaping amplifiers · reliable high performance · protected inputs, outputs and supplies modules individually powered—mains or optional dc supply · housings for single modules and up to 17 in a standard 19" crate · compatible modules for most low & high level signal conditioning

FYLDE ELECTRONIC
LABORATORIES
LIMITED

49/51 Fylde Road
Preston PR1 2XQ
Telephone 0772 57560

The XLC 1000 10 MHz Timer Counter from Exel.



The XLC1000 is a 4 digit counter with facilities for frequency, period, multi period, frequency ratio, time and event measurements, all functions being crystal controlled.

Choice of operating mode is by internal plug and socket or interconnection of the rear edge connectors, panel cutout size remains constant to facilitate interchange with existing units.

BCD outputs are standard and provision is made for the fitting of simple modifications to meet special requirements.

FUNCTIONS

Frequency—Sensitivity via shaper or TTL (d.c.—10MHz). Accuracy—Crystal accuracy ± 1 count. Gate Times—1mS, 10mS, 100mS. Full Scale—9.99MHz, 999.9KHz, 99.99KHz. Gate Times—1S, 10S. Full Scale—9.999KHz, 999.9Hz.

Period—Sensitivity via shaper or TTL (d.c.—10MHz). Accuracy—Crystal accuracy ± 1 count. Timing units 1 μ S to 10S.

Multi Period—Sensitivity via shaper or TTL (d.c.—10MHz). Accuracy—Crystal accuracy \pm

1 count. Number of periods 10 to 10⁵. Timing units 1 μ S, 10 μ S, 100 μ S.

Pulse Width—Positive to negative edge timing or negative to positive edge timing. Sensitivity via shaper or TTL (d.c.—10MHz). Accuracy—Crystal accuracy ± 1 count. Timing units 1 μ S to 10S.

Timing—Clock units 1 μ S to 10S from internal oscillator. Trigger—single or double line +ve or -ve slope selection.

Counting—Counting external

events. Trigger single or double line +ve or -ve slope selection. Sensitivity via shaper or TTL (d.c.—10MHz). Prescaling 1-10⁷ may be applied to this function.

Frequency Ratio—Sensitivity via shaper or TTL (d.c.—10MHz). Accuracy—Crystal accuracy ± 1 count, f1/f2 or f1/f2 \times N, N=10 to 10⁷.

One pre-wired plug is normally provided with each XLC1000 and will be connected for frequency unless otherwise specified. Additional plugs may be ordered if required.

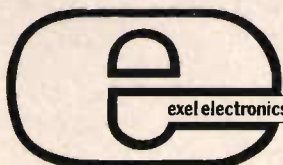

exel electronics/the panel meter people

Exel Electronics Limited, Wollerton Road, Branksome, Poole, Dorset.
Tel: Bournemouth (0202) 291430 & 66166

This laser diode has infinite application possibilities....

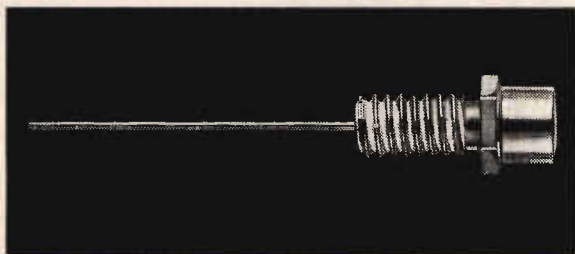

which is why ITT have introduced it.

In so many areas of application, you name it, these laser diodes can do it.

Up to now, the sheer capability of lasers has often been outweighed by the practical disadvantages of operating them. Now these gallium arsenide laser diodes by ITT effectively overcome all the disadvantages:

They're small and light, can be operated on a transistor power pack, operate at normal ambient temperature, tolerate extremes of humidity and temperature. They are portable, and are ruggedly constructed giving a consistently reliable performance under really adverse conditions.

Their uses are as varied as you can imagine, plan or cater for. There are obvious applications in

the fields of communications, high-speed infrared photography and film marking. Security. Distance measurement. Industrial processing. Defence functions. And, of course, research in the very widest sense.

ITT laser diodes are now being manufactured in Paignton – Europe's foremost production centre for laser diodes – after years of research and development by a team of more than twenty scientists and engineers.

They are available in two forms: Single Heterostructure for short pulses of high peak power (about 10 watts), and Double Heterostructure for comparable mean power but high duty factor.

If you would like to know a lot more about these little lasers, write to: Marketing Department, ITT Components Group, Electron Device Division, FREEPOST, Brixham Road, Paignton, Devon, TQ3 1XJ.

Name _____

Address _____

Tel _____

EE12/76

Components **ITT**

The instruments on the left are our good old Models 152 and 159 programmable function generators—the ones that are ASCII coded and compatible with the GPIB.

And at right is our new Model 583 Autoprogrammer, designed to be used only with our programmables. By means of its plug-in memory, the Autoprogrammer can store

commands for up to 100 separate tests. Test sequencing can be manual as well as automatic. Size of the memory is 1024 eight-bit words. You can program the memory supplied with the blank plug-in cartridge, or we can furnish you EROMs that are pre-programmed to your specs.

The Model 583 Autoprogrammer goes for just

£815, the blank plug-in EROM cartridge is £125; a custom-programmed plug-in is £205. But none of these will do you any good unless you have one of our programmables. So get one.

Wavetek Electronics Ltd., 109 Crockhamwell Road, Woodley, Reading, Berks RG5 3JP
Tel. Reading (0734) 694944 Telex: 849301

WAVETEK®

**If you have
one of these,**

**you
ought to
have one
of these.**



APPLIED IDEAS

Steam engine whistle simulator circuit

This circuit was designed to simulate the whistle of a steam engine in a model train layout. A magnet carried by the train momentarily closes the contacts of the reed switch R_s at the approach to a tunnel or a level crossing. This initiates the whistle for a period determined by the time constant provided by R_1 and C_1 . The time delay required is achieved easily by

making R_1 a 470 Ω preset potentiometer and fixing C_1 at 10 μF . Immediately following the closure of R_s the output voltage at pin three of the 555 timer IC1 rises to nearly 12 V and this energises the whistle generator circuit based on the 741 op amp, IC2.

The hissing component of the steam whistle is produced by the noise generator comprising the

reversed biased base-emitter junction of Tr_1 and the series current limiting resistor, R_3 . This resistor should have a value of 100 K or more. The noise generated by Tr_1 modulates the square wave of the basic whistle tone to produce a shrill wet whistle waveform.

This waveform is amplified by the single stage transistor amplifier Tr_2 . Resistor R_4 determines

the amount of steam in the whistle and can be adjusted if required. Capacitor C_3 determines the pitch of the whistle. If the value of this component is increased to 1 μF and the steam component is switched off a passable imitation of a diesel train is obtained. The circuit and the speaker can be hidden in the hills or tunnel workings.

M. Plant, Trent Polytechnic.

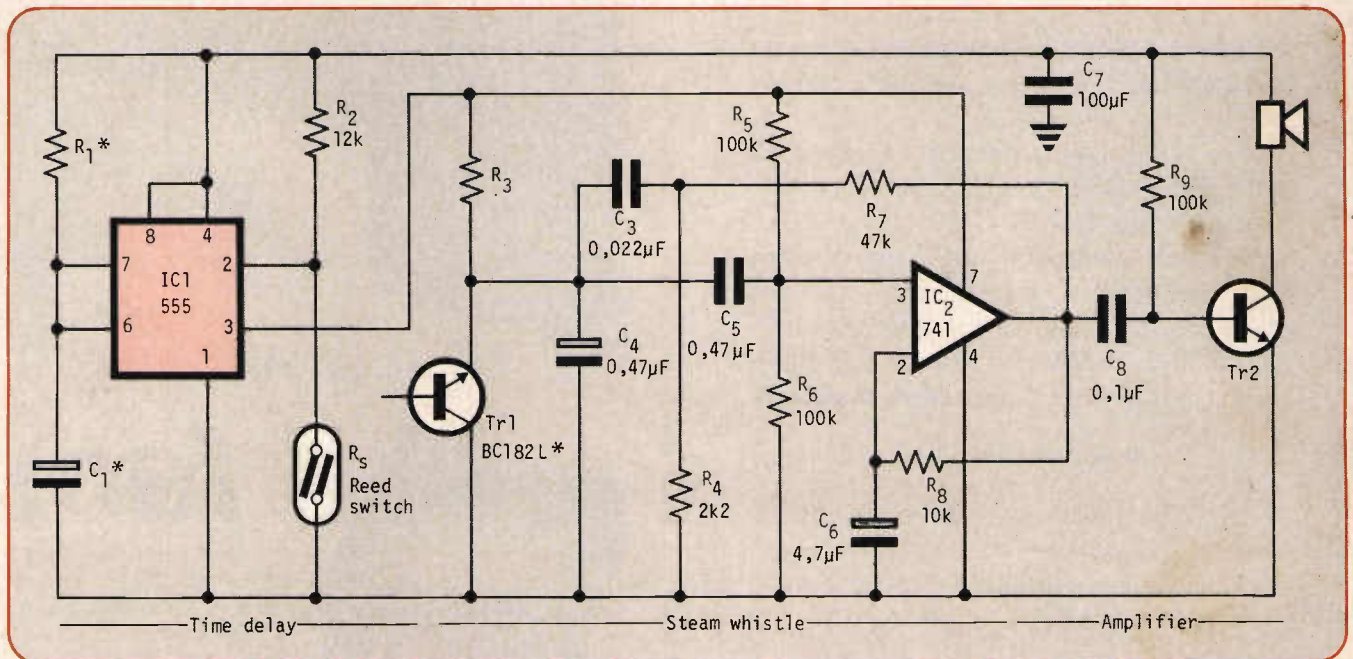

Low power cmos switch debouncer

The conventional cross coupled flip flop debouncer has the drawback that pullup resistors must be used to interface the switch contacts. These consume

power and by raising the circuit impedances result in the degradation of noise immunity for the open circuit input.

In the circuit shown in Fig. 2

the flip flop output is used as an active load for the switch contacts. This reduces the steady state power consumption to that of the leakage current of the

cmos gate. Since the circuit has only one input (which is always connected to one supply) the noise immunity is preserved.

P. G. Hinch, Altrincham.

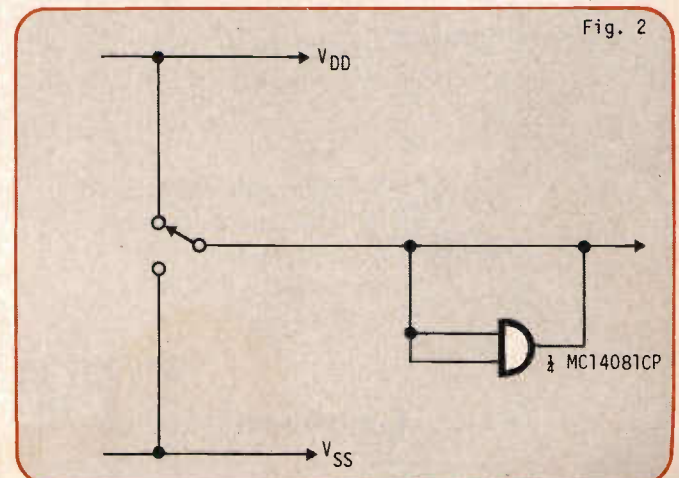
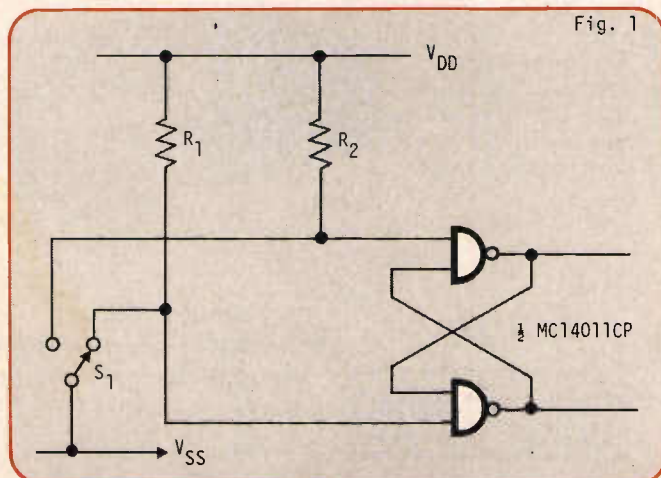

We've Got A World Of Power In A Small Relay.

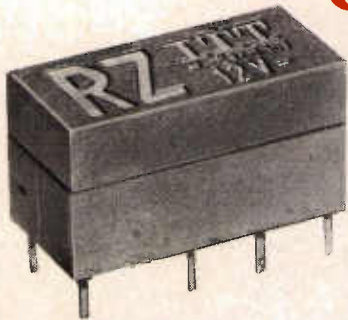

A New PC Board Relay – Optimized for the Best Combination of Size and Performance

Now with this combination we have a relay that offers a significant advancement in the state of the art. Our RZ relay has a unique symmetrical layout in a dual in line package and 2 changeover single silver cross-bar contacts which provide switching characteristics of 1,25A; 30W; 50 VA. But with all this the RZ relay stands only 11.0 mm above the board.

That's a lot of power in a little package.

The ITT name on the snap-on cover tells you that it is just one more of the many products available from ITT Components' world wide resources.

Our vast, fully automated, global production facilities offer you the most complete range of electro-mechanical components available on earth.

To find out more about what we can do for you, 'phone, write or telex Harlow (0279) 26811, extension 2251, for samples and specifications.

ITT Components Group Europe
Electro-Mechanical Division,
Edinburgh Way,
Harlow, Essex CM20 2DE
Telex 81146

Components **ITT**

boxing clever
with
IMboxes

from

imhof-bedco

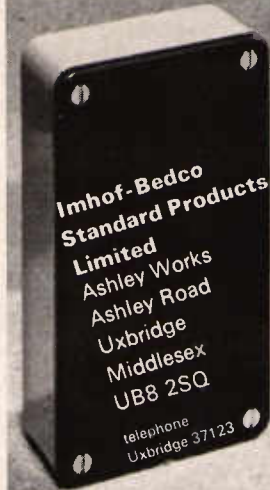

'all-purpose' plastic boxes

w62



fans

There are over thirty models in our range of highly efficient Frilec fans – all of which can be supplied with a choice of windings to suit your requirements. Special trays are also offered, which will accept up to six of these fans, suitable for rack mounting.

and blowers

Powerful blowers are also available with models suitable for either forced or induced ventilation. Type B13 and B26 (shown here) can have optional Filter State Indicator fitted if desired.

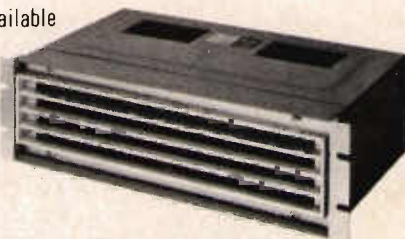

Send to-day for full details.

from
imhof bedco

**Imhof-Bedco
Standard Products Limited**
Ashley Works Ashley Road
Uxbridge Middlesex UB8 2SQ

telephone Uxbridge 37123 w65

APPLIED IDEAS

Reduction of amplifier offset and drift

Offset and drift are two parameters that can restrict the use of general purpose amplifiers in low dc analogue signal applications. Expensive chopper amplifiers are often considered necessary to achieve the desired results. As an alternative, a system comprising a general purpose amplifier and fet switches can prove to be a good way of reducing these errors.

The output voltage, V_o , is the amplified version of the input signal and is equal to $-V_a R_f / R_a$. This voltage is independent of the amplifier drift and offset. Each sampling cycle is determined by the charging times of the capacitors C1 and C2 and the response time of the amplifier. With 0.1 μF capacitors the analogue input can be sampled at regular intervals of 0.5 ms.

The switching operation can be split into six time intervals. When SW2, 3 and 6 are closed C1 charges and is fully charged when these are open. The same procedure is observed for C2 with SW1, 5, 6 when SW7, 8 are closed the total voltage developed is $V_o = -AV_a$.

The particular switching sequence explained will reduce voltage errors that may be developed across C1 and C2 due to switching transients. For example, SW3 and SW6 are identical and turn off simultaneously. The charge transferred into C1 by SW3 is practically cancelled by the charge transferred into the same capacitor C1 by SW6.

J. O. M. Jenkins, Siliconix Ltd.

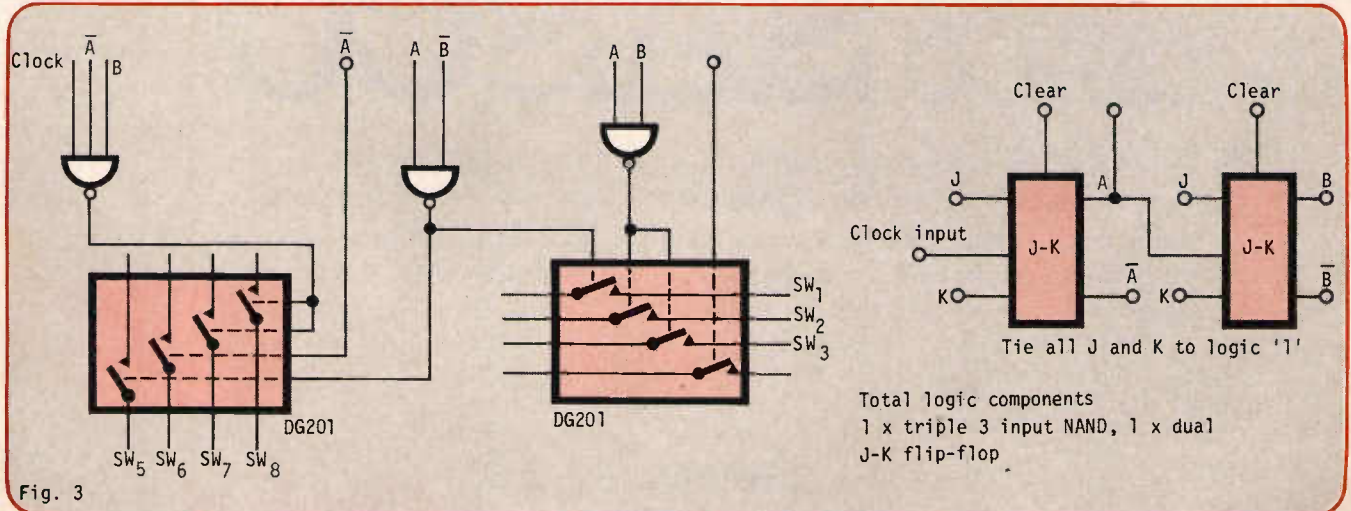
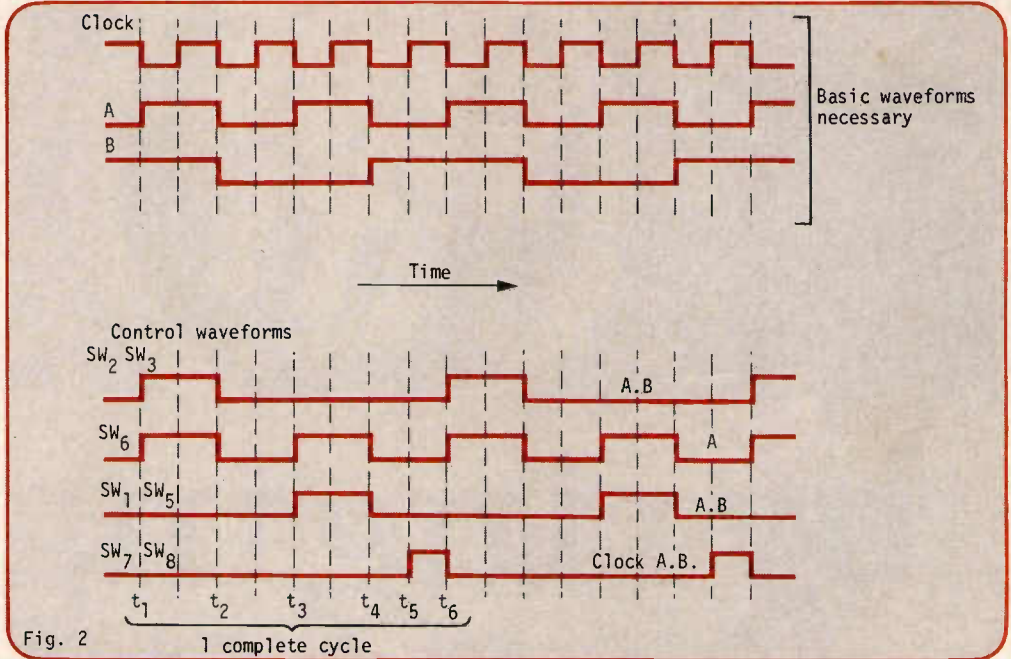
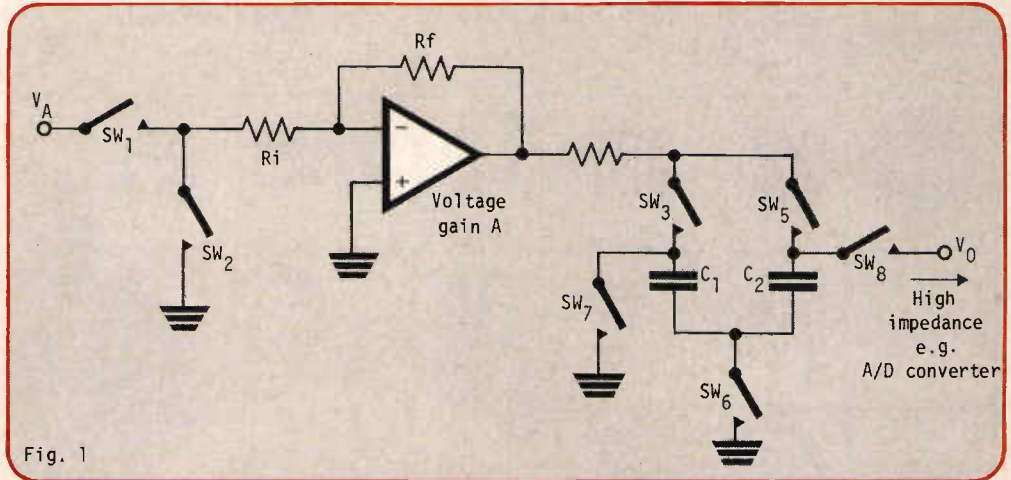

by ringing

0293
28700 **SASCO**

- * Ringing SASCO at *Crawley* saves you long-distance phone bills.
- * That *single call* puts you through direct to 26 top-line component ranges.
- * We'll give you price and availability answers, literally *in seconds*.
- * Your phone orders will be processed *fast* . . . one major SASCO customer is saving 50% on his phone bills !

SASCO PO Box 2000, 61/63 Gatwick Road, Crawley,
Sussex RH10 2RU Telex : 87131

SASCO . . . THE ON-LINE **BROADLINE** COMPONENT DISTRIBUTORS

APPLIED IDEAS

Current to frequency converter without insulation

An ordinary current to frequency converter intended for small current requires a switch with a high insulation in the *off* state. Its leakage current in this state should be lower than the current for conversion. If the current is in the nA region finding such an element is a serious problem.

There is a method of overcoming this problem and involves the use of silicon diode based on the principle that the diode has a high resistance at a low voltage.¹ The same characteristic of the diode is used in the quasi-logarithmic system.²

Figure 1 shows the block diagram of a conventional current to frequency converter. In the circuit resistor R_a is immaterial since its value is low enough, but switch S should have a small leakage in the *off* state.

To avoid this requirement the circuit has been slightly modified to that of Figure 2. The voltage between the amplifier inputs is very small and the diode has a high resistance. In this way the input current flows into the capacitor only. When the amplifier output becomes higher than a given discrimination voltage the multivibrator starts and activates the switch.

The multivibrator must provide a pulse large enough to provide discharge. After the pulse ends the current flows in the capacitor and the resistor R_a protects the amplifier from overload.

The minimum value of current which may be converted depends on the input resistance and the diode reverse current. At the present time this may be in the region of pico amps.

Figure 3 shows the complete converter circuit. The discriminator uses only one pnp transistor. The multivibrator is explained in an earlier article.³ The circuit works up to 10 kHz (10 μ A). With the capacitor at a value of 200 pF and a voltage excursion of 5 V the converter produces one pulse per 1 nA.

The circuit was experimentally tested with an amplifier composed of a fet differential source follower (2N5912 Siliconix) and amplifier 741S. The diode should be carefully chosen. The circuit may be used as a voltage to frequency converter by inserting a resistor at its input.

Dragoljub D. Damjanovic, Beograd, Yugoslavia.

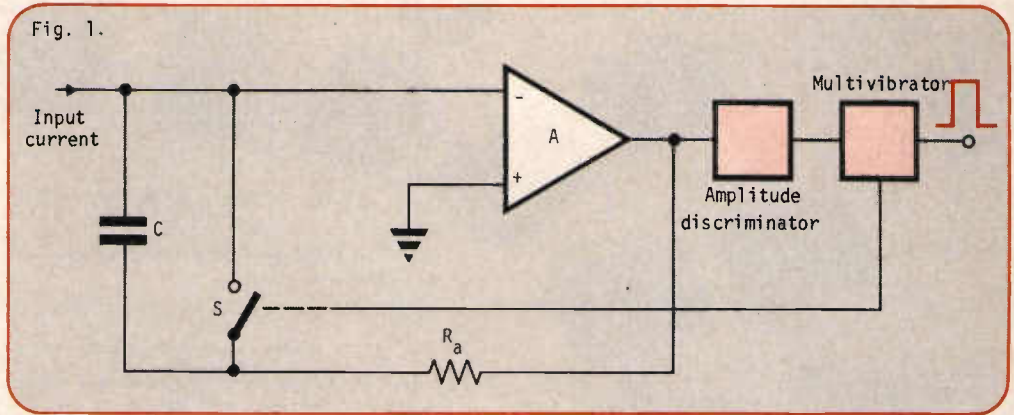

Fig. 1: Ordinary current-to-frequency converter requires switch with high insulation.

Fig. 2: A way to avoid the high insulation switch uses a silicon diode.

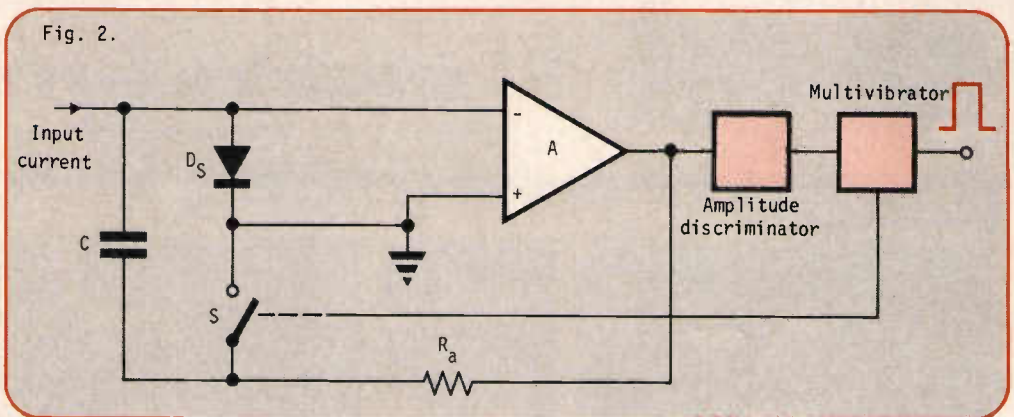
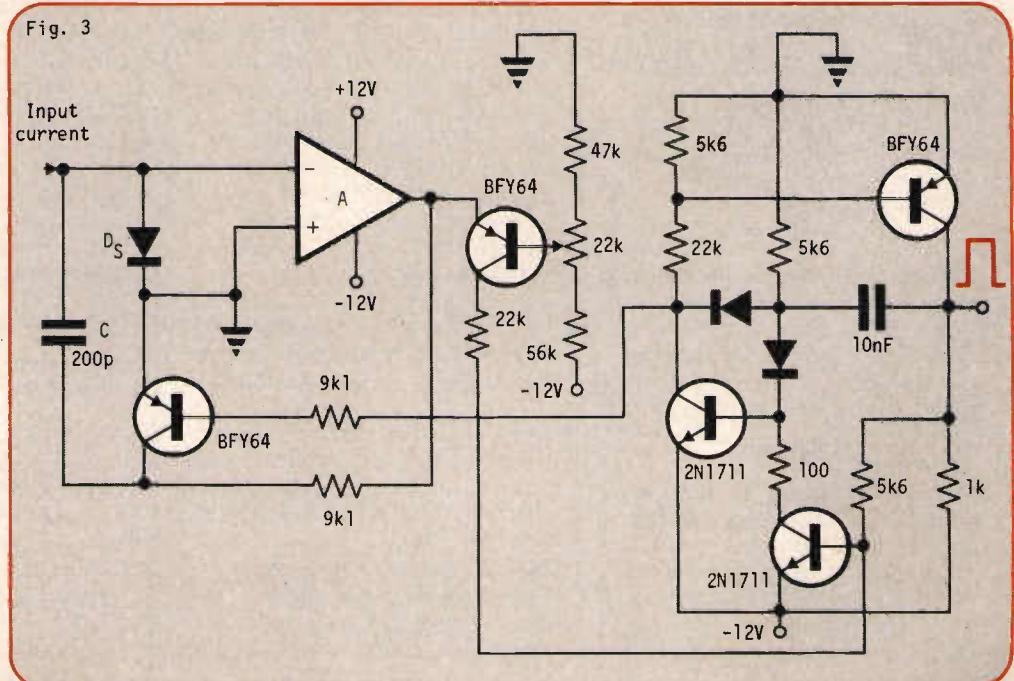

Fig. 3: A practical solution of the small-current-to-frequency converter.





'THE 1600 BLUES'
D - LD - CD - ?



NOW...
COUNT
LATCH
DECODE!

Spectra-Tek's NEW 1977 RANGE of DISPLAYS :-

- A. Are TTL or CMOS compatible or alternatively will accept pre-decoded information, i.e. 7-wire input.
- B. Will Decode, Latch Decode, Count Decode and now also Count Latch Decode.
- C. Give '*1' in Decode, Latch Decode and 7-wire only.
- D. Offer a choice of secondary functions available - e.g. Blanking and Ripple Blanking, or Blanking and Lamp Test, etc., etc. (See new Technical Data Sheet).

The New 1100 and 1600 Series with PCB's in blue punchable laminate look better than ever (though only the engineer sees this!).

All you need is our current Price List and Technical Data Sheet, Part I (Mod. A) and you can order EXACTLY what you need, using the new Code Number.
Digits Heights - 11, 14, 16, 26, 45 and 75mm.

SPECTRA-TEK UK LTD

OUTGANG ROAD PICKERING NORTH YORKSHIRE YO18 7EL ENGLAND Phone PICKERING (0751) 72941 Telex 57725 SPECTR

RIFA

Glass encapsulated 1A Diodes PAB 219

For immediate delivery
The original GE (USA) design, made under licence by Rifa.

Glass diodes in general are better than plastic diodes, with better performance, longer life, fewer breakdowns and hermetic sealing suitable for tough environments and for use in potted circuits.

RIFA PAB 219 glass diodes are better than ordinary glass diodes, for a number of reasons:-
1 Passivation The glass-powder manufacturing process is superior to the conventional method using two separate pieces of glass.

2 Overload resistance A well-known TV manufacturer compared 6 makes of similar glass diodes, to find the forward peak destruction current (1ms surge time). Most failed under 50A. Some reached 58, some 68A. RIFA PAB 219 consistently beat 90A.

3 High peak reverse power rating 1kW, 20µs, non-repetitive, half sine-wave!

4 Low Power Voltage drop is lower than in conventional glass diodes; 0.9V for 1A compared with the usual 0.96-0.99V. In a big circuit this adds up.

5 Dip-tinned leads Dip-tinning gives superior solderability. L. M. Ericsson, our biggest customer, insists on it, so you get the advantage at no extra cost.

PAB 219 diodes are ideal for Telecommunications, data transmission and computer peripheral circuits (long life and low

power); for TV, hi-fi and radio (less fire risk); for industrial and automobile electronics (mechanically strong and sealed against rough environments).

Nominal current is 1A but many customers use PAB 219 diodes up to 2.5A. Four standard voltages are available:-

- 200V: PAB 2192 (1N 5059)
- 400V: PAB 2194 (1N 5060)
- 600V: PAB 2196 (1N 5061)
- 800V: PAB 2198 (1N 5062)

Deliveries are good and prices are competitive. Send for full data.

Rifa AB, S-161 11 Bromma, Sweden.
Telephone Stockholm (8)26 26 00
Telex 10308. UK Distributors:
Adrian Electronics, Winslow, Bucks.
Telephone (029) 671 3535;
Jermyn Distribution, Sevenoaks, Kent.
Telephone (0752) 50144;
Cartwright Electronics, Glasgow.
Telephone (041) 429 7771.

Linearity



Would you believe one-part-in-a-million?

Design a DVM of this accuracy, add a true 0.00011% three month stability – without recalibration – and you're liable to create a credibility gap. That's what happened with our SM 215.

For there was no way that conventional design could achieve this unique spec'. Certainly not in a portable lab instrument capable of operating over a wide temperature range.

But we did it with a unique combination of two basically different techniques of digitisation. For the most significant decades we replaced the conventional resistor network with an inductive divider system. Then for the remaining decades we employed integrating dual ramp technology. The result – the best of both worlds. Standards room accuracy, while still retaining the outstanding noise rejection needed for routine measurements.

Now there's MK II – or to give its full title SM 215 MK II Programmable dc Voltage Transfer Standard/Digital Voltmeter – the world's most accurate DVM. We can hear you saying – "with a spec' like this who needs a Mark II?" Simply, to provide programmability for the ATE man. And would you believe that SM 215 MK II costs less than many lesser DVM's? Don't take our word for it. Let us demonstrate just how far ahead of conventional thinking it really is.



EMI SE Labs

SE LABS (EMI) LIMITED,
Spur Road, Feltham, Middlesex TW14 0TD, England.
Telephone: 01-890 1477. Telex: 23995.

A member of the EMI Group of companies. International leaders in music, electronics and leisure.

New portable DMMs.

Only Fluke make them - only ITT sell them.

New Fluke DMMs Fluke have introduced two new digital multimeters. That is big news in itself, because when you are already producing the best selling instruments on the market, how do you bring off another success? The answer has been to take an outstanding specification and shrink it into a truly portable instrument.

True RMS a.c. This is the most important feature - especially when you realise that it is incorporated in a battery operated instrument that measures less than 6 x 5 x 2½ in. and weighs only 2½ lb. It means that you can take lab. quality measurement out in the field, free from the shackles of size, weight and power points.

Two versions - 8030 & 8040 Both models offer five ranges over

five measurement functions and include autozero. The 8030 is a 3½ digit instrument with a useful diode test facility. The 8040 has 4½ digits and incorporates autoranging.

The only way to buy Both these briefcase sized DMMs are available from ITT Instrument Services; and from nobody else, not even from Fluke. Which brings together the best sellers among portable DMMs and the biggest name in the instrument distribution business. That means no-delay telephone ordering, streamlined internal processing, and delivery from stock.

Ask for a spec. sheet now. Or better still, get ITT to arrange a demo. You will be more amazed by the performance than the price!

Fill in this coupon for your copy of the data sheet on the 8030 and 8040 and send it to:

ITT Instrument Services.
Edinburgh Way, Harlow, Essex.

Name _____

Company _____

Address _____

Tel No _____

ITT instrument services

The only way to buy.

Harlow (0279) 29522.

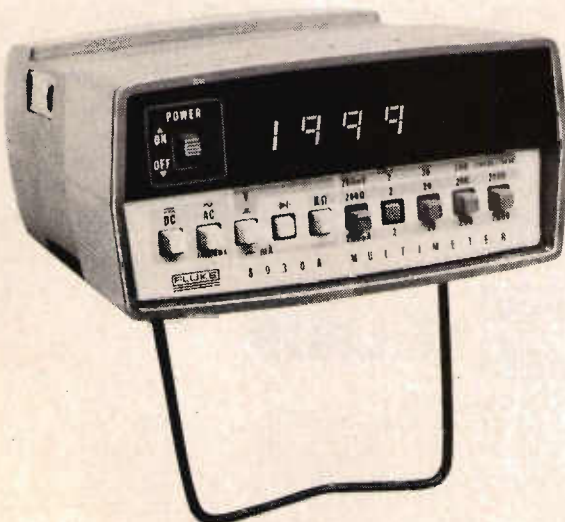

APPLIED IDEAS

Complement adders give unambiguous zero output

It is common practice to enter and display negative numbers in sign and amplitude form. However, in digital circuits it is often more efficient to handle negative numbers as a complement since the hardware for addition and subtraction remain the same.

Two types of complements, true and radix minus one are possible for each number system. They are the one's and two's and, the nine's and ten's complement in binary and decimal systems respectively. In certain applications, despite the slow speed of operation due to an *end around carry*, one's and nine's complement adders are preferred.

However the main drawback is that the circuit is sequential in operation due to feedback from the carry out to the least significant bit. This means that the output depends on the previous input giving two versions of the zero output +0 and -0. This poses a problem for further checking, controlling and arithmetic operation. The unwanted -0 output can be eliminated by the addition of extra gates in the feedback loop of the complement adders. A four bit one's complement adder shown in Fig. 1 uses a conventional binary adder with the carry out bit, C_o , feedback to the carry in, C_{in} . The msb of the two inputs and C_{in} are exclusive or'd to obtain the msb of the

output. This configuration places no constraint on the inputs a and b so that they may have positive and negative values.

The unwanted zero is removed by *anding* the inputs S_0 to S_3 and *oring* the output of this gate with C_o before feeding into C_{in} as shown by the dotted line. As

soon as the sum outputs are all equal to *one*, C_{in} goes to *one* and forces all the sum outputs to *zero* and C_o to *one*. A delay, at least equal to the propagation delay from C_{in} to C_o has to be introduced between the *and* and *or* gates to avoid the *or* gate becoming *zero* as the sum

outputs go to *zero*.

After a propagation delay of t_p , C_o and C_{in} become *one* keeping the sum outputs at *zero*. So only the 00000 version of the zero output is possible. The nine's complement adder can be constructed in the same way. S. Murugesan, Bangalore, India.

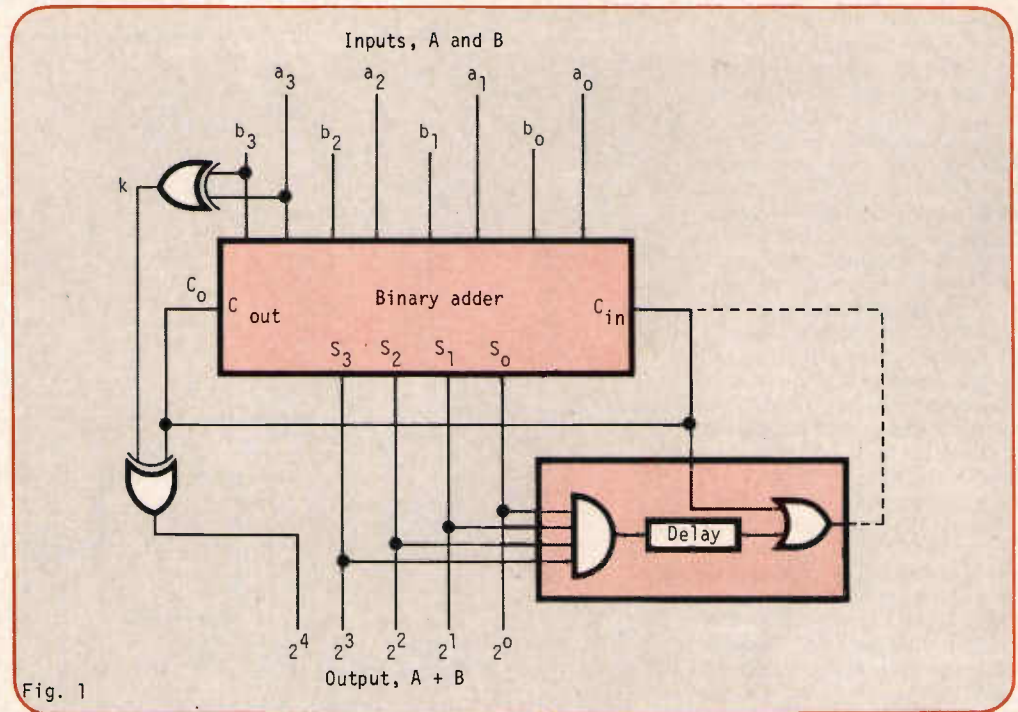

Fig. 1

Flip-flop helps in multiplexing control bits

Sometimes one process may need to be controlled from two panels which are separated by a considerable distance. In such a case a simple select switch will not do since it may be inaccessible to one of the panels.

Instead the multiplexing can be controlled by means of an RS flip-flop (see Fig. 1) which can be reset and set from panel 1 and panel 2 respectively (by means of pushbuttons). A simple led display can indicate the state of the flip flop. If the control is to be exercised from more than two panels a circuit discussed in the reference paper can be used with a suitable multiplexer.

A. Mageswaran, Radio Astronomy Centre, Tamil Nadu, India.

Reference
Elias, Jack: Latch circuits interlock switches electronically. *Electronics*, January 9, 1975, p. 11.

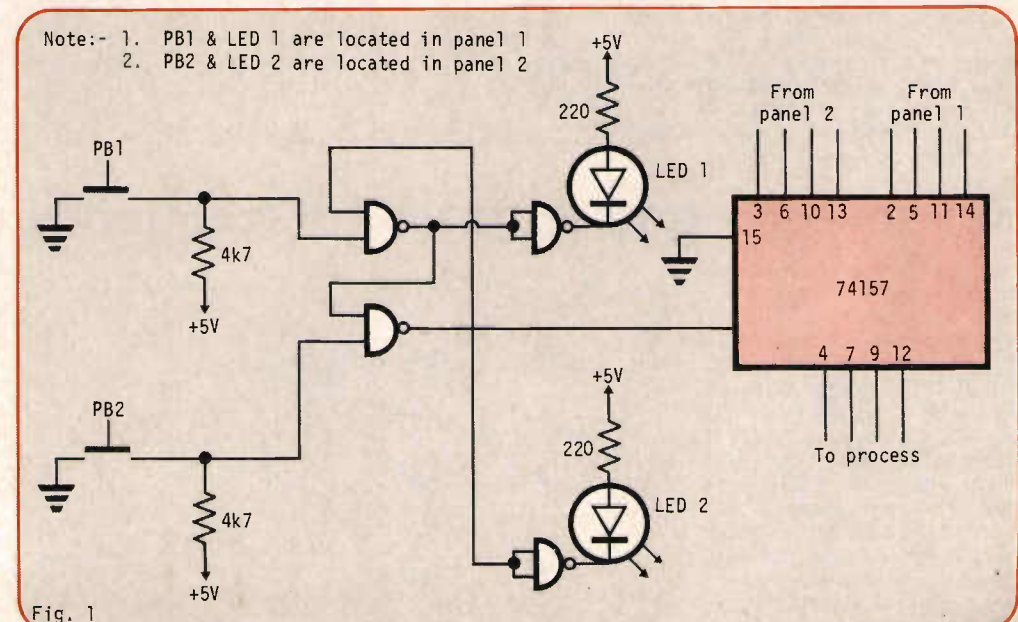

Fig. 1

APPLIED IDEAS

RAM storage adaptor for oscilloscopes

Long term monitoring of signal trains is often necessary in digital measurements. To handle this task two types of oscilloscopes are used; storage and long persistence types. The prices of both are high and their use may sometimes be complicated.

The adaptor described here breaks up the input pulse train and stores the result into a ram. Once the storage capacity of the ram is filled the cycle is ended and the repeated waveform of the pulse train is displayed.

The storage time can be set by adjusting the time capacitor. This period is 252 times longer than the cycle time of the schmitt trigger oscillator. A pushbutton starts the storage cycle and ICS1-4 are cleared. On release of the pushbutton the oscillator steps IC1 to the fourth count and the oscillator stops. During the first four steps the starting level is written into the ram. The storage process of the signal train begins on the effect of its signal transition. The output of IC3 changes and enables the oscillator which operates the storage process for IC5 and the ram. When the output of the oscillator goes low the ram can be written into and as it goes high the counters IC1 and IC2 step so incrementing the ram address. At the end of the cycle (256 counts) further writing is inhibited but the oscillator continues to count and the ram contents are displayed.

The sync out line serves for oscilloscope triggering. Resolution of the waveform can be improved by increasing the storage capacity of the ram and the circuit can be used for storing more than one train.

Deáki Tibor, Hungary.

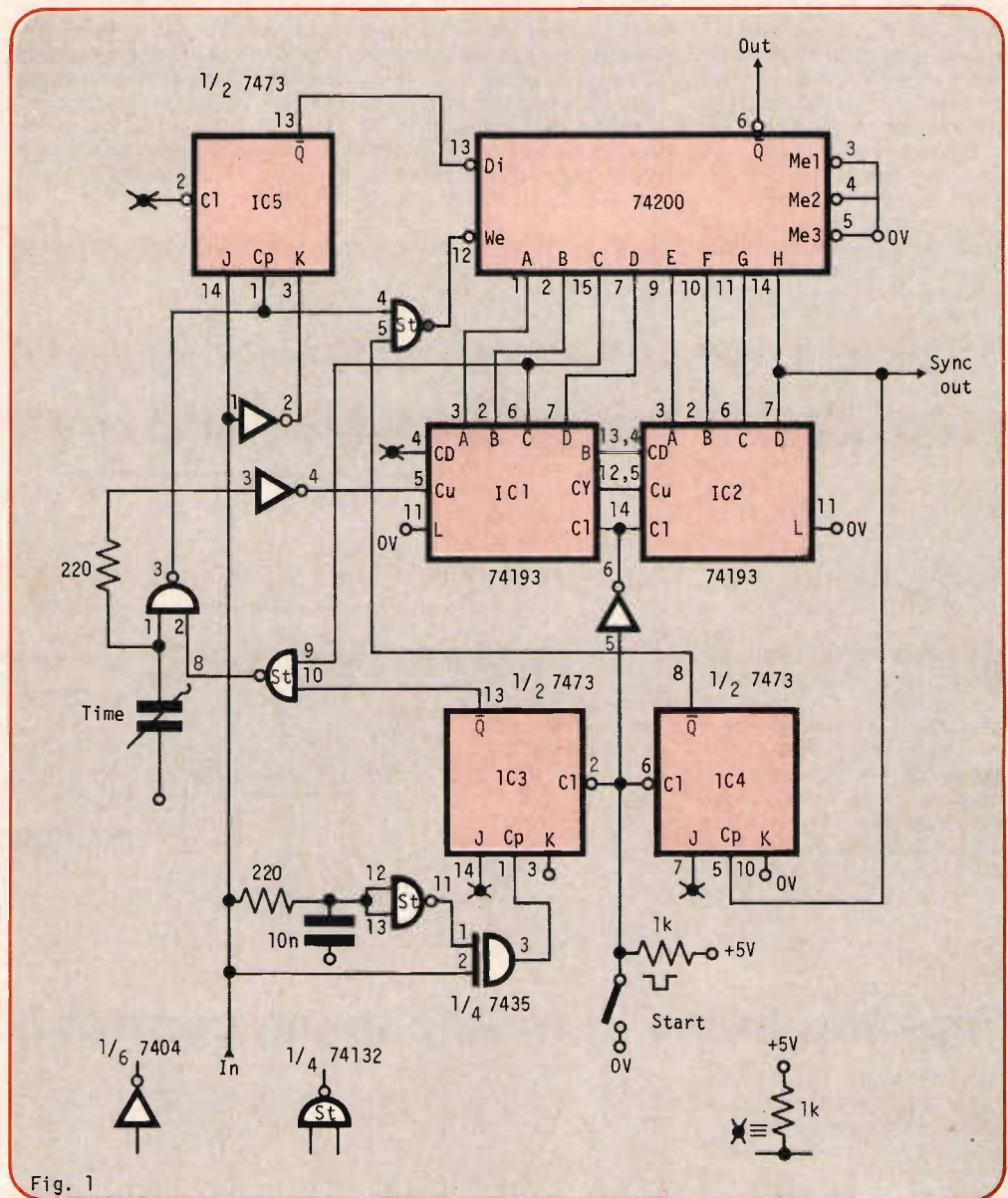

Fig. 1

Hex inverter and or gates for frequency doubler

Digital frequency doublers are frequently used in many electronic systems. Basically they require a monostable multivibrator which is triggered at both edges of the square pulse. Despite the fact that this technique is a successful one, it is limited by the pre adjusted pulse width which the multivibrator provides. This means that there is an upper limit of operation. This limitation is often lifted by the use of a feedback loop which complicates the circuit.

A simpler method is in Fig. 1.

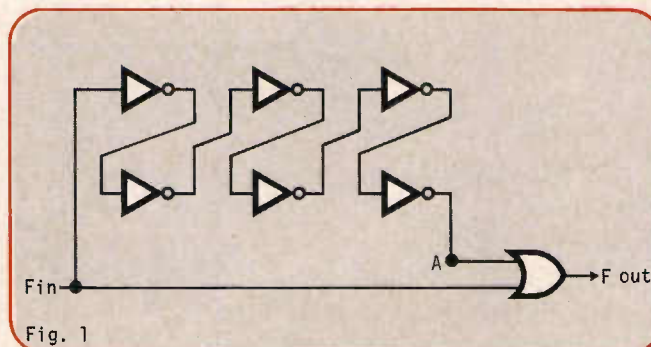

Fig. 1

When delayed pulses are exclusively *ored* with original ones then two pulses of 120 nsec each are obtained.

The number of inverters in the delay path may be increased or decreased as desired. A difference in the output pulse width is observed depending on the number of inverters employed. If the number is even then an output as in Fig. 2a is obtained. If the number is odd the output appears as in Figure 2b.

Stamatios V. Kartalopoulos, Toledo University, Ohio 43606.

APPLIED IDEAS

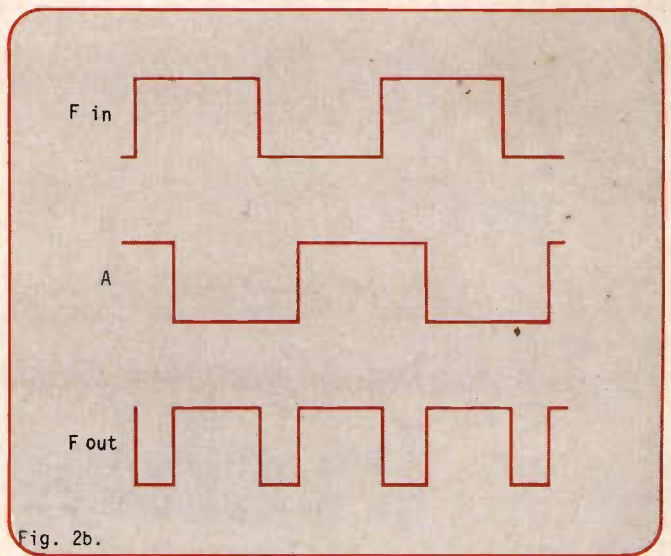
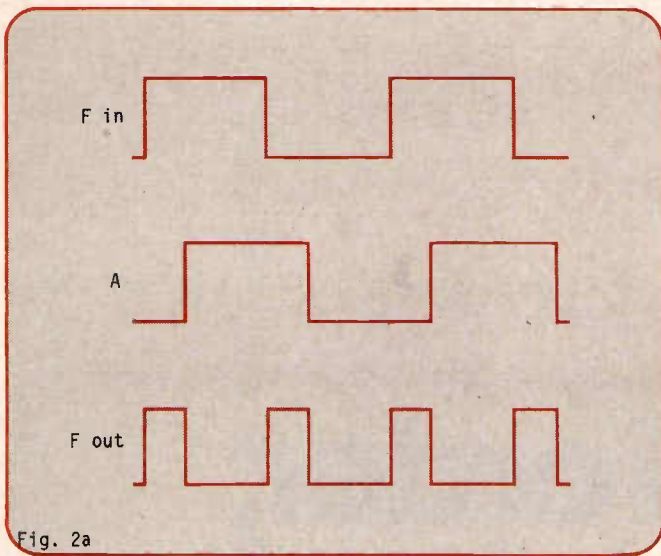

Low power cassette data recorder

A low power 0-500 Hz recorder data may be realised using a cmos phase locked loop and an LM3900N in conjunction with any cheap audio cassette.

The circuit consists of an LM3900N voltage controlled oscillator which is biased at

about 5 kHz for 0V input. This means that a $\pm 5V$ input will result in a frequency output of ± 5 kHz. Variable resistor VR1 sets the oscillator for 5 kHz with the input shortcircuited. The output is then fed to a 4046 cmos PLL which is set for 0V input

and 5 kHz free run via VR2. The output of the 4046 is then fed into a 1 kHz low pass filter to remove the carrier signal.

The system accuracy is dependent on the cassettes performance, wow and flutter and the accuracy to which the vco and

PLL are set. The circuit will operate from the cassette voltage supply and may be regulated by using the zener diode on the 4046 chip. The total current drain is between 10-20 mA depending on the load.

Vernon Boyd, Cambridge.

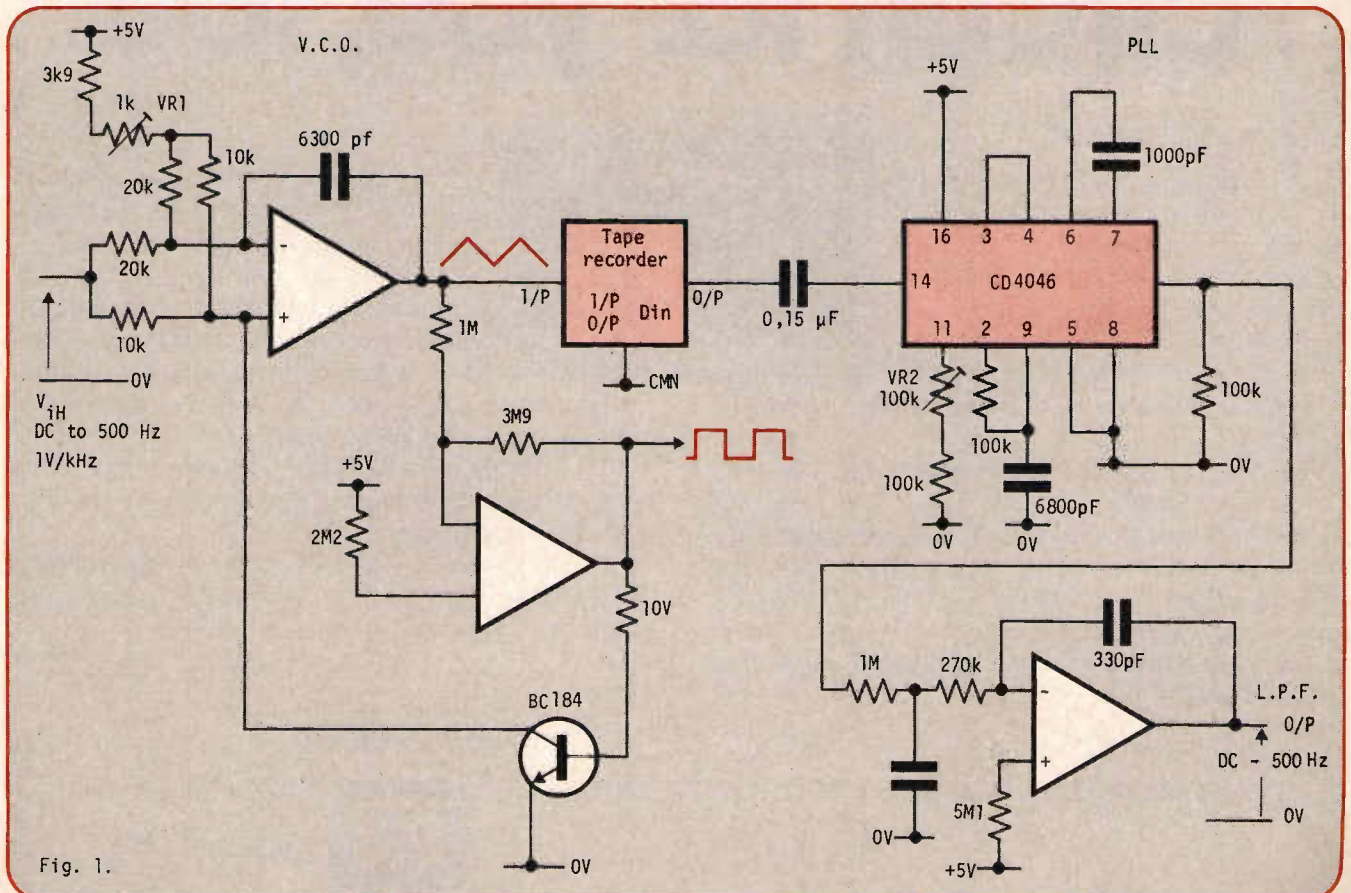

Our microprocessor is masterminding a major line of microwave ovens.

In short order, we can cook up an appliance control circuit for you, too.

There's a revolution simmering in a microwave oven. With the sweet smell of success. We're glad to say, it's the one with our microprocessor in it. Controlling the cooking. The defrosting. Even the time to even out the temperature in between. Controlling the program and the reset. The display of the time or the timing.

Everything. Right down to the beep. Electronically.

Activated by not even a button, but only a touch. It's the first microwave oven with Total Electronic Control. Which probably makes it the most sophisticated kitchen appliance in the world today. And it's only a matter of time before other appliances follow the lead.

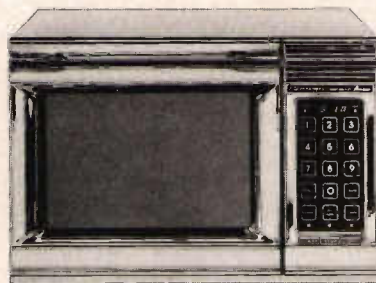

Because the time has come for the Total Electronic Control. As surely as it is running out for the electro-mechanical control. Which, in the long run, cannot compete. Not in feature-oriented consumer appliances. Not when one circuit can carry in it the control features for a whole line, top to bottom, and be the one-item basis for a whole inventory.

This "no-cost/low-cost" features concept of the Total Electronic Control cannot be denied. Not for long. Not in the marketplace.

It's the kind of control, we believe, you will want in your home appliances. For it's the kind of control, we believe, the consumer will have in hers.

We help you compete.

GENERAL INSTRUMENT MICROELECTRONICS LTD



57-61, Mortimer Street,
London, W1N 7TD
England.
Telephone: 01-636 2022
Telex: 23272

APPLIED IDEAS

Constant speed for a permanent magnet motor

In any applications where permanent magnets are used it would be useful to maintain a constant speed under a variety of loads. Consider the speed equation for such a machine

$$V = \frac{E_a - R_a I_a}{K \phi}$$

It can be seen that to achieve a speed V which is constant and directly proportional to the applied voltage E_a the term $R_a I_a$ must go to zero. This can be accomplished by the introduction of a term $-R$ which is equal in magnitude to the armature resistance R_a . The speed equation then becomes:

$$V = \frac{E_a - (R_a - R) I_a}{K \phi}$$

and with $R = R_a$, $V = E_a / K \phi$
This cancellation can be rea-

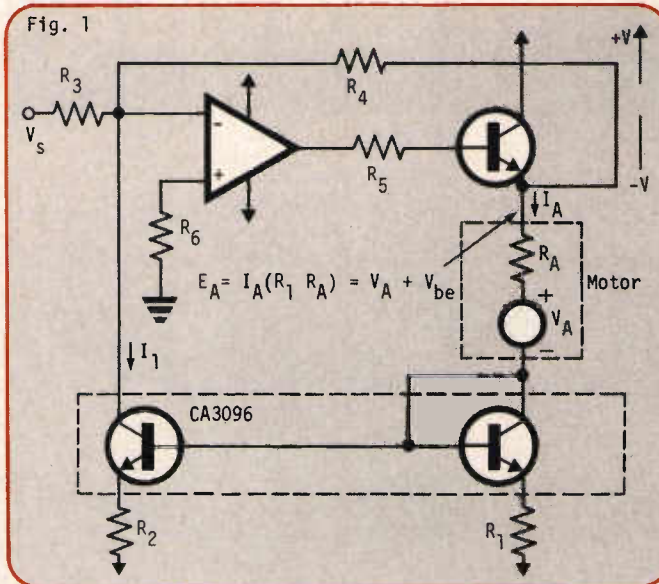

lised by the circuit shown.

At point A

$$E_a = I_a(R_a R_1) + V_a + V_{be} \quad (1)$$

$$I_1 - I_a R_1 / R_2 \quad (2)$$

$$I_1 = V_s / R_3 + E_a / R_4 \quad (3)$$

$$\text{Equations 1 and 2 into 3 results in } V_a = I_a(R_1(R_4/R_2 - 1) - R_a) - V_s R_4 / R_3 - V_{be}$$

To compensate for R_a ,

$$R_a = (R_4/R_2 - 1)R_1.$$

Thus from $V_s < 0$ and $V_s R_4 / R_3 > V_{be}$: $V_a = V_s R_4 / R_3$.

Also R_2 should be very much greater than R_1 .

Thus if the dc value of R_a is measured and R_1 , R_2 and R_3 are selected to compensate, the resulting armature voltage will be constant and consequently the speed will be constant. A variety of circuits of this form may be realised to use both dual and single power supplies.

R. McGillivray, Toronto.

Automotive battery voltage indicator for 12 volts

An indication of battery voltage is useful to the motorist in many ways such as monitoring the battery's capacity to deliver current and as a check on the efficiency of the dynamo and regulator. The circuit described is a solid state alternative to a moving coil meter. Table 1 shows the output which uses three different colour leds to give an indication of the battery

voltage over the critical range 10 to 14 V.

When the voltage is less than 10 V transistors Tr_2 , Tr_3 and Tr_4 are off and Tr_1 is turned on with a base current via R_2 , R_3 and led_2 illuminating led_1 . As the voltage rises above 10 V the Zener diode Z_1 begins to conduct, Tr_2 receives its base current via R_4 and turns Tr_1 off.

At approximately 11 V both

led_1 and led_2 are lit while at 12 V Tr_2 is on, led_2 has reached its full brightness while Tr_1 is off so turning led_1 off. Similarly led_3 is turned on by Tr_4 as the voltage rises to 14 V and Z_2 conducts. Tr_3 takes current away from led_2 and turns it off by shorting it out while Tr_2 remains in conduction to keep led_1 off. The circuit can be easily modified for different voltages by changing zener

diodes or extended by adding alternating polarity versions of Tr_3 and Tr_4 .

P. H. Boyce, Swindon, Wilts.

Red	Yellow	Green	Voltage
1	0	0	≤ 10 V
1	1	0	11 V
0	1	0	12 V
0	1	1	13 V
0	0	1	≥ 14 V

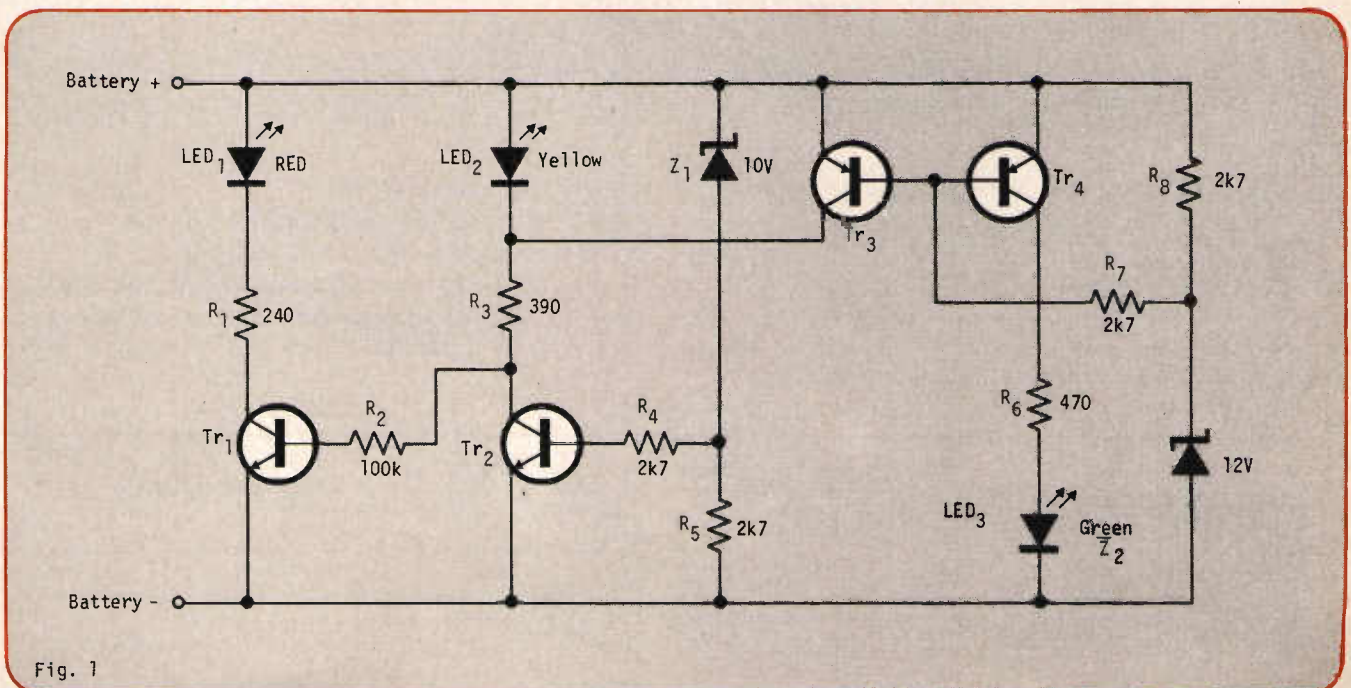

Looking for performance, reliability and price in miniature plug-in relays?



We are one of the largest manufacturers of miniature plug-in relays in Europe.

The Miniaturised Bi-stable polarised relay type VPR and the P.O. approved relay type 23 are but two from a range used and approved throughout

the electronics world.

Each is built to uncompromising quality standards . . . with ultrasonic cleaning throughout coupled with exacting performance and timing checks.

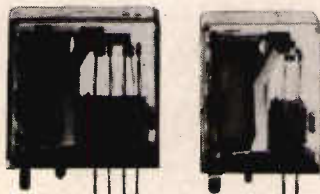

The same goes for our AC range.

These miniature plug-in relays have the same physical dimensions as the DC range. Shown: 2 and 4-contact versions. For all the help you need, contact Varley Technicians now or send for the catalogue.

Oliver Pell Control Ltd.,
Cambridge Row, Burrage Road, London SE18 7JN.
Tel: 01-854 1422 Telex: 897071

Name _____

Company _____

Address _____

EE12/76

APPLIED IDEAS

Programme generates N phase oscillations

Consider first the generation of a 2-phase waveform by micro-processor. Initial values of say $\sin = 0$ and $\cos = 1$ are first set in. Then the sum of two angles formulae:

$$\sin(n+\omega) = \sin n \cdot \cos \omega$$

$$+\sin \omega \cdot \cos n \dots \dots \dots (1)$$

$$\cos(n+\omega) = \cos n \cdot \cos \omega$$

$$-\sin \omega \cdot \sin n \dots \dots \dots (2)$$

is repeatedly performed. Here n is the current values and ω is the step size. If ω is to be 5° then the $(n+1)$ th sine and cosine values are

$$\sin(n+1) = (\sin n) (0,99)$$

$$+(0,087) \cos n$$

$$\cos(n+1) = (\cos n) (0,99)$$

$$-(0,087) \sin n$$

Such a procedure will result in a sinusoidal sequence of values where, if an analogue waveform is required a digital and analogue converter is used. But the system is not useful as the maximum amplitude attained per cycle diminishes finally to zero. This is entirely

due to the finite word-length used for the factors $\sin 5^\circ$ and $\cos 5^\circ$. But because of this no reduction in amplitude occurs over any number of cycles if the following approximation is used. Consider that:

$$\text{as } \omega \text{ tends to zero, } \cos \omega \text{ tends to } 1 \dots \dots \dots (3)$$

$$\text{as } \omega \text{ tends to zero, } \sin \omega \text{ tends to } \omega \dots \dots \dots (4)$$

In (4), ω is in radians, for example, if $\omega = 1^\circ$ then

$$\sin 1^\circ = 0,017452$$

Finally, substituting (3) and (4) into (1) gives,

$$\sin(n+\omega) = \sin n + \omega \cdot \cos n$$

$$\dots \dots \dots (5)$$

For the cosine, substituting (3) and (4) into (2), gives,

$$\cos(n+\omega) = \cos n - \omega \cdot \sin n$$

$$\dots \dots \dots (6)$$

Where ω is the step-size.

Approximation (5) and (6) when continuously repeated produce a sine-wave sequence of values with a period of $2\pi/\omega$ steps. The smaller is ω the

smaller the error, which is sinusoidal with a period of $1/\omega$ cycles. Modulation in amplitude is performed by the addition of a constant k thus, $\sin(n+\omega) = \sin n + \omega \cdot \cos n + k$

The amplitude is increased in the ratio $1+k/\omega$. If the omega factor differs for sin and cosine then the number of steps per cycle is $2\pi/\sqrt{\omega_1 \omega_2}$.

Phase modulation can be performed by computing, $\sin(n+\omega) = A \cdot \sin n + \omega \cdot \cos n$
 $\cos(n+\omega) = (1/A) \cdot \cos n - \omega \cdot \sin n$

Where $A = 1 + \omega \cdot \sin \theta$ and θ = the required phase change. The last is demonstrated in Table 1 for a phase change (θ) of 40° , with $\omega = 0,5$ radians ($= 28,6^\circ$). From which $A = 1,32$. Fig. 1 is a plot of Table 1.

Such sequences of sinusoidal values are an ideal medium for waveform synthesis and it is a

natural extension of the approximation (5) and (6) to a 3-phase system where the three phases A, B and C are 120° apart. One cycle of oscillation is tabulated in Table 2 where, for ease of working $\omega = 0,4$ ($= 39^\circ$).

Figure 2 shows the actual results to a graph plotter for a 5-phase system. The program is shown in Table 3. Here $\omega = 0,04$. For 5-phase each phase is $360/5 = 72^\circ$ apart. Therefore initial values were $A = 0$, $B = \sin 72^\circ$, $C = \sin 144^\circ$; $D = \sin 216^\circ$; $E = \sin 288^\circ$.

However, in a 3-phase system the number of steps per cycle is found to be $2\pi\sqrt{3}/\omega$
N. Darwood, Feltham, Middx.

Table 3. 5-phase approximation

$A = A + \omega(B - C + D - E)$
$B = B + \omega(C - D + E - A)$
$C = C + \omega(D - E + A - B)$
$D = D + \omega(E - A + B - C)$
$E = E + \omega(A - B + C - D)$

Table 1 Phase change of 40° with $\omega = 0,5$ radians

STEP	SIN = $A \sin n + 0,5 \cdot \cos n$	COS = $(1/A) \cos n - 0,5 \cdot \sin n$
0	0	100,0
1	$0 + 50 = 50$	$75,7 - 25 = 50,7$
2	$66 + 25 = 91$	$38 - 45 = -7$
3	$120 + -4 = 116$	$-5 - 58 = -63$
4	$153 + -31 = 121$	-108
5	103	-133
6	ETC	69
7	23	-114
8	-26	-73
9	-71	-19
10	-103	37
11	-117	87
12	-110	121
13	-84	134
14	-44	123
15	-40	91

Table 2

STEP	$A = A + 0,4(B - C)$ $B = B + 0,4(C - A)$ $C = C + 0,4(A - B)$
0	$A = 0$ $B = 100$ $C = -100$ } INITIAL VALUES
1	$A = 0 + 0,4(100 + 100) = 80$ $B = 100 + 0,4(-100 - 80) = 28$ $C = -100 + 0,4(80 - 28) = -79$
2	$A = 80 + 0,4(28 + 79) = 123$ $B = 28 + 0,4(-79 - 123) = -53$ $C = -79 + 0,4(123 + 53) = -9$
3	$A = 123 + 0,4(-53 + 9) = 105$ $B = -53 + 0,4(-9 - 105) = -98$ $C = -9 + 0,4(105 + 98) = 72$
4	$A = 105 + 0,4(-98 - 72) = 37$ $B = -98 + 0,4(72 - 37) = -84$ $C = 72 + 0,4(37 + 84) = 120$
5	$A = 37 + 0,4(-84 - 120) = -44$ $B = -84 + 0,4(120 + 44) = 18$ $C = 120 + 0,4(-44 - 18) = 95$

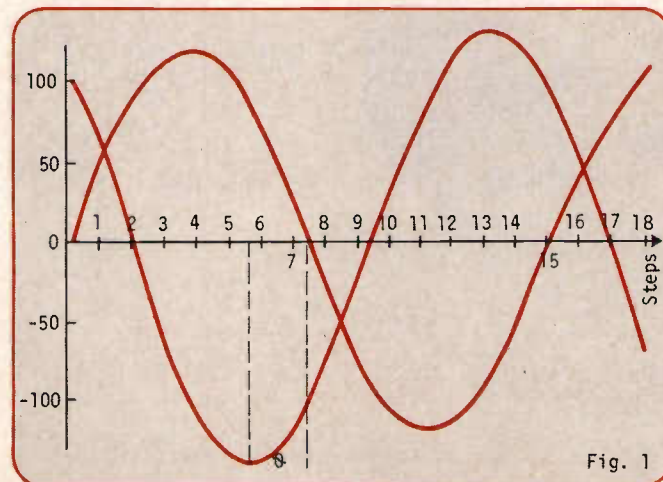

Fig. 1

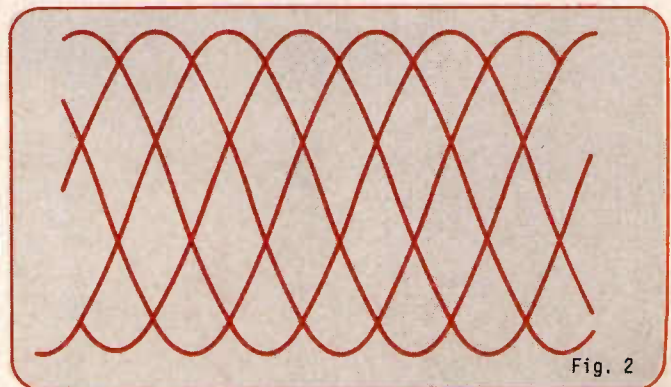
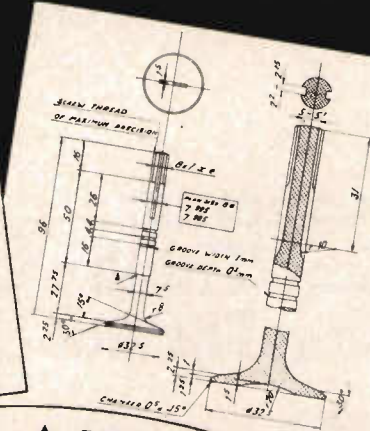

Fig. 2

YOUR OWN LABELS IN HOUSE, IN MINUTES WITH 3M SCOTCHCAL PHOTOLABEL SYSTEM

DO-IT-YOURSELF

All you need is an ultra-violet light source and a 3M one-step developer. No training needed.



Precise
Perfect reproduction of simple or complex images from any black on translucent artwork.

VERSATILE

Identification tags, instruction panels, warning plaques, nameplates, instrument dial faces, circuit diagrams, badges etc.

WARNING:
Eye Protection required

TERMINAL BLOCK A

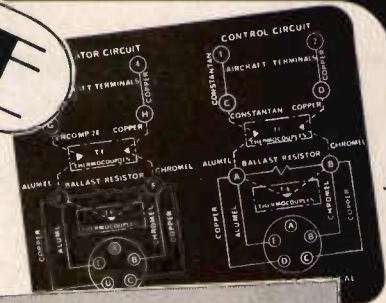
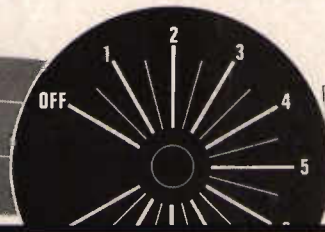
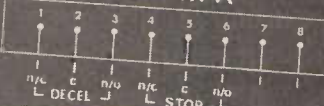

J. WOOLYARDS
Manager

COLOURFUL A choice of colour combinations for maximum eye-appeal and visibility.

TOUGH Indefinite indoor life. 1-3 years outdoor life.

SELF-ADHESIVE No screws to fix, no holes to drill.

ECONOMICAL Labels cost about 2½p per square inch.

QUICK Easy, three stage process takes 5-15 minutes. No darkroom, no waiting for outsiders.

FREE DEMONSTRATION

Return coupon to arrange a free demonstration on your premises. And discover for yourself why corporations like British Rail, BAC and the RAF are making their marks with 'Scotchcal' Photolabels from 3M.

Complete the coupon for your **FREE DEMONSTRATION** or for your **INTRODUCTORY KIT**

£3 INTRODUCTORY KIT

If you prefer, send £3 with the coupon for a complete introductory kit. All you need is an ultra-violet light source. Your £3 kit contains everything else for your first set of photolabels. (Sorry, only one kit per person.)

3M UNITED KINGDOM LIMITED
Regd. Office: 3M House, Wigmore Street, London W1A 1ET
Eire Telephone Dublin 851555
3M and Scotchcal are trade marks.

Regd. No. 241888.

To D. Graddon, Decorative Products Group, 3M United Kingdom Limited, FREEPOST 18 London W1E 1YZ. I should like to know more about your Photolabel System.

- Please arrange a free demonstration.
- Please send me your introductory kit. I enclose cheque/PO for £3, made payable to 3M United Kingdom Limited.
- Please send further literature.

NAME _____
TITLE _____
COMPANY _____
INDUSTRY _____
ADDRESS _____
TEL. NO. _____

EE 12/76

Photolabel





Thinking Economic Tape Readers? Think Data Precision FER 201

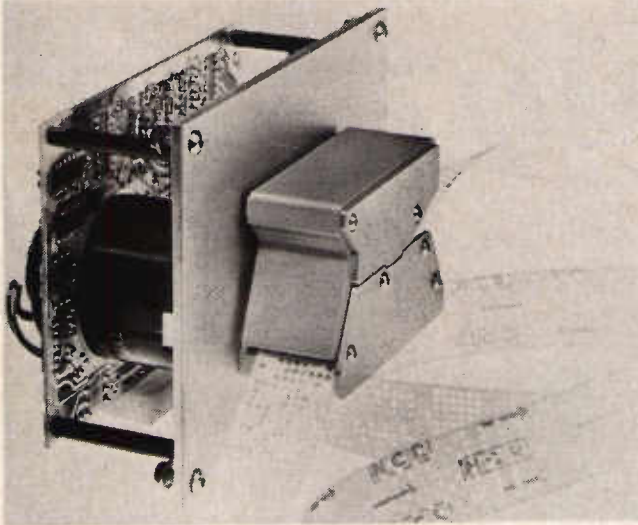

Although priced at only £185.00 with generous quantity discounts, the Data Precision FER201 operates up to 250 characters/second and is bi-directional.

Total control and interface logic is mounted on a single card while a stepping motor, mounted directly onto the back of the read head helps to keep the design simple and the device exceptionally silent in operation.

No preventive maintenance is necessary.

All 5 and 8 track tapes to ECMA and DIN standards etc. and a transparency up to 70% for infra-red are acceptable.

The reader can be supplied as a complete unit for customer mounting into their own panels or with 19" rack, tape spooling or fanfold cassette.

THINK Data Precision

Data Precision (Equipment) Ltd
81 Goldsworth Road, Woking, Surrey GU21 1LJ
Telephone: Woking (04862) 67420 & 64444

NORTHERN SALES OFFICE
98 Kenworthy Lane, Manchester M22 4BE
Telephone: Wythenshawe (061-998) 2612

ERMA-BUCHANAN THE CRIMPING TOOLS THAT KEEP IN STEP WITH CONNECTOR MINIATURISATION!

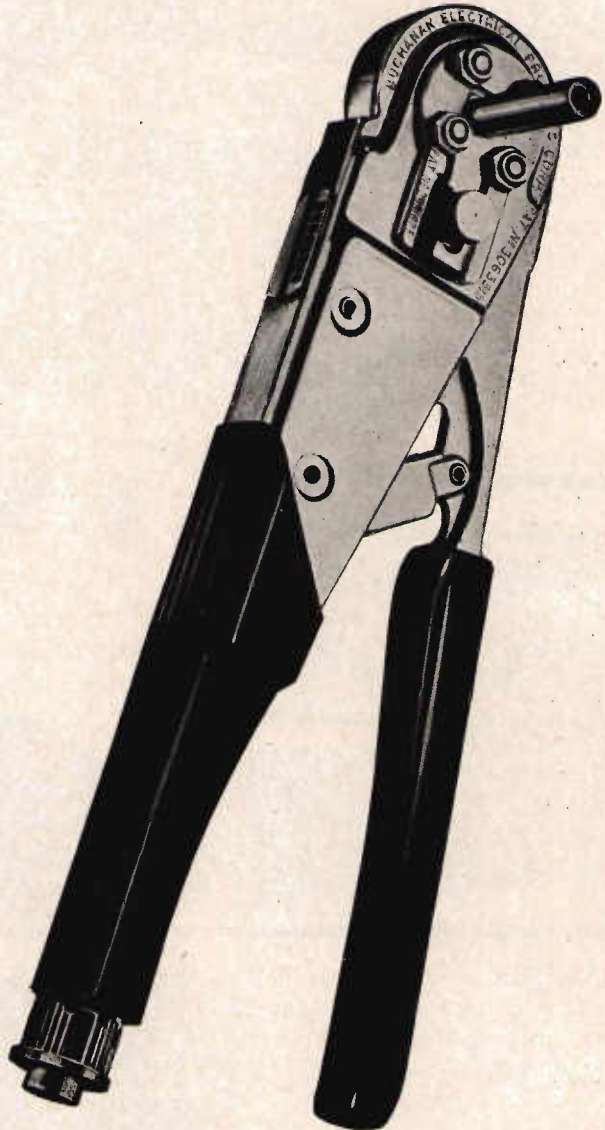

The Microcrimp Tool crimps even the smallest contacts

Deals with solid and stranded conductors

Infinitely adjustable crimping depth with direct reading indicator

Ratchet control

Can be locked after setting

For this and other tools to cover all your crimping needs write to



ERMA LIMITED

Mount Pleasant, Alperton, Wembley, Middlesex
Telephone: (01) 903-4561 Telex 264229

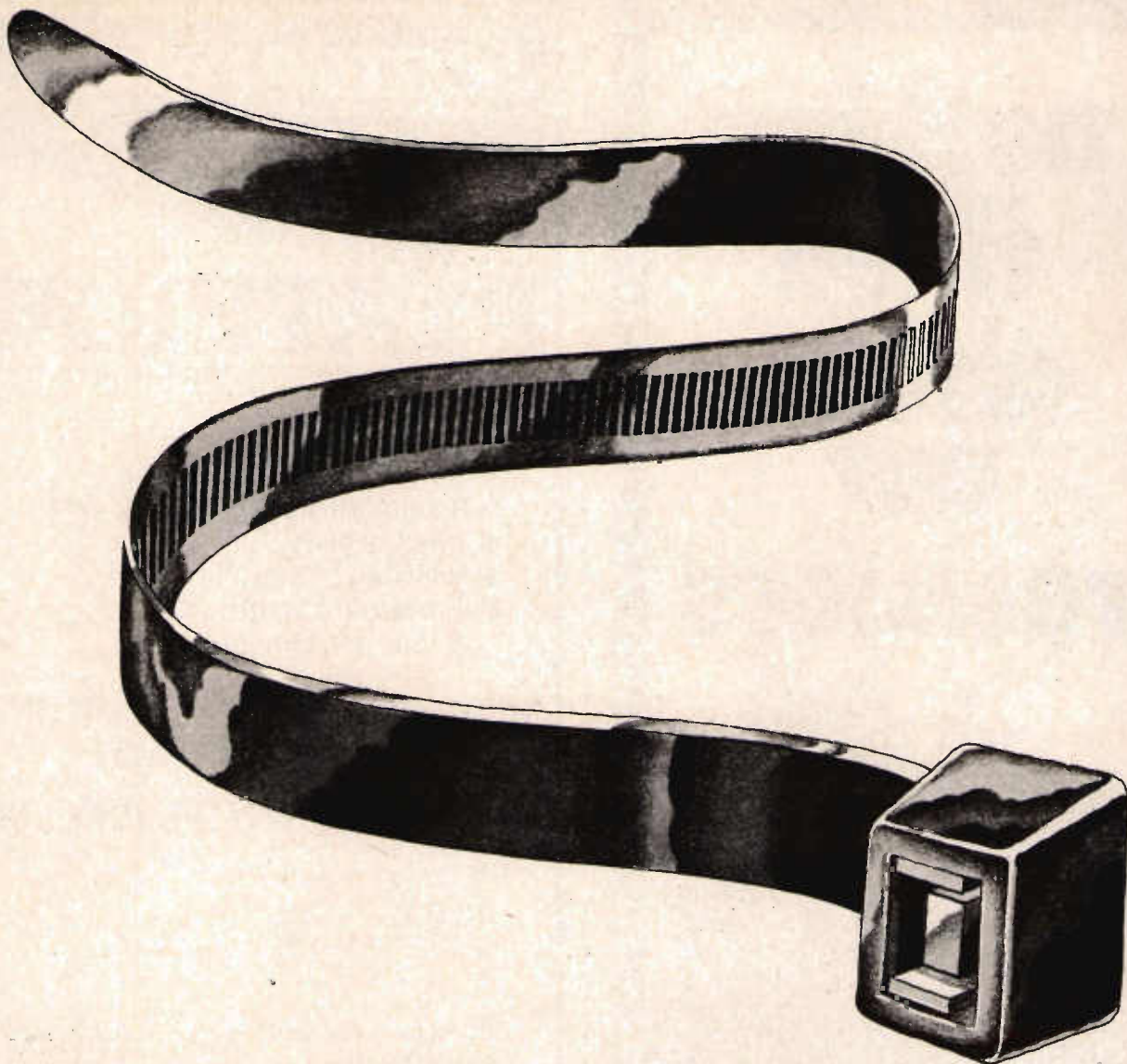

Currently travelling at twice the speed of sound

You'll find Hellermann Insuloid products travelling supersonically on the Concorde, keeping wiring harnessed safely, efficiently and permanently.

Hellermann Insuloid products are used at the frontiers of technology as well as in down-to-earth applications, like washing machines, telephone exchanges, hi-fi sets, underground trains - anywhere you have cables that need fixing, securing, hanging, identifying or protecting.

Hellermann Insuloid is a division of the Bowthorpe-Hellermann Group - established leaders in 'Cable Care'. The company manufactures a complete and diverse range of cable tie harnessing systems and accessories including Insulok cable ties, cable saddles, bridge saddles,

insulated cable clips and clamps, flexible trunking, hose clips, terminal shrouds, harness breakouts and bus bar insulation. Everything in fact, that you need to fix, hang, secure, label or protect wire and cables.

All products are designed to MOA, ARB and US military specifications and are backed by a complete design and application service.

If you have a cable harnessing problem - move fast. Contact Hellermann Insuloid today.

insuloid
Hellermann Insuloid
 Wythenshawe, Manchester M22 4RH
 Tel: 061-998 5415/6/7. Telex: 667657



THE BOWTHORPE-HELLERMANN GROUP CONNECTIONS THROUGHOUT THE WORLD

Hellermann Deutsch · Hellermann Electronic Components · Hellermann Electric · Hellermann Insuloid · Bowthorpe-EMP · Bowthorpe-Hellermann Distributors
 Power Development Ltd · Hellermann Cassettes Ltd · Hiatt & Co. Ltd □ The Bowthorpe-Hellermann Group, Gatwick Road, Crawley, West Sussex.

nothing fixed about our resistors



You can have them virtually
any way you want them.

Spirals. Tubulars. Hexagonals.
Mica-cards. From 12W - 3kW.
Single or ganged.

You name it - we'll supply it.

Claude Lyons Controls Ltd
Ware Road, Hoddesdon, Herts. EN11 9DX.
Tel: Hoddesdon 67161 Telex: 22724

CLAUDE LYONS CONTROLS LTD

Temperature Sensing?

NEW

PLATFILM

PLATINUM RESISTANCE TEMPERATURE DETECTORS

- * Resistance $100 \pm 0.1\Omega$
- * BS1904 Grade II (DIN43760)
- * Temperature range -50 to $+500^\circ\text{C}$
- * Alumina body
- * Available ex stock
- * One size for single and
double detector units

**MEET 90% OF APPLICATIONS
AT 20% LESS COST**

VERY COMPETITIVE PRICES!

PF41 Single unit
£2.60 each + VAT
Minimum order *50 units

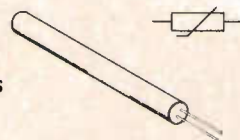

PF42 Double unit
£4.30 each + VAT
Minimum order *30 units

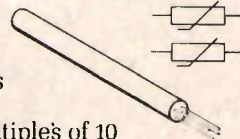

* Larger quantities in multiples of 10

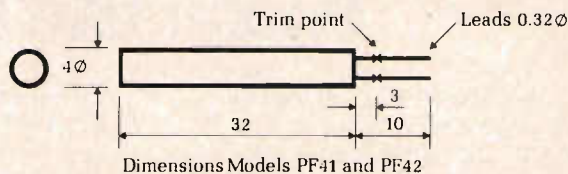

FREE SAMPLE!

For free sample of Model PF41 just phone
or write (company letterhead, please)

Rosemount

Leaders in resistance thermometry

Rosemount Engineering Company Limited
Durban Road ~ Bognor Regis ~ Sussex PO22 9QX
Tel: Bognor Regis (02433) 3121



Buy a British DMM....



35 on enquiry card

.... and buy the best performance at the lowest cost

1057: The latest from Datron

The Datron 1057 is a digital multimeter which combines the high performance of a sophisticated DVM and the low cost of a conventional multimeter. This has been achieved by making use of the unique circuitry developed by Datron for the company's range of Premium DVMs and applying the benefits of their volume production. The result is an instrument with a performance only slightly below that of the most advanced DVMs – but at less than half the price.

Who else can offer:

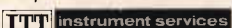
- ★ 199,999 full scale
- ★ DC and True RMS AC volts
- ★ 1 μ V resolution
- ★ DC accuracy 0.015%R for a full 6 months
- ★ 10 mOhm — 10 Megohm resistance measurement
- ★ Fully floating guarded input
- ★ 1000 V overload protection
- ★ 2 year comprehensive warranty
- ★ Ex stock availability from 



datron

The only wholly British-Owned
manufacturers of Premium DVMs

Datron Electronics Ltd · Meteor Close · Norwich Airport Industrial Estate · Norwich

Tel (0603) 412126·7·8 Telex 975173

New from Gould Advance. 50MHz you can get carried away with.

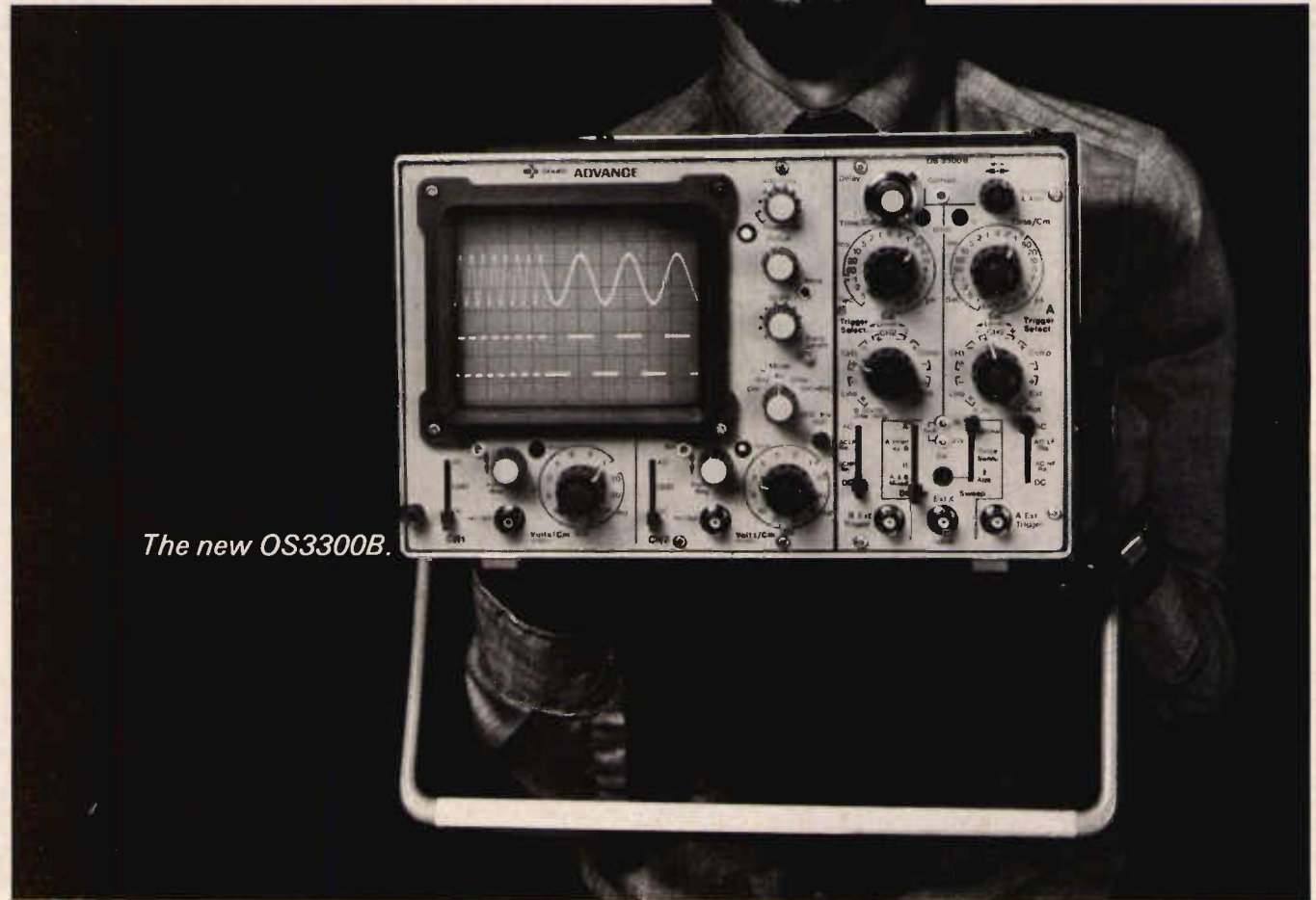

The new OS3300B.

The Gould Advance OS3300B gives you 50MHz bandwidth with 5mV/cm sensitivity, 1mV to 10MHz.

Which you can get up and go with since it weighs only 28lbs.

Worth heavy consideration are the wide range of applications for general purpose and

high quality laboratory work.

And the details are appropriately mobile. Dual delayed timebases with mixed sweep, trace location and uncal lamps help ensure it.

As do the bright CRT-13kV EHT and fast timebase speeds - 10ns/cm, fastest.

The price will make you lighthearted.

And we recommend you ask for data by using our enquiry number.

We'll get it to you faster than you can say 'Gould Advance have produced a better scope. Again!'

Gould Advance Limited
Roebuck Road, Hainault, Essex IG6 3UE, England.
Telephone: 01-500 1000 Telex: 263785

 **GOULD ADVANCE**

1781

It's the end of the line for old 8-bit thinking and planning. The TMS 9900 has won the day with an unbeatable display of power and efficiency - opening up the big, new country of 16-bit microprocessor hardware. Ride off into the sunset with the 9900 family and the Magnificent 16-bit.

This is the score

The TMS 9900 and 990 family of minicomputers are opening up new territory in architecture, software support and instruction power. The designer with 9900-based product is now way ahead of others using 8-bit microprocessors both in performance and design cost. The 9900 is a 16-bit microprocessor with Memory to Memory architecture giving complete programming flexibility. The powerful instruction set includes hardware Multiply and Divide. It's quick on the draw with 16 x 16-bit Multiply in 17.3 microseconds.

And there's more support on the way:

- TMS 9901 - a programmable interrupt and I/O controller.
- TMS 9902/3 - asynchronous/synchronous communication controllers.
- TIM 9904 - a four phase clock generator.

Teaming up with the 9900

The 9900 doesn't ride alone. The family will soon include:

- SBP 9900 - 1²L implementation of the TMS 9900 for military applications, with an operating temperature range of -55°C to +125°C.
- TMS 9980 - a 9900 with the data bus multiplexed to fit into a low cost 40 pin package and still retaining the full instruction set.
- TMS 99XX - a microcomputer for high volume low cost applications, using a sub-set of the TMS 9900 instructions.
- SN54 S481 - a 4-bit slice arithmetic element, micro-programmable to emulate the 9900 or any other instruction set.

The Good Guys ride together

The whole team are *Software Compatible* - not only with each other, but with the TI 990 range of minicomputers too. Ride into the 1980's with the good guys - 8-bit is dead, long live the Magnificent 16.

Write or 'phone now for full information to



TEXAS INSTRUMENTS LIMITED

Microprocessor Centre (MS15), Manton Lane, Bedford MK41 7PA. Telephone 0234 67466.

The Magnificent 16.

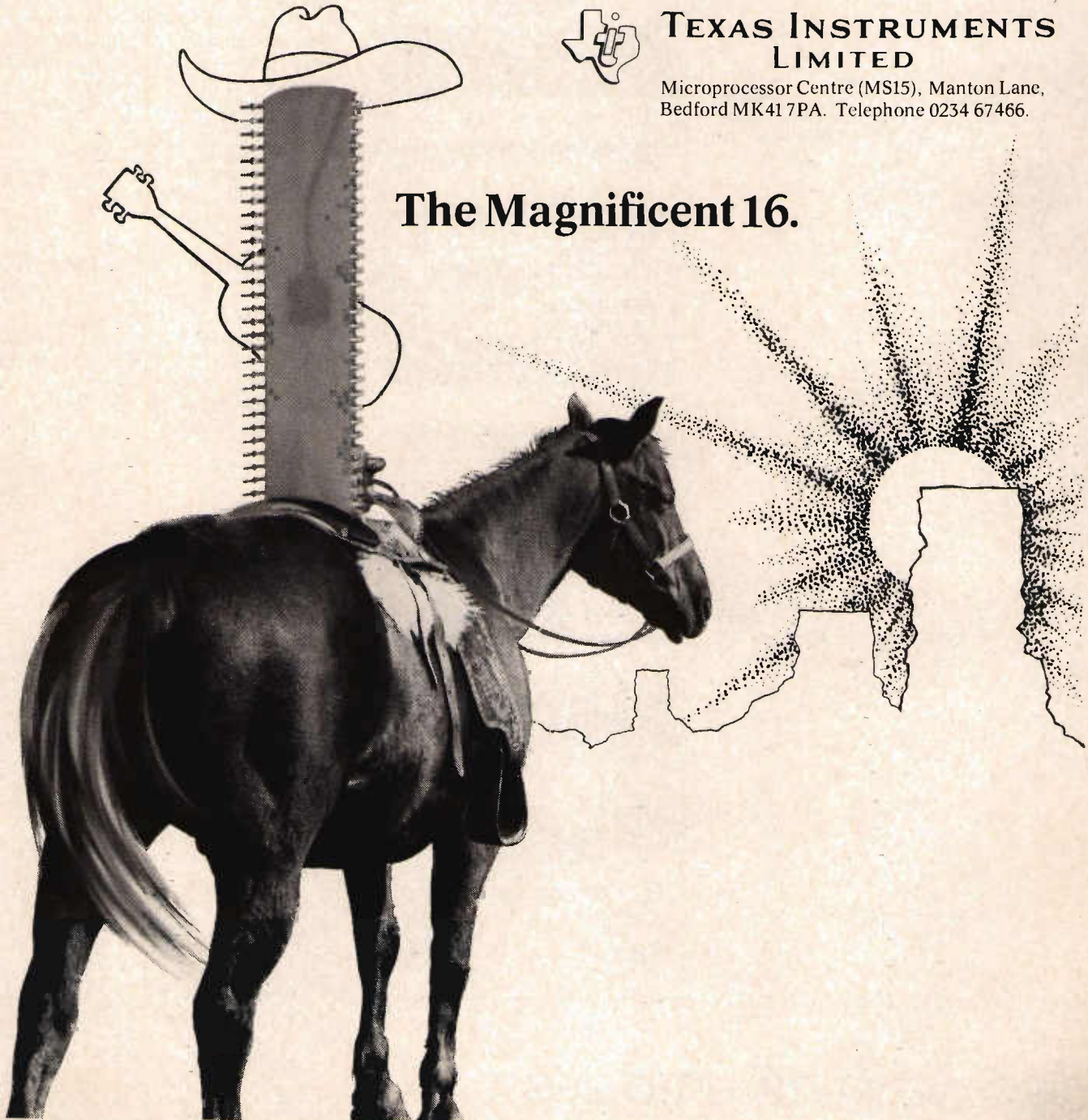

We measure up to your standards

B900
Automatic Digital Bridge 1kHz 0.1%

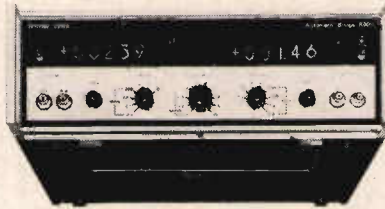

B224
Wide-range Audio Bridge 1592Hz
(200Hz-20kHz external)

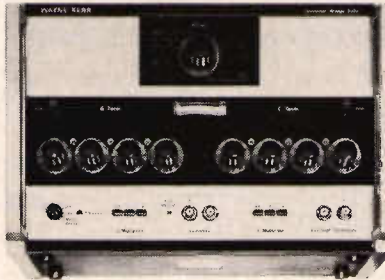

B331
Self-balancing 0.01% Precision Bridge

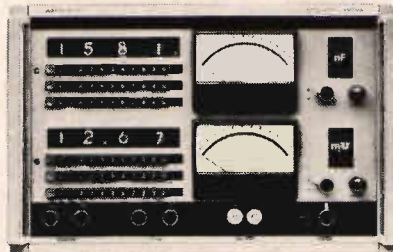

B642
Autobalance Universal Bridge 0.1%



B421
Direct-reading Component Meter 0.25%

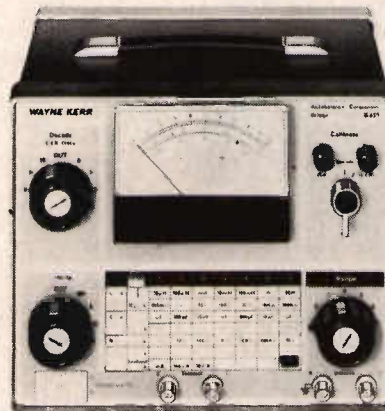

Whether you check components at Goods Inwards, during production or on Final Test, Wayne Kerr has the bridge you need. For fast measurements of resistance, capacitance and inductance, or for continuous monitoring of changing values, you can select the ideal instrument from our comprehensive range.

All models—AF, RF and VHF—have a wide measurement range and are easy to use. Many have automatic readout and automatic lead compensation; most will measure components *in situ*.

Only part of our range is illustrated. Send in the coupon for further information.



Wilmot Breeden Electronics Limited,
Durban Road, South Bersted, Bognor
Regis, West Sussex, England.
Telephone: Bognor Regis 25811
(STD code 02433)

Please send me the Wayne Kerr short form catalogue.

Name

Position

Company

Address

Telephone EE12/76



Wilmot Breeden
Electronics Limited,
Durban Road,
South Bersted,
Bognor Regis, West
Sussex, England.
Telephone: Bognor
Regis 25811
(STD code 02433)

WAYNE KERR BRIDGES



One jump ahead.

Almost overnight Westcode put its house in order.

Now we've gone one step further. We don't just provide a competitive service – we're one jump ahead in processing of orders, availability of stocks, speed of delivery.

Hang on tight . . . we could be the world's first supersonic kangaroo!

WESTCODE



Westcode is a registered trademark of Westinghouse Brake & Signal Co. Ltd.

Semiconductor Division, Westinghouse Brake & Signal Co. Ltd., Chippenham, Wilts SN15 1JD.
Tel: Chippenham (0249) – 4141. Telex: 44751.

VITAL STATISTICS OF THE R220 THYRISTOR

Look at them closely and you will begin to get ideas . . . design ideas to put you one jump ahead. Consider the R220's balanced dynamic performance for both H.F. and switching duties:- 2000A peak sine wave current at 5KHz plus voltages to 1200V and repetitive di/dt ratings to 1,000 A/ μ s.



Consider how this increased output per device can save auxiliary circuitry for snubbers, firing circuits etc., reducing components and increasing equipment reliability. Send for the data sheet – use the reader reply service for your copy.

UK STOCKIST DISTRIBUTORS: Consort Power Sales Ltd., Rosebank Parade, Yateley, Surrey. (0252) 874075. Telex: 858809; Semicomps Northern Ltd., Kelso, Scotland. Kelso 2366. Telex: 72692; G.D.S. (Sales) Ltd., Slough, Berks. (0753) 30211. Telex: 847571; Harmsworth Townley & Co. Ltd., Todmorden, Lancs. 070-681 2601.

Meet the Maestro...

...by any definition,
the master in the art of
digital voltmeter
technology

Quite simply, the Maestro is the finest voltmeter in the world. A masterpiece in measurement technology.

It's the product that gives you more than any other on the market. Like unique Decastat display ; seven 9's scale plus over-range ; one ppm linearity ; 200 readings/s and fast auto-range.

The new Maestro gives one in 14 million resolution. It knows the answer to 1nV, it gives a result to 10nV in systems, and the display is rounded to 1 μ V

- dc voltage 1 μ V to 1kV
- true rms ac voltage 1 μ V to 750V
- resistance 1m Ω to 14M Ω

The Maestro cannot lie – not with a built-in self-check facility. And all its features are controlled by remote programming. Features like 70dB series mode rejection, 144dB common mode rejection. A choice of five speeds, scale lengths and resolutions. And digital filtering for fast settling without dielectric storage effects.

Truth in the specmanship game is important. Solartron don't play specmanship. The Maestro – or 7075 if you prefer type number designations – is backed by Solartron's Standards Laboratory where the Volt is known within 1 μ V of the National Physical Laboratory.

With a product like the Maestro we can't help banging the big drum. Find out more about it. Contact us direct, or fill in the magazine's reader reply card. The Maestro's specification will be sweet music to your ears.

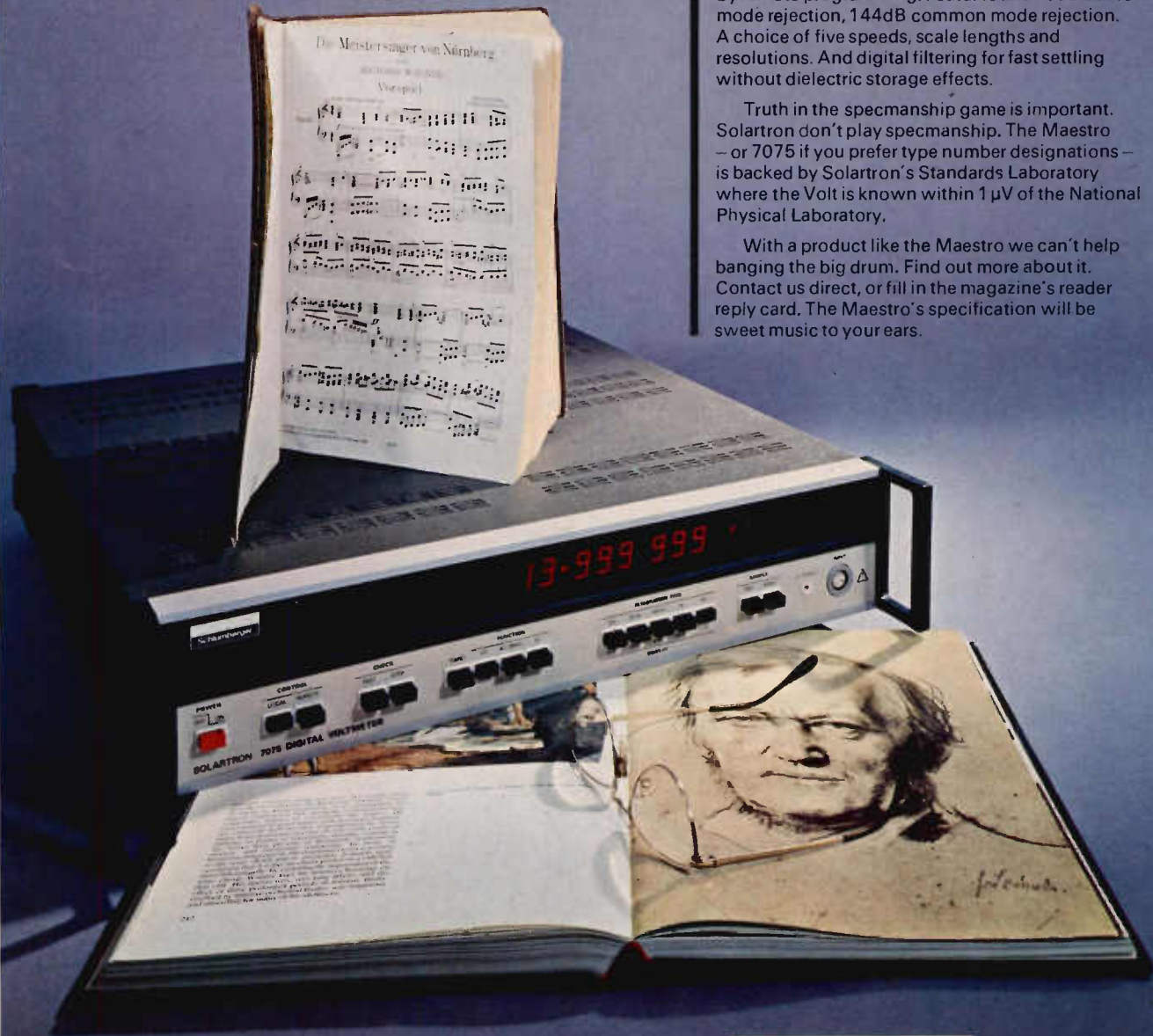

SOLARTRON

Schlumberger

The Solartron Electronic Group Ltd.,
Farnborough, Hants. England.

Telephone: (0252) 44433. Telex: 858245.



UECL
IN CLOSE CONTACT

standard connectors modular connectors the best connectors

We offer a multitude of options in edge connectors. Choose from 0.050", 0.100", 0.150", 0.156" and 0.200" pitch; allow for integral or separate mountings, polarising, open or closed ends; consider contact forms ("Bellows", Cantilever), termination styles (solder, wrap, mother board); single or double-sided assemblies. And then — optional plating finishes. If you use edge connectors — then you know we stand for quality. Make contact today!

**New modular
catalogue now
available**

Ultra Electronics (Components) Limited

Fassetts Road, Loudwater, Bucks., England.
Telephone: High Wycombe (0494) 26233
Telex 83173

Ultra Electronique (France) S.A.R.L.
85-87 Rue des Gros Grès, 92700 Colombes, France.
Tel: 781 40 78

Ultra Electronics GmbH
8 München 90, Geiseltasteigstrasse 100, W. Germany.
Tel: (089) 64 08 84/5

Ultra Electronics Sweden AB
BOX 350, 17203 Sundbyberg 3, Sweden.
Tel: (08) 29 02 55

Agents in all major countries throughout
the world.

McMurdo focus on five

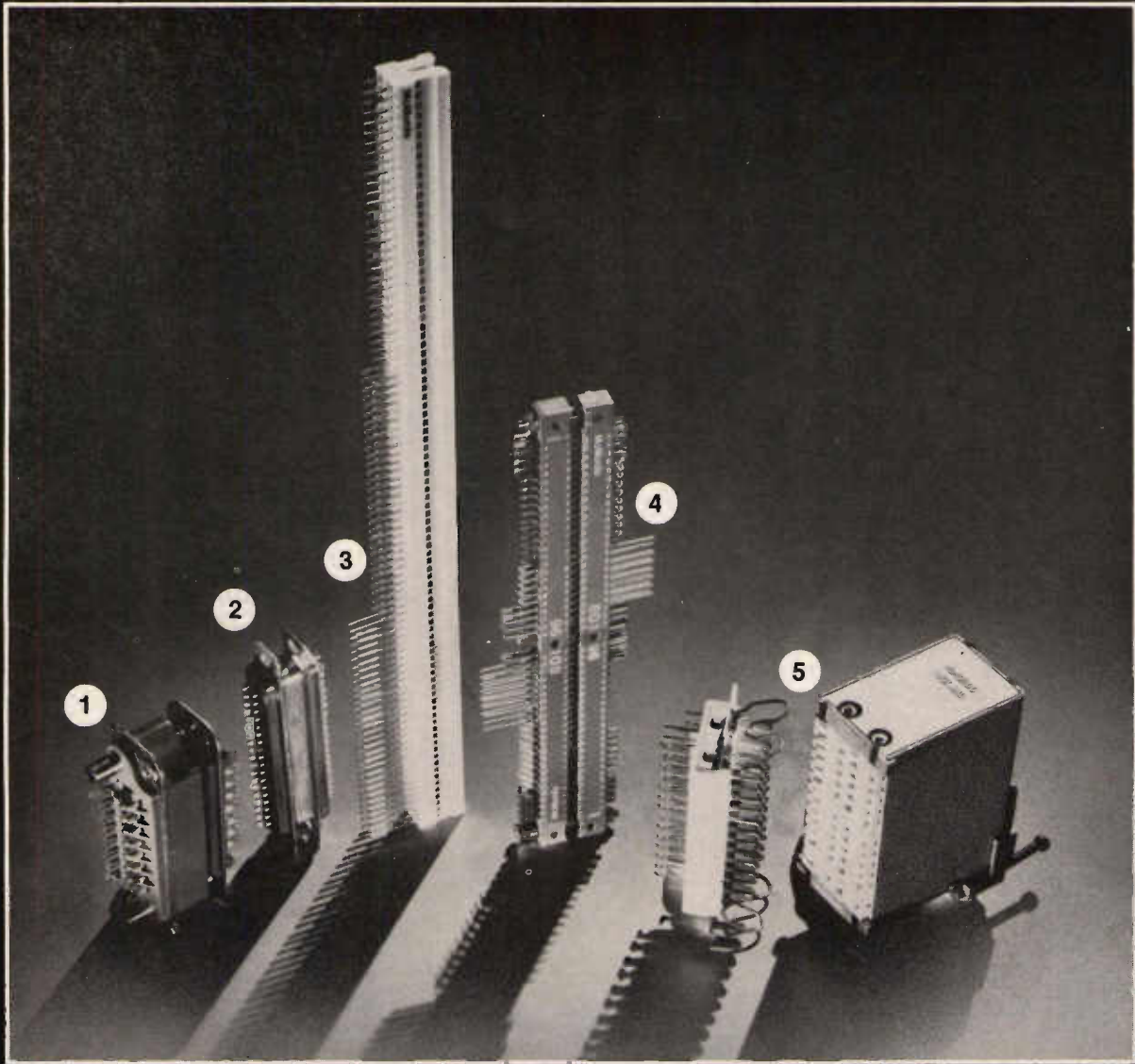

the professional quality connectors

1 Red Range

Heavy duty rectangular rack and panel or line to line connector with low insertion and withdrawal forces. 8-32 ways.

2 Dee Range

Compact rectangular connectors for line to line or line to panel mounting. 9-50 ways.

3 Keymec®

High reliability professional class edge connector of 2.54mm pitch. Up to 90 ways single or double sided with three termination styles. Designed to meet BS 9526 N001-2-3 and 4 and BPO Specification D2552.

4 801 Series

High density 1.27mm pitch. Premier quality two part printed circuit board connector designed to meet BS 9525 N001; CCTU 08-11 (HE 801/2); IEC 48B (CO) 92; NFC93-424. 17-96 ways. Mixed high and low frequency contacts available.

5 700 Series

General purpose high density rectangular connector for line to panel and line to line applications. 7-71 ways (2 and 4 rows).

Specials

We are able to undertake custom design and manufacturing work.

the
McMurdo
connection

THE McMURDO INSTRUMENT CO. LTD.
Rodney Road, Portsmouth, Hampshire PO4 8SG.
Tel: Portsmouth 35361 (STD Code 0705) Telex 86112

Narrow beam five layer heterostructure lasers

A variety of (GaAl) As/GaAs heterostructure lasers have been fabricated with two pairs of heterojunctions, the inner pair for carrier confinement and the outer pair for optical confinement writes *G H B Thompson, G D Henshall, J E A Whiteway and P A Kirkby.*

Heterojunctions of (GaAl)As/GaAs are used in semiconductor lasers to provide carrier and optical confinement. This dual function is possible because substitution of Al for Ga in GaAs increases the band gap and lowers the refractive index. Structures with two pairs of heterojunctions, the inner pair for carrier and the outer pair for optical confinement, exhibit versatile characteristics.

A localized gain region (lgr) is created by sandwiching the lowest-band-gap active layer between two oppositely doped passive layers of intermediate band gap. The optical waveguide is produced by sandwiching the first three layers between two outer layers of even greater band gap (and lower refractive index). If certain conditions are satisfied, the characteristics of the two regions may be made sufficiently independent of each other to be individually optimized for any given application. The active-layer thickness may be adjusted to give low-threshold current density and the optical resonator may be designed to give the appropriate optical distribution and suitable discrimination against unwanted transverse modes. This is of benefit where a wide optical distribution is required in the direction perpendicular to the junction plane.

The condition for providing independence between optical and carrier confinement is largely determined by the active layer and the heterojunctions which confine it. The steps in AlAs content at the boundaries should be large

enough to give satisfactory carrier confinements without any contribution from the outer heterojunctions. This becomes more demanding for narrow active layers and for high-threshold current density. Also, the active layer should be narrow enough to avoid perturbing the optical distribution excessively. This becomes more demanding as the composition steps increase. These apparently conflicting requirements can in theory be reconciled by making the active layer very narrow (eg, $<300\text{\AA}$) and using relatively large composition steps at the confining heterojunctions (eg, $>25\%$). In practice such thin layers are difficult to grow by liquid-phase epitaxy (lpe). So it is doubtful if any of the five-layer devices so far made incorporate any large degree of independence between optical and carrier confinement.

In the absence of sufficient independence between the two types of confinement, compromises have to be made in the design. For devices with wide optical distributions the compromise is generally at the expense of carrier confinement. The composition steps at the boundary of the active layer are made smaller than would be acceptable in a double-heterostructure laser.

Fig 1: Schematic diagram of layer structure with AlAs content, dielectric constant, band diagram and optical distribution.

Fig. 2: Pulsed output power from one end of various lasers versus current.

The outer heterojunctions of the five-layer structure are relied upon to control carrier leakage. Minority carriers spread throughout the resonator and their recombination rate in layers adjacent to the active layer must be limited.

The multilayer heterostructure devices reported up to the present in literature have used 10-12% AlAs steps or simply p-n junctions to confine carriers. In this article five-layer devices are discussed where 20-25% carrier confinement steps are used and where the structure is further modified to reduce both carrier leakage and the optical confinement effects of the active layer. This five-layer structure uses an asymmetrical layout with one of the outer heterojunctions having a large composition step. The asymmetry allows the active layer to be made wider, to ease the lpe growth problem. Also the outer heterojunction with the large step can be positioned on the p side to intercept the predominant electron leakage from the active layer. The onus of mode discrimination is then put entirely on the opposite outer heterojunction.

Also lasers of the above design are described that combine narrow beam widths and relatively wide single-mode optical distribution in the direction perpendicular to the junction, with low-threshold current density, low temperature coefficient of threshold, and the ability to work efficiently in a pulsed mode at currents up to 10 or 20 times threshold. The performance is compared with that of symmetrical five-layer and double heterostructures.

Thompson et al are with STL at Harlow.

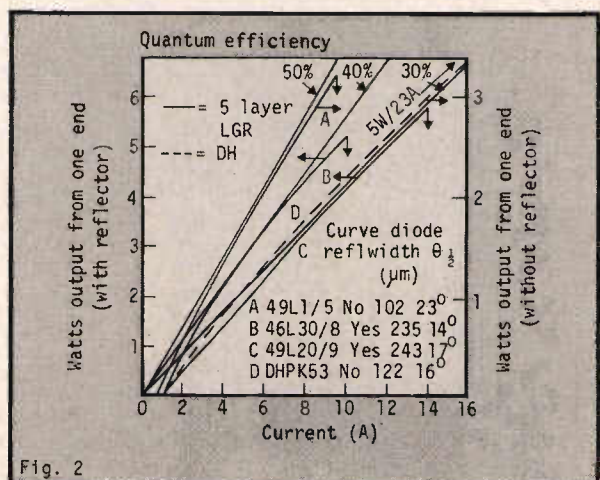
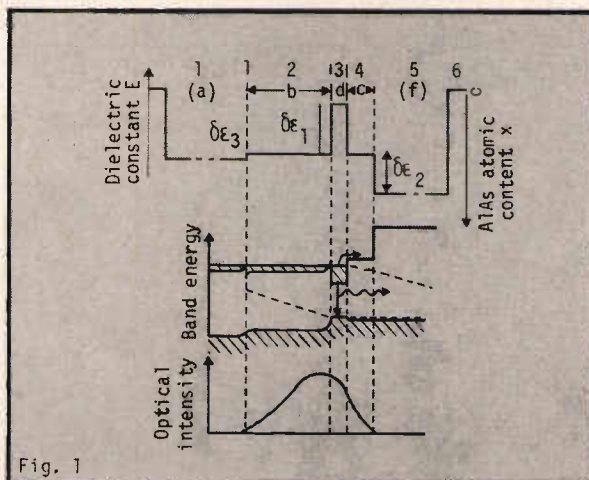

A typical asymmetrical five-layer structure is illustrated in Fig. 1. Injected carriers are confined within layer 3, and the light is guided within layers 2-4. The layer dimensions and compositions are chosen to confine the carriers within the active layer 3, even at elevated temperatures, whereas the light is allowed to spread out of layer 3 but is still restricted to a single transverse mode. In a comparable double heterostructure, where it is necessary to use an AlAs composition step δx at the boundary of the active layer of at least 0,25 for satisfactory carrier confinement, the condition for light to spread over a total width greater than $1 \mu\text{m}$ ($d\delta x < 0.009 \mu\text{m}$) requires the thickness d to be less than about $0.04 \mu\text{m}$. Considerable demands are imposed on the liquid-epitaxy growth. However in the five-layer structure of Fig. 1 the demands are less stringent. Optical asymmetry allows $d\delta x$ to be increased to about $0.015 \mu\text{m}$ for the same optical spread and the addition of a second barrier for electron confinement at the layer 4/5 interface allows δx to be reduced without causing electron leakage, so that the thickness of d can be increased to about $0.08 \mu\text{m}$. The size of the AlAs composition step at the 1/2 interface in Fig. 1, is chosen to provide control of transverse-optical modes. It is made sufficiently small that the critical angle of reflection at the interface is less than the propagation angles of all transverse modes except the zero-order mode.

Device structures

The heterostructure layers were grown by conventional liquid-phase epitaxy using a rotating graphite crucible in a vertical furnace. Thin layers of (GaAl)As were more difficult to grow than GaAs. The 5 at.% AlAs included in the thin layers for the present work was sufficient to change growth characteristics considerably from that of pure GaAs. To attain the same control of layer thickness as was originally obtained small changes were made in the growth schedule. The more important of these con-

sisted of reducing the cooling rate from the original $0.2^\circ\text{C}/\text{min}$ to $0.05\text{-}0.1^\circ\text{C}/\text{min}$ and maintaining this rate from the start of cooling to the end of the growth of the important layers. Using these methods it has been possible to grow layers of $\text{Ga}_{0.95}\text{Al}_{0.05}\text{As}$ of thickness down to $0.05 \mu\text{m}$ with thickness variation of the order of $\pm 0.02 \mu\text{m}$.

All layers relevant to the lasing action were doped at $5 \times 10^{17} \text{cm}^{-3}$ except the active layer in slice KW 39 where the higher doping of $2 \times 10^{18} \text{cm}^{-3}$ was used. Sn was used as the donor and Ge as the acceptor except in the active layers of the KW and PKB slices.

After growth the slices were contacted by evaporating Au/Zn and Au/Sn on to the p and n sides, respectively, alloying at 500°C and further evaporating nichrome-copper and Au, respectively, on the two sides. The slices were then cleaved into bars and a reflective coating was normally applied to one of the cleaved faces by evaporating a half-wavelength-thick insulating layer of Al_2O_3 and then a layer of Al. The bars were parted with a diamond saw to produce individual lasers of $240 \mu\text{m}$ width, and lengths, of 300, 425 and $550 \mu\text{m}$.

Evaluation of asymmetric five-layer lasers was carried out on 20 different slices (KW series). Measurements were made on a sample of 30 or 40 lasers of various lengths from each slice. For comparison, measurements were made on three narrow-beam symmetrical double-heterostructure lasers (PKB series).

Figure 2 shows the light-current characteristics for pulsed operation (pulse length, 200 ns) of various narrow-beam lasers comprising three asymmetric five-layer devices and one double-heterostructure device. Two of the lasers are $240 \mu\text{m}$ wide with reflectors at one end and two are approximately $100 \mu\text{m}$ wide without reflectors. The threshold

currents of all the lasers lie between 0,6 and 1,1 A ($900\text{-}1500 \text{A}/\text{cm}^2$). The light-current characteristics of the asymmetric five-layer lasers remain straight up to about 10 times threshold with incremental quantum efficiencies for total light emitted between 33 and 50%.

At higher currents there is some saturation which amounts to less than 10% at the point where the laser stops operating due to permanent end face damage. The latter arises from the intense optical field and occurs at an optical power density of between 3 and $5 \text{MW}/\text{cm}^2$, which for these lasers, where the near-field optical distribution is spread to a width of about $0.7 \mu\text{m}$, corresponds to about $20\text{-}35 \text{W}/\text{mm}$ of junction width. The light-current characteristics of the narrow-beam double-heterostructure laser starts to curve at a lower current than asymmetric five-layer structures. The peak optical power density produced at a current of 23 A was greater than that of the five-layer structures.

Figure 3 shows far-field patterns in the plane perpendicular to the junction of the two asymmetric five-layer lasers with reflectors and the double heterostructure laser whose light-current characteristics are illustrated in Fig. 2. The effective beam widths are about one-third of those produced by a normal double-heterostructure laser because of the spreading of the optical distribution in the laser waveguide. The lasing spectrum of one of the above asymmetric five-layer lasers is given in Fig. 4. A series of about 20 longitudinal modes are present at a current of 30% above threshold, centered on a wavelength of 8200\AA . This wavelength tends to be about 100\AA shorter than the centre of the spontaneous-emission spectrum due to the high electron concentration injected into the active layer at threshold $(1.5 - 2) \times 10^{18} \text{cm}^{-3}$. The effective spectral width is about 15\AA . This increases as more current is applied.

The near-field pattern in the junction plane of one of the asymmetric five-layer lasers is given in Fig. 5, for currents of 1,3 and 3,3 times threshold. Although

Fig. 3: For field emission pattern in the direction perpendicular to the junction for (a) five layer LGR lasers and (b) DH laser.

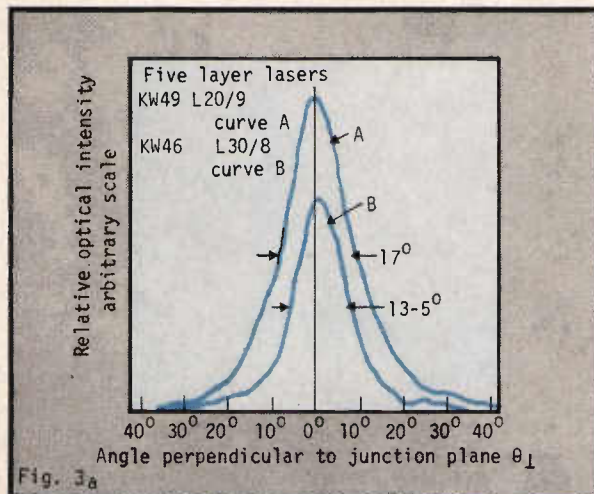

Fig. 3a

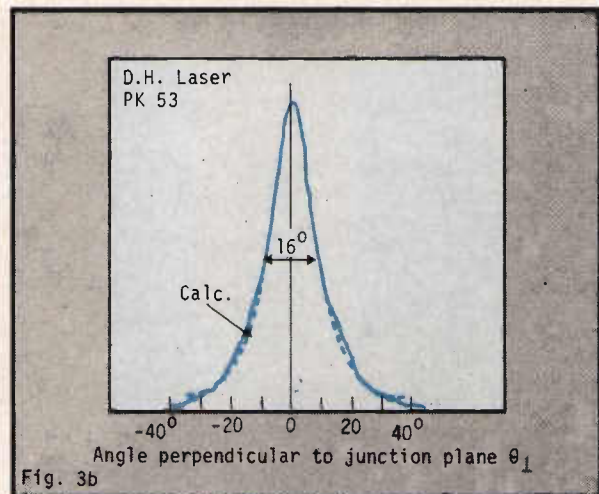

Fig. 3b

considerable fine structure is present the total distribution is reasonably uniform and improves at higher currents.

Figures 6 and 7 give threshold current density versus reciprocal length for an asymmetric five-layer laser and a double-heterostructure laser. These results represent the best 60% or so of those lasers measured. They illustrate the low values of threshold which can be obtained for lasers of average beam width. Also small increases occur for narrow-beam-width lasers. On each figure the approximate relation, $J_t - 4000d$

$$+ 28 \left(\alpha + \frac{\ln(1/R_1 R_2)}{2L} \right) \frac{S_{\text{eff}}}{k} \left(\frac{\text{A}}{\text{cm}^2} \right) \quad (1)$$

is also plotted. Here d (μm) is the active layer thickness, α (cm^{-1}) = optical absorption coefficient, L (cm) = laser length, R_1 and R_2 = reflection coefficients at the laser ends, $S_{\text{eff}}(\mu\text{m})$ = the effective width of the optical distribution in the plane perpendicular to the junction, and k is the coupling coefficient describing the effective relative optical intensity over the active layer width. This expression is a reasonable approximation in cases where the second term is not less than 50% of the first.

Figure 6 gives the threshold performance of a set of asymmetric five-layer lasers with relatively narrow optical distribution from slice KW 27. The current density measured for lasers of length $550 \mu\text{m}$ of $500 \pm 30 \text{ A/cm}^2$ is the lowest reported for Fabry-Perot (GaAl) As lasers at 300°K . The previous lowest of 575 A/cm^2 was obtained with a symmetrical five-layer PK 64⁶. The improvement can be attributed to the use of a reflector and is attained in spite of a wider d and a larger S_{eff} .

Experiments on five-layer lasers from slice KW 49 with the narrow beam width shown in curve A of Fig. 3 revealed that the threshold current density for $550 \mu\text{m}$ long lasers with reflectors is almost double that for similar lasers with wider beam width from slice KW 27, but is still below 1000 A/cm^2 . A plot to determine the effect of immersion in CHCl_3 on a laser without a

reflector showed that the immersion reduces the reflection coefficient of the output face to 0,17. This experiment indicates agreement with the relation for threshold current of Eq. 1.

In Fig. 7 the threshold/reciprocal-length dependence for double-heterostructure lasers from slice PKB 21, with $d = 0,11 \mu\text{m}$ and a relatively wide far field beam width of 33° is shown. The threshold current density of $650 \pm 50 \text{ A/cm}^2$ obtained from lasers of length $550 \mu\text{m}$ with reflectors is the lowest figure reported for double-heterostructure (GaAl)As lasers of normal composition at 300°K . A study of the behaviour of narrower-beam (25°) double-heterostructure lasers from slice PKB 5 with $d = 0,09 \mu\text{m}$, gives that the threshold current density for lasers of length $550 \mu\text{m}$ with reflectors was $750 \pm 50 \text{ A/cm}^2$. This performance is relatively poor when compared to the threshold relation of Eq. 1 than that of the PKB 21 lasers, and is an indication of a loss of injected carriers across the confinement barrier due to the injected concentration being higher.

Figures 8 and 9 compare the incremental quantum efficiency as a function of laser length between a set of asymmetric five-layer lasers and double-heterostructure lasers, both of narrow beam width. The results are typical of the majority of all lasers. The reciprocal of the incremental efficiency of total emission $1/\eta_i$ (including the optical power calculated to be dissipated in the reflector) is plotted against $2L[\ln(1/R_1 R_2)]^{-1} = x$. The straight line so produced has an intercept on the $1/\eta_i$ axis of $1/\eta_0$, where η_0 is the internal quantum efficiency, and an intercept of the x axis of $-1/\alpha$, where α is the coefficient of optical absorption. Figure 8 applies to the asymmetric five-layer slice KW 49. The shortest lasers show the highest

Fig. 4: Spectrum of a five layer LGR laser at current 30% above threshold.

Fig. 5: Optical density distribution across output face of five layer LGR laser.

efficiency. This is expected if they remain well behaved and no cross modes are generated as a result of the less favorable length-to-width ratio. The average internal efficiency is estimated to be $0,66 \pm 0,15$. The optical absorption coefficient should be $11 \pm 4 \text{ cm}^{-1}$. Precise measurements gave $\alpha = 9 \pm 2 \text{ cm}^{-1}$.

Figure 9 applies to the double-hetero-structure slice PKB 5 and the incremental quantum efficiency of most of these double hetero-structures is very similar to that of five-layer devices. However shorter lasers have lower than expected efficiency due to the generation of internally reflected cross modes. Even for the intermediate-length lasers plotted in Fig. 9 the reflection coefficient was reduced from the sawn edges (by proton bombardment) before consistent results could be obtained. Double-heterostructure lasers from other slices have shown considerable average internal efficiency for the lasers from slice PKB 5 is $0,67 \pm 0,15$ which is similar to the five-layer lasers.

Variation with composition

With the exception of the three slices KW 32, 36, and 39, where the carrier-confinement step corresponds to 12% or less change in AlAs content, all the asymmetric five-layer lasers (KW slices) show threshold current density in reasonable agreement with Eq. 1. The AlAs steps for carrier confinement were at least 20% in these lasers.

In three other sets of five-layer lasers from slice PK 68 ($d = 0,07 \mu\text{m}$) and the longer lasers from slices PK 42 and 64 ($d = 0,04 \mu\text{m}$) also approximately obeyed Eq. 1 in spite of their 12% barriers. However, in these lasers there were additional 18% confinement barriers on both sides of the active layer, within $0,4 \mu\text{m}$ or less, to provide confinement back up. However some of the shorter lasers from slices PK 42 and PK 64 showed excess current. This arose from the higher injected carrier concentration.

Of the five double-heterostructure slices only slice PKB 15 (with the smallest d of $0,06 \mu\text{m}$) showed appreciable

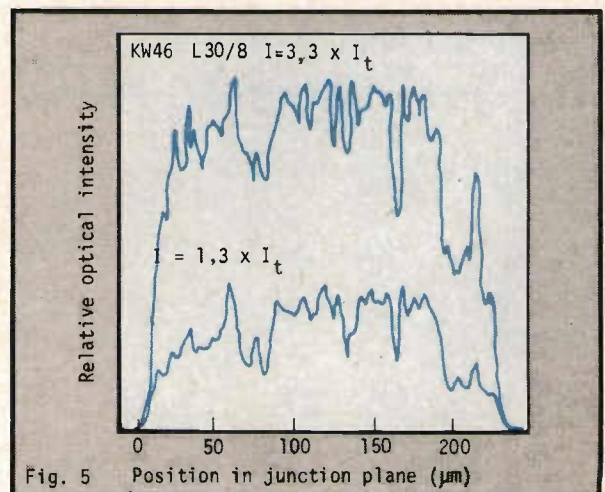
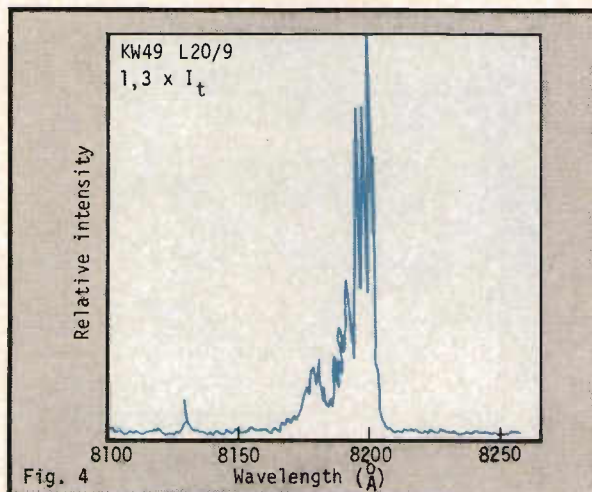

excess threshold current at room temperature. However, carrier confinement in these lasers was not sufficient for satisfactory operation at 65°C.

The asymmetric five-layer slices KW 36 and 39 required about twice the current for threshold predicted by Eq. 1. The 5% AIAs step used for carrier confinement would be insufficient on its own to provide this degree of confinement for electrons or holes and both the outer AIAs composition steps must have been involved. Slice KW 36 did not show temperature-sensitive behaviour, and hence the factor of 2 increase in current at room temperature is accounted for by those minority carriers which spilled out of the active layer but remained within the three centre layers. Slice KW 32 (with a 12% confinement step) showed some increase in threshold current beyond the expected value.

With the exceptions of slice KW 39, where the active layer was doped to $2 \times 10^{19} \text{ cm}^{-3}$ with Si and of slice PKB 15, a marginally confined double-heterostructure laser, there is little difference in the efficiency of the longer lasers. The same is true of the shorter lasers if the narrower-beam double-heterostructure lasers that suffer from cross modes are excluded. The average estimated internal efficiency of most lasers lies around 65% with a few lower at around 55%. The estimated optical absorption coefficient lies close to 10 cm^{-1} with some values, particularly for the double-heterostructure lasers, of around 8 cm^{-1} . Of this 4 cm^{-1} is estimated to be due to free-carrier losses, leaving $4\text{--}6 \text{ cm}^{-1}$ to be accounted for by interface roughness.

The ratio of the threshold current at 65°C to that at 10°C lies close to 1.5 for almost all the well-confined five-layer lasers of the KW series.

The total beam width to the half-power points of these lasers varies from 12° to 56° over the range investigated. In the asymmetric five-layer lasers of the KW series the beam width is a sensitive function of the thicknesses of layers 3 and 4, d and c . As a rule of thumb the

dividing line between wide- and narrow-beam behaviour occurs at $d + \frac{1}{2}c = 0,1 \mu\text{m}$. The symmetrical five-layer lasers PK 42, 64, and 68 show less sensitive dependence of beam width on d . The important parameters are the thickness of the three centre layers and the AIAs step size at their outer boundary. In the symmetrical devices d must be small and $\theta_{1/2}$ varies approximately as $1/d$. In the asymmetrical devices d may be larger but $\theta_{1/2}$ is an even more sensitive function of d .

Threshold characteristics

The optical distribution in the direction normal to the junction of the guided wave in the heterostructure guide may be derived in terms of the thickness and dielectric constant of the various layers and the wavelength of the radiation concerned. This is required for obtaining the threshold current density and the perpendicular far-field beam width.

Expression 1 for the threshold current density involves the optical loading factor of the active layer. This factor is given by the ratio of the total optical energy contained in the width of the guide to that contained in the active layer. This is expressed in terms of a total effective width S_{eff} of the guided mode and a coupling constant k for the active layer. S_{eff} is given by

$$S_{\text{eff}} = \int_{-\infty}^{\infty} Ids / I_{\text{max}}, \quad (2)$$

where I_{max} is the peak optical intensity over the cross section and ds is an element of distance in the direction normal to the junction. k is given by

$$k = \int_a d ds / I_{\text{max}} d, \quad (3)$$

where the integral is taken over the width of the active layer. The optical loading factor is given by S_{eff}/kd .

Fig. 6: Threshold current density versus reciprocal length for low threshold five-layer LGR lasers.

Fig. 7: Threshold current density versus reciprocal length for low threshold DH lasers.

The optical gain g becomes

$$g = g_0 kd / S_{\text{eff}}, \quad (4)$$

where g_0 is the gain loading factor of unity and the guided wave is within the gain region. Expression (1) for the threshold current density can be obtained from Eq. (4) by using a linear relation between g_0 and current density J of the form $g_0 = (J/d - A)B^{-1}$ (5)

and equating g at threshold to the sum of the dissipation loss α and the end loss $\ln(1/R_1 R_2) 2L^{-1}$. Empirically A and B have the values $A \approx 4000 \text{ A/cm}^2 \mu\text{m}$ and $B \approx 28 \text{ A/cm}^2 \mu\text{m}$.

The far-field beam pattern is obtained using a Fourier transform of the optical field distribution as described by Kirkby *et al.* Because the angles are small the obliquity factor may be neglected.

The optical distribution for the TE_{00} mode has been computed by conventional methods for a series of four-layer structures which are representative of the five-layer structures used for the KW lasers. Four-layer structures were analyzed to avoid the introduction of too many variable parameters. The results, can be extended to apply to five-layer structures by approximate methods. The layer compositions investigated are illustrated in Fig. 10. The difference in dielectric constant $\delta\epsilon$ at the heterojunction boundaries is taken as being linearly related to the step in composition δx of the $\text{Ga}_{1-x}\text{Al}_x$ As by $\delta\epsilon = 4,33\delta x$.

Figure 10 shows how S_{eff} and S_{eff}/k vary with the thickness d of the active layer for two values of b of 0,8 and 1,2 μm . In both cases the optical confinement is determined mainly by d for $d > 0,12 \mu\text{m}$ and mainly by $(b+d)$ for $d < 0,10 \mu\text{m}$. The switch-over from one condition to the other is more abrupt where b is larger and guiding in the combined layers is stronger. Although the effective optical width becomes relatively independent of d when $d < 0,10 \mu\text{m}$ the quantity S_{eff}/k continues to increase rapidly as d is narrowed. This is because the peak of the optical distribution moves out of the active layer into the b layer, and the optica

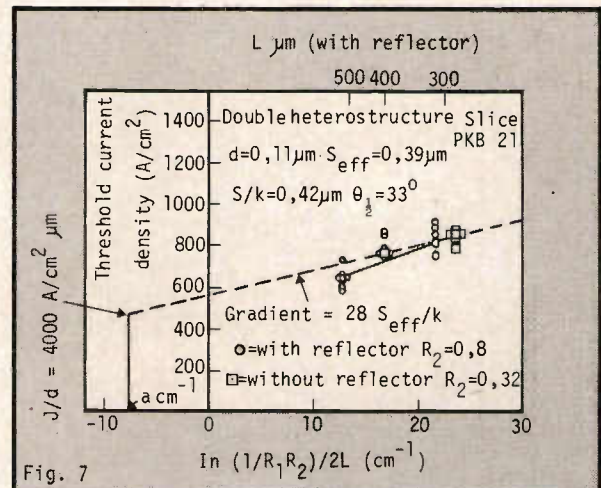
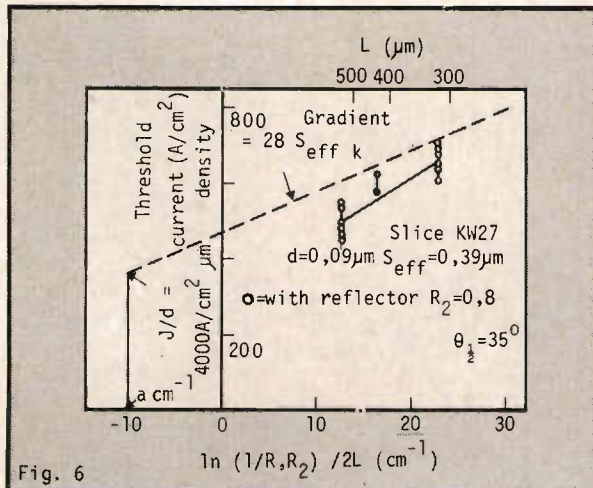

intensity in the active layer can become very small due to the large dielectric-constant step which bounds it on one side. Under these conditions the term in the threshold Eq. 1 containing S_{eff}/k rapidly becomes dominant and causes an increase in threshold current. To combine a value of S_{eff} of around $1 \mu\text{m}$ with a threshold current density of less than 1500 A/cm^2 it is necessary for d to lie in the range $0,09\text{--}0,11 \mu\text{m}$. This is close to the value which, if the b layer were infinitely wide, would produce a cutoff condition.

This observation gives a means of extending the analysis from four-layer to the five-layer structure. Consider the structure shown in the inset of Fig. 11 which is a four-layer structure in which the c layer of the five-layer structure is retained but the b layer is omitted. If the cutoff condition for this structure is a function of the thicknesses d and c , the two layers of the new structure replaces the single d layer of the original. The same behaviour should result if the thickness of the two new layers is varied. This was shown by varying the original d layer over the important range $0,09\text{--}0,11 \mu\text{m}$. Figure 15 shows the combinations of d and c that give an unchanged cutoff condition for two different values of the asymmetry η of the main dielectric-constant step and for two different values of the composition of the additional c layer. The curves can be generalized to a variety of dielectric-constant steps $\delta\epsilon$ by using the normalized thicknesses C and D [$C = 2\pi(\delta\epsilon)^{1/2}c/\lambda$, $D = 2\pi(\delta\epsilon)^{1/2}d/\lambda$]. The curves show that d must be narrowed as c is increased to maintain the behaviour.

The c layer reduces the threshold current density in two ways. It allows d to be reduced and so reduces the left-hand term of Eq. 1. It also reduces the right-hand term by increasing k , because the reduction in d can be regarded as occurring over the poorly coupled part of the original active layer, and sometimes, because the peak of the optical distribution is drawn out of the b layer and back the active layer.

Consider a structure designed to produce the same optical distribution as for $d=0,1 \mu\text{m}$ in the four-layer structure of Fig. 10. According to Fig. 11 ($\xi=0$) d in the five-layer structure is $0,08 \mu\text{m}$ with $c=0,06 \mu\text{m}$ or $d=0,06 \mu\text{m}$ with $c=0,14 \mu\text{m}$. The added thickness of c contributes about one-third of the effect of the thickness reduction in d , assuming that this relationship will apply over a range of values of d in the cutoff condition for small c values.

The computed optical distribution in the four-layer structure has been used for deriving the far-field beam width in the plane perpendicular to the junction. The far-field beam width is a useful means of assessing the spread of the near field in any laser and giving an indication of the permissible peak optical power output that occurs at the power density of $3\text{--}5 \text{ MW/cm}^2$. In Fig. 12 the relation between S_{eff} and the beam width to the half-intensity points $\theta_{1/2}$ for four-layer structures is plotted for three values of b , d varies.

As a comparison the relation between S_{eff} and $\theta_{1/2}$ is plotted for the zero-order mode in a double heterostructure with $0,2 \text{ AIA}$ s composition steps defining the active layer. The upper branch corresponds to large values of the active-layer width in which the guided wave is tightly confined within the active layer and the lower branch corresponds to small values of the active-layer in which the majority of the optical distribution is located outside the active layer in the form of exponential tails extending into the surrounding layers. To emphasize the two types of behaviour asymptotic curves are plotted, curve I for perfect confinement of one-half sinusoidal period of the optical distribution within the active layer and curve II for a pair of exponential tails both outside an active layer of infinitesimal thickness. A given far-field beam width may correspond to

a near-field width lying within a 3-1 range, the low end applying to the limit in weak guiding and the high end applying to the limit in strong guiding.

The four-layer optical distribution may also be described in terms of strong and weak guiding. Take for instance, curve C which applies to the widest optical cavity. At the low S_{eff} end the guiding is mainly controlled by the active layer, which, however, only weakly guides, allowing an appreciable proportion of the light to extend outside. The relation between S_{eff} and θ lies close to the weak-guiding asymptote. But, as d is narrowed eventually the light starts to fill the wider optical cavity and for this value of b the dielectric barrier at the far side provides fairly strong guiding. Curve C moves across to higher values of S_{eff} to lie close to the strong-guiding asymptote. Curve B applies when the wider guide has weaker guiding characteristics because of the smaller value of b . For small S_{eff} curve B shows a less pronounced version of the behaviour of curve C, but for the largest value of S_{eff} reverts to weak guiding as the optical distribution penetrates beyond even the wider optical cavity. Curve A, for the smallest value of b , shows a behaviour similar to the weakly guided branch of the double heterostructure.

The curves of Fig. 10 for effective optical width and of Fig. 12 for far-field beam width may be used in conjunction with the threshold-current relation of Eq. 1 to obtain a theoretical relation between threshold current density and beam width.

This is illustrated in Fig. 13. Three cases are shown: a double heterostructure with 20% AIA's confinement steps, the four-layer structure investigated in Figs. 10 and 12 with two values of b , and a five-layer structure with two values of b and with an active-layer width of $0,07 \mu\text{m}$. The latter curves are estimated assuming that the substitution of the active layer in the four-layer structure for a pair of layers comprising an active layer of thickness d' and an additional c

Fig. 8: Incremental quantum efficiency versus laser length for narrow beam LGR lasers. Fig. 9 As for Fig. 8 but for narrow beam DH lasers.

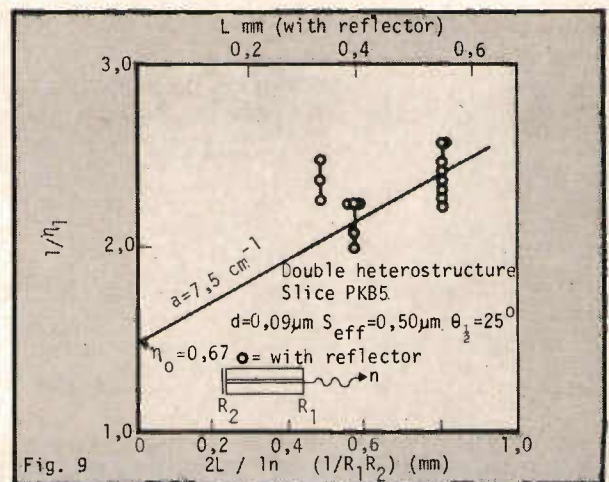
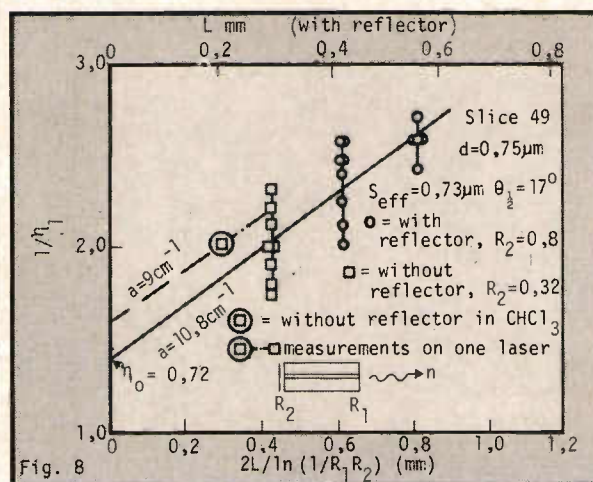

AVX SkyCap[®] ceramics at the centre of most applications

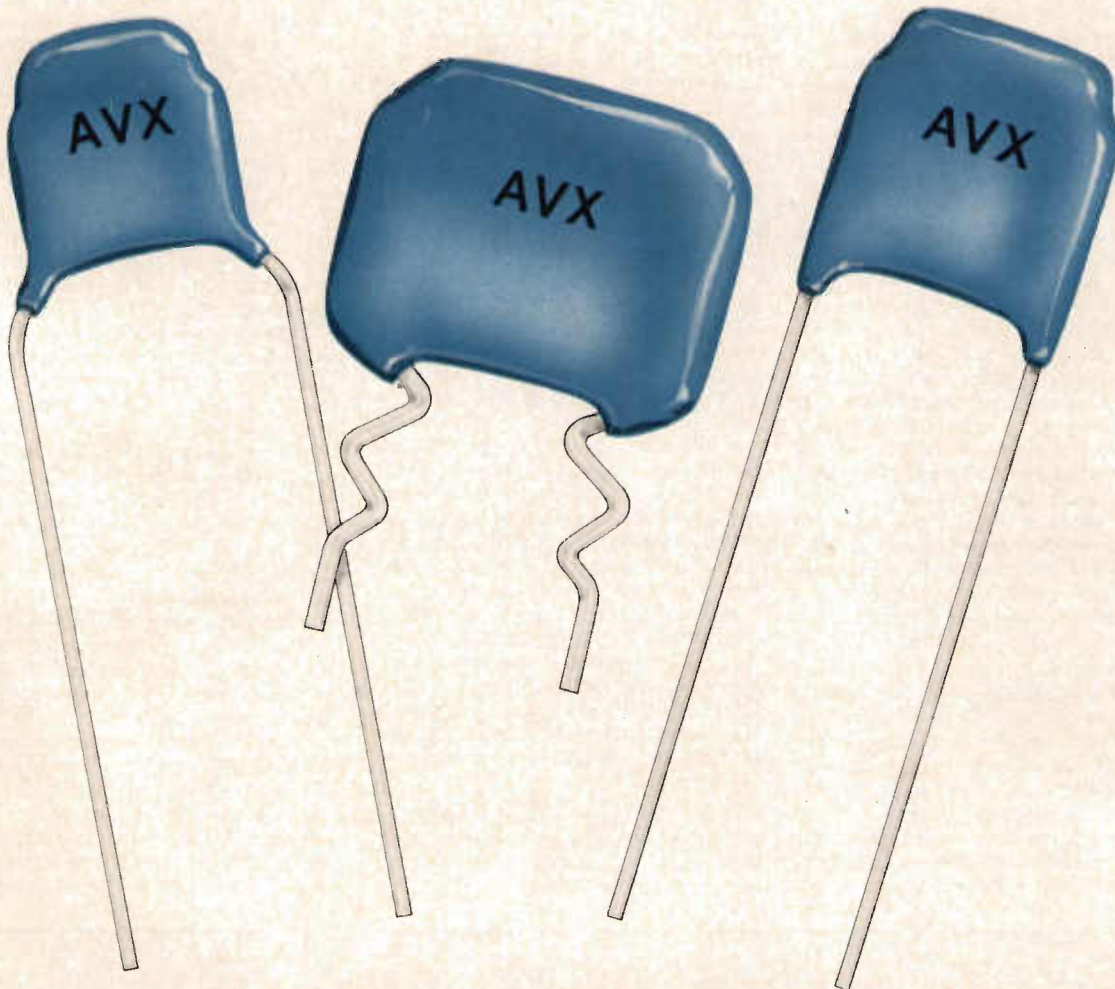

AVX SkyCap – the multi-layer ceramic capacitor for most applications

Capacitance Range 100pF to 4.7mfd
 Tolerances From 1% to +80, -20%
 Voltage Ratings 50V and 100V.d.c.
 Temperature Coefficients 3 choices from 0 ± 30 ppm/°C
 to +22, -56% (+10° to +85°C)
 Construction Dipped monolithic
 PCMs From 0.1 to 0.4 inches

SkyCap are manufactured by AVX Limited, England. AVX have unrivalled experience in the development and manufacture of multi-layer ceramic capacitors. This experience is reflected in the widest range of ceramics available and in the AVX world-wide reputation for quality. Contact Waycom for full data.

Waycom-reliable in so many ways

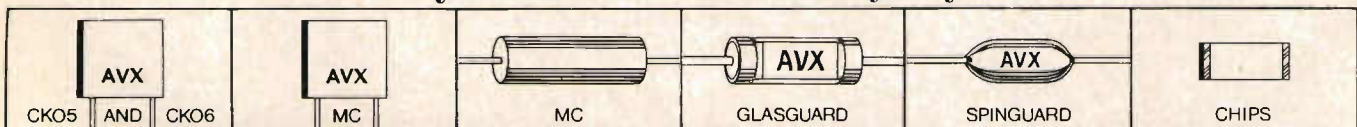

WAYCOM LIMITED

Wokingham Road, Bracknell, Berks RG12 1ND
 Tel: Bracknell 22751 Telex: 848402

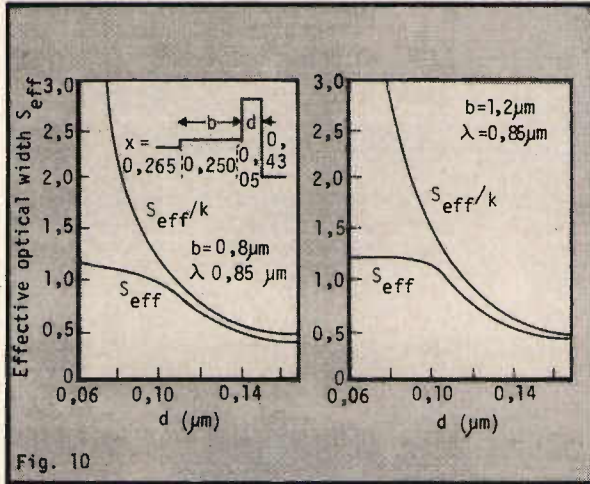

Fig. 10

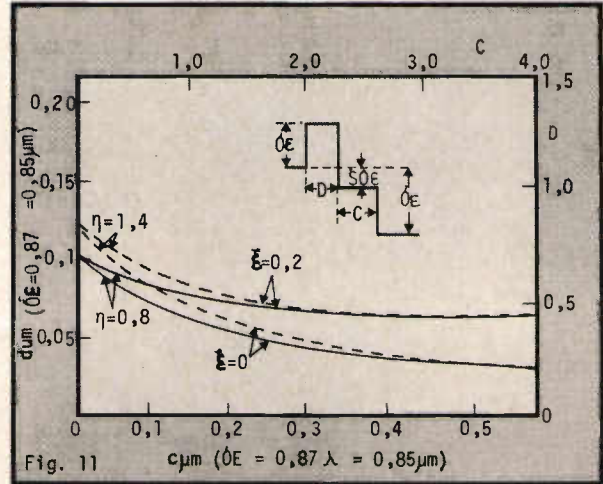

Fig. 11

layer of appropriate thickness to give the same value of S_{eff} will not interfere with the $S_{eff}/\theta_{1/2}$ relationship. The threshold may then be obtained using the appropriate value of d' ($< d$), the value of S_{eff} for the four-layer structure, and a value of k calculated over the appropriate portion of the original active layer of the four-layer structure assuming that the optical field distribution remains the same in the five-layer structure.

Figure 13 shows that the double heterostructure is apparently the best of the three structures for combining low threshold and narrow beam width. The lower branch of the curve has not yet been achieved due to difficulty in growing the narrow active layer and obtaining adequate carrier confinement. The five-layer structure gives the lowest threshold current at wide beam widths, the actual threshold being determined to a considerable extent by the value of d' used. The four- and five-layer devices become unsatisfactory for beam widths below a value that depends on layer thickness and composition due to low values of the coupling k . The curves in this region are shown dashed. Figure 13 should not be used for assessing structures for high-peak-power use since there is no simple relation between effective width S_{eff} and $\theta_{1/2}$. For instance the 18° beam width

Fig. 10: Theoretical relation between effective optical width S_{eff} and active layer width d for four layer LGR's.

Fig. 11: Relation between widths of active layer d and adjacent p passive layer c to give zero-order mode cut-off.

Fig. 12: Theoretical relation between beam width $\theta_{1/2}$ and effective optical width S_{eff} for various four layer LGR structures and three layer DH structures.

Fig. 13: Estimated relation between far-field emission pattern and threshold current density for four and five layer LGR lasers and three layer DH lasers using the expression: $J_0 = 3000 d^1 + 28 [\alpha + \ln(1/R_1 R_2) (2L)^{-1}] S_{eff} k^{-1}$

of the $b=0,8$ four- and five-layer structures is associated with the same effective width of the near field as the 12° beam width of the $b=0,4$ four- and five-layer structures.

The majority of the work has been carried out on the asymmetrical five-layer structure and it has proved a versatile design, capable of producing lasers at one extreme with threshold current densities as low as 500 A/cm^2 and at the other extreme with far-field beam widths perpendicular to the junction plane of 15° or less and with threshold current density still 1000 A/cm^2 .

Double-heterostructure lasers with similar carrier confinement steps ($\approx 20\%$ AIAs) have also been designed to give, at one extreme, threshold current densities as low as 650 A/cm^2 and at the other extreme beam widths of 15° and peak power handling capability of up to 40 W/mm . For narrow beam width the threshold current density of these double heterostructure lasers is higher than for the five-layer structures ($> 1200 \text{ A/cm}^2$) and, more seriously, increases much more rapidly with temperature.

The design of both the five-layer devices and the double-heterostructure devices is limited by the layer structure which can be grown at the present state of the art in liquid-phase epitaxy. The main problem is that if the active layer is grown with a large enough composition step to retain carrier confinement at high temperature it must be made very thin. The asymmetric five-layer structure is at an advantage because of the additional carrier confinement provided by the outer heterojunction boundaries, one of which may be chosen independently of the optical requirements. To provide comparable performance in a symmetrical double heterostructure would require a confinement step of $25\text{-}30\%$ AIAs and as a result an active layer width of less than $400\text{-}300 \text{ \AA}$.

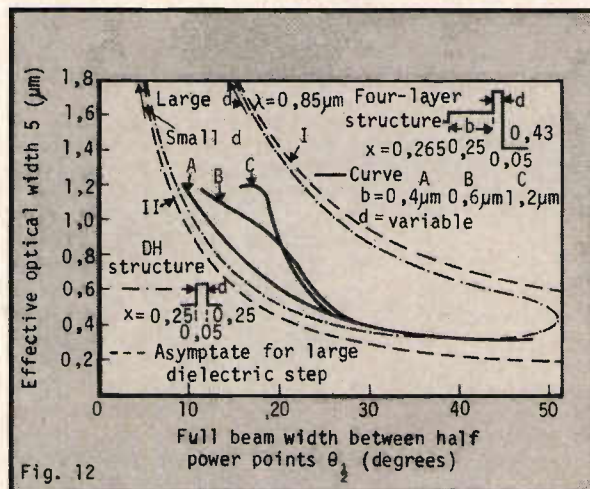

Fig. 12

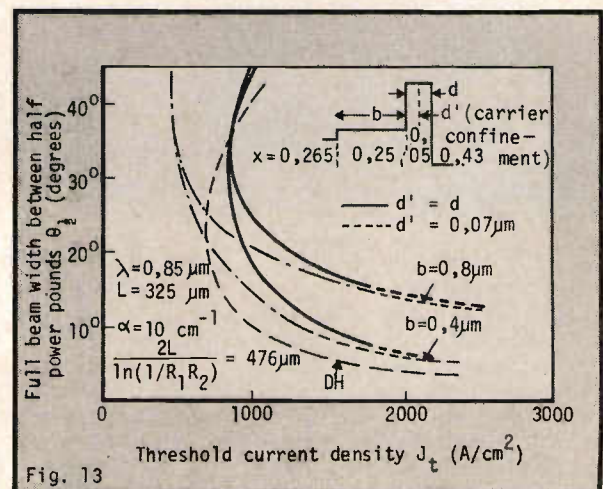
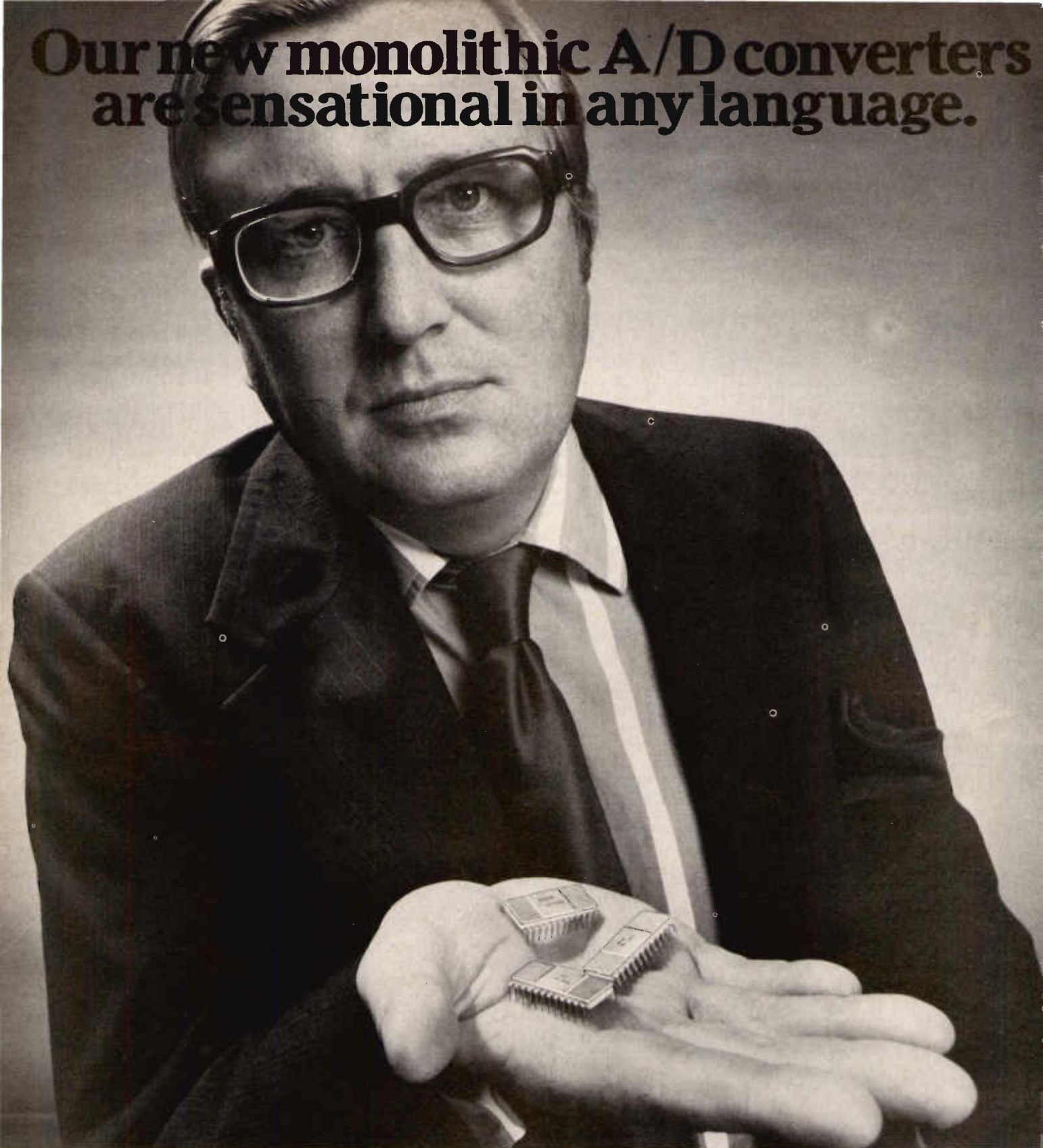

Fig. 13

Our new monolithic A/D converters are sensational in any language.



Trust Teledyne Semiconductor to come up with a sensational new 8700 series of CMOS A/D converters which combine on a single chip all linear and digital circuits required to convert an analogue signal. The 8700's are not fast converters which means that because of their integrating conversion principle, they are highly accurate, reliable and inexpensive. With their latched parallel binary outputs, the converters are logically compatible with processors such as micro computers and mini-computers, tri-state and other output versions becoming available shortly.

With the 8700 series an unlimited range of input signal voltages can be converted and unlike most IC converters, the outputs are not encoded and operate at standard logic levels.

So, if you require a data converter to translate your analog information into digital signals for subsequent processing and analysis, it's got to be the 8700 series from Teledyne Semiconductor.

A 3½ digit BCD version is also available.

Teledyne Semiconductor
Heathrow House, Bath Road, Cranford,
Middlesex. Tel: 01-897 2501. Telex: 935008.

44 on enquiry card

8700

series

A logical decision.

 **TELEDYNE
SEMICONDUCTOR**

The software challenge for microprocessor engineers

Microprocessors are likely to become an essential tool for the electronics engineer. Alan Potton explains the need to understand and the ability to use software to successfully exploit this exciting new device.

Of all developments in electronics since the arrival of the transistor, microprocessors are likely to have the greatest impact on the way engineering systems of all kinds are designed. The analogy has been drawn that if the invention of the digital computer is compared with the invention of writing then the coming of microprocessors can be compared with the invention of printing. In the same way that the use of microprocessors will influence all spheres of engineering requiring new approaches, digital system designers themselves will need to acquire new skills and techniques to exploit these devices.

The transition from discrete component logic design to the design of systems using integrated circuits was a relatively painless process for most engineers. The system elements, gates, flipflops, etc, changed in form but not in function. The arrival of msi devices actually made life easier for the digital system designer since the behaviour of registers, counters et cetera was well understood from the equivalent ssi circuits.

Intuitive design

Up to this time the design of digital systems was often an intuitive activity

Alan Potton is senior principal lecturer at Leicester Polytechnic.

with occasional recourse to Boolean algebra, Karnaugh maps or sequential system theory. In any case, msi and lsi tends to require an intuitive approach since although well established theoretical design techniques exist for combinational and sequential digital systems employing gates and flip flops, no such generally accepted and useful body of theory exists to handle the design of systems composed of more complex system elements such as counters registers, et cetera.

With the arrival of lsi capability by the semiconductor manufacturers a few years ago a common assumption was that system design would concentrate on the use of lsi and msi for 'one off' and short production run systems with custom design lsi being widely used for systems required in quantity. In practice, although custom designed lsi chips have a place in the current scenario, another option has become available, that of programmable systems using microprogrammed roms or microprocessors. An essential feature of both microprogrammed rom based systems and microprocessor based systems is that the behaviour of the system is determined by stored data comprising the program or microprogramme. The design of the system therefore involves construction of the programme or microprogramme in addition to the circuit design.

In early microprocessors, interfacing the microprocessor chip to the remainder of the system was by no means straightforward and the system design involved a substantial amount of logic hardware. The more recent microprocessors have much simpler input-output arrangements and the amount and complexity of the associated hardware is correspondingly less. The amount of design effort involving hardware is tending to decrease as the amount of software design is increasing. The emergence of programmable interface chips has accelerated this tendency. The characteristics of a programmable interface are under the control of the programme which determines the overall system behaviour.

Typical problems

As an example of the options open to the digital systems designer, consider a simple temperature control problem. Suppose it is desired to heat a quantity of material to a temperature θ_1 , hold it at that temperature for a period of time t_1 , allow it to cool to a temperature θ_2 and hold it at θ_2 for a time interval t_2 . We assume that simple on-off temperature transducers indicate whether the temperature is above or below θ_1 and θ_2 . Such temperature control systems are widely used in situations ranging

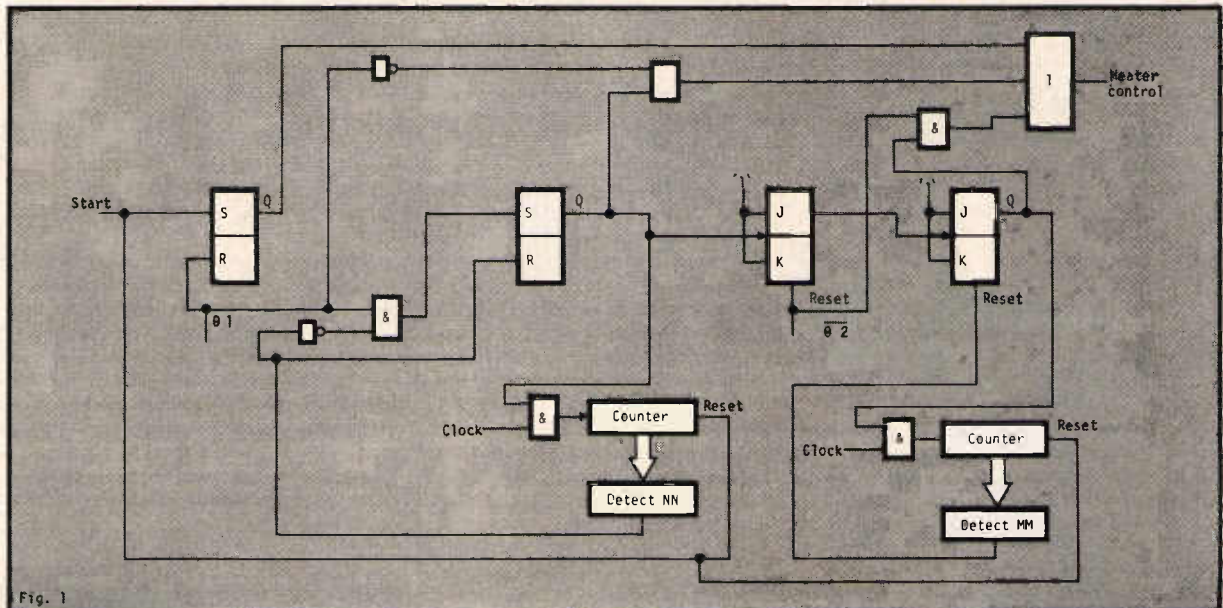

Fig. 1

continued on page 53

LINEAR IC SUPERMART

With the Signetics range of ICs you get more choice than with any other range of integrated circuits in the UK. And they're not all digitals. There's a big healthy slice of linears.

There are 'industry standard' linears for industrial, EDP and communications applications . . . a variety of packages and military options are offered. AND there are high performance state-of-the-art linears that could help put you out in front in tomorrow's market place. For a wallchart giving a rapid run-down on all Signetics linears use reader enquiry service no. 151

VOLTAGE REGULATORS

Labour-saving range newly extended

The time and labour saving Signetics μ A7800 family of voltage regulator ICs has recently been considerably supplemented. The original family comprises three series of devices with output capabilities of 150mA, 500mA and 1A, and fixed output options in the +2.6 to +24V range. Current limiting and thermal overload protection are built in.

Now, these highly popular ICs have been complemented with companion

devices – the μ A7900 family – for negative operation.

Four further devices have also been introduced. These, with the aid of two external resistors, provide for continuous adjustment of the output voltage over approximately the same range as the fixed output voltage types.

Two of these adjustable types, the 78G and 79G, are 1A devices for positive and negative operation respectively. The other

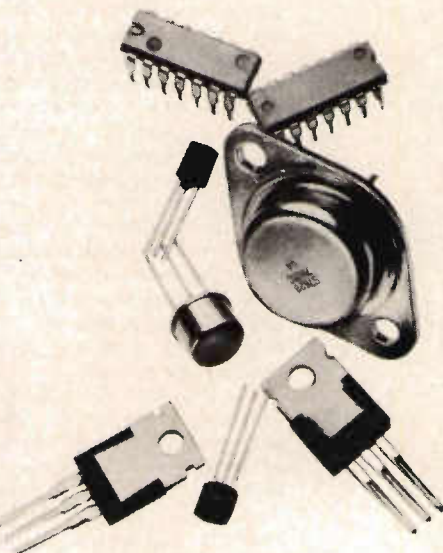

Voltage stabilisers – plastic or metal packages according to choice. Also available, four-terminal devices for adjustable voltage output.

two adjustable types, the 78MG and 79MG, are 500mA devices for positive and negative operation respectively.

For further details use reader enquiry service no. 152

PHASE-LOCKED LOOPS

NEW NEW HIGH PERFORMANCE TYPE

An attractive newcomer to the PLL range is the 564. This IC can be used with supplies from 5 to 12V. Operation is up to 50MHz with low noise and low carrier feedthrough. Standard FM and frequency-shift keyed signals can be demodulated without additional components.

A variety of other PLL circuits are offered including types with FM, AM and tone-decoded outputs. Reader enquiry service no. 153 for further information.

OP=AMPS

The op-amp range is based on thirty different types from general purpose circuits to high technology precision devices, and includes dual and quad versions, and a variety of packaging options.

'Old reliables' like the 741 continue, but there's no shortage of advanced devices such as the 535 developed by Signetics. This IC, functionally the same as, and pin compatible with, the 741, has vastly improved slew rate and input characteristics. Another Signetics innovation, the 536, has an FET input and carries a bonus of high slew rate and high output drive.

Three other 'stars' are the LM108, LM4250 and LM124. The LM108 is a bipolar op-amp which can be operated

An outstanding choice

from a source resistance of the order of 10M Ω and has very low drift. The LM4250 can be programmed by an external resistor and be operated from supplies as low as $\pm 1V$ with negligible power consumption. And the LM124 comprises four precision op-amps in one package which operates from a single $\pm 5V$ rail.

For a list of op-amps complete with potted data use reader enquiry service no. 154

Signetics
ICs from Mullard

TIMERS

Many roles

The 555 timer needs no introduction. This classic IC lends itself to diverse applications - and with the minimum of peripheral components.

A dual version (556) is also available, and quad versions (553 and 554) rated at 400mA per output. *Reader enquiry service no.155 for further information.*

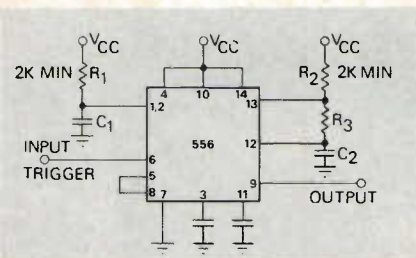

One burst generator - one of many uses for the 556 timer.

SPECIALISED ICs

More scope for designers

A glance through the list of linears reveals a variety of specialised ICs which can't be neatly categorised except in that they all offer increased scope for the equipment designer. To mention but half-a-dozen...

Analogue compander 570 - two independent signal channels: each may be used as dynamic range compressor or expander.

Generator simulated inductor TCA580 - with two resistors and a capacitor replaces inductances of up to a million henries.

Variable audio delay line TDA1022 - bucket brigade circuit providing delays from 0.5 to 50ms.

Stepper motor driver SAA1027 - performs all functions between data information pulses and stepper motor windings.

Time-proportional control TDA1023 - delivers positive gate pulses at zero crossing of the mains for triggering triacs.

Switched-mode control TDA2640 - all control and protective functions for driving single-ended switched-mode power supplies.

For data on these devices use reader enquiry service no.156

Signetics

ICs from Mullard

Widest range of ICs in the U.K.

- Logic
- Memories
- Microprocessors
- Interface
- Linears
- High REL ICs

DISPLAY INTERFACES

LED and gas tube drivers

Three devices definitely worth knowing about in the range of display interfaces are the 582 and 584/585.

The 582 comprises six drivers each having an output capability of 400mA with a correspondingly low saturation voltage - a natural for LEDs.

The 584 and 585 are, respectively, cathode and anode drivers for multiplexed gas discharge displays. Both can drive up to nine segments, and the current of the 584 can be programmed by one external resistor. *Reader enquiry service no.157 for further information.*

D-MOS DEVICES

High-performance switch arrays

The Signetics D-MOS (Double-diffused MOS) technology is exploited in a series of analogue switch arrays capable of very high speeds, excellent transient response and high voltage operation.

The SD5000 series handles a wide variety of analogue switching and driving applications. Speed is high and feed-through and feedback transients low.

The SD5300 is an 8 x 2 telephone crosspoint switching array with first-class transmission characteristics. Outputs are TTL- and CMOS-compatible. *Reader enquiry service no.158 for further information.*

COMPARATORS



to choose from

Range includes fast and sensitive Schottky types. Dual and quad devices available.

Note the NE521, a dual type with 12ns propagation delay and 20µA maximum input current. TTL compatible strobes and output. Large common mode input voltage range.

Also check the LM139 series. Each type comprises four independent precision voltage comparators in a single package. Single supply operation down to +2V. Directly interfaces TTL and MOS. *Reader enquiry service no.159 for further information.*

IC Distributors-Nationwide

For linear and all other integrated circuits contact:

A. M. Lock & Co. Ltd.,
Neville St., Middleton Rd.,
Oldham, LANCs. OL9 6LF
Telephone: 061-652 0434
Telex: 669971

Gothic Electronic
Components Ltd., Box 301,
Beacon Hse, Hampton St.,
BIRMINGHAM B19 3LP
Telephone: 021-236 8541
Telex: 338731

Semicomps Ltd.,
Wellington Road,
London Colney, St. Albans,
HERTS. AL2 1EZ
Tel: Bowmansgreen 24522
Telex: 21108

Apex Components Ltd.,
396 Bath Rd., Slough,
BERKS.
Telephone: (06286) 63741
Telex: 848519

Quarndon Electronics Ltd.,
Slack Lane, DERBY
Telephone: (0332) 32651
Telex: 37163

Semicomps Northern Ltd.,
East Bowmont Street,
Kelso, ROXBURGHSHIRE
Telephone: (05732) 2366
Telex: 72692

Farnell Electronic
Components Ltd.,
Canal Road, LEEDS
Telephone: (0532) 636311
Telex: 55147

SDS (Components) Ltd.,
Hilsea Industrial Estate,
Gunstore Rd., Portsmouth,
HANTS. PO3 5JW
Telephone: (0705) 65311
Telex: 86114

Semicomps Ltd.,
North Midlands Division,
Ingrow Lane, Keighley,
WEST YORKSHIRE
Telephone: (0535) 65191
Telex: 517343



Mullard Limited Mullard House
Torrington Place London WC1E 7HD
Telephone 01-580 6633
Telex 264341

Mullard



PRODUCT OF THE MONTH

DIGITRON
instrumentation Ltd



275 AUTORANGING DIGITAL THERMOMETER

Digitron Instrumentation have chosen Electroplan to distribute their range of temperature measurement equipment. The 275 is a mains powered digital thermometer covering the range -50°C to 1200°C , with a large LED display and an analogue recorder output.

The 275 features automatic zeroing, cold junction compensation and gives a resolution of 0.1°C below 185°C and automatically autoranges to 1°C resolution up to 1200°C . A range of fast response NiCr/NiAl probes is available, together with coupling and scanning units.

with
electroplan
a service to measurement

VARLEY Rechargeable Power Sources
EVER READY Rechargeable Power Sources
TIME ELECTRONICS Calibration & Potentiometric Measurement
WEIR INSTRUMENTATION DC Power Supplies
INTEGRATED PHOTOMATRIX LIMITED DC Power Supplies
GREENWOOD ELECTRONICS Tools and Accessories
GOULD ADVANCE Frequency Counter Timers
WESTON INSTRUMENTS Digital Multimeters
SOLARTRON Digital Multimeters and Voltmeters
INTEGRATED PHOTOMATRIX LIMITED Digital Panel Meters
WESTON INSTRUMENTS Digital Panel Meters
DIGITRON INSTRUMENTATION Digital Thermometers
DELRISTOR Reference Chambers
LABFACILITY Thermocouples

EDGCUMBE PEEBLES Insulation Testers
GULTON EUROPE Miniature Recorders
BRYANS SOUTHERN INSTRUMENTS Recorders and Plotters
ELECTRON SYSTEMS Digital Printers
TELEQUIPMENT Oscilloscopes
GREENPAR ENGINEERING Oscilloscope Accessories
WESTON INSTRUMENTS Analogue Multimeters
RISSO Analogue Multimeters
BACH SIMPSON Analogue Multimeters
WAVETEK Function Generators
SYSTRON DONNER Pulse Generators
GOULD ADVANCE Signal Generators
RILEY AUTOMATION Logic Test Equipment
TREND COMMUNICATIONS Computer Peripherals

Electroplan Limited
P.O. Box 19 Orchard Road Royston Herts SG8 5HH
Telephone: (0763) 41171 Telex: 81337 Ecplan

 An Electrocomponents Group Company

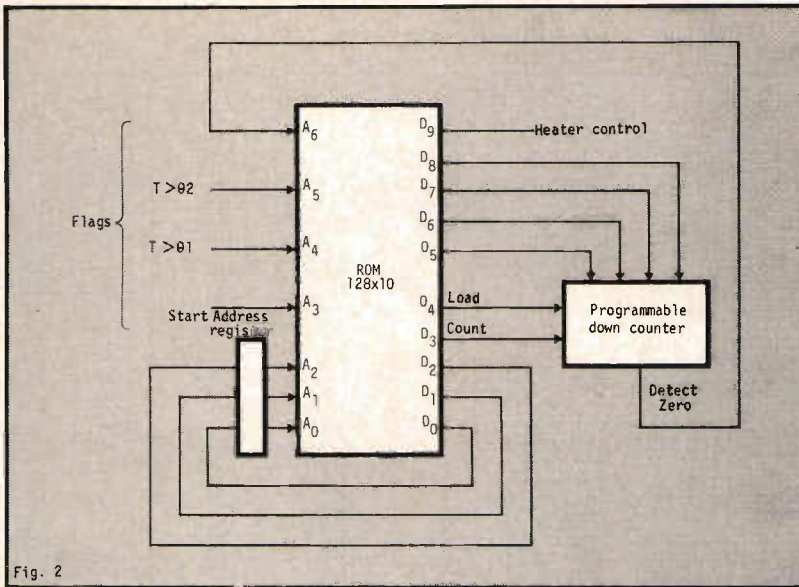

Fig. 2

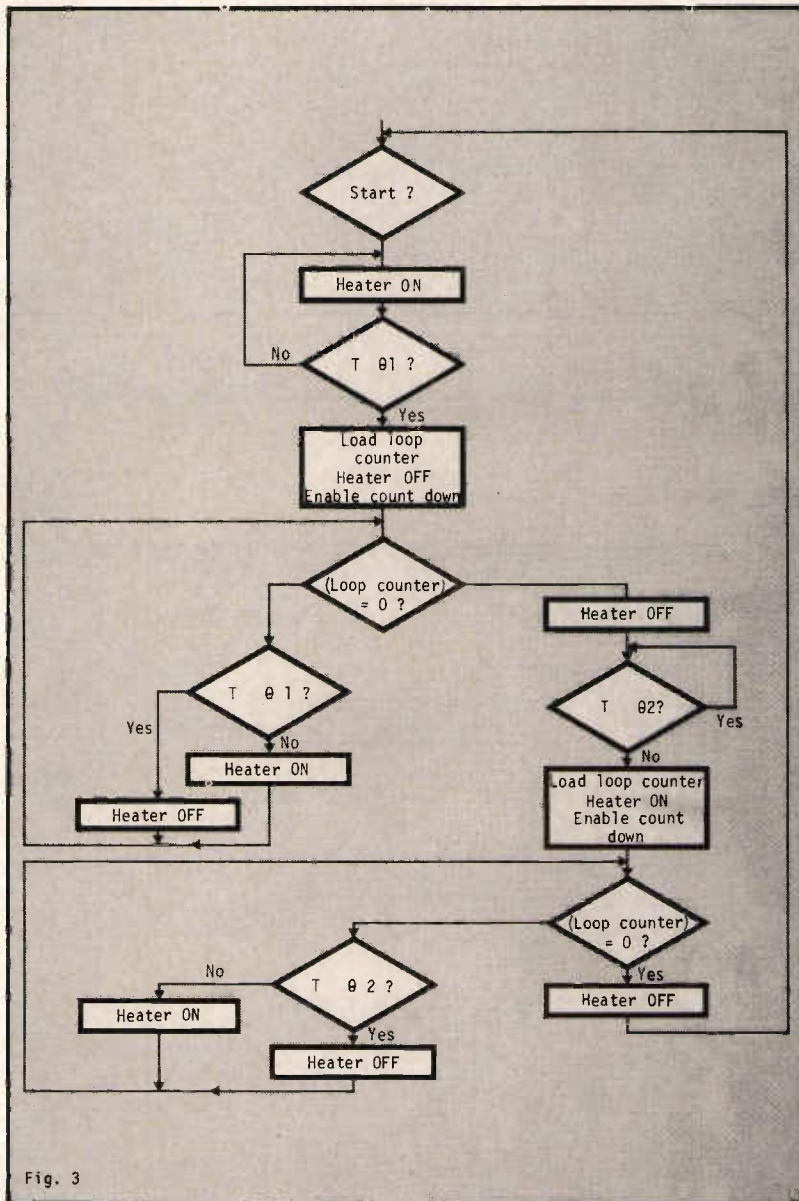

Fig. 3

from domestic washing machines to industrial chemical process plants.

Figure 1 shows a traditional approach to the problem. Generation of a start signal sets the first RS flip flop which switches on the heater. The heater remains switched on until the temperature reaches θ_1 when the first bistable is reset. At the same time, the second RS flip flop is set. This enables the input to the first counter and switches on the heater whenever the temperature drops below θ_1 . When the counter reaches NN, determined by the clock frequency and t_1 , the bistable is reset which triggers the first J-K flip flop into the set condition. The heater remains switched off until the JK flip flop is reset when the temperature falls below θ_2 . This finally sets the second JK flip flop initiating another timing cycle during which the heater is switched on when the temperature falls below θ_2 . Formal sequential system theory can be employed but most engineers appear to design systems such as this by intuitive means based on an understanding of the circuit elements and past experience.

Alternative Approach

An alternative approach to the problem is demonstrated in the rom based microprogrammed system shown in figure 2. This implements the description of the problem given in figure 3. Figure 4 shows the contents of the rom.

Various types of trade off are possible in microprogrammed systems which usually involve a reduction in rom size at the expense of additional components external to the rom. The method of employing flags directly as address modifiers as shown in figure 2 involves a fairly wasteful use of rom. Figure 4 shows that only a small proportion of the 128 locations are actually involved in the microprogramme. Multiplexing of flags as shown in figure 5 drastically reduces the size of rom required although this may not result in a lower overall system cost. This technique certainly complicates the writing of the microprogramme.

A microprocessor based system is shown in figure 6. As can be seen, the system is implemented using only four integrated circuits in addition to a clock. The programme is stored in the rom, the number of locations used depending on the skill of the programmer. In practice an adequate programme can easily be written to occupy less than 120 locations. Ram requirements are limited to one location used as a loop counter.

Having established the three methods for implementing the system it is instructive to make a comparison. The hardware only system shown in figure 1 would certainly have the lowest component cost and very probably the lowest overall production cost. Since the system characteristics are determined solely by the layout, changes in the system specifications may involve a consider-

able amount of redesign work. Modifications could be made to the time intervals t_1 and t_2 without too much difficulty by making minor changes to the circuits which detect the terminal state of the two counters and if necessary to the clock frequency.

Control systems of this kind are often required to offer a selection of temperature cycles combined with the ability to switch on pumps, valves etc. Provision of selection facilities such as this increases the complexity of hardware only systems very considerably with any major specification changes usually requiring a complete system redesign.

Greater flexibility

The microprogrammed system shown in figure 2 offers a much greater degree of flexibility. Changes in temperature set points or timing intervals in the control cycle simply require changes in the contents of the rom. Provided the rom has sufficient capacity, a variety of temperature cycles can be offered simply storing the microprogrammes for the different cycles in different parts of the rom. The particular cycle desired is selected by simply choosing the correct starting address to enter the appropriate microprogramme. Additional control functions are easily provided by choosing a rom with some unused output lines. Read only memory is relatively low cost and it is feasible to leave some 'slack' in the system for future development by allowing some spare rom capacity.

The microprocessor based system shown in figure 6 would involve the highest component cost of the three systems at current prices. The fact that the system characteristics are determined by the stored programme leads to a very considerable degree of versatility. Indeed, it is true to say that the same basic arrangement of four integrated circuits can be used to implement not only a wide variety of temperature control functions but also control mechanical, electrical, pneumatic and other systems.

Since the microprocessor system possesses such flexibility even compared with the microprogrammed systems, it may be possible to improve the performance of the control system considerably. In the temperature control system, by employing an analogue-digital converter to provide a continuous monitor on temperature, a more sophisticated control algorithm could monitor be implemented. The on-off heater control could be replaced by a pulse width modulation system, the variable width control pulses being generated directly by the microprocessor.

We may also compare the three methods in terms of the engineering skills required to develop a satisfactory system. The techniques employed in developing a system of the type shown in figure 1 are the traditional methods of

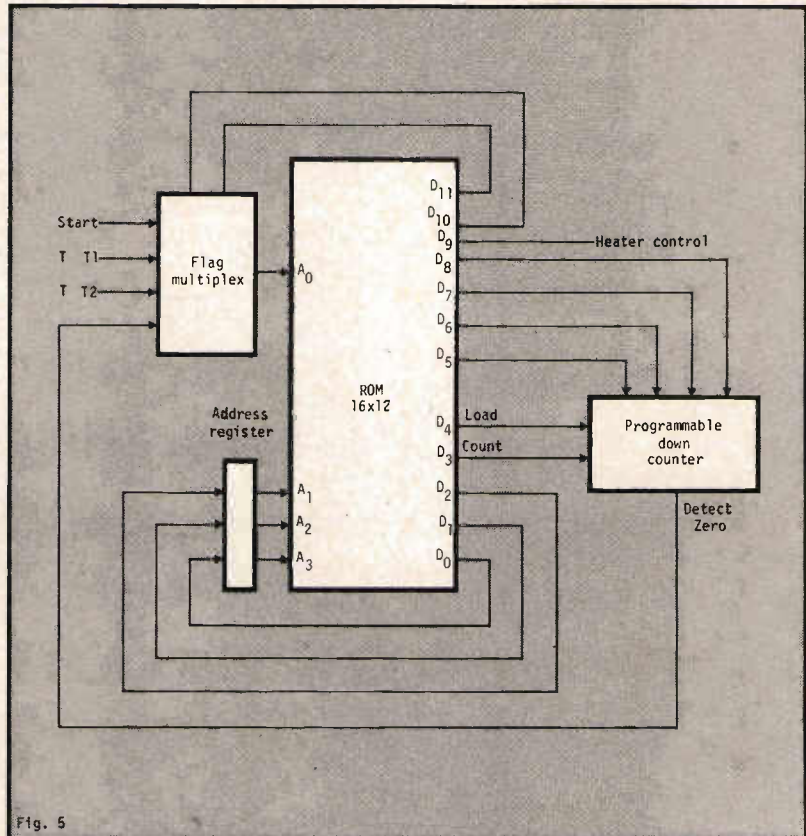

Fig. 5

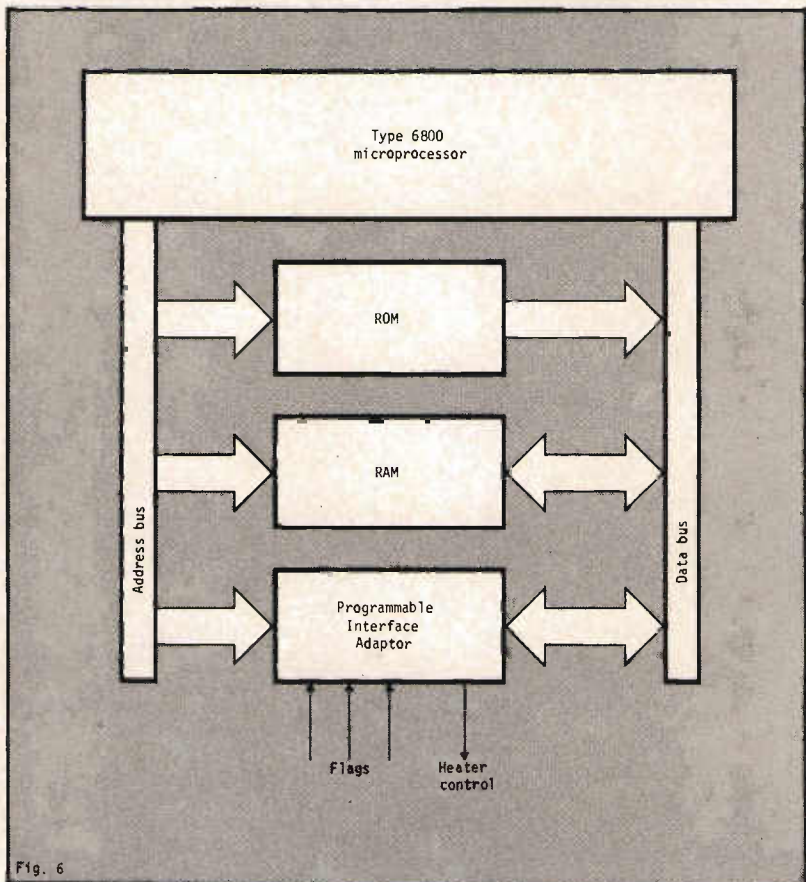

Fig. 6

hardware combinatorial and sequential logic system design. The prototype equipment would probably be developed with the aid of conventional oscilloscopes, logic level indicators, pulse generators etc.

The same basic laboratory equipment would probably be adequate to develop systems of the type shown in figures 2 and 4. To design systems of this kind however, the control algorithm needs to be clearly defined, most often with the help of a flow diagram such as the one shown in figure 3. This is in any case a desirable preliminary step to all of the design methods described.

Systematic method

Microprogramming is no longer a new technique. It was originally developed to allow a more systematic method of implementing the instruction repertoires of digital computers. Although very widely used in computers, it is only relatively recently that the price of rom has become low enough to make microprogramming an economically viable alternative to hard wired logic for more general system design.

The problems presented by the design of microprocessor based systems such as that shown in figure 6 are somewhat different to those arising in the development of hardwired logic or microprogrammed systems. The layout of the system elements is straightforward and has been indicated earlier, may well be standardised. A competent digital system designer would have no difficulty in laying out a board to accommodate the elements shown in figure 6. Once designed the board should not require modification even for quite major modifications in the system specification. For this type of system, hardware development costs are in all probability a fairly minor proportion of the total system development costs.

It is now generally accepted that for most microprocessor based systems, the major proportion of overall development costs will be incurred in designing software, that is, in writing the microprocessor programme. For the unwary engineer, attempting to predict the cost of developing software can be a chastening experience.

Engineers have been designing on line control systems involving computers for many years, of course. In the past however, the cost of the computer meant that only fairly major systems justified this approach. The difference today is that the cost of the computer hardware, in the form of microprocessor chip sets is now so low that on line computer control is being considered for relatively simple situations such as the temperature control system described here. What must not be forgotten however is that although the hardware costs have fallen in this way, software costs remain the same. Indeed, it may well be for

reasons discussed below that the cost of developing software for a microprocessor will be greater than that for say a minicomputer.

Software investment

Electronic engineers readily understand that the availability of appropriate laboratory instruments can reduce hardware development time and often allow more economical and reliable designs. Investment in software development aids is similarly important. When a minicomputer based system is developed, a computer is available with a wide variety of aids to the programmer. A control/display panel allows access to the working registers and memory for reading and writing data. Standard programmes such as assemblers, compilers, editors etc. are provided by the computer manufacturer. Investment in these facilities is considered as a normal part of the development costs.

The purchase of a microprocessor chip set provides none of these develop-

ments are available. Those who have worked with dynamic devices will be aware that conventional oscilloscopes, so long the mainstay of the electronic engineer, are no longer adequate for debugging purposes. A logic analyser should be regarded as the most appropriate instrument for this purpose. Specialised analysers relating to specific microprocessors are available as are more general purpose instruments.

Avoiding pitfalls

There is one further pitfall to be avoided. Many engineers having produced their first working microprocessor based system seem to assume that they have become overnight programming experts. It is generally accepted that to become a competent designer of efficient and reliable electronic hardware requires the correct education together with appropriate training and experience. A vast difference exists between designing a system which just works and designing a system with the proper considerations

Fig. 4: Contents of the read only memory.

Address lines							Data lines										
6	5	4	3	2	1	0	0	1	2	3	4	5	6	7	8	9	
*	*	*	0	0	0	0	0	0	0	0	0	0	0	0	0	0	
*	*	*	1	0	0	0	0	0	1	0	0	0	0	0	0	1	
*	*	0	*	0	0	1	0	0	1	0	0	0	0	0	0	1	
*	*	1	*	0	0	1	0	1	0	0	1	N	N	N	N	0	
0	*	0	*	0	1	0	0	1	0	1	0	0	0	0	0	1	
0	*	1	*	0	1	0	0	1	0	1	0	0	0	0	0	0	
1	*	*	*	0	1	0	0	1	1	0	0	0	0	0	0	0	
*	0	*	*	0	1	1	1	0	0	0	1	M	M	M	M	1	
0	*	0	*	1	0	0	1	0	0	1	0	0	0	0	0	1	
0	*	1	*	1	0	0	1	0	0	1	0	0	0	0	0	0	
1	*	*	*	1	0	0	0	0	0	0	0	0	0	0	0	0	

ment aids. For serious programme development they are essential. Manufacturers of microprocessor chips offer systems which give the facilities of a normal minicomputer but are designed around the microprocessor. Engineers should be aware that investment in such equipment will be part of the development cost of microprocessor based systems.

It is possible to purchase a microprocessor chip set and develop a simple system without the aids described above. In contrast to the advice offered by the microprocessor manufacturers, the author believes that this can be a useful educational introduction for the engineer. This exercise however will normally only serve to give the engineer an understanding of what the development problems actually are. After this, he will be fully aware of the need for software development aids.

Many of the available microprocessors are dynamic although a few static

of reliability and efficiency. Why then should it be assumed that the situation is different when computer programmes are designed? As is the case in other types of computer system development it is likely that the efficient microprocessor system development team will include both hardware and software specialists with each having a good understanding of the other's area of work.

If this paper seems unduly cautionary and pessimistic, this is not intentional. Going back to the statements made at the beginning, there is no doubt that the microprocessor will generate a truly major expansion in the use of electronic control techniques at all levels and in all fields of engineering. This paper represents a plea to electronic engineers not to be misled by the seductively low price of microprocessor chips and to realise that the approach to microprocessor system design really must be different to that for the more traditional types of digital systems.

Designed for the 70's

GRIPS is a range of compact, modular mains switching power supplies designed to meet today's needs in terms of size, price, performance and reliability. Our latest 50W switching PSU, for example, offers remarkable value. Because, for just £70 you get a unit offering efficiencies in excess of 70% with line and load stability of 0.15%, temperature coefficient of 0.005%/°C and an operating temperature range of -10° to + 70°C. Added to this, fewer components means higher reliability than conventional linear power supplies.

This new unit complements an already impressive GRIPS range. Working from inputs of 250V, there are units giving outputs ranging between 5 and 30V at 50, 150 and 300W. And every GRIPS unit is inherently safe, the 50W unit will even meet a 4kV rms insulation test.

Care and attention to detail are features that

Gresham Lion are well known for. It shows in the quality of every one of our extensive range of products. It shows in the continual testing being undertaken by our Quality Assurance Department. It shows in every transformer we make. It shows in the impressive reputation we have established for ourselves over the past 36 years.

So, if you'd like to know more about the GRIPS range, or about Gresham Lion products in general, send for our Standard Product Catalogue simply by writing, ringing or circling the card at the back of this publication.

You'll find our service is designed for the 70's, too.

Gresham Lion Limited

Gresham House, Twickenham Road, Feltham, Middx. TW13 6HA. Tel: 01-894 5511. Telex: 27419.

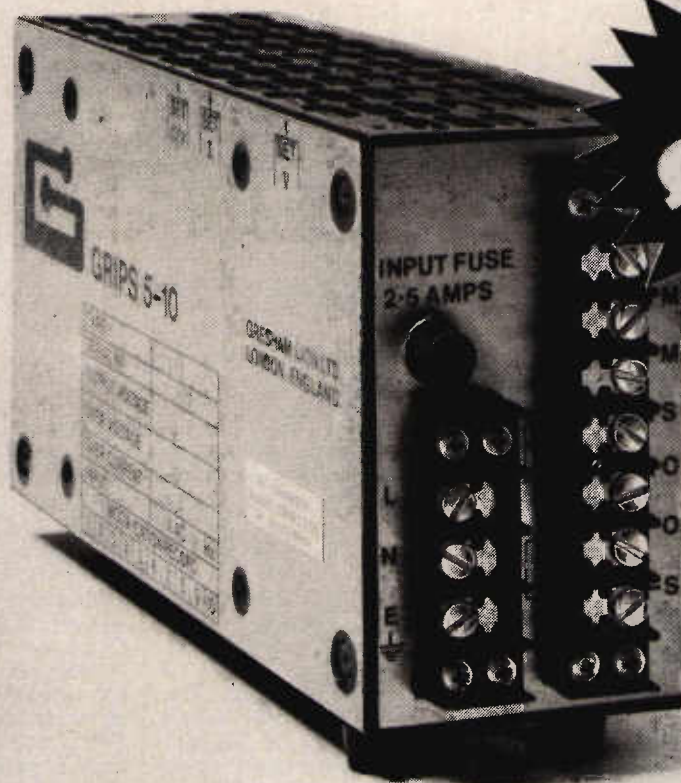

The people in power.

TOMORROW'S SEMICONDUCTORS ARE HERE



**WITH TODAY'S
SERVICE FROM**

**MEMEC
LTD**



PROM

G. Prom	Bits	Organisation	D.I.L. Pins	Max Access Time *	Available
HM-7602 Open Collector O/P HM-7603 Three-State O/P	256	32 x 8	16	40nS	Now
HM-7610 Open Collector O/P HM-7611 Three-State O/P	1024	256 x 4	16	60nS	Now
HM-7620 Open Collector O/P HM-7621 Three-State O/P	2048	512 x 4	16	70nS	Now
HM-7640 Open Collector O/P HM-7641 Three-State O/P	4096	512 x 8	24	70nS	Now
HM-7642 Open Collector O/P HM-7643 Three-State O/P	4096	1024 x 4	18	70nS	Now
HM-7644 Active Pull-up	4096	1024 x 4	16	70nS	Now

Established leaders in field programmable read-only memories, Harris is now offering industry standard pin-out CMOS static rams. All offer 2.2V data retention and extremely low operating powers – 15µW/bit at 1MHz.

CMOS RAM

CMOS RAM	Bits	Organisation	D.I.L. Pins	Max. Access Time ns	Max. Standby I _{cc} µA
HM-6508 HM-6508B	1024	1K x 1	16	400 290	100 10
HM-6518 HM-6518B	1024	1K x 1	18	400 290	100 10
HM-6501 HM-6501B	1024	256 x 4	22	400 285	100 10
HM-6551 HM-6551B	1024	256 x 4	22	400 285	100 10
HM-6561 HM-6551B	1024	256 x 4	18	400 285	100 10
HM-6562 HM-6562B	1024	256 x 4	16	400 285	100 10

GUARANTEED Ta 0° to 70°C AND V_{cc} 5V ± 5% (5V ± 10% MILITARY VERSION)
HIGHER SPEEDS EASILY SELECTABLE IF REQUIRED

PROM PROGRAMMING FROM MEMEC

MICROPROCESSOR

A 12 bit, fast, low power PDP8 on a chip? – That's what Harris offer with their HM-6100, plus HD6101/A, the parallel interface element, HM6312/A 12K ROM, HD6402/A/HD6403/A UART and the SIMON prototyping system – ask MEMEC for full details. Also ask about the CMOS PROM HM6110/1/2 – another Harris first!

CMOS LOGIC

PLASTIC

4000/14500/74C SERIES

CERAMIC

ANALOGUE

HA-2425 – The Sample and Hold on a chip – Harris technology saves your design time and board space! Ask for data and applications note.

HI-200/201 Dual and Quad CMOS switches, HI506/7 and HI506A/507A/508A/509A Analogue Multiplexers plus the large HI-5040 range of switches makes Harris's range of CMOS switches the largest available.

AND DIELECTRIC ISOLATION MAKES THEM LATCH-UP PROOF.

LINEAR

HARRIS OPERATIONAL AMPLIFIERS 0-75°C FOR INDUSTRIAL APPLICATIONS. Available in -55/+125°C versions.

DESCRIPTION	FAMILY NUMBER	INPUT CHARACTERISTICS										TRANSFER CHARACTERISTICS						OUTPUT CHARACTERISTICS				TRANSIENT RESPONSE				POWER SUPPLY CHARACTERISTICS				PACK-AGE	COMMENTS			
		Offset Voltage (mV)	Drift Typ (µV/°C)	0/75°C max	Bias Current (nA)	Offset Current (nA)	Input Resist (MΩ)	Common Mode Range (V)	Large Signal Voltage Gain	Common Mode Rejection Ratio (dB)	Gain Bandwidth prod (MHz)	Output Voltage Swing (V)	Output Current (mA)	Full Power Bandwidth (kHz)	Slew Rate (V/µs)	Settling Time (µs)	Supply Current (mA)	Power Supply Rejection Ratio (dB)	TO-99															
QUIET	Low Noise, Gen Purpose	HA-911	2	30	10	7.5	200	750	100	450	0.25	±12	20K	45K	74	90	716	±11	±15	—	—	—	—	—	—	—	—	—	—	—	—	—	—	Equivalent Input Noise 1µV 1Hz - 1000Hz, 8Ω = 10K, 0
NO LOAD	F.E.T. Input	HA-2055	30	60	65	1pA	1	0.5pA	0.5	10 ⁻¹⁰	±10	7.5K	15K	70	90	20 ⁽²⁾	±10	±10	—	2000	—	120	0.4	6	8	70	90	90	90	90	90	90	FET Input version of HA-2025	
VERSATILE	F.E.T. Input	HA-2085	16	60	65	1pA	1	0.5pA	0.5	10 ⁻¹⁰	±10	80K	150K	70	90	100 ⁽²⁾	±10	±10	—	600	—	35	—	4	6	70	90	90	90	90	90	90	FET Input version of HA-2025	
FAST	Four Channel	HA-2406	4	30	11	50	500	5	100	30	±10	50K	150K	74	100	40 ⁽²⁾	±10	±20	—	500 ⁽³⁾	—	50 ⁽²⁾	1.5 ⁽⁴⁾	4.8	6	74	90	90	90	90	90	90	4 Channel TTL - Selectable Op Amp	
	High Rise Rate	HA-2506	4	20	10	125	500	20	100	60	±10	15K	25K	74	90	12 ⁽²⁾	±10	±10	300	500	—	20	30	0.33	4	6	74	90	90	90	90	Stable at Av=1		
	High Slew Rate	HA-2615	5	20	14	125	500	20	100	100	±10	7.5K	15K	74	90	12 ⁽²⁾	±10	±10	600	1000	—	40	60	0.25	4	6	74	90	90	90	90	Differential Input Stable at Av=1		
	High Slew Rate	HA-2525	5	20	14	125	500	20	100	100	±10	7.5K	15K	74	90	12 ⁽²⁾	±10	±10	1200	1600	—	80	120	0.20	4	6	74	90	90	90	90	Differential Input Stable at Av=10		
BROADBAND	Very High Slew Rate	HA-2535	0.8	5	5	15	200	8	20	2	—	100K	2x10	80	100	70 ⁽²⁾	±10	±25	4MHz	5MHz	—	250	320	0.5	3.5	6	80	100	100	100	100	Input Impedance Only		
	Gen. Purpose Wideband	HA-2606	3	5	7	5	40	5	40	300	±11	80K	150K	74	100	12 ⁽²⁾	±10	±10	50	75	—	4	7	1.5	3	4	74	90	90	90	90	90	Unity Gain Current Driver with Current Limit	
	Gen. Purpose Wideband	HA-2625	3	5	7	5	40	5	40	300	±11	80K	150K	74	100	100 ⁽²⁾	±10	±10	320	600	—	20	35	—	3	4	74	90	90	90	90	90	Output Short Circuit Protected	
POWER	Current Booster	HA-2635	70	—	—	300	300µA	—	—	2	—	0.85	0.95	—	8	10	±400	—	8MHz	200	—	500	—	15	23	—	66	TO-8	Indicated	Indicated	Indicated	Indicated	Channel Separation - 100dB	
HIGH VOLTAGE	High Voltage	HA-2645	2	15	7	12	50	15	50	200	±35	100K	200K	74	100	4 ⁽⁴⁾	±35	±10	—	23	—	5	—	3.2	4.5	74	90	90	90	90	90	90	V supply up to ±40V High 1500 pin-for-pin	
SPACE SAVING	Dual High Performance	HA-2655	2	8	7	50	300	2	100	20	±13	20K	40K	74	100	8	±13	±16	30	80	—	2	6	—	3	4	74	100	100	100	100	100	100	Stable at Av = 1 V supply ±2 to ±20V Channel Separation - 100dB
	Quad High Performance	HA-4605	0.5	2	4	130	400	30	120	—	—	75K	250K	80	—	8	±10	±10	—	60	—	4	30	—	5	6.5	80	—	—	—	—	—	Stable at Av = 1 Channel Separation - 100dB	
	Quad High Performance	HA-4625	0.5	2	4	130	400	30	120	—	—	75K	250K	80	—	90	±10	±10	—	400	—	4	30	—	5	6.5	80	—	—	—	—	—	Stable at Av = 1 Channel Separation - 100dB	
	Quad, Gen. Purpose	HA-4741	1	5	6.5	80	400	30	100	5	±12	25K	50K	80	—	—	±12	—	—	25	—	1.6	—	3.2	7	80	100	—	—	—	—	—	New Quad 741 Channel Separation - 100dB	
COOL	Low Power (High Slew)	HA-2705	1	5	7	5	70	2.5	40	—	±11	200K	2M	80	106	1	±11	22 ⁽³⁾	—	—	—	10	20	—	75µA	150µA	8	100	—	—	—	—	Stable at Av = 1 High 1500 pin-for-pin	
PROGRAMMABLE	Programmable	HA-2725	2	—	7	8	40	1	20	5	—	25K	120K	74	90	—	±10	±8	—	—	—	0.8	—	—	—	—	—	—	—	—	—	—	Spec at V _s = 15V I _{sat} 15µA	
	Dual Programmable	HA-2735	2	—	7	8	40	1	20	5	—	25K	120K	74	90	—	±10	±5	—	—	—	0.8	—	—	—	—	—	—	—	—	—	—	Spec at V _s = 15V I _{sat} 15µA	
PRECISE	Chopper Stabilized	HA-2905	20µV	0.2	80µV	150pA	1000pA	50pA	500pA	100	±10	10 ⁵	2x10 ⁵	120	60	3	±10	7	—	40	—	2.5	—	3.5	5.0	120	160	—	—	—	—	—	0.2µV/°C and 1µA/°C offset drift Monolithic Chopper	

(1) 3dB bandwidth (2) Av > 10 (3) Typical (4) Av = 1 (5) 75°C (6) Unity Gain Bandwidth < 90mV 1 Improved Version Available

STOP PRESS: New parts coming include Quad Comparators and a 12 bit A/D and D/A with a separate voltage reference chip

EMM SEMI THE BEST IN 4K STATIC RAMS

The original pioneers in 4K NMOS Static Rams, EMM Semi are unsurpassed in fast, commercial or military applications. All product is 100% 20 hour burnt-in and being static is easy to use and free of pattern sensitivity problems.

Polysilicon resistor technology results in the extremely good power/speed performance of these Rams.



STATIC

means:

- EASY TO USE
- NO REFRESH:
 - LESS COMPONENTS
 - LESS SPACE
 - MEMORY AVAILABLE
 - TIME GREATER
- DATA RETENTION POSSIBLE
- RELIABILITY

Part No.	Organisation	Package D.I.L.	Max. Access Time	Power Supplies Volts	Output	Available
Semi 4200	4096 x 1	22 pin	215nS	12/±5	TTL	Now
Semi 4402A/B	4096 x 1	22 pin	150/100nS	12/-5	Differential	Now
Semi 4801A	4096 x 1	18 pin	500/1000nS	5	TTL	Dec. 76
Semi 4104A	1024 x 4	22 pin	200nS	12/±5	TTL	Now
Semi 4804A	1024 x 4	18 pin	500nS	5	TTL	Now
Semi 1801	1024 x 1	16 pin	90nS	15/5/-3.5	TTL	Now
Semi 1802	1024 x 1	16 pin	70nS	15/-3.5	Differential	Now

MEMORY CHECKLIST FROM MEMEC

MEMORY						
4K	DYNAMIC RAMS	NMOS	4K x 1			22/18 PIN (NATIONAL SEMI)
4K	STATIC RAMS	NMOS	4K x 1		22 PIN 200NS	
4K	STATIC RAMS	NMOS	1K x 4		22/18 PIN 200NS/500NS	18 PIN 200NS (INTEL 2114)
1K	DYNAMIC RAMS	PMOS	1K x 1			(1103A)
1K	STATIC RAMS	NMOS	1K x 1		70NS 16 PIN	FAST/LOW POWER 2102
1K	STATIC RAMS	NMOS	256 x 4			16/18/22 PIN FAST 2101/11/12
1K	STATIC RAMS	CMOS	1K x 1	16/18 PIN 290NS		
1K	STATIC RAMS	CMOS	256 x 4	22/18/16 PIN 400NS		
	PROMS	TTL		32x8, 256x4, 512x4, 512x8, 1024x4		
	PROM	CMOS	256 x 4	16/18 PIN		
	FPLA	TTL		COMING SOON 14x48x8		
	PROGRAMMABLE DIODE MATRICES (CMOS)			6x8, 8x6, 10x4, 4x10		
8K/16K	ROM	NMOS			✓	✓
12K	ROM	CMOS		✓		
	STATIC/DYNAMIC SHIFT REGISTERS					LARGE PMOS/NMOS RANGE



Now manufacturing in Wakefield, Massachusetts, Transitron are a force to be reckoned with in power transistors, thyristors and voltage reference diodes and zeners

IN821/IN829 REFERENCE DIODES

6.2V 400mW DO-7 $-55/+125^{\circ}\text{C}$ 0.01 to 0.0005%/ $^{\circ}\text{C}$ Temperature coefficient at 7.5mA

SVM61/SVM605 IMPROVED IN821/IN829 SERIES

SPECIFIED FOR USE AT CURRENTS OTHER THAN 7.5mA

BZY88 ZENERS

400mW range in DO-7 or DO-35

IN4000 FAMILY DIODES

1 amp DO-41 to 1000V PRV

BLX FAMILY SILICON PLANAR POWER TRANSISTORS

TO-5 AND TO-3 NPN AND PNP POWER TO 20A I_C AND 150W P_{DISS}

WHERE HIGH SWITCHING SPEEDS ARE REQUIRED

STOLZ AG

UNIVERSAL PROM PROGRAMMER

A modular system of programming equipment that will programme any PROM from any manufacturer (EPROMS too). The heart of the system is the manual programming unit (MPU) to which may be added

tape reader, computer interface or RAM unit. With all those it is a comprehensive editing copier, but remember, with the addition of a copy module only the MPU is the cheapest manual and copying facility around. **FAMILY MODULES** now available with plug-in sockets for different organisation PROMs in the same family (e.g., Harris GPROMs).

Ask MEMEC for full information.



MPU WITH TAPE READER AND RAM



MELCHER

SWITCHING MODE REGULATORS

SMALL, COOL and EFFICIENT – not the office secretary but the Melcher range of switched mode power supplies!

For DC/DC applications the two SMR ranges offer 5V output up to 12A, 12V output up to 6A and variable 7.5V to 16V output regulators from inputs of 11-33V.

For AC/DC applications the LSR range takes 176 to 264VAC (40 to 440Hz) input and gives outputs of 5V 3A, 12V 1.25A, 15V 1A, or 24V 0.625A.

Units are sealed in diecast heatsinks and feature 70 to 80% efficiency with -40°C to $+85^{\circ}\text{C}$ operation.

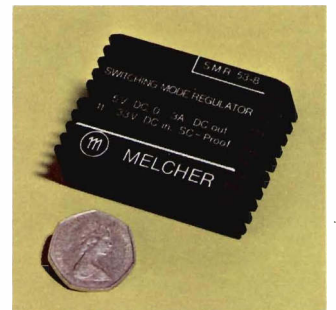

5V 3A DC/DC SMR53

Manufacturing in Florida, near Cape Canaveral, Solitron Devices is recognised as a pacesetter in the Semiconductor industry not only for the high quality of its components but also for its advanced technology. This is indicated by the successful use of Solitron components in most western satellite programmes including all Apollo craft and Skylab.

Solitron's power transistor lines have recently expanded into such areas as thick film power hybrids, fast recovery planar diodes and Schottky diodes.

Solitron's power transistor processes encompass three design concepts: Planar Epitaxial, Planar Triple Diffused and Single Diffused Mesa.

FETS

Low RDS(ON) High Current and High Speed N-Channel fets plus P-channel complements

A large range of P and N channel general purpose amplifiers

A large range of P and N channel general purpose dual junction fets

N channel low frequency and wideband junction fets give noise levels down to $10\text{mV}/\sqrt{\text{Hz}}$ at 10Hz

N channel duals of the 2N 5900 family feature I_{GSS} down to 2pA at 20V V_{GS}

- SWITCHES
- AMPLIFIERS
- DUALS
- LOW NOISE DUALS
- ULTRA LOW LEAKAGE

TRANSISTORS

POWER

- From 2N 3055's (Single Diffused) to the 100 Amp SDT 3622, Solitron excel.

HIGH VOLTAGE

- 350V 1 Amp 2N5416 PNP and 2N3439 NPN for fast switching and linear applications.

SWITCHING

- Multiple diffused planar devices give excellent on/off times and Safe Operating Areas.

HI-REL

- The revolutionary S^2 PAK hi-rel package is just the peak of Solitron's achievement.

DARLINGTONS

5 Amp and 10 Amp 20MHz f_T , TO-3, NPN darlingtons SDM20302 and SDM20312

Complementary NPN/PNP, TO-66, 5 Amp darlingtons SDM3101 and SDM3201

- FAST
- 5 AMP

DIODES

500MA SCHOTTKY

- MS9000 family DO-7 Schottky diodes up to 70V V_{BR}

3A SCHOTTKY

- SSP 300 family DO-4 Schottky diodes up to 60V V_{BR}

20A SCHOTTKY

- SSP 2000 family DO-4 Schottky diodes up to 40V V_{BR}

FAST RECOVERY

- SPD 640 in DO-4-150A surge at 400V V_{R} with t_{rr} 150nS (maximum)

REGULATORS

The CJSE family offers foldback and short-circuit protected TO-3 regulators up to $\pm 30\text{V}$ output

With the CJCA family output volts up to $\pm 56\text{V}$ may be set. In an 8 pin TO-3 pack

- 3 AMP FIXED
- 5 AMP VARIABLE



Synertek 5 VOLT TTL COMPATIBLE NMOS

Advanced ion implantation techniques give 60% speed-power improvements and allow the design of totally TTL compatible, single 5V supply static devices. Full temperature range parts available too.

DYNAMIC RAM

RAM	Organisation	D.I.L. pins	Max. Access Time nS	Comments
SY5280	4096 x 1	22	200	MOS Chip Enable I/P
SY5281			250	Bipolar Chip Enable I/P
SY5270	4096 x 1	18	200	MOS Chip Enable I/P
SY5271			250	Bipolar Chip Enable I/P
SY1103A	1024 x 1	18	145	Fast, Low Power, Low Standby

The 4K Dynamic RAMS above are EXACT National Semiconductor second sources – from identical masks. Same numbers, same product, and Syntel delivers! All feature 400nS Read/Write Cycle Time, TTL compatible inputs and three-state outputs with on-chip address and chip select registers. Slower/Low Cost – 5 parts available too.

STATIC RAM

RAM	Organisation	D.I.L. pins	Max. Access Time nS	Comments
SY2101 2111 2112	256 x 4	22 18 16	500 to 1000	Low Cost versions 70mA supply (max.)
SY2101A 2111A 2112A			256 x 4	22 18 16
SY21H01 21H11 21H12	256 x 4	22 18 16	150 to 200	Fastest versions 90mA supply (max.)
SY2102 2102A			1024 x 1	16
21L02	350 to 1000	Low Power, 15 to 40mA (max.)		
21H02	150 to 200	Fastest version, 90mA (max.)		
SY2114	1024 x 4	18	200 to 450	Intel 2114 equivalent available December 76
SY1101 1111 1112	256 x 1	16	800 to 1000	PMOS IM 7501/11/12 compatible

MICROPROCESSOR

The SY6500 group of microprocessors is software compatible within the group and compatible with all MC6800 peripherals. Second-sourced by cross licensing with MOS Technology, all 9 microprocessors (five have on-board clock oscillators) are TTL compatible I/O with single 5V supply and feature 55 instructions and 2MHz operation. A low cost MC6800 alternative.

SHIFT REGISTERS

P-CHANNEL LOW POWER DYNAMIC REGISTERS

Syntel Part No.	Description	Directly Replaces	Comments
SY1404A	1K x 1 Dynamic	AMD, Intel NSC, Signetics, (SIG 2502, 2503, 2504)	60% Less Icc (22 mA) 40% Less C ϕ (85 pF) No 'Bit Dropping'
SY1403A	512 x 2 Dynamic		
SY1402A	256 x 4 Dynamic		
SY2804	1K x 1 Dynamic	AM 2804, 2803, 2802	10MHz 35% Less Icc 40% Less C ϕ (85 pF)
SY2803	512 x 2 Dynamic		
SY2802	256 x 4 Dynamic		
SY2825	1K x 2 Dynamic	NSC 5025, 5026, 5027 AM 2825, 2826, 2827	30% Less Power
SY2826	1K x 2 Dynamic		
SY2827	2K x 1 Dynamic		
SY7712 SY7722	1K x 1 Dynamic Recirculating		
SY7780	80 x 4 Dynamic Recirculating	16 pin d.i.l.	Single phase TTL clock 2.5MHz independent recirculate

N-CHANNEL, TTL COMPATIBLE STATIC AND DYNAMIC REGISTERS

Syntel Part No.	Description	Directly Replaces	Comments
SY2401	1K x 2 Dynamic	Intel, 2401, AM 2401	Low cost
SY2401-1	1K x 2 Dynamic	AM 9401	2.5MHz
SY2533	1K x 1 Static, 1.5MHz	SIG & AM2533 National 5058	50% Less Power
SY2833	1K x 1 Static, 2.0MHz	AM2833 TI 3133	Eliminate Negative Power Supply
SY2833A	1K x 1 Static 3.0MHz	FSC3355 TI 3133	
SY2833B	1K x 1 Static, 4MHz	FSC3355	
SY2534	512 x 2 Static	SIG2527	Double Density Low Cost
SY2535	480 x 2 Static	SIG2529	

ROM

SY3514/15, 512 x 8 N-Channel	FSC3514/5 NSC NM5233 MK2600P
SY2530, 512 x 8 N-Channel	Signetics 2530
SY4600, 2048 x 8 N-Channel	EA4600
SY2316A/B, 2048 x 8 N-Channel	Intel 2316A/8316A Intel 2708

All 5V supply and completely TTL Compatible

NEW SPECTRUM ANALYSER

● **AM/FM monitor**

● **Easy to operate**

● **Low cost**

New from Dana is the Cushman CE-15 spectrum analyser, with a total range of 1 MHz to 1 GHz. Portable 12-volt operation is offered as an option, making it a valuable tool in radio service work.

Interlocked controls ensure simplicity of operation, and levels from +20 dBm to -115 dBm can be measured directly from the display, which has a range of 70 dB.

Measuring only 240 by 220 by 470 mm, the CE-15 takes up little bench space and, weighing in at 13.6 kg, is easily carried. How have you managed (so far) without one?



Others measure by us.

Makers of High-quality Instruments : Frequency Counters
 Digital Voltmeters
 Waveform Generators
 Communications Test Equipment
 Microwave Counters
 Frequency Synthesizers

Dana Electronics Ltd.,
 Collingdon Street,
 Luton, Beds. Telex : 82430
 Telephone : 0582 24236

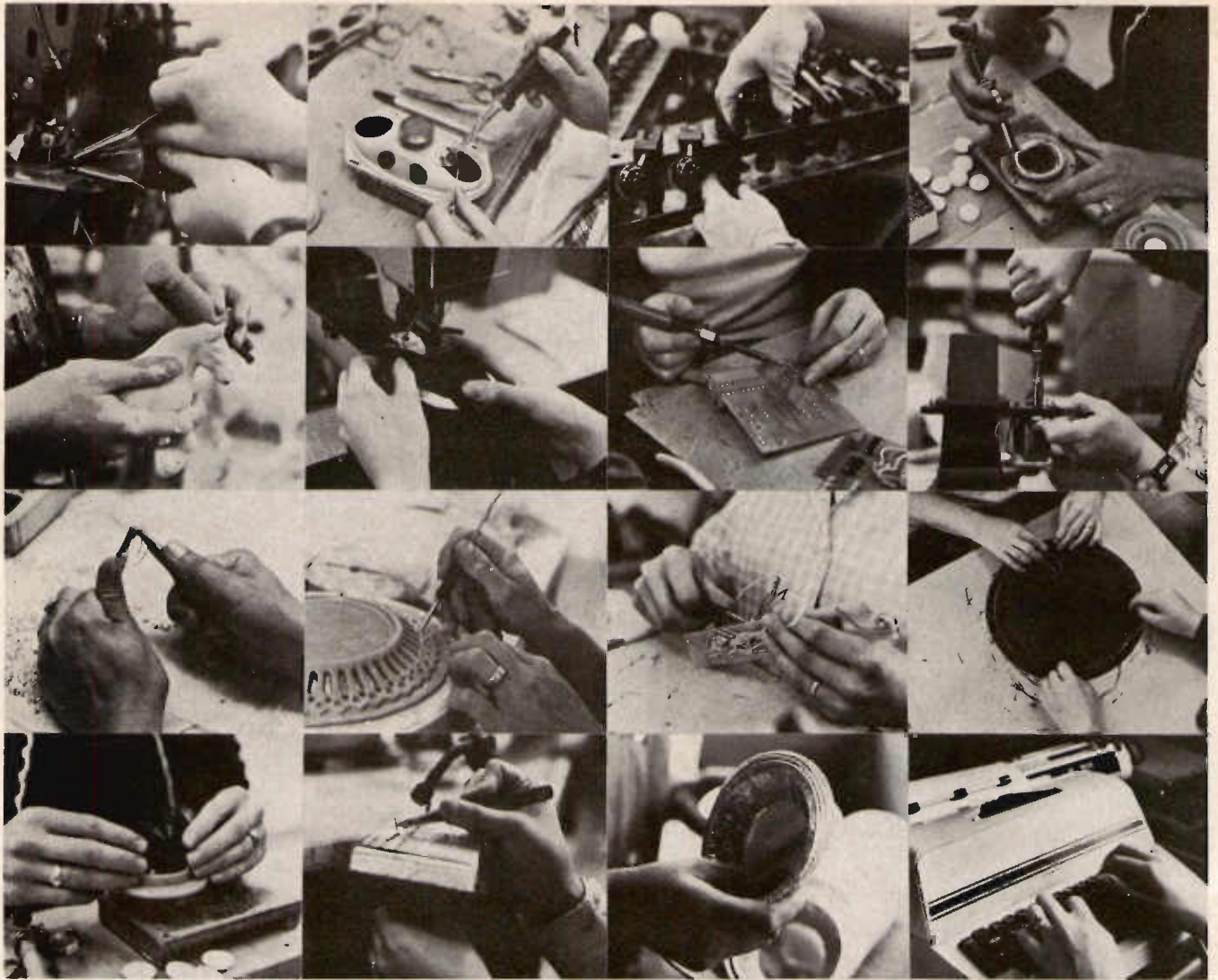

Telford: where girls have the golden touch.

Hands that are willing and ready to do productive and profitable work. They belong to over 1,000 girls up to 60 years of age who would like jobs in incoming industry, and whose names we know, along with the names of lots of men too, both skilled and unskilled.

Skilled labour

Telford has a register of skilled people of many trades. 1013* of them in fact. They are ready to move to Telford with their families when suitable work is available. The unique 'Homes & Jobs' Plan ensures attractive low-rent homes for these newcomers.

New factory units

There's a wide choice of factory, from 1,000 to 37,000sq. ft., many with expansion room alongside. Leases can be surrendered without penalty to allow for a move to larger premises in Telford. Rents start from as low as 75p per sq. ft.

Communications

Telford gives the businessman all the connections he needs. The town's urban motorway links industrial estates and will connect with the M6 when the M54 is completed.

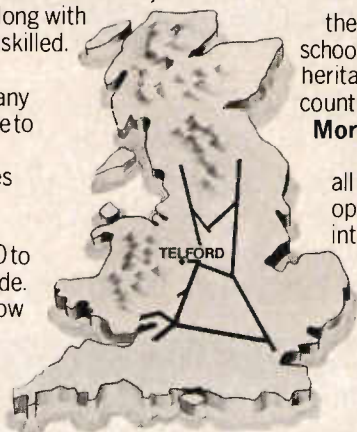

A good life

At Telford, the needs of industry are balanced with the needs of the people. You'll find first class homes, schools, shops, sports and leisure facilities. Plus a rich local heritage and the renowned beauty of the Shropshire countryside.

More details

Bob Tilmouth, Commercial Director is ready with all the facts and figures on development opportunities at Telford. He'd love the chance to introduce your company to Telford's girls. Please phone him or write for further details of labour availability and industrial development opportunities at Telford.

*There were 1013 skilled people on our list on 26th October 1976.



Telford Development Corporation

Priorslee Hall, Telford, Salop TF2 9NT Phone: (0952) 613131 Telex: 35359

Design considerations for optically coupled isolators

In this article *Chris Williams* describes the two basic opto isolator families and describes methods of obtaining the best results from these devices.

Opto-isolators fall into two basic families the phototransistor and the photo diode/transistor. In the phototransistor an led emitter is optically coupled to a phototransistor detector. The active area is the base of the transistor, the size of which presents a large effective base-collector capacitance. This inherently restricts the device to low frequency operation. For data transmission greater than a few tens of kHz, the second family of devices must be used.

For the photo-diode/transistor an led emitter is optically coupled to a pin photo-diode diffused into a substrate. In the same substrate, a single transistor, Darlington pair, or linear amplifier can be diffused. This design approach has several major advantages:

- The use of a fast photodiode with a separate transistor can reduce rise and fall times by as much as 4000% while still having an equivalent output stage voltage gain.
- Choice of amplifier stage gives flexibility of gain, speed and drive condition. The split Darlington system allows a very high gain (400% min), yet the output transistor can saturate as low as 0,1 V for improved noise margin with ttl when compared with high gain standard Darlington photo-

transistors. The 4371 device from Hewlett-Packard for example is cmos compatible on the output.

- The simplest most general purpose device is a single transistor amplifier. The 4360 series is specifically designed for ultra high speed digital operation. A range of isolators is shown in Fig 1.

The fundamental purpose of any isolator is to enhance in the output, the ratio of differential mode to common mode signals. It should reduce the level of noise present in the output signal compared to that in the input signal by virtue of having no common electrical connection between input and output. The two ways by which noise, or common mode signals can appear in the output are by modulation of the (wanted) input signal current and stray capacitive coupling.

Modulation is a property of the external input circuitry and can be eliminated, if necessary by correct impedance matching (Fig. 2). The parameter of the isolation which warrants close attention is therefore the common mode coupling capacitance. This capacitance is only a

small part of the total effective stray capacitance due to packaging. It can be reduced further by the addition of an internal screen, (without screen common mode coupling capacitance 0,07 pF, with screen common mode coupling capacitance 0,007 pF).

Analogue isolation expressed as common mode rejection ratio (cmrr), is the ratio of the relative effects of the differential mode voltage and common mode voltage on the output current. In dB this reduces to common mode rejection (cmr)

$$cmr = 20 \log_{10} (cmrr) \text{ dB}$$

CMRR is dependent on the common mode coupling capacitance and the frequency of the common mode signal but is independent of isolator amplifier gain (see Fig. 3). Attention to the graph shown in Fig. 3 for any particular isolator should show whether the cmrr at any known frequency of noise or interference present in the input signal is great enough to prevent undue noise coupling to the output. If the cmrr appears to be insufficient, then a superior device should be used, or neutralisation employed.

For most analogue applications the single transistor amplifier would be most suited since it offers the best combination of gain, speed and low distortion characteristics. The split Darlington type whilst having a very much higher

Fig. 1: (a) Split Darlington isolator has moderate speed; (b) photodiode/transistor allows high speed and high voltage gain.

Chris Williams is with Hewlett-Packard Ltd.

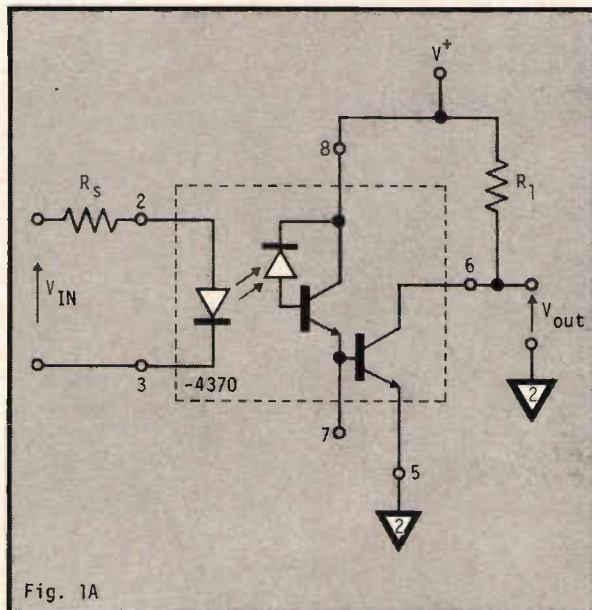

Fig. 1A

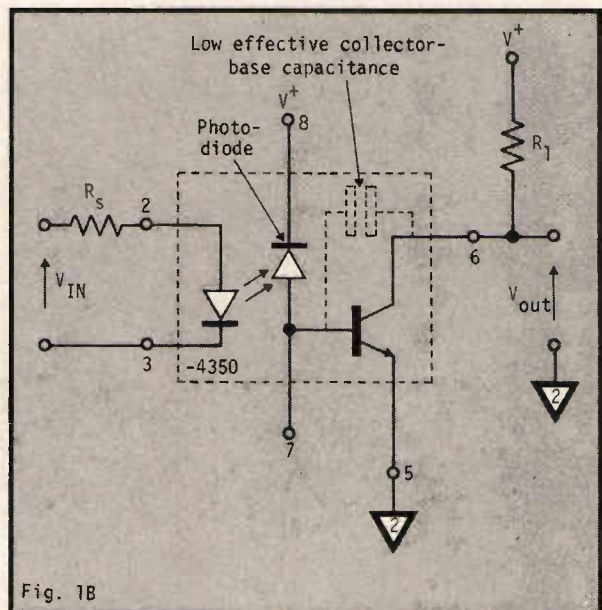

Fig. 1B

gain, has the disadvantage that the base of the first transistor cannot be accessed, thus preventing its incorporation into a closed loop feedback system for low distortion operation. Additionally, because of the higher gain, the reduced speed of the device prevents its use in amplifiers above 1 MHz bandwidth.

The cmrr of the single transistor isolation can be improved by the addition of a neutralising capacitor between the transistor collector and either of the input pins (Fig. 4). The value of the capacitor is set by:—

$$C = \beta \times C_M \approx 7 \text{ pF}$$

where β is the isolator amp gain.

This capacitor should have a voltage rating compatible with the application. Neutralisation can be employed with dual versions of this isolator provided each capacitor coupled the collector to its respective input diode.

Digital operation

Digital operation requires that the output remain in proper logic stage despite the interference from e_{cm} . This e_{cm} can be in the form of sinusoidal or transient so, two different measuring systems are necessary to evaluate an isolator response. Detailed description of such measurement is given by refs 1, 2 and 3. A digital system cmr can be enhanced in the following ways (Fig 5):

- Neutralisation
- Balanced differential amplification
- Amplifier de-sensitisation
- Use of high cmr devices

As for analogue isolations, neutralisation can be used for single transistor amplifier isolators. It is effective only when the transistor is active, not saturated or cut off. However, since it is while the transistor is active that e_{cm} can cause most problems it is worth while trying this solution.

Balanced differential amplification

also only works if the isolator output amplifiers are active. If both isolators are driven to cut off or saturated by an e_{cm} transient, they will not maintain a differential response to e_{dm} .

Amplifier de-sensitisation is a simple defence to use against e_{cm} . The base bypass resistor R_{be} reduces the impedance in which the e_{cm} transient, coupled via C_{cm} , causes a current flow. So a larger e_{cm} transient can be tolerated. It also reduces the amplifiers sensitivity to photocurrent generated by the wanted signal, and requires a higher current in the input diode for an *on* condition. The base bypass can be used with either single transistor or split Darlington isolators, and has the added benefit of higher data rate capability. R_{sk} is recommended for protection of the isolator if large e_{cm} transient (static electricity discharge) may be exposed to the effective common mode coupling capacitance.

Use of high cmr devices encompass two types, either addition of internal screen to existing type of isolator or using isolator with fibre optic medium to reduce e_{cm} even further. For optimum performance of cmr, the board layout of isolators should be such as to separate the input and output leads physically. A small ground trace under the isolator between input and output leads will also improve cmr performance.

Insulation techniques

Many designers unaware of corona or its effect assume insulation can be operated at any voltage up to the breakdown voltage. Others may assume that corona occurs only at the exposed terminal pins. In fact, corona, or partial

discharge can occur within isolation materials possessing microvoids. Due to non-homogeneous fields within the material, the field across a microvoid can rise to a critical level at which local discharge takes place. The resulting ions locally degrade the insulation. The cumulative effect over time is to reduce the terminal to terminal breakdown voltage.

By using sophisticated detection equipment, such discharges can be detected when applied voltage exceeds a threshold level, the corona inception voltage (civ). To maintain their insulation quality some isolators are built using a "back filling" system that forces a silicone oil under pressure to fill any microvoids. This results in the civ being well above the rated V_{I-O} .

The main properties of insulation are breakdown, voltage and leakage resistance. In some isolators leakage resistance of the order of 10^{12} leads to a typical leakage current of only 3 nA when subjected to the 3000 Vdc max rating for V_{I-O} . If performance superior to this is required, the more expensive fibre optic devices, with greater physical separation between emitter and detector must be employed.

Speed of response

For analogue and digital operation, speed of response is a function of the external circuitry as well as isolator characteristics. In both types of system, the speed, can be improved by feedback or peaking.

Analogue operation requires the isolator to remain in its active region (no *cut off* or saturation). Speed of response is characterised in terms of 10%-90% rise time if input signal is a step function, or 3 dB bandwidth if the input signal is a sine wave.

The principal bandwidth limiting elements are the photo emitter, the

Fig. 2: Modulation circuitry external to the isolator must be matched.

Fig. 3: Typical sinusoidal common mode rejection curve.

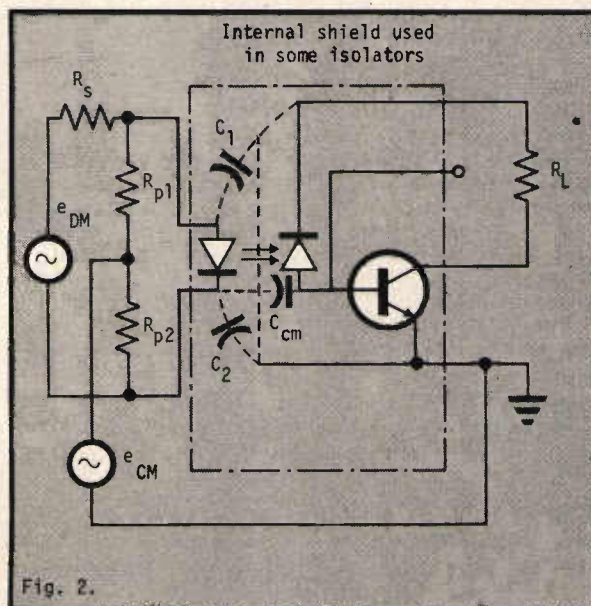

Fig. 2.

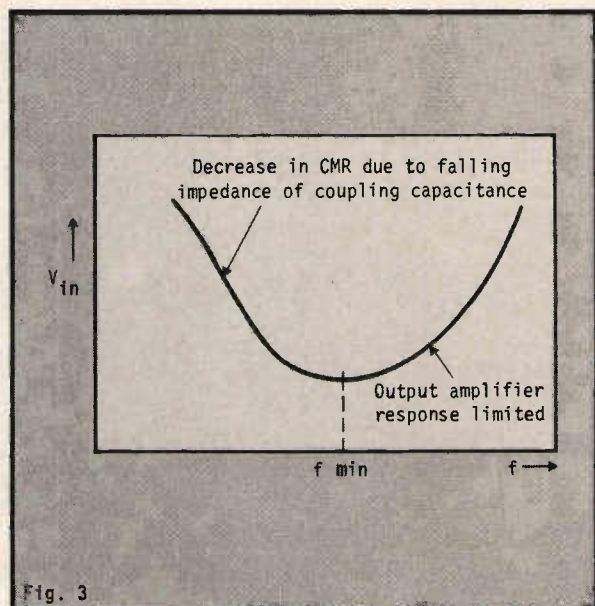

Fig. 3

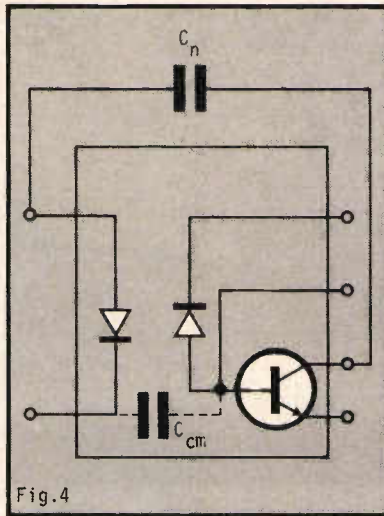

Fig. 4

amplifying transistor, and the capacitance of the photodiode. The base time constant of a single transistor isolator in common emitter mode is given by:—

$\tau_B = R_B(C_{PD} + C_{BC}) + \beta R_L C_{BC}$ (1) where $C_{PD} \approx 10$ pF = photo diode capacitance C_{BC} is base to collector capacitance plus stray external capacitance between collector and base connections, R_L is the load resistance and R_B is the dynamic resistance to ground at base. With no base bypass resistance.

Substituting typical values for such an isolator gives:—

$$\tau_B = \beta C_{BC}(R_L + 175\Omega) \quad (2)$$

This shows the importance of having a low C_{BC} . (C_{BC} for photodiode/transistor combination is typically 0.5 pF for a phototransistor it is typically 20 pF. Also the base time constant is only limited by R_L if $R_L > 175\Omega$.)

Use of feedback to reduce β can also improve the speed. A typical ac amplifier circuit is shown in Fig. 5. Note that the input current is peaked for maximum speed response with the dynamic range limited for low distortion characteristics.

The bandwidth of single isolators may be improved by clipping the base lead if not required. This reduces the stray capacitance element of C_{BC} . If several circuits are in close proximity the use of dual isolators is recommended since the base is not brought out to an external terminal. The base rise time equation shows why the high gain of the split Darlington type of isolator results in a reduced speed response. This and the inaccessibility of the first transistor base for full feedback reduces its attraction for low distortion analogue usage.

It should be noted that when feedback is used with the single transistor type, the base lead is needed to provide a trade off between bandwidth and distortion improvement due to feedback and bandwidth improvement because of the reduction of stray capacitance (base lead). Both techniques should be considered before deciding on one for the final circuit.

Digital operation requires the isolator

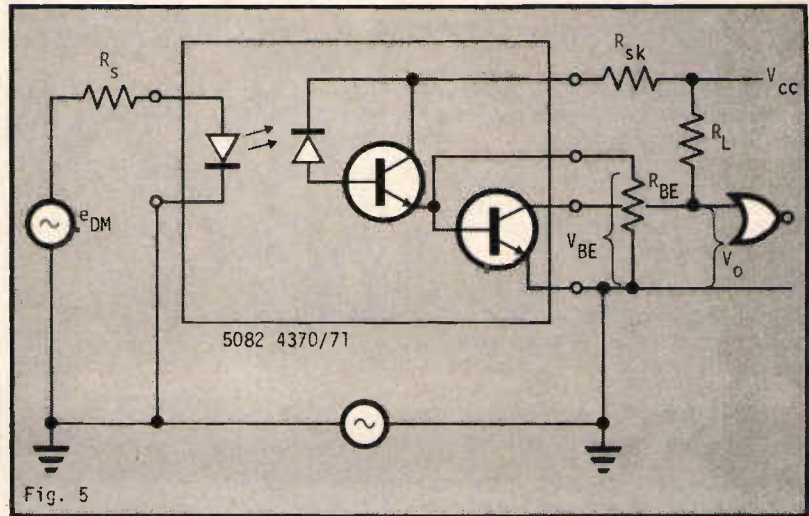

Fig. 5

Fig. 4: CMR improved by the addition of a 7pF neutralising capacitor from output collector to input.

to switch from one logic state to another. For the *low* condition, I_F should be large enough to bring V_C well below some defined threshold, and for the *high* condition, I_F should be low enough for V_C to rise well above threshold. Speed of response is defined as the time required for V_C to reach the threshold in response to a change of logic state at the input. Characterisation is either in terms of propagation delay or data rate, where propagation delay is the time for a change of logic state to propagate through the isolator and cause a change of state in the load. There are two values, one for *low* to *high* transistor at the output, t_{PHL} , and one for *high* to *low*, t_{PLH} .

Isolator influences

Isolator characteristics influence t_{PHL} and t_{PLH} but propagation delay is also contracted by the external circuitry. Raising I_F reduces t_{PHL} by causing large collector current but raises t_{PLH} by causing the output to be deeply saturated, thus increasing the storage time.

Raising the value of R_{LOAD} also reduces t_{PHL} by reducing the current it sources to the V_C node, but this in turn raises t_{PLH} by reducing the current available to pull V_C up again.

For any application, a device with better propagation delay characteristics is to be preferred to squeezing the last microsecond from a slower device. Speed enhancement techniques usually degrade the cmr, so the advantage you gain on the speed you may immediately lose on having reduced raise immunity.

The fastest devices available can handle data rates up to 20M/bits. This speed is gained by having an integrated linear amplifier, and Schottky clamped output state. The linear amp does not saturate at either logic level, and is maximised for speed response with the photodiode.

In a high speed system, the isolator may need to be decoupled to prevent internal oscillation which would degrade performance. This decoupling is effected by having a 0.01 μ F ceramic capacitor between V_{CC} and ground, as close to the device as possible. To optimise performance, this capacitor should be located so as to minimise the coupling of noise generated by the isolator lead into V_{CC} and ground of the isolator.

Reverse coupling

The high leakage resistance of opto isolators ($\approx 10^{12}\Omega$) virtually eliminates DC ground loops. Internal capacitance allows AC ground loops to flow according to

$$I_{GL} = C_{I-O} \frac{de_{cm}}{dt} \text{ where } C_{I-O} = \text{input}$$

to output capacitance

Note that C_{I-O} is a function of packaging; it is much larger than C_{cm} and is effectively independent of whether an internal screen is fitted or not.

There are no circuit techniques by which C_{I-O} can be reduced. In applications where C_{I-O} (1 pF) is too high, a device incorporating greater physical separation from input to output must be used. With $C_{I-O} = 1$ pF, the ground loop current that flows from a 50 Hz, e_{cm} is only 520 pA per volt rms.

Forward coupling

In analogue systems, forward coupling is simply gain and is specified as current transfer ratio (ctr). For digital systems, it is more useful to consider it in terms of fan out capability. CTR is not constant for all levels of input current. This is largely due to the change in gain (h_{fe}) of the output amplifier, especially if it has more than one transistor. This is plotted by giving either output current or ctr as a function of input current.

It is an inevitable fact that light output from an led degrades slowly with



A wide range of quality insulators

With the Harwin reputation to maintain, we are bound to make the best insulated terminals you can buy. Our good name is founded on precision workmanship, fast production, and consistently low costs. . . and our insulated terminals are no exception. Within our large stock of insulators made from Alkyd or P.T.F.E., we have just what you are looking for. . . at just the price you want to pay.
 For the full details of our insulated terminal range, send today to:

Harwin insulated terminals

HARWIN ENGINEERS SA, Fitzherbert Road, Farlington, Portsmouth, PO6 1RT. Tel: Cosham 70451/6 Telex: 86125
 Please send me the full details about the Harwin range of insulated terminals.

NAME _____

POSITION _____

COMPANY _____

ADDRESS _____

EE12/02

Pulse Engineering

A complete range of Delay Lines

Example

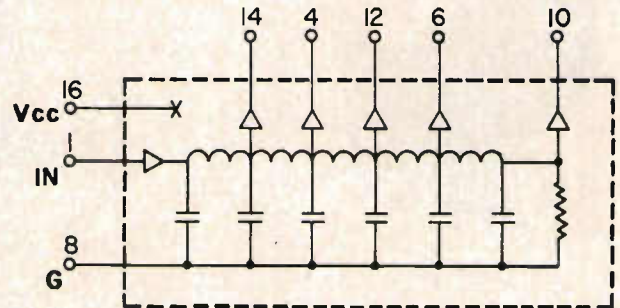

DIGITAL DELAY MODULE

Designed specifically for TTL and DTL compatibility.

Built-in interface allows direct plug-in without additional components.

Module load incorporation reduces number of required components for specific delays.

Standard Models can delay an input pulse by 25 ns to up to 1,000 ns. Each model has five intermediate taps.

Output risetime is below 4 ns.

Drive capability is up to 20 TTL loads per unit.

D.I.L. low profile package.

Your most economical approach to digital timing.

Representative in U.K.

AURIEMA Ltd.,
 442, Bath Road,
 SLOUGH, SL1 6BB
 United Kingdom
 Tel.: (06286) 61931
 Telex: 847155

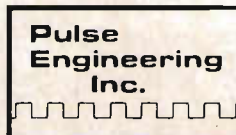

PULSE ENGINEERING IRELAND
 Dunmore Road,
 TUAM (Co. Galway)
 IRELAND
 Tel.: (093) 24107
 Telex: 8325

Failure mechanisms in COS/MOS integrated circuits

This article discusses the reasons why failures occur in integrated circuits fabricated in cos/mos technologies. *Gallace and Pujol* explain how some of these failures may be avoided

As a measure of reliability of COS/MOS integrated circuits, test programmes must evaluate the known or expected failure mechanisms. These mechanisms can be determined by proper reliability programmes which intelligently use accelerated tests. Supplementing these tests should be careful analysis of field failures when they occur.

The pie chart in Fig. 1 shows the mechanisms that normally occur in field failures. Over-current and elongated types of failures predominate. About 50% of all devices analysed are found to have failed as a result of electrostatic damage, overstress, and/or application-related problems.

In order to detect electrostatic damage, normally a curve-tracer check is made. The area in question has to be isolated by electrical test. For example, if a gate oxide is shorted, it will show up as a high input leakage (positive) varying in magnitude depending on how bad the short is or how marginal the break. A degradation of some other parameters, such as noise immunity, functional capability, output drive, or diode check may also be seen.

An overstress failure is seen internally as a burned or open metallisation path. Fig. 2 is a photomicrograph showing metallisation as a result of current overstress in the V_{SS} line of a cmos device. An SCR-type latch failure is always seen as V_{SS} burned metallisation

L J Gallace and H L Pujol are with RCA Solid State, Somerville, NJ, USA

because all of the current is concentrated in that area.

There are other modes of failures related to basic processing problems. In the semiconductor industry, failure may mean anything from a catastrophic inoperable condition after some period of use to some minor cosmetic defect that bothers a customer who is concerned with the overall quality of the product he is buying. This discussion of failures is confined to problems

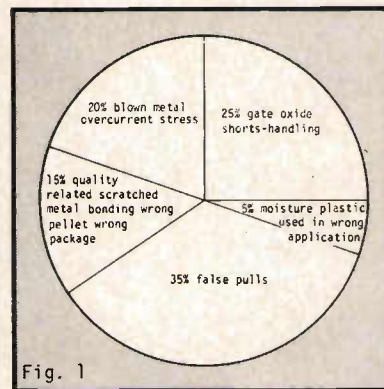

Fig. 1: Mechanisms that normally occur in field failures.

Fig. 2: Photomicrograph showing metallisation as a result of current overstress in the V_{SS} line of a cmos device.

Fig. 3: SEM photomicrograph of a ruptured gate oxide.

that cause inoperability in system use, or dramatic changes in performance during high-stress testing.

Basic failures

Regardless of complexity, the basic failures occur within small cells, composed exclusively of mos transistors and mos loads, with an occasional diffused resistor or mos capacitor. The most obvious and important mode of failure is an open circuit. This open circuit could occur within the mos device or in the conductive interconnect that leads to the device. If the device is totally operable at the time of shipment, an open circuit can only be caused by excessive current density or a break caused by thermal or mechanical shock. Mechanical shock is more likely to cause an open circuit when the pellet is joined to the package by fine wire bonded by thermal-compression or ultrasonic techniques. One of the most damaging environments is the ultrasonic cleaning commonly used for flux removal from printed-circuit boards.

The short circuit is the second obvious symptom that is caused by innumerable failure modes. There are probably more types of short circuits or partial short circuits than there are types of open circuits. A short circuit may be caused by the following:

- Contaminants between two conductive areas of different potential.
- Metal deposition. Faults in the photoresist or in the actual metal-defining mask may cause a bridging

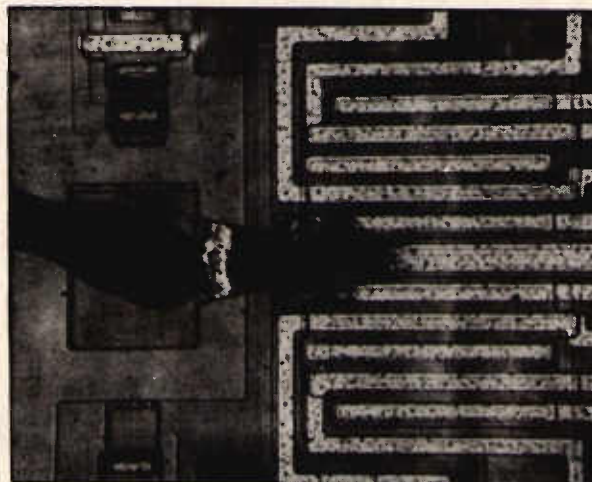

continued on page 67

The widest range of Subminiature Switches available

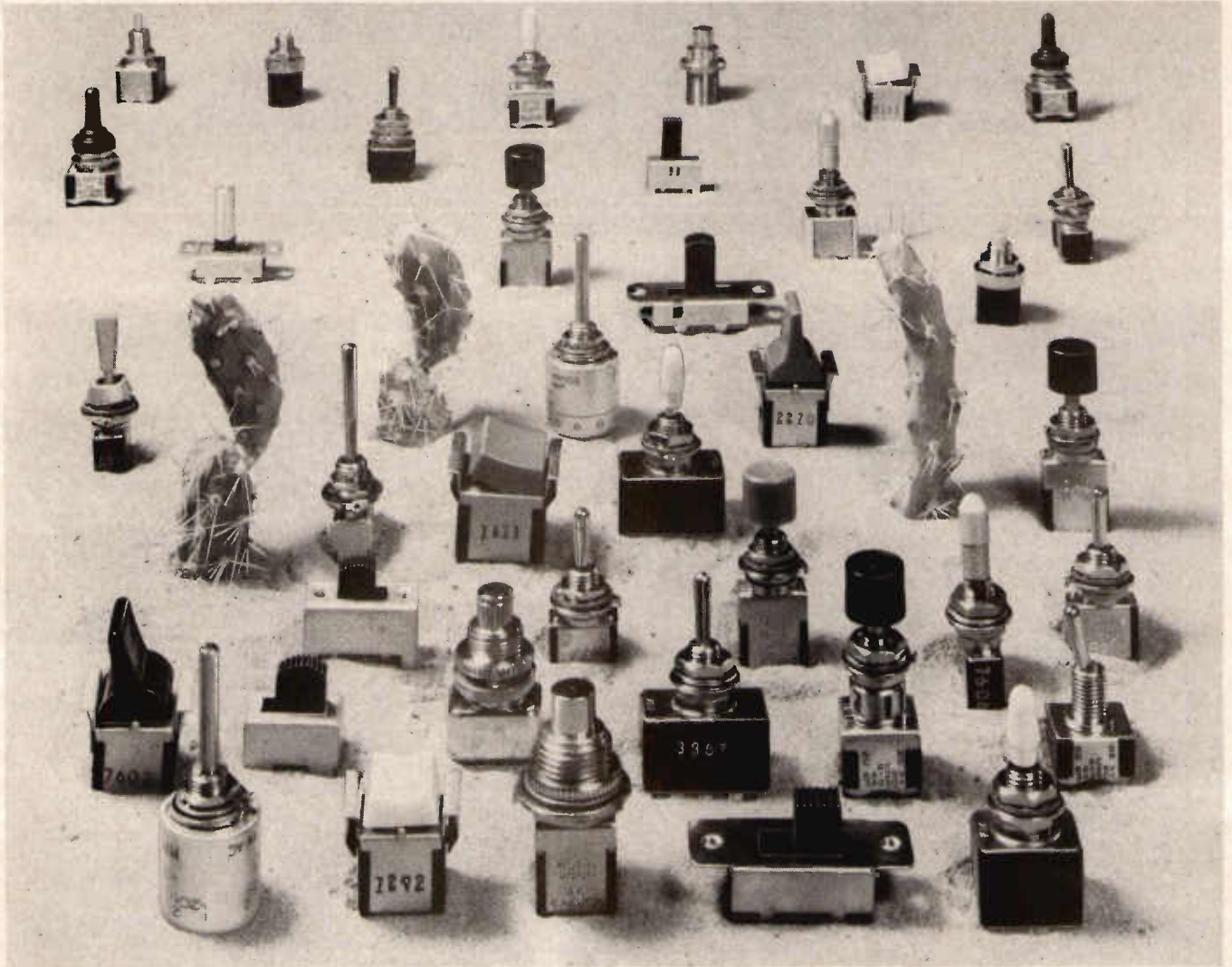

Waycom Subminiature Switches

- * Subminiature slide, rotary, pushbutton, lever and rocker switches
- * Very wide selection of switch actions and circuits
- * Numerous optional features
- * High reliability
- * Ergonomically designed
- * 1, 2, 3 and 4 poles operation
- * Cosmetic appeal to meet functional and aesthetic panel requirements
- * CAA & M.O.D. release

For more than a decade Waycom have set the standard for subminiature switches. Today, part of the popular lever and pushbutton series are manufactured at Bracknell to provide an ex-stock service.

Waycom are equally strong in slide, rotary, thumbwheel and illuminated switches. In fact they have one of the most comprehensive ranges of switches available for the electronics industry.

Switch to Waycom for all your switch requirements.

- Naturally the best!

Waycom-reliable in so many ways

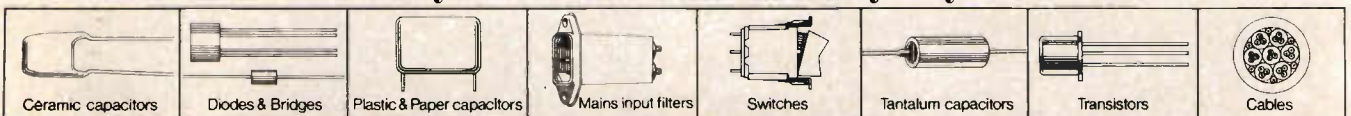

WAYCOM LIMITED

Wokingham Road, Bracknell, Berks RG12 1ND
Tel: Bracknell 22751 Telex: 848402

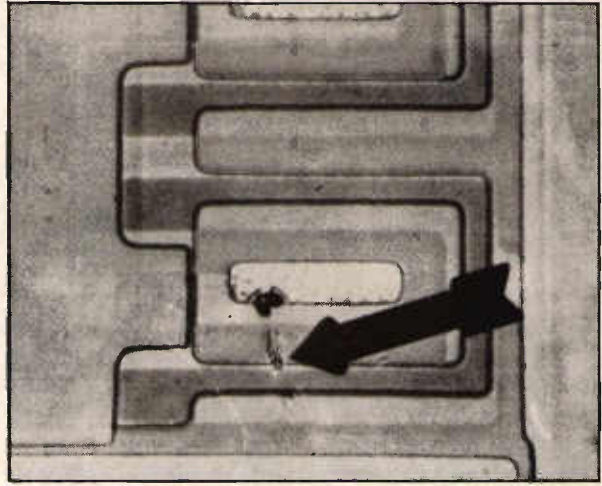
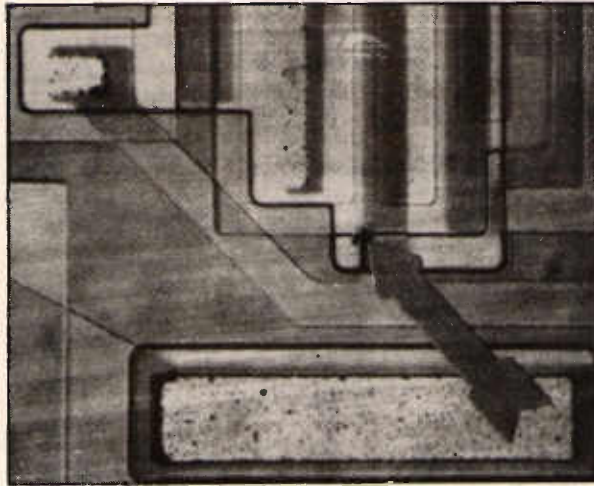

Fig. 4: Examples of gate-oxide rupture on a p-channel device and an n-channel device.

Fig. 5: Gate oxide rupture points in a perfect mos transistor

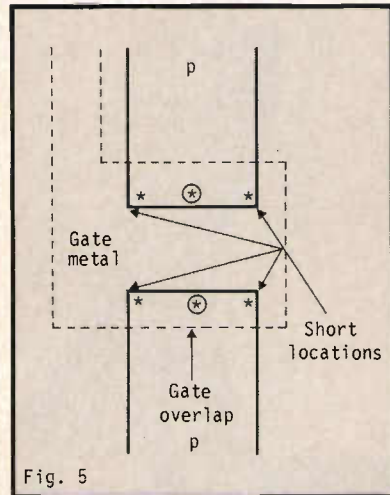

Fig. 5

which can be detected optically and should not be a significant field failure mode.

- Liquid contaminants left on the surface as a result of poor cleaning procedures.

- Surface short circuits may also be caused by metallic particles. Common pre-form material used for soldering the pellet to the package is a source of small pieces of conductive material. Extraneous bonding wires are similarly dangerous and are not easily detectable after the package is sealed.

- The degree to which the surface metal is alloyed with the base silicon is a subject of much discussion. Over-alloying is dangerous; it can lead to short circuits.

- Ruptured oxide causes a short circuit between the surface metallisation and the substrate material.

Gate-oxide shorts

This failure mode is probably the most common for mos devices. It can be caused by customer mishandling, manufacturing defects, or a combination of both. Essentially, the basic cause is overstress of the gate oxide by application of excessive voltages either directly (ie application of excessive external voltage spikes or signals directly to gate oxides at input terminals and/or power terminals) or indirectly (ie internal gate oxides stressed by V_{DD} and signal voltages not directly accessible from external package leads). The term *excessive* refers to voltages too high for the existing oxide conditions and protection networks.

COS/MOS units are subjected to many applications in which excessive above-rating voltages, both d.c. and spike, cause oxide rupture. This type of problem is probably easier to resolve and Fig. 3 shows a scanning-electron-microscope photomicrograph of a ruptured gate oxide. Fig. 4 shows examples of gate-oxide rupture on a p-channel device and an n-channel device (arrows point to rupture). Theoretically, a perfect mos transistor overstressed to

rupture the gate oxide should have the rupture points located at one or more of the four corners of the gate area, or along the periphery of the gate diffusions, as shown in Fig. 5. Such rupture would occur because the electric field at these points is higher than at the edges.

In practice, however, voltages greatly in excess of puncture threshold might cause one or more corners to short-circuit and, in addition, may puncture a weak spot elsewhere (not necessarily a defect point) because of the quantity of charge available and the amount of over-voltage applied. Normally, the p-channel devices are more sensitive to gate oxide shorts because the gate oxide is thinner than on n-channel devices. Devices with the short-circuit locations shown in Fig. 5 (more than one unit sample) may have non-homogenous oxide problems, oxide pinholes or silicon hills, which could cause premature rupture. These defects can sometimes be visually observed after the gate metal is removed.

By far the greatest number of gate shorts occur when excessive voltages are directly connected to external terminals; this fact indicates the inability of protective circuits to function with 100% reliability under all conditions.

Moving ionic charges

Another mos failure mode is the threshold drift phenomenon caused by the presence of ions under gate structures. Because positive ions are more likely than negative ones, most contaminations are caused by sodium ions.

Another problem related to ionic contamination is surface contamination, which may cause leakage between source and drain. The threshold voltage may appear to be low, which is likely to seriously reduce the noise immunity of the device.

Movable ionic charges in the thermal oxide can reduce or increase threshold voltages, depending on the ionic charge and the type of device (n- or p-channel) affected. Sodium ions (+) in the thermal oxide of n-channel devices seem to be the most difficult to control. Although very clean gate oxides are grown, most sodium ions tend to move in from the field oxide.

Figure 6 illustrates a thermal oxide with positive-ion sites randomly distributed throughout because of natural diffusion at room temperature (290°K). Although these sites have some effect on the initial threshold, compensation can be introduced by variation of oxide thickness in manufacture if the concentration of ions is known and controlled.

As soon as bias is applied to the gate metal, however, ions begin to move as a result of electric field forces. The charges finally relocate as shown in Fig. 7, where the positively charged gate has pushed the majority of positive ions under the metal toward the silicon-thermal oxide interface. This concentration is sufficient to reduce the threshold voltage, and may be enough to cause the new n-channel to remain after the gate bias is withdrawn, forming a permanent channel from n to n (source to drain). The rate at

continued on page 69

56 on enquiry card

A service for professionals



GEC
SEMICONDUCTORS

GEC Semiconductors Ltd
East Lane Wembley
Middlesex HA9 7PP
Telephone: 01-904 9303

which ions are driven into this condition is proportional to the silicon dioxide temperature and the gate voltage. When gate bias is removed, ions begin to diffuse and revert to initial conditions.

If a negative polarity is applied to the gate metal, then a transverse field is established which sweeps the positive ions into the gate oxide, when accumulation take place. This mode of operation can cause an increase in leakage failure of eight times as compared to the positive gate polarity.

When positive-ion concentrations are high, or high voltages are used in most units, field inversion (p-layer inversion under field oxide) can occur, causing formation of parasitic mos devices and resulting in unwanted coupling of two or more circuits together, as shown in Fig. 7. It is thus necessary to install channel stoppers between adjacent devices in the form of extra diffusions to prevent unwanted current paths. When n-type substrates are used, separate p-type wells or guard rings can be used for each device as channel stoppers, as shown in Fig. 8.

Complementary devices

COS/MOS units use complementary n-channel and p-channel devices on the same substrate. In the case of an n-channel device, positive ions cause permanent inversion of the p-type well. When the gate is negative with respect to the substrate, positive ions are driven in a direction which tends slightly to increase the threshold voltage above that for normally dispersed ions.

Comments that apply to positive-ion

content in thermal oxides also apply to negative-ion contamination except that the results for p-channel and n-channel units are reversed. However, negative-ion content is easier to control in processing and is not a major factor in leakage failures.

Life tests to check for the presence of contamination are varied. The most effective seems to be HTRB (high-temperature, reverse-bias), where gate voltages are d.c. (100% duty cycle) and temperatures are elevated to speed up

Fig. 9: Equivalent diode circuit characteristics for a p-channel device without protection.

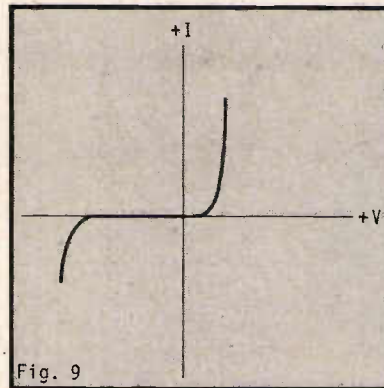

Fig. 6: Thermal oxide with positive-ion sites randomly distributed throughout.

Fig. 7: Relocation of charges after application of bias to gate metal.

Fig. 8: Guard rings used as channel stoppers in n-type substrates.

ion movement. Gates are normally biased with their on polarities, and the resulting changes in threshold voltage indicate what type of ion contamination is present. HTRB tests are preferred to ac operating life tests for detecting ionic problems. In ac testing, gates that are operated at, for example, 50% duty cycle, allow time for diffusion of ions between pulses at rates equal to that for recovery at the life-test temperature. As a result, devices having low levels of contamination may not drift enough to be failures. HTRB tests, however, would cause these devices to fail. Worst-case conditions should be used because the device could be subjected to dc bias in field use.

Diode leakage

A COS/MOS device consists essentially of diode areas diffused into a substrate. Fig. 9 shows an equivalent diode circuit characteristic for a p-channel device without protection. The diodes shown are capable of exhibiting all the characteristics of ordinary diodes. Localised contamination at the silicon-dioxide silicon interface can cause degraded reverse diode characteristics, which result in degraded device performance.

B_{vr} degradation, where B_{vr} becomes less than V_{DD} is troublesome in complex circuits. A soft reverse B_{vr} characteristic also reduces the load impedance at the drain or source, and can change the gain or digital logic levels. Poor B_{vr} can also be attributed to defects in the silicon bulk material.

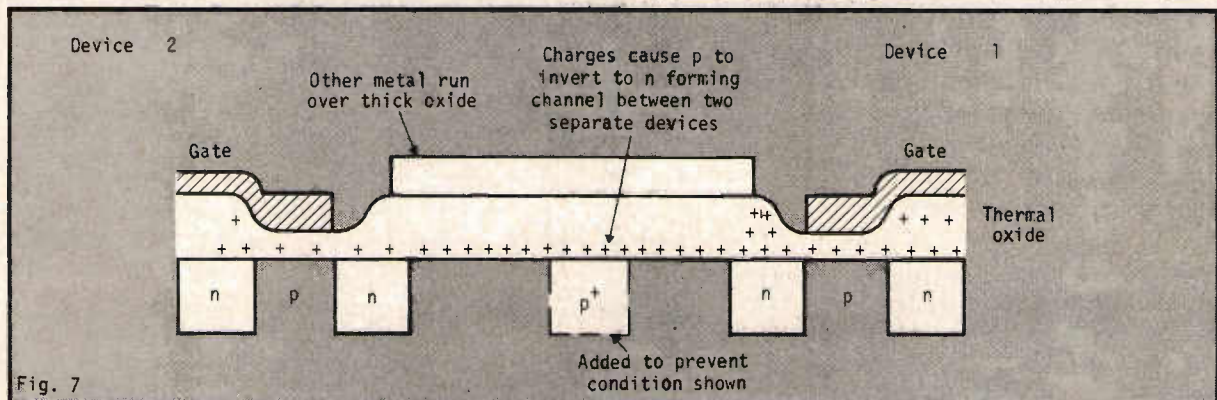
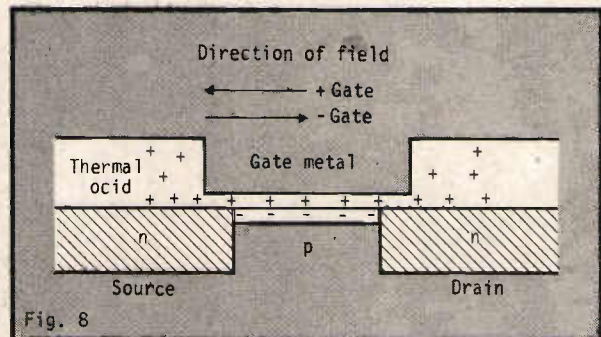
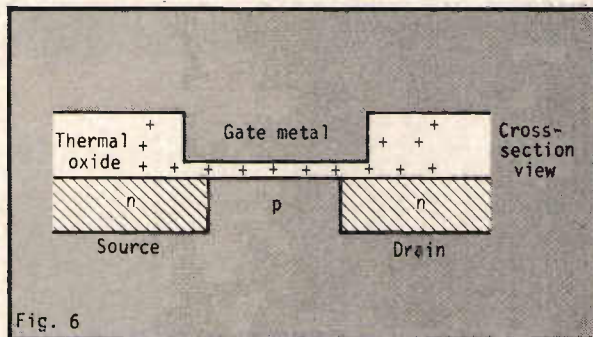

Rich Harvest

If you're in business—anywhere between automotive and yacht manufacturing—you can improve your output with the fully automatic **AWS4 Wire Stripper**. Profitably, it will cut to length and strip both ends of up to 6,000 pieces of insulated wire in an hour. Which beats handwork and outwork every time! And it's complete. With storage base unit, a set of standard cutters and full setter's tool kit. No extras to buy, except special purpose accessories—which are readily available—and the robust, competitively priced AWS4, available only from Cetrionic, can be delivered ex-stock.

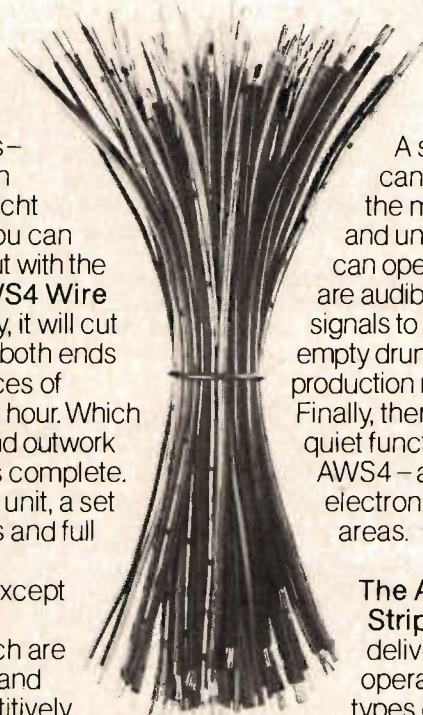

A semi-skilled fitter can set up the machine and unskilled labour can operate it and there are audible and visible signals to indicate an empty drum or a completed production run. Finally, there's the smooth, quiet function of the AWS4—a must for electronic assembly areas.

The **AWS4 Wire Stripper**. Easily delivered, easily operated. For most types of insulated wire, cut and stripped in a host of lengths.

Cut waste in time and money—with the automatic AWS4. For full specifications and a demonstration, contact Cetrionic today.

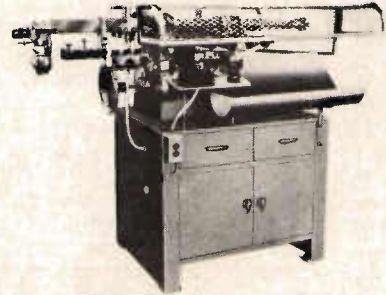

Cetrionic Limited

Hoddesdon Road,
Stanstead Abbots, Ware, Herts. SG12 8EJ.
Tel: Ware (0920) 871077. Telex: 817293.

WE'VE GOT CONNECTIONS

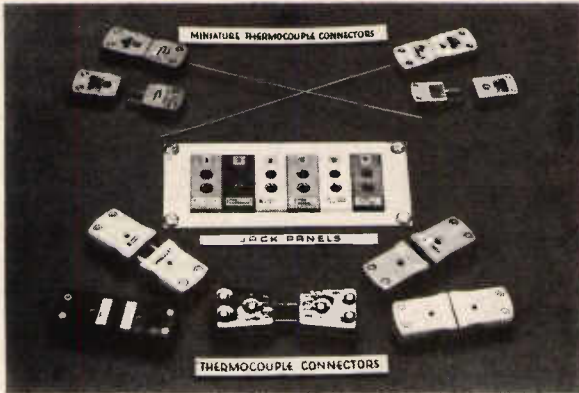

- MINIATURE PLUGS & SOCKETS
- HIGH TEMPERATURE CONNECTORS
- CERAMIC CONNECTORS
- STRIP PANEL JACKS
- INSULATORS
- SLIP RINGS
- PROTECTION TUBES

TEMPERATURE MEASUREMENT ENGINEERING

ancom DEVONSHIRE STREET
CHELTENHAM ENGLAND

TELEPHONE 0242 53861/24600

Brilliance in miniature

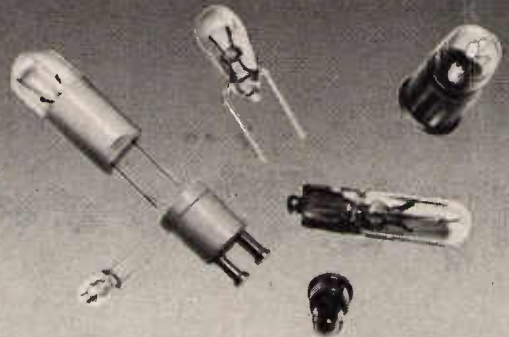

Now available from your local distributor:
Black Arrow Electronics Ltd., BRISTOL (0454) 315824
Valiant Electrical Wholesale Co., FULHAM 01-736 8115
Farnell Electronic Components Ltd., LEEDS (0532) 636311
Townsend-Coates Ltd., LEICESTER (0533) 769191

Vitality
LIMITED



A SUBSIDIARY OF
GENERAL INSTRUMENT
CORPORATION

Beetons Way, Bury St. Edmunds, Suffolk
Telephone (0284) 62411

“Lovely to look at, delightful to hold...”

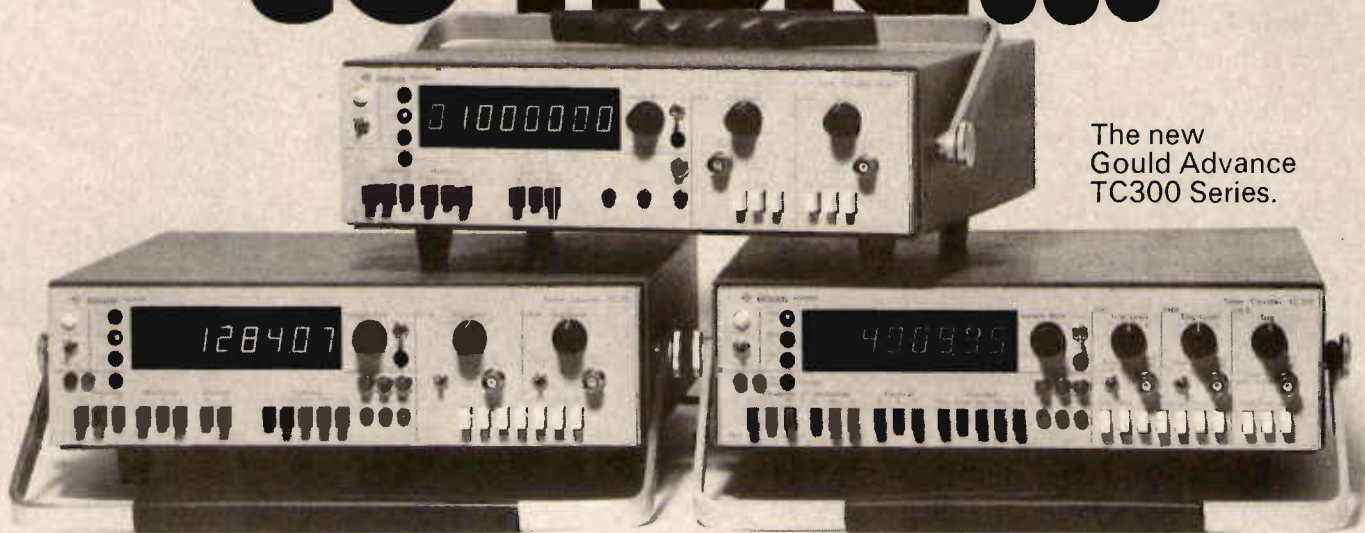

The new Gould Advance TC300 Series.

Two new timer counters in one fell swoop. Plus a frequency counter.

That's what Gould Advance offers you with our new TC300 Series.

They've got what *you* want, as well. A good, solid spec at a sensible price.

Times three.

But they've got an extra: ergonomics.

The digits are 0.8" — so you can take in the

reading at a glance.

And the controls you'll operate are big and firm: to cut out that irritating factor — human error.

For servicing simplicity you'll not find another timer counter to touch ours. One more way of ensuring the TC300 Series' low cost of ownership.

And for the parameters, demand our data sheets right now.

(They'll put a song in your heart...)

**The new Gould Advance
TC300 Series. Do get the details.**

There's a new Tower in London.

THE TOWER OF POWER

With the opening of our new offices at Old Park Road, Hitchin, ENI brings new **solid state power** directly to Europe. Solid state power for general laboratory instrumentation. Communications systems.

RFI/EMI testing. Signal distribution. NMR/ENDOR. Nuclear acceleration. Induction heating. Ultrasonics. And more.

ENI's full line of all solid state Class A power amplifiers cover the frequency spectrum of 10 kHz to 1 GHz, with power outputs ranging from 300 milliwatts to over 4000 watts. Driven by any signal generator, frequency synthesizer or sweeper, these compact, portable amplifiers are completely broadband and untuned. Amplifying inputs of AM, FM, SSB, TV and pulse modulations with minimum distortion. And ENI power amplifiers will deliver their rated power to any load, regardless of match. They are unconditionally failsafe and stable (impervious to severe load conditions including open or short circuit loads).

ENI Power Systems power generators are versatile and flexible sources of power for a wide variety of applications. Units are available covering the frequency range of 9 kHz to 250 kHz, with 350 to 8400 watts power output.

ENI's Tower of Power. It's the new Tower in London. Bringing solid state power to all of Europe.

For further information, contact:

eni POWER SYSTEMS, LTD.

23 Old Park Road
Hitchin, Hertfordshire
England SG 2 JS
Telephone: Hitchin 0462 51711
Telex: 825153 ENI HITCHIN



ENI products also available as follows: UNITED KINGDOM: Dale Electronics, Ltd., Frimley Green, Camberley, Surrey, England, Tel: Deepcut (02516) 5094 AUSTRALIA: Elmeasco Instruments Pty. Ltd., 7 Chard Road, Brookvale, N.S.W. Australia, Tel: 939-7944 BENELUX COUNTRIES: Coimex, Hattem, Holland, Tel: 05206-1214 DENMARK: Tage Olsen A/S, 2100 Kobenhavn 0, Denmark, Tel: (01) 294800 FRANCE: Comsatec, 92300 LaVallois-Perret, France, Tel: 270.87.01 GERMANY, AUSTRIA: Kontron Elektronik GmbH, 8057 Eching/Munich, Oscar-von-Miller-Str. 1, Tel: 08165/77336 ITALY: Romagnoli Elettronica, 57100 Livorno, Italy, Tel: (0586) 407.301 JAPAN: Astech Corporation, Shinjuku-ku, Tokyo 160, Japan, Tel: Tokyo 343-0601 NORWAY: Solberg & Andersen A/S, Brynsveien 5, Oslo 6, Norway, Tel: 47 2 19 1000 SOUTH AFRICA: Associated Electronics (Pty.), Ltd., Johannesburg, South Africa, Tel: 724-5396 SPAIN: Aupoca S.A., Madrid 16, Spain, Tel: 457-53-12 SWEDEN: Saven AB, S-185 00 Vaxholm, Tel: 07641315 80 SWITZERLAND: Kontron Electronic Limited, 8048 Zurich, Switzerland, Tel: 01 62 82 82

Digital logic board design with test needs in mind

With the growth in the variety, complexity and use of digital logic integrated circuits over the past few years, the need for ensuring the testability of digital systems has become more and more critical
writes *David Tose*

Printed circuit assemblies today contain vast quantities of electronic circuitry, shrunk by modern technology to a fraction of the size required by their predecessors. The reliability of these devices and consequent assemblies is very high but, when a fault exists within the circuit assembly, the problem of fault isolation is a very real one.

Economics invariably influence the design layouts of pcb's and unfortunately, the problems of testability rarely cross the mind of the design engineer at the initial stage. However, just keeping to a few basic rules at the time of design can result in rewards during the production phase of a product's life cycle.

It should always be remembered that even if pc boards have not been designed with ATE (automatic test equipment) in mind, they can still be tested by such equipment. The point is that a lot of time and money can be saved, and frustrations avoided, if the speed and board throughput rates possible using ATE are considered at the outset.

It is the ease with which a board can be tested and faults isolated, that should be one of the design engineer's major criteria. He must accept that when a pcb comes off a production line there is a strong probability that it may not work. If the assumption is made that the production board is certain to be good, and its testability is neglected at the design stage, then problems will arise.

This article is intended to provide some guidelines on improving testability and reducing test bottlenecks of which design engineers are often unaware since the problem is unfortunately experienced by the production test department after the design phase has been completed.

General Considerations

The different types of test procedure are many and varied, but they divide into four main groups, namely *goods inwards*, *assembly visuals*, *functional* and *fully dynamic*. They all have their merits and complement one another; this article however will consider only aspects of functional circuit testing.

At the pcb design stage many techniques can be applied to assist testability and general rules are listed here:

- Keep logic fan outs to a minimum,

and never exceed the rated fan out.

- Do not use (or use the minimum of) 'select on test components'.
- Avoid the use of one shots if possible, though if used do not route their signals via the edge connector.
- Provide adequate decoupling, both at the board edge and locally at each ic.
- Use a single large edge connector if possible, and provide test/control points via this connector in addition to the normal input/output control signals.
- Where signals leave the pcb, provide them with the maximum fan out drive, or buffer them.
- Where signals enter the pcb load them with only one load if possible.
- Buffer edge-sensitive components from the edge connector (eg clock lines, Q and \bar{Q} flip flop outputs).
- Terminate unused inputs with a resistive pull up to minimum noise pick-up.
- Keep complex logic functions divided up into smaller combinational logic sections by proper board layout.

In addition to these general design suggestions, there are other features which can be easily incorporated at the time of layout and which will enable the board to be automatically tested more simply. For example, keep the logic depth on any pcb to a low level—if necessary, by using edge terminated test and control points. Utilise test points, routed to the edge connector, to enable monitoring and control of the internal board functions and to assist in fault diagnosis. And do not use high fan out logic devices on the board, but use multiple normal fan out devices and keep their outputs separate.

These precautions can be supplemented by the test programmer at the software design stage by keeping test sequences as short as possible (using parallel test techniques if appropriate), avoiding operator intervention wherever possible, and using automatic fault isolation techniques when practical, to speed up the test and fault isolate modes.

Initialising the logic

At this stage in the pcb design, external reset controls should be provided for all memory elements on the pcb. Counters, shift registers and sequential logic are normally self-initialising when used in a systems environ-

ment, but for a single pcb it is easy to overlook circuit initialisation.

Figure 1 shows a frequently used divide by four counter for generating internal clock phases. The counter runs continuously as long as the inhibit line is held *low*, but when the inhibit line goes *high* the counter continues to run until it is back to a *count zero* state. It is therefore self-initialising.

However, the circuit has two problems from the viewpoint of being suitable for automatic testing. First, several clock pulses will be required to initialise the logic at switch on, and this number will vary from zero to three. As the number of divide by two networks is increased, the number of initialisation clocks will also increase, logarithmically. Secondly, if a fault exists in the initialisation, then the circuit may never initialise and such a fault in a feedback network of this sort is difficult to diagnose since it is not always repeatable.

If the circuit were changed to that of Figure 2, then automatic testing would be much simpler. In this version of the divide by four circuit, the *reset* line is brought out to the edge connector, thus enabling a single pulse initialisation. In the system, the reset line can be left unconnected in the back panel wiring.

Chains and loops

Long logic chains often take many pulses or operations to provide output changes, and so their test time is long. If long chains are broken via the edge connector however, the test programme can be written to treat the short chains as individual circuits, and can often test them at the same time. The circuit interrogation becomes more straightforward and fault diagnosis from the edge connector is easier.

Logic loops, like chains, are also difficult to test, because the source of the fault is hidden by the loop. If the loop is broken or at least capable of being over-ridden at the connector, then the source of the fault can be located. The logic loop shown in Figure 3 could be reconfigured as shown in Figures 4 and 5. In Figure 3, an earth at A, B or C will lock up the function, whereas in Figure 4 the feedback loop has been broken, point D has now become a circuit monitor point, whilst E is available for signal injection. By adopting the circuit in Figure 5, the logic loop can be over-ridden by use of point D.

David Tose is with Industrial Products Division, CAI Ltd.

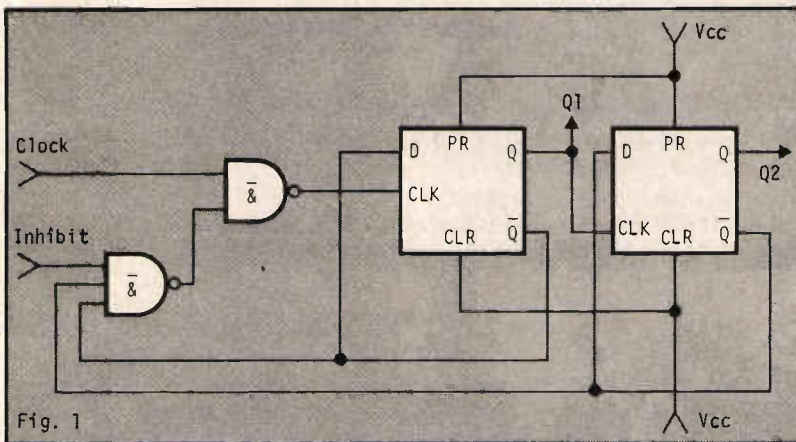

Fig. 1

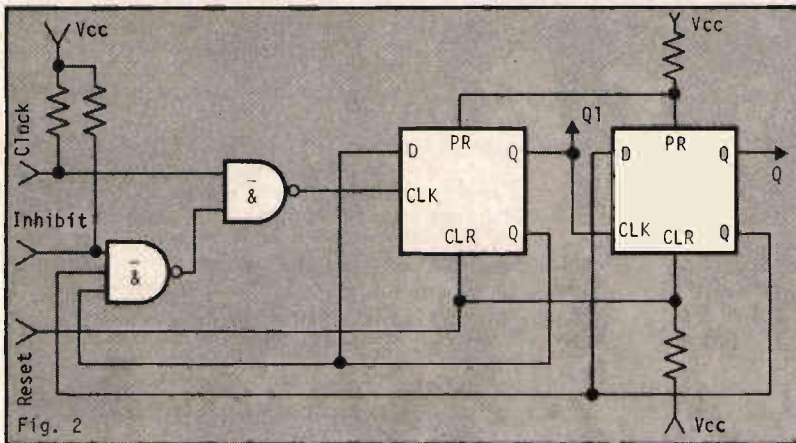

Fig. 2

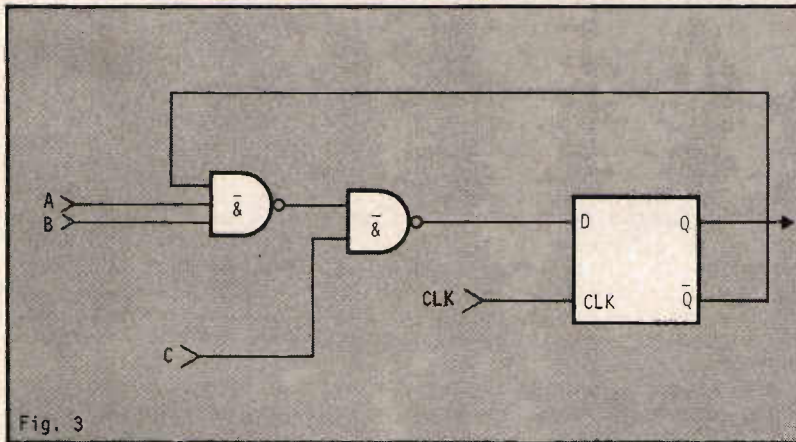

Fig. 3

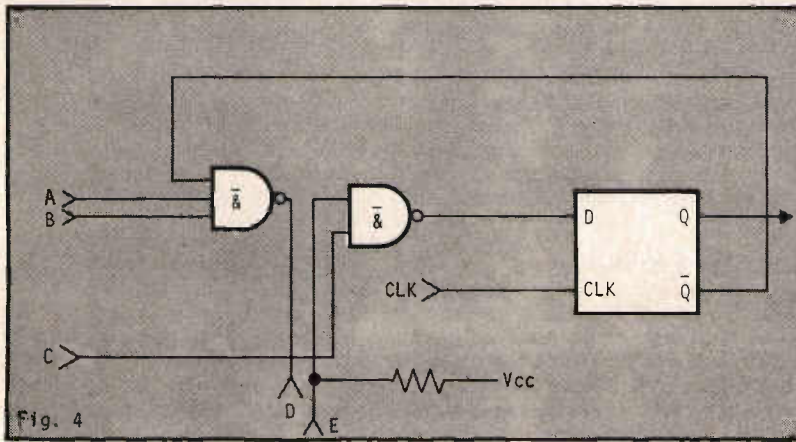

Fig. 4

One shots are best forgotten. They are difficult to test with any equipment, noise prone and are often only used as a design get out. When they are cascaded, the problems snowball and there is no way that the overall logic sequence can be slowed down to assist fault diagnosis. Fully clock-synchronised systems have no such problems.

In the event that one shot insertion is unavoidable, the following points should be borne in mind: use one shots with a dc reset capability; provide a means of external over ride control; and use one shots with time periods of not less than a few hundred nanoseconds.

When free running oscillators are used, a means of external over-riding should be provided as shown in Figures 6 and 7. The circuit in Figure 6 allows the oscillator to be over-ridden by A and an external clock to take its place via B. The circuit shown in Figure 7, which is normally connected between A and B via the back wiring, enables the use of an external oscillator for stimulus synchronisation. Oscillators of this nature should be located near the board edge connector to enable simple over-ride control and minimise signal crosstalk.

Elements in some logic families allow the use of common output stringing to make up *wired and* or *or* gates. This is possible because the logic elements only have an active pull down circuit, pull up normally being achieved by a resistor which is either internal or external to the logic function. This practice, although economic in terms of logic usage for the design engineer, creates problems for fault diagnosis because the fault source can be one of several logic elements. An additional summing gate should be used instead of the wired configuration; Figure 8 illustrates this point. When this is not practical, gates in the same integrated circuit package should be utilised since this can greatly reduce the number of ic replacements.

The more test/control points that are available on a printed circuit board and the better they are sited, the more comprehensive will be the test and more accurate and faster will be the fault diagnosis, resulting in greater throughput.

Control points can be employed as test injection points to provide either an extra external reset capability, or perhaps over-ride signal injection. They can also be particularly useful at logic junctions where large numbers of inputs or outputs converge. If the master edge connector does not have sufficient pins available for test points, then it is worth considering the use of an additional connector at the other end of the board in order to provide these points.

Integrated circuit clips can be employed to supplement I/O pins, but their advantage is dubious because they increase board connection time considerably and impede guided fault isolation techniques. As a general rule, the ratio of input/output pins to number of inte-

grated circuits should ideally be 2:1. A ratio of less than 1:1 should be avoided.

Other design factors to bear in mind are as follows:

- Do not terminate logic outputs directly into transistor bases; use a current limiting resistor instead.
- Buffer flip/flop output signals before they leave the pcb.
- Do not hardwire the pcb's into the system but use only one large connector if possible.
- Avoid the use of potentiometers.
- Make pcb input and output signals ttl compatible whenever possible since this keeps automatic test equipment interface costs low and gives greater flexibility.
- Where d-to-a conversions take place, bring out test points as near to the conversion point as possible.
- Use free collector devices with pull up resistors, since these enable external over-ride control.
- Allow sufficient room adjacent to each ic to attach a test clip.
- Standardise on power and earth pins to avoid a multiplicity of test harnesses.
- If the pcb uses complex integrated logic such as cpu's, long dynamic shift registers or uarts (universal asynchronous receiver/transmitters), mount these devices in ic sockets in order to
 - a) facilitate their simple replacement in the event of failure and
 - b) enable the board to be tested prior to the insertion of the device at the end of the production line. This also has the advantage of allowing simpler automatic test programmes to be written.
- Provide linked pins at the edge connector end of the pcb to enable the tester to check the pcb's correct insertion. These pins can be coded to provide a unique address, recognisable by the tester, which can identify the board type or variant prior to applying the unit under test power.
- If lamps or displays are mounted on the pcb, route their logic drives to the edge connector so that the tester can check for correct operation.
- Unit under test mounted switches cannot be operated by the tester, and manual intervention slows down throughput rate; so route switch output lines to the edge connector to enable external over-ride (Figure 9).
- RC networks are often employed as a power up reset for memory logic. Because these circuits are of limited use to the tester, an over-ride line to such circuits should be provided.

If the points discussed above in this article are heeded, the initial design costs of a product might increase slightly. But such an increase will quickly be recouped during the product's life in terms of quicker, more comprehensive and reliable testing, easier re-working and simpler modification.

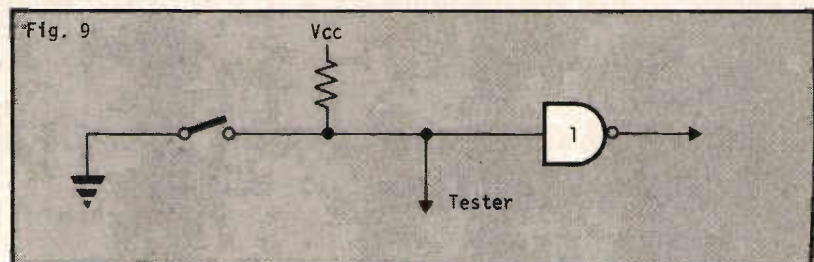
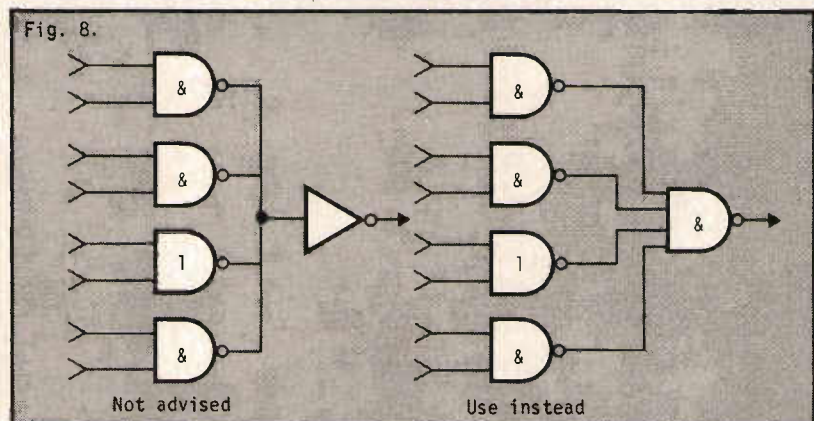
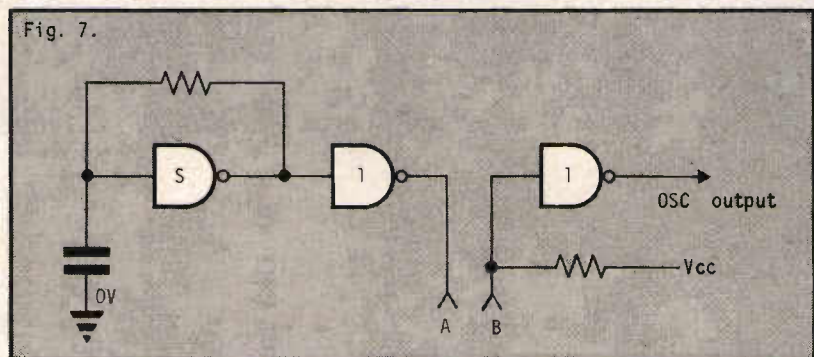
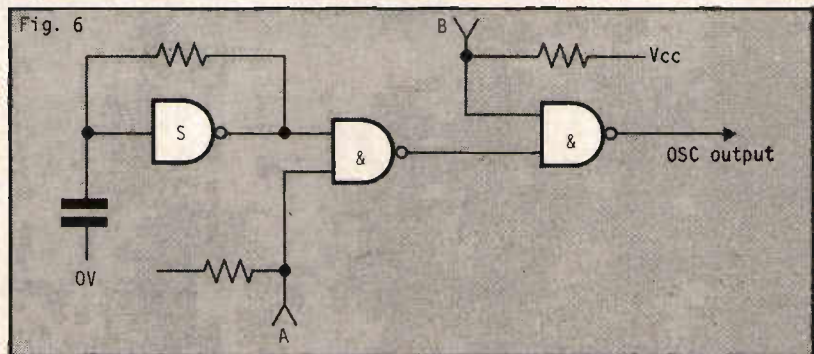
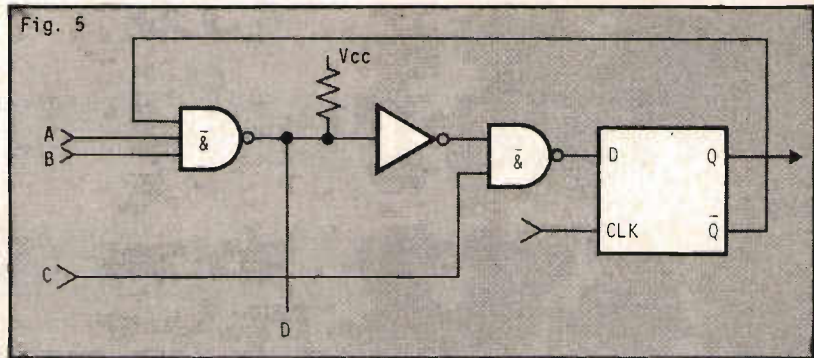

For high performance receiver testing, you need high performance signals.

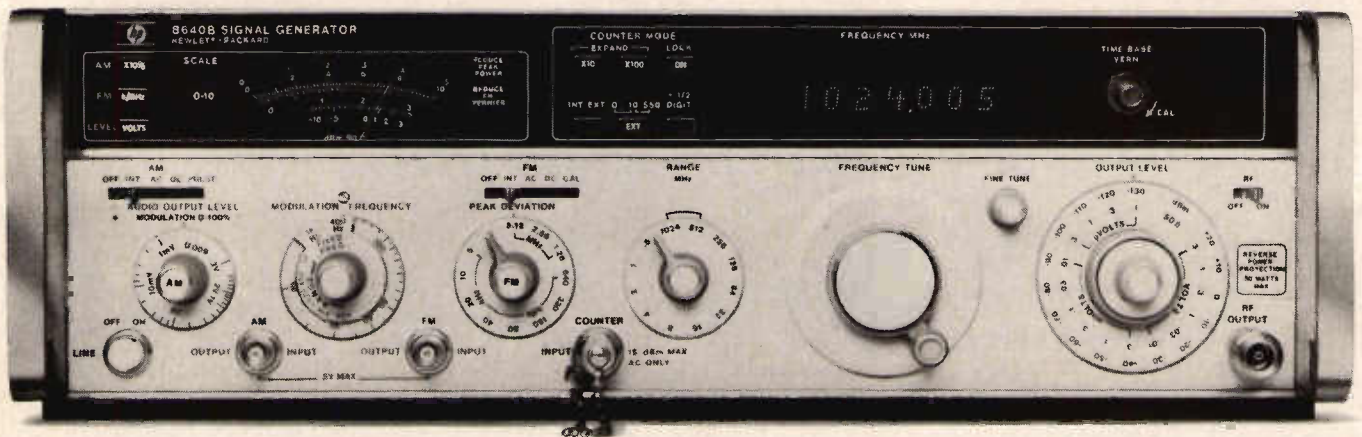

HP 8640B w/Opt. 001,002, 003 - 0.5 to 1024 MHz.

When HP introduced the 8640B, its product concept brought together the superior characteristics needed for high performance receiver testing:

- Spectral purity <130 dB/Hz, 20 kHz offset
- Wide dynamic range; +19 to -145 dBm
- Phase lock stability/external count capability

Since then we've continued to add to the original capabilities:

- Opt. 001 - Variable modulation
- Opt. 002 - Extended frequency, 0.5 to 1024 MHz
- Opt. 003 - Reverse power protection to 50 watts
- Opt. 004 - Avionics version for NAV/COM tests
- 8640M - Ruggedized/military version

Now with the 8640B you get 1/2 digit phase-lock resolution (500 Hz, 100 to 1000 MHz), improved modulation and power settability. You can also use the new Model 11710A Down Converter to extend output frequency down to 5 kHz and test standard IF amplifiers at 262 kHz and 455 kHz.

So for your high performance receiver testing, you'll still choose the performance leader in RF signal generators. For more information, contact your local HP sales office.

HEWLETT  PACKARD

Sales and service from 172 offices in 65 countries.
Wokingham, Wokingham, Berks RG11 5AR Tel. Wokingham 784774

Advances in medical electronics

There are several interesting developments in the medical electronics field. The use of lasers and ultrasonics provides both powerful diagnostic and treatment facilities writes *Elaine Williams*

The use of electronics in many areas of medicine has increased dramatically over recent years. Today electronics is used not only in a research environment but in practical situations such as patient monitoring systems and diagnostic equipment. Although we are still a long way from the bionic age, electronics has made a considerable contribution to the study and treatment of a wide range of diseases and abnormal conditions.

The understanding of the workings of body functions which exhibit electrically measurable phenomena such as the heart and brain have particularly profited from the electronics engineer. The brain has been one of the first areas to be studied in this way since it is the most active area in electrical terms and, for so many years defied any other type of investigation. Most measurements concerning the activity of the brain are grouped under the term electroencephalography.

Normally measurements are recorded from electrodes placed on the scalp although some relatively rare diagnostic procedures require electrodes on or beneath the cerebral cortex (which is the outer layer of grey matter of the brain). The electroencephalograph commonly known as the EEG has been known for some 40 years and is especially useful in the study of epilepsy. Although there are several forms of epilepsy the EEG waveforms can give an indication of the type and this outlines the treatment to be undertaken.

Also the study of EEG has been known to help in the detection of brain tumours since they alter the normal brain patterns by showing a lack of organised electrical activity in the region of the tumour. This is limited however because of the variability in the response between tumours of different types.

Sensitive indicator

The EEG is a very sensitive indicator of the state of awareness of the brain since the patterns generated during various activities are markedly different. Another application in which this measurement has proved valuable is for monitoring patient activity during surgery involving the heart. Should the heart stop for any length of time cerebral monitoring equipment can determine the extent of brain damage if any, since it is generally agreed that the likelihood of permanent anoxic damage is almost

certain if the brain is starved of oxygen for more than four minutes.

Measuring the electrical activity of the heart is performed by measuring potentials at the surface of the body. Any variation from the normal rhythm is known as arrhythmia. It is for this reason that patient monitoring systems have become popular over recent times. These systems can not only measure all the important body parameters but monitor several patients simultaneously. Most of these measurements are made externally by probes and internally by catheters so that EEG, ECG, arrhythmia detection, pulmonary artery pressure and arterial blood pressure can be determined.

Transducers are extensively used in medical measurements. Transducers are either attached internally or externally. It is more desirable to have probes externally fitted since this causes less discomfort to the subject but makes readings more susceptible to the very noisy environment of the body. Blood flow is measured by placing a mean velocity transducer in an artery having a known cross sectional area. The most common type of these transducers is the electromagnetic type which consists of an electromagnet to generate a magnetic field and two electrodes to sense the flow signal. They are encapsulated in epoxy in a form to allow them to fit around the blood vessel.

In some areas of medicine, ultrasonics can overcome the problem of internal probes. Ultrasonics is proving

The two electrodes of the pain controller are fitted so that the affected area is situated between them.



to be a very powerful measurement diagnostic tool and its probes are external and therefore non-invasive. Also it overcomes the obvious dangers associated with x-rays. The main limitations of this technique are that bone and gases strongly affect high frequency sound waves so interfering with transmission through certain areas of the body such as the lungs, skull and gastrointestinal track.

Ultrasound is generated by a transducer made of piezoelectric material in a probe. The material vibrates at high frequency when a pulse of electricity is applied. Normally ultrasound is considered to be above 20 kHz but a working figure of above 100 kHz is commonly employed. As high frequency sound does not travel well in air the transducer must be coupled to the body by a liquid.

Applications for this technique are in obstetrics and gynaecology and the Doppler effect is used from the measurement of arterial blood flow and velocities. Ultrasound also has an interesting role to play in the treatment of tumours. It can destroy or shrink tumours by applying heat to cancer cells. These cells are apparently more susceptible to high temperatures than healthy ones. Heat is focussed on the tissue by the sound which raises the temperature of the cells to about 180°F. There has also been evidence to suggest that treatment by ultrasound may increase the sensitivity of these cells to further treatment by x-rays or drugs. Methods are also being developed to monitor internal temperatures to control the ultrasound dosage.

Another device which has found some application in the treatment of tumours and other malignant growths is the laser although, by far its largest use is in the area of eye surgery. However its use will never assume the same proportions or impact that x-rays have had on medicine although it does have a significant contribution to make in the area of eye treatment.

Experiments have been going on in the use of pulsed solid state lasers in the treatment of skin cancers (melanomas) with some success as has the use of a CO₂ laser knife for surgical purposes where there is a high concentration of blood vessels (highly vascular areas).

Eye surgery utilises the laser largely for repairing detached retinas. If the retina becomes detached from the choroid or some part of it, blind spots occur. By flattening the retina against

Picofuse the smallest thing OFF earth

5 miniature Picofuses were built into the circuits of Surveyor 3 - the spacecraft which sent back to earth so much information about the surface of the moon.

A project such as this demanded the very best in electronic equipment protection which is why NASA called in Littelfuse.

Picofuse, the smallest fuse available, is the ultimate answer to your requirements for so many, more down-to-earth applications.

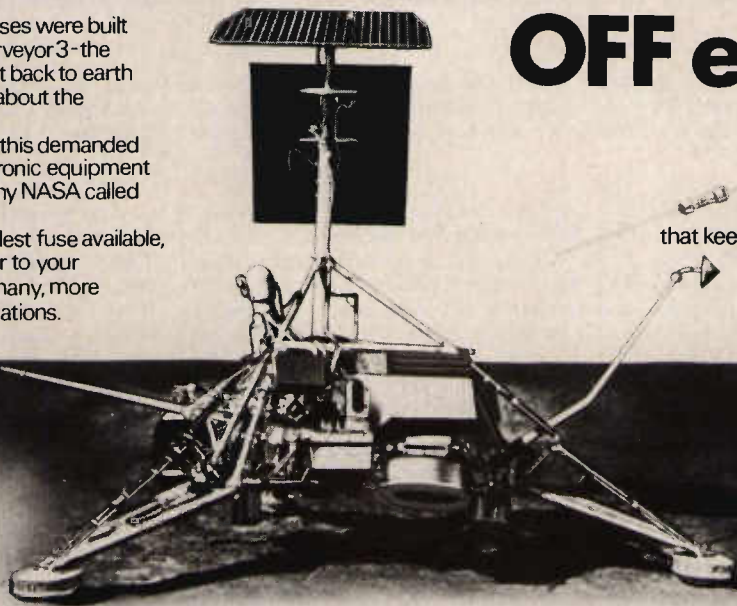

It's the LITTEL things that keep the big things going.

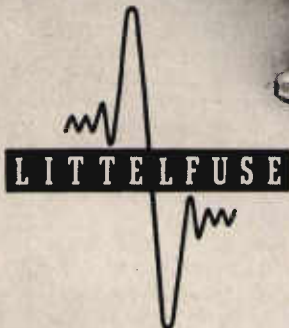

LITTELFUSE (GB) LIMITED

CROWTHER, DISTRICT 3, WASHINGTON, TYNE & WEAR NE38 0AB, ENGLAND. TEL: 0632 462479. TELEX 537095

UK Distributors:-
 WOOLLEY COMPONENTS LTD., 214A Manchester Road
 Broadheath, Altrincham, Cheshire W14 5LU
 Tel. 061 928 2289/7425 Telex 669735
 THE RADIO RESISTOR CO. LTD., P.O. Box 12,
 4 Trust Industrial Estate,
 Wilbury Way, Hitchin, Herts SG4 0TN
 Tel. 0462 54077 Telex 826251

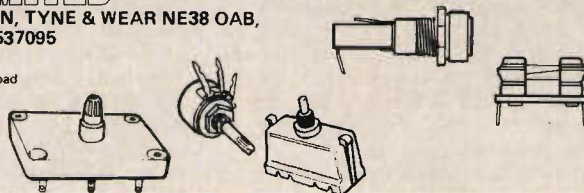

At +125°C you can burn your fingers on some DAC's our 4058 stays cool

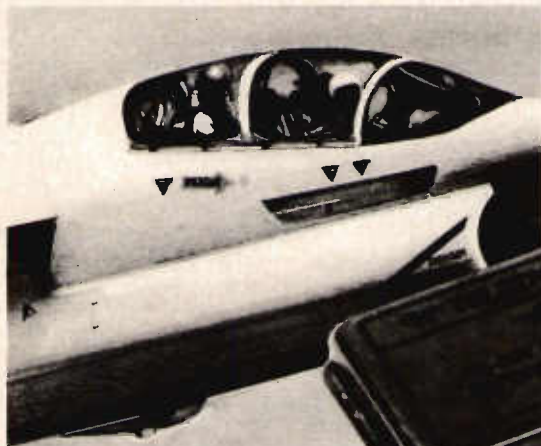

Because this new, hybrid 12 bit DAC was specifically designed for the temperature range - 55 to +125°C. It is not merely a top-end selection of commercial DAC's, where you don't know today what tomorrow's yield will be.

Your application may not need the full temperature range nor the hermetically sealed metal DIP. But for a lot of industrial applications these and other features of the new DAC offer you vital safety factors.

For example, it is produced to MIL Std 883 giving extremely high reliability. It has a very low temperature drift of 5 ppm/°C gain, 10 ppm/°C max. offset.

And if you want to fly with it, the 4058 is shock, vibration and acceleration tested - its already being used in the new MRCA.



Heathrow House, Bath Rd, Cranford, Middx. Tel: (01) 897 2501
 Telex: 935008

the choroid (which is a vascular and pigmented membrane extending around the back of the eye) it is sometimes possible to re-attach the retina. Even if this cannot be achieved the detached area should be sealed off to prevent the retina becoming totally removed from the choroid.

The basic principle is to produce a localised welding of the retina and choroid. There are several techniques which exist such as diathermy, cryosurgery and the xenon arc coagulator. The coagulator for example requires that the patient is anaesthetized so that the eye can be immobilised because an exposure of several seconds is needed. However, a ruby laser pulse lasts about 1 ms so there is no need to provide immobilisation and the operation may be provided in the outpatient department.

More down to earth techniques are also applied in medical electronics such as the use of thick film hybrids in heart pacemakers. These devices are produced in hermetically sealed packages and are placed in the abdomen to avoid tissue irritation and rejection. Connection to the heart is then made by cardiac catheter or electrode.

There are currently three types of pacemaker available which are internally fitted. These vary in price from about £300 to £2000. The least expensive of the internal pacemaker (which is really a signal generator delivering 71 beats per second) uses a mercury cell and will last up to about five years. More recently we have seen the lithium cell which has a life expectancy of ten years and finally the nuclear cell which is estimated to last 25 years but only time will tell.

Internal devices are preferable to external ones in the long term since stimulation from an external source requires a considerable level of current

to ensure that sufficient stimulating current passes directly to the heart. This can mean that the subject may experience a significant amount of pain.

The study of pain or rather the control of it is an extremely fascinating area of medicine. Since pain varies so much between individuals and, cannot be measured accurately in any way, it becomes an interesting but frustrating problem. In some cases patients may be in continuous pain after an operation or illness. Post operative pain is a common phenomenon and often disappears with time but sometimes it does not. Also illnesses such as shingles which attack the nerves may cause continuous pain even after the virus has been destroyed.

Until recently the only way of easing the pain has been through the use of drugs or anaesthetising the affected areas but obviously this is not very desirable in the long term but neither is the prospect of pain. Some work has been going on in electronics to control the level of pain in these patients and some encouraging results have been noted.

The principle by which the pain controller works can be explained by the analogy that to relieve toothache one bangs one's head against a brick-wall ie to lessen the effect of pain one diverts attention by introducing another stronger signal. This principle is embodied in the gate control theory which was postulated by Melzack and Wall in 1965 and has proved to be the starting point for the treatment of

Left: this recorder provides permanent chart records of eight patient parameters on a common time base.

Right: this equipment is a high speed analyser for ambulatory monitoring.

severe pain after an operation or illness (post herpetic pain).

Melzack and Wall suggested that by exciting the myelinated cutaneous fibres this would reduce the effect of an input via the small myelinated fibres. Since the activity of some of these small nerve fibres causes pain, the effect of the excitation might diminish the effect of pain.

The treatment itself consists of electrical stimulation of the affected pain areas by the use of two large electrodes which are placed on the skin near the affected parts. The introduction of a small electrical signal in effect overrides the signal to the brain which the pain provides, hopefully reducing the overall effect.

There have been several studies made on the effectiveness of such treatment and they have concluded that pain relief was possible by use of such treatment which is commonly known as transcutaneous electrical stimulation. In one study the figure showed that 77 per cent of subjects using this method benefited from some pain relief.

Although there are few areas left in medicine where the use of electronics has not been investigated there is still room for considerable improvement. On the one hand we see highly sophisticated equipment such as patient monitoring systems (and it will not be too long before some of this equipment will be microprocessor based) while, on the other there are some relatively old fashioned instrumentation compared with the state of the art technology being used today. The medical profession has always been a conservative one but it will be interesting to see in the years to come how it reconciles itself with the fast changing technology and wide opportunities the marriage with electronics can provide.



Module Library

Standardisation

Standardisation

- Wire-wrappable interconnection packaging system
- Complete yet flexible – sizes standardised
- From development to production with minimum delay and redundancy
- Meticulously designed – combines all the elements often overlooked or compromised
- Incorporates precise module guidance, vibration suppression, correct grounding and power distribution
- Unique provisions for heat sinking, noise suppression and contact protection
- Digital, analog and interface modules all available

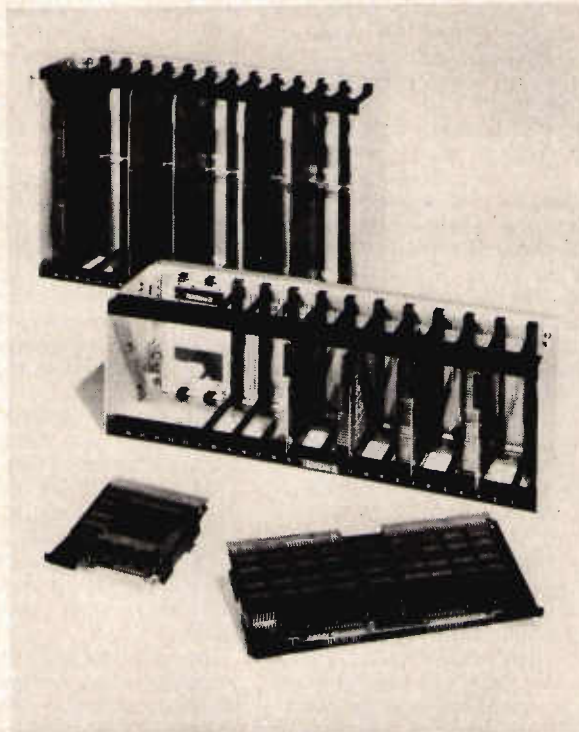

TERADYNE

Teradyne Components Limited, 47a Newnham Road, Cambridge CB3 9EY Tel: Cambridge (0223) 66896/7

Just connect up and read out.

That's the simple story behind our complete and new range of high stability, high voltage, dc voltmeters.

Compact and versatile, they neatly complement our existing 10kV to 120kV models.

It's the only meter range that

extends up to 180kV. And such versatility makes it ideal for a whole host of activities, particularly in laboratory and quality control inspections.

Just clip the coupon below for our illustrated brochure and full technical specification.



Please send me details of the Hunting Hivolt 0-180kV dc voltmeter.

Name _____

Company _____

Address _____



**HUNTING
HIVOLT LIMITED**

Old Shoreham Road, Shoreham-by-Sea, Sussex BN4 5FL.
Tel: 07917 4511-8 Telex: 87466.

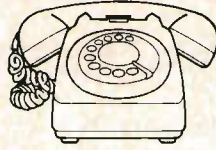
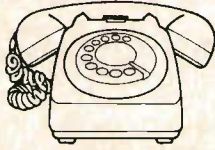
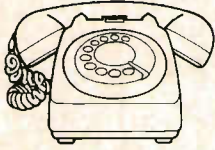

British Central
Electrical Ltd.
Briticent House
172 Honeypot
Lane
Stanmore
Telephone:
01-204 9111
Branches at:-
Slough 28616
Mitcham
01-640 9121
Cosham (07018)
83621
Yeovil 5596
Twickenham
01-894 7561
Chingford
01-529 3715

D.T.V. Group Ltd
126 Hamilton Road
West Norwood
London SE27
Telephone:
01-670 6166

Farnell
Electronics Ltd
Canal Road
Leeds LS12 2TU
Telephone: Leeds
(0532)636311

Lock Distribution
Neville Street
Middleton Road
Oldham
Telephone:
061-652 6166

Spenco
Electronics
(Phoenix) Ltd
79 Carron Place
Kelvin Industrial
Estate
**East Kilbride,
Scotland**
Telephone:
East Kilbride
(03552) 36311

Your nearest phone will solve your encapsulant problems. Immediately.

Whatever your encapsulant, potting or sealant requirements, your local specialist Dow Corning distributor is able to supply you immediately. Wherever you are, there is a local Dow Corning silicone trained electrical/electronics product expert to help you.

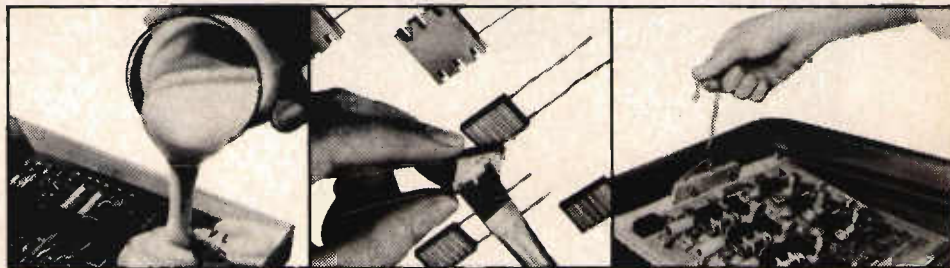

DOW CORNING



**New
from
ESI**

New micro processor controlled LRC digital meter from ESI

Tranchant bring you ESI's latest auto LRC Meter - Model 296. It measures R, L, C, G and calculates D and Q. Because it's microprocessor controlled, the cost of optional features is reduced making them plug-in accessories.

Model 296 is the perfect answer to your manual or automatic testing of components. A 24 button keyboard enables easy selection of function ranges, test voltages and frequencies, or these can be programmed via the optional IEEE 488-1975 interface bus.

Here are the features that make the 296 a money-saver for anyone with QA on his mind:



- * dual 4½-digit displays.
- * 1 kHz and 120 Hz freq.
- * wide ranges (C to 200,000µF).
- * 0.1% basic accuracy.
- * autoranging.
- * selectable test voltages.
- * 100-300 ms measurement speed.
- * low cost options including:
 - IEEE 488-1975 interface bus.
 - limits comparators.
 - higher measurement speed.
 - D.C. resistance measurement.

	Capacitance	Inductance	Resistance	
Full	1 kHz	0 to 20,000µF	0 to 2000 H	20 m Ω to 2 M Ω
Scale	120 Hz	0 to 200,000µF	0 to 20,000 H	20 m Ω to 2 M Ω
Ranges	D range is 0.0001 to 1.9999. Q range is 0.5 to 10,000. Gp 200 S to 2000 nS.			

Send for your copy of the 296 data sheet giving full specifications today.

esi
ELECTRO
SCIENTIFIC

tranchant electronics (uk) limited

Tranchant House 100a High Street
Hampton Middlesex TW1 2ST
Tel: 01-979 0123.

Tomorrow's Electronics Today

High current earth continuity tester.

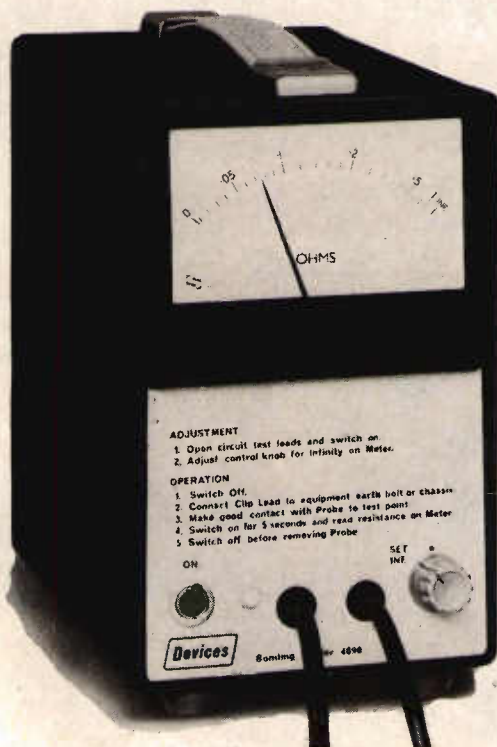

The Devices Bonding Tester provides an effective and convenient means of determining the resistance of earth continuity paths and will assist engineers responsible for the testing, installation and maintenance of electrical and electronic apparatus.

Conventional continuity meters provide an output current of about 50µA but the Bonding Tester applies 6V. and delivers 25 A. with an 0.1Ω load. The short circuit current limits at 30 A.

The compact and portable instrument is mains-energised with the output isolated from the mains. Flexible leads terminated in a clip and probe provide heavy duty connections to the apparatus under test and a four inch meter indicates resistance values between 0—1Ω.

A leaflet is available from

Devices

Devices Limited

Hyde Way, Welwyn Garden City, Hertfordshire AL7 3AP, England.
Telephone: Welwyn Garden 28511. Telex: 269404. Cables: Devices Welwyn Garden

Devices-experience that shows.

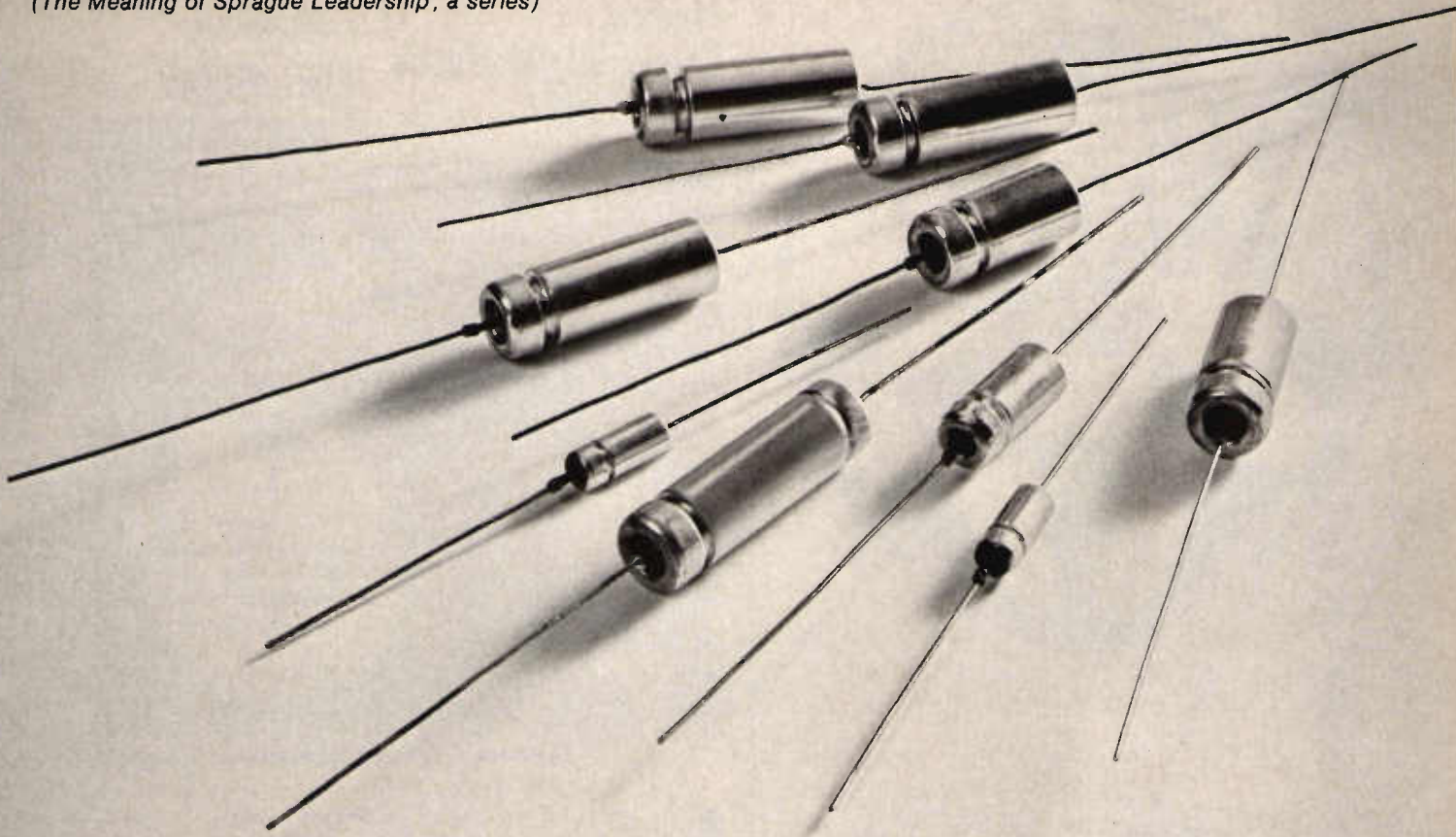

SPRAGUE LEADERSHIP: PROVEN, BRITISH MADE TANTALUM CAPACITORS

These gelled electrolyte, sintered anode Tantalex[®] capacitors form an important part of SPRAGUE's total capability in tantalums.

Produced to the very highest standards of quality at our Galashiels, Scotland factory, our tantalum capacitors are especially noteworthy for superior volume efficiency and low leakage current. Moreover, they offer exceptionally fine performance – with respect to frequency and temperature variations – over an extended capacitance range.

Such characteristics, plus true glass-to-metal hermetic sealing and minimal case size, contribute to their extensive use in military and aero-space equipment.

Applications, like these, attest to the technological capabilities of our

tantalum capacitors. To ensure that every production-line capacitor will measure up to such exacting standards, SPRAGUE-Galashiels has initiated a stringent quality control programme. Called "customer oriented QAR", it offers optimum application performance security.

Equally important to customers is the quality of the sales/service organisation. Our's, experienced in electronic engineering and with an indepth knowledge of the SPRAGUE product line, provides unexcelled technical assistance.

Or, in circumstances calling for a specially designed component, a SPRAGUE-Galashiels engineering specialist will work directly with the customer to resolve the problem.

This combination...the right people – the right product...means

leadership. SPRAGUE LEADERSHIP in service to our customers.

All inquiries, on any aspect of this advertisement, should be addressed to: Mike Jones, Sales Manager, Sprague Electric (UK) Limited, 159 High Street, Yiewsley West Drayton, Middlesex. Telephone W. Drayton 44627, telex 261524.





Announcing the new Heinemann
Re-Cirk-It
 pushbutton circuit protector
 —a low-cost direct replacement
 for a fuse and fuseholder

Send for Re-Cirk-It details
 and data on solid state devices
 to **SOLE AGENT.**

Electro-Match Limited

57 Ashleigh Road
 HORSHAM
 Sussex RH12 2LE
 Phone: (0403) 68756
 Telex: 877361 Fintyre Bhurst

**Kenure
 Developments
 Limited**

**Precision
 Low Torque
 Potentiometers**



Kenure Developments Limited

 Blackwater Station Estate,
 Blackwater, Camberley,
 Surrey. GU17 9AQ
 Telephone 0276 32111. Telex 858719

**New
 Series 100**

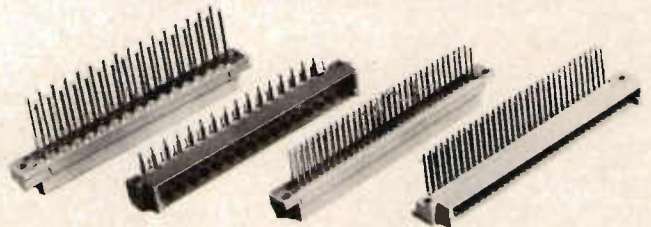
**Extension of the fuller range of
 Panduit DIN Connectors**



NEW FROM PANDUIT — Extension of the two piece Series 100 DIN Connector range, offering male and female connections with 32, 48, 64, or 96 contacts.

UNIQUE TO PANDUIT — Individual female contacts can be removed or exchanged. Polarizing key-way eliminates 180° mis-mating.

Extended bent pin printed circuit versions now available.

Like to know more? Write for full technical data.

Please send technical data on Panduit Series 100 Connectors

Name Position

Company

Address



Panduit Limited, Sittingbourne Industrial Park,
 Unit 22a, Crown Quay Lane, Sittingbourne, Kent.
 Telephone: (0795) 75333 Telex 965393

There's a lot to be said for having good connections in the right circuits.

Also for 10mm pin spacing in both 6 amp and 10 amp ratings and 2-12 ways.

Connectors specially for printed circuit boards with 5mm pin spacing. Suitable for up to 10 amps, 660 volts in 2 to 24 ways.

Single push-on tab type connectors for 5mm spacing are recommended for individual connections. Current ratings 6, 10 and 16 amps at 250 volt ac. for 2.8mm, 4.8mm and 6.3mm size receptacles.

All types are available with cable entry at the top instead of at the side, and are moulded in grey, glass reinforced nylon 6 for temperatures up to 110 C.

The 6 amp, 5mm pin spacing connectors are made for 2, 3, 4, 5, 6 and 12 way connections.

Wire protectors can be fitted to all patterns to give added protection to cable strands.

Our range also includes push-on edge and miniature plug-socket connectors and fuse-holders for PCB's. For full details send now for our catalogue ME1 73/SEC 3

Metway Electrical Industries Ltd.,
Canning Street, Brighton, BN2 2ES. Tel: 0273 66433/4/5.

METWAY

73 on enquiry card

VEROWIRE®. GET THE CONNECTION

- A new and ideal wiring system for prototypes, Breadboards, and limited production.
- Achieves a permanent interconnection of components, at high speed, on a very high density.
- Based on the use of Verowire(R) wiring pen with unique spring wire clamp for wire retention, advancement and retraction.
- Moulded wiring combs fitted to board route the wire from point to point neatly holding and stabilising the wiring layout.
- By using a specially designed tool, I.C. legs are deformed and positively held in the board enabling the wire to be easily wrapped around them.
- Using a self-fluxing polyurethane coated wire, no pre-stripping is required. Connections are completed by soldering, melting the insulation and at the same time making a permanent soldered joint.
- A complete introductory Verowire kit is available consisting of a wiring pen, spools of wire, terminal pins and all tools necessary. You only require a temperature controlled soldering iron to Verowire a board. A sample board from the Vero high density D.I.P. board range is also included in the introductory kit.

Vero Electronics Ltd.
Industrial Estate, Chandler's Ford,
Eastleigh, Hampshire SO5 3ZR.
Telephone: Chandler's Ford 2956
Telex: 47551

Available through 3 subsidiary
Companies and 25 agents

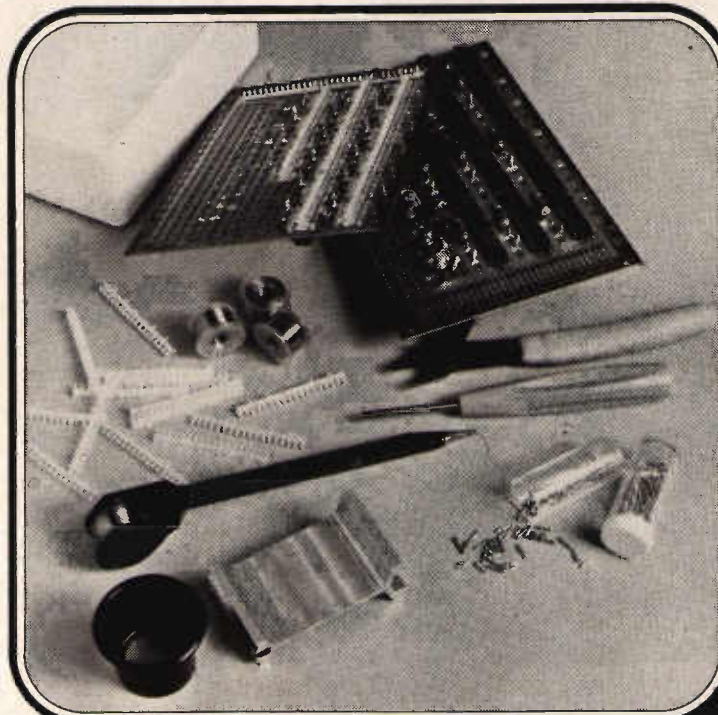

WORLD LEADERS IN PACKAGING TECHNOLOGY



WE REIGN SUPREME

AS STOCKISTS OF:

ELECTRICAL CONNECTORS

Distributors for:

Plessey Interconnect Ltd
Thorn Electrical Components Ltd
Flight Connector Corp (USA)

Stocks also held of electrical connectors from:

Amphenol Ltd
Belling & Lee Ltd
Greenpar Engineering Ltd
ITT Cannon Electric (GB) Ltd
Precision Electronic Terminations (EMI) Ltd
Post Office Specials Services/
NATO Specials

LAMPS AND LIGHTING EQUIPMENT

Distributors for:

Cryselco Ltd
Osram (G.E.C.) Ltd
Rival Lamps Ltd
Thorn Electrical Components Ltd
Grimes Manufacturing (USA)
Leecraft International Corp (USA)

Stocks also held of lamps and lighting
equipment from:

Hivac Ltd Vitality Ltd

AVIATION ELECTRICAL & RADIO Co. Ltd.

Moons Lane, Horsham, West Sussex RH13 5BY

Tel: Horsham 60206/7/8 (STD code 0403) Telex: 87645

Filtered!

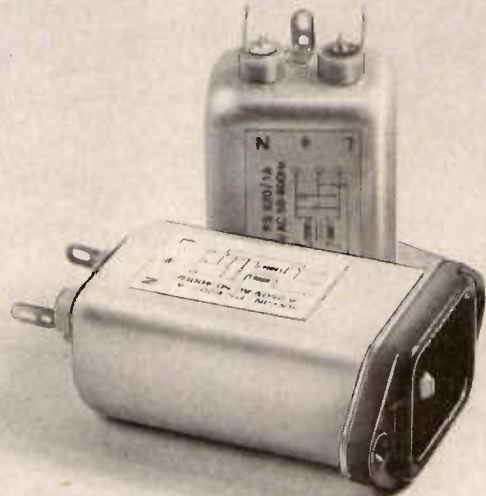

Having trouble with mains-borne voltage transients? Our combined three pole mains connector/interference filter unit solves the problem! Interested?

BULGIN Bypass Rd. Barking Essex
Telephone 01: 594 5588

ROXBURGH



Buzz on.

In certain situations, there's every need to get alarmed. And we've the means of creating a song and dance about virtually any situation.

A series of miniature, solid-state electronic audible alarms capable of operating from a whole range of d.c. supplies: 1.5V; 3V; 6V; 12V; 16V – and now 24V too.

They're simple to install, most economical to run, and built to endure. And we can provide them with either a continuous or intermittent tone.

So don't wait 'til it's already happened.

Call us right away.

It could be a sound investment.



Roxburgh. Way out front.

Roxburgh Electronics Ltd,
22 Winchelsea Road, Rye, Sussex.

Telephone: Rye 3777, Telex: 957066.

Professional rectangulars from Plessey are high on quality yet low on price

Quantity production using the most advanced, automated assembly and test procedures enables us to offer professional quality, general purpose rectangular connectors at lowest possible cost to you. The current ranges of Plessey multi-way connectors incorporate many valuable features – the result of many years' specialised experience in the development of electronic connectors.

And available from stock

Multicons and 159 series rectangulars are in full production and available for immediate delivery from your usual Plessey distributor.

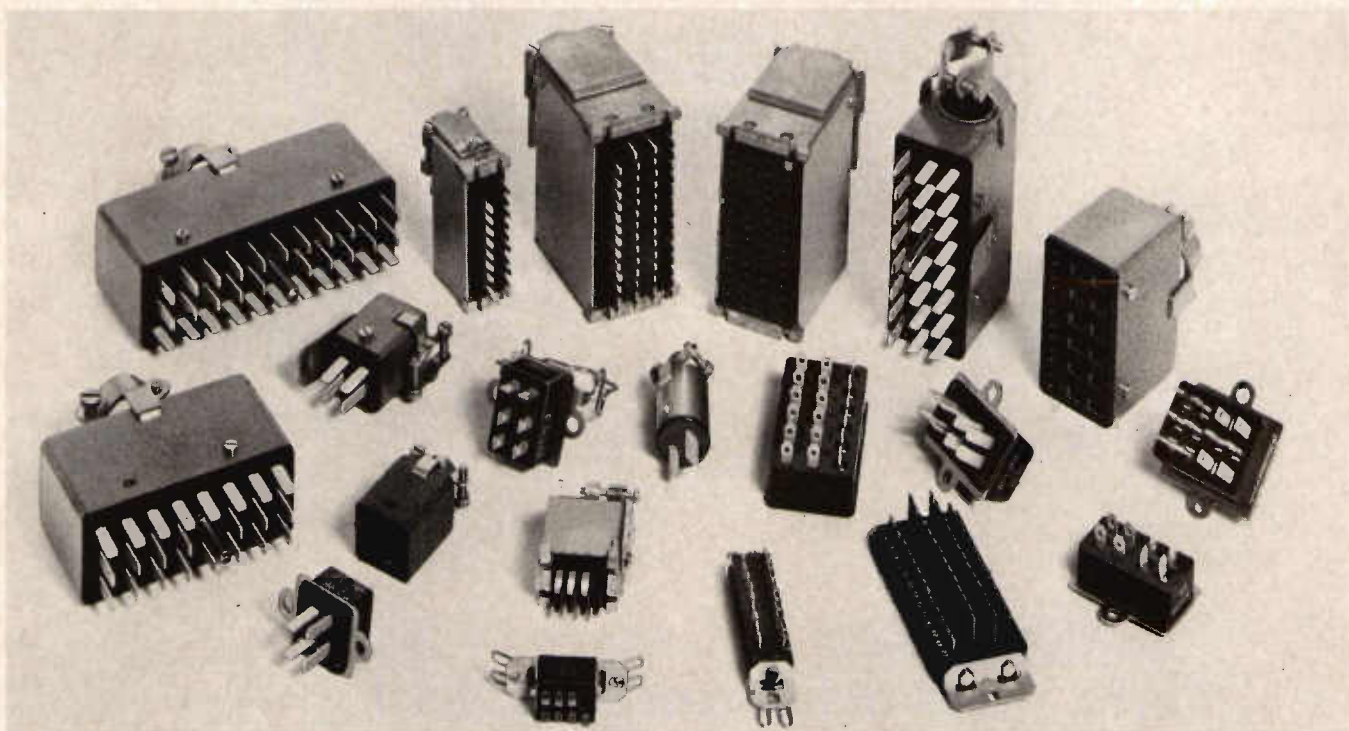

PLESSEY
CONNECTORS

F.C. Lane

Horsham
(0403) 790661

Sasco

Crawley
(0293) 28700

ITT

Electronic Services
Harlow
(0279) 26777

Intel

Henlow (0462) 812505

Farnell

Leeds
(0532) 636311

AERCO

Horsham
(0403) 60206

Plessey Distributors

Ilford
(01) 478 3040
Ext. 3391

Europe's largest connector manufacturer

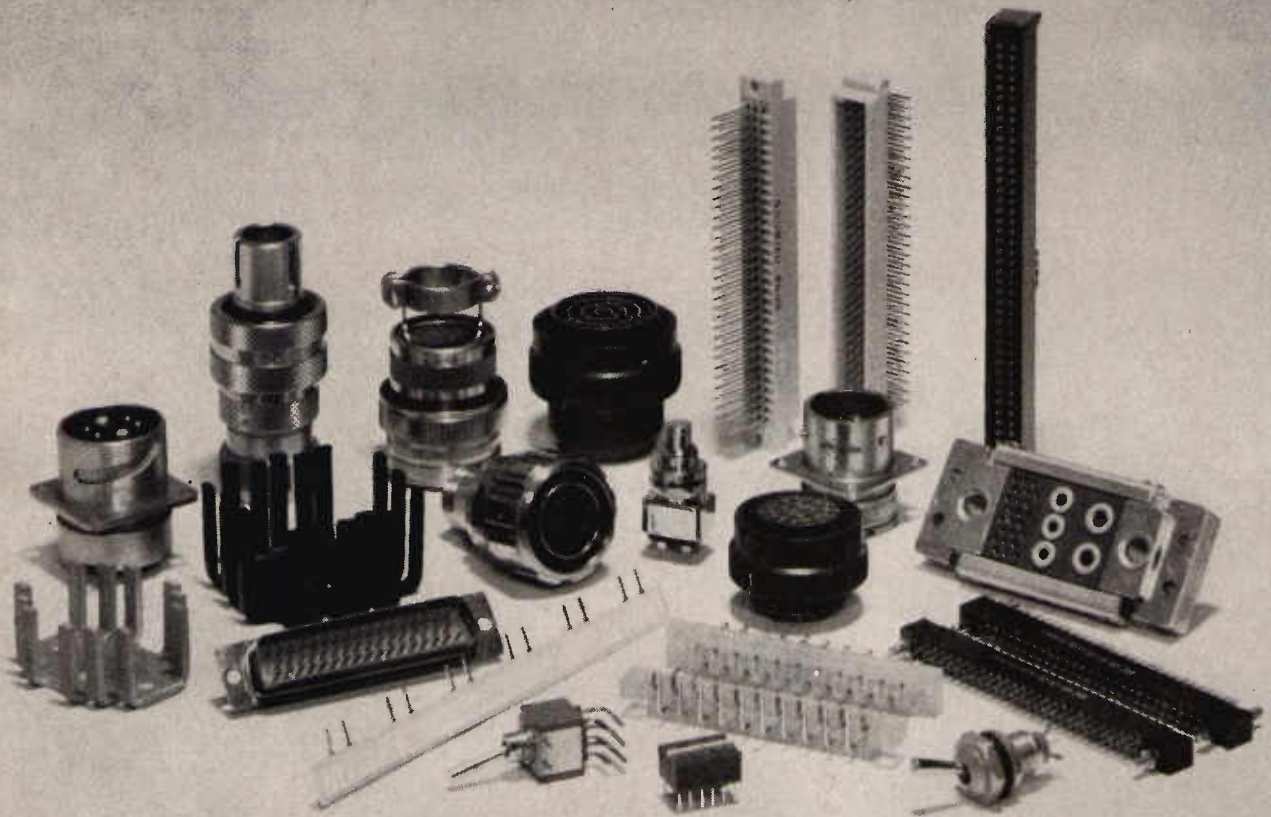

for quality connectors, switches,
heat dissipators & bus bars

SOURIAU

Souriau connectors and components are used throughout Europe in applications ranging from computers to oil rigs, telephone exchanges to Concorde and metro systems to MRCA.

Our standard product ranges cater for every type of industrial and aerospace application. If you'd like our latest product information, circle our reader reply number or telephone us at 075-35-69471.

SOURIAU (UK) LTD.

Shirley Avenue, Windsor, Berkshire. Telephone: 075-35-69471 Telex: 848456

PRODUCT FOCUS

This market analysis is concerned with manufacturers and distributors of "professional" connectors, that is types of connectors normally used in the field of military equipment, aerospace, telecommunications, computers, instrumentation and underwater. The newest developments in the connector field relate to the requirements of under water exploration, where depths of working are becoming such that, the so-called "sealed" connector is rendered unsuitable; the growth of fibre-optics and the increasing use of flat cables both with standard and flat-foil conductors.

When assessing UK market shares companies become unwilling to release specific sales figures, or where they manufacture a number of different types of component figures relating specifically to the professional electronic connector sales and therefore the figures obtained are assumptions made against the yardstick of those companies. Total market estimations arrived at, have given a figure of £46 million which includes the export sales of British made items. This figure is substantially more than any official statistics as companies who did not make a return are included. The following breakdown for connectors gives the percentage share of the UK produced component sales (including export) and an estimated total sales including imports. The market is roughly divided into the five classifications. See Table 1.

To list all the companies, their types of connector and billings would be laborious and beyond the scope of this aspect of the article. Therefore, the following compilation of twenty six companies with sales exceeding £250 000 represents a justifiable insight into the connector market. The listings conform from the greatest to the least market percentage. See Table 2.

The remaining 3,74% is claimed by a further fourteen manufacturers.

The figures quoted in the previous paragraphs do not include dual in-line sockets, of which both imported and UK manufactured versions account for an estimated £1 million per annum.

Statistics published in 1974 (the latest available) show that 45% of the components industry is concentrated in South East England; 11% in the North West; followed by 8% in Scot-

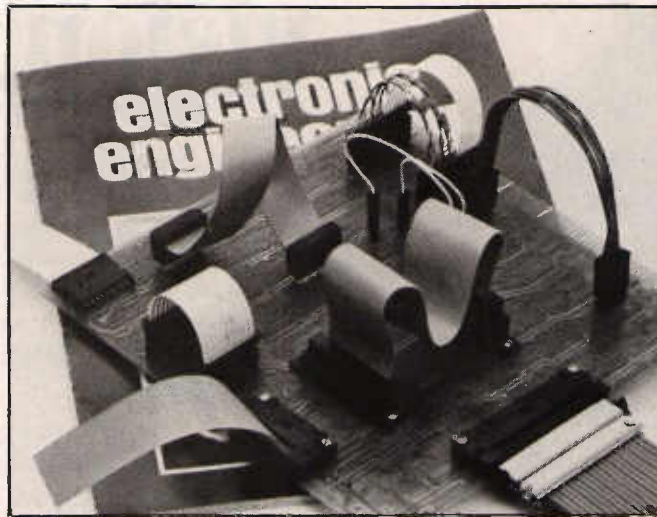

CONNECTORS

Ignoring the effects of business recessions, which tend only to slow the development process, it is reasonable to assume that the overall trend in connector development will continue and in the not too distant future there will exist a demand for a more advanced design of environmental connector, superceding existing designs for specific applications—writes Brian Jennings.

Table 1: Connector classifications

Description	Home product sales £38,22m	Total sales £45,90m
Multiway circular	28,63%	29,33%
Printed circuit types	33,05%	31,59%
Rectangular (rack & panel)	17,21%	17,77%
Co-axial	10,34%	10,75%
Miscellaneous	10,75%	10,53%

Table 2: Company market shares

Company Name	Market Share		Market Share
Cannon	9,87	Varelco	3,04
Plessey Interconnect	9,43	Smiths Hypertac	2,78
Amphenol	8,69	Sealectro	2,60
UECL	6,26	Belling-Lee	2,19
BICC Burndy	5,58	Souriau	2,06
Hellermann Deutsch	5,32	Precision Elect. Term.	1,69
Thorn Electrical	5,19	Ferranti	1,65
Carr Fastener	5,04	Hughes Micro electronics	1,36
AMP of Great Britain	4,73	Transradio	1,07
Pye Connectors	3,93	Suhner	0,86
Greenpar	3,47	Viking	0,86
A.B. Electronics	3,47	Henry & Thomas	0,86
McMurdo Insts.	3,26	Mullard	0,76

Fig 1. Typical selection of pc cable connectors from AMP

land and 7% in the West Midlands. Although for the components market, these figures more or less match the pattern for the connector breakdown, except that an estimated 60% is concentrated in the South East.

Over the past five years the average growth of the industry (connector) appears to have been approximately 18% per annum, but this is based on sales figures and seems to convey a completely false impression. The very large increases in material and labour costs in the period '73-'74 undoubtedly resulted in increased selling prices distorting the figures to such an extent that the real average increase is nearer 6 to 7%. In 1975 price increases by major companies varied between 10 and 30%, the average figure being 18,5% which is considerably more than the growth figure for 1975 over the previous twelve months.

There are currently more than 40 manufacturing companies engaged wholly or partly in the production of professional connectors, a number of them multi-million pound concerns with diverse interests. Of these companies seventeen now appear to have connector sales in excess of £1 million per annum and with total sales of over £38 million, this means some 47% of companies share 85% of the estimated sales.

End of recession

Whilst there are signs that the recession is coming to an end, an upturn in the industry is not foreseen until mid 1977 and only in the region of 10% of the 1976 figures. This is, of course, assuming that prices remain at their present level and that there are no further cuts in Defence spending, since although this primarily affects one sector of the connector market it is the sector containing the highest value units and consequently has the largest impact on overall figures.

For a designated period, to the end of 1980 the average yearly increases, based on current prices, will grow at 8,5% per annum, although yearly fluctuations are inevitable.

Technological developments during the past few decades have significantly advanced the performance capability of electrical connectors where there is a continuing need to improve designs to meet requirements particularly for performance, size, weight and reliability.

A sweet little number by Honeywell



You get quite a lot in a 1lb bag – about 75 – and they'll all be different. In fact there are so many different features you can specify that you could buy a cwt and still have them all different. With all that range of different miniature switches to choose from, there must be one that suits your need.

**just try one~ you'll be
sure to come back for more**

Honeywell

Honeywell Ltd. Honeywell House, Charles Square, Bracknell, Berkshire. RG12 1EB Tel: 0344-24555 or your nearest Authorised Distributor

Double vision...?

That's what you experience with the Vision Comparascope . . . simply a better method of checking P.C. boards, or any other products that must be visually identical. The Comparascope is several times faster than conventional viewing methods, yet offers greatly improved reliability, showing up any difference between two objects immediately.

For further information on the Vision Comparascope, or to arrange for a demonstration, please telephone or fill in the coupon and send it to us.

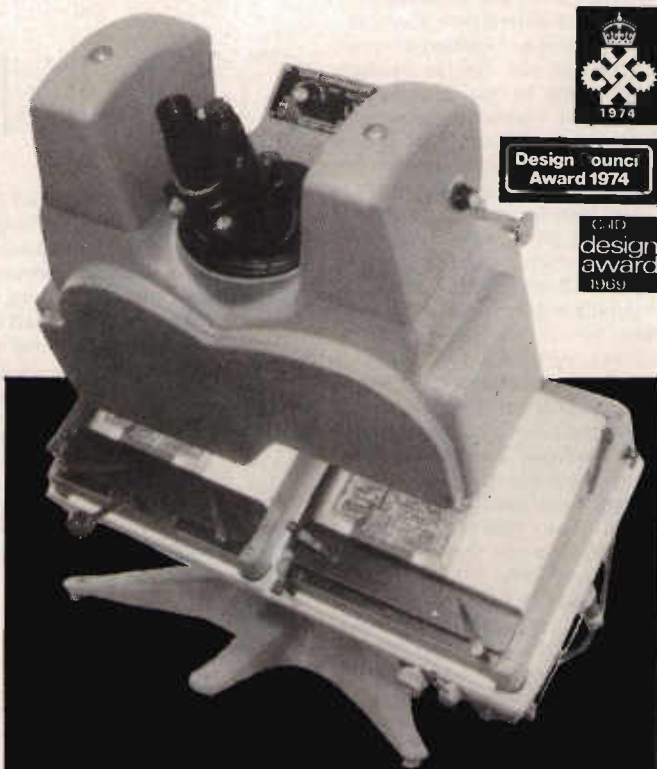

'LOOK AT THINGS A BETTER WAY'



**Vision
Engineering Ltd.**

SEND ROAD, SEND, WOKING,
SURREY GU23 7ER, ENGLAND

Tel: Guildford 223417 Cables: 'Vision' Woking Telex: 859301

To: Vision Engineering Limited
Send Road, Send, Woking, Surrey GU23 7ER England
Please send more information on the Vision Comparascope
Please ring me to arrange a time for a demonstration
(Tick as appropriate)

Name _____
Position _____
Organisation _____
Address _____
_____ Tel: _____

EE12

PRODUCT FOCUS

The extent of this development can best be assessed by comparing performance characteristics of modern day designs with those available fifteen years ago. Working temperatures have doubled, contact density has increased by a factor of five, weight per termination has been reduced by in excess of 80% and the rate of connector failure for present designs is better than 0,05/10⁶ operating hours, compared with 1,5 for older designs operating in less severe areas.

This particular assessment attempts to look at developments during the past years, to examine factors that have influenced connector designs and to define parameters that are likely to form the basis for the next generation.

Life-span patterns

Assessing established connector designs reveals that the life span for most environmental (multi-way) connectors follows a pattern that is common to most designs, categorised in three identifiable stages. Firstly, initial development against a specific requirement, here environmental connectors are designed to meet the most severe user requirements at the design concept stage. These are predominantly aerospace applications.

Secondly, the establishment of a complete range of connectors, during this stage of development the availability of connector styles increases steadily as a design gains national and subsequently international recognition and becomes available from a number of manufacturers. Thirdly, the replacement by improved design, here the gap between user requirements and the performance capability of a connector design increases and as improved designs become available there commences a stage where the design is no longer acceptable.

Present day specifications covering environmental connectors are essentially adaptations of proven techniques, capable of suiting new or more severe user requirements and because designs and specifications tend to evolve as a simultaneous process, in many respects they represent the limitations of current technology. Even so, performance specifications provide essential design criteria enabling the designer to accurately define minimum acceptable levels.

An analysis of the quality assurance requirements con-

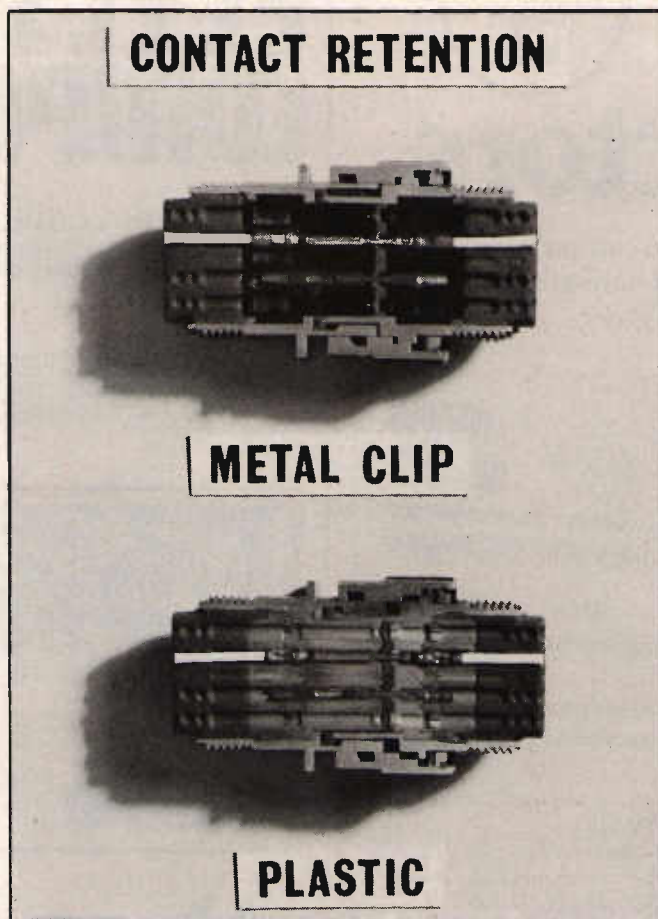

Fig 2. Sectional view of contact retention from Amphenol

tained in various national specifications introduced since 1950 provide an interesting study of trends in performance requirements. To obtain design approval for a range of connectors in 1950 it was necessary to meet the requirements of 11 individual performance tests, today the average number of tests per design is 31 requiring in many instances a much higher level of performance. During the same period the number of individual tests introduced for the purpose of measuring the performance of environmental connectors increased from 12 to 58, this would seem to be an indication that many tests are introduced covering specific requirements for particular designs having no practical value as standard tests.

To establish a more realistic trend in performance requirements it is necessary to eliminate the effect of generic specifications covering more than one basic design. After making adjustments of this nature, it is possible to indicate a general trend applying to an homo-

geneous range of connectors and predict that future specifications will contain between 30 and 35 individual performance requirements. Consistent with this conclusion, it is reasonable to assume that there is a practical limit to the amount of performance testing which can be applied to a connector, and that we have reached this stage. This being the case, then new tests which will inevitably be introduced in the future can be expected to replace, rather than supplement existing tests.

During the past decade or so, there has been a distinct trend towards a greater usage of low power circuits and connectors with high contact density inserts. Responding to this demand for higher density termination systems a corresponding change in connector designs has come about. Within the limitations of maintaining conformity with existing designs, the present high density connectors are close to the practical limits of present technology. This limit is placed at 200 contacts in a

conventional size shell and to progress beyond this figure would necessitate the introduction of an entirely new concept.

On the applications front a multiplicity of connector requirements abound. Take for instance the "low-profile" connector, here the requirement is for the overall height of the connector relative to the mounting plane to be as low as possible. They are mainly used in positions where there are space limitations and restricted access for coupling/uncoupling, or where connectors are unprotected in situations where they are vulnerable to damage. The profile dimensions of a connector design are dependent upon the length of the termination systems including the wire sealing and support mechanisms. The trend is certainly towards shorter length contacts and a reduction in wire sealing and support mechanisms. The extent of problems relating to maintaining compatibility with developments in wire design can be appreciated by the following comparison. In the early 1950's the overall outside diameter (O/D) of a wire used in aerospace applications was 2,5 mm with the conductor accounting for 1,2 mm. Today the insulation O/D is in the region of 0,6 mm with the conductor diameter some 0,3 mm. This basic example at least illustrates how conductor and insulation diameters have decreased since the introduction of crimp terminations. There is little doubt that future wire developments are going to present design problems for connector designers and as previously mentioned, entirely new designs are foreseeable for wire sealing and support mechanisms.

Weight critical

The problem of weight is critically important in aerospace applications, where large quantities of terminations are used; an example being, that the most advanced connector design in use today proffers a weight per contact some 20% of the figure of earlier designs. As a point of interest a "Jumbo Jet" can contain as many as 6000 connectors representing approximately 150 000 connections and 200 km of wire!

For both simple and complex designs a connector can only fail if the conductors or the dielectric supporting the conductors cause an unacceptable

Multi-way Connectors



Today's reminder of what you can get from Radiatron Components right now — the professional choice for connectors.

Our Ermi range of direct and indirect Connectors has all the approvals to win your approval, with exceptional performance under severe shock and vibration conditions.

STV 2M and 3M

96, 64 and 32 way, two part PCB connectors designed to DIN 41612.

Three Families.

- (a) Military spec. VG 95324.
- (b) IEC standard.
- (c) Industrial standard.

A very wide range of terminations is offered.

Circle Reply No. 164

A special 160 way version is designed for computer applications.

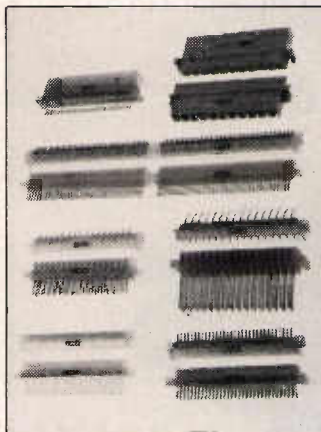

STV 311

High current capacity two part PCB connectors 20A, 32 ways.
Circle Reply No. 165

STV D

Direct PCB connectors Euro-card and 19" standard versions.
Circle Reply No. 166

TMC

Two part trapezoidal chassis mounted multi-way connectors.
Circle Reply No. 167

Connector housings Available as required.
Circle Reply No. 168

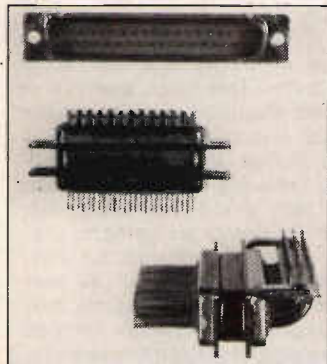

ELECTRONIC COMPONENTS

2 Piece PCB Connectors

The series 219 is designed for rack and panel systems where a high contact density is required.

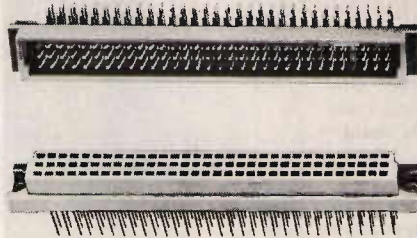

- 2 or 3 row — up to 96 contacts
- Contact pitch 2.54mm
- Qualified to V.G. 95324
- Wire terminations for solder or wrapping
- Housing and contact polarization

160 on enquiry card

Wire Wrapping Equipment

A complete range of wire wrapping tools and accessories from Standard Pneumatic.

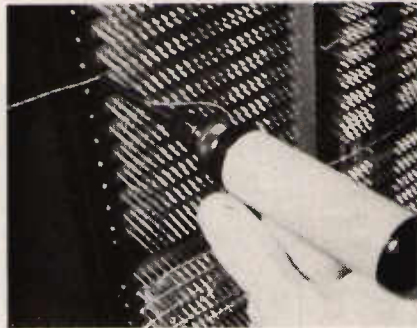

- Standard bits and sleeves for wire range 18-32 AWG, with facility for standard and modified wrapping
- Manual, pneumatic, battery and electric tools

NEW — 'CSW' Bits and Sleeves.

- Range 20-30 AWG.
- Cuts wire — strips and wraps all in one operation to produce the lowest applied connection cost.

161 on enquiry card

Electronic Test Equipment Accessories

A comprehensive range of components including

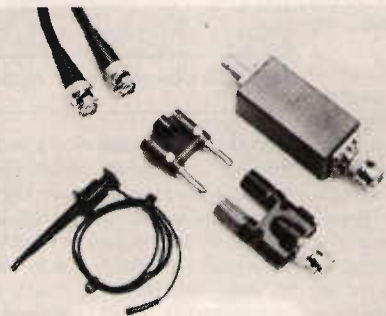

- Adaptors for BNC receptacles and plugs to banana plugs
- Binding posts
- Shielded boxes with externally mounted coaxial connectors
- Cable assemblies with stress relieved BNC connectors, banana plugs, UHF connectors, clips and test probes
- Patch cords
- High voltage probes up to 36KV
- IC test clips

162 on enquiry card

Wire to Board Connectors

The series 237 is a modular connector manufactured in two, three and six way modules which assemble to each other, permitting combinations of two or more ways to the maximum desired number.

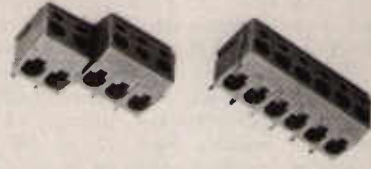

- 5mm pin spacing
- Screw clamp with wire protector
- 380V, 16A
- Additional end fixing pieces for screw fastening
- 2mm test socket facility

163 on enquiry card

HELLERMANN ELECTRONIC COMPONENTS

EAST GRINSTEAD
SUSSEX RH19 1RW
ENGLAND

Tel: E. Grinstead 21231 & 27411

Telex: 95118

Cables, CONNECTORS EAST GRINSTEAD

A division of Bowthorpe Hellermann Ltd.

For full details of any of these Radiatron Products, complete and return this coupon or circle the appropriate reply number.

NAME _____

POSITION _____

COMPANY _____

ADDRESS _____



Crown Road, Twickenham, Middlesex, TW1 3ET
Telephone 01-891 1221 Telex 267807

MWC

EE12/76

PRODUCT FOCUS

change in the electrical characteristics of the circuits being connected. Maintaining a satisfactory level of performance for circuits that are becoming more sensitive to conductivity variations, in environments that are becoming more hazardous, is today's connector design problem. This situation is accentuated by the reduced size of contacts and dielectric wall thickness between contacts. During the past decade there have been important developments in materials, both for contacts and dielectrics which have, in themselves, significantly advanced the technology concerning connector manufacture.

Contacts used in high density connectors have an inherent mechanical weakness due to their small diameters. This has created a need for high conductivity alloys with properties providing a combination of mechanical strength and ductility for crimping in one piece.

With currently available materials there is scope for a further reduction in size. This in itself

would put the manufacture of contacts in the watchmaker classification but only a small reduction in size is possible before costs become a prohibitive factor.

The introduction of new plastics materials has probably contributed to the greatest advance in connector design in recent years. Rear removable designs are currently considered to be the most advanced retention systems in use today and are likely to form the basis for future developments. The advantages of this form of dielectric retention against the equivalent metal-clip design, see Fig. 2, are shown in a better and more reliable performance characteristic of the dielectric, which offers an improved electrical and temperature endurance property. The stability of dielectric materials under thermal load can be related to the degree of outgassing which occurs, assessed by measuring the amount of weight loss. With the advent of improved materials and designs it is possible to maintain a level

of performance for high density designs comparable with, or better than designs utilizing larger shells and contacts.

Like everything that offers a benefit, there are trade-offs, the most noticeable in this instance is the cost for performance. Sophisticated designs have a rate increase three times greater than for low performance products. These increases are readily attributed to the effect of increased labour and materials cost. The rising cost of gold is an example of materials increase.

Five fold increase

The trend during the period 1970-75 shows a five fold increase in cost for plating 2,5 microns of gold. Despite major activity in the search for a less costly plating finish, manufacturers, particularly those in high-grade types, will continue to use gold plated contacts. Future developments in this field are expected to concentrate on improved performance from thinner deposits of gold and the use of selective plating techniques. In

addition to establishing a pattern of development for multiway connectors, the previous paragraphs only substantiate that little has changed in the past few decades. Suggestions have been put forward that future developments will either recognise this fact, in which case new designs will utilize round shells, crimp terminations and wire sealing, or follow a pattern rejecting convention. This could evoke an entirely new design approach evolving new shapes, new forms of construction, sealing and termination. It is possible that future developments in this field will employ the use of technologies such as conductive elastomers or field serviceable electronic welded terminations.

Irrespective of the form of interconnection, one aspect is paramount in a manufacturer's mind, quality at a competitive price. If a producer can insert a component into an assembly and anticipate zero defects on the product, he does not encounter rejects and the subsequent overcost operation.

80 on enquiry card

NEW LEMO 'B' RANGE



Made to the same standard of mechanical perfection and aesthetic beauty as established LEMO connectors and incorporating the well-known LEMO self-latching system but with the following new features.

1. Integrally machined keying system to prevent mismatching and/or insert damage.
2. All internal components keyed to each other and shells to prevent rotation.
3. Crimp/solder contacts in RYTON inserts.
4. Increased contact density.
5. Easier method of assembly.
6. Self-locking collet system.



LEMO (UK) LIMITED

WORTHING HOUSE · 6 SOUTH STREET · WORTHING
WEST SUSSEX BN11 3AE

TELEPHONE: WORTHING 204651

TELEX: 877543

From ASTRALUX..

I.C. sockets

NEW EXTRA LOW PROFILE I.C. SOCKET

- Low profile of 0.150" allows closer pitching of P.C. boards.
- Designed to be mounted end-to-end and side-by-side on 0.100" matrix.
- 'Self-locking' leads retain socket in the printed circuit board during wave soldering.
- Easy I.C. insertion with high I.C. retention force under vibration conditions, by unique contact design.
- Wide temperature range (-65°C to +125°C) by the use of flame resistant glass-filled polyester.

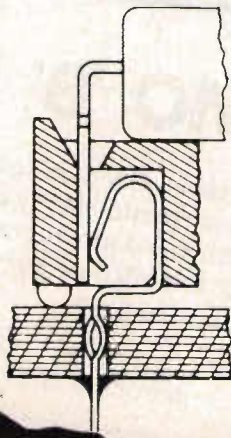

I.C.L. SERIES

- Gold or tin plated contacts to suit customer's requirements.
- Reduced assembly costs due to automatic assembly feature.
- From 8 to 40 ways, giving versatility from one manufacturer.

Famous R-N 'side-wipe' sockets for better contact

All this plus the famous R-N side wipe contact design, which makes contact with the wide smooth side of your I.C. leads. Contact integrity starts better, stays dependably trouble free.

ASTRALUX DYNAMICS

bring you the entire **Robinson**

Production I.C. sockets, test sockets, plugs, headers, socket boards - a total I.C. capability by Robinson Nugent. Renowned worldwide for quality, value and advanced features. All UK available, fast from Astralux Dynamics, backed by Astralux know-how and services. Top lines in stock here - and every

all the **RN** best-sellers!

Quality production I.C. sockets up to 64 way!

- Suitable for up to 80 insertions/withdrawals, ideal for prototype work.
- Solder tail or wire wrap terminations cater for most design needs.
- Gold or tin plated contacts.
- Designed for automated I.C. insertion by means of special frame design.
- Available in various configurations from 6 to 64 ways.
- Suitable for your burn-in applications, with special high temperature version (-65°C to + 220°C).

I.C.N. SERIES

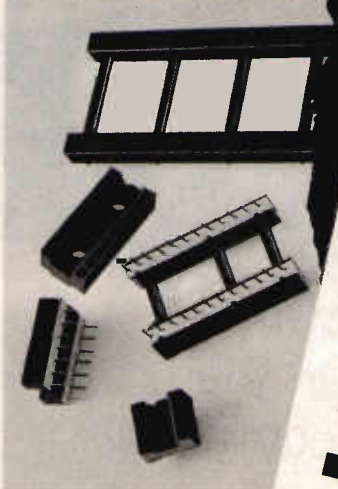

A low-cost option too!

Low cost option—ICY series, same range and design features but with tin plated copper alloy contacts for economy.

Cut-to-size service in socket strip



- Typical applications—use as plug and socket or for hybrid circuits.
- Available in any size up to 25 ways on 0.100" pitch.
- Solder tail termination (SB series), or wire wrap terminations (WB series).
- High temperature option (-65°C to + 220°C) on SB series caters for burn-in needs.
- Gold plated contacts.
- Special 'Skinny-Strip', available 0.100" wide to suit 0.100" contact spacing on both X and Y axis (SB-100 series).

WITH COMPATIBLE MATING HEADERS

- Available in any size up to 25 ways.
- Right angled solder terminations. (WB-PR series) for flow solder applications.
- Straight-through pin termination (WB-P series).
- Gold plated contacts.



other R-N product flown in to order, so smartly you'd hardly notice the difference! Make sure a catalogue and selector guide is on your desk now.

Astralux Dynamics Limited,
Red Barn Road, Brightlingsea, Colchester C07 0SW.
Telephone: Brightlingsea (0206-30) 2571/5.
Telex: 987751. AN ANTIFERRENCE GROUP COMPANY

urgent range-read all about it!

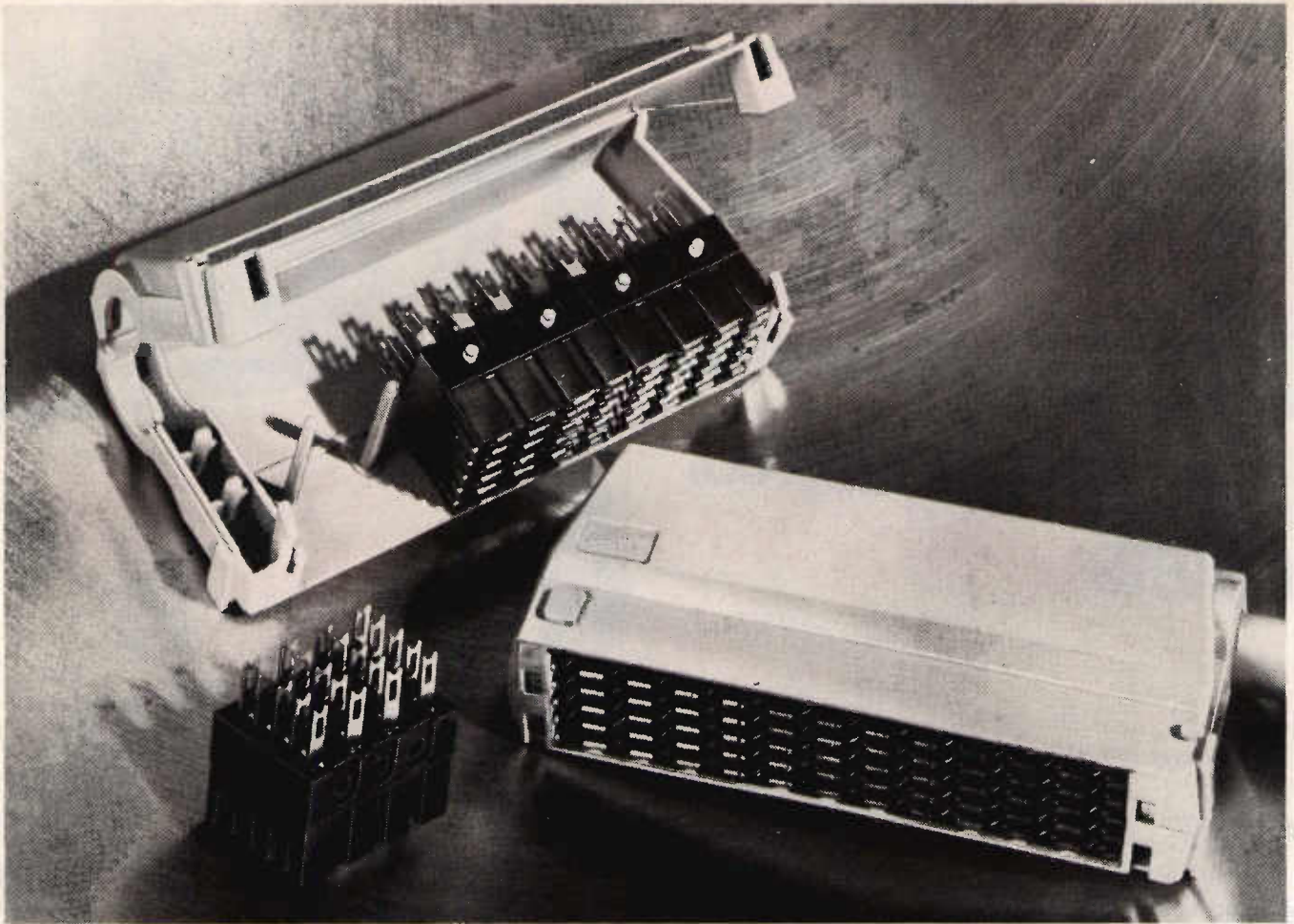

The Swedish Connection

At its best in every way in the LM Ericsson range of X-connectors

Ericsson Design **Ericsson** Quality

Ericsson Reliability **Ericsson** Price

The new 20, 40, 60 and 80 multi-way connectors in the unique, snap-close plastic casing. The standard range in 20 to 600 ways. The special designs of multi-way connectors up to 1,400 ways.

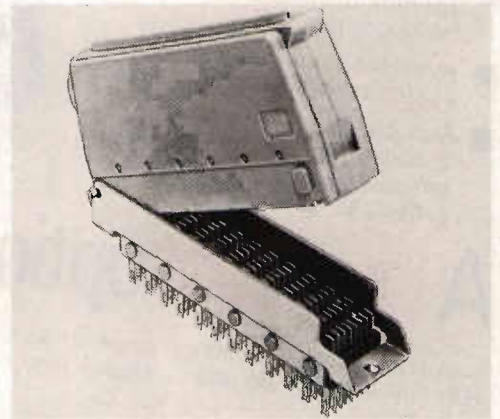

COMPONENTS LTD.

Aberdeen Avenue, Slough Trading Estate, Slough, Berkshire
Telephone: Slough 20961 Ext. 44

Sole U.K. Agents for the components of LM Ericsson of Sweden

PRODUCT FOCUS

The trend today is toward total assembled cost applied to the product used, rather than just the purchase price of the component. More and more consumer products are utilizing ic's as the cost of the device goes down and reliability in performance increases. The introduction of these devices causes problems at engineer level, with servicing costs and warranty periods increasing, an early decision must be made into the form of connection; ie, sockets for ic's or direct fastening to the printed circuit board. The decision to use sockets is usually made because of the sometimes questionable reliability of the ic's and, because the manufacturing techniques used in assembly do not normally produce the close centre spacings required for available dual-in-plastics. A plug-in, removable capability is today's requirements for fragile or failure potential components, so too is this capability desired for assembly of modular designed units. The idea of a systems approach to interconnection is fast gaining

credence, since the reduction in inventory makes for a more compatible interchange. The Molex miniature (KK) interconnection system for instance rationalises the use of plastics and metals, providing the user with an economical, yet comprehensive board interconnection system. A variety of connectors have been designed permitting vertical and horizontal harness-to-board and board-to-board linkages. These offer the facility for plugging daughter boards into their respective mother board, from either side.

As stated previously, modern day trends are towards less material usage and greater flexibility, furthering this philosophy toward greater standardisation and interchangeability. With the continuing development of ic's there will be a greater usage of low or zero insertion force devices. More reliable interconnections for flat and ribbon cable will appear especially in the one operation termination approach. A greater capability in automated attachment will be

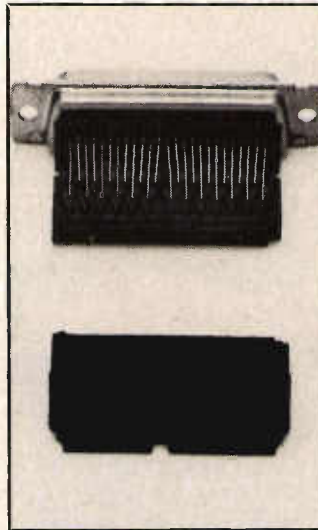

Ribbon cable connector design

seen, both for discrete, ribbon and flat cable as well as for connectors and sockets to pcb's. Connectors with foolproof mating will proliferate and, similarly, connectors will reject themselves if not fully mated. Sizes will almost certainly remain on 2,54

mm pitch, except for specials because of the handling limitations. On the plating front, a greater degree of tin and tin lead will be used, especially where terminal design can insure a gas tight contact interface.

The benefits to be gained from ribbon cable assemblies are manifest, for instance, speed in digital equipment has reached the point where shielding and attenuation have become critical. The use of co-axial cable in volume applications was uneconomical but now, with the introduction of co-axial ribbon cable assemblies the problems associated with the economics and reliability have been dramatically reduced. The AMP system as an example, includes 50 ohm cable and 20 co-axial conductor connectors mating with 0,64 mm² posts. They are applicable to 90 degree board mounted pin headers or I/O posts on 2,54 mm grid spacings. The ribbon cable consists of 20 individual co-axial cables encased in a pvc jacket, making up a standard flat co-axial ribbon cable configura-

83 on enquiry card

Entrelec component terminals from HIGHLAND ELECTRONICS

Polarised Plug & Socket for diodes, resistors, fuses. Nap fit fuse carriers to 33A 10A screw in type fused terminals disconnect switches. Range of P.C.B. terminals 0.2" pitch.

ex-stock deliveries from
Scottish Factory

Highland Electronics Ltd
Donibristle Industrial Estate, Dunfermline KY11 5JX
Fife, Scotland.
Tel: Edinburgh (031) 331 2506. Telex: 72672.
and from our Scottish distributor

W.S. McMillan & Co. Ltd.
61, Colvilles Place, Kelvin Industrial Area East Kilbride
(03552) 38641. Telex 778771.

Highland Electronics Ltd

33-41 DALLINGTON STREET,
LONDON EC1V 0BD Tel: 01-253 9107
Telex: 267284 Cables: Hielec London E.C.1.

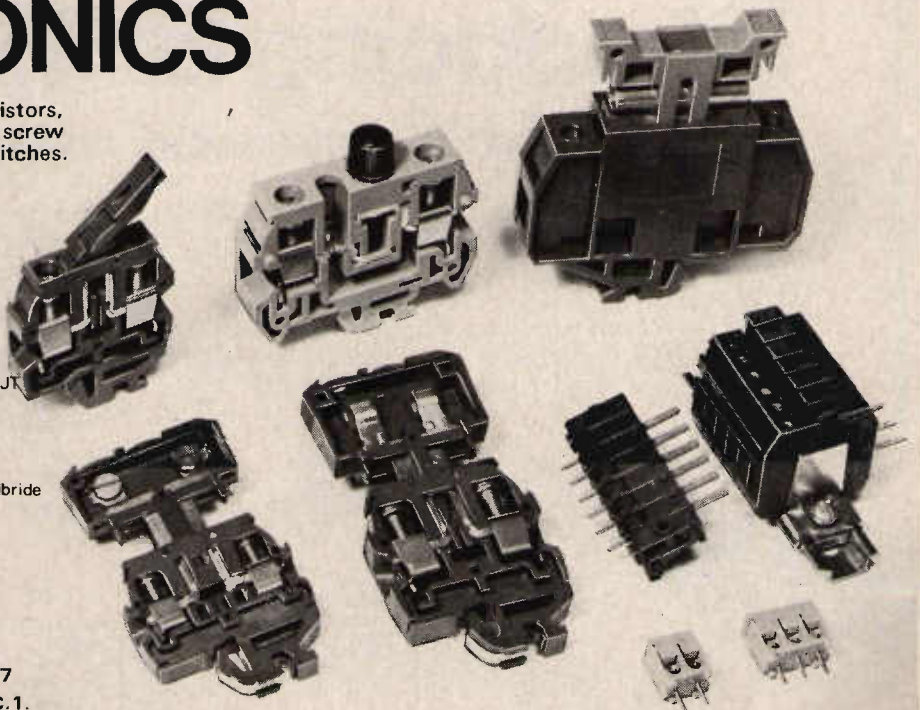

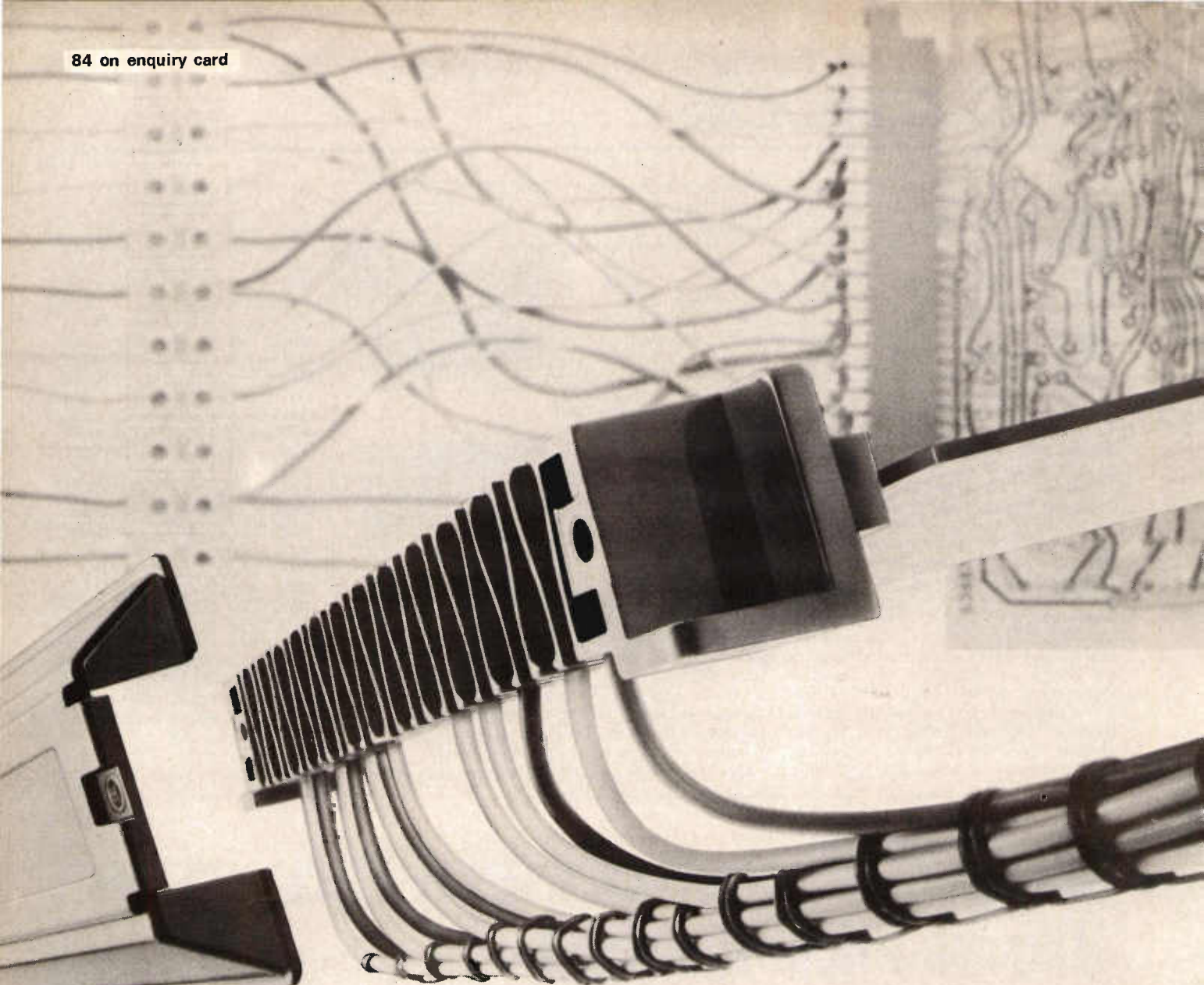

Introducing **EDGEBLOCK BJ**

the combined **EDGE** connector and screw terminal **BLOCK**.

Pye EDGEBLOCK BJ is unique. A *high quality* PCB edge connector and screw terminal block combined. In a range of sizes 4 to 24 way on 0.2" centres, single-sided.

If you manufacture electronic instruments you don't need PCB connectors *and* screw terminations anymore. Just use EDGEBLOCK BJ. Inside the

instrument, plug your printed circuit board directly into EDGEBLOCK BJ. Externally, make your screw terminal connections in the usual way. The saving's enormous. Materials, stockholding, time, *expense*. No intermediate wiring, soldering, wire wrapping, power tools. And fewer wired connections just *has* to improve the quality of your product. All with greater packaging density.

Servicing's simpler too, if you ever need it! Send for the literature on EDGEBLOCK BJ. There are many more features – all to help you save.

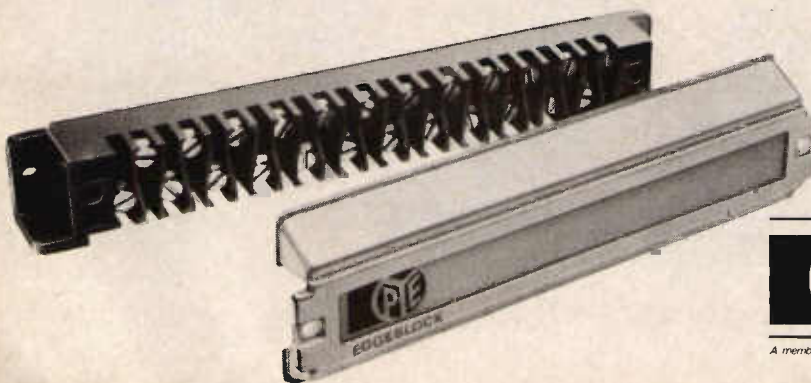

Pye Connectors Ltd

Hitchin Street, Biggleswade, Bedfordshire, SG18 8BH, England
Tel: Biggleswade (0767) 312086
Telex: 82288 PYECONNS BWADE

A member of the Pye of Cartridge Group

PRODUCT FOCUS

URGENT!
MULTIWAY
CONNECTORS

**POLAR
JAEGER**

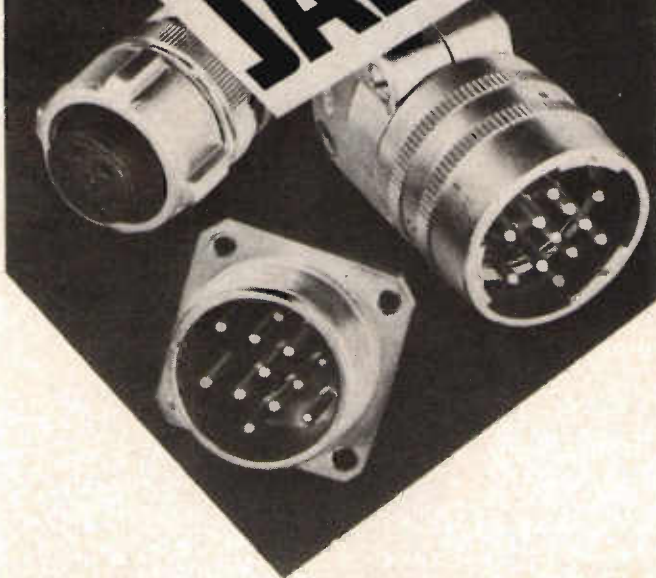

No holdups! We can deliver many of these precision Jaeger multiway connectors straight from stock. Standard, quick-release, sealed and miniature types—all at really competitive prices. The famous Jaeger ranges are available world-wide, to meet international specifications. For *your* needs, contact the sole U.K. distributors, Wingrove and Rogers. We also manufacture the Polar range of Variable Capacitors, Terminal Strips and Stand-off Insulators.



Wingrove & Rogers Ltd.

Domville Road, Liverpool L13 4AT, England.
Tel: 051-220 4641
Telegrams: Components Liverpool 13.
Telex: Chamcom Liverpool 627110 for Winrog.

tion. Each co-axial lead has a solid centre conductor and a foil-drain wire shield. This construction allows the cable to be cut in any length, maintaining the exact positioning of the centre conductor and drain wire. By using manufacturers stripping and termination equipment, the 20 conductor cable is stripped simultaneously and then gang terminated. The signal conductors are terminated on one side of the connector and the drain wires to the other. Complete assemblies are presently available using 50 ohm co-axial ribbon cable, in 20 wide configurations on 2.54 mm centre lines in lengths ranging from 152.4 to 3048 mm. As the technology of co-axial ribbon cable advances a wider range of connector configurations will become available offering a capability of terminating 75 and 93 ohm cable.

A further development lies in a magnet wire interconnect system bringing insulation displace-

insulated wire. All cables and wire connections are preformed simultaneously without the need for pre-stripping the insulation.

The generation of electronics in the 1970's will create the requirements for the connector of the future. Frequencies in the gigahertz range and pulse rise times in the pico-seconds require impedance matching from source to load on microstrip, strip-line, multi-layer, co-axial or cable—and sometimes several at once. Solid-state, hybrid or lsi has reduced the component's size to the point where the connector often determines the package size rather than what is inside. Many sub-assemblies are not made pluggable even when their reliability or cost warrants it, because of the lack of an appropriate connector.

If the electronic and mechanical engineers of an advanced system manufacturer were to sit down together and dream up the specifications to an ideal con-

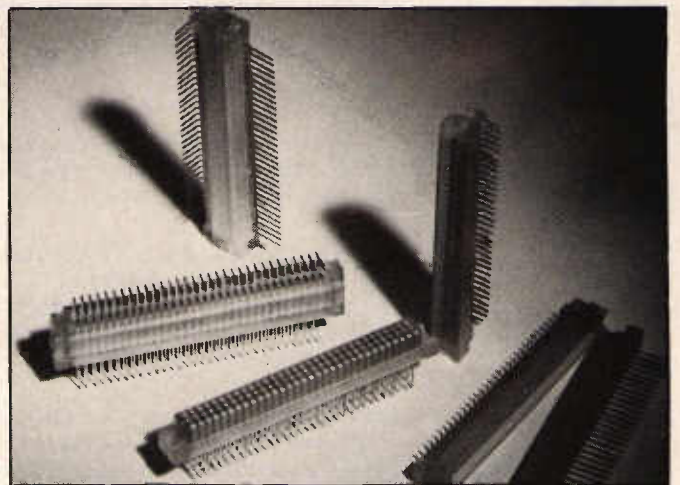

Fig 4. A selection of Radiatron pc connectors

ment technology to magnet-wire termination. This insulation displacement heralded the industries first mass termination application. By utilizing the same concept, but in reverse, that is, by driving the terminal over a prepositioned wire instead of driving the wire into a terminal, a terminating system can be achieved that automates magnet wire interconnections and is compatible with present day automatic assembly equipment. Another type of connector providing instant multiple terminations is the Latch connector. This device terminates flat cable with round conductors, flat ribbon cable, woven ribbon cable and conventional stranded or solid

connector for the future, it would probably read as follows. Most important would be the impedance match with a vswr of 1.0 in the gigahertz range. They'd specify a connector so small in all dimensions that it was smaller than the package of components. They'd want to intermix the dc and rf lines to reduce printed circuit lengths and cross-overs and want it to push-on with a low insertion force. The circuit isolation requirement would vary but cross-talks below 80 dB could be needed. Some would specify 75 and some would need 50 ohm systems. The manufacturing engineer would specify easy compatibility with the type of trans-

**BUNKER
RAMO**

AMP

**BUNKER
RAMO**

AMPHENOL

**Product
Finder**

RF COAXIAL CONNECTORS

2 & data sheets
PD 2 & data sheets
Delevan
Tuchel Rack & Panel
Tuchel Circular
Tuchel Printed Circuit
U M D
Cable ass. leaflet
CT-1
Cable products
172/179 leaflet
SS 2
Barnes
Relay data sheets
FST 1

THE WHAT WHERE WHO BOOK

FREE FROM AMPHENOL

Every Engineer's opportunity to acquire the latest facts on the extensive range of Amphenol connectors and electronic devices — in one clear short-form publication.

WHAT —

Power, Printed Circuit, Rack and Panel, Micro-Miniature, Audio, Filtering, Industrial and R.F. Connectors; Integrated Circuit Components; Trimming and Precision Potentiometers; Concentric and Digital Microdials; Relays and Keys; and Fixed and Variable Inductors. All products linked to DEF, MIL, DIN and other specifications as applicable.

WHERE —

A comprehensive catalogue listing of the Company's full range of literature, literally dozens of colour productions clearly dealing with each series. All publications are cross-referenced to whatever product you are interested in.

WHO —

The Amphenol distribution network covers all parts of the United Kingdom. The organisation is thoroughly tried and tested, each Distributor has close links with the factory and trained Specialists supported by in-depth stocks of 'preferred ranges' of components. This publication details specific ranges stocked by the Distributor in your region.

**ALL THE FACTS IN ONE CONCISE PUBLICATION —
YOURS BY REQUEST**

**BUNKER
RAMO**

AMPHENOL

Thanet Way, Whitstable, Kent. CT5 3JF
Tel: Whit. (0227) 264411 (12 lines). Telex: 96157

PRODUCT FOCUS

mission line used and rapid termination using conventional methods. The reliability engineer would have a few words on its quality and the purchasing agent would like the connector to be free.

The culmination of this hypothesis is the Chevron-shaped connector, designed for the modern breed of fast, miniature electronic equipments requiring impedance matching and connectors that will not detract from performance. This type of connector combines the leading attributes of both co-axial and pcb connectors: intermixing dc and rf lines in a single connector and affording compatibility with pcb's. VSWR's as low as 1,06 at 5 GHz, crosstalk as low as -80 dB and signal centrelines down to 1,27 mm are possible.

Turning full circle, we arrive at sockets for ic interconnections, often defined as a source of trouble joining two other sources of trouble; but part of the problem is that insufficient attention has been paid to the evaluation and selection of these sockets.

There are two main methods of designing plug-in contacts to achieve efficient mating with leads on ic's. The majority of sockets and board systems are designed with contacts that bear on the shear edges of the lead in either a circular or a rectangular configuration. The alternative approach is a contact that bears on the wide side of the lead frame. The prime methods used are: edge-bearing contacts; side-wipe contacts; cylindrical contacts; zero and low insertion; force contacts. The majority of socket manufacturers have opted for the edge bearing version to achieve lower cost, and this design allows these sockets to be made narrower, typically 10,30 mm wide on a 14-pin socket. The contact, however, bears on the rough, shear edges of the lead frame, which have poor finishes. As with multi-way connectors, gold plating of contacts still offers the best results. However, due to the high cost of the material other "substitute" finishes are being assessed. For example acid-tin, bright-tin, tin-

lead, bright tin-lead, bronze, copper and gold over nickel, on identically plated printed wiring boards along with their associated card-edge connectors in an attempt to resolve a suitable low cost replacement for gold over nickel plating in card-edge connectors. The conclusions reached so far indicate that bright tin-lead plating is comparable to gold over nickel in all respects except durability.

Acknowledgement is afforded to Jordan Dataquest for the assistance given in formulating market share figures.

Ferranti manufacture a wide range of edge, multi-pole low force micro-circuit and special connectors to high commercial and military specifications. The EZD range, available either as single or double sided has from five to 90 ways, satisfies the requirement for a 2,54 mm pitch component compatible with modern racking techniques such as CAMAC used by atomic energy authorities throughout Europe. The EXT 100 series has

provisional BPO approval to specification D2552. The EWD series of edge connector features rolling leaf spring contacts limiting stress. **450**

FC Lane produce circular, aluminium or brass compatible to Mk4 types, pc-types, rectangular, miniature and rf co-axial devices. Contact pitches for the pc-types span 2,54 to 5,08 mm and the frequency limitations on the rf products range from 200 MHz to 12 GHz. **451**

Amphenol's contribution to the connector market is enormous, offering circular, high density, power emi/rfi filtering, hermetically sealed miniature/sub-miniature, pc-types, rectangular, rf and co-axial. One product causing interest is the Merlin series of rear release, polymer contact retention clip circular connectors. This product is commented upon and referenced in Fig 2. **452**

Qikstack is the latest addition to the BICC-Burndy range of GTH connectors, enabling inter-

87 on enquiry card

ARE YOU USING PURE ENOUGH WATER?

ULTRA PURE WATER USED IN ELECTRONIC
COMPONENTS MANUFACTURE IMPROVES
PRODUCTION QUALITY AND LOWERS
REJECT RATE!

THE NEW DEIONISING SYSTEMS,
PRODUCE ULTRA HIGH QUALITY WATER
AT FLOW RATES FROM A FEW LITRES TO
SEVERAL THOUSAND LITRE/HOUR.

Houseman Hegro
'the water people'

HOUSEMAN HEGRO LIMITED,
The Priory,
Burnham, Slough SL1 7LS.
Telephone: Burnham (062 86) 4488.
Telex: 848252.

Please circle Reader Enquiry Number
for literature



Portals Water Treatment

88 on enquiry card

AUGAT the EXPERTS in Wire Wrap® Socket Panels



over 700 different panels
catalogued, and special
designs are no problem
to the EXPERTS

® Reg. trademark of GARDNER-DENVER Co.

AUGAT LTD. 19a Regent St. Rugby. CV21 2PE
tel:—0788 75483

AUGAT N.V. 103 Bd. A. Reyers. Brussels 1040 Belgium
tel:—(02) 736.9399.

HIGH VOLTAGE CONNECTORS

The connectors shown here are an example of high voltage connectors manufactured by Reynolds Industries for a wide variety of applications. Typical are: laser power supplies, exploding bridgewire detonators and pyrotechnic devices, spark chambers, photomultipliers, travelling wave tubes, cathode ray tube display systems, magnetron Power leads, and high voltage power supplies for both ground and high altitude environments.

SERIES 600.....HIGH VOLTAGE, HIGH ALTITUDE, COAXIAL CONNECTORS

VOLTAGE RATING: 10,000 VDC*

A complete line of subminiature high voltage coaxial connectors and cable assemblies designed to operate at any pressure altitude at a rated voltage of 10 KVDC. Cable assemblies and cable connectors effect an altitude and moisture seal through use of internal seals which require no encapsulation. Panel connectors require encapsulation or shrink tubing at the junction of the terminal and the insulator.

PANEL CONNECTOR: P/N 167-3771

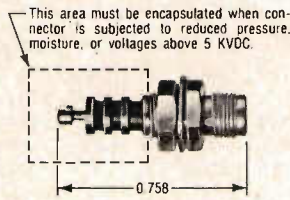

CABLE CONNECTOR: P/N 167-3770-A

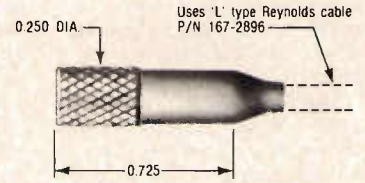

* The voltage ratings shown are for limited service under steady-state DC conditions at sea level. Under these conditions, the connectors operate in the corona region, and therefore have a limited service capability.

SERIES 521.....SAFE HIGH VOLTAGE, HIGH ALTITUDE, COAXIAL CONNECTORS

VOLTAGE RATING: 25,000 VDC*

A series of high voltage connectors and cable assemblies rated at 25 KVDC mated, and designed to minimize the risk of electrical shock to personnel through the use of recessed contacts. Both the panel and cable connectors have recessed contacts and will stand off the rated voltage of 20 KVDC in an unmated condition. The connectors also feature a spring finger contact on the connector body which assures a reliable ground circuit prior to engagement of the center contact further reducing the risk of electrical shock.

PANEL CONNECTOR: P/N 167-3517

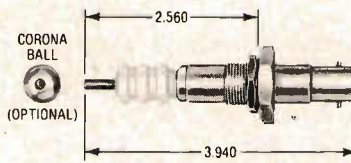

CABLE CONNECTOR: P/N 167-4534

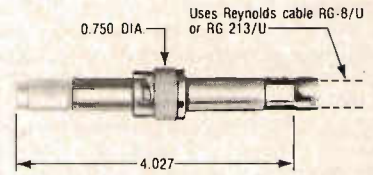

* The voltage ratings shown are for limited service under steady-state DC conditions at sea level. Under these conditions, the connectors operate in the corona region, and therefore have a limited service capability.



REYNOLDS INDUSTRIES INC.

LOS ANGELES, CALIFORNIA U.S.A. 90066

Represented in the United Kingdom by:

AVIQUIPO OF BRITAIN LTD.

St. Peters Road, Maidenhead, Berkshire SLX 7QU. Tel: Maidenhead 34555.

PERFECT MATING

with

SWITCHCRAFT

AUDIO CONNECTORS



EASY TO WIRE

The easy-open design and larger, uniquely designed solder cups cut wiring time in half.

IMPROVED FEATURES

BIFURCATED CONTACTS 3-pole contacts ensure extra positive grip on mating contact pins, even under severe conditions of shock and vibration.

LATCHLOCK

Now made of die-cast zinc for exceptionally long life and reliable operation.

INSERT STRENGTH

New design grub screw and tougher plastic eliminates breakage problems.



NO LOST SCREWS

Captive design insert screw for fast simple assembly and disassembly - can't drop out and get lost.

NO EARTHING PROBLEMS

Extra earth terminal electrically integral with shell automatically engages the earth contractor of the mating shell.



MODERN STYLING

Compact modern shape made of durable die-cast zinc with satin nickel finish compatible with other makes.

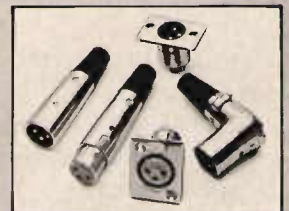

F.W.O. Bauch Limited

49 Theobald Street, Boreham Wood, Hertfordshire, WD6 4RZ
Tel: 01953 0091 Telex: 27502

PRODUCT FOCUS

connections between pcb's. Other devices include the Bantam range of circulars conforming to MIL-C-26482 and Flexlok, flexible pc and flat cable connector. **453**

Steatite Insulations, who handle Chromerics Inc products, have available Cho-Strel and Cho-Nector, which are one and two dimensional discrete-path conductive elastomers and a non-discrete path material called 1250. Currently the electronic watch market uses this material for inter-connections but NASA is developing a version of Cho-Nector that will handle some 16 000 contacts/sq ins, for use in an array or parallel processing computer. **454**

Aviquipo, who represent Reynolds Inds. Inc in the UK, cater for the multi-pin hv connector area. Operating voltages up to 15 kV dc at altitudes of 21 538 m (MIL-STD-202 Method 105 condition C) are available. RI also produce hv co-axials rated between five and 10 kV dc. **455**

Plessey offer amongst their wide selection the Mk 14, 18 and 22 circular connectors; a comprehensive range of rectangular and pc-types. Their rf co-axial types, series SMA, /B and /C, BNC, TNC, N, HN, C and UHF afford an improved cable/connector assembly. Two unique constructions exist, namely the Wedge-lock and Wedge-eze, neither requiring combing or trimming of the braid. **456**

Aveley Electric's range of rf devices from Rhode & Schwarz, cover sexless rf devices with impedances from 50 to 75 Ω , frequencies span from zero to 18 GHz. Power handling capabilities up to 9 kW at 100 MHz and 3,5 kW at 1 GHz are offered. **457**

Siemens latest products include a mixed contact pcb connector available with either 78, 60 or 42 signal contacts and either two, four or six special contacts respectively. They are designed to accept, in addition to small signal contacts, individual af contacts for higher loading and/or a variety of co-axial contacts along with polarising keys. The other product is a tape cable pcb receptacle meeting series 2 DIN 41612 requirements, for use with 48 contact plugs. **458**

Tekdata offer a range of rack and panel connectors manu-

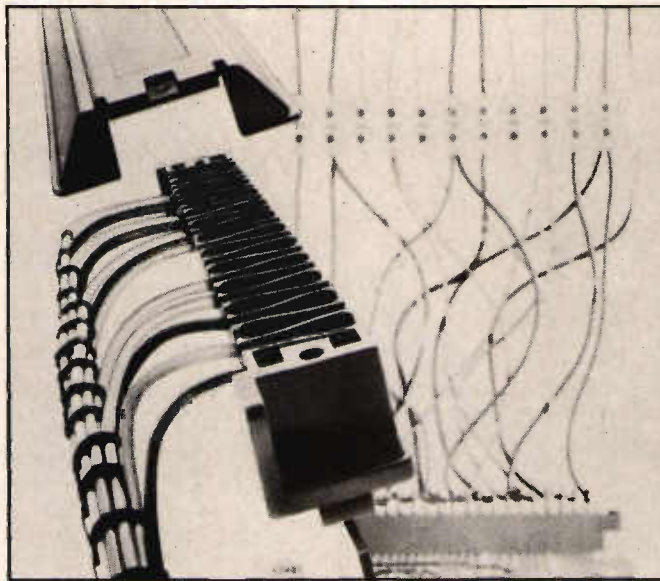

The new Edgeblock BJ connector/terminal from Pye eliminates the need for intermediate wiring

factured by Positronic Ind. Inc, consisting of miniature/sub-miniature, rectangular, side-mounting and pc-types. They also act as distributors for Winchester, AMP, Cinch and Amphenol. **459**

ML Comps., are agents for LM Ericssons range of modular connectors. These are built up from standard contact modules, containing either 20 or 30 contacts and combined into connectors offering either one, two, three or four modules. **460**

Amongst **Varelco's** newer additions is the series 6072, 2,54 mm pitch modular connector, along with the series 8223 two-part device available with a selection of contact terminating techniques. The series 8257 connector conforms to DIN 41612 and is available either in a discrete form or for metal backplanes with a variation for press-fit into pcb's. **461**

Further information can also be obtained on connector products from the following organisations by encircling the required reader service number.

AB Electronic Comps. Ltd	470	NSF Ltd	481
AMP of (GB) Ltd	471	Panduit Ltd	482
Astralux Dynamics Ltd	473	Pye Connectors	483
Belling-Lee Ltd	474	Radial Microwave Comps. Ltd	484
Berg Electronics Ltd	475	Radiatron Comps. Ltd	485
Cambion Electronic Pdts. Ltd	476	Sealectro Ltd	486
Flair Electronics	477	Souriau Ltd	487
Greenpar Electronics Ltd	478	Townsend-Coates Ltd	488
Invader Components Ltd	479	Vero Electronics Ltd	489
Nimrod Electronics Ltd	480	Molex Electronics	472

The **AWP Group** handle four connector manufacturers, **Sargus, Kings Electronics, PSP** and **ALD Comps.** The former of these companies has designed and developed a new range of multi-pin circular connectors, type SPD. They will be available in four shell sizes, 18, 22, 28 and 36 with four sizes of contact ranging from three to 35. Kings Electronics produce high-density quick connect/release products, designed to replace BNC type devices. PSPs contribution is the **T & B/Ansley Blue Macs**, flat cable/connector system. Finally ALD offer the Hellerman Deutsch RR series rear release contact termination system produced to EL2113 Pattern **602**. **462**

3M's connection option is the Scotchflex flat-cable and connector system. By removing the connector covering and laying the cable into the grooves in the cover a perfect alignment is ensured. The electrical reliability is guaranteed by the contact

formed by two parallel legs with bevelled tips, ensuring maximum spring loaded contact pressure on the conductor. **463**

Lemo's B range of self-latching connector offers excellent electrical and mechanical properties enhanced by an aesthetic appearance. All components within the mating shells and the shells themselves are keyed to prevent rotation, mismatching and/or insert damage. **464**

Smiths Hypertac recently announced a new high density connector (HCV). The range includes 0,5 to 1 mm signal pins, co-axial power and filter pins and caters for up to 5000, 5 A contacts. Continuing the high density theme, a new 160 way pcb device provides 1,27 mm pitch with three rows of 15,24 mm pins. **465**

UECL's range of modular edge connectors for pcb's are offered with pitch sizes from 2,54 to 5,08 mm. These devices can be tailor made to individual customer requirements. Various contact styles are available, including cantilever (plain and staggered), inverted bellows and switching. **466**

Hughes Microelectronics range of connectors now includes the new snap-lock device, a quick connect/disconnect device aimed at bulk heat wave applications. It has one to three way contact configurations with either power or coax contacts, or a mixture. Another series is the HAC-PAK range, a packaging concept allowing the designer to decide on a series of connectors at the outset of his project capable of fulfilling all his requirements. **467**

McMurdo offer a comprehensive range of high density two part connectors, pc edge and strip connectors. Subminiature rack and panel, rectangular and a series of micronectors are also available. **468**

Hellermann Deutsch number amongst their latest introductions the following: the series 219, a two part connector qualified to VG 95324 specs. The DCI range of underwater connectors; high temperature connectors in the series 991, /2 and /3, capable of working at 350°C. Extensions have been made to the LL series of military connectors, facilitating the use of crimped contacts with hermetic receptacles. **469**



BICC-BURNDY

Parr, St Helens, Merseyside WA9 1PR
Telephone: St Helens 24000

Limitation of design flexibility was a common connector problem. Until TRIM-TRIO.

TRIM-TRIO is a unique system that reduces these kind of complications in design. And in production. Once employed, it is a lasting design decision. Once evaluated it gives you practically all the flexibility you need.

It's simple. Choose any from the three crimp contact families and your choice can be used in a multitude of connector styles and sizes. You can interface with wrapped and soldered techniques without deviating from your original contact choice.

There's an expanding range of connectors which include circular plastic types with metal coupling rings. Low profile styles. Rectangular multipins for many applications. And low cost self mounting types. All constructed for outstanding performance and reliability.



Production becomes more efficient and more economical with TRIM-TRIO. Fewer contact types speed production with less tooling, longer runs and fewer special skills. And there's a comprehensive range of production tooling for low to high volume needs.

Stock control is simplified too. And the reduced number of TRIM-TRIO components cuts inventory costs.

So get the freedom of connector design that only the TRIM-TRIO system can give you. And get all the U.K. based know-how behind you. Plus the international resources associated with BICC-BURNDY.

**TRIM
TRIO** SYSTEMATICALLY YOURS

for three
pins we'll
give
you our
system

NEW PRODUCTS

IR emitter

A new small area high radiance ir-emitting diode designed for fibre optics applications at 1,06 micron wavelength, has been designated GAL103. This gallium indium arsenide emitter represents a significant breakthrough in optical fibre systems. Encapsulated in a standard S4 micro-

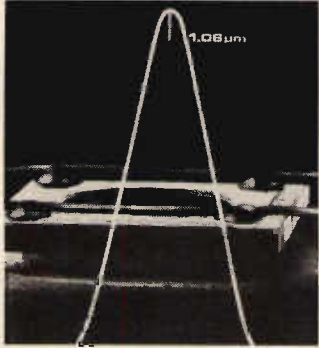

wave stud package, these diodes offer a combination of high modulation >200 MHz and high radiance >10 W/steradian/cm². The 50 micron diameter emitting area is designed to provide efficient coupling of single fibres and an etched well 0,15 mm diameter is provided for this purpose. *Plessey Opto., Towcester, Northants.* 340

Drive systems

With an unformatted data capacity of 3,2 megabits (single) or 6,4 megabits (double density), the model 76 diskette drive provides the user with the facility for either IBM 26 sector formatting or 32 fixed length sectors. The recording head is ceramic/ferrite, with tunnel erase structure and average access to stored data is 164 ms. *Data Recording, Staines, Middx.* 344

Print heads

The EP101 miniature, drum print head offers a print format of 21 columns with 16 characters per column. Print speed is 180 lines per minute. Interfaces are available for driving the unit from eight or 16 channel bcd i/p at ttl levels. *Roxburgh Electronics, Rye, Sussex.* 341

Controllers

A new series of indicating controllers known as Transitrol II has five basic types; an indicator, one and two limit signallers and two and three position controllers. The instruments operate on a null-balance principle. Inputs from single or differential thermo-electric or variable resistance sensors as well as from transmitters with voltage or current o/p, are all acceptable. *Pye Ether, Stevenage, Herts.* 342

Power supply

This power supply unit finds use in conjunction with emergency audio and visual alarms. It provides a 24 V dc, 5 A regulated o/p from 220/250 V ac mains at 50/60 Hz or 24 V dc, 4,5 Ah from two 12 V sealed lead acid batteries. *Barkway Electronics, Royston, Herts.* 343

Admittance meter

This versatile uhf admittance meter, type 1602B, has a measurement capability between 20 MHz and 1,5 GHz. Typical accuracies of $\pm 3\%$ are obtainable. The instrument is a nulling unit, measuring impedance and admittance in coaxial systems. It may also be used as a reflectometer for SWR, impedance magnitude and reflection co-

efficient magnitude measurement. *GenRad, Bourne End, Bucks.* 345

IR source

Using a GaAsP on GaP chip, this visible, near ir-source is optimised for maximum efficiency at 670 nm.wavelength. Designated the HEMT 3300, this emitter is designed for optimum coupling to silicon detectors and plastics fibres. Axial radiant intensity is typically 500 μW / steradian. Bandwidth is dc to 3 MHz. *Hewlett-Packard, Winnersh, Berks.* 346

Digital multimeter

The DMM51 features a 1 μV sensitivity on dc (5 ranges); 10 μV on ac (4 ranges); 1 m Ω on the six ohm ranges with full autorange on all functions. Basic accuracy is 0,002% with a speed of 3,33 reading/s with 66 dB noise rejection. Integration period is 100 ms providing >140 dB cmrr. *Wessex Electronics, Yate, Bristol.* 347

Coaxial connector

This high tension coaxial connector with ceramic insulation, permits use up to 400°C and high radiation usage. A test voltage of 9 kV can be withstood from the centre contact. Designated 103A028, it features an overall diameter of 13 mm and a coupled length of 78 mm. *Sealcraft, Portsmouth, Hants.* 348

Pressure indicator

The DPI 100 digital pressure measuring instrument has an fs of 19999 and an accuracy of 0,05% fs with fast response.

It provides a secondary pressure standard for ranges from

one to 5000 psi. The device is all solid state from sensor to read-out. Options include a bcd o/p, buffered analogue o/p and manual or solenoid operated vent facilities. *Druck, Groby, Leicestershire.* 349

Vibration meter

The PR9255 measures peak or rms values of velocity in calibrated ranges from zero to five, 15, 50 or 150 mm/s or uncalibrated up to 510 mm/s. The unit will work with absolute and relative active vibration transducers with nominal 30 mV/mm/s sensitivity. The nominal frequency range of 10 Hz to 1 kHz can be reduced by using external filters. *Pye Unicam, Cambs.* 350

Preamplifiers

Three new low noise, high gain uhf preamplifiers for frequency groups A (470/581 MHz), B (615/717 MHz) and C/D (695/860 MHz), have been designated the CM6051 series. The group A devices have a gain of 16 dB, B 14 dB and C/D 12 dB. All three have typical nf of 5 dB, maximum o/p of 28 dB mV and i/p to o/p impedance of 75/ohms *Labgear, Cambridge.* 351

Load cells

This cell is fully waterproofed and gives precision performance, typical non-linearity is $\pm 0,05\%$ of fs, hysteresis being $\pm 0,03\%$ and non-repeatability $\pm 0,02\%$ of fs. The SSB is available in two capacities namely 100 and 250 lbs. *REL Equipment & Comps, Hitchin, Herts.* 352

Multimeters

This 50 k Ω /V device incorporates an lcd controlled by the range

meet some of the family...

... of 'hypertac' connectors that are now meeting the rigorous demands of avionics, telecommunications, electrical and nuclear energy, and the various Service ministries. The unique 'hypertac' socket design ensures precise mating, or unmating, of all contacts throughout a range which includes p.w.b. connectors, modular connectors, circular connectors, single pole connectors, rectangular units and the recently developed high density modular connectors which have 5,000 signal pin capability.

Find out more about the most versatile electrical connector range available today by writing or 'phoning Barbara Butler on 01-452 3333 extension 4284.

hypertac

NEW PRODUCTS

selector switch. The LCD900 offers six cd-V from one to 1 kV; five ac-V from 10 to 1 kV; four dc-A from 300 μ A to 300 mA; an ac-A at 3 A and a resistance range from 1 k to 1 M Ω . *Quality Electronics, Lydd, Kent.* **353**

Calculators

Powerful, fast and accurate, the new 852, 4650 and 4660 range



of scientific calculators are aimed at a cost effective price bracket for consumer usage. Both the 852 and 4650 have accumulating memories whilst the 4660 has three separate fully addressable memories. *National Semiconductor Corp, Bedford.* **355**

Trimmers

The Voltronic A range of precision air dielectric trimmers offers insulation resistance from 10⁶ M Ω up to 150°C. Capacitance drift is 0,01 pF; tempco +50, \pm 50 ppm/°C; Q at 100 MHz is 4000 minimum and

voltage rating is 125/250 V dc. Major features of the range include a non-rotating movable electrode, a fixed position tuning screw and facilities for eliminating dust or moisture hazards. *ITT Comps Group, Harlow, Essex.* **354**

Frequency standard

The type 2031 frequency standard is a transportable source of accurate reference frequencies. Two standard o/p are provided at 10 and 1 MHz and the oven controlled crystal oscillator has an aging rate of $<5 \times 10^{-10}$ /day and $<1,5 \times 10^{-7}$ /year. *Dymar Electronics, Watford, Herts.* **356**

Indicators

The M range of led indicators offer the combination of fast switching speeds, high reliability and low cost. Typical luminous intensity figure is 1,6 mcd at I_F=10 mA with viewing angles of 55°. These long-life devices are fully ic compatible and will operate between -55 to +100°C. *Boss Ind. Mouldings, London.* **357**

Microwave transistor

This microwave bipolar transistor, model HXTR-6102, has a guaranteed nf of 2,7 dB at 4 GHz, with 2,5 dB typical. Associated gain is 9 dB. *Hewlett-Packard, Berks.* **358**

Tone converters

The CM1720 provides line dedicated touch tone to dial pulse conversion for pabx and central applications. The unit features one and two digit programming for stop dialling (single or multiple), wink start and release. *Danbury Consultants, Chelmsford, Essex.* **359**

Slide switch

These miniature slide switches, series 200, offer two position control and are available in 11 different versions. Typical operational characteristics include a standard temperature range from -25 to +85°C and switching capability of up to 3 A at 125 V ac. *Diamond H Controls, Norwich.* **360**

Prototype pcb's

A new concept in prototype pcb's allows the user to go direct from circuit diagram to completed board without using chemicals. Blob boards as they are known are initially available in 12 patterns, which, between them, accommodate discretcs to ic's. *P B Electronics, Saffron Walden, Essex.* **361**

Solid state relays

This range of ssr's includes a new type of gating circuit, giving high dv/dt ratings of 500 V/ μ s, making them ideal for high inductive loads. The ac versions provide sp/no or nc o/p, whereas the dc range offers, in addition, both single and dp, dt, non-bias, break before make switching configurations. *National Semiconductors, Altringham, Cheshire.* **362**

Capacitors

Various new ranges of foil, polypropylene, film, polyester and ceramic capacitors have been announced by this manufacturer. The KP1835 polypropylene series spans 470 pF to 0,03 μ F between 63 and 630 V dc. The KP1838 series of polypropylene/foil devices have values from 100 pF to 0,1 μ F with working voltages from 63

to 160 V dc. The KP1834 range has been extended to cover 100 to 470 pF at 160 V dc. The KT1805 series offers capacitances from 1000 pF to 0,068 μ F at 63 V. The ceramic series are ideally suited to telecommunications operation. *Steatite, Birmingham.* **363**

Pulse counters

An extension to the ET series of counters offers a five and 7-digit time and totalising counter respectively. The latter device features a counting rate of 15 pulses/s for dc and 10 pulses/s for ac. Various colours in drum configuration are available. *Sodeco-Saia, Geneva, Switzerland.* **364**

Circuit testers

These testers are designed for use with solid state circuits. The LCI identifies logic level at any point in a digital circuit. Indication is via a tone, high or low depending on state. The tester is suitable for use on fet's, cmos and ttl, operating at clock rates up to 5 MHz. Single pulses down to 200 ns duration will be detected. The CT1, continuity tester aids the location of poor solder joints, dirty switch contacts, etc., by indicating resis-

Enquiry Service

For rapid access to further information, use the reply paid card at the start of the commercial section. Our R.E.S. department provides same day turnaround on all enquiries.

continued ▶

92 on enquiry card

hypertac

Type HHD High Density connector is the answer to miniaturisation and densification of electronic packaging.

Type HPD connector, designed to conform to the forthcoming British Standards specification.

Type HMC Modular connector solves the equipment designers problem of obtaining special connectors quickly and inexpensively.

HYPERTAC CONNECTORS

Chronos Works, North Circular Road, London NW2 7JT

Telephone 01-452 3333

Telex 25847

a registered business name of



SMITHS INDUSTRIES LIMITED

We thirst to be first.

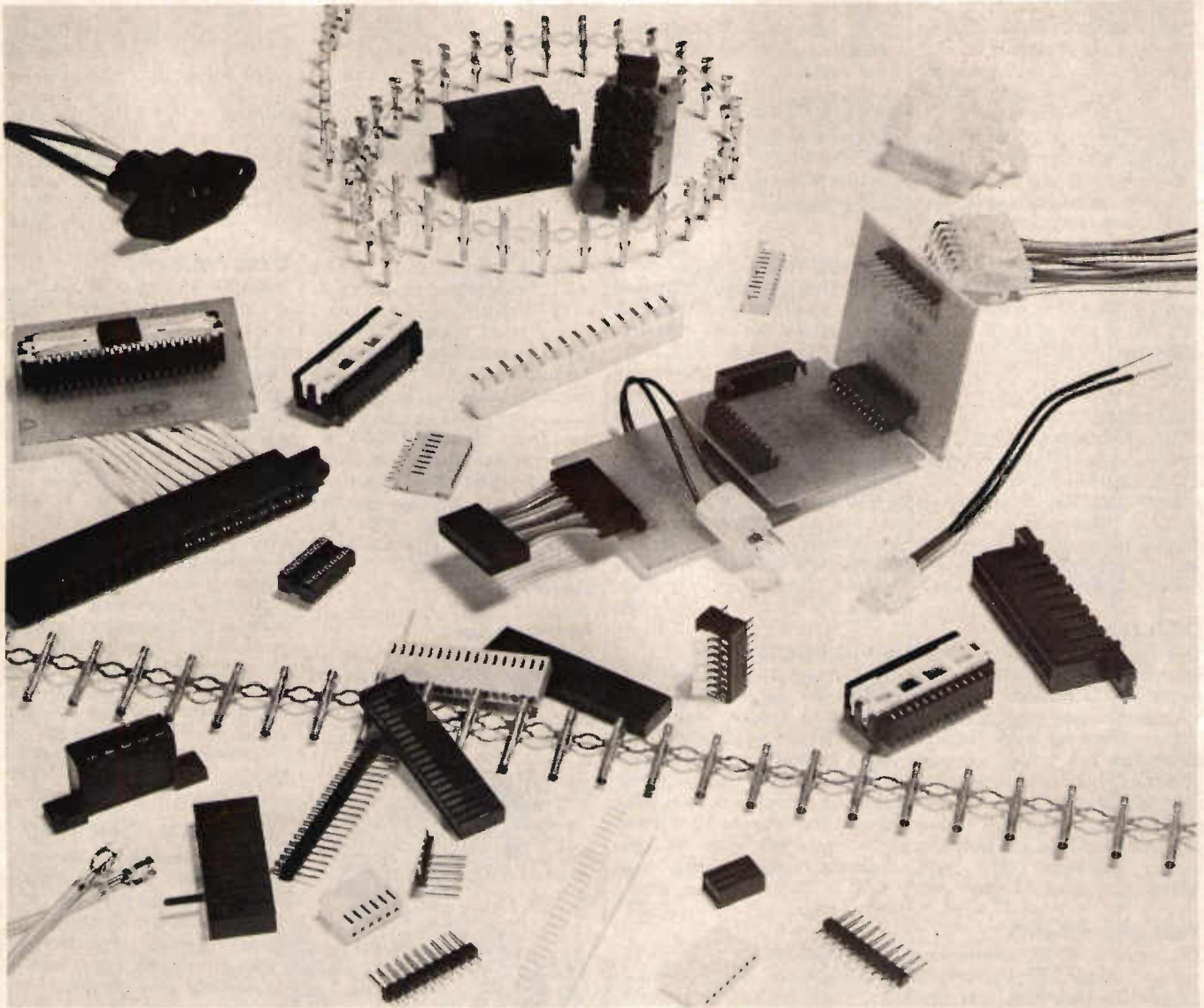

Since our foundation back in 1938, our development into one of the industry's leaders in connector system design and production has been punctuated with one first after another.

For instance, Molex were first to introduce continuous chain-form round-pin and socket type multi-way connector terminals for automatic crimping – and they're still in volume production.

The first modular interconnection system was also ours. (It was this Molex Inconnect system that introduced modular construction into the modern domestic t.v. receiver.)

Molex were first, too, with free standing transistor and IC terminal sockets. And first with a family of commercial connectors, the 1991 series, specifically created to meet international requirements.

Our Konektcon series, the first total systems approach to modular interconnection, is now the largest selling system anywhere. And our recently

introduced commercial interconnection system, featuring 2.5 mm. and 2.54 mm. spacing, established a new standard in miniaturization.

So, with almost 40 years at the forefront we've a wealth of experience to draw on, in meeting the demands of industry today.

And you can be certain we'll be the first to meet them tomorrow.



AFFORDABLE TECHNOLOGY

Molex Electronics Ltd.,
1 Holder Rd., Aldershot, Hants. GU12 4RH.
Tel: 0252 313131. Telex: 934658.

2482

NEW PRODUCTS

Pulse generators

This programmable pulse generator has been designed for ecl and other high speed applications. The model E-H 1501A/129 offers facilities such as memory read-out or optical isolation. The programmable o/p stage can deliver positive or negative pulses with up to 2 V amplitude and ± 1 V offset. The rise and fall times are < 500 ps at full amplitude. Programmable frequency is 50 MHz. *Elex Electronics, Henley - on - Thames, Oxon.* **375**

Balanced mixer

This economical double balanced mixer has been designed for rf signal processing applications. The M-109 includes frequency ranges from one to 500 MHz; typical conversion losses are 6 dB from one to 200 MHz and 7.5 dB from 200 to 500 MHz. Noise figures are within ± 1 dB of conversion loss. DC offset is typically +1 mV and maximum i/p power 50 mW. *Merrimac Inds Inc, U.S.A.* **379**

Pressure transducer

The model 2900 pressure transducer features a solid state sensor, four element piezoresistive silicon semiconductor bridge, high o/p, etc. Ideal applications will be found in the measurement of static and dynamic pressure in liquid and gas systems. *Bourns (Trimpot), Hounslow, Middx.* **380**

Circuitry

A wide selection of pcb's are available from this supplied including double-sided pth, multi-

layer (up to 20 layers), flexible and flex-rigid, manufactured to ESRO and CCT approval. Other types of circuitry available include hyper-frequency circuits. *TSS, Camberley, Surrey.* **381**

Programmable calculator

The PR100 has in excess of 30 pre-programmed functions, 10 independent memories with full memory arithmetics and the added capability of storing 72 programme steps. The device is rechargeable with a 10-digit accuracy with an eight plus two large led display. *Commodore, Slough, Berks.* **382**

Deflection yokes

The C-9370 is intended for use in crt displays where excellent geometry and repeatability at low cost is the requirement. Stator wound on a ferrite core, designed-in geometric correction and good resolution are all attributes of the device. Deflection angles up to 90° are possible. *Sylvan Ginsbury, Rochester, Kent.* **383**

Tone receivers

The CM8822 and CM8825 tone receivers are high performance, low cost modules developed for applications where touch tone receivers are required. Both devices interface with cmos and ttl. The units have 30 k Ω i/p impedance and achieve low simulation rates through multiple signal quality checking circuitry. Current drain for applications in data transmission is 10 mA when connected to a +12 V dc source. *Danbury Consultants, Chelmsford, Essex.* **384**

Portable 'scope

This dc to 25 MHz bandwidth portable oscilloscope, model 9386, offers a sensitivity variable



from 10 to 50 mV/cm in 12 calibrated ranges. Accuracy is $\pm 3\%$ and there are 19 calibrated ranges controlling timebase speeds from 200 ns/cm to 200 ms/cm with a $\times 5$ magnification providing speeds up to 40 ns/cm. The 101.6 mm crt operating at 6 kV ensures a bright display. *Racal Insts, Windsor, Berks.* **385**

RAM systems

This 16k \times 20-bit memory system, organised into 16 000 twenty-bit words, is contained on a single card. The NS3000-1 is designed for high speed operation, providing high reliability at low cost. Access time is 280 ns with a read or write cycle time of 430 ns. Memory refresh can be implemented for individual applications either in synchronous or asynchronous mode. The standard version requires sources of +15, -5 and +5 V. *National Semis, Bedford.* **386**

Phase filters

A range of three phase filters have been designed for the suppression of mains transients in three phase power sources. Attenuation from one to 300 MHz is provided over the frequency range in both the symmetric and asymmetric modes.

Current ratings available span four to 25 A/phase. *Waycom, Bracknell, Berks.* **387**

Bridge mixer

This high performance, single balanced, four diode bridge mixer—the WJ-M29C—has a frequency range from one to 18.5 GHz, and is both multi-octave and biasable. Conversion loss is typically 12 dB with -10 dBm LO drive and ± 15 V dc bias. The unit features a high isolation of typically > 20 dB. *Watkins - Johnson, Windsor, Berks.* **388**

Power Darlingtons

A series of complementary power Darlingtons, available as pnp or npn types offer voltages up to 100 V at 12 A throughout. The BDX85 series are npn and BDX86 series are pnp types. Power dissipations range to 120 W with high gain (minimum 1000 at 5 A). *SGS-Ates, Aylesbury, Bucks.* **389**

Digital voltmeter

The model 8500A dvm, is a bus oriented, μ P controlled measurement system capable of registering ac-V, dc-V, current and resistance by the addition of

Enquiry Service

For rapid access to further information, use the reply paid card at the start of the commercial section. Our R.E.S. department provides same day turnaround on all enquiries.

continued ▶

96 on enquiry card

TOTAL CRYSTAL OSCILLATOR CAPABILITY PLUS FAST DELIVERY FROM LYONS



- * Frequency range 0.01 Hz to 400 MHz
- * Logic compatible clock oscillators
- * High-stability oven controlled crystal oscillators
- * Voltage controlled crystal oscillators (VCXOs)
- * Temperature compensated crystal oscillators (TCXOs)
- * VHF crystal oscillators
- * Laboratory frequency standards

Send for full details today to

LYONS INSTRUMENTS

Hoddesdon Herts EN11 9DX Telephone 67161
Telex 22724 A Claude Lyons Company

Exclusive UK Representatives:

NEW PRODUCTS

plug-in modules. There are five dc voltage ranges from 1 μ V to 1.2 kV with a basic accuracy of $\pm 0.001\%$. The ac-V is measured with one or two options; the -01, which is an average converter and the -02 offering four terminal resistance measurements from 10 Ω fs to 100 M Ω . AC/dc current measurement, from 1 nA to 1.28 A are enabled by using option -03. *Fluke International, Watford, Herts.* **390**

Power supplies

The GRS range of single o/p, high power density linear regulator supplies are available in three different case widths. A wide range of o/p currents and voltages are offered with versions available with edge connector or terminal block termination for designer appeal. All units have dual i/p, built-in over voltage protection and re-entrant over current limit. *Gresham Lion, Feltham, Middx.* **391**

Capacitors

These metallised polyester and polycarbonate capacitors are available from 1 nF to 22 μ F with tolerances to 0.5 and 1% respectively. Temperature range spans -55 to $+125^\circ\text{C}$. *Torno Electronics, Attenborough, Notts.* **392**

Clock oscillators

This device, the QC1453, is offered in two versions, the -/1A-1 for frequencies from one to 5 MHz and the -/1A-2 from four to 10 MHz, both suitable for zero to 70°C . Operating powers are low, 200 and 100 mW at a supply voltage of 5 V. Other features of this plastics encapsulated quartz crystal oscillator

include complementary o/p at standard ttl levels. *Salford Electrical Insts., Heywood, Lancs.* **393**

Switching modules

These units are designed on a single module per channel basis, eliminating cross channel interference. The range includes c/o and cross over modules, spare single and multiport modem switches and a matrix switch for patching computer ports into an equivalent number of modems. *Nolton Communications, Waltham Cross, Herts.* **394**

Strain gauges

A miniature electric resistance strain gauge that can measure strains at temperatures up to 1093.3°C has recently been announced. The gauge is applicable in hostile environments at critical stress locations of high temperature energy generation systems, space vehicles and hypersonic aircraft. It has been developed from an alloy and drawn into wire two-thirds the diameter of a human hair. *Batelle Columbus Labs., U.S.A.* **395**

Thyristors

The SKT70F, /90F and 110F ranges of thyristors, due to their high di/dt ratings, can be used at frequencies up to 10 kHz. They have critical di/dt values of 800 A/ μ s with available turn-off times from 15 to 40 μ s with reapplied dv/dt of 200 V/ μ s. Average forward currents from 87 to 140 A and peak reverse voltages from 200 to 1.4 kV are available. *Semikron, Hertford.* **396**

Amplifier systems

This new twin channel ac carrier amplifier system is for use with transducers and strain gauges. Full scale o/p is achieved from i/p signals as low as 2.3 mV up to 5 V with a linear over-range of 100% and digital read-out up to ± 1999 digits. The built-in oscillator provides 5 V at 5 kHz allowing dynamic signals up to 500 Hz to be recorded. *Sangamo Western Controls, Bognor Regis, Sussex.* **397**

Acquisition systems

This data acquisition system, designated DAS1128, features a high speed 15 μ s 12-bit adc, an s/h amp, precision reference,



high stability buffer-amp and a 16-channel multiplexer. Non-linearity temperature coefficient is 2.5 ppm/ $^\circ\text{C}$ and 8 ppm/ $^\circ\text{C}$ for high stability, $\pm 0.012\%$ of fsr relative accuracy at 33 kHz throughput rate. Power requirements are 15 V at 40 mA, -15 V at 70 mA and 5 V at 250 mA. *Analog Devices, E. Molesey, Surrey.* **401**

Converters

The model A8402 v-f-v converter requires one supply rail in the range $+4$ to $+18$ V and has a linearity of $\pm \pm 0.05\%$ up to 10 kHz and $\pm 0.1\%$ up to 100 kHz which is its full range.

The device is cmos and ttl compatible. *Teknis Electronics, Slough, Berks.* **398**

Opto isolators

The series includes 3N243, /44 and /45 types. They offer guaranteed minimum current transfer ratios of 15, 30 and 60% respectively. All devices feature 1 kV isolation and will withstand htrb at 125°C and 20 V_{CE}. *Norbain Opto-Electronics, Reading, Berks.* **399**

Servomechanisms

This range of synchro actuated direct drive servomechanisms will operate from supply frequencies between 50 and 400 Hz. Output torques between three and 50 oz/in with positional accuracies of 10 arc mins are possible. Within the housing is a high efficiency dc torque motor and a synchro control transformer mounted on a single shaft. *Servodata, Newbury, Berks.* **400**

PLL circuits

The SP8760 multi-function circuit finds use in phase-locked loop systems. It incorporates a crystal oscillator and divide-by-four scaler, a digital phase/frequency comparator and a low frequency two modulus divide by 15 or 16 prescaler. This device may be used with a prescaler to phase lock single frequency transmitters or receivers in the hf, vhf or uhf bands. The two-modulus prescaler will operate to 18 MHz typically and the phase comparator has only a 30 ns zero phase pulse width. *Plessey Semiconductors, Swindon, Wilts.* **402**

Connector Capability

Keep to the connectors you know. At Ferranti we're keeping to the high standards we set ourselves right at the start. That's why so many people choose Ferranti connectors.

Pitches of .100" (2.54mm) (modular connector), .150" (3.81mm), .156" (3.96mm) and .200" (5.08mm). Non-porous gold plating on the contacts—or gold flash if you wish. Terminals for wire wrapping or soldering. And a variety of end feet.

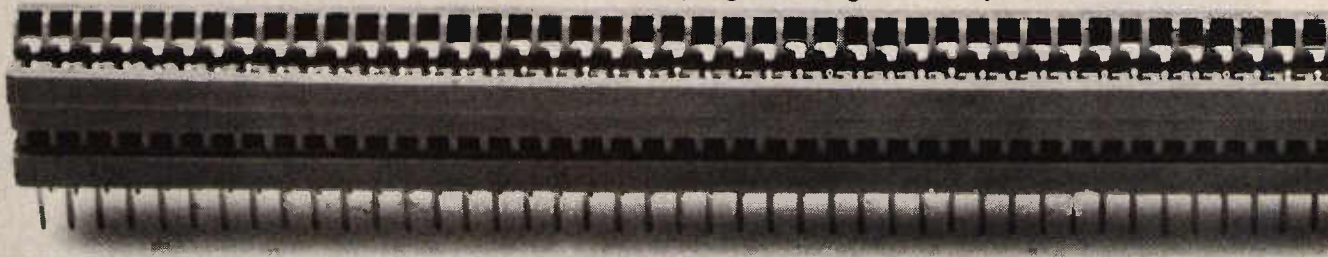

NEW PRODUCTS

Electrolytics

Two new ranges of computer grade aluminium foil electrolytic capacitors conform to IEC 103 type 1 requirements. Voltage ranges span 6.3 to 250 V with capacitances from 68 to 470 000 mF. Both types are designed for professional usage. *Dean Electronics, Ascot, Berks.* 406

Clock oscillators

The model CO-238T compatible clock oscillator is available at any frequency in the range three to 20 MHz and incorporates a tuning adjustment for accurate setting ($\pm 0.0001\%$, 1 ppm). The device operates from 5 V dc providing a ttl compatible square wave o/p with stability $> \pm 0.0025\%$ over zero to 70°C. *Lyons Inst., Hoddesdon, Herts.* 407

Modulation meters

The AMM has been designed to simplify modulation measure-



ments made in developing, production testing and the servicing of fixed or mobile communications systems. Am and fm measurements are possible over the range 1.5 MHz to 2 GHz. On the fm, five deviation ranges are provided from one to 100 kHz fs. AF bandwidth is selectable, the response being dictated by active filters providing standard or psophometric weightings and de-emphasis correction where needed. *Farnell Insts., Wetherby, Yorks.* 408

Reference diode

A new linear ic, -6.9 V reference diode offers a dynamic impedance two orders of magnitude less than discrete Zeners. The LM129 operates over a 0.5 to 15 mA range. Long term stability is typically 20 ppm whilst noise is guaranteed to be $< 20 \mu\text{V}$. Dynamic impedance is one ohm. *National Semis., Bedford.* 403

PCB relays

The MHP range features an improved cover and base/blade support, 5 mm contact pin spacing, large contact area and stronger contact blades. This type of device has SEV and other approvals and its AgCd oxide contacts give lifetime figures > 500 k operations when switching 5 A at 250 V ac. *Quiller Comps., Bournemouth, Hants.* 404

Bipolar circuits

Five new 2900 family components are now available complementing the Am2901, 4-bit μP slice and the Am2909 microprogramme sequencer. The 2905 is a 4-bit bus transceiver; the 2906 is also a 4-bit transceiver with parity. The 2907 is similar to the /06 with the two way multiplexer at the i/p to the bus driver register eliminated, to allow for compact packaging. The 2918 is a general purpose 4-bit register with two sets of o/p; ttl and three state. The final product, the 93415 is a 1024×1 -bit fully decoded ram for use in high speed and control stores. *Raytheon Semis., Harlow, Essex.* 405

Operational amps

The models A970 and /75 op-amps are wideband devices featuring high slew rates, low bias currents, high i/p impedances and high cmrrs. The A970 has a gain bandwidth of 100 MHz and an open loop gain of 95 dB. The A975 offers a slew rate of $80 \text{ V}/\mu\text{s}$ whilst both units have i/p impedance of $> 100 \text{ M}\Omega$ and operate over a temperature range of zero to $+70^\circ\text{C}$. *Hybrid Systems, Camberley, Surrey.* 409

Alphanumeric display

This 7×5 dot alphanumeric led display features 17 mm high characters and has integral mos shift registers for serial feed electronic drive systems. Brightness is controlled by a single dc-V and any number of displays can be controlled by one clock and one data line. Either red or green emission is available. *ITT Comps., Harlow, Essex.* 410

Switching sources

The SOL series of direct off-line switching mode power supplies, offer efficiencies in excess of 70%; line and load regulations of $0.05\% \pm 5 \text{ mV}$; ripple and noise $< 2 \text{ mV rms}$ (10 mV pk-pk) and low rfi. Output resolution is $< 30 \text{ mV}$ and internal protection shuts down the source when the heat sink temperature exceeds 110°C . *Coutant Electronics, Reading, Berks.* 411

A/D converters

A series of monolithic adc's featuring excellent linearity and the ability to operate with 20 mW power drain from $\pm 5 \text{ V}$ dc supplies, has been designated ADC-EK. The series consists of

three binary coded o/p models with resolutions of eight, 10 and 12-bits and a bcd-coded o/p model with a resolution of three

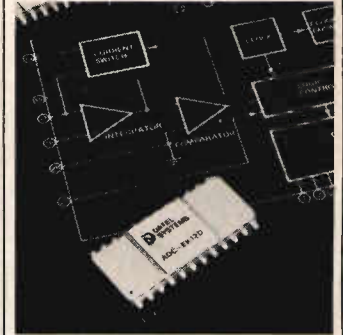

bcd digits. Maximum conversion times are 1.8, 6 and 24 ms for the binary coded models and 12 ms for the bcd unit. *Datel, Basingstoke, Hants.* 412

Marking kit

This cable marking kit, marketed under the name of Pentronics, contains ten rolls of white crepe tape each marked with bold numbers, letters or symbols and backed with high-tack adhesive suitable for temperatures of up to 148°C . The tapes come housed in a feed-out container. *Bowthorpe Hellermann, Birmingham.* 413

Enquiry Service

For rapid access to further information, use the reply paid card at the end of the commercial section. Our R.E.S. department provides same day turnaround on all enquiries.

continued ▶

97 on enquiry card

As well as edge connectors Ferranti offer multi-pole low force connectors with a choice of 35, 50, 70 or 91 contacts. All with low spring rate for easy insertion and withdrawal.

Contact Connector Sales, Ferranti Limited, Professional Components Department, Dunsinane Avenue, Dundee DD2 3PN, Scotland. Telephone: 0382 89321 Telex: 76166.

Distributors: Giltech Components Ltd, 22 Portman Road, Battle Farm Industrial Estate, Reading, Berks. RG3 1ES Tel: 0734 582131

FERRANTI
the better connector

Cost-saving Crimper

3,600 terminals-an-hour output max.

Big production economies with the Hollingsworth H27Q tape-feed automatic crimping machine, which can also be operated manually.

High-speed and portable, weighing only 34 lbs, it handles insulated, non-insulated "U" (open) barrel, insulation-grip, metal-grip and slip-on terminals. Also butt splices in all 26-4 AWG sizes/0.1 mm² - 25 mm² made by Hollingsworth.



Loose piece terminals and hand tools also available.

HOLLINGSWORTH[®]
TERMINALS LIMITED

Barwell Trading Estate, Leatherhead Road, Chessington, Surrey.
Tel: 01-397 9233/4. Telex: 929382.

LABORATORY INSTRUMENTS

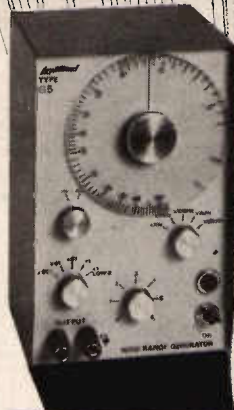

UK price
£58.70
Plus VAT and P&P

WIDE BAND AUDIO SIGNAL GENERATOR
a high accuracy solid state sine/square wave generator with 600 ohm attenuator output or low impedance output delivering 3 watts into a 5 ohm load.

UK price
£54.50
Plus VAT and P&P

HIGH IMPEDANCE AC/DC MILLIVOLTMETER
(The Modern equivalent of the Valve Voltmeter)
an AC/DC wide range meter with 20 scales covering 1.2 mV to 400 volts FSD incorporating a power scale in decibels.



LINSTEAD
MANUFACTURING CO LTD
ROSLYN ROAD LONDON N15 5JB ENGLAND
Tel: 01-802 5144

INVADER COMPONENTS LTD

New, wafer thin, 700 series touch keyboards - the answer for performance and low price

Invader Components announce the availability of a new Series of elastic diaphragm touch sensitive keyboards. Designed to be the ultimate in low price, flexibility and performance the new 700 Series are ideal for communications, appliances, automotive and unlimited other applications. The new Datanetics keyboard can be produced in virtually any size, shape, key spacing, colour etc. and the proven elastic diaphragm switch concept ensures exceptionally long life.

Keyboards and Keys from:

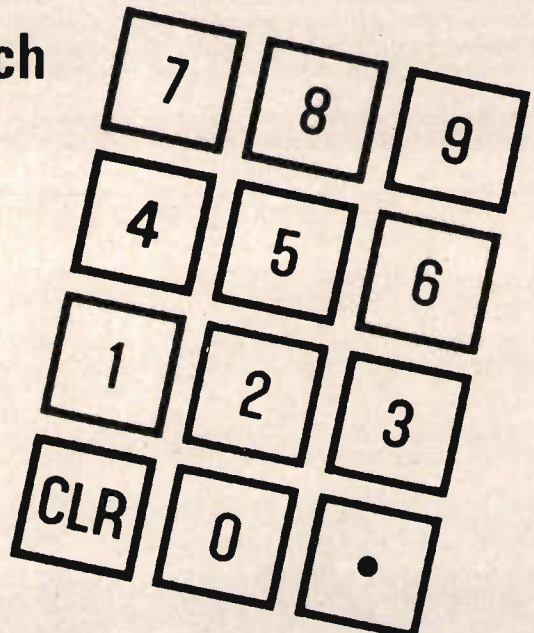

INVADER COMPONENTS LTD

30 TRIBUNE DRIVE · TRINITY TRADING ESTATE · SITTINGBOURNE · KENT ME10 2PG
Tel: Sittingbourne (0795) Telex: 965313

TRANSIPACK®

NO BREAK POWER SUPPLIES

NEW 2000 SERIES — FOURTH GENERATION

1KVA TO 200KVA

24 HOURS WORLDWIDE SERVICE 2 YEARS' GUARANTEE AVAILABLE

BRITISH MADE

VISIT US AT HASTINGS AND SEE OUR
STATIC INVERTER CENTRE

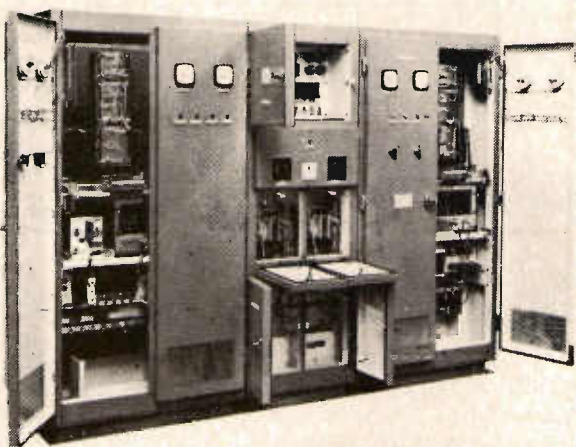

TYPICAL TRANSIPACK
NO-BREAK POWER SUPPLY
AS DELIVERED TO C.E.G.B.

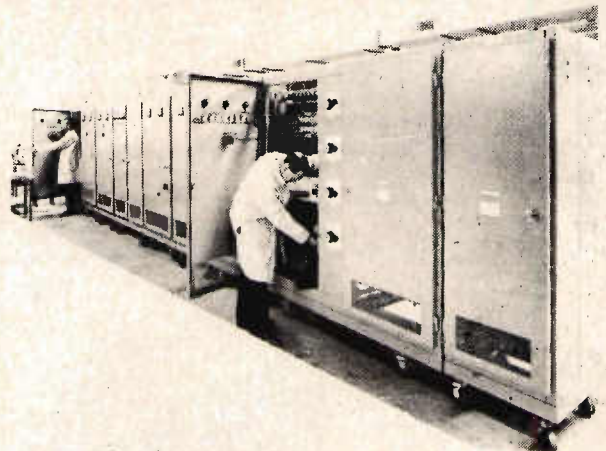

TYPICAL
TRANSIPACK U.P.S.
FOR COMPUTER
APPLICATIONS

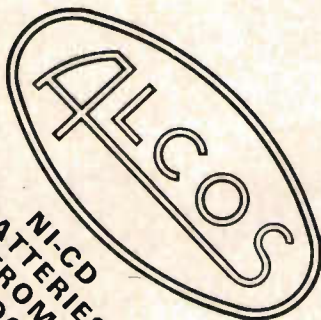

NI-CD
BATTERIES
FROM
STOCK

**INDUSTRIAL
INSTRUMENTS
LIMITED**
TRANSIPACK®

Sales and Laboratories
STANLEY ROAD
BROMLEY BR2 9JF
KENT, ENGLAND
Telephone: 01 460 9861/5
Telegrams: TRANSIPACK, BROMLEY
Telex: 896071

Factory
THEAKLEN DRIVE
PONSWOOD INDUSTRIAL ESTATE
HASTINGS, SUSSEX, ENGLAND
Telephone: Hastings 427344

OXLEY 

range of best connections

Oxley Connector/Test Point

The Design Award winning Oxley Snaplox® connector/test point is an addition to Oxley's wide range of connectors, which clicks 'on' and 'off' but if pulled sideways by accident, beyond a generous angle, detaches itself without damage. Two spills—stand-off or lead through—are available. The flying socket, PTFE insulated, spherical spring contact, is available in eleven standard colours. The Snaplox® incorporates many features and information is available on request.

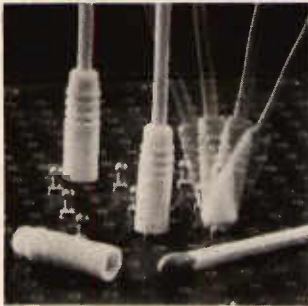

Oxley 'Snale' Printed Circuit Connectors

Being tapered and micro-machined with serrations and splines, OXLEY 'Snale' Printed Circuit Connectors have a very high resistance to extraction and rotation and at the same time accommodate themselves to wide hole tolerances (sizes 0.040" - 0.050"). The ease with which they can be assembled results in their wide use in printed circuit boards as test points, component supports and connection points.

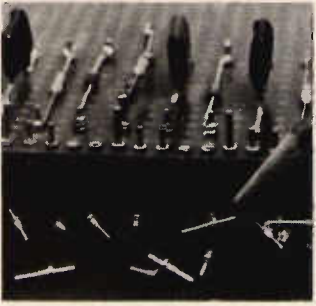

Oxley 'Barb' Cone-Lock Plugs and Sockets

The OXLEY 'Barb' Cone-lock range of plugs and sockets provide a wide range of connectors incorporating dispersion quality PTFE as the insulating medium. The range covers a sub-miniature version type 0.55mm for chassis mounting holes 2mm diameter to the large 4mm instrument types, having 8mm diameter mounting holes. Available in our very attractive range of colours.



Oxley Printed Circuit Sockets

They are designed for direct mounting on standard 0.1 module printed circuit boards. The mounting is arranged so that test probes may be inserted in a plane parallel to the printed circuit board, thus permitting close stacking of circuit boards. Sockets may be supplied in 1 to 12 ways and are available in our standard colours. Vertical mounted plugs and sockets designed for 0.040" PC mounting are also available.

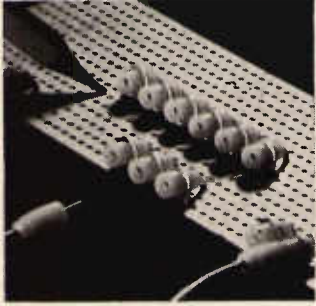

Oxley Special Purpose Plugs & Sockets

Used for a wide variety of chassis mounting and printed circuit mounting applications. Special types include a stackable version 50P/156/S which provides multiple lead-outs in combination with standard sockets 50S/156. The upper half of the plug is female, a slit in the socket is reinforced by a PTFE body, the lower half being a plug to fit the socket. A number can be stacked upon one another for test points, etc. Range of colours.



OXLEY  **Oxley Developments Co. Ltd.**
 ULVERSTON · CUMBRIA · LA12 9QG · ENGLAND
 CABLES OXLEY ULVERSTON · TELEX 65141 · TELEPHONE: 0229 52621

A thumbwheel switch is more...

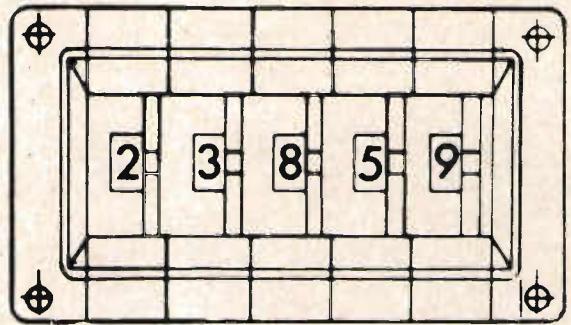

...or less than you think

MORE in terms of Options, including output codes, wheel colours, special legends and five basic styles with many other factors which will give you greater versatility.

LESS in terms of Cost, panel space, delivery and engineering time, because you could probably fill your particular requirement with just one call to Cosmocord.

Switch on to Cosmocord-Stolec and see for yourself.

COSMOCORD-STOLEC

Cosmocord Ltd. Eleanor Cross Road, Waltham Cross, Hertfordshire EN8 7NX Tel: Lea Valley 716666. Telex 24294

NEW PRODUCTS

Diodes

The low forward voltage rating (0,85 V) and fast recovery characteristics of a new family of diodes, BYW29 to 31, improve the o/p efficiency of inverters and switched mode power supplies. A reverse voltage rating, up to 150 V, enables an improved efficiency in hv supplies. *Mullard, London.* 414

Dielectric testers

The TUPD series of testers have rated o/p voltages of three, six and 10 kV. Power ratings are 600 and 1 kVA. Besides insulation testing with high ac-v the testers include capabilities for fault burning and locating with currents up to 0,2 A. Routine production testing is facilitated by the leakage current signalisation with adjustable levels ranging from three to 20 mA. *Statomat-Micafil, Rugby, Warks.* 415

Fixed attenuators

The 6534 series of high quality 50 Ω fixed attenuators, operate from dc to 18 GHz with mean i/p power rating of 5 W providing a choice of attenuations from three, six, 10 or 20 dB. The devices use resistive networks giving accurate insertion loss and vswr at all frequencies within their specified range. *Marconi Inst., Stevenage, Herts.* 416

Microwave transistors

These low cost, high power microwave transistors operate at a frequency range of 1,5 to 2,3 GHz. The devices are i/p matched, gold metallised with overlay emitter site ballasting. Output powers range from five to 30 W with an option of 24 or 28 V. *Tranchant Electronics, Hampton, Middx.* 417

Photodiodes

Four new silicon avalanche photodiodes find use in laser detection, ranging, optical communications and high speed electro-optic switching. Three of the devices, the C30817, -/84 and -/95 are supplied in TO-5 cans with a useful photosensitive area of 0,5 mm². The fourth device the C30872 has a larger area of photosensitivity, 7 mm². The types -/17 and -/72 have spectral ranges extending from 400 to 1100 nm and rise and fall times of 2 ns. The -/84 version has a high modulation capability up to 400 MHz and a rise and fall time of 1 ns. *RCA Solid State, Sunbury-on-Thames, Middx.* 418

Capacitors

The RNRC range of metallised polycarbonate capacitors have ranges extending from 0,01 to 15 μ F. The dc working voltages span 63 to 400 V. Working temperature ranges cover -55 to +85°C and have a 0,3% dissipation factor measured at 1 kHz. *Nortronic Assoc., Nantwich, Cheshire.* 419

Isolators

The OPI 6000 is available in a six pin dil package and features 1,5 kV dc i/p to o/p isolation with an o/p capability of 300 V dc break down. It is comprised of a GaAs ir-led and an hv npn photo-transistor. Guaranteed maximum o/p leakage current is 100 nA with a collector emitter voltage of 200 V. Saturation voltage for the o/p transistor is 0,4 V with an i/p current of 10 mA and o/p of 0,5 mA. *Norbain Opto-Electronics, Reading, Berks.* 420

Diodes

These diodes, type PMD500, are capable of operating equally well as zero-bias detectors or high sensitivity mixers over the entire frequency range 12,4 to 18 GHz. The junction is formed such that the detector sensitivity is -56 dBm at zero-bias, thus eliminating dc drift caused by biasing. Overall single side band nf is 6,2 dB over the frequency range. *Tranchant Electronics, Hampton, Middx.* 421

Rectifiers

These glass and plastics technology, rugged low power rectifier diodes are available with current ratings between one and 3 A. An important feature of the Superrectifier is the brazed rather than soldered junctions and leads. The unit will withstand temperatures as high as 600°C. *Distronic, Harlow, Essex.* 422

Character generator

The type 2608 CN0040 is a 1k8 mos/rom programmed to give the fully approved teletext character font, ie 7 x 5 upper and lower characters. Features include static operation (no clocks); an access time of 650 ns; single power supply 5 V; ttl compatible i/p and o/p; 400 mW power dissipation; tri-state o/p; n-channel silicon gate technology and a standard 24-pin package. *Mullard, London.* 423

Wattmeter

The model M2104 recording wattmeter, comprises a solid state transducer having a dc o/p proportional to ac power consumption. The dc o/p of the transducer is recorded on pressure sensitive chart paper. Several standard ranges are available between zero and 40 kW and zero and 1600 kW. *Channel Electronics, Seaford, Sussex.* 424

Enquiry Service

For rapid access to further information, use the reply paid card at the end of the commercial section. Our R.E.S. department provides same day turn-round on all enquiries.

Pye Push Keys

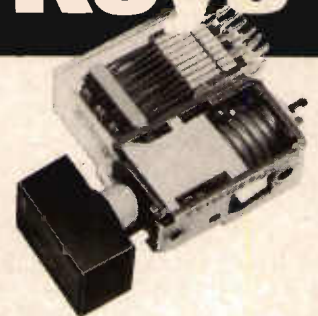

Series '200'
Momentary, Locking, Interlocking, Cancel/Interlocking types. Barred Access and Blocking facilities. Up to 6 pole changeover.

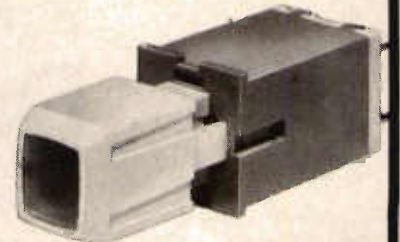

Series '400'
Multi-reed key with optional illumination. 65 gm or 300 gm operate force. Collapse or non-collapse actions.



Type 5
Reed Key for standard and terraced keyboard applications. Wide range of key tops.



Dialight '554'
A new competitively priced illuminated key with matching indicator in identical package.



Pye TMC Components Ltd.,
Controls Div., Exning Road,
Newmarket, Suffolk CB8 0AX
Tel: Newmarket (0638) 3451
Telex: 81245

Increase your standard of living

ARE YOU AWARE that the purchase of a retail business – i.e. a modern Foodstore with sub Post Office or a Newsagents & Confectioners – is an investment over which you have personal control and from which you can expect to receive not only a substantial income, but one where enterprise and personal effort will bring rewards far in excess of those attainable in the role of an employee?

ARE YOU AWARE that a house in itself is entirely unproductive, but by investing the proceeds, for example £15,000 in cash plus an easy payment loan you could obtain a business that would produce over £10,000 p.a. clear profit together with virtually cost free private accommodation. Within 2 or 3 years the purchase of a second business would be quite practicable during which time your assets would have at least doubled and once again, the purchase of a private house could be achieved out of the profits, if desired.

Your introduction to the many hundreds of businesses currently available can be found in Daltons Weekly, price 10p from newsagents.

Daltons Weekly

The Shopwindow for Shops and Businesses

Freedom of choice



That's what's important to us at Optima. And that's why Optima cabinets and cases come in more sizes and colours than any other kind you can buy. With Optima you get 11 different colours to choose from, in fact. And hundreds of different models and sizes. Not to mention a great long list of optional features like rack adapters and perforated panels and tiltstands and spring-loaded handles.

In other words, you can have any enclosure, the way you want it. That's what freedom of choice means.

And that's what Optima means, too.

OPTIMA

Optima® Enclosures, a division of Scientific-Atlanta, Inc.
Macmerry, East Lothian, EH33 1EX, Scotland
Telephone Tranent 610747
Telex 72623

When size presents a problem



- the MN7100 8-bit,
8 channel data acquisition system

New to the UK and available from Tranchant, the MN7100 is the first complete data acquisition system offered in hermetically sealed, 32 pin dual-in-line package.

It's small size and low power consumption makes it ideally suited to a wide variety of process control applications and many others including: **Aerospace, Nuclear Power Generation, Hospital Patient Monitoring.**

Check the following features and you'll see just how much the MN7100 offers:

- ★ 8-bit resolution $\pm 1/2$ bit linearity
- ★ Microprocessor compatible
- ★ 90,000 conversions/sec
- ★ 8 channels expandable to 256 channels
- ★ $\pm 15V$ and $+5V$ Power supplies
- ★ Adjustment-free
- ★ Random or sequential addressing
- ★ Complete multiplexer sample and hold A/D Converter controlling logic

Contact Tranchant today for a data sheet on the MN7100 which is also available in extended ($-25^{\circ}C$ to $+85^{\circ}C$) and full military ($-55^{\circ}C$ to $+125^{\circ}C$) temperature ranges.

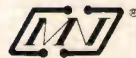

Micro Networks Corporation

tranchant electronics (uk) limited

Tranchant House 100a High Street
Hampton Middlesex TW1 2ST
Tel: 01-979 0123.

Tomorrow's Electronics Today

Sanwa precision circuit testers – Big on features. Bigger on selection.



1



2



3



4



5



6



7

1. BX-505

- Fast-response, $24\mu A$ movement – fuse & diode protected with high resolution factor ($0.4\mu A$ /scale division)
- Revised scale marking – intermediate readings readily determined

2. U-60D

- $44\mu A$ movement – quality performance, diode protected
- Stable ACV measurement – solid-state rectifier & enlarged frequency coverage

3. SP-10D

- Easy operation – multiposition rotary selector switch & well-lighted scale
- Stable ACV measurement – durable diode rectifier

4. N-501

- $2\mu A$ suspension movement – $0.05mA/1mV$ resolution
- Double protection – fuse & Si diode

5. CX-505

- $16.5\mu A$ movement – varistor protected & $50k\Omega/V$ for DC
- Capacitor tester – push-button operation with solid-state oscillator built in

6. PDM-500 (Insulation Tester)

- Battery operated – 3 small-size 1.5V batteries built in
- Push-button operation – pointer calibration & insulation test

7. CAM-300D (Clamp Meter)

- Two scales, front and bottom, for reading convenience
- Specially-designed, scissor-action core arms

Sole Importers in U.K.

Quality Electronics Limited

24 High Street, Lydd, Kent, TN29 9AJ
Telephone: LYDD 20252 Telex: 965265

sanwa
MULTITESTERS

NEW DATA

The book, **Electromagnetic horn antennas**, edited by AW Love contains 82 pages to provide background on fundamental theory and to give practical information on the applications of horn antennas. £8.25. *John Wiley and Sons Chichester, Sussex.* 251

GDS sales has just released its new catalogue intended to interest engineers and contains shortform data on the products available from the company. *GDS Sales, Slough, Berks.* 252

A leaflet is available on the Karl Suss model MJB 55 production mask aligner which can handle slices up to 127mm diameter and substrates up to 127mm square. *Epak Electronics, Reigate, Surrey.* 253

Broyce Control has produced an eight page general and technical leaflet which covers about 5000 timers manufactured by the company. *Broyce Control, Brierley Hill, West Midlands.* 254

A technical specification bulletin on the Medilog recorder for a physiological data system for ambulatory monitoring is available from *Oxford Instruments, Oxford.* 255

A booklet entitled "Employing staff" by Mr MJ Boella is one of a series intended to help owners of small businesses to overcome the problems of employing staff. *Department of Industry, London.* 256

The book **Visual display units**, £7, is aimed at users of computers who either employ or intend to use VDU's to enhance their systems. *IPC Science and Technology Press Ltd, Guildford, Surrey.* 257

Fact sheets are available on the range of products from **Boss Industrial Mouldings Ltd** including breadboards and plastic and diecast boxes. *Boss Industrial Mouldings, London.* 258

Information is available on the micro-wave bonded packages made by **Exacta circuits**. A brochure can be obtained from *STC Ltd, London.* 259

A leaflet describes a portable bin system especially designed for small assembly industries, so if you want to store it—bin it. *Noronix Ltd, London.* 260

The thick film hybrid integrated circuits capability of **Welwyn Electric** is described in a four colour brochure from the company. *Welwyn Electric, Northumberland.* 261

Three **Permanoid** leaflets cover a range of pvc flexible and lightcords, pvc equipment wires and silicone rubber wires. *Permanoid, Manchester.* 262

A four page leaflet is available on the **Edgeblock BJ edge connector** and screw terminal block from **Pye Connectors**. *Biggleswade, Bedfordshire.* 263

A shortform catalogue from **Deltron** describes its range of components including plugs, switches and enclosures. *Deltron, London.* 264

A brochure has been published covering the full range of **fluid control** equipment manufactured and marketed by **Hymatic, Redditch, Worcs.** 265

Sealed **nickel cadmium** cells and batteries are subjects of a leaflet from **Tadiran** which are marketed in this country through *Stanley Palmer Ltd, East Molesey, Surrey.* 266

Computer Automation has published an eight page colour brochure which explains the company's **SyFA** decentralised data processing system. *CAI, Rickmansworth, Herts.* 267

Motorola's **cmos data book** is available from the company at a price of £2.50 including postage. *Motorola, Wembley, Middx.* 268

A four page leaflet is now available from **LC Automation** giving details of a range of projectors, receivers, photo-electric controls, timers and electronic counters. *LC Automation, Manchester.* 269

The second edition of the discontinued **diode data book** can be obtained from *London Information* at £19.70 (single issue). The mechanical and electrical characteristics from 24108 discontinued devices are listed. *London Information Ascot, Berks.* 270

The telematic 2000 push button private automatic **branching exchange** has been introduced by **Telephone Rentals** and is described in a leaflet from the company. *Telephone Rentals, London.* 271

A high resolution low light level **tv camera** designed to operate all **Westinghouse 25 mm secand ebs camera tubes** is the topic of a new technical bulletin. *Westinghouse, Windsor, Berks.* 272

A new brochure available from **Data Recording Heads** describes the activities of the company at its factory which produces digital magnetic recording heads. *Data Recording Heads, Egham, Surrey.* 273

Teradyne Components has produced a 48 page technical information booklet on the company's **module library** which is a standardised electronic packaging system. *Teradyne, Cambridge.* 274

A mini series of **ic pluggable packaging** assemblies that measure as little as 123.4 x 111.3 mm is described in a leaflet from *Garry Manufacturing, New Brunswick, USA.* 275

A leaflet outlining **Rediweld Plastics** service as suppliers of **plastics mouldings**, includes all the common engineering plastics. *Rediweld, Crawley, Sussex.* 276

The 1977 edition of **Hi-Fi Year Book** contains 500 pages and details on all aspects of the Hi-Fi world. £3. *IPC Electrical Electronic Press, London.* 277

Part of **Data I/O** customer service includes the publication of a **prom comparison chart** which provides essential data on every prom currently manufactured. *Data I/O, High Wycombe, Bucks.* 278

For every viewpoint.



NEW DATA

ITT Components Group has issued a 56 page illustrated catalogue covering its range of relays and counters, *ITT, Harlow, Essex.* 279

Another London Information data book on **optoelectronics** is claimed to be 40 per cent larger than last year. It can be obtained at a price of £49.45 for a year's subscription. *London Information, Ascot, Berks.* 280

The 1977 Hewlett Packard catalogue contains information on a wide range of products including **oscillators**, recorders and medical instrumentation. *Hewlett-Packard, Winnersh, Wokingham.* 281

An autumn issue of AGA Nav Aid review deals with two major light installations, for fog detector signal systems that the company has installed. *AGA Navigation, Brentford, Middx.* 282

A brochure is available on the range of moving coil meters including centre coil, full scale movements and mirror scales manufactured by *British Physical Laboratories, Radlett, Herts.* 283

Industrial digital transducers are discussed in a catalogue from Orbit Controls which also includes technical information on the three broad ranges of transducers the company has available. *Orbit Controls, Cheltenham, Glos.* 284

Static power frequency changers, £20, describes the basic operating principles of ac changers and presents

recently developed frequency changers and their applications. *John Wiley and Sons, Chichester, Sussex.* 285

Yet another London Information data book comes in the guise of **linear ics** which can be obtained at a price of £35.05 for a year's subscription which comprises two issues. *London Information, Ascot, Berks.* 286

A brochure from Tally describes the fully plug compatible T2000 line printer interface package for the PDP11 minicomputer. *Tally, Reading, Berks.* 287

Holden cords has a leaflet describing its range of cables and wires which can be made to customer specification. *Holden Cords, London.* 288

Copies of two new ASEA publications have been received in the United Kingdom. One is the ASEA journal vol 49 no 3, the other is the 40 page pamphlet entitled ASEA Today which covers the company's major product areas. *ASEA, London.* 289

General Electronics Circuits by JJ de France, £12, is intended as a first course on **electronic circuitry** aimed at the level of the engineering technician. *Holt Sanders Ltd, Eastbourne, Sussex.* 290

An eight page application note from Hewlett Packard describes the design and construction of a single stage bipolar amplifier at 4 GHz with a noise figure of 2.6 dB and an associated gain of 10.8 dB. *Hewlett-Packard, Wokingham, Berks.* 291

Practical electronics **project building** is the latest in the series of constructors guides from *Newnes Butterworth, Sevenoaks, Kent.* 292

Information is available on the Capable 4000 family of **minicomputer** based automatic circuit board testers from computer *Automation, Rickmansworth, Herts.* 293

A product note has been produced by Zehntel on the company's **automated test equipment** known as the trouble-shooter 400. *Zehntel, BFI Electronics, London.* 294

A four page application note is available on a **photodiode/amplifier** combination made by United Detector Technology. The leaflet can be obtained from *Rofin, Egham, Surrey.* 295

The Euromicro newsletter is intended to facilitate the international flow of information in the field of **microprocessing** and microprogramming. Information can be obtained from *Warren Spring Labs, Stevenage, Herts.* 296

Geometrical Theory of **diffraction** and its applications, is the first volume in the IEE electromagnetic waves series covering both theory and application of gdt. *Peter Peregrinus, Stevenage, Herts.* 297

The volume of the proceedings of the LDA symposium held in Copenhagen is entitled "The accuracy of flow measurements by Laser Doppler methods" and comprises 736 pages. Its 52 papers are related to subjects such as **Doppler signals**, and signal processing. Pro-

ceedings *LDA symposium, Copenhagen.* 298

Profile is the name of ITT's house journal with many topics of interest in both general and technical terms. *ITT London.* 299

Multi-colour **stikons** are the subjects of a short brochure from *Bishop Graphics, California, USA.* 300

Power system transients, £10, gives a detailed description of the mathematical methods which may be applied to the calculation of fast transient over-voltages which occur in power system networks. *Peter Peregrinus, Stevenage, Herts.* 301

Information is available on **ate equipment** ranging from programmable system modules and subsystems to complete semiconductor ate such as the E-H 1100 bench top wave-form analyser. *Elex Electronics, Henley, Oxford.* 302

More **ate equipment** in the form of the basic 40 test point module from Ancom is discussed in a leaflet. *Ancom, Cheltenham, Glos.* 303

Enquiry Service

For rapid access to further information, use the reply paid card at the end of the commercial section. Our R.E.S. department provides same day turn-round on all enquiries.

109 on enquiry card

EEV makes a vidicon.

If you use closed circuit TV, you need EEV vidicons.

Our tubes ensure reliable round-the-clock operation, and cover all TV pick-up applications.

In mono or colour. For most cameras. In electrostatically focused and magnetically focused types (separate or integral mesh). With a range of photosurfaces.

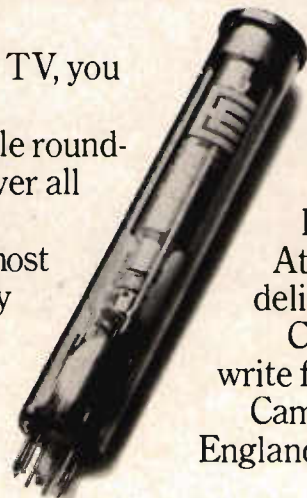

And special rugged types are made to withstand shock or vibration.

EEV makes the dependable, high quality vidicons you need.

At attractive prices. For quick delivery now.

Contact your local EEV agent or write for data and prices to

Camera Tube Sales at Chelmsford, England.

EEV and M-OV know how
Members of GEC—turnover £1902 million

ENGLISH ELECTRIC VALVE CO LTD, Chelmsford, Essex, England CM1 2QU. Tel: 0245 61777. Telex: 99103. Grams: Enelectico Chelmsford. **S&C**

FILM CAPACITORS

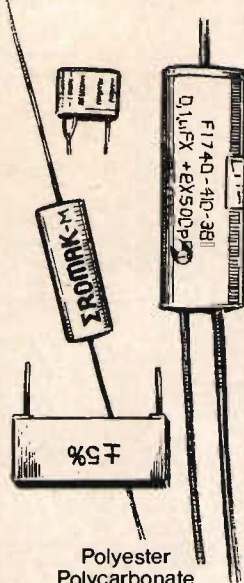

Polyester
Polycarbonate
Polypropylene
Mains RF Suppression
ENQUIRY No.173

CERAMIC FIXED & TRIMMER CAPACITORS

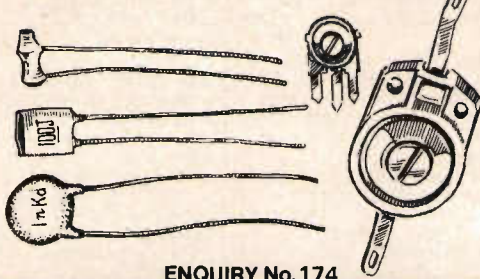

ENQUIRY No.174

SEMICONDUCTORS

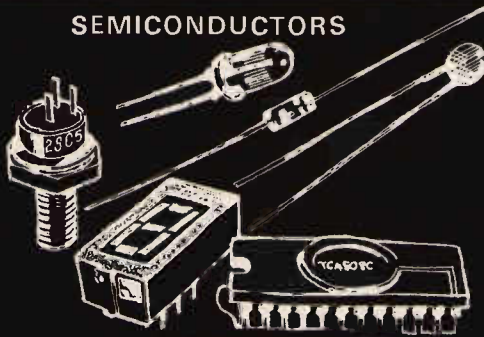

ENQUIRY No. 175

RFI SUPPRESSION DEVICES & INDUCTORS

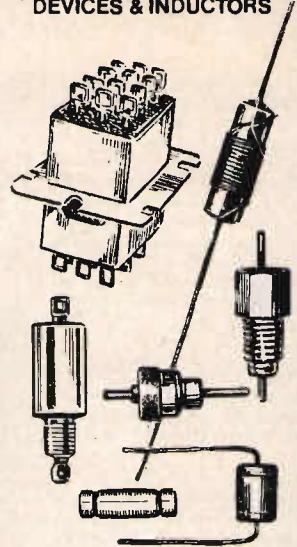

ENQUIRY No.176

MONOLITHIC CERAMIC CAPACITORS

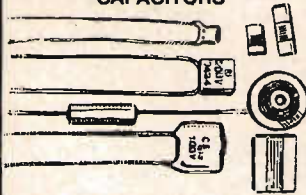

Moulded, Glass Encased
Resin Coated, Chips
ENQUIRY No. 177

CONDUCTIVE ELASTOMER PRODUCTS & COMPOUNDS



RFI Environmental Gaskets
Conductive Elastomeric Sheets
Conductive Compounds
Conductive Heat Shrinkable Shielding
Thermally Inductive Insulation
Keyboards

ENQUIRY No.178

FIXED & VARIABLE RESISTORS

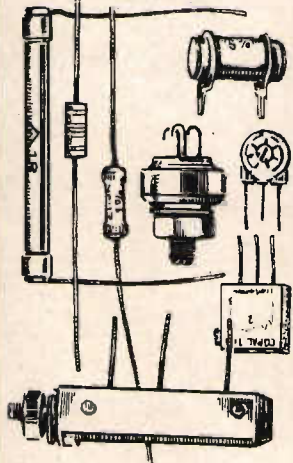

Solid Carbon
Carbon Film
Metal Oxide Film
Metal Film, Cermet
Precision Wirewound
ENQUIRY No. 179

Please circle the relevant enquiry numbers for further information on these products.

The Steatite Group of Companies
Hagley House
Hagley Road
Birmingham B16 8QW
Tel: 021 454 6961

ELECTROLYTIC CAPACITORS

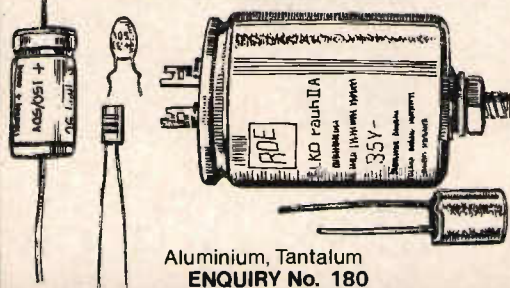

Aluminium, Tantalum
ENQUIRY No. 180

MAINS & SLIDER SWITCHES

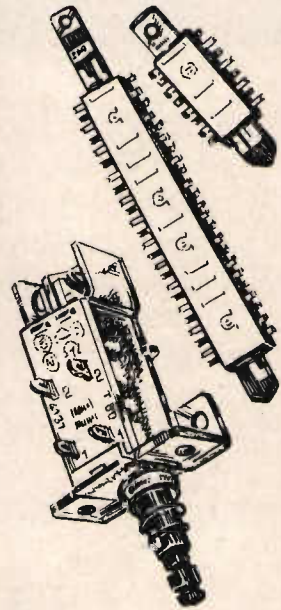

Single Section, Multi-banks
ENQUIRY No. 181

Please, note on your diary ...

31st march

1st april

2nd april

4th april

5th april

6th april

PARIS closed on Sunday 3

salon international des
**composants
électroniques 77**

4 sections : Components - Measurement
Raw Materials & Products - Equipement & Methods

an ever increasing number of visitors :
1974 - 57.000
1975 - 61.000 permanent entrance cards
1976 - 72.000

You must come to Paris again this year !

Further particulars and free entrance cards on request: FRENCH TRADE EXHIBITIONS
196 Sloane Street LONDON S.W. 1
☎ 235.32.34 - 235.32.35 ☒ 91 91 32 Francom Londres

Association of Certified Accountants

Incorporated by Royal Charter

finance and accounting diploma for engineers and managers

Ten-month part-time courses

As a specialist or manager you need an understanding of financial management and planning management accounting and an insight into taxation.

Acquire this expertise by studying for the Certified Diploma in Accounting and Finance (designatory letters CDipAF), a qualification specially designed for non-accountants awarded by the Association of Certified Accountants.

Many professional people have already received the Diploma Scheme with enthusiasm and it has been described by a Chartered Engineering Institution as '... invaluable for planning, controlling and measuring business in financial terms ...'

START NOW to study by the Association's own successful composite course based on correspondence study supplemented with five days of full-time personalised tuition.

To: The Secretary,
Certified Diploma Scheme (EMG1)
Association of Certified Accountants,
9 Museum House, Museum Street,
London WC1A 1JT (01-580 7179)

Please send me details of the Certified Diploma Scheme

Name

Address

.....
.....

By order of
Thorn Consumer Electronics, Ltd.

LIGHT ELECTRONICS FACTORY & OFFICES

31,300 sq. ft.

SOUTHEND-ON-SEA

TO LET or FOR SALE

Existing semi-skilled mainly female
labour force of about 350 could be
available.

Chamberlain & Willows

Estate Agents · Surveyors · Valuers
23 MOORGATE LONDON EC2R 6AX 01-638 8001

- Q** Does anyone know of a good engineering reference book?
- A** Yes. Kempe's Engineers Year Book.
- Q** What's in it?
- A** Everything you need to know about engineering.
- Q** Who's the author?
- A** It has a select team of contributors. All specialists in their chosen subjects.
- Q** Is it a new book?
- A** No. The 1976 edition is new. But it is the 82nd edition. Engineers have been using it for generations.
- Q** Doesn't that make it a bit old fashioned?
- A** Absolutely not. Every year the complete text is read, checked and updated.
- Q** I suppose it's terribly expensive?
- A** No. £14.50 for a two volume set in a presentation case.
- Q** It sounds exactly what I'm looking for. Where can I get a copy?
- A** From your local bookseller or direct from the publisher at the address below.

Kempe's Engineers Year Book
30 Calderwood Street
Woolwich, SE18 6QH

LIQUID CRYSTAL DISPLAYS

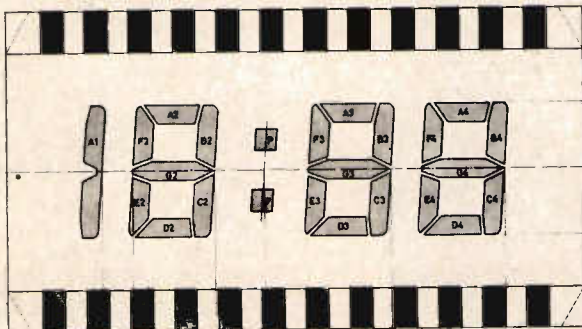

Electrovac LCD's - field effect, multicolour are available in production quantities, feature long life for a variety of consumer and professional applications. Full catalogue available from:-

JOSEPH ELECTRONICS LTD.,
Westminster House,
Stratford Road,
Shirley,
Solihull,
West Midlands B90 3AQ

Tel: 021 745 3251-2-3
Telex: 339325

ANTI STATIC PROBLEMS?



ANTI STATIC & CONDUCTIVE PLASTIC PRODUCTS
PLUS DESTATICIZING BLOWER FROM WESTCORP.

AVAILABLE FOR USE IN ELECTRONIC, ORDNANCE,
MEDICAL & ALL APPLICATIONS WHERE STATIC
ELECTRICITY IS A PROBLEM.

TELEPHONE:
BILLINGHURST (040 381) 3633
NIMROD ELECTRONICS LTD.
NIMROD HOUSE, BILLINGHURST,
WEST SUSSEX RH14 9QX ENGLAND



THE COMPLETE TEST FACILITY



Solving test problems requires modern, regularly calibrated test equipment and skilled staff. We sell both in one package. Our equipment, technicians, approved facilities and procedures are all yours when you use our services.

We collect your untested P.C.B.'s, test, repair and return them to you complete with test record and guarantee. It's the complete solution to your testing problems.

Our customers include many well known companies — and they know that our services save them money and cure their testing headaches all in one go.

So don't play expensive games with A.T.E. — spend a few pence to telephone us instead.

You've nothing to lose but your problems!



APPLIED DIGITAL DEVICES LTD.

36 Tewin Road, Welwyn Garden City, Herts AL7 1AH

Telephone: Welwyn Garden 33491

117 on enquiry card

The Daturr corner post: it's as long
and strong
as you want

(with apologies to Guinness)



Look at that section of the Daturr rack corner post—there's none stronger. As one customer said "We can rack our brains but we can't brain your racks". Made in 7 standard heights, from 14U to 44U, and 4 standard depths, the Daturr steel rack takes some beating.

As well as the welded version there's a knock-down type too.

For lighter applications try the *new* all-aluminium rack. It's made in 35 sizes.

Daturr Limited, Market Road, Richmond, Surrey, TW9 4NE
Telephone 01-876 0589/6244 Telex 929949

CLASSIFIED

telephone:
01-855 7777

CAPACITY

SUB-CONTRACT CAPACITY

Our modern facilities are available under qualified engineering management for:—

- P.C.B Assembly
- Electro-Mechanical Assembly
- Cableforms
- Sheet metal and Press Work
- Coil-Winding

Production Engineering & Electricals (Southern) Ltd.,

Boden Street, Chard, Somerset TA20 2AH
Tel: Chard (046-06) 4211



APPOINTMENTS

ENGINEERS

WANTED:

CE, ME, AND EE with Ph.D or MS Arabic language required. Write to Royal Scientific Society P.O. Box 6945. Amman — Jordan.

PRINTED CIRCUITS IN THE MIDLANDS

We have capacity for the manufacture of Printed Circuit Boards, single or double sided. Hard Gold Plate and machined to any shape required. We specialise in giving Good Fast Service for Short Runs. One off Prototype Service from receipt of 2X Artwork. Glass Fibre only. No through hole plating, please.

DIKTRON DEVELOPMENTS LTD.

5 Highgate Square, Birmingham B12 0DR
Telephone: 021-440 1321-2

STRIPPER FOR HIRE !

Your free issue wire cut and stripped from 75p per 1,000 leads, tinning facility also available.

Printed circuits assembled. Cable looms and complete equipment manufactured to order. Wire supplied and cut, a quotation will cost you nothing from:—

Hamer & Emmins Ltd., Deseronto Wharf, St. Mary's Road, Langley, Bucks.
Tel: Slough 75-46760 or 46769.

WANTED

ROTARY SCREENING MACHINE WANTED

Second-hand rotary screening machine for CRT manufacture, preferred size 12 or 18 head but larger machine would be considered for modification. State price required together with condition and whether dismantled or stored.
Box No. EE 1305

BUSINESS OPPORTUNITIES

RECORDED ANNOUNCEMENTS

Advertiser wishes to contact firm interested in commercialisation of recorded announcements idea. Applications to process control, lifts, crowd control, security, etc.

Box No. 1304.

CAPACITY AVAILABLE

For electronic wiring, P.C.B. assembly, (Batch-work & Prototype) Test and light engineering if required.

SWIFT AND ACCURATE SERVICE. USING ONLY EXPERIENCED PERSONNEL. SUPERVISED BY SENIOR GRADE TECHNICIANS

Contact:—

Appleton Audio Services Ltd., Electronic Engineers, 66 Silvester Road, London SE22.
Tel: 01-693 5051.

SERVICES

SYSTEM ENGINEERING ELECTRICAL, ELECTRONIC AND MECHANICAL

HAVE YOU A PROBLEM?

- Interfacing Equipment
- Equipment requiring production engineering
- Prototype manufacture
- Specialized test rigs

We have a group of highly trained Electronic and Mechanical Design and Production Engineers.

MAIN CONTRACTORS TO M.O.D.

A.P.T. RADAR SYSTEMS LIMITED,

Chertsey Road, Byfleet, Surrey.

Tel: BYFLEET 41131

Telex 262525

Member of E.M.C. Group of Companies

SERVICE TO TRADE AND INDUSTRY

Nameplates, control panels, Labels, badges of all descriptions, in all materials. Cast in metal, injection moulded in polystyrene, silk screen printed on aluminium (and other materials), hot-blocking, engraving.

Also industrial gift and trade promotions. Gift items available including decimalisation conversion tables. Literature on request.

I. Markovits Ltd., 1/2/3 Cobbold Mews, W.12.
Tel.: 01-743 1131/2 1313

PUBLICITY AND TECHNICAL PRINTING for the Electronics Industry Design, Single and Multi-colour Printing

Write or 'phone: Stan Peddle, MD CREATIVE PRESS (Reading) LTD.,

42 Portman Road, Reading, Berks.
Tel: 0734 55388

ELECTROCIRCUITS (P.C.) LTD., DELAMARE ROAD, CHESHUNT, HERTS. EN8 9UB

Manufacturers of P.C.B's Thro' hole plated Conventional, gold plating, All or part service

Tel: Waltham Cross 38600 or 20344, for leaflet or ask for quotation.

ARTWORK & PCBs

from Specialist Manufacturer 1 off or 10,000

LORMAY LTD

Wappenham Blakesley
Towcester (032-732)
Northants 209

Circle 121 on enquiry card

DESIGN & DEVELOPMENT

Competent engineering effort available for all aspects and levels of electronic design. Single circuits or complete systems to production stage.

INTEK ELECTRONICS LTD.

4 Lowfield Lane, Hoddesdon, Herts.
Tel. Hoddesdon 62053

ERKO limited

SUBCONTRACTORS TO THE ELECTRONIC INDUSTRY

Capacity available for comprehensive production service under qualified engineering management.

For enquiries relating to PCB assemblies; cable forms; panel and switch wiring; testing; sheet metal work, contact:

ERKO LTD.

Thameside Industrial Estate, Silvertown, London E16.

Tel: 01-511 0877 or 01-511 0725



LAMPS

SWITCH, TELEPHONE, MICRO-MIDGET, AND SMALL INDICATORS.

COMPONENT SERVICES LTD., South St., Hertford, Herts.
Tel: Hertford 57766

Circle 120 on enquiry card

FOR SALE

ENAMELLED COPPER WIRE

swg	1 lb	4oz	2oz
14-19	2.40	.69	.50
20-29	2.45	.82	.59
30-34	2.60	.89	.64
35-40	2.85	1.04	.75

inclusive of p&p and VAT
SAE brings Catalogue of copper & resistance wires in all coverings
THE SCIENTIFIC WIRE COMPANY
PO Box 30, London E4 9BW 6243

PLEASE RING 01-855 7777 EXT. 2016 TO PLACE YOUR ADVERTISEMENTS

Engineers and Programmers a career in Microcomputers with **CAP/MicroSoft**

The CAP Group, CAP MicroSoft's parent, was established in 1962 and has a uniquely successful record of growth to its current position of the UK's largest independent software house. The main group activities have been the implementation of systems for computer users ranging from large on-line financial systems to advanced technology projects in such fields as avionics and process control. The group employs over 500 professional staff at present.

CAP MicroSoft was formed earlier this year to extend our services into the microprocessor field. CAP was the first group in the country to take this step and is now expanding further to meet present demands. Areas of work include a variety of client projects from feasibility studies to system implementations, development of software and hardware components for development systems, and data communication networks for distributed processing applications.

Engineers

A number of vacancies exist for engineers with at least 2 years' industrial experience to work on microcomputer systems. It is expected that applicants will be currently designing systems using MSI/LSI Logic or alternatively working in the minicomputer interfacing area. Applicants should have done some programming, although not necessarily of microcomputers.

Graduate Membership of an appropriate institute is desirable.

Salary to £5,000

Programmers

A number of vacancies are also available for programmers with two or more years' experience to work on microcomputer projects.

It is expected that applicants will be currently working with minicomputer systems, probably in the system software area. Some interest or background in electronics would be an asset although the prime requirement is an interest in microcomputers.

Salary to £4,150

These posts will be based initially in our Reading office and there will be some opportunity for travel. In any new operation such as CAP MicroSoft, the willingness to be flexible as the company develops will be looked for but the well developed career plan mechanisms applicable throughout the CAP Group will apply and all opportunity for promotion will be given.

All staff get 4 weeks holiday and other benefits include staff mortgage service, group health insurance and a two-tier pension scheme. Senior staff may be offered CAP shares in this staff-owned Group.

If you would like to apply, write to the address below quoting the relevant reference. (EE.1116)

A.V.W. Knott,
Assistant Personnel Manager,
Computer Analysts and Programmers Ltd.,
CAP House, 14-15 Gt. James Street,
London WC1N 3DY.

CAP Britain's largest
independent software house

London, Reading, Manchester and Overseas

Substantial Japanese instrument company requires sub-agents to franchised U.K. distributor in all European countries with OEM and/or direct marketing experience preferably covering panel meters, instruments and amateur radio equipment.

BOX No. EE 1307.

THE UNIVERSITY OF LANCASTER

DEPARTMENT OF ENVIRONMENT SCIENCES EXPERIMENTAL OFFICER IN ELECTRONICS

The successful candidate will undertake the design, construction and operation of electronic equipment of a geophysical nature and be responsible to Dr. McIlveen. This is a 2-year appointment.

Salary scale £2,776 - £4,602 (under review).

Further particulars may be obtained, quoting reference L58/A from the Establishment Officer, University House, Lancaster LA1 4YW to whom applications (5 copies) naming three referees should be sent not later than 5 January 1977.

YOU CAN REACH OVER 100,000 READERS WITH AN ADVERTISEMENT ON THESE PAGES

ZENITH MAINS VOLTAGE STABILISERS

Mains voltage variation, for any reason, will affect production, measurement and control.

The Zenith ranges of Powerstay Automatic Voltage Stabilisers or VST Voltage Stabilising Transformers correct mains supply variations and provide accurate, reliable and steady mains voltage accurate to 0.5% from mains supplies varying by up to 30% for loads from 8VA to 366 kVA.

Response is fast—no knob twiddling or meter watching. Send for details now.

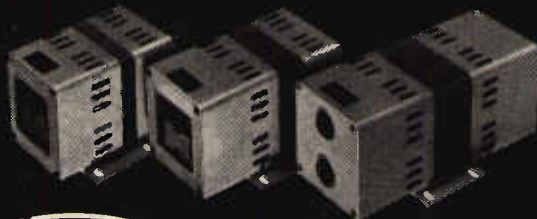
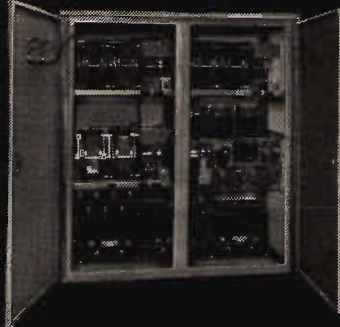

ZENITH
POWER CONTROL

The Zenith Electric Company Ltd.
Wavendon, Milton Keynes MK17 8AT
Telephone: Woburn Sands (0908) 582531
Telex: 825020

VS 9/75

SILVER SAVINGS?

Electro-conductive silvered
plain and hollow glass beads

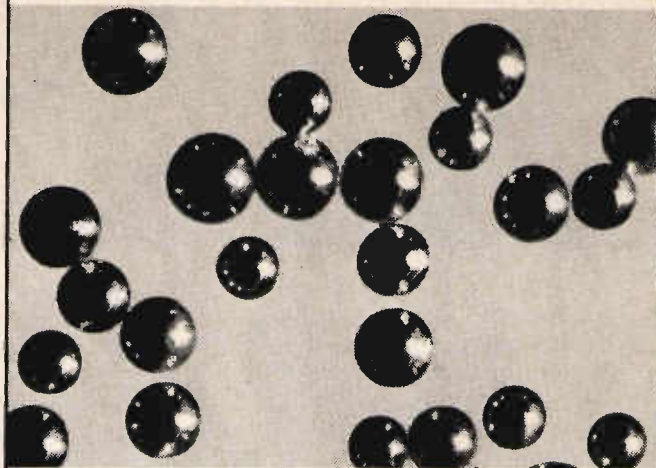

low cost conductive resin gaskets, seals, adhesives, coatings, greases and inks for:

- RF shielding and electrostatic control
- component lead termination
- printed circuits repairs, etc...

SOVITEC S.A.,

Glass beads experts for 20 years

19-21/4, rue Léopold, BP 39, 6000 Charleroi, Belgium
tel.: 071/31.23.16 telex: Svitec b 91447

INDEX TO ADVERTISERS

Allen Bradley Electronics Ltd	3	Harwin Engineering Ltd	64	Plessey Windings Ltd	8
Alma Components Ltd	6	Hellermann Electric Ltd	92	Pye Connectors Ltd	98
Amphenol (UK) Ltd	100	Hellermann Insuloid Ltd	32C	Pye TMC Components Ltd	117
Ancom Ltd	70	Hengstler (GB) Ltd	32	Pulse Engineering Ltd	64
Applied Digital Devices Ltd	125	Hewlett Packard Ltd	OBC, 76	RIFA	22
Association of Certified Accountants	123	Highland Electronics Ltd	97	Radiatron Components Ltd	92
Astralux Dynamics Ltd	94/95	Hollingsworth Terminals Ltd	114	Rosemount Engineering Ltd	32D
Augat Ltd	101	Honeywell Ltd	90	Roxburgh Electronics Ltd	86
Aviation Electrical & Radio Co Ltd	86	Houseman Hegro Ltd	101	SDSA	123
Aviquito (Great Britain) Ltd	102	Hunting Hivolt Ltd	80	SE Labs (EMI) Ltd	9, 23
Barr and Stroud Ltd	10	ITT Components Ltd	15, 18	Sanwa Electric Instrument Ltd	119
Bauch, F W O Ltd	102	ITT Instrument Services Ltd	24	Sasco Ltd	20
BICC-Burndy Ltd	104/105	Imhof Bedco Ltd	18	Smiths Industries Ltd	106/107
Bryans Southern Instruments Ltd	10	Industrial Instruments Ltd	115	Solartron Ltd	38
Bulgin, A F & Co Ltd	86	Intel Group Ltd	109	Souriau (UK) Ltd	88
Burr Brown Research Group	12	International Rectifier Ltd	63	Sovitec, SA	128
Cetronic Ltd	70	Invader Components Ltd	114	Spectra-Tek (UK) Ltd	22
Chamberlain & Willows Ltd	124	Joseph Electronics Ltd	124	Sprague Electric (UK) Ltd	83
Comark Electronics Ltd	Insert	Kenure Developments Ltd	84	Steatite Insulations Ltd	122
Cosmocord Ltd	116	Lane, F C Ltd	Insert	Technical Tapes Ltd	12
Dana Electronics Ltd	57	Lemo Ltd	Insert	Teledyne Semiconductors Ltd	48
Data Precision Ltd	32B	Linstead Manufacturing Co Ltd	114	Teledyne Philbrick Ltd	78
Datron Electronics Ltd	33	Littelfuse (GB) Ltd	78	Telford Development Corporation	58
Daturr Ltd	125	Lyons, Claude Ltd	32D	Teradyne Ltd	80
Devices Instruments Ltd	82	Lyons, Instruments Ltd	111	Texas Instruments Ltd	35
Dow Chemicals Ltd	81	McMurdo Ltd	40	Thomas & Betts Ltd	IFC
ENI Power Systems Ltd	72	3M (UK) Ltd	32A	Thomson, C S F Ltd	11
Electro Match Ltd	84	ML Components Ltd	96	Tranchant Electronics (UK) Ltd	82, 119
Electroplan Ltd	52	Memec Ltd	Insert	Ultra Electronic Components Ltd	39
English Electric Valve Co Ltd	120/121	Metway Ltd	85	Varelco Ltd	IBC
Erma Ltd	32B	Molex Ltd	110	Vero Electronics Ltd	85
Exel Electronics Ltd	14	Mullard Ltd	50/51	Viking Industrial Ltd	108
Ferranti Ltd	112/113	Nimrod Electronics Ltd	124	Vision Engineering Ltd	90
French Trade Exhibitions	123	Optima Enclosures Ltd	118	Vitality Ltd	70
Fylde Electronic Products Ltd	14	Oxley Developments Ltd	116	Wavetek Ltd	16
GEC Semiconductors Ltd	68	Panduit Ltd	84	Waycom Ltd	46, 66
General Instruments Ltd	28	Pell, Oliver Ltd	30	Westinghouse Brake & Signal Ltd	37
Gould Advance Ltd	34, 71	Plessey Connectors Ltd	87	Wilmut Breedon Electronics Ltd	2, 36
Gresham Lion Ltd	56	Plessey Microsystems Ltd	13	Wingrove & Rogers Ltd	99
				Zenith Electronic Co Ltd	128

our modular connector enables you to make only the contacts you want to accept.

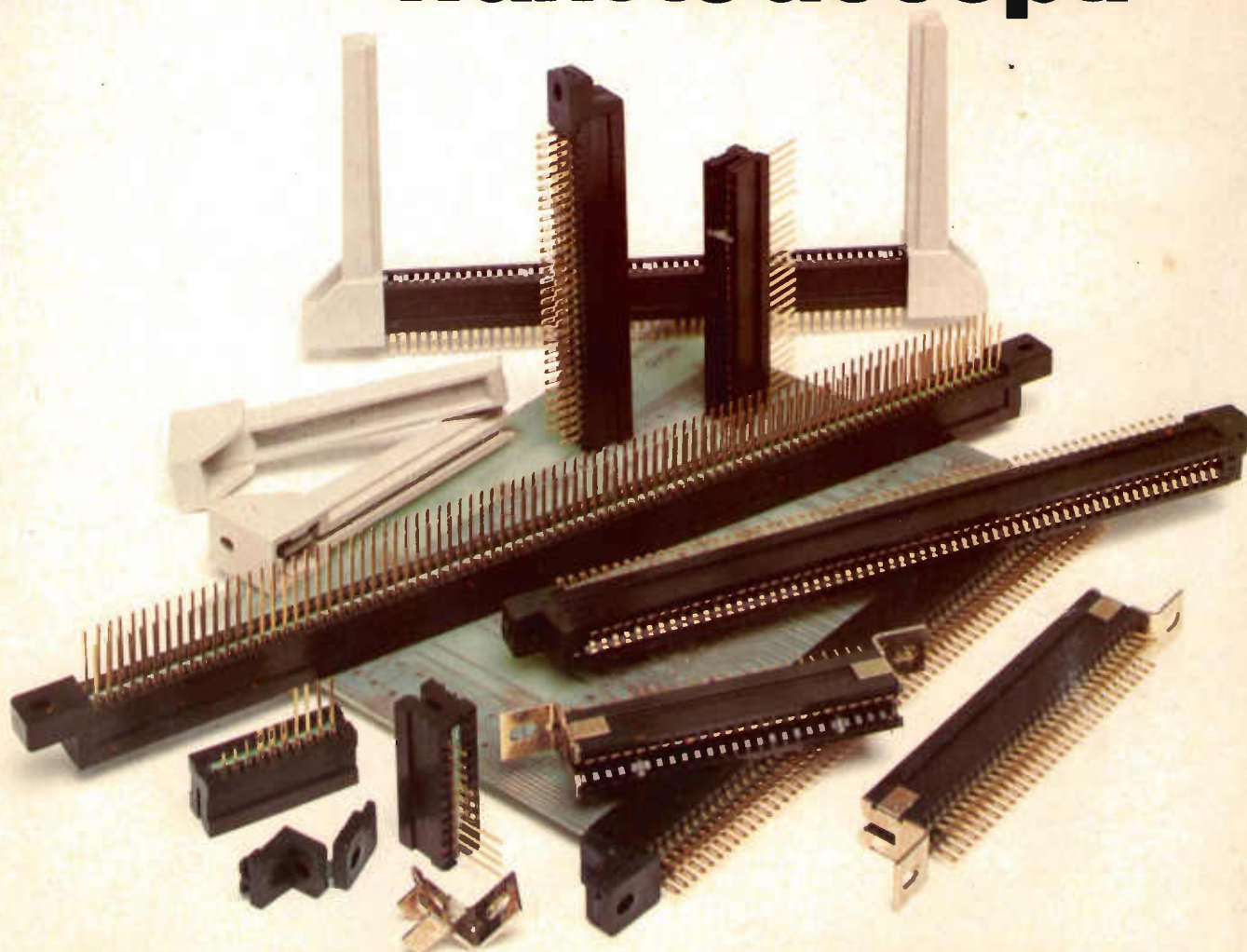

Varelco's Series 6072 Modular Connector is the one with all the options. Look at the variations available to suit your specification. Up to 89 contacts in a single row or 178 in the dual configuration. So, when you state the number of contacts, you determine the length of moulding. You want polarisation? No problem. A choice of two keying inserts, one uses the contact position, the other, the between-contact position, so no loss of contacts.

Terminations? You have a choice of mini wire-wrap posts, solder eye or P.C. terminals. And, in accordance with the accepted high standards of Varelco, contacts are of phosphor bronze, gold plated in nickel. Contact rating – 3 amperes, contact resistance – 10 milli-ohms.

Which only leaves the mounting and, again, the choice is yours. Full lengths are available with integrally moulded plastic lugs, but for shorter

lengths there are supplementary mounting flanges in plastic or metal, and the metal version provides an open card slot feature. Or you can choose an extended card guide with integral lug.

That's the Series 6072, another cost-effective connector from Varelco; the modular connector with all the options to enable you to make only the contacts you really need.

"GREAT CONNECTIONS . . . WORLDWIDE"

Varelco Limited
Exning Road Newmarket Suffolk England CB8 0BB
Tel: Newmarket 4516 Telex: 81519



**Varelco
Limited**



Super-bright colours in a wide variety of packages

Hewlett-Packard's super-bright LEDs, using the latest transparent substrates and nitrogen doping technology (TSN), are up to 5 times brighter than those using conventional GaAsP on GaAs and come in four colours with dominant wavelengths (λ_D) of approximately 640 nm (deep red), 625 nm (orange-red), 585 nm (amber-yellow), and 570 nm (green).

With this new technology HP can offer an unexcelled range of LED lamps: T-1s and T-1 $\frac{3}{4}$ s, normal and low-dome, miniature and arrays, rectangulars, IC-LEDs, R-LEDs, hermetic (JAN, JANTX), narrow beam, clear, diffuse, etc.

For immediate delivery please contact our distributors.

Celdis Ltd., 37-39 Loverock Rd., Reading, Berks RG3 1ED. Tel: Reading 582211.

GDS Sales Ltd., Michaelmas House, Salt Hill, Bath Road, Slough, Berks SL13 3UZ. Tel: Slough 31222.

Macro Marketing Ltd., 396 Bath Road, Slough, Berks. Tel: Burnham 63011.

Or, for further information, write to us direct.

HEWLETT  PACKARD

Sales and service from 172 offices in 65 countries. Winnersh, Wokingham, Berks. RG11 5AR. Tel: Wokingham 784774.