

ELECTRONIC ENGINEERING

VOL. 27

No. 330

AUGUST 1955

Commentary

THERE can be few developments which, judged by their impact on human affairs, have progressed so rapidly as has the science of aeronautics during the last half century. During that relatively short space of time we have travelled from the balloon and man-lifting kite to the supersonic jet aircraft of today and much of the credit for this rapid development, as far as British aviation is concerned, must be given to the Royal Aircraft Establishment at Farnborough whose Golden Jubilee was celebrated last month.

The occasion was marked by a three-day Exhibition and Flying Display demonstrating the history of British aviation over the past fifty years and providing, at the same time, a glimpse into the future.

To many of us "Farnborough" brings to mind the spectacular flying display of the Society of British Aircraft Constructors which has become such a feature of the post war years, but only those intimately connected with aeronautics are aware of the activities taking place in the sprawling buildings near the runway which form the home of the Royal Aircraft Establishment.

Farnborough was born just fifty years ago, for it was in 1905 that the War Office moved its Balloon Equipment Store from Woolwich to the open spaces of Farnborough Common where the early pioneers of the heavier-than-air machines were beginning to launch their hesitating and unpredictable contraptions into the sky. Impressed by the efforts of such men as J. W. Dunne and S. F. Cody, the War Office came to the conclusion that these flying machines might have some advantages over the balloon for military purposes and accordingly formed the Farnborough Air Battalion which later became the Royal Flying Corps. And so was founded what later became the Royal Air Force.

At that time there was no aircraft manufacturing industry as such and the Balloon Factory was transformed into the Royal Aircraft Factory whose task it was to produce the aircraft required for the Royal Flying Corps up to and during the first World War.

In 1916 it was decided that the proper function of Farnborough was to learn how aircraft should be designed and flown and that the machines themselves should be made by the rapidly expanding aircraft industry, and it was then that the Society of British Aircraft Constructors was formed. The Royal Aircraft Factory eventually became the Royal Aircraft Establishment, "The nerve centre of our efforts in the air" as Sir Stafford Cripps described it, and thus were laid during the inter war period, the firm foundations for that close collaboration which exists between the R.A.E. and industry.

The same period marked the beginnings of the science of aeronautics and the angular biplanes of 1918 gave way to

the beautifully streamlined monoplanes of which the Hurricane and the Spitfire were the classical examples.

Meanwhile, at R.A.E., radio engineers were preparing a major contribution to the shape of things to come by the successful design of new v.h.f. radio communication systems which, together with the newly developed radar, played such a vital role in the Battle of Britain. Much work was also done by them on radio control methods for pilotless aircraft out of which has grown the present day techniques of guided missiles.

Since the last war the pace of aeronautical development has quickened enormously due principally to the advent of the jet engine and it is only as we look back over the past fifty years that we realize the tremendous advances that have been made. The year 1908 saw the first official British flight when S. F. Cody, at Farnborough, flew for a measured distance of 496 yards at an estimated height of 50 to 60 feet and it was in the following year that Bleriot made his historic crossing of the English Channel. How insignificant these appear in the light of today's achievements when no place in the world is out of reach of the aeroplane.

The aeroplane of today flies almost at the speed of sound for thousands of miles and as an instrument of war it is probably the most deadly weapon man has invented.

But, fortunately, not all the activities of Farnborough and elsewhere have been concentrated on the military potentialities of the aeroplane and there is at the moment the faint glimmer of hope for a better understanding among the nations. In its more peaceful role the aeroplane has provided a speedy and safe form of transport and as such has conferred benefits on mankind. It has annihilated distance to such an extent that a journey of a few hundred miles takes less time than the journey to the airport by earth bound transport.

As we stand at the dawn of the next fifty years a most exciting era spreads before us, the shape and form of which no one can accurately predict. The sound barrier has already been broken and soon flights across the world at supersonic speeds will be as commonplace as the hop from London to Paris. In this respect, Sir George Thomson thinks that "four times the speed of sound will be enough; more would be showing off".

New forms of propulsion and our increasing knowledge of guided missiles open up the prospect of journeying into outer space and in the next fifty years we may succeed in journeying to our nearest neighbour the moon and inspecting the face she has for so long hidden from us.

These things and more are but the shape of things to come and they may well be practical realities by the time the R.A.E. celebrates its centenary. In the meantime, one dares to hope that however much faster, higher, further the future aeroplane goes, it will do so with far less noise than it does today.

A Commercial Electronic Calculator

By W. Woods-Hill*

Electronic calculators are moving from the laboratory stage into mass-producible machines suitable for business accountancy. The following is a description touching briefly on the main features common to three types of such machines, and attempts to describe how these are made to perform the four basic arithmetic functions.

THE arithmetic unit described in a previous article¹ has been used as the nucleus of three different types of electronic calculating machines: Type 542, Type 550 and Type 555.

The first of these has been called a multiplier because it was designed to process data for payroll (P.A.Y.E.) and stores, all of which involve numerous multiplications of hours or quantity, by pounds, shillings and pence; tons, hundredweights and quarters, etc. This machine was capable of three basic arithmetic functions—multiplication, addition and subtraction, plus other special features required on P.A.Y.E., but not division. Its main features are listed under Table 1(a).

The second, type 550 calculator has division as a built-in sub-routine an extra register in the arithmetic unit and as shown by Table 1(b), thirty-six programme steps.

The third, type 555, as yet not in production, is an advanced version of the last two, involving some 1 300 valves, magnetic drum storage and some special alterations to the Hollerith card feeding mechanism, which allows about six times the calculating time between successive cards (with cards feeding continuously) i.e. 535 primary cycles as against 75. This last machine fringes on the computer field and will be suitable for payroll and accounting work and yet be capable of performing scientific or statistical computations during off-peak periods.

Logical Sequence

Excluding the mechanical card feeding and punching mechanism, the calculator sub-divides quite naturally into five parts; Fig. 1.

- (1) Input-Output buffer stores.
- (2) Main Storage Unit.
- (3) Arithmetic Unit.
- (4) Electronic Sub-routines.
- (5) Control Unit.

Numbers obtained from the punched card mechanism are loaded in bulk into the input buffer and from there transferred to main storage. As and when they are required, these numbers are selected and transferred to the arithmetic unit. Results of these arithmetic operations are fed back to the main store and when all have been processed, shifted in bulk back to the output buffer. The shifting of numbers in bulk is automatic and requires no programming.

The need for input-output buffers can be readily understood when it is realized that calculation is going on during the entire card sensing and punching process and therefore the main storage unit is fully occupied in supplying numbers to the arithmetic unit. That is, at any given time (except for a short period between cards):

- (a) The input is receiving new data
 - (b) The *AU** and *MS** is processing existing data
 - (c) The output is feeding-out previously processed data
- **AU* = arithmetic unit **MS* = main storage.

All these processes are, of course, being controlled by the control unit and sub-routines.

Control Board

The sequence of arithmetic operations to be performed such as transfer of numbers to and from *MS*, which sub-routine \times , \div , $+$, $-$, and the entire set of instructions

TABLE 1

| INPUT-OUTPUT | ARITHMETIC UNIT | STORAGE | MAIN SUB-ROUTINES | PROGRAMME STEPS | PRIMARY CYCLES AVAILABLE AT FULL 100 CARDS/MIN. |
|---|---|--------------|--|-----------------|---|
| (a) Type 542— 238 80 column Hollerith Punched Card Gang Punch | Three registers 14-14-9 Decimal digits | Five words | Multiplication \pounds .s.d. Decimal Addition Subtraction Column Shift Divide \pounds .s.d. by ten Compare | 30 | 75 |
| (b) Type 550— 239 80 column Hollerith Punched Card Gang Punch | Four registers 10-10-10-10 Decimal digits | Six words | As above, plus Division \pounds .s.d. \div \pounds .s.d.; \pounds .s.d. \div Decimal, Di- vision decimal \div decimal | 36 | 200 |
| (c) Type 555— 240 80 column Hollerith Punched Card Gang Punch | Three registers 10-10-10 | 100 words | As 550 | 120 | 535 |

* The British Tabulating Machine Co. Ltd.

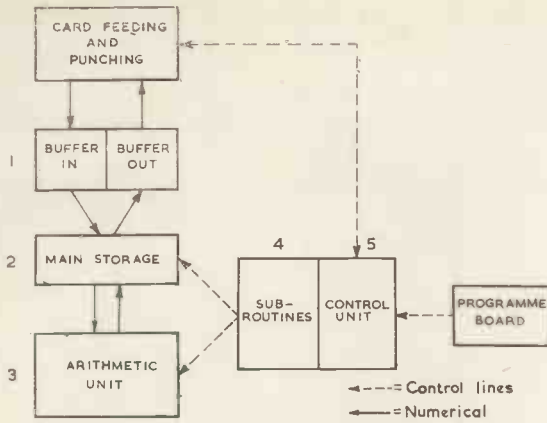

Fig. 1. The five sections of the computer

required to make the machine perform its programme, is set up on a "control panel" consisting of 2 100 sockets into which are plugged patchcords similar to telephone jack plugs, but only 1in long by 1/8in wide. The control board is, in fact, only a mask about 1/2in thick with sockets on the front connected through to contacts on the back. These make contact, when the mask is inserted into its holder, with a similar number of springs which are fixed to the frame of the machine and wired to the appropriate points of the circuit.

Fig. 2 shows a drawing of a section of this "mask" or plugboard, with one patch cord plugged-in. This arrangement enables new programmes to be plugged-up on spare boards, and inserted in place of a previous programme in a matter of seconds.

Schematic

The block schematic of the machine (less control unit) is shown in Fig. 3.

At the top are the input-output buffers, below this the main storage unit and the remainder, the arithmetic unit, consists of registers, 1, 2 and 3, divide by two, multiply by two, add and complementer. All these are interconnected by three highways, *A* and *B* on the left and *C* on the right. *A* and *B* are known as the "from" highway, and *C* as the "to", because any number contained in any register or storage position, must be run out "from" its present address along *A* or *B* via the adder and complementer

Fig. 2. Section of a plugboard

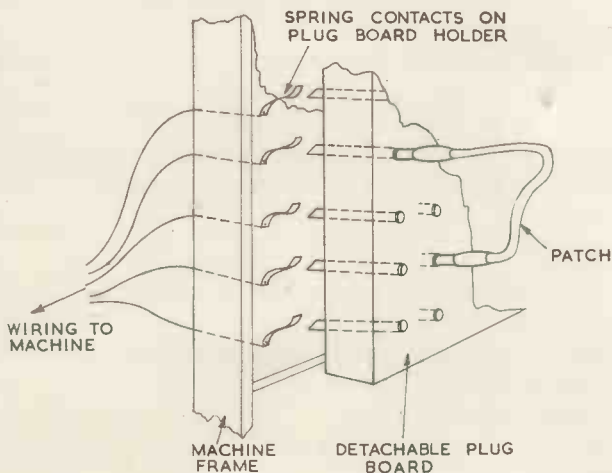

along *C* "to" its future address. The usefulness of having numbers automatically routed via the adder like this is apparent during programming because the two most commonly used instructions in most calculations, add and transfer, need not be programmed on this machine.

For example, to add the contents of register 1 to that of register 2 and place the sum in register 3 ($X + Y = Z$) one needs but specify:

From R_1 on *A*
 From R_2 on *B*
 To R_3

which is three plugs.

"On *A*, On *B*", is simply specifying which highways each number should use.

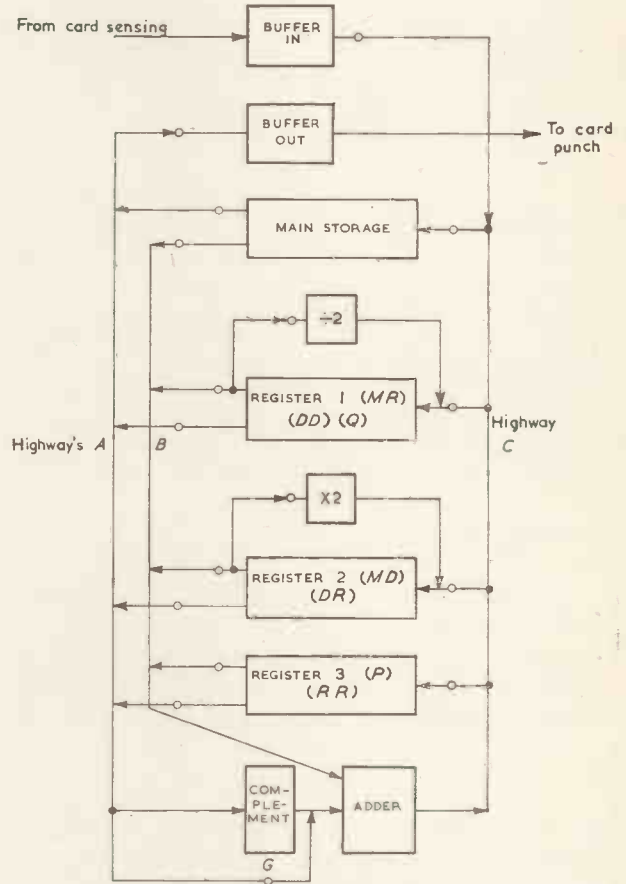

Fig. 3. Arrangement of the machine

This operation would only require one primary cycle, i.e. one addition time because the contents of R_1 and R_2 appear at the same time, on both highways, merge and add in the adder, the sum appears simultaneously on *C* and runs into R_3 .

To transfer R_1 to R_3 is the same as saying $X + 0 = X$ which involves the same instruction as before, but the address of R_2 is left out, i.e.:

From R_1 on *A*
 To R_3

From the foregoing it can be seen that the machine is based on a multi-address code, though the word code is not strictly applicable to a plugboard controlled machine.

To subtract R_1 from R_2 and place the result in R_3 requires the same routine as addition but with one extra instruction "Complement".

i.e. From R_1 on A
 From R_2 on B
 To R_3
 Complement

The effect of instruction "Complement" is to remove the by-pass around the complementing circuits (gate G Fig. 3) so that they are now brought into effect. This automatically translates any number from "true" at its input terminals to its 10's complement at its output and passes it on to the adder. That is: $-3 + 5 = 2$ would become (complement of 3 is 7), $7 + 5 = 12$ ignoring the one carry the answer is correctly 2.

Though all examples have shown numbers being drawn from registers, the same principle of addressing applies if one of the factors is drawn from the main storage.

i.e. From $MS17$
 From R_2
 To R_3

Multiplication

Because of the inherently complex sequence of events, multiplication is controlled by a sub-routine which takes charge of the whole affair and is simply called into life by one instruction plug, "Mult". As explained in a previous article¹, multiplication is done by doubling the multiplicand (register 2) and halving the multiplier (register 1) simultaneously, and at each stage, transferring the contents of the multiplicand (R_2) out to the product (register 3) if, and only if, the value in R_1 is an odd number at that stage.

For example:

$$8 \times 3 = 24$$

| $MR(R_1)$ | $MD(R_2)$ | $PROD(R_3)$ |
|--------------------|----------------|---------------|
| 8 (even) | 3 | No transfer 0 |
| Halve 8 = 4 (even) | Double 3 = 6 | No transfer 0 |
| Halve 4 = 2 (even) | Double 6 = 12 | No transfer 0 |
| Halve 2 = 1 (odd) | Double 12 = 24 | Transfer → 24 |
| | | 24 |

In this example no transfer to product occurred until the last cycle, but a different multiplier value could have produced partial products which accumulating in the product register would produce the right answer on the last cycle. The need for $\times 2$ and $\div 2$ boxes is now clear. This system is equally applicable to irregular scales of notation such as £ s. d., t. cwt. qtr., Rupees, Annas, Pies, as long as these are entered into the $MD (R_2)$ register.

Because the growth of numbers follows a geometrical progression, the answer to quite large multiplications take a surprisingly few cycles. For instance, the answer to $999\ 999\ 999 \times 999\ 999\ 999$ would take 33 addition times (cycles).

Divide by Ten Circuits

Because the MR is only capable of multiplying by whole numbers and ignores any decimal points, the product of $10.5 \times £1\ 0\ 0$ will appear as $£105\ 0\ 0$ and must be divided by ten to give the correct answer.

Had there been two figures to the right of the decimal point, divide by ten would have been carried out twice $\times/100$,

three figures = $\times/1\ 000$ etc.

Note that this does not simply involve one column shift, but a different set of figures.

This is achieved by making use of the $\times 2$ box and the adder in the following way. The relation between pounds sterling and $\frac{\text{pounds sterling}}{10}$ is:

| |
|---------------|
| £1 ÷ 10 = 2/- |
| £2 „ = 4/- |
| £3 „ = 6/- |
| £4 „ = 8/- |
| £5 „ = 10/- |
| £6 „ = 12/- |
| £7 „ = 14/- |
| £8 „ = 16/- |
| £9 „ = 18/- |

That is, the figure of pounds times two expressed in shillings (shifted to the shillings column) is the correct answer.

A similar relation exists between shillings and $\frac{\text{Shillings}}{10}$

| | d. |
|-----------------------------------|----|
| 1/- ÷ 10 = 1.2 | |
| 2/- „ = 2.4 | |
| 3/- „ = 3.6 | |
| 4/- „ = 4.8 | |
| 5/- „ = 6.0 = 5 + 1.0 = 5 + 10/10 | |
| 6/- „ = 7.2 = 6 + 1.2 = 6 + 12/10 | |
| 7/- „ = 8.4 = 7 + 1.4 = 7 + 14/10 | |
| 8/- „ = 9.6 = 8 + 1.6 = etc. | |
| 9/- „ = 10.8 = 9 + 1.8 | |

that is, the figure of shillings expressed in pence plus twice the same figure expressed in tenths of a penny.

Note that though the sequence of tenths of pence appears to break at 5/-, the figures (grouping the pence with the decimals of pence) remain truly twice the figures in the shillings column. Thus it suffices to make use of already existing doubling and adding circuits and arrange that correct column shifts occur while the £ and 1/- are moving through the adder to achieve the division of sterling values by ten. The time taken to divide the contents of a register by ten, once, is one addition time.

A second use of the divide by ten arrangement is to break £ s. d. down to pence, i.e. $\frac{£10\ 10\ 0d.}{1\ 000} = £00\ 0\ 2.520d.$,

ignoring the decimal place gives 2 520 pence. As explained later, this feature is used when sterling by sterling division is required.

Division

Division is also controlled by a sub-routine marked "div."

The principle used is straightforward over and over subtraction with decimal column shift.

To divide 248 by 124 = 2

Place 248 in R_1 with its highest digit ready to come out on to highway B .

Place 124 in R_2 with its lowest digit ready to come out on highway A (Fig. 3).

This is equivalent to placing the numbers like this:

(R_3) 0000 00248 (R_1) (Q)
 12400 (R_2)

Now by making use of the complement box attempt to subtract R_2 from R_1 and place the result in R_3 . The result is immediately a negative (12400 into 00248 will not go, but to find this out the machine had to make the subtraction) so as soon as the number in R_3 goes negative, add back once to restore.

Clock up zero in the Temporary Quotient counter (this is a simple one stage device in the control unit) and shift contents of R_1 up one decimal place.

The numbers now look like this:

(R_3) 0000 02480* (R_1) $(Q) = 0$
 12400 (R_2)

The zero clocked up in the Temporary Quotient counter must be moved out to make room for a possible input during the next series of subtractions. There is no need for a fourth register to hold this quotient because a blank digit position (marked with an asterisk) has been provided by R_1 being column shifted up one and the quotient digit is parked in there.

The cycle is repeated and our example would look like this:

(R_3) 0000 24800** (R_1) $(Q) = 0$
 12400 (R_2)

Notice that the quotient tagged on to the bottom of the dividend (*) is column shifted along with the rest.

During the next sequence a successful subtraction is at last achieved (twice) before the dividend goes negative and the numbers would look like this:

(R_3) 0000 00002*** (R_1) $Q = 2$
 12400 (R_2)

with the dividend number in R_1 replaced by the quotient.

This is a deliberately simplified explanation. The machine would take, assuming the worst case, 100 addition times to give a 10 digit quotient.

It is possible to divide numbers with irregular scales of notation, such as, £ s. d. ÷ £ s. d. = decimals.

$$\text{£ s. d.} \div \text{decimals} = \text{£ s. d.}$$

by breaking down the sterling values into pence before dividing (as previously explained by using the divide by ten routine), and where a sterling quotient is required, building the pence answer into £ s. d. by multiplying the quotient by 10^n , with the standard multiplication sub-routine.

The value of n of course will depend on how many times the original sterling dividend had been divided by ten to ensure it was wholly expressed in pence.

Notation

Though Fig. 3 shows the highways round the machine as a single line, there are in fact four for every line shown. These four lines are allocated the values 1, 2, 4 and 8. The registers are also groups of 4, and as shown in Fig. 4 have the value 1, 2, 4, 8 down the Y axis and units, tens, hundreds, thousands, etc., along the X axis. Each square is an Eccles-Jordan trigger so connected to the next on the left that a pattern of "set" triggers will move left, one stage

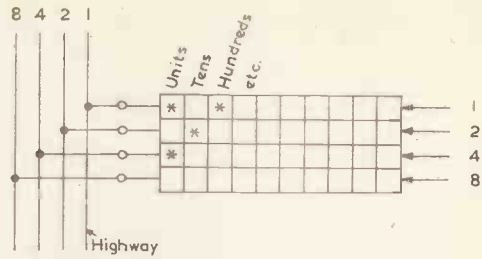

Fig. 4. Notation used in registers

(one decimal shift down) every time one pulse is applied to the register. In Fig. 4 if the asterisks are assumed to indicate that a trigger is set, then the pattern represents 125. i.e. Binary 0001 in the hundreds column = 100

„ 0010 „ „ tens „ = 20
 „ 0101 „ „ units „ = 5

This form of notation is known as sequential parallel.

Magnetic Storage Drum

The techniques for storing digital information by magnetizing localized areas on the surface of a drum are now well known. The drum used here differs a little from accepted techniques in that instead of oxide coating or nickel plating the surface, a helix of 0.004in stainless steel wire has been used. This helix is not wound at the same pitch right along the length of the drum, but is grouped in bunches of tight turns of 0.004in pitch and interspersed with gaps of one turn in $\frac{1}{2}$ in. The bunches are $\frac{1}{2}$ in wide and are arranged to coincide with the location of a recording or reader head. (Fig. 5.) The effect of these gaps in the recording media is to reduce crosstalk from track to track. The body of the drum is made of non-magnetic metal.

The "winding-on" of the wire is simple and involves starting at an anchor post, spinning the drum 30 revolutions to make the first track, with the wire acting as its own laying guide, moving the feed point of the wire $\frac{1}{2}$ in onwards and spinning the drum another 30 revolutions and so on, the wire is kept under tension the whole time and finally anchored at the second binder post. No form of adhesive is used, the friction with the surface being quite adequate to keep the wire in place, even at drum speeds twice that normally in use (3 000rev/min). The tracks are electrically in groups of four to keep in line with the notation used in the arithmetic unit, i.e. track 1 records ones, 2 twos, 3 fours, and 4 eights. Calling a storage location calls all four tracks at a time. There is no loss of packing density over the more usual single track systems because the word

Fig. 5. The magnetic storage drum

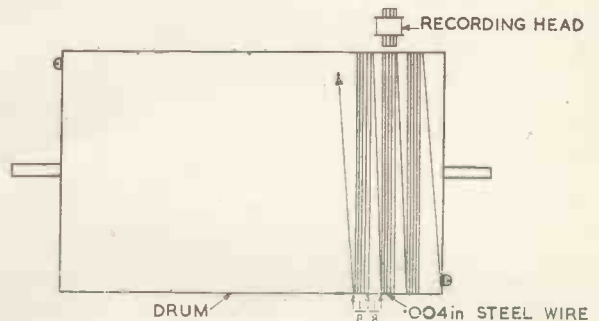

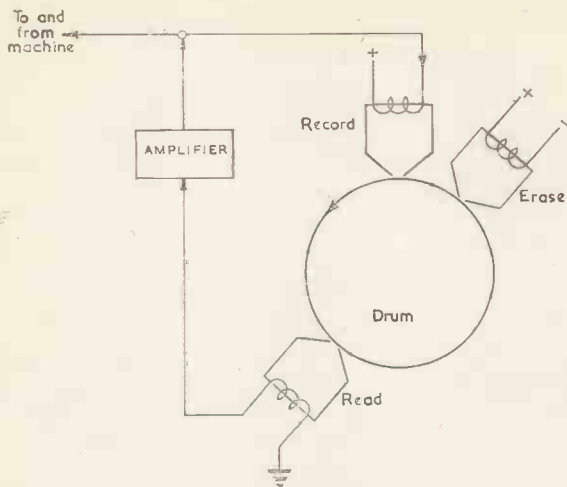

Fig. 6. Arrangement of erase, record, read heads

is one-quarter the length. "Non-return to Zero" recording is used where only the change from 0 to 1 or 1 to 0 produces an output.

Input-Output Buffer

The buffer stores consists of four tracks of short read-write, with four recording and four reading heads spaced 100 digit times apart round the periphery of the drum, a permanently energized electromagnet erases the tracks just in front of the recording heads (Fig. 6). Any information sent to the recording head is picked up 100 digit times later and regenerated back to the recording head. This ensures that the contents of the buffer store is available once every 6.2/3msec. The first 50 digits of these 100 are devoted to the input, the latter 50 to the output buffer.

This short access time is necessary because the active part of any one mechanical index point on the card sensing and punching mechanism is only available for some 10msec with cards feeding at 100 per minute and any one of the 100 digits might have to be read in or out, which requires that the whole contents of the buffer stores be reviewed during any index point. Waiting for the drum to complete one revolution would require 20msec and is too long.

Programming

Within the control unit are 120 Eccles-Jordan triggers connected as a single line shifting register (Fig. 7). Each

Fig. 7. Single line shifting register

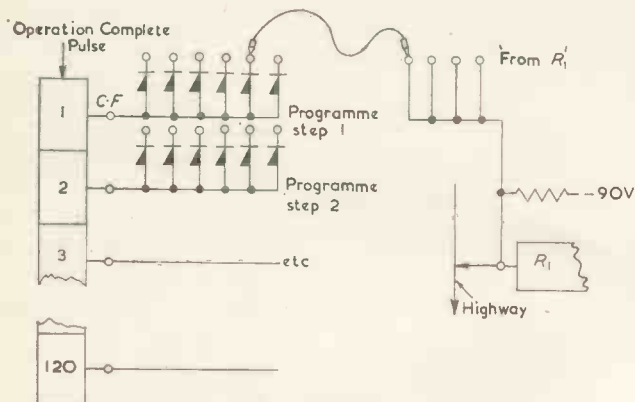

trigger is connected via a cathode-follower to a bank of six or more selenium diodes. Each one of these diodes is connected to a socket on the control panel. Each bank of these sockets is marked Programme Step 1, Programme Step 2, etc., to 120.

Before the start of calculation the first trigger is set. This raises the grid and hence the diodes connected to the cathode of the cathode-follower (CF), from -50V to 0V. If, as shown in Fig. 7, a jumper had been plugged from one of the PS_1 diodes to the socket connected to the control of, say, gate "from R_1 ", then the paralysing bias normal to this gate would have been superseded by the programme step voltage. Should trigger "1" be reset and trigger "2" set instead, then gate "from R_1 " will close and whatever instructions are connected to PS_2 sockets would be obeyed. PS_2 trigger would then reset and PS_3 would set and so on. To reset one trigger and set the next requires the application of a pulse to a line marked "Operation Complete". This "operation complete" pulse is generated by every subroutine called and is naturally the very last pulse of that subroutine. Thus it is not necessary to instruct the machine to stop one operation before starting the next, this will happen automatically. More than one socket is provided to the "from R_1 " gate because this may be called many times during computation, as indeed may any of the addresses or functions.



Fig. 8. A plug-in "turret"

Construction

The circuits are built on "turrets" which plug into sockets fixed and wired to the main frame. As can be seen by Fig. 8, they contain two valves (12AU7) in the centre, with the components mounted on tag boards on the outside. Flexible wires run from the circuit elements to an 18-way plug which is hinged at one end to allow access to the valves and back of the plug. When the plug is hinged down into place, two lugs lock into holes in the body of the turret. This form of construction gives unhindered access to the components for assembly, forms a column for air flow over the valves when the turrets are mounted vertically one above the other, and being pluggable packaged units, allow rapid replacement for servicing.

A machine will contain between 600 to 1000 (depending upon type) units, but not all these will contain valves. In some cases a valve position will be used for a transformer and on others for a potentiometer. These 600 to 1000 turrets are divided into 30 to 50 different types, the largest number of the same type being about 100, the next 70, and so on downwards, to the "one off" variety, the master oscillator being a good example of this.

Fig. 9 shows a typical frame used to mount these turrets. This one has six gates, all hinging like the leaves of a book to give access to both sides. Only four are visible in this photograph because they have been opened to show the rows of turrets in position. The right-hand gate has a few blank positions showing the sockets on the frame.

Each gate has a centrifugal air fan blowing into a com-

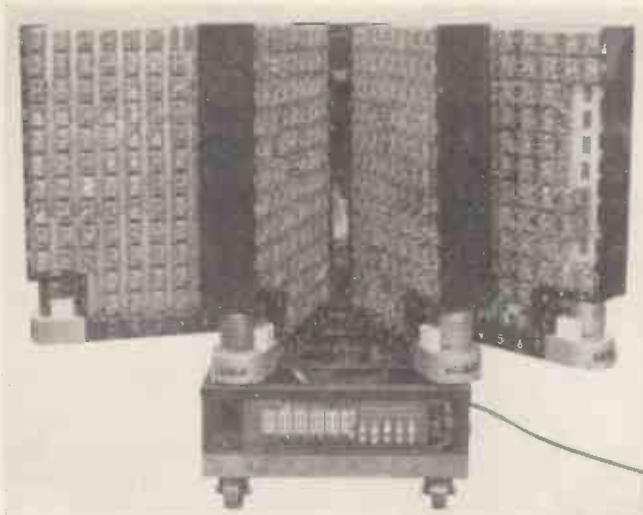

Fig. 9. A typical frame for mounting the turrets

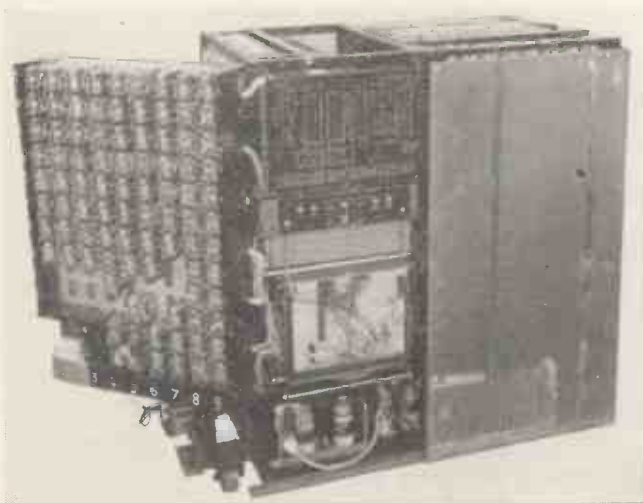

Fig. 10. A front view of the calculator

Fig. 11. An aerial view of the type 550 calculator



pression chamber running along the base. Deflectors and slots ensure an even distribution of air to each row of turrets. Fig. 10 shows a front view with one of the metal dust covers in place. Along the base, two of the power units drawers are visible with four grid-controlled thyatron rectifiers in the foreground. These power units can be withdrawn by means of the handles provided and are connected to the machine by multi-plug and sockets. Immediately above this is the plugboard with some patch cords in place. Above this can be seen the banks of selenium rectifiers associated with the programme sockets. These rectifier banks are individually held by clips so that any one can be removed without disturbing the others. Between these and the display panel at the top, is sandwiched a small but very useful group of switches, which enable the routine of the machine to be broken down into convenient sections. For instance, any selected sub-routine can be made to repeat continuously to enable an oscilloscope analysis of the waveforms to be made. There are three speeds of operation available, fast—slow—manual, which give 14kc/s, 1 to 200c/s (variable), and a key which will give one impulse each time pressed. These switches combine with others such as single programme steps, single cycle, (one addition time) and others, to enable the complex routines to be broken down under control, for testing and servicing. The display panel at the top consists of many hundreds of NT2 neons which are connected to every major circuit in the machine. This neon display has been deliberately laid out to look like the block schematic of the arithmetic unit.

If a neon indicates that a particular circuit is misbehaving, the general location on the diagram is immediately apparent because of the similarity in layout between the schematic and display. Once the exact turret is located on the diagram its physical location is given by lettering of the following form.

1A3.

This means it is the first gate—row A—3 in from the left side.

The aerial view of the Type 550 Calculator in Fig. 11, gives an indication how a control board can be removed. Lifting the handle causes the board to be pushed clear of the spring contacts and banks it outwards so that it may be withdrawn upwards along the guides. Lowering the handle returns the board to intimate contact with the springs, ensures correct registration, and locks it in position.

The air inlet grilles are located towards the centre so that most of the air demanded by the gate blowers will be drawn in over the power units. A multi-contact plug is used to connect the calculator to the card feeding and punching mechanisms.

Conclusion

The instruments described are of moderate proportions yet capable of handling the problems of modern business accounting, with a very much greater speed and flexibility than has hitherto been possible using electro-mechanical or hand methods.

Acknowledgments

The author would like to express his thanks to all the members of the Company who contributed to these projects and to the British Tabulating Machine Company Limited for permission to publish.

REFERENCE

1. WOODS-HILL, W. An Electronic Arithmetic Unit. *Electronic Engng.* 27, 212 (1955).

A Scanning-Coil for an Off-Centre P.P.I. Display

By G. W. Harvey*, B.Sc., A.M.I.E.E.

A description is given of the design, construction and performance of a scanning-coil developed specifically for a radar p.p.i. display having the facility of off-centreing.

IN the production of radar plan-position indicator (p.p.i.) displays, as in the case of television, both electrostatic and electromagnetic scanning systems have been used. The accuracy demanded of p.p.i. displays is normally high compared with commercial television practice where low initial cost is in general a more important consideration.

The accuracy which can be obtained with electrostatic scanning is limited by the accuracy of alignment of the deflector plates of commercially-available cathode-ray tubes. In the case of electromagnetic scanning, the accuracy can be "built into" the scanning-coil and can be as high as considerations of efficiency and initial cost permit.

Considering electromagnetic scanning for a p.p.i. raster, two basic methods may be recognized. The first may be termed polar scanning. In this case, the radial component is produced by a single-axis coil, and the rotation of the radial scan is effected by mechanically rotating the coil. The second method may be termed cartesian scanning. In this case, two orthogonal windings are fed with a pair of component currents, each component being of sawtooth waveform. The rate of rise of current for one component varies sinusoidally and, for the other component, cosinusoidally with aerial rotation.

If off-centreing is required, it is necessary, in the case of polar scanning, to employ a separate coil for producing the off-centreing field. In the case of cartesian scanning, however, it is possible to use the same windings for both scanning and off-centreing, and thereby to gain a number of advantages.

In the particular application to be considered, an accurate off-centre display was required, and, in view of the above considerations, electromagnetic scanning in cartesian co-ordinates was employed.

Application

The p.p.i. display unit for which the scanning-coil was developed was designed to supplement the A- and B-type displays of an existing radar set. The radar itself operated in the X-band and was originally intended for field artillery purposes. It was subsequently modified for coastal defence, and the off-centre display was added to increase the resolution in that role.

The display unit incorporated a 9in magnetic c.r.t. operating at 7kV. Off-centreing of the display of up to 25km was required on all range scales, viz., 6.25, 12.5, 25 and 50km for 1 tube radius. Thus, on the fastest scan, the amount of detail available was equivalent to that which would be obtained with a 31.25km scan on a 45in diameter c.r.t.

The scanning-coil contained two separate orthogonal winding systems for the two axes and the scan generator for

each axis combined the scanning and off-centreing currents into a single waveform. In this way, it was possible to achieve off-centreing by a combination of current bias and time delay and to employ a single control (for each axis) for the amount of off-centreing required. This arrangement resulted in economy of scanning power, and it was important to achieve such an economy for the following reason. The radar pulse recurrence rate, and therefore the scan repetition rate, was relatively high so that, on the longest-range scan, there was little time available between scans for the dissipation of the energy stored in the scanning-coil. For the same reason it was essential to minimize the scanning-coil inductance, that is, to achieve a high efficiency (as defined later).

Each winding system was driven by a separate scan generator employing a high-gain d.c. feedback amplifier with compensation for the time-constant of the scanning-coil. A separate feedback path provided forced resetting of the coil current at the end of each scan.

The display incorporated an electronic bearing and range marker combined on a time-sharing basis with the p.p.i. raster.

Although the scanning-coil was designed specifically for this particular display unit, a number of features of the design are of more general interest.

Design Considerations

In the design of a scanning-coil, it is necessary in general to satisfy two basic requirements, namely, efficiency and accuracy. The efficiency of a scanning-coil may be regarded as the ratio of the energy of the useful deflecting field to that of the total field produced, while the accuracy may be regarded as the ability of the scanning-coil to produce a distortionless scan. These two requirements are interdependent and to some extent conflicting. For example, it is shown later (Appendix B) that the field distortion introduced by practical winding distributions increases rapidly towards the outer radius of the field. Therefore, by making this radius large compared with the radius of the field actually used (i.e., the inner radius of the c.r.t. neck), the distortion within the "working" field can be greatly reduced. However, since the "working" field is then a smaller proportion of the total field, the efficiency is also reduced. On the other hand, it is also true that a scanning-coil which produces a small amount of field distortion is inherently more efficient than a component (of the same radius) which produces a greater amount of distortion. This statement may be verified from the following consideration. Field distortion is due to the presence of space-harmonics in the exciting m.m.f. distribution, and such harmonics represent a proportion of the total energy supplied. If, therefore, the accuracy of a scanning-coil be increased (by

* Formerly British Thomson-Houston Co. Ltd. Now with Ferranti Ltd.

improvement of the m.m.f. distribution), its efficiency is increased as a consequence.

Various types of scanning-coil for use in p.p.i. displays have been described^{1,2}. Three main types may be recognized:

- (a) Air-core coils, with pre-formed windings.
- (b) Slotted iron-core coils, with "motor stator" windings.
- (c) Cylindrical iron-core coils, with toroidal windings.

As regards efficiency, Woroncow¹ has shown the superiority of iron-core components by quoting comparative figures for a number of designs. This writer states that "the slotted core appears to be far superior in every respect to any other circular non-slotted core". However, in the course of the development of the coil being considered here, it was established that components of type (c) could be produced with efficiencies equal or slightly superior to the best example of type (b) quoted by Woroncow. (See Appendix A).

As regards accuracy, the performance of type (b) is inherently inferior to that of type (c), for, in the former case, distortion is introduced by the slotting of the core and by the disposition of the cumbersome end-turns.

Since both efficiency and accuracy were of prime importance in the application being considered, it was decided to develop a component of type (c).

As far as the author is aware, no coil of this type, that is to say, a two-axis toroidal scanning-coil, has hitherto been described.

Winding Distribution

In the hypothetical case of an infinitely long tunnel of circular cross-section within a magnetic material of infinite permeability, it can be shown that, in order to produce a uniform magnetic field inside the tunnel, the ampere-turn or magnetomotive force (m.m.f.) distribution of a winding located at the radius of the tunnel must be sinusoidal.

In the practical case of a scanning-coil having a core of finite length and of high but not infinite permeability, a sinusoidal m.m.f. distribution gives rise to the most nearly uniform field which can be achieved.

It is difficult in practice to produce an exactly sinusoidal distribution, but a sufficiently close approximation can be achieved by suitable grading of the turns. Various methods of grading are possible and some of the factors which influence the choice of the method to be employed in a particular case are enumerated below:

- (a) the degree of distortion which can be expected from a given arrangement,
 - (b) the feasibility of producing a winding of the desired accuracy,
- and particularly in the case of two-axis scanning-coils:
- (c) the need to ensure accurate orthogonality, and
 - (d) to minimize the capacitive interaction between the two winding systems,
 - (e) the need to maintain a high winding space-factor.

The distortion introduced by a particular winding distribution may be investigated theoretically as indicated in Appendix B. The various possibilities may then be compared, taking this factor and the others listed above into account.

In the present case, the best method of grading was considered to be to dispose the conductors in a number of

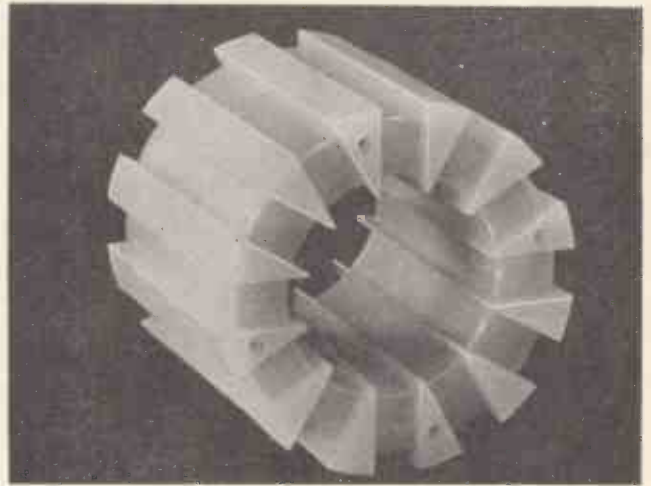

Fig. 1. Moulded polythene former enclosing core assembly

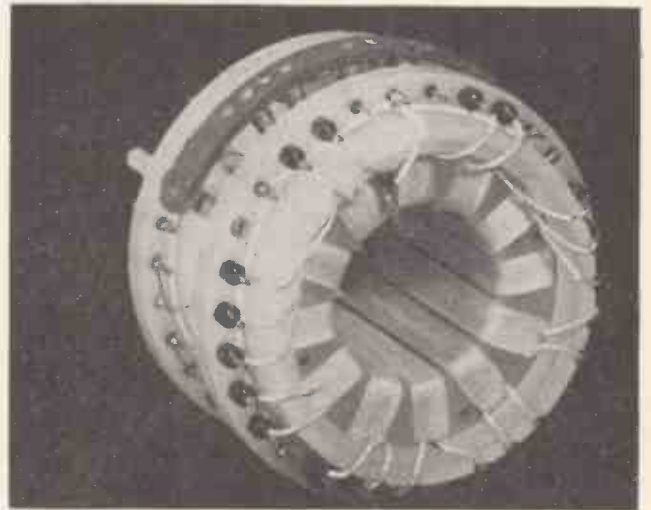

Fig. 2. Wound and interconnected assembly ready for encapsulation



Fig. 3. The completed scanning-coil

identical slots in an accurately made former, and to grade the number of turns per slot. The optimum number of slots and the exact number of turns per slot were determined on the basis of the results quoted in Appendix B.

Construction

Before the final design was evolved, several experimental models were constructed. These models were basically of the same type as the final component, but employed machined bonded-fabric formers. One model contained 8 slots and the remainder 12 slots. Certain practical limitations which were imposed on the final design by manufacturing considerations were absent in the experimental models, and it was possible to make the models somewhat smaller in diameter. As a result, the models were rather more efficient than the final product. Comparative figures are given in Table 2 (Appendix A).

The core and former assembly before winding is illustrated in Fig. 1. The core consisted of a set of machined Ferroxcube rings bonded inside a copper eddy-current sheath. Ferroxcube was used as the core material because of its low loss at high frequencies and because a material having a low remanence was required in order to minimize interference on the display resulting from the time-sharing of the bearing-marker and p.p.i. scans. The eddy-current sheath was included to increase efficiency by reducing the inductance contributed by the "useless" conductors, i.e., those outside the effective magnetic circuit.

The former was produced by the injection of polythene in a specially-designed mould so that the core was completely enclosed. The moulding incorporated twelve parallel-sided slots as shown in Fig. 1.

Since the number of scanning-coils required did not warrant expenditure on the development of a special winding machine, the coils were wound by hand. Each slot was layer-wound, the number of turns being held to within 1 of the correct number. Eight of the slots contained conductors of both winding systems. In these slots, the windings of the two systems were separated by an electrostatic screen and were adequately insulated from each other.

A pair of moulded polythene end-caps enclosed the wound former and contained suitable tags which enabled the coil sections to be interconnected. The screens were also interconnected by this means. The wound and interconnected assembly is illustrated in Fig. 2.

Since the component was required to withstand severe climatic conditions (equivalent to the Joint Service Specification K.114); special insulation treatment was necessary. As a final process in the manufacture, therefore, the scanning-coil was encapsulated by cold vacuum impregnation technique in a polyester resin. The formulation of the resin

TABLE 1
Summary of Characteristics

| | |
|---|--------------------|
| Dimensions : | |
| Core diameter | 1.78 in |
| Core length | 2.00 in |
| Overall diameter | 4.0 in |
| Overall length | 3.0 in |
| Weight (encapsulated) | 2.5 lb |
| Winding resistance | 105Ω |
| Winding inductance | 41mH |
| Current for one radius deflexion at 7kV | 110mA |
| Specific sensitivity* | 390 rad/A |
| Efficiency factor (see Appendix A) | 3.70×10^6 |
| Permissible temperature range | -40 to +70°C |

* Defined as the deflexion in radians due to a deflecting current of 1A when the c.r.t. accelerating potential is 1V.

was developed for this particular application, since the treatment involved a number of special problems (for example, the need to keep the temperature of the mould, during setting, well below the melting point of polythene).

The appearance of the completed coil is shown in Fig. 3.

A summary of the characteristics of the component is given in Table 1.

Performance

When operated in conjunction with the display unit for which it was designed, the scanning-coil produced a completely satisfactory display. The requisite sensitivity was obtained with direct currents and with scanning waveforms up to and including those at the fastest scan speeds required. There was no observable departure from linearity between the spot deflexion and the scanning current apart from that due to the "flatness" of the c.r.t. screen. It should be noted that, in the case of cartesian p.p.i. scanning, it is not possible to compensate for this form of distortion by modifying the winding distribution, and in any case, the distortion affects both bearing-marker and p.p.i. scans equally, so that it does not affect the accuracy of measurements taken on the display.

There was no evidence of field distortion or of deflexion defocusing even at the extreme edges of the picture. Interaction between the two winding systems was completely negligible and no departure from orthogonality of the scanning axes could be detected. At the highest scan speed (approximately 2.5mA/μsec) there was very slight distortion at the start of the scan due to transient effects. At lower speeds, transient effects could not be detected.

Acknowledgments

The author wishes to acknowledge the guidance of Mr. D. J. Mynall in the initial development of the scanning-coil, and the co-operation of Mr. R. W. Maton who was responsible for the design of the display unit. Acknowledgment is due to the Directors of the British Thomson-Houston Co. Ltd. for permission to publish this article.

APPENDIX A

COMPARISON OF SCANNING-COIL EFFICIENCIES

The deflexion efficiency of a scanning-coil may be defined as the ratio of the energy of the "ideal" deflecting field to that of the actual field produced. The "ideal" field may be regarded as a uniform field of strength H within a volume $\pi d^2 l / 4$, where d is the inside diameter of the c.r.t. neck, and l is the axial length of the field which just causes the electron beam to "graze" the c.r.t. neck at the maximum deflexion required. The energy of this field is:

$$W_1 = H^2 / 8\pi \cdot \pi d^2 l / 4 = H^2 / 32 \cdot d^2 l.$$

Now, for a given deflexion angle, θ ,

$$\sin \theta = H \cdot l \sqrt{e/2Em}$$

where E = c.r.t. accelerating anode potential, and

e/m = electron charge/mass ratio.

This expression, for angles, θ , of the order of 25° , may be simplified without appreciable error to:

$$\theta = H \cdot l \sqrt{e/2Em} \\ = \sqrt{k} H \cdot l / \sqrt{E} \quad \text{where } k = e/2m.$$

Therefore,

$$H^2 = E\theta^2 / kl^2$$

and

$$W_1 = E\theta^2 / 32k \cdot d^2 l.$$

The energy, W_2 , supplied to an actual coil of inductance L passing a current I is given by:

$$W_2 = \frac{1}{2}LI^2.$$

Thus, the deflexion efficiency, M , is given by:

$$M = W_1/W_2 \\ = E\theta^2/32k \cdot d^2/l \cdot 2/LI^2 \\ = 1/16k \cdot S^2/L \cdot d^2/l$$

where $S = \text{Specific Sensitivity}$
 $= (\theta/I) \cdot E^3.$

Now, d^2/l is a constant for a given type of c.r.t., and $1/16k$ is also a constant. Therefore,

$$M \propto S^2/L.$$

Thus, for a given c.r.t. the deflexion efficiency for any applied scanning-coil (assuming the effective length is not sufficient to cause "neck shadow") is proportional to S^2/L , and this expression may be termed the Efficiency Factor for that coil, where S is in terms of radians per ampere at $E = 1$ volt, and L is in henrys.

The efficiency factor as defined above is the reciprocal of the "inductance figure", $f_L = L/S^2$, defined by Woroncow¹.

Table 2 gives the value of the efficiency factor for a number of widely different scanning-coils.

TABLE 2

| SCANNING-COIL TYPE AND REFERENCE | SPECIFIC SENSITIVITY S (rad/A) | INDUCTANCE L (henrys) | EFFICIENCY FACTOR $S^2/L \times 10^{-6}$ |
|---|----------------------------------|-------------------------|--|
| 1. Single-axis toroidal (Woroncow ¹ No. 3) | 416 | 0.047 | 0.37 |
| 2. Air-core (Woroncow No. 1) | 411 | 0.177 | 0.96 |
| 3. Single-axis toroidal (Reference 2) | 164 | 0.023 | 1.14 |
| 4. Air-core (Reference 2) | 920 | 0.555 | 1.52 |
| 5. Synchro stator (Reference 2) | 942 | 0.400 | 2.22 |
| 6. Two-axis, 8-slot core (Woroncow No. 5B) | 458 | 0.073 | 2.87 |
| 7. Two-axis toroidal (Described herein) | 390 | 0.041 | 3.70 |
| 8. Two-axis, 12-slot core (Woroncow No. 7B) | 1 100 | 0.262 | 4.60 |
| 9. Two-axis toroidal (Development model of No. 7 above) | 387 | 0.030 | 5.00 |

APPENDIX B

ANALYSIS OF WINDING DISTRIBUTIONS

The various possible methods of grading a scanning-coil winding may be examined and compared by means of Fourier analyses of the corresponding m.m.f. distributions. Thus, the fundamental of the Fourier series gives rise to the desired uniform field and the rest of the terms in the series correspond to unwanted space-harmonic components. Distributions can be compared, therefore, by comparing

the magnitudes of their harmonic components relative to their respective fundamental components. In this way, not only may different types of grading be compared, but the optimum winding arrangement for a particular type may be determined.

In the particular case described here, such investigations were carried out, and it was concluded that an "equi-angle, graded turns per slot" distribution would be the most satisfactory. Such a distribution is shown in Fig. 4. This distribution was then examined in more detail and the following conclusions were drawn.

(1) In the case of two identical winding systems occupying the same former, the number of slots must be a multiple of 4, i.e., the number of slots = $4m$, where m is any integer.

(2) Considering one of the winding systems in this case, the relative number of turns in a given slot must be proportional to the sine of the angle of the centre-line of that slot from the point of zero ampere-turns.

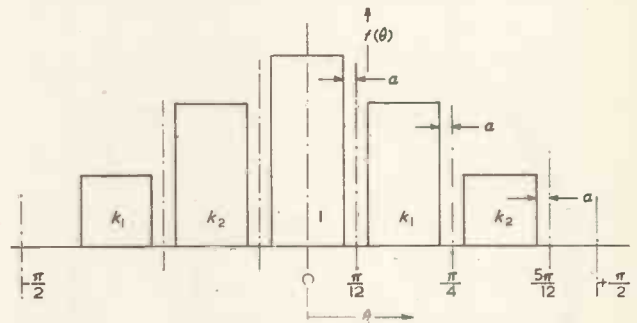

Fig. 4. M.M.F. waveform of gapped, 12-slot winding

(3) The space-harmonic of lowest order, and of greatest magnitude, which occurs in a correctly-graded winding in $4m$ slots is of order $(4m - 1)$. More generally, harmonics of order $(4mn \pm 1)$ are produced, where n can be any integer from 1 to infinity. Thus, in a 12-slot winding, harmonics of order 11, 13, 23, 25, 35, 37, . . . etc., are present.

(4) With a continuous distribution, i.e., one in which there are no "gaps", the magnitudes of these harmonics are inversely proportional to their order. For example, in a 12-slot winding, the magnitude of the 11th harmonic is $1/11^{\text{th}}$, or about 9 per cent of the fundamental.

(5) In a practical winding, the presence of gaps in the distribution is inevitable. This fact does not invalidate statements (2) and (3) above. The orders of the harmonics which occur in the Fourier series of a gapped distribution are the same as if no gaps were present, but their magnitudes are considerably greater. The magnitude of the fundamental is also affected. Thus, for a gap semi-angle of a , the fundamental, $a_1 = C \cdot \cos a - S \cdot \sin a$, and the magnitude of the $(4mn \pm 1)^{\text{th}}$ harmonic, $a_{4mn \pm 1} =$

$$\frac{1}{4mn \pm 1} \left\{ C \cdot \cos(4mn \pm 1)a \mp S \cdot \sin(4mn \pm 1)a \right\},$$

where m and n have the significance already explained and C and S are constants for a given winding arrangement. The values of C and S depend on the number m , and for the distribution shown in Fig. 4, $C = 0.987$ and $S = 3.69$.

The extent to which the field is distorted by these space-harmonics is not directly indicated by the above analysis. The analysis may, however, be extended, by a method due to D. J. Mynall, to determine the field distortion.

The method consists of assuming a potential function at any point, (r, θ) , within a circle of radius, a , as indicated in Fig. 5, due to a uniform m.m.f. (at radius a) of I (ampere-turns/rad) spanning an arc of $\pm\beta$. By comparing the assumed function, which constitutes an infinite series, with the infinite series of Fourier terms for this distribution, the coefficients in the function may be determined.

From this potential function, the field strength at any point, (r, θ) , may be derived. In particular, the field strength along the x-axis, $X-O-X'$, ($\theta = 0$), is of the form:

$$[B_{\theta}]_{\theta=0} = \frac{16 I}{a} \sum_{N=0}^{\infty} (r/a)^{2N} \cdot \frac{\sin(2N+1)\beta}{(2N+1)} \quad (1)$$

and consists of a constant term, $\frac{16 I}{a} \sin \beta$, (when $N = 0$) and a variable part which is a function of r .

The constant term expresses the uniform field which is desired in an actual scanning-coil, and the variable part (which is zero at $r = 0$) corresponds to the field distortion.

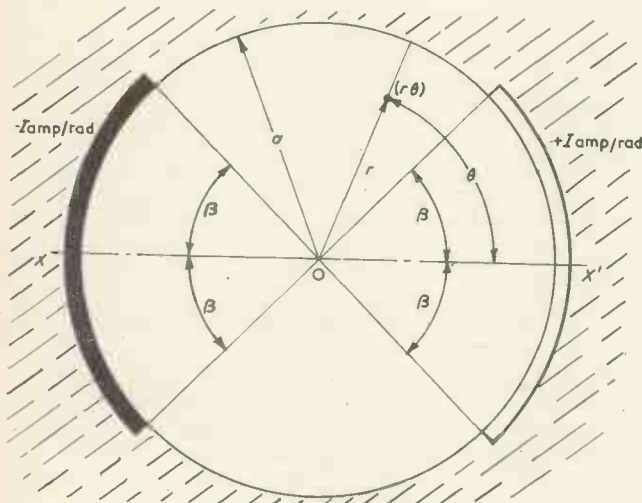

Fig. 5. Calculation of field distortion

The field distortion at a given radius, r , can be expressed as the fractional departure of the field from this uniform value.

Thus, the distortion:

$$D = \frac{(\text{Total Field at } r) - (\text{Uniform Field})}{(\text{Uniform Field})} = \frac{(\text{Total Field})}{(\text{Uniform Field})} - 1 = \left\{ \frac{1}{\sin \beta} \sum_{N=0}^{\infty} (r/a)^{2N} \cdot \frac{\sin(2N+1)\beta}{(2N+1)} \right\} - 1$$

The infinite series contained in this expression may be summed and expressed in the closed form:

$$1/2x \cdot \tan^{-1} \left(\frac{2x \cdot \sin \beta}{1 - x^2} \right)$$

where $x = r/a =$ relative radius.

Therefore:

$$D = \left\{ \frac{1}{2x \cdot \sin \beta} \tan^{-1} \left(\frac{2x \cdot \sin \beta}{1 - x^2} \right) \right\} - 1 \dots (2)$$

Equation (2) applies for a single-bank winding spanning $\pm\beta$ radians on each side of the centre-line. By the prin-

ciple of superposition, it is possible to derive corresponding results for more complicated arrangements. The method can be extended to cover graded and gapped distributions such as the one finally adopted in the coil described here. During development, therefore, it was possible to assess the effect of changing the number of slots, and of varying the angular width of the gaps.

Some results of computation of the distortion due to a number of winding arrangements are shown in Fig. 6.

From these curves, the following conclusions may be drawn.

(1) The distortion increases rapidly towards the outer radius of the field. At a relative radius, x , ($= r/a$) less than 0.6, the distortion is negligible except in the case of curve (1). It should be noted that, in a typical scanning-coil, the "working" field (i.e., that within the c.r.t. neck) would extend to a relative radius of not more than about 0.6.

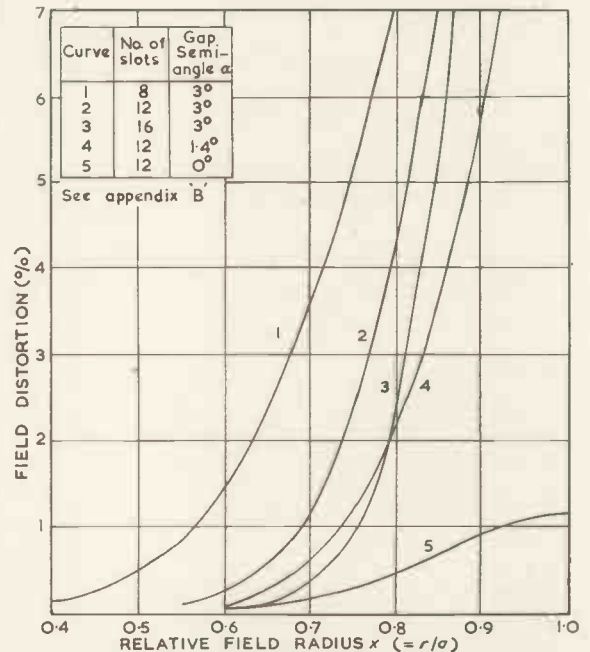

Fig. 6. Field distortion, as a function of field radius, for some "correctly graded" windings

Moreover, even at maximum deflexion, the electron beam, during most of its passage axially through the scanning field, would be at a much smaller radius. The curves therefore tend to give a pessimistic impression of the distortion which could be expected to be seen on the c.r.t. screen.

(2) The presence of gaps results in a great increase in distortion at the outer radii compared with the distortion at similar radii due to a continuous distribution (as in curve (5)). At relative radii less than 0.5, the difference between gapped and continuous distributions is insignificant. (The gap angles have been made the same in examples (1), (2) and (3) because, for practical reasons, the gap angle is largely dependent of the number of slots).

(3) There is little or no advantage to be gained by using 16 slots rather than 12, but considerable improvement results from the use of 12 slots rather than 8.

REFERENCES

1. WORONCOW, A. Iron-cored Deflecting Coils for Cathode-Ray Tubes. *Instn. Elect. Engrs.* 93, Pt. 3a (1946).
2. SOLLER, STARR, VALLEY. Cathode-Ray Tube Displays. M.I.T. Radiation Laboratory Series, Vol. 22 (McGraw Hill).

Anode Control of Small Thyratrons

By L. Molyneux*, B.Sc.

A method of using a small thyatron in a "self hold" mode, and a practical example of its use are described. The arrangement is not critical in adjustment, but economic considerations are likely to limit it to small thyratrons.

IN the electrical control of mechanical devices it is sometimes necessary to make a mechanism change its state on receipt of a small electrical impulse, and to remain in this state until a further electrical impulse occurs. The characteristics of a thyatron are such that it would seem to offer a solution to this type of problem, since its "lock on" characteristic is combined with a high current carrying capacity.

A possible circuit arrangement might be one where the grid of the thyatron is normally held at a negative potential; the load being connected between the anode and a positive d.c. supply. Current will be turned on in the circuit by momentarily bringing the grid to cathode potential, and turned off by interrupting the anode supply. But while this type of circuit can be turned on by the output of a small amplifier or the closing of contacts in a high impedance circuit, it cannot normally be turned off in a similar way. It is the purpose of this article to show how this may be done in the particular case when the thyatron is used with an a.c. anode supply.

If the anode of the thyatron is connected to an a.c. supply, and its grid held at a negative potential, ionization and conduction in the valve may be initiated during that part of the positive half cycle when the anode voltage is above the valve's ionization potential, by bringing the grid to cathode potential. The ionization will end shortly before the end of the positive half cycle. If the circuit is arranged so that a small subsidiary anode current can flow when none can flow through the load, then the thyatron will maintain a low level of ionization during this period. The ionization will increase as the voltage in the load circuit rises above the running voltage, and will return to its original level when the load circuit voltage falls below this value. Thus a continuous, though varying state of ionization can be initiated by bringing the grid of the thyatron momentarily to cathode potential. The ionization is ended by interrupting the maintaining current during the period when it is the only source of anode current. Fig. 1 shows the arrangement. Since the maintaining current can be small (of the order of 1 per cent normal load current) the maintaining circuit can be of reasonably high impedance. The rectifier in the anode circuit allows the anode to remain on the positive side of zero. If it were not there, the anode would be driven negative by the low impedance a.c. supply.

An Example of the Use of the Circuit

The circuit in Fig. 2 is used to control a respirator† in the operating theatre, where inflammable gases are

commonly present. The device operates in the following manner. When the water touches the right-hand contact, the grid of the thyatron is made slightly positive. The thyatron conducts and operates a magnetic valve which applies pressure to the right-hand limb so that the water moves away from the contact. Ionization is then maintained in the interval between the half cycles of load current by the current flowing through R_3 . When the water touches the left-hand contact the grid of the pentode is taken slightly positive and the anode "bottoms" so that the potential of the thyatron's anode is insufficient to maintain ionization between the half cycles of load current. Once this has happened the magnetic valve closes and the water falls back till it touches the right-hand contact, when the cycle of events is renewed.

Fig. 1. Basic circuit

Fig. 2. Respirator control circuit

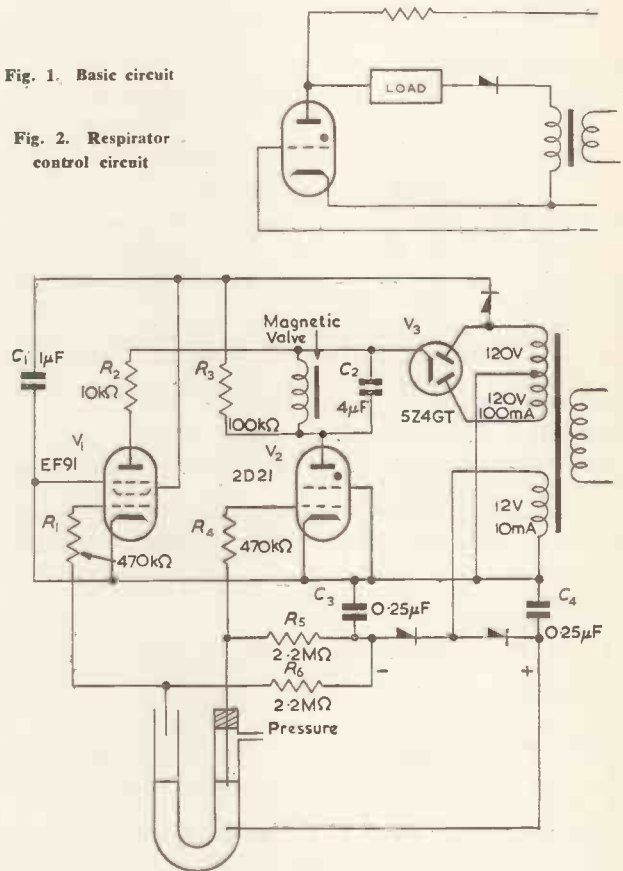

Conclusion

The circuit lends itself well to conditions where electronic apparatus is intended to operate a solenoid or similar control element on the receipt of one pulse and continue to operate it until the receipt of another. There are no contacts of any kind in the "hold" circuit, and there is no setting up procedure. There is no particular limitation on the "start" pulse, but the "stop" pulse, if it is random, must be longer than half a cycle. The inclusion of "small" in the title is intended to suggest that the circuit is economically feasible at currents of the order of 100mA, since at larger currents the size and expense of the rectifier would probably outweigh the advantages of the circuit.

* Dept. of Anaesthetics, Durham University.

† The respirator, using self hold relays whose sparking prevented its use in the theatre, was described by PASK, E. A., *Lancet*, 2, 141 (1953).

Transistor Voltmeters

By M. H. N. Potok*, B.Sc., A.M.I.E.E. and R. A. McF. Wales†

Transistors are, by virtue of size and power consumption, particularly suitable for instruments, especially portable ones.

An experimental voltmeter using a transistor current amplifier has been designed giving a reasonable stability, an input impedance of several megohms and a consumption of under 1mW from a 3V dry cell.

THE very low power consumption and robustness of transistors should be of great value in instrumentation. So far little appears to have been done in that direction. This article examines the principle of using transistors instead of vacuum valves for voltmeters.

Basic Considerations

A valve-voltmeter has three essential characteristics:

- (a) sensitivity
- (b) wide frequency response
- (c) high input impedance

All these follow from the characteristics of valve amplifiers.

Transistors have at present a very limited frequency response and a low input impedance. Of these shortcomings the impedance difficulty can be overcome by remembering that the transistor is primarily a current amplifier. A gain of 50 is feasible with junction transistors. This means that when a meter, giving full scale deflexion at $50\mu\text{A}$, is preceded by a suitable transistor amplifier only $1\mu\text{A}$ need be taken from the measured terminals. Thus a maximum input impedance of $1\text{M}\Omega/\text{V}$ is possible, and this compares well with valve-voltmeters.

Experiments have been carried out to check this idea, and promising results were obtained. These are described below.

D.C. Voltmeter

Good results were obtained using the junction transistor OC71, which gives a current gain of 50 when the emitter is earthed, in a circuit shown in Fig. 1.

Fig. 2 shows the calibration curves for two values of resistor R_1 . Resistor R is used to set zero. The dotted lines show the calibration when collector bias E_b is reduced to 1.5V.

These results show that the calibration is linear and largely independent of the bias voltage so that changes in battery voltage are unimportant. Practically no short time drift has been detected. The circuit has been left operating for hours without any apparent change in readings. Only change of resistor R_1 is required if the transistor is changed.

A.C. Voltmeter

Due to the poor frequency response of the junction transistors available it has been decided that rectification should precede amplification. Very good results are obtainable with the circuit shown in Fig. 3.

A high reverse resistance germanium diode GEX56 was used in an attempt to obtain high input impedance, but even then the impedance was only $200\text{k}\Omega$. It would appear

that successful use of this circuit depends on developing crystal diodes with very much higher reverse resistance than available to date.

In order to increase the input impedance, a large resistor was placed on the input side as in Fig. 4.

It is possible to change the voltmeter range by either varying R_1 or R_2 . R_1 largely defines the input impedance. The calibration curves for $R_1 = 1\text{M}\Omega$, $2\text{M}\Omega$ and $4\text{M}\Omega$ are given in Fig. 5 for a 1kc/s signal.

The curves appear quite satisfactory, but to retain a common scale for all ranges it would be necessary to shunt the meter by a suitably chosen set of resistors R_2 switched together with the resistors R_1 .

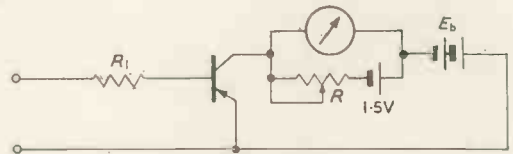

Fig. 1. Basic d.c. voltmeter circuit

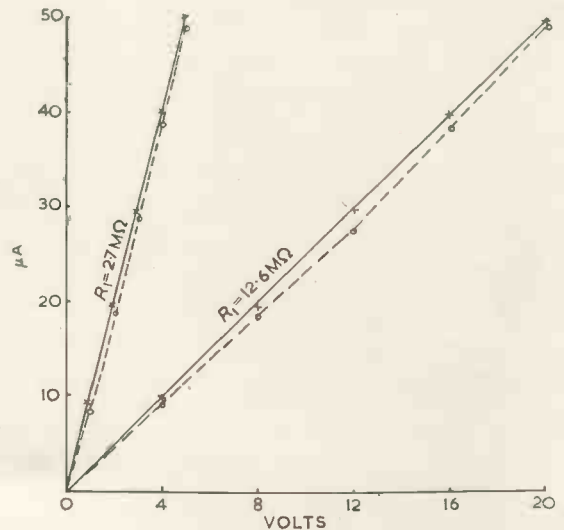
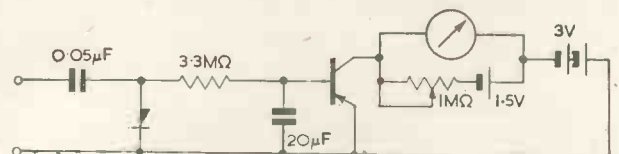

Fig. 2. D.C. voltmeter calibration curves $R_1 = 2.7\text{M}\Omega$ and $12.6\text{M}\Omega$. The solid lines refer to a collector voltage of 3V and dashed ones to 1.5V.

Fig. 3. Basic a.c. voltmeter circuit



* The Royal Technical College, Glasgow.
† Now with Barr & Stroud Ltd.

The frequency response of this circuit for a full-scale deflection of 10V ($R_1 = 2M\Omega$) is shown in Fig. 6.

Further experiments have tended to show that an increase of R_1 above $5M\Omega$ tends to upset the frequency response, hence for larger voltages R_2 should be reduced, thus shunting the meter.

A circuit using a transformer has also been experimented with. A miniature output transformer of an indifferent frequency response characteristics has been used in a circuit shown in Fig. 7.

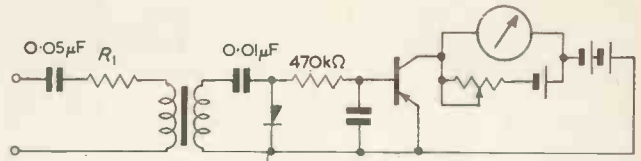

Fig. 7. A.C. voltmeter circuit with a transformer input

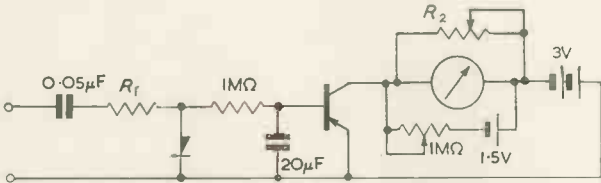

Fig. 4. A.C. voltmeter with large input impedance

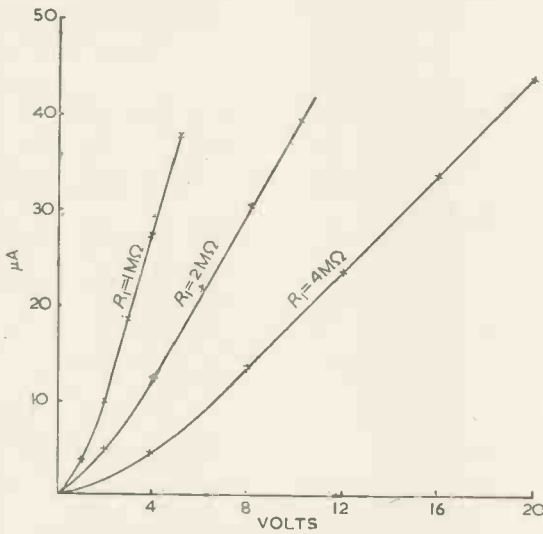

Fig. 5. A.C. voltmeter calibration curves $R_1 = 1M\Omega, 2M\Omega$ and $4M\Omega$ at 1kc/s.

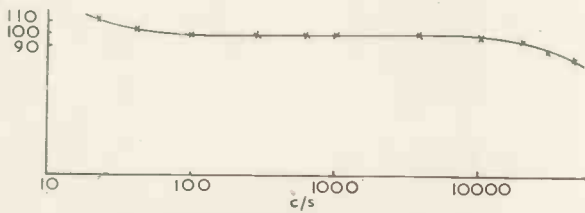

Fig. 6. Frequency response of a.c. voltmeter

Calibration curves with 15V and 50V measured signal are given in Fig. 8 at 1kc/s, and frequency response for 50V full-scale deflexion appears in Fig. 9.

Using the above circuit measurements were also carried out at 50c/s, 100V and 250V with $E_b = 3V$ and also 1.5V. The results appear in Fig. 10.

Conclusions

The experiments show that it is possible to design a voltmeter with a high input impedance using transistors. Such a voltmeter could be not much larger than the meter itself if used with small components and batteries. It could thus

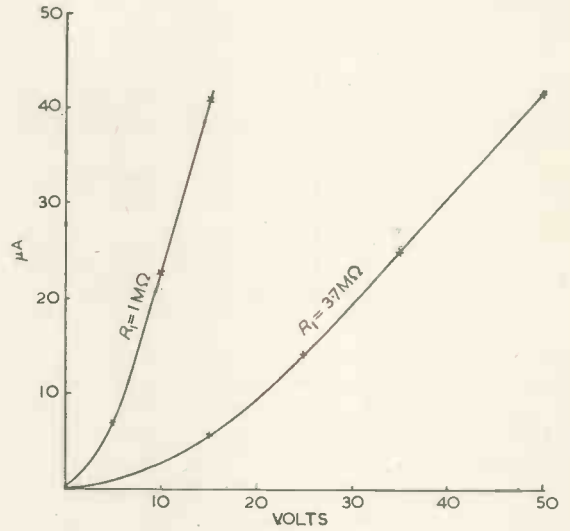

Fig. 8. Calibration curves for the a.c. voltmeter with transformer input $R_1 = 1M\Omega$ and $3.7M\Omega$ at 1kc/s.

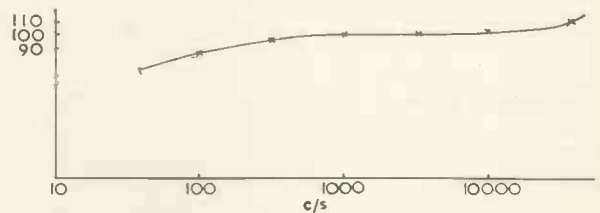
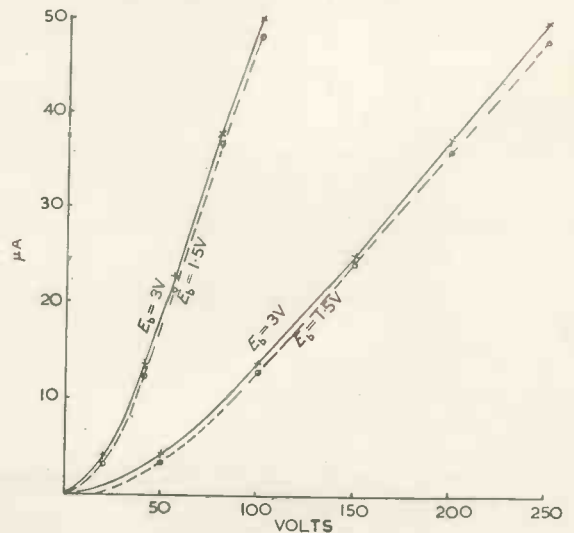

Fig. 9. Frequency response of a.c. voltmeter with transformer input

Fig. 10. Calibration curves of a.c. voltmeter at 50c/s. Solid lines—collector voltage at 3V; dashed lines—collector voltage at 1.5V.



be easily portable and independent of supplies, robust and stable. The low power consumption, less than 1mW, ensures long life to the battery. By comparison a sub-miniature directly heated pentode would have a filament consumption of at least 6mW, and would require a 15V h.t. battery.

The junction transistor, by virtue of low operating voltages and high current gain appears ideal for this applica-

tion. There appears no reason why this type of voltmeter could not be used over a wide frequency range.

In particular the development of suitable crystal diodes with very high reverse resistance or a very low consumption directly heated subminiature diode would greatly simplify the problem. In its final form this voltmeter would be an improvement on the characteristics of most popular multi-range test meters on the market.

A Twin-T RC Oscillator

By M. J. Tucker*, B.Sc., A.Inst.P.

The well-known twin-T rejector filter can be unbalanced to give a considerable transmission with a 180° phase-shift at a particular frequency. It can then be used with a single valve amplifier to form a simple and satisfactory oscillator. However, only a limited frequency variation can conveniently be obtained.

IT is well-known that an acceptor filter may be produced by connecting a twin-T rejector network in the feedback path of a negative-feedback amplifier. Many workers must have noticed that if the twin-T network is badly unbalanced the circuit may oscillate, but as far as the author is aware this effect has not been examined with a view to its deliberate use in the design of oscillators†. It is shown below that oscillators based on this principle have some advantages over the commonly used types for applications where the frequency is either fixed or is required to vary over a small range.

Theory

The twin-T network is shown in Fig. 1 and the corresponding vector diagram in Fig. 2. With the correct component relationships it is possible to achieve a considerable transmission with a 180° phase-shift at a particular frequency. The network can thus be used in conjunction with a single valve amplifier, which provides a further 180° phase-shift, to make an oscillator.

If the output of the network is left on open-circuit and

$$R_2 = mR_1 \quad C_2 = C_1/m$$

$$R_3 = nR_1 \quad C_3 = C_1/n$$

$$\omega C_1 R_1 = p$$

$$E_1/V_0 = 1 + \frac{1}{n} \left[\frac{1 + (1/m) + (1/n)}{1 + (1/m) - (1/n) + (j/n)(p - 1/p)} \right] \quad (1)$$

The frequency at which 180° phase-shift occurs is given by $p = 1$, that is $\omega_0 = 1/R_1 C_1$.

The greatest negative value of V_0 when $p = 1$ is obtained when:

$$n = (\sqrt{2} - 1)/(1 + 1/m) \quad (2)$$

* National Institute of Oceanography.

† Since this article was in proof the author has seen a paper by G. Francini and E. Zaccheroni in *Alta Frequenza*, Vol. 22, p. 282 (December 1953), describing a similar oscillator. The present article discusses some aspects of the circuit not dealt with in the Italian paper, and in any case the author feels it will be of interest to readers of *Electronic Engineering*.

and the output under these conditions is given by:

$$(E_1/V_0) = 1 - (1 + 1/m)/(3 - 2\sqrt{2}) \quad (3)$$

which shows that the higher the value of m the greater is the negative output.

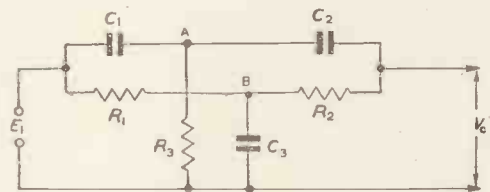

Fig. 1. The twin-T network

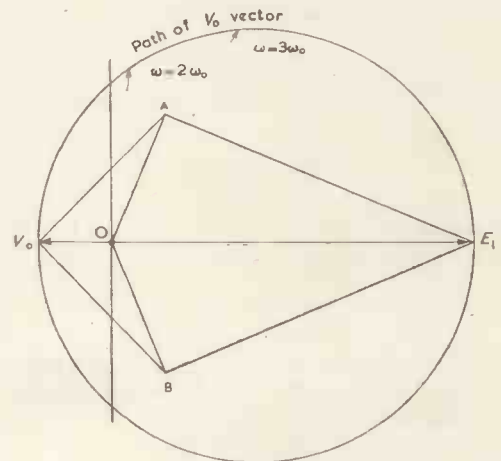

Fig. 2. Approximate voltage relationships in the circuit of Fig. 1
When $R_2 = 10R_1$, $C_2 = 0.1C_1 = 0.04C_3$ and $\omega = 1/C_1 R_1$

The greatest possible negative value of V_0/E_1 is -0.207 , obtained when m is very large and $n = \sqrt{2} - 1 = 0.414$. It is therefore possible to construct an oscillator of this

type with an amplifier gain of just under 5, but in practice considerably higher gains can easily be obtained using the simplest triode circuit and it is convenient to put $m = 1$, that is $R_1 = R_2$ and $C_1 = C_2$. The optimum n is then 0.207 and a gain of 10.66 is required to produce oscillation. The value of n is not at all critical and can be varied considerably to suit preferred component values without appreciably altering the gain required.

A feature of RC oscillators is that harmonics generated in the amplifier tend to be fed back negatively through the RC frequency-controlling network and are therefore reduced in amplitude. This is because the phase and amplitude of the transmission through the network vary rapidly with frequency. The twin-T network is particularly good in this respect, and a simple oscillator in which the amplitude is limited by valve characteristics will give quite a good waveform.

Varying the Frequency of Oscillation

It is inconvenient to vary all the network resistors or capacitors at once since the values of the components of

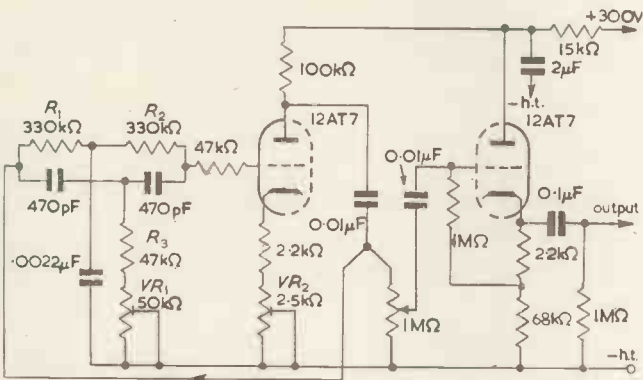

Fig. 3. A simple twin-T oscillator with cathode-follower output stage P_1 is a fine frequency control and P_2 is adjusted until oscillation is just maintained. Nominal frequency 1000c/s. High stability components are used in the oscillator section, except for the 47kΩ grid stopper.

one type are not equal. It is possible to vary the frequency over ranges of a fraction of an octave by varying either R_1 or R_3 alone, but this also requires some adjustment of the amplifier gain. The author must confess that he has not been able to work out the relevant equations in a form which is sufficiently simple to be of much use, and the effect has been investigated experimentally using the oscillator circuit shown in Fig. 3. Figs. 4 and 5 show how the frequency and the gain required to maintain oscillation vary with changes in either R_1 or R_3 . R_1 must not be reduced to less than 100kΩ, otherwise the shunting effect of the network on the anode load of the first valve becomes excessive and oscillation cannot be maintained by adjustment of VR_1 .

It will be seen that with $R_1 = 330kΩ$ and $R_3 = 68kΩ$, corresponding to $m = 1$ and $n = 0.21$, the gain required to maintain oscillation is 11 compared with the theoretical value of 10.7. This discrepancy is within the possible inaccuracies of the author's measuring instruments, but is more probably due to the network components differing from their nominal values: the selection tolerance was ± 10 per cent for the capacitors and ± 5 per cent for the resistors.

Parasitic Oscillations

Limited experience with this circuit shows that it has a tendency to suffer from parasitic oscillations. At very high frequencies it probably forms a phase-shift oscillator using the stray capacitances to earth of the coupling capacitor and of C_1 and C_2 together with the inductances of the leads

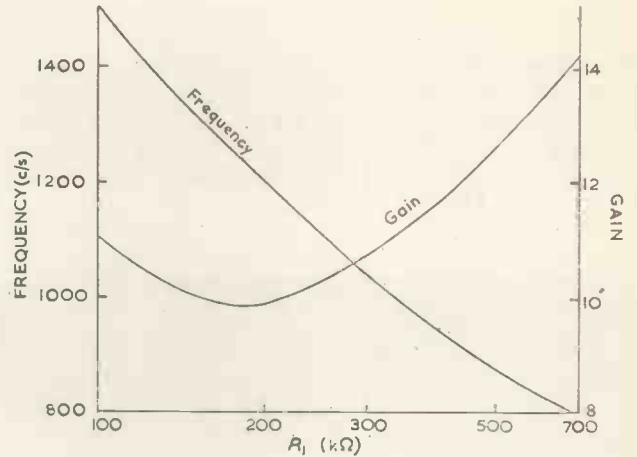

Fig. 4. Dependence of the frequency, and of the gain required to maintain oscillation, on the value of R_1 (Circuit of Fig. 3 with $R_3 + P_1 = 68kΩ$).

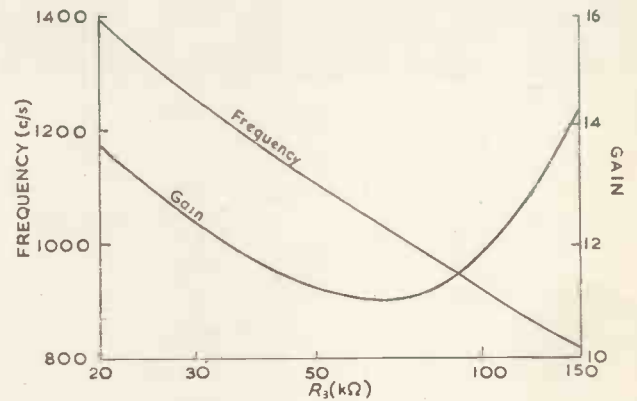

Fig. 5. Dependence of the frequency, and of the gain required to maintain oscillation, on the value of R_3 (Circuit of Fig. 3).

between them. It is therefore advisable to include a grid stopper in the circuit.

Conclusion

The twin-T oscillator described has some advantages over the more conventional types of oscillator; in particular oscillation can be maintained with a single amplifying stage of low gain, and negative feedback of harmonics is high so that a good waveform is produced. Its main disadvantage is that its frequency cannot be varied conveniently over a wide range.

A Miniature Analogue Computer

By A. B. Johnson*, B.Sc., A.M.Brit.I.R.E.

An analogue computer of unusually compact form is described. It is capable of solving linear differential equations of orders up to the tenth and intended for preliminary design investigations and educational purposes.

ELECTRONIC analogue computers, although in general cheaper than digital machines, are still expensive and often very large, so that they are by no means as readily available or convenient to use as slide rules or desk calculators. Some problems are so complicated that analogue

* Saunders-Roe Ltd.

computation is inevitably attended by high cost and large size of the equipment required, but there are many applications which can be accommodated on a relatively simple machine, and it was with these in view that the Saunders-Roe Miniputer was designed. It will analyse linear servomechanisms, simple aircraft flutter problems and simultaneous equations with the speed and convenience of a desk calculator, at a similar price. It is also useful for training operators of larger machines which can be ill-spared for this purpose.

General Description

The instrument consists of two units (Fig. 1). The left-hand case contains all necessary power supplies, that on the right is the computer unit and incorporates:

- (1) Ten operational amplifiers.
- (2) Twenty coefficient potentiometers.
- (3) Patch panel.
- (4) Display and control circuits.
- (5) Ten capacitor reset circuits.

The general arrangement of the computer is shown in Fig. 2.

OPERATIONAL AMPLIFIERS

Each consists of a miniaturized three-tube circuit (Fig.

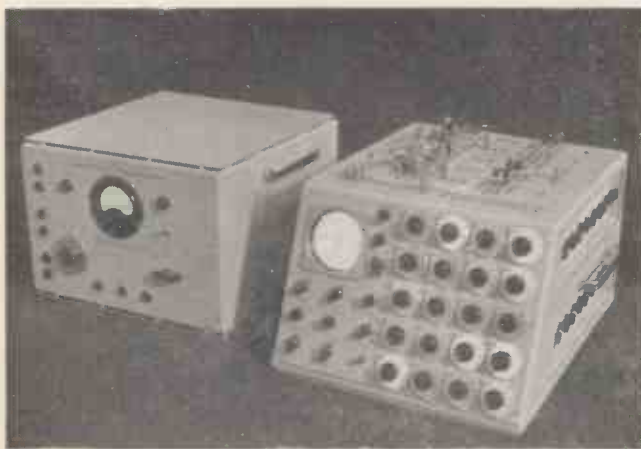

Fig. 1. The Miniputer and power supply unit

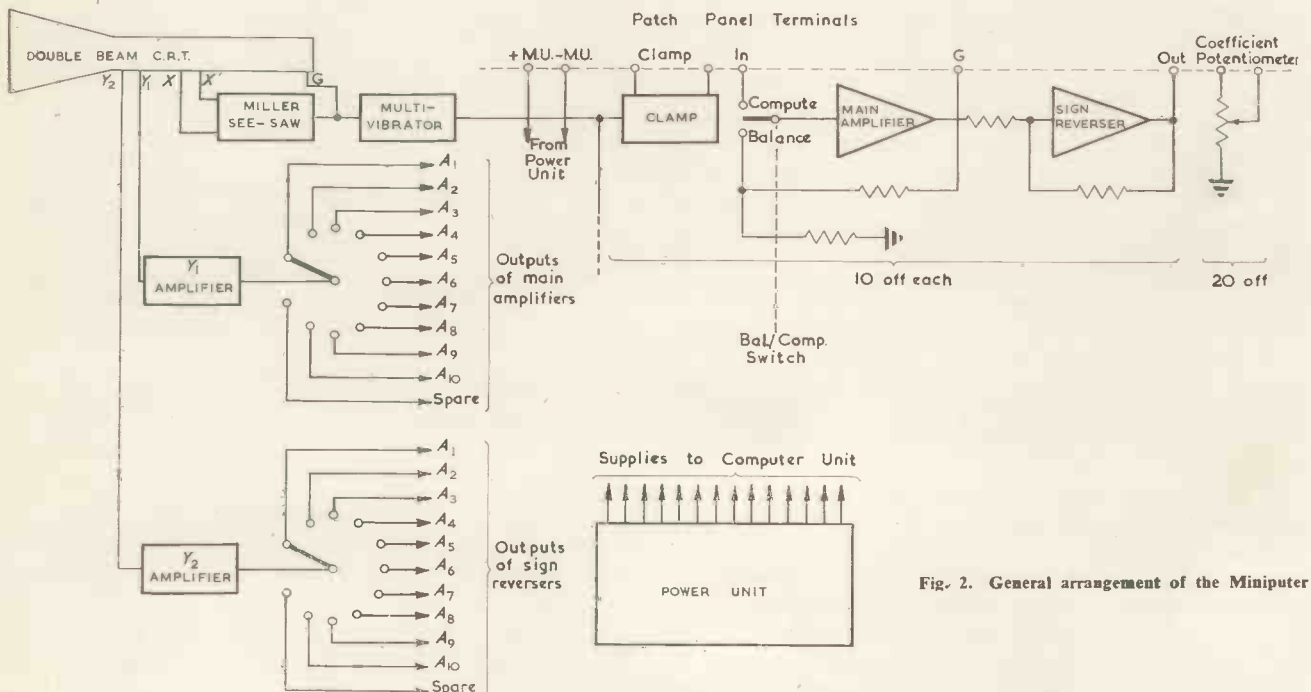

Fig. 2. General arrangement of the Miniputer

3). It is seen that there are in fact two nearly identical amplifiers, one of which, known as the sign reverser, has equal input and feedback resistors and is permanently connected to the output of the other, known as the main amplifier. The result of this is that each operational amplifier unit has two outputs of opposite polarity or sign, affording increased scope and convenience.

Scan durations of 10, 20; 40msec can be selected by means of a switch.

CAPACITOR RESET CIRCUITS

These consist of back-to-back double triode arrangements which can be connected via the patch panel, across each capacitor occurring in the problem set up. They are con-

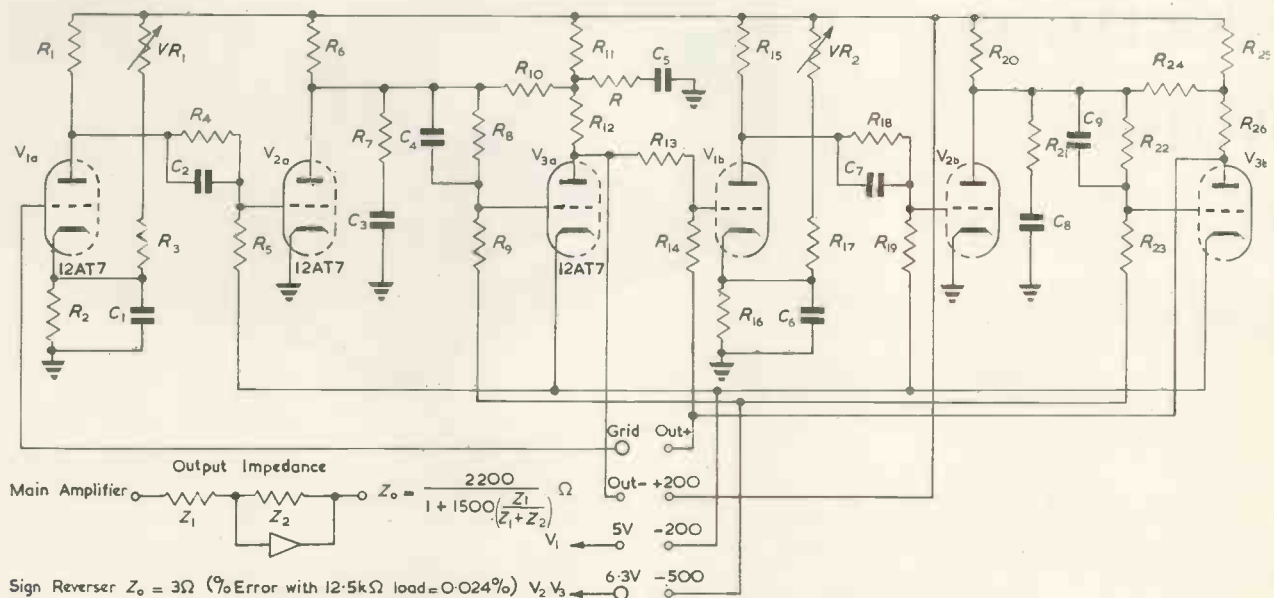

Fig. 3. An operational amplifier

Each amplifier section has an internal gain of 1500 and a bandwidth of 10kc/s. The first stages are supplied with stabilized heater voltage from a constant voltage transformer in the power unit. The output stages are capable of producing a swing of $\pm 50V$ in a load of 12.5k Ω , i.e. the equivalent of four coefficient potentiometers. 50V is the machine unit for this computer. An amplifier removed from the computer unit is shown in Fig. 4.

COEFFICIENT POTENTIOMETERS

These are 50k Ω wire wound potentiometers which can be set by means of their dials and cursors to within 1 per cent.

PATCH PANEL

This is situated on top of the computer unit and provides access to the terminals of the operational amplifiers, coefficient potentiometers, capacitor reset circuits or clamps and machine unit sources. Problems are set into the machine by plugging into the patch panel sockets, resistors, capacitors and connecting leads. The plugs used have sockets coaxial with the pins, so enabling any number of connexions to be made to a point on the patch panel.

DISPLAY AND CONTROL CIRCUITS

Any variable occurring in the problem set up can be displayed on a 3½in double beam c.r.t. Each Y trace is driven by a feedback amplifier, the input of which can be switched to the output of any one of the ten operational amplifiers. There are two gain positions for each Y amplifier giving full scale deflexions of ± 1 machine unit and ± 0.5 machine unit. The X scan is derived from a multivibrator driving a Miller integrator and see-saw push-pull circuit.

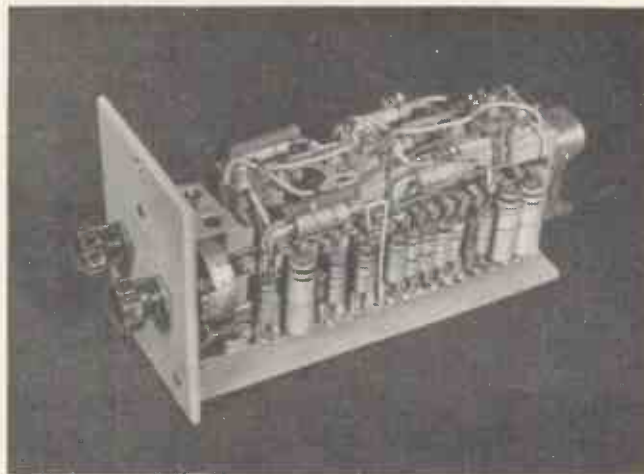

Fig. 4. A complete amplifier

trolled by a square wave from the multivibrator mentioned above which also brightens the c.r.t. trace during the forward scan and suppresses it during the return scan. The reset circuits or clamps are "freed" (rendered open-circuit) by a negative pulse during the forward scan and conduct so as to discharge all capacitors during the return stroke.

Acknowledgments

Acknowledgments are due to Messrs. Saunders-Roe for allowing publication of this article and to Messrs. P. Hegg, D. Hames and M. Allen for their parts in the development of the Miniputer.

The Design of Electronic Music Generators

By Alan Douglas, M.I.R.E.

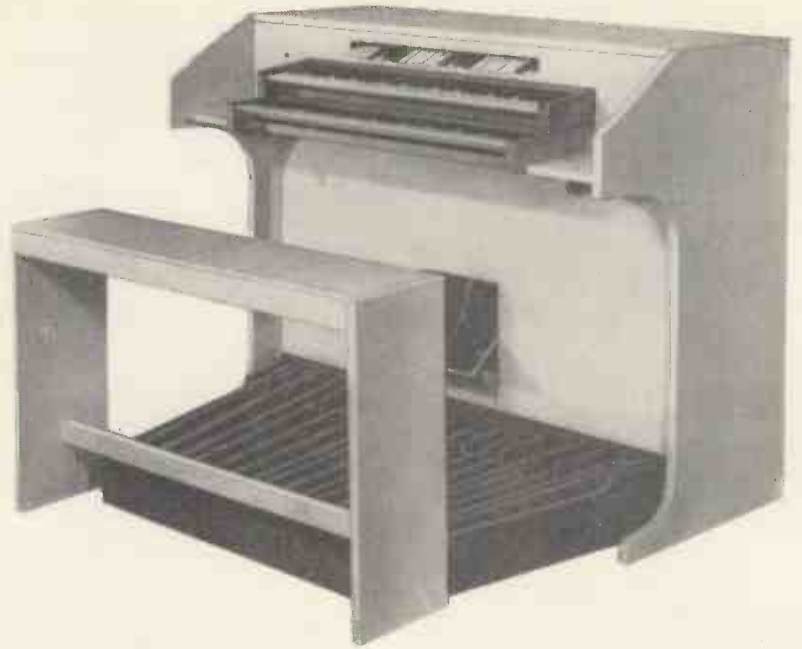

(Part 1)

As explained in previous issues of this journal¹, it is only the kinds of tones associated with keyboard control which form a profitable basis for polyphonic synthesis. Development of known oscillators over the past three years has resulted in an inexpensive generator combining a high degree of tonal realism with the simplicity required for home construction. Additional generators to extend the resources of this main unit will be described in future issues.

TO appreciate the reasons for this design, it is necessary to look at the lines along which existing musical instruments have developed. Detailed study of methods and circuits available for polyphonic music generators today show that the really feasible ones were known and exploited twenty years ago. What this means is that these five major methods were at once patented so far as possible, and the various companies exploiting these methods narrowed their activities to these respective channels for commercial development. As a result, each of these instruments has marked characteristics of its own, limiting its performance to the capabilities of that method and almost inevitably increasing the mechanical complication as the instruments grew larger. Thus most of the satisfactory commercial polyphonic generators are beyond the constructional capabilities of the average amateur organ builder.

Fundamental requirements of an acceptable music generator are:

- (1) Such tonecolours as are provided must be truly imitative of sounds known to us, by tradition, to be agreeable; but other sounds are, of course, permissible if they are pleasant.
- (2) The addition of the different complex tonecolours provided should be possible, without change in or degradation of the individual voices. It is in this respect that the major shortcomings of many commercial instruments are apparent.
- (3) The way in which the sounds start and stop should correspond as nearly as possible to the way in which this takes place in the instruments imitated.
- (4) The different tonecolours should have a range of

minimum to maximum volume corresponding with that of the instruments imitated. Here again, the discrimination in some commercial instruments is very poor.

- (5) Contact devices to control the generating system should be simple, cheap and reliable.
- (6) There should be a complete absence of internal screening or critical positioning of components if possible.
- (7) A vibrato generator, if provided, should ensure both frequency and amplitude variation and must not in itself generate an interfering waveform.
- (8) Each single note should be capable of independent regulation for volume level, since the behaviour of loudspeakers associated with unknown rooms is unpredictable.

Compactness, ease of construction and low cost are other desirable features, but static circuit complication is not a disadvantage except on the score of cost.

Basic Design

To enable the generator to be constructed without specialized equipment, all forms of tone producers involving rotating or vibrating elements were ruled out. The circuit, then, employs valves. It has been pointed out elsewhere² that frequency division does not provide suitable waveshapes for accurate tonal synthesis, except in circuits of extreme complexity³. But in any case, it is essential to generate more than one waveshape for each note.

It is permissible to take some liberties with the number

The illustration above shows a complete instrument built from the details given in these articles.

of generators really required. Careful examination of published keyboard music shows that in very few works is it strictly necessary to provide a generator for every note. Thus one can simplify the design by causing each generator to form two notes. If there is absolute insistence on performing some of the works of Rheinberger, Brahms or Bach, then only a very few extra generators are required. All light and popular music and over 95 per cent of classical music can be interpreted exactly as written on this design, which reduces the generator cost by nearly 50 per cent. These simplifications do not in any way impair the tonal capabilities of the unit, indeed it has been played by many professional musicians and used for lectures, without anyone detecting this circuit artifice.

The same principle, extended to embrace three or four notes, is used in certain other instruments, but this does result in some interpretive limitations.

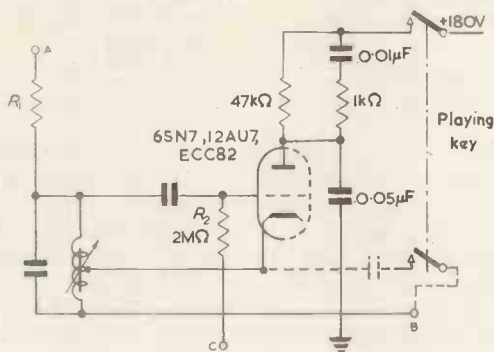

Fig. 1. The oscillator circuit

Most commercial valve generators of repute use some variant of the Hartley oscillator. This is simple, stable, flexible, has a large output, but especially lends itself to the generation of a complex waveform in which the harmonic series is correctly related to the fundamental; this latter point is very important, and a great difficulty with some kinds of rotating or vibrating generators. The Hartley circuit is also easily tuned. It can be keyed in the grid or anode leads but as it is necessary to have an independent negative supply exceeding the cut-off bias of the valve if grid keying is adopted, we have adopted anode keying. This allows of a vibrato voltage being injected in a simple manner.

The circuit is the same for all oscillators and is shown in Fig. 1. Note that certain elements are of the same value over the whole pitch range, which is from 65.4 to 2 093c/s for five octaves, or 65.4 to 4 186c/s for six octaves. Experience has shown that the compounding of tone qualities requiring simple waveforms is not successful if such waveforms are extracted from a complex wave, part or all of which is in use for some other tonecolour at the same time. It is necessary to have at least two independent waveforms from the same oscillator, and even more for a larger instrument.

Fortunately this is possible with the above circuit. The outlet A from the grid resistor R_1 is almost sinusoidal, whereas the outlet B from the lower end of the coil across a low resistance to earth is a reasonably good sawtooth. An approximately square wave can be obtained from the anode circuit, but is not required in this application. The grid leak R_2 is normally connected to earth, but can be

TABLE I
Table of Oscillator Component Values

| NOTE SIGN | NOTE NO. | COIL | MAIN TUNE | CATHODE TUNE | GRID CAPACITOR |
|-----------|----------|------|-----------|--------------|----------------|
| CC | 1 | 1 | 0.1 | 0.168 | 0.005 |
| C# | 2 | | | | |
| D | 3 | | | | |
| D# | 4 | 2 | 0.1 | 0.06 | 0.005 |
| E | 5 | | | | |
| F | 6 | 3 | 0.1 | 0.052 | 0.005 |
| F# | 7 | | | | |
| G | 8 | 4 | 0.05 | 0.02 | 0.005 |
| G# | 9 | | | | |
| A | 10 | 5 | 0.05 | 0.018 | 0.005 |
| A# | 11 | | | | |
| B | 12 | 6 | 0.05 | 0.017 | 0.005 |
| C | 13 | | | | |
| C# | 14 | 7 | 0.027 | 0.016 | 0.005 |
| D | 15 | | | | |
| D# | 16 | 8 | 0.027 | 0.01 | 0.005 |
| E | 17 | | | | |
| F | 18 | 9 | 0.02 | 0.009 | 0.005 |
| F# | 19 | | | | |
| G | 20 | 10 | 0.02 | 0.008 | 0.005 |
| G# | 21 | | | | |
| A | 22 | 11 | 0.02 | 0.01 | 0.005 |
| A# | 23 | | | | |
| B | 24 | 12 | 0.02 | 0.015 | 0.005 |
| C | 25 | | | | |
| C# | 26 | 13 | 0.02 | 0.01 | 0.005 |
| D | 27 | | | | |
| D# | 28 | 14 | 0.02 | 0.01 | 0.005 |
| E | 29 | | | | |
| F | 30 | 15 | 0.03 | 0.02 | 0.002 |
| F# | 31 | | | | |
| G | 32 | 16 | 0.02 | 0.01 | 0.002 |
| G# | 33 | | | | |
| A | 34 | 17 | 0.02 | 0.01 | 0.002 |
| A# | 35 | | | | |
| B | 36 | 18 | 0.02 | 0.007 | 0.002 |
| C | 37 | | | | |
| C# | 38 | 19 | 0.02 | 0.007 | 0.002 |
| D | 39 | | | | |
| D# | 40 | 20 | 0.015 | 0.006 | 0.002 |
| E | 41 | | | | |
| F | 42 | 21 | 0.015 | 0.007 | 0.002 |
| F# | 43 | | | | |
| G | 44 | 22 | 0.01 | 0.005 | 0.002 |
| G# | 45 | | | | |
| A | 46 | 23 | 0.009 | 0.0047 | 0.002 |
| A# | 47 | | | | |
| B | 48 | 24 | 0.007 | 0.0047 | 0.0005 |
| C | 49 | | | | |
| C# | 50 | 25 | 0.007 | 0.004 | 0.0005 |
| D | 51 | | | | |
| D# | 52 | 26 | 0.004 | 0.002 | 0.0005 |
| E | 53 | | | | |
| F | 54 | 27 | 0.005 | 0.0038 | 0.0005 |
| F# | 55 | | | | |
| G | 56 | 28 | 0.004 | 0.0019 | 0.0002 |
| G# | 57 | | | | |
| A | 58 | 29 | 0.004 | 0.0019 | 0.00015 |
| A# | 59 | | | | |
| B | 60 | 30 | 0.0038 | 0.001 | 0.00015 |
| C | 61 | | | | |

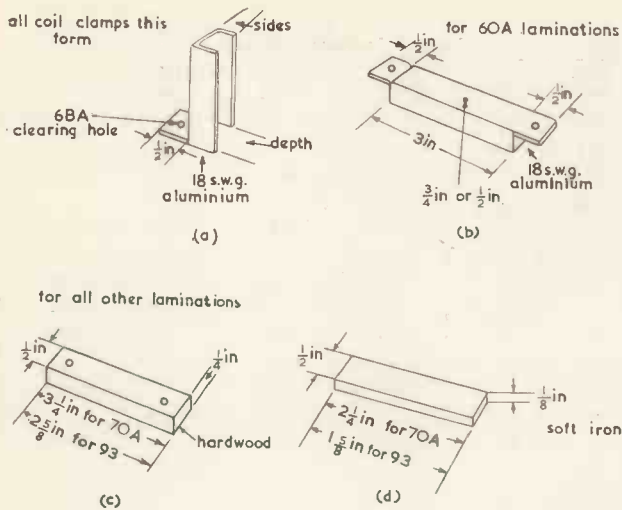

Fig. 2. Details of coil side and top clamps

All holes in the clamps to be 6 B.A. clearance. The T sections of 60A laminations are held in the clamps with Bostik cement. 70A and 93 laminations require tuning slips as shown at (d).

supplied with a cyclically changing source of d.c. to provide a vibrato. The right-hand part of the anode RC network ensures that the oscillator will always start even if the grid is at the maximum negative end of the vibrato voltage. The anode networks as a whole control the rate of the tone onset and are adjusted to the same delay for convenience; for strictly rhythmic playing this time-constant can be reduced without any trace of click or thump, but the values shown are eminently suitable for most kinds of music and represent the average opinion of more than 100 musicians who have heard different rates of attack and decay.

The coil is approximately tuned by a shunt capacitor, and fine tuned by adjustment of the iron core. To form the second note, a capacitor is keyed in between cathode and earth by additional contacts. The lowest three notes are all formed from the same oscillator to bring the total number of coils and valves to a round figure, and since it is virtually out of the question to play any combination of CC, CC# and D simultaneously at the bottom of the keyboard.

Table 1 gives the coil, main tuning, cathode tuning and grid capacitor details for the basic range of five octaves.

Fig. 2 shows the construction of the clamps, and Table 2 gives details of the coils. Note that for simplicity, there are only a few different windings and lamination sizes, which means that the output from some oscillations will exceed that from others; but that is conveniently regulated by adjustment of R_1 .

Now we are providing for a full five octave keyboard, which is standard organ practice. Thus it may well be that a pedalboard would be fitted at

TABLE 2
Coil Details

| | | | |
|-----------------------------|----|---|--------------------------------|
| Coils 1 to 6 inclusive | .. | $\frac{3}{4}$ in \times $\frac{3}{4}$ in stack | stalloy No. 60A |
| Winding | .. | 4 000 | 0.4 000 turns 39 s.w.g. enamel |
| Bobbin end cheek dimensions | .. | $2\frac{3}{4}$ in \times $2\frac{1}{2}$ in.* | |
| Side clamp dimensions | .. | $1\frac{1}{4}$ in high \times $\frac{3}{4}$ in deep \times $\frac{1}{2}$ in sides | |
| Coils 7 to 14 inclusive | .. | $\frac{3}{4}$ in \times $\frac{1}{2}$ in stack | stalloy No. 60A |
| Winding | .. | 4 000 | 0.4 000 turns 39 s.w.g. enamel |
| Bobbin end cheek dimensions | .. | As above | |
| Side clamp dimensions | .. | $1\frac{1}{4}$ in high \times $\frac{1}{2}$ in deep \times $\frac{1}{2}$ in sides | |
| Coils 15 to 20 inclusive | .. | $\frac{3}{4}$ in \times $\frac{1}{2}$ in stack | stalloy No. 70A |
| Winding | .. | 2 500 | 0.2 500 turns 39 s.w.g. enamel |
| Bobbin end cheek dimensions | .. | $1\frac{1}{2}$ in \times $1\frac{3}{8}$ in.* | |
| Side clamp dimensions | .. | As above | |
| Coils 16 to 30 inclusive | .. | $\frac{1}{2}$ in \times $\frac{3}{8}$ in stack | stalloy No. 93 |
| Bobbin end cheek dimensions | .. | $1\frac{3}{8}$ in \times $1\frac{1}{4}$ in.* | |
| Side clamp dimensions | .. | $1\frac{1}{2}$ in high \times $\frac{1}{2}$ in deep \times $\frac{1}{2}$ in sides | |
| Windings—coils 16 to 20 | .. | 2 500 | 0 2 500 turns 39 s.w.g. |
| 21 to 25 | .. | 2 000 | 0 2 000 " " |
| 26 to 30 | .. | 1 500 | 0 1 500 " " |

* This side of cheek to have three Tucker S110 solder tags riveted through.

some future date. In this case, the minimum width of the instrument is fixed by the dimensions of the pedals so that there is no need to cramp the generator components. The length of the keyboard is 34in approximately; and the width of the pedalboard 52in: but, even within the compass of the keyboard there is ample room to lay out the oscillators on two chassis each 28in by 10in by 3in. It is for ease of tuning that so much space is allowed for each oscillator.

Fig. 3 is a photograph of a larger instrument from the rear, embodying this generator, from which the arrangement will be clear. Observe that each main chassis is mounted on silentbloc rubber buffers and that all valves

Fig. 3. A rear view of a complete instrument

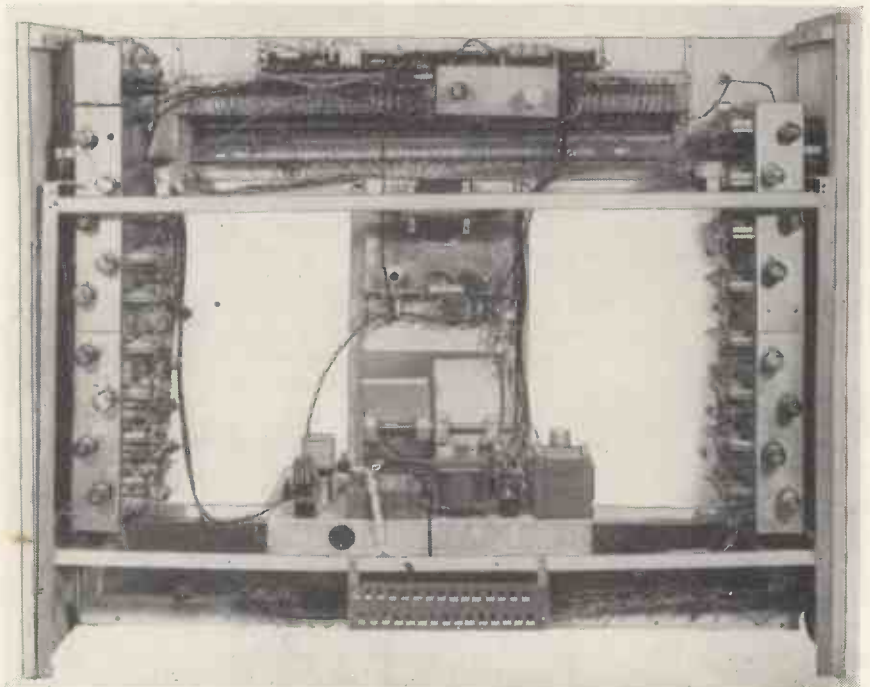

face the rear, where the heat is easily dissipated and cannot reach the coils.

Fig. 4 shows part of a chassis; the layout of the elements is in no way critical and it is worthy of note that no screening of any kind is required for the internal wiring, the quite long keying leads, and the waveform outlet circuits. The easiest way to arrange the wiring is to run three busbar wires the whole length of the chassis, on which the outlets A, B, and C can be terminated from each oscillator. The grid capacitors and one end of the grid leaks are soldered directly to the valve holder socket tags, then all the other parts can be mounted on tag strips transversely across the chassis. On the side wall facing that occupied by the valveholders a series of 32 equally spaced holes are made; these are to take the keying leads. The

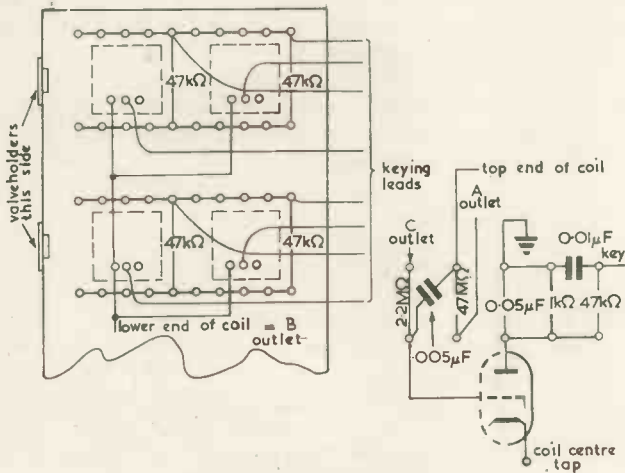

Fig. 4. Part of chassis interior

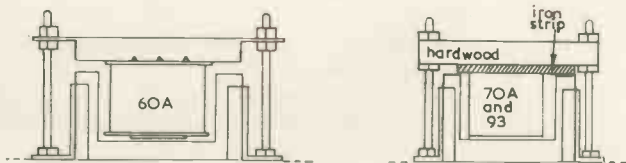

Fig. 5. Method of mounting coils

chassis for the upper frequency coils has two extra valveholders which can be seen in Fig. 3. These are for the vibrato oscillator. Since the coils at the top end of this chassis are quite small in size, there is ample room for all the elements of the vibrato circuit inside the chassis.

Thus we have a bass chassis with all the 60A coils and a treble chassis with the 70A and 93 coils; and the vibrato apparatus. It will be understood that the coils are external to the chassis and everything else except the valves, inside. The coils are secured by short pieces of 6B.A. screwed brass rod⁴ in the manner of Fig. 5, so that in the case of the 60A coils they can be tuned by raising or lowering the top bridge holding the *T* part and coil. This can be set with accuracy by the nuts. The 70A and 93 coils have a strip of soft iron under their wooden bridges, which is swivelled radially across the poles to alter the tuning. Again, these can be locked in position by the nuts. Wood is used for the higher frequencies to damp any tendency to vibrate audibly. Should the side clamps not fit tightly

for any reason, the lower part of the 60A laminations (and the whole of the 70A assemblies), with clamps on, may be boiled in beeswax. The coils on 93 laminations must not be so treated.

We have started on the coils because they are by far the most difficult part of the instrument. Yet there is ample space on all the bobbins for random winding, since it is neither practical or necessary to layer wind. Details for simple coil winders have appeared in the press⁵.

Assuming all the circuit elements to be soldered to tag strips, note that the lead from each grid capacitor goes through R_1 to one of the busbars. It is best to start with R_1 about $4.7M\Omega$. Then the lower end of all the grid leaks goes to the middle busbar, and the lower or inner end of each coil to the remaining busbar. Flex leads then connect these busbars to a four-way terminal block on the outside of the chassis, the fourth way being an earth to the chassis. Keying leads come from all oscillators as on Fig. 1 and pass through alternate holes in the series of 32 already

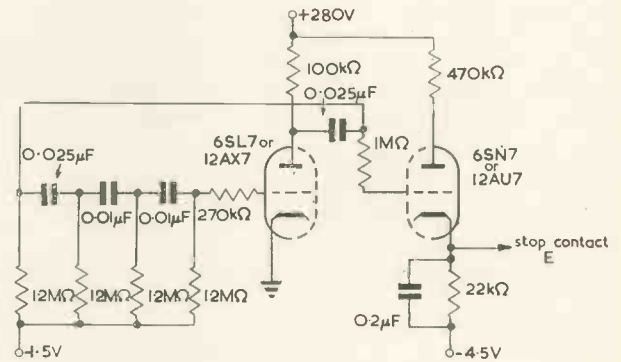

Fig. 6. Vibrato oscillator

drilled. In addition, an extra keying lead is soldered to each coil centre tap and taken out through the remaining holes. It is well to use different colours for these two kinds of lead.

Before continuing with the generator connexions, the vibrato circuit may be assembled. The circuit for this is given in Fig. 6. The second valve is a switch so that the voltage across the $22k\Omega$ resistor is changed cyclically at the frequency of the phase shift oscillator. One-half of this double triode is also used as the oscillator for note number 61, C_4 . The small dry cells shown have given a life of over three years, but if a very long life is called for, Mallory mercury cells type RM12 may be used. The vibrato frequency is $7.5c/s$.

Perhaps the key contacts should be dealt with next, then it is easier to set up the generator. Undoubtedly the acquisition of a suitable keyboard will present the greatest difficulty to the electrical engineer, but it must be emphasized that no satisfaction can ever be obtained from any instrument unless the keys are sound and of the proper dimensions. Fortunately, such keyboards are not expensive and will last a lifetime. The compass we require is 5 octaves, C_4 to C_9 ⁶.

It is assumed that mechanical compactness is required and for this we specify "back hung" keys. Although these are frowned on in the pipe organ world, such well-known electrical tone producers as Hammond, Baldwin Wurlitzer and Compton use them. Let us take a section

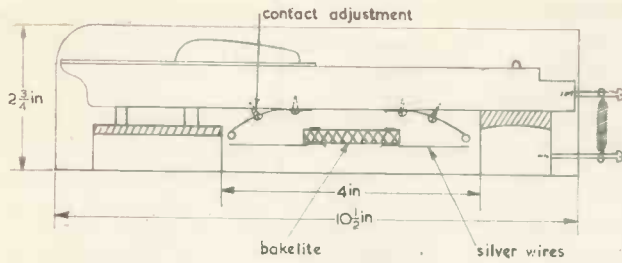

Fig. 7. Section of keyboard

through this kind of keyboard, Fig. 7. The dimensions are typical. The part which is important is the centre open space under the keys. This should not be less than 4 in wide. Much has been written on "cheap" contact construction, but the use of incorrect materials spells nothing but trouble and the proper contacts are inexpensive⁶. We are keying d.c. on one contact and a.c. on the other, but this latter is set to close first so that, by the time the anode network allows the oscillator to commence, this circuit is made. Therefore no clicks or thumps can occur; although in fact if both contacts close at the same time there would still be no click as the delay for the oscillator is about 50msec. The keys are returned by small coil springs⁴ threaded on to 2 1/2 in by 6B.A. screws in the keys and frame as shown. Drill the holes with a 43 drill and the screws will tap their own threads in this way, they will always remain tight. The upper limit of movement is fixed by the stop panel, to be described later; it allows a depth of touch of 1/2 in and if other kinds of keyboard are used this should be borne in mind.

The contacts are housed in the central space. There are 61 at the rear and 31 at the front; therefore every key has a rear contact and the front ones are arranged as follows: One on CC, one on CC#, one on D#, one on F, one on G, one on A, one on B; and then on every alternate one to the top of the compass, which will result in C61 having one rear contact only. The adjustable contact plates are best purchased⁶, and they are attached by 3/8 in by No. 3 round head brass screws, of which 184 will be required. Each plate will be found to be bent and the adjusting screw should be set so that about half the plate travel is taken up. This will make subsequent setting of the contacts easier.

A small part of the contact wire assembly is shown in Fig. 8. Prepare a strip of grade 1 Bakelite or perspex 1 in wide by 1/2 in thick by as long as the inside of the key frame. 184 Tucker S110 solder tags⁷ and 23ft of 28 s.w.g. standard hard silver contact wire⁸ are needed. The wire is cut into

Fig. 8. Contact arrangement

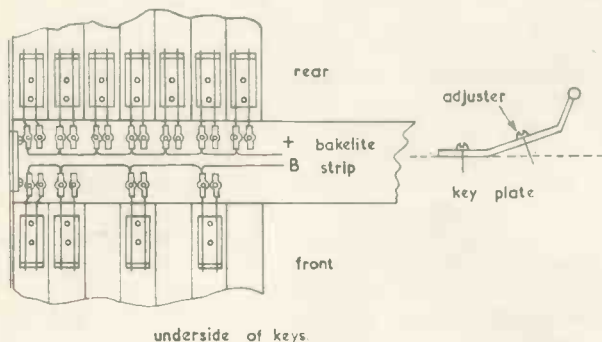

lengths of about 1 1/2 in. The solder tags are inserted into the Bakelite strip (No. 42 drill) as shown and lightly secured by a tap with a centre punch. Each key requires two tags within its width facing to the rear, and two tags facing the front for such notes as have secondary tuning contact plates. Now every alternate tag on each row is joined by a length of 28 s.w.g. bare tinned copper wire soldered on, so as to form a busbar for each set of contacts. This wire must be looped so that it does not touch the other contacts in between, thus we have a front and a rear busbar as it were.

At this stage the contact strip can be inserted between the keys. Meccano brackets are ideal for fixing it to the key-frame ends. The strip is so positioned that if a piece of silver wire is laid on a contact plate and on the corresponding tag, it will be horizontal (with the keyboard upside down). It is necessary to make sure the keys are in the raised position when doing this, so a 1/4 in thick strip of wood can be placed between the bottom of the keys and the felt to ensure this condition. All the silver wires can then be soldered in position and it should be noted that it pays to thoroughly wet the wires with solder at one end before attaching to the tags.

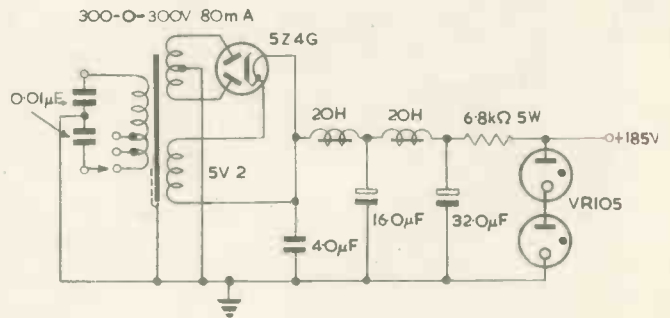

Fig. 9. Oscillator power supply

The keyboard should now be stood on end and the wood strip removed. Depress one key about the middle of the compass and set the contact plates so that the front plate touches its wires before the rear one does. Proceed in the same way for all the notes. It is most important that this adjustment be correct, and if there is any tendency for the centre of the contact strip to flex under the pressure of playing, say, 10 notes, a Meccano bracket should be attached to stiffen it there. It is understood that all contacts are open when the keys are fully up.

The "live" contacts on both front and rear sides of the Bakelite strip will be dealt with subsequently, but the two busbars should be taken out, on flexes of different colours, to a two-way tag strip at each end of the back of the key-frame. Mark the rear tag +, the front one -.

We can now revert to the generator and consider the power supplies. The valve complement is 15 6SN7, 12AU7 or ECC82; also one 6SL7, 12AX7 or ECC83 for the vibrato oscillator. The h.t. load is approximately 10mA, but in assessing this we are not taking any main amplifier into account as is obvious; the tone forming amplifier is included. Some stabilization is desirable in the present state of the public supply.

A simple but well-filtered unit such as that of Fig. 9 is very satisfactory. There is no trace of hum even on full gain and it must be remembered that part of the instrument is on full gain all the time. The vibrato oscillator supply

need not be stabilized. This power unit should be mounted at the bottom of the case and can be seen, with other power supplies, at the right centre of Fig. 3.

The heater supply is more of a problem if 6SN7 valves are used, since they require nearly 10A at 6.3V. It is best to provide a separate transformer.

Primary. 0.900 + 90 + 90 turns 24s.w.g. enamel copper wire.

Secondary. 30 turns 10 s.w.g. enamel copper wire.
Maximum secondary current, 12A

If, however, the 12V class of valve is used, the current becomes 2.8A and this is easily obtained from a small commercial transformer. In either case, a "humdinger" should

be examined in conjunction with Figs. 11 and 13. It is arranged to conform with the contacts required for the "stops", which will be detailed in due course. The oscillator outlet A is responsible for the flute and tibia tones, while B is used as generated for the string tone. The same waveform is modified by the resonant circuits to form the oboe and trumpet, in conjunction with the harmonic switch shown. Fig. 11 shows the sawtooth filter which forms the harmonic switch and gives details of the resonating chokes, which it will be noticed are mutually coupled on a common iron core. Fig. 12 shows the waveforms of actual organ

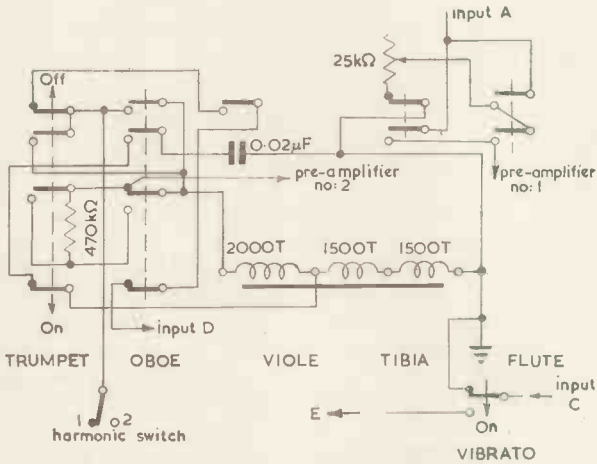

Fig. 10. Stop controls shown "off"

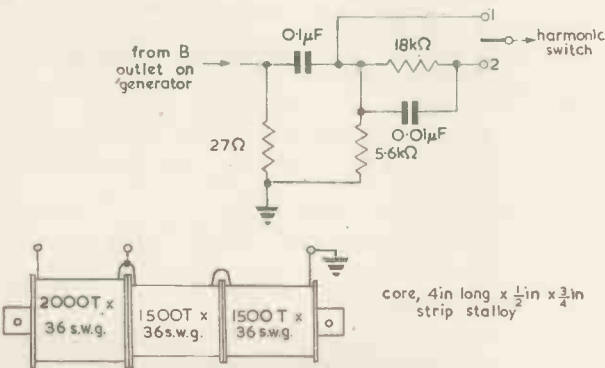

Fig. 11. Sawtooth filter and details of resonating chokes

be fitted as shown, and the leads, which should be twisted, should be of very low resistance.

We can now pay some attention to the tone forming circuits. The voices provided are, flute; tibia; viole; oboe; trumpet. A harmonic switch is fitted to suppress the fundamental on the oboe and trumpet, converting these approximately to a vox humana and clarion, very useful for special effects. A modest range of tones, but of excellent fidelity and quality over the whole of the compass. By additions to be described later, their usefulness can be much extended.

Fig. 10 is the complete tone circuit and should be

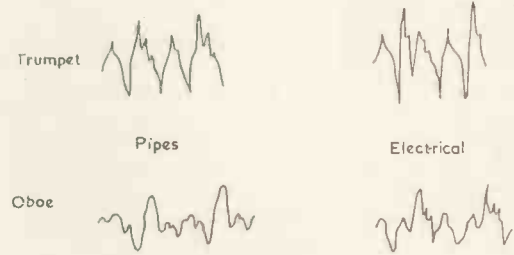

Fig. 12. Tone spectra—original and as synthesized

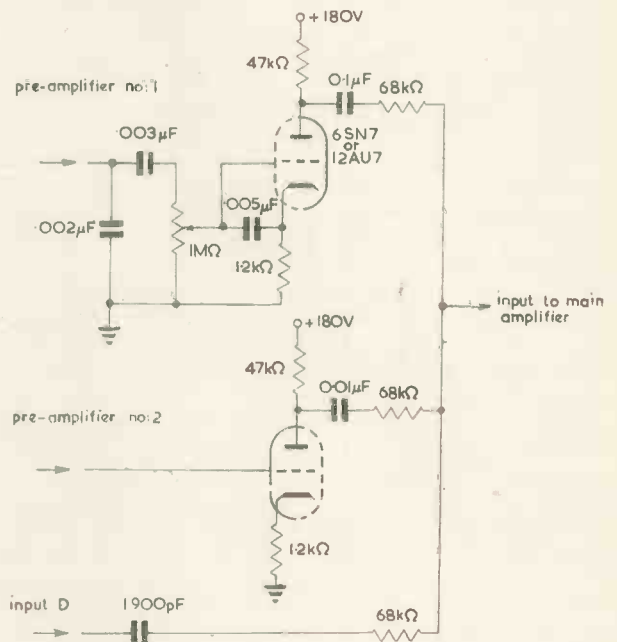

Fig. 13. Tone mixing circuits

trumpet and oboe pipes, with the tones as synthesized on this circuit. Addition of the viole or tibia does not affect the other tones, but the trumpet masks the oboe as would indeed be expected. Level controls are provided to set the volume of the tibia and flute tones as these are found to be more critical than the others in a room which is virtually without reverberation. Personal tastes and the kind of subsequent power amplification used also call for some adjustment of this kind. The preamplifiers are shown in Fig. 13.

No detailed instructions for a frame on which to mount the generating system are given, since the final form could

be that of a complete two or three manual organ; a simple unit as now described, on a metal frame; or merely one keyboard with a multiple plug, which could be laid on a table with the generator elsewhere, since it is an advantage of this system that the keys can be quite a long way from the oscillators. This makes it possible, for instance, to add the generator as an extra clavier to an existing pipe organ or even a piano, 2½in representing the total depth required for the keys, frame and contacts.

Should it be decided to make a complete instrument including subsequent tonal extensions, the following dimensions are recognized as being an acceptable standard. Overall height, 44in. Distance from top of keyboard naturals to centre DD pedal on pedalboard, 31in. Amount by which the front end of pedal DD♯ key is set forward, under the keyboard, using a line dropped from the front of mid-C manual key, 10½in. Height of stool top from floor, 27in. Width of stool top, 10in. Length, to embrace pedalboard. A complete single manual and pedal organ using this generator was illustrated in the September 1953 issue of this journal, page 372. A complete two manual and pedal instrument using the subsequent tonal extensions will be shown at the conclusion of these articles.

Now there are a few practical details concerning connecting up the units. A strip of Bakelite 1in wide, 35in long and 1/16in thick can be fixed across the rear of the key frame, and should have 65 Tucker S.110 eyelets inserted in a row. The extreme right- and left-hand tags are marked +, those next being marked b. Stick on small squares of white card bearing the indications. Then, each note should be similarly identified, e.g. C/61 B/60 A♯/59 etc., so that the connexions will be obvious from the outside. To connect the tags, take a flex from C/61 to the idle tag of the corresponding rear row under the keys, and for B/60, to the corresponding tag of the front row. This procedure is carried out over the whole compass; but it will be found that the rear tag for B/60 is not connected. This must be joined to the C/61 tag which has just been brought out to the rear tag strip. Similarly, A/58 must be joined to A♯/59, G/56 to G♯57, and so on; otherwise there will be no h.t. supply to those oscillators when re-tuned by the cathode capacitors.

If the leads from the anode networks of the oscillators have been similarly marked there will be no difficulty in connecting to the correct keys. Equally, the outlets from the coil centre-taps are taken via the correct capacitor (from Table 1) to the appropriate keyboard tag. The capacitor values are, of course, based on the tolerance of these elements being fairly close. If they are not, then padding with smaller units must be resorted to, since the value will have to be within one part in a thousand of the correct values. For while the primary note can be tuned by the coil over a wide range, once this tuning is set we rely on the value of the capacitor for correct secondary tuning.

The question of the initial tuning of the whole instrument can be tackled in several different ways, but if the constructor is at all uncertain, by far the best procedure is to call in a piano tuner for the initial setting up. The tuning is very stable and will hold for at least six months; even then, possibly only one or two notes will require re-tuning and this is found to be due to ageing of the paper capacitors. After these have been corrected, most notes have remained in tune during the three years over which this circuit has been undergoing life tests.

One of the not inconsiderable advantages of this circuit is that we are not so concerned about the frequency

response of any loudspeaker envisaged, since, in contrast to records or radio, we have the means of adjusting the generator response to what we like. This does not mean that we can force a powerful bass out of a small cone, but it does mean that given a good unit in a suitable enclosure, the overall tonal balance can be regulated to suit a particular room. This accounts in part for the smooth response of the tone generator with a complete absence of resonances, regrettably prominent in some systems.

It is not proposed to supply any amplifier or loudspeaker details since nearly all modern circuits perform admirably with this generator. If, however, the addition of a further bass extension is contemplated, then we are faced with a response down to 32c/s. This calls for a 15in loudspeaker and one of the better amplifiers. It has been found, taking a cross-section of the several installations of this generator, that 5 to 6 watts is an adequate maximum for the average home. A simple amplifier which performs well up to 7 watts has been described in this journal⁹. The bass response of this circuit is only down 1dB at 4c/s and it is completely stable.

However, it will be assumed that a suitable amplifier and loudspeaker is available. It is almost certain that, in running over the compass, some notes will be louder than others. This can be compensated for, and regulated as desired, by altering the value of the 4.7MΩ resistor R₁ in the A outlets. Reducing the value will increase the level, but the minimum value permissible is 1MΩ. On the other hand, an excessively loud note may require up to 10MΩ. This may also apply if any pronounced physical resonance is met with, due to some peculiarity of the room. Thienhaus-Willms¹⁰ has shown that the optimum effect from a combination of reeds and flue pipes is practically a straight line over the whole compass, but this is in part due to the flue pipes rising to a maximum intensity between C₁ and C₃ with a peak at C₂; and the reeds decreasing slightly but steadily from CC to C₄. We shall then find the best effect if the resistors are set to produce the above flue pipe characteristic on the tibia; the resonant circuits will automatically produce the required reed response. The viole is practically uniform over the whole compass and, being a quiet voice, this is just what we want. Thus a properly-balanced tonal spectrum can be obtained and this will have the correct perspective for any combination of the voices selected.

Now we have a complete music generator capable of giving satisfying results in itself, and in further articles we will consider:

- (1) Possible mechanisms for the stop controls;
- (2) a wide-range solo generator for an extra keyboard;
- (3) a pedal generator for bass notes;
- (4) an octave coupler mechanism.

REFERENCES

1. DOUGLAS, A. The Electrical Synthesis of Musical Tones. *Electronic Engng.* 25, 278, 336 and 370 (1953).
2. *Electronic Musical Instrument Manual* (Pitman).
3. U.S.A. Patents 20831, 21137 (re-issues).
4. WHISTON, K. R. New Mills, Stockport.
5. NORTHALL, B. V. A.F. Coil Winder. *Wireless World* 59, 376 (1953).
6. HOLT, ERNEST, 102, Wolverhampton Street, Walsall.
7. Tucker Eyelet Co., Walsall Road, Birmingham, 22.
8. Johnson, Matthey & Co., 73, Hatton Garden, London, E.C.1.
9. MILLER, E. J. A Stable, High Quality, Power Amplifier. *Electronic Engng.* 24, 366 (1952).
10. Thienhaus-Willms, *De Lautstärke von Orgelregistern*, Vol. 3 (1933).

(To be continued)

A Square Wave Inductance Bridge

By K. Lamont*, M.I.R.E.

Orthodox inductance measurement of small laminated cored components gives no direct information regarding core losses. It is possible, under certain circumstances, to obtain direct indication of the eddy current loss by simultaneously balancing a bridge at more than one frequency. An experimental bridge utilizing a square wave signal is described.

THE testing of laminated iron cored transformers and inductors frequently presents problems by virtue of the number of parameters involved. The technique to be described was developed in order to facilitate measurement of inductance and eddy current loss independently of copper loss in small transformers normally operating at low flux densities.

The Behaviour of Iron Cored Inductors

Before the bridge technique is explained, it is relevant to consider the behaviour of an iron cored inductor and to deduce its approximate equivalent circuit. As is well known, the losses due to eddy currents increase with frequency and above a certain frequency the inductance starts to fall. An inductor having eddy current losses only may be represented as an inductance and a resistance. Up to a certain critical frequency, the inductance may be considered either as being in series with a resistance which is proportional to the square of the frequency, or as being shunted by a constant resistance. The shunt equivalent circuit is the most convenient one in the present instance and this aspect will be considered throughout.

Above a certain frequency, interaction takes place between the eddy current flux and the main flux in each of the individual laminations with the result that the outer surface performs no useful function. Consequently, the inductance starts to fall, and the eddy current losses, though still increasing with frequency, do so more slowly. This state of affairs implies that eddy current loss can no longer be represented by a constant (i.e. non-frequency dependent) resistance. The critical frequency, up to which the square wave technique is useful, depends upon the core material and lamination thickness and is given approximately (see Appendix) by:

$$0.1 \rho / \mu t^2$$

where t is the lamination thickness in cm.

The Principle of Square Wave Excitation of Bridges

The use of square waves as a means of resolving for example series-shunt ambiguities, which would otherwise require measurement at more than one frequency, is not new^{1,2}. The basic bridge circuit previously described by Roddam³ was found to be most suitable under practical conditions and it has the virtue that both signal source and detector may be earthed one side.

The bridge was designed to cover 10mH to 100H in four ranges, a choice being available between a 50c/s or 10kc/s square wave having 10 per cent to 90 per cent mark-space

ratio or a 50 per cent to 50 per cent 1 000c/s square wave. This arrangement has been found to be generally useful in the case of miscellaneous small transformers. As will be described, it was found possible to make approximate measurements of winding capacitance which, though not accurate in absolute terms, were helpful in checking relative values.

The circuit arrangement employed by Roddam is shown in Fig. 1, and in such a form it is unsuitable for inductance

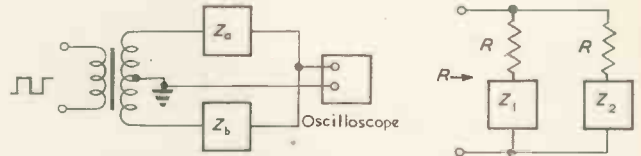

Fig. 1. Roddam's circuit arrangement

Fig. 2. Constant resistance network

| | Z_1 | Z_2 |
|---|-------|-------|
| a | | |
| b | | |
| c | | |
| d | | |
| e | | |

$$K^2 = Z_1 Z_2$$

Fig. 3. Reciprocal impedances

measurement. However, by application of the theory of inverse or reciprocal impedances⁴, it is possible to arrive at a circuit arrangement⁵ in which inductance may be measured in terms of capacitance which is, of course, more convenient in practice. Fig. 2 shows a constant resistance network in which Z_1 and Z_2 are reciprocal impedances, thus Z_1 and Z_2 may be any pair of impedances (or others appropriately related) shown in the table in Fig. 3. An iron cored inductor and its reciprocal are equivalent to the Z_1 and Z_2 networks shown in Fig. 3(e) and these items, it

* Formerly Cinema-Television Ltd.

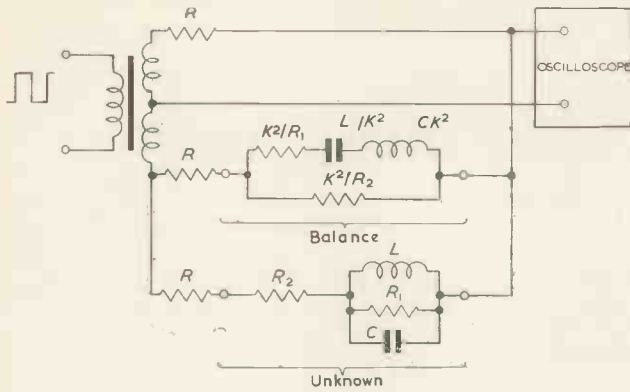

Fig. 4. Basic circuit arrangement

will be recalled, will not upset the resistive property of the Fig. 2 network. The bridge may now be redrawn in such a way as to have an arm equal to R in each side, one side containing a straightforward resistance and the other the network of Fig. 2; such an arrangement is shown in Fig. 4. A bridge in which the various parameters may be individually balanced has now been derived, and it only remains to consider the practical aspects.

Practical Considerations

The practical circuit is shown in Fig. 5, and it will be observed that minor changes have been made to the method of balancing out winding resistance and capacitance as it was not required to measure winding resistance and accurate evaluation of self-capacitance was not necessary. The winding resistance being usually small, it is normally more convenient merely to reduce the R element in series with the unknown by the appropriate amount, rather than to compensate by means of a shunt component in the balance network as shown in Fig. 3(e). So far as self-capacitance balance is concerned, the procedure adopted was for a coil to be incorporated in the balance network which would balance out say 500pF in the unknown. A calibrated variable connected across the unknown may then be adjusted for balance, provided the unknown does not represent a

Fig. 5. Practical circuit

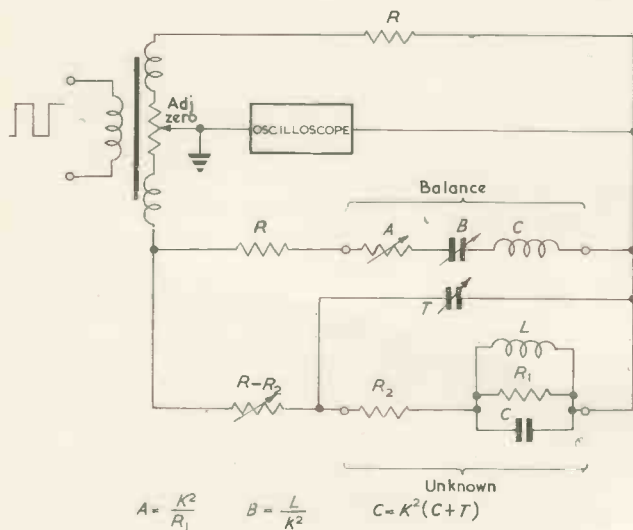

capacitance greater than 500pF. The exact arrangement would depend upon the use to which the bridge is to be put.

For zero balancing arrangements, provision is made to switch in a simple resistance R in the lower arm, when the zero adjustment may be set up. A standard type of oscilloscope having adjustable gain is satisfactory as a "detector", and the extent to which the overall response is maintained depends upon the circumstances. One of the most important features is the balance/unbalance transformer: this must be carefully designed if a satisfactory zero is to be obtained, which in turn limits the overall accuracy. Ranges may be switched by simultaneously changing all three R arms. The variable resistance element in the balance network is constructed in the form of a conductance box and may therefore be calibrated directly in terms of the unknown shunt resistance, of which it is the reciprocal,

Conclusion

Though little time has been spent in its development, the bridge described has been found to be generally useful and capable of accurate measurement of inductance and shunt resistance, provided the frequency is not above the critical value and provided hysteresis effects are small. It should be remembered that dielectric loss and residual loss will also be manifest as shunt resistance components, though normally they will be very high compared to eddy current loss in laminated cores.

At the time this work was carried out, the writer had no opportunity for making measurements on Ferrite cored components. The application of the square wave technique would be limited to those regions in which both real and imaginary components of μ are substantially independent of frequency.

The technique would appear to have possibilities in the determination of unknown complex impedances.

Acknowledgments

The author wishes to acknowledge the assistance rendered by Mr. A. B. Highfield: he also wishes to thank the Chief Engineer of Messrs. Cinema-Television Ltd for permission to publish this article.

APPENDIX

Derivation of equivalent parallel circuit for an iron cored inductor in which eddy current losses are significant. Limiting conditions for square wave inductance measurements.

LIST OF SYMBOLS

- a = Cross-sectional area of core (cm^2)
- f = Frequency (c/s)
- Φ = Total flux
- H_0 = Magnetizing force at surface of a lamination (Oersteds)
- H_x = Magnetizing force in a plane parallel to the length of the lamination x cm from the central plane
- l = Magnetic path length of core (cm)
- L_0 = Low frequency inductance = $4\pi N^2 a \mu / 10^9 l$ (Henries)
- L_e = Equivalent shunt inductance allowing for effects of eddy currents (Henries)
- μ = Initial permeability (at low frequencies)
- N = Number of turns on winding

- R_e = Equivalent shunt resistance due to eddy current losses
- ρ = Resistivity of core material (cm³) (m Ω)
- t = Thickness of lamination (cm)
- u = Core material factor = $2\pi t \sqrt{f(\mu/\rho)}$
- ω = Angular frequency (2 πf)
- X_e = Equivalent shunt reactance with eddy current losses
- Y = Admittance of iron cored inductor (mhos)

Consider a lamination 1cm wide and t cm thick in which magnetic flux is flowing longitudinally. The thickness t is assumed small compared with the width.

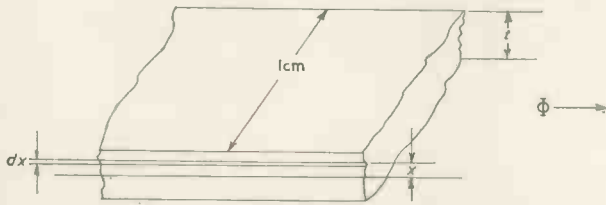

Fig. 6. Eddy current and magnetic flux in lamination

The e.m.f. x cm from the central plane (Fig. 6) may be written:

$$E_x = \omega \Phi_x / 10^8$$

Assuming the flux to be uniform over the range dx :

$$E_{x+dx} = (\omega / 10^8) (\Phi_x + 2\mu H_x dx)$$

$$E_{x+dx} - E_x = -j \frac{2\omega\mu H_x}{10^8} dx$$

or:

$$dE/dx = -j \frac{2\omega\mu H_x}{10^8} \dots \dots \dots (1)$$

The eddy current produced by this voltage is given by:

$$I_x = \frac{E_x}{2\rho/dx} = (E_x / 2\rho) dx$$

The value of H_x in the range dx being given by:

$$\begin{aligned} dH_x &= (4\pi/10) I_x \\ d^2H_x/dx^2 &= \gamma^2 H_x \dots \dots \dots (3) \end{aligned}$$

Differentiating equation (2) and substituting for dE/dx , we may write:

$$d^2H_x/dx^2 = \gamma^2 H_x \dots \dots \dots (3)$$

where $\gamma = 2\pi \sqrt{[2j(f\mu/\rho)]}$.

The solution may be shown to be of the form:

$$H_x = H_0 \frac{\cosh \gamma x}{\cosh \gamma(t/2)}$$

where H_0 is the field at the surface of the lamination.

It is clear that the behaviour of a given magnetic material is characterized by the quantity γ and it is therefore desirable to relate the total flux to γ :

$$\Phi = \mu \int_{-(t/2)}^{t/2} H_x dx$$

from which:

$$\Phi = \frac{2\mu H_0}{\gamma} \tanh \gamma(t/2)$$

or alternatively:

$$\Phi = \frac{2t\mu H_0}{(1+j)u} \tanh(1+j)u/2 \dots \dots (4)$$

where $u = \gamma t / \sqrt{2j} = 2\pi t \sqrt{f(\mu/\rho)}$.

It will be observed that u , which is a more convenient parameter than γ , is a simple quantity depending only upon the physical constants of the core material used. As equation (4) represents the total flux in a core of cross-section t we may now introduce the core dimensions and derive the admittance of a laminated core inductance.

Rewriting equation (4):

$$H_0 = \frac{\Phi(1+j)u}{2t\mu \tanh(1+j)u/2}$$

Thus in an inductor having a magnetic path length l we may write the magnetizing current as:

$$i = \frac{10\Phi(1+j)u}{8\pi t\mu N \tanh(1+j)u/2}$$

and since the applied voltage:

$$E = j\omega N\Phi \cdot 10^{-8}$$

The admittance may be written:

$$Y = \frac{(1+j)u}{2j\omega L_0} \coth(1+j)u/2$$

where L_0 is the low frequency inductance $\frac{4\pi N^2 a\mu}{10^9 l}$ (in this case $a = t$).

We may therefore represent an iron cored inductor as a parallel combination in which:

$$R_e = \frac{2\omega L_0}{u} \cdot \frac{\cosh u - \cos u}{\sinh u - \sin u}$$

and:

$$X_e = j \frac{2\omega L_0}{u} \cdot \frac{\cosh u - \cos u}{\sinh u + \sin u} = \omega L_e$$

It may be shown that for values of $u < 2$, R_e and L_e are independent of frequency. The operation of a square wave bridge is thus restricted to values of $u < 2$. Since hysteresis loss cannot be represented as a non-frequency conscious resistance, hysteresis effects must be small, i.e. the measurements must be made at low flux densities.

Putting $u < 2$, the usable frequency range for square wave technique may be written:

$$f < \rho / \pi^2 t^2 \mu$$

This figure approximates to 10kc/s for 0.014in Stalloy.

This implies that the use of a waveform having component frequencies greater than 10kc/s will not permit a perfect "zero" to be obtained at balance. Some latitude is, however, permissible, depending upon the ultimate accuracy desired and upon any preference which may exist in the use of certain frequencies. Thus in the case of the experimental bridge described it was desired to obtain as much information as possible upon circuits containing frequency components up to 40kc/s, and the resultant "zero" condition was found adequate for the degree of accuracy required.

REFERENCES

1. YATES, J. G. Pulse Excitation of Impedance Bridges. *Nature* 163, 132 (1949).
2. PROWSE, W. A., LAVERICK, E. Differential Transformer Bridge Operated by Square Waves. *Nature* 163, 571 (1949).
3. RODDAM, T. New Bridge Technique. *Wireless World* 56, 8 (1950).
4. STARR, A. T. *Electric Circuits and Wave Filters*, p. 163 (Pitman and Sons).
5. British Patent No. 685,006.

Saturated Diodes

The Characteristics of some Commercially-Obtainable Valves

By F. A. Benson*, M.Eng., Ph.D., A.M.I.E.E., M.I.R.E., and M. S. Seaman*, B.Eng., Grad. I.E.E.

The characteristics of several types of saturated diode for use as controlling elements in voltage-stabilizer circuits are presented and compared with those for the 29C1 diode which have been previously reported by the authors¹. Short- and long-term tests have been carried out and several of the valves have been examined at ratings in excess of the specified limits.

It is concluded that the A2087 and AV33 valves have rather poor long-term characteristics compared with the 29C1 diode which is capable of performing satisfactorily as a stabilizer controller, while the large-filament-power requirement of the GRD6 valve is a disadvantage for continuous saturated-diode operation.

SATURATED diodes are now commonly used as the controlling element in certain voltage-stabilizer circuits, and a knowledge of the relative merits of different valves is required. The characteristics of several GRD6 (Ferranti) A2087 (Osram) and AV33 (Amalgamated Wireless Valve Company Pty. Ltd. of Sydney, Australia) have been investigated and compared with the Mazda 29C1 diodes, whose characteristics have been previously reported by the authors¹.

The GRD6 (since superseded by the GRD7) consists of a single straight filament wire with a concentric anode structure. The latter is in three parts, the central part being the main part and the two end parts serving as guard rings. If the three parts are at the same potential, the field between the filament and the main anode will be uniform, and that part of the filament within the main anode is practically at a uniform temperature. Three valves of this type, from the same batch have been tested.

The A2087 (CV2171) is a miniature noise-generator diode, having a single-wire filament. Four valves of this type, consisting of two lots of two, have been tested.

The AV33 is designed to operate as a saturated diode, and has two straight filament wires in parallel. Three valves of this type, from the same batch, have been tested. All these valves have pure tungsten filaments, as has the 29C1.

Test Circuit

This was the same as that used by the authors for their earlier tests with the 29C1 diodes¹. Filament power was obtained from accumulators, the filament voltage being measured with a potentiometer in conjunction with a potential divider, and maintained to within 0.001V of the desired value during tests. Anode power was obtained from the d.c. mains. When testing the GRD6 diodes, the main-anode and guard-ring currents were measured separately, the two always being at the same voltage.

Static Characteristics

SATURATED-DIODE OPERATION

As a result of several tests on each valve on different occasions, it was found that after a short running-in period, the valves settled down and gave characteristics which are reproducible. The duration of this period varied between 12 and 36 hours for both the GRD6 and A2087, and

between six and nine hours for the AV33, compared with up to 24 hours for the 29C1. The anode current at given electrode voltages increased during this period by between 3 per cent and 30 per cent for the GRD6, and between 2 per cent and 5 per cent for the A2087, these increases being general over the whole range. With the AV33, the increase was up to 50 per cent at a filament voltage of 3.0V, but only about 1 per cent at a filament voltage of

Fig. 1. Diode characteristics
Anode voltage = 100V for all valves.

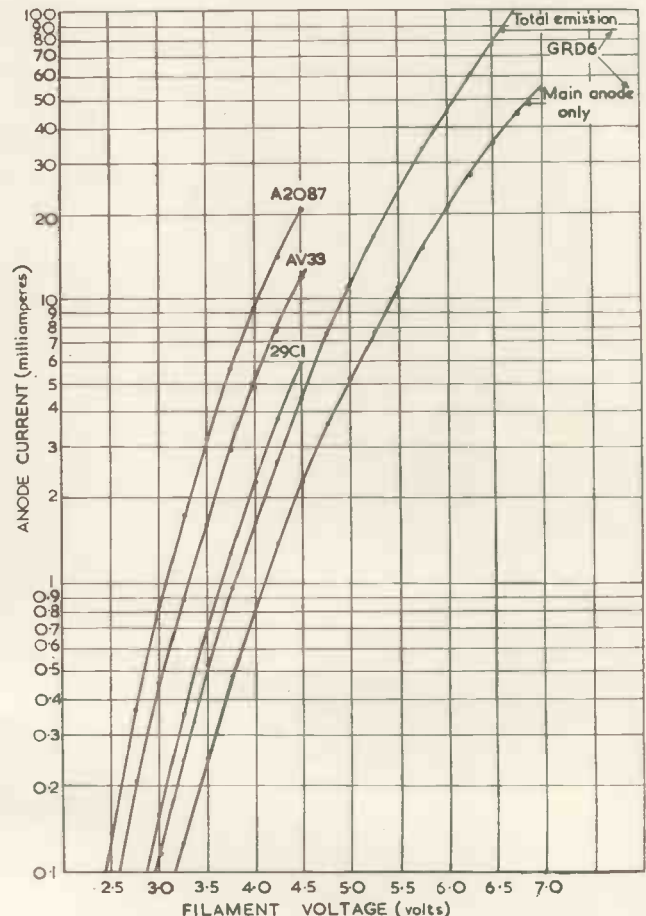

* The University of Sheffield.

4.4V. At the nominal operating voltage ($V_f = 3.7V$) the increase varied between 3 per cent and 15 per cent, this being of the same order as for the 29C1.

After appreciable changes in electrode voltages, the valves usually require a short time to settle down. The GRD6 may require 10 minutes or more if its filament voltage is changed by about 0.5V or its anode voltage by about a hundred volts, and requires up to half an hour after switching on from cold. These effects are much reduced in the case of the A2087 and the AV33, the initial period after switching on from cold being about five minutes. If the anode dissipation is considerably changed, the valves settle down to their new anode currents within a minute or two. If the anode dissipation can be maintained nearly constant, no drifting of the anode voltage has been noticed when the filament voltage is varied over a small range.

In view of the high operating temperature of the filaments (usually above 2000°C) the characteristics of the valves are uninfluenced by normal changes in ambient temperature, and after the initial warming-up period they are quite stable. The GRD6, A2087 and the AV33 valves do not appear to be susceptible to mechanical vibration or shocks, which are sometimes troublesome with the 29C1².

Fig. 1 shows the manner in which the anode current varied with the filament voltage at constant anode voltage, from which it will be seen that the valves have similar

characteristics. For filament voltages below about 3.9V, the guard-ring current of the GRD6 was less than the main-anode current, the reverse being true for higher filament voltages. This shows that the cooling effects at the filament supports are far from negligible.

The variations in the anode current at given electrode voltages for all the valves tested are given in Table 1. It will be seen that two of the three GRD6's varied by about 20 per cent from the mean, while the maximum divergence

TABLE 1

Saturated-Diode Characteristics, Showing Divergences from Mean Values

| BATCH AND VALVE NUMBER | ANODE CURRENT (mA) | DIVERGENCE FROM MEAN ANODE CURRENT (mA) |
|---|--------------------|---|
| <i>(a) 29C1 diodes. Filament Voltage = 40V. Anode Voltage = 80V.</i> | | |
| First Batch | 1 | + 0.14 = 6.4 per cent |
| | 2 | - 0.09 = 4.1 " |
| | 3 | - 0.05 = 2.3 " |
| Second Batch | 4 | + 0.05 = 2.3 " |
| | 5 | - 0.37 = 17.1 " |
| | 6 | - 0.14 = 6.4 " |
| Third Batch | 7 | + 0.13 = 6.0 " |
| | 8 | + 0.34 = 15.6 " |
| | 9 | + 0.02 = 0.9 " |
| Mean | 2.18 | — |
| <i>(b) GRD6 diodes. Filament Voltage = 5.5V. Anode Voltage = 200V (Main Anode only)</i> | | |
| 1 | 13.9 | + 2.5 = 21.9 per cent |
| 2 | 11.1 | - 0.3 = 2.6 " |
| 3 | 9.2 | - 2.2 = 19.3 " |
| Mean | 11.4 | — |
| <i>(c) A2087 diodes. Filament Voltage = 3.75V. Anode Voltage = 100V.</i> | | |
| First Batch | 1 | + 0.33 = 5.7 per cent |
| | 2 | - 0.02 = 0.3 " |
| Second Batch | 3 | - 0.15 = 2.6 " |
| | 4 | - 0.15 = 2.6 " |
| Mean | 5.76 | — |
| <i>(d) AV33 diodes. Filament Voltage = 3.8V. Anode Voltage = 100V.</i> | | |
| 1 | 3.16 | - 0.11 = 3.4 per cent |
| 2 | 3.16 | - 0.11 = 3.4 " |
| 3 | 3.50 | + 0.23 = 7.0 " |
| Mean | 3.27 | — |
| Maker's data sheet | 3.65 | — |

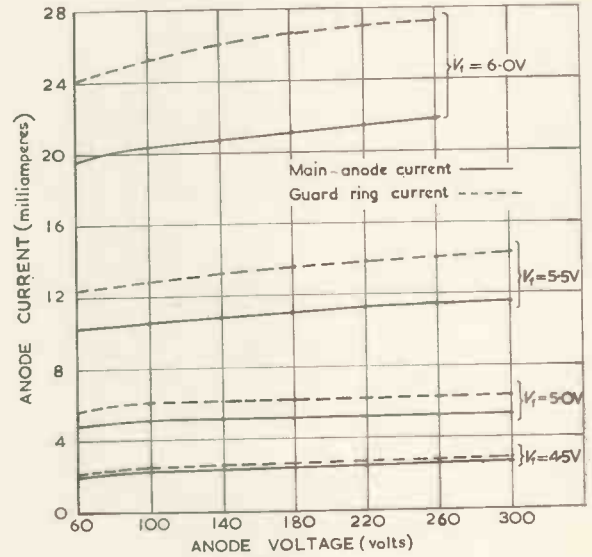

Fig. 2. GRD6 characteristics

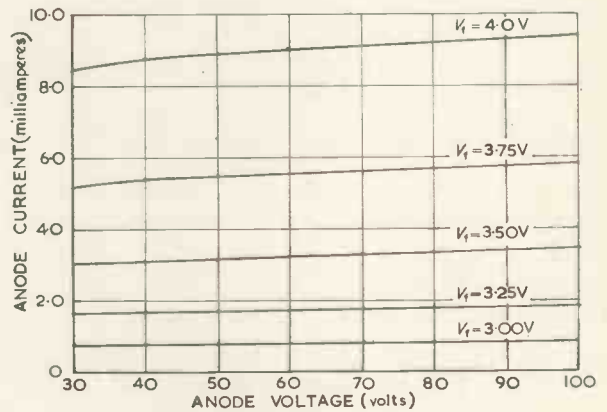

Fig. 3. A2087 characteristics

noted for the four A2087's was just over 5 per cent and for the three AV33's was about 7 per cent, compared with 15 per cent for the nine 29C1's.

Figs. 2 to 4 show that the anode currents of the GRD6, A2087 and AV33 vary very little with changes in anode voltage. By increasing the anode voltage from 30V to 100V, the anode currents increase by between 8 per cent and 12 per cent (mean, 9.3 per cent) in the A2087, and between 9 per cent and 12.5 per cent in the AV33, compared with between 12 per cent and 21 per cent (mean, 17.5 per cent) for the 29C1 over the range 20 to 100V. Increasing the anode voltage of the GRD6 from 30V to 100V increases the main-anode current by between 6 per cent and 18 per cent (mean, 12.5 per cent) and the guard-ring current by between 13.5 per cent and 18.5 per cent (mean, 15 per cent).

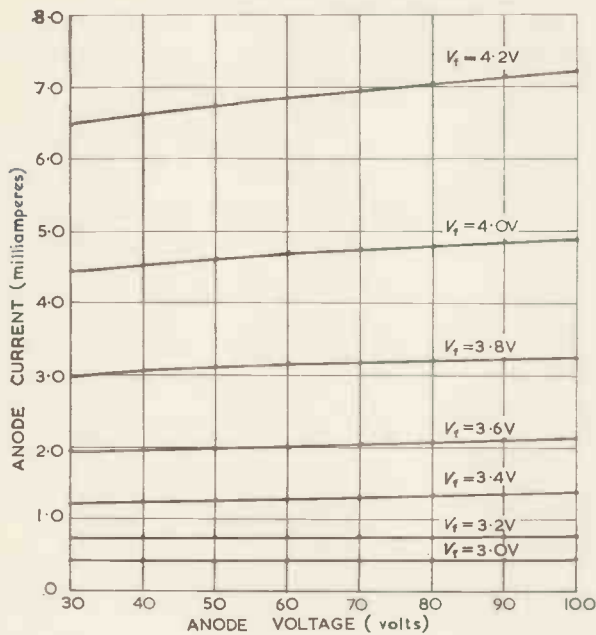

Fig. 4. AV33 characteristics
Average values for all three valves. (Initial tests).

cent) showing the effects of the irregular fields at the ends of the anode. In all cases, the rate of increase of anode current decreases with increasing anode voltage.

OVERLOAD TESTS

Several of the valves have been tested at ratings in excess of the makers' limits. In the case of the GRD6, this is not recommended owing to the large amount of heat normally liberated within the envelope—sufficient to make the envelope too hot to handle. A continuous main-anode dissipation of 5 watts is sufficient to raise the anode temperature to dull red, which is not often apparent with the filament on.

Overload operation of the A2087, AV33 and 29C1 does not appear to damage the valves. Typical curves for anode

Fig. 5. Saturated diode characteristics
Typical anode current/anode voltage curves for excessive anode voltages.

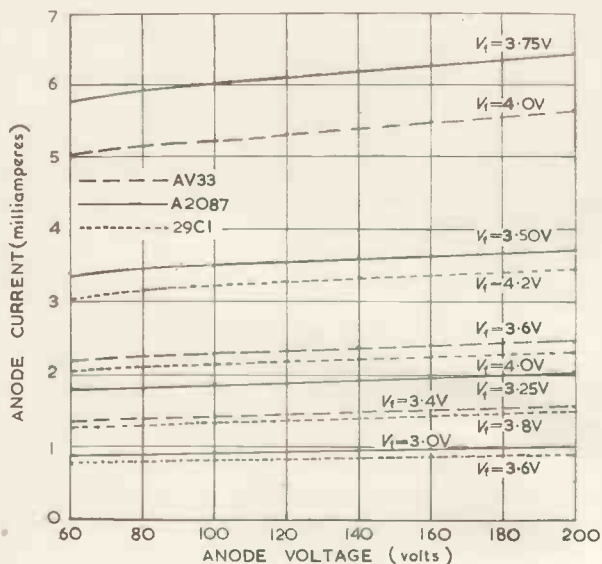

current against anode voltage for anode voltages up to 200V (the makers' limits for these three valves is 100V) are given in Fig. 5. Operation at filament voltages above normal is shown in Fig. 1, but it should be noted that saturation may not necessarily exist at the specified minimum anode voltages (20V for the 29C1, 30V for the AV33, and 40V for the A2087).

In general, however, the anode dissipation should be small compared with the filament dissipation to avoid drifting and for this reason the makers' recommended maxima should not be exceeded.

POWER-LAW RELATIONSHIPS

Providing saturation is complete, the anode current can be related to the filament voltage by an equation of the type $I_a = KV_f^n$, for constant anode voltage. For all four types of valve, the value of the index n is practically

TABLE 2
Values of the Index n in the Relationship $I_a = K \cdot V_f^n$

| AVERAGE FILAMENT VOLTAGE (VOLTS) | INDEX n | |
|----------------------------------|-----------------|----------------|
| | 29C1 | AV33 |
| 3.1 | — | 8.5 |
| 3.3 | 9.3 | 8.4 |
| 3.5 | 9.0 | 8.2 |
| 3.7 | 8.9 | 8.0 |
| 3.9 | 8.6 | 7.9 |
| 4.1 | 8.4 | 7.8 |
| 4.3 | — | 7.7 |
| A2087 | | |
| 3.13 | — | 8.95 |
| 3.38 | — | 8.35 |
| 3.63 | — | 8.0 |
| 3.88 | — | 7.6 |
| GRD6 | | |
| | MAIN ANODE ONLY | TOTAL EMISSION |
| 4.75 | 7.95 | 8.2 |
| 5.25 | 7.7 | 7.9 |
| 5.75 | 7.25 | 7.5 |

independent of the anode voltage, but depends on the filament voltage, as is shown in Table 2. This again shows the end effects which are apparent in the figures quoted for the GRD6.

The filaments of the valves are non-linear resistors, as shown by their characteristics in Fig. 6. There are small variations in these results between the valves; about 1.5 per cent for the 29C1, 3 per cent for the GRD6, 0.5 per cent for the A2087 and 1 per cent for the AV33. The relation between filament voltage and current can be expressed in a law of the type $V_f = k \cdot I_f^m$, the value of m being about 1.95 for the 29C1, between 2.0 and 2.1 for the A2087, between 1.8 and 1.9 for the GRD6 and 1.8 for the AV33 over the normal operating range. (Attree² gives a value of $m = 1.77$ for the 29C1, which does not agree with the present results.)

By combining these results, it is found that $I_a = K' \cdot I_f^{mn}$, where mn has a value of about 16 for these valves. Such

“constant-current” operation can be obtained by inserting a large resistor in series with the filament, but it results in rather large losses².

LOW ANODE VOLTAGE TESTS

Tests were carried out on all the valves to see whether their behaviour in the unsaturated region approached the ideal as expressed by the Child-Langmuir three-halves power law.

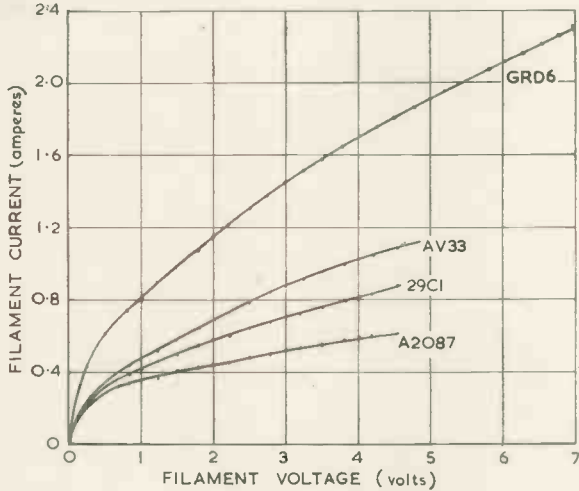

Fig. 6. Saturated diode characteristics

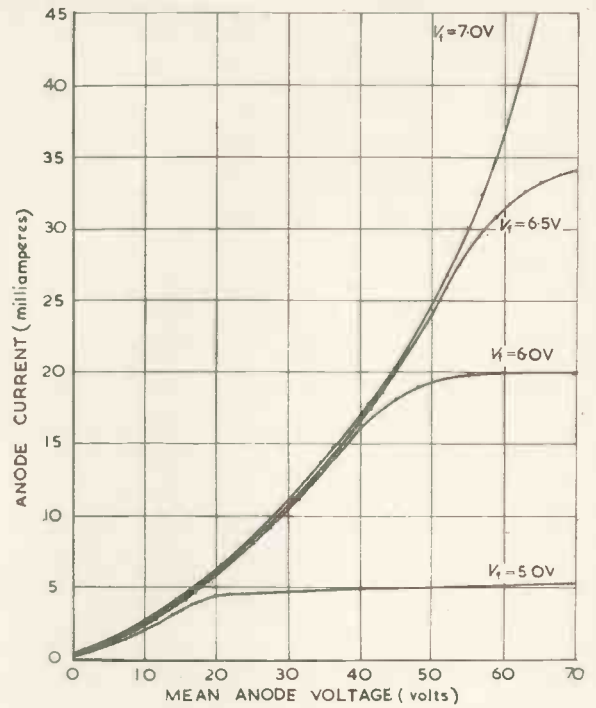

Fig. 8. GRD6 characteristics

Typical anode current/anode voltage curves for low anode voltages.

It has been found that over considerable ranges, the anode current and anode voltage can be related by a law of the type $I_a = k \cdot V_a^p$. For the 29C1, the value of p is about 1.1 at $V_f = 3.6V$, increasing to 1.4 at $V_f = 4.2V$. Further increases in filament voltage failed to give a higher

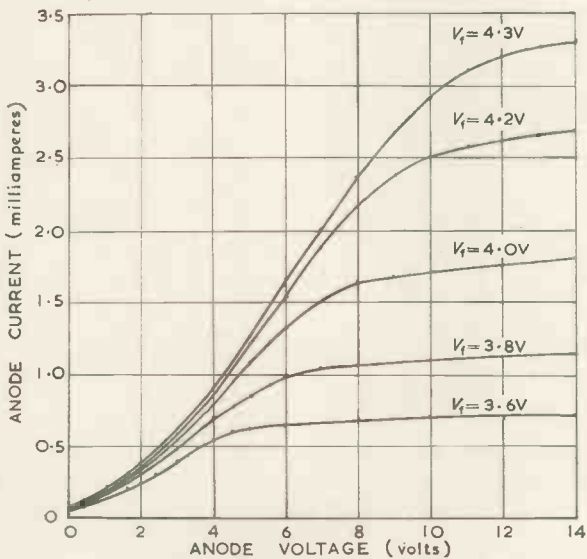

Fig. 7. 29C1 characteristics

Typical anode current/anode voltage curves for low anode voltages.

Typical results are shown in Figs. 7 to 10, which include those for the 29C1 valves since these have not been previously published. In the case of the 29C1, A2087 and AV33 valves, the anode voltage shown was measured with respect to the negative end of the filament, but in the case of the GRD6 the values are relative to the mean potential of the filament, on account of the construction of that valve. The ideal field conditions in the GRD6 are shown up in the much sharper transition from unsaturated to saturated operation in that valve compared with the others.

Fig. 9. A2087 characteristics

Typical anode current/anode voltage curves for low anode voltages.

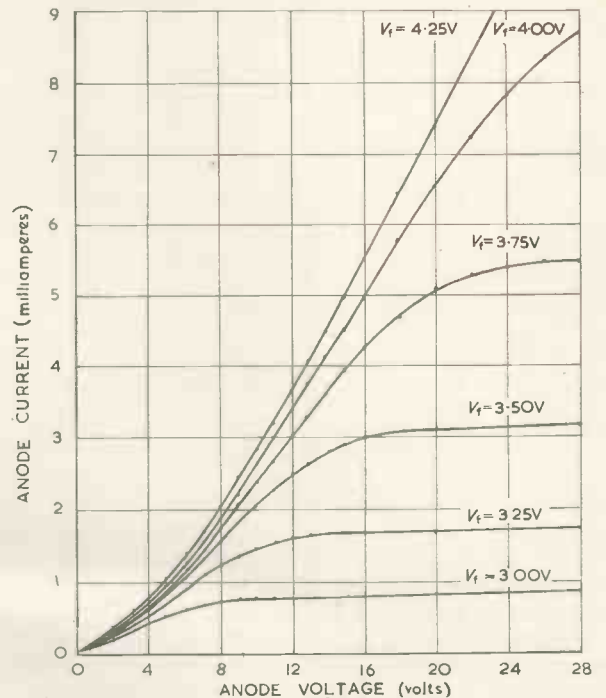

value for p . For the A2087, p has a value increasing from 1.3 at $V_f = 3.0V$ to 1.48 at $V_f = 4.25V$, and for the AV33 a value of $p = 1.5$ is obtainable at all filament voltages above 3.0V. Generally speaking, these relationships are only obtainable when the anode is positive with respect to the whole of the filament. A value of $p = 1.5$ is obtainable with the GRD6 with filament voltages above 6.0V and anode voltages above 25V. At 10V on the anode, p has fallen to about 1.3.

EMISSION EFFICIENCY

This is a quantity which has been used before³ to serve as a basis for comparing the operating temperatures of saturated diodes, owing to the difficulty of measuring the

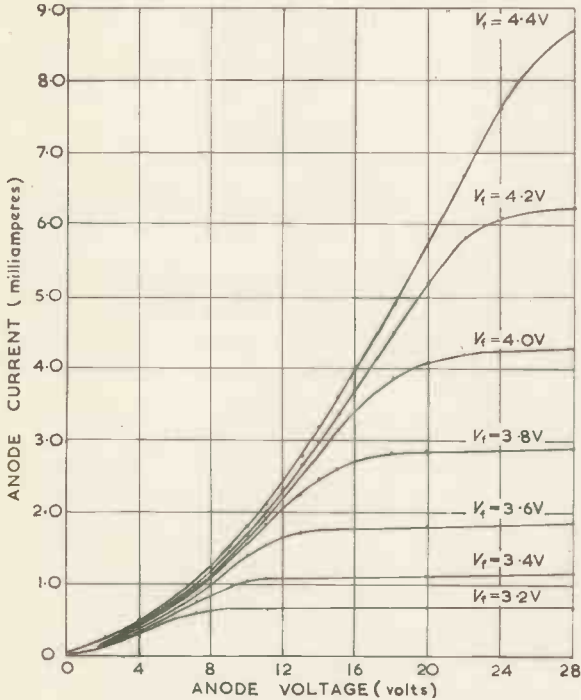

Fig. 10. AV33 characteristics

Typical results for low anode voltage operation. (Initial tests).

temperature by direct methods. The ratio of the emission current (in milliamperes) to the filament power (in watts) is, to a first approximation a function of the mean temperature of the filament for a given material. Fig. 11 shows how this quantity varies with the filament voltage for all four types of valve, from which it will be seen that the recommended operating temperature for the A2087 is considerably higher than for the 29C1. Comparison with Fig. 1 shows that at any emission current, the 29C1 and AV33 are operating at about the same emission efficiency.

GENERAL REMARKS

If the relationship between filament current and emission current is considered, then for the GRD6 and A2087 the variations between valves are much smaller than those quoted in Table 1, being about ± 5 per cent for the GRD6 and ± 1 per cent for the A2087. This seems to suggest that the variations between valves are mainly due to tolerances in the length of the filament wire. With the 29C1 and AV33, the filaments consist of two wires in parallel, the connections being made inside the envelope, and, as might be expected, similar results were not observed for these valves.

Although the characteristics of the 29C1 and AV33 appear to make them non-interchangeable, this is not necessarily the case. With a supply voltage of 6.3V, it has been found that the amount of external filament-circuit resistance required to limit the emission to any given current in the range 0.5mA to 5mA is approximately the same for both valves, the differences being less than 10 per cent. In general, the resistor would need to be variable over a greater range to accommodate the variations between valves and the variations of the characteristics with life. Both

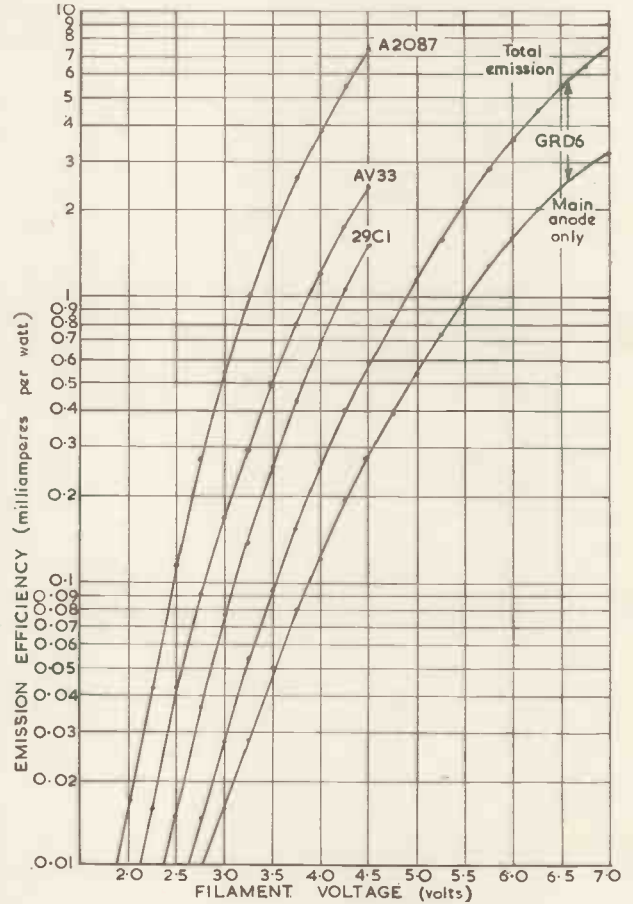

Fig. 11. Saturated diode characteristics

these valves have been designed around the CV430 specifications, and have the same base and pin connexions, although the AV33 is about an inch taller than the 29C1.

Long-term Tests

Four 29C1, two A2087 and two AV33 valves have been run for varying periods at constant electrode voltages to investigate the variation of emission with time. As the GRD6 appeared to be unsuitable for most saturated diode uses, the authors have carried out no tests on this valve. All the tests have been carried out with the filaments supplied with direct current for convenience. The results of the tests on the 29C1 diodes have already been reported by the authors¹. Attree³ has also described some tests on four 29C1 diodes at constant emission current, the variations in filament voltage and current being recorded. These results agree reasonably well with the others when the relationship between filament voltage and anode current is

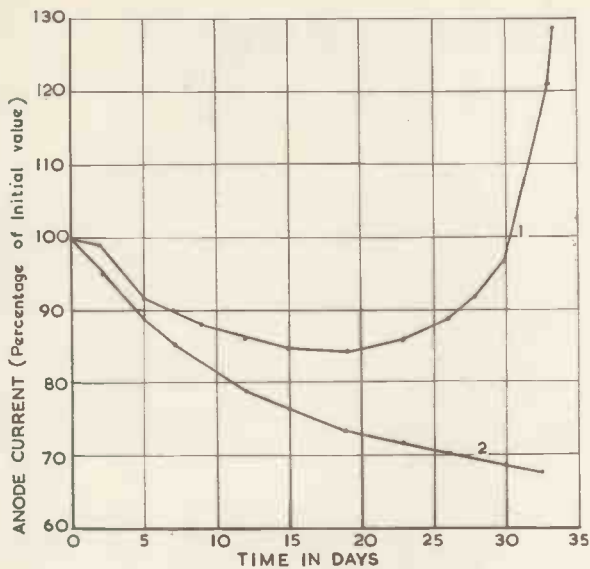

Fig. 12. A2087 characteristics
Life test results.

Curve no. 1: filament voltage = 3.75V (valve no. 2).
Curve no. 2: filament voltage = 3.00V (valve no. 1).
In both cases. Anode voltage = 90V.
Initial anode currents:
Curve no. 1: 5.68mA.
Curve no. 2: 0.992mA.

used, although Attree used an a.c. supply for his filaments. Some of the author's tests were carried out under overload conditions with little adverse effect.

Attree³ also reports on a life test carried out on a single GRD6. From the data he gives, it appears that the emission of a GRD6 deteriorates at a somewhat greater rate than a 29C1 under equivalent conditions.

The results of the life tests on the A2087 diodes are shown in Fig. 12. Both valves were run at an anode voltage of 90V. One valve was run at a filament voltage of 3.75V

Fig. 13. AV33 characteristics
Life test results.

Curve no. 1: filament voltage = 4.00V (valve no. 1).
Curve no. 2: filament voltage = 3.75V (valve no. 3).
In both cases. Anode voltage = 90V.
Initial anode currents:
Curve no. 1: 4.70mA.
Curve no. 2: 3.08mA.

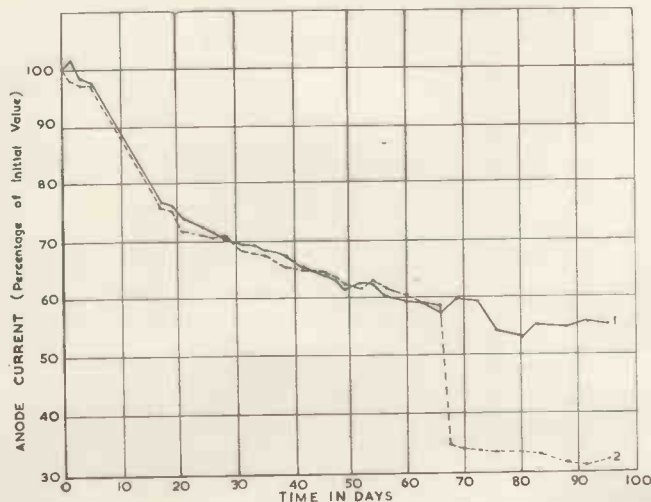

(maker's typical operating voltage is 3.7V), its anode current decreasing by about 15 per cent in the first 400 hours, but after this it started to increase, returning to its initial value after about 750 hours. When the test was discontinued after 800 hours running, the anode current was increasing at a rate of approximately 1.5 per cent per hour.

The other valve was run at a filament voltage of 3.0V, and rather surprisingly its anode current decreased at a faster rate than for the first valve. The rate of decrease is considerably greater than for the 29C1 valves, the anode current decreasing by 30 per cent in about 27 days, compared with 70 to 120 days for the 29C1. This result was unexpected considering that the valve was operating at an emission efficiency of about 0.55mA/W, compared with approximately 0.7mA/W for a 29C1 running at a filament voltage of 4.0V. Small random variations, which were observed during the running of the 29C1 and AV33 were not observed during the life tests of the A2087.

The results of the life tests on the two AV33 diodes are shown in Fig. 13. Again, the anode voltage was 90V for both valves, the filament voltages being 4.0V and 3.75V. The anode currents of both valves decreased at about the same rate, the rate again being considerably greater than for the 29C1, a 30 per cent decrease having occurred in about 30 days.

Rather surprisingly, on the 67th day the diode running at the lower filament voltage was found to be running on only one filament wire, the other one having burnt out. The remaining wire was then emitting 60.7 per cent of the anode current noted the previous day, which suggests that the burnt-out wire had developed a "hot spot", since the valve continued working on the remaining wire for another 30 days.

Conclusions

The rather poor long-term characteristics of the A2087 may be due to its not being designed for continuous operation as a saturated diode. The makers give a life of only 1 000 to 2 000 hours when used as a noise generator under typical operating conditions. Since the AV33 has been designed as a saturated diode, its poor long-term characteristic is surprising.

As previously mentioned, the GRD6 is an experimental valve, and its rather heavy filament-power requirement is a disadvantage for continuous saturated-diode operation.

The 29C1 is capable of performing satisfactorily over quite a large range, and in addition, for most saturated-diode circuits, the twin-wire filament (also found in the AV33) is a useful safety factor, since it appears improbable that both wires would fail almost simultaneously, with possible detriment to other components in the circuit.

Acknowledgments

The authors wish to thank the Amalgamated Wireless Valve Company Pty Ltd of Sydney, Australia, for the supply of the AV33 valves, and also Mr. O. I. Butler, M.Sc., M.I.E.E., A.M.I.Mech.E., for facilities afforded in the laboratories of the Department of Electrical Engineering at the University of Sheffield, where the work recorded here has been carried out.

REFERENCES

1. BENSON, F. A., SEAMAN, M. S. Characteristics of the Temperature-Limited Diode Type 29C1. *Electronic Engng.* 25, 462 (1953).
2. ATTREE, V. H. A Differential Voltmeter using a Saturated Diode. *J. Sci. Instrum.* 29, 226 (1952).
3. ATTREE, V. H. Measurements of Saturated Diode Stability. *Bri. J. Appl. Phys.* 4, 114 (1953).

LETTERS TO THE EDITOR

(We do not hold ourselves responsible for the opinions of our correspondents)

A Design Method for Direct-coupled Flip-flops

DEAR SIR,—We would like to comment on several points in Mr. Renwick and Dr. Phister's article in your June issue. The limiting valve characteristics shown in Figs. 3(a) and 3(b) seem to us to be unduly optimistic. Those in Fig. 3(a) (which we assume refer to the CV455) represent a tolerance of ± 25 per cent on the average characteristic, and those in Fig. 3(b) a tolerance of ± 27 per cent.

Referring to the CV specification for the CV455 it is regrettable that no limit figures for the anode current at zero grid potential are given. They can however be estimated as follows. The specification states that with an anode potential of 250V and 200 Ω cathode resistor the anode current must lie between 7 and 14mA, and the mutual conductance between 4.5 and 6.5mA/V. Thus at the lower limit of anode current a potential of -1.4V is applied between grid and cathode. Neglecting for the moment the variation of mutual conductance with anode current, the minimum anode current with zero grid potential is $7 + (1.4 + 4.5)$, i.e. 13.3mA. Similarly the maximum values of anode current and mutual conductance give a maximum anode current at zero grid potential of $14 + (6.5 \times 2.8)$, i.e. 32.2mA. These figures represent a tolerance of ± 41.5 per cent of their mean value. Repeating these calculations for the CV138 under the specified test conditions ($V_a = V_{g2} = 250V$, $R_k = 160\Omega$) gives a minimum anode current of 14.7mA and a maximum of 30.2mA representing a tolerance of ± 34.6 per cent of the mean figure. The increase of mutual conductance with anode current would tend to increase the limiting values of anode current and, to a lesser extent, the tolerance.

It must be pointed out that the figures in the CV specification relate to a new valve, and that for design purposes it is essential to make allowance for the reduction in anode current and mutual conductance during life.

There is no doubt that to design a circuit that would operate with any valve within the CV specification all the above factors would have to be considered. To do so, however, would present the designer with severe difficulties and prevent him from using the valve to the best advantage. We have found that reasonable tolerances to allow are + 30 per cent and - 50 per cent of the average value. These figures take account of initial tolerance and ageing. We feel that while most new valves would fall within the limits given by Mr. Renwick and Dr. Phister, they could not be expected to remain so for more than a comparatively short life.

In connexion with resistor tolerances we would stress the importance of considering not only the initial selection tolerance but such factors as voltage and

temperature coefficients, climatic conditions and ageing. Information on the change in resistance due to each of these causes separately can be obtained from Specification RCS 112 of the Inter Service Standards, but unfortunately the specification gives no indication of the change to be expected when the various factors operate together as occurs in practice. Merely to add the individual changes gives figures which in the light of experience seem unreasonably high, e.g. in the case of Grade 2 (composition) resistors operated under temperate conditions a variation of ± 40 per cent would have to be allowed for in addition to the initial selection tolerance. More detailed information from manufacturers and testing authorities on this subject and on valve characteristic tolerances under the conditions encountered in switching circuits would be of the greatest help to circuit designers.

Yours faithfully,

F. BECKETT,

D. M. TAUB,

Ericsson Telephones Ltd,
Beeston,
Nottingham.

The Authors' reply:

DEAR SIR,—We are well aware of the fact that the tolerance on anode current, for given anode and grid voltages, permitted in the CV specification is usually about 40 per cent. The characteristics shown in Figs. 3(a) and 3(b) were never intended as an accurate representation of the permissible spread in valve characteristics, although in the case of the CV455 the limits were those measured for both halves of a batch of 100 valves and for the CV138 a batch of 20 were measured.

Your correspondents rightly stress the importance of considering the variation in value of resistors due to various causes in service. We would point out, however, that the effect of most of these factors can be reduced by taking some simple precautions, if possible. For example, resistors can be sited in such a way as to reduce the temperature extremes to which they may be exposed.

The object of the circuit designer, especially when the circuits are for a large computing machine, is to reduce the probability of circuit failures, and the effect of all components must be taken together. A flip-flop which has resistors outside the design tolerance range is not necessarily unstable since the drift in value of the resistors must be in opposite directions to produce instability, and the valve also must be near the lower tolerance extreme. Similarly, if the resistors are close to the design tolerances, in fact if their ratio is close to the design tolerances, the valve characteristic may be considerably less than the design

minimum and the circuit will remain stable.

The whole question of circuit design for reliability is one which is receiving our attention in this laboratory and we hope to publish some of our conclusions in the near future.

Yours faithfully,

W. RENWICK,

The University Mathematical
Laboratory,
Cambridge.

Cascode Amplifier Degenerative Stabilizer

DEAR SIR,—I am grateful to Mr. O. S. Puckle for drawing my attention to the E.M.I. patent which, I note, was not published until 24 November, 1954. The patent describes the use of a modified cascode amplifier (Fig. 1) (i.e. a conven-

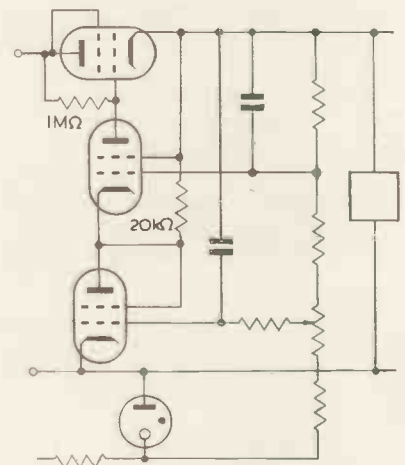

Fig. 1. The E.M.I. circuit.

British Patent Specification No. 719,064 reproduced by kind permission of H.M. Stationery Office.

tional cascode with one additional resistor), as in the article in this Journal.

Unfortunately, the specification avoids all reference to either valve types, component values (with two exceptions) or to the gain actually obtained. However, it is apparent from the circuit diagram that both the reference neon and the cascode anode-load are run from the unstabilized supply. This gives rise to unwanted feedback which will result in loss of performance. Further, there seems no advantage in using two tetrode valves in the shunt amplifier instead of a double triode.

I should like to comment on two statements made in the text of the patent,

Firstly (line 97) it is stated that the gain is enhanced if the grid of the upper valve is taken to a tap on the divider chain, instead of to a point of fixed potential. This is strictly true but it is perhaps as well to note that the gain from the upper grid is relatively low and that the gain-improvement is only about one per cent. Secondly (line 108), the high gain of the lower valve is attributed to the high impedance at the upper cathode. This also is true but not particularly helpful in estimating the overall gain. As I see it, to a first approximation the impedance at the junction point is $1/g_{m2}$ so that the gain to the junction is g_{m1}/g_{m2} and from the junction point to the load is $g_{m2}R_L$. This gives an overall gain of $g_{m1}R_L$ which does not involve the impedance at the junction.

Yours faithfully,

V. H. ATTREE,

Manchester College of Technology,

Effect of Instrument Impedance in the Measurement of "Quality Factor" by Parallel Resonance

DEAR SIR,—Mr. J. P. Duncan uses for the comparison of unequal impedances a measuring technique which is much more versatile than his note (p. 235 May issue) suggests. As his equations show, the impedance (Z_c) of his measuring instrument has no influence upon the calculated impedance ratio. Z_c may therefore have any impedance whatever, provided it remains constant during the comparison.

This statement conflicts with Mr. Duncan's, that Z_c must be resistive. The reason is that he leaves Z_c connected to the resonant circuit while tuning it. If, instead, he adjusts V_1/V_2 to a maximum, Z_c can have any value whatever.

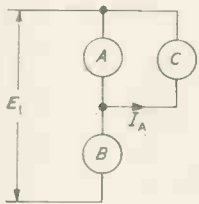

Fig. 1. Voltmeter bridged across A.

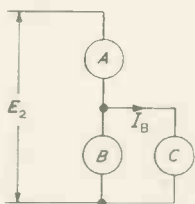

Fig. 2. Voltmeter bridged across B.

In Fig. 1 the "voltmeter" of impedance C is bridged across A and current i_A flows in C ; in Fig. 2 across B and the current is i_B .

By Thevenin's theorem:

$$i_A = E_1 A / \{ (AB + C)(A + B) \}$$

$$\text{and } i_B = E_2 B / \{ (AB + C)(A + B) \}$$

so that $A/B = (i_A E_2) / (i_B E_1)$ (To prevent harmonics upsetting the reading of the meter, C can be tuned circuit). The inverse proposition is also true for impedances in parallel (Fig. 3).

In this case $A/B = (i_B I_1) / (I_2 I_1)$ (Note the inversion).

An impedance comparator based on Figs. 1 and 2 uses a "voltmeter" (C) of

about 500Ω shunted by several thousand picofarads to compare impedances of $10k\Omega$ or more at audio frequencies. The ultimate precision of such comparators, particularly at radio frequencies, is conditioned by the stray capacitance to ground of element C (ignored in the diagrams).

The two propositions above were published in British Patent 573 615 in which

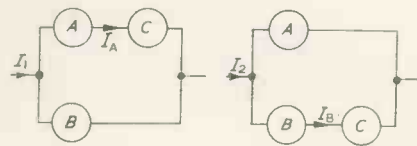

Fig. 3. Impedances in parallel.

the extension of the principle to a coordinate a.c. potentiometer was described. For such a purpose two currents i_1 and i_2 are required to flow in two slide wires P_1 and P_2 . It is necessary that $|i_1| = |i_2|$ and that i_2 is in quadrature with i_1 .

This is achieved as shown in Fig. 4.

It will be seen that E_1 and E_2 of Fig. 1 and Fig. 2 have now been made identical,

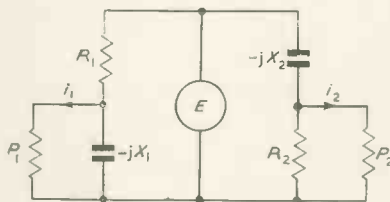

Fig. 4. Impedance comparator.

$$R_1 = R_2 = R$$

$$X_1 = X_2 = X$$

$$P_1 = P_2 = P$$

so if $R_1 = R_2$, $X_1 = X_2$ and $P_1 = P_2$ the currents i_1 and i_2 bear the ratio $-jX/R$. (Imperfections in the capacitors can be allowed for by an artifice described in the patent quoted). If, in addition, $R = X_1 / |i_1| = |i_2|$ as required. Residual reactance or self-capacitance of P_1 and P_2 has no effect provided $P_1 = P_2$.

A number of interesting extensions of these propositions are possible. One, which is not at first obvious, is shown in Fig. 5.

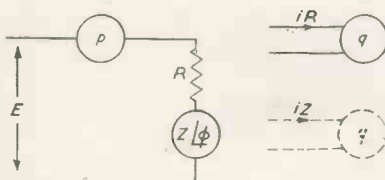

Fig. 5. An extension of the proposition.

For the special condition that $|Z| = R$, the two currents i_R and i_Z

have equal magnitude if

$$pq = R^2$$

The quantity p can include the internal resistance of the power source E , but in general p and q need not be individually resistive.

Yours faithfully,

E. R. WIGAN,

B.B.C. Research Department.

The Correspondent replies:

DEAR SIR.—Mr. Wigan draws attention to the generality of the technique described in your columns in the May issue of your journal. He further describes some interesting and valuable extensions of this technique.

The writer's interest in this matter was incidental to an electrical analogue study of mechanical problems. These are described in *Engineering*, 1 April, 1955, page 404. The development of a Q meter which could be devised with resources available to him was his primary concern. The circuit described was one of several that were tried and its properties as quoted in your pages were derived from first principles.

Mr. Wigan speaks of a "conflict" between the writer's general result and his statement that Z_c must be resistive. This qualification is accompanied in the original letter by the same explanation as is given by Mr. Wigan. It was stated to justify the writer's conscious choice of a method for tuning the resonant circuit. The measuring instrument available happened to have an impedance which was almost entirely resistive. Thus it was a practical convenience to follow the procedure outlined. The need to adjust V_1/V_2 to a maximum, involving some repeated measurements or the detection of minimum line current, was thus avoided. In using the term "voltage generator" a controlled constant voltage E is implied and can readily be ensured practically.

The writer fully appreciates the neatness of the technique which Mr. Wigan describes. He feels that in the particular problem under discussion, the method of tuning the resonant circuit and of allowing for the variation of source voltage is a matter of convenience and personal preference.

Yours faithfully,

J. P. DUNCAN,

Engineering Department,
University of Manchester.

Erratum

In the letter from Mr. T. H. B. Baker which appeared in the July issue, p. 323, the "procedure" should read as follows:

- (1) Set cursor over λ_c on D.
- (2) Bring λ_c on C under cursor.
- (3) Note value of A opposite the "1" or "100" on B and subtract unity.
- (4) Set cursor to new number on A.
- (5) Bring λ_c on C under cursor.
- (6) Read answer on C opposite "1" or "10" on D.

ELECTRONIC EQUIPMENT

A description, compiled from information supplied by the manufacturers, of new components, accessories and test instruments.

Digital Counting Units

(Illustrated below)

THE digital counting unit Type CU.541A is a direct reading electronic counter capable of operating at any speed up to 100kc/s from input pulses of the appropriate shape. The units may be connected in cascade to give as many places of decimals as may be required and the output of the unit is designed to provide the necessary pulse for operating the unit which follows without any intermediate circuit being necessary.

Indication of the count is given on the illuminated numbered scale on the front of the unit, counting proceeding from 0 to 9; at the tenth pulse it automatically resets to 0 and at the same time provides an output pulse for



operating another counting unit. Thus in addition to counting and indicating, the unit divides the frequency of the input pulses by a factor of ten. It may be reset to 0, after having reached any count, either by applying a positive pulse to the reset line which is brought out to a pin on the base, or by opening the reset line circuit.

The counting unit is constructed in a black anodized aluminium case, connections being made through an international octal plug mounted at the base. Uniformity of performance and a high degree of reliability is achieved by the use of printed wiring techniques.

The CU.541B unit is similar in construction and specification to the CU.541A and differs only in that it resets to 9 instead of to 0, a requirement in certain time-base applications to reduce the delay between the operation of a reset or "start" control and the commencement of counting.

Racal Engineering Ltd,
Western Road,
Bracknell,
Berkshire.

Precision Wirewound Resistors

(Illustrated above right)

THE main feature of this range of wirewound resistors is a protective coating of polythene approximately 1/16in thick. The formers are of ceramic (Steatite).



Resistors can be supplied adjusted to any accuracy up to 0.1 per cent of the nominal value $\pm 0.01\Omega$ whichever is the greater. Adjustment is carried out at 20° C. and they will remain within the stated tolerance up to the maximum power rating.

Where required resistors can be supplied in matched pairs (or larger quantities) to even greater accuracy.

The winding is put on in sections, each adjacent section being wound in opposite directions to reduce the inductance to a very small value.

They are available in power ratings of $\frac{1}{4}$ W, $\frac{1}{2}$ W and 1W.

Rivlin Instruments Ltd,
7a, Maitland Park Villas,
London, N.W.3.

Silicone Rubber Glass Cloth Tapes

(Illustrated below)

DUNLOP silicone rubber glass cloth tapes are produced by coating a glass fabric of high tensile strength with silicone rubber, which is a recently developed synthetic material combining the properties of flexibility, elasticity and ease of fabrication found in natural rubbers with the ability to withstand extremes of temperature.

It retains its rubber-like properties at temperatures far above those which cause other rubbers to decompose. It may be operated at a continual working temperature of 250°C and will withstand a maximum of 300°C intermittently. At the other end of the scale, some grades of silicone rubber will begin to stiffen in the region of -50°C while others will remain flexible down to -80°C.

The use of this material near the upper temperature limit will not jeopardize its efficiency in the sub zero ranges. This means that it has an operational temperature range of 300°C.

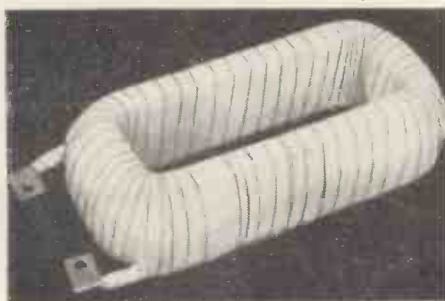

As the dielectric properties are maintained over this extensive temperature range, silicone rubber glass cloth tape provides a valuable electrical insulating material.

Vulcanization after assembly bonds the tapes into a homogeneous, moisture-proof and oil-resistant jacket which, unlike resinous coating and insulations, does not become progressively more brittle when exposed to a high temperature.

Dunlop Rubber Co. Ltd,
Cambridge Street,
Manchester, 1.

U.H.F. Signal Generator

(Illustrated below)

A RECENT addition to the Marconi Instruments range of signal generators is the u.h.f. signal generator type TF 1078. This instrument covers the frequency range 960 to 1250Mc/s in one

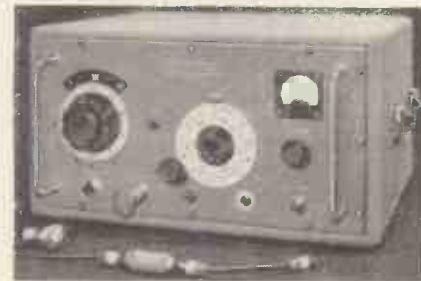

continuous band; the tuning dial has an arbitrary numerical calibration and its reading is related to frequency by reference to a chart; both dial and chart allow a high order of discrimination and give a frequency accuracy of 0.3 per cent. The instrument incorporates a high-quality piston attenuator and has an effective output impedance of 50Ω. A crystal voltmeter monitors the output from the attenuator which is calibrated over a range of 110dB relative to the maximum power output of 1mW. Normally, the output from the generator is c.w.: but switching and a coaxial inlet on the front panel permit external pulse modulation at recurrence frequencies up to 100kc/s. The modulating system has a design which allows the reproduction of pulses with durations as short as 0.5μsec.

Marconi Instruments Ltd,
St. Albans,
Hertfordshire.

Noval Plugs and Sockets

(Illustrated above right)

THE McMurdo Instrument Company announce that their range of moulded B9A (noval) type plugs and sockets is now generally available.

The range is divided into two sections. One includes the plug which may be inserted in any standard B9A valveholder. With cover and cable clamp this is the XLM9/USP, and less cover, is

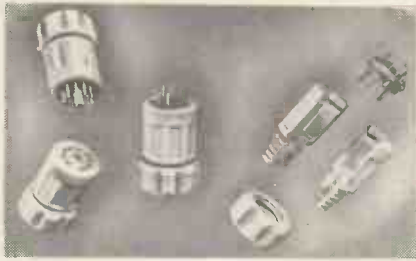

the XLM9/USP.1. It is shown in the exploded and complete views in the accompanying illustration.

The other section includes mating plugs and sockets with a 'D' shaped central locating key, as shown in the illustration, to assist in blind insertion. The plug is known as the XLM9/UTP and the socket as the XLM9/UTS, and both are also available without cover and cable clamp.

To complete this section, chassis mounting versions of both plug and socket are available.

The McMurdo Instrument Co. Ltd,
Victoria Works,
Ashtead,
Surrey.

Silver Brazing Alloy

EASY-FLO silver brazing alloy is now available in a new form. In certain brazing applications, the nature of the assembly is such that a paste preparation is more convenient than brazing material in one of the more familiar solid forms. Easy-flo paint, consisting of a mixture of finely divided Easy-flo metal powder and flux in a liquid medium, has been produced to meet such requirements. It will satisfactorily braze a wide range of materials and can be used with any of the various methods of heating in general use.

Johnson, Matthey & Co. Ltd,
78-83, Hatton Garden,
London, E.C.1.

Moulded Relay

(Illustrated below)

THE body of this relay (type MOL) is moulded from high grade insulating material and designed so that the sections bearing the contact terminals can be removed without disturbing the adjustment. The contact springs are mounted in a moulded block which allows for individual contacts to be replaced easily if required.

The relay can be fixed direct to a panel of any material by means of 2-4B.A. screws. The terminals of both coil and contacts are of the screw type, but if required connexions can be made

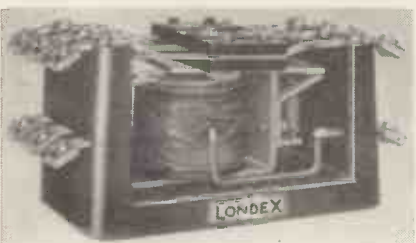

from the back of the panel by means of stud terminals. This feature applies only to 'make' or 'break' contact arrangements.

The coil of this relay can be supplied for voltages up to 450V a.c. or 165V d.c. The power required for operating is between 1 and 3W.

A variety of contact arrangements are available; from one to five sets of 'make' or up to three 'break' or change-over. The standard contacts are rated at 5A at 230V a.c. and are 6mm solid silver, other contact material can be fitted for certain conditions.

Overall dimensions of the relay type MOL are approximately 3¼in by 1½in by 1¼in.

Londex Ltd,
Anerley Works,
207, Anerley Road,
London, S.E.20.

Vibration Generator

(Illustrated below)

A NEW and larger model has recently been added to the range of Goodman's vibration generators. This is the model 16/600 which is a dual

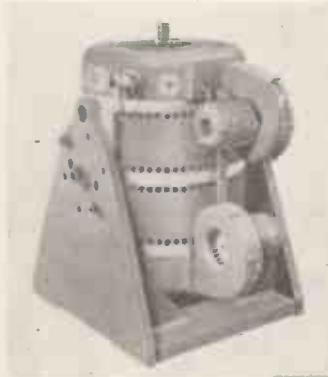

armature design having a peak force of 500lb.

The thrust force factor is 27lb/A, the maximum continuous current rating is 13A, the d.c. resistance is 5.5Ω and the impedance at 500c/s is 28Ω.

A trunnion mounting is supplied complete with each generator and permits four driving angles of 30 degrees intervals between vertical and horizontal. The trunnion incorporates lifting eyes to enable the instrument to be moved easily during transit.

A dual armature system is employed consisting of a number of coils of special heat resisting enamelled copper wire wound on two light alloy formers which are suitably slotted to minimize eddy current damping. Series-parallel connexions of the coils are afforded by terminal links.

Goodmans Industries Ltd,
Axiom Works,
Wembley,
Middlesex.

Power Supplies for Klystrons

(Illustrated above right)

APLIED Electronics recently announced a range of power supply units designed specifically for the opera-

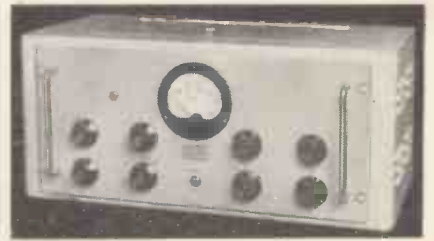

tion of development and experimental equipments utilizing klystrons, travelling wave tubes and similar devices.

Maximum power available within the range is 10kV at 1A; equipments can be supplied either fully enclosed or suitable for rack mounting.

The model illustrated is the AP.2 which provides the following voltages referred to the klystron cathode:—

Resonator: 250 to 350V positive: 30mA with 0.05 per cent regulation. Ripple content 10mV max.

Reflector: 0 to 250V negative: 1mA max with 0.05 per cent regulation. Ripple content 1mV max.

Heater Supply: 6.3V 1A.

The meter provides monitor facilities for positive and negative outputs and cathode current.

Both sine and sawtooth modulation can be applied to the reflector while oscilloscope sweep with variable phasing is also incorporated.

Applied Electronics,
3a, Chestnut Grove,
New Malden,
Surrey.

Decade Resistance Box

(Illustrated below)

THIS resistance box employs a patent 11 position switch, which enables the bulk of the capacitor box to be much less than would otherwise be the case and also results in a considerable saving in manufacturing costs.

The three decade switches, 10's, 100's and 1000's enable any ohmic value between 10 and 11kΩ to be set in 10's. The switching action is very firm and definite, with the result that the value set is always obtained to within one per cent, which is the tolerance of the resistances employed.

The lower values are wire-wound, the higher values are of top-grade carbon. The current capacity is 100mA for the 1st decade, 35 mA for the 2nd, and 10mA for the 3rd. It weighs 2lb and is 8in by 3¼in by 3in.

Winston Electronics Ltd,
Hampton Hill,
Middlesex.

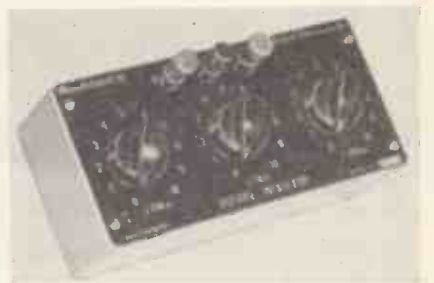

CHAPMAN & HALL

Just Published

NINTH EDITION

OF

MATHEMATICS FOR ENGINEERS

PART ONE

by

W. N. ROSE, B.Sc.

540 pages Illustrated 21s. net

In the ninth edition of the first part of this standard work, a general revision has been carried out and a few minor alterations have been incorporated. But the general plan and form of the book remains the same as in previous editions, which have been so widely used and appreciated.

37 ESSEX STREET, LONDON, W.C.2

CATHODE RAY TUBE TRACES

By H. Moss, Ph.D.

Price 10/6

(Postage 6d.)

This monograph is based on a series of articles published in *Electronic Engineering* and contains in addition, the elementary theory of common types of traces with notes on their production.

Order your copy through your bookseller
or direct from

Electronic Engineering

28 ESSEX STREET, STRAND, W.C.2

BOOK REVIEWS

Magnetic Amplifiers

By H. F. Storm. 545 pp. 368 figs. Demy 8vo. John Wiley & Sons, Inc., New York. Chapman & Hall Ltd., London. 1955. Price 108s.

THIS book comprises three introductory chapters by associates of Dr. Storm at General Electric (Schenectady) on the physics, properties and testing of magnetic materials; seventeen chapters by Dr. Storm on the theory of saturable reactors and magnetic amplifiers; and a chapter each on "Core and Coil Assemblies" and "Metallic Rectifiers" together with six chapters on different fields of application by G.E. engineers. Of the last, the chapter by Dr. E. F. W. Alexanderson on the use of saturable reactors about 1920 for telephonic modulation of radio transmitters powered by high-frequency alternators is of outstanding historical interest, and although it is of a different kind from the rest of the book its inclusion is very welcome.

The author states that the book is addressed to "practising (*sic*) electrical engineers and to senior students of electrical engineering" and that the treatment is based on physical principles with the mathematics limited to undergraduate level. Although the reviewer believes that this treatment is the correct approach to the engineering of magnetic amplifiers, there are times when the author seems to pander unduly to the limitations of the undergraduate: on page 71 four numbered formulae are involved in going from the peak value to the mean rectified value of a sinusoidal e.m.f., and the sheer weight of symbols begins to be confusing when a fairly simple step on page 77 is introduced as "Substituting from Eqs. 5.31, 26, 32, 33 into 5.34 gives . . ."

Dr. Storm's theoretical analysis is based throughout on the behaviour of the magnetic core, with currents such as the control current presented as dependent variables. Since the behaviour of the magnetic amplifier is governed by the core this is a fundamentally sound approach, and although it seems unusual to those who have thought of saturable reactors as elements in electric circuits, it pays dividends when one comes to the "half-cycle" (or "Ramey") magnetic amplifier. Incidentally the very brief treatment of the latter is justified by pointing out that its control circuit must handle instantaneous voltage and current which are each as large as those of the load circuit, and that the presence of a rectifier in the control circuit gives it very poor zero-stability.

There is a table of the very many symbols used in the book (nearly five pages long), citing where necessary the number of the formula which defines the quantity, and this makes it possible to use the book for reference as well as for systematic study. (An item of nomenclature which is not obvious is "output resistance," which is defined as

the sum of the load resistance and the resistance of the circuit in the magnetic amplifier through which the load current flows). In addition to the bibliography by chapters there is a supplementary bibliography of 1954 papers and both a subject index to the book and a name index to the bibliography. This book can be warmly recommended to anyone who wishes to undertake a serious study of magnetic amplifiers.

D. A. BELL.

Sensitometry

By L. Lobel and M. Dubois. 263 pp. 60 figs. Demy 8vo. Focal Press Ltd. 1955. Price 25s.

THIS volume, written by two leading emulsion scientists, starts by explaining fundamentals. It concerns itself with all the basic facts which will help any amateur to understand the many graphs and curves on data sheets of films, plates or papers. For the benefit of the laboratory worker, it also deals fully with the apparatus and methods used to obtain these data.

Special chapters are devoted to colour sensitivity and its effect on filter factors; to colour photography where consistent results depend on accurate matching of emulsion characteristics; and colour printing where sensitometric control provides the only scientific check on quality. A final section consists of a comprehensive introduction to sensitometry in photographic sound recording and reproduction.

Dictionary of Television Radar and Antennas

By W. E. Clason. 720 pp. Demy 8vo. Elsevier Publishing Co. Distributed by Cleaver-Hume Press Ltd. 1955. Price 120s.

IN planning this new dictionary the author and publisher have been guided by certain principles proposed by UNESCO. The object of these principles is to ensure that the volume shall fit into place in a pattern which, it is hoped, may progressively extend over all inter-related fields and cover all necessary languages.

The basic word list is English, British and American usages being clearly distinguished, and definitions in English are included for each subject. The other languages have alphabetical word-lists numerically keyed to the English list. Extensive typographical experiment has shown that the system of arranging corresponding words in the several languages horizontally was the most helpful. Languages have been arranged in Anglo-Saxon, Latin, and Germanic groups.

The convenient size, flexible binding and excellent printing will make this dictionary of permanent value to its user.

Short News Items

The Council of the Radio Communication and Electronic Engineering Association has appointed a publicity committee consisting of the following: C. H. T. Johnson, Decca Radar Ltd; S. C. Naish, Redifon Ltd; R. P. Raikes, Marconi's Wireless Telegraph Co Ltd; J. Read, Standard Telephones & Cables Ltd; V. M. Roberts, British Thomson-Houston Co Ltd; E. E. Walker, Metropolitan-Vickers Electrical Co Ltd; W. M. York, E. K. Cole Ltd. Mr. Roberts is chairman of the new committee. He and Mr. Johnson are members of the Council of RCEEA, and Mr. Raikes, Mr. Walker and Mr. York are members of the Public Relations Committee of the Radio Industry Council, Mr. York being chairman of that committee.

The BBC has been informed by the Post Office that the first section of the permanent vision link between London and the Continent, ordered by the BBC last January, will be completed in September this year. This section consists of a two-way coaxial cable circuit between London and St. Margaret's Bay. The next section, which will be a two-way radio link across the English Channel, has also been ordered but is not due for completion until 1958. Meanwhile, in order that Britain can participate in a series of international television programme exchanges planned for the coming autumn, the coaxial cables will be temporarily extended from St. Margaret's Bay to Swingate, near Dover, where the BBC and Radio-diffusion-Television Francaise will provide and operate a temporary two-way radio link across the Channel between Swingate and Cassel in Northern France.

The Institution of Electrical Engineers recently held a premiere of a film, "The Inquiring Mind", produced for them by Verity Films Ltd. The purpose of the film is to depict the diverse fields of opportunity open to electrical engineers. Particulars regarding loan of the film may be obtained from the Secretary, The Institution of Electrical Engineers, Savoy Place, London, W.C.2.

The Nuclear Power Plant Co Ltd, registered with an authorized capital of £1m, is a recently incorporated company which will concentrate on the research, design and construction of nuclear power stations. A group of firms who either have had close association with the United Kingdom Atomic Energy Authority in the design and construction of the Calder Hall Atomic Power Station, or in experimental reactors for Harwell, are associated with this new company. The combination of these firms will enable

the Nuclear Power Plant Co Ltd to design and construct atomic power stations in any part of the world.

The Broadcasting Division of Marconi's Wireless Telegraph Co Ltd have established the first fully-equipped television training studio of its type in Britain at St. Mary Abbot's Place, London, W.8. The centre is available to any organization wishing to use the equipment for training their own studio and production staffs. A complete training course in the operation and maintenance of television studio equipment is undertaken by the Marconi College. Among those making use of the facilities are Associated-Rediffusion Ltd.

1st International Exhibition of the Peaceful Uses of Atomic Energy, Geneva. Several SIMA members will be taking part in this exhibition. Ten have combined to form a joint stand covering 330sq.ft. Isotope Developments Ltd will be exhibiting a wide range of equipment for industry, research, and experimental and power reactors.

The Battersea Polytechnic announce a series of lectures on "The Theory of Microwave Circuits" to be given on Wednesday evenings from 7 to 9 p.m., commencing on 12 October. The lectures will be suitable for graduates in Physics, Mathematics or Electrical Engineering. Inclusive fee for the series is £4 4s. Application for admission should be sent with the fee as early as possible to the Secretary (Microwave Circuits Course), Battersea Polytechnic, Battersea Park Road, London, S.W.11.

Standard Telephones and Cables Ltd have received an order, through their associates, The Nippon Electric Co Ltd, Tokyo, for an extensive Standard s.h.f. radio network for installation in Japan. This will cater simultaneously for telephone and television requirements between Osaka and Fukuoka over a route distance of about 385 miles.

Standard Telephones and Cables have also received an order, worth more than £125 000, placed by the Government of Burma, to equip a new overseas radio telephone and telegraph centre. New radio stations at Rangoon will provide Burma with a direct public radio telephone circuit to London, and radio telephone and telegraph circuits to Madras. These stations will assist Burma in communications with the Commonwealth and other parts of the world, putting the Burmese telecommunication services on a par with the other modern international systems.

The British Thomson-Houston Co Ltd were hosts to members and friends at the summer meeting of the Radio Section of the Institution of Electrical Engineers, which this year was held at Rugby. Part of the programme consisted of a tour of the B.T.H. Rugby lamp works and the electronics factory, where a selection of electronic equipment was in various stages of production and assembly. The tour of the Rugby works concluded with a demonstration of domestic electrical appliances. Some of the party visited the new Post Office Radio Transmitting Station at Rugby, which was an alternative to the works visit.

The British Thomson-Houston Co Ltd have established a London Publicity Department at Crown House, Aldwych. The Press Officer in London is Mr. G. A. T. Burdett.

The Leipzig Autumn Fair, covering consumer goods of all kinds, will be held from 4-9 September. The Leipzig Technical Fair will be held next year from 26 February to 7 March. Further information may be obtained from Leipziger Messeamf, Postfach 329, Leipzig C1.

The College of Aeronautics, Cranfield, held its eighth annual presentation of diplomas on 1 July. The presentations were made by the Minister of Supply, The Rt. Hon. Reginald Maudling, M.P.

Thermionic Products Ltd have taken over the exclusive world distribution of all acoustical equipment developed by Kelly Acoustics Ltd. All inquiries for the RLS/1 loudspeaker are being handled at the head office of Thermionic Products Ltd, Hythe, Southampton.

British Insulated Callender's Cables Ltd have instituted a Travelling Scholarship as a tribute to Sir Alexander Roger, K.C.I.E., for many years chairman of the company and now its first honorary president. It will be known as the Sir Alexander Roger Travelling Scholarship. With a value up to £1 000 in addition to normal emoluments, it will be awarded annually to an employee of BICC or of one of the various companies of the BICC Group and will enable a young man or woman of ability to travel overseas for study, training and general education for a period of not more than twelve months.

Edwards & Co (London) Ltd will in future be known as Edwards High Vacuum Ltd. The address is Manor Royal, Crawley, Sussex.

The Ministry of Education, in conjunction with the Radio Industry Council, has recently conducted a course for full and part-time teachers of radio and television servicing and of radio in telecommunications engineering courses.

E. K. Cole Ltd announce that they have acquired a controlling interest in Dynatron Radio Ltd.

The British Radio Valve Manufacturers' Association recently held a dinner at the Savoy Hotel, London, in honour of delegates to I.E.C. Technical Committee 39, Electronic Tubes and Valves.

Hirst Electronic Development Ltd have taken over an extensive new factory at Crawley. The address is Gatwick Road, Crawley, Sussex.

The Ministry of Supply announce that Mr. J. Hanson has been appointed Chief Superintendent, Aeroplane and Armament Experimental Establishment, Boscombe Down.

Hivac Ltd have moved their registered offices to Stonefield Way, Victoria Road, South Ruislip, Middlesex.

Goodmans Industries Ltd announce that Mr. Kevin Hughes has now become a director of the company.

RCA Photophone Ltd have issued a list of new RCA products which are available for supply to customers in the United Kingdom and Republic of Ireland. Details may be obtained on request from RCA Photophone Ltd, 36 Woodstock Grove, London, W.12.

Jack Davis Relays Ltd have changed their address to Tudor Place, Tottenham Court Road, London, W.1.

The General Electric Co Ltd is supplying the General Post Office with equipment for two new television links which will extend the coverage of the I.T.A. transmissions. The first of these is a microwave radio link between Birmingham and Lichfield, which will provide two channels from Birmingham to Lichfield and one channel in the reverse direction. The G.E.C. is providing all equipment for this link, which is similar to the links supplied by the G.E.C. over the Eurovision network. The second link is from Birmingham to Winter Hill, near Bolton. The G.E.C. is supplying all the line equipment needed for the transmission of I.T.A. signals over a coaxial cable link between these points.

The Radio and Electronic Component Manufacturers' Federation has now moved to 21, Tothill Street, London, S.W.1.

The R.E.C.M.F. has taken a large stand in the British Exhibition, arranged jointly by the British Import Union, Denmark and the Federation of

British Industries, which will be held in Copenhagen from 29 September to 16 October.

The British Standards Institution recently organized technical discussions, visits and social events for some 650 delegates from 25 different countries during the 1955 series of meetings of the International Electrotechnical Commission.

Mr. J. A. Smale, engineer-in-chief of Cable and Wireless Ltd, has been appointed by the Government of Cyprus to be first chairman of the new Cyprus Inland Telecommunications Authority. The appointment is a part-time one, and Mr. Smale will continue to serve Cable and Wireless Ltd in his present post, visiting Cyprus as necessary.

Mr. H. C. Van de Velde, who has held senior executive posts in Marconi's Wireless Telegraph Co Ltd and The Marconi International Marine Communication Co Ltd for thirty-six years, has relinquished his position as deputy to the managing director of the Marconi Marine Co. Mr. R. Ferguson, the general manager, will in future extend the scope of his responsibility for the company's affairs as senior executive.

Mr. C. G. F. Pritchett has taken over the position of chief engineer to Chloride Batteries Ltd, Exide Works, Clifton Junction, Swinton, Manchester, in succession to the late Mr. C. P. Lockton.

Decca Radar Ltd have been awarded a contract for the installation of Decca Airfield Control Radar Type 424 at Dum Dum Airport, Calcutta. This equipment is to be used as an approach aid at this airport. Although this is the first installation of this equipment in India, the Decca 424 has been supplied for a large number of military and civil airports in various countries, including the United Kingdom, Iceland, France, Germany, New Zealand, South Africa, Australia, Rhodesia, and U.S.A.

The Third International Congress on High-Speed Photography will be held in London from 10 to 15 September. It will be sponsored by the Department of Scientific and Industrial Research, and will take place at Government Offices, Horse Guards Avenue, London, S.W.1. An extensive international exhibition of high-speed photographic and cinematographic equipment as well as associated instrument aids used in the whole field, will run concurrently with the Congress. Those wishing to participate in the Congress either by contributing papers or by supplying exhibits should contact the Congress Secretariat, Department of Scientific and Industrial Research, Charles House, 5-11 Regent Street, London, S.W.1.

Erratum. We regret that in the article "Isocline Diagrams for Transistor Circuits", by Francis Oakes, which appeared in the July issue, Fig. 9 on page 316 was printed upside down.

PUBLICATIONS RECEIVED

RADIO ISOTOPE INSTRUMENTATION AND ACCESSORIES is a new handbook compiled and edited by Dr. D. Taylor and Mr. A. G. Peacock. Its purpose is to assist the potential user of radioactive isotopes in selecting electronic equipment to suit his special needs. The first copy of this handbook was recently presented to Sir John Cockcroft, Director of the Atomic Energy Research Establishment, Harwell. The Scientific Instrument Manufacturers' Association of Great Britain, 20 Queen Anne Street, London, W.1.

PLESSEY is the title of a brochure giving a visual impression of the Plessey organization. The list of products that appears in alphabetical order on each page is intended to give an idea of the productive output of this company. Many of the more specialized instruments and equipment have naturally been omitted. The Plessey Co Ltd, Ilford, Essex.

REMOTE CONTROL BY RADIO, 2nd edition, by A. H. Bruinsman, Chief Engineer of Philips' Central Exhibition Service, Eindhoven, has been published in the Philips' Technical Library popular series. The first edition was written to answer the requests for information about Mr. Bruinsman's radio controlled model ships which have aroused the interest of many radio amateurs. Improvements in the equipment has made a revised edition necessary. Cleaver Hume Press Ltd., Wright's Lane, London, W.8. Price 8s. 6d.

MODERN SOLDERS is a completely revised edition of the original publication. The booklet contains several interesting articles on the uses of cored solder and the characteristics of alloys of which Ersin and Arax multicore solders are made. More than 35 illustrations include pictures of soldering processes in factories in various parts of the world where the company's products are used. Multicore Solders Ltd, Hemel Hempstead.

JOURNAL OF THE INSTITUTION OF TELECOMMUNICATION ENGINEERS, NEW DELHI. The first number of this new journal was published recently and will be issued as a quarterly. The Institution of Telecommunication Engineers, New Delhi, was inaugurated in India in connexion with the Telegraph Centenary Celebrations in 1953. The Institution of Telecommunication Engineers, PX Stores, Curzon Road, New Delhi.

THE SARGROVE SERVICE TO INDUSTRY mentions, in leaflet form, the principal items of equipment available from Sargrove Electronics Ltd, Alexandra Road, Hounslow, Middlesex.

MARCONI SIGNAL is a leaflet with a card-board disc which may be turned to find which of the series of Marconi signal generators is for use in a particular frequency band. Marconi Instruments Ltd, Longacres, St. Albans, Herts.

THIRTY-FIFTH ANNUAL REPORT OF THE BOARD OF THE INSTITUTE OF PHYSICS shows that the total membership in the several grades continues to increase steadily and reached 4 749 at the end of the year. The newly established Graduate examination was held in London, Birmingham and Paisley, and of the 54 candidates who sat only 19 satisfied the examiners in those papers they were required to take. The Institute has continued to take an active part in discussions on higher technological education. The Institute's 16 local branches and specialist subject groups again held many meetings and visited various laboratories and works. The Institute of Physics, 47 Belgrave Square, London, S.W.1.