

ELECTRONIC ENGINEERING

VOL. 27

No. 328

JUNE 1955

Commentary

THE death of Professor Albert Einstein at Princeton, New Jersey, on April 18, deprived the world of, perhaps, the greatest scientist of modern times, a man of a stature such as few reach in any generation. Indeed, when looking for a comparable scientific intellect, it is necessary to turn to such as Newton. But Einstein was not only a great scientist, he was a great and good man; a man who believed in, and worked for, peace among men. Yet he was, withal, modest and retiring.

Albert Einstein was born, of Jewish parents, at Ulm in Württemberg in March 1879 and was of comparatively humble beginning, his father having a small electro-chemical factory. His early years were spent in Munich, Milan, Zürich and Berne, and at this time he was far from being an outstanding scholar; he confessed, in fact, to being "extremely stupid" at learning by rote. From the age of 17 to 21 he studied at the Swiss Federal Polytechnic School in Zürich, following the course prescribed for a teacher of physics and mathematics. Owing, in part, to his ancestry, he had difficulty in obtaining a teaching post and in 1902 he was appointed as a technical assistant in the Swiss Patent Office. Three years later, in 1905, while still employed at the Patent Office he made his first major contributions to theoretical physics.

Einstein had earlier simplified Boltzmann's theory of the random motions of the molecules of a gas, and in 1905 he applied this to the "Brownian movement"—the movement of microscopic particles suspended in a fluid, that is caused by molecular bombardment.

In the same year he advanced a new theory of the photo-electric effect which has exercised considerable influence on the modern quantum theory of light. It was, in fact, his work in this field which, seventeen years later, won him a Nobel prize.

It is, however, the theories of relativity with which his name is mainly associated and, in this same momentous year, the "Special Theory of Relativity" was published. In this he deduced, among other things, a relationship between mass and energy and showed the conditions under which one could be converted to the other. For this work he may well be called the "Father of Nuclear Physics", for it is on these facts that the whole of atomic energy and machines such as the synchrotron depend.

The "General Theory of Relativity" was published in 1916 and this took into account the effects of gravitation and acceleration, and the bending of light rays by gravity.

From the time of his early publications until 1933 Einstein occupied a number of professorial posts in

Europe. In that year the purge of Jewish scientists in Germany decided him to leave the country and he accepted a Professorship at the Institute of Advanced Study at Princeton, a post which he held until 1945.

In 1949 he advanced a "Unified Field Theory" which is an attempt to explain the relationship between all physical laws and, in particular, to establish a mathematical link between the effects of gravity and those of electricity and magnetism. This theory still remains to be proved or disproved and it will, doubtless, be many years before the true worth of the whole of the work of Einstein can be correctly evaluated. That its worth is very great is, however, beyond doubt.

* * *

The official opening of the BBC'S very high frequency transmitters at Wrotham last month is the beginning of a new chapter in sound broadcasting in this country and, at long last, promises improved reception in the London area and South East England.

As is well known, reception of the BBC'S sound broadcasting services has been very unsatisfactory in many areas in this country since the war, due principally to the overcrowded state of the medium and long wave bands. Equally well known have been the BBC'S plans to overcome this congestion by the building of a network of v.h.f. frequency modulated stations. These plans were laid down shortly after the war, but economic difficulties prevailing at the time prevented their being put into operation and it is only now that the first of the v.h.f. stations has been brought into regular service.

For those listeners whose reception has been unsatisfactory and whose broadcast receiver is due for replacement, a new v.h.f. receiver will provide the solution. The radio industry has been keeping in step with the BBC during the development of the v.h.f. network, and has provided a range of suitable receivers, some of which made their debut at the Northern Radio Show held in Manchester at the beginning of last month.

The need at the moment is obviously a receiver which will not cost much more than present types, to provide interference-free reception in areas where previously it did not exist.

In the main sets of this type are standard multi-band receivers with an additional band of 88-100Mc/s arranged for reception of the frequency modulated transmissions. As such, they will probably be the general pattern for some time until the industry has "sampled the market."

An Infra-red Radiation Pyrometer

For Measuring the Surface Temperature of Brake Linings

By R. A. Bracewell*

The study of brake performance and the development of brake linings to withstand the high temperatures experienced with modern motor car brakes calls for a means of measuring the actual surface temperature of the friction linings. This article describes the application of the lead sulphide cell to this problem. Pulses of heat radiation are detected as they radiate from the lining through a small slot in the brake drum. These pulses are amplified and displayed on a c.r.t. where they are compared with pulses from calibration lamps. 35mm film records the comparison of the pulses. Lining temperatures of over 1 000°C have been recorded.

IN the investigation of the performance of brakes and brake linings, both on the road and in the test laboratory, it has been usual to note the temperature of the brake drum surface which is in contact with the brake lining.

There are two good reasons why the brake drum surface temperature is a very poor indicator of the duty required from the brake lining:—

- (1) Owing to the arc of contact of the lining being roughly only two-thirds of the drum circumference.
- (2) Most brake linings are poor conductors of heat and the shoe to which they are attached has very little chance of dissipating heat. On the other hand, the brake drum is a very good conductor and has every chance of dissipating its heat into the surrounding air stream.

Because of these conditions there is a steep temperature gradient on each side of the braking surfaces, but the drum surface is much cooler than the lining surface, especially under dynamic conditions.

It is, therefore, desirable to be able to indicate the actual lining temperature with a detector which has a very rapid response.

Owing to the lining surface being entirely covered by the drum, radiation from the lining through a hole in the drum would appear to be the only method possible. In the past, thermo-couples have been embedded in the lining, but the very high temperature which exists on the surface of the lining cannot be indicated by any indicator below the surface, as the temperature gradient near the surface of the lining must be very steep.

By use of the lead sulphide cell as a detector of radiation, it is possible to detect the radiation on the surface temperature of the lining as it radiates through a $\frac{1}{4}$ in diameter hole in the drum and to obtain a series of sharp pulses which can be calibrated in terms of temperature. The lead sulphide cell is, however, not entirely suitable for use as a direct detector owing to drift and change of sensitivity with change in ambient temperature and also, because the thin film of lead sulphide is easily overheated by strong radiation, causing the cell to be unreliable in these conditions.

If, however, the cell is used as a comparator and only subject to flashes of radiation which will not overheat the film of lead sulphide, then stable results can be obtained and all the advantages of this type of cell can be employed.

These advantages are:—

- (1) High sensitivity particularly to infra-red radiation.
- (2) High speed of response (40 μ sec).
- (3) Long life.
- (4) Simplicity.
- (5) Freedom from microphony.

(1) and (2) are particularly important in the present application; high speed of response being very essential to the investigation of the brake lining surface temperatures under dynamic conditions, when the stopping time may be only 3 or 4 seconds and one of several flashes of radiation are to be indicated every revolution of the brake drum. For instance, at 60 m.p.h. using an average size car wheel, the speed of rotation is 775rev/min or 12.9rev/sec, and if one hole is used in the brake drum through which to view the radiation the frequency is nearly 13c/s, and if the one hole is $\frac{1}{4}$ in wide and $\frac{1}{2}$ in long the duration of the pulse is approximately 1msec.

(3) and (4) are very desirable characteristics.

(5) Freedom from microphony is very necessary as considerable vibration is bound to be encountered when working with high speeds pressure and deceleration. With the lead sulphide cell vibration does not give any interfering signal as used in this application.

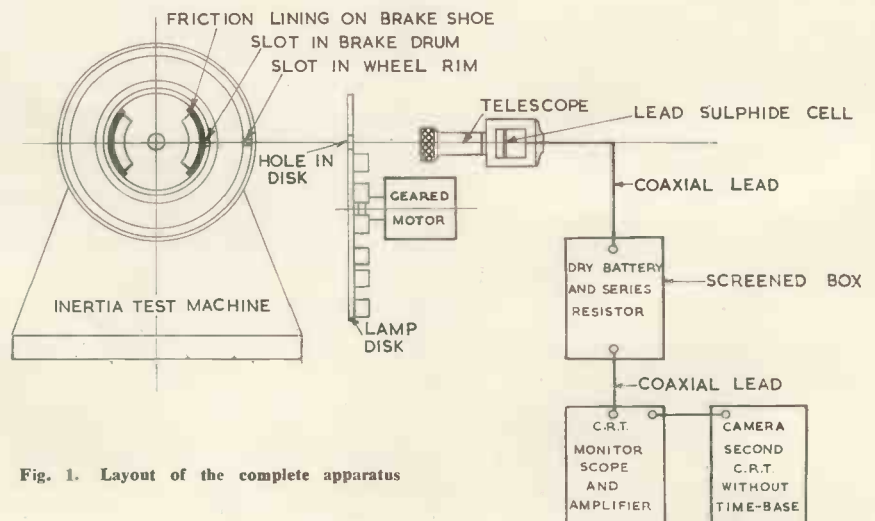

Fig. 1. Layout of the complete apparatus

* Creswell's Asbestos Co., Ltd.

A schematic diagram of the complete apparatus is shown in Fig. 1.

The very fact that the radiation is chopped up by being viewed through a hole or holes in the drum overcomes the over-heating of the cell which would be experienced by any direct viewing methods. Except for radiation from the hot drum, which is overcome by having the wheel rim in place with a second slot, which permits only the radiation from the lining to reach the cell.

The use of the cell as a comparator has been achieved by having a series of calibrated lamps rotating and radiating on the cell which give a series of pulses in the form of a step-ladder. These pulses are calibrated in temperature and can be compared with the actual temperature pulses obtained from the surface of the brake lining.

The calibrating lamps, nine in number, are mounted on a disk which is driven by a motor at 167rev/min. The lamp disk is divided into ten equal spaces, nine of which contain a lamp and in the tenth space there is a large hole in the disk. The disk is so arranged that at a turn of the switch it will either rotate, or stop with a hole opposite the telescope from which the cell views the radiation from the brake lining through the hole in the disk and the hole in the brake drum.

The output of the cell is fed into an amplifier and displayed on a cathode-ray tube. The display is photographed by a moving film 35mm camera.

By using the comparator method the sensitivity of the cell or the gain of the amplifier does not affect the calibration, as if these vary they affect the signal and the calibration step-ladder to the same extent, and it is only necessary to adjust the overall sensitivity of the amplifier to give the desired size of the picture from the signal and the calibration will still be correct, although the top of the ladder, i.e. the higher temperatures, may be out of the picture if the signal does not require the full calibration range.

It follows that drift and changing sensitivity, except of very short duration, do not affect the calibration. In the instrument described the calibration range is from 600° to 1400°C in nine steps of 100°C.

Applying the pyrometer to the flywheel type of test machine, the cell is mounted in a 1in diameter bronze tube of heavy section which is a push fit in the end of the telescope which is focused on the brake lining.

On this test machine, a cycle time switch performs the following operations:—

- (1) BRAKE OFF.
- (2) CLUTCH IN and motor acceleration.
- (3) CLUTCH OUT (free-wheeling).
- (4) BRAKE ON.

This cycle can be repeated at any desired frequency from one cycle every $\frac{1}{2}$ minute to as long as required. From CLUTCH IN until just before brake, the calibrating lamp disk is arranged to revolve, and just before BRAKE ON the disk stops with the hole in line with the telescope and the lining. This is controlled by a separate switch on the time switch assembly and is adjustable.

In order to economize in film, the camera is controlled by a hand operated on and off switch to the film drive. Several sweeps of the calibration ladder are taken between stops and the whole of the deceleration signals are recorded.

A second cathode-ray tube without time-base is used for the camera so that the display can be observed continuously on the original scope. Owing to the retardation

the temperature signals are not always synchronized on the monitor scope as it is not practical to adjust the time-base frequency during a stop, but this is not of importance as the moving film ensures that the display is correctly formed in the photographs. The speed of response is such that with a film speed of 1in/sec the pulses from the actual lining radiation are sharp vertical lines and it is only on the last revolution or so that these appear to have any width, i.e. when the drum is almost stopped. (See Fig. 2.)

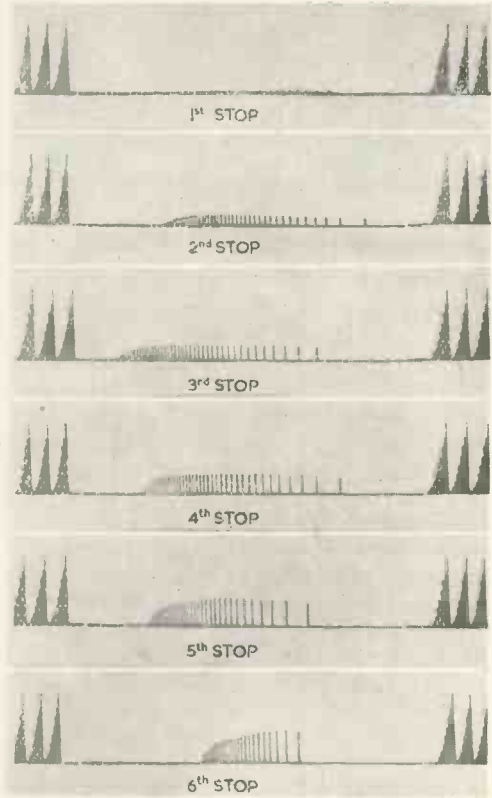

Fig. 2. Series of six stops made from 60 m.p.h. Maximum temperature on 6th stop is 1050°C.

Mechanical Set-up

The main details of the mechanical layout are shown in Fig. 1.

A Satchwell Control geared motor was used to drive the lamp disk. Most of the gears were removed to obtain a speed of 167rev/min. The motor is mounted on a channel bracket which carries the telescope, the eyepiece of which can be exchanged for the lead sulphide cell in its holder (see Figs. 3 and 4). This arrangement ensures that the calibrating lamps are always at a fixed distance from the cell. A small motor and switch operated friction drive to the outer edge of the disk is used to arrest the stopping disk and rotate it until the large hole is opposite the telescope. This takes place automatically when the Satchwell motor is switched off. The operation is completely automatic, a special power pack being so arranged that the disk stops just before the brake is being applied and runs again when the flywheel is accelerated for the next stop.

This assembly is mounted on a radial bracket which can be rotated so as to view any part of the lining and so we are able to observe the temperature over the full length of the lining, which owing to the geometry of the shoe, would be expected to show different results.

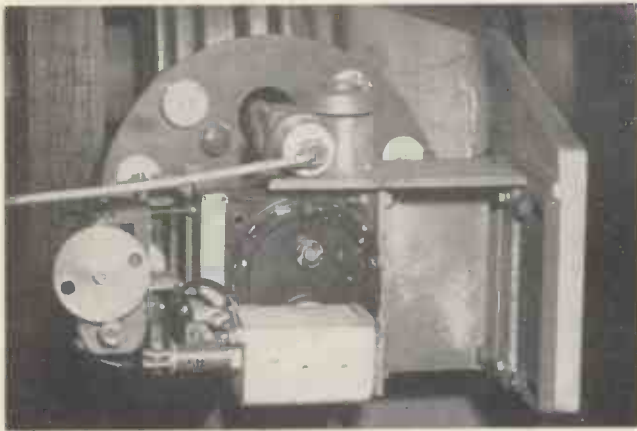

Fig. 3. The lamp disk viewed from the rear showing the cell in its mounting



Fig. 4. The brake drum and lamp disk

Amplifier

The amplifier, which is shown in Fig. 5, is direct coupled, this arrangement giving a straight base line to the pulses. RC coupling was tried, but this gave the effect illustrated in Fig. 6. The areas above and below zero being equal, the shorter the pulse frequency, the deeper the line below zero. D.C. restoring circuits were tried, but it was not found possible to obtain a straight base line, owing to the variation in frequency caused by the deceleration. With a d.c. coupling, the base line is very satisfactory and this is most important as the whole basis of the calibration is the comparison of the height of the pulses above the base level.

The cathode-follower valve V_1 enables the input to the amplifier to be made at zero d.c. level and the adjustment of the $50k\Omega$ potentiometer in the cathode of V_1 gives this condition.

As the volume control is at zero d.c. level, adjustment

of this control does not affect the position of the trace on the c.r.t. provided the d.c. level control is correctly adjusted.

The 120V dry battery and $820k\Omega$ series resistor are housed in a screened box to avoid 50c/s pick-up and con-

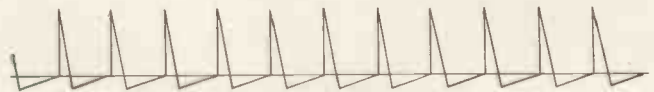

Fig. 6. Effect of RC coupling

nected to the cell and the amplifier by coaxial cable with plugs and sockets.

The $560k\Omega$ grid resistor on V_1 is placed on the valve leg to chassis and earth, and while this reduces the signal, it also entirely eliminates any 50c/s hum.

The amplifier is fairly free from drift, but slight drift is not important in this application, as the Y position con-

Fig. 5. The amplifier circuit

The lead sulphide cell is a B.T.H. type M2. All resistors are high stability type.

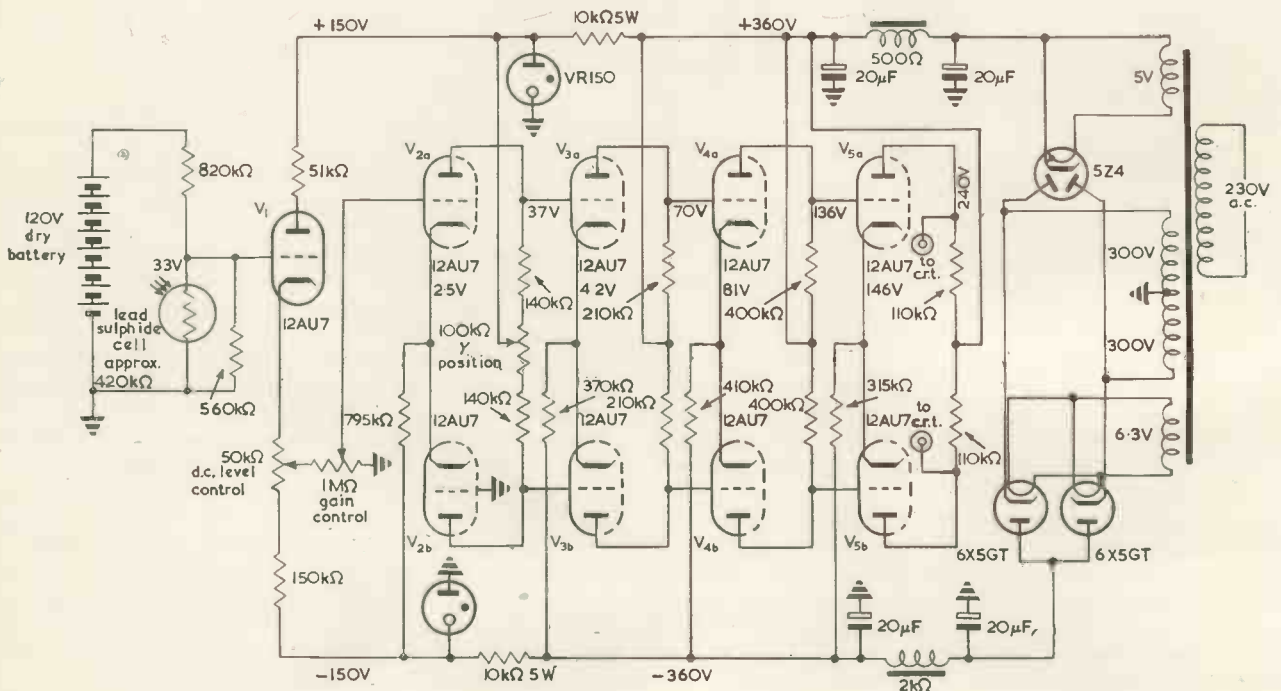

trol can be adjusted to give a central picture on the monitor-scope just before photographs are taken.

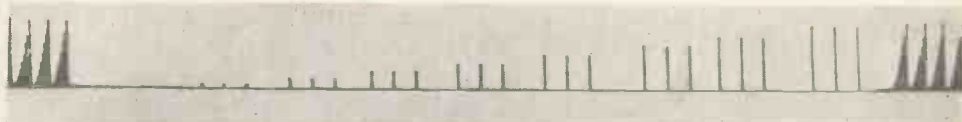

Fig. 7. Print of film of calibration of Infra-red pyrometer 600°C to 1400°C in 100°C steps
Centre part is signal from platinum heat source. Step ladder on each side is signal from lamps.

Calibration

For this purpose the drum and wheel rim were set up on a lathe with the open side of the drum towards the saddle and the pyrometer with calibrating disk was set up at a given distance from the brake lining surface, in this case (7in). A heat source was used in place of the lining and this consisted of a piece of platinum foil 0.001in thick, about ½in wide and 1½in long, which was mounted in a U-shaped holder and as near the drum as possible. This was so arranged that both sides of the platinum can be used, one side to radiate in the same manner as the heated brake lining and the other side can be inspected by an optical pyrometer to check the temperature of the heat source.

The platinum is heated electrically, 2V giving a maximum true temperature of approximately 1400°C and taking about 45A. This current is fed from a 230 to 2V transformer and an auto transformer gives the necessary control of the platinum foil temperature. The readings of the optical pyrometer (Foster Disappearing Filament type 2571/3000) were corrected for black body conditions. The lowest reading on the Foster Optical Pyrometer is 700°C and the current through the platinum was found to be linear with corrected temperature so that by continuing the current to temperature graph the calibration was extended down to 600°C and then by direct observation up to 1400°C in 100°C steps.

Calibration was taken with a brake drum speed of 165rev/min. All the lamps but the one to be adjusted to give a calibration of 1400°C were masked and the heat source was adjusted to 1400°C (true temperature) and the lamp variable resistor adjusted to give the same signal, which was set at 2in deflexion on the tube by adjustment of the amplifier gain; each lamp was so adjusted in turn against the corresponding calibration temperature of the platinum source.

The results were checked by taking a series of photographs of the display of the heat source and the corresponding lamp, as the observation of the pulses on the cathode-ray tube cannot be done with precision.

The hole in the brake drum was ¼in wide and ½in long and a corresponding hole was made in the wheel rim. The reasons for having the wheel and rim in place were to ensure that the cooling on the test machine was the same as on the road, and to give a flat base line to the trace on the cathode-ray tube—if the cell were to look at the hot drum the base line of the trace would be deflected when the temperature of the drum rises high enough to be detected by the cell and as the height of the pulses above the base line is the basis of the calibration, it is convenient to use the rim as a shield from the hot drum. In addition, a fan is geared to the main drive so as to blow air on the drum at a velocity equal to road speed.

35mm film was taken of the pulses of the heat source and of the lamps. This was projected on to graph paper in order to check the pulse heights. (See Fig. 7.) Table 1 gives the results.

A nomogram based on Wiens formula and supplied by Elliot Bros. (London) Ltd. was used to convert from observed temperature to true temperature.

TABLE 1

| TEMPERATURE | IMAGE HEIGHT (mm.) | | ERROR (mm.) + or - | PERCENTAGE ERROR |
|-------------|---------------------------|-------|-----------------------|------------------|
| | PLATINUM FOIL HEAT SOURCE | LAMPS | | |
| 1 400 | 212 | 205 | -7 | -3.3 |
| 1 300 | 169 | 171.5 | +2.5 | +1.5 |
| 1 200 | 142.5 | 145 | +2.5 | +1.8 |
| 1 100 | 112.5 | 113 | +0.5 | +0.45 |
| 1 000 | 84 | 84.5 | +0.5 | +0.59 |
| 900 | 59 | 61 | +2 | +3.4 |
| 800 | 37 | 37 | Nil | — |
| 700 | 22 | 20.5 | -1.5 | -6.9 |
| 600 | 10 | 10 | Nil | — |

Table 2 shows the relation between true temperature, observed temperature, and current through the platinum.

TABLE 2

| TRUE TEMPERATURE (°C) | OBSERVED TEMPERATURE (Black Body Conditions) (°C) | CURRENT (A) |
|--------------------------|---|----------------|
| 600 | 590 | 21.9 |
| 700 | 675 | 24.4 |
| 800 | 760 | 27.0 |
| 900 | 840 | 29.4 |
| 1 000 | 935 | 30.0 |
| 1 100 | 1 020 | 34.6 |
| 1 200 | 1 115 | 37.5 |
| 1 300 | 1 195 | 40.2 |
| 1 400 | 1 285 | 44.5 |

Brake Drum and Radiation Slot

Drum 9in diameter, 1½in wide.

Slot ¼in by ½in formed by drilling two ¼in round holes ½in apart and opening out to a slot.

Considering a ¼in band around the drum:

| | | |
|--------------------|---------|---------------|
| Area of plain band | 6.88in | 97.6 per cent |
| Area of slot | 0.17in | 2.4 per cent |
| | 7.05 in | 100 per cent |

The reduction in area of the drum of 2.4 per cent is not considered large enough to affect the results; actually, this would result in a slightly lower lining temperature, but is so small that it is felt it can be disregarded.

Heater Circuit for Calibration Lamps

These are run from a.c. through a 6V transformer fed by a constant voltage transformer.

A sensitive rectifier voltmeter is provided and a resistance to set the input to the lamp circuit to 5V.

Acknowledgments

The author wishes to thank Mr. C. Kinsey, managing director of K. R. S. Radio Ltd, Shipley, Yorks, for his assistance with the electronic circuits and reading the proofs, and also Mr. L. J. Davies and Mr. B. N. Watts, B.Sc., of B.T.H. Co. Ltd, for their assistance and information on their research with the lead sulphide cell.

A Very High Input Impedance Oscilloscope Probe Unit

By G. O. Crowther*, B.Sc., A.C.G.I.

This article describes a probe unit with a very high input impedance primarily developed to assist in investigations into the behaviour of cold-cathode trigger valves. It is capable of responding to large and rapid potential changes. The output is suitable for direct connexion to an oscilloscope or to a voltmeter to give a direct reading of the mean d.c. potential at the input. The probe unit should have many applications in other spheres of work either as an oscilloscope probe or a high impedance voltmeter.

IN nearly all investigations into the behaviour of cold-cathode tubes operating under dynamic conditions, it is essential to be able to measure the potential and observe potential changes of electrodes which have a very high impedance to earth. The impedances involved are generally too high to permit direct connexion of an oscilloscope or standard moving-coil voltmeter and may have a value anywhere in the range 10^6 to $10^{12}\Omega$.

The probe unit has been made up in two sections: (1) a small input probe, and (2) the main unit and output section. In order to obtain a compromise between speed and input impedance requirements, two types of probe heads have been designed with the following general characteristics: (a) very high input impedance with a comparatively slow speed of response, and (b) high speed of response but with a lower input impedance.

The circuits have been designed to meet the following specification:

Input Impedance

The input should be regarded as a constant current generator in parallel with a very high leakage resistance. In practice, the leakage resistance is very high and may be neglected compared with the constant grid current, which for the fast probe is 10^{-9}A , and for the high impedance probe $2 \times 10^{-13}\text{A}$.

Voltage Input Range

The probe is capable of measuring direct voltages in the range -300 to $+650\text{V}$ and will respond to a rapid change of 200V anywhere in the above d.c. range.

Speed of Response

The high speed probe responds to a rate of change of $50\text{V}/\mu\text{sec}$, while the high input impedance probe responds to a rate of change of $5\text{V}/\mu\text{sec}$.

General

Accuracy of voltage measurement is ± 1 per cent for voltages greater than 100V . Below this voltage it is $\pm 1\text{V}$. The input capacitance is in the region of 1pF , and the output impedance of the order of 150Ω . The drift of zero setting is 0.3V in the first half hour, further changes being less than 0.1V .

Basic Circuit

The circuit employed is essentially a cathode-follower using an electrometer-type valve to obtain the required high input impedance. Because of the small permitted anode voltages, an electrometer valve cannot be employed

in a simple cathode-follower circuit giving a wide range of input voltages. The maximum anode voltage for the ME1401 is 10V . This small anode voltage limits the input variations to a few volts. Circuits of high input impedance voltmeters which have overcome this difficulty have been described in the literature^{1,2}. These circuits may be adapted to an oscilloscope probe unit, and Figs. 1 and 2 show series and parallel arrangements respectively.

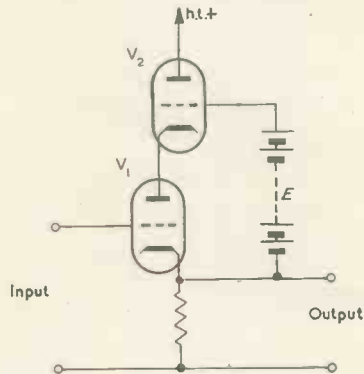

Fig. 1. Series circuit

Consider first the circuit shown in Fig. 1. The valve V_1 is an electrometer valve, and V_2 is a normal receiving-type valve. Both V_1 and V_2 are wired as cathode-followers, V_2 having V_1 as a cathode load. The first cathode-follower V_1 acts as the signal input and output in the normal manner. The function of the second cathode-follower V_2 is to maintain the anode-to-cathode voltage of V_1 at a constant value E independent of the input voltage. The input to the grid of V_2 is taken from the output of V_1 with the constant voltage E superimposed. This circuit therefore retains the very high input impedance associated with the electrometer valve for the wide range of input voltages for which the cathode-follower V_2 maintains the anode-to-cathode voltage of V_1 substantially constant.

The maximum rate of change of the input voltage to which the circuit is capable of responding is set by the maximum permissible current of the electrometer valve V_1 and the stray capacitance to earth at the cathode of V_1 . (This capacitance includes the stray capacitance to earth of the battery E .) If this maximum rate of change is exceeded, for a negative change, V_1 is cut off and the output voltage falls to the new steady value at a rate determined by the circuit. For a rise in excess of the maximum value, the valve takes excessive current and the

* Mullard Radio Valve Co. Ltd.

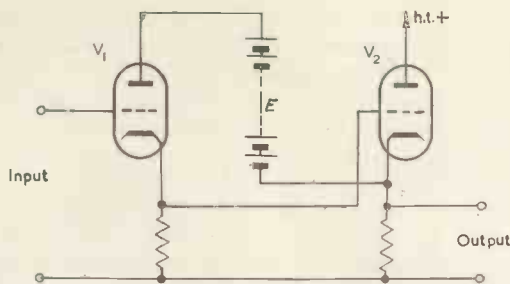

Fig. 2. Parallel circuit

input impedance is considerably reduced owing to grid current. The maximum rate of change dV/dt , either positively or negatively, may be calculated from the expression

$$\frac{dV}{dt} = \frac{I_{\max}}{2} \frac{1}{C}$$

where I_{\max} is the maximum permitted current of the electrometer valve and C is the total stray capacitance.

In a mains-operated circuit, the stray capacitance C may be as large as 500pF and the maximum permissible current of a ME1401 is 100 μ A. This gives a maximum rate of rise or fall of 0.1V/ μ sec, which is considerably below the required performance.

However, a substantial gain in the speed of response may be obtained by using the circuit of Fig. 2. In the circuit of Fig. 2, V_1 is again an electrometer valve and V_2 a normal receiving-type valve. Both valves are again wired as cathode-followers, but in this case V_1 acts only as the signal input while V_2 acts as the signal output as well as providing the constant anode-to-cathode voltage

for V_1 . The large stray capacitance due to the battery E and any capacitance added at the output terminal in this circuit are charged and discharged by the comparatively large currents of V_2 , which has not the stringent input impedance requirement of V_1 . The speed of response of this circuit is again limited by the stray capacitance at the cathode of V_1 , but by careful design this may be kept below 20pF, a factor of 20 to 30 below that of the series circuit. This parallel circuit is the basic circuit of the final probe unit.

Details of the Complete Circuit

The complete circuit of the probe unit is shown in Fig. 3. A number of additions to the basic circuit of Fig. 2 have been necessary in order to obtain the performance required. These additions are discussed in the following sections.

CURRENT GENERATOR (V_3 and V_4)

It has been shown in the previous section that the unit will retain the very high input impedance of the electrometer valve provided the second cathode-follower V_2 maintains the anode-to-cathode voltage of the electrometer valve V_1 substantially constant over the operating range. The working anode voltage of an ME1401 electrometer valve is about 9V, and therefore anode voltage changes of about 1 or 2V only can be tolerated over the complete working range: this represents a required gain of at least 0.99 for the second cathode-follower V_2 . A constant current generator V_4 has been added to maintain the cathode current of V_2 constant, and a floating stabilized voltage has been connected between screen and cathode of V_2 in order to obtain this required gain. It is only possible to obtain a gain of the order of 0.9 with the simple circuit shown in Fig. 2.

Fig. 3. The complete probe unit

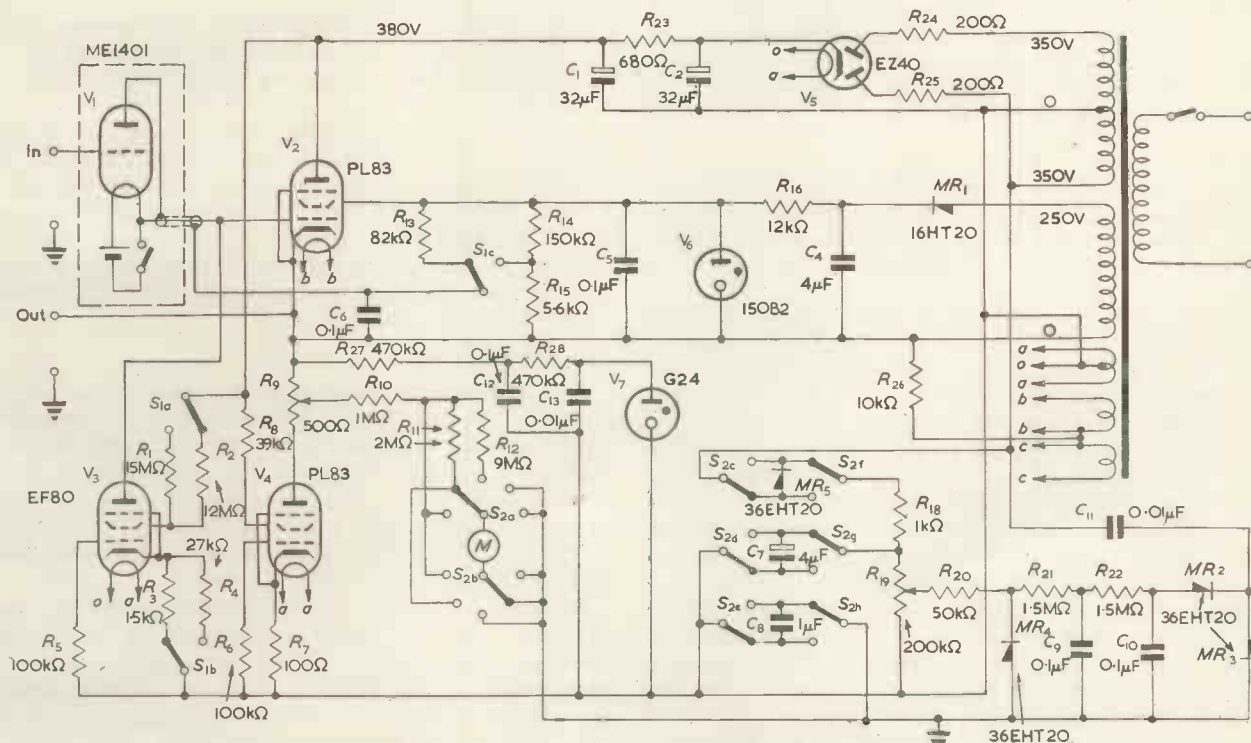

A second constant current generator V_3 has also been added to maintain the cathode current of V_1 constant. This current generator is not essential to maintain the high input impedance, but has been added to give a greater overall gain to the circuit, and therefore give greater accuracy of measurement. It also considerably simplifies the anode voltage supply E for V_1 , which is obtained from the V_2 screen voltage supply. This will be discussed in greater detail in a later section.

"SET D.C. LEVEL" (R_{19})

To obtain the maximum speed of response from the circuit, and to ensure that the electrometer does not receive excessive transient anode voltages when sharp voltage changes are applied to the input, the output cathode-follower must be capable of a more rapid response than the input cathode-follower V_1 . To obtain the required speed of response, in spite of the large stray capacitance at the cathode due to the floating screen supply, the cathode current of V_2 must be at least 20mA. To obtain the wide operating range quoted in the specification, a valve with high values of g_m and r_a capable of withstanding an anode-to-cathode voltage of 1.2kV with an anode dissipation of 24W is required. No such valve was available, and for this reason it has been necessary to use the PL83 and to keep the maximum anode-to-cathode voltage of V_2 below 300V, restricting the range of operation to 200V on the input. This would be a severe restriction on the use of the probe, as it would only allow variations of $\pm 100V$ about a predetermined voltage. To obtain a wider range of operation, arrangements have been made to vary the predetermined voltage by floating the whole circuit on a variable supply connected between the negative line of the circuit and earth. The variable supply is made up of MR_5 , C_7 , C_8 , R_{18} , R_{19} and R_{20} , the rectifier MR_4 is part of a protection circuit, and normally may be regarded as a direct connexion to earth. The voltage is varied by the potentiometer R_{19} and may be either positive or negative, dependent on the position of switch S_2 . This additional circuit allows the centre value of the 200V operating range to be varied to any value in the voltage range -200 to $+600V$.

THE PROBE HEADS

Two probe heads have been designed for use with the main unit, a very high input impedance probe and a high speed probe. As stated earlier, this was to obtain a compromise between the input impedance and speed of response requirements.

The very high input impedance probe is shown in detail in Fig. 3. It employs an ME1401 for the electrometer valve V_1 . The small filament battery employed is the "penlite" size Mallory mercury cell RM 502. These cells have a useful working life of about 150 hours in the circuit. A larger battery could be employed, but unless care is taken the speed of response may be reduced owing to a larger stray capacitance to earth. Under normal conditions the electrometer valve has an anode-to-cathode voltage of about 10V and an anode current of approximately $50\mu A$. The input impedance is best stated as a constant current fed into the circuit under investigation of $2 \times 10^{-13}A$. This current, which is due to grid current, is independent of input voltage changes over the operating range, since the electrode potentials and anode current are maintained substantially constant.

The high speed probe head is similar to the high input

impedance probe except that a selected EF86, connected as a triode, is used for the electrometer valve. The valve is run with a heater voltage of 5.5V, taken from the winding cc on the mains transformer. Under normal conditions the anode-to-cathode voltage is 80V, the anode current 1mA, and the current fed into the circuit under test approximately $10^{-9}A$.

The heater voltage of the EF86 has been lowered from 6.3 to 5.5V to reduce the component of grid current due to grid emission. However, with the 1mA of anode current, the grid current is mainly due to gas current and therefore no further reduction in this current can be obtained by reducing the heater voltage to the 4.5V normally recommended for electrometer applications. A considerable fall in speed of response would also be experienced with a heater voltage of 4.5V owing to the low cathode emission.

It should be noted that in order to obtain the very small values of grid current quoted above for the EF86, the valve should be aged for a period of at least 30 minutes at an anode current of 1mA if it has been idle for a period in excess of a few days. This is necessary to clean up the small quantities of gas which are liberated under idle conditions and which would cause excessive grid current for this application.

As stated earlier, the anode voltage for the electrometer valves is obtained from the floating screen voltage supply for V_2 . Since the anode current to the electrometer is maintained constant over the operating range, the required anode voltage can be obtained by inserting a dropping resistor from the 150V screen voltage line in series with the anode of V_1 . If the electrometer current is not kept constant, it is necessary to add a further stabilizer to obtain a steady anode voltage for the high speed probe head. The capacitor C_6 maintains the anode voltage constant during a rapid input voltage change. It should be noted, particularly in the case of the high impedance probe, that the grid-to-cathode voltage of V_2 also forms part of the anode-to-cathode voltage of V_1 . The required anode voltage and current is selected by the switch S_1 .

The output from the probe head is taken to the main unit via a coaxial cable; the inner conductor carries the input to V_2 and the outer conductor the anode voltage for V_1 . There is very little loss in the speed of response due to this long lead, since the voltage between the inner and outer conductor is maintained substantially constant and therefore the effective capacitance seen by the cathode of V_1 is almost zero.

THE OUTPUT CIRCUIT

The oscilloscope output is taken from the cathode of V_2 , as in the basic circuit, and is suitable for direct connexion to any standard oscilloscope. The effective output impedance is approximately 150Ω . It should be noted, however, that owing to an electrometer valve protection circuit erroneous results may be obtained if a d.c. path is connected between the output terminal and earth which takes a d.c. current in excess of $50\mu A$.

An indicator circuit has been added to indicate when the "set d.c. level" control is set to give the centre of the operating range. The circuit is a simple gas diode relaxation oscillator, which indicates when the output to negative line voltage exceeds the breakdown voltage of the diode. The limits to the operating range occur when either of

the valves V_2 and V_4 is driven into the "knee" of its anode characteristic, i.e. when the output to the negative line voltage is either 90V or $380 - 90 = 290$ V. A small indicator diode has been selected with a breakdown voltage of 180V which is equivalent to the centre of the operating range.

Owing to the limited d.c. load which may be applied to the output, a voltmeter with a $100\mu\text{A}$ movement has been incorporated in the units made up for the laboratory to give a direct indication of the mean voltage at the input. This meter has the following voltage ranges: 0 to 100, 0 to 300, 0 to 1 000, 0 to -300 , 0 to -100 V. The meter resistors were made up of high stability resistors wired as shown in Fig. 3 to keep the effective stray capacitance at the cathode of V_2 as low as possible. The voltmeter circuit is taken from the potentiometer R_9 connected in series with the valves V_2 and V_4 to obtain a correction for the constant positive voltage which exists between the input and the cathode of V_2 . This positive voltage is equal to the sum of the grid-to-cathode voltages of V_1 and V_2 . The potentiometer R_9 is employed as the "set zero" control and is normally set with the circuit operating at the centre of the operating range.

The accuracy of voltage measurements is about 1 per cent for all voltages in excess of 100V, either positive or negative, at any point in the operating range. The accuracy of measurement for voltages below 100V is dependent on the position in the operating range at which the measurement is made, and is about ± 1 V under the worst conditions. An accuracy of 1 per cent can, however, be obtained for these voltages if the measurement is made at the same point in the operating range at which the "set zero" control was set. Under these operating conditions the voltages and currents existing in the circuit are substantially the same as those present when the "set zero" control was set. This may be readily carried out by taking the measurement and setting zero at the centre of the operating range as indicated by the neon indicator.

THE ELECTROMETER VALVE PROTECTION CIRCUIT

Under certain conditions of input and settings of the "set d.c. level" control, it is possible for the electrometer valve to pass several milliamperes of grid current. To prevent damage to the electrometer valve, a protection circuit has been added to limit the grid current under these conditions to 200 to $300\mu\text{A}$.

Consider for the present that the rectifier MR_4 is short-circuited and the input to the probe is connected to a low impedance supply of, say, 600V. The circuit will behave as already described, provided the "set d.c. level" control is correctly set. However, if this control is set such that the valve V_2 is driven well into the "knee" of its anode characteristic, then the constant current from the anode of V_4 cannot flow to the anode of V_2 , but flows to the grid of V_1 , via the grid of V_2 . This grid current is only limited by the resistor R_{19} and may be as large as 3 or 4mA. The rectifier MR_4 is connected such that under the above conditions it presents a very high impedance between earth and the potentiometer, R_{19} limiting the grid current to a safe value. Under normal conditions of use, the rectifier is held in its low impedance condition by a small forward current from a negative supply made up of $MR_2, MR_3, C_9, C_{10}, C_{11}, R_{21}, R_{22}$.

The grid current which flows under the above conditions with the rectifier in the circuit is given by the

expression

$$i_g = i_t + \frac{E_{in}}{R} - \frac{E_s + 300}{R} - i_{do}$$

where i_t is the forward current in the rectifier MR_4 under normal conditions.

E_{in} is the input voltage.

E_s is the voltage existing between the common negative line and the cathode end of the rectifier MR_4 (the "set d.c. level" voltage).

R is the effective resistance between the common negative line and earth (the back resistance of the rectifier MR_4 in parallel with the effective d.c. resistance of the negative supply (MR_2, MR_3 , etc.)).

i_{do} is the magnitude of any current flowing from the output terminal to earth due to the meter or other d.c. path.

It will be seen from the above expression that it is desirable to keep the normal forward current i_t of the rectifier MR_4 as small as possible. However, it is essential that this forward current exceeds the maximum value of any current i_{do} which may exist. This current will vary dependent on the meter range or other d.c. paths connected to the output. The return path for these currents is through the rectifier and the direction of flow is the same as for the grid current. Therefore, if the forward current of the rectifier is insufficient, the rectifier will present a high impedance even under correct operating conditions, causing unreliable results.

ZERO DRIFT

The zero drift during the first half hour is 0.3V and afterwards is less than 0.1V using the high speed probe. There is an additional drift when using the high input impedance probe owing to the slow discharge of the filament battery. This drift is about 0.3V for a change of battery voltage from 1.25 to 1V. In practice, using the Mallory cell, this is not serious.

Construction

The main unit is housed in a small Imhof case type 1 050 measuring 10in \times 7in \times 6in. The probes are made up in small paxolin cases measuring $1\frac{1}{2}$ in \times $1\frac{1}{2}$ in \times $3\frac{1}{2}$ in for the high speed probe and $2\frac{1}{2}$ in \times $1\frac{1}{2}$ in \times $\frac{3}{4}$ in for the high input impedance probe. The input insulation of both probe heads is made up of polished polystyrene to obtain the high insulation required. Protective metal plates have been placed in front of the polystyrene, spaced a small distance away, to prevent fingerprints, etc., appearing on the polished surface.

Conclusion

This probe unit should have many applications, not only in the cold-cathode field but also in any application where high impedances are encountered and where it is required to observe rapid voltage changes on an oscilloscope. The probe unit has been invaluable in all investigations on cold-cathode trigger tubes where the impedances encountered are often greater than $1\text{M}\Omega$.

REFERENCES

1. BROWN, D. E., KANDIAH, K. A Very High Impedance Valve Voltmeter *Electronic Engng.* 24, 320 (1952).
2. BREWER, A. W. An Electrometer Valve Voltmeter of Wide Range. *J. Sci. Instrum.* 30, 91 (1953).

A Design Method For Direct-Coupled Flip-Flops

By W. Renwick*, M.A., B.Sc., and M. Phister*, Ph.D.

A method is developed for designing a flip-flop which will be stable with a given tolerance on resistors, voltage supplies and valve characteristics, which is a requirement for a flip-flop for use in a high-speed digital computer. It is shown that when the supply voltages are not fixed by other considerations the principal time-constant of the circuit can be minimized by properly choosing the supply voltages. The method is applicable to all direct-coupled switching circuits.

A FLIP-FLOP or bistable trigger circuit which is to be used in an electronic computer must satisfy two important conditions:

(a) *Stability*: changes in the characteristics of valves or of other circuit parameters must not affect the stability of the flip-flop. In particular, a flip-flop built from standard (that is, not specially selected) valves and resistors must be stable, and variations of the characteristics of these components within certain limits should not make the circuit unstable.

(b) *Speed*: when changing from one state to the other the circuit must reach equilibrium in as short a time as possible. Furthermore, it is usually desirable that all transients die out in the interval between the end of one switching pulse and the beginning of the next.

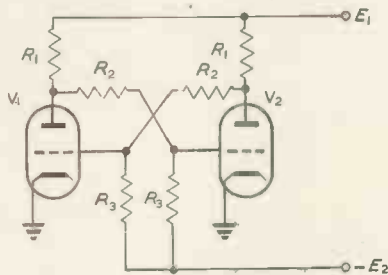

Fig. 1. The flip-flop circuit

The purpose of this article is to describe a systematic method for designing the flip-flop of Fig. 1 for use in an automatic computer. This circuit was chosen from the number of well-known flip-flop circuits because of its simplicity and symmetry.

The design problem will be solved in three stages. First, non-varying components will be assumed and an "ideal" flip-flop developed. Second, the circuit will be redesigned so that it remains stable when resistors, valve characteristics and h.t. voltages vary within certain limits. Both of these problems assume that E_1 and E_2 are fixed, and that values must be given to R_1 , R_2 , and R_3 . Finally, a method will be developed for choosing E_1 and E_2 so that the principal time-constant of the circuit is minimized, and the resulting "optimum" flip-flop is still stable regardless of parameter variations within the given tolerances.

The Ideal Flip-Flop

The conditions for stability of the circuit of Fig. 1 can be taken to be:

$$V_{g2}' = \frac{E_1 R_3 - E_2 (R_1 + R_2)}{R_1 + R_2 + R_3} \geq 0 \quad \dots \dots (1)$$

$$V_{g1} = \frac{(E_1 - i_a R_1) R_3 - E_2 (R_1 + R_2)}{R_1 + R_2 + R_3} \leq E_c \quad \dots (2)$$

Here V_{g2}' is the voltage that the grid of V_2 would reach if that valve did not draw grid current and E_c is the cut-off voltage of V_1 when its anode is at voltage E_1 . If the valves are identical and corresponding resistances are equal, as shown, the equations ensuring stability of the other state are the same as equations (1) and (2).

Two other relationships completely define the flip-flop. The first connects the anode voltage of the conducting valve with the other circuit parameters.

$$V_{g1} = \frac{V_a R_3 - E_2 R_2}{R_2 + R_3} \leq -E_c \quad \dots \dots (3)$$

The final requirement is some information about the valve characteristic, although for the purposes of flip-flop design, it is not necessary to know the entire characteristic. If the circuit is operating correctly, each valve is either cut off or conducting heavily. If it is conducting, and equation (1) holds, grid current must flow. The grid voltage will be a function of the grid-current/grid-voltage characteristic of the valve, and at the limit of equation (1) will be slightly negative. The effect of grid current is shown in Fig. 2. The anode-current/anode-voltage characteristics for this grid voltage only need be considered, and in general this may be taken as the zero-grid bias characteristic. Even this curve will be eliminated from the present analysis, and a single point on it taken to contain the given data. Exactly how and why this point is chosen will be discussed later.

In the ideal case, resistances and voltages remain fixed and equations (1), (2), and (3) may be written as equalities rather than inequalities. In other words, the circuit is designed so that grid voltages lie at exactly zero and $-E_c$. The three equations may then be solved for $i_a R_1$, R_1/R_2 , and R_1/R_3 , the results being:

$$i_a R_1 = E_c (1 + E_1/E_2) \quad \dots \dots (4)$$

$$R_1/R_2 = E_1 (E_2 - E_c)/E_2 (V_a + E_c) - 1 \quad \dots \dots (5)$$

$$R_2/R_3 = (V_a + E_c)/(E_2 - E_c) \quad \dots \dots (6)$$

* The University Mathematical Laboratory, Cambridge.

R_1 , R_2 , and R_3 may now be calculated from equations (4), (5), and (6). However, in order to use these equations, V_a and i_a must first be determined from the valve characteristics. Generally speaking, a fast-switching flip-flop requires that R_1 be as small as possible, and for that reason i_a and therefore V_a must be chosen to be as large as possible. There is, however, a limit on the magnitude of V_a . Since the ratio of two resistances must be positive, we can set equation (5) greater than zero and solve for V_a :

$$V_a < E_1 - E_c(1 + E_1/E_2) \dots \dots \dots (7)$$

The entire design procedure may now be stated. First V_a and i_a are chosen from the zero-grid-bias characteristic, with V_a as large as possible subject to equation (7) and to the maximum permissible cathode current or anode dissipation of the valve. E_c is chosen as the cut-off voltage corresponding to anode voltage E_1 , and finally R_1 , R_2 , and R_3 are calculated from equation (4), (5), and (6).

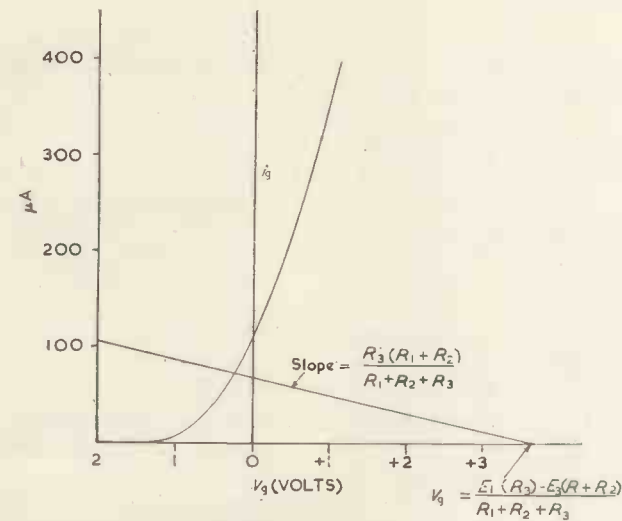

Fig. 2. The effect of grid current

If such a circuit were practical, the time taken for it to change state would be very short. This time has been calculated by Tillman¹.

A Practical Flip-Flop

A practical flip-flop is built with resistors and valves whose characteristics are determined only within certain tolerances, and it must operate with voltage supplies which change by an amount depending on the degree of stabilization provided. In this section a flip-flop will be designed which will be stable when built with resistors varying by $\pm p$ per cent of their nominal values, which will operate with voltages E_1 and E_2 each of which may change independently by $\pm q$ per cent; and which uses a valve whose characteristics may vary over a wide range.

Typical variations in characteristics for a group of supposedly identical double triodes (CV455 = ECC81) and pentodes (CV138 = EF91) are shown in Fig. 3. If a flip-flop is to be stable using any of these valves, it must be stable using the "worst" one, which is the valve with the smallest anode current for a given anode voltage. Consequently, in the following analysis V_a is the anode voltage corresponding to an anode current in the worst valve. Exactly how V_a and i_a are chosen depends to some extent on p , q , E_1 , and E_2 as will be explained below.

Supposing for the moment that V_a and I_a have been chosen, it is necessary to derive equations corresponding to (1), (2), and (3) that make the circuit stable even when all resistors and voltages have the worst possible values. The grid voltage of the conducting valve, given by equation (1), is lowest when E_1 and R_3 are low, and E_2 , R_1 , and R_2 are high. Under these circumstances we want the grid

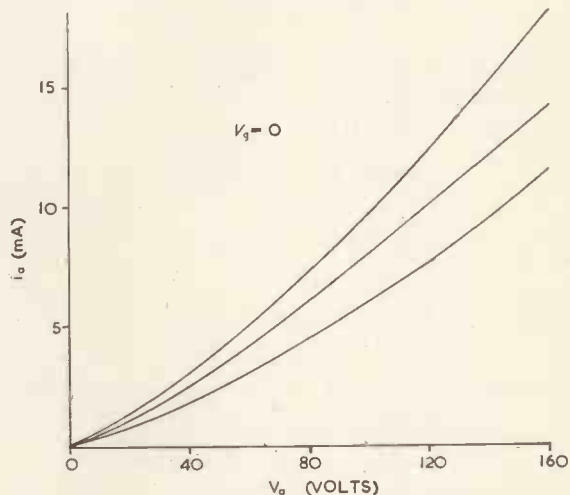

Fig. 3(a). Variation of anode characteristic of CV445 (ECC81)

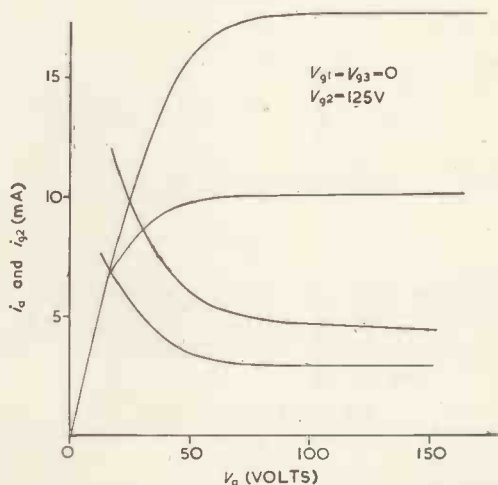

Fig. 3(b). Variation of anode characteristic of CV138 (EF91)

voltage to be greater than zero, or in the limit exactly equal to zero. That is,

$$\frac{E_1 R_3 (1 - p)(1 - q) - E_2 (R_1 + R_2)(1 + p)(1 + q)}{(R_1 + R_2)(1 + p) + R_3(1 - p)} \geq 0 \dots (8)$$

On the other hand, the grid voltage of the cut off valve is highest when E_1 and R_3 are high, and E_2 , R_1 , and R_2 low. Under these conditions the grid voltage must be less than or equal to $-E_c$:

$$\frac{R_3(1 + p)[E_1(1 + q) - i_a R_1(1 - p)] - E_2(R_1 + R_2)(1 - p)(1 - q)}{(R_1 + R_2)(1 - p) + R_3(1 + p)} \leq -E_c \dots (9)$$

$$\frac{V_a R_3(1+p) - E_2 R_2(1-p)(1-q)}{R_2(1-p) + R_3(1+p)} \leq -E_c \dots (10)$$

These three inequalities may be solved as follows: from equation (8) we can write:

$$(R_1 + R_2)/R_3 = R_2/R_3(1 + R_1/R_2) = \frac{E_1(1-p)(1-q)}{E_2(1+p)(1+q)} (1 - \delta_1) \dots (11)$$

where $\delta_1 \geq 0$.

Solving equation (9) for $i_a R_1$, and substituting $(R_1 + R_2)/R_3$ from equation (11) we get:

$$i_a R_1 \geq E_c(1 + k_1 E_1/E_2)/(1-p) + k_2 E_1 + \frac{k_1 E_1 \delta_1 (1-q - E_c/E_2)}{1-p} \dots (12)$$

$$\text{where } k_1 = \frac{(1-p)^2(1-q)}{(1+p)^2(1+q)}$$

$$\text{and } k_2 = \frac{4(p+q)(1+pq)}{(1+p)^2(1-p)(1+q)}$$

From equations (10) and (11) we find

$$\frac{k_1 k_3 E_1/E_2}{1 + R_1/R_2} \geq R_2/R_3 \geq \frac{k_3(V_a + E_c)}{E_2(1-q) - E_c} \dots (13)$$

where $k_3 = (1+p)/(1-p)$,

and from the first and last parts of this inequality we find

$$1 + R_1/R_2 = \frac{E_1 k_1 (E_2(1-q) - E_c)}{E_2(V_a + E_c)} (1 - \delta_2) \dots (14)$$

where $\delta_2 \geq 0$.

Substituting from (14) into (11)

$$R_2/R_3 = \frac{k_3(V_a + E_c)(1 - \delta_1)}{(E_2(1-q) - E_c)(1 - \delta_2)} \dots (15)$$

and comparing this with (13) we see that

$$1 - \delta_1 \geq 1 - \delta_2 \dots (16)$$

As in the case of the ideal flip-flop, we must choose V_a , i_a and E_c before using equations (11), (12) and (14). If we set R_1/R_2 equal to zero in (14), noting that $\delta_2 \geq 0$, it is possible to solve for V_a :

$$V_a < \frac{k_1 E_1 (E_2(1-q) - E_c)}{E_2} - E_c \dots (17)$$

The design procedure is therefore as follows.

(a) Choose V_a and i_a to be as large as possible, subject to equation (17) and the maximum cathode current or anode dissipation of the valve. E_c is the cut-off voltage corresponding to anode voltage E_1 .

(b) Find a minimum value for R_1 , using equation (12) but neglecting the last term, since δ_1 is not known.

(c) From equation (14), find the minimum value for R_2 with the R_1 calculated in step (b).

(d) Taking R_2 larger than this minimum, try various standard values for R_2 and R_3 , making δ_1 in equation (11) positive and as small as possible.

(e) A tentative choice of R_1 , R_2 , and R_3 may be confirmed by making sure that:

$$(1) 1 - \delta_1 \geq 1 - \delta_2$$

(2) The addition of the term $\delta_1 K_1 E_1/(1-p)[1-q - E_c/E_2]$ to $i_a R_1$ does not make necessary a larger value for R_1 than that chosen in step (b).

EXAMPLES

We shall design two flip-flops using the triodes of Fig. 3(a), and two more with the pentodes of Fig. 3(b). In each case we shall assume that $E_1 = 150V$ and $E_2 = 300V$.

(a) $p = q = 0.05$. Substituting E_1 , E_2 , q , p , and $E_c = 10V$ into equation (18) we find, for the triode, $V_a < 92V$. Choosing $V_a = 80V$ and $i_a = 4.5mA$, we calculate $i_a R_1 \geq 60V$ from equation (12). With $i_a = 4.5mA$, the nearest 5 per cent resistor satisfying this relationship is $R_1 = 16k\Omega$. Next, from equation (15) we find $R_1/R_2 \leq 0.1315$, and therefore $R_2 \geq 121k\Omega$; we must then choose R_2 and R_3 from the available resistor values so that equation (11) is satisfied. By a process of trial and error we find $R_2 = 160k\Omega$ and $R_3 = 430k\Omega$, and from these calculate that

$$1 - \delta_2 = 0.9725 \quad 1 - \delta_1 = 1.00$$

therefore equation (16) is satisfied, and since $\delta_1 = 0$ no extra term need be added to $i_a R_1$.

For the pentode we choose an operating point at the knee of the "worst" expected valve: $V_a = 50V$, $i_a = 9.5mA$. Using equation (12) we find $i_a R_1 \geq 61.8V$, and with $i_a = 9.5mA$ the nearest 5 per cent standard resistor satisfying this relationship is $R_1 = 6.8k\Omega$. Next, from equation (14) we find $R_1/R_2 < 0.885$ so that $R_2 > 8k\Omega$. By trial and error, we arrive at $R_2 = 30k\Omega$, and $R_3 = 91k\Omega$, whence $(1 - \delta_1) = 0.988$ and $(1 - \delta_2) = 0.65$. Therefore $1 - \delta_1 > 1 - \delta_2$, and since $\delta_1 = 0.012$ the last term in equation (12) adds only about 1.5V to $i_a R_1$, and this does not necessitate an R_1 greater than 6.8k Ω .

(b) $p = q = 0.10$. Applying equation (17) again, we find, for the triode, $V_a < 61V$. Choosing $V_a = 50V$ and $i_a = 2.5mA$, we get $R_1 = 47k\Omega$, $R_2 = 620k\Omega$, and $R_3 = 2M\Omega$. For the pentode, with $V_a = 50V$ and $i_a = 9.5mA$ as before, we get $R_1 = 12k\Omega$, $R_2 = 56k\Omega$, and $R_3 = 220k\Omega$.

These results are summarized in Table I.

TABLE I

| | p | q | V_a (V) | i_a (mA) | R_1 (k Ω) | R_2 (k Ω) | R_3 (k Ω) |
|------------|-----|-----|--------------|---------------|------------------------|------------------------|------------------------|
| Triode .. | .05 | .05 | 80 | 4.5 | 16 | 160 | 430 |
| | .10 | .10 | 50 | 2.5 | 47 | 620 | 2 000 |
| Pentode .. | .05 | .05 | 50 | 9.5 | 6.8 | 30 | 91 |
| | .10 | .10 | 50 | 9.5 | 12 | 56 | 220 |

$$E_1 = 150V.$$

$$E_2 = 300V.$$

Switching Time

It has been mentioned that the ideal flip-flop, whose grids swing only between 0 and $-E_c$ volts, has a very small switching time, since both valves conduct during the entire transient. A practical flip-flop, on the other hand, may have a grid swing many times E_c . For example, in the 5 per cent triode flip-flop designed in the example of the last section, if R_1 , R_2 , and E_c have values at the high end of their allowed range, and R_3 and E_1 values at the low end, and if the valve used has a very low anode resistance, the grid voltage may swing from zero to $-72V$. The switching time of such a circuit, then, is largely taken up by the swing of one or both grids below the cut-off level, the excursion of voltages through the grid base occupying only a very small proportion of the total time.

Fig. 4 shows a simple form of compensation intended to improve the switching properties of the flip-flop. In that figure, C_1 and C_3 are the stray capacities measured at anode and grid, respectively, and C_2 is an added "compensating" capacitor. The value of C_2 chosen depends on what transient characteristic the designer wants. A large compensating capacitance results in a circuit which very quickly changes from one stable state to the other, but introduces a long time-constant which greatly increases the time taken for the transient to die out and therefore decreases the repetition rate at which the flip-flop may be triggered.

Rubinoff² has shown that when $R_1C_1 < R_3C_3$ (which is invariably the case) and when $R_2C_2 = R_3C_3$ the flip-flop reaches equilibrium most quickly without the introduction of a long-time constant. The resulting switching time depends to some extent on the method used to trigger the flip-flop. The usual method involves a negative voltage pulse at either the grid or anode of the circuit, and Rubinoff showed that under this condition the most

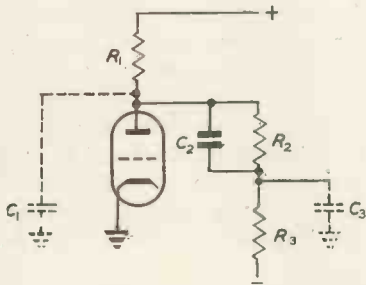

Fig. 4. Simple form of compensation

important transient which occurs during switching has a time-constant

$$T = \frac{R_1C_3 [1 + C_1/C_3(1 + R_2/R_3)]}{1 + R_1/R_3 + R_2/R_3} \dots \dots \dots (18)$$

It should be noted that the non-linearity due to the diode action at the grid re-introduces a long time-constant into the voltage waveform at the grid. However, since the time taken for the grid of the non-conducting valve to rise to cut-off is in general the longest time involved in the transition of the flip-flop, the time-constant given in equation (18) is still valid as a measure of the switching time of the circuit.

The Optimum Flip-Flop

If E_1 and E_2 are fixed, we have seen that equations (11), (12), and (14) determine the resistors and therefore the time-constant of the circuit. In this section we make E_1 and E_2 variable, and derive an "optimum" flip-flop by minimizing T . Two cases will be considered. In the first case E_0 will remain constant corresponding to a flip-flop built with pentodes with fixed screen voltage. In the second E_0 will be a function of E_1 corresponding to a triode flip-flop. Equalities rather than inequalities will be assumed, so that $\delta_1 = \delta_2 = 0$.

(a) *The Pentode flip-flop.* Setting $R_2/R_3 = y$ and $1 + R_1/R_2 = x$, from equation (11) we have:

$$E_1/E_2 = xy/k_1k_3 \dots \dots \dots (19)$$

Solving equation (13) for E_2 and substituting into equation (19):

$$E_1 = \frac{xy}{k_1k_3(1-q)} \left\{ \frac{k_3(V_a + E_0)}{y} + E_0 \right\} \dots \dots \dots (20)$$

Now substituting from equation (19) and (20) into equation (12), and the resulting value for R_1 into equation (18):

$$T = \frac{E_0C_3}{i_a(1-p)} \left\{ \frac{1 + C_1/C_3(1+y)}{1+xy} \right\} \left\{ 1 + xy/k_3 \left[1 + \frac{k_2(1-p)}{k_1(1-q)} \right] + \frac{xk_2(1+V_a/E_0)(1-p)}{k_1(1-q)} \right\} \dots \dots (21)$$

It can be shown that this expression for T is a minimum when x is a minimum for all positive values of y . When unity is substituted for x in equation (21), the resulting expression for T has a minimum value when y is given by:

$$y_0 = \sqrt{\left[C_3/C_1 \left(\frac{2p}{1-p} + \frac{4V_a(p+q)(1+pq)}{E_0(1-p^2)(1+q)^2} \right) \right]} - 1 \dots \dots \dots (22)$$

Substituting this value for y , and unity for x into equation (21) gives:

$$T_{min} = \frac{E_0C_3(1+p)(1+q)^2}{i_a(1-p)^2(1-q)^2} \left\{ 1 + \sqrt{\left[C_1/C_3 \left(\frac{2p}{1-p} + \frac{4V_a(p+q)(1+pq)}{E_0(1-p^2)(1+q)^2} \right) \right]} \right\}^2 \dots \dots (23)$$

y_0 as given by equation (22) is negative when:

$$C_1/C_3 > \frac{2p}{1-p} + \frac{4V_a(p+q)(1+pq)}{E_0(1-p^2)(1+q)^2}$$

In this case y should be made as small as possible to

Fig. 5. Variation of time-constant with x and y

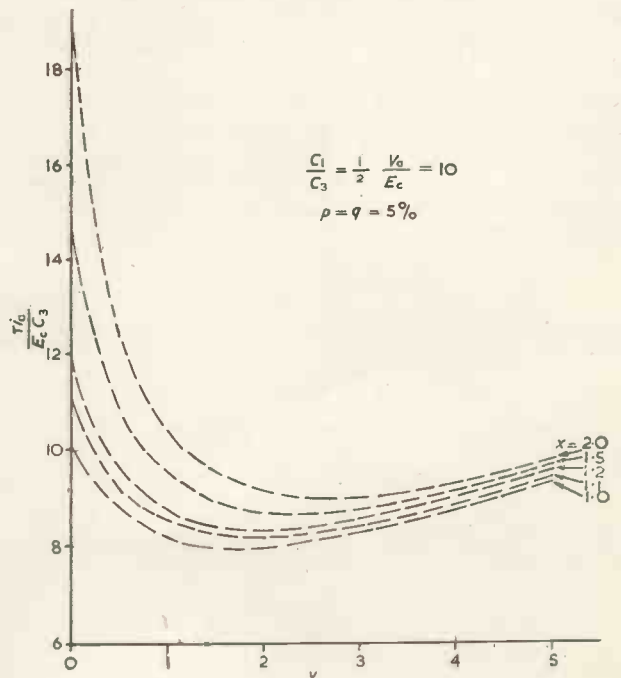

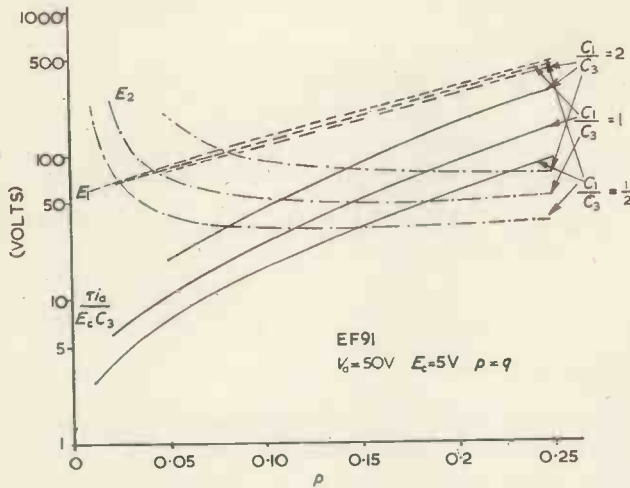

Fig. 6. Variation of minimum time constant and supply voltages with p

minimize the time-constant which is given by:

$$T_{\min} = \frac{E_c C_3 (1+p)(1+q)^2}{i_a (1-p^2)(1-q)^2} (1 + C_1/C_3) \times \left(1 + \frac{2p}{1-p} + \frac{4V_a(p+q)(1+pq)}{E_c(1-p^2)(1+q)^2} \right) \dots (24)$$

when unity and zero are substituted for x and y respectively in equation (21).

Examination of equation (23) and (24) shows that the time-constant increases with E_c and V_a/E_c and decreases with i_a . It follows, therefore, that the best operating point on the pentode characteristic is at the knee. Fig. 5 shows the variation of the time-constant with x and y of a flip-flop built with EF91's, taking $V_a/E_c = 10$ and $C_1/C_3 = \frac{1}{2}$, and using 5 per cent resistors and allowing 5 per cent variation in the voltage supplies. In Fig. 6 the minimum time-constant is plotted against p for the same type of valve for three different values of C_1/C_3 , and for equal tolerances on resistors and voltage supplies. The required voltage supplies, calculated from equations (19) and (20) are also shown.

(b) *The Triode Flip-Flop.* The cut-off voltage of a triode depends on the anode voltage, and therefore, for the circuit under discussion, on $E_1 R_2 / (R_1 + R_2)$, which is the maximum voltage on the anode. The relationship between anode voltage and cut-off voltage may be assumed to be linear and here we will take:

$$E_o = E_1 / \mu \frac{R_2}{R_1 + R_2}$$

Again writing the variables as x and y we have from equation (11):

$$E_1/E_2 = xy/k_1 k_3 \dots (25)$$

and from equation (20) substituting for E_o :

$$E_1 = \frac{x k_3 V_a}{\mu k_1 k_3 (1-q) - k_3 - y} \dots (26)$$

Substituting into equation (12), and the resulting value for R_1 into equation (18) we find the time-constant given by:

$$T = \frac{V_a C_3}{i_a (1-p)} \left\{ \frac{x \mu k_2 k_3 (1-p) + xy + k_3}{\mu k_1 k_3 (1-q) - y - k_3} \right\} \left\{ \frac{1 + C_1/C_3 (1+y)}{1+xy} \right\} \dots (27)$$

As in the case of the pentode flip-flop it can be shown that the time-constant is a minimum when x is equal to unity and y is given by:

$$y_o = \frac{\sqrt{[AB(1 + (B - A)C_1/C_3)] - A}}{1 + B C_1/C_3} - 1 \dots (28)$$

where $A = \frac{2p}{1-p} + \frac{4\mu(p+q)(1+pq)}{(1-p^2)(1+q)}$

$$\text{and } B = \frac{(1+p)(1+q)}{1-p}$$

From equation (27) it is obvious that the time-constant increases as V_a/i_a increases and, therefore, to make the time-constant minimum, the operating point should be chosen where this ratio is a minimum. Since most triodes have anode characteristics which are concave upwards, V_a and i_a are usually chosen to be as large as possible consistent with the maximum power and current ratings for the valve. As in the pentode case, when y_o is negative E_2 should be chosen to be as large as possible.

The procedure for designing an optimum flip-flop may now be stated. Firstly, the operating point is chosen according to the approach given above. Secondly y_o is calculated from equation (22) or equation (28), remembering that a negative value of y_o indicates that E_2 should be as large as possible. With this value of y_o and some estimate near unity for x , E_1 and E_2 are found from equations (26) and (25) in the triode case and equations (20) and (19) in the pentode case. With the supply voltages chosen, the flip-flop may be designed using the method detailed.

Conclusions

Though this article has treated the design of one particular circuit in considerable detail, certain of the results have general and important implications. In the first place, the circuit, though it incorporates no negative feedback, can be made as stable as desired. That is to say, it can be designed to remain stable for any voltage and resistor variations (with the proviso that equation (18) holds, and that $E_2(1-q) > E_c$), and for any group of valves having any specified minimum characteristic.

In the second place, an increase in stability is invariably accompanied by a decrease in switching speed. This can be looked on as a gain-bandwidth limitation, for stability corresponds to gain, and transient response to bandwidth. The effect of increasing tolerances is particularly noticeable in equation (24), which expresses the optimum pentode time-constant in terms of valve constants and tolerances.

Finally, it has been shown that the switching speed for a given degree of stability is a function of the supply voltages used, and can be minimized by suitably adjusting these voltages. This would seem to be true generally for all direct-coupled circuits and designers of direct-coupled circuits should keep in mind that the choice of proper supply voltage levels may have as much effect on transient response as the provision of higher switching currents.

REFERENCES

1. TILLMAN, J. R. Transition of an Eccles-Jordan Trigger Circuit. *Wireless Engr.* 28, 101 (1951).
2. RUBINOFF, M. Further Data on the Design of Eccles-Jordan Flip-Flops. *Elect. Engrg. (N.Y.)* 71, 905 (1952).
3. PAIVINEN, J. O., AUERBACH, I. R. Design of Triode Flip-Flops for Long-term Stability. *Trans. Inst. Radio Engrs.* EC-2, 14 (1953).

A Ringing Choke Power Supply

By J. Houldsworth*

A stabilized e.h.t. power supply giving an output voltage adjustable between 1 and 2kV for load currents up to about 1mA was needed in connexion with a cathode-ray tube data storage system. The unit was required to give a steady output when operated from a.c. mains, the voltage of which might vary by ± 10 per cent. Good stabilization was necessary against both slow and rapid changes in the load, and the output voltage was required to be free from 50c/s and other ripple. It is shown below that the above requirements can be met by using a pulse type power supply, in preference to rectifying a 50c/s voltage derived from the a.c. mains, and details are given of a unit of the "ringing choke" type which was developed. The complete unit operates satisfactorily in the application for which it was intended, and it is believed that it may find other applications as a general purpose stabilized e.h.t. power supply.

IT is important that the e.h.t. supply should be free from 50c/s or any other ripple which may interfere with the cathode-ray tube data storage system for which it is intended. The conventional method of obtaining a steady voltage by rectifying and smoothing the output from a mains transformer is not very satisfactory due to the difficulty in eliminating 50c/s ripple from the output. On the other hand, a high frequency pulse operated power unit presents very little difficulty in this direction and the pulse source can, if necessary, be synchronized with the operating frequency of the storage elements. Fig. 1 shows the circuit diagram of a power unit which has been developed to meet the requirements outlined.

The pentode V_1 is triode-connected and operates in a free running blocking oscillator circuit. The recurrence rate of the oscillator is about 3kc/s; it may be varied over a small range by means of VR_1 . The blocking oscillator may be locked to the scan frequency of the c.r.t. store by injecting 10V negative pulses at the synchronization

terminal. In this way radiated interference and ripple due to inadequate smoothing can be made to occur within the flyback time of the storage cathode-ray tube time-base.

V_1 conducts for only a few microseconds during the blocking oscillator cycle; during the short conducting period it forms a low impedance discharge path for C_3 . When the valve is cut-off C_3 recharges through R_3 . Due to the rapid charge and slow discharge of C_3 , the voltage at the grid of V_2 is of sawtooth waveform.

Each time C_3 is discharged, the potential of the grid of V_2 falls rapidly, causing a sudden interruption in the current carried by the primary winding of T_2 . The rapid change in the current in the primary winding of T_2 induces a voltage of high initial amplitude across the secondary winding of the transformer. This voltage is rectified by MR_1 and applied to C_5 , C_6 and R_6 forming a low-pass filter to give a steady voltage across the output terminals. On account of the slow rise in the grid potential of V_2 , caused by the relatively long recharge time of C_3 , the anode current of V_2 increases gradually; this is done to prevent a voltage of opposite sense being produced by the trans-

* Ericsson Telephones Limited.

Fig. 1. The ringing choke power supply unit

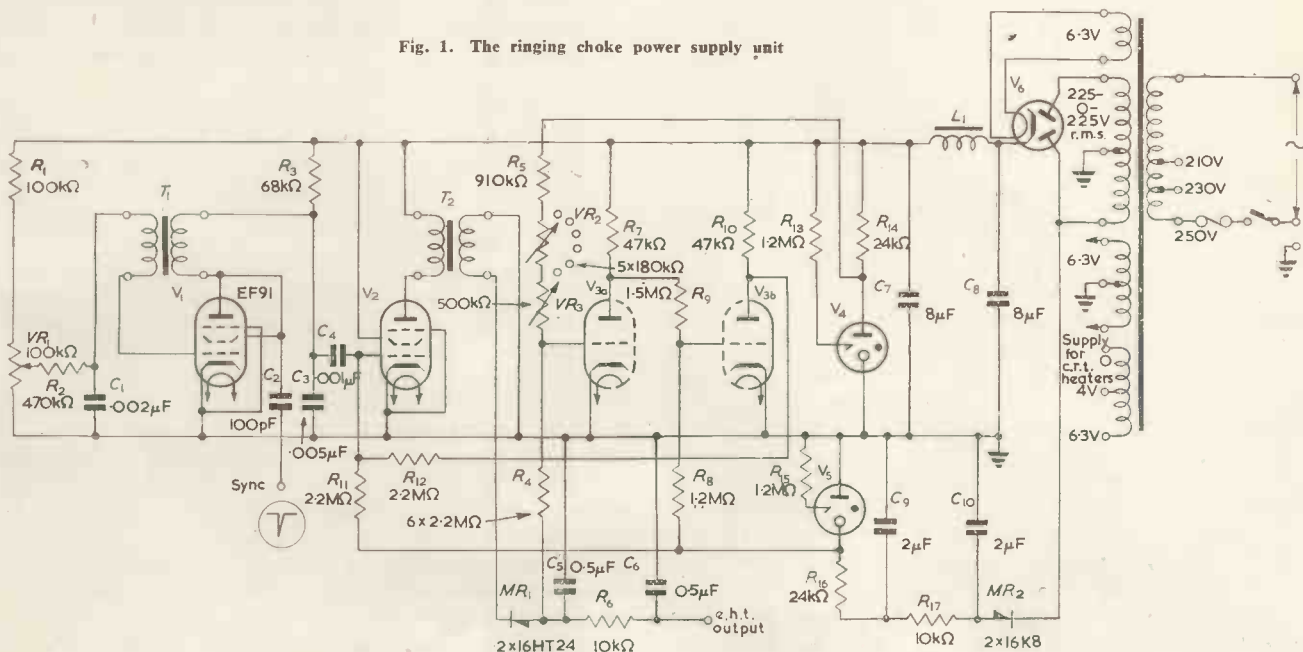

former. If such a reverse voltage were produced, it would only increase the peak inverse voltage across the rectifier to an extent which might cause breakdown, without producing any additional rectified output.

The output voltage varies with the voltage induced in the secondary winding of T_2 , and consequently it varies with changes in magnitude of the current step in the primary winding. The maximum anode current of V_2 , which deter-

mines the amplitude of the current step in the primary winding, may be controlled by variations in the mean potential of either the control grid or the screen.

mines the amplitude of the current step in the primary winding, may be controlled by variations in the mean potential of either the control grid or the screen.

To obtain the required output voltage range, the mean potential of the screen, grid 2, must be varied between wide limits; since grid 2 draws an appreciable mean current, these potential variations could only be obtained from an amplifier stage which has a low output impedance. For the same range of rectified output voltage, only small changes are needed in the mean potential of grid 1: since no grid current flows the potential variations can be obtained from an amplifier of high output impedance.

The relationship between e.h.t. voltage and the grid 1 potential of V_2 was investigated to find the upper and

lower limits of grid 1 potential necessary for the desired e.h.t. output range, which is 1kV to 2kV for load currents between $100\mu\text{A}$ and 1mA.

The potential at the grid of V_{3a} in the d.c. amplifier is a function of the setting of VR_2 and VR_3 , and of the voltage across the output terminals. The mean grid-1 potential of V_2 is set by the control amplifier, and component values are so chosen that the extreme settings of VR_2 and VR_3 correspond to the desired limits of e.h.t. voltage. Using one-half of a double triode for each amplifier stage, sufficient gain is available to give satisfactory operation over the designed output range.

To ensure that the unit is insensitive to mains voltage fluctuations, reference potentials of +150V and -150V with respect to earth are provided. These auxiliary supplies are obtained from the main +250V and -250V lines and

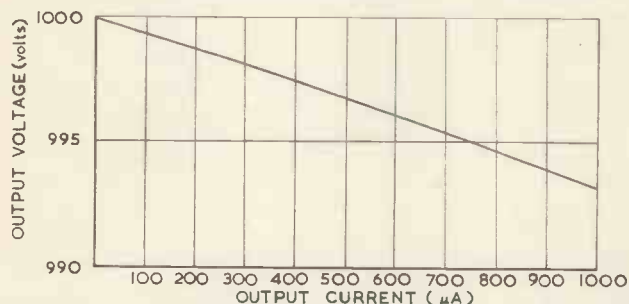

Fig. 2. Output voltage/output current
Unit set for 1 000V at no load.

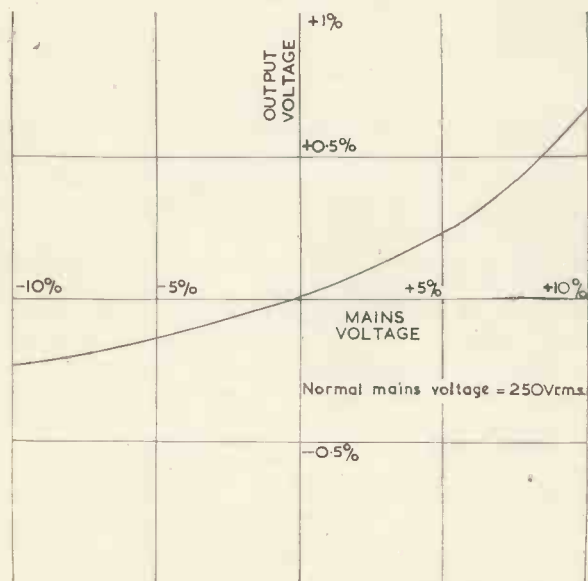

Fig. 3. Variation of output voltage with mains voltage
Mains voltage and output voltage variations expressed as a percentage of 250V r.m.s., and 1 000V respectively.

mines the amplitude of the current step in the primary winding, may be controlled by variations in the mean potential of either the control grid or the screen.

To obtain the required output voltage range, the mean potential of the screen, grid 2, must be varied between wide limits; since grid 2 draws an appreciable mean current, these potential variations could only be obtained from an amplifier stage which has a low output impedance. For the same range of rectified output voltage, only small changes are needed in the mean potential of grid 1: since no grid current flows the potential variations can be obtained from an amplifier of high output impedance.

The relationship between e.h.t. voltage and the grid 1 potential of V_2 was investigated to find the upper and

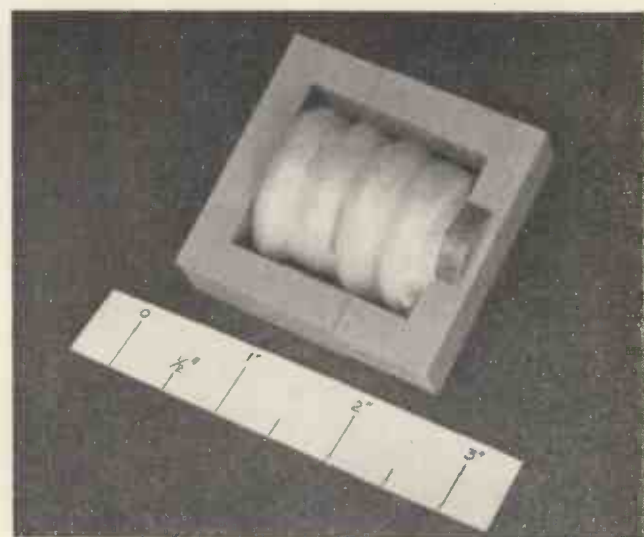

Fig. 4. Encapsulated pulse transformer with laminations

are stabilized by cold cathode tubes. The +150V supply acts as a reference voltage for the dividing network across the output, while the -150V supply provides bias for the control d.c. amplifier.

The +250V supply is obtained from a mains transformer and conventional full wave valve rectifier circuit. A half-wave metal rectifier connected to the same secondary winding of the mains transformer is used to obtain the -250V supply, which is smoothed by a resistance-capacitance filter circuit.

The complete unit has been tested to determine the variation of output voltage over the design range of load current and mains voltage. Curves plotted using the results obtained and reproduced in Figs. 2 and 3 demonstrate the performance of the power unit in the above circumstances. The maximum ripple voltage across the output terminals at any setting of the controls is 30mV, which is 0.03 per cent of the minimum output voltage. This is far less than the percentage ripple obtained across the output of a conventional mains e.h.t. power unit unless uneconomic sizes of smoothing components are incorporated. Apart from the size and cost of these components, the energy stored in the larger smoothing capacitors needed for 50c/s smoothing is undesirably greater.

An additional advantage of this type of supply unit is

in the ease of construction of the transformer producing the e.h.t. voltage; in a 50c/s supply the number of turns required is such that a large transformer core and bobbin must be used to provide space for the winding plus insulation. In this unit which operates with pulses at 3kc/s, the e.h.t. transformer requires 650 turns on its primary, in the anode circuit of V_2 , and 1950 turns on its secondary winding; these can easily be included in the window area of a type 410 lamination. In this case, the necessary insulation can be provided by constructing the secondary as three wave-wound "pies", supported on an insulating tube carrying the primary, which for convenience is a single wave-wound coil; details of the construction can be seen in Fig. 4. The secondary winding develops a maximum

APPENDIX

TRANSFORMER WINDING DETAILS:

MAINS TRANSFORMER

Wound on bobbin SSK 5839 using $1\frac{1}{4}$ in stack of type 440A laminations.

Primary

250V r.m.s. 50c/s

1 557 turns of 0.01in dia. s.s.c.e. copper wire, tapped at 1 308 and 1 432 turns.

Resistance = 85 Ω approx.

Voltage regulation on full load = 12V approx.

Secondaries

H.T. 225V - 0 - 225V
60mA full load current

0 - 1 539 - 3 078 turns of 0.0068in dia. s.s.c.e. copper wire.

Resistance = 407 Ω approx.

Voltage regulation on full load = 12V approx.

L.T.1 3.15V - 0 - 3.15V
1.4A full load current

0 - 22 - 44 turns of 0.028in dia. s.s.c.e. copper wire.

Resistance = 0.2 Ω approx.

Voltage regulation on full load = 0.3V approx.

L.T.2 0 - 6.3V
0.6A full load current

43 turns of 0.02in dia. s.s.c.e. copper wire.

Resistance = 0.2 Ω approx.

Voltage regulation on full load = 0.3V approx.

L.T.3 0 - 4V - 6.3V
1A full load current

0 - 27 - 43 turns of 0.024in dia. s.s.c.e. copper wire.

Resistance = 0.2 Ω approx.

Voltage regulation over the whole winding on full load = 0.3V approx.

SMOOTHING CHOKE

Approximately 5 000 turns of 0.0084in dia. s.s.c.e. copper wire wound on bobbin SSK 5837, using a $\frac{3}{4}$ in stack of type 401A laminations.

Inductance = 15H approx.

Resistance = 500 Ω approx.

Air-gap = 0.007in approx.

PULSE TRANSFORMER

Former: A bakelite insulating tube of external diameter $27/32$ in, internal diameter $\frac{3}{8}$ in and length $1\frac{7}{8}$ in. The former is partially milled away at one end to admit a $\frac{1}{2}$ in stack of type 410 radiometal laminations with an air-gap of approximately 0.007in.

Primary: 650 turns of 0.004in d.s.c. copper wire, wound as a "pie" of $\frac{1}{4}$ in width and $1\frac{3}{8}$ in overall diameter.

Secondary: 3 "pies", each of 650 turns, wound in series with dimensions approximately the same as the primary.

Spacing between primary and secondary windings, and between the "pies" of the secondary winding is approximately $\frac{1}{4}$ in.

The complete winding is totally encapsulated in bakelite varnish.



Fig. 5. Rear view of the complete unit

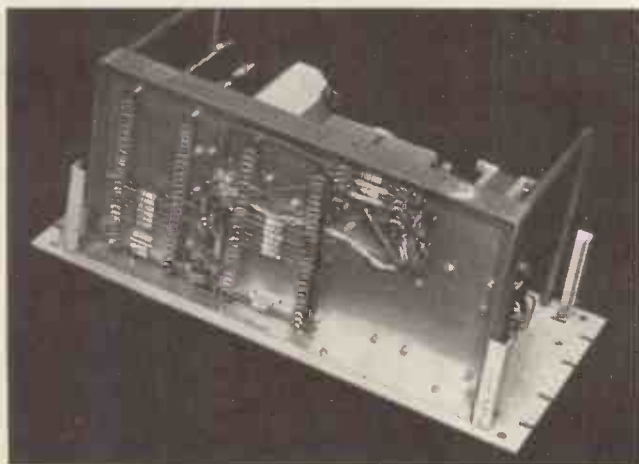

Fig. 6. Underside view of the complete unit

of just over 2kV peak; as the winding is divided into three, the maximum voltage between sections is only 700V peak, and the distance between the sections is sufficient to withstand this voltage. Further protection is provided for the completed winding by complete encapsulation to provide a smooth moisture-resisting surface. The construction of the complete power supply unit is shown in Figs. 5 and 6.

Acknowledgments

The author wishes to thank the Directors of Ericsson Telephones Ltd. for permission to publish this article.

Wirewound Resistors

Some Practical Considerations in design of the types used in the Electronic Industry

By R. H. Mapplebeck*

An outline of some of the physical constituents that affect the design and construction of low wattage wirewound resistors is followed by a discussion of factors that also have to be taken into consideration, including the elimination of undesirable effects, when such resistors are used in a.c. circuits up to about 20Mc/s.

MODERN electronic techniques demand close tolerances in many respects, and maintaining a high degree of accuracy and stability in the manufacture of wirewound resistors means paying close attention to details which, though they may be unimportant where wider tolerances would be satisfactory, become prime factors for consideration in more delicately balanced equipment.

It is proposed to deal with some of these and indicate some of the factors governing the design of this humble yet essential component which can so easily be produced in values ranging from near zero to about 10^6 ohms, and adjusted to cover a wide range of conditions.

Rating

The current carrying capacity of a wirewound resistor depends in large measure on how rapidly the heat can be dissipated. In cases where a resistor may be poorly ventilated, it is usual to allow for about one-quarter of the nominal rating though a well ventilated resistor may be run at a much higher temperature. Apart from ventilation, rating is controlled by proximity to other hot components, ambient temperature, and even fire regulations. Long resistors will run hotter than short ones, and tapings will reduce the effective heat radiation.

When designing a resistor for a particular job therefore, these points should be borne in mind and also that Ohm's law is adequate only when the resistor is to be used in d.c. and l.f. alternating current circuits.

In a.c. circuits, due allowance must be made for losses of energy due to the formation of electromagnetic and electrostatic fields that vary with time and introduce:

1. Eddy current losses in conductors and other masses of metal in or near the circuit.
2. Hysteresis losses in magnetic materials.
3. Dielectric losses in insulation mediums.
4. Absorption of energy by neighbouring conductors due to induction or even radiation.

Skin effect also increases the resistance due to non-uniform current density and so the Joulean relationship $P = I^2R$ is only effective where P is the power loss due to all causes.

Although resistors may be designed to carry heavy currents and dissipate considerable energy, their use in electronic instruments is usually limited to fairly low values of power dissipation and the maximum energy losses seldom exceed 10 watts.

As cooling will in many cases be by air convection, the heat loss will depend primarily on the surface area and it is usual to allow from 0.005 to 0.01 watt dissipation per degree centigrade per square centimetre above air temperature.

Temperature

Power rating and the effects of heat on resistance are bound up with the choice of wire material and its behaviour with change in temperature which, together with the current to be carried and the possible physical dimensions required will decide the gauge of wire to be used for a particular purpose.

For d.c. working, the resistance $R = \rho(l/a)$, where ρ is the resistivity of the wire material, l the length and a the cross-sectional area.

Now the resistance of a conductor being a function of its temperature, and having decided on the dimensions of the conductor and its resistance per unit length, the required value may be computed at the temperature for which it applies. Within ordinary limits $R_{t_2} = R_{t_1}[1 + \alpha(t_2 - t_1)]$ where α is the temperature coefficient of resistance of the wire material per °C and may be ascertained by reference to a set of suitable tables, while t_1 and t_2 are the initial and final working temperatures in °C respectively.

For accurate results, resistors are usually wound with constantan, manganin or eureka wire on account of their low temperature coefficients, their constancy of resistance and except in the case of constantan, their low thermoelectric effects with copper. Manganin, although excellent for all low temperature work is not so useful as eureka at higher temperatures. Nichrome on the other hand, although possessing a slightly higher temperature coefficient may be run at red heat (1 000°C) without noticeable oxidation.

In a.c. circuits, residual capacitance must be kept low if the material surrounding the wires is a poor dielectric, as the dielectric constant will alter quite appreciably with temperature changes. Dissipation of energy in a poor dielectric will therefore be reduced if the C_0 is kept low.

Stability

No wirewound resistor will keep its initial value of resistance with time unless subjected to ageing, which may be regarded as an annealing process designed to remove strain from the wire.

During winding, the inner surface of the wire suffers some compression due to bending of the conductor, while the outer surface becomes subjected to tension. If no ageing process is carried out, in course of time the displaced material tends to creep back to its original position which

* Marconi Instruments Ltd.

causes a change in resistance of the conductor by an amount which may be as much as 0.5 per cent. Manufacturers' ideas on the subject of ageing differ somewhat, but in general, baking for three hours duration at a temperature of 150°C is sufficient, though some engineers advocate 24 hours at about 120°C.

Occasionally it is found advisable to make cyclic heat runs under actual operating conditions where the annealing is carried out on the resistor after assembly in the equipment for which it is to be used. That is to say, the heat generated by the normal working current is that which anneals the wire material. In this case, periodic checks have to be made on the resistance value until no further change takes place indicating that the resistance has reached a stable condition. Such a heat run may easily occupy several days before stability is realized.

Formers and Protective Coatings

Most resistors are given a protective covering, the nature of which depends on the temperature at which they are designed to work. The composition of the formers will also be affected by temperature and must be chosen for this and other qualities which are enumerated later on in the text and apply particularly if they are to be used in a.c. circuits where absorption of moisture by a dielectric will give a change in C_0 .

Resistors may be wound on ceramic formers, strips of fibre, bakelite, mica, cores of textile or glass fibre. Obviously, ceramic and mica formers will be the most heat resistant, though heat is not the only criterion. Windings must be protected from mechanical injury, electrolytic effects and corrosion due to moisture and bacteria.

Common among such protective coverings are vitreous enamel, cement with organic or inorganic binding materials, moulded bakelite, waxes and paper. Here again, heat decides the covering to a great extent. Up to 250°C the first two mentioned are good for humidity protection without deterioration, but it is worthwhile noting that sodium silicates are useless for protection against moisture. Moulded bakelite may be used up to temperatures of 175°C depending upon the quality of the binding material;

another then at high frequencies the currents concentrate on the parts of them which are nearest and is known as proximity effect¹.

It has been shown by Butterworth² that the resistance of a cylindrical wire at frequency f is given by:

$$R_i = R_0[1 + F(z)]$$

where R_0 = resistance to d.c.

$$z = \sqrt{8\pi^2 a^2 \mu f / \rho}$$

a = radius of wire.

μ = permeability.

ρ = specific resistance.

Copper, eureka and manganin have $\mu = 1$ and for the purpose of skin effect and eddy currents, the resistance is calculated in electro-magnetic units, one ohm being 10^9 e.m.u. Now with ρ for copper = $1.7 \times 10^{-6} \times 10^9 = 1700$ and manganin 44 000. Table 1 gives values of $F(z)$ against z .

For $z < 2$, $F(z) = z^4/192$

$z > 3$, $F(z) = \frac{1}{4}(z\sqrt{2} - 3)$ to 2 per cent accuracy.

Table 2 gives values of z for various gauges of copper wire at 1Mc/s, the value of z for manganin being $1/\sqrt{44/1.7} = 1/5.1$ times the value for copper.

At frequency f the value is $\sqrt{f/1000}$ times the tabulated value.

The skin effect is not noticeable until z becomes equal to unity, i.e. $f = \rho/8\pi^2 a^2$. At this value of z the skin effect increases the resistance by something less than 1 per cent. Table 3 gives values of frequency at which skin effect is present for various gauges of copper and eureka, while Table 4 gives the largest permissible wire diameter in mils. for a skin effect ratio of 1.01 up to 3Mc/s for advance or manganin and nichrome.

TABLE 1
Values of $F(Z)$ against Z

| | | | | | | | | |
|--------|---|-------|-------|-------|-------|-------|-------|-------|
| Z | 0 | 0.5 | 1.0 | 1.5 | 2.0 | 2.5 | 3.0 | 3.5 |
| $F(Z)$ | 0 | .0003 | .0053 | .0258 | .0782 | .1756 | .3180 | .4930 |

TABLE 2

Values of Z for Various Gauges of Copper Wire at 1Mc/s

| | | | | | | | | | | | | |
|--------|------|------|------|------|------|-----|-----|-----|-----|-----|------|------|
| S.W.G. | 10 | 12 | 14 | 16 | 18 | 20 | 22 | 24 | 26 | 30 | 36 | 40 |
| Z | 35.0 | 28.5 | 22.0 | 17.5 | 13.1 | 9.7 | 7.7 | 6.0 | 4.9 | 3.4 | 2.07 | 1.31 |

TABLE 3

Frequency at which Skin Effect begins to be Appreciable

| | | | | | | | | | |
|---------------|------|------|-------|-------|-----|-----|-----|-----|-----|
| S.W.G. | 20 | 24 | 28 | 30 | 32 | 34 | 36 | 38 | 40 |
| COPPER (kc/s) | 10.3 | 27.6 | 61 | 86 | 114 | 157 | 230 | 370 | 580 |
| EUREKA (kc/s) | 267 | 715 | 1 580 | 2 220 | — | — | — | — | — |

resinous binders are superior to asphalt binders for moisture resistance, though they will not stand such high temperatures.

A.C. Circuits

Skin effect imposes considerable modification in design and it is essential for the designer to know the equivalent a.c. resistance of a given wire sample at specific frequencies. The current crowds in a thin layer on the outside of a conductor, but if two cylindrical wires are parallel to one

TABLE 4

Largest Permissible Wire Diameter in Mils for Skin Effect Ratio of 1.01

| | | |
|------------------|----------|------------------|
| FREQUENCY (kc/s) | NICHROME | ADVANCE MANGANIN |
| 100 | 104.5 | 70.2 |
| 200 | 74.5 | 49.6 |
| 500 | 46.8 | 31.4 |
| 1 000 | 33.1 | 22.2 |
| 2 000 | 23.4 | 15.7 |
| 3 000 | 19.1 | 12.8 |

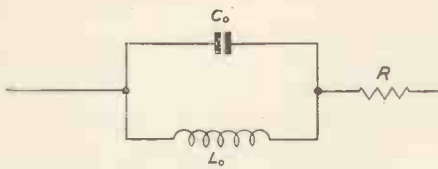

Fig. 1. Equivalent circuit of wirewound resistor

Measurements at radio frequencies are more difficult on account of residuals affecting measurement³.

An approximation of the C_0 and L_0 in a resistance coil of R ohms is represented as shown in Fig. 1. The impedance for the inductance and capacitance combination is:

$$z = \frac{R + j\omega[L(1 - \omega^2 CL) - CR^2]}{(1 + \omega^2 CL)^2 + \omega^2 C^2 R^2}$$

L and C are small so that approximately:

$$R' \approx R[1 + \omega^2 C(2L - CR^2)]$$

and:

$$L' \approx L - CR^2$$

The phase displacement between voltage and current flowing into the coil is:

$$\phi = \tan^{-1} \frac{\omega(L - CR^2)}{R} \\ \approx \tan^{-1} (\omega L'/R)$$

L' is the effective residual inductance.

If inductance preponderates over capacitance (i.e. $L > CR^2$) then L' is positive. If capacitance preponderates then CR^2 exceeds the inductance and L' is negative.

The time-constant T of the coil = $L/R - CR = L'/R$ which is positive or negative according as L is greater or less than CR^2 and is of the order of 10^{-7} sec or less in a well designed resistance coil.

The resistance will be pure if $L = CR^2$. More exactly, $C = \frac{L}{R^2}$ but generally $\omega^2 L^2$ is negligible compared with R^2 . Thus by suitable spacing it is possible to balance the inductance and capacitance to get a reasonably pure resistance.

Design and measurement are wide subjects, some branches of which are not amenable to exact calculation and are best approached by trial methods and the help of experience.

Design depends very much on the frequency and it is unfortunately a fact that the resistance, capacitance and inductance of a resistor may vary with frequency.

Apart from skin and proximity effects, the inductance of a piece or coil of wire will decrease for these effects, but the effective inductance as measured by an a.c. bridge will rise because of the C_0 , reach a maximum, diminish to zero and then the reactance becomes capacitive.

One of the oldest and simplest forms of winding a resistor is the bifilar method where the wire is folded back on itself at the middle point and the conductor so formed is wound on a cylindrical bobbin. The inductance of the

Fig. 2. Bifilar loop

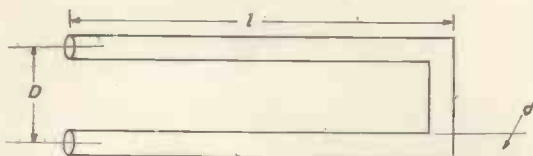

coil will be small and reduced further by twisting the leads together before winding. Since the go and return leads lie close together, there is a considerable capacitance with the full potential difference between the terminals which will preponderate over inductance at high values of resistance as it has a comparative long length of fine wire. This method of winding is thus used more for lower value resistors.

For d.c. work, the wire may be coiled or bunched indiscriminately, but as will be appreciated, in a.c. circuits, the method of construction is important.

The impedance of a bifilar loop (Fig. 2) is that of a short-circuited transmission line which may be shown to be the impedance shunted by one-third of the shunt admittance, in this case the total C_0 between the wires. In order to produce a pure resistance, L_0 and C_0 must be made very small or balanced against each other in the range of frequencies employed.

A popular method of winding is after Chaperon, made by winding with a single wire an even number of layers reversing the direction of winding of each layer. Sometimes the modified form of Wagner and Weitheimer is used where considerable control may be exercised over the time-constant of the coil by arranging the winding in a number

TABLE 5
Time-Constants Resulting from Figures Published by Several Leading Manufacturers

| RESISTANCE | TIME-CONSTANT | AVERAGE |
|------------|----------------------------------|---------------------------|
| 0.1 ohm. | 13 to 100×10^{-8} secs. | — |
| 1.0 „ | 5 to 40×10^{-8} „ | 12×10^{-8} secs. |
| 10 „ | 2 to 8×10^{-8} „ | 2×10^{-8} „ |
| 100 „ | 0.2 to 1×10^{-8} „ | 0.4×10^{-8} „ |
| 1 000 „ | $\pm 5 \times 10^{-8}$ „ | — |
| 10 000 „ | $\pm 18 \times 10^{-8}$ „ | — |

of Chaperon sections connected in series. Various modified forms of this are used when manufactured under works conditions of mass production and fairly wide variations of time-constant result. Some of these are included in Table 5, which is an examination of some figures published by several leading manufacturers. They offer the conclusion that the precise values in any particular case depend on whether shielding is provided or not and the physical arrangement of the resistors etc.

Reverting to Fig. 2, if the wires are length l diameter d , and D is the distance between centres then⁴:

$$L = 0.004l (\log 2D/d - D/l + \mu\delta) \mu\text{H}$$

and the total capacitance between the wires is:

$$1.11/2 \cosh^{-1} (D/d) \text{ pF.}$$

Also for a bifilar resistor the effective inductance can be shown to be approximately $L - \frac{1}{3}CR^2$ so that for some value of D , the expression $L - \frac{1}{3}CR^2$ can be made equal to zero, giving an approximately pure resistance.

A popular method is to wind one-half of the resistor in one direction and the other half at a suitable distance in the opposite direction.

The capacitance between layers may be varied by varying the distance between them which thus balances the inductance. A resistance coil cannot be wound so as to be entirely free of all self-inductance and self-capacitance, and

it thus becomes a question of careful design and construction to effect the best compromise.

In general, sub-dividing a given length of wire into n non-inductive sections will give a self-capacitance effect approximately $1/n^2$ as great as that obtained if the wire were arranged in one non-inductive winding.

Many methods described in text books for reducing

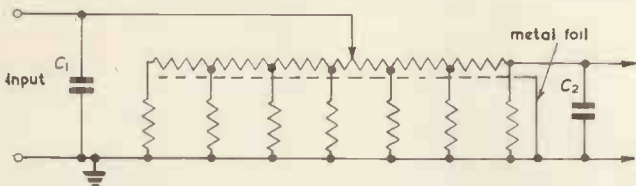

Fig. 3. Output attenuator of a signal generator showing circuit modifications to offset residual inductance

residuals are interesting and only practical for special applications such as the construction of standard components and instruments. What is of importance in industry is to produce as far as is possible a resistor that has as many desirable features as possible and yet can be manufactured under mass production conditions if necessary, at a low cost.

The useful frequency range of a wirewound resistor is obviously determined by the degree of residuals that can be tolerated and it is seldom that such resistors of whatever

construction are used much above 25Mc/s except perhaps in special cases and then they are usually low values of necessity, as corrections for residuals begin to become unwieldy, such that actual circuit modifications are called for to offset them as exemplified in the schematic diagram of the variable r.f. attenuator in Fig. 3. The elements of the latter, although perhaps non-inductively wound, may still be slightly inductive predominant say, requiring small capacitances C_1 and C_2 in the input and output circuits respectively, together with a distributed capacitance provided by a strip of metallic foil mounted adjacent to the variable slide arm element to lift any resonant rise of voltage beyond the frequency range contemplated.

Conclusion

Resistors employing many of the features in these notes are used in electronic equipment where accuracy is the keynote, and, without wishing to labour the point, may it be stressed that it is such careful attention to detail in the construction, testing and ageing processes that enables this component to maintain its stability with time and retain the initial high accuracy to which it was adjusted.

REFERENCES

1. RUSSEL, A. *Alternating Current Theory*, Ch. 7. (Cambridge University Press.)
2. BUTTERWORTH. *Phil. Trans. Royal Soc.* 1921A, Vol. 222, p. 70.
3. MOULLIN, E. B. *Radio Frequency Measurements*, Ch. 6. (Griffin.)
4. REYNER, J. H. *Electrical Engineers' Data Book*, Vol. 3, p. 3.

An Impact Microphone for Counting and Batching

The Sargrove impact microphone is designed to solve the problem of counting at high speed light weight small parts of diverse shapes from $\frac{1}{16}$ in up to 2 in dimensions which by their nature (such as perforated cylinders or wrapped sweets) cannot be conveniently catered for by photo optical perception. It is particularly suitable where objects of different sizes have to be dealt with by the same counting apparatus.

Where the objects to be counted and dispensed cannot be presented in a regular flow and the succession of objects may be very close together at times, the impact microphone is especially suitable due to its very high perception speed also the feature of design, whereby the microphone shell, on which the falling objects strike, is also the batching gate, thus eliminating time delay to a minimum in the exact discrimination between the end of one batch and the start of the next.

IMPACT MICROPHONE HEAD

This consists of a miniature pressure type moving-coil microphone assembly fully sealed against dust or moisture. The microphone is coupled acoustically to a pneumatic chamber calculated to resonate with the impact shell which forms the top end of the assembly in a disk some $2\frac{1}{2}$ in. in diameter.

The whole assembly is poised on a central axle shaft to which is coupled a quick return spring loaded twin solenoid assembly, arranged to rotate the microphone through 90° at very high acceleration so that it is held at 45° to the vertical and can discharge the falling objects in the horizontal plane to right or left hand. When the number set on the electronic unit has been counted, instantly the microphone is rotated into the alternative position carrying with it the next object to fall (if this should be following on the heels of the last object) counting this object at the same time as number one in the next batch.

PROCESS OF COUNTING

A falling object strikes the sloping disk of the microphone shell and bounces off into its appropriate batch chute, but in so doing it triggers off the natural resonance of the microphone

by compressing instantaneously the pneumatic chamber which in turn compresses the microphone diaphragm generating a series of sonic middle frequency electrical pulses.

The resonance is rapidly damped by the acoustic resistance in the course of a few cycles, but the electronic circuits associated with the microphone circuit accepts only the initial part of the steep slope of the first pulse, shaping this to adequate proportions to suit the electronic counter batcher unit, thus variations in striking force do not affect the pulse amplitude.

Allowing adequate time for the vibrations to die down, the electronic unit becomes un-muted and ready for the next

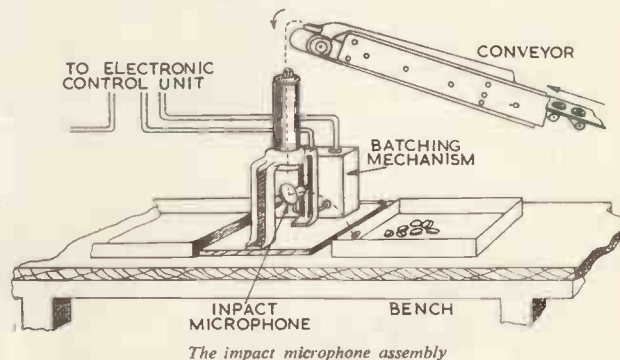

impact. A total time of approximately one hundredth of a second is occupied by this process, thus impacts can be handled comfortably at 30 per second, or 2000 per minute counting rate.

Each properly shaped and amplified pulse is fed into an electronic counter batcher capable of counting at 200 per second which adds these pulses until the total number pre-set on the controls has been reached, when it instantaneously resets to zero and operates the batching mechanism simultaneously, which swings the microphone over to be in its position to deflect the next object into the alternative batch channel.

The Matrix Approach to Filters and Transmission Lines

By M. E. Fisher*

(Part 2)

Canonical Form of the Filter Equations

For a finite line of similar quadripoles it has been shown that the currents and voltages at the input and the n^{th} terminals are related by the matrix equations:

$$\mathbf{x}_0 = \mathbf{A}^n \mathbf{x}_n \quad \mathbf{x}_n = \mathbf{A}^{-n} \mathbf{x}_0 \dots\dots\dots (58)$$

Now \mathbf{A}^n is a square matrix which can be found by multiplying \mathbf{A} by itself n times in succession. Although not difficult, this method is tedious and does not give a general result for all n . Such a general expression will be derived which avoids repeated matrix multiplication.

First of all notice that if \mathbf{x}_n happens to be an eigen-vector of the matrix \mathbf{A} , say \mathbf{w} , then the effect of the matrix multiplication is merely to multiply \mathbf{x}_n or \mathbf{w} by ξ where ξ is the appropriate eigen-value. In symbols:

$$\mathbf{x}_0 = \mathbf{A}^n \mathbf{x}_n = \mathbf{A}^n \mathbf{w} = \xi^n \mathbf{w} \dots\dots\dots (59)$$

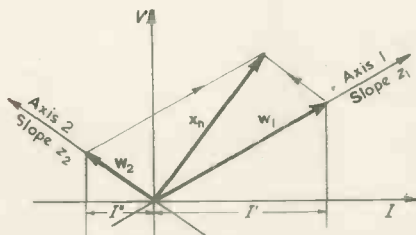

Fig. 11. Illustrating the decomposition of a general vector \mathbf{x}_n into the sum of two eigen-vectors

In general, though, \mathbf{x}_n will not be an eigen-vector of \mathbf{A} . For example if the line is terminated at the n^{th} pair of terminals with an impedance Z different from the iterative impedance, we have $V_n = Z I_n$ which does not fulfil the condition for the slope of the eigen-vector, viz., $V_n = \zeta_1 I_n$. In such a case we can use the device of vector resolution. \mathbf{x}_n can be interpreted as a vector not lying along the axes of the matrix (Fig. 11). Then it can be decomposed into the sum of two vectors, each being along one of the axes and hence being eigen-vectors.

Thus:

$$\mathbf{x}_n = \mathbf{w}_1 + \mathbf{w}_2 = \begin{bmatrix} z_1 I' \\ I' \end{bmatrix} + \begin{bmatrix} z_2 I'' \\ I'' \end{bmatrix} \dots\dots\dots (60)$$

z_1 and z_2 are the characteristic impedances measuring the slope of the eigen-values (equation (45)). We are now in a position to simplify equation (58) into a form not requiring matrix multiplication but only needing multiplication by the n^{th} powers of the eigen-values.

$$\mathbf{x}_0 = \mathbf{A}^n \mathbf{x}_n = \mathbf{A}^n (\mathbf{w}_1 + \mathbf{w}_2) = \mathbf{A}^n \mathbf{w}_1 + \mathbf{A}^n \mathbf{w}_2 = \xi_1^n \mathbf{w}_1 + \xi_2^n \mathbf{w}_2 \dots\dots\dots (61)$$

Thus by equation (56) and equation (60):

$$\mathbf{x}_0 = \xi_1^n \begin{bmatrix} \zeta_1 I' \\ I' \end{bmatrix} + \xi_2^n \begin{bmatrix} -\zeta_2 I'' \\ I'' \end{bmatrix} \dots\dots\dots (62)$$

This simplification is analogous to the method where in elementary mechanics, forces are split into their components which are added together and then recombined to give the resultant force rather than use the more difficult method of adding forces by the triangle law.

Equation (60) can be rewritten using the iterative or surge impedances ζ_1 and ζ_2 as:

$$\begin{aligned} V_n &= \zeta_1 I' - \zeta_2 I'' \dots\dots\dots (63) \\ I_n &= I' + I'' \end{aligned}$$

Solving these for I' and I'' , and substituting into equation (62) gives:

$$\mathbf{x}_0 = \begin{bmatrix} V_0 \\ I_0 \end{bmatrix} = \frac{1}{\zeta_1 + \zeta_2} \begin{bmatrix} \zeta_1 \xi_1^n + \zeta_2 \xi_2^n & \zeta_1 \zeta_2 (\xi_1^n - \xi_2^n) \\ \xi_1^n - \xi_2^n & \zeta_2 \xi_1^n + \zeta_1 \xi_2^n \end{bmatrix} \begin{bmatrix} V_n \\ I_n \end{bmatrix} \dots\dots\dots (64)$$

This equation gives \mathbf{x}_0 directly in terms of \mathbf{x}_n by multiplication by a single matrix whose coefficients are functions of n , ξ_1 , ξ_2 and ζ_1 , ζ_2 only.

If γ is the propagation constant $e^\gamma = \xi_1$ and $e^{-\gamma} = \xi_2$ and the matrix in equation (64) can be simplified. Furthermore the equation can be inverted to give V_n and I_n in terms of input voltages and currents. The matrix for this is:

$$\mathbf{A}^{-n} = \frac{1}{\zeta_1 + \zeta_2} \begin{bmatrix} \zeta_1 e^{n\gamma} + \zeta_2 e^{-n\gamma} & -2\zeta_1 \zeta_2 \sinh n\gamma \\ -2 \sinh n\gamma & \zeta_2 e^{n\gamma} + \zeta_1 e^{-n\gamma} \end{bmatrix} \dots\dots\dots (65)$$

This is known as the *canonical form* of the matrix for the line of n quadripoles.

If the quadripoles are reversible there is a further simplification since $\zeta_1 = \zeta_2 = \zeta$

$$\mathbf{A}^{-n} = \begin{bmatrix} \cosh n\gamma & -\zeta \sinh n\gamma \\ -\zeta^{-1} \sinh n\gamma & \cosh n\gamma \end{bmatrix} \dots\dots\dots (66)$$

This matrix is important since it generalizes to the case of a continuous line, which is, of course, reversible.

The analysis has thus carried us to a stage where we can directly calculate the voltages and currents at any pair of terminals if we know the input conditions for a line.

EXAMPLE

To illustrate this, consider a hypothetical filter fed by an a.c. generator delivering 10V peak with an internal impedance of $R = 50\Omega$. Suppose that the filter sections are reversible and that at the frequency in question the iterative impedance is 100Ω and the propagation constant is $\gamma = j\pi/2$, i.e. the frequency is in a pass-band of the filter. Suppose also that the filter is correctly terminated with the iterative impedance ζ . The current in the generator, I_0 , is given by Ohm's law as:

$$I_0 = \frac{V_0}{R + \zeta} = 10/150 = 1/15 \text{ amps} \dots\dots (67)$$

Now:

$$\mathbf{x}_n = \mathbf{A}^{-n} \mathbf{x}_0$$

and:

$$\cosh j\theta = \cos \theta, \quad \sinh j\theta = j \sin \theta \dots\dots (68)$$

* Department of Physics, King's College, London.

so that using equation (66) for A^{-1} :

$$V_n = V_0 \cos \frac{1}{2}n\pi - \zeta I_0 j \sin \frac{1}{2}n\pi = 10 \cos \frac{1}{2}n\pi - j 20/3 \sin \frac{1}{2}n\pi \quad (69)$$

$$I_n = -V_0 \zeta^{-1} j \sin \frac{1}{2}n\pi + I_0 \cos \frac{1}{2}n\pi = -j 1/10 \sin \frac{1}{2}n\pi + 1/15 \cos \frac{1}{2}n\pi$$

Thus for example at the third pair of terminals the peak voltage is $7\frac{1}{2}$ V and the peak current $1/10$ A the phase of both being 90° in advance of the generator, while at the fourth pair of terminals the peak values are 10V and $1/15$ A and both voltage and current are in phase with the generator.

Equations for a Continuous Line

The equations governing the voltage and current distribution on continuous lines are usually derived by the use of differential equation theory. We will avoid this method by generalizing the results of the preceding paragraphs to the continuous case. We regard the continuous line as a series of indefinitely small similar quadripoles connected in cascade.

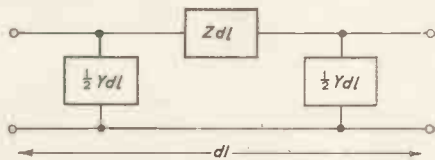

Fig. 12. Infinitesimal quadrupole of π -type

The voltage and current will now be a function of l the length along the line. However, we can write:

$$\mathbf{x}(l) = \begin{bmatrix} V(l) \\ I(l) \end{bmatrix} = \mathbf{A}^{-1}(l) \begin{bmatrix} V_0 \\ I_0 \end{bmatrix} = \mathbf{A}^{-1}(l) \mathbf{x}_0 \quad (70)$$

by analogy with equation (58).

The matrix $\mathbf{A}^{-1}(l)$ will be a matrix with elements depending on l . The object is to evaluate this matrix in terms of the series impedance Z per unit length of the line and the parallel admittance Y per unit length.

Suppose that the line is made up of a series of small π -type reversible quadripoles of length dl . (See Fig. 12; there is no loss in generality through including all the series impedance in one arm, since the matrix is the same however the impedance is split between the two arms.)

The matrix for this quadrupole is:

$$\begin{bmatrix} 1 + \frac{1}{2}YZ dl^2 & Zdl \\ (1 + \frac{1}{4}YZl^2)Ydl & 1 + \frac{1}{2}YZdl^2 \end{bmatrix} \quad (71)$$

Since the quadrupole is reversible, the two iterative impedances will be equal: thus by equation (57):

$$\zeta = \sqrt{(a_{12}/a_{21})} = \left[\frac{Z}{Y(1 + \frac{1}{4}YZdl^2)} \right]^{\frac{1}{2}} \quad (72)$$

In the limit as the length of the elementary quadripoles becomes vanishingly small, i.e. as $dl \rightarrow 0$, this gives the well-known expression for the surge impedance of a continuous line:

$$\zeta = \sqrt{(Z/Y)} \quad (73)$$

In a practical case with negligible resistance and leakage the surge impedance is $\rho = \{L/C\}^{\frac{1}{2}}$ where L and C are the inductance and capacitance per unit length. This illustrates the familiar fact that the surge impedance, ρ , of a lossless line is purely resistive and is frequency independent.

The trace of the matrix equation (71) is:

$$a_0 = 2 + YZdl^2 \quad (74)$$

we relate this to the propagation constant γ for the quadrupole by equation (36):

$$a_0 = \zeta + 1/\zeta = e^\gamma + e^{-\gamma} = 2 \cosh \gamma \quad (75)$$

Now the propagation constant for an overall quadrupole formed of n -similar quadripoles in cascade is just n times the propagation constant for the individual quadripoles. (This follows from the canonical form of the \mathbf{A}^n matrix equation (65)). So that if the propagation constant of a unit length of continuous line is Γ the propagation constant for one of the elementary quadripoles is:

$$\gamma = \Gamma dl \quad (76)$$

Using this result and equating the two expressions for a_0 (74), (75) we obtain, after expanding $\cosh \Gamma dl$ in a power series:

$$YZ = \Gamma^2 + 1/12 \Gamma^4 dl^2 + \dots$$

which in the limit as $dl \rightarrow 0$ gives:

$$\Gamma = \sqrt{YZ} \quad (77)$$

In the case discussed above of negligible resistance and leakage $\Gamma = \{-\omega^2 LC\}^{\frac{1}{2}}$ and is thus purely imaginary so that all frequencies are transmitted down a lossless continuous line without attenuation. The speed of the waves is obtained from equation (34). For this case it gives the well-known result:

$$c = 1/\sqrt{LC} \quad (78)$$

since $\beta = \Gamma/j = \omega\sqrt{LC}$; the wavelength being:

$$\lambda = 2\pi/\beta = 2\pi/\omega\sqrt{LC} \quad (79)$$

We are now in a position to generalize the reversible \mathbf{A}^{-1} matrix of equation (66), to the matrix $\mathbf{A}^{-1}(l)$ matrix for the continuous line. By equation (76) above $n\gamma = n\Gamma dl = \Gamma(ndl)$ where Γ is the propagation constant for the continuous line. n is the number of elementary quadripoles forming a given section of the line so that $ndl = l$, the length of the section. Thus for a continuous line we have the matrix:

$$\mathbf{A}^{-1}(l) = \begin{bmatrix} \cosh \Gamma l & -\zeta \sinh \Gamma l \\ -\zeta^{-1} \sinh \Gamma l & \cosh \Gamma l \end{bmatrix} \quad (80)$$

so that at a distance l from the beginning of the line:

$$\begin{bmatrix} V(l) \\ I(l) \end{bmatrix} = \mathbf{A}^{-1}(l) \begin{bmatrix} V_0 \\ I_0 \end{bmatrix} \quad (81)$$

In the case of negligible resistance and leakage $\Gamma = j\beta = 2\pi j/\lambda$ and the matrix becomes:

$$\mathbf{A}^{-1}(l) = \begin{bmatrix} \cos 2\pi l/\lambda & -\rho j \sin 2\pi l/\lambda \\ -\rho^{-1} j \sin 2\pi l/\lambda & \cos 2\pi l/\lambda \end{bmatrix} \quad (82)$$

Here the surge impedance $\zeta = \rho$ is independent of frequency by equation (73), while the wavelength is inversely proportional to frequency by equation (79). In other words the velocity is constant.

Equations (80) and (81) together with (73) and (77) are the basic equations for a continuous line. From them the complete theory of lines can be developed directly.

The Loaded Line

In a practical transmission line there will always be some attenuation present due to the finite resistance of the line

which cannot economically be reduced below certain limits. Furthermore, the presence of this resistance makes the velocity of propagation depend on frequency and so leads to distortion of the signal. This effect can be examined by taking the series impedance per unit length to be $Z = R + j\omega L$ and the parallel admittance to be $Y = j\omega C$. (In most practical cases the leakage can safely be disregarded.) The propagation constant is then given by equation (77).

$$\Gamma = \alpha + j\beta = \sqrt{YZ} = \sqrt{j\omega C(R + j\omega L)} = j\omega \sqrt{LC}(1 + R/j\omega L) \dots \dots \dots (83)$$

When R is small we can expand the factor under the root sign by the binomial theorem whence comparing real and imaginary parts

$$\alpha = \frac{1}{2}RV(C/L) \quad \beta = (\omega \sqrt{LC}) \cdot \left\{ 1 + \frac{R^2}{8\omega^2 L^2} \right\} \dots (84)$$

The velocity of propagation is given by:

$$c = \beta/\omega = (\sqrt{LC}) \cdot \left\{ 1 + \frac{R^2}{8\omega^2 L^2} \right\} \dots (85)$$

which shows how the velocity depends on the frequency. However if L the inductance per unit length is made large, α , the attenuation, is reduced and the velocity of propagation becomes less dependent on frequency. The inductance per unit length of a transmission line is difficult to increase by direct methods, so, as is familiar to all electrical

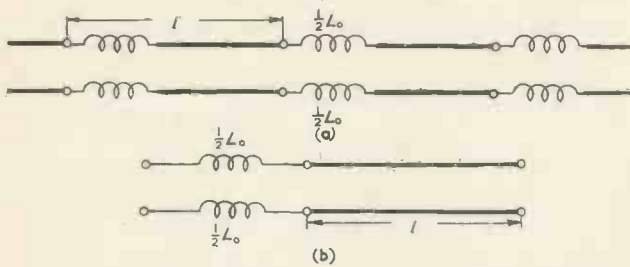

Fig. 13(a). Loaded transmission line as a chain of similar quadripoles. (b) Structure of a single quadrupole forming the transmission line

engineers, this problem is solved in practice by loading the transmission line with coils at regular intervals. Of course, this is not exactly equivalent to increasing the inductance per unit length, since it destroys the continuity of the line and introduces a periodic structure determined by the coil spacing. Because of this the line behaves as a filter cutting out certain frequencies.

To illustrate the power of matrix methods this problem will be discussed on the basis of the foregoing theory. Fig. 13(a) shows a loaded transmission line which can be regarded as a chain of similar quadripoles, each quadrupole consisting of a length of continuous line adjoined to a total series inductance L_0 .

Fig. 13(b) shows how each of these similar quadripoles can be regarded as two quadripoles in cascade. One of these is formed by the inductors and has a matrix:

$$\mathbf{B} = \begin{bmatrix} 1 & j\omega L_0 \\ 0 & 1 \end{bmatrix} \dots \dots \dots (86)$$

The other quadrupole is formed by a length l of the continuous transmission line, where l is the spacing distance of the loading coils. The direct matrix for this is given by equation (80):

$$\mathbf{C} = \begin{bmatrix} \cosh \gamma l & \zeta \sinh \gamma l \\ \zeta^{-1} \sinh \gamma l & \cosh \gamma l \end{bmatrix} \dots \dots \dots (87)$$

where γ is the propagation constant per unit length of the unloaded line.

The matrix for the complete quadripoles which go to form the transmission line is given by the matrix product:

$$\mathbf{A} = \mathbf{BC} = \begin{bmatrix} \cosh \gamma l + j\omega L_0 \zeta^{-1} \sinh \gamma l & \zeta \sinh \gamma l + j\omega L_0 \cosh \gamma l \\ \zeta^{-1} \sinh \gamma l & \cosh \gamma l \end{bmatrix}$$

This matrix completely determines the behaviour of the loaded transmission line. For example the trace of this matrix is:

$$a_0 = 2 \cosh \gamma l + j\omega L_0 \zeta^{-1} \sinh \gamma l = 2 \cosh \Gamma l \dots (88)$$

where Γ is the effective propagation constant per unit length for the loaded line. This equation determines Γ and hence the attenuation and velocity of propagation on the loaded line.

The pass-band structure of the loaded line can be obtained graphically from a_0 as for simple filters. For this purpose we ignore the resistance so that γ becomes purely imaginary. The trace then is:

$$a_0 = 2 \cos \omega l \sqrt{LC} - \omega L_0 \zeta^{-1} \sin \omega l \sqrt{LC} \dots (89)$$

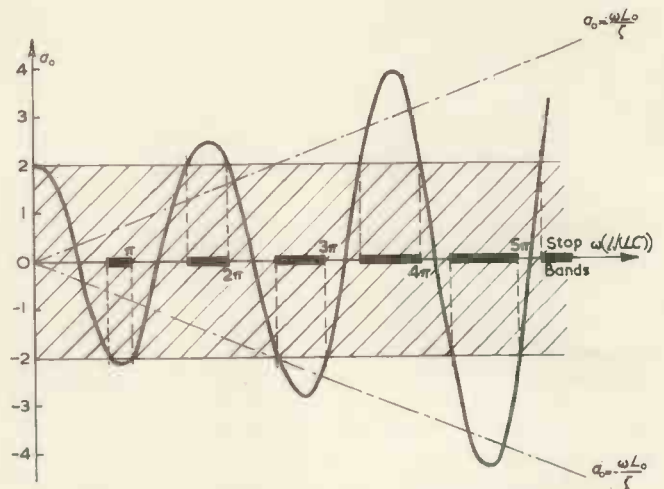

Fig. 14. Graph of a_0 against ω for a loaded transmission line

Fig. 14 shows a graph of a_0 against ω . As before the ranges of ω for which this curve leaves the region $-2 \leq a_0 \leq 2$ give the stop-bands. These stop-bands are marked along the ω axis. The first one occurs at the region given by:

$$\omega \sqrt{LC} = \pi \dots \dots \dots (90)$$

This corresponds to $l = \lambda/2$, that is to a spacing of the coils at distances of one-half wavelength. Thus in a practical case there must be a number of coils to the wavelength of the highest frequency which the line is required to transmit. At higher frequencies the stop-bands grow progressively broader, although they never coalesce to wipe out the pass-bands. The rate at which the stop-bands broaden is determined by the ratio of the load inductance L_0 to the surge impedance ζ of the continuous line.

Input Impedance to a Quadrupole

A commonly occurring type of network is illustrated in Fig. 15 which shows a quadrupole with matrix \mathbf{A} loaded with an impedance Z connected across its output terminals. The input impedance to the network, Z_0 , is given by the

ratio of the input voltage V_o , to input current I_o . The relations are:

$$V_o = Z_o I_o \quad V_1 = Z I_1 \dots \dots \dots (91)$$

and:

$$\begin{bmatrix} V_o \\ I_o \end{bmatrix} = \begin{bmatrix} a_{11} & a_{12} \\ a_{21} & a_{22} \end{bmatrix} \begin{bmatrix} V_1 \\ I_1 \end{bmatrix}$$

Writing out the two equations corresponding to the matrix equation and dividing one by the other gives:

$$Z_o = \frac{a_{11}Z + a_{12}}{a_{21}Z + a_{22}} \dots \dots \dots (92)$$



Fig. 15. Loaded quadripole and its input impedance

tional relationship between Z_o and Z remains unchanged. Following Pipes⁵ and other authors⁶ we may regard the quadripole as an *impedance transformer*, the particular nature of the transformation being determined by the matrix of the quadripole. The output impedance Z is transformed and appears at the input terminals as another impedance Z_o . Conversely if equation (92) is solved for Z in terms of the input impedance Z_o a similar type of equation is obtained showing that for a given quadripole only one value of terminal impedance Z will give a required input impedance Z_o .

Transformations of Z to Z_o by equations of the type of equation (92) are called *Bilinear* or *Homographic* transformations and are well known in mathematics.

They have a number of properties of importance to our theory.

- (i) The bilinear transformation is the most general transformation that transforms a unique value of Z into a unique value of Z_o and vice-versa.
- (ii) The bilinear transformation transforms the complete Z -plane into the complete Z_o -plane. By the term Z -plane is meant the plane determined by the axes of the resistive and the reactive components of Z , so that any given value of the impedance Z is represented by a point in this plane (Fig. 16). This property of transforming the complete Z -plane into the complete Z_o -plane shows that any value whatsoever of input impedance can be realized by some suitable output impedance and vice-versa.
- (iii) Finally, the bilinear transformation transforms circles in the Z -plane into circles in the Z_o -plane. In this case straight lines are regarded as degenerate circles with infinite radius. This property is illustrated in Fig. 16 for the particular transformation.

$$Z_o = \frac{Z + 2j}{jZ - 1} \text{ with matrix } \mathbf{A} = \begin{bmatrix} 1 & 2j \\ j & -1 \end{bmatrix}$$

and $|\mathbf{A}| = 1$

Here the circle $|Z| = 1$ is transformed into the line $X_o = -3/2$ while the radial lines in the Z -plane representing a constant ratio of X to R are transformed into circles in Z_o -plane (shown dotted) passing through the points $Z_o = -j$ and $Z_o = -2j$. These two points correspond to $Z = \infty$ and $Z = 0$, i.e. to open- and short-circuited conditions, respectively.

This property of the bilinear transformation with respect to circles accounts for the large number of circle diagrams and circular calculators that occur in the theory of impedance transformation and matching^{5,6}.

Variation of Input Impedance to a Line

If as in many practical cases the quadripole or *impedance transformer* consists of a series of n similar quadripoles in cascade, the coefficients of the overall matrix can be obtained from equation (65). Then the expression (equation (92)) for the input impedance to the chain becomes:

$$Z_o = \frac{Z(\zeta_1 e^{n\gamma} + \zeta_2 e^{-n\gamma}) + 2\zeta_1 \zeta_2 \sinh n\gamma}{2Z \sinh n\gamma + \zeta_2 e^{n\gamma} + \zeta_1 e^{-n\gamma}} \dots \dots \dots (93)$$

where ζ_1 and ζ_2 are the iterative impedances in the forward and reverse directions and $\gamma = \alpha + j\beta$ is the propagation constant for a single quadripole of the chain.

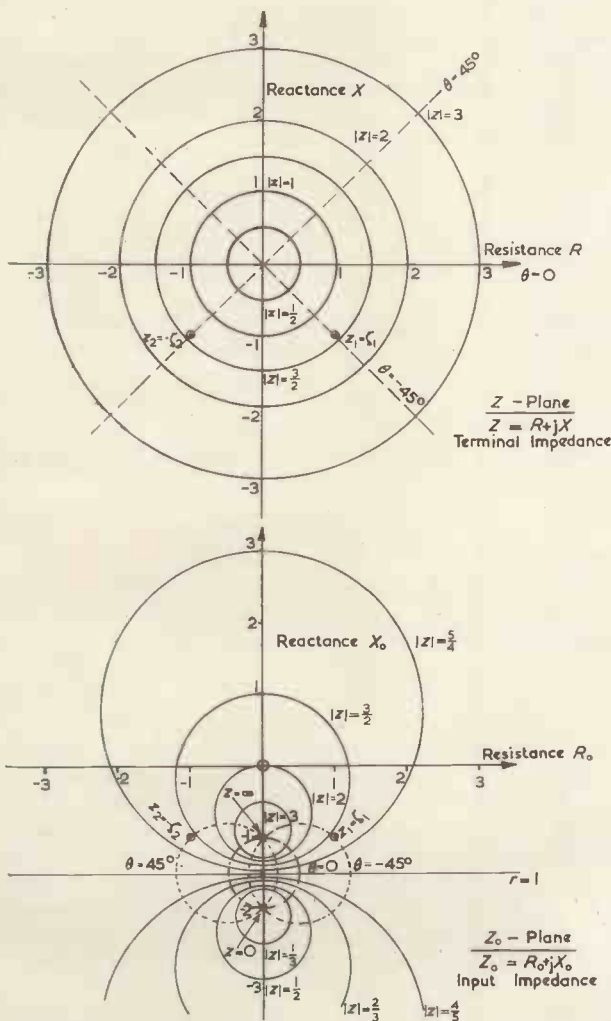

(\odot indicates the values of Z which transform into themselves i.e. ζ_1 and ζ_2)

Fig. 16. Z and Z_o plane for the transformation $Z_o = \frac{Z + 2j}{jZ - 1}$

The values of the complex coefficients a_{ij} , depend on the nature of the particular quadripole, which may be formed from a length of transmission line, a chain of quadripoles or other combinations. However, the form of the func-

Suppose the chain is terminated with the forward iterative impedance, i.e. $Z = \zeta_1$, then the input impedance is $Z_o = \zeta_1$, by equation (93). In other words the forward iterative impedance is transformed into itself. (See Fig. 16 where $z_1 = \zeta_1$ and $z_2 = -\zeta_2$ are shown in the Z and Z_o -planes). This demonstrates the well-known fact that the impedance of a finite chain, correctly terminated with the iterative impedance, is the same as of the corresponding infinite chain.

If the chain is not terminated with the iterative impedance ζ_1 , there are two cases to consider depending on whether the line is operating in a pass-band or a stop-band. If the line is attenuating the waves so that γ the propagation constant has a real part, we may neglect $e^{-n\gamma}$ provided comparison with $e^{n\gamma}$ provided the chain is long (n large). The expression for input impedance then reduces to:

$$Z_o = \frac{Z\zeta_1 e^{n\gamma} + \zeta_1 \zeta_2 e^{n\gamma}}{Z e^{n\gamma} + \zeta_2 e^{n\gamma}} = \zeta_1 \dots \dots \dots (94)$$

Thus the input impedance to a long line which is attenuating is equal to the iterative impedance and effectively independent of the terminal impedance.

In a pass-band where the attenuation is negligible γ becomes purely imaginary, and equal to $j\beta$. In this case the input impedance is:

$$Z_o = \frac{Z(\zeta_1 + \zeta_2) \cos n\beta + j\{Z(\zeta_1 - \zeta_2) + 2\zeta_1 \zeta_2\} \sin n\beta}{(\zeta_1 + \zeta_2) \cos n\beta + j\{(\zeta_2 - \zeta_1) + 2Z\} \sin n\beta} \quad (95)$$

and the input impedance is critically dependent on the length of the quadripole chain.

In particular if:

$$n\beta = m\pi, \text{ i.e. } n = m\lambda/2 \dots \dots \dots (96)$$

where m is an integer, then $Z_o = Z$.

Thus if the length of the line fulfils the condition of equation (96), i.e. if it is an integral number of half wavelengths long, then the input impedance is the same as the terminal impedance. The chain of quadripoles acts as a one-to-one transformer.

Equation (95) generalizes directly to the continuous case by putting $\zeta = \zeta_1 = \zeta_2$ and replacing $n\beta$ by $2\pi l/\lambda$, where l is the length of continuous transmission line between the input and output terminals.

Then:

$$z_o = \frac{z + j \tan 2\pi l/\lambda}{1 + jz \tan 2\pi l/\lambda} \dots \dots \dots (97)$$

where z_o and z are the so-called *normalized* input and terminal impedances given by:

$$z_o = Z_o/\zeta \text{ and } z = Z/\zeta \dots \dots \dots (98)$$

This is the general equation behind the usual theory of matching line impedances. It is discussed at length in standard works⁶. For example, we can consider the case of open-circuited output terminals, i.e., $Z = \infty$.

In this case:

$$Z_o = j\zeta \cot 2\pi l/\lambda \dots \dots \dots (99)$$

Since ζ is real corresponding to a resistive surge impedance the input impedance is generally reactive. Furthermore if the line is an odd number of quarter-wavelengths long we have the condition of resonance, i.e.:

$$l = (2m + 1)\lambda/4 \text{ so that } Z_o = 0 \dots \dots \dots (100)$$

Conversely if the line is an integral number of half-wave-

lengths long we have the condition of anti-resonance, that is infinite input impedance.

$$l = m\lambda/2 \text{ and } Z_o = \infty \dots \dots \dots (101)$$

Reflexion by the Terminal Impedance

It is a well-known result that a wave of voltage and current travelling down a transmission line or a chain of quadripoles is reflected at the terminal impedance unless this is equal to the forward surge or iterative impedance. The reflexion coefficient for a given termination can be defined as the complex ratio of incident voltage to reflected voltage across the terminal impedance. An alternative definition is in terms of the ratio of the forward-going incident current to reflected current taken in reverse sense. These reflexion coefficients can be evaluated on the basis of the vector interpretation if we remember that a forward-going or incident wave is represented by an eigen-vector w_1 with ratio $z_1 = \zeta_1$ between its components and a reflected or reverse-going wave by an eigen vector w_2 with ratio $z_2 = -\zeta_2$ (equations (45) and (46)). Then if the subscript n refers to total voltages and currents at the output terminals and the subscripts i and r to incident and reflected components we have, for terminal impedance Z :

$$\begin{aligned} V_n &= V_i + V_r \\ I_n &= I_i + I_r \end{aligned} \dots \dots \dots (102)$$

and:

$$V_n = ZI_n \quad V_i = \zeta_1 I_i \quad V_r = -\zeta_2 I_r \dots \dots (103)$$

Eliminating I_i , I_r and I_n and then V_n we obtain V_r/V_i which is t the voltage reflexion coefficient at the output:

$$t = \zeta_2/\zeta_1 \cdot \frac{Z - \zeta_1}{Z + \zeta_2} \dots \dots \dots (104)$$

Similarly the current reflexion coefficient at the output is:

$$\tau = \frac{Z - \zeta_1}{Z + \zeta_2} \dots \dots \dots (105)$$

If Z_s is the internal impedance of the voltage generator supplying the input terminals we can similarly define two input reflexion coefficients for voltage and current, viz:

$$s = \zeta_1/\zeta_2 \cdot \frac{Z_s - \zeta_2}{Z_s + \zeta_1} \quad \sigma = \frac{Z_s - \zeta_1}{Z_s + \zeta_1} \quad (106)$$

If in equations (104) and (105) the terminal impedance Z is equal to ζ_1 the forward iterative impedance, the reflexion coefficients for both current and voltage vanish, proving the fact already referred to that there is no reflexion from a matched termination of the line. The vector interpretation of this is as follows. A certain value of terminal impedance fixes the ratio of V_n to I_n and hence the direction of the vector representing voltage and current x_n . This vector can be resolved into a sum of two eigen-vectors w_1 and w_2 as is done in equation (102). These eigen-vectors represent pure waves travelling in the forward and reverse directions respectively. Now if x_n lies in the direction of the first axis of the matrix A of the quadripoles it can be represented as just a single eigen-vector w_1 for a forward travelling wave, since w_1 also lies in the axis (Fig. 11). In this case there is no reflected wave. The condition of same direction for x_n and the first axis of the A matrix is just that of equality of Z and ζ_1 which represents the slopes of the vector and the axis respectively.

In the case of a reversible chain of quadripoles or a con-

tinuous line the expressions for the reflexion coefficients simplify to the well-known form. In particular the distinction between voltage and current reflexion coefficients disappears.

$$s = \sigma = \frac{Z_s - \zeta}{Z_s + \zeta} \quad t = \tau = \frac{Z - \zeta}{Z + \zeta} \dots (107)$$

Standing Waves

The concepts of reflexion coefficient enable us to solve one important problem tackled by the usual theory of lines; that is, what is the voltage distribution on a line fed by a voltage generator of internal impedance Z_s and electromotive force E , terminated by an impedance Z ? The situation is shown in Fig. 17 where the internal impedance Z_s of the generator is regarded as forming an additional quadripole connected between the e.m.f. of the generator and the chain of n similar quadripoles. The problem is to find an expression for the voltage and current, V_l and I_l at the l^{th} pair of terminals in terms of the e.m.f., E of the generator, the coefficients of the A matrix specifying the quadripoles, or rather the propagation constant γ and

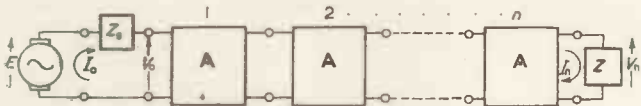

Fig. 17. Voltage generator feeding a terminated chain of quadripoles

the iterative impedances ζ_1 and ζ_2 for the quadripoles, and finally in terms of the impedances Z_s and Z .

We must start with the basic matrix equation for a chain of quadripoles:

$$\mathbf{x}_0 = \begin{bmatrix} V_0 \\ I_0 \end{bmatrix} = \mathbf{A}^l \begin{bmatrix} V_l \\ I_l \end{bmatrix} \dots (108)$$

When $l = n$ we have the relation $V_n = ZI_n$ so that:

$$\begin{bmatrix} V_0 \\ I_0 \end{bmatrix} = \mathbf{A}^n \begin{bmatrix} V_n \\ I_n \end{bmatrix} = \mathbf{A}^n \begin{bmatrix} 1 \\ 1/Z \end{bmatrix} V_n \dots (109)$$

Equation (108) can be inverted to give an expression for the \mathbf{x}_l matrix in terms of \mathbf{x}_0 and hence by equation (109) in terms of V_n .

$$\begin{bmatrix} V_l \\ I_l \end{bmatrix} = \mathbf{A}^l \begin{bmatrix} V_0 \\ I_0 \end{bmatrix} = \mathbf{A}^{n-l} \begin{bmatrix} 1 \\ 1/Z \end{bmatrix} V_n \dots (110)$$

Our problem can now be solved directly if we can find V_n in terms of E the generator e.m.f. To do this we consider the quadripole formed by the generator impedance Z_s . This gives:

$$\begin{bmatrix} E \\ I_0 \end{bmatrix} = \begin{bmatrix} 1 & Z_s \\ 0 & 1 \end{bmatrix} \begin{bmatrix} V_0 \\ I_0 \end{bmatrix} = \begin{bmatrix} 1 & Z_s \\ 0 & 1 \end{bmatrix} \mathbf{A}^n \begin{bmatrix} 1 \\ 1/Z \end{bmatrix} V_n (111)$$

When the matrix multiplication of the last part of this equation is carried out we obtain two equations. One gives E in terms of V_n and hence V_n in terms of E which is required, while the other gives I_0 in terms of V_n and is already contained in equation (109). The first of these equations is:

$$E = \{a_{11}^{(n)} + a_{22}^{(n)} Z_s/Z + a_{21}^{(n)} Z_s + a_{12}^{(n)}/Z\} V_n (112)$$

The coefficients $a_{ij}^{(n)}$ are the coefficients of the matrix \mathbf{A}^n . These coefficients are given by the previous work, equation (65), in terms of the propagation γ and the iterative impedances ζ_1 and ζ_2 . Generally we have:

$$\begin{aligned} a_{11}^{(n)} &= (\zeta_1 e^{m\gamma} + \zeta_2 e^{-m\gamma}) / (\zeta_1 + \zeta_2) \\ a_{12}^{(n)} &= 2\zeta_1 \zeta_2 \sinh m\gamma / (\zeta_1 + \zeta_2) \dots (113) \end{aligned}$$

$$\begin{aligned} a_{21}^{(n)} &= 2 \sinh m\gamma / (\zeta_1 + \zeta_2) \\ a_{22}^{(n)} &= (\zeta_2 e^{m\gamma} + \zeta_1 e^{-m\gamma}) / (\zeta_1 + \zeta_2) \end{aligned}$$

If these values are used in equation (120) and then inserted together with equation (120) in equation (118) we obtain the required expressions for V_l and I_l in terms of E . The algebra is straightforward but a little tedious. The solutions are:

$$V_l = \frac{\zeta_1 E}{\zeta_1 + Z_s} \cdot \frac{e^{-\gamma l} + t e^{\gamma(l-2n)}}{1 - st e^{-2\gamma n}} \dots (114)$$

$$I_l = \frac{E}{\zeta_1 + Z_s} \cdot \frac{e^{-\gamma l} + \tau e^{\gamma(l-2n)}}{1 - \sigma\tau e^{-2\gamma n}} \dots (115)$$

s and t are the voltage reflexion coefficients at the input and output and σ and τ the corresponding current reflexion coefficients already referred to. These are the solutions usually obtained by solving the differential equations of the line and imposing the boundary conditions.

By expansion of the denominators of equations (114) and (115) using the binomial theorem these solutions are interpreted as a standing wave on the line formed by repeated reflexions at the output and input terminals.

Conclusion

The matrix approach to problems involving quadripoles in the form of filters and transmission lines gives a direct and flexible method of handling the theory. The use of differential equations is avoided and the concepts of interest to electrical theory and practice find an immediate interpretation in the symbolism of matrices.

NOTE.

Recently the ideas explained in this article in connexion with quadripoles have been extended by Shekel⁹ to deal with multi-terminal transducers. Such an m.t.t. is a network with a set of n -input terminals and n -output terminals instead of the two input and two output terminals of a quadripole.

As in our analysis transfer matrices are derived for the m.t.t.'s and complicated m.t.t.'s are treated as a cascade of simpler ones. Shekel does not restrict himself to networks obeying the reciprocity relations, as we have done. Thus he is able to treat the theory of the distributed amplifier which involves m.t.t.'s with three input and three output terminals.

Acknowledgments

The author wishes to thank Dr. D. M. MacKay for encouragement and advice during the preparation of this article and also Professor H. C. Longuet-Higgins for facilities generously offered.

REFERENCES

- SIMMONDS, J. C. Matrix Algebra and the Solution of Electrical Network Problems. *Electronic Engng.* 16, 160 (1943); 16, 272 (1943).
- (a) BIGGAR, H. P. Application of Matrices to Four-terminal Network Problems. *Electronic Engng.* 23, 307 (1951).
(b) BIGGAR, H. P. Transfer Matrix of a Four-terminal Passive Network in Terms of its Image Parameters. *Electronic Engng.* 25, 152 (1953).
- (a) HINTON, W. R. Design of RC Oscillator Phase Shifting Networks. *Electronic Engng.* 22, 13 (1950).
(b) HINTON, W. R. Measurement of "A" Matrix Elements of a Passive Network. *Electronic Engng.* 25, 151 (1953).
- DEARDS, S. R. Matrix Theory Applied to Thermionic Valve Circuits. *Electronic Engng.* 24, 264 (1951).
- GUPTA, Q. C., DUERDEN, F. Geometrical Solution of Some Transmission Line Problems. *Electronic Engng.* 22, 525 (1950).
- JACKSON, WILLIS. High Frequency Transmission Lines. Ch. VI. (Methuen's Monograph Series).
- BRILLOUIN, L. Wave Propagation in Periodic Structure. Ch. IX and X. (McGraw Hill Book Company).
- PIRES, L. A. Matrix Theory of Four Terminal Networks. *Phil. Mag.* 30, 370 (1940).
- SHEKEL, J. Matrix Analysis of Multi-terminal Transducers. *Proc. Inst. Radio Engrs.* 42, 840 (1954).

The BBC V.H.F Sound Broadcasting Station at Wrotham, Kent

THE first of the BBC'S high-power, v.h.f. transmitting stations, at Wrotham, Kent, was brought into full service on May 2nd. It will transmit the Home Service, Light Programme and Third Programme in parallel with the existing long and medium wave stations and will serve a potential audience of some 13 millions in Greater London and the south-east of England.

In recent years the service given by the existing medium and long-wave broadcasting stations operated by the BBC has been restricted by the limited number of wavelengths available for broadcasting within the United Kingdom. Moreover, interference from foreign stations has drastically reduced the coverage—particularly of the Home Service—in many parts of the country.

This situation had long been foreseen by the BBC and as long ago as 1945 the Research Department began a series of tests in order to get first-hand information on the possibilities of broadcasting on very high frequencies. As a result, it was decided, as a long-term project, to carry out comparative tests at high power.

To this end, an experimental station was built in 1950 at Wrotham, Kent¹. It comprised a single storey brick building and a 470ft mast, the base of which is 730ft above sea level. The station was equipped with a 25kW f.m. transmitter and an 18kW a.m. transmitter both built by Marconi's Wireless Telegraph Co. Ltd, and from July 1950 until March of this year has been radiating on v.h.f. a series of f.m. and a.m. signals. Invaluable experience was gained from these full-scale experiments² as a result of which the BBC decided that it would be in the interest of the public to use f.m. for sound broadcasting in the v.h.f. band; this recommendation was subsequently endorsed by the Television Advisory Committee whose second report, published early in 1954, dealt solely with v.h.f. sound broadcasting.

On the basis of its information and the experience provided by the prolonged tests from Wrotham, the BBC'S Engineering Division put forward a scheme for providing a frequency-modulated v.h.f. service which will cover some 98 per cent of the population. This scheme is divided into two parts.

Stage 1, which will cover the main centres of population as quickly as possible and bring a v.h.f. service to about 83 per cent of the population. Stage 2, which will require about 16 further high, medium, and low-power stations, has not yet been approved.

The ten stations comprising Stage 1 with frequency allocations are given in Table 1.

It is expected that v.h.f. stations will be operating from Pontop Pike, Divis and Meldrum by the end of this year and that Wenvoe will be in partial operation. By the end

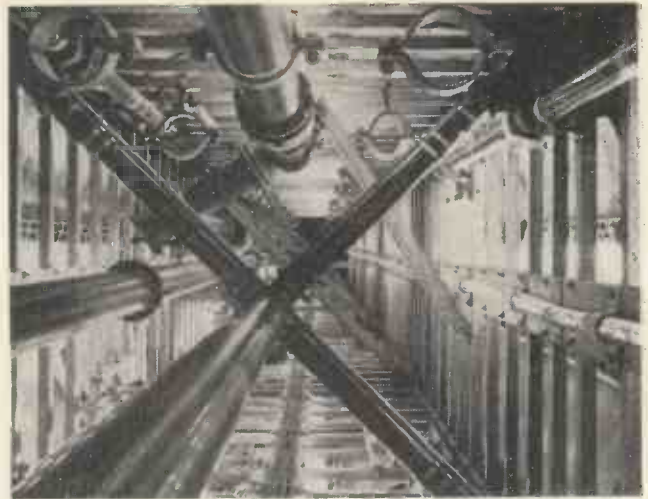

Inside the cylindrical section of the mast which with the slots in its surface forms the v.h.f. aerial system. The horizontal bars form a screen behind the slots and serve to increase the bandwidth of the aerial. All the slots are fed with currents in phase and of equal amplitude via concentric feeders.

of next year Wenvoe will be completed and further stations will be built at Sutton Coldfield, Holme Moss, Norwich, North Hessary Tor and Blaen Plwy (West Wales). This will mean that v.h.f. will be within reach of some eighty-four per cent of the population of the British Isles.

When these first ten v.h.f. stations are completed, Home Service reception will have been made available to an additional 5 300 000 listeners, Light Programme reception to an additional 2 900 000 and Third Programme reception to an additional 11 800 000 listeners. All these listeners are at present out of range of the BBC transmitters and the figures do not include some 3½-4 million Home Service listeners whose reception is at present spoiled by foreign interference.

At Wrotham, the original transmitters were designed so that they could be adapted to work as either f.m. or a.m. transmitters depending upon the outcome of the tests. In fact, the a.m. transmitter was converted to f.m. in January 1954. Since the cessation of the experimental transmissions in March 1955, work has been in progress at Wrotham to install additional transmitters and carry out modifications to those already on site, together with the associated aerial, drive, programme input and other auxiliary equipment.

TABLE 1

| Station | Frequencies (Mc/s) | | |
|-------------------|--------------------|-------|-------|
| | Light | Third | Home |
| Wrotham | 89.1 | 91.3 | 93.5 |
| Pontop Pike | 88.5 | 90.7 | 92.9 |
| Divis | 90.1 | 92.3 | 94.5 |
| Meldrum | 88.7 | 90.9 | 93.1 |
| North Hessary Tor | 88.1 | 90.3 | 92.5 |
| Sutton Coldfield | 88.3 | 90.5 | 92.7 |
| Norwich | 89.7 | 91.9 | 94.1 |
| Blaen Plwy | 88.7 | 90.9 | 93.1 |
| Holme Moss | 89.3 | 91.5 | 93.7 |
| Wenvoe | 89.9* | 92.1* | 94.3* |

* Frequencies not yet confirmed.

The existing transmitters known as FM1A and FM2A will normally carry the Light and Third Programmes respectively. These are backed up by two new 4.5kW transmitters FM1B and FM2B which will act as spares. Two further new transmitters FM3A and FM3B, each of 10kW output will operate together and carry the Home Service. The layout and design of the equipment for the Home Service transmitters has been so arranged that they will, ultimately, be automatic in operation. Certain ancillary equipment common to all three services will also be automatic.

The output and combining arrangements of these six transmitters are unusual and are of considerable interest. In the case of the first two pairs, the failure of the normal transmitter is covered by the reserve; manual switching of the outputs and application of power to the reserve being necessary. The outputs of whichever transmitters of these two pairs are operating are fed to a combining circuit, at the output of which the Light and Third programmes appear as a combined signal. This output is then split into two halves, each half being fed to one section of a further combining circuit.

The output of each 10kW Home Service transmitter is arranged to feed the other section of this combining circuit. Thus at the outputs of the second combining circuit the signal appears as two half-power combinations of Home, Light and Third signals, and under normal conditions these two half-power combined signals are taken over separate feeders to the two halves of the aerial system. By this means the effect of faults developing in the transmitters is reduced to a minimum and the failure of any one transmitter or of one-half of the aerial would be almost undetected except by listeners on the fringe of the service area. In addition, a very comprehensive emergency switching installation is provided to guard against the failure of the various combining circuits and the aerial system.

Duplicate f.m.q. drives are installed for each service and these are fed simultaneously with the programme. Automatic changeover arrangements ensure that either drive may be selected, with the other acting as spare. The f.m.q. system of frequency modulation was developed by Marconi's Wireless Telegraph Co. Ltd and comprises a quartz crystal oscillator connected through a quarter-wave network to a balanced modulator, the susceptance of which varies with the modulating signal, and in turn varies the frequency generated by the crystal oscillator. The crystal is specially cut so that it does not produce spurious harmonics within the operating range. The chief advantage claimed for this system of frequency modulation is that the circuits are much simpler than those of other systems, and

One half of the f.m. transmitter output stage, which consists of two BR128 valves in parallel in an earthed grid circuit.



therefore more reliable and easier to maintain.

The output of the crystal oscillator is passed through three stages of frequency doubling and one tripling stage to produce the required carrier frequency. In the case of the two original transmitters FM1A and FM2A there then follow five stages of amplification. The first two are conventional push-pull stages, while the remaining three are single-ended earthed-grid stages with coaxial-line tuning elements. The output stage consists of two BR128 valves in parallel, giving an output of 25kW. Supplies at 6kV and 3kV for the valve anodes are obtained from hot-cathode mercury-vapour rectifiers in the power conversion plant which is installed behind the transmitter.

The 4.5kW (FM1B and FM2B) transmitters are generally similar in electrical design to the earlier ones, the first two stages are push-pull and these feed two single-ended earthed-grid stages provided with coaxial-line tuning elements, one of which forms the output stage.

The new 10kW transmitters (FM3A and FM3B) also follow closely on the design of the earlier transmitters having two push-pull stages followed by three single-ended earthed-grid stages and these three stages are again provided with coaxial-line tuning elements. The final stage has two BR191B valves operating in parallel.

All six transmitters use air-cooled valves. The cooling system of the 25kW transmitters serves a dual purpose, in that air is drawn from outside, filtered, passed through the transmitter cabinets and then is either exhausted to atmosphere or re-circulated within the building for heating in cold weather. The re-circulation system is fully automatic and controlled by thermostats. In the case of the 10kW transmitters the air is drawn from within the building and exhausted to atmosphere while the 4.5kW standby transmitters are cooled by air circulation entirely within the transmitter building.

Since the transmissions are automatically monitored at Broadcasting House no master control position is installed at Wrotham. If, however, a programme fault occurs an alarm will be given on the alarm and indication panel in the control room. This panel is equipped with a series of lamps indicating the condition of the various transmitters, drives, supplies and other auxiliary equipment associated with each programme. Any faults involving plant or equipment at Wrotham will be automatically indicated so that the appropriate action can be taken to remedy the trouble.

Provision is included for the unattended operation of the Home Service transmitter in the early morning. For normal daytime operation three automatic monitors of BBC design, are installed at Broadcasting House, London, and these will compare the outgoing programmes with those received by radio from Wrotham; they are arranged to give an alarm at Wrotham in the event of programme faults being detected. For operation during the early morning, however, changeover panels are provided at Wrotham and Broadcasting House which, when switched to the appropriate position, transfer the Home programme monitor alarms at Broadcasting House. At the same time this permits the Home programme to be sent to Wrotham by either the normal line and programme input equipment or by the Third programme line and its associated programme input equipment (which are not normally required for the Third programme until the evening).

REFERENCES

1. The A.M. and F.M. Transmitters at Wrotham, Kent. *Electronic Engng.* 23, 94 (1951).
2. BEVAN, P. A. T. Some Aspects of V.H.F. Sound Broadcasting and F.M. Broadcasting Stations. *Electronic Engng.* 27, 96 and 147 (1955).

Reversible Dekatron Counters

By L. C. Branson*, B.Sc., A.Inst.P.

The basic problems involved in the bi-directional coupling of standard Dekatron tubes are briefly stated. A simple modification of the tubes permits the carry signals to be taken from transfer electrodes, and avoids the use of gating circuits. Several bi-directional coupling circuits are described.

DECADE counters employing multi-electrode gas-discharge tubes of the kind typified by the Dekatron GC10B are now well known¹. In these tubes, the discharge is transferred from any one cathode to an adjacent cathode by applying negative voltage pulses to two groups of transfer electrodes which are interspaced between the cathodes. A unit count is effected by a sequential pair of pulses, one to each group of transfer electrodes, and the direction of transfer is determined by their sequence. Thus a single Dekatron is readily reversible.

Problem With Standard Tubes

However, when additional stages are added to extend the reversible counting range to 10s, 100s, etc., difficulties arise in the derivation of the necessary carry signals. For a uni-directional additive counter, the arrival of a discharge at a zero cathode provides a carry signal from which to derive pulses to operate the following stage. Similarly, in a counter operating on the subtractive sense only, the arrival of a discharge at a number-9 cathode can initiate the carry to the next stage. For a reversible counter in which each unit count may be positive or negative, it is not, however, sufficient to insert resistors in the connexions to the zero and number-9 cathodes and use all the resulting signals. A carry in the positive sense is required only when the count in the first stage progresses from 9 to 0, and not when it regresses from 1 to 0; and similarly a negative carry is required only when the count regresses from 0 to 9, and not when it progresses from 8 to 9. Thus if carry signals be taken from the ninth and zero cathodes, they must be gated according to the direction of counting, and the circuit must be considerably more elaborate than for uni-directional counting.

Modified Tubes

In the counters to be described² these difficulties are avoided by taking the carry signals not from the cathodes, but from selected transfer electrodes. For this purpose, special Dekatron tubes were obtained having separate terminals for the two transfer electrodes between the ninth and zero cathodes. These transfer electrodes are herein called the carry electrodes. Fig. 1 shows the arrangement of electrodes and internal connexions, and Fig. 2 shows the symbol adopted to represent the tube, and the basic circuit connexions.

In a first counting stage, a unit count is effected by a pair of pulses, one being applied directly to the nine internally connected transfer electrodes 0_a-8_a and through an impedance Z_a to the tenth, 9_a . A similar circuit is provided to apply the second pulse to the second group of transfer electrodes, 0_b-9_b . Now when the count changes from 9 to 0 in the positive direction, or from 0 to 9 in the negative direction, the discharge passes tem-

porarily in turn to each of the carry electrodes, 9_a and 9_b , to produce differential voltages across the impedances Z_a and Z_b . These constitute the carry signals required for operating the following stage. A carry in this next stage is required, and carry signals are provided, whenever the discharge in the first stage passes to the carry electrodes. Negative voltage pulses are derived from these signals and applied respectively to the *a* and *b* groups of transfer electrodes of the following stage, so that the sense of the

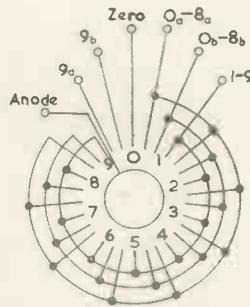

Fig. 1. Arrangement of electrodes and terminals

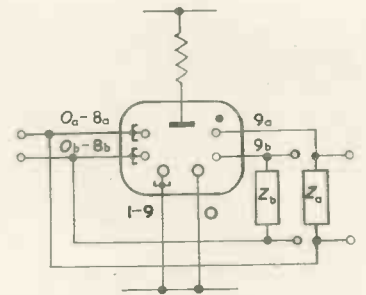

Fig. 2. Basic connexions

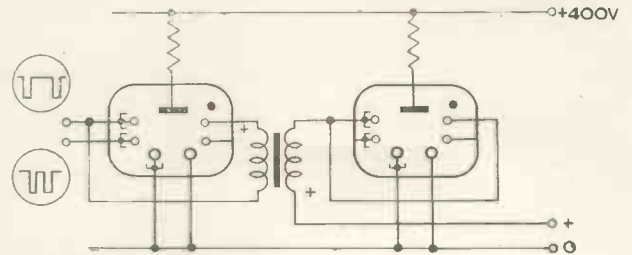

Fig. 3. Simple transformer coupling

carry is correctly determined by the sequence of the signals, *a,b*, or *b,a*.

Transformer Couplings

The form of circuit chosen to drive a following stage may be varied according to the type of pulses driving the first. In some applications, each unit count is initiated by a pair of pulses of predetermined waveform, duration, and relative delay, and one following stage may then be driven using simple transformer couplings as shown in Fig. 3. The pulses required for one forward and one backward count are indicated. In this, and the succeeding figures, the circuit associated with only one of the two groups of transfer electrodes is shown. Here, each impedance *Z* is made the primary of a transformer, and the secondary is connected, appropriately phased, between a positive bias

* Now with Ericsson Telephones Ltd.

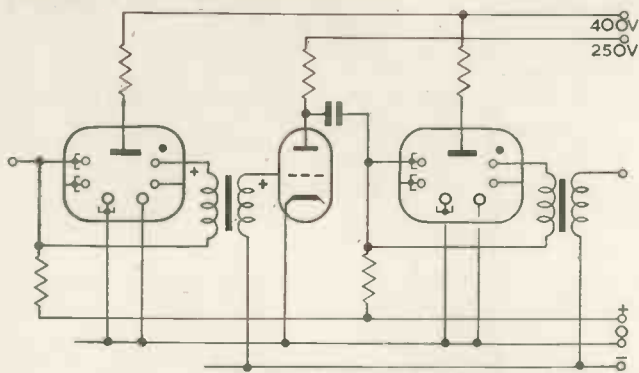

Fig. 4. Coupling by transformers and amplifiers

supply and the corresponding electrodes of the second stage. The shape of the transmitted pulses may be modified by tuning or loading the transformers, but they are inevitably degenerated in amplitude and waveform compared with the pulses to the first stage. Consequently this method has not been extended to further decades.

More stages may be coupled by following the transformers with triode amplifiers as shown in Fig. 4, or with cold-cathode trigger tubes. However, such circuits still impose some limitation on the type of input pulses, since they must fail if the duration and relative delay of the pulses are long in relation to the low frequency response of the transformers or to the duration of the pulses provided by trigger tubes. The first pulse to the second stage would then decay, and the discharge return to the adjacent cathode, before the start of the second pulse.

Resistive Couplings

The usable variety of pulses may be extended by making the impedances Z_a and Z_b resistors followed by differential amplifiers. Such an amplifier, RC coupled, is shown in Fig. 5. The two valves V_1 and V_2 are so biased by the resistors R_1 , R_2 , and R_3 that current normally flows through V_2 and not through V_1 . Input pulses which transfer the discharge to electrodes other than a carry electrode are applied equally to the two grids, without causing current through V_1 . But the arrival of the discharge at the carry electrode, 9_a , makes V_1 grid positive with respect to V_2 grid, so that V_1 passes current. A negative pulse is thus produced in the anode circuit for operation of the following stage.

A further step is to make the amplifiers direct-coupled

Fig. 5. Coupling by resistors and RC coupled amplifiers

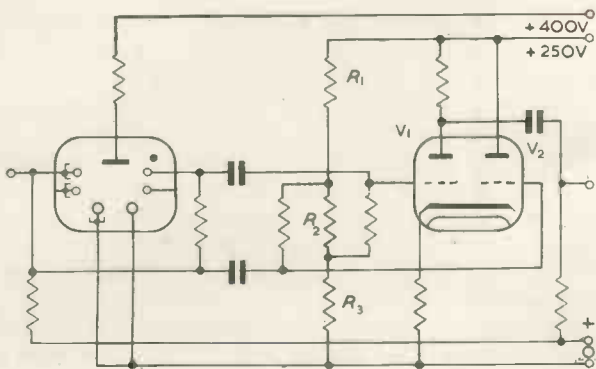

as shown in Fig. 6. Here each stage is driven by cathode-followers, V_1 and V_3 , which provide low impedance sources and enable the required positive bias to be applied to the transfer electrodes. The grid and cathode of the differential amplifier V_2 are directly connected across the resistor R_1 which is in series with the first carry electrode. The resistor R_2 is chosen so that V_2 is normally biased to cut-off; it has but little effect on the voltage at the carry electrode if a valve with a short grid base, such as a 6SL7, is selected for V_2 - V_3 . Arrival of the discharge at the carry electrode 9_a causes current through V_2 , and the large negative pulse at V_2 anode is fed through the potential divider R_3 , R_4 to the grid of the cathode-follower V_3 , which provides one of the drives to the next stage.

Such a counter may be driven in either sense by suitably phased sine or square-wave inputs over the full frequency range from zero to 3kc/s. The counting rate may be extended by increasing the amplitude of the transfer pulses by by-passing the resistor R_3 with a capacitor. However, if the pulses change the transfer electrode voltages from +40 to -40V relative to the cathodes, the transfer between the a and b electrodes is effected by a potential difference of 80V, whereas transfers to and from the cathodes are effected by only 40V. The performance is improved if pulses are also applied to the cathodes.

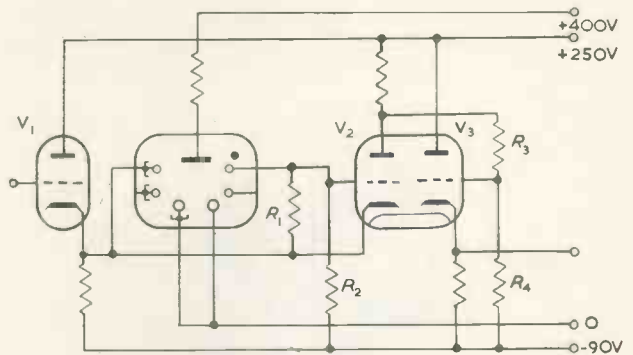

Fig. 6. Coupling by resistors and direct-coupled amplifiers

For this purpose, a common anode resistor is provided for the two valves, and the anode voltage applied through a potential divider to the grid of another cathode-follower which drives the Dekatron cathodes. The cathodes are thus driven negative when both transfer electrodes are positive, and positive when either transfer electrode is negative. In this way, and with rectangular input pulses of suitable mark-space ratio, counting speeds in excess of 10kc/s have been achieved.

By injecting alternate positive and negative counts, the total may be caused to oscillate between 99 999 and (1)00 000 at high speed without loss of control. A carry is transmitted from stage to stage with a delay of some $2.5\mu\text{sec}$ only. In contrast, in the usual system in which carry signals are taken from the cathodes, the carry is delayed in each coupling by the duration of two pulses, at least $40\mu\text{sec}$.

A counter according to Fig. 6 has been in use for the past year. It employs direct coupling throughout. The primary controlling voltages are of sine form, in phase quadrature. They are applied to the deflector plates of a c.r.o. to indicate fractions of a cycle, and also to trigger circuits which provide inputs of square form to the first Dekatron. With this system the discharges may

invest transfer electrodes when a reading is required, but a display of discharges at the electrodes 2,7_a,9_a,9_a, for example, is simply interpreted as a count of 2799. An alternative system uses flip-flops to cause the passage through zero in the c.r.o. display to coincide with the initiation of a pair of pulses to operate the decade counter. But then a display 1234:0 may indicate a true count of 1234-0₁ or 1234-9₃ according to whether the flip-flops have just operated or are just about to operate. This ambiguity is avoided with the direct-coupled system, which indicates

the true count with a display 1234-0 or 1234_b-0 which is interpreted as 1234-0₃ or 1235-0.

Acknowledgment

The author wishes to thank Messrs. Ericsson Telephones Ltd, Beeston, for supplying the special Dekatron tubes used.

REFERENCES

1. BACON, R. C., POLLARD, J. R. The Dekatron. *Electronic Engng.*, 22, 173 (1950).
2. British Patent 721 058.

The Economics of the Transistor d.c. Transformer

By G. Grimsdell*

The advent of the power junction transistor makes possible a new method of converting a low voltage d.c. supply to a h.t. supply. In this article this method is compared, from an economic aspect, with the more conventional methods.

A WIDE range of portable or vehicle-borne electronic instruments require high tension supplies at very low currents for their operation. Besides h.t. batteries, there are at present two well-known methods of generating high tension from a low tension d.c. source; these are the rotary machine and the vibrator, transformer, and rectifier.

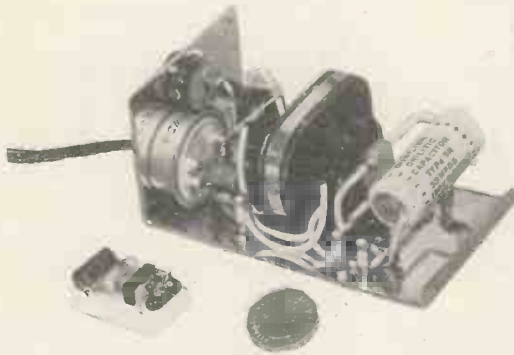

Two typical junction transistor d.c. converters

The small unit delivers 30V at 60 μ A from a 1.5V input, and the larger unit delivers 125V at 40mA from a 12V input, with an efficiency greater than 70 per cent.

The use of power junction transistors makes possible a third method of h.t. generation. It is the aim of this article to examine the economic aspects of the junction transistor h.t. generators or d.c. transformers as they have been called, and to compare them with those of existing methods.

Both the rotary machine and the vibrator have mechanical losses which are relatively independent of the electrical power being handled by a particular machine.

When the electrical output is comparable in power with this fixed mechanical loss, the total efficiency of the device will be low. Thus there is a lower limit of output power beyond which the efficiency falls very rapidly. An average small motor generator with 24V input gives an efficiency of 50 to 60 per cent at 50W and 20 to 30 per cent at 5W. This falls to an even lower efficiency at 2V input, while a typical vibrator power supply gives an efficiency of 70 per cent at

50W and 40 per cent at 5W. At 100mW output both these devices have fallen to a very low efficiency indeed. Turning now to the transistor d.c. transformer it is possible to maintain an efficiency of 60 to 75 per cent or better down to a power level of one or two milliwatts.

Before suggesting the type of application where this new device can satisfactorily compete with existing methods a brief description of its essentials will be necessary.

In general the basic steps of operation are the same as those in a vibrator power supply:—

- (1) To convert the d.c. input to a.c.
- (2) To transform the low voltage a.c. to a high voltage.
- (3) To rectify it and smooth the output.

The fundamental fact that makes the transistor such a good generator of a.c. from a low voltage d.c. is its ability to pass a large current with very low voltage drop across it.

A typical pentode valve may drop some 30V across itself to pass a current of 100mA in the "bottomed" condition.

A junction transistor will drop only 0.2V.

Thus even with a d.c. input of only 6V, the transistor acts as a very efficient switch.

There are two possible modes of design approach:—

- (1) To use the transistor as a switch and generate non-sinusoidal a.c. leading to inductive surges, ringing, and the like.
- (2) To use the transistor as a sinusoidal generator.

The first method is in general simpler and more efficient, but the latter may be preferable in special cases.

In the second the sinusoidal waveform is perhaps more easily transformed to a high voltage and rectified, but has a much lower efficiency in its initial generation. In general the design problems are those of ensuring that the transistor spends as much of its time as possible in the fully "cut-off" or full "on" condition where its losses are low while keeping to a minimum the partially conducting transition time where losses are high.

Returning to a comparison between the transistor d.c. transformer and other devices it can be seen that there are

* Mullard Ltd.

no fixed mechanical losses at all and the fixed electrical losses, caused by the transistor back leakage current, can be kept very low (microwatts). In addition, since no mechanical movement is involved the frequency of operation can be made high enough (1kc/s or above) to simplify the subsequent smoothing problems.

From an efficiency point of view the main use for the transistor d.c. transformer is in the low power level application. This will range from a few watts to about one milliwatt. Here the efficiency of generation is as far as the writer is aware very much better than any other device. It is even good enough to replace the h.t. battery in a number of uses, where it will be found that a low voltage battery and d.c. transformer is cheaper, smaller and more reliable than a high voltage battery.

Among typical applications are supplies for Geiger Müller nuclear counting tubes such as those which require

between 400V and 600V at from 10 μ A to 50 μ A. The h.t. supply for battery operated cathode-ray tube instruments, h.t. for valve hearing aids (some 30V at 50 μ A), h.t. for radio frequency valve circuits in otherwise transistor operated battery radio and walkie-talkies, h.t. supplies for insulation testers, photo-multipliers, ionization chambers, see-in-the-dark infra-red image convertors, and many other devices.

Another advantage of the d.c transformer is that, with suitable circuits similar to those of the electronically valve regulated mains power supply, the output voltage can be stabilized against load variations and battery input voltage changes.

Undoubtedly other new applications will be found, once this new device is in use and becomes accepted as a reliable method of solving the h.t. supply problem where very low powers are needed.

Comparison of H.T. Supply Sources

| | AVERAGE MOTOR GENERATOR | AVERAGE VIBRATOR POWER SUPPLY | TRANSISTOR D.C. TRANSFORMER | DIRECT H.T. BATTERY |
|--------------------------------------|---|---|---|---|
| USEFUL POWER LEVELS | Kilowatts to watts | Hundreds of watts to one or two watts | Several watts to one or two milliwatts | Watts to "no lower limit" |
| MAINTENANCE AND LIFE | Lubrication, brush wear and commutator maintenance. Life very long indeed | No maintenance usually given, but contact erosion usually sets limit of useful life | No mechanical maintenance at all, but device still so new that actual life not yet determined. Some life tests of thousands of hours already completed | Relatively short shelf life, particularly at high temperatures. |
| WEIGHT AND SIZE | In general, heavier than the other two devices | Lighter than motor generator | Lightest and smallest of the three, particularly at very low power levels | Very high voltage low power batteries have a large ratio of insulation to active ingredients. |
| VIBRATION AND NOISE | Some vibration and noise, has some gyroscopic effects and sensitivity to acceleration in aeroplanes | Some vibration and noise, has some sensitivity to acceleration and vibration, particularly where designed for maximum efficiency at low output powers | Produces no noise or vibration. Is not sensitive to acceleration or vibration | Produces no noise or vibration. Is not sensitive to acceleration or vibration. |
| ELECTRICAL INTERFERENCE | Produces some electrical interference, can be suppressed over a given bandwidth | Produces some electrical interference, can be suppressed over a given bandwidth, but with rather more difficulty | Produces no electrical interference as sine wave oscillator. Produces some electrical interference as non-sinusoidal oscillator but in general easier to suppress than a mechanical contact | No interference at all. |
| REGULATION | Good, can be fitted with stabilization circuits | Fair | Not very good, but can be fitted with stabilization circuits | Good. |
| INPUT VOLTAGE RANGE | Any | Any | 1.5 to 24V | Any voltage, but bulky and heavy at high voltages. |
| OPERATING TEMPERATURE RANGE | Up to 150°C or higher | Up to 150°C or higher | Present transistors limited to 60°C or perhaps 80°C. Future types may go up to 150°C | Upper limit of about 80°C. |
| OUTPUT VOLTAGE | Any | Any | Any | Any |
| INTERRUPTION FREQUENCY AND SMOOTHING | Very little smoothing required, commutator ripple at kc/s | 50 c/s to 500 c/s. Full smoothing required | Any frequency up to tens of kc/s, usual choice about 1kc/s, full smoothing required | D.C., no smoothing at all required. |

A Simplified Method for the Design of Logical Conversion Matrices

By M. L. Klein*, S.B., A.M., Ph.D.

Some uses for logical diode matrix networks are described. A numero-graphical method is explained for converting from one numbering system to another. Some possible practical applications for programming sequence control are suggested.

THE purpose of this article is to show how logical networks can be evolved quite simply. In particular, the design of diode matrices is shown to be essentially a translation from one numbering system to another. These networks find use in computers. More recently they have been applied to controlling sequences of events taking place at speeds in excess of the operational speed of relays and in the control of industrial processes where a sequence of events can be programmed. In the latter case, the network is programmed so that certain actions will take place as a consequence of the existence of certain conditions. The network, in conjunction with suitable transducers, senses the existing conditions and acts according to the programme. This is fundamentally what a logical network does. The operation of these networks is easily understood by examining how they translate from one numbering system (such as binary) to another (such as trinary).

Numbering Systems

There are several numbering systems in use. Probably the most familiar is the decimal system upon which most day-to-day transactions are based. This system uses ten distinct symbols or marks: the numbers 0 to 9 placed in specific order in accordance with certain rules of sequence which are common to all numbering or counting systems. Numbers such as 1954, 10, 19, 179 203 are thus quite familiar to us.

Earlier civilizations, in a way more ingenious, did not use ten distinct symbols for counting. A numbering system used by the Mayan Indians had only five symbols. Although their symbols did not resemble ours, for simplicity and by convention we will say their numbering system ran from 0 to 4; five distinct symbols only.

The most commonly used system in computers and the simplest uses only two symbols and is called binary code. We will call these symbols 0 and 1. With this system, counting can be accomplished with only two rules of addition and two of multiplication to commit to memory. Moreover, electronically these two operations are performed readily with bistable devices.

More lately, work has progressed using tristable devices allowing use of a trinary or three-symbol code.

Another system uses binary coded decimal in which only the numbers 1, 2, 4 and 8 in our decimal system are used to represent all the numbers between 0 and 9. Thus, 3 is presented as the sum of 1 and 2. The number 5 is the sum of 1 and 4, and so on. This is particularly convenient in allowing binary-operated equipment to be read in decimal magnitudes.

Conversion to a Common Raster

Since there are several coding systems in use, it is often necessary to convert from one numbering system to another. A simple method to allow conversion from one system to another makes use of a raster or mesh of non-intersecting leads and crystal diodes. In particular, a

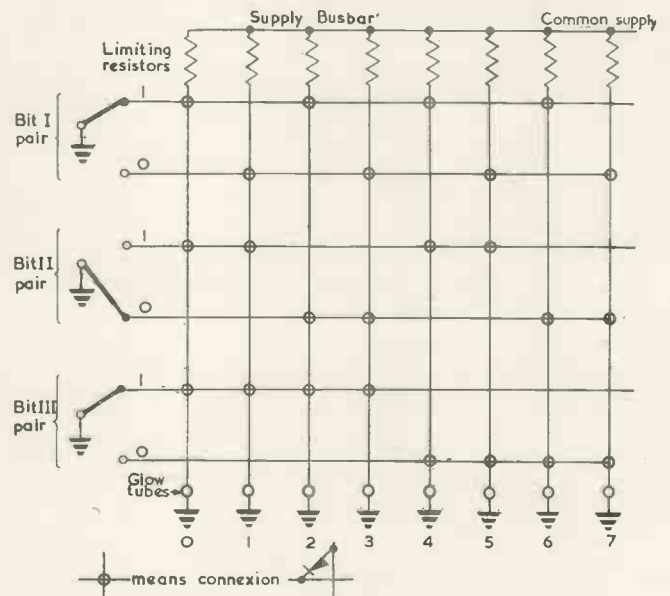

Fig. 1. Eight count binary-decimal diode conversion matrix

method using a common raster will be discussed which permits a plug-board construction. This permits changing the conversion matrix quite simply depending upon which number system is being translated. More important, while it does not use the minimal number of diodes possible, it is readily understood. We will first be concerned with converting the input code to the vertical leads of the common raster.

The conversion is ordinarily accomplished electrically with a diode matrix. Refer to Fig. 1. This is a binary to raster matrix. Setting up the binary numbers on the switches at the left implies that certain lines are grounded and certain lines are not grounded. At the top of a matrix is a voltage supply bus-bar, and each vertical line has a current-limiting resistor. If the orientation of the binary code switches is such that the current can flow through a diode to ground, the line supply potential is dropped across the current-limiting resistor and the neon light at the

* North American Aviation Inc., California.

bottom of the line will not glow. On the other hand, if the vertical line is not grounded anywhere, part of the potential is available to light the neon bulb at the bottom of the line. Notice that no matter how the switches are oriented, one and only one vertical line is ungrounded at a time and therefore a single lamp glows at a time. This is a logical network to the extent that a certain set of conditions (binary numbers) lead to a certain unique conclusion (a single glowing tube).

Suppose now we are confronted with the problem of constructing this matrix—that is, designing the array of diodes and interconnexions. This can be done with Boolean algebra with some labour. An alternate procedure, which performs the same logic, can be set down to reduce the problem to a single graphical process. It is necessary to know how many decimal numbers are to be represented—that is, 128, 8, 904 093 and so on. A vertical line is ruled for each number. In Fig. 2, for simplicity, we have used a sixteen lead raster. We are to convert to 0 to 15 from a

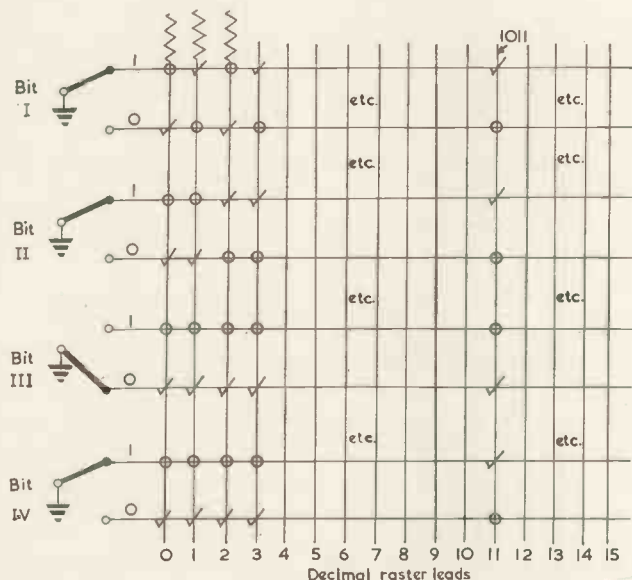

Fig. 2. Sixteen count diode matrix in binary configuration 1011

The next step is to construct a table of numbers converting binary to decimal. Thus, for sixteen numbers:

TABLE 1

| BINARY | DECIMAL | BINARY | DECIMAL |
|--------|---------|--------|---------|
| 0 000 | 0 | 0 111 | 7 |
| 0 001 | 1 | 1 000 | 8 |
| 0 010 | 2 | 1 001 | 9 |
| 0 011 | 3 | 1 010 | 10 |
| 0 100 | 4 | 1 011 | 11 |
| 0 101 | 5 | | |
| 0 110 | 6 | | etc. |

The next step is to "read" the chart on to the raster. This is done by making a check mark at the intersections of the horizontal (binary) and the vertical lines in the following way:

1. Refer to the conversion table, choosing one decimal number and its binary code.
2. Identify the vertical lead with the decimal number.
3. Check the intersection of this lead with each horizontal lead representing the binary code for the number.

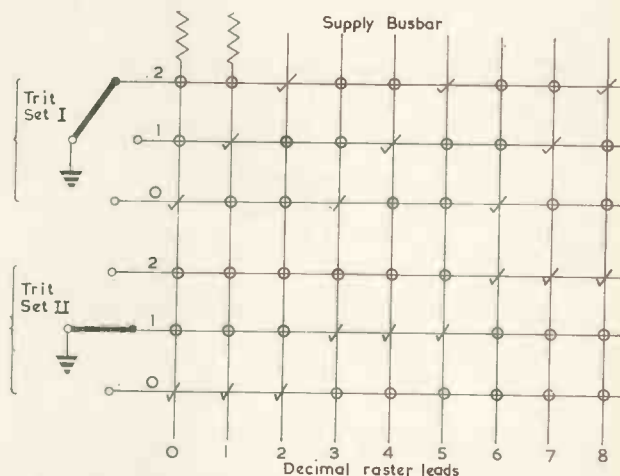

Fig. 3. Nine count trinary diode conversion matrix

binary code. In binary, we recognize that four bits or columns of 0's and 1's are needed to represent all the numbers from 0 to 15. In general, the power of the number of marks in the system gives the number of bits (binary digits) needed to represent (no. marks)ⁿ decimal numbers. Since a binary system has two marks, $(2)^4 = 16$ decimal numbers, and therefore four bits will represent any decimal number from 0 to 15. Orthogonal to the vertical leads we draw a pair of lines for each bit required. Here we require (see Fig. 2) four pairs of lines, and the top of each pair has been marked "1" and the bottom of each pair "0." Thus, each of the pairs represents one of the binary numbers in the bit, and a switch connecting "1" to ground means the bit has the significance of "1", and connecting "0" to ground means the bit has the significance of "0."

We have adopted the convention that the topmost pair is the right-hand bit. Therefore, the top switch touching "1," the second "1," the third "0" and the fourth "1" represents the binary coded number 1011. It is important that the convention be kept in mind.

For example, for decimal 0, one finds checks at each intersection of the 0 vertical line with a 0 horizontal line. For decimal 2, one finds checks at the intersection of the 2 vertical line with horizontal 0 topmost, 1 next pair down, 0 next pair down, 0 last pair down. This, by the convention adopted above, reads binary 0010, which from Table 1 we see is decimal 2. The final step is to indicate a diode at each intersection where a check has not been placed. The result is the matrix performing the unique conversion to a single vertical lead for any orientation of grounding switches representing binary code. As a further example, a trinary to raster conversion will be performed. Fig. 3 shows the raster. We will now use nine decimal numbers which are represented by two sets of three lines. Notice with a three-number system, each set of horizontal leads has three lines instead of the two of binary. In general, each set requires as many lines as there are distinct marks in the numbering system. In binary there are two, in trinary three, in quinary five.

We now set down the table converting trinary to decimal.

TABLE 2

| TRINARY | DECIMAL | TRINARY | DECIMAL |
|---------|---------|---------|---------|
| 00 | 0 | 12 | 5 |
| 01 | 1 | 20 | 6 |
| 02 | 2 | 21 | 7 |
| 10 | 3 | 22 | 8 |
| 11 | 4 | — | — |

Next we check each line intersection, following the same convention as before, topmost set of leads representing the right-hand column of trinary numbers. All unchecked intersections are diode-connected to produce the result wanted.

Operational Usage

This same sort of reasoning can be used to perform an operational control on a system which performs a

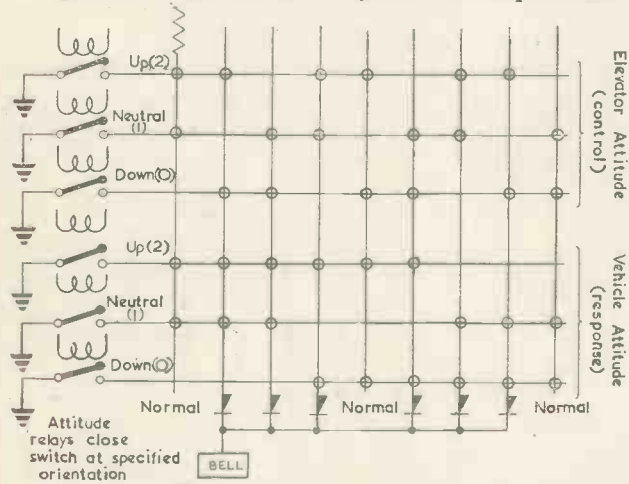

Fig. 4. Trinary to decimal conversion matrix applied as an operational indicator

NORMAL STATES—NO SIGNAL
 Up-up ; trinary 22 ; dec. 8
 N-n ; trinary 11 ; dec. 4
 Dn-dn ; trinary 00 ; dec. 0

thinking operation in a sense. Take the trinary system of Fig. 3 and redraw it. As Fig. 4, it will now be considered as representing one of three positions of an aeroplane elevator and one of three attitudes of the aeroplane. There are nine distinct combinations of the elevator position and the resultant aeroplane attitude. Each of these we represent as a trinary number. It is assumed that the elevator positions up, neutral, down are indicated by the switch as well as the aeroplane attitude up, neutral, down. Let us free the pilot from worrying about some things by programming that when the elevator is up, the plane's attitude must be up; when down, the plane's attitude must be down; when neutral, the plane is neutral or straight and level. If these situations exist, everything will be considered normal and we will not notify him of these conditions. However, if the elevator is down and the plane goes up or remains straight and level, or the elevator is up and the plane goes down or straight and level, or any other situation but the previously mentioned three exists, he should be notified that things are not as they should be. This we will do by ringing a bell.

This problem is precisely the logic of a trinary to raster conversion matrix. Those decimal numbers (see Table 2) representing any condition but the three acceptable ones are terminated through a diode connexion to the common

bell. Thus, any indication of a non-acceptable set of conditions will warn the pilot.

It is obvious how this can be expanded to deal with a multiplicity of possible operational states and their possible results to perform logical operations for any given combinations of states. The methodology indicated for numbers would be perfectly adaptable.

Conversion from Raster to Arbitrary Code

Having obtained decimal equivalents of an arbitrary input code by causing a signal to arrive on a distinct line, we are interested in a method for developing a diode matrix for coming back out with any other arbitrary code. This is again a matrix developed by graphical means. Refer to Fig. 5. Say we choose to come back out with a binary code. This means the signal must be fed to those lines representing the binary digits of the

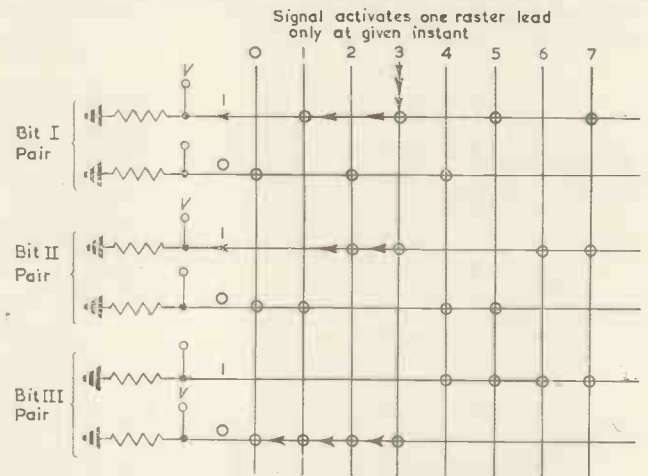

Fig. 5. Raster to binary eight count diode conversion matrix
 Specific conversion shown converts decimal 3 to binary 11.

decimally numbered leads. This is the same as Table 1. Now we again draw the vertical raster for each decimal number of the system and the horizontal pairs of lines representing the binary code, topmost pair again representing the right-hand bit. We again check the intersectional points representing the binary numbers for each decimal number. However, to go from raster to code, we now connect at those points where the checks are made with a diode. The diode direction is found by inspection and must allow current to pass to the proper horizontal leads. A resistor is shown at the end of each binary line to develop a voltage when the current flows through it, and this voltage can be used as needed.

Code to Raster to Code

There remains to connect the two matrices together. This quite obviously would consist of connecting the appropriate common raster vertical lines of the input decoder to the output coder. Thus, connecting the raster lines of Fig. 3, trinary to common, to the raster lines of Fig. 5, common to binary, would produce a composite matrix which would instantaneously convert a trinary code to a binary code. Any arbitrary input can be converted to any other arbitrary output. The raster becomes convenient as a standard intermediary, since a uniform plug patching arrangement can be devised for all output coding matrices.

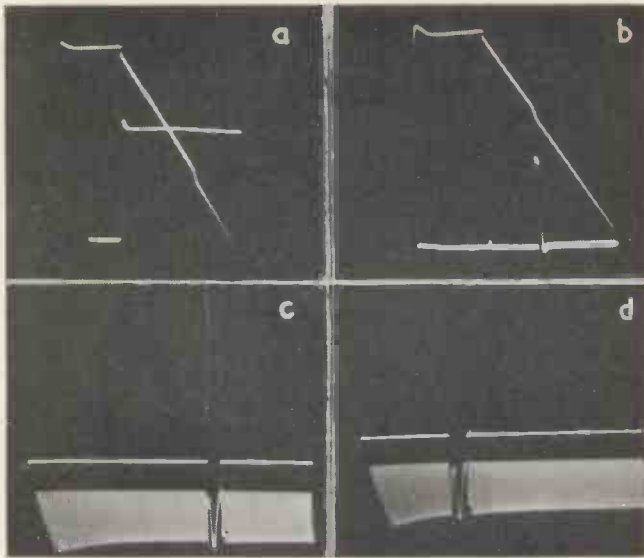

Fig. 2. Circuit waveforms

where A = Voltage amplification of V_2

$$R_g = R_1 + R_2$$

E = the potential to which the grid leak resistance R_g of V_2 is returned.

As a result of the application of the positive pulse, the time-base will have a constant slope over all the portions except over the portion where the pulse is applied. Here the slope will be higher by an amount which depends on the ratio of the pulse amplitude E_o to the voltage E_{ht} . By varying the amplitude of this pulse, the slope of the expanded portion can be varied. Also by varying the potential of V_o , the position of the expanded trace can be moved.

Some of the waveforms obtained with the above circuit are shown in Fig. 2. The time-base waveform along with the waveform at the second anode of V_1 is shown in Fig. 2(a). The time-base along with the pulse can be seen in Fig. 2(b). In order to demonstrate the improvement in range resolution with this type of time-base, oscillations obtained in a ringing circuit are shown in Fig. 2(c) with this time-base applied to the X plate of the cathode-ray tube.

The pulse which causes the expansion of the time-base is also shown in the figure for comparison. The effect of moving the position of the expanded portion may be seen by comparing Figs. 2(c) and 2(d). Also it can be seen from these figures that the speed of the expanded trace is about three times that of the rest of the time-base.

REFERENCES

1. WILLIAMS, F. C., MOODY, N. F. Ranging Circuits, Linear Time Base Generators and Associated Circuits. *J. Instn. Elect. Engrs.* 93, Pt. 3a, No. 7 (1946).
2. LAWS, C. A. A Precision Ranging Equipment using a Crystal Oscillator as a Timing Standard. *J. Instn. Elect. Engrs.* 93, Pt. 3a, No. 2 (1946).

A Transfer Function Analyser

An equipment is described which will indicate to a first order, the resolved components of a test signal at the output of a servo amplifier or similar device. The indication provided remains accurate when harmonic distortion is present, even when this interference is comparable in amplitude to that of the fundamental test frequency. The transfer function analyser is also suitable for analysis of passive networks which have an overall loss.

IN the course of servo-mechanism development and manufacture, it is customary to examine performance in terms of phase and amplitude characteristics over the frequency range concerned. In the development stage where complete information is required, it is usual to plot this information in the form of a polar diagram (i.e. Nyquist diagram). (Automatic presentation of results in the form of a Nyquist diagram have so far failed to discriminate against harmonics). In production testing however measurement at say three fixed frequencies will usually provide the necessary proof of satisfactory performance.

The measurement of phase and amplitude may on first consideration appear a straightforward matter as it can be argued that such measurements are commonplace in the electrical laboratory. However, servo-engineers are only too well aware that while a servo can readily be disturbed with sinusoidal influence, the presence of non-linearities in the system frequently give rise to an output which is far

from sinusoidal. Consequently, if the results of measurements are to be reliable, it is essential that the technique employed be capable of operating on the fundamental component only and discriminating against harmonics and unrelated frequencies which may be present, and the system of measurement should then give an overall accuracy to within (say) ± 1 per cent. The Transfer Function Analyser was primarily developed for use in the design and testing of servo systems and the above mentioned need for high discriminating power of overall accuracy received foremost consideration. The complete equipment comprises two separate units:—

- (1) L.F. oscillator OS.103, and
- (2) L.F. phase sensitive voltmeter VP.253.

The transfer function analyser.

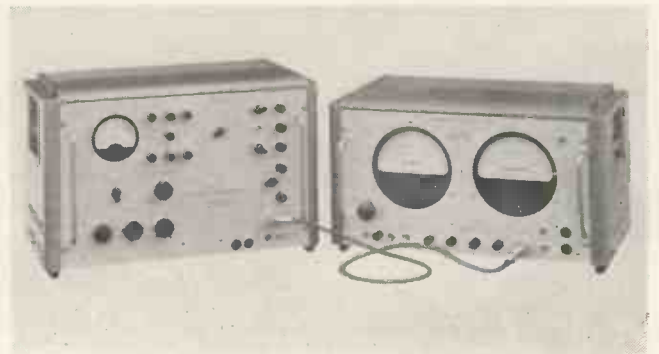

Dielectrics and Waves

Edited by A. R. von Hippel. 284 pp. 115 figs. Demy 8vo. Wiley & Sons Inc., New York. Chapman & Hall Ltd., London. 1955. Price 128s.

PROFESSOR von Hippel, who is the Director of the Laboratory for Insulation Research at M.I.T., is one of the leading American workers on the subject of dielectrics and has used his wide experience of the subject to write a comprehensive review. Dielectrics are of interest not only to electrical engineers but also to physicists and chemists and the aim of the author is the very laudable one of combating specialization by discussing insulating materials in a way designed to interest these three groups of workers. The electrical engineer is usually only interested in the "macroscopic approach" in which a material is described by the three

The latest
"Electronic Engineering"
monograph

RESISTANCE STRAIN GAUGES

By J. Yarnell, B.Sc., A-Inst.P.

Price 12/6. (Postage 6d.)

This book deals in a practical manner with the construction and application of resistance gauges and with the most commonly used circuits and apparatus. The strain-gauge rosette, which is finding ever wider application, is treated comprehensively, and is introduced by a short exposition of the theory of stress and strain in a surface.

Order your copy through
your bookseller or direct from

Electronic Engineering

28 ESSEX STREET, STRAND
LONDON, W.C.2

constants, permittivity, permeability and conductivity, and this forms the theme for the first part of the book. The interest of the chemist and the physicist is in the "microscopic approach" by which the material properties are related to the molecular structure and this is discussed in the remainder of the book.

The first section of some 90 pages gives a conventional treatment of electric and magnetic fields, developing Maxwell's equations and giving solutions for plane wave and waveguide propagation. Vector methods are used, an appendix giving the results which are required, but the condensed nature of the treatment makes it unsuitable for anyone coming to the subject for the first time.

BOOK REVIEWS

The second section is less familiar to the electrical engineer and so of more interest. The keynote of the author's development of the subject is that enough is now known of the relation of the electrical constants of a material to its molecular structure for it to be nearly possible to "engineer" materials to have desired properties. The importance of this idea to the development of electrical engineering is obvious and it is desirable that research engineers should know what can in fact be done. A necessary step is a knowledge of present theories of atomic and molecular structure and this topic is introduced together with a descriptive account of wave mechanics. The author has succeeded in producing a clear summary of what is essentially a difficult subject.

The remainder of the book applies the ideas of the molecular structure in discussing a variety of topics including dielectric and magnetic effects, piezoelectricity, ferroelectricity, conduction and breakdown. The only major criticism which can be made is that the author has tried to do too much, and as a result many of the topics introduced have to be dropped just as they become most interesting. This is offset, however, by numerous references to published papers.

JOHN BROWN.

Handbook of Microwave Measurements

Edited by Moe Wind and Harold Rapaport. 1,000 pp., 500 figs. Royal 4to. Two volumes. Polytechnic Institute of Brooklyn. 1954. Price \$12.00.

THIS book is an attempt to present in the simplest possible form a large number of microwave measurement techniques. As the editors point out, most quantities can be measured by several different methods, and it has been their aim to present as many different methods as possible for each type of measurement. There are 20 chapter headings, covering all the common measurements such as frequency, standing-wave ratio, Q-factor, antenna measurements, etc., and some less common ones, such as voltage breakdown, r.f. leakage, and duplexing tube characteristics.

Clearly, a primary objective has been to explain the experimental methods in the simplest possible way, even to the extent of employing a step-by-step description of the procedure which the reviewer suspects is not really necessary in most cases.

For example, the procedure for measuring frequency with a "frequency meter with an internal indicator" begins as follows:—

1. Select a frequency meter that will cover the approximate range required.
2. Plug or screw the antenna used

with the frequency meter into the receptacle supplied (if necessary).

3. If an 'on-off' switch is supplied, turn it to the 'on' position and allow thirty seconds for the warm-up of the tubes."

The final step is:—

- "9. If necessary, make use of equation (1) to convert wavelength to frequency or vice-versa."

This is followed by an account of the procedure for using a "frequency meter without internal indicator".

The above example is an extreme one, but in many other places obvious advice is given at great length. Another gem is—"To determine the accuracy of a specific instrument, refer to the applicable instruction book!"

For some measurements sources of error are considered most carefully, for others the treatment is rather superficial. For example, a limit is set to permissible v.s.w.r. of the receiver in measuring the directivity of a directional coupler, but no indication is given of the effect of this on the final result.

Having made these criticisms, it must be said that the book contains a great deal of very useful material, and the plentiful detailed numerical examples will be found most helpful by the beginner in this field of work.

The book is Lithoprinted in facsimile of typewriting, no doubt for economy, and the lines are not justified, so that the general appearance is not particularly attractive. Volume I contains the text, and Volume II the illustrations. This arrangement has some advantages (for example, the illustrations are really adequate in size and are always easily referred to), but a drawback is the large amount of desk space taken up when both volumes are open at the same time.

A. L. CULLEN.

Protective Wrappings

By C. R. Oswin. 268 pp., 50 figs. Demy 8vo. Cam Publications Ltd. 1955. Price 32s.

THIS collated work was first published in the form of a series of articles in The British Packer. Mr. Oswin has spent many years on research into the properties and applications of wrappings. He has become well known throughout the world as a leading authority on the subject.

The book is an analysis of the use of thin flexible wrappings for protecting perishable merchandise. It presents the manufacturer with a means of restricting his field of choice, consequently reducing the amount of experiment necessary for the final selection of a wrapping material. It is in three parts, each complete with references, and describes the common commercial wrappings selection for generalized purposes, and specific applications.

Television

By V. K. Zworykin and G. A. Morton. 1,037 pp. 200 figs. Demy 8vo. 2nd Edition. John Wiley & Sons Inc., New York. Chapman & Hall, London. 1954. Price 140s.

THE second edition of this comprehensive treatise on television practice recommends itself once again by the reputation of its authors. First published in 1940, when television was still a novelty to the general public, and a headache to industry, it comprised some 600 pages. The 1954 edition of over 1 000 pages, reflects the considerable progress made in the entertainment side of television since those early days, and its many new applications in the industrial field. It is lamentable that this same progress has also increased the price of the book from 36s. to 140s., which will debar many who would profit from its possession from having it on their bookshelves. This is an example of a situation to which publishers of text books must give increasing attention.

The original character of the book, which covers the whole range of the subject from fundamental physics to engineering applications, has been retained. Every chapter has been revised and brought up to date. New devices, such as transistors, are included within the original framework. Two new sections have been added, dealing respectively with Colour Television, and Industrial Television. Of course the general approach is American in viewpoint, although generous reference is made to British and other contributions. There are some notable omissions however, particularly our work on flying-spot continuous motion film-scanners, our contribution to camera-tubes, and work on using television processes for film production. The bibliography given at the end of each section is comprehensive, but not complete.

In conclusion, it should be said that anyone remotely connected with television will profit by reading this book.

L. C. JESTY.

Protective Current Transformers and Circuits

By P. Mathews. 253 pp. Demy 8vo. Chapman & Hall Ltd. 1955. Price 36s.

THIS book is one of a series recommended for publication by the Technical Papers Panel of the British Thomson-Houston Company, Rugby. It has been written in the interests of those concerned with advanced theory and practice of engineering. A careful selection of material has been made so as to give a consistent and adequate theoretical groundwork and to illustrate its application to practical problems.

Radar Pocket Book

By R. S. H. Bonding. 176 pp. 70 figs. Post 8vo. George Newnes Ltd. 1955. Price 15s.

THIS book provides, in clear and concise form, information on the basic electrical principles and formulae applicable to radar, together with data on the various parts of a radar installation. It is well illustrated, and includes many typical circuit diagrams of the different

units of modern radar equipment, with their operation clearly explained. Engineers and operators concerned in the construction, installation and use of radar equipment will find this compendium useful.

Frontier to Space

By Eric Burgess. 174 pp. 50 figs. Demy 8vo. Chapman & Hall Ltd. 1955. Price 21s.

THIS book gives an account of how modern rockets are enabling man to obtain knowledge on conditions at the frontier to interplanetary space in order that he will be able to predict the behaviour of vehicles moving at high speeds in the rarefied upper regions of the earth's atmosphere. Most of the book could be read with interest by persons with little, if any, scientific knowledge. A few parts require a moderate knowledge of the engineering sciences and mathematics. There is an interesting foreword by the Astronomer Royal, Sir Harold Spencer Jones.

Magnetic Alloys and Ferrites

Edited by M. G. Say. 200 pp., 55 figs. Demy 8vo. George Newnes Ltd. 1954. Price 21s.

THE object of this book is to provide information on the wide variety of materials now at the disposal of the electrical engineer and component designer. In the first section of the book Professor Brailsford gives an account of modern views on the fundamental processes of magnetization. The related subjects of materials for magnetic recording and magnetostriction, together with magnetic compensating and non-magnetic alloying are included.

Chemical Engineering Instruments and Control Methods

Edited by E. Molloy. 182 pp., 100 figs. Demy 8vo. George Newnes Ltd. 1954. Price 21s.

THIS book has been compiled to provide a practical guide for industrial chemists and chemical engineers both in the chemical industry and in the various industries where chemical engineering techniques are employed in the manufacturing processes.

Generation and Transmission

By C. S. Beckett. 124 pp., 50 figs. Demy 8vo. 3rd Edition. Blackie & Sons Ltd. 1954. Price 8s. 6d.

IN this book the author has attempted to present these two subjects in such a way that the student may obtain a good general knowledge of them. A great deal of the material is naturally descriptive, and although it has not been possible to go into detail about all parts of the equipment, points of major importance have been emphasized. The general standard is that of an engineering degree and the work, as a whole, is intended to meet the needs both of the university and technical college student and of the practising engineer.

CHAPMAN & HALL

A JOHN WILEY PUBLICATION

Abstracts of the Literature
on
SEMICONDUCTING
AND
LUMINESCENT
MATERIALS
AND THEIR
APPLICATIONS

1953 Issue

Compiled by

BATTELLE MEMORIAL
INSTITUTE

Sponsored by
The Electrochemical Society, Inc.

11" x 8½" 169 pages 40s. net.

37 ESSEX STREET, LONDON, W.C.2

Keep up-to-date with the aid of this **NEW BOOK**

This new work of reference on Permanent Magnets is one of the most authoritative available on the subject.

The purpose of the Book is to help YOU to achieve required performances at minimum cost, by efficient design and use of the most appropriate materials.

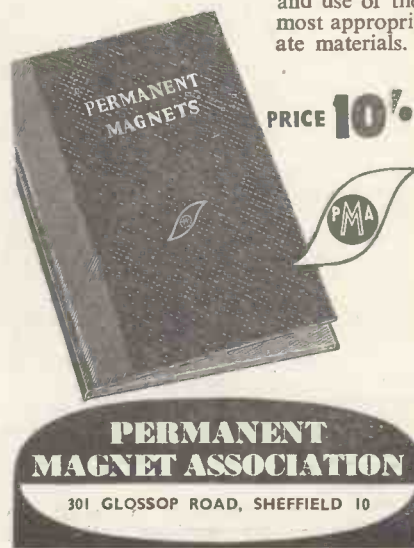

**PERMANENT
MAGNET ASSOCIATION**

301 GLOSSOP ROAD, SHEFFIELD 10

ELECTRONIC EQUIPMENT

A description, compiled from information supplied by the manufacturers, of new components, accessories and test instruments.

Electronic Counter (Illustrated below)

THE Counter Type 865 is a high speed electronic scaling unit with a maximum counting speed of 1 million per second and no limit to the minimum counting speed.

It provides a large, clear and brilliant display consisting of numbered windows illuminated by 6.3V 2W bulbs. Each window is $\frac{3}{4}$ in square and the indication is easily readable up to a distance of 20ft. Six decades are provided, with 10 lamps in each decade, so that the instrument gives a direct reading of all counts up to 999 999, and a non-resettable electro-mechanical counter mounted on the front panel extends the range of indication up to 9 999 million.



The main display may be switched on or off at will without affecting the operation of the counter in any way, and this facility ensures, negligible wear of the lamp switching relays.

The instrument will count any input of negative peak amplitude between 1.5 and 50V providing the waveform passes through zero once every cycle. Hence sinusoidal signals and both recurrent and random pulses can be counted. A gating circuit is incorporated to enable the counting operation to be switched on and off both manually and by means of an external signal. The speed of operation is such that no errors are introduced up to the maximum counting rate of one million per second.

Resetting the counter to zero is accomplished either by operation of the reset switch or by externally closing a circuit. Since both gating and resetting operations may be carried out externally, the instrument may be employed in conjunction with suitable auxiliary equipment for making time, speed and frequency measurements.

The relays employed to switch the lamp display are provided with extra contacts to enable an external circuit to

be made or broken at a pre-determined count in the range of 0 to 999 999 and two terminals are fitted on the front panel to bring out the connexions. In addition to an output signal in the form of a narrow pulse at every millionth count is available from an output plug.

Airmec Ltd,
High Wycombe,
Buckinghamshire.

Microwave Spectrum Analyser (Illustrated below)

THE Racal spectrum analyzer type SA.18 is designed to give direct visual indication of the energy distribution of r.f. signals over the frequency range of 2 000 to 4 000 Mc/s.

A feature of the analyzer is that it utilizes a new type oscillator valve known as the "Carcinotron." This valve is basically a microwave oscillator of the backward wave type combining the principles and advantages of the magnetron and the travelling wave amplifier. Its most important characteristic is that its exceptionally wide tuning range is covered solely by varying the h.t. volts applied to the line electrode. No mechanical tuning is required.

In this instrument the Carcinotron is employed as a local oscillator the output of which is mixed with the input signal in a low Q coaxial line mixer. The signal is then taken through a variable precision attenuator to the i.f. stages, detected and after video amplification fed to the Y plates of a cathode-ray tube.

The centre frequency of the Carcinotron is determined by adjustment of the h.t. voltage and sweeping of the frequency is achieved by applying the sawtooth time-base voltage, via a series regulating valve to the line voltage. The steady voltage is displayed on a meter which is calibrated to show the centre operating frequency.

The visual display is presented on a 6in cathode-ray tube which is situated



together with a line voltage meter, showing frequency, and time-base and tuning controls on the sloping upper panel. The lower panel carries the controls and meters for adjusting and monitoring the Carcinotron power supplies.

Racal Ltd,
Western Road,
Bracknell,
Berkshire.

Moving-coil Relays (Illustrated below)

THIS type of relay, which is extremely sensitive and positive in operation may be used for a wide variety of purposes. It is particularly useful where a



close differential between operating and resetting values is desired. The movement is of the conventional d'Arsonval type.

Besides a normal pointer, the moving-coil carries a light contact arm, which, on reaching the setting value, makes contact with a high or low fixed contact. The latter are movable over the scale in order to adjust the setting value.

In order to relieve the contacts from heavy duties which might have an adverse effect on the relay sensitivity, one or more "slave" relays are mounted in the relay case.

These relays are available designed for a number of applications and in a wide range of sensitivities.

The Record Electrical Co. Ltd,
Broadheath,
Altrincham,
Cheshire.

Measuring Oscilloscope (Illustrated above right)

THE type WM.I oscilloscope is a compact general purpose instrument provided with d.c. coupled amplifiers.

Voltage measurements are carried out



by means of a circuit unique to E.M.I. oscilloscopes. A displayed waveform or a selected portion can be expanded (with the unwanted parts excluded) and measured on the voltmeter. In addition, voltages may be measured relative to points above or below earth potential. This is invaluable when servicing a.c.-d.c. equipments. The time-base locks accurately to multiples or sub-multiples of the scanning waveform and the synchronizing signals may be derived either internally or from an external source. External signals may be used for the horizontal scan and are symmetrically fed to the c.r.t. X plates.

The range of voltage measurements covered is from 0.2 to 500V a.c. and d.c.; the deflexion sensitivity is 1cm/V and the maximum bandwidth is 3Mc/s. Time-base frequencies extend from 3c/s to 120kc/s and a saw-tooth of amplitude 160 to 200V is available for use with other apparatus.

E.M.I. Electronics Ltd,
Hayes,
Middlesex.

Power Oscillator (Illustrated below)

THE model D120 power oscillator which provides a power output of 120 watts over a wide frequency range has been designed for use with the Goodmans vibration generator model 390A, where appreciable power is required for forced vibration excitation.



The unit is a complete drive equipment consisting of an oscillator and power amplifier with its associated power supplies contained in a mobile console cabinet.

The frequency range is 10c/s to 10 kc/s in three ranges; calibration accuracy is ± 2 per cent; hum level is -70db; and distortion less than 2 per cent.

Goodmans Industries Ltd,
Axiom Works,
Wembley,
Middlesex.

Transistor Transformers

(Illustrated below)

BELCLERE type F transformers have been designed for use in transistor circuits, the size of these units being 17/32 by 7/16 by 5/16in. Five standard types covering input, interstage and output requirements are available and special types can be wound to order. The transformers can be supplied either open or mounted in mumetal screening cans.

John Bell and Croyden,
117, High Street,
Oxford.

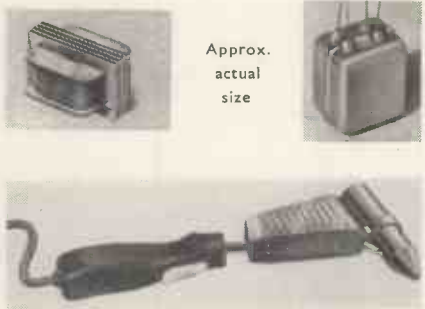

Approx.
actual
size

Aluminium Soldering Tool

(Illustrated above)

THE Belark soldering tool is designed to overcome the difficulties encountered in making soldered connexions to aluminium.

A small steel wire-brush located in the solder-bit vibrates and cleans the surface by mechanical means. A pool of molten solder around the solder-bit protects the spot from air, which would otherwise oxidize again immediately. As soon as the oxide film is broken up, the molten solder tins the surface. The joining operation can then be finalized either with the same tool or by any appropriate method.

The heating element is directly connected to the mains while the vibrator is controlled by a trigger.

The Belark Tool & Stamping Co. Ltd,
33, Sussex Place,
London, W.2.

"Vitricon" Capacitors

"VITRICON" capacitors have a dielectric material and a protective material consisting of vitreous glazes, which are fired on to the copper plates at very high temperature. No organic materials are used in the construction, and they are therefore capable of operating at high ambient temperatures. The electrical properties are also satisfactory at high temperatures, the insulation re-

sistance being maintained in excess of $10^{10}\Omega$ at an ambient temperature of 150°C .

The composition of the dielectric glaze may be varied in order to provide a selected value of temperature coefficient, anywhere in the range of 400 parts per million/ $^\circ\text{C}$ negative, to 120 parts per million/ $^\circ\text{C}$ positive. The capacitors are manufactured in styles having the terminals integral with the copper plates, or wire terminals welded to the plates.

At normal ambient temperatures, the insulation resistance is better than $10^{12}\Omega$ and the upper working temperature is 200°C . At present, the capacitors are being made in three miniature sizes, the largest of which is 0.64in. \times 0.42in \times 0.15in and having a maximum value of 400pF.

Metal Film Resistors

IN these hermetically sealed metal film resistors the resistive element comprises a noble metal alloy, burned into the surface of a glass tube. A helix is cut in this film, thereby increasing the aspect ratio considerably and enabling the resistors to be made to a close tolerance. The element is mounted within a second glass tube, and both are soldered into metal caps hermetically sealing the space containing the film. The resistors have a stability comparable with the best wire wound resistors, but have the advantage of offering considerably higher resistance values in a given size. The size at present being produced, which is 1.4in long \times 1/4in diameter, is available in values from 1k Ω to 1M Ω . The stability is better than 0.05 per cent.

The temperature coefficient is dependent on resistance value, and is between 300 parts per million/ $^\circ\text{C}$ and 360 parts per million/ $^\circ\text{C}$ positive, higher values having the lower coefficient.

The size of resistor mentioned above is rated at 1 watt, and since there is no voltage limitation of the component, it is capable of the maximum dissipation in the highest resistance values.

Welwyn Electrical Laboratories Ltd,
Bedlington,
Northumberland.

Process Timers

THE range of electronic process timers now standardized by Hilton, have several interesting features. A predetermined voltage attained across a capacitor fed from a d.c. source through adjustable resistors calibrated in time, is detected by a cold cathode gas discharge triode. The triode, at the expiration of the time set on the two dials, fires, and a pulse of current is passed through a "pilot" relay which controls the main a.c. power relay. The main relay, in addition to carrying "work" contacts capable of switching 10A at 440V a.c., is fitted with auxiliary contacts for hold on and for switching the timing circuit.

The range includes timers designed for push button starting and for starting by the sustained closing of a pair of contacts. Provision is made for linking two or more timers to operate automatically in sequence with or without self cycling.

Hilton Electric Co. Ltd,
52, Pool Street,
Wolverhampton.

Short News Items

The Seventh British Electrical Power Convention will be held at The Dome, Brighton, from 27 June-1 July. The president of the convention is Sir Harry Railing, chairman and managing director, General Electric Co Ltd, and the vice-president is Sir John Dalton, chairman, W. T. Henley's Telegraph Works Co Ltd.

The 11th annual meeting of the American Institute of Navigation will be held at Montgomery, Alabama, from 23-25 June. Presentations will cover theoretical and practical aspects of civil and military navigation.

The Radio Component Show, held recently at Grosvenor House, London, was visited in three days by more than 20,000, including visitors from twenty-three foreign countries.

A Silicones for Industry Exhibition will be held in Manchester at the Midland Hotel from Monday, 13 June, to Saturday, 18 June. Invitations to the exhibition can be obtained on request from Midland Silicones Ltd, 19 Upper Brook Street, London, W.1.

The School of Engineering, Burnbank, Hamilton, Lanarkshire, recently staged an exhibition of electronic equipment which was patronized by some twenty-six firms.

A new mobile Decca Radar Unit has left London on a tour of all the ports of the United Kingdom and will be returning to London towards the end of September. This new unit consists of a specially constructed caravan equipped with the Decca 212 having ample space to accommodate up to ten people at a time in comfort. The caravan is hauled by a Land Rover specially fitted with a 5kW generator driven from the main engine which provides the power to drive the radar alternator, also fitted in the Land Rover, and all other electrical services.

On 25 April, 1955, the total number of ships of all classes for which Decca radar has been ordered exceeded 4 000.

E.M.I. Ltd announce that their trainees in this year's Physical Society Craftsmanship and Draughtsmanship Competition scored outstanding successes, being awarded the 1st, 2nd and 3rd prizes in the Class VI, Senior Grade. The judging was made from 130 selected entries in this nation-wide competition which included 21 organizations such as the radio, electrical and motor industries, the National Coal Board, British

Electricity Authority, British Railways, six schools and one training centre.

The College of Technology, Birmingham, recently held a Diamond Jubilee Year Associateship Presentation ceremony at the Town Hall, Birmingham. The occasion was for the conferment of Honorary Associateships of the College on five men who have risen to control some of the largest industrial organizations in Great Britain, and the awarding of Associateships of the College of Technology to 128 men and women working in Midland industry who have completed to high standards schemes of advanced study in the several departments of the College,

Gresham Transformers Ltd, on extending their manufacturing capacity, have transferred the production of small transformers for the Electronics Division to their Lion Works on Hanworth Trading Estate, Feltham. Mr. K. G. Lockyer has been appointed manager of Lion Works. He was formerly production manager with Solartron Laboratory Instruments, having previously been with Philips (Mitcham Works) Ltd, Plessey, and London Electrical Co Ltd.

Cable & Wireless Ltd announce the opening of a new direct multi-channel v.h.f. radiotelephone service between Gibraltar and Tangier. Prior to the new service being inaugurated, telephone communication across the Straits of Gibraltar to Tangier could only be offered by a landline and cable route, by way of Spain. The improved facilities now offered will reduce the cost of calls to 5s. for three minutes.

Dowty Nucleonics Ltd has been registered as the new trade name and title of the firm Davis, Wynn & Andrews, pioneers in the development of instruments used in electronics, recently acquired by the Dowty Group. The new company represents an important and far-reaching addition to the Dowty interests, which already include aircraft, agriculture and coal mines. The organization will now be in a position to participate in important new fields of development and in line with the recent Government announcement regarding the future development of atomic energy.

Electran Coil Winding & Transformer Co Ltd, following on recent changes in management and reorganization of staff, announce a reduction in the price of radio transformers and chokes. The current catalogue is available and there is an open invitation to visitors who would care to inspect the works at Lichfield Road, Aston, Birmingham, 6.

The Radio Industry Council announces that the first of the students who entered three-year technical training courses started in 1952 are now about to enter the radio industry. The courses were organized by the Ministry of Education, following consideration of training problems by the Radio Industry Council's Technical Training Committee and the Radar Sub-Committee of Lord Hankey's Technical Personnel Committee, at five London and provincial centres. The object of the courses is to provide students so well trained in the theory and practice of electronics that they will be able, on completion, to take their places at once as assistants to qualified research and development engineers.

Aero Research Ltd, Duxford, Cambridge, were visited by H.R.H. The Duke of Edinburgh on the occasion of a special display commemorating their twenty-first anniversary.

The General Electric Co Ltd has supplied the equipment for another microwave radio television link in Switzerland. It connects Uetliberg (Zurich) with La Dole (Geneva) and on the way ties in with the trans-Alpine Chasseral-Monte Generoso link, which was supplied by the G.E.C. twelve months ago for the Eurovision exchange of programmes. The new link forms part of a television network which will cover most of Switzerland. It was installed by Hasler S.A. on behalf of the Swiss Post, Telegraph and Telephone Administration.

The 15MeV Accelerator for radiotherapy and radiobiological research which was designed and constructed by Mullard Ltd, and described in the December, 1954, issue, has now been installed at St. Bartholomew's Hospital. The president, His Royal Highness The Duke of Gloucester, recently performed the official opening ceremony.

The BBC, as the result of a recent meeting with the Lieutenant-Governor's Advisory Committee on Broadcasting in the Isle of Man, has now decided its plans for the future development of television and sound broadcasting for the island. The temporary television transmitter at Carnane, near Douglas, is giving a satisfactory service to about 60 per cent of the island's population. In addition to this, a new permanent television station has been erected at Divis, near Belfast. This station is expected to begin operating in July of this year, and it is hoped that it will give a satisfactory service to viewers living in the North of the Isle of Man, provided they are favourably situated and use good aerials. This transmission from Divis,

together with the transmission from Carnane and also with the transmission already received in reasonable quality by viewers of Holme Moss direct, will mean that from the summer this year the majority of the population of the island should receive satisfactory service. Meanwhile, the BBC has been searching for a suitable site on which to erect a permanent television transmitter for coverage of the whole island. After considering and testing a number of alternative proposals, it became obvious that the summit of Snaefell would give an entirely satisfactory service to the island as a whole. The Ministry of Transport and Civil Aviation, for reasons of safety of life, was not prepared to grant permission for such a station to be erected unless the BBC could demonstrate by tests that no interference would be caused to the Ministry's transmitting and receiving station which is already operating on Snaefell. For reasons of geography, and other commitments, these tests cannot take place until early summer 1956. The Ministry also reserves the right to close down the transmitters temporarily should the safety of aircraft be in danger. However, the BBC confidently hopes to begin the erection of the permanent television transmitter on the Snaefell site immediately after the necessary tests have been carried out. At the same time, in order to improve the island's sound broadcasting reception, the BBC proposes, subject to Post Office approval, to incorporate three v.h.f./f.m. transmitters in the Snaefell site.

The Post Office announce that two sets of regulations come into force on 1 September giving the Postmaster-General power to control interference with radio (including television) from refrigerators, and from domestic and industrial appliances which are driven by small electric motors. The regulations lay down the requirements which must be complied with by manufacturers, assemblers, and importers of all electrical refrigerators and by users of new and old electric motors. These arrangements were recommended by the Advisory Committees appointed under Section 9 of the Wireless Telegraphy Act 1949, and the regulations have been drawn up with the agreement of these Committees.

The Societe Belge de Physique held its annual general meeting recently and the following officers were elected. President, Professor P. Wings; Vice-Presidents, Professors W. de Kryzer, J. Delfosse and G. A. Homes. The Secretary-General is Dr. M. C. Desirant and the address of the Secretarial Office is A.C.E.C. Physics Research Laboratory, Charleroi, Belgium.

Crane Packing Ltd., of Slough, a member of the Tube Investment Group of Companies, has just completed the design and construction, in their own works, of special plant and equipment for the extrusion in substantial quantities, to exact and uniform standards of quality, of the plastic polymer Polytetrafluoroethylene (PTFE).

Pye Ltd announce that the largest television outside broadcast van yet produced by them recently left their Cambridge factory bound for Bayerischer Rundfunk, the Bavarian State Broadcasting Station in Munich. The van has provision for three camera chains, as well as standby equipment to enable it to work independently of the main station. Space has been left in it for special German sound equipment and tape recording machines.

At the annual general meeting of the British Radio Equipment Manufacturers' Association, Mr. M. M. Macqueen was re-elected chairman. No vice-chairman was elected and the existing Council was re-elected without change.

The Portuguese Civil Aviation Authorities have purchased from International Aeradio Ltd the basic units of an Air Traffic Control Trainer capable of application for aerodrome approach and airways training. The equipment will be installed at Portela Airport, Lisbon.

Sydney S. Bird & Sons Ltd announce that their works have now removed to Fleets Lane, Poole, Dorset. Telephone Poole 1640. The London sales office is now at 3 Palace Mansions, Palace Gardens, Enfield, Middlesex.

Atkins, Robertson & Whiteford Ltd, 92/100 Torrisdale Street, Glasgow, S.2, have opened a London office and showroom at 53 Victoria Street, London, S.W.1, to deal with the inquiries from London and the South for transformers and electronic instruments.

Armstrong Wireless & Television Co. announce the appointment of three of their senior staff to the Board of Directors. They are Mr. A. Adams (Sales Manager), Mr. T. Nikolin (Production Manager), and Mr. G. Tillett (Chief Engineer).

The Solartron Electronic Group Ltd., announce that Mr. Bowman Scott, M.B.E., has been elected a Member of the Board. Mr. Scott, who joined the Company from Urwick, Orr & Partners, will continue his duties as Personnel and Training Officer for the Group and will also be concerned closely with Group organization and policy.

Harwin Engineers Ltd. have recently acquired additional premises at Uxbridge, Middlesex, to be devoted to increased production of Terminal Lugs. All sales and technical inquiries should continue to be addressed to 101-105 Nibthwaite Road, Harrow; telephone: Harrow 0381. Mr. D. D. Windram has been appointed General Works Manager to the company.

Erratum. In the letter entitled "A Versatile Pulse Shaper" which appeared on p. 188 of the April issue, for "... delays up to 1.5Mc/s" read "... delays up to 1.5μsecs".

PUBLICATIONS RECEIVED

APPLIED RESEARCH IN ELECTRICAL ENGINEERING is a summary of this research in progress in university colleges and technical colleges in London and the Home Counties. The summary has now been prepared for the seventh year in succession and copies may be obtained from the Secretary, Regional Advisory Council for Higher Technological Education, London and Home Counties, Tavistock House South, Tavistock Square, London, W.C.1.

C.M.A. RUBBER AND THERMOPLASTIC INSULATED CABLES is the subject of a recent brochure produced by Enfield Cables Ltd, Victoria House, Southampton Row, London, W.C.1.

SINGLE SIDEBAND FOR THE RADIO AMATEUR prepared by the Headquarters staff of the American Radio Relay League is a comprehensive digest of articles on the subject, reviewed in line with current practice. There are over 300 illustrations, including charts, tables and formulae. American Radio Relay League Inc., Administrative Headquarters, West Hartford 7, Connecticut. U.S.A. Price \$1.50 in the United States, \$1.75 elsewhere.

SOME RECENT ADVANCES IN TINPLATE MANUFACTURING PROCESSES by W. E. Hoare is a reprint of an address given at the 9th International Congress on Packaging held at Parma, Italy, in September, 1954. The paper is a review of the present state of development of tinplate manufacturing methods. Tin Research Institute, Fraser Road, Perivale, Middlesex.

THE 1955 MARCONI INSTRUMENTS CATALOGUE OF TELECOMMUNICATION MEASUREMENT EQUIPMENT AND INDUSTRIAL ELECTRONIC INSTRUMENTS is available to senior engineers and executives, on request. This publication contains sections on frequency measurement, voltage and power measurement, distortion measurement, transmission measurement, signal generators and accessories, oscillators and accessories, bridges and Q meters, television and radar test equipment, pH measurement, moisture measurement, and industrial X-ray apparatus. The instruments are indexed both alphabetically and by type number. Marconi Instruments Ltd, St. Albans, Hertfordshire.

WIRELESS AND ELECTRICAL TRADER YEAR BOOK 1955. A valuable new feature of this 26th edition is the special section giving both alphabetical and territorial lists of radio and electrical wholesalers in which association members are indicated, while the complete text of the wages agreement covering radio and television service engineers together with wage rates and details of the rates of pay of radio and television shop managers and assistants, is again included. Other data includes specifications of current radio receivers covering over 250 models, legal and licensing information and a directory of trade associations. Trader Publishing Co. Ltd, Dorset House, Stamford Street, London, S.E.1. Price 12s. 6d.

PAYMENT SECURED gives a brief description of the work undertaken by the Exports Credits Guarantee Department, 9 Clements Lane, Lombard Street, London, E.C.4.

INSTRUMENTS FOR ELECTRICAL, ACUSTICAL, RADIOACTIVE, VIBRATIONAL, STRAIN GAUGE AND ELECTRO-CHEMICAL MEASUREMENTS is the subject of a catalogue produced by the Danish company Bruel and Kjaer, for whom Rocke International Ltd act as their London office. This range of electronic equipment is imported in quite large numbers. Rocke International Ltd, 59 Union Street, London, S.E.1.

VALVES FOR A.F. AMPLIFIERS is a booklet in the Philips' Technical Library series and shows the radio designer and amateur setmaker how to build amplifiers. Cleaver-Hume Press Ltd, 31 Wrights Lane, London, W.8. Price 10s. 6d.

LETTERS TO THE EDITOR

(We do not hold ourselves responsible for the opinions of our correspondents)

An Electromechanical Current Stabilizer for an Electrolytic Cell

DEAR SIR,—We have recently found a need to stabilize the current through an electrolytic cell running at a current of 1A with a p.d. of about 5 to 10V. A coulometer is not suitable for measuring a current of this magnitude and since the resistance of the cell tends to fluctuate during an electrolysis, automatic current stabilization is necessary so that the quantity of electricity passed can be estimated from the time occupied by the run.

Many of the d.c. current stabilizers previously reported in the literature are unsuitable for our purpose as they produce much smaller currents than we required. Others giving the necessary power employ gas-filled valves which we did not possess. We have, therefore, designed and built an electromechanical controller using only parts readily available in most research laboratories, which will give a continuously variable controlled d.c. output of up to 2A. The stability has been checked by a recording meter and is about ± 0.2 per cent at 1A. With slight modifications much larger controlled currents could be obtained.

The circuit is shown in Figs. 1 and 2. It is essentially a balanced 2-stage push-pull d.c. amplifier. Through a relay system this operates a reversible 24V motor, mechanically coupled by a worm

gear to a Variac supplying the power transformer and rectifier. The operating voltage is obtained across the variable control resistor VR_1 which is in series with the electrolytic cell or cells; making this resistor variable enables us to set the magnitude of the stabilized current. If VR_1 is varied or if the current through it varies, the voltage change is reflected in a change of potential between the anodes of V_3 and V_4 , between which is connected relay A , a polarized micro-armature changeover relay. This relay is the heart of the controller and operates on $25\mu A$; in turn it energizes one or the other of two P.O. type relays B or C feeding the reversible motor. The connections are such that the Variac is driven in the sense which tends to produce zero voltage across relay A .

If an open-circuit develops in the cell line or if the resistance of a cell rises beyond the controlling range of the circuit, relay B will close and the controller will drive the Variac up to its maximum setting. In order to avoid damage a fourth relay, D , is provided which is energized through the mechanically operated microswitch S_2 to cut the power to the motor when the Variac setting reaches some arbitrary value, in our case 220V. (Switch S_2 is normally shut). With this simple arrangement however, when this point is reached the controller is no longer capable of re-setting itself when the cell circuit is re-made or the resistance reduced. To avoid the need for

mechanical re-setting, S_2 is connected across an extra pair of contacts on relay C (which is used to drive the Variac to lower settings). On remarking the circuit, relay B opens and relay C closes: S_2 is thus shorted out and the motor can operate again. As soon as the Variac

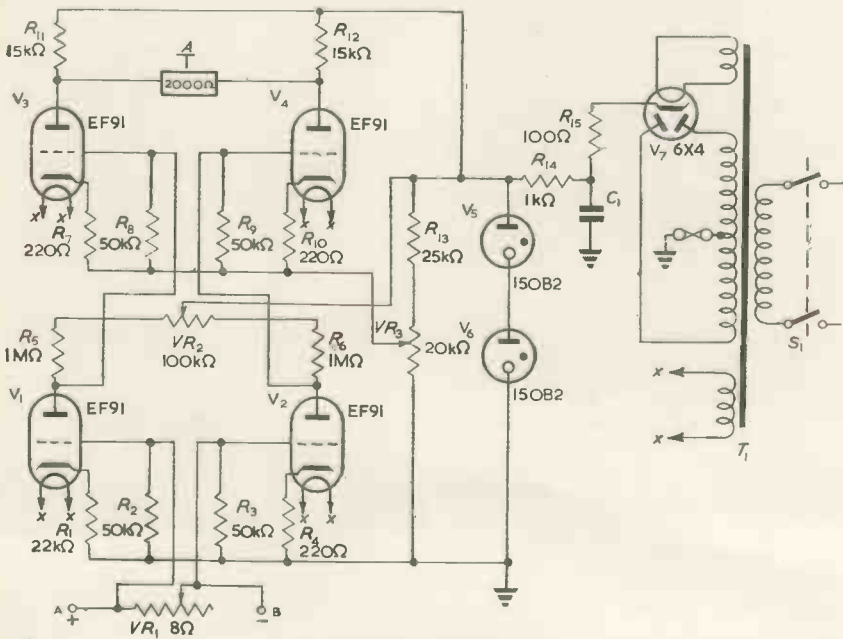

Fig. 1. Circuit showing a balanced 2-stage d.c. amplifier

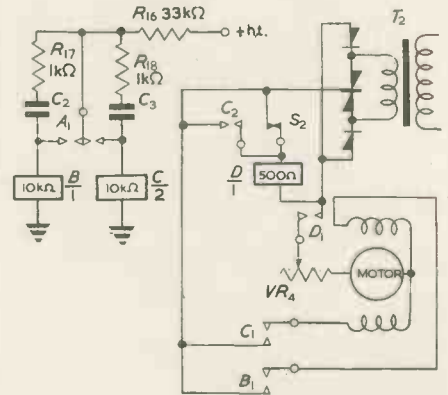

Fig. 2. Reversible Aircraft Antenna Motor (U.S. surplus equipment). G.E. type BA 24V 5.5A Fitted with magnetic clutch and reduction gear

setting falls below 220V, S_2 closes again and the operation becomes normal.

The sensitivity of the instrument is such that with the motor running at full speed the overshoot causes hunting, even with the mechanical reduction of 130 to 1 provided by the worm gear. To avoid this it is necessary to reduce the voltage supplied to the control motor, by means of the variable resistor VR_2 . It may also be necessary to connect a small capacitor, say $0.1\mu F$, between the anodes of V_1 and V_2 . By being able to vary the voltage, the control point can be approached rapidly when setting the control to a particular value. The voltage across relay A may be appreciable when the instrument is off balance at the start of a run but the overload permitted on this relay is sufficient to prevent any damage on this account. The controller will operate with a minimum of 5V input. It can therefore, be run at currents greater or smaller than 1A if there is sufficient range to VR_2 and if there is sufficient output voltage available. By increasing the ratings of the output transformer and rectifier the controlled power can be greatly increased.

This note is published by permission of the Director.

Yours faithfully,

J. A. MORRIS,
R. B. TEMPLE,

Chemical Research Laboratory,
Teddington.