

# Electronic Engineering

Incorporating

ELECTRONICS, TELEVISION & SHORT WAVE WORLD

VOL. 22 No. 270

AUGUST, 1950 *HF Issue*

PRICE 2/-



## Some Advance features in AUDIO GENERATOR design

### COVERS

15 c/s to 50 Kc/s in three stages

### ACCURACY

Plus-minus 1% Plus-minus 1c/s

### SINE & SQUARE WAVE OUTPUT

Full particulars in Leaflet No. S16/L sent on request.

THE combination of wide-range, high accuracy and low distortion will commend the Advance H.1 Audio Generator to all critical Service Engineers. The 15 c/s to 50 Kc/s coverage is achieved by the use of a bridge type resistance-capacity oscillator with three switched ranges. Stability throughout is attained by a highly efficient stabilizing circuit followed by two amplifier stages with heavy negative feedback. Output: Sine wave 200 microVolts to 20 Volts, plus/minus 1 db, or Square wave 400 microVolts to 40 Volts (800 microVolts to 80 Volts peak to peak). Measured distortion is less than 1% at 1,000 c/s. In attractive cream enamel sprayed steel case, 13¼" × 10¼" × 8". Weight only 14 lbs.

LIST PRICE **£20**

**ADVANCE COMPONENTS LTD**  
BACK RD, SHERNHALL ST, WALTHAMSTOW, LONDON. E.17. 'Phone: LARkswood 4366/7/8

# A GOOD SET DESERVES A BICC T/V DOWNLEAD

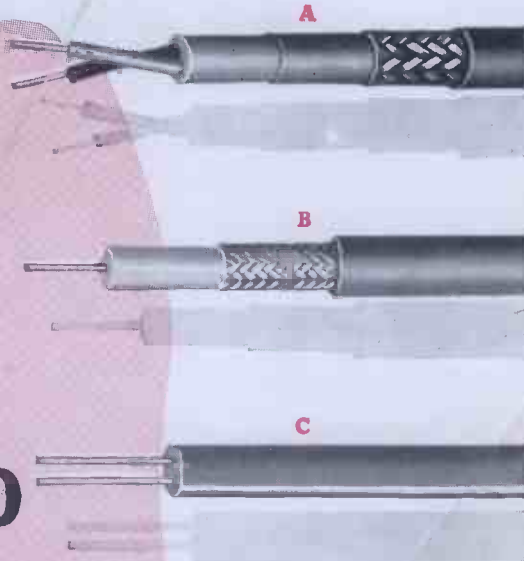

**A**  
80-ohm screened twin  
cable. T3109

**B**  
71-ohm solid dielectric  
coaxial cable. T3022

**C**  
80-ohm unscreened  
twin cable. T3066

Use BICC Downleads for all your T/V installations. They're made to close specifications from first grade materials to ensure a long dependable life and precise characteristics. Keep your customers satisfied by giving them the *best possible* results.

Further information on BICC T/V Downleads is available in Publication No. 244 R. Write to-day for a free copy.



## T/V DOWNLEADS

*keep your customers satisfied!*

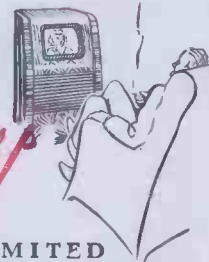

BRITISH INSULATED CALLENDER'S CABLES LIMITED  
NORFOLK HOUSE, NORFOLK STREET, LONDON, W.C.2

# Electronic Engineering

Published Monthly on the last Friday of the preceding month at 28 Essex Street, Strand, London, W.C.2.

Telephone CENTRAL 6565    Telegrams 'LECTRONING, ESTRAND, LONDON'

Managing Editor H. G. Foster, M.Sc., M.I.E.E.

Subscription Rate: (Home or Abroad) Post Paid 12 months 26/- or \$3.75 (U.S.).

Vol. 22. No. 270.	CONTENTS		August, 1950
Planning V.H.F. Mobile Systems ... ..	298	Design Problems of V.H.F. Mobile Equipment ...	331
By E. R. Burroughes		By L. W. D. Sharp, M.A., A.M.I.E.E.	
The Thames Radio Service ... ..	305	A New Permanent Magnet Electron Microscope	338
V.H.F. Equipment for Sound Broadcasting ...	309	A Hard Valve Time Base ... ..	339
A Survey of V.H.F. Valve Developments ...	310	By C. H. Banthorpe	
The Metropolitan Police Radio Communication System ... ..	316	V.H.F. Equipment ... ..	340
By E. C. Brown		V.H.F. Testing and Measuring Equipment ...	349
Multi-Station V.H.F. Schemes ... ..	323	Notes from the Industry ... ..	351
By J. R. Brinkley		Book Reviews ... ..	352
Some Recent V.H.F. Installations ... ..	326	Letters to the Editor ... ..	355
The Port of Liverpool V.H.F. Radio System ...	328		

## V.H.F. Mobile Radio-Telephony

ONE of the features of the post-war development of radio communication has been the growth of mobile radio systems operating in the very high frequency band from 30 Mc/s. to 300 Mc/s.

According to a recent statement by the Postmaster General in the House of Commons there were 434 "business radio" licences in force by the end of May this year covering the operation of some 3,500 stations.

Comparing this with pre-war conditions when the only vehicles equipped were a few police cars, it is apparent that an important new application of radio communication is establishing itself here in Britain. In addition, a considerable export market has been opened by the manufacturers concerned who are obviously paying increasing attention to it.

Interesting though the figures are, a glance at the corresponding American figures will dispel the notion that they represent a phenomenal expansion.

A glance at the pages of this issue, which is largely devoted to a survey of the present state of the art in Britain, will convince the reader that slower progress has not been due in any part to lack of enterprise on the part of the British manufacturer. The range of equipment offered is more comprehensive as regards power levels, frequency coverage, choice of modulation systems and in design for special applications.

In Britain we even have (so far as can be ascertained) the advantage of larger frequency allocations and it is not congestion, nor any immediate threat

of congestion of the channels, which is causing discouragement.

The F.C.C. of America have published detailed allocation plans showing precisely what frequency bands are available and specifying exactly the channels nominated to each type of service. The conditions of use for each service are also carefully detailed.

The picture in Britain is different. Far from defining bands or nominating channels for given services, the P.M.G. has never even formally stated that business radio licences are available. Nor has any comprehensive attempt been made to define the conditions under which licences are available to the various classes of user. It can scarcely be denied that the resulting lack of *status* has been a strong deterrent against healthy growth. As an example of the uncertainty prevailing, the would-be user is served with a rather bleak assurance, in writing, that his channel will be shared and that interference will be experienced. Neither he nor his advisers are in a position to make a worthwhile estimate of what this statement means.

It has been argued that frequency allocations present most complex problems and that there is virtue in making haste slowly in such matters. We cannot subscribe to this view. Business radio has been operating in Britain for three years now without having any stated policy to guide its progress. The longer the formulation of a policy is postponed the more difficult it will be to resolve. We feel there is need for haste in the matter of setting the course.

# Planning V.H.F. Mobile Systems

By E. R. BURROUGHS\*

**T**HE principal advantages of v.h.f. for Mobile communication services are now becoming well known and may be summarized as set out below:

1. Under normal conditions the range is mainly confined to line-of-sight so that with careful planning it is possible to repeat frequency allocations. In this way many more services can be provided with a clear channel and sharing of frequencies becomes largely unnecessary.
2. Frequencies used are not affected by atmospheric disturbances and are also less susceptible to interference by man-made noise. As an example, the ignition system of an internal combustion engine can be much more easily suppressed than on the lower frequencies.
3. A comparatively low-powered equipment can provide a reliable communication service, thus reducing to a minimum the power drain required in the mobile unit.
4. An efficient aerial system of small size and weight is easily obtained. This is particularly important in the case of the mobile equipment and also permits the use of comparatively cheap masts or towers in fixed stations.

## Applications

v.h.f. telephone services are now in use in a very large number of fields and new applications are continually being found. In Great Britain the major users are undoubtedly the Police Forces, and their v.h.f. services are in the main organized on a County or Borough basis. The conditions to be met in these services are by far the most stringent as 100 per cent coverage must always be obtained throughout the complete service area.

Another extensive application is to fleets of private hire cars or taxis operating in areas where the individual units are normally stationed at a garage. It has been found that radio-equipped cars under suitable conditions can show savings of up to 15 to 20 per cent on fuel costs, etc., compared with vehicles that are not fitted. This economy when spread over a fleet of any size can reach appreciable proportions.

Operators of fleets of tugs and towing craft have also found the use of v.h.f. equipment to be of considerable value in their business, and in the marine field further applications are for docking and pilotage services. Marine applications are, to a large extent, of a special nature, as the question of operation on the internationally agreed frequencies for ship-to-ship and ship-to-shore communication have also to be considered. Special equipment, including frequency switching facilities, will in many cases be required.

Public utility undertakings such as electricity authorities, municipal transport, water systems, etc.,

have already accepted v.h.f. communication as part of their normal routine. To these users rapid communication is of great importance in connexion with maintenance and repair work. One of the more interesting applications is for newspaper reporting, and here again the v.h.f. radio is now accepted as part of the routine equipment for mobile reporting work. One large newspaper group in this country uses v.h.f. radio not only for the normal reporting, but also for the transmission of pictures.

There are many further applications which are already being met, these including professional men such as doctors, veterinary surgeons, etc.

## Frequency Bands

The frequency bands for v.h.f. mobile communications have been allocated at International conference, although a certain amount of flexibility has been permitted on a national basis. As a result, some small variations exist in various parts of the world, although the basic frequency bands are the same.

The first frequency allocations used for short distance mobile communication were in the 30-40 Mc/s. band, and these were extensively used in the United States for police and other services. Developments over the last 10 to 12 years have, however, shown that these frequencies are by no means the best for mobile communication and the most widely used frequencies now lie between the limits 70-100 Mc/s. and 156-184 Mc/s. The 30-40 Mc/s. band is too low to conform to the true propagation characteristics of v.h.f. and suffers from a considerable amount of long distance interference in certain seasons of the year.

On these bands good communication is possible up to and, for an appreciable distance, beyond the horizon although the higher band is sometimes inferior to the lower over non-optical paths. The performance on the two bands is, however, in the main very similar. In the band 70-100 Mc/s. frequency allocations are frequently made on a basis of 50 kc/s. channels and in the higher band the channel separation is usually increased to 100 kc/s. In most cases the tendency has been for the licensing authorities to allocate frequencies in the lower band first, and as a result all available channels are rapidly being filled.

Where a service is licensed for two-frequency operation the spacing adopted in Great Britain is 4.5 Mc/s. and this is adequate to permit operation to be carried out in the duplex system if desired.

At the last International Radio Conference at Atlantic City a further frequency band of 460-470 Mc/s. was allocated for both fixed and mobile services, but it is doubtful if this will come into general use for some years. A relatively small amount of data is available at the present time on the performance which can be obtained with a mobile system

\* The Marconi W.T. Co., Chelmsford.

on this band, and in any event there will be relatively few channels available as it will be necessary to increase the width to ensure interference-free operation.

**Operating Systems**

The three operating systems which may be used are:

1. Common frequency simplex.
2. Double frequency simplex.
3. Duplex.

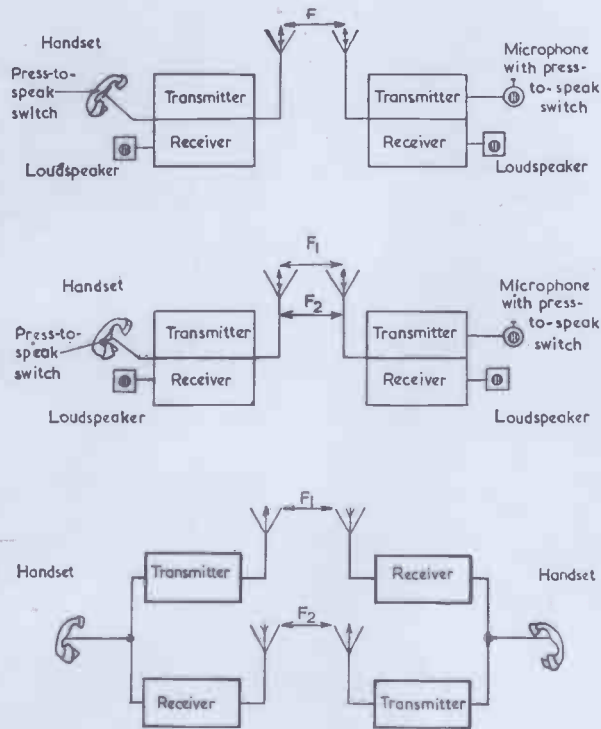

Fig. 1.

Schematic diagram. Simplex and duplex V.H.F. communications systems

In common frequency simplex the outward and inward channels are both on the same frequency, whereas in the double frequency case two frequencies are used. In the common frequency system the mobile units in a scheme can communicate directly with each other, whereas in the case of double frequency operation they are unable to communicate except through their headquarters or control station. At first sight it would appear that the double frequency system is uneconomical in frequency allocations, but in practice this is not so, as it permits of a number of services in a given area being operated at closer frequency spacings without adjacent channel interference.

In simplex systems the transmitter and receiver are energized in turn, and the change over from the receive to the send condition is normally effected by means of a press-to-talk switch mounted in the microphone or handset. There is no operational difference between common and double frequency simplex.

In the duplex system both the transmitter and receiver are energized at the same time and conversation may be carried on as though a normal telephone

line circuit were being used. This system is thus particularly suitable for use by unskilled personnel as no knowledge of operating procedure is required, and it is also essential where the fixed station is connected into a standard telephone system. The three operating systems are illustrated diagrammatically in Fig. 1.

Two frequency operation is, of course, essential for duplex working, and as both the transmitter and receiver are running at the same time it is necessary to provide means of eliminating interference from the local transmitter. This is commonly achieved by the use of separate aerials for transmitter and receiver and arranging the physical spacing to be such that the radio frequency carrier is adequately attenuated at the receiver input. For most mobile applications difficulties are experienced in the fitting of two aerials and in obtaining adequate spacing between them. In these cases it is possible to use a common aerial and to include R.F. filters in order to reduce the interference from the transmitter to a reasonable level.

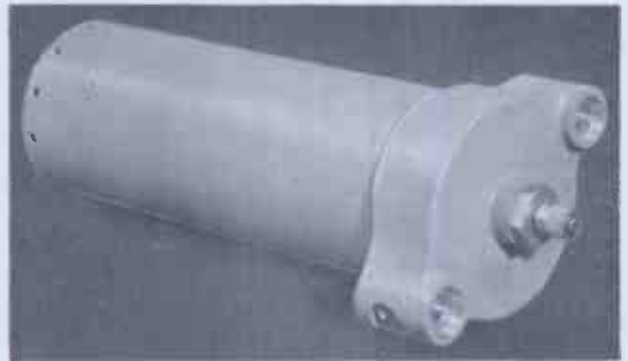

Fig. 2.

Cavity or shortened line filter

To obtain adequate rejection the efficiency of the filter circuits must be of a very high order, and the most commonly used pattern is the so-called cavity or shortened line filter. With filters of this type it is possible to obtain "Q" values of 1,000 and more, and a typical example is illustrated in Fig. 2.

**Ranges**

In general, v.h.f. mobile communication systems are planned on a basis of an optical path being obtained. The propagation is, however, such that ranges extending over the true optical path are achieved and this can, of course, be used to advantage on fixed point-to-point circuits.

From the foregoing it will be seen that the range to be obtained from a given transmitting site will depend almost entirely on the height of the transmitting aerial in relation to the surrounding terrain, and it is therefore difficult to anticipate ranges without reasonably accurate knowledge of the contours of the country. Correct siting of the main station equipment is, therefore, of the utmost importance and it is desirable to make a careful survey of suitable positions in the early stages of any system planning.

With a well sited fixed station, good two-way operation can be obtained up to a radius of 20 miles over

average country without relying to any great extent on non-optical paths. It will be found that the frequency bands below 100 Mc/s. give a rather superior performance where a certain amount of the operation involves paths which are not truly optical.

### Siting the Fixed Station

As has been stated in the previous section, the correct siting of the aerial system for the main station is the most important factor in satisfactory operation. The aerial should, as far as possible, be erected in a position where it is not shadowed by nearby buildings or hills and it should, in fact, be at a greater height than nearby obstructions. This point is particularly important in the case of services where operation is required mainly in urban areas, as a considerable amount of screening from buildings may be present and this will materially effect the performance of the service.

Once the aerial position has been determined it is then necessary to consider positioning the radio equipment, and it is highly desirable that this should be installed in such a way that the length of r.f. feeder is kept down to a minimum. At 100 Mc/s. the most commonly used types of r.f. feeder introduce a loss of approximately 2 db per 100 ft. and the normal practice is not to exceed this length wherever possible. Feeder cables having better characteristics are available, but these are considerably more expensive than the type mentioned above and their use is, therefore, normally avoided.

Where the desired operating position does not fulfil the condition of being within 100 ft. of the aerial it is then the common practice to arrange for the equipment to be within the specified distance and remotely controlled. The control can be carried out in two ways, depending upon the distance between the equipment and the control point. Where the distance over which control is required does not exceed approximately 300 ft. it is usually possible to extend the switching and audio circuits of the transmitter and receiver, and this is the most economic method.

Most modern fixed station equipments can also be remotely controlled over a pair of telephone lines for distances up to five or six miles, and they can also be arranged for duplex operation by means of 4 wire/2 wire transformers. Full control is normally available at the operating point, this including switching the equipment on and off.

### Coverage of Large Areas

In planning a v.h.f. mobile communication system it is frequently found that the area to be covered is too large for a satisfactory service to be obtained by the use of one fixed station. In these cases two or more fixed stations situated strategically at different points in the area will be required.

The use of more than one main transmitter, however, immediately raises an operational problem in that if more than one nominal carrier frequency is radiated simultaneously serious heterodyne interference will be experienced unless an elaborate method of ensuring absolute carrier synchronization is used. Additionally, steps must be taken to ensure that transmitters which are energized simultaneously are also modulated with the correct phase.

It has been claimed that the use of frequency modulated systems permit the use of more than one main station transmitter running simultaneously owing to the complete "capture" of a receiver by the predominant carrier. It can readily be shown, however, that the difference in signal level required for complete "capture" of the receiver by one carrier to the exclusion of the others is of the order of 10 db. This difference in signal level is such that the area between

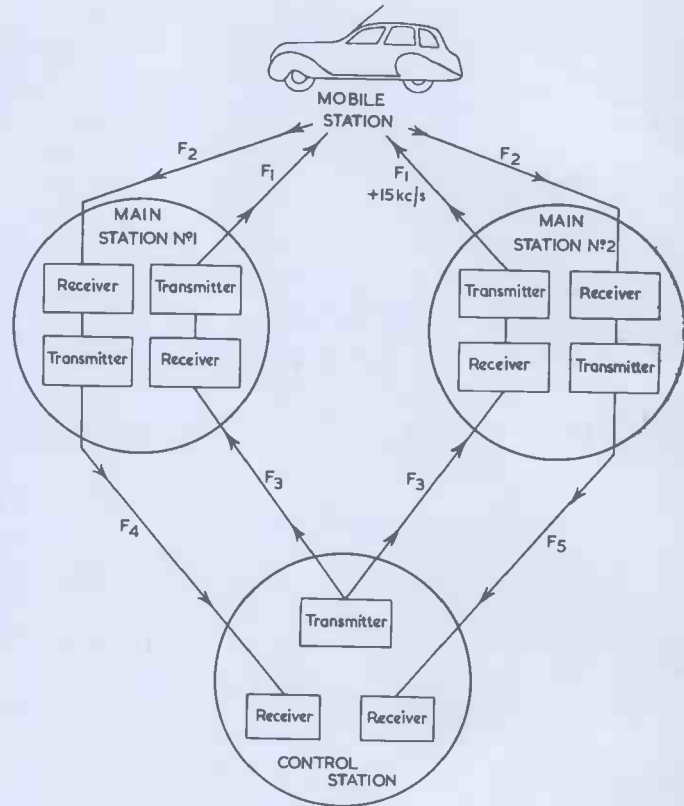

Fig. 3.

Schematic diagram. Twin diversity V.H.F. communication system

two fixed stations in which the receiver will not be fully "captured" by either of the two carriers is very considerable in extent, and, of course, in this region a varying amount of distortion will be present.

In order to overcome the difficulties with both amplitude and frequency modulation systems outlined above, a form of diversity transmission has been evolved and is being used by the police services in Great Britain. In this system, which is usually confined to amplitude modulation, the fixed station transmitters are given a small frequency difference of such an order that the heterodyne beats are well above the speech frequency band. In this way elaborate and expensive methods of obtaining absolute synchronization between the various carriers are avoided, and the only problem is to ensure that all transmitters are modulated in phase in order to avoid audio distortion.

There is, of course, no fundamental reason why this diversity system should not be applied also to narrow band frequency modulation, but it is not possible operationally, because of the very large channel width which would be required.

The main station transmitters are linked to control either by physical lines or by radio circuits and arrangements can, of course, be made to carry out switching operations in addition to the passing of the modulating frequencies. In order to ensure that the transmitters are modulated in phase it is normal to include delays in the shorter lines where large path differences exist. The operation of a twin diversity scheme is shown diagrammatically in Fig. 3.

The mobile receivers are provided with a pass band of a sufficient width to accommodate all the main station carriers, and in order to eliminate any heterodyne beats which may arise if one or more of the main station transmitters drifts slightly in frequency, it is normal to include low-pass filters in the audio circuits which provide a high order of rejection to frequencies above 3,000 cycles.

Apart from the increase in the service area achieved by the use of the diversity system, tests have also shown that the presence of two or more carriers at a mobile receiver considerably reduces the flutter fading effect which is experienced when a single carrier only is used. These tests showed that the fields from the various transmitters were rapidly interchanging in strength and that with the combined carriers the receiver was selecting the best combination of signals.

### Modulating Systems

The most suitable method of modulation for mobile v.h.f. services is a subject of considerable controversy, and both frequency and amplitude modulated systems are claimed by their exponents to have outstanding advantages. It is true to say that both methods can be used to provide a first-class mobile service, and under suitable conditions there may be little to choose between them. In Great Britain the majority of equipment in service uses amplitude modulation, but in the United States frequency modulation is almost exclusively employed.

The principal advantage claimed for frequency modulation is that a better signal/noise ratio is obtained for a given field strength, and provided that the input signal is above a certain level this statement is true. It is, however, found in practice that a large proportion of any service area is operated with field strengths of a low order which are frequently below the level necessary for frequency modulation to obtain its maximum advantage. The second major point in favour of frequency modulation is that the inherent design of the receiver provides better protection than its amplitude modulated counter-part against certain types of man-made noise. This is particularly so in the case of electrical interference of a more or less uniform level such as is frequently experienced in areas containing large factories, etc. It is also claimed that impulse noise such as that obtained from motor car ignition systems has less effect on frequency modulated receivers, but this is not necessarily true as this type of noise does also possess frequency modulation characteristics.

A further advantage frequently claimed is that for a given drain from the primary supply the frequency modulated transmitter can produce a considerably greater carrier power than the amplitude modulated set. This is not completely true, as in order to obtain adequate deviation at the radiated frequency of the frequency modulated transmitter a comparatively low crystal source must be used and this involves a greater number of multiplier stages.

In amplitude modulated equipment, the fundamental frequency-controlling source can be at the highest possible frequency for which crystals can be economically cut, and as a result the number of multipliers required is reduced to a minimum. The latest developments in noise limiter circuits for use in amplitude modulated receivers now provide a performance which is comparable with that of the frequency modulated set in providing protection against car ignition interference, etc.

One more aspect of the amplitude/frequency modulation controversy which has not always received the attention it merits is that of economical use of the available frequency channels. As has already been stated, in Great Britain frequencies are allocated below 100 Mc/s. on a basis of 50 kc/s. channels. With amplitude modulated transmitters the band-width required for good quality speech communication need only be  $\pm 5$  kc/s., so that quite a considerable amount of frequency drift can be tolerated before interference will be experienced on an adjacent channel. The normal narrow-band frequency modulated transmitter has a maximum deviation of  $\pm 15$  kc/s. and it will, therefore, be seen that if a comparable drift is experienced in this case interference on the adjacent channel will be much more severe. This aspect is less important in the high frequency band where 100 kc/s. channelling is used. It may be, however, that at some future date the channelling of the high frequency band will be reconsidered with a view to reducing the channel spacing, and the problem outlined above will then be even more difficult.

### British and American Practice

A comparison between the systems and methods used in Great Britain and the United States is of interest, as there is a considerable divergence between the two countries. v.h.f. mobile systems were in service in America much earlier than in this country, and although the first services were operated on amplitude modulation, frequency modulation is now almost exclusively used.

Since the war considerable strides have been made in the development and design of mobile v.h.f. equipment and, as a result, instruments suitable for all types of service are now generally available. Most manufacturers in Great Britain have laid down a comprehensive series of equipments and, as specifications have been drawn up by the General Post Office covering the various types, performance has become largely standardized. Performance has also been largely standardized in America where equipment must comply with the regulations and frequency allocations laid down by the F.C.C.

The first frequency allocations in the States were between 30-40 Mc/s. and it is now generally recognized that this band is inferior in performance to fre-

quencies above 70 Mc/s. In order to obtain the maximum performance possible on this low frequency band the trend in the States was to operate with transmitter powers as high as 50 watts, and this figure is comparatively easily obtainable between 30 and 40 Mc/s. without special valves, although somewhat heavy battery drains must be accepted. As a result of the need for high transmitter powers on this low frequency band the Americans have tended to aim always at maximum power on the higher frequencies, and transmitters having carrier ratings of 25-30 watts are common practice up to 180 Mc/s.

In Great Britain where little, if any, work was carried out on the 30-40 Mc/s. band, it was realized that efficient services could be operated with transmitters having carrier ratings considerably below those obtaining in the States. The first equipments produced commercially in this country used transmitters with carrier powers of 10-12 watts and they were of the amplitude modulated type. As the use of v.h.f. has increased, the tendency has been to reduce still further the transmitter power in the mobile equipment, and carrier ratings of the order of 5-6 watts are now the common practice.

#### Circuit Design

All v.h.f. equipment used in this country must conform with the appropriate specification issued by the General Post Office, and as a result the performance of both transmitters and receivers has reached a very high standard. Before being put into service all equipment must be type-approved by the Post Office against the relative specification. The purchaser is, therefore, adequately protected against inferior products.

#### Amplitude Modulation

The primary requirements of the transmitter are good frequency stability and minimum of radiation on any frequency outside the allocated channel. The rapid increase in the number of services in operation has made the problem of spurious radiations particularly important. In order to reduce the unwanted radiations to a minimum, extensive use is now made of high frequency crystal technique so that the number of multiplier stages in the transmitter can be reduced to a minimum. Fundamental frequency crystals as high as 20 Mc/s. are commonly used and some use has also been made of crystals working on third overtones at frequencies up to 40 Mc/s. This materially assists in reducing the number of spurious radiations and most commercially produced transmitters show attenuations as high as 80-90 db on all unwanted frequencies with the exception of the second harmonic. Although earlier designs of transmitters in general showed attenuation at the second harmonic of about 40 db, advances in technique have now raised this figure to a level comparable with that obtained on all other unwanted frequencies.

All transmitters employ high power modulation of the final r.f. amplifier, and the modulator systems are normally designed to give a good frequency response throughout the speech band with low distortion. In mobile equipments of 5 watts carrier power and over, the modulator system is usually designed to operate into a public address speaker if desired.

Great strides have undoubtedly been made in

receiver circuit design during the past few years, with particular attention being paid to obtaining a high degree of protection against electrical interference. The most commonly used noise limiter circuit involves the use of two diodes, one being used in series and the other in shunt across the audio frequency path. The action of this noise limiter circuit is to cut off the



Fig. 4.

Two 50 watt transmitters mounted in single cabinet

peaks of noise, and they are normally set to operate at levels corresponding to 60-70 per cent modulation. As a result, beyond this modulation level some distortion is introduced, but in practice it is found that this is not objectionable on the average mobile system. A number of variations on the circuits described above are in use, but basically they spring from the same arrangement.

In order to obtain a good degree of image or second channel rejection, the majority of receivers are of the double superheterodyne type and in some instances a single crystal oscillator is used to feed the two frequency changers. The principal disadvantage of the double superheterodyne is that, while it does permit a reasonable order of image signal rejection, the risk of



spurious responses owing to the use of two frequency changers is considerably increased. As in the case of spurious radiations on the transmitter, this question of unwanted responses in the receiver is of major importance—particularly where v.h.f. communications are growing rapidly.

With the latest r.f. amplifier valves which are suitable for frequencies up to 200 Mc/s., adequate signal-to-noise ratios can be obtained with inputs as low as 1  $\mu$ V, and a well designed v.h.f. receiver will now have a noise factor as low as 6 db.

#### Frequency Modulation

The majority of frequency modulated mobile transmitters employ a phase-modulated crystal oscillator circuit, various degrees of pre-emphasis being used. This method of modulation is to be preferred for mobile applications over the reactance modulated oscillator used in conjunction with a crystal reference, as it is much less susceptible to frequency variations caused through temperature changes and vibration. A phase-modulated crystal oscillator is usually operated on frequencies around 2-3 Mc/s. and thus the multiplication to final frequency is quite considerable. Good speech quality is easily obtainable with this method of modulation, the maximum deviation of



Fig. 5.

5-6 watt Transmitter-Receiver installation in a car

$\pm 15$  kc/s. being now accepted as a satisfactory standard.

In the receiver the circuit design normally follows that already outlined on the amplitude modulated equipment until the last intermediate frequency stage is reached. The majority of modern frequency modulated receivers use two amplitude limiters, and these are in most cases followed by a discriminator of the Foster-Seeley type. All modern designs include some form of muting or "squelch" so that, in the absence of a signal, no audio output is obtained. It is common practice for the "squelch" operation to be controlled from the operating position so that it may be adjusted for variations in signal level. De-emphasis is also included in order to provide a good overall frequency response in conjunction with the pre-emphasis already mentioned on the transmitters.

On such points as spurious radiations in the transmitter and unwanted responses in the receivers, fre-

quency modulated receiver design follows the same lines as those already described in amplitude modulation.

#### Equipment

The majority of manufacturers of mobile v.h.f. equipment in Great Britain now produce a comprehensive series so that a suitable type for most applications is readily available. The equipment broadly falls into three categories which may be conveniently divided with regard to use as follows:

1. Fixed stations.
2. Mobile or fixed stations.
3. Portable.

Transmitters designed solely for fixed station use are usually of 50 or 100 watts carrier rating and these powers are usually adequate for all services. Beyond 100 watts carrier power, valves for use on frequencies up to 200 Mc/s. tend to become expensive and this economic factor has further influenced designers in restricting the output of fixed station transmitters. These types are normally powered from a.c. mains and are capable of continuous operation. Fig. 4 shows an installation where two 50 watt transmitters are mounted in a single cabinet.

For mobile or fixed service, the maximum power of the transmitters in common use in this country is of the order of 15 watts, and the majority of equipment use transmitters of 10 watts carrier rating. This power is adequate for the majority of services operating in rural areas and it will also satisfy the requirement of a very large number of systems used in urban or built-up areas. The same basic radio equipment is used for both the fixed and mobile applications, the power supply being altered to suit. Most mobile equipments of 10-15 watts are of such dimensions that they must be fitted in the luggage compartment of a car, and a small control unit is installed in a position accessible to the operator. The power requirements of a set of this type are also of such an order that the normal electrical system fitted in the car is not capable of carrying the additional load and as a result large-capacity batteries and heavy-duty charging dynamos have to be fitted.

This need for increasing the generator output on car installations has been a major factor in influencing designers to produce an equipment of rather lower carrier power. An equipment using a transmitter with a carrier rating of 5-6 watts, and with a power supply designed for optimum efficiency, can usually be fitted to a car without any modifications to the electrical system. The reduction in output power also enables the size of the equipment to be reduced so that it becomes a practical proposition to install it in a position in the car where direct control is possible and this, of course, produces a considerable saving in cost. Fig. 5 shows a typical installation of this kind.

For portable use, weight and dimensions become of primary importance and the performance of an equipment designed for such applications is largely controlled by these factors. Depending upon frequency, the transmitter will have a carrier rating varying between 100 and 360 milliwatts, this being decided first by suitable valves and secondly by the maximum permissible drain on the primary power

source. These equipments are of the type usually described as "Walkie Talkies" and they are normally arranged for carrying by hand or on the back with a suitable harness.

In parallel with the production of the radio equipment, manufacturers have designed a series of aerials to meet the requirements of all systems. The simplest form of aerial, the use of which is normally confined to mobile applications, is the  $\frac{1}{4}\lambda$  rod which may be mounted directly on the set in the case of the Walkie Talkie, or on the roof of a car or van. As in its simplest form the  $\frac{1}{4}\lambda$  aerial requires a ground plane for satisfactory operation, its use is normally confined to mobile applications. For fixed station use the most commonly used aerial is the  $\frac{1}{2}\lambda$  centre fed dipole. This aerial may be fed through a single wire



Fig. 6.  
Typical  $\frac{1}{2}\lambda$  aerial installed on ship's bridge

70 ohms feeder and its light weight and simple construction make it particularly suitable for mounting on small masts, etc. Fig. 6 shows a typical  $\frac{1}{2}\lambda$  aerial.

Where the maximum possible radiation is required from an omni-directional aerial it is possible to stack two or more  $\frac{1}{2}\lambda$  sections and thus to obtain a gain of 2-3 db over a single element. The difficulty with this type of aerial is that in the lower frequency bands the physical dimensions become so great that heavy masts or towers are required for satisfactory mounting.

In some applications radiation is required to be confined mainly in one direction and in these cases the most commonly used aerial is the Yagi. A Yagi array consists of a driven  $\frac{1}{2}\lambda$  element with a reflector, and a number of directors, and it may be used to

provide either vertical or horizontal polarization. The gain of such an aerial depends upon the number of directors and also, to a smaller extent, on the physical spacing between the elements. A commonly used aerial of this type has a reflector and two directors and provides a gain over that of the standard  $\frac{1}{2}\lambda$  dipole of about 8 db. The driven element of an aerial of this type requires a balanced input and it is therefore necessary to use a balanced-to-unbalanced transformer where it is desired to feed it from a single wire feeder of 70 ohms impedance. A typical four element Yagi array is shown in Fig. 7.

#### Selective Calling Systems

In some communication systems it is desirable to be able to call one mobile station individually, and this operation may be carried out by the use of a selective calling system. There are a number of suitable systems available, ranging from a simple type in which only a few selections are required, to a comprehensive arrangement whereby one of a hundred or more mobile units may be selected.

A simple arrangement may consist of an individual audio-frequency for each of the mobiles, the frequency corresponding to the desired mobile unit being used to modulate the fixed station transmitter. The mobile receiver is fitted with a simple audio filter which accepts only its own frequency and has

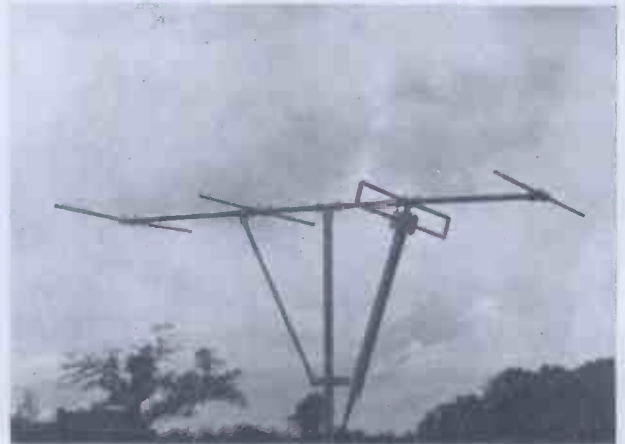

Fig. 7.  
Typical four element Yagi array

adequate rejection on the other frequencies in the group. The attention of the operator may then be called by the ringing of a bell or the lighting of a lamp.

In the more comprehensive systems a number of different methods are employed. Here it is usual to arrange that when one particular mobile station is called all the others in the group are locked out and are thus unable to interfere with communication by putting their own transmitters into operation. Some systems employ two audio tones in conjunction with a five-figure code, each receiver then having a special coded latching relay which responds only to its own particular selection. Others use three or more audio tones in conjunction with tuned filters in the mobile receivers.

# The Thames Radio Service



The Thames River Tug Gull

A public radiotelephone service to small craft on the River Thames has been in operation for some months, using frequencies around 160 Mc/s. The following is a general survey of the problems involved and a brief description of equipment used to provide the service.

THE history of the Thames radiotelephone service dates from August 1946, when an inquiry was received from the Port of London Authority regarding the possibility of providing communication to their launches. The P.L.A. controls the River Thames between the Nore Buoy and Teddington Lock, but it was stated that if service could be provided between the Nore and somewhere near Chelsea Bridge, most of the requirements would be met. Inquiries were made of a number of tug owners and other bodies to obtain some idea of the probable response if such a service were provided by the Post Office. The number of small craft plying on the Thames is very large and it was evident that, if a fair proportion of them were fitted with radio, a number of channels would be required to carry the traffic. As the response appeared to be encouraging, authority was given in June 1948 to proceed with the establishment of an experimental service.

Provision was to be made initially for two channels, with scope for expansion up to six channels if justified by traffic requirements, and after discussions between the headquarters departments concerned and the London Telecommunications Region, it was decided to establish the switching centre for the Thames service in the International Telephone Exchange, Wood Street, but to bear in mind the possibility of shifting it to an auto-manual switchboard at one of the London automatic exchanges if experience indicated that this would prove satisfactory.

It was further decided that the owners of boats would have to obtain and maintain the radio equipment at their own expense and the equipment would have to conform to a Post Office specification.

It will be understood that these and other decisions were made only after long and careful study and

consultation between the departments concerned and that some of them were only made after the service was in experimental operation.

Two-frequency working was envisaged from the outset; i.e., transmission in the two directions on different frequencies, with a separation of several Mc/s. Not only does this enable full duplex speech facilities to be given but, more important in practice, it enables a number of channels to be operated in the same area (even from the same radio station) on adjacent frequency assignments, with a minimum of interference between them.

As a result, a number of adjacent two-frequency channels are available for public radiotelephone service to ships, and it is from these channels that the frequency assignments are made for the Thames service. The actual carrier frequencies of the first channel in operation are 157.5 Mc/s. for the inward direction (mobile to fixed station) and 161.5 Mc/s. for the outward direction. The former frequency is being changed to 157.0 Mc/s. very shortly to conform with a recent rearrangement of the frequency channelling scheme. The frequencies for the second channel will be 157.1 Mc/s. and 161.6 Mc/s. and it will be noted that this constitutes an adjacent channel by virtue of a frequency separation between channels of 100 kc/s., while the frequency separation between outward and inward frequencies remains at 4.5 Mc/s.

Finally, it was decided that the first channel of the service would use amplitude modulation. A decision has since been taken to standardize A.M. for marine radio services in the United Kingdom.

#### Choice of Sites

Having undertaken to provide service to boats anywhere on the Thames below Chelsea Bridge and out

as far as the Nore Buoy, it was necessary to decide on the number of fixed land stations that would be required, and to find suitable sites for them. Information regarding the propagation of radio signals at 160 Mc/s. was at that time very scanty, and a series of field trials was necessary to ascertain the range of such signals over built-up areas. No 160 Mc/s. equipment was available, and the trials were therefore carried out with transmitters and receivers which were obtained from the Air Ministry. These operated on approximately 124 Mc/s., and it was thought that the results obtained at this frequency would give sufficient information about the propagation characteristics of frequencies in the 160 Mc/s. band.

The lower reaches of the Thames flow through country which is rather flat, and the number of sites even moderately suitable for fixed stations is very limited. A Port of London Authority launch was temporarily equipped as a mobile station, and tests were carried out from likely positions including the roofs of some of the higher buildings in London. The sites tested included two water towers, one on Shooters Hill, near Woolwich, and the other at Langdon Hills in Essex. Their positions are shown in Fig. 1. The tops of the towers are 530 ft. and 446 ft. respectively above low water. From one or the other of these two test sites communication with the launch was possible over practically the whole of the river below Tower Bridge. All other positions tested were unsuitable or ineffective and it was decided to base the initial plans on two stations with the transmitting and receiving aerials on these water towers.

Before describing the equipment in more detail, brief mention will be made of the scheme as it has emerged from the planning and early development stages to the present time. The first channel of the Thames Radio Service, as it is now known, has been

in operation for nearly a year. Since the early field trials, the development of equipment for these frequencies has brought about remarkable improvements in performance, and in consequence it has been found that the coverage required can be given adequately from a single fixed station. Only the Shooters Hill station, therefore, has been installed, and good service is available for suitably equipped boats anywhere below Richmond and well out to sea. The Langdon Hills station will not now be required, unless it is decided to widen considerably the scope of the service.

A block schematic diagram of the existing arrangements is given in Fig. 2.

#### The Fixed Station

At the Shooters Hill radio station the equipment is mainly housed at the foot of the water tower and connected to the aerials by coaxial feeders. There is at present a 12 ft. square wooden hut which is being replaced in due course by a standard Type A brick building. This allows space for working and reserve equipment for as many as six channels, together with auxiliary apparatus. The equipment for one channel comprises two transmitters, two receivers, monitoring equipment and automatic changeover and alarm gear which maintains the service in the event of a fault occurring.

#### Aerials and Associated Equipment

At present, simple centre-fed vertical dipoles are used and the service was opened with one transmitting and one receiving aerial mounted at the level of the eaves of the tower roof. Recently, the receiving aerial has been connected through a pre-amplifier, installed at the top of the tower. This amplifier consists of a grounded grid triode with a broadly tuned anode circuit. Power supplies for it are superimposed on the coaxial cable connecting the

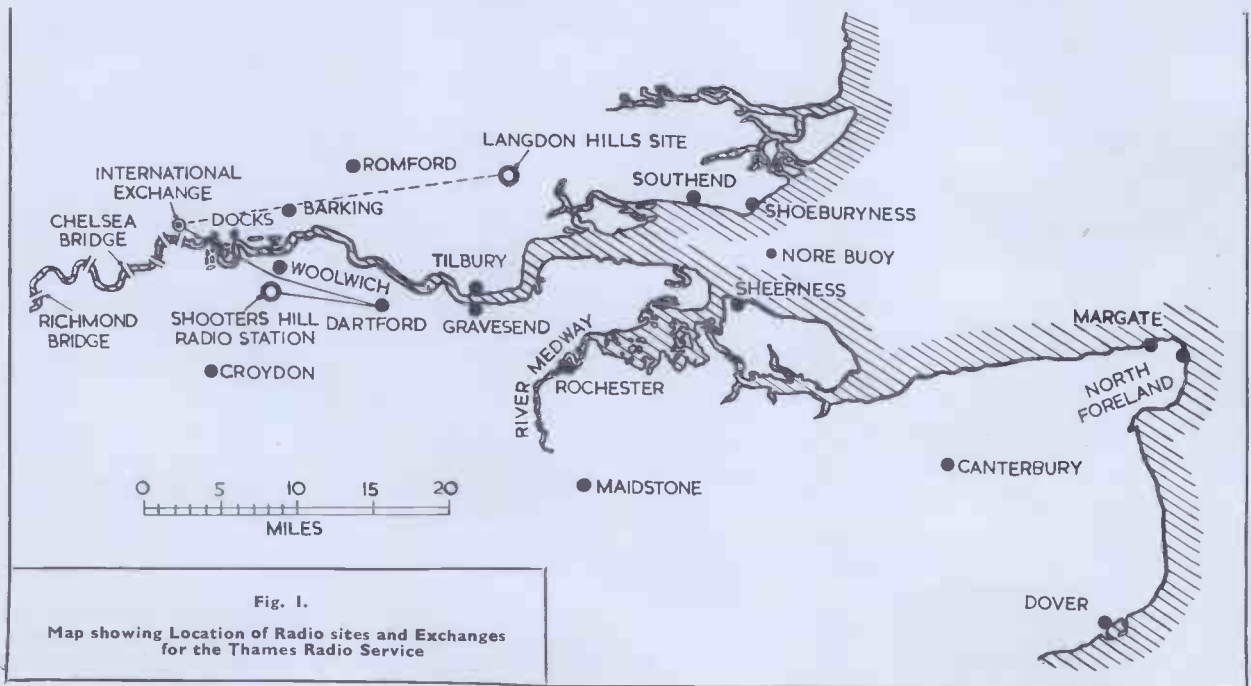

Fig. 1.

Map showing Location of Radio sites and Exchanges for the Thames Radio Service

amplifier to the receivers at ground level. The amplifier has a noise factor somewhat better than that of the receivers and, in addition, avoids the loss of signal in the feeders, thus giving valuable gain in performance in the ship-shore direction of the service.

As the transmitting aerials are within a few feet of the receiving aerials, it is necessary to insert filters in the feeders of the latter to prevent high voltages being applied to the receiving apparatus. Various types of filter have been examined for this purpose. An attenuation of approximately 30 db is required at frequencies 4 Mc/s. from the pass band, within which an insertion loss of more than 0.5 db becomes serious. Filters formed by cavities and coaxial lines give the best performance, but tend to be very bulky and expensive. The filters at present in use are of the lumped inductance-capacitance type and give a performance very close to the figures quoted above.

Various improvements to the receivers have been developed in the radio branch laboratories and, in conjunction with the pre-amplifier, the receivers now

squelch circuits. These, in effect, examine the quality of an incoming signal and pass it to the operator's switchboard only if it has a signal/noise ratio of 15 db or more. These circuits also control the calling lamp on the operator's switchboard, in conjunction with a relay set at the terminal, the lamp being illuminated two seconds after the first appearance of a signal from the boat. This delay prevents false calling, due to short bursts of electrical interference or static. The same circuits come into operation if, after a call has been established, the signal/noise ratio falls to less than about 14 db. This occurs if the mobile subscriber closes down or goes out of range. The audio output from the receiver is immediately prevented from reaching the terminal, and after five seconds' delay the operator's supervisory lamp is illuminated indicating that the call can be cleared down. The five-second delay in this case avoids false clearing if the signal from the boat fades for a short time.

The signal analyzer also maintains a constant check on the receiver performance. It will be appre-

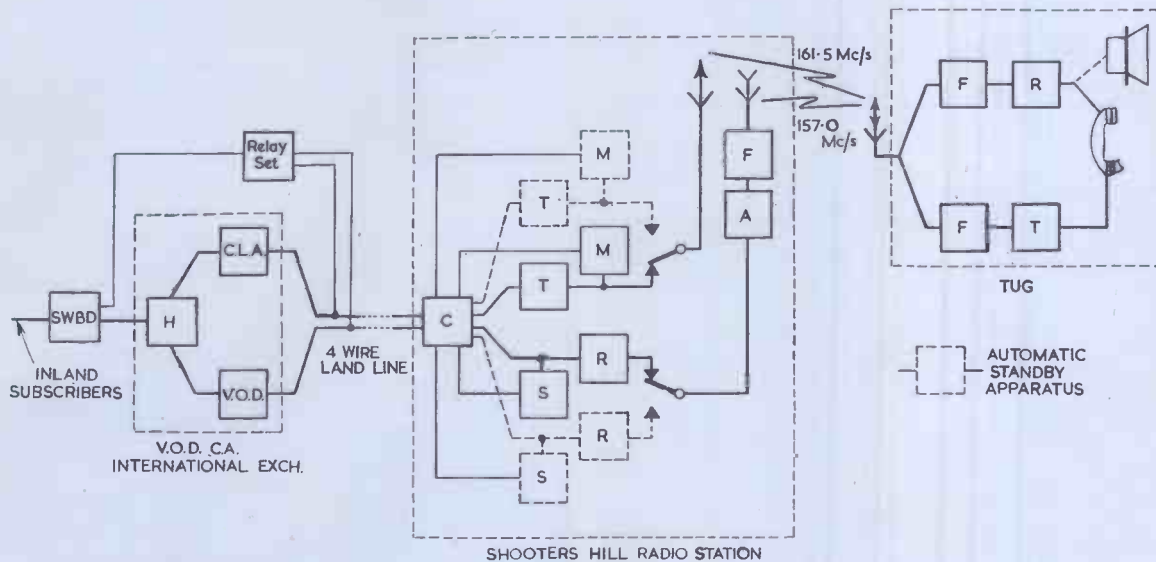

Fig. 2.

Block Schematic diagram of the equipment

SWBD—Switchboard. A—R.F. Amplifier. F—Filter. H—Hybrid. R—Receiver. S—Signal Analyzer. T—Transmitter. V.O.D.—Voice Operated Device. C.L.A.—Constant Level Amplifier

have a noise factor of approximately 5 db. Even with the simple aerials at present in use, their sensitivity is sufficient to give an average signal/noise ratio of 15 db on transmissions from 5 watt mobile equipments anything up to 40 miles away. The frequency stability and bandwidth are such as to allow ample margin for the rather less stable carrier frequencies of the boats, and at the same time ensure freedom from adjacent channel interference. The automatic gain control maintains the level at the receiver output constant within  $\pm 1$  db, irrespective of the strength of the incoming signal.

**Signal Analyzers**

Associated with each receiver is a unit called the signal analyzer. This has several functions, the most important of which relate to the muting or

ciated that if no signal is being received, the automatic gain control increases the receiver gain so that radio and valve noise appears at full level in the receiver output, even though the analyzer prevents its transmission to the terminal. If neither a signal nor noise appears at this point, the receiver is faulty and the analyzer passes a start signal to the automatic changeover gear.

The design of the analyzer also includes other functions which are mentioned later.

**Standby Equipment**

Throughout the system, duplicate equipment has been provided and at the radio station, which is, of course, normally unattended. Arrangements are included to bring this reserve apparatus into use automatically in the event of a fault. For each



The Transmitter/Receiver Unit of the ship's equipment

channel a control unit is provided and the appropriate four-wire circuit from the International Exchange terminates on it. The transmit pair is connected normally to the "main" transmitter and when the operator at the exchange inserts her answering or calling plug into the circuit, the associated relay set applies battery to the line and the H.T. contactor in the main transmitter closes. Simultaneously, the changeover circuit in the control unit prepares to operate. Associated with each transmitter there is a monitoring circuit which is, in effect, a very simple type of receiver. As soon as the transmitter carrier frequency appears, the monitor prevents the changeover in the control unit. If, however, the carrier wave fails, or falls more than 3 db below 50 watts, the control unit completes the changeover operation and brings the reserve transmitter into action. A coaxial relay is used to change over the transmitting aerial.

At the moment there is no standby power supply although this may be necessary when the system develops. There are common power units for relay circuits and alarms, and reserve units are provided with automatic switching in the event of failure.

When any part of the automatic changeover gear has operated, a non-urgent alarm is passed to the fault control, who then advise the maintenance officer. In the unlikely event of a failure of reserve equipment before normal working has been restored, an urgent alarm would be given.

#### Landlines

There is a four-wire circuit from Shooters Hill radio station to the apparatus room of International Exchange. Shooters Hill is seven miles from Wood Street Building as the crow flies, but the line was routed via Dartford so that the route mileage is approximately equal to that for the Langdon Hills site, which is 23 miles.

#### Mobile Subscribers

A typical mobile unit is illustrated opposite and both in layout and lineup is similar to mobile V.H.F. equipment such as is used in police cars. The use of frequencies near to 160 Mc/s. is, however, comparatively new, and the Thames Radio Service is the first mobile system in this country to use full duplex working with a common aerial for transmitting and receiving. The receivers are fitted with muting relays which are arranged to illuminate a channel engaged lamp in addition to the normal function.

The supply of power to the mobile equipment is in some cases rather a problem, as many of the tugs and other river craft wanting to use the service have no electrical equipment of any sort on board. There are, however, some very small steam-driven generators available and the possibility of using these is being considered. Where the boat already has an electricity supply the problem is relatively simple, as in most cases standard power units for A.C. or small rotary converters for D.C. can be employed.

At the present time loud-speaker calling is used and the speaker is fitted in the wheelhouse or bridge, together with the hand microtelephone and control box. In some designs the controls are incorporated into the actual transmitter/receiver units in which case the whole equipment is fitted in the wheelhouse. Generally, access to the actual transmitter and receiver is not required and it is convenient to install it in the engine room or other suitable space below deck.

#### Operating Procedure

The Thames Radio Service is available throughout the 24 hours, although the number of calls during the

River Service position at the International Exchange, Wood Street, London. Operator connecting a call from a subscriber to a ship



night is small. Boats keep their receivers in operation while they are on the move and at quaysides during the daytime.

If the crew of the boat wish to initiate a call they choose a moment when the channel upon which they work is free and lift the hand microtelephone from its hook. This disconnects the monitoring loud-speaker and brings the mobile transmitter into full operation. The calling lamp at International Exchange is illuminated and the operator then inserts her answering plug and announces "Thames Radio Service". The mobile subscriber then identifies himself, asks and waits for the number required.

Inland subscribers making a call to a boat ask for the service and are connected to the appropriate position at International Exchange. The operator then broadcasts a call for the boat required and when a reply is received the circuit is completed.

#### Monitoring Station

It often happens that the boats do not reply when the operator calls them. This may be due to several causes, e.g., the crew may have forgotten to switch on the receiver, or the boat may have moved out of range. A monitoring station has therefore been

set up to enable the operator to make a test call and so ensure that the service is functioning correctly. The station equipment is fitted in the apparatus room near the terminal rack and is operated by the test room staff, who initiate test calls periodically as a further check. This ensures that the quality of transmission and reception remains satisfactory. The aerials are mounted on the roof of the Wood Street building so that the working range is about seven miles.

#### Conclusion

The Thames Radio Service is likely to prove the forerunner of many similar systems, not confined to tugs and boats, but available to road vehicles and aircraft. The use of v.h.f. radio communication with vehicles is already regarded as indispensable by many organizations, such as police, fire, ambulance and taxi services, but these are private schemes without access to the telephone network, and are only economic for large groups of vehicles. It is envisaged that, within a few years, a network of v.h.f. radiotelephony schemes covering a large part of the country may be required, so that any vehicle or boat can have facilities for making a telephone call.

*This article is an extract from "The Thames Radio Service," by J. Neale, B.Sc.(Eng.), A.M.I.E.E., and D. W. Burr, A.M.I.E.E., published in the Post Office Electrical Engineers Journal (January 1950)*

*Permission to publish this abridged version and the diagrams, has been kindly granted by the Editor of the P.O.E.E.J., and the accompanying photographs appear by courtesy of the Postmaster General. They were originally reproduced in the Post Office Telecommunications Journal of May 1950.*

## V.H.F. EQUIPMENT FOR SOUND BROADCASTING

**A**LTHOUGH most of the B.B.C.'s programmes that originate outside the studios are sent over G.P.O. lines, v.h.f. radio links find occasional uses for broadcasting. Typical examples of the kinds of programme for which radio links are used are the commentary on the Boat Race and broadcasts from remote places to which no line link is available. For this type of work a 35-watt frequency-modulated transmitter is used. The carrier frequency on which this transmitter works is just below 30 Mc/s., but as soon as new equipment becomes available a change will be made to the 90-Mc/s. band.

A recent innovation in this field has been the introduction of a v.h.f. pack-set for B.B.C. commentators. At many outside broadcasts, such as golf matches or race meetings, the commentator's freedom of movement is hampered by the trailing lead from his microphone to the point at which the amplifiers are installed. In order to free the commentator from this restraint, a pack-set, consisting of a transmitter and a receiver which he carries on his back, has been developed and is now in production. Equipped with this set the commentator can mingle freely with the crowds, while his comments are picked up at a receiving point nearby and then

sent on, probably by G.P.O. line, to the nearest B.B.C. studio centre.

The pack-set transmitter is frequency-modulated and operates in the 90-Mc/s. band. Its power output is about 1 watt with a frequency response that is sensibly uniform from 50 c/s. to 6 kc/s. It is battery operated, an accumulator being used for the filament supply and a 250-volt mercuric oxide battery for h.t. supply. The capacity of the batteries is sufficient for three hours continuous running, which is more than adequate for the broadcasts on which the set is used. A quarter-wave whip aerial plugs into the top of the transmitter case.

The receiver, which is mounted alongside the transmitter, enables the commentator to receive cues and information from the engineer at the control point, which is equipped with a small amplitude-modulated transmitter. This link operates at present in the 70-Mc/s. band.

Every effort has been made to keep the weight of the pack-set to a minimum without sacrificing quality or range. The transmitter, complete with its batteries, and the harness weigh only 17 lb. The cueing receiver, which is usually carried as well, weighs another 9 lb., giving an all-up weight of 26 lb.



## A Survey of V.H.F. Valve Developments

*This article is based on information kindly supplied by the Mullard Valve Measurements and Applications Laboratory, and the Mullard Vacuum Physics Laboratory*

**T**HE rapid advances in communications, radar, television and other V.H.F. systems that have been made during recent years have been largely dependent upon the development of a wide variety of entirely new valves specially designed for operation at V.H.F. and U.H.F. frequencies. In the design of these valves a compromise has had to be made between such conflicting factors as cost, physical size, power consumption, useful output power, and the requirements of high conversion efficiency, reasonably low H.T. voltages and minimum driving power. In order to meet these requirements it has been necessary to depart from many of the design practices and manufacturing techniques employed before the war.

In this article it is intended to deal briefly with the principal difficulties encountered in the development of these valves, and then to make a survey of the types at present available for use in V.H.F. communication systems.

### Basic Design Considerations

The upper frequencies at which ordinary valves can operate are limited by three principal factors as follows:—

1. The transit time of the electrons.
2. Undesired couplings caused by capacitances and self-inductances.
3. General losses, such as dielectric losses in the glass, and resistive losses in the electrode connexions and in the electrodes themselves.

### Transit Time

It is well known that the flow of electrons from the cathode to the anode in a conventional valve is controlled by the instantaneous potential difference existing between the grid and cathode.<sup>2,3,4,5</sup> Now since it takes a finite time for a bunch of electrons to move across the space from cathode to grid on the way to the anode, it follows that, in order to maintain normal operation, the control voltage should remain on the grid during this transit time. When a valve is operating at high frequency, however the r.f. drive voltage may be falling towards the cut off point, while the electrons are still moving towards the anode.

Many of the energized electrons do not, therefore, reach the grid but find their way back to the cathode. As a result of this the following important effects appear:—

1. "Back-heating" of the cathode.
2. Increased loading of the control grid circuit.
3. Debunching of the pulses of anode current, reducing mutual conductance.

The transit time effect is sometimes known as "transit loss" or "transit angle", the latter referring to the vectorial relationship between the current flow and the grid voltage. The transit angle increases as the square of the frequency. This means that

as the frequency is increased the power gain per stage becomes progressively smaller, until a point is reached where it is uneconomical to use valves of conventional design. For example, in a particular tetrode the grid drive power at 3 Mc/s. is 150 mW, while at 180 Mc/s. it increases to well over 1 watt.

The most obvious way of shortening the transit time is to reduce the spacing between the electrodes. The spacing between the cathode and grid is especially important, because the electron velocity here is low, and the time taken for the electrons to traverse this space is therefore relatively high.

### Capacitance Effects

A particular problem resulting from the reduction in electrode spacing is that the inter-electrode capacitances are immediately increased. In order to overcome this difficulty it has been found necessary to reduce the area of the electrodes and their supporting pins. This modification in itself is of no value unless adequate means are provided for protecting the grid and anode from over-heating. In the design of a number of V.H.F. valves this problem has been successfully overcome through the judicious choice of materials, and the use of special coatings such as carbon and zirconium which assist radiation. Electrode cooling is also assisted by the use of lead-out rods specially designed to provide good conduction to the external terminals. These, in turn, are shaped to give maximum radiation, and sometimes forced-air cooling is employed.

This composite problem—involving the use of close electrode spacing to reduce transit time, small areas to limit the capacitance, efficient cooling to permit reasonable power handling capacity and short structure to reduce self-inductance—led to the production by R.C.A. of the V.H.F. tetrode 8D21. In this valve the anode and the supports for the grid and screen consist of hollow boxes with special tubular lead-outs to provide for water-cooling actually within the valve envelope. Valves of this type meet the demand of 5 kW peak output for television transmitters operating at frequencies within the region of 256 Mc/s.

### Inductance Effects

Another important factor limiting the operating frequency of conventional valves is the inductance of the connexions between the electrodes, and more especially the lead-out connexions to the external circuit. These inductances, together with the capacitances of the leads and the electrode system, have to be considered as part of the L-C circuit. As a result of this, the external circuit is affected when it is required to operate the valve at a specified frequency. Where lead inductances have been reduced to the absolute minimum, the fixed inter-electrode capacitances take control, and a frequency is reached such that the inductance required to



produce resonance is so small that it is impractical to couple the valve to the load.

In the design of valves for v.h.f. work, the inductance of the electrodes is kept down to a minimum by employing a short, "squat" assembly. The lead inductance and resistance is also reduced through the use of short, thick leads. In order to improve the r.f. conductivity, the leads are often plated with copper, silver or gold. In the design of large valves this, however, tends to increase the conduction of heat to the seals, and in order to compensate for this the terminals have to be massive.

#### Losses

In operating conventional valves at high frequencies a condition is reached where the oscillatory current flowing in the valve leads gives rise to considerable resistive losses. In order to avoid overheating of the seals due to this cause, it is necessary to reduce the valve voltage rating. An additional loss of power can occur through dielectric heating of the glass envelope. The principal parts affected are those located between conductors at high potential differences, both within the valve and between the valve and chassis. For this reason it is common practice to keep the grid and anode terminals of high-frequency valves as far apart as possible.

#### Twin Valves

In the driven amplifier stages of v.h.f. circuits the inductance of the cathode lead-out connexion is particularly troublesome. The reason for this is that it forms an impedance common both to the grid and anode circuits. This causes not only a simple series drop of some of the driving voltage, but also a measure of negative feed-back from the anode current pulses, a defect which can only be off-set by increasing the drive power even further.

The solution to this problem was found in the twin tetrode valve. In valves of this class the separate electrode assemblies are mounted in a common envelope, and the two cathodes are joined by means of a low-inductance strip. Used in a balanced or push-pull circuit, such valves require no flow of r.f. current through the external cathode connexions, the current flowing in the valve pins being confined to d.c.

Valves of this class are typified by the well-known QQVO7-40 (829B) tetrode, illustrated in Fig. 1, which is widely used in a large variety of commercial v.h.f. communication equipments.

By careful design of the screening between control-grid and anode, this valve has a low anode-grid capacitance. It gives an output power of between 60 and 70 watts at 200 Mc/s., while the maximum operating frequency for reduced input is 250 Mc/s.

In order to reach frequencies of 200 Mc/s. and upwards it is essential to use transmission lines as resonant circuits, and it is important to note that modern twin valves are specially shaped for use with lecher lines.

In the double tetrode QQVO6-40 illustrated in Fig. 2 the twin assembly principle is extended a stage further to provide a common heater and cathode, separate planar control grids, and two planar anodes. The planar control grids are placed one on each side of the cathode, and the complete group is surrounded by a common screen grid. This

is illustrated in Fig. 3, which shows in diagrammatic form a plan view of the electrode assembly of the QQVO6-40. As a result of this new form of construction it has been possible still further to increase the operating frequency. For example, the QQVO6-40, which has a similar rating to the QQVO7-40 (829B) previously mentioned, has an upper frequency limit of over 500 Mc/s. and a maximum output of 40 watts at 300 Mc/s.

#### All-glass V.H.F. Power Valves

During recent years a considerable amount of work has been carried out, especially in Holland and America, on a series of hard-glass valves in which the electrodes are arranged as concentric cylinders, and all leads are kept very short. With this form

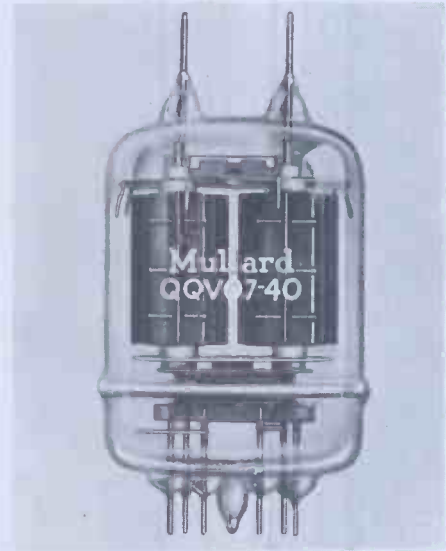

Fig. 1.  
The QQVO7-40 (829B) Double Power Tetrode  
( $\frac{1}{8}$ th actual size)

of construction it has been possible to produce v.h.f. valves of remarkably small size, yet providing relatively high powers.

Typical of valves of this type at present available in this country are the two illustrated in Fig. 4, and typical operating conditions for selected types are given in Table 1.

In these valves the electrodes are mounted on the terminal pins which are fixed in a moulded glass base. The anodes are made of zirconium-impregnated graphite resulting in small dimensions for their rated dissipation. The screen grid of the QY3-125 is mounted on a horizontal disk which extends right up to the envelope, so providing effective shielding of the input terminals from the anode. This removes the need for neutralization of the grid-to-anode capacitance. Two of the base pins which connect to this shield provide a low inductance connexion from the screen-grid to the external circuit. A similar disk, with three base pins, is used in the TY2-125 for the control grid. This valve is thus well suited to grounded-grid (inverted amplifier) applications. The resultant filament-to-anode coupling is only 0.1 pF.

The thoriated-tungsten filaments used in these valves are wound in the form of a double helix, thus reducing hum.

The **TY2-125** is a triode rated to dissipate 135 watts at the anode. It has a maximum operating frequency at full ratings of 150 Mc/s., while the maximum frequency at reduced ratings is 200 Mc/s. This valve is designed for use as an R.F. or L.F. amplifier or oscillator and for use in grounded-grid amplifiers.

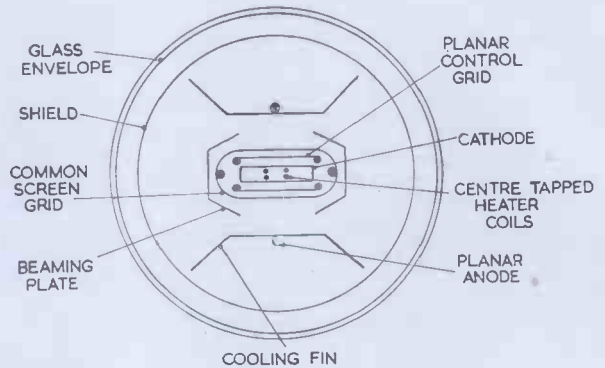

Fig. 2.  
The **QAVO6-40**  
Double Power Tetrode  
( $\frac{1}{4}$ th actual size)

Fig. 3 (right).  
Cross section of electrode  
assembly of the  
**QAVO6-40**

widely used in the U.S.A. in two-way taxicab radio systems operating on the 152-162 Mc/s. band.<sup>8</sup> Sub-miniature valves have also found certain applications in v.h.f. communication systems, and their use in this field will probably increase.<sup>9</sup>

Other important valves in this group include the directly-heated triode **DC80** and the indirectly-heated triodes **EC80** and **EC81**. In these valves the electrode system is mounted on the connecting pins, which are moulded into a flat glass base. The leads are thus very short and the inductance is greatly reduced. The chrome-iron base pins as well as the nickel connectors between the pins on the electrodes are silver-plated to reduce R.F. resistance. The electrodes themselves are very small, being less than  $\frac{1}{2}$  in. high. This allows closer spacing without excessive capacitance. The resulting reduction in the transit time enables the valves to be operated at frequencies up to 750 Mc/s. The use of fins on the anodes has enabled dissipations up to 4 watts to be obtained. These valves, which are provided with standard noval bases, are suitable for lower-power applications on decimetric waves, for example, Business radio, radio links, measuring instruments. etc.



The **QY3-125** is a tetrode having a maximum anode dissipation of 125 watts and is capable of providing a power gain of 150. Used as a single R.F. power amplifier, this valve is suitable for use up to 200 Mc/s.

**Small All-glass Valves**

Some interesting work has also been carried out on the design of small all-glass valves for operating at v.h.f. frequencies. A particular valve in this group is the miniature **6AK5** pentode which has been

**Disk-Seal Construction**

In the design of valves for operation above 600 Mc/s. an even more radical departure from conventional design principles is required.<sup>10,11</sup> This will be appreciated by the fact that as the frequency is increased the troubles due to electrode-lead inductance and transit time become more acute. This difficulty has been overcome by a form of construction whereby the valve becomes an integral part of the circuit. Typical of this form of construction is

**TABLE I**

Typical operating conditions (Class C Telegraphy) of a selected range of hard-glass valves

Type	(Mc/s.)	V <sub>a</sub> (V)	V <sub>g2</sub> (V)	V <sub>g1</sub> (V)	I <sub>a</sub> (mA)	I <sub>g2</sub> (mA)	I <sub>g1</sub> (mA)	v <sub>in</sub> (pk) (V)	P <sub>out</sub> (W)	η%	P load approx. (W)	Max. f 30% Eff. (Mc/s.)
TY2-125	150	2500	—	-200	200	—	40	350	360	72	290	250
TY3-250	70	3000	—	-250	373	—	70	420	850	76	689	150
TY4-500	70	4000	—	-350	550	—	100	625	1670	76	1330	130
QY3-125	120	3000	350	-150	166	35	10	280	375	75	300	250
QY4-250	80	4000	500	-225	312	50	8	315	970	78	780	160

a series of disk-seal valves which were developed during the war for use in radar equipments and which have since found certain applications in U.H.F. communication systems. The basic design features of valves of this class are illustrated in Fig. 5 which shows a cross-sectional view of the well-known disk-seal triode cv.273. It will be seen from this that the pins or terminals used in conventional valves for connecting the internal electrodes with the external circuit, are in this valve replaced by flat rings, sealed directly in the bulb.

The disk-seal valve is not limited to the planar construction, being often used in conjunction with electrodes of cylindrical shape. This configuration is commonly found in high power disk-seal valves, and the basic form of construction is illustrated in Fig. 6.

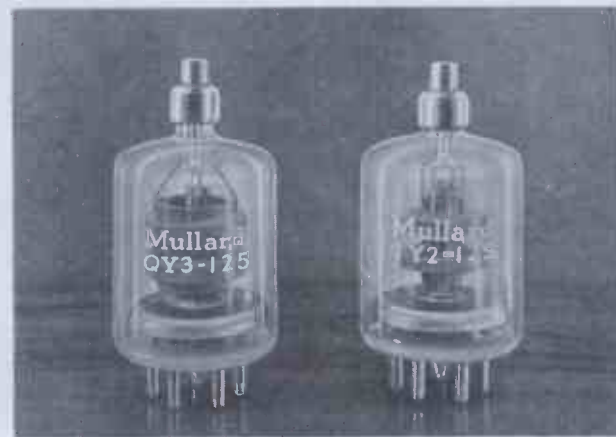

A wide range of disk-seal triodes has been produced both in this country and in America having various power-handling capacities both as oscillators and amplifiers. Many of these types were originally developed for military purposes but are now available for commercial use. One marked difference between British and American designs, lies in the fact that the Americans have almost exclusively used steel sealing alloys for their disks, while in this country copper has been used to a great extent. This matter can be of considerable significance in valve design especially as it effects the heat generated in the glass seal by high frequency circulating currents.<sup>15</sup> For instance, it can be shown that for a Kovar disk seal the maximum permissible circulating current at a frequency of 300 Mc/s. is 9.5 amps. per cm. diameter. The equivalent figure for copper is 54 amperes per cm. diameter. This

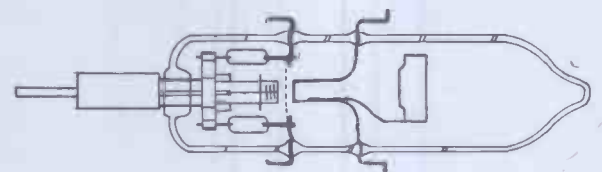

Fig. 4 (left).  
Two typical power valves in the hard glass V.H.F. range (about 1/3 actual size)

In order to use the highest frequencies at which a particular disk-seal valve can operate, it is usual to employ low-loss resonant cavity or coaxial line circuits.<sup>10</sup> Fig. 7 shows a typical coaxial-line oscillator circuit of the common-grid, grounded-anode type,<sup>12</sup> with the valve inserted (in this case a cv.273).

**Advantages of Disk-Seal Valves**

Apart from providing low-loss and low-inductance connexions, the disk seal type of construction has many incidental advantages. For example, the electrodes can be cooled very efficiently by conduction through the disks. This reduces grid emission problems and enables a high anode dissipation to be obtained in a valve of small dimensions. In lower powered valves where the electrodes are of planar construction, it also becomes possible to set the electrode clearances accurately at very low values with the result that good valve performance can be achieved at even higher frequencies.

For their size, disk-seal valves normally have very low inter-electrode capacitances, and it is not unusual for such valves to be used on account of this property alone. For instance, disk-seal valves are sometimes used at relatively low frequencies in broad-band communication transmitters. In such applications their low anode-grid capacitances permit loading for a large bandwidth, enabling several channels to be covered without the necessity of retuning the circuits.

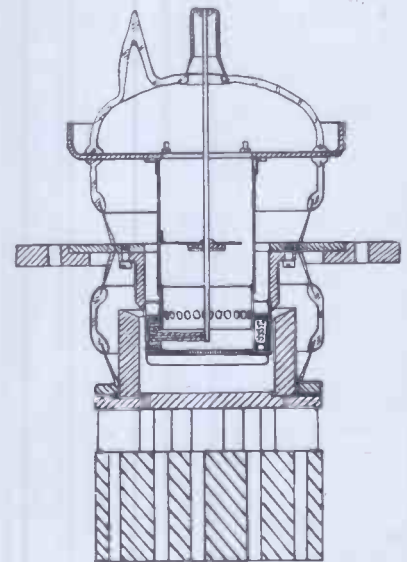

Fig. 5 (top)  
Cross section of the CV273 disk-seal triode

Fig. 6  
Cross section of the CV288 disk-seal triode

consideration has caused much work to be done on the development of special running alloy-glass seals, which usually take the form of high-conductivity plating, super-imposed upon the base metal before sealing into the glass.

Although it is not within the scope of this article to provide a complete catalogue of available disk-seal valves, the general trend of the present range is indicated in Table 2.

### Disk-Seal Tetrodes

To date there has been relatively little development of the disk-seal tetrode. The principal advantage of the tetrode is that high power amplification can be obtained per stage, and consequently fewer stages are required—an important point in many applications where overall size and weight of equipment are concerned.<sup>14</sup> Nevertheless, the disk-seal tetrode may have serious disadvantages compared with its triode counterpart involving such considerations as neutralizing, modulation and physical geometry of its associated circuit. The justification for the use of a tetrode in any one position can be decided for that particular case alone.

Among disk-seal tetrodes currently available are the American 4X150A (150-watt dissipation) and the British E1824 (100-watt dissipation). It is possible that a range of disk-seal tetrodes will eventually be developed to provide a complete series of amplifiers and drivers with powers ranging from a few watts to a few kilowatts for use at frequencies up to 600 Mc/s.

### The CV 273 Disk-Seal Triode

Although there is a fairly well defined lower frequency boundary at which disk-seal types take

over from conventional valves, there is, however, a continuity of available types which make it possible to cross the boundary without difficulty, according to requirements.

At the higher frequency end of the disk-seal range, however, there is a definite limit which, for the moment cannot be passed for lack of available valves which operate at still higher frequencies. It is probably true to say the cv.273 triode represents the maximum in frequency performance in a currently available type, yielding about  $\frac{1}{2}$ -watt at 3,000 Mc/s. (10 cm.) and a few milliwatts at frequencies up to 5,000 Mc/s. (6cm.). This valve therefore is of considerable interest and its characteristics are given more fully in Table 3.

### Still Higher Frequencies

The application of disk-seal triodes at frequencies beyond their present capabilities is an ever present demand and the extent to which this demand is being met is a measure of the development of the valve makers art. From a specification of the valve required, involving performance at a certain frequency with a specific high gain and low noise factor as an amplifier, it is possible to deduce the physical requirements of the construction. These

TABLE 2  
Characteristics of Selected Range of Available Disk-Seal Triodes

A = American ; B = British ; C = Convection or Conduction Cooling ; F = Forced-air cooling.

Valve Type No.	Origin	Type of Cooling required	Max. Anode Voltage (Volts)	Max. Anode Dissipation (watts)	Typical R.F. Output (Watts/at Freq. in Mc/s.)	Mutual Conductance (mA/V)	Amplification Factor	Capacitances		Remarks
								g-k (pF)	a-g (pF)	
CV273	B	C	350	10	0.5/3000 3.0/1000	6	30	2.2	1.1	—
2C40	A	C	450	5	0.2/3000	4.8	36	2.1	1.3	—
CV354	B	C	350	5	—	6.5	70	2.2	0.9	Amp. with following power gains : 2000 Mc/s. 11.5 db 1500 Mc/s. 13.5 db 1000 Mc/s. 15.0 db
5588	A	F	800	25	65/1000	—	16	13.0	6.0	—
CV397	B	C	400	20	14/750	12	33	4.8	1.9	—
VP20	B	C	500	25	17/750	12	30	5.0	2.0	—
CV257	B	F	600	75	110/600 90/750 60/100	20 approx.	23	15.0	6.0	—
VPI00	B	F	600	100	110/600 90/750 60/1000	20 approx.	23	15.0	6.0	Tentative data
CV288	B	F	1000	250	300/600 250/750 150/1000	—	42	21	17	—
4X150A	A	F	1000	150	—	15	—	21.1	4.6 (output)	Tetrode
2C39	A	F	1000	100	20/400	17	100	6.5	1.95	—

TABLE 3

Characteristics of the Disc Seal Triode CV 273

	CV 273
Heater Voltage (V)	6.3
Heater Current (A)	0.4
Max. Anode Voltage (V)	350
Max. Anode Dissipation (W)	10
Max. Anode Current (mA)	50
Max. Peak Anode Current (mA)	150
Power Output (W)	0.5 (at 3,000 Mc/s.) 3.5 (at 500 Mc/s.)
Mutual Conductance (mA/V)	6
Amplification Factor	30

briefly are as follows:—

- (a) small clearances between electrodes, and low transit times.
- (b) uniform cathode emission at a high optimum current density with avoidance of variation in transit times.
- (c) finer grids.
- (d) lower losses in dielectrics and seals.

That the required techniques are gradually being developed is demonstrated by the recent announcement in America of the triode BTL416A which has a gain of 5 db, with 500 milliwatts output at a frequency of 4,000 Mc/s.<sup>15,16</sup> This high performance is achieved with the use of an extremely fine cathode coating, with a carefully polished surface. The grid-cathode spacing is only 0.0006-in., and the anode grid spacing only 0.010-in. During this development work new methods had to be evolved for winding at high tension a grid of 0.001-in. pitch, using wires of no more than 0.0003-in. in diameter. The clearances required are so small that the assembly has to be performed in an air-conditioned atmosphere to avoid the risk of interference by dust particles.

A further development along the same lines is the Phillips 14EC triode, which has dimensions of the same order although the method of achieving them is considerably simpler. A notable feature here is a complete departure from normal cathode techniques. The emissive surface consists of a highly polished porous tungsten pellet through which the active elements diffuse from a reservoir at the rear. The advantages of this type of cathode are: relative ease of construction, long life with high current densities available, and the avoidance of an oxide layer at the surface with resultant reduction in noise. When the 14EC is used as a pre-amplifier in front of a 10 cm. receiver consisting of crystal and i.f. stages with 6 Mc/s. bandwidth, the overall noise figure is improved by 5 db.

Future Trends

To judge from the progress of present work, there is a high probability that the disk-seal triode will eventually be made to operate at wavelengths as low as 3 cm. Clearances will have to be reduced still further and finer grids will have to be employed. However, it is probable that grids can be made

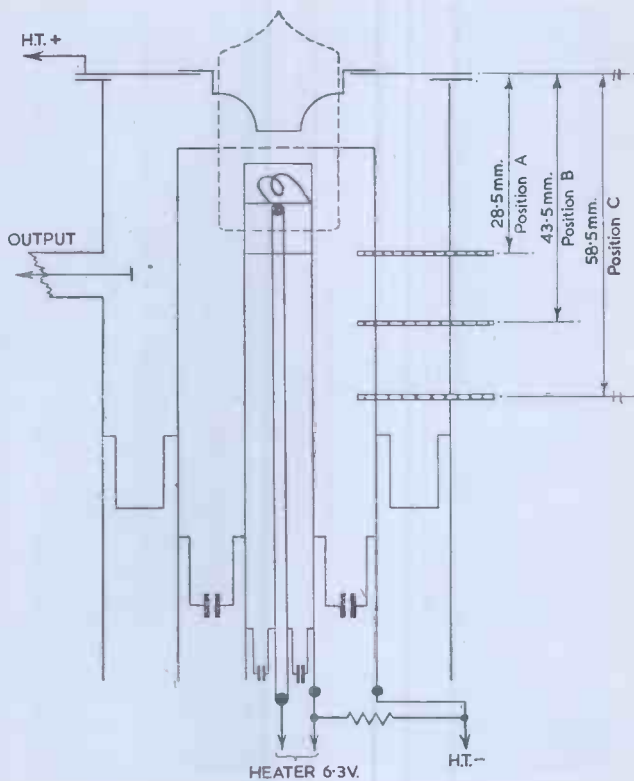

Fig. 7. Coaxial line oscillator using a CV273 Triode

using wire diameters down to 2 microns and less in diameter (25 microns = .001 in.) and this may present no difficulty. There will undoubtedly be competitive types of valves available for use at these short wavelengths, for example, the travelling wave tube and the klystron, each with its own particular advantage for specific applications.<sup>17</sup> Nevertheless, it is likely that in the not too distant future the simple disk-seal triode will come into its own to simplify some of the outstanding communications problems.

References

- 1 W. H. Aldous, "Transmitting Valves for Communication on Short Wavelengths." *Journ. Brit. I.R.E.*, Sept., 1947.
- 2 F. B. Llewellyn, "Electron Inertia Effects." Cambridge University Press, 1941.
- 3 W. R. Ferris. *Proc. I.R.E.*, Jan., 1936.
- 4 D. O. North. *Proc. I.R.E.*, Jan., 1936.
- 5 Begovich. *Proc. I.R.E.*, Nov., 1949.
- 6 F. E. Terman. *Radio Engineering*, 3rd. edition. McGraw-Hill. p. 403.
- 7 E. G. Dorgelo, "Glass Transmitting Valves for High Efficiency in the 100 Mc/s. range." *Philips Tech. Review*. Vol. 10, No. 9. Mar. 1949.
- 8 Samuel Freedman. "Two-way Taxicab Radio System." *Communications*, Feb., 1948.
- 9 Eugene A. Falley, "400 Mc/s. Oscillator with Sub-miniature Tube." *Electronics*, May, 1949.
- 10 J. Bell, M. R. Gavin, E. G. James and G. W. Warren: "Triodes for very Short Waves." *Journ. I.E.E.*, Part IIIA, 1946.
- 11 R. R. Law, "A Survey of the Performance of U.H.F. Triodes." *Proc. I.R.E.*, March, 1949.
- 12 Van d. Ziel, "Theory of Grounded-grid Oscillators." *Philips Research Reports*. Vol. No. 5, Nov., 1946.
- 13 R. H. Rheume. Cathode Press, Winter, 1949.
- 14 W. C. Wagneer, "Design Conditions for 500 Mc/s. Tetrodes." *Proc. I.R.E.*, p. 611, May, 1948.
- 15 J. A. Morton, "B.T.L. Triode 416A." *Bell Laboratory Record*, May, 1949.
- 16 "New Triode for Centimetre Waves." *Nature*, July 23rd, 1949.
- 17 F. M. Penning, "Transmitting Valves for Decimetre and Centimetre Waves." *Communication News (Philips)*. Vol. X, No. 4, April, 1950.



## The Metropolitan Police Radio Communication System

By E. C. BROWN

(Wireless Engineer, Metropolitan Police, London).

THE possibility of using wireless for Police purposes was considered in the early part of 1922, when several small demonstrations were given using a fixed station and a receiver fitted in a motorcar. These early experiments necessitated the use of an elevated aerial which sometimes took the form of a fishing rod and at others a length of wire thrown over a tree.

It soon became evident that the Metropolitan Police would have to acquire their own equipment if development were to proceed, and in 1923 an aircraft transmitter was installed in a police tender. The aerial was carried in a frame mounted on the roof of the tender and capable of being raised to a maximum height of 6 ft. above it. The transmitters used at headquarters and on vehicles were modulated self-oscillators with provision for I.C.W. working. The receivers comprised loose coupled tuners with aperiodic H.F. amplifiers. Tests were carried out on R/T and I.C.W., and later on C.W. was tried: the use of the latter being finally decided upon. Original wavelengths were in the neighbourhood of 700 metres, and subsequently 145-150 metres. Elevated aerials on tenders disappeared in due course and were replaced by copper

gauze suspended from insulators fixed to the inside of the roof.

The use of wireless-telegraphy equipment was confined to mobile units and was first installed in vehicles of the Criminal Investigation Department of New Scotland Yard. These vehicles were popularly known as the "Flying Squad" and received messages from a headquarter station at the Yard. The first operational use of two-way w/t equipment was on the occasion of the Epsom Races Spring Meeting, in 1923.

Thereafter and until 1932 w/t was employed in this limited manner. In that year it became apparent that the number of cars equipped with wireless would have to be increased and the employment of these vehicles would have to be more general in the Metropolitan Police to meet the demands of those times. After a series of tests, the use of w/t was confirmed, and in 1933 it was decided to go ahead with the equipment of certain C.I.D. cars, called "Q" cars, and with cars of the Traffic Patrol. In the following year a scheme was inaugurated organizing the whole of the wireless equipped fleet under central control from the Information Room at New Scotland Yard (see

photo), which was also the focal point in the Metropolitan Police telephone and teleprinter networks. The effect of the scheme was that the whole of the Metropolitan Police District was patrolled in areas, throughout the day and night, by police vehicles fitted with wireless.

The receivers used during this period had two stages of H.F. amplification, detector, and one L.F. stage. For use on open cars the aerial, consisting of several strands of insulated wire, was attached to the underside of the hood, which was kept up. The sets were carried in cases made to match the car upholstery.

Various types of aerials were tried for use on steel-bodied saloon cars, but results were poor and finally fabric topped saloons were adopted. The aerial consisted of several lengths of insulated wire threaded through the wooden struts between the fabric top and the head lining. With the use of superheterodyne receivers, however, it was possible to use steel-bodied saloons with a fabric insert in place of the sliding roof. The aerial consisted of a sheet of copper gauze fitted between the fabric insert and the roof lining.

During the earlier stages the headquarter transmitting and receiving equipment was installed at Scotland Yard. The transmitter used in 1930 had an input of  $\frac{1}{2}$  kW to two T250 oscillator valves working in parallel. The circuit was a high C Hartley.

The limitations of Scotland Yard as a site for a headquarter station soon made themselves felt. Electrical interference to reception grew rapidly worse and the low effective aerial height limited range. Attention was therefore drawn to the desirability of obtaining more suitable sites for transmitting and receiving stations which could be remotely controlled from Scotland Yard.

Tests indicated the suitability, for medium frequency service, of a site in the Denmark Hill district for a receiving station; and one on the southern outskirts of London, at West Wickham, for a transmitting station. The stations were built and put into service in 1936 and 1937 respectively. Three transmitters were installed, with a power of 1 kW; one incorporated a Franklin master oscillator and two were crystal controlled. To cover the possibility of a failure of the land-line system used for remote control, a V.H.F. wireless link was provided.

Before the commencement of the war, consideration was given to the maintenance of communications between Scotland Yard and the principal police stations in the event of air raids, during which dislocation of the telephone system might be anticipated. Tests were instituted accordingly and it was demonstrated successfully that a V.H.F. radio-telephony service in the vicinity of 80 Mc/s. would fulfil the requirements. A duplex system was accordingly installed at 87 police stations and maintained an excellent service with Scotland Yard throughout the "blitz" periods when other means of rapid communication were often out of the question for extended periods.

#### Planning the R/T System

In 1943 work started on planning an R/T system on V.H.F. to replace W/T. The Metropolitan Police district covers an area of 735 square miles, situated

within a radius of approximately 15 miles from Charing Cross, and for the most part heavily built up. Two-way communication was required between Scotland Yard and vehicles in any part of the area, together with patrol launches on the river between Twickenham and Erith. The frequencies to be employed were in the 80-100 Mc/s. band.

The first problem was to find a suitable site for a headquarter station, which should be on high ground as near to the centre of the area as possible. A mobile headquarter station was prepared, consisting of a 100 watt transmitter and a receiver in a van; together with a turntable ladder, kindly loaned by the National Fire Service, to raise the aerial. Wherever possible power was obtained from the supply companies' mains, but a petrol-electric generator was available for use where a supply from the mains was unobtainable. A car, fitted with mobile equipment, patrolled the district, covering standard test runs which sampled the whole area. The best sites were found to be Hampstead and Forest Hill; the latter was chosen for the headquarter station.

The next consideration was to determine which system, A.M. or F.M. should be adopted. This is a controversial subject which never fails to invite heated argument; it should therefore be stressed that the question was approached with an open mind, and that the choice was made purely with a view to provide the best means of fulfilling the particular requirements with equipment then available. The service requirement was straightforward; solid two-way cover over the entire district permitting messages to be exchanged between mobile units and a single H.Q. station remotely controlled from Scotland Yard.

Two transmitters, one A.M. and one F.M., each with an R.F. output of 100 watts, were installed at the fixed site. Arrangements were made for either of them to work into a common aerial and feeder system; together with their appropriate receivers. The test car carried mobile equipment for both systems, permitting rapid comparisons to be made. It was found that the F.M. equipment provided solid two-way cover over the entire district, whereas A.M. failed to provide complete cover in the outer parts of the district. It was therefore decided to proceed with the planning of the system on the basis of using F.M. equipment.

Owing to the prospect of delays due to supply difficulties, however, a limited V.H.F. R/T scheme was got going with such equipment and facilities as were already available, or quickly obtainable. A 100 watt A.M. station was set up at the existing W/T receiving station at Denmark Hill, where a 100 ft. lattice mast was available on ground 100 ft. above sea level. It was remotely controlled by line from Scotland Yard Information Room, and gave a service to about 20 cars operating in the inner Divisions. The scheme was single-frequency Simplex in the 80 Mc/s. band.

#### Present R/T System

The scheme provides for a two-way radio telephony service between New Scotland Yard and some 200 vehicles which deal with crime, traffic and matters

relating to ordinary police patrol work. Thirteen launches of the River Thames Division also participate in the scheme.

At the present time two main channels of communication are used, on separate frequencies. A subsidiary channel is also used on special occasions such as demonstrations, processions, political meetings, etc., and for communicating with a fleet of vehicles used exclusively on these occasions.

The scheme as planned will eventually include four main channels and two subsidiary channels.

**Main Station Equipment**

In planning the main station it was decided to develop a system of co-axial filters to enable the separate transmitters to feed into a common wide-band aerial, thus avoiding the necessity of providing a large number of aerials. A similar system, suitably modified, has been developed for the receivers.

A diagrammatic representation of the system, showing two transmitters in use, is given at Fig. 1. Transmitter A, operating on frequency  $f_1$ , is coupled to its filter by a coaxial cable of any convenient

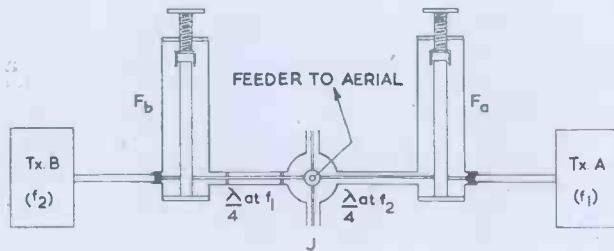

Fig. 1.

Filter system enabling separate transmitters to feed into a common wide-band aerial

Fig. 2. (right).

Headquarters transmitters with associated filter system

length, the filter being coupled to the junction box J via an air-spaced coaxial line which, for the present, we will assume to have an electrical length of  $\lambda/4$  at  $f_2$ , the frequency of the transmitter B. Transmitter B is coupled to J in a similar manner, with the exception that the quarter-wave line between its filter and J has a length of  $\lambda/4$  at  $f_1$ . The characteristic impedance of all feeder cables and quarter-wave lines is 72 ohms.

The filters, which have a high Q, will present a very high impedance at resonance, and a low impedance at the frequency of an adjacent channel. The operation of the system is as follows:  $F_a$ , tuned to  $f_1$ , presents a high impedance in shunt with the output of transmitter A, which thus delivers power via the  $\lambda/4$  section "a" to J without appreciable loss. At J two alternative paths exist, one via the aerial feeder, and the other via  $\lambda/4$  section "b," which has an electrical length of  $\lambda/4$  at  $f_1$ .  $F_b$ , being tuned to  $f_2$ , will appear as a virtual short circuit to  $\lambda/4$  section "b" at  $f_1$ , and will thus present a high reactive impedance at J. The

greater part of the R.F. energy from transmitter A will therefore pass to the aerial feeder. Transmitter B and its associated filter system will likewise deliver its energy to the aerial system with little loss.

When, as in the case of the system installed at the Forest Hill station, more than two transmitters are used, it is not possible to make the  $\lambda/4$  sections of the exact length to correspond with the frequencies of the remaining transmitters. All sections are therefore related to the mid-frequency of the band. In spite of this compromise, however, the loss is of the order of 10 per cent only. The complete filter system is illustrated in Fig. 2, which also shows two of the 250 watt transmitters, one operational and one stand-by; associated with one of the main channels.

The receiving filter system is identical in principle with that for the transmitters. In the receiving case the filter elements are made in rectangular form and are smaller in size and consequently have a lower Q than the transmitting filters. They are each followed by a grounded-grid amplifier, in the plate circuit of which is another coaxial line of rectangular form. The whole assembly folds itself into an oblong case. Four of these units can be seen at the top of the receiving rack depicted in Figs. 3 and 4. It will be noted that the  $\lambda/4$  sections in this instance are constructed from polythene-filled coaxial feeder cable. By these means the receivers are arranged to accept energy over a band narrower than would be the case if normal tuned circuits were used. Thus, almost the entire energy





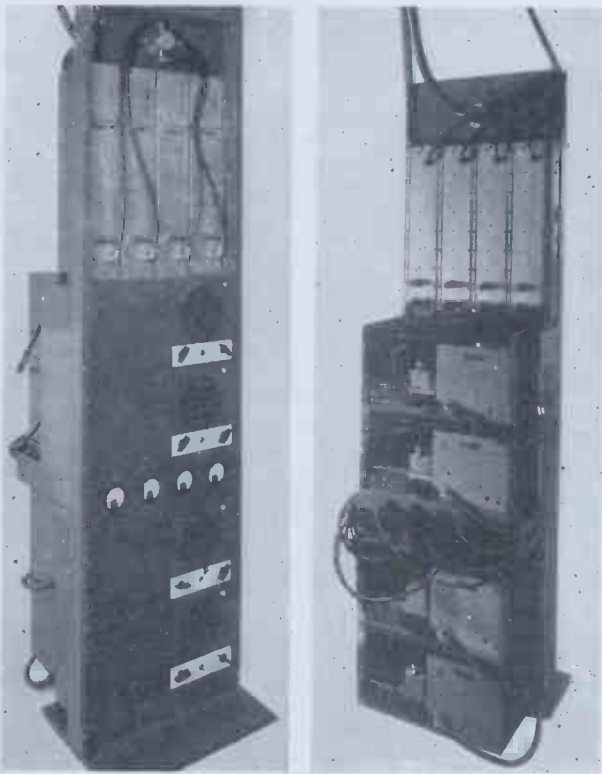

Fig. 3. (left).

Front view of receivers with filter amplifiers designed to operate from a single aerial system

Fig. 4. (right).

Rear view of receivers

Fig. 5 (below).

Wide-Band aerial used in conjunction with multi-transmitter and receiver systems

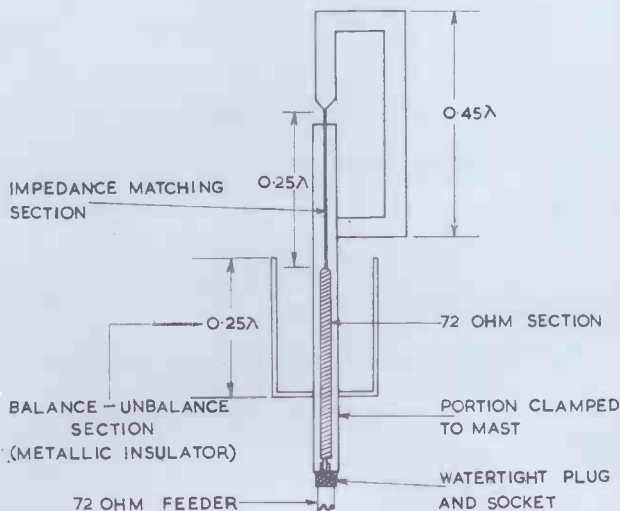

from the aerial, at the desired frequency, is available to the corresponding receiver.

The broad-band aerial consists of a so-called folded dipole made of large diameter (2 in.) steel tubing. Fig. 5 shows the method of feeding, which avoids distortion of the polar diagram that might result if the feeder cable were brought around the outside of the aerial. The matching section will be seen, together with the means by which the balanced load (the aerial) is fed by the unbalanced coaxial feeder. The standing wave ratio on the feeder does not exceed 1 to 1.5 over a band width of about 10 per cent. The transmitting and receiving aerials are mounted on 100 ft. lattice masts situated 100 yards apart.

The main transmitters employ phase modulation with a frequency correction network. The multiplication is 72 times; two frequency trebling and three doubling stages following the crystal oscillator and phase modulator. The crystal is mounted in a thermostatically controlled oven. A deviation of  $\pm 12.5$  kc/s. is employed. The radio frequency output is 250 watts in the 95-100 Mc/s. band.

The receivers, operating in the 80-84 Mc/s. band, are of the double superheterodyne type. A stage of R.F. amplification and the first mixer stage is followed by one stage of amplification at the first intermediate frequency of 8 Mc/s. The second mixer stage uses a triode-hexode valve. The triode section is utilized as a crystal oscillator, acting as a local oscillator for the hexode section, and feeding the multipliers for the first mixer. The second mixer stage is followed by one stage of amplification at the second intermediate frequency of 455 kc/s. Then follows a tetrode limiter stage, a diode second limiter and the discriminator, followed by two stages of audio amplification. The noise present in the output of the final stage during periods when no carrier is being received is filtered, and, after rectification and amplification, is used to operate a muting relay. The mute opening level of the receiver is about 1 microvolt.

The station is remotely controlled from the Information Room at Scotland Yard, and an emergency single-channel radio link is available for use in the event of land line failure. The subsidiary services previously referred to will probably be allocated frequencies in a higher band, with lower power than the main channels. A temporary subsidiary service to special mobiles is being operated on A.M. with low power from Scotland Yard.

Power is obtained from the public electricity supply. A voltage regulating transformer is used to deal with the voltage variations normally experienced during peak load conditions in the winter months. Mains failure or variations outside the scope of the voltage regulator automatically bring into service battery driven rotary converters.

The transmitters and receivers, fixed and mobile, were manufactured by the General Electric Co.

#### Mobile Equipment

Two types of mobile F.M. equipment are in use; one comprising three units, transmitter, receiver, and power unit; the other, recently introduced, combines these items into a single unit.

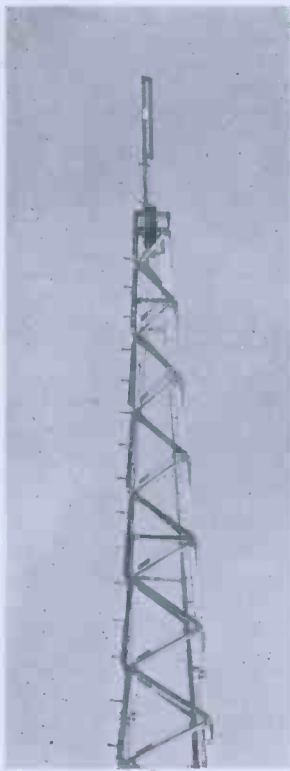

Fig. 6

100 ft. Lattice Mast with wide band aerial

In the former case the transmitters are crystal controlled, phase modulation corrected to give equivalent frequency modulation is employed, and the frequency multiplication is 72 times, as in the case of the main station transmitters. The radio frequency output is 10 watts in the 80-84 Mc/s. band. The receivers are identical with those used at the main station. Reception is in the 95-100 Mc/s. band.

The power unit contains two rotary converters for receiver and transmitter H.T. supplies, together with contactors controlling valve heater and rotary converter supplies. The equipment is placed in the boot of the car, and is remotely controlled from a panel fitted to the dashboard.

The single unit equipment uses miniature components and valves: it is smaller in size and considerably lighter than the three unit type. The transmitter is crystal controlled, the crystal being mounted in an evacuated B7G envelope and placed in an oven. Frequency stability is within 1 part in  $10^5$ . To permit the use of a crystal oscillator in the range 7-10 Mc/s. whilst obtaining the required frequency deviation at output frequency, a frequency changing system is employed. The crystal oscillator has two outputs, one at fundamental frequency  $f_c$ , and one at a multiple,  $mf_c$ . The first output  $f_c$  is fed to a phase modulator and thence to a multiplier chain, the output  $n(f_c \pm \Delta f_c)$  being applied to the mixer stage together with the second crystal output  $mf_c$ . Since  $n - m$  is made to equal unity, the resultant signal will be at fundamental

frequency but with a deviation of  $\pm n \Delta f_c$ . It is then multiplied 10 times. The push-pull output stage uses a TT15 valve. Power output is 15 watts and deviation  $\pm 12.5$  kc/s.

The receiver is again of the double superheterodyne type, the stage sequence being very similar to that described in the three unit equipments. Two pentode limiter stages are used. The mute opening level is 1 microvolt.

The current consumption of the mobile equipment is 9-10 amps at 12 volts in the "receive" condition; this includes current for the transmitter valve heaters, which are kept running to allow instant operation. Since police cars may patrol at low speeds in top gear and may park at strategic points for extended periods, it will be appreciated that the normal car electrical system would be totally unable to meet such additional demands. A dynamo capable of delivering 25 amps continuously is therefore fitted, together with batteries of 130 ampere hour capacity. In order to cater for slow patrol work, arrangements are made for full charge to be attained at 15 miles per hour in top gear.

#### Maintenance

In general, police patrol cars fitted with radio are in operation 16 hours per day. These long hours of usage, coupled with the fact that equipment must not be allowed to fall off much in efficiency if reliability is to be maintained with this type of service, mean that maintenance arrangements are of considerable importance. In order to minimize faults in actual service a system of preventive maintenance is adopted. Power units, incorporating rotary transformers which require lubrication and attention to commutators and brush gear at regular intervals, are replaced monthly by serviced units, while transmitters and receivers are replaced every three months. Quick release arrangements simplify the removal and fitting of units, and all connexions are made by multi-way plugs and sockets. The changing of equipment is thus a simple matter.

With regard to servicing at a maintenance depot, it will be appreciated that severe interference would result from the testing of mobile transmitters and it would be difficult to line up receivers, without the provision of suitable screening. To meet the situation, screened cages have been installed; they are double screened, half inch mesh galvanized iron wire being used. The usual measuring instruments are provided; medium and v.h.f. signal generators, meters for measuring valve feeds and receiver output level, dummy loads and thermo-ammeters for checking transmitter outputs. Mains supply units are available for lining up and checking units, but provision is made for a final check from a 12 volt supply prior to being issued as service replacements.

#### Operational

For police administrative purposes the Metropolitan Police District is divided into 23 Divisions, including the River Thames Division. Each Division is identified by a letter of the alphabet and is further divided into Sub-Divisions, Sections and Beats.

(Continued on p. 322)

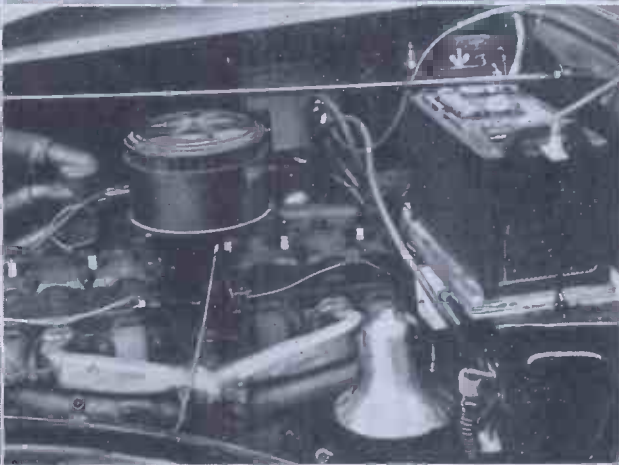

(Top left). Traffic accident group car, fitted with public address equipment in addition to R/T.

(Top right). Area wireless car showing quarter-wave aerial mounted on roof.

(Middle left). View of interior of one of the maintenance vans used for servicing mobile equipment. Spare sets, testing equipment and tools are carried.

(Middle right). Heavy duty batteries and regulator installed in patrol car.



(Bottom right). Installation of three-unit F.M. equipment in boot of patrol car.

For the purpose of the wireless scheme the District is divided into 75 wireless areas. Each wireless area is patrolled by a car fitted with radio-telephony and manned by two or more constables of the uniform branch. These cars, which are called area wireless cars, attend to all matters and incidents requiring police attention. Since the inception of the Area Wireless Scheme the original framework has been retained, but there has been some increase in the number of vehicles in each group, and the amount of work handled has been increased.

There are also 32 wireless cars manned by police officers of the Traffic Patrol. These, together with motorcyclists, form Traffic Accident Groups, whose function is to deal mainly with accidents, traffic congestion, motoring offences, and other traffic problems. In addition to radio-telephony, these cars are fitted with public address equipment for use in controlling crowds and giving advice to pedestrians and motorists. Traffic accident group cars patrol in accordance with local requirements.

A number of other wireless cars, known as "Q" cars, which deal mainly with crime and crime prevention, are manned by officers in plain clothes. Additionally, a fleet of vehicles fitted with wireless is maintained for use by detectives of the "Flying Squad" attached to New Scotland Yard.

On special occasions such as demonstrations, Royal processions and functions, sports and race meetings, etc., communications are provided by means of a fleet of vans equipped with radio-telephony on a different frequency from the remainder of the wireless equipped cars. These units are either centrally controlled from the Information Room or operate as a separate network. The disposition of the vans is made in accordance with the arrangements for the control of traffic and crowds.

In 1937 the General Post Office introduced the "999" emergency public telephone system, and arrangements were made for all emergency calls for police, made from places within the Metropolitan and City of London Police Districts, to be received in Information Room.

The Information Room is a central organisation at Scotland Yard where information relating to crime and other matters concerning police is received from the public or police and disseminated, as necessary, by telephone, teleprinter or wireless.

It is the focal point of the Metropolitan Police Communications system, and, for this purpose, is linked:—

- (a) With the Metropolitan Police private telephone system, in which all Police Stations, boxes, and pillars are connected;
- (b) to the public telephone system to which all Police Stations and establishments are also connected;
- (c) to the Metropolitan Police teleprinter network in which all District and Divisional Stations, Sub-Divisional Stations, and District Garages are connected; 100 points in all;
- (d) with the national police wireless stations of other European countries.

In the London Area the emergency public telephone service provided by the General Post Office enables members of the public to obtain speedy connexion with the Police, Fire and Ambulance Services through a public telephone by dialling "999" when a dial is fitted, or by following the appropriate local telephone instructions in other cases. In the case of emergency calls for police, the public telephone exchange operator connects the caller direct to Information Room, from where it is possible to give instant response to requests for police assistance. This Room is staffed by experienced police constables under the supervision of an Inspector who is responsible for all action and has authority to direct the wireless units to incidents. Calls for assistance are normally dealt with by sending one or more wireless cars to the scene in addition to informing the police station concerned so that any other necessary local action may be taken.

The disposition of the wireless units is plotted on a large scale map of the Metropolitan Police District by means of plastic tokens. The maps are mounted on four glass-topped tables, and tokens of differing shapes and colours indicate the type of vehicle in operation. Coloured rings are placed over the tokens to indicate when a vehicle is assigned to a call or placed out of service.

With the exception of the period of the war years the number of calls of all kinds handled in Information Room steadily rose to a total of 631,478 during the year 1949. Calls over the "999" emergency system have risen from 9,959 in 1937 to 81,857 in 1949. The number of arrests made by the crews of cars operating in the scheme totalled 8,233 during the year 1949.

#### Further Developments

An immediate problem is the provision of R/T equipment for use on solo motorcycles. The performance required is the same as for motorcars; two-way communication with Scotland Yard throughout the Metropolitan Police District. It is necessary, however, that power consumption, weight, and size, be cut to a minimum; and that the equipment be capable of standing much greater mechanical stresses than in car use. Equipment which promises to fulfil these requirements is now becoming available; and preliminary tests are promising. Steps are also being taken to improve the power supply position on the machine.

Selective calling will be used in conjunction with the motorcycle scheme, to ensure that only the rider for whom the message is intended is warned. Group and general calls are also being arranged to cater for messages routed in this manner.

In view of the promising developments in motorcycle R/T sets it is proposed to use similar equipment suitably adapted for car use, thus rendering the installation of large dynamos and batteries unnecessary. Tests are about to commence using equipment of this type, which it is hoped will be available for fitting to new cars in the near future.

The use of Walkie-Talkies, which have proved very useful, is being extended. They are used in conjunction with the communications vans or as separate groups.

# Multi-Station V.H.F. Schemes

By J. R. BRINKLEY\*

**S**INGLE-STATION V.H.F. mobile schemes have a natural limitation of range imposed upon them by the propagation characteristics of the frequencies used. If the fixed station is installed at the operational headquarters of the service concerned, a two-way communication range of 10 to 15 miles is typical of what may be obtained using conventional techniques.

By selecting a commanding site for the main transmitter and receiver and employing remote control, either by line or radio link, from the operational headquarters, an increase in range may be expected. If, for example, the aerial of the remote installation is 400 ft. above the average surrounding terrain, a radius of some 20 to 25 miles may be anticipated.

Many, in fact the majority, of V.H.F. mobile communication problems can be solved by the single-station method. It is, for example, possible to cover all towns and most metropolitan areas by one of these single-station methods, which have the important advantage of simplicity. An increasing number of V.H.F. problems are, however, arising which are beyond the capabilities of single-station working. Large rural areas, counties, river estuaries, trunk roads and railways, for example, present problems which clearly need more than one station to provide the required service. While it is theoretically possible to provide a number of stations throughout the area, each on an entirely separate channel, and to provide the mobile station with a tunable or "switch-tuned" equipment, this solution is wasteful of frequencies. Further, it leads to operational complication and to very costly apparatus.

The British Home Office were first to see the significance of this problem, and as a result of requests to provide a satisfactory V.H.F. service for county police forces, the multi-carrier multi-station scheme was developed using amplitude modulation.



The Control Station Equipment at the Motherwell Station of the Lanarkshire Fire Authority, showing Link Transmitters and Receivers

The development of this system has been described in detail elsewhere,<sup>1</sup> but for those to whom it is unfamiliar, it will be briefly described by reference to Fig. 1. This shows the simplest form of two-station multi-carrier scheme with radio remote control. Transmission to the cars takes place from the Link transmitter at the control point on frequency  $f_1$  via the link receivers and main transmitters at the two-main station. These main station transmitters radiate carriers  $+f_1$  and  $-f_1$  respectively from the centre of channel  $f_1$ . The mobile receivers are tuned to  $f_1$  and have an I.F. pass-band adequate to accept both of the spaced carriers and their associated sidebands.

The L.F. amplifier in the mobile receiver incorporates a low-pass filter cutting off at 3 kc/s. This eliminates the 10 kc/s. heterodyne whistle between the two main carriers which would otherwise be audible. It also eliminates certain distortion products. Care is taken to ensure that the two main transmitters are modulated in substantially the same phase.

Over a large area between the two stations the mobile receiver will receive both transmissions simultaneously in varying relative strengths. It is found that under all normal working conditions no distortion is caused, and it is impossible to tell which

\* Pye Ltd., Cambridge.

station or combination of stations is providing the signal.

On the return circuit, signals from the mobile are picked up on main receivers 1 and 2 and passed back over the two links on frequencies  $f_2$  and  $f_3$  to the control point. Here the signals arriving over the two paths are mixed and passed to a common loud-speaker. The main stations are unattended and fully automatic in operation.

The first scheme to operate on this principle was installed by the Home Office on behalf of the Hertfordshire County Police in 1947 and it has been operating most satisfactorily ever since. No difficulties have arisen due to the novel principle employed and the radio remote control has proved both economic and reliable. Since then a further ten multi-carrier schemes have been installed by the Home Office in various counties throughout England. Seven have been two-station schemes and three have been three-station schemes.

now operating to give a v.h.f. radio telephony service to planes flying over the whole of southern England and its approaches. Very long trunk lines (up to 100 miles in length) are used to link the stations to the flying control centre at Uxbridge and the remote control is by a voice-frequency switching system using pilot tones in the speech band of the trunk lines carrying the signals (see Fig 2).

Two further M.C.A. schemes are planned and when these are installed, v.h.f. coverage will be available over practically the whole of Britain.

It is interesting to note that in planning their Thames mobile v.h.f. radio service the G.P.O. initially proposed to use a two-station multi-service scheme with line linkage. Final tests from the first site proved the second station to be unnecessary, at least for initial requirements. The G.P.O. have stated that future estuary and coastal problems are likely to involve multi-station schemes and the comparative simplicity of the multi-carrier amplitude modulated system had some influence on their decision to standardize on the use of A.M. for all maritime v.h.f. schemes.

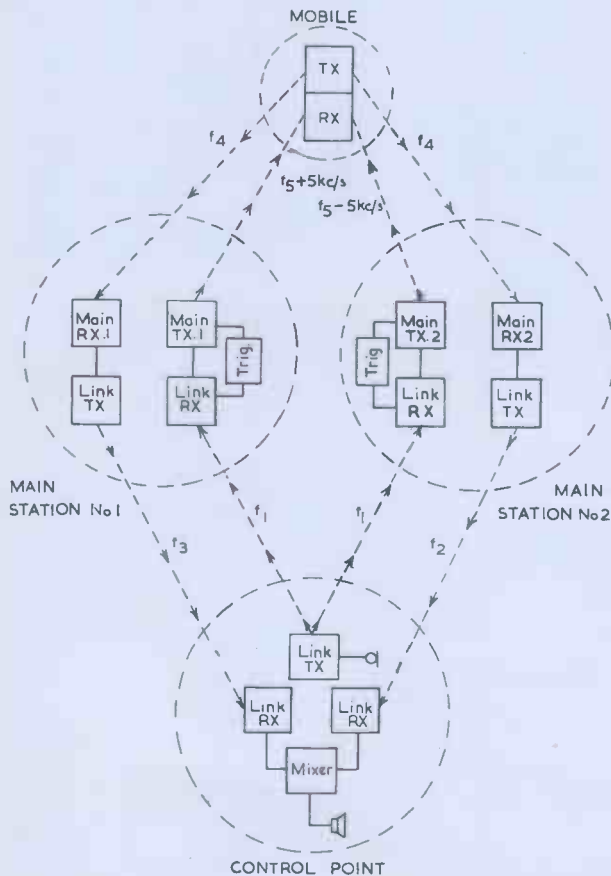

Fig. 1.

Schematic diagram of multi-carrier multi-station scheme

Other multi-carrier development has included a two-station scheme installed for the Singapore Police. A two-station scheme using line remote control has been installed for the Auckland taxis in New Zealand.

In this country the Ministry of Civil Aviation is about to employ the principle in a four-station scheme

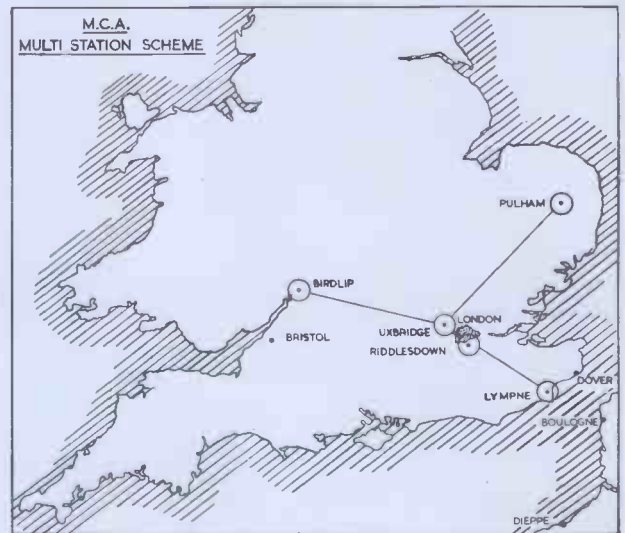

Fig. 2.

V.H.F. linkage over Southern England for Ministry of Civil Aviation

An interesting three-station scheme has just been installed in Lanarkshire in Scotland on behalf of the Lanarkshire Fire Authority. The layout of this scheme is shown in Fig. 3. The control point is at the County Fire Headquarters at Motherwell and it has been possible to site the main stations at or very near to the three main fire stations in the county. This has the advantage that, in addition to complete control from the headquarters, each fire station can break into the scheme and talk both to mobile units in its own area and also back to headquarters. All stations have full monitoring facilities which enables a very rapid appraisal of fire occurrences to be obtained throughout the brigade.

An unusual feature of this scheme is the method of linkage. Radio control is used from the headquarters to each of the main stations. The "break-in" facilities at these stations are provided direct in the case of the Rutherglen station and remotely

over a short G.P.O. line in the case of the Coatbridge and Lanark stations.

So far, no multi-station schemes have been installed covering trunk roads and railways. The system is obviously directly applicable to such problems and it is likely to be brought into use when these services develop.

It is interesting to note that there has been no comparable multi-station v.h.f. development in the

has been suggested whereby a F.M. multi-station scheme could be synchronized when telephone lines are used for linkage and it would appear likely that this is impracticable. This last point is one of considerable importance. As v.h.f. schemes increase it will be increasingly difficult to obtain separate frequencies for linking.

In the three years which have elapsed since the Hertfordshire Police scheme was installed, fifteen

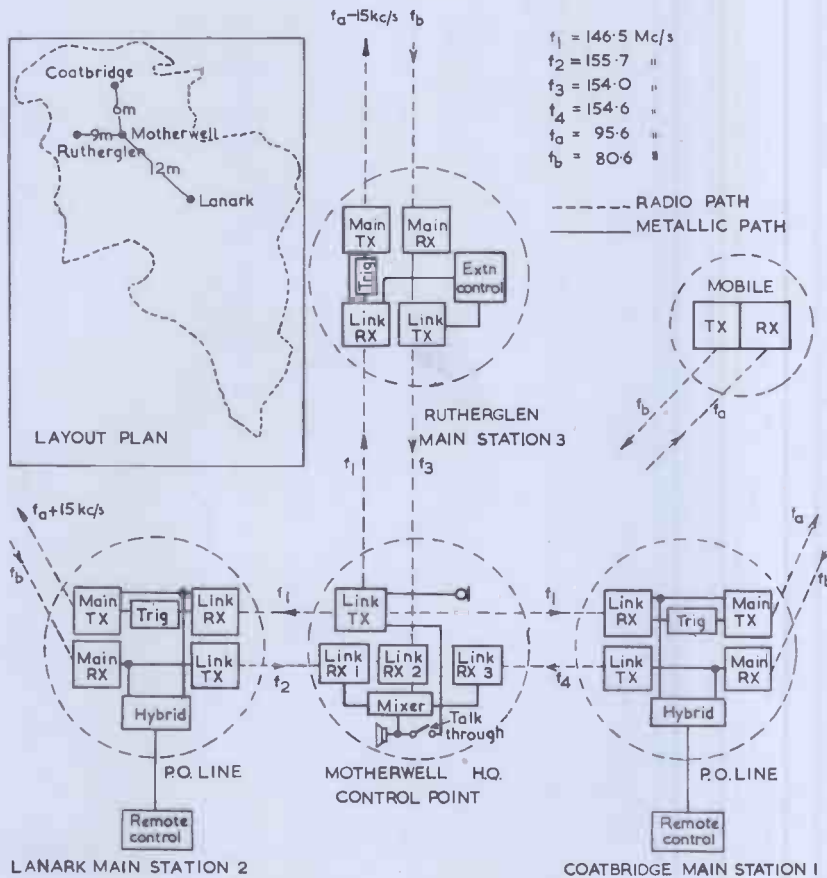

Fig. 3. Lanarkshire Fire Service multi-station V.H.F. scheme

U.S.A. This is almost certainly due to the American pre-occupation with F.M. for land mobile schemes. One of the original claims made for F.M. was that the "capture" effect was so abrupt that common modulation schemes using a number of stations would be readily practicable. This was found not to be the case and the claim has been dropped.

In this country a considerable effort has been expended in trying to evolve a F.M. counterpart for the multi-carrier A.M. scheme. It has been found that to reduce interaction distortion areas to negligible proportions it is certainly preferable and perhaps essential to lock the main station carriers in synchronism. This is possible where radio linkage is used, but the methods proposed are in the author's opinion very complicated and inflexible. No method

further multi-carrier schemes have been completed for a wide variety of purposes and many more are planned. While it is clear that single-station schemes will continue to satisfy the great majority of needs, it is also clear that the multi-station scheme meets a real and growing requirement in v.h.f. mobile communication schemes. It is also apparent that the multi-carrier solution is an eminently practicable one.

References

- "A Method of Increasing the Range of V.H.F. Communication Systems by Multi-carrier Amplitude Modulation." J. R. Brinkley, *J.I.E.E.*, 93, III, 23, 1946.
- "A Multi-carrier V.H.F. Police Radio Scheme." J. R. Brinkley, *May/June, 1948, Proc. Brit. I.R.E.*
- "The Thames Radio Service," J. Neale and D. W. Burr. *P.O. E.E. Journal*, Jan., 1950. (See also p. 305 of this issue of "Electronic Engineering.")

## SOME RECENT V.H.F. INSTALLATIONS

The following photographs are intended to illustrate the versatility of V.H.F. Mobile and Transportable equipments as applied to Public Services and Private undertakings.

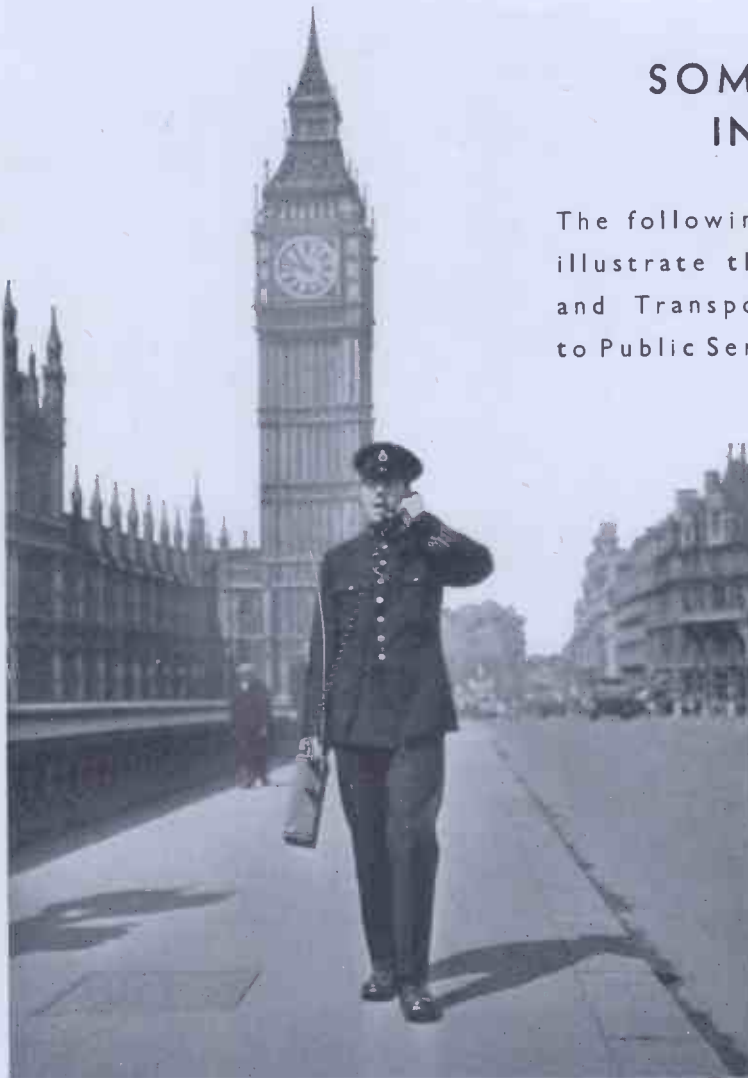

(Left). Latest type of British Communications Corporation's "Walkie Talkie" being demonstrated by the Metropolitan Police.

(Below.) A ship's pilot coming aboard with a Marconi Type H19 "Walkie Talkie" for communication with the tugs during docking operations.



Locomotive driver using a Pye PTC 112/113 mobile Radio Telephone Set at a goods marshalling yard. The transmitter and receiver are housed in a special dust and fume proof protective case mounted just in front of the driver's cab. Power supplies are obtained from a steam driven 24V 500 c/s generator.





The photos in the right hand column illustrate:—

A Marconi "Walkie Talkie" Type H19 in use by a tractor driver in a ploughing demonstration. The driver gave a running commentary which was transmitted to a local control where it was relayed by loudspeakers to the spectators.

A Marconi type H18 portable V.H.F. equipment mounted on a towing tractor at London Airport.

A Service Van of the North Thames Gas Board equipped with a G.E.C. V.H.F. F.M. mobile equipment. The headquarters transmitter is situated at Hampstead some 400 ft. above sea level and has an output power of 50 watts.

An experimental installation of a Plessey V.H.F. F.M. radio telephone equipment on a diesel engine for British Railways. This mobile unit is fitted with a cylindrical aerial (seen in the photo) specially designed for use on locomotives. It is claimed that this aerial is virtually unbreakable and that the efficiency is higher than the conventional whip aerial.

(Below). The Ekco mobile V.H.F. F.M. transmitter-receiver mounted on a motor cycle.





## The Port of Liverpool V.H.F. Radio System

ON Thursday, June 1, a new marine radio system was formally handed over to the chairman of the Marine Committee of the Mersey Docks and Harbour Board, Mr. Charles McVey, by Air Vice-Marshal O. G. Lywood, C.B., C.B.E., Director of Automatic Telephone & Electric Co., Ltd., and their associated company, British Telecommunications Research, Ltd., who, with Radio Gramophone Development Co., Ltd., have been responsible respectively for the design and manufacture of the equipment.

The inaugural ceremony took place on board s.s. "Galatea", the Board's own yacht, which steamed down the Crosby Channel and entered the Gladstone Dock.

The passage of the "Galatea" afforded a practical demonstration of the greatly improved communication facilities being extended to ships of all tonnages using the port's harbour and dock amenities. For the background to these facilities it is necessary briefly to recount the circumstances which led originally to their earlier adoption in a much less refined form.

During the war years convoys of as many as 60 vessels would arrive on one tide, and the problem which had always faced port authorities in the past, particularly those whose harbours are tidal, of regulating vessels into the docks became very acute. The existing methods of communication—Aldis lamps, semaphore, whistles and tug boats—proved inadequate and it was decided that the only satisfactory solution was radio-telephony. The port authority approached the Ministry of Transport and the War Office who loaned them a number of Army sets, which proved, in the radio conditions which then prevailed, extremely satisfactory and of inestimable value to those responsible for the docking of vessels in the port.

The opening of the new Liverpool Radar Station in the post-war years and the very much wider scope which it afforded for assisting vessels approaching the river entrance, showed that sets of this type had considerable limitations, and also that operating on frequencies of between 7 and 9 megacycles they were subject to a great deal of "jamming" from commercial stations, some of which were located as remote

as South Africa and North America. In any case, by international agreement at the Atlantic City World Radio Conference held in 1947, the use of this frequency band for harbour communications was to be discouraged and frequencies in the band of between 156 and 174 megacycles were allocated.

A wartime exigency had become in the eyes of the Mersey Docks and Harbour Board a peacetime necessity and a rigorous specification was drafted for the guidance of those British radio manufacturers who were in a position to develop suitable equipment to operate in the permissible frequency band.

The main requirements stipulated were that satisfactory communications should be maintained at ranges up to 25 miles; that the mobile sets should

and the shore station equipment for these channels is located at Port Radar (see photo on p. 328). The other four frequencies, viz., Channels 3-6, are shared between nine dock stations, each of which has individual shore station equipment. The division is so arranged that docks the farthest distances apart share channels, and a code-calling system is used, employing a 1,000 c/s. note, which permits the portable sets to call the required shore station.

**Technical Design**

The major problem, as it was first considered in the Mersey Docks and Harbour Board scheme, was to obtain communication over a distance of 23 sea

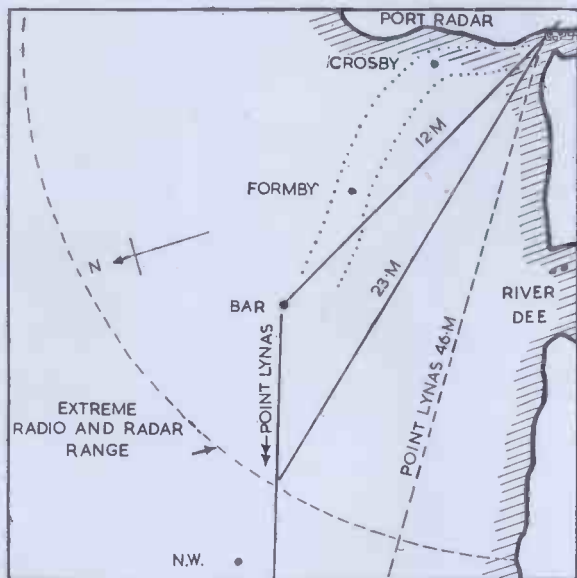

Fig. 1 (left)

The approach channel to the River Mersey, together with communication distances and radar range in respect to Port Radar

Fig. 2 (above)

The position of Docks in the River Mersey, and the points at which the equipment is housed

be readily portable, not exceeding 20 lb. in weight, and that they should give a choice of sufficient channels to enable pilots to communicate with the radar station and the principal dock entrances.

After exhaustive trials the contract for 150 portable transmitter-receivers and 10 shore stations was awarded to British Telecommunications Research, Ltd.

It had been decided that the equipment should be amplitude-modulated and that both transmitters and receivers should be crystal controlled and, to meet the various requirements of the specification mentioned above, it was necessary to make use of six radio frequency channels within the internationally-agreed band which had been licensed by the British Post Office for harbour communications in the United Kingdom.

These channels were accordingly allocated, two for navigational aid and harbour supervision and four for communications in respect of docking. The land transmission frequencies are from 163.1 to 163.6 megacycles and the mobile transmission frequencies from 158.6 to 159.1 megacycles. The channels are separated, 100 kilocycles apart and the "go" and "return" frequencies are spaced 4.5 megacycles apart. The two frequencies used for navigational and harbour supervision are Channel 1 and Channel 2

miles on Channel 1 at the frequency employed. This difficulty was further increased by the size and weight limitations of the pilot's hand portable equipment, restricting the transmission power to not more than 1/4 watt and the receiver sensitivity to approximately 15 microvolts. Added to this, the cost of building a high tower to carry the shore station aerial had to be kept within reasonable bounds.

The angular bearings and distances in respect to Port Radar at the required range are shown in Figs. 1 and 4, and preliminary calculations were made to determine the approximate field strength which could be expected over a distance of 23 sea miles at the land station.

Calculations showed that for an aerial power of 1/4 watt the signal strength at the land station aerial would be in the order of 0.8 microvolt per metre, or 0.32 microvolt signal.

This level of signal is well down into the noise region, and below a manageable signal strength of the shore station. To this, aerial feeder losses must be added, and to facilitate calculations these losses were fixed at 3 db.

This indicated that a high gain beam aerial should be employed with as wide a beam width as practicable. It had been ascertained that a signal of 3 microvolts was required at the receiver terminals, and Fig. 3 shows that an aerial gain of some 20 db. is required, not including feeder losses.

Consideration was then given to the transmitter

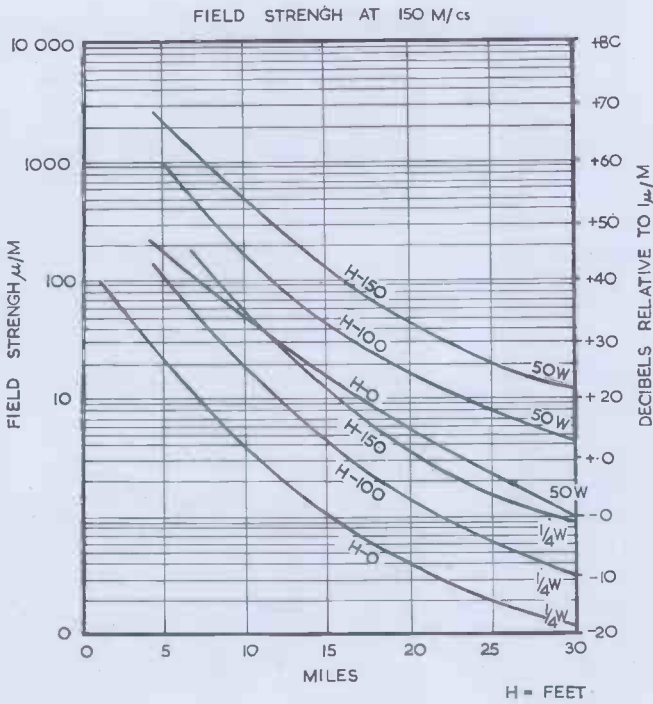

Fig. 3.

Showing field strength using single dipoles at 150 Mc/s. over sea for aerial powers of 50 watts and  $\frac{1}{4}$  watt at various heights of aerial (Based on "Short Wave Reflexion and Deflexion" by T. L. Eckersley, J.I.E.E. 8, 286, 1937)

power required at the shore station utilizing an aerial with a gain of 20 db to produce the required field strength at the portable equipment.

As a 15 microvolt signal was considered reasonable for a good signal-to-noise ratio, it was found that the transmitter power required is approximately 35 watts.

In practice, however, somewhat higher aerial powers at the land station were obtainable than were originally thought to be possible (i.e., 45 watts) and the portable set's sensitivity was also improved (i.e., 10 microvolts for 10 db signal-to-noise). This produced a slight unbalance in signal levels biased in favour of shore to ship, but this was considered to be a slight advantage when operating in bad weather and high winds.

It was decided that the aerial to be employed should be a 32-element centre-fed beam with a meshed metal reflector, which came as near as practicable to giving the required gain (i.e., 18 db) with a theoretical beam width of  $\pm 15^\circ$ . The overall size of this aerial is approximately 30 ft. long and 12 ft. wide and the weight some 1,000 lb.

This aerial mounted on an 80 ft. high tower situated approximately 50 ft. from Port Radar control room is shown in Fig. 4.

Channel 2 at Port Radar, which requires an operational range of 14 sea miles, employs a Yagi type aerial with one driven element and four directors, giving a forward gain of 5 or 6 db. This aerial is mounted on a metal pole extending 20 ft. above the beam aerial on the same tower. At this

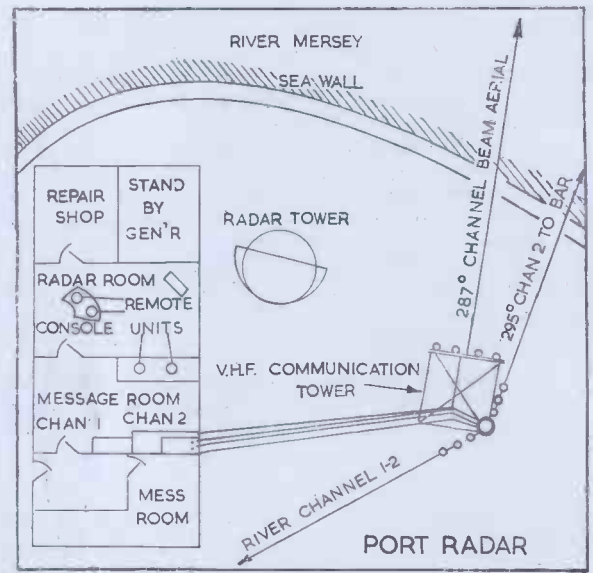

Fig. 4.

Plan view of Port Radar, showing the distribution of equipment and aerial bearings

height (i.e., 100 ft. plus sea wall) it is visual distance to the Bar Lightship, thus eliminating the requirement for a high gain aerial array.

The next point which had to be considered was communication coverage using directional aeri-

As communication is required on both the seaward approaches and the river, it necessitates the use of four aeri-

Two receivers are employed per channel and are connected to their respective aeri-

One transmitter unit only is employed per channel, and the operator, by the movement of a switch, can select direction of transmission. Switching and aerial arrangements are shown in Fig. 5.

Mechanical Design

Land Station Equipment

Emphasis has been laid earlier on the major requirements of the installation, but coupled with these were a number of other factors which had to be taken into consideration when the apparatus was being designed. The Dock Board were anxious that

- (a) Any long delay in service due to a fault occurring in the shore equipment should be avoided.
- (b) Non-technical personnel in the various offices should not have access to the equipment.
- (c) The operator should have the minimum of controls.

These requirements were met by fitting the equipment in cupboards with lockable doors, and the various units are arranged to withdraw on telescopic runners for inspection. Each unit, with the exception of the transmitter power unit, is divided into two or more sub-units, which allows a semi-skilled

(continued on p. 337)

# Design Problems of V.H.F. Mobile Equipment

By L. W. D. SHARP, M.A., A.M.I.E.E.\*

**T**HIS paper is intended to provide a description of the general problems involved in the design of mobile v.h.f. radio equipment. An outline of technical development up to the present time is given, but in the interests of brevity, specific circuit details have been avoided.†

The term "business radio" is commonly used in Britain to describe private radio systems used for industrial and commercial purposes. We shall deal with equipment for this class of service, and for use by public and semi-public bodies, such as in police, ambulance and fire services. The requirements and frequency allocations are similar in either case, and the equipment must be operated by those who are neither skilled in radio techniques nor trained radio operators.

We shall exclude from this paper equipment for point-to-point, ground-to-air and airborne services; while these use similar frequencies and general techniques, the operating requirements are such as to put them outside the scope of this paper.

## The Development of V.H.F. Applications

Before the 1939-45 war, little use was made of the v.h.f. band (30-300 Mc/s.) except at the lower extreme for the television service. Very little was known of the possible uses to which the higher frequencies could be put. Simple equipments, comprising self-oscillating transmitters and super-regenerative receivers, were used widely at frequencies above 200 Mc/s. for communication between army vehicles at ranges of a few hundred yards.

The congestion existing at lower frequencies, combined with the need for communication over a few miles without the risk of sky-wave transmission, accelerated development of the v.h.f. band. Parallel development was carried out in airborne v.h.f. communications equipment and radar systems, with the result that the special valves and circuits required to obtain gain and stability at these frequencies were developed, and the British radio industry rapidly accumulated a fund of design and production experience which embraced amplifiers for the whole of the v.h.f. band, with the accompanying narrow and wide-band I.F. amplifiers with frequencies ranging up to 40-50 Mc/s. Much of this experience was passed to our American allies in 1942, who were able with their large resources to extend and exploit it to our mutual benefit.

Soon after the war, the experience thus amassed was put to the task of designing and producing equipment for "business radio" uses. Sufficient time has now elapsed that a wide range of equip-

ment is available in the British market, both for general and specific purposes. Sufficient operating experience has been obtained to permit the production of highly efficient apparatus, and to arouse wide interest in its possible uses.

Growing experience has shown that certain minimum standards of performance are desirable to ensure good service with reasonable immunity from interference to or from other users. This has caused the General Post Office, after extended consultations with the industry, to issue specifications<sup>1</sup> for certain classes of equipment. The G.P.O. is responsible for the issue of licences to all private users in Britain, and they are issued only to users of equipment type-approved to the relevant specification.

Further specifications are to be prepared in due course to cover other classes of equipment. Meanwhile, existing specifications form a framework within which all equipment must fit, and ensure that a certain minimum performance is attained in every important respect. It has been found however, that such general specifications lay down a performance insufficient for many particular requirements, and equipment exists today in which far higher performance is achieved in certain respects. Much development is being directed at the improvements of performance at the lowest possible cost, with an eye on conditions likely to arise in the future.

## Operating Requirements

The frequencies allocated for mobile communication in Britain lie in the ranges 67-100 Mc/s. and 156-184 Mc/s. Similar frequency ranges are allocated in other countries.<sup>2</sup> Parts of these bands are allocated for use by police, public authorities, coastal marine systems, taxis, industry, the press and other users, and the expansion of services involves congestion at some frequencies. The operational problems common to all are as follows:—

- (1) The attainment of reliable operation without interference to and from other users.
- (2) Use by unskilled staff requires that controls should be few and fool-proof. The need for repeated adjustments must be avoided.
- (3) Most applications involve continuous use for at least 8 hours per day; and in some cases for 24 hours a day. The likelihood of failures must be minimized.
- (4) If servicing is required it must be easily carried out and without immobilizing the vehicle.
- (5) The equipment must operate from electrical supplies available on the vehicle without straining them.
- (6) The operating range must be satisfactory.

\* The Plessey Company Ltd., Ilford.

† Patents are pending on a number of the devices described in this paper.

**Design Requirements**

It is first necessary to decide what form the equipment will take. Generally it will be one of the following, depending on the function to be performed.

- (1) *Portable* (e.g., "walkie-talkie"); highly compact equipment capable of being carried by one man in the course of his duties, and of being operated while being carried. Powered by self-contained dry batteries or an accumulator.
- (2) *Transportable* (e.g., "pack-set"); compact equipment of higher performance than (1). Capable of being carried by one man from point to point. Usually operated when stationary and powered from an accumulator.
- (3) *Mobile*; equipment of the highest performance fitted to and operated in a vehicle. Powered by the vehicle's batteries.
- (4) *Heavy Duty*; equipment of the highest performance designed to withstand rough treatment and exposure to weather, fumes and dirt. Fitted to locomotives, lorries and small ships. Power supplies as available.

For the remainder of this paper, consideration will be confined to cases (3) and (4) above.

In addition the following major points are involved:—

- (5) *Transmitter Power*; this is decided in the light of the range required and the power supply available. Powers ranging from 3 watts to 25 watts are in use at present.
- (6) *Receiver effective sensitivity*: The present trend is to make this as high as circuit technique will allow, to permit the use of lower transmitter powers.
- (7) *Type of Modulation*; the relative merits of A.M. and F.M. have been considered elsewhere,<sup>3</sup> and the writer will confine himself to observing that each has both advantages and drawbacks. For some services one or the other is preferable; for others, each will serve satisfactorily.

(8) *Transmission System*: this can be single frequency Simplex, Duplex or double frequency Simplex. Here again each has its advantages for certain requirements. In Britain, however, single frequency operation is discouraged on the score of adjacent-channel interference.

(9) *Control System*: here there are many alternatives ranging from straightforward calling by call sign to automatic systems involving the selective calling of numbers of stations or groups of stations, with all transmitters and receivers except the selected one disabled. Such systems provide the privacy and convenience of a normal dial telephone system, but the added cost and complexity is not always desired where only a few mobile units are used. Provision is made for selective calling as an optional fitting on equipment now available, but space permits only a brief reference.

**Receiver Design**

Receivers may be required to work with either F.M. or A.M. systems. The differences involved are mainly confined to the circuit between the last I.F. amplifier and the first A.F. amplifier. In the A.M. receiver this comprises a signal rectifier, an A.G.C. rectifier (and possibly amplifier), and an impulse limiter, while the F.M. receiver uses two limiter stages and the frequency discriminator. Fig. 1 shows these differences in block form—the selectivity and gain required up to this point are similar in either case, and the discussion that follows refers to both types.

Table 1 gives average performance figures representing equipment now available. For simplicity it refers only to the higher frequency band, but comparable performance is attained on the lower band.

The signal-noise ratio determines the effective sensitivity of the receiver. Atmospheric noise is negligible in the V.H.F. band, and man-made static

Fig. 1. Block Schematics showing differences between F. M. and A.M. receivers

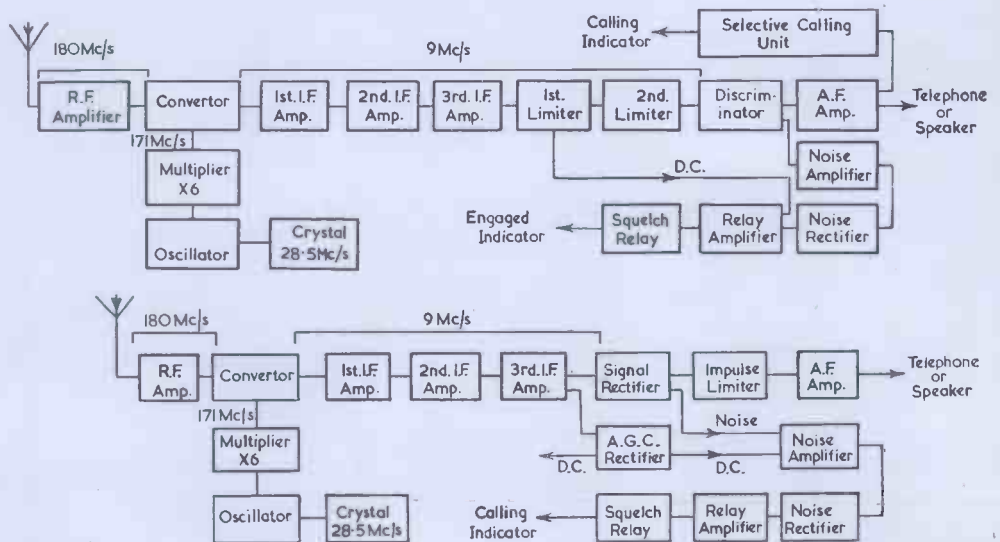

(a) Typical F.M. receiver with selective calling

(b) Typical A.M. Receiver with conventional squelch relay.

can be rendered unimportant by efficient noise suppressors or limiters. The remaining sources of noise are the shot-noise of the first valve, the thermal noise of the aerial resistance, and the thermal noise of the first tuned circuit. The latter can be made negligible by minimizing circuit losses, while the aerial resistance noise is irreducible, leaving the shot-noise of the valve, commonly expressed in terms of the equivalent noise resistance,  $R_{eq}$ .

The use of a valve with a high ratio of  $R_g$  to  $R_{eq}$  ( $R_g$  = grid shunt resistance of the valve due to transit time and cathode lead inductance) is necessary. For the lower band the c.v.188 in its various commercial forms has proved satisfactory, but at frequencies higher than 150 Mc/s. special types such as the 6AK5 pentode or the EC91 grounded grid triode show an improvement.

It has been assumed in the foregoing that the R.F. stage provides sufficient gain to render the noise contribution of the convertor unimportant. The heterodyne signal for the convertor is provided by a harmonic multiplier from a crystal oscillator operating in the range 10-30 Mc/s. The choice of crystal frequency and of I.F. must be considered together in order to place all spurious responses where they can be rejected by the R.F. circuits.

Table I  
Mobile Receiver Performance

Frequency Range	156-184 Mc/s.	
	A.M.	F.M.
Signal-to-noise ratio at 1 $\mu$ V ...	6 dB	10 dB
Output variation, 3 $\mu$ V to 30 mV ...	6 dB	3 dB
Squelch operation (adjustable) ...	1-10 $\mu$ V	0.8-8 $\mu$ V
Spurious rejection ...	60 dB	60 dB
Blocking, 100 mV interfering signal ; ± 5 Mc/s. ...	-2 dB	-0.5 dB
6 dB bandwidth ...	±18 kc/s.	±25 kc/s.
60 dB bandwidth ...	±83 kc/s.	±90 kc/s.
Total drift, crystal and I.F.—20° C to +70° C ...	±9 kc/s.	±9 kc/s.

Spurious responses are caused not only by the normal image response but by unwanted crystal harmonics reaching the convertor.

The R.F. tuned circuits have to reduce the response to spurious frequencies; generally two tuned circuits are used between R.F. amplifier and convertor, and one before the R.F. amplifier. Sometimes an image trap is also used.

Unwanted frequencies can also cause interference by cross-modulation (particularly in A.M. receivers) and blocking. This occurs when the unwanted signal reaching the grid of any valve is greater than it can handle; generally this is so with a very strong carrier occurring at a frequency close to the correct receiver frequency. This effect is avoided if the necessary selectivity is provided in the input circuit to prevent overloading the first valve, and if the gain of all subsequent stages is less than unity at the inter-

fering frequency. In present equipment a single circuit prior to the first grid, and subsequently the number of circuits required in any case for other purposes, is usually sufficient. Growing congestion in the frequency bands will render this type of interference more serious in future, and greater selectivity will have to be provided to combat it.

The I.F. amplifier provides the selectivity against adjacent channels, and at the same time must give a sufficiently wide pass-band to pass the required modulation sidebands after allowing for all the likely frequency drifts in receiver and transmitter. A response curve of the required shape can be obtained either by using very high-Q coils with a high I.F., or coils of lower Q with a lower I.F. In the former case, a single superheterodyne is used with the general arrangement shown in Fig. 1; a frequency of 8-10 Mc/s. can be used for the high band with coils having a Q of 180, and similarly at 4-5 Mc/s. for the low band.

If a lower I.F. is used, a satisfactory response can be obtained with a coil Q of 80-120, depending on the number of stages used. An I.F. of 3.0 or 1.6 Mc/s. for high and low band would be fairly typical, but present difficulties in the R.F. stage due to the small image separation. Usually this difficulty is met by using a double superheterodyne circuit. This can take a number of forms, but the type shown in Fig. 2 has the advantages of using only a single crystal and minimizing the number of extra spurious responses which may arise. Circuits at the first I.F. are required to provide sufficient selectivity to reject the image frequency of the second convertor. If frequencies of the order shown in Fig. 2 are used, one coupled pair is sufficient and no amplification is necessary between the two convertors.

The frequency drift of the receiver is the sum of the crystal and I.F. drifts. The crystal drift is minimized either by using a closely controlled cutting angle, which can yield remarkably stable crystals, or by using normal crystals in a temperature-controlled oven at between 70° C. and 80° C. The I.F. drift has to be controlled by using temperature compensation and coils have to be designed for thermal stability. A high-grade receiver such as that shown in Fig. 3 has I.F. coils which are wound hot on to ceramic formers. The winding shrinks into place, and the thermal expansion is then a function only of the former which is extremely stable. The R.F. circuits do not determine the received frequency, and therefore the drift can be greater, but if it exceeds ± 0.3 per cent performance may suffer.

Any initial error in alignment will reduce the permissible drift and must therefore be minimized. It is customary to use crystal calibrated generators for I.F. alignment, and the receiver crystals are usually

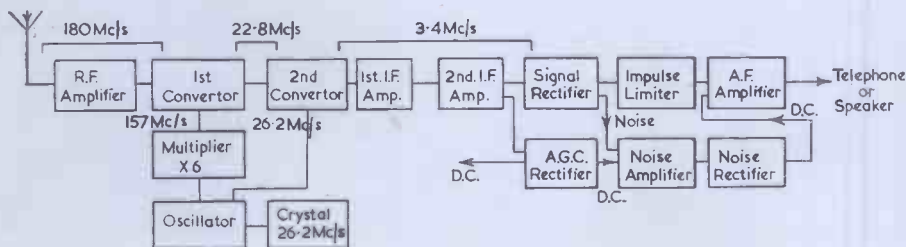

Fig. 2.  
Block schematic showing a typical A.M. double superheterodyne receiver with electronic squelch

cut to the best possible initial accuracy; any remaining error is removed by adjusting a trimmer shunting the crystal. Thus each receiver is precisely aligned to its operating frequency. A crystal-controlled frequency source of high accuracy is needed for this purpose.

The noise output of a V.H.F. receiver is so high in the absence of a signal that provision is usually made for muting. The muting or squelch circuit has to operate differentially on signal strength and noise output; only in this way can sufficiently sensitive operation be obtained without the risk of operation by bursts of noise or interference. The actual muting may be performed by biasing an A.F. amplifier or by relay switching. The latter is used if it is desired to use control refinements such as calling bells and lamps. In this case a time delay of about a second is usually applied to prevent the relay falling out during momentary fading. The relay operation should however be rapid to avoid missing the start of the message. Alternative squelch arrangements are shown in Fig. 1 and Fig. 2.

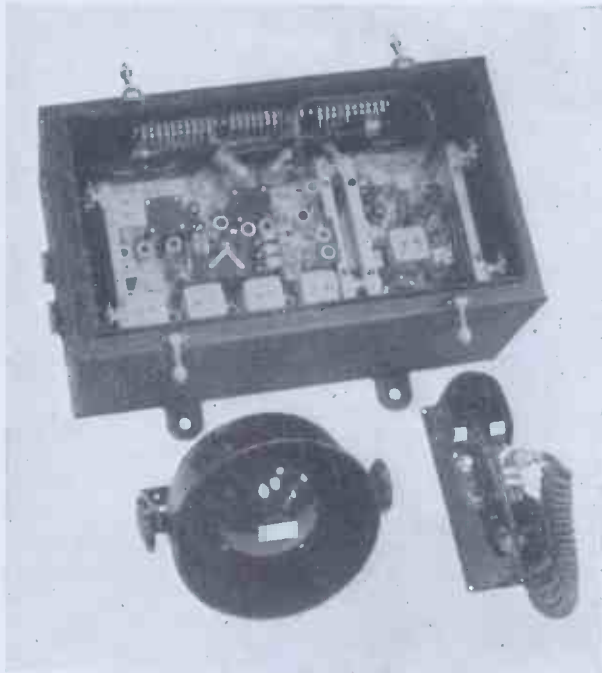

Fig. 3.

Heavy-duty equipment for railway and industrial purposes. The water-tight lid of the housing has been removed, and also the transmitter and receiver dust-covers. Loudspeaker and control unit are also shown

Selective calling arrangements are fitted to the receiver where a large number of mobile units are to be operated from a single central point. The method used is either to count chains of tone pulses on uniselectors, in a similar manner to the dial telephone, or to use a combination of two or more tones to represent each station, the tones always being transmitted in a particular time sequence. The latter method can be made particularly immune from false operation due to noise, fading or other causes, and is used on the receivers shown in Figs. 3 and 5. A selective calling unit can be clearly seen in Fig. 3, where it is fitted in the centre of the receiver chassis.

### Transmitter Design

The paramount aim in a mobile transmitter is to provide the highest possible efficiency in all stages and to reduce the power consumption. Crystal control is employed, the stability being similar to that of the receiver. The crystal frequency is then multiplied to the required final frequency.

The harmonics and other spurious responses of the transmitter must be kept at a low level to avoid interference with other users.<sup>1</sup> This generally necessitates double tuned circuits in each stage to prevent undesired multiples of the crystal frequency reaching the output. The P.A. circuits must be carefully arranged to reduce harmonics.

Fig. 4 shows in block form typical circuits for A.M. and F.M. transmitters. Dealing first with the A.M. case, the crystal frequency should be as high as possible in order to reduce the number of spurious emissions. Fig. 4(a) shows a multiplying factor of six using third overtone crystals, but normal crystals are commonly used, and multiplied eight or twelve times.

Amplitude modulation is generally applied to the P.A. anode and occasionally to the driver stage as well. A 10-watt transmitter of typical efficiency will require 10-12 watts A.F. power to modulate it to a depth of 85-90 per cent, after allowing for the reduction in peaks caused by distortion. Thus the power drawn by the modulator is considerable, being as great as that actually required for the P.A. This is particularly true as the A.F. amplifier is usually operated in class A to avoid difficulties with power supply regulation.

Fig. 4(b) shows a phase-modulated transmitter of the type generally used in F.M. systems. Phase-modulation is used as it permits direct crystal control, but it provides an effective frequency swing which increases with modulation frequency. That is generally an advantage and provides a slight gain in signal-noise ratio when the receiver has the inverse characteristic. A conventional phase modulator will provide a phase deviation of up to  $\pm 0.5$  radian before distortion becomes severe. To provide a frequency swing of  $\pm 15$  kc/s. at 1,000 c/s. modulation frequency means that a multiplying factor of at least 30 is needed.

When a true F.M. characteristic is required, A.F. compensation is applied at the transmitter and a multiplication of 72 times has been used to give a frequency swing of  $\pm 12-15$  kc/s. over the modulation range 300-3,000 c/s. Such a high multiplication factor not only requires a large number of stages in the transmitter, but also gives an output rich in unwanted crystal harmonics, and much development has been devoted to improved types of phase modulator.

Among the types now in use are a magnetic phase modulator which is capable of phase deviations in excess of  $\pm 1$  radian, and a circuit which only requires a single valve as both crystal oscillator and modulator, and has a performance as good as conventional types.

The A.F. amplifier is only required to provide a very small power to the phase modulator, and economies are possible here compared with A.M. However, strong signals at high audio-frequencies can cause very large frequency deviations unless some form of modulation limiting is employed. One such



device is the slope limiter, while another method is to adapt the voice-operated gain control principle, which must have a suitable frequency characteristic and an instantaneous action.

On both F.M. and A.M. equipment, a voice-operated gain control circuit is valuable also for the purpose of avoiding overloading at noisy locations, and maintaining a high modulation level at all times. This can increase the range of a system by improving the signal-to-noise ratio at the receiver. This device is shown diagrammatically in Fig. 4(b), and is fitted to the equipment depicted in Fig. 3, together with an expander to prevent external noise being picked up during speech intervals.

Considerable economy in consumption can result from careful design of the early stages of the transmitter. The performance of the transmitter portion of the equipment shown in Fig. 5 probably represents the ultimate in this respect; that of the 20-watt version is given in brief in Table II. The transmitter employs the magnetic modulator already mentioned, with directly heated valves in the earlier stages, and indirectly heated valves for the final stages.

motor-cycles, ships and locomotives. Where the vehicle battery is the source of supply, the permissible load depends upon the surplus charging rate normally available, while if the equipment is to be operated when stationary, it depends upon the battery capacity and the expected life. Thus the continuous consumption should be limited to 40-60 watts for cars, and 20 watts for motor-cycles. In diesel locomotives and small ships, similar conditions are met, but the batteries are larger than on a car. On larger ships A.C. or D.C. is available at 100-250 V, while on steam locomotives a high frequency alternator can supply power at 24-110 V.

Thus the requirements are diverse. Hitherto most equipment has been used in cars, using one or more rotary transformers for the H.T. supply. The power consumption has generally been in the range 60-100 watts while standing by, and 150-200 watts while transmitting. Demands of this order in addition to the vehicle's normal requirements have thrown a heavy strain on the battery, and operation on motor-cycles has been impracticable.

Reference has already been made to low-consump-

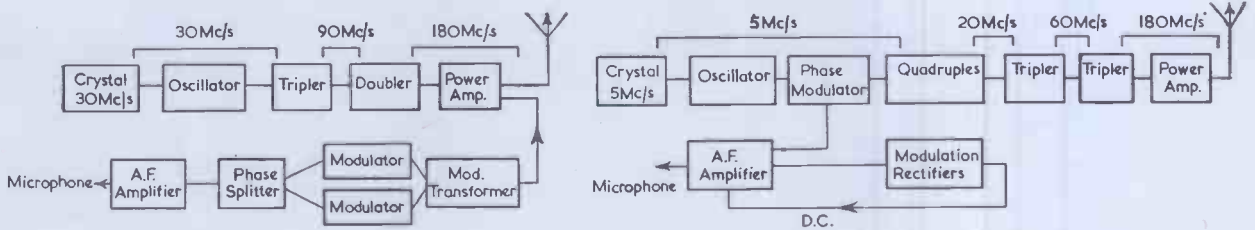

Fig. 4. Block Schematics showing differences between A.M. and F.M. transmitters  
 (a) Typical A.M. Transmitter  
 (b) Typical Phase-Modulated F.M. Transmitter.

Valves

Reference has already been made to types of valves for R.F. amplifiers. The remaining receiver valves, and most of the transmitter ones are generally normal 6.3 V indirectly heated types on the B7G and B9A bases. B8A types are used to a very limited extent.

The transmitter P.A. stage is generally a single or twin beam tetrode, fitted on the B8G or B9A base. For lower powers, small triodes are sometimes used, but neutralizing presents difficulties unless the grounded-grid connexion is adopted. Earlier types of transmitting valve deteriorated rapidly between 150 and 184 Mc/s., but types are now available more suited to this frequency range. Even so, efficiencies rarely exceed 50 per cent after circuit losses are accounted for.

A recent development is the use of directly heated valves; used in the transmitter they eliminate the heater current normally required to keep the transmitter ready during standby periods. Used in the receiver they permit considerable economies in power consumption, although more stages are usually needed to obtain the required performance. For example, the receiver of Fig. 5 employs such valves, and the consumption from a 6-volt battery is only 18 watts, including the stand-by current of a 10-watt transmitter similar to that described in Table II.

Power Supplies

Mobile equipment is fitted mainly in motor-cars,

tion equipment in which the consumption is reduced to 30 watts while standing by, and 114 watts while transmitting, and a version of the same equipment for motor-cycles, with a 10-watt transmitter, which has figures of 18 watts and 78 watts respectively. That such reductions can be made while maintaining the same equipment performance is due to the following developments.

- (a) Improved reliability of vibrators has enabled them to be used in mobile equipment, providing proper operating conditions are assured. Efficiency is higher than with rotary machines, and split-reed synchronous types and heavy duty non-synchronous types with paired contacts have met most of the requirements.
- (b) Vibrator transformers with special low-loss laminations have enabled an efficiency of 75 per cent to be obtained, including filtering and smoothing.
- (c) The use of directly heated valves, which has already been referred to, and transmitting valves and circuits of higher efficiency.

Another way in which consumption can be reduced is by reducing transmitter power from the usual 10-25 watts to 3-6 watts. For many purposes this is sufficient.

For A.C. supplies, normal transformer and valve rectifier combinations are used. For high-frequency supplies space and weight can be saved in trans-

formers and smoothing components, but precautions are necessary against pick-up in microphone transformers and other sensitive points, as the resulting hum is most objectionable.

For D.C. supplies of 24 V or more, rotary transformers are almost invariably used, in addition to their applications at lower voltages. The smallest have a single output of 10-20 watts, while larger types for operation on high D.C. voltages (e.g., on diesel locomotives and ships) have separate outputs for L.T. and H.T. and the total loading may be 150 watts while transmitting.

Voltage regulation is sometimes used to maintain performance over supply variations of  $\pm 20$  per cent. Rotary machines can be controlled by centrifugal switches or by means of a carbon pile, which provide close control. Barretters can be used to regulate the heater and filament supplies of vibrator-driven equipment.

If regulation is not used, it is still necessary for the equipment to tolerate supply variations of  $\pm 20$  per cent and remain operating, although considerable alterations in performance are to be expected over such a wide range. Difficulty is experienced sometimes in maintaining adequate emission in transmitting valves, as the heavy current drawn generally introduces voltage drop in the supply leads. This has been dealt with effectively in recently developed equipment by having the transmit relay switch in an additional boosting voltage in series with the valve heaters. Thus the transmitter can maintain full output, while there is no possibility of the valves being over-run during stand-by periods.

#### Components and Construction

Mobile equipment has to encounter severe vibration and shocks. When fitted to locomotives, housings are used to protect the equipment, generally being made

of heavy gauge sheet steel, or suitable alloy castings. The housings are sealed, all the wiring is run in conduit, and dessicators are fitted. Control units and loudspeakers must also be weatherproof and heavily constructed. The transmitter and receiver are mounted on rubber and are fitted with quick-release fasteners and connectors, to permit rapid servicing. Fig. 3 shows an example of equipment of this type, which is suitable for heavy duty operation of all kinds.

On road vehicles the mechanical requirements are not so severe, but rubber mountings are generally employed. On cars equipment is fitted in the luggage boot with a small remote control unit. On motor-cycles rubber mountings of considerable compliance are needed to absorb the road shocks produced in an unsprung frame. Equipment of the type shown in Fig. 5 is fitted in pannier-type splash-proof cases, and fitted on either side of the rear wheel, the weight being accurately balanced.

The miniaturization of valves and other components has led to the small single-unit transmitter receiver. Controls are fitted directly on the front panel, which measures only about  $9\frac{1}{2}$  in. by  $4\frac{1}{2}$  in. It is easily fitted directly below the car dashboard, the power unit generally being disposed elsewhere. The transmitter power of this type is limited to about 6 watts due to difficulty in dissipating surplus heat.

Ventilation is seldom satisfactory in mobile installations, and equipment designed for moderate climates with an ambient temperature of  $-10^{\circ}\text{C.}$  to  $+40^{\circ}\text{C.}$  must have components rated for operation at  $-10^{\circ}\text{C.}$  to  $+65^{\circ}\text{C.}$  This means that components must be of a higher grade than are normally used. In order to be suitable for general use in any country, an ambient temperature of  $-40^{\circ}\text{C.}$  to  $+55^{\circ}\text{C.}$  must be catered for, and components rated for use over the range  $-40^{\circ}\text{C.}$  to  $+80^{\circ}\text{C.}$  must be used.

Fig. 5. Equipment for motor-cycle fitting, shown without cases and mountings. On the left is the transmitter and power unit, in the centre is the matching unit fitted in the base of the half-wave aerial, and on the right is the receiver

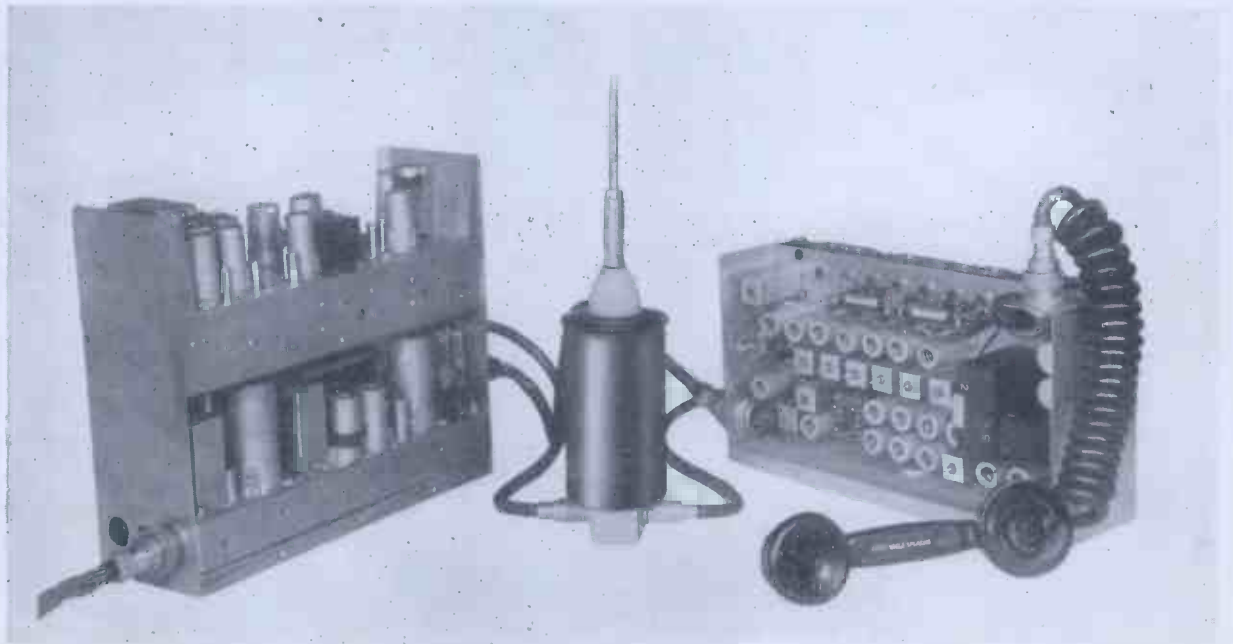

Table II  
Mobile Transmitter Performance

Frequency Range	70 88 or 80-100 Mc/s.
Transmitter R.F. output	20-25 Watts
2nd Harmonic output	0.5 mW.
3rd Harmonic output	0.2 mW.
Frequency deviation (—3 dB at 300, 3000 c/s).	±15 kc/s.
Modulating factor	36 times
P.A. H.T. input (Anode and Screen)	45 watts
Remaining H.T. input (including modulator)	8.4 watts
P.A. heater input	6 watts
Remaining heater and filament input	13 watts
Total input at 12v D.C. (including voltage regulator and relays)	114 watts
Overall efficiency, D.C. to R.F.	20% approx.

Many of the components used for such conditions are hermetically sealed, the leads being brought out through ceramic or synthetic rubber seals. Among the components of this type are paper capacitors, transformers and other inductors. Wax coated mica capacitors are not entirely satisfactory over such a wide range, and so R.F. capacitors are exclusively moulded mica or ceramic types. Electrolytic capacitors are perfectly reliable over the more limited range, but their use is avoided in heavy-duty equipment. Coils are wound hot on to ceramic formers to minimize temperature drift, and ceramic stand-offs and lead-throughs are used in place of normal tag-boards for R.F. and I.F. circuits. Flameproof wire with a woven glass covering is used, and chassis fixings are secured with self-locking nuts.

Tuned circuits must be particularly rigid and stable. I.F. transformers employ substantially air-cored coils with small dust-iron slugs for trimming in the larger sets, while miniature types with coils totally enclosed in a special grade of dust-iron, can give a Q of 200 if needed for the smaller sets. Slug-tuned R.F. circuits are sometimes used, but trimmer capacitors permit a better coil Q, particularly on the higher frequency band. Transmitter circuits follow receiver practice in the early stages; air-cored coils are used

for the final stage in the lower band and sometimes in the higher band, but folded lines are more usual in the latter case.

All aspects of construction have to undergo extensive tests, both in artificial conditions of vibration, humidity and temperature simulated in the laboratory, and in the form of extended practical trials, before equipment can pass from the prototype to the production stage.

Conclusion

Useful advances have been made in V.H.F. equipment in this country recently, particularly in regard to efficiency, economy in power supplies and reliability. Much present work is devoted to meeting the requirements which will arise with increasing congestion. Future development will probably lie in the direction of multiple channel operation and the wider use of duplex, while smaller equipments using sub-miniature valves will become available for restricted ranges.

The author is indebted to the Plessey Company, Ltd., for permission to publish this paper, and for providing the photographs.

References

- 1 Private Mobile V.H.F. Radio Telephone Service: Specification for Amplitude-Modulated Transmitter-Receiver.
- 2 Public Mobile V.H.F. Radio Telephone Service: Specification for Mobile Station Amplitude-Modulated Transmitter-Receiver.
- 3 Provisional Specification for Wireless Apparatus for use under Private Business Licenses
- 4 Radio and Radar for Merchant Ships. Issued by H.M. Stationery Office for G.P.O.
- 5 International Radio Regulations, Atlantic City, 1947. H.M. Stationery Office.
- 6 M.V. Callendar, "Signal-to-Thermal Noise Ratio," *Wireless Engineer*, March, 1950.
- 7 M. G. Nicholson, "Comparison of Amplitude & Frequency Modulation," *Wireless Engineer*, July 1947, and subsequent correspondence.
- 8 H. J. Finden, "Frequency Generation & Measurement," *Electronic Engineering*, June 1950.
- 9 W. T. Board Specification No. K.114, "Climatic & Durability Testing of Services Telecommunication Equipment."

THE PORT OF LIVERPOOL V.H.F. RADIO SYSTEM

(Continued from p. 330)

engineer to service the unit quickly by substitution. Spare units for this purpose are stored at the maintenance depot.

The equipment is operated from a remote unit similar to the standard G.P.O. desk set with the inclusion of the "press to talk" key in the hand set.

The Portable Set

As designed, the equipment is housed in a hermetically sealed case, rain- and water-proof, and fitted to the top of the case are an "on/off" switch combined with the transmitter-receiver switch spring loaded so that it cannot be left on when not in use, a six-way channel switch, a signal press-button and the aerial plug. Together with non-spill chargeable accumulators and collapsible aerial the whole of the equipment is protected by a padded canvas case fitted with rope loops and weighs just under 20 lb.

Fig. 5.

Schematic plan of aerial switching at Port Radar

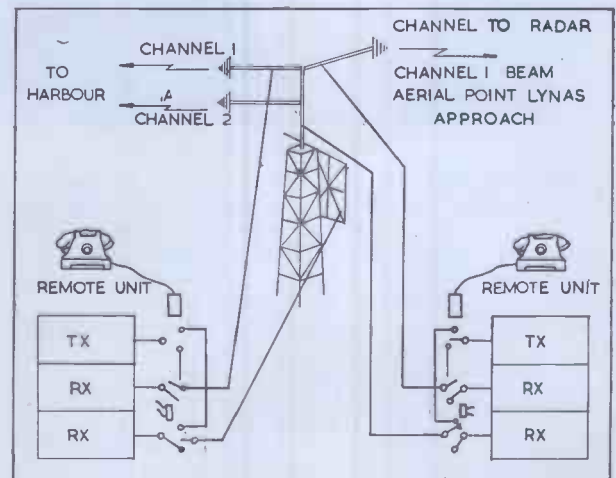

NEW  
PERMANENT  
MAGNET  
ELECTRON  
MICROSCOPE



**T**HE Scientific Instruments Group of Radio Corporation of America has recently announced the first commercially available permanent magnet type of electron microscope. This new instrument is intended to supersede the RCA console unit type EMC and will place electron microscopy within reach of many industrial and research laboratories, hospitals, colleges, and other institutions previously unable to afford this modern research tool.

The outstanding feature of the new microscope is the introduction of permanent magnets to energize the magnetic fields that focus the electron beam. The photograph shows the microscope proper, which is

only 30 in. high, with, on the right, the control unit, which provides readings of vacuum and electrical values.

The advanced design of the microscope permits introduction of specimens without breaking the vacuum. To change specimens, the operator need only withdraw a sliding rod (shown immediately below the large metal sphere), lift out the specimen holder, insert a new specimen and push the rod back into the column.

The camera used with this model is of new design and may be opened for changing plates without letting down the vacuum to any great extent. It is possible to restore the operating vacuum in 90 seconds after inserting a new plate.

Typical of the detailed information which may be obtained with the new microscope is the microscope of calcite reproduced above. This micrograph

was made from a collodion replica stripped from the cleavage face of a piece of calcite and then shadowed with gold-manganin. An electronic magnification of 3,000 diameters was increased photographically to 20,000 diameters. It is possible to use permanent magnet lenses giving up to 6,000 times magnification, which can be photographically enlarged up to 40,000 diameters without loss of detail.

The new RCA electron microscope will be distributed in the British Isles by RCA Photophone, Ltd., 36 Woodstock Grove, W.12, from whom additional information may be obtained.

# A HARD VALVE TIME BASE

By C. H. BANTHORPE

FOR good interlacing, it is important that the frame time base should be triggered by the frame sync. pulses only. In practice it is fairly easy to ensure that the flyback is accurately triggered, but much more difficult to make certain that the start of the trace is unaffected by line impulses which may get in due to imperfect line/frame sync. separation, or from the line generator itself by direct pick-up or via the scanning coils.

If therefore we cannot obtain instantaneous frame flyback, a second best is to control the flyback time, or trigger the start of the scan. A circuit used by the writer during the last two years, in production, makes use of such a principle to ensure good interlacing and in addition, is not too complicated or expensive, uses standard parts, and is reliable and linear. The time base consists of five valves in three envelopes, a double diode, a triode-hexode, and an output pentode, and the circuit is as shown.

It is convenient when describing the action of such a circuit to assume it is already running, and that various capacitors are charged, and in this particular one we assume that the scan is just commencing,  $C_1$  and  $C_2$  are discharged,  $C_3$  is charged, the triode section of  $V_2$  is cut off, and so too is the anode of the hexode section, but  $G_2$  is conducting and therefore its potential is low, holding  $G_1$  of the triode negative.

This condition cannot continue for long, however,

for as  $C_3$  discharges the potential at the grid of the triode rises towards earth, and the anode rises, as  $C_1$  and  $C_2$  become charged, towards H.T.

After a time interval, the triode starts to take current, the anode of the hexode takes current, and  $G_2$  of the hexode takes less current, its potential rises, and this rise is applied to  $G_1$  of the triode and  $G_2$  of the hexode. The action is cumulative and the triode is driven to full current, the anode potential falling as  $C_1$  and  $C_2$  become discharged, and the anode potential of the hexode falling as  $C_1$  becomes discharged. After a second time interval however the flyback time, the fall at the hexode anode is sufficient, through  $V_3$  to lower the potentials of  $G_1$  of the triode and  $G_2$  of the hexode, and initiate the change-over to the original state, and the scan recommences.

The second feature to ensure interlace is the critical time constant at the sync. input which gives sharp frame pulses; and to make sure no line pulse can get in,  $V_1$  is added as an amplitude clipper. It is set so that the diode is biased off sufficiently to allow only the inverted half line pulses to pass and hold back the small line pulses. This method of applying sync. is fundamentally accurate and is fully described elsewhere.<sup>1</sup> The frequency of the time base is best adjusted by  $R_1$  and the amplitude by  $R_2$ .

The sawtooth voltage developed across  $C_1$  and  $C_2$  is applied to the output pentode, the anode of which is transformer coupled to the scanning coils. Negative feedback is applied to the grid circuit from the anode, and this ensures a really linear scan. This feed-back method, due to A. D. Blumlein<sup>2</sup> was possibly the first application of the Blumlein or Miller Integrator circuit, which has since been so generally used

<sup>1</sup> K.S. Davies, *Jour. Tel. Socy.* Dec. 1937.  
<sup>2</sup> A.D. Blumlein. Pat. 479113.

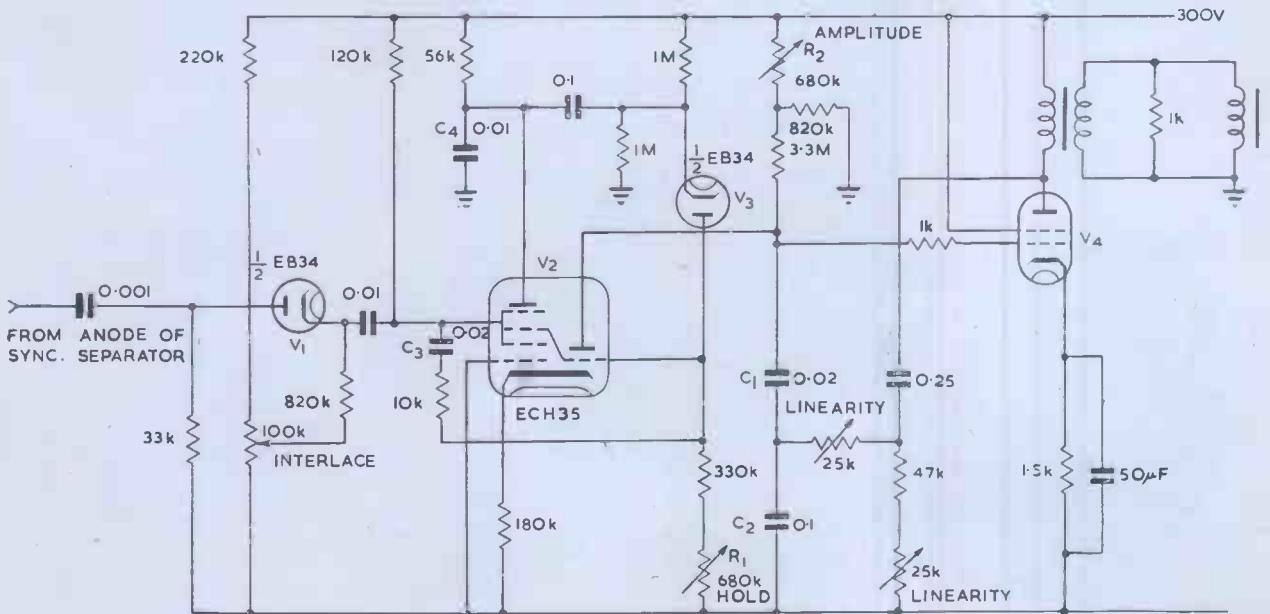

# V.H.F. EQUIPMENT

## A review of British transmitting and receiving equipment for V.H.F. Mobile Radio Services.

This review is compiled from information supplied by the manufacturers concerned who will supply further details on request.

### B.C.C. Portable Transceiver

(Illustrated below)

THE Model L45 "Walkie Talkie" is the smallest crystal controlled battery operated transceiver in full production in this country, and it is designed to provide two-way communication over 1 to 5 miles between sets. This range is greatly increased when used between a mobile or central station and distances of 15 to 20 miles have been obtained under operational tests with a clear, audible signal.

The transmitter and receiver will operate either on a single frequency or on different frequencies within the 75-100 Mc/s. band.

The use of quartz crystals for stabilization of the transmitted and received frequencies and temperature compensated I.F. circuits of high selectivity in the receiver ensures operation with 100 kc/s. channels.

The equipment has an extremely flexible aerial which assures full mobility

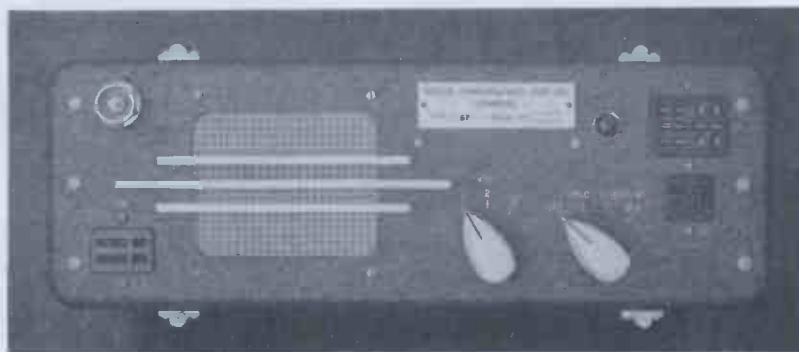

to the user under most difficult conditions. Low power consumption gives 24 hours intermittent use with batteries, and the whole equipment weighs only 16 lbs.

The B.C.C. microphone housing incorporates on/off and send/receive switches which eliminate all switches on the outer case.

The receiver has a sensitivity of 5 microvolts R.F. input at full audio frequency output, with a signal to noise ratio of 5 microvolts input giving 12 db.

### B.C.C. V.H.F. Transmitter/Receiver Type L67

(Illustrated above)

THE V.H.F. Transmitter/Receiver Type L67 is primarily intended for installation in moving vehicles and as such is most suitable for communication with other mobile objects or a fixed station.

The transceiver unit and its power pack are easily accommodated below the instrument panel of a motor-car.

Special anti-vibration mounting ensures that the equipment can be quickly taken out for maintenance, etc.

The equipment can be used for operation on any frequency in the range, 75-100 Mc/s. The operating frequencies are pre-set and crystal controlled. Provision has been made for operation of a P.A. system.

The power pack is energized from a

6 or 12 volt accumulator. The transceiver can also be used as a fixed station and can be supplied from 120 or 230 volt A.C. mains.

### Transmitter

R.F. Power Output : 5 watts.  
Frequency Stability : 3 parts in  $10^6$  per degree Centigrade.

Carrier Noise Level : 52 db below 30 per cent depth of modulation.

Spurious Emissions : Second harmonic attenuated 54 db.

All other harmonics at least 70 db down.

Public Address : Audio output of 4.5 watts.

### Receiver

Sensitivity : Better than 1 microvolt.

Selectivity : -30 db at  $\pm 50$  kc/s. off tune (or 35 kc/s.). -50 db  $\pm 65$  kc/s. off tune (or 50 kc/s.).

Signal plus Noise to Noise Ratio : 12 db or better for  $1 \mu\text{V}$  input signal.

A.F. Output : Maximum undistorted power is 1 watt.

Noise Limiter : Peak clipping at 60 per cent depth of modulation.

Spurious Responses : Image frequency of the I.F. attenuated 60 db or better. Other responses at least 75 db down.

Harmonic Content : Less than 15 per cent for all frequencies between 300 c/s and 3,000 c/s.

Power Input : When the power pack is fed from a 6 volt accumulator the total current taken is approximately as follows: Receiving,  $5\frac{1}{2}$  amps.; Standby, 7 amps.; Transmitting, 10 amps.

The Type H67 is a similar transmitter-receiver assembly, working in the frequency range of 156-184 Mc/s. Both models weigh  $14\frac{1}{2}$  lb. The transmitter of the H67 has an R.F. output of 4 watts, and second harmonic spurious emissions attenuated 40 db, with other harmonics at least 56 db down. The receiver has a sensitivity of less than 2.5 microvolts.

Also manufactured by the same firm are fixed station equipment to work with the equipment described above, type L111 operating in the 75-100 Mc/s. band and type H111 in the 156-184 Mc/s. band.

British Communications Corporation Ltd.,  
Gordon Avenue,  
Stanmore, Middx.  
(Developed for Marconi Wireless Telegraph)





**B.T.R. 10 Watt V.H.F. Radio Telephone (Type PM)**

(Illustrated centre)

**T**HE 10 watt V.H.F. radio telephone is intended to provide a radio-telephone link between ship and shore for short range harbour communications, etc., and for use in vehicles or fixed stations where suitable power supplies are available.

The photo at the top of this column shows a bulkhead type remote control unit for use with this equipment.

**Transmitter**

The modulator employs valves of a similar type to that used for the final R.F. amplifier, and plate and screen modulate the final stage of the transmitter.

An aerial relay is provided which switches the aerial automatically from the transmitter to the receiver, according to the conditions under which the set is operating.

**Power Unit**

Alternative power units are available to operate from any of the following:  
 110 volt, 40-60 c/s mains.  
 230 volt, 40-60 c/s mains.  
 12V, 24V, 48V, or 110V D.C. driving a rotary transformer.

Summary of Technical Details:

**General**

**Frequency Range:** 156-184 Mc/s.  
**Channels:** Up to 6 channels with 100 kc/s. spacing.  
**Operation:** Simplex. Either single or two frequency.  
**Transmission:** Amplitude modulated telephony.

**Transmitter**

**R.F. Output:** 10 watts.

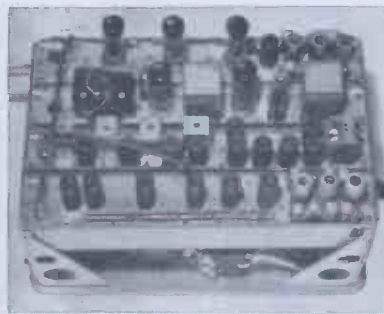

**Oscillator:** Crystal control.  
**Modulation:** Plate and screen modulation of final amplifier.

**Receiver**

**Sensitivity:** 3 microvolts for signal-to-noise ratio of 10 db.  
**Bandwidth:** ± 20 kc/s. at 4 db down. ± 100 kc/s. at 80 db down.  
**Intermediate Frequency:** 4.5 Mc/s.  
**Second Channel Rejection:** Better than 60 db.  
**Oscillator:** Crystal controlled.  
**Automatic Volume Control:** Flat to within 4 db for a signal increase of 60 db.  
**Muting:** Adjustable to local noise level.  
**Audio Output:** 1 watt.

**B.T.R. V.H.F. Harbour Radio Telephone (Type HPS.I)**

(Illustrated below)

**W**HILST built to withstand rough handling and adverse weather conditions, the portable set is compact and lightweight. The case is hermetically sealed and is fitted with a desiccator. Each set is housed in a padded, rot-proofed, canvas carrying case which has



compartments for the accumulators, handset and sectional aerial.

The transmitter is crystal controlled, any one of six crystals being selected by the channel switch. A pentode audio amplifier, followed by a push-pull triode stage, constitutes the modulator, which both anode modulates the power amplifier and screen modulates the driver stage. The pentode amplifier is arranged to generate a 1 kc/s. calling tone when the call button is depressed.

The receiver is of the superheterodyne type with a push-pull R.F. amplifier stage, a germanium crystal mixer, four stages of I.F. amplification, a germanium crystal detector and an audio output stage.

Summary of Technical Details:

**General**

**Frequency Range:** 6 spot frequencies at 100 kc/s. spacing, selected by channel switch, in the band 150-170 Mc/s.

**Crystal Frequency Range:** 8-11 Mc/s.  
**Crystals:** Evacuated bulbs in B7G valve base type.

**System:** Two frequency simplex.  
**Transmission:** Amplitude modulation.  
**Dimensions:** 9½ in. by 8 in. by 11½ in.  
**Weight:** Complete with ancillary equipment, 20 lb.

**Power Supply:** Two 2-volt dry-type accumulators driving synchronous vibrator unit.

**Battery Life:** Sufficient for five hours continuous operation with approximately 10 per cent of the time on transmit.

**Transmitter**

**R.F. Output:** 250 milliwatts.  
**Oscillator:** Crystal controlled.  
**Microphone:** Carbon type.

**Receiver**

**Oscillator:** Crystal controlled.  
**Sensitivity:** 10 microvolt for signal/noise ratio of 10 db.  
**Selectivity:** At ±20 kc/s., 6 db. At ±100 kc/s., more than 60 db.  
**Image Frequency Response:** More than 30 db down.  
**I.F.:** 4.5 Mc/s.  
**Telephone:** Moving iron.

**B.T.R. V.H.F. Harbour Radio Telephone—Coast Station Type HDE**

**V**.H.F. equipment type HDE is designed to be a counterpart of the portable set type HPS. I. Provision is made for operation both locally and from a remote point such as a control office some distance from the equipment room.

Metal cabinets are used to house the radio equipment. Two sizes of cabinet, 4 ft. and 6 ft. high, are available to hold four or seven main units respectively. The panel sizes are suitable for mounting the equipment on 19 in. racks where this system is preferred.

Since the equipment is intended for use over long periods without attention, each cabinet is provided with a door which can be locked. With the door closed, the only items visible are meters

and an indicator lamp to provide an indication of the functioning of the transmitter and receiver.

The photo illustrates a 6 ft. rack housing 2 transmitters, 3 receivers and 2 transmitter power units.

#### Transmitter

The output of a telephone-type carbon microphone is fed through a phase splitter to a push-pull modulator. An output of over 50 W audio frequency power is available, and a limiter is used to prevent over-modulation. The bandwidth is chosen to give the maximum intelligibility at the limiting distance of operation.

In the power amplifier, a 9 Mc/s. crystal oscillator and three frequency multiplying stages are followed by a buffer amplifier to reduce harmonic radiation and a push-pull output stage using a twin tetrode.

#### Receiver

The I.F. sub-unit includes the I.F.

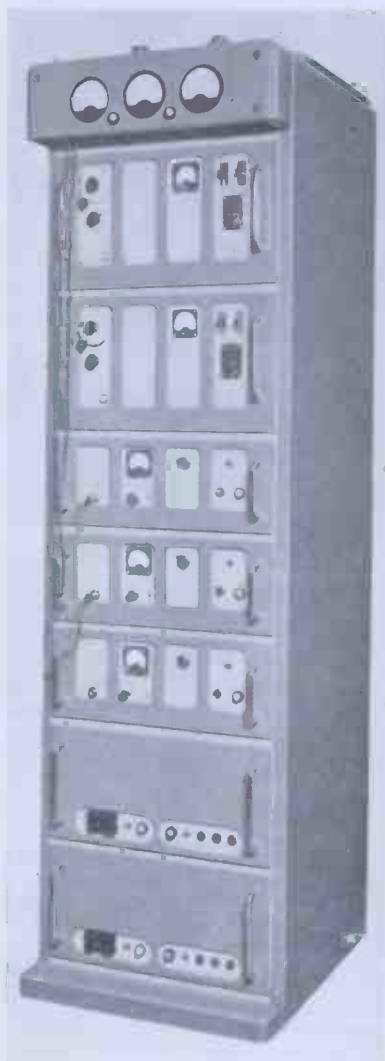

amplifiers, detector, A.G.C. and noise silencing and muting circuits. Four pairs of critically coupled tuned circuits are used to give a response which is essentially flat over  $\pm 20$  kc/s. and more than 80 db down at  $\pm 100$  kc/s.

Technical Details:—

#### General

**Frequency Range:** Single spot frequency in the range 150-170 Mc/s.

**Crystal Frequency:** 8-10 Mc/s.

**Crystals:** Evacuated bulbs in B7G valve base type.

**System:** Amplitude modulation.

**Power Supply:** 200-250 v. 40-60 c/s (other A.C. voltages or D.C. mains can be provided for).

**Operation:** By remote control unit.

**Cabinet Dimensions:** 21 in. by 24½ in. by 45 in. high overall.

21 in. by 24½ in. by 73 in. high overall.

#### Transmitter

**R.F. Output:** 40 watts.

**Oscillator:** Crystal controlled.

**Microphone:** Carbon type.

#### Receiver

**Oscillator:** Crystal controlled.

**Noise factor:** 4.5 db.

**Sensitivity:** 1 microvolt for signal/noise ratio of 10 db at 30 per cent modulation.

**Selectivity:** At  $\pm 20$  kc/s.: less than 4 db.

At  $\pm 100$  kc/s.: more than 80 db. Image frequency response: more than 80 db. down. Spurious responses: more than 70 db. down.

**I.F.:** 5 Mc/s.

**Telephone:** Moving iron.

#### B.T.R. Portable F.M. "Walkie Talkie" Model FWT2

(Illustrated above)

THE Portable Radio Telephone Model FWT2 is a compact light-weight unit designed for use by unskilled personnel. Novel circuit arrangements and a special assembly have been combined to reduce size and weight to a minimum whilst maintaining a robust construction to allow for rough handling under all weather conditions. The set is hermetically sealed and provided with a deslccator.

The system employed is frequency modulation, single frequency simplex using any frequency in the band 60-100 Mc/s.

The transmitter consists basically of a self-excited oscillator followed by a neutralized power amplifier. Frequency modulation is achieved by modulating the bias on a pair of germanium diodes associated with the oscillator circuit and allowing a peak deviation of  $\pm 15$  kc/s.

The superheterodyne receiver consists of an R.F. amplifier, a mixer and local crystal oscillator, three stages of self-



limiting I.F. amplification, a phase discriminator and an audio output valve. The I.F. chain is arranged to self-limit at signal inputs of 30 microvolts and above to provide a measure of A.G.C. and to supply the discriminator with signals substantially free of amplitude modulation.

The transmit/receive switch is spring loaded to the "Off" position to obviate the risk of battery waste by leaving the set switched on accidentally. An optional additional feature is an audio oscillator operating at approx. 1.5 kc/s. for the transmission of a continuous calling tone when the "Call" button on the top panel is depressed.

**Frequency Range:** 60-100 Mc/s.

**Crystal Frequency Range:** 9.5 Mc/s.

**Crystals:** Carried in evacuated bulb on B7G valve base.

**Operation:** Single frequency simplex.

**Transmission:** Frequency modulation.

**Deviation:**  $\pm 15$  kc/s.

**Dimensions:** 10¾ in. by 4½ in. by 9¾ in. high (to top of carrying handle).

**Weight:** 14 lb. complete with all ancillary equipment.

#### Transmitter

**R.F. Output:** 500 milliwatts.

**Oscillator:** Self excited, with centre frequency stabilization against a crystal controlled reference.

**Modulation:** Direct frequency modulation of oscillator.

**Microphone:** Carbon type.

#### Receiver

**Sensitivity:** 10 microvolts for signal to noise ratio of 10 db.

**Bandwidth:**  $\pm 25$  kc/s.-4 db.

$\pm 100$  kc/s.-50 db.

**Intermediate Frequency:** 3.1 Mc/s.

**Output:** 10 milliwatts with 30 microvolts input.

**Telephone:** Moving iron insert.

#### Power Supply.

2 volt 15 A.H. lead acid accumulator of dry type, driving synchronous vibrator unit.

British Telecommunications Research Ltd.,  
Taplow Court,  
Taplow, Bucks.





### Ekco Light Weight V.H.F. Equipment

(Illustrated above)

A WIDE range of frequency-modulated equipment has been introduced by E. K. Cole Ltd., to meet the communications requirements of public services or commercial organizations operating a number of cars, motor-cycles, ambulances, fire appliances, locomotives, river vessels, and the like.

#### Fixed Station Equipment

##### Transmitter

R.F. Output : 50, 25 or 10 watts as required.

Frequency Range : 30-100 Mc/s.

Maximum Deviation :  $\pm 15$  kc/s.

Oscillator Crystal temperature controlled to maintain frequency stability of  $\pm 0.001$  per cent over range of temperature— $10^{\circ}$  C. to  $+55^{\circ}$  C.

Total harmonic distortion is less than 10 per cent at full modulation.

Sensitivity :  $1 \mu\text{V}$  over frequency range 30-100 Mc/s.

Signal-Noise Ratio : Not less than 20 db at full deviation of  $\pm 15$  kc/s.

Image Reflexion : Better than 80 db.

Muting Level : Adjustable but normally set at a s/n ratio of 20 db i.e. at signal level of  $1 \mu\text{V}$ .

A.F. Output : 1 watt with total distortion not exceeding 5 per cent.

The receiver is a double super-heterodyne employing 2 R.F. stages followed by two frequency changes, 2 I.F. stages and 2 limiters. The discriminator is followed by 2 A.F. stages.

A crystal oscillator and multiplier provide the required heterodyne frequencies.

#### Selective Calling Unit

The selective calling unit is designed to provide for three-digit selection of up to 1,000 individual mobile units, or alternatively, for communication schemes involving a lesser number of mobiles, for two-digit selection of up to 100 individual mobile units.

#### Mobile Units

**Transmitter/Receiver :** An electrical performance comparable with that of the fixed station equipment but for a very much reduced power consumption has been obtained by the use of 6.3 V heater valves for the critical stages of the equipment.

**Receiver :** Essentially similar in design and performance to the fixed station receiver.



### Ekco Wireless Set No. 88

(Illustrated above)

THE Ekco Wireless Set No. 88 is a light-weight portable transmitter-receiver ("Walkie-Talkie") employing 14 valves. It gives four alternative frequency channels spaced 0.4 to 0.8 Mc/s. apart in the 40 to 42.5 Mc/s. band.

The set was originally designed as a man-pack set for military use, especially for infantry patrols in forward areas; it is, however, equally suitable for a variety of civilian applications.

The equipment, including set batteries, aerial, phones and microphone, is sufficiently small and light to permit the operator to continue with his normal job without inconvenience.

The main features of the set are : simplicity of operation—the only controls are an on-off switch, a send-receive switch and a frequency switch ; weight of the complete equipment is only about 12 lbs. ; the set is carried in one pouch, and battery, phone, etc. in the other ; the set is completely airtight and a robust diecast case is employed ; the set is suitable for use under the most exacting conditions, e.g. exposure to tropical humidity or to sea water ; the transmitter and receiver are both completely crystal controlled, eliminating the necessity for any ordinary tuning, and ensuring a frequency accurate to within  $\pm 0.02$  per cent.

E. K. Cole Ltd.,  
Ekco Works,  
Southend-on-Sea,  
Essex.

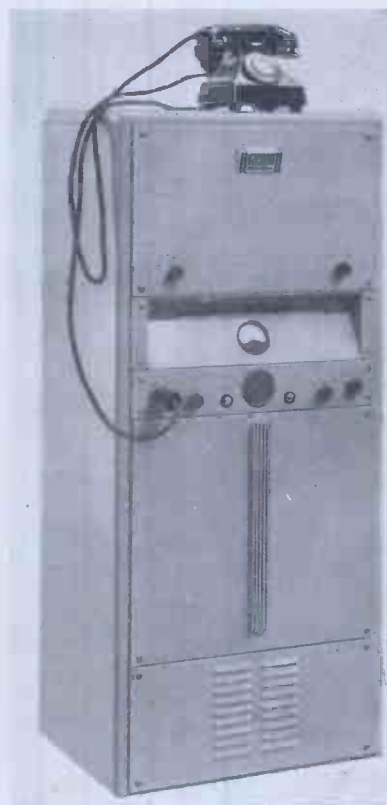

### G.E.C. 100 Watt Frequency Modulated V.H.F. Transmitter/Receiver

(Illustrated above)

V.H.F. Headquarters Station Equipment for Radio-Telephone Communication with Mobile Units, or for Short Range Point-to-Point Service

#### Specification

**Frequency Range :** Operation on a single, crystal-controlled, channel in the band 75-100 Mc/s. ; under certain circumstances operation on a second channel, spaced not more than 400 kc/s. from the main frequency/ies, is possible.

**Service :** Telephony. "Simplex" or "Duplex."

**Control Facilities :** A wide range of facilities is possible by using various types of control units, for example :

**Local or extended control :** A desk type control unit for use adjacent to, or up to 250 ft. from the station transmitter receiver.

**Remote control :** The equipment may be controlled over a two-wire telephone line up to several miles in length.

**Telephone switchboard :** The transmitter/receiver can be arranged for operation from a manual telephone switchboard, thus enabling telephone subscribers to be connected to the radio system.

**Selective Calling :** The G.E.C. system of selective calling permits private

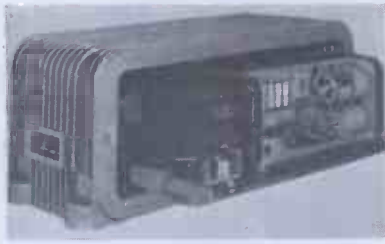

communication with any one (or group) of a number of substations, to the exclusion of the remainder.

Power Supply : 100/120, 200/250 volts, 50/60 c/s.

### G.E.C. Single-Channel Amplitude Modulated V.H.F. Aircraft Transmitter/Receiver

The unit has been designed with low weight as the main feature, making it ideally suited for use in light aircraft

#### Specification

Frequency Range : Crystal-controlled, single channel, in the band 117.9 Mc/s.-131.9 Mc/s.

Service : "Simplex" telephony.

R.F. Power Output : 0.25 watts.

Finish : Fully tropical, with forced air cooling.

Power Supply : 24 volts D.C., 2.4 amps. ; 12 volts D.C., 4.5 amps.

In addition the G.E.C. range includes : 500 watt frequency modulated V.H.F. Transmitter. 100 watt amplitude modulated V.H.F. Transmitter. 15 watt amplitude modulated V.H.F. Station and Mobile Transmitter/Receivers Frequency Modulated V.H.F. Pack. Set.

### G.E.C. 15/20 Watt Frequency Modulated V.H.F. Transmitter/Receiver

(Illustrated above)

#### Specification

Frequency Range : Operation on a single, crystal-controlled, channel in the band 30-170 Mc/s. ; under certain circumstances operation on a second channel, spaced not more than 400 kc/s. from the main frequency/ies, is possible.

Service : Telephony. "Simplex" or "Duplex."

"Mobile" Public Address : The mobile transmitter can be used to deliver an audio output of 5 watts to a suitable loudspeaker.

Control Equipment : The station version uses a desk-telephone control unit, while the mobile model has a special panel control assembly.

Control Facilities : Similar to the 100 watt unit.

Power Supply : 6-volt or 12 V battery operation, or 100/120, 200/250 volts, 50/60 c/s single phase A.C.

The General Electric Co. Ltd.,  
Magnet House,  
Kingsway, London, W.C.2.

### Marconi "Walkie Talkie" V.H.F. Equipment Type H.19

THE Type H.19 is a completely self-contained C.H.F. transmitter/receiver designed to be carried and operated without impeding freedom of movement. It is normally carried on the back in a set of adjustable webbing harness, but can also be slung at the side. A special Bergen rucksack type carrier frame can be supplied if preferred, in place of the webbing harness.

The set can be supplied either for amplitude or frequency modulation and for common-frequency or dual frequency working on a simplex basis.

The unit is housed in a light metal container, with lids fitted to the top and bottom and held in position by quick release catches. Both lids have a second lip, which fits the inside of the case, and a rubber gasket to make the unit completely watertight.

The transmitter and receiver are built on separate chassis and these are mounted back to back and secured, together with the vibrator power pack, to the upper lid of the case.

The aerial is of the flexible rod type and screws into an insulated bushing in the upper lid. It is made in two sections which push together easily, and are locked together by means of a knurled nut.

A synchronous vibrator unit provides anode and grid bias supplies.

This equipment can be supplied in the following ranges of frequency : 36-44 Mc/s., 65-78 Mc/s., 78-100 Mc/s., 118-132 Mc/s. and 156-174 Mc/s. It has a transmitter power of 100-300 mw, depending on frequency range. Frequency tolerance is  $\pm 0.01$  per cent, with crystal frequencies of 9.0-19.5 Mc/s. A.M. and 2.25-11.5 Mc/s. F.M. Multiplication is of 4 to 12 times A.M., again depending on the frequency, and 16 times F.M., with modulation for A.M. 80 per cent, and for F.M.  $\pm 15$  kc/s. deviation (100 per cent modulation). The receiver sensitivity is between 3 and  $8\mu\text{V}$  for 10 db s/n ratio, according to the frequency range. The power consumption is 6.5W on "receive" and 7.5W on "transit" from a 2-volt accumulator, having a capacity of 30 AH at the 20-hour rate. The equipment weighs  $14\frac{3}{8}$  lb., and its dimensions are  $8\frac{1}{8}$  in. by  $9\frac{3}{8}$  in. by  $15\frac{1}{8}$  in.

### Marconi V.H.F. Equipment Type 16 and 16A

(Type 16 above, Type 16A below)

THE mobile edition, known as the Type H.16 consists basically of a transmitter and receiver, a microphone, loudspeaker and control unit. The transmitter and receiver are separate units and are mounted on a rack fitted with shock absorbers and suitably designed for fitting in such places as the boot of a car. The remaining units are mounted within easy reach of the operator and may be conveniently mounted on the dashboard of a car. A



loud hailer can also be supplied if required.

The Type H.16A is the fixed station edition and all the units are housed in a pressed steel cabinet which is particularly suitable for desk mounting. Control may be either local, extended, or remote.

Both amplitude and frequency modulated versions are available for operation on any crystal-controlled spot frequency in the selected bands with the exception of the 118-132 Mc/s. band ; the amplitude modulated version only being available in this case.

The basic transmitter and receiver circuits for both fixed and mobile editions are identical apart from their power supply arrangements.

Summary of Technical Data

#### Transmitter

Frequency Ranges (range to be specified when ordering) : 36-44 Mc/s., 65-78 Mc/s., 78-100 Mc/s., 118-132 Mc/s., 156-184 Mc/s.

Power Output : 10-14 watts, depending on frequency range.

Frequency Tolerance :  $\pm 0.01$  per cent.

Crystal Frequencies : AM—9-16.7 Mc/s. (fundamental), 29.5-40 Mc/s. (3rd overtone) ; FM—407 kc/s.-2.9 Mc/s.

Multiplication : AM—4 to 12 times, depending on frequency range ; FM—60-160 times, depending on frequency range.

Modulation : AM—80-90 per cent ; FM— $\pm 15$  kc/s. deviation (100 per cent modulation).

AF Response : Within  $\pm 3$  db from 300 to 3,000 c/s.

#### Receiver

Frequency Ranges (range to be specified when ordering) : 36-44 Mc/s., 65-78 Mc/s., 78-100 Mc/s., 118-132 Mc/s., 156-174 Mc/s., 174-184 Mc/s.

Sensitivity : AM—between 1.0 and  $2.5\mu\text{V}$  for 10 db s/n ratio, according to



frequency range. FM—between 1.0 and 2.0  $\mu$ V for 20 db quieting according to frequency range.

Audio Output : 1 watt.

Crystal Frequencies : 8.5-18 Mc/s.

Multiplication : 2 to 5 times, depending on frequency range.

I.F. Bandwidth : 35 kc/s. at 6 db (narrow band edition). 50 kc/s. at 6 db (wide band edition).

Image Protection : 30-60 db, depending on frequency range and IF bandwidth.

AGC : 6 db output change for 60 db input variation.

AF Response : Within  $\pm 3$  db from 300 to 3,000 c/s.

**General**

Dimensions—Mobile Edition : Transmitter and Receiver (each unit) : Width, 8 in. (20.3 cm.) ; depth 15½ in. (39.3 cm.) ; height, 7½ in. (18.4 cm.) ; weight, 15 lb. (6.8 kg.). Overall dimensions of Rack Assembly for boot of car Width, 16 in. (40.6 cm.) ; depth, 17½ in. (44.4 cm.) ; height, 8 in. (20.3 cm.) ; weight, 40 lb. (18.1 kg.) ; Fixed Station Edition : width, 21½ in. (54.6 cm.) ; depth, 17 in. (43.8 cm.) ; height, 9½ in. (23.5 cm.) ; weight, 69 lb. (31.2 kg.).

Power Supply : 6, 12 or 24 volt battery ; 110-130 volt or 200-250 volt, 50-60 c/s, AC mains.

**Power Consumption :**

Supply	Transmit	Standby	Receive
6V	27A	13A	10A
12V	13A	7A	5A
24V	6.5A	3.5A	2.5A
AC	200W		110W

**Marconi Portable V.H.F. Equipment Type H18**

(Illustrated below)

THE equipment is built into a sheet metal case, the controls, and sockets for supply and handset leads being mounted on the front panel.

An alternative mounting can be supplied for installing the equipment under the dashboard of a vehicle ; power supplies would then be taken from the vehicle's battery.

In the transmitter a crystal oscillator drives into a double-triode valve, both halves of which act as frequency multipliers, and these are followed by two power amplifier stages.

In the frequency modulated edition, phase modulation is produced by means of a reactance modulator network connected across the output of the R.F. oscillator. A correcting network is

incorporated in the audio input circuit of the phase modulator to give in effect, frequency modulation.

The receiver employs a double super-heterodyne circuit.

The transmitter and receiver can each be pre-set independently to any one crystal-controlled frequency in the specified frequency band.

The set takes its supplies from a 6-volt accumulator, and is normally operated from the battery of the vehicle where it is installed. For the sake of completeness as a fully transportable equipment, however, it can be supplied with a 6-volt lightweight accumulator. In this case the continuous service working of the set is reduced to approximately three hours.

**Summary of Technical Data**

Frequency Range : 36-44 Mc/s., 65-78 Mc/s., 78-100 Mc/s., 118-132 Mc/s., 156-174 Mc/s. (range to be specified when ordering).

Frequency Tolerance :  $\pm 0.01$  per cent.

Transmitter Power : 1.5-2.5 watts, depending on frequency range.

Crystal Frequencies : AM—9.0-19.5 Mc/s. ; FM—2.25-11.5 Mc/s.

Multiplication : AM—4 to 12 times, depending on frequency range ; FM—16 times.

Modulation : AM—90 per cent. ; FM— $\pm 15$  kc/s. deviation (=100 per cent modulation).

Receiver Sensitivity : Between 2 and 6  $\mu$ V for 10 db s/n ratio, according to frequency range.

Power Consumption : 30 watts on "receive" and 42 watts on "transmit," from 6-volt accumulator.

Dimensions : Width 13½ in. (33.6 cm.) ; depth, 8½ in. (20.9 cm.) ; height, 5½ in. (14.5 cm.) ; weight 14½ lb. (6.6 kg.).

Marconi Wireless Telegraph Co. Ltd.,  
Marconi House,  
Chelmsford,  
Essex.

**Plessey V.H.F. Frequency Modulated Transmitter/Receiver, Type PTR.7**

(Illustrated below)

FREQUENCY Modulated, crystal controlled and operating on a spot frequency within the 68.0-100.00 Mc/s. band, the 6 volt, 10 watt R.F. output transmitter/receiver, type PTR.7 has

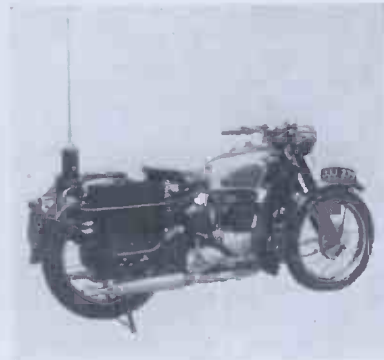

been especially designed for use on motor-cycles.

A Selective Calling system is available whereby one, or all, of ninety units, each consisting of one or more vehicles, may be called from the control station. This system can be supplied either to "lock-out" all stations not being called, or to allow these stations to interrupt communication between the fixed and a mobile station should it be necessary. Notification of an incoming call is given by a bell or buzzer and a lamp.

The Receiver with Selective Calling, Transmitter and Power Unit are combined within two waterproof cases mounted on either side of the rear wheel. Every effort has been made both to distribute the weight evenly and to keep the centre of gravity low.

Power consumption on "standby" is claimed to be as low as 18 watts, service being about 20 miles, dependent on terrain and installation conditions, when operating in conjunction with a 20 watt control transmitter.

This 27-valve equipment is crystal controlled throughout, and therefore requires no adjustment in operation. Sensitivity is 1 microvolt carrier input for 10 db quieting. Spurious responses are at least 60 db down on wanted signal. Fully tropicalized in accordance with RCS 1,000, all components are suitable for use within the temperature range -40° C. to +71° C. with humidity as stated for K110.

**Plessey V.H.F. and H.F. Medium Powered Transmitter, Type PT. 16**  
(Illustrated overleaf)

ONE of the range of communication units for ground and airborne operation developed by The Plessey Company Limited, the V.H.F. and H.F. transmitter, type PT. 16 provides medium power telephone, MCW and CW transmission for general communications service covering aeronautical, marine and civil administration in any part of the world. Various combinations of standard panel units provide a wide range of facilities.

Any one of four frequencies, two in each of the ranges 2.5-13 Mc/s. and 116-132 Mc/s. respectively, may be selected by local or remote control. In the latter case, the appropriate RF channel, together with "switching-on" facilities, is selected in one dialling operation, over a single telephone pair up to a distance of 14 miles. The remote control unit is suitable for desk or rack mounting, and consists of a small cabinet with a telephone dial.

RF, control, modulator and power units are housed in a steel cabinet approximately 5 ft. 4 in. high, having a single door back and front. The former lifts from its hinges for easy servicing, while a window in the latter permits of easy reading of the meter panel. All components are to tropical specification.





Cooling of the interior of the transmitter is accomplished by a blower, the air intake of which is filtered through a fibre-glass filter.

**Plessey V.H.F. Fixed Station Transmitter, Type PT.10**  
(Illustrated below)

DESIGNED originally to meet airport local control requirements, the 12 Watt, V.H.F. Transmitter, Type PT.10, introduced by The Plessey Company Limited, has a wide field of application wherever a compact fixed-station transmitter with an RF power output of this order is required. The complete equipment consists of a Modulator and an RF unit conveniently mounted for desk operation in a rigid steel frame. Where preferred, however, these units may be mounted otherwise, in a standard rack for instance, with a suitable receiver and loudspeaker unit to form a complete transmitter-receiver installation.

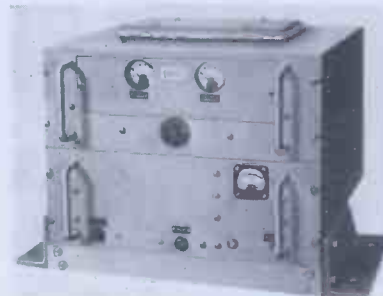

Covering the 118-132 Mc/s. frequency band, the crystal controlled operational frequency can be varied by insertion of the appropriate crystal. It is then necessary only to tune for a maximum or minimum meter reading, according to the stage concerned. Frequency stability fully complies with international requirements.

Operation is simple, band-pass circuits in the RF unit minimizing the necessary tuning controls, and a preset circuit in the Modulator unit automatically preventing over-modulation. Servicing, too, is simplified by switched two-meter indication of each stage in the R.F. unit, test points being provided to cover all other sections. A third meter records the cathode current of the modulator power amplifier valves, and lamps indicate "Modulation H.T. On" and "R.F. H.T. On."

The equipment operates from 230 volt 50 cycle supply.



**Plessey V.H.F. Fixed Frequency Receiver, Type PR. 71**  
(Illustrated above)

OPERATING in the 118-132 Mc/s. band, the V.H.F. fixed Frequency Receiver, Type PR.71, provides single channel crystal controlled reception of R.T. and M.C.W. Stability is exceptionally good, and special circuits prevent overloading from nearby transmitters, while electronic muting eliminates background noise in the absence of an incoming signal. Designed to International Aeradio Specification and intended primarily for aeronautical ground station use, the compact size and ease of operation of this receiver make it suitable for operation in many different applications.

**Plessey Type PTR. 61**  
(Illustrated right)

Specifically designed for use in small and medium private and training aircraft, the V.H.F. Transmitter-Receiver, Type PTR.61, provides R/T facilities on any one of six crystal controlled channels within the aeronautical band 118-132 Mc/s. Once the appropriate channel has been selected, a single control tunes both the transmitter and receiver, enabling the instrument to be set up with one hand. Extra crystals may be carried and easily inserted by the operator, providing a wide choice of channel frequencies. Remote control facilities are available, and the equipment



allows intercommunication up to three positions.

The Plessey Co. Ltd.,  
Ilford,  
Essex.

**Pye 3-5 Watt Mobile Radio-Telephone Series PTC 112/113**  
**General Specification**  
(Illustrated below)

SINGLE unit construction is employed. Transmitter, receiver and power unit are built on a single chassis, and are housed in a robust, easily detachable metal cover. The complete unit is mounted on a shock absorbent cradle.

Controls: (1) Receiver on/off switch. (2) Transmit/Receiver switch. (3) Loud-speaker volume control.

Extended control is used, and controls (1) and (3) are on an extension control unit with the loudspeaker. Control (2) is a press switch on the microphone.

Frequency Range: 60-184 Mc/s. The set is intended for simplex working on a "press-to-talk" basis, in either double or single frequency schemes. A model for operation between 30-60 Mc/s. can be supplied to special order.

Power Supply: 6, 12 or 24 volts D.C. supply, positive or negative earth.

Current Consumption at 12 volts: (1) Receiver "on" and Transmitter heaters, 5.4 amps. (2) Transmitter "on" and Receiver heaters, 7.2 amps.

At 6 volts these figures are approximately doubled.

**Technical Specification Receiver**

The receiver is a high performance double superheterodyne with efficient



noise limiting characteristics. It incorporates 11 valves, comprising R.F. amplifier, two mixers, two 2nd I.F. amplifier stages, Detector and A.G.C. Noise limiter, A.F. amplifier, output, crystal oscillator multiplier.

**Crystal Frequency:** In band 8.8-11.5 Mc/s. (Frequency tolerance 0.0003 per cent.).

**Sensitivity:** 1 microvolt.

**S/N Ratio:** Better than 6 db at 1 microvolt. (100 Mc/s.).

**First Intermediate Frequency:** 12.0-13.5 Mc/s. approx.

**Second Intermediate Frequency:** 2.9 Mc/s.

**Second I.F. Bandwidth:**  $\pm 17.5$  kc/s.—6 db (narrow band) or  $\pm 25$  kc/s.—6 db (wide band).  $\pm 50$  kc/s.—60 db (narrow band) or  $\pm 60$  kc/s.—60 db (wide band).

**Spurious Responses:** (a) At 160 Mc/s. First I.F. image—52 db. All other spurious responses—60 db. (b) At 70 Mc/s. First I.F. image—78 db. All other spurious responses—80 db.

**Audio Response:** 6 db down 200 and 2000 c.p.s.

**Audio Power Output:** 1 watt.

#### Transmitter

This incorporates 7 valves, comprising Crystal oscillator multiplier, 2nd multiplier, driver, push-pull power amplifiers, push-pull modulators (2nd multiplier valve is omitted below 100 Mc/s.).

**R.F. Output:** 3-5 watts.

**Microphone:** Double button carbon.

**Modulator response:** 0 db at 400 c.p.s. + 2 db at 10 kc/s.

**Modulation Capability:** 100 per cent. Crystal frequency tolerance at 0.003 per cent.

**Note:** The PTC 112/113 has received Type Approval from the British Post Office.

#### Pye 3-5 Watt Mobile Equipment Series PTC 108

(Illustrated above)

**T**HE Universal 3-watt radio-telephone has been designed to meet the need for a compact, single unit equipment of high performance.

The small size, light weight and low battery consumption of this transmitter-receiver make it ideal for many uses where installation of high powered equipment is impracticable.

Single unit construction is employed with the transmitter, receiver and power unit mounted on a single chassis.

**Frequency Range:** 60 to 132 Mc/s. The set is intended for simplex working only, in either double or single frequency schemes.

**Power Supply:** 6 or 12 volt D.C. supply, Positive earth or Negative earth. A battery version or a mains/battery version is available, the latter version has an additional mains power pack measuring 4 by 7½ by 6 in.

**Current Consumption at 12 volts:** (1) Receiver only, 4.7 amps. (2) Receiver and transmitter standby, 5.8 amps. (3) Transmitter on and Receiver heaters, 6.9 amps.



At 6 volts these figures are approximately doubled.

The Test Meter and Radiation Tester Type PTC 405 illustrated with the PTC 108 equipment, is specially designed to facilitate Transmitter adjustments in this radio-telephone. An indication of Receiver A.V.C. action is also provided. This Test Meter is not included with each PTC 108 equipment, but is supplied as necessary. One Test Meter is usually sufficient for 10 mobile sets.

#### Technical Specification

##### Receiver

This incorporates 11 valves, comprising R.F. amplifier, mixer, crystal oscillator multiplier, 2nd multiplier, three I.F. amplifier stages, double-diode signal and A.G.C. detector, double-diode noise limiter, A.F. amplifier, pentode output.

**Sensitivity:** 1 to 2 microvolts.

**S/N Ratio:** Better than 8 db at 1 microvolt.

**Intermediate Frequency:** 4.5 Mc/s.

**Selectivity:** Narrow band, 6 db down for  $\pm 20$  kc/s., more than 80 db down at  $\pm 100$  kc/s. Broad band, 6 db down for  $\pm 30$  kc/s., more than 40 db down at  $\pm 100$  kc/s.

**Audio Response:** 6 db down at 200 and 2,000 c.p.s.

**Audio Power Output:** 1 watt.

##### Transmitter

This incorporates 5 valves, comprising crystal oscillator multiplier, 2nd multiplier, power amplifier, push-pull modulator.

**Microphone:** Double button carbon.

**R.F. Output:** 3-4 watts.

**Modulator Response:** 6 db down at 200 and 3,000 c.p.s.

#### Pye 12-15 Watt Mobile Radio-Telephone Series PTC 114/115

(Illustrated right)

**T**HE equipment, which is in two-unit form, consists of a transmitter chassis and a receiver chassis. The transmitter chassis carries one rotary converter which is used in conjunction with the receiver rotary converter for "Transmit" purposes. Each of the two units may be quickly and individually withdrawn from a common mounting cradle. The inter-unit connexions are made at the rear of the cradle via self-locating plugs and sockets.



**Dimensions:** 17 in. by 14 in. by 8 in. (43.2 by 35.6 by 20.3 cm.).

**Weight:** 40 lb. (18.2 kgs.).

**Frequency Range:** 60-184 Mc/s.

**Power Supply:** 6, 12 or 24 volts D.C. positive or negative earth.

**Current Consumption at 12 volts:** Receiver only, 4 amps. Receiver plus Transmitter heaters, 5-4 amps. Transmitter on plus Receiver heaters, 12.5 amps.

At 6 volts these figures are approximately doubled.

**Loud Hailing:** Transmitter modulator used, giving an audio power output of 15 watts.

#### Technical Specification

##### Receiver

The receiver is a high performance double superheterodyne with efficient noise limiting characteristics. To ensure a minimum spurious response a common crystal oscillator provides the heterodyne injection to both mixers. It incorporates 11 valves, comprising R.F. amplifier, two mixers, crystal oscillator/multiplier, 2nd multiplier, two 2nd I.F. amplifier stages, detector and A.G.C., noise limiter, A.F. amplifier, and output stage.

**Crystal Frequency:** In band 8.8-11.5 Mc/s. (Frequency tolerance 0.003 per cent.).

**Sensitivity:** 1 microvolt.

**Noise Factor:** Better than 6 db at 100 Mc/s.

**Intermediate Frequencies:** 2nd I.F., 2.9 Mc/s. 1st I.F., Crystal frequency, plus 2.9 Mc/s.

**Second I.F. Bandwidth:**  $\pm 17.5$  kc/s.—6 db (narrow band) or  $\pm 25$  kc/s.—6 db (wide band).  $\pm 50$  kc/s.—60 db (narrow band) or  $\pm 60$  kc/s.—60 db (wide band).

**Spurious Responses:** (a) At 160 Mc/s. First I.F. image—52 db. All other spurious responses  $> -60$  db. (b) At 70 Mc/s. First I.F. image—78 db. All other spurious responses  $> -80$  db.

**Audio Response:** 6 db at 200 and 2000 c.p.s.

**Audio Power Output:** 1 watt.

##### Transmitter

The transmitter incorporates 6 valves, comprising crystal oscillator multiplier, multiplier, driver/multiplier, power amplifier and modulators. (1 multiplier valve is omitted below 100 Mc/s.).

**Microphone:** Double button carbon.

**R.F. Output:** 12 watts at 184 Mc/s. 15 watts at 100 Mc/s.

**Modulation Capability:** 100 per cent. modulation.

**Modulator Response:** 1.0 db at 100 c.p.s. and 6000 c.p.s.

Crystal frequency tolerance 0.003 per cent.

Note: The PTC 114/115 has received Type Approval from the British Post Office.

### Pye Fixed Station Equipment

(Illustrated below)

THE simplest type of self-contained fixed station is the PTC 703/4. This station includes a fixed receiver and a medium-power 12-15 watt transmitter housed in a pressed steel cabinet. A station of this type is ideal for communication with mobile stations in a "Business Radio" scheme.

Two alternative types of auxiliary control, in addition to the usual local control, can be provided if required. The extension control unit enables the station to be operated from another point in the same building, while the remote control unit can be connected to a telephone line to give control over distances up to 15 miles.

#### Fixed Receiver

This is a crystal controlled, double superheterodyne V.H.F. receiver, designed for the reception of radio-telephony signals on any one spot frequency in the frequency range 60 to 184 Mc/s. A model for operation in the 30-60 Mc/s. band can be supplied to special order.

It incorporates a relay operated, noise compensated muting circuit which effectively quietsens the receiver in the absence of a signal, and provides facilities for remote switching by radio.

The front panel is designed so that the receiver may be mounted either in a standard G.P.O. 19 in. rack (in which case dust covers are supplied) or in a cabinet together with the 12-15 watt fixed transmitter, to form the medium power fixed station type PTC 703/704.

A monitor speaker is mounted on the front panel, and mains fuses are incorporated which adequately safeguard the receiver from overloads.

#### Technical Specification

The receiver is designed to be coupled to a 75 ohm concentric aerial feed.

**Sensitivity:** Better than 1 microvolt.

**First Intermediate Frequency:** Crystal frequency 2.9 Mc/s.

**Second Intermediate Frequency:** 2.9 Mc/s.

**I.F. Bandwidth:** Above 100 Mc/s.  $\pm 28$  Kc/s. Under 100 Mc/s.  $\pm 28$  Kc/s. or  $\pm 18$  Kc/s.

**S/N Ratio:** Better than 9 db at 80 and 184 Mc/s. for 1 microvolt input.

**Spurious Responses:** Image, at least 55 db between 100-184 Mc/s.; 75 db between 60-100 Mc/s/L. All other spurious responses better than 80 db down.

**Audio Responses:** 6 db down at 200 and 2,000 c.p.s.

**Audio Output:** 2-3 watts to loud-speaker with independent 600 ohm

output at low power level for working into G.P.O. lines.

Crystal frequency tolerance 0.003 per cent.

**Dimensions:** Panel for rack mounting, 19 in. (48.3 cm.) wide, 8 $\frac{1}{2}$  in. (22.3 cm.) high. Depth, 11 $\frac{1}{2}$  in. (29 cm.) overall.

**Weight:** 23 $\frac{1}{2}$  lb. (10.7 kilos).

**Frequency Range:** 60-184 Mc/s. (30-60 Mc/s. to special order).

#### 12-15 Watt Fixed Transmitters

Single unit construction is employed, the transmitter, modulator and power supply being accommodated on a single rack mounted chassis.

#### Technical Specification

**Power Supply:** 100-150 V or 200-250 V, 40-60 c.p.s.

**High Band:** Standby 60 watts, transmit 188 watts.

**Low Band:** Standby 42 watts, transmit 168 watts.

**Input Circuit:** 15 ohms balanced for high quality moving coil microphone, 1 $\frac{1}{2}$  millivolts for 100 per cent. modulation. Gain control at maximum. 600 ohms balanced for lines input. 1 milliwatt for 100 per cent. modulation. Gain control at maximum.

**Modulation Capability:** 100 per cent. modulation with low distortion.

**Modulator Response:**  $\pm 6$  db, 100 to 10,000 c.p.s. (reference frequency 400 c.p.s.).

**Hum Level:** Better than—45 db on 100 per cent. modulation.

**R.F. Output:** 15 watts up to 100 Mc/s. 12 watts up to 185 Mc/s.

**Dimensions:** Panel for rack mounting, 19 in. (48.3 cm.) wide, 7 in. (17.8 cm.) high. Depth 11 $\frac{1}{2}$  in. (29 cm.) overall. Vertical distance between fixing hole centres 4 in. (10 cm.).

**Weight:** 35 lb. (15.8 kilos.)

**Frequency Range:** Low Band version, 60-100 Mc/s. (30-60 Mc/s. to special order). High Band version, 100-185 Mc/s. Crystal frequency tolerance, 0.003 per cent.

**Power Supply:** 100-150 V, 200-250 V, 40-60 c.p.s.

**Power Consumption:** 85 watts.

Pye Ltd.,  
Radio Works,  
Cambridge.

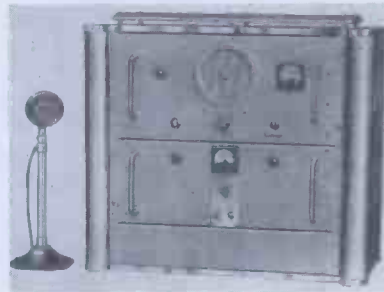

#### Redifon V.H.F. Equipment Type G.71/R.72

THERE are two versions of this equipment, one operating in the 70-100 Mc/s. band and designed for Broadcasting Suite purposes.

The other version operates in the Civil Aviation Frequency band of 116-132 Mc/s. and is intended for airfield approach control purposes.

#### Transmitter Model G.71

The G.71 transmitter consists of two separate units, the power supply unit and the transmitter and modulator unit, each of which is constructed on a conventional inverted tray chassis secured to a front panel 19 inches wide.

It is arranged for telephony transmissions on any one pre-determined crystal controlled frequency within the overall range and all the tuning controls associated with a change of frequency are of the pre-set type, being protected by a hinged flap.

#### Receiver Type R72

The R.72 receiver is arranged for mounting in a standard 19 inch rack. The power supply components are mounted on the same chassis making an entirely self-contained unit.

The receiver is suitable for either local or remote control. It is designed for operation on any one crystal controlled frequency within the overall range, tuning of the various circuits being carried out by adjustment of a number of pre-set trimmers, the controls for which are concealed behind a hinged flap.

Brief Performance Data (for airfield approach service):—

#### Transmitter Model G71

**Output Power:** 50 watts unmodulated carrier.

**Frequency Range:** 116-132 Mc/s.

**Frequency Control:** Crystal tolerance  $\pm 0.01$  per cent.

**Transmission:** Telephony—high level modulation.

**AF Response:**  $\pm 3$  db between 200 and 4000 cps.

**Audio Input:** 0.1 volt in 600 ohms.

**Power Supply:** 100/125 and 200/250 volts, 50/60 cycles AC.

#### Receiver Model R72

**Frequency Range:** 116-132 Mc/s.

**Frequency Control:** Crystal Tolerance  $\pm 0.01$  per cent.

**Sensitivity:** 5 microvolts for 20 db signal/noise ratio.

**Maximum Output:** 2 watts.

**IF Bandwidth:**  $\pm 40$  kc/s. at 6 db.  $\pm 140$  kc/s. at 60 db.

**AVC Characteristic:** Output held within 6 db for a change of input of 100 db.

**AF Response:**  $\pm 3$  db between 200 and 4,000 cps.

**Power Supply:** 100/125 and 200/250 volts 50/60 cycles AC.

Redifon Ltd.,  
Broomhill Road,  
Wandsworth, S.W.18.

## V.H.F. TESTING AND MEASURING EQUIPMENT

A brief review of electronic test and measuring equipment suitable for use in the V.H.F. range of frequencies. This review has been compiled from information supplied by the manufacturers who will give further details on request.

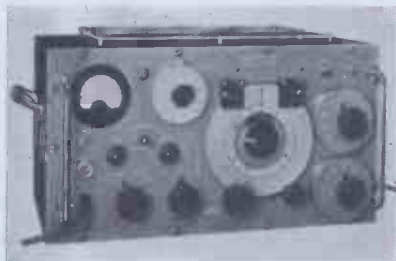

**Marconi**

### Signal Generator TF 801A

(illustrated above)

**T**HIS generator is for use in the range 10-300 Mc/s., and has a maximum output of 0.2 V R.M.S. at a source impedance of 75 ohms, providing both wide and narrow band modulation—internal and external—and is A.C. mains operated.

The dial is directly calibrated in frequency, and an incremental control is fitted to facilitate communication receiver investigations. The output is variable over a range of 100 db in 1 db steps. Contactless waveband selection eliminates the variable factor of R.F. contact resistance.

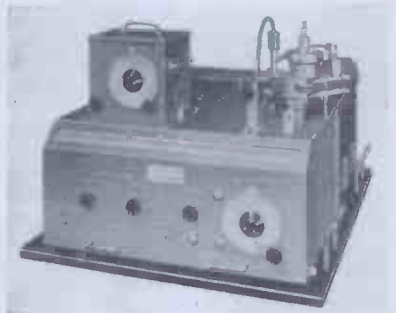

**Marconi**

### Dielectric Test Set TF 704B

(illustrated above)

**T**HE Dielectric Test Set TF 704B measures permittivity and power factor of dielectrics in the continuous frequency range of 50 kc/s., to 100 Mc/s.

The method used is that of capacitance variation in a tuned circuit, a square-law thermionic mirror voltmeter being used as the resonance indicator. Both the permittivity and power factor are obtained as a ratio of capacitance readings; frequency is not involved in their calculation, a feature which gives the instruments its very wide frequency range.

Other V.H.F. testgear manufactured by this firm includes the following:

A Carrier Deviation Meter TF 791B, a portable mains-operated instrument for the determination of carrier frequency deviation at audio rates, with a carrier range of 4 to 250 Mc/s. A Circuit Magnification Meter TF 886, a direct reading Q meter for use in the

frequency range of 15-170 Mc/s. A Transmitter Output Meter TF 912, an instrument for checking a power output of small transmitters, operating in the frequency range of 80-160 Mc/s. An H.F. Field Intensity Meter TF 930, a portable instrument, complete with adjustable dipole aerial, for R.F. field strength measurements in the range of 18 to 125 Mc/s. A Wavemeter TF 643A, for use in frequency range of 20 to 300 Mc/s., a portable battery-operated instrument with a visual resonance indicator.

A valve millivoltmeter TF 899, intended for the measurement of A.F. and R.F. voltages up to 100 Mc/s. A valve voltmeter TF 428B, a high impedance instrument for A.C. measurement up to 150 volts. For field use the valve-voltohmmeter TF 887 is suitable as it may be operated from mains or batteries, and F.M. Receiver Tester TF 913 and FM/AM Signal Generator TF 948, which were described in previous issues of *Electronic Engineering*.

Marconi Instruments Ltd.,  
St. Albans,  
Herts.

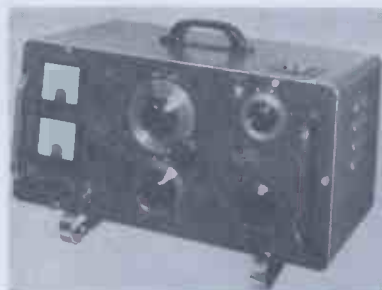

**Dawes**

### "Q" Meter Type 623A

(illustrated above)

**T**HIS resonance type "Q" Meter is for use in the frequency range of from 25 Mc/s. to 200 Mc/s.

A worm drive with micrometer dial is provided to facilitate tuning and, due to the spread out scale, changes of circuit capacity of the order of 0.01 pF can be determined. This feature permits the determination of circuit "Q" by the measurement of the width of the resonance curve (reactance variation method) and thus provides a means for obtaining even greater precision than the direct indication of "Q" as given by the calibrated meter.

### Technical Details

Oscillator Frequency: Range, 25 Mc/s. to 200 Mc/s. Accuracy,  $\pm 2$  per cent.

"Q" Measurement: Range, Direct reading 80 to 300 with a multiplier calibrated from times 1 to times 4. Accuracy, For direct reading measurement "Q" 100-300,  $\pm 10$  per cent up to 100 Mc/s. decreasing with increasing frequency.

Capacity: Range, 15 to 75 pF. direct reading. Accuracy,  $\pm 1$  per cent or 0.5 pF. whichever is greater.

Power Supply: 200-250 volts. 40-100 c/s.

Power Consumption: 50 watts approximately.

Dawe Instruments Ltd.,  
130, Uxbridge Road,  
Hanwell, London, W.7



### "Avo" Electronic Testmeter

(illustrated above)

**T**HE "Avo" Electronic Testmeter is a 56 range measuring instrument co-operating on 100-120 V and 190-250 V, 50-60 c/s A.C. It consists basically of a highly stable D.C. valve millivoltmeter with subsidiary circuit switching to provide the different ranges.

This instrument will operate up to 2 Mc/s., over a range of 0.1 V to 2,500 V. R.M.S., and this is extended to 200 Mc/s. with an external probe. The voltage range then becomes 0.1 V to 250 V.

Automatic Coil Winder and Electrical Equipment Co. Ltd.,  
Winder House,  
Douglas Street,  
London, S.W.1.



Wayne Kerr

#### V.H.F. Admittance Bridge

THIS bridge is designed primarily for use with aerials and cables in the frequency range, 50-250 Mc/s., and is intended only for unbalanced measurements. The normal bridge terminals have been replaced by a co-axial outlet to which plugs and sockets can be attached by means of a range of adapters.

#### Technical Details

**Susceptance Range:** Equivalent to  $\pm 75$  pfd.

**Discrimination:** .5 pfd. at all frequencies.

**Conductance Range:** 0-100 millimhos.  
**Discrimination:** .1 millimho at all frequencies.

**Source:** External, 1 volt R.M.S. into 50 ohms.

**Detector:** External, Sensitivity, better than 5 microvolts at unity signal to noise ratio.

A V.H.F. Bridge manufactured for the range of 1-100 Mc/s., was described in *Electronic Engineering*, June, 1948.

The Wayne Kerr Laboratories Ltd.,  
New Malden,  
Surrey.



Plessey

#### V.H.F. Test Gear Wavemeter Test Set 272, 15 10,000 Mc/s.

THE frequencies of the Wavemeter Test Set are measured by reference to a calibrated butterfly oscillator, 400-800 Mc/s. This oscillator is referred to a second, 15-30 Mc/s, and to a third, 14.9-30 Mc/s, which can be set in terms of harmonics from a 100 kc/s., G.T. quartz crystal. The frequency difference between the second and third oscillators is determined by a fourth, 200-300 kc/s., and a final accuracy of 1 in  $10^5$  is given over a wide range of temperature.

The Plessey Co. Ltd.,  
Ilford, Essex.

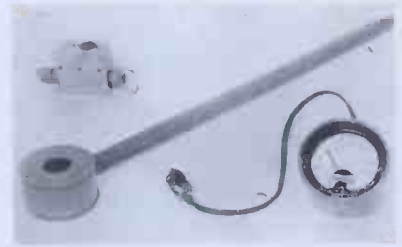

between 65-200 Mc/s. having power outputs up to 20 watts R.F.

It consists basically of a toroidal current transformer housed in an insulated loop, fitted to a suitable handle which contains a crystal rectifier and meter socket.

The unit can be slipped over a  $\frac{1}{4}$ -wave whip aerial, and when used in conjunction with an 0-500 microammeter, gives a comparative measurement of R.F. power in the base of the aerial.

Mullard

#### Valve Impedance Test Gear

A new valve impedance test gear has been developed by Mullard Electronic Research Laboratory, and was shown for the first time at the Physical Society's Exhibition earlier this year, and was described in our account (*Electronic Engineering*, May, 1950, page 203) of this event. The gear is illustrated below.

#### Mullard V.H.F. Measuring Instruments

Types GME501/X, GME501/Y,  
GF506/X

(Illustrated above, right)

#### Radiation Monitor, Type GME501/X

This instrument is intended for use with any mobile equipment operating

#### 50-0-500 Microammeter, Type GME501/Y

This test meter is primarily intended for use with the above test instrument, and it is mounted in a special case so that it can be placed in any convenient position and easily read. The displaced zero of this meter facilitates discriminator alignment of F.M. receivers.

There are two leads from the bottom of the case, terminating in a 2-pin plug, which is designed to fit the meter sockets in the tuning indicator, radiation monitor.

#### Tuning Indicator, Type GF506/X

Also an R.F. monitoring device, this instrument is specially designed for use with fixed and mobile transmitters. It basically consists of a short section of concentric line which can be inserted into the aerial feeder at the transmitter end.

This section of line incorporates an R.F. probe and rectifier in order to measure the R.F. voltage on the inner conductor, without disturbing the characteristic impedance or continuity of the line.

The unit is housed in a metal box and is fitted with Pye coaxial terminations for easy connexion. A meter socket is provided on the base of the unit for connexion to a 0-500 microammeter.

This indicator unit is suitable for use with transmitters having an R.F. output power between 4-20 watts in the frequency range of 65-200 Mc/s.

Mullard Electronic Products Ltd.,  
Communications Division,  
Century House,  
Shaftesbury Avenue,  
London, W.C.2.



## NOTES FROM THE INDUSTRY

## 1950 S.I.M.A. Exhibition and Symposium

The Electronics Section of this Association is holding its Annual Exhibition and Symposium at the Examination Hall, Queen Square, London, W.C.1, from Tuesday, September 5, to Friday, September 8.

Entrance to the Symposium itself will be by ticket of admission (covering also the exhibition), obtainable on application to the Secretary of the Scientific Instrument Manufacturers Association, 17 Princes Gate, London, S.W.7. A programme of the technical papers to be read can also be obtained from the same address.

## Increased Power of Midland Home Service Transmitters

From Sunday June 25, the power of the Midland Home Service transmission on 276 metres (1088 kc/s) from Droitwich was increased from 60 kilowatts, to 150 kilowatts, the maximum permitted by the Copenhagen Wavelength Plan. The power of the Norwich transmitter, which broadcasts this programme on the same wavelength, was also increased.

The increased power from Droitwich has been achieved by modifying a high-power long-wave transmitter to work on medium waves.

## The F.M. Receiver Monograph

We have been informed that the 6½ in. speaker illustrated in the advertisement of Messrs. Cyril French, Ltd., on page 96 of the F.M. Receiver booklet is too small to handle the output from the F.M. Receiver, and the constructor should use the Celestion Model P.44, retailing at £3 15s. for 3 ohms output, or the Model P.74, price £6 10s. for 15 ohms output.

## This is Britain No. 42

This C.O.I. film is one of a series of cinematographs produced by the Crown Film Unit for the Board of Trade, and is principally intended for audiences overseas.

This issue contains three items of telecommunications: radio telephony on land, radio telegraphy at sea and television. Scenes include the directing of Police; the General Post Office's wireless station at Burnham, where a complete record and location of all British deep sea vessels afloat is kept, and views of Alexandra Palace and B.B.C. television studios, as well as of the transmitter at Sutton Coldfield.

## New Publicity Manager for Marconi's

Marconi's Wireless Telegraph Company, Ltd., announce that Mr. R. P. Raikes was appointed Publicity Manager recently, in succession to the late Mr. W. G. Richards.

In 1947, Mr. Raikes was appointed Press and Publicity Officer of the British Legion in Scotland and joined the Publicity Department of Marconi's Wireless Telegraph Company, Ltd., as Deputy Publicity Manager in 1949.

## The Tensor Club of Great Britain

The Tensor Club of Gt. Britain has been formed with the intention of putting engineers into touch with one another and at the invitation of the Organisers Gabriel Kron has consented to become its Patron.

The Club's activities—in the early stages at least—will necessarily be confined to furthering its objects by correspondence. Membership is open to all those who are actively interested in determinants, dyadics, matrices or tensors, and their application to engineering, wherever they may reside. There is no entrance fee. Members pay an annual subscription of one guinea, and Associated Members half a guinea. Prospective members and others who are interested may write to either of the Club's Organisers, S. Austen Stigant, 7 Courtlands Avenue, Haves, Kent, and W. J. Gibbs, 53 Hillmorton Road, Rugby.

## Agency Requirements for Portugal

The Counsellor (Commercial) to H.M. Embassy at Lisbon has been approached by Messrs. Daun & Bleck, Ltd., Rua dos Fanqueiros 268-1°, Lisbon, regarding their desire to represent United Kingdom firms manufacturing the following equipment:—

VHF Direction Finders  
VHF Receivers  
VHF Transmitters  
HF Receivers  
HF Transmitters  
Approach Radio Beacons  
Omni-Directional Radio Beacons  
Directional Radio Beacons  
Sound Recorders (Air-to-ground and ground-to-air)  
Transmitting and Receiving Antennas  
Emergency Generators

Manufacturers should forward literature, prices, delivery dates, etc., direct to Messrs. Daun & Bleck, Ltd., at the same time sending a copy of their correspondence to the Board of Trade, Millbank, London, S.W.1, quoting reference CRE(IB) 56411/50.

## PUBLICATIONS RECEIVED

*Cintel Instruments for Research and Industry.*

A brochure describing the "Cintel" instruments for laboratory and industrial applications. *Cinema-Television, Ltd., Worsley Bridge Road, Lower Sydenham, London, S.E.26.*

## 1950 Summer Programme

This is a programme of courses and conferences held by the *National Institute of Industrial Psychology, 14 Welbeck Street, London, W.1.*

*Philips Research Reports, August 1949.*

A scientific journal of theoretical and experimental research covering a wide field. Obtainable from the *Publication Dept., Philips Electrical, Ltd., Century House, Shaftesbury Avenue, W.C.2.*

*Twelfth Edition of the Regulations for the Electrical Equipment of Buildings.* This publication lays out the Wiring Regulations of the Institution of Electrical Engineers, which has been completely revised and recast. *The Institution of Electrical Engineers, Savoy Place, London, W.C.2, price 3s. 6d. bound in paper, or 5s. bound in cloth.*

## Modern Solders.

This attractive brochure has been produced mainly for manufacturers, sales and technical staffs, and concerns *Ersin Multicore Solders.* Obtainable from *Multicore Solders, Ltd., Mellier House, Albemarle Street, W.1.*

## Wiggin Nickel Alloys.

Articles in this issue show how nickel and Monel equipment is used in modern chemical plant all over the world. *Henry Wiggin & Co., Ltd., Wiggin Street, Birmingham 16.*

## Shaker Hearth Conveyor Furnaces.

This leaflet explains the approach of *Birlec, Ltd., Tyburn Road, Erdington, Birmingham 24,* to the hardening of small steel articles.

## The Nickel Bulletin—March, 1950.

This issue describes the developments in modern magnet alloys. *The Mond Nickel Co., Ltd., Sunderland House, Curzon Street, W.1.*

## Export of Electrical Equipment to Canada.

This is the report of the Electrical Exports Standards Mission to Canada, and can be obtained from the *British Standards Institution, 24-28 Victoria Street, Westminster, S.W.1.*

## THE MODERN BOOK CO.

- TELEVISION SERVICING** by Heller & Shulman. 47s. Postage 9d.
- THE RADIO AMATEUR'S HANDBOOK**, 1950 Edition, by A.R.R.L. 20s. Postage 9d.
- THE MAGNETIC AMPLIFIER**, by J. H. Reyner. 15s. Postage 6d.
- THE THEORY & DESIGN OF INDUCTANCE COILS**, by V. G. Welsby. 18s. Postage 9d.
- THRESHOLD SIGNALS**, Ed. J. L. Lawson & G. E. Uhlenbeck. 42s. 6d. Postage 9d.
- RADIO VALVE DATA**, compiled by "Wireless World". 3s. 6d. Postage 3d.
- THEORY & DESIGN OF ELECTRON BEAMS**, by J. R. Pierce. 26s. Postage 9d.
- CATHODE-RAY OSCILLOGRAPHS** by J. H. Reyner. 8s. 6d. Postage 4d.
- TELEVISION SERVICING MANUAL**, by E. N. Bradley. 4s. 6d. Postage 3d.
- REFERENCE DATA FOR RADIO ENGINEERS**, by W. L. McPherson. 5s. Postage 4d.
- HIGH FREQUENCY INDUCTION HEATING**, by F. W. Curtis. 51s. Postage 9d.
- RADIO ENGINEERING**, by F. E. Terman. 59s. 6d. Postage 9d.
- THE MATHEMATICS OF CIRCUIT ANALYSIS**, by E. A. Guillemin. 60s. Postage 9d.

We have the finest selection of British and American radio books in the Country Complete list on application.

(Dept. E.8) 19-23, Praed Street, LONDON, W.2 PADDINGTON 4185.

## CHAPMAN & HALL

Just out

### INTRODUCTION TO ELECTRONICS

by

J. Yarwood,

M.Sc., A.INST.P.

344 pages 121 figures 28s. net

### TESTING RADIO SETS

by

J. H. Reyner,

B.Sc., A.C.G.I., D.I.C., M.I.E.E.

Fifth Edition, Revised.

224 pages 130 figures 22s. 6d. net  
15 plates

37 ESSEX STREET, LONDON, W.C.2

## Electron and Nuclear Counters

1. *Ionization Chambers and Counters, Experimental Techniques* by Bruno B. Rossi and Hans H. Staub. 243 pp. + xviii. First edition 1949. Published by McGraw-Hill Book Company Inc. Price (in Great Britain), 19s. 6d.

2. *Counting Tubes* by S. C. Curran and J. D. Craggs. 238 pp. + xi. First Edition, December, 1949. Published by Butterworths Scientific Publications. Price 35s.

THE question should be put to the publishers of why two books almost identical for size and difficulty of reproduction, should be priced so differently even after the American book has borne the cost of carriage across the Atlantic. Regarded simply as examples of book production, the American volume is considerably better than the British, as is too often the case nowadays. However, purchasers of technical and scientific books are chiefly interested in the contents, and are generally uncritical of paper, binding, etc., unless these are grossly deficient in quality.

Similarities of content and treatment between these two books are surprisingly few; it would be difficult to imagine two books more dissimilar, written on this apparently narrow topic of electron and nuclear counters.

1. *Rossi and Staub*. This book does not pretend to be a complete review of the subject of electron and nuclear counters, indeed 11 pages are occupied with forewords, prefaces, and acknowledgments intended to explain to the reader to what extent the National Nuclear Energy Series covers the work done under the American Atomic Energy Commission's various projects, and what a small section of the whole this book represents.

It contains less than two dozen bibliographical references and these appear either in footnotes or in subscripts to the diagrams; there is no general bibliography and the subject index is sometimes inadequate.

The book is confined almost entirely to ionization chambers and proportional counters. Its chief value lies in its generously large and detailed figures (147 in all) from which data can be read with fair accuracy. The constructional diagrams appear to be reduced from working drawings provided for the engineers who had to make the instruments; if so it is excusable that these should be scaled in inches. However, the same excuse cannot be made for the mixture of units which will displease some European physicists. (See for example Fig. 4.19; Fig. 5.9 and Table 9.1). The construction and operation of many proportional

# BOOK

counters and ionization chambers are described, including one interesting auxiliary technique: that of attaching a hot calcium purifier so that convection circulation keeps the permanent gas in a standard condition of purity.

There are many figures showing counting rate versus bias curves, and differential pulse-height plots for proportional counters, but beyond a hint in the subscript to Fig. 4.7 the authors do not explain how such plots are obtained. It is necessary (although the authors do not make the cross reference) to turn to Chapter 4 of the companion volume in this series, "Electronics" by Elmore and Sands, to find that in the associated electronic counter circuit it is necessary to have a simple amplitude discriminator whose bias can be varied by known amounts. By this means the counting rate versus bias curves, or "integral" pulse-height plots are obtained. With more elaborate circuits, the analysed or "differential" pulse-height plots may be obtained directly.

The detection of slow and fast neutrons is treated much more fully than in the British book, and there is a final chapter on Fission Detectors not treated at all by Curran and Craggs. Applications of counters are not treated separately but are mentioned incidentally and briefly in the sections on the various types.

2. *Curran and Craggs*. This book was announced by the publishers several months ahead of the date when it actually became available, and no doubt it has been awaited with some impatience by workers in this field. However, it proves to have been worth waiting for.

It is inevitable that new books on counters should be compared with *Electrical Counting* by Lewis (1942) and *Electron and Nuclear Counters* by Korff (1946). Curran and Craggs represents a considerable advance on both the older texts, being more comprehensive, better balanced, and naturally more up to date. One of its chief features is the good bibliography, and the book is also well indexed under both author and subject.

The internal mechanisms of proportional counters and of both externally and internally quenched Geiger-Muller counters are especially well treated. The necessary circuits for use with counters are adequately covered, except that no mention is made of the analysis of counts from

# REVIEWS

the proportional type of tube, with an amplitude discriminator.

There are descriptions of the preparation and assembly of representative types of counter, and we note in passing that where the authors find it necessary to state dimensions in English units, metric equivalents are given.

Chapter 10 deals with some "Special Forms of Counter," including the scintillation counter which uses an electron multiplier. It would appear more logical for this chapter to have followed immediately after Chapter 7: certainly it seems out of place between two chapters on applications.

This is the first text-book on counters to give an appreciable portion of its space to actual applications, and in this section "Counters in Atomic and Nuclear Research" gets a complete chapter as also does "Cosmic Ray Studies." In the last chapter on "General Applications" we find that inspection of materials, health monitoring, geological prospecting, X-ray diffraction, and tracer techniques are all touched upon. Each user of counters will no doubt turn to the item of especial interest in his own particular field, and feel that it is inadequately treated or that the examples chosen are not the best, but the authors have probably done as well as could be managed in the restricted space allowed. The authors hint in the preface that they have been allowed insufficient space, and there is other internal evidence of this restriction, in particular the rather small figures. While allowing for the fact that authors usually want twice the amount of space allowed by the publishers, it does seem rather a pity that say another 16 or 32 pages were not allowed for the authors to enlarge on the general applications of counters, and perhaps on more of their own work. The book designer (should we have credit titles as do films?) must take part of the blame where unwise use has been made of the space allotted. For example, a single bibliography at the end of the book, besides being more convenient for the reader would have saved five pages; then there are six other pages which could have been utilized for text without seriously interfering with the book aesthetically.

In the preface a second edition is forecast when some later chapters of this edition get out of date. We hope that this prediction will come

true, as the collaboration between these joint authors seems to have been very successful despite the fact that professional activities keep them separated at the Universities of Glasgow and Liverpool.

3. *General Remarks.* Both books place some emphasis on proportional counters, and Curran and Craggs predict that the use of this type will increase greatly. We must agree with this view, for while the G-M tube has the advantage of sensitivity and so is the obvious choice for "searching" applications such as geological prospecting, the proportional type will count at a much higher rate, and will give quantitative information about the energies of the radiations emitted by a sample under test.

Curran and Craggs also give an estimate of the life of a proportional counter and find it to be at least 1,000 times that of an internally quenched G-M tube of similar size. This should recommend the proportional type of tube for such applications as X-ray measurements where counting rates are sometimes so high that the G-M tube has marked limitations of both life and accuracy.

A few misprints were noted in each volume, but these are readily seen and are therefore not dangerous.

Undergraduate and most post-graduate students of physics will find Curran and Craggs adequate for their needs in the field of electron and nuclear counters, but those laboratories primarily concerned with nuclear physics, and technical reference libraries in general, will naturally require both the volumes reviewed here.

E. E. SHELTON.

## Experimental Techniques

By Associate Professor W. C. Elmore and Assistant Professor M. L. Sands (National Nuclear Energy Series, Division V, Volume 1). xviii+417 pages. McGraw Hill Book Company, Inc. 1949. Price 32s.

**D**URING the war a considerable amount of secret work was done on electronic instrumentation for various specific purposes. It is to be welcomed that with the end of the war much of the work has been declassified and released for publication.

The book under review deals with such declassified work carried out by a group of workers, the Electronics Group, in the Los Alamos Laboratory of the United States Atomic Energy Commission. The authors, both of whom were responsible members of the Electronics Group, undertook the arduous task of sifting the considerable amount

of material made available for publication, and of arranging it into an organic whole. The subject-matter is presented under the following chapter headings, viz.: circuit components and construction practice (brief discussion of components suitable for constructing the various electronic circuits); circuit elements (description of the different elements constituting the complete electronic circuits); voltage amplifiers (discussions of linear voltage amplifiers that are useful in nuclear physics investigations); electronic counters (practical circuits that record the occurrence of a large number of electrical pulses of restricted properties of amplitude and of time of occurrence); oscillographs and associated equipment (cathode-ray oscillographs); test and calibration equipment; power supplies and control circuits.

The authors have admirably achieved their aim of presenting in coherent form a large amount of useful practical knowledge which is of particular value for advanced students and research workers in physics laboratories engaged in nuclear research work inclusive of cosmic ray work. The book contains a large number of clear and well-designed circuit diagrams, and is recommended as a valuable source of important information and useful practical advice to electronic engineers whose task is to build electronic equipment for physical laboratory measurements.

R. FEINBERG.

## The Mathematics of Circuit Analysis

By Ernst A. Guillemin. 590 pages, 48 figures. Chapman & Hall, 1949. Price 60s.

**T**HE circuit engineer of the present day requires to be familiar with many branches of higher mathematics, and this book by the Professor of Electrical Communications at the Massachusetts Institute of Technology is designed to supply the necessary background. Some idea of the scope of the book is given by the titles of the chapters: determinants, matrices, linear transformations, quadratic forms, vector analysis, functions of a complex variable and Fourier series and integrals. It is stated in the preface that "a mathematical textbook written by engineers is to be looked upon as an idea conveyor without claim to rigour." What the author omits in the way of rigorous proofs however, he more than makes up in a clear exposition of underlying principles. Throughout the book the practical aspects of each subject are very fully dealt with: in the

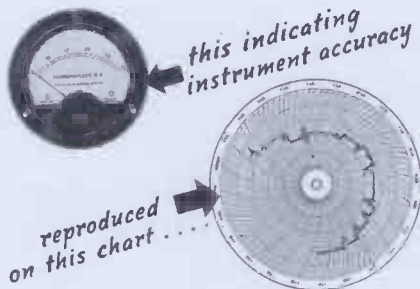

reproduced  
on this chart . . . .

this indicating  
instrument accuracy

by the

## Fielden Servograph

SERVOGRAPH OPERATES DIRECTLY FROM VERY LIGHT CURRENT SOURCES, consuming but a few micro watts for full scale deflection.

Its working principle is unique and sets up a new high standard of accuracy and robustness for graphical recording meters. SEVOGRAPH'S accuracy is to B.S. 89 for Grade 1 Indicating Instruments—because its servo-driven pen arm removes all load from the instrument movement, admits a robust and trouble-free pen, and maintains this accuracy with full or empty ink reservoir. Needing no levelling, it operates correctly in any position and can be connected directly to tachometers, thermo-couples, resistance thermometers, CO<sub>2</sub> indicators, pH meters and so on, repeating their accuracy on the chart. Equally useful, too, as an ammeter, voltmeter, etc., it may embody a moving iron, moving coil, dynamometer or electrostatic movement.

Please write for technical leaflets 100/4

Movements available from 50 micro-amps or 15 milli-volts upwards.

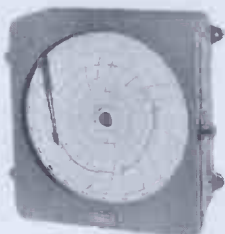

**FIELDEN  
(ELECTRONICS)  
LIMITED**

PASTON ROAD, WYTHENSHAW, MANCHESTER.

Fielden Electronics (Australia) Pty Ltd.,  
409 Collins Street, Melbourne, Australia.

Specialists in Industrial Electronic Equipment

Hopwood

## BOOK REVIEWS (Continued)

chapter on matrices for example, the frequently occurring problem of the numerical evaluation of the inverse of a matrix is treated at greater length than is usual in books of this type. At the end of each chapter there are numerous examples which will soon show the reader how well he is progressing.

The longest and perhaps the most outstanding chapter in the book is that devoted to functions of a complex variable: the author's description of the singularities of such functions as "the mainsprings upon which their very existence depends" is in accord with the latest approach to the theory of networks and is in marked contrast to the more usual viewpoint that such singularities are rather tiresome irregularities. Discussions of stability criteria and conformal mapping are both well illustrated with judiciously selected examples. In the final chapter Fourier series are discussed from several points of view, and the limitations upon their use imposed by the Gibbs phenomenon are described.

The only complaint (apart from the price) which the reviewer has, is that there are a number of misprints, mostly in the examples to be worked out by the reader. Otherwise this book is to be commended as an extremely valuable text-book. It should certainly be read by any radio engineer who wishes to be in a position to keep abreast of modern developments in the theory of circuits.

J. BROWN.

### Newnes Short-Wave Manual

By F. J. Camm. 192 pages. Seventh edition. George Newnes, Ltd. Price 6s.

**T**HE fact that this book has gone into seven editions proves that it fills a need for a work on the whole subject of short waves.

It deals thoroughly with the special problems underlying the design of short-wave apparatus, the special circuits which yield the best results, and designs for receivers based on those circuits. It covers: some short-wave aerial systems, eliminating interference, bandspread tuning, H.F. amplification, the morse code, aerial couplings, coil design, measuring wavelengths, the ultra-short-waves; and concludes with designs of several satisfactory short-wave receivers. A selection of useful tables is also included.

### Electrical Measurements and the Calculation of Errors Involved

By D. Karo. 191 pages, 106 figs. Macdonald & Co., Ltd., 1950. Price 18s.

**A**S this book contains no preface, the claims made for it must be accepted as those printed on the dust cover. The gap in the technical literature which this book seeks to close, arises from the fact that the calculation of experimental errors is usually treated in the fields of physics and mathematics.

In one volume, the author has provided a useful analysis on errors, particularly directed towards certain practical electrical measurements and bridge circuits restricted to p.c. applications. The absence of an index is offset by a detailed and sectionalized list of the contents.

Evidence of the mathematical rather than the practical approach is to be found in the fact that no mention is made of the design modifications consequent upon the use of anisotropic magnets and beryllium copper control springs.

There appears to be some lack of liaison between the author and the publisher, as shown by the misalignment of equation 3 at the middle of page 25 and the mixed style of the diagrams. Slightly larger symbols would improve some figures and there seems to be little reason for passing the arrows through the words as in figures 45(a), 77 and 85. Taken individually the diagrams show the points they are intended to illustrate except for figure 67, where the polarities of the magnets in the Broca galvanometer are obviously wrong.

In chapter IV, on the calibration of D.C. instruments, there is technical justification for the statement that the results "should be presented as a percentage error plotted against the reading of the sub-standard meter". It would be as well to point out that the user of a calibrated meter is usually happier to know that when the meter he has before him (not the sub-standard) reads 10A, he must add (or subtract), say, 0.1A, without having to perform any other calculation. When necessary, the uncertainty range can be indicated together with the appropriate limit lines for B.S. grading.

This book should prove useful to engineers, particularly if their work involves the assessment of errors in electrical measurements.

A. P. JARVIS.

# LETTERS TO THE EDITOR

(We do not hold ourselves responsible for the opinions of our correspondents)

## Electronic Instruments in Diagnostic Medicine

(The following extracts are from correspondence concerning the above article.)

DEAR SIR,—Reference to the above article, page 46, last paragraph which reads "A shutter attached to the vibrating reed then controlled the current to the storage capacitor." The arrangement is shown in Fig. 5. Fig. 6 shows a photograph of the commercially produced instrument, described by Baldock and Grey Walter.

I would beg to suggest that this description indicates to the ordinary reader that the commercially produced instrument uses tuned reeds and photoelectric pickup as detailed at great length in this article. This is not so; electronic resonators are used which are free from the adjustment and maintenance troubles associated with the original reeds, and have improved linearity.

Yours faithfully,

S. N. POCOCK,

Edison Swan Electric Co. Ltd.

Mr. Hughes replies:

"I am indebted to Mr. Pocock of the Edison Swan Electric Co., Ltd., for his criticism of my account of the E.E.G. frequency analysis equipment. I must claim his forgiveness for omitting to describe the electronic resonators used in the commercial instrument shown in Fig. 6, and detailed in reference 20."

DEAR SIR,—The article by Mr. Hughes on "Electronic Instruments in Diagnostic Medicine" contains several misleading statements. For the last five years it has not been British practice to use single-sided stages in biological amplifiers. The circuit reproduced on page 44 is taken from a paper published seven years ago and was long since superseded by that given in ELECTRONIC ENGINEERING in 1947 (Vol. 19, pp. 222-226, Walter and Brooks). This arrangement is used also in two of the British

commercial electroencephalographs and is superior in certain respects to that of some foreign instruments. To represent an obsolete war-time expedient as representative of British design is embarrassing to electro-physiologists and may harm the reputation of those firms which have had the courage to enter a small and highly competitive field. It is particularly difficult to condone this mis-representation since the more recent design was published not in some obscure foreign periodical but in the same journal as the article in question.

Second, the circuit developed by Johnston for the Marconi E.E.G. has many interesting and valuable original features but the use of a pentode as a common cathode impedance was first described in detail by Goldberg to whom Johnston makes due acknowledgment. The general idea of the balanced input stage with a large common cathode resistor was first elaborated by Buchthal and Nielsen in 1936.

Third, the rather elaborate discussion of sources of noise in amplifiers seems out of place in an article dealing in title with instruments, and moreover is lacking in just that information which would be most valuable, that is the practical calculation of noise in balanced high-discrimination amplifiers in which the equivalent circuit is by no means as straightforward as in other cases. In the expression given for "resistance noise" (p. 45) is the  $V$  intended to stand for R.M.S. or peak-to-peak volts or microvolts, and in a balanced circuit with, say, 1 megohm grid leaks and a grid-grid resistance during operation of, say, 5000 ohms, what is the value of  $R$  to be inserted in this expression? Further, how does this expression relate to that given by Oakes on p. 57 of the same issue for what he terms "thermal agitation noise" using different symbols and with square root sign embracing both  $R$  and  $\Delta f$ , as is more usual?

Fourth, the method of analysis by tuned reeds (British patent

No. 562817) was superseded five years ago in my laboratory by that using tuned phase-shift amplifiers (British Patent No. 627481), the system embodied in the instrument manufactured since 1946 by the Edison Swan Electric Company. Here again the author is four years out of date, although the information is available in the reference he quoted (ELECTRONIC ENGINEERING 1946) and from which the illustration in Fig. 6 is copied.

The section on Stimulators omits consideration of what is perhaps the only controversial feature—that of the effective output impedance, which in the case of the Ritchie stimulator is relatively low and in that of the Denny one, relatively high. It has been found that low impedance sources, giving in effect a constant voltage output, provide quite different results from those with a high impedance, constant-current, output. The tissue impedance is complex with a relatively high capacitance reactance. Such differences are responsible for many of the contradictions and paradoxes in the stimulation literature and it is extremely important in the design of a stimulator and in reporting the results of its use to specify the effective impedance of the output circuit.

In the section of EMG recording, the publications of the English workers Weddell and Bauwens are ignored although these are representative of English practice.

Finally, in the Bibliography the books and articles referred to are out of date by many years and cannot be considered as giving a trustworthy picture of present interests and practice. In the Annual Review of Physiology for example, there have been several articles on electrical studies since the one quoted, the most recent being in 1949 on the Electrical Activity of the Brain.

Yours faithfully,

W. GREY WALTER.

Bristol.

Mr. Hughes replies: "It would appear that Dr. Grey Walter has taken exception to one major omission from my paper, namely, the non-inclusion of the circuit described in *ELECTRONIC ENGINEERING*, vol. 19, p. 222, 1947. For this I apologise, and make no excuse, save that I was not aware of it. In my account of the subject I have purposely included circuits which I have considered important in the development of the more up-to-date instruments. Fig. 1 comes in this category. Johnston's circuit was one which I considered representative of the most modern design in E.E.G. equipment. I did not attribute the use of a pentode as a common cathode impedance to Johnston, but was careful to point out that his paper included an excellent bibliography dealing with this and other circuit techniques involved.

I do not consider the "elaborate" discussion of sources of noise is out of place. How one could give practical calculations of the type suggested without giving a short account such as I have done, I do not quite see. Having talked about "equivalent noise R.M.S. voltage" in the preceding paragraph I would have thought it obvious that "V" in the equation for resistance noise stood for R.M.S. volts.

A little simple arithmetic would establish the equivalence of my expression and that given by Oakes on p. 57, after substituting  $290^\circ \text{A}$  for the "T" in his expression, making the reasonable assumption that  $\sqrt{R \cdot \Delta f}$  was the printer's method of writing  $\sqrt{R \cdot \Delta f}$ , and noting that Oakes has adjusted his numerical constants to express the noise in microvolts. As regards his numerical problem the words "circuit resistance" are intended to cover the total effective resistance (including that of the resistance of the patient in parallel with the grid leaks).

The fourth point has been covered in my reply to Edison Swan's criticism of the same point. Again I would point out the value of describing apparatus which may still be in use, and which uses essentially the same

principles of operation as the most recent models.

I appreciate Dr. Grey Walter's concern for the reputation of English commercial E.E.G.s. (and its designers). However, I would again stress that I did not intend to advertise the most recently manufactured electro-medical equipment, but rather to survey a wide field. It is perhaps unfortunate that my article could not have appeared as a complete whole, when the general scheme would have been more apparent. The reason that the section on electroencephalography is slightly more detailed than the others which follow, is because the design considerations, including the question of "noise," are relevant to the design of all biological amplifiers; here again to my mind, detailed performance data on instruments would have been out of place.

I would not wholly agree that reduplication of work is likely to arise from a survey article of this type. Any competent person who wished to begin work in this field would realise that the bibliography given served only as an entry-point into the literature, and was by no means comprehensive. I entirely agree with Dr. Grey Walter's remarks on the relative contributions of physiologists and physicists or engineers to the subject of electrophysiology. This I have indicated in the conclusion to my article. A possible explanation lies in his own words concerning out-of-date textbooks. The words imply that the physiologist has not accepted the engineer as a colleague on equal terms, but has rather expected him to produce results whilst having had little clinical experience or contacts, other than through technical literature. While this state of affairs may be now remedied in some of the larger institutes, its continuance is a major obstacle to outside contributions to the subject. An analogy may be made here to the employment of physicists in radiotherapy departments; here the physicist is not looked upon as a glorified technician whose purpose is merely to build apparatus for dosage measurements, but as a colleague who may make important contributions to the subject as a whole.

## Phase-Angle Measurements

DEAR SIR,—The appearance of the paper by Messrs. Benson and Carter in your June issue prompts me to remind your readers of the simple method for measuring phase angle when the two components produce equal-amplitude deflexions given by J. A. Fleming in the *I.E.E. Journal* Vol. 63, page 1,045, November, 1925: The angle subtended by the minor axis at the end of the major axis is the phase-angle.

Yours faithfully,

L. H. BAINBRIDGE-BELL,  
Haslemere, Surrey.

## A Modern Home-Built TELEVISOR

Alexandra Palace and Sutton Coldfield

### Components

Further components have now been tested and approved for use in the Electronic Engineering Televisor. The full list of such components approved to date now reads:—

#### Scanning Coils

- (i) Haynes Radio Ltd.
- (ii) Scanco Ltd.
- (iii) Allen Components.
- (iv) A.M.C.
- (v) Denco Ltd.

#### Focus Coil

- (i) A.M.C.
- (ii) Haynes Radio Ltd.
- (iii) Porthminster Engineering Ltd.
- (iv) Scanco Ltd.
- (v) Walpole Norman Engg. Co., Ltd.
- (vi) Allen Components
- (vii) Denco Ltd.

#### Focus Ring

- (i) Bel Sound Products.
- (ii) A.M.C.
- (iii) Elac
- (iv) Haynes Radio Ltd.

#### Line Output Transformer

- (i) Haynes Radio Ltd.
- (ii) Scanco Ltd.
- (iii) Walpole Norman Engg. Co., Ltd.
- (iv) A.M.C.
- (v) Banner Electric Co., Ltd.
- (vi) Allen Components.
- (vii) Denco Ltd.

#### E.H.T. Transformer

- (i) Haynes Radio Ltd.
- (ii) Partridge Transformers Ltd.
- (iii) Varley (Oliver Pell Control Ltd.)
- (iv) Vortexion Ltd.
- (v) Woden Transformer Co., Ltd.
- (vi) Gardners Radio Ltd.
- (vii) Allen Components.
- (viii) Stewart Transformers, Ltd.

#### H.T. Transformer

- (i) Gardners Radio Ltd.
- (ii) Partridge Transformers Ltd.
- (iii) Varley (Oliver Pell Control Ltd.)
- (iv) Vortexion Ltd.
- (v) Woden Transformer Co., Ltd.
- (vi) Stewart Transformers Ltd.

#### 250mA and 80mA Chokes

- (i) Gardners Radio Ltd.
- (ii) Partridge Transformers Ltd.
- (iii) Varley (Oliver Pell Control Ltd.)
- (iv) Vortexion Ltd.
- (v) Woden Transformer Co., Ltd.
- (vi) Stewart Transformers Ltd.

A.M.C. have also submitted a satisfactory chassis, complete with valve holders and coil formers.

## CLASSIFIED ANNOUNCEMENTS

The charge for these advertisements at the LINE RATE (if under 1" or 12 lines) is: Three lines or under 7/6, each additional line 2/6. (The line averages seven words.) Box number 2/- extra, except in the case of advertisements in "Situations Wanted," when it is added free of charge. At the INCH RATE (if over 1" or 12 lines) the charge is 30/- per inch, single column. Prospectuses and Company's Financial Reports £14 0s. 0d. per column. A remittance must accompany the advertisement. Replies to box numbers should be addressed to: Morgan Bros. (Publishers), Ltd., 28, Essex Street, Strand, London, W.C.2, and marked "Electronic Engineering." Advertisements must be received before the 14th of the month for insertion in the following issue.

### OFFICIAL APPOINTMENTS

**MINISTRY OF SUPPLY** invites applications from Physicists for unestablished appointments in Scientific Officer grade at Royal Aircraft Establishment, Farnborough, Hants. (a) For work on display, computer and communication research (two posts). (b) For work on V.H.F. and U.H.F. navigation, direction finding and landing systems (two posts). Candidates should have a good honours degree in Physics and some research experience in one of the fields outlined would be an advantage. Applications from 1950 potential graduates accepted, but preferably accompanied by a note on student's work from College Tutor or Professor. Salary according to age, date of graduation, experience etc., within scale £380-£620 (men); £380-£495 (women). Posts carry F.S.S.U. benefits. Application forms obtainable from Ministry of Labour and National Service, Technical & Scientific Register (K), York House, Kingsway, W.C.2, quoting Order No. A184/50A. Closing date 21st August 1950. W 2425

**MINISTRY OF SUPPLY** invites applications from Physicists and Engineers for unestablished appointments in Experimental Officer Class at the Royal Aircraft Establishment, Farnborough, Hants, in following fields of work. (1) Development work on electrical and optical apparatus for measurement of flight parameters. (2) Circuit design and engineering of miniaturised radar equipment. (3) Light mechanical and electrical design for work on small servo mechanisms, etc. Minimum qualification expected is Higher National Certificate in Electrical Engineering or equivalent qualification, and for senior posts under (2) and (3) a degree in Physics or Electrical Engineering would be an advantage. Salary according to age, qualifications and experience within ranges:- Senior Experimental Officer: £705-£895 (min. age 35). Experimental Officer: £495-£645 (min. age 28). Assistant Experimental Officer: £220-£460. Rates for women somewhat lower. Application forms obtainable from Ministry of Labour and National Service, Technical and Scientific Register (K), York House, Kingsway, W.C.2, quoting A186 50A. Closing date, 14th August, 1950 W 2427

**MINISTRY OF SUPPLY** invites applications from Electronic Engineers and Physicists for unestablished appointments in the Scientific Officer and Experimental Officer Classes at the Royal Aircraft Establishment, Farnborough, particularly in the fields of Radio Communications including microwave techniques, circuit design and measurements, servo mechanisms and measurement of flight parameters. (1) Scientific Officer Class. Candidates must have a good Honours Degree in appropriate subject or equivalent qualifications. At least three years post graduate research experience required for Senior posts. Grade and salary to be assessed according to age, date of graduation and experience within following ranges:- Senior Scientific Officer (min. age 26): £670-£860. Scientific Officer: £380-£620. Rates for women somewhat lower. Posts carry F.S.S.U. benefits. (2) Experimental Officer Class. Minimum qualifications is Higher School Certificate with mathematics or a Science subject as a principal subject, but candidates with other qualifications, such as Higher National Certificate in electronics or light electrical engineering, or a pass degree in Physics, are invited to apply. Appropriate experience is required for senior posts and would be an advantage for all appointments. Grade and salary to be assessed according to age, experience etc., within following ranges:- Senior Experimental Officer (min. age 35): £705-£895. Experimental Officer (min. age 28): £495-£645. Assistant Experimental Officer: £220-£460. Rates for women somewhat lower. Application forms obtainable from Ministry of Labour and National Service, Technical & Scientific Register (K), York House, Kingsway, W.C.2, quoting D.220/50-A. Closing date 8th September, 1950. W 2440

**B.B.C.** invites applications for the following posts in Planning and Installation Department, London. Applicants should have a University Degree in Electrical Engineering or equivalent qualifications. Studio Section: Applications should also have a good basic knowledge of television theory and practice. (1) Engineer for work on development of television recording processes, preparation of specifications for manufacture of equipment, supervision of installation and acceptance trials and conduct of necessary correspondence. Practical experience of cinematographic equipment for sound and picture recording and knowledge of optics, photography, control of film processing and mechanical design of cameras are desirable. (2) Engineer for planning and development of television studios and preparation of specifications, etc., as in (1). Practical experience of television cameras and associated equipment and apparatus for film scanning, etc. and/or working knowledge of film studio practice are desirable. (3) Engineer for assistance in television work. Practical experience of television studio or O.B. equipment is desirable but applicants with considerable experience of studio sound equipment considered. Radio Section: (4) Engineer for preparation of specifications for radio and video frequency transmitters, supervision of installation and acceptance trials and conduct of necessary correspondence. Thorough basic knowledge of power and radio engineering is essential. Experience in planning and installation of short wave and V.H.F. transmitters and associated equipment desirable. Knowledge of television theory and practice and/or transmission line and aerial technique advantageous. Salaries for posts (1) (2) and (4) in grade with annual increments of £40 and maximum £890 per annum; salary for post (3) in grade with annual increments of £30 and maximum £680 per annum. Applications stating age, qualifications and experience and for which post application is being made to reach Engineering Establishment Officer, Broadcasting House, London W.1, within seven days. W 2446

**MINISTRY OF SUPPLY** invites applications from Electronic Engineers or Radio Physicists for an unestablished appointment in the grade of Scientific Officer in London (Headquarters). Candidates should have a good Honours Degree with experience in the design and development of radio test gear, radar, communications or navigation equipment. Salary according to age, date of graduation, experience, etc., within the Scientific Officer range, £400-£650 (men); £400-£525 (women). Post carries F.S.S.U. benefits. Application forms obtainable from Ministry of Labour and National Service, Technical & Scientific Register (K), York House, Kingsway, W.C.2, quoting D.215/50A. Closing date 28th August, 1950. W 2435

### SITUATIONS VACANT

**APPLICATIONS** are invited for the position of Technical Representative in the Manchester and Northern area in connection with the Company's manufactures of Industrial electronic equipment. Appropriate technical and commercial experience with this class of equipment is essential. The position is permanent and the successful candidate will be required to live in the Manchester area. Car will be provided. Apply, quoting reference 356B to Central Personnel Services, English Electric Co. Ltd., 24-30, Gillingham Street, London, S.W.1. W 2406

**SENIOR TELEVISION** Engineer required by the English Electric Co. Ltd., to supervise development and take general technical control of television receiver engineering at their Liverpool Works. Applicants, who should be qualified engineers with extensive experience in this class of work, should write, giving full details quoting reference 447, to Central Personnel Services, English Electric Co. Ltd., 24-30, Gillingham Street, London, S.W.1. W 2414

**VICKERS ARMSTRONGS LTD.**, Weybridge, invite applications for the post of Electronics Engineer to take part in electronic side-of special projects. Write, stating experience and qualifications, to: Employment Manager, Weybridge Works. W 2379

**VICKERS ARMSTRONGS LTD.**, Weybridge, invite applications for the post of Project Engineer to be in charge of certain special projects. Qualifications required for this post include experience of control methods and knowledge of electronics and instruments. Write, stating experience and qualifications, to: Employment Manager, Weybridge Works. W 2380

**JUNIOR** Electrical Engineers are required for the development and design of television camera and associated equipment at Marconi's Wireless Telegraph Co. Ltd., Chelmsford. Salary, £350-£550 p.a. Senior Engineers with research or development experience in this field also required. Salary £600-£800 p.a. Send full details quoting reference 323A to Central Personnel Services, English Electric Co. Ltd., 24-30, Gillingham Street, London, S.W.1. W 2394

**ELECTRONICS.** Interesting vacancies now exist in the Nelson Research Laboratories of the English Electric Co. Ltd. University trained engineers or physicists are required for design of special circuits for electronic computing machines at Stafford and in the London area. Vacancies also exist in these laboratories for electronic engineers with H.N.C. (Elect.). Please write, giving full information, quoting reference 305, to Central Personnel Services, English Electric Co. Ltd., 24-30, Gillingham Street, London, S.W.1. W 2395

**ENGLISH ELECTRIC CO. LTD.**, Chelmsford, require a Junior Engineer for design and development work on high power transmitting tubes. The successful applicant will be required to serve at least 12 months testing transmitting valves in order to gain necessary experience. Write, giving full details, quoting reference 419A, to Central Personnel Services, English Electric Co., 24-30, Gillingham Street, London, S.W.1. W 2389

**SENIOR PHYSICIST** or Electronic Engineer is required by the English Electric Valve Co. Ltd., Chelmsford, for Research and Development work on travelling wave tubes. Applicants with considerable experience in this field should write, giving full details of qualifications and experience, quoting reference 440 to Central Personnel Services, 24-30, Gillingham Street, Westminster, London, S.W.1. W 2390

**FERRANTI LTD.**, Moston Works, Manchester, have staff vacancies in connection with long term development work on an important Radio Tele-control Project. (1) Engineers and Scientists. Ref. R.Sc. Qualifications include a good Degree in Physics or Engineering, and preferably experience in Electromechanical and servo control work, or microwave valve and/or circuit work. Salary according to age and experience, in the range £500-£1,000 p.a. (2) Technical Assistants. Ref. R.Tech. For experimental work on Radar, electronic circuits, microwaves, servo control and electro-mechanical devices. Qualifications required: H.N.C. or its equivalent in Electrical or Mechanical Engineering. Salary in the range, £275-£550 p.a., according to age and experience. (3) Designer Draughtsmen, Draughtsmen and Junior Draughtsmen. Ref. R.D. With experience in design of Precision medium and light mechanical and electro-mechanical devices or electronic equipment. Salary according to age and experience based on A.E.S.D. Rates as minimum. The Company has a Staff Pension Scheme. Application forms from the Staff Manager, Ferranti Ltd., Hollinwood, Lancs. Please quote appropriate reference. W 2368

**DEVELOPMENT ENGINEER**, experienced in Radio Test Equipment. Good pay and prospects. Write, Taylor Electrical Instruments Ltd., Slough, Bucks. W 2369

## CLASSIFIED ANNOUNCEMENTS (Cont'd.)

**ELECTRONIC ENGINEERS** are required by a large aircraft company for experimental work on a new and interesting project. Applicants, who should preferably be under 35 years of age, must have received technical education up to a Degree standard and should be experienced either in UHF design and measuring techniques or in instrumentation work. Apply, stating age, experience and salary required to Box No. W 2388.

**TELECOMMUNICATION** research and development engineers are required for work on line communication problems. Applicants should preferably have had experience in this field and should possess a good all round knowledge of present day line techniques and of the analysis and design of transmission networks. A university Degree in engineering or physics would be an advantage. Salary within the range of £300 to £800 p.a. according to qualifications and experience. Applications should be made to the Director of Research, British Telecommunications Research Ltd., Taplow Court, Taplow, Bucks. W 2366

**DEVELOPMENT ENGINEER** for industrial electronic control gear. Experience of radio or instrument development essential. Elcontrol Ltd., 28a, Tilehouse Street, Hitchin. Hitchin, 1598 W1155

**RADIO ENGINEERS** required. The General Electric Co. Ltd., are expanding their Radio Development Laboratory at Coventry and a number of vacancies for Senior and Junior Engineers exist at present and a further considerable number of vacancies will occur during the next few months in the new laboratory. Applications are invited from Development Engineers with experience of microwave radio or radar techniques who are capable of developing equipment and components to Service Specifications. Write, quoting Ref. CHC(3) to Personnel Officer, General Electric Co. Ltd., Radio and Television Works, Coventry W 2438

**SENIOR ELECTRONIC** Draughtsman required by large light engineering company in East London area. Write, giving age, experience and salary required to Box No. W 2437.

**DESIGN DRAUGHTSMEN** required by old established firm in S.E. London area. Experienced in development of small precision mechanisms. Some electrical experience preferred. Apply, with details of age, salary, experience to Box No. W. 1152.

**DEVELOPMENT ENGINEER** required for work on a wide range of electronic equipment. Applicants must have Degree in Electrical Engineering (Communications) or Physics, and preferably some industrial experience. Write, stating qualifications and experience to Southern Instruments Ltd., Fernhill, Hawley, Camberley, Surrey. W 1157

**DESIGNER DRAUGHTSMAN** required for the Design and Development Laboratory of an engineering company of international repute, in London. Applicants must possess Higher National Certificate or equivalent qualifications, and have a practical experience of plastic moulds, small special purpose machinery, press tool work and general machine tool knowledge. Apply, stating age, qualifications and experience to Box No. W 2417.

**OCCASIONAL TECHNICAL** advice required in connexion with the production of various types of capacitors, radio resistors, potentiometers and metal rectifiers. Write, stating experience, etc. Box No. W 1156.

**ELECTRONIC ENGINEER** for development work on electronic measuring and control instruments. Good general knowledge of telemetering and automatic control desirable. Minimum technical qualifications. Higher National Certificate. Apply, Bailey Meters & Controls Ltd., Progress Way, Purley Way, Croydon. W 1154

**APPLICATIONS** are invited by Kolster-Brandes Ltd., Footscray, Sidcup, Kent, for a development engineer aged 25-35 years. Must possess experience and first-class Honours Degree in Physics, Electrical Engineering or Tele-Communications. Capable of carrying out work in connexion with television development on own initiative. Apply, in writing, stating age and qualifications, to the Personnel Officer, at the above address. W 2433

**YOUNG GRADUATE PHYSICIST** or Chemist required for interesting research and development work in connexion with semi-conductors. Some experience in this field desirable but not essential. Write, Personnel Manager, Standard Telephones & Cables Ltd., Ilminster, Somerset. W 2432

**A VACANCY** exists in the Specification Section at Brimar Valve Works for a man of 30-45 years of age, educated to National Certificate standard and having a broad knowledge of manufacture of radio valves and cathode ray tubes. Write, stating age, qualifications, experience and salary required to the Personnel Officer, Brimar Valve Works, Footscray, Kent. W 2431

**LONDON COUNTY COUNCIL.** South East London Technical College. Applications are invited for the post of Senior Assistant for the Radio Communications Section of the department of Electrical Engineering and Applied Physics. Applicants should have a university degree or its equivalent, together with industrial and teaching experience. Salary £700-£25-£800, plus London allowance of £36 or £48, also degree and training allowances where applicable. Application forms obtainable from the Secretary (stamped addressed foolscap envelope necessary), South East London Technical College, Lewisham Way, S.E.4, should be returned not later than fourteen days after the appearance of this notice. W 2434

**DEVELOPMENT ENGINEERS** required. Electrical Engineers fully acquainted with up-to-date electronic work and with sound mechanical knowledge are eligible for vacancies in our Development Laboratory. B.Sc., A.M.I.E.E. or H.N. Cert. essential. Write, stating personal details, qualifications, experience, and salary required, to Personnel Manager, Edison Swan Electric Co. Ltd., Ponders End, Enfield. W 2428

**QUALIFIED ENGINEER** required for Television Aerial and Transmission line development and research for laboratory in the London area. Wide experience of S.W. aerial measurements essential. Permanent position offered with liberal salary to suitable candidate. Write, Antiference Ltd., 67, Bryanston Street, London, W.1. W 2426

**JUNIOR PHYSICISTS** or Electrical Engineers. Vacancies exist for graduates in the Electronics and Electrical Departments. Subjects covered include thermionic emission electrical contact phenomena, electronic recording and controlling devices, electro-magnetic systems. Age 21-26. Experience not essential except in the case of thermionic emission, when some previous work on electron-emitting devices would be preferable. Salary in accordance with age and experience. Apply in writing to the British Scientific Instrument Research Association, "Sira," Southill, Elmstead Woods, Chislehurst, Kent. W 2416

**PROTO-TYPE WIREMEN** required for producing highest grade television transmission and other equipment. Applicants to possess sound fundamental knowledge of both radio and television together with some experience of layout and wiring of video equipment. Wiring to be of instrument standard and applicants must be capable of producing own component layouts. City and Guilds, Higher National or similar qualifications desirable but comprehensive practical experience acceptable in lieu. Salary £300-£350 p.a. according to experience. Cinema-Television Ltd., Worsley Bridge Road, Lower Sydenham, S.E.26. W 2412

**PROJECT ENGINEERS** required for assisting the production of highest grade television transmission and other equipment. Applicants to be capable of taking charge of a complete project which includes supervision, progressing, testing and possibly installation. Sound fundamental technical knowledge of both radio and television is required together with experience of work involving similar responsibility. Technical qualifications are desirable up to Degree standard but where considerable practical experience can be shown, lower standards might be considered. Salary, £400-£500 p.a. according to experience. Cinema-Television Ltd., Worsley Bridge Road, Lower Sydenham, S.E.26. W 2413

**APPLICATIONS** are invited from Senior Radio Development Engineers who are interested in the Electrical or Mechanical Design of Airborne Radio Equipment to Service Specifications. Write, quoting Ref. C.H.C. (2) to Personnel Officer, General Electric Co. Ltd., Radio and Television Works, Coventry. W 2419

**LONDON COUNTY COUNCIL.** South East London Technical College. Applications are invited for the post of lecturer in Radio Communication to commence duties in September, 1950. Applicants should have a University Degree or the equivalent and have had industrial experience. Salary in accordance with the London Burnham Technical Scale, which would be in the range of from £335-£15-£603 a year, plus graduate and training allowance where applicable. To a suitably qualified candidate an addition to the scale of £50 may be paid. Initial increments will be paid for suitable previous teaching and/or industrial experience. Application forms may be obtained by forwarding a stamped addressed foolscap envelope to the Secretary, South East London Technical College, Lewisham Way, London, S.E.4, and should be returned not later than fourteen days after the appearance of this notice. W 2422

**ENGLISH ELECTRIC VALVE Co. Ltd.,** Chelmsford, require two Junior Engineers for micro-wave work. Previous experience not necessary, but applicants must hold physics or engineering Degree or exempting qualifications from Graduate I.E.E. Also Senior Engineer for work on Klystron and Travelling Wave Tubes. Qualifications: Engineering or Physics Degree or exempting qualifications from A.M.I.E.E. and several years experience. Write, giving full particulars quoting reference 440A to Central Personnel Services, English Electric Co. Ltd., 24-30, Gillingham Street, London, S.W.1. W 2423

**TECHNICAL ASSISTANT** required by Airmec Laboratories Ltd., Cressex, High Wycombe, for their Mechanical Engineering Laboratory. Applicants should have had previous experience in light engineering and electro-mechanical engineering and have technical qualifications to the Higher National Certificate standard in Mechanical Engineering. Applications should be made in writing to the Personnel Manager, stating age, qualifications, experience and salary required. W 2424

**THE BRITISH THOMSON-HOUSTON Co. Ltd.,** has a few vacancies on the design staff for Electronic Engineers experienced in development work on audio-frequency, radio-frequency, or radar display equipment. Age 25-30. Qualifications: Honours degree or equivalent in engineering with subsequent experience in circuit development work. Salary according to qualifications, age, and experience. Apply, giving full particulars to: Manager, Electronic Engineering Department, The British Thomson-Houston Co. Ltd., Rugby. W 2420

**FERRANTI LTD.** invite applications from suitably qualified men to fill vacancies in a scientific team working on the development of electronic digital computers. Ref. D.C.E. Electronic Scientists, graduates in physics or electrical engineering, preferably with some experience of pulse circuitry. Ref. D.C.M. Mathematicians, honours graduates interested in numerical analysis applied to the operation of high-speed digital computers. Ref. D.C.T. Technical Assistants, with a minimum qualification of H.N.C. and some electronic experience. Liberal salaries, based on Civil Service Scale. Successful candidates will participate in the benefit of a Staff Pension Scheme. Application forms from the Staff Manager, Ferranti Ltd., Hollinwood. Please quote appropriate reference. W 2418

**CHEMIST.** A development chemist required, age 25-30. Experienced in radio valve and television tube industry desirable though not essential. Applicants must be live and versatile and possess an Honours Degree in Chemistry. Salary in accordance with experience and qualifications. Apply Personnel Officer, Standard Telephones & Cables Ltd., Footscray, Sidcup, Kent. W 2441

**DESIGNER DRAUGHTSMAN** required for a Design and Development Laboratory. Applicants must possess Higher National Certificate or equivalent qualifications, and have a practical experience of plastic moulds, small special purpose machinery, press tool work and general machine tool knowledge. Apply, stating age, qualifications and experience to The Employment Officer, Hoover Ltd., Perivale, Greenford, Middx. W 2442

CLASSIFIED ANNOUNCEMENTS  
continued on Page 4



*This is the symbol  
of the Ekco organisation,  
whose products are  
recognised throughout  
the world as among  
the finest in their class*



**Ekco VHF Aircraft Equipment**—Valuable contributions to the safety and efficiency of aviation have been made by Ekco VHF Aircraft Communications Equipment, and will be made in the future by Ekco Cloud and Collision Radar Equipment.

**Ekco Nucleonic Equipment**—Scientific research is aided by the wide and fast-growing range of Ekco Nucleonic Equipment.

**Ekco Radio**—Ekco Radio and Car Radio are already in service in many lands, and as television transmission develops Ekcovision will follow.

**Ekco Plastics**—The largest Thermosetting and Thermoplastics plant in the country, backed by a full technical advisory service, is able to deal with any industrial moulding problem.

**Thermovent**—Famous ships including the "Queen Mary" and the "Queen Elizabeth," employ the Thermovent system of electric space heating, as do the homes and offices of countries far and wide.

Such is the magnitude of the Ekco organisation, whose long-standing reputation for quality and reliability is your assurance of satisfaction.

# EKCO

E. K. COLE LTD · SOUTHEND-ON-SEA · ESSEX · ENGLAND



THEY SANG THE PRAISES OF THE 10 INCH ★

## *NOW we present a* *12" Stentorian* **Concentric Duplex** **HIGH FIDELITY REPRODUCER**

Similar in construction to our highly successful 10" Concentric Duplex, it combines the same high quality with large power handling capacity, achieved by a very high flux density magnet, and special cone material (made from newly-developed long fibre pulp) which enables a resonant point of below 50 c.p.s. to be obtained. The all-metal high frequency diaphragm and speech coil gives rigidity of construction and maximum driving efficiency. This rear assembly is totally protected by a bakelite and perspex housing.

Full details of both 10" and 12" models on request.

**SPECIFICATION** Series Gap magnet of Alcomax 3.  
OF 12": Flux in LF gap 14,000 gauss on 1½" pole  
" " HF " 17,000 gauss " " "  
Power handling capacity, 15 watts. Frequency range  
30-17,000 c.p.s. Fundamental bass resonance, 45 c.p.s.

**PRICE** Complete with cross-over network and transformer, **£15 - 15 - 0**  
" Without transformer, **£14 - 14 - 0**

★ The "WIRELESS WORLD" said:  
"The makers' claim of a frequency range of 50 to 14,000 c/s can be substantiated . . . gives a clean and full-bodied bass response of surprisingly good quality for a 10 in. diaphragm."

WHITELEY ELECTRICAL RADIO CO. LIMITED · MANSFIELD · NOTTS

## CLASSIFIED ANNOUNCEMENTS (Cont'd.)

**SALES ENGINEER** for Photo-Electric and Electronic Controls to operate from London office of well known manufacturers. Good general experience of electrical and mechanical equipment is essential as is proved sales ability. Duties include handling of enquiries, new business and advising customers on the application of photo-electric control. Good progressive position assured to a capable and energetic young man, car owner preferred. Remuneration is by salary and expenses. Our staff know of this advertisement. Full details in confidence to Box No. W 2439.

**DECCA RADAR LTD.** require a Senior Engineer for work on new radar projects of an important and interesting nature. The position offers excellent opportunities to a man who can show proof of outstanding ability as a development engineer. Applicant should have received a sound training in electrical engineering and have extensive experience in the development and design of complete radar systems. Write only in first instance giving full details, age, experience and salary required to Ref. EF2, Decca Radar Ltd., 1-3, Brixton Road, S.W.9. W 2444

**DECCA RADAR LTD.** require a Radar Circuit Engineer for research and development work on receivers. The position offers good opportunities to a man of sound training and experience who wishes to join a firm in which individual ability and energy will be appreciated. Write only in first instance giving full details, age, experience and salary required to Ref. E2 EF3, Decca Radar Ltd., 1-3, Brixton Road, S.W.9. W 2445

**APPLICATIONS** are invited for the position of Technical Design Engineer in the F.H.P. Motor Laboratory at a large electrical engineering company in the West London area. Experience of F.H.P. motor design and performance, and ability to accept full responsibility of a project from the initial design stage to factory production is essential. Applicants should possess engineering degree or equivalent qualifications. Salary will be in the region of £600 to £900 per annum according to qualifications. Apply giving details of age, education and job history to the Employment Officer, Hoover Ltd., Perivale, Greenford, Middx. W 2443

## FOR SALE

**1949 Fordson Van**, equipped as mobile recording van, complete with twin recorders, generators, battery bank, mics, cables, etc., all gear completely installed and van P.A.; also would sell complete or in part; cost nearly £2,000 new. Rapstone Radio & Recording Co., 44, Fountayne Road, London, N.16. W 1139

**T.V. DI-POLE Insulators** in moulded bakelite, fit  $\frac{1}{2}$  in. elements and 1 in. boom, 5s. each. C.W.O. M. & B. Radio, 120, Holt Road, Liverpool, 7. W 1138

**WOODWORK** of all descriptions, large and small quantities: your enquiries invited. Repetition Woodworks Ltd., Old Roller Mill, South Darenth, Kent. W 1132

**COILS.** Special inductances  $1\mu\text{H}$  to  $2\text{H}\Omega$  at RF wound to order. Bel Sound Products Co., Marlborough Yard, Archway, N.19. Archway 5078. W 112

**INDUCTANCES**—Ferrous Oxide Cores  $3\text{H}$  to  $3\mu\text{Cr}$  MCS. Q100 to 300. Bel Sound Products, Mfs. Elect. Engrs., Marlborough Yard, Archway N. 19. North 1025. W 111

**ELECTRONICS.** Write to the firm which specialises in electronic equipment for your requirements in relays, valves, thyratrons, photocells, electron multipliers, special C.R.T., image converters, selsyns, velodynes, etc., as well as all components. A. McMillan, 5, Oakfield Road, Bristol, 8. W 1102

**TELEVISION.** All parts in stock for E.E. television, Haynes scan and focus coils; line trans. model on view. H. G. Radio, 1350, Stratford Road, Birmingham, 28. W 1113

**VALVE BOXES**, new, plain, 1,000, 25s.; 2,000, 45s.; 5,000, £5. C.W.O., C/P. Amateurs' Paradise, 155, Humberstone Road, Leicester. W 1126

**M/COIL MICAPHONES**, new, boxed, 1s. each. Valves VR54, VR65, AVR02, all 2s. each. 6J5, VR65, 6SU7, 6AC7, 3s. each.; EF50, 6L6, 5U4, 6s. each, new, boxed; XTAL 21-22, 10r Sylvanite, 3s. 6d. each. 2-pin plugs, sockets, 6d. complete. V/Controls, 2s. each. Belling & Lee plugs, 5-pin and 7-pin and sockets, 6d. each. C.W.O. Harry White Amateurs Paradise, 155, Humberstone Road, Leicester. W 1123

**CONDENSERS**, 0.01 mfd. 5,000 wkg., 0.02 8,000 wkg., Can type, 2s. 6d. each. Amateurs' Paradise, 155, Humberstone Road, Leicester. W 1125

**TELEVISION.** The trade is invited to contact us for P.M. focus rings, televisor R.F. and deflector coils, Low C line transformers, and new iron-cored inductances of high upper frequency limit and remarkably low ECH loss. Value for money assured, quality precludes low prices. Bel Sound Products Co., 10, Marlborough Yard, Marlborough Road, Upper Holloway, London, N.19. W 110

**AMERICAN MAGAZINES.** One year post free. "Radio Electronics," 32s. 3d.; "Audio Engineering," 28s. 9d.; "Radio and Television News," 46s.; "Popular Science," 28s. 6d. S.A.E. for full list from Willen Ltd. (Dept. 9), 101, Fleet Street, London, E.C.4. W 2214

**WEBB'S** 1948 Radio Map of World, new multi-colour printing with up-to-date call signs and fresh information; on heavy art paper, 4s. 6d., post 6d. On linen on rollers, 11s. 6d., post 9d. W 102

**AUTOMATIC** Voltage Regulators for AC mains. Ferranti 7.5 KVA; moving coil; frequency compensated; undistorted output waveform. Tapped to suit any nominal supply between 200 and 250 V, 1 ph. 45 to 66 cps. Input voltage may vary from 88 per cent to 108 per cent of nominal. Output: 100 per cent  $\pm$  1 per cent. Complete with voltmeter, spares, handbook. Brand new, in original oiled paper wrappers and export packing cases. Gov't surplus. Offered at a fraction of normal cost. Overseas enquiries invited. P. B. Crawshaw, 166, Pixmore Way, Letchworth, Herts. W 2355

**MERCURY SWITCHES** are made by Hall Drysdale & Co. Ltd., of 58, Commerce Road, Wood Green, London, N. 22. Phone BOWES Park 7221-2. W 107

**HIGH QUALITY** mains and output Transformers available in quantities large enough to be of interest to manufacturers. 12-watt Mains Transformers. Primary: 110, 210 or 230 volts, 50 cycles. Sec. 1, 5V 2A; Sec. 2, 6.3V 2A; Sec. 3, 600V, C.T. 150 mA from rectifier. Frame: 2 in. Stack Rola No. 6 stampings. 40-watt Mains Transformers. Primary: 110, 210 or 230 volts 50 cycles. Sec. 1, 6.3V 2A; Sec. 2, 5V 2A; Sec. 3, 5V 2A; Sec. 4, 620V, C.T. 60 mA; Sec. 5, 950V, C.T. 180 mA. Frame:  $1\frac{1}{2}$  in. Stack M.E.A. No. 136A stampings. 12-watt Output Transformers. Suitable for a 6V6 push-pull output stage. Sec. 1, for 600 ohm line; Sec. 2, 15 ohm and 4 ohm. Frame:  $1\frac{1}{2}$  in. Stack Rola No. 4 laminations. 40-watt Output Transformers. Primary: Suitable for EL37 valves in push-pull. Sec., 15 ohm and 4 ohm. Frame:  $1\frac{1}{2}$  in. Stack Rola No. 6 laminations. Enquiries to: A. Kershaw & Sons, Harehills Lane, Leeds, 8. Phone: Leeds 44601, ext. 13. W 2421

**ELECTRONIC BUSINESS** in Bradford for disposal as a going concern. Well equipped with machinery, stock in trade and buildings. At present producing own design in portable amplifiers, inter-communication instruments speaking all ways, burglar alarms including the most sensitive sound location unit, or capable of developing the most intricate electronic devices by men with Degrees. To the right man or firm with organising abilities and sales organisation this definitely presents the most extraordinary opportunity for acquiring a sound and lucrative business where 80 per cent of the purchase price can be paid out of profits over a number of years. Further details and particulars can be had from Fred Snowden, 1, Norfolk Street, Bradford. W 2447

**I.P.R.E.** Technical Publications, 5,000 alignment peaks for superheterodynes, 4s. 9d. post free; "The Practical Radio Engineer," quarterly publications of the Institute, sample copy, 2s. post free; membership and examination data, xs. post free. Secretary, I.P.R.E., 20, Fairfield Road, London, N.8. W 2320

**PROCEEDINGS** of the Institute of Radio Engineers for disposal. Vols. 8 to 36 incl. Full particulars from and offers to Catt, 33, Hempstead Road, King's Langley, Herts. W 1153

**SELENIUM METAL** Rectifiers. Various voltages at 4 amps. or over available. State requirements. Wilfo Products, 222, Corbals Street, Glasgow, C.5. W 2436

**POLYSTYRENE**, sheets, rods and foil. Sheets:  $\frac{1}{8}$  in. to  $1\frac{1}{2}$  in. thick up to 15 in. by 24 in. Rods:  $\frac{1}{8}$  in. to  $1\frac{1}{2}$  in. diam. up to 24 in. long. Foil:  $1\frac{1}{2}$  in. wide,  $3\frac{1}{2}$  mils. thick, 800 ft. coils. Polythene, sleeving, braided and plain in coils. Altogether about 3 tons, but small quantities supplied. John Castle & Co., Ltd., 5, Hurley Road, London, S.E.11. Phone: REL. 4274/5. W 1158

## EDUCATIONAL

**CITY AND GUILDS**, (Electrical, etc.), on "No Pass—No Fee" terms. Over 95 per cent successes. For full details of modern courses in all branches of Electrical Technology, send for our 112-page handbook—free and post free. B.I.E.T. (Dept. 337C), 17, Stratford Place, London, W.1. W 100

## SERVICE

**GLASSBLOWING**, repetition and scientific, by Hall Drysdale & Co. Ltd., of 58, Commerce Road, Wood Green, London, N.22. Phone BOWES Park 7221-2. W 109

**ELECTRICAL** Measuring Instruments of every make repaired and standardised. The Electrical Instrument Repair Service, 329, Kilburn Lane, London, W.9. Tel.: Lad. 4168. W 1151

**ARMATURE** and motor repairs of all descriptions; vac. grinders, drills, gram. motors, split phase, transformers rewound; lowest quotations and speediest service; new commutators and bearings supplied and fitted. W. D. T., 77, Gt. Western Street, Manchester, 16. W 1103

**CHARLES AMPLIFIERS LTD.**, are now able to produce amplifiers, radio units, and electronic equipment to specification. Enquiries invited for development work and for short production runs. Charles Amplifiers, Ltd., 40, Kensal Road, W.10. W 2399

## RELAYS

For A.C. and D.C.



Multiple-contact heavy duty Relays. Sensitive Relays, measuring and impulse Relays, mercury switch Relays, time delay Relays, photo-electric Relays.

Ask for Leaflets RE/EO

**LONDEX LTD.**

Manufacturers of Relays

207, ANERLEY ROAD, LONDON, S.E.20

SYDenham 6258

# DECADES WITH A DIFFERENCE

## DECADE CAPACITANCE UNITS TYPE **B - 23**

**D**ISCERNING ENGINEERS will not be slow to appreciate the advantages offered by these improved decade capacitance units:—

- CONTAINER** • The redesigned container of cubic form provides considerably greater space for the condensers without increasing the effective panel space.
- CONDENSERS** • The increased space permits the use of high-stability mica condensers up to the maximum of one microfarad.
- SWITCH** • The improved switch is easily accessible for cleaning and is designed to reduce surface leakage to a minimum.
- SEALING** • Condenser units are completely sealed within the container by an approved sealing compound.

### SPECIFICATIONS

- CONDENSERS** • Clamped mica type for long-period stability.
- ACCURACY** • 0.001  $\mu\text{F}$  steps :  $\pm 5\%$ .  
0.01 and 0.1  $\mu\text{F}$  steps :  $\pm 1\%$ .  
Closer adjustment can be provided at an extra charge.
- POWER FACTOR** • 0.0005 at 1 kc/s.
- TEMPERATURE COEFFICIENT** •  $-20$  to  $+10$  parts in  $10^6$  per  $^{\circ}\text{C}$ .
- WORKING VOLTAGE** • Up to 250 v. peak.

### STANDARD MODELS

#### B-23-A

0.01  $\mu\text{F}$  in steps of 0.001  $\mu\text{F}$

#### B-23-B

0.1  $\mu\text{F}$  in steps of 0.01  $\mu\text{F}$

#### B-23-C

1.0  $\mu\text{F}$  in steps of 0.1  $\mu\text{F}$

For details of our full range of Laboratory Condensers, send for Publication C-103-A.

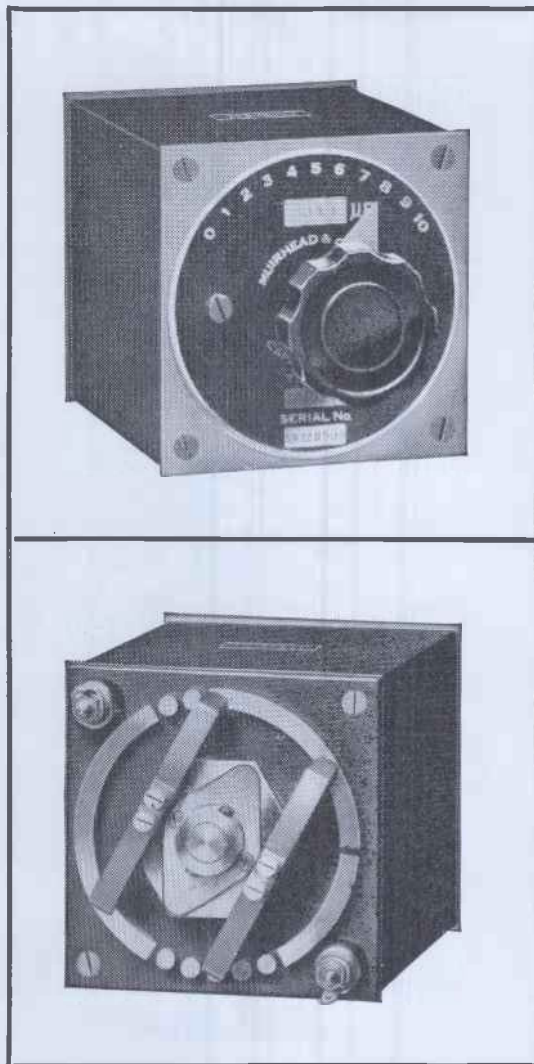

## MUIRHEAD

Muirhead & Co. Ltd., Elmers End, Beckenham, Kent. Telephone : Beckenham 0041-2.

FOR OVER 60 YEARS DESIGNERS AND MAKERS OF PRECISION INSTRUMENTS

# THE *POWER* IN THE PACKAGE

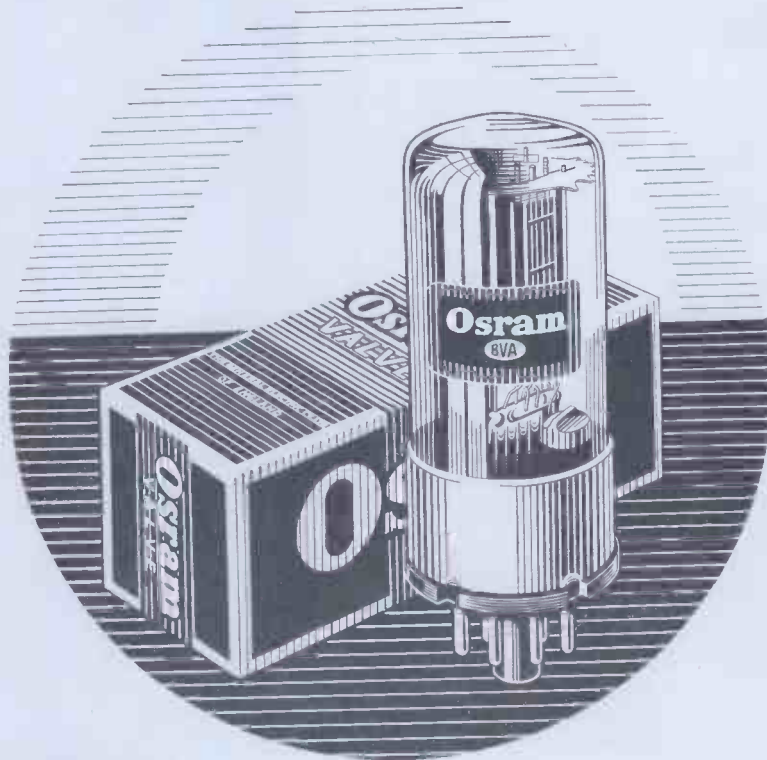

## **Osram VALVES**

*A tonic to any set!*

**Osram**  
PHOTO CELLS

**G.E.C.**  
CATHODE RAY TUBES

**Osram**  
VALVES

THE GENERAL ELECTRIC CO. LTD., MAGNET HOUSE, KINGSWAY, W.C.2.

# We thought of everything

... when we designed and built the B50 and B51

Microphones we thought of everything. Asymmetrical physical design for easy use in either hand

... press-to-speak switch which can be locked in the 'ON' position by rotating

with thumb or forefinger. ... die-cast aluminium case finished in hard-wearing plastic enamel

... comprehensive range of switching arrangements to suit most possible demands colour-coded by disc indicator

on each instrument ... two types—B50 with dynamic insert which can be safely used under

tropical and marine conditions, and where utmost reliability is essential ; and B51 with crystal

insert where high output is essential. Both types can

confidently be specified for use with mobile equipment

and transmitters for speech frequencies.

And, of course, VITAVOX Inherent

quality is incorporated in both.



## VITAVOX

### MICROPHONES LOUDSPEAKERS

Vitavox Limited, Westmoreland Road, London, N.W.9,  
England

Telephone : COLindale 8671-2-3; Telegrams : Vitavox,  
Hyde, London; Cablegrams : Vitavox, London, England.

# DISC-SEAL TRIODES

## for Ultra High Frequencies

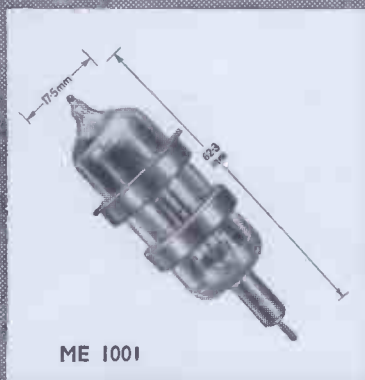

ME 1001

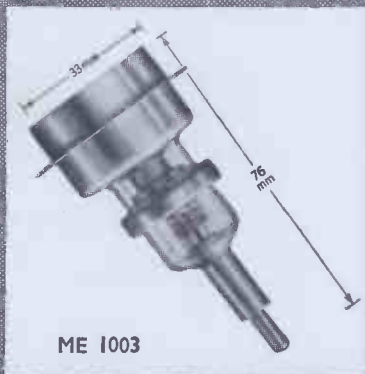

ME 1003

### Mullard News Letter

Manufacturers, designers and consultants who are not already on the mailing list for this service of advance information on new valves, are invited to write for full particulars.



INDUSTRIAL POWER VALVES · THYRATRONS · INDUSTRIAL RECTIFIERS · PHOTOCELLS  
FLASH TUBES · ACCELEROMETERS · CATHODE RAY TUBES · STABILISERS AND  
REFERENCE LEVEL TUBES · COLD CATHODE TUBES · ELECTROMETERS, ETC.

For U.H.F. links, local oscillators, and wide band applications such as multi-channel communication systems and radar altimeters, frequencies up to 1500 Mc/s or even 3000 Mc/s are often required. The Mullard Disc-Seal Triodes have been designed specifically for such purposes.

In the ME1001, adequate cooling and low inductance are combined in the design of the anode and grid discs to give an anode dissipation of 10 watts and an upper frequency limit (as an oscillator) of 3750-3500 Mc/s (8-8.5 cm).

The ME1003 is basically similar in design to the ME1001, but the larger electrodes permit an anode dissipation of 25 watts. However, the larger clearances necessary to obtain this value, limit the upper frequency to 2500 Mc/s.

### PRINCIPAL CHARACTERISTICS

	ME 1001	ME 1003
Heater Voltage (V)	6.3	6.3
Heater Current (A)	0.4	1.0
Max. Anode Voltage (V)	350	500
Max. Anode Dissipation (W)	10	25
Max. Anode Current (mA)	50	200
Max. Peak Anode Current (mA)	150	500
Power Output (W)	0.5 (at 3000 Mc/s) 3.5 (at 500 Mc/s)	6 (at 1500 Mc/s) 20 (at 430 Mc/s)
Mutual Conductance (mA/V)	6	20
Amplification Factor	30	30

# Mullard

## THERMIONIC VALVES & ELECTRON TUBES

**Which switch  
fits the  
niche?**



TYPE B.T.

By the time that has rolled round your tongue half a dozen times the Type B.T. Switch could be fitted! It's that sort of switch—small, compact, designed specially to fit easily into small spaces. It'll save you a lot of trouble. We have recently included some new features. Here they are—

WALTER SWITCHES—MADE FOR LIFE

**Walter  
Instruments  
LIMITED**

- The contact blades are fixed in a new way. This makes them completely rigid all the time.
- The drive spindle is positioned definitely in the wafer. This provides double bearing.
- Steady contact resistance.
- Improved insulation between contacts.
- Positive contact.
- Self-cleaning action.

All these make the Type B.T. a better switch—more efficient and lasting. In fact just the switch you need for limited space and simple switching.

# Ferranti

MINIATURISED HERMETICALLY SEALED

# Transformers

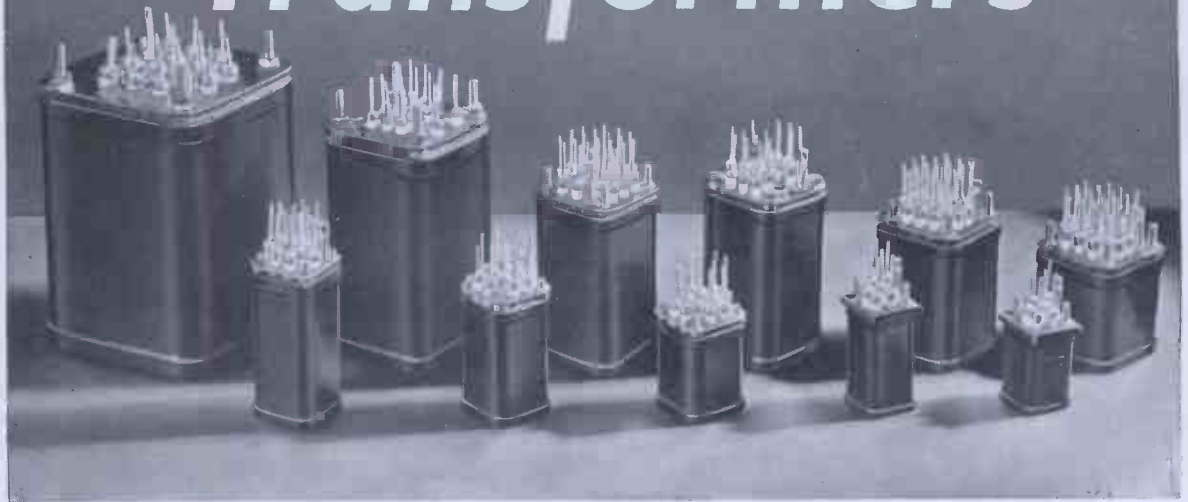

**T**HE Ferranti range of miniature hermetically sealed transformers and chokes has been designed to meet the increasing demand for high-grade components by equipment manufacturers, and is specially suited for use in equipments in which reliability, miniaturisation and full tropicalisation combined with lightness

of weight are of major importance.

The transformers are housed in cans of monel metal, which has excellent anti-corrosive properties. These cans have ceramic bush-type terminals and are spray-painted black for maximum heat dissipation. Ferranti transformers are designed to customers' specific requirements.

For further information and descriptive leaflet write to:

## Ferranti Ltd

FERRANTI LTD · TECHNICAL SALES DEPT · FERRY ROAD · CREWE TOLL · EDINBURGH 5







**EXPERIENCE SPEAKS..**



**...in Communications  
Equipment by**

**Plessey**

The crystal set era and the early days of valve amplifiers seem long ago. Yet even then, Plessey was a respected name in radio. Plessey experience in the field of electronics is probably unequalled. That experience produced well over 160,000 major electronic and communications equipments during the war years. And it all adds up to this: that for a first-class product in the field of communications equipment, it is a good policy to remember Plessey.

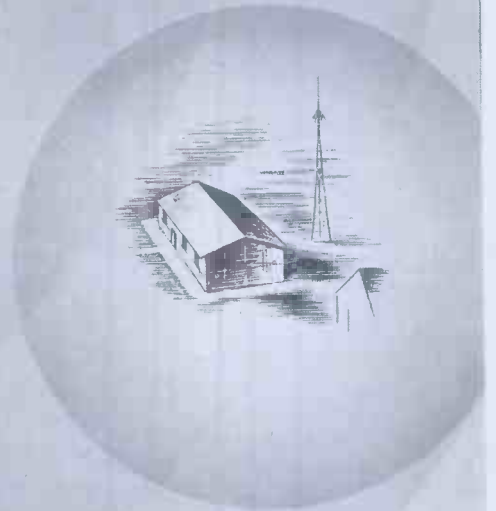

## V.H.F. LITERATURE YOU SHOULD HAVE—

*Detailed literature describing complete communications systems or individual units to meet particular applications will gladly be forwarded upon request.*

MOBILE V.H.F. SYSTEMS (A.M. & F.M.)    V.H.F. AIRPORT EQUIPMENT  
V.H.F. AIRBORNE EQUIPMENT    RAILWAY COMMUNICATIONS SYSTEMS

THE PLESSEY COMPANY LIMITED · ILFORD · ESSEX

**To the electrical and radio service engineer . . .**

**An oscilloscope in miniature . . .**

The criterion of usefulness of a cathode-ray tube as an oscilloscope is the ratio of the screen diameter to the diameter of the spot but there is a practical limit to the extent to which the screen diameter can be reduced, even though the spot size is reduced in proportion. One outstanding feature of this oscilloscope is the comparatively large screen for an instrument of such small dimensions. Although the overall dimensions of the case are  $11\frac{1}{2}$  in.  $\times$   $5\frac{3}{4}$  in.  $\times$   $4\frac{1}{4}$  in., the tube has a  $2\frac{3}{4}$  in. screen.

**The  
Miniature  
Cathode-ray  
Oscilloscope  
Type 244**



**METROPOLITAN-VICKERS ELECTRICAL CO. LTD.**

MANCHESTER 17, ENGLAND

# NATIONAL RADIO EXHIBITION 1950

Sept. 6th – 16th at Castle Bromwich

## VISIT STAND No. 41

where Automatic Telephone & Electric Co. Ltd. (Radio & Transmission Division) will be exhibiting among many new developments their

### V.H.F. MULTI-CHANNEL TELEPHONE EQUIPMENT

TYPE VMS



**AUTOMATIC TELEPHONE & ELECTRIC Co. Ltd.**

*(Radio and Transmission Division)*

**Strowger House, Arundel Street, London, W.C.2.**

Telephone : TEMple Bar 9262

Telegrams : Strowger, Estrand, London.

STROWGER WORKS, LIVERPOOL, 7.

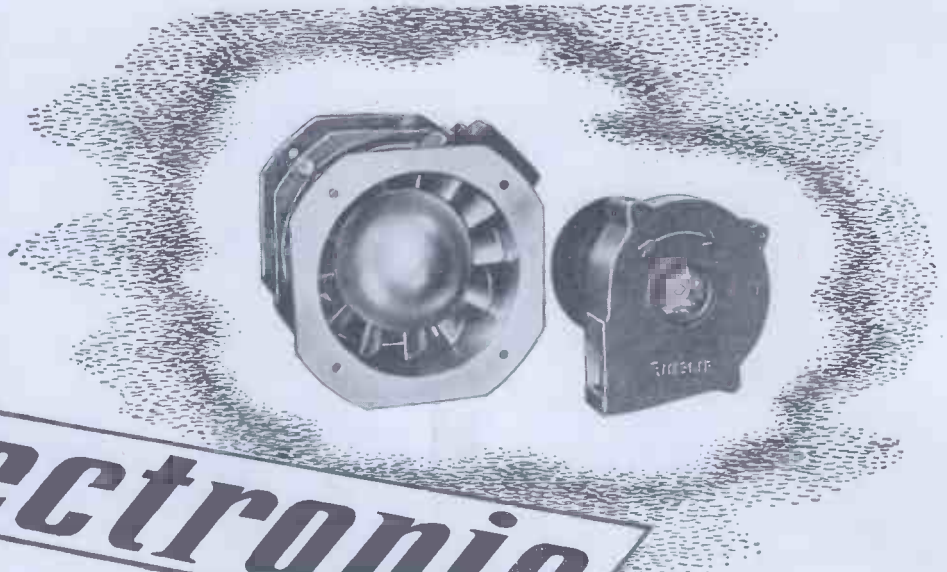

# *electronic* COOLING

The wide range of blowers for force-cooling of valves and maintenance of desired temperature levels in electronic and general electrical apparatus is typical of the progress maintained by **ACI**. The illustration shows the smallest of the blowers (4" Axial Flow type and 2½" Centrifugal type), but our range covers duties from 5 c.f.m. up to many thousands of c.f.m. at pressures up to 45 or more inches w.g. These blowers are used in MARINE & AERODROME RADAR INSTALLATIONS, AIRCRAFT AUTOMATIC PILOTS, COMMUNICATION AND BROADCASTING STATIONS, R.F. HEATING EQUIPMENT, Etc. Let us know your application—we shall be pleased to put forward our proposals.



Complete  
Air Treatment  
Plant

## AIR CONTROL INSTALLATIONS LTD.

Manchester

RUISLIP, MIDDX.

Glasgow

Telephone : Ruislip 4066 (8 lines)

Telegrams : Controlair, Ruislip

# OVER 66% PYE...

Pye Telecommunications Limited have supplied more than two-thirds of all the V.H.F. communications equipment in use in the United Kingdom. "Type approved" by the G.P.O. for the business bands 156/184 Mc/s and the essential bands 60/130 Mc/s. Over 30 police forces, over 70 car hire and taxi firms, and many ambulance services, fire services and tug firms use Pye V.H.P. equipment.

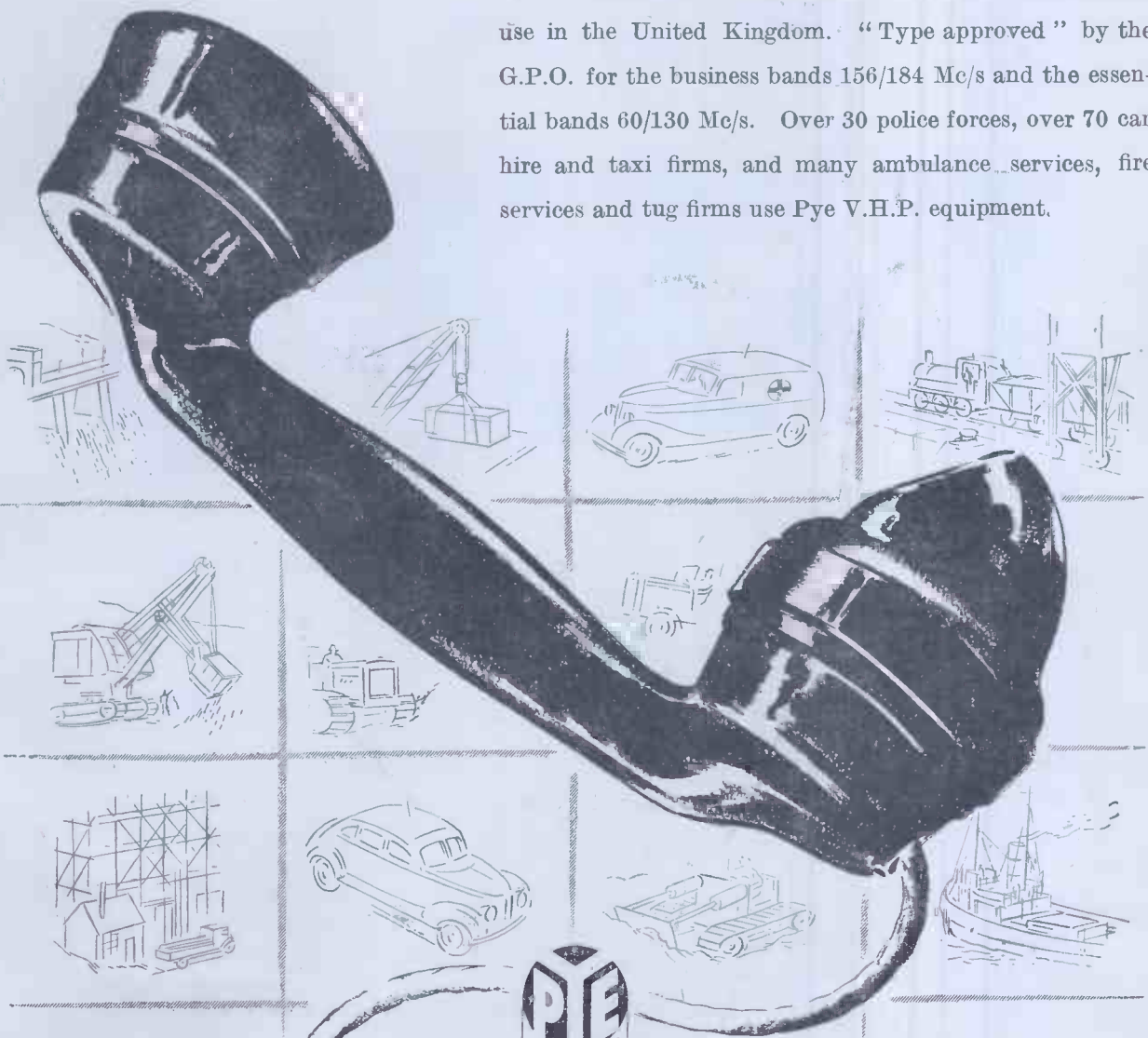

Write to-day  
for full details  
to :—

  
**Telecommunications**  
 CAMBRIDGE ENGLAND  

# EDISWAN LOW FREQUENCY OSCILLATOR TYPE R 666



- ★ VERY LOW FREQUENCIES
- ★ HIGH STABILITY
- ★ WIDE RANGE
- ★ PURE WAVEFORM
- ★ PUSH-PULL OUTPUT
- ★ FREQUENCY INCREMENT SWITCH
- ★ CONSTANT OUTPUT VOLTAGE
- ★ OUTPUT ATTENUATOR
- ★ COMPACT AND PORTABLE
- ★ STANDARD RACK MOUNTING

**T**HIS is a much-needed oscillator designed specifically for testing, calibration and set-up of biological amplifiers and recorders, strain and vibration recorders, and low frequency wave analysers.

It has a resistance/capacity circuit of special design with automatic amplitude control to ensure constant output and good waveform at frequencies from 1.1 to 5,000 c.p.s. The circuit is remarkably free from

trouble associated with change of valve characteristics, ensuring that accuracy is dependent only upon the frequency selective network components.

An incremental frequency switch is included specifically for the measurement of 'Q' in frequency selective circuits of filters or wave analysers.

Further details will be given on request.

# EDISWAN

THE EDISON SWAN ELECTRIC CO. LTD., 155 CHARING CROSS ROAD, LONDON, W.C.2

RA.116

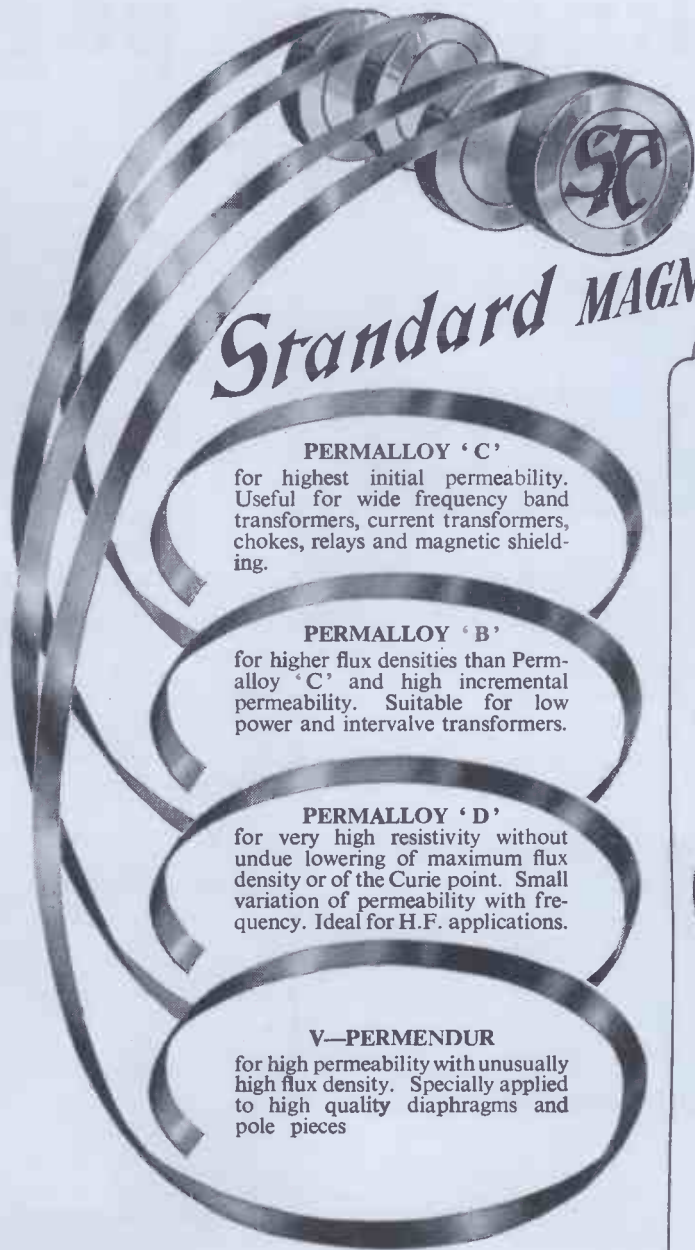

# Standard MAGNETIC MATERIALS

### PERMALLOY 'C'

for highest initial permeability. Useful for wide frequency band transformers, current transformers, chokes, relays and magnetic shielding.

### PERMALLOY 'B'

for higher flux densities than Permalloy 'C' and high incremental permeability. Suitable for low power and intervalve transformers.

### PERMALLOY 'D'

for very high resistivity without undue lowering of maximum flux density or of the Curie point. Small variation of permeability with frequency. Ideal for H.F. applications.

### V-PERMENDUR

for high permeability with unusually high flux density. Specially applied to high quality diaphragms and pole pieces

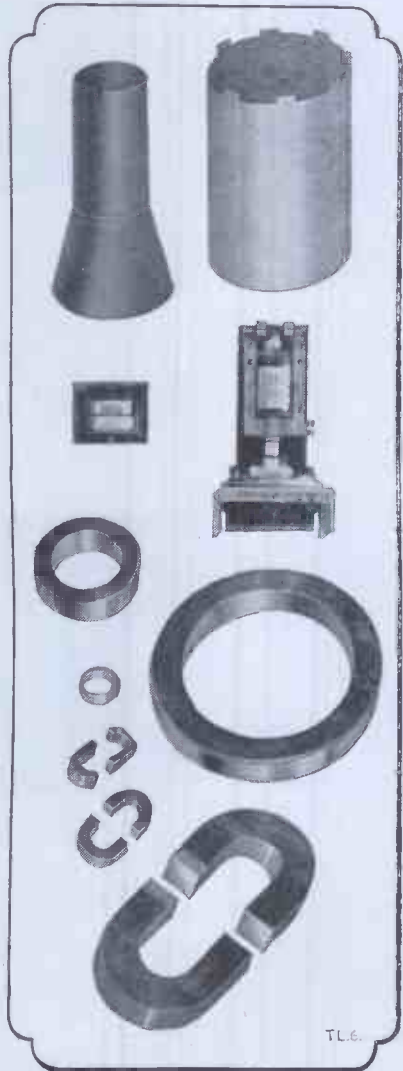

Standard Magnetic Materials, which have been steadily improved and extended in range over many years, are produced by a Company which has the unique advantage of being also a large scale user of these materials.

## Standard Telephones and Cables Limited

(Registered Office: Connaught House, Aldwych, London, W.C.2)  
(Telephone Line Division)

NORTH WOOLWICH, LONDON, E.16.

Telephone: Albert Dock 1401

# The "Belling-Lee" page for Engineers

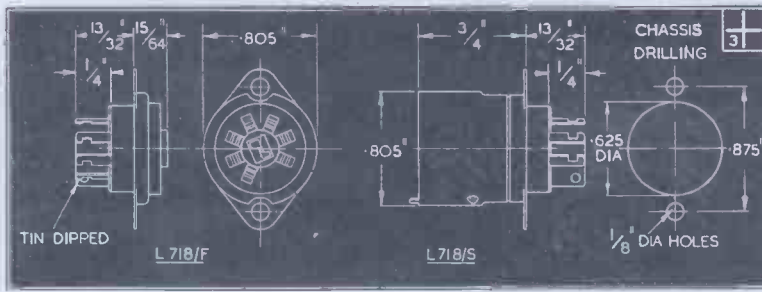

**B7G Valveholder**  
**L718/F with Flange**  
**L718/S with Skirt**

This valveholder has been approved by the Services Committee on Valveholder Development and has reached its final production stage. We believe that it is the very best of its type having regard to price. It will be supplied with either a fixing flange or skirt to take the standard screening can. Features in its design include :—

1. Low loss nylon filled moulded insulators.
2. Beryllium copper contacts differentially hardened to obtain the best possible contact pressure.
3. A flat type screen providing adequate screening between contacts, easily shortened if there are space limitations.
4. Tin dipped solder tags which do not snap on bending.
5. Complies with RCS/251.

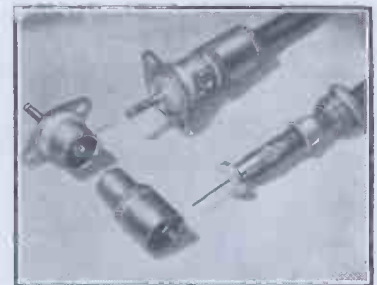
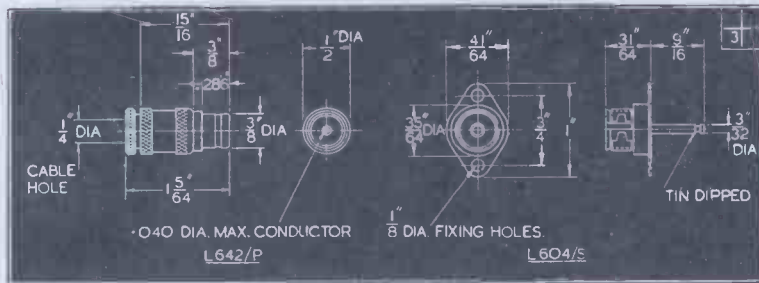

**Coaxial connectors**

List Numbers	Cable dia. (nominal)
L.642/P standard	.25 O.D.
L.632 large	.312 O.D.
L.727 small	.18 O.D.
L.614 right angle	.25 O.D.
L.615 twin right angle	.25 O.D.
L.604/S standard chassis socket	
L.616 line coupling	
L.617 through chassis connector	

This plug complies with the R.E.C.M.F. standard for coaxial plugs for the aerial input of domestic television receivers and is also widely used in the electronic instrument and apparatus field working on frequencies up to 250 Mc/s.

Features include :—

1. Very easy method of loading.
2. Very low self capacitance (1.5 pF).
3. Very low contact resistance.
4. Bright nickel plated finish.
5. Three sizes available for various cable diameters (see table).

*These Components are suitable for V.H.F. receivers*

**BELLING & LEE LTD**  
CAMBRIDGE ARTERIAL RD., ENFIELD, MIDDX., ENGLAND



*A versatile aid  
to research*



The unique Double Beam Tube enables the traces of two related phenomena to be examined simultaneously. Signals are normally fed through the Amplifiers. Calibrated Y1, Y2 and X Shifts give measurement of applied Signal Voltages and Time. The Time Base operates repetitively or by external trigger with positive or negative sync. selection. A Camera Model 1428 may be fitted for photographic recording.

# COSSOR

**MODEL 1035**

*Double Beam*  
**OSCILLOGRAPH**

Enquiries should be addressed to:

**A. C. COSSOR LIMITED, INSTRUMENT DIVISION, HIGHBURY GROVE, LONDON, N.5.**

Telephone: CANonbury 1234

# FOR HIGH-FREQUENCY INSULATION—

*specify*

## 'FREQUELEX'

*Photograph by permission of  
The Marconi Wireless Telegraph  
Co. Ltd., Chelmsford.*

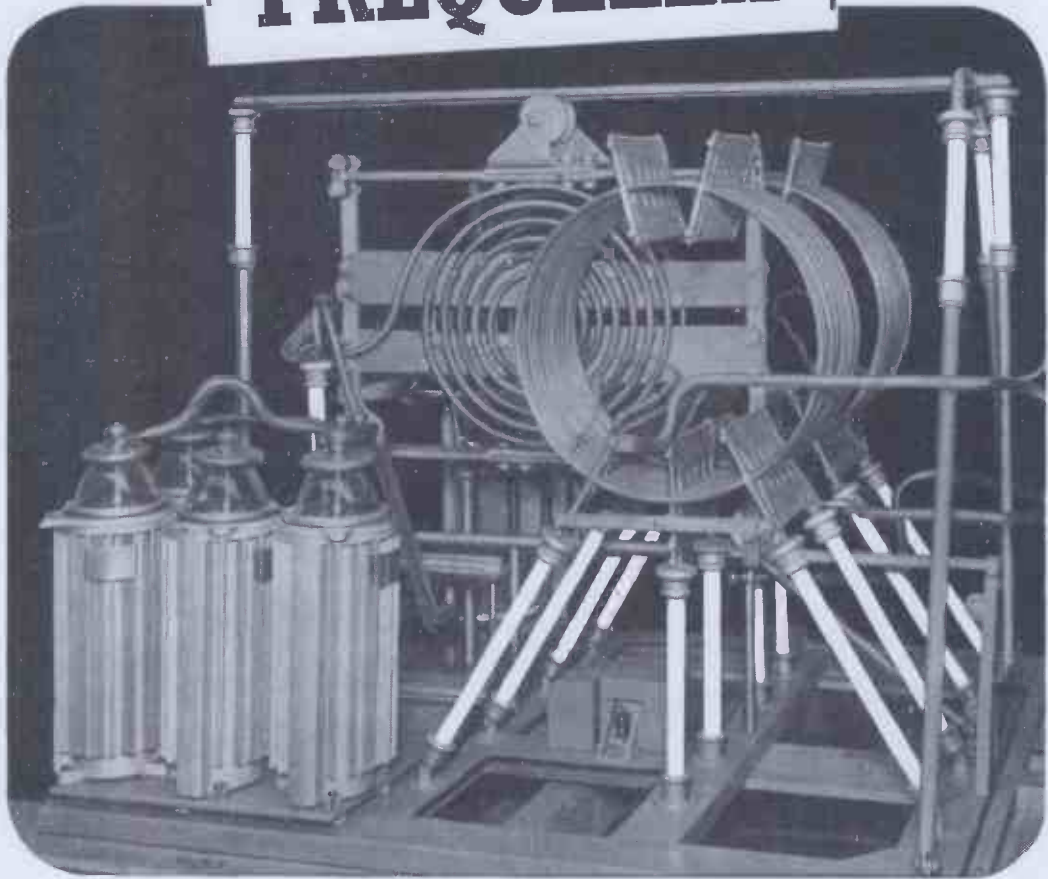

The Inductance shown is supported by our "FREQUELEX" Ceramic Rods and forms part of a 100 k.w. Radio Transmitter.

This is only one of many applications where Rods made to close limits are required.

We specialise in the manufacture of Ceramic Rods and Tubes of various sections in several classes of materials over wide dimensional ranges.

*The Principal Materials Are:—*

1. Porcelain for general insulation.
2. Frequelex for High Frequency Insulation.
3. Permalax and Templex for Capacitors.

The degree of accuracy depends on the size of the Rod or Tube, but the standard degree of accuracy is outlined in the Inter-Service Component Manufacturer's Council — Panel R Specification embodied in our Catalogue of Radio Frequency Ceramics, copy of which will be sent on request.

Large Rods up to 44" long and 1¼" square are used as supports for Tuning Coils, etc.

*We shall be pleased to have your enquiries for all sizes of Tubes and Rods. Prompt deliveries can be given for most sizes.*



# Bullers

## LOW LOSS CERAMICS

BULLERS LIMITED, 6 Laurence Pountney Hill, E.C.4. Phone: MANsion House 9971 (3 lines). Grams: 'Bullers, Cannon, London'

# INSIDE INFORMATION

*about the switch that is superior*

We agree that there are cheaper 3 amp. toggle switches than the Cutler-Hammer types made by British N.S.F. — but there are none better. If super-reliability is the yardstick by which you choose a switch then this is the switch for you.

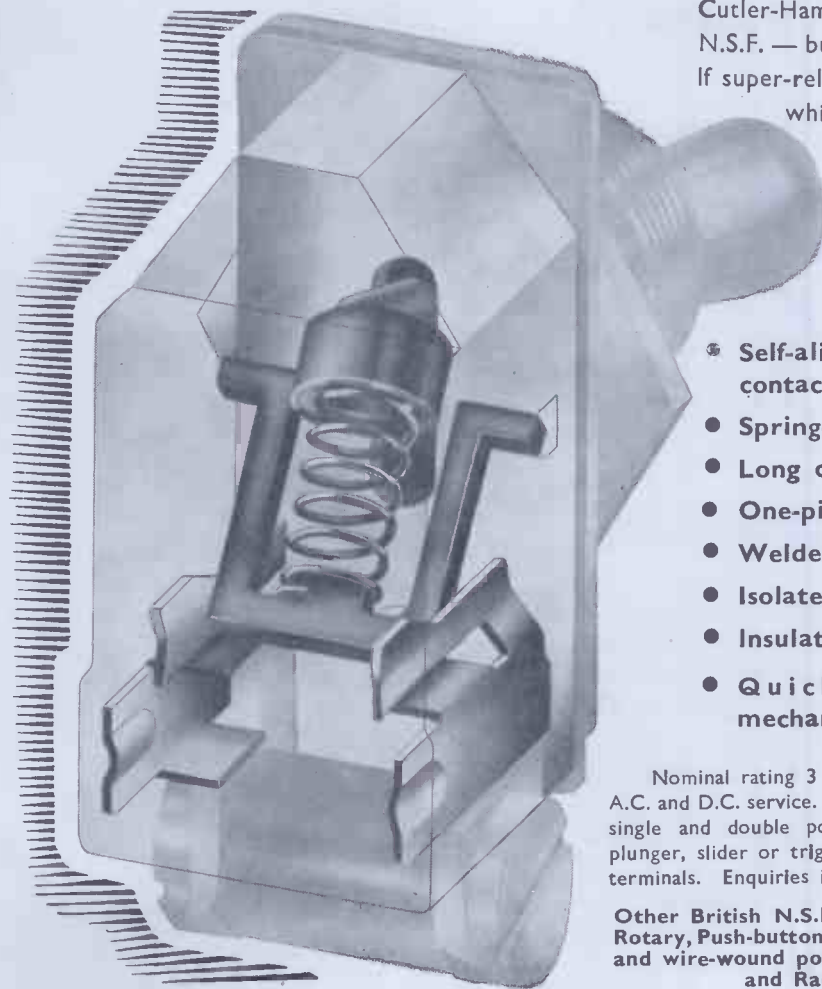

## NOTE THESE C-H FEATURES

- Self-aligning "wiping" moving contact.
- Spring-leaf fixed contacts.
- Long coil spring.
- One-piece moulded case.
- Welded terminal plates.
- Isolated toggle lever.
- Insulated terminal bridge.
- Quick make and break mechanism.

Nominal rating 3 amps. 250 volts—suitable for A.C. and D.C. service. Available in a wide range of single and double pole types operated by lever, plunger, slider or trigger, with screw or solder-lug terminals. Enquiries invited.

Other British N.S.F. Products include: 'OAK' Rotary, Push-button and Slider switches; Carbon and wire-wound potentiometers for Television and Radio applications.



**BRITISH N.S.F. CO. LTD**  
**KEIGHLEY YORKS**

Phone: Keighley 4221/5. Grams: ENESEF, Keighley.

LONDON OFFICE: 9 Stratford Place, W.8. Phone: Mayfair 4234.

Licenses of Igranic Electric Co. Ltd. for the above products of Cutler-Hammer Inc., Milwaukee, U.S.A.

## NO ORCHARDS FOR MISS APHIS...

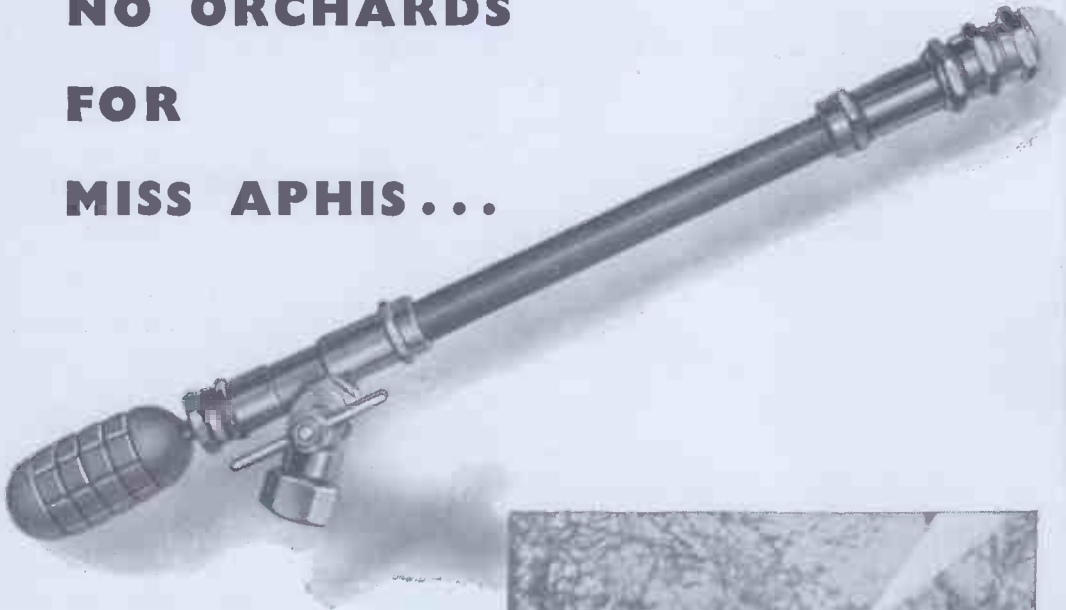

Photograph shows a "Noblox" Spray Gun fitted with a Tufnol barrel, (used for spraying fruit trees.) Tufnol is unaffected by insecticide fluids and it is light and easy to handle.

There are no flies on the British farmer when it comes to Tufnol. Whether he is waging chemical warfare on arboreal pests or confronted with the very real problems of mechanised agriculture, he finds that Tufnol stands up to the searching tests of chemical corrosion, atmospheric exposure, and grinding wear.

This, our oldest industry, is among the latest recruits to the ranks of Tufnol users who finds in its unique qualities of electrical insulation, its resistance to chemical action, its shear, tensile, and compressive strengths, a lightweight material which combines the virtues of metal and hardwood, whilst avoiding their many disadvantages.

Tufnol is supplied in sheets, rods, tubes, bars, angles and channels, or in specially moulded shapes. It can be quickly, easily, and accurately machined in your own workshops.

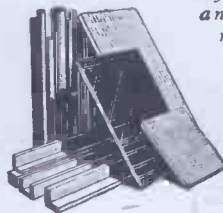

### HAVE YOU A PROBLEM THAT TUFNOL CAN SOLVE?

*Its solution may lie in the extensive data already collected in various Tufnol publications—or it may be an entirely NEW proposition, a challenge which our Technical Staff will accept with enthusiasm, and on which they will report helpfully and objectively. Why not write us TODAY?*

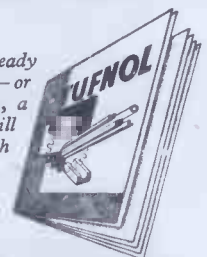

# TUFNOL

REGISTERED TRADE MARK

An ELLISON Product

TUFNOL LTD • PERRY BARR • BIRMINGHAM • 22 B

*Specialists in*

HIGH SENSITIVITY  
D.C. COUPLED  
OSCILLOSCOPES  
AND VALVE VOLTMETERS

Type 1684D  
DC - 3 M/cs 21 mV/cm  
DC - 1 M/cs 7 mV/cm



ask

*Furzehill*

first

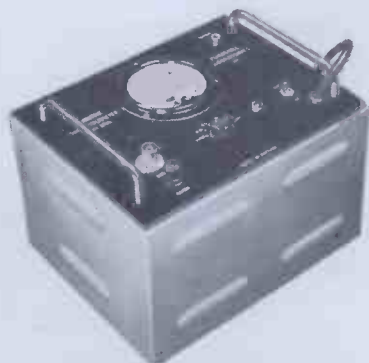

Type 378B/2  
1mV to 100V  
10 c/s to 500 Kc/s

Please send for literature

FURZEHILL LABORATORIES, LTD  
BOREHAM WOOD, HERTS, ENGLAND

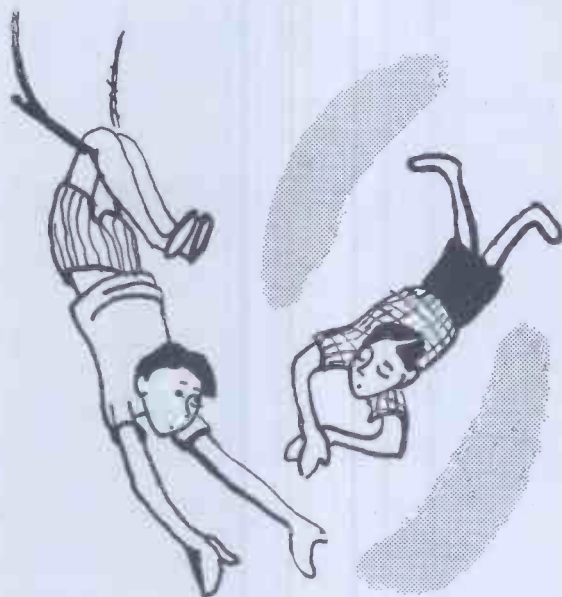

**confidence** *is a fine thing...*

. . . . for the manufacturer of Electronic Equipment, no less than for the trapeze artist (the results may be less spectacular but they make far more effective balance sheets!).

Parmeko Transformers are produced by specialised production on single-purpose plant, and for 20-odd years have inspired confidence in Great Britain's manufacturers of Electronic and Electrical Equipment.

**PARMEKO** *of* **LEICESTER**

Makers of Transformers for the Electronic and Electrical Industries.

# Suppress E.H.T. radiation

SIMPLY EFFECTIVELY ECONOMICALLY

with **'dag'** COLLOIDAL GRAPHITE

A quick-drying conducting paint of 'dag' colloidal graphite applied by brush to the inside of a television cabinet effectively suppresses radiation from the E.H.T. valve, the line transformer and their associated circuits.

A radio receiver can be satisfactorily operated on the long waveband *within a few feet* of a television receiver thus treated.

**SEND FOR DETAILS**

To: **ACHESON COLLOIDS LIMITED**  
18 PALL MALL, LONDON, S.W.1.

Please supply full technical information concerning the treatment of television cabinets with 'dag' dispersion 479.

NAME .....

ADDRESS .....

.....  
.....



D/18

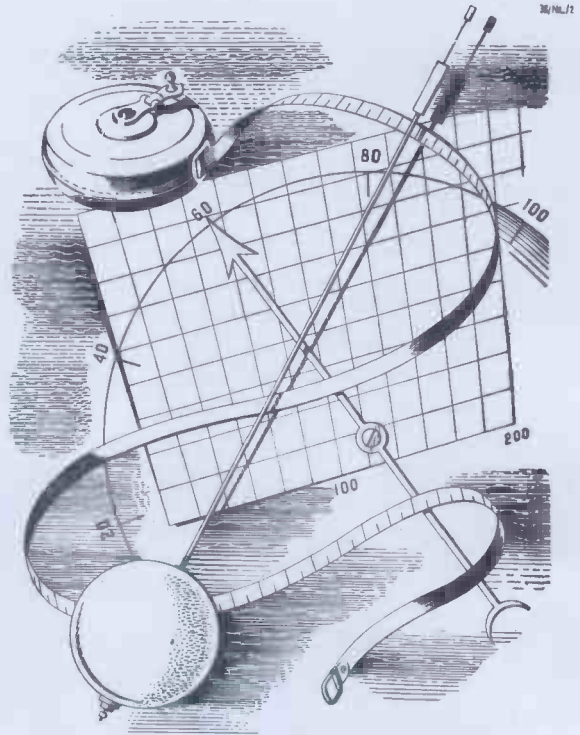

## NILO 36

This grade of nickel-iron alloy has a coefficient of thermal expansion which, at atmospheric temperatures, approaches zero. For this reason Nilo 36 is widely used for parts where constant dimensions with changing temperature are essential, as in clock pendulums, measuring tapes and gauges and instrument details. Properties of the range of nickel-iron alloys are described in our publication—“The Nilo Series of Low-Expansion Alloys.”

Write for a free copy.

NILO is a registered trade-mark

**HENRY WIGGIN & COMPANY LTD**

Wiggin Street, Birmingham 16



**WHEN IT'S A  
QUESTION OF  
CAPACITY...**

or rather, the accurate measurement of capacity, we think we can help you.

**The "CINTEL" WIDE RANGE CAPACITANCE BRIDGE**

enables capacitance in the range 0.3 picofarads to 100 microfarads to be measured to an accuracy within  $\pm 1\%$ . Capacitance can be measured *in situ* and resistance in the range 1 ohm to 30,000 Megohms can also be measured. For further technical details please write for leaflet No. CBI/1.



**CINEMA - TELEVISION LIMITED**

A Company within the J. Arthur Rank Organisation

**FOREMOST IN THE MANUFACTURE OF**

- Counters & Chronometers • Metal Detectors • Oscilloscopes • Photo-Electric Cells • Cathode Ray Tubes • Geiger-Muller Tubes • Electronic Instruments

**WORSLEY BRIDGE ROAD · LONDON · S·E·26**

**Telephone: H1Ther Green 4600**

Northern Agents:  
**F. C. ROBINSON & PARTNERS LTD.**  
287 Deansgate, Manchester 3

Scottish Agents:  
**ATKINS, ROBERTSON & WHITEFORD LTD**  
100 Torrissdale Street, Glasgow, S.2



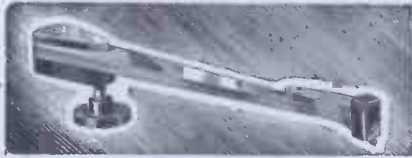

## “HIGH FIDELITY” REPRODUCTION

To the scientific mind, the phrase “high fidelity” as applied to acoustic reproduction has a much more precise meaning than it has for the layman who has not the expert’s advantage of acoustic measuring devices. It was with full appreciation of the expert’s point of view that the ACOS “G.P.20” Pick-up was given the description “high fidelity.” The G.P.20 is the most complete answer yet made to those purists looking for high fidelity in a commercially available pick-up. The G.P.20 has an automatic bass-boost which eliminates the need for equalising components, and an output up to 20 times greater than lightweight magnetic types. A needle pressure of only 12-14 grams, and a flexible stylus mounting prolong the life of the stylus to at least 2,000 playings. These features, added to a non-hygroscopic and unbreakable crystal element, make the G.P.20 unique among reasonably priced pick-ups.

## “LONG PLAYING” RECORDS

A further great advantage of the G.P.20, and typical of the ACOS long term approach to design, is that two interchangeable heads are available—one for standard records and the other for long playing records (exerting a needle pressure of only 6-7 grams). It would be a reasonable prophecy that long playing records will eventually oust the standard type altogether; in the meantime the owner of a G.P.20 Pick-up can have the best of both worlds.



COSMOCORD LTD., ENFIELD, MIDDLESEX

# S.E.M 2 speed GRAMOPHONE MOTORS for the new long playing records

S.E.M Gramophone motors can, by simple finger-tip control, be used both for the normal playing record and the new long-playing record of lower r.p.m.

The S.E.M motor is a 2 speed type—78 r.p.m. and  $33\frac{1}{3}$  r.p.m. for use on standard A.C. voltages and frequencies. Designed and built with a background of more than 35 years’ experience in the manufacture of small electric motors, the S.E.M gramophone motor will meet the requirements of the most discriminating manufacturer.

SMALL ELECTRIC  
MOTORS LTD

BECKENHAM KENT

Phone : Beckenham 006t & 112





# PHOTO-ELECTRIC RELAY

for "ON" or "OFF"  
control of  
ELECTRIC POWER

The standard relay is extremely sensitive and responds to the incidence of interruption of a beam of light, the intensity of which may be as low as 1-Foot candle and the duration as short as one-tenth of a second.

*Applications to industrial processes include :—*

Control of temperature, liquid level, lighting, register, dimensions, weighing, counting, etc. ; also alarm devices.

*Delivery from stock*

**ACTUATED  
BY  
LIGHT**

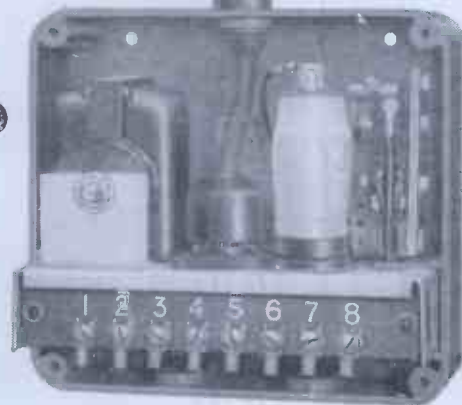

## BRITISH THOMSON-HOUSTON

THE BRITISH THOMSON-HOUSTON COMPANY LIMITED · RUGBY · ENGLAND

A3854



# *Marconi VHF*

## FOR ALL COMMUNICATIONS

In every field of operations where sudden developments call for rapid decisions and efficient communications, Marconi VHF radio has proved its efficiency.

Marconi Mobile VHF Equipment, light, simple to operate and constructed by craftsmen of long experience, is the natural choice of Surveyors, the Press, Police Forces, Fire and Ambulance Services, Airport Authorities, Breakdown Services, Harbour Authorities and similar services all over the world.

# *Marconi MOBILE VHF*

MARCONI'S WIRELESS TELEGRAPH CO. LTD., MARCONI HOUSE, CHELMSFORD, ESSEX

## FOR USERS OF NAGARD TYPE 103 OSCILLOSCOPE

### UNIT CONSTRUCTION

The unit construction enables any one of these amplifiers to be used in the NAGARD Type 103, then providing time and voltage calibration.

They can also be had as self-contained cased or rack-mounted instruments with inputs and outputs to meet specific requirements.



### THREE NEW D.C. AMPLIFIERS

**D.C. to 20 k/cs.**  
GAIN OVER 100,000  
NOISE LEVEL  $5\mu V$ .

**D.C. to 2 Mc/s.**  
GAIN OVER 15,000  
NOISE LEVEL  $60\mu V$ .

**D.C. to 10Mc/s.**  
GAIN OVER 250  
RISE TIME 0.05 $\mu$ secs.

ALL STABLE AND DRIFT FREE

SEE  
what you measure!

**NAGARD**  
LTD

Phone : BRixton 3550  
Grams : Intertel, Claproad, London.

245, BRIXTON ROAD, LONDON, S.W.9



# DAWE TYPE 1400

## SOUND LEVEL METER

gives a direct reading measurement of sound level over the full audible range

*NOW  
Half the Size!  
and Half the Weight!*

but with all the features of the previous model !

For full particulars write to :—



130 UXBRIDGE RD., HANWELL, LONDON, W.7 : EALING 6215

\* Visit S.I.M.A. Exhibition and Symposium 4th to 8th September, 1950



### To be published shortly :—

The first two books of the new "Electronic Engineering" monographs

## 1 VOLTAGE STABILIZERS

By F. A. Benson, M.Eng., A.M.I.E.E., M.I.R.E.

(University of Sheffield)

Price 12/6

## 2 ELECTROPHYSIOLOGICAL TECHNIQUE

By C. J. Dickinson, B.A., B.Sc.

(Magdalen College, Oxford)

Price 12/6

To be followed at intervals by other monographs on the latest techniques and applications in the ever-widening field of electronics

Obtainable from all Booksellers or from :—

# Electronic Engineering

28 ESSEX STREET, STRAND, LONDON, W.C.2.

## — ALL-POWER —

### CONSTANT VOLTAGE LABORATORY SUPPLIES

We can supply Standard, Semi-standard and Special Power Supply Units to meet any requirements. These Units provide an exceptionally constant and stable power source for use in Meter Calibration and Standardizing Laboratories, and for accurate Research work of all types.



#### MODEL 102-A

OUTPUT - - 220-320 VOLTS, 0-250mA.  
 STABILIZATION RATIO- - - > 20,000.  
 INTERNAL RESISTANCE - - < 0.05 OHM.  
 OUTPUT RIPPLE - - - - > 1mV. R.M.S.

**ALL-POWER TRANSFORMERS LTD.**  
 CHERTSEY ROAD, BYFLEET, SURREY.

TEL. BYFLEET 3224, 3225.

### With collar attached or...

Pardon the parallel—but it is homely and intimate. We of DE LA RUE feel that wires for electrical circuits should, like shirts, be adequate to cover the subject, and in the colour of your choice. You can have them "complete with collar" (which is HAMOFIL) or buy the collars separately (that's DELAFLEX).

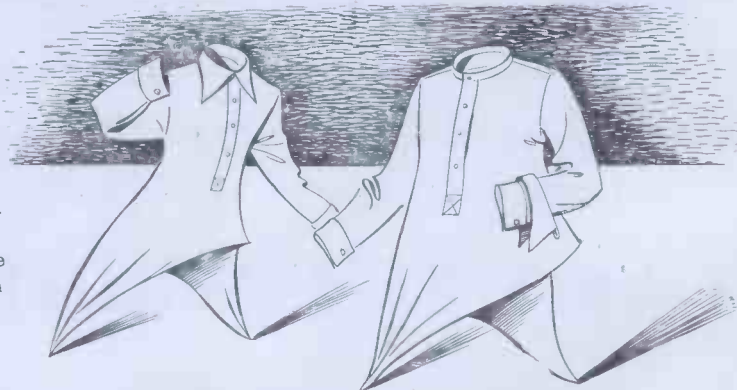

# HAMOFIL DELAFLEX

CONNECTING WIRES INSULATING SLEEVINGS

Materials: P.V.C., RUBBER, and DOUBLE COTTON BRAIDED & WAXED ("push back"). The range includes single and stranded conductors. Available in various colours for coding. P.V.C. and Rubber can be supplied with metal screening.

Materials: VARNISHED COTTON, VARNISHED ART SILK (Rayon), ROLLED SILK, and P.V.C. Internal diameters from 0.5 mm. Available in assorted colours. Varnished cotton and P.V.C. can be supplied with metal screening.

THOMAS **DE LA RUE** & CO. LTD.

(PLASTICS DIVISION), IMPERIAL HOUSE, 84/86 REGENT STREET, LONDON, W.1

'Delaflex' & 'Hamofil' are registered trade names of Thomas De La Rue & Co. Ltd.

*Yours for the asking!*

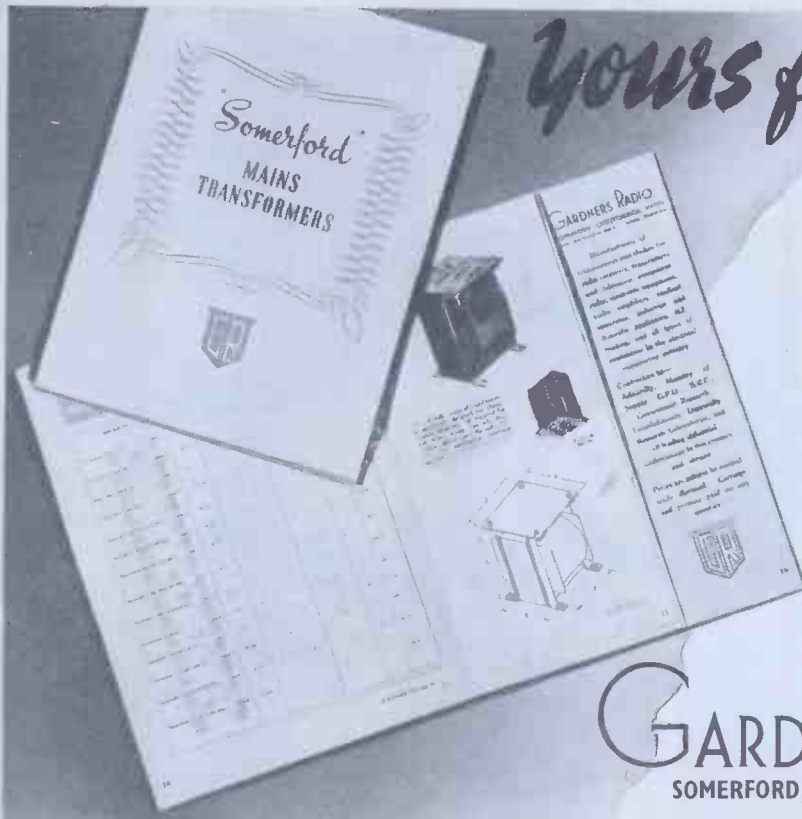

**All you need to know about the "SOMERFORD" range of Mains Transformers**

You are invited to write for this new 28-page booklet. Specifications, dimensions, fixing centres, weight, price, etc., all the information relating to the Somersford Mains Transformers including the Avon, Hengist, and Burley types is contained in this latest publication. You will find it an invaluable work of reference.

Somersford Transformers are designed to meet the standard requirements of the Radio, Television and Electronic Industries.

Obtainable direct from the manufacturers.

**GARDNERS RADIO**  
SOMERFORD, CHRISTCHURCH, HANTS.

Tel.: CHRISTCHURCH 1025.

*For Designers who want more 'ELBOW ROOM'*

**in dealing with VHF and other special apparatus!**

The W99—another Hunt development—settles layout, weight and space problems—and is the first major stride forward in types of capacitors designed to allow the most efficient use to be made of the new miniature valves. In conjunction with these, it will inspire numerous applications in every possible kind of modern, compact and portable electronic, communication and T.V. equipment.

● Technical co-operation with you in the adaptation and application of capacitors of all types to your requirements will be welcomed.

*The ENTIRELY NEW*  
**W99**  
solves problems of space and weight stands up to arduous conditions

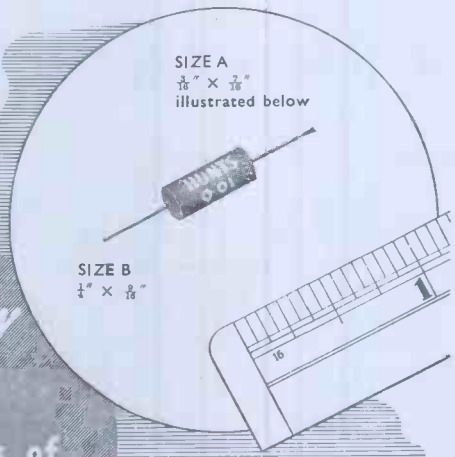

REGISTERED TRADE MARK  
**HUNTS**  
**CAPACITORS**  
THE TRADE MARK OF RELIABILITY

ELECTROLYTICS - MINIATURE, STANDARD & HIGH TEMP TYPES for operation up to 85°C.  
Also METALLISED PAPER - FOIL & PAPER STACKED MICA - SILVERED MICA, ETC., ETC.

**W99 MIDGET MOLDSEAL METALLISED PAPER**  
CAPACITANCE TOLERANCE ± 20% (Closer tolerances are available).  
TEMPERATURE RANGE --40°C. to +71°C.  
INSULATION RESISTANCE Not less than 20,000 megohms.  
SELF-HEALING  
CAPACITANCES up to .04 150 volt D.C.  
.01 350 volt D.C.  
.002 600 volt D.C.  
.002 300 volt A.C.  
For operation up to 100 megacycles per sec.

*Control by*

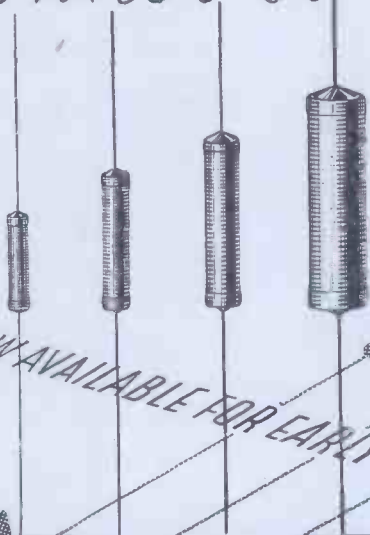

*NOW AVAILABLE FOR EARLY DELIVERY*

Swedish Agents:  
Messrs. Elektrotensilier,  
Rosundavägen 101,  
Stockholm-Solna, Sweden.

PAINTON & CO. LTD · KINGSTHORPE · NORTHAMPTON TELEPHONE 2820

★ *The Basis of*  *World Standards*

## TELCON R.F. CABLES

Technical excellence supported by constant research and an unrivalled knowledge and experience of Radio Frequency Cable applications, ensures the continuance of the lead established by TELCON in this field.

Even before the introduction of Telcothene\* as a cable dielectric, an application pioneered by TELCON, a range of Radio Frequency cables with unique capacity and attenuation characteristics was produced, using Telconax.

Today, developments are still going on and the solution of any problems involving the application of Radio Frequency cables will be found in the wide range manufactured by TELCON.

★ *Telcothene (Regd.)—Polythene processed by Telcon to provide specific characteristics*

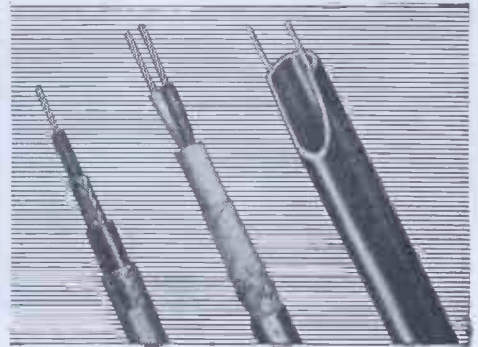

Ask also for details of  
**TELCON METALS**

**THE TELEGRAPH CONSTRUCTION & MAINTENANCE CO. LTD** 

Head Office : 22, Old Broad Street, London, E.C.2. Tel : LONDON Wall 7104  
Enquiries to : Telcon Works, Greenwich, S.E.10. Tel : GREENWICH 3291

*Vortexion*

**TYPE C.P.20A  
AMPLIFIER**

For AC Mains and 12 volt working giving 15 watts output, has switch change-over from AC to DC and "Standby" positions. Consumes only 5½ amperes from 12 volt battery. Fitted with mu-metal shielded microphone transformer for 15 ohm microphone, provision for crystal or moving iron pick-up with tone control for bass and top. Outputs for 7.5 and 15 ohms. Complete in steel case with valves. - - - - - PRICE £28-

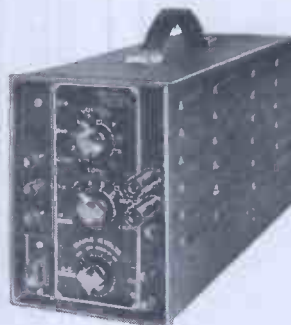

OTHER MODELS IN OUR RANGE OF AMPLIFIERS

"SUPER-FIFTY WATT" - - - - - PRICE 36½ gns.

"THIRTY WATT" - - - - - " 30½ gns.

"10-15 WATT RECORD REPRODUCER" - - - - -  
PRICE 25½ gns.

These are fitted in well ventilated steel cases with recessed controls, as illustrated.

EXPORT ENQUIRIES INVITED

**VORTEXION LIMITED**

257-261 THE BROADWAY, WIMBLEDON, LONDON, S.W.19

Telephone: LIB 2814 and 6242-3

Telegrams: "Vortexion Wimble, London."

*Ceramic stand-off Insulators*

by  
**UIC**

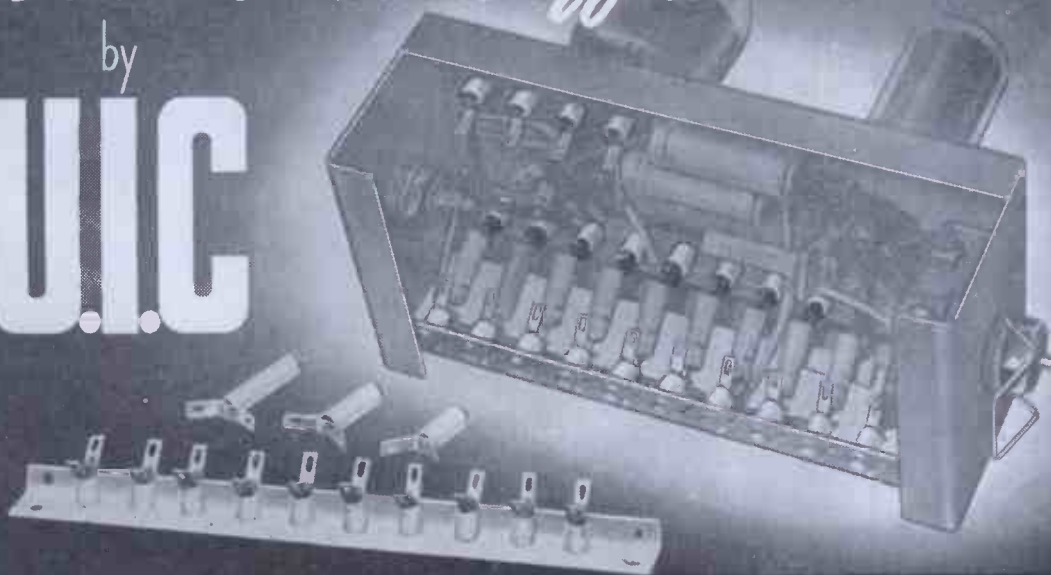

UNITED INSULATOR CO. LTD. OAKCROFT RD. TOLWORTH · SURBITON · SURREY  
TELEPHONE: ELMBRIDGE 5241 CABLES: CALANEL, SURBITON

# Video Oscillator

Type. O.222 7 Kc/s - 8 Mc/s

Amplitude range of adjustment  $+10\text{db}$  to  $-55\text{db}$  on 1 volt peak to peak, adjustable— $0.5\text{db}$  steps. Amplitude constant to  $\pm 0.2\text{db}$  at any frequency setting. Harmonic content better than 50 db below fundamental—output impedance 75 ohms  $\pm 5\%$ .

The instrument is built to meet a specification of the Design Department of the B.B.C. It can be mounted to a standard G.P.O. 19" rack or alternatively is supplied with a light transportable case as illustrated.

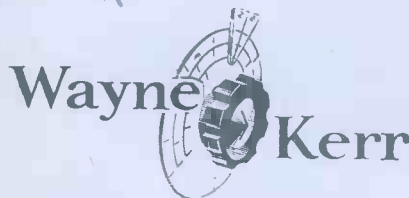

THE WAYNE KERR LABORATORIES LIMITED  
NEW MALDEN, SURREY, PHONE: MALDEN 2202.

*Handwritten notes:* 12.2.50, A. POTTER, HYDE, 0703-843205



# VALVE VOLTMETERS

The Airmec Valve Voltmeter, Type 712, provides another example of the advanced technical design which is a characteristic of all Airmec instruments.

The use of balanced circuits ensures a degree of stability hitherto unknown in this type of instrument, and enables the meter zero to remain constant on all ranges over considerable periods of time and under conditions of widely fluctuating mains voltage.

A low capacity, high impedance probe enables measurements of balanced, unbalanced and differential voltages to be made over the frequency range of 30 c/s - 200 Mc/s. Both positive and negative direct voltages to earth may be measured, and also resistances up to 100 megohms.

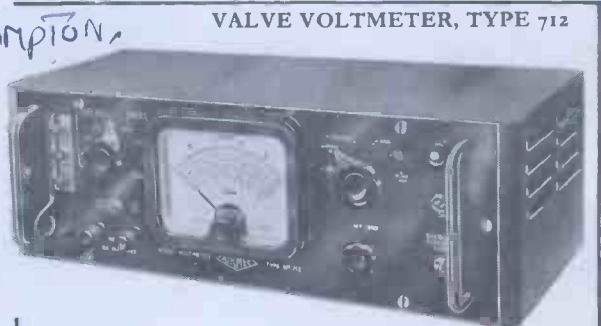

**Alternating Voltage Ranges**

0-1.5V, 0-5V, 0-15V, 0-50V, 0-150V, balanced, unbalanced or differential.

**Direct Voltage Ranges**

0-5V, 0-50V, 0-500V.

**Resistance Ranges**

0-100 megohms in 6 stages.

**Frequency Range**

30 c/s-200 Mc/s.

**Accuracy**

$\pm 2\%$  of F.S.D. above 5 volts A.C., and  $\pm 5\%$  of F.S.D. for D.C. and ranges below 5 volts A.C.

**Input Impedance**

At a frequency of 1 Mc the input impedance from the High terminal to the Low and Earth terminals strapped is 1.3 megohms in parallel with 5 pF. The D.C. input resistance is 38.7 megohms.



## AIRMEC LABORATORIES LTD

HIGH WYCOMBE · BUCKINGHAMSHIRE · ENGLAND

TEL: HIGH WYCOMBE 2000

CABLES: COMMLABS HIGH WYCOMBE

DESIGNERS AND MANUFACTURERS OF SCIENTIFIC AND INDUSTRIAL ELECTRONIC EQUIPMENT

A.C. (A) 2





**one step ahead!**

Our experience in the manufacture of toroidal-wound resistors goes back such a long way that we are confident of always maintaining the lead in design and efficiency. As the pioneers of this type of unit in this country, we can offer our customers a product which is the result of long research and practical experience, and we are also able to supply more alternative arrangements than any of our competitors.



**TOROIDAL WOUND POTENTIOMETERS**

BRITISH ELECTRIC RESISTANCE CO. LTD., Queensway, Ponders End, Middlesex  
BR4013—EHI Telephone: Howard 1492. Telegrams: Vitrohm, Enfield

## NOT JUST A FEW BARS BUT A COMPLETE INTERLACED PATTERN!

**T**HERE are cheaper Pattern Generators than the Murphy T.P.G. 11 but their performance is limited. You pay more for the Murphy because it gives you the first essential—THE COMPLETE SYNCHRONISING WAVEFORM AS USED IN THE B.B.C. TRANSMISSION — *necessary* for the correct alignment of Television receivers.

Far better to pay the extra cost and have a Murphy T.P.G. 11 with a pattern which checks **EVERYTHING** rather than a cheaper unit which gives an over-simplified pattern with many deficiencies. The Murphy is cheaper in the end—and a lot more satisfactory

★ *In one large firm of Television Service Engineers, the introduction of the Murphy T.P.G. 11 enabled the time taken on diagnosis repair and re-alignment to be cut by half!*

**THERE IS NO SUBSTITUTE FOR THE  
MURPHY TV  
PATTERN GENERATOR  
(TPG II)**

# F. LIVINGSTON HOGG

SPECIALIST IN HIGH-GRADE INSTRUMENTS FOR THE COMMUNICATIONS INDUSTRY  
**65 BARNBURY STREET, LONDON, N.I.**

For further details and appointments for demonstrations Telephone TUDor 5277

# TUSKITE



The Name to remember for . . .

**BOBBINS, FORMERS,  
TUBES & SHROUDS**

Your enquiries will receive our immediate attention

**ARMAND TAYLOR & CO. LTD.**

TUSKITE WORKS, MARSH ROAD, PITSEA, ESSEX

Telephone: VANGE 2167

**a good  
saver  
is a good  
worker**

**Have YOU got  
a staff savings group?**

Starting a Staff Savings Group is a simple process. All the information, equipment and publicity material you require will be gladly sent free of charge on application to your Local Savings Committee or to the National Savings Committee,

1-5 Prince's Gate, London, S.W.7.

Issued by the National Savings Committee

## Scophony BAIRD

**TRANSFORMERS & CHOKES**

designed and manufactured to  
suit your specific needs

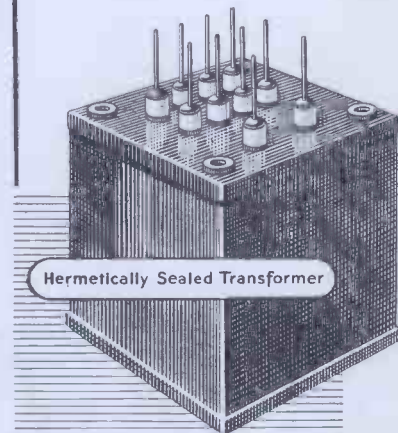

Hermetically Sealed Transformer

HERMETICALLY  
SEALED TYPES  
-up to 1 KVA.

DOUBLE and  
AUTO-WOUND  
OIL/AIR  
COOLED TYPES  
-up to 50 KVA.  
(Single or 3-phase)

Send your next enquiry to:-  
**SCOPHONY-BAIRD LTD.**, (Division 6), WELLS, SOMERSET.  
Telephone: WELLS 2081-5.

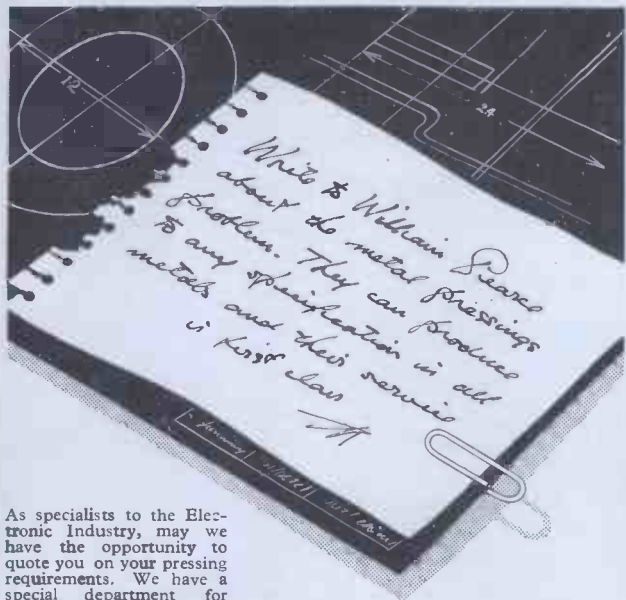

As specialists to the Electronic Industry, may we have the opportunity to quote you on your pressing requirements. We have a special department for enamel finishing to order.

**WILLIAM PEARCE**  
*(Pressings)* LTD.  
ORMOND STREET, BIRMINGHAM, 19

**Permanent Magnets**

CAST OR FORGED  
IN  
LATEST TYPE  
MAGNETIC  
MATERIALS  
BY

**DARWIN'S LTD**  
TINSLEY SHEFFIELD. 9.

D.18

# WEBB'S RADIO

## FOR "LONG-PLAYING" GRAMOPHONE EQUIPMENT

Call and hear 33 $\frac{1}{3}$  r.p.m. apparatus at Webb's, giving high-fidelity reproduction with almost non-existent surface noise — a revelation in general realism.

**CONNOISSEUR DUAL-SPEED MOTOR**  
A precision made mechanism, giving either 78 or 33 $\frac{1}{3}$  r.p.m. at the turn of a switch. A.C. operated 200/250 volts ... £13 15 0  
Purchase Tax £5 19 2

**CONNOISSEUR "SUPER LIGHTWEIGHT" PICK-UP** has three interchangeable heads for Standard, Microgroove and older standard recordings. Low downward pressure of 10/12 grams for standard recordings, and 5/7 grams for microgroove.  
Price of Pick-up with one head ... £4 0 0  
Purchase Tax £1 14 8  
Extra heads cost each £2 10 0  
Purchase Tax £1 1 8  
Transformer 15 0

**"COSMOCORD GP. 20" PICK-UP**  
A high fidelity crystal pick-up taking interchangeable heads for standard and microgroove work. Output 0.5 volts at 1,000 c.p.s. Permanent sapphire. Has automatic bass boost allowing direct fitment to domestic radio. Price with one head ... £2 10 0  
Purchase Tax £1 1 5

Alternative head, standard or microgroove, costs

£1 10 od. plus 13s 4d. Purchase Tax. Pressure automatically adjusted by changing the head, being 12/14 grams for standard, and 6/10 grams for microgroove.

**DECCA "3378" DUAL-SPEED HIGH FIDELITY PLAYING DESK**

Built in strong wood case, covered leather cloth with carrying handle. Size 15 $\frac{1}{2}$  x 13 $\frac{1}{2}$  x 6 $\frac{1}{2}$  in. high. Robust constant speed induction motor giving both 33 $\frac{1}{3}$  and 78 r.p.m.

Two interchangeable 3-pin plug-in pick-up heads with sapphire styli: for 33 $\frac{1}{3}$  and 78 r.p.m. records. Difference in weight of heads provides automatic weight compensation. Spring balanced arm. Price ... £11 14 5  
Plus Purchase Tax £5 1 7

**DECCA "33A" OPEN TYPE PLAYING DESK**  
Robust, constant speed 33 $\frac{1}{3}$  r.p.m. motor, rubber covered turntable. Lightweight pick-up with spring balanced plastic arm, replaceable crystal

capsule with sapphire stylus. Price £6 4 2  
Plus Purchase Tax £2 13 10

**DECCA "33B" PLAYING DESK WITH LID**  
Same specification as "33A" for motor and pick-up. Fitted in leather cloth covered wood case with lid. Price £8 8 6  
Plus Purchase Tax £3 13 0

**DECCA "33C" PLAYING DESK WITH LID**  
As model "33B" but fitted with "Decca fir" lightweight pick-up, either type "C" 850 ohms impedance, or type "D" 4,200 ohms impedance. Price £8 8 6  
Plus Purchase Tax £3 13 0

**DECCA "LONG-PLAYING" HEADS**  
for fitment to existing standard type "Decca fir" pick-ups. Supplied with a compensating counterweight. Type "C" 850 ohms, and type "D" 4,200 ohms. Both types. Price £2 8 0  
Plus Purchase Tax £1 0 11

**WEBB'S Radio**

14 SOHO STREET, OXFORD STREET,  
LONDON, W.1. Phone: GERrard 2089

Shop Hours 9 a.m.—5.30 p.m. Sats. 9 a.m.—1 p.m.

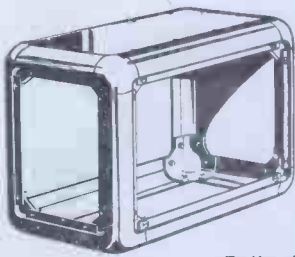

**Widney-**  
REGD. **DORLEG**  
**CABINET SYSTEM**

Fully illustrated and dimensioned lists are available on request of this prefabricated method of building practical cabinets without elaborate tools. The system is now available in two gauges\* and proving more popular than ever.

\* "Standard" gauge  
Outside Radius  $1\frac{3}{16}$ "  
(List R2)

"Small gauge" Outside  
Radius  $\frac{3}{8}$ " (List R3).

Technical & Sales Agent  
**C. H. DAVIS**  
Dept. A

59 BROMPTON RD.,  
LONDON, S.W.3  
Telephone: KEN. 4201



MANUFACTURERS

**HALLAM, SLEIGH & CHESTON LTD**  
WIDNEY WORKS, BIRMINGHAM 4

Phone: Aston Cross 0914 (4 Lines) • Grams Superfine, Birmingham 4

## THE BRITISH NATIONAL RADIO SCHOOL

ESTD. 1940

Now in our eleventh year and still—

### NO B.N.R.S. STUDENT HAS EVER FAILED

to pass his examination(s) after completing our appropriate study course. Nothing succeeds like SUCCESS and what we have done already for so many of your colleagues, we can do again for YOU.

All our courses are conducted by correspondence, on INDIVIDUAL lines and our Syllabus includes:

A.M.I.E.E. (in approved cases); M.Brit.I.R.E.; City and Guilds, Radio Telecommunications, Mathematics; P.M.G. (theory only) examination courses; also what we believe to be the finest RADAR course available anywhere.

Free Booklet and specimen lessons (please mention this advt.) from

STUDIES DIRECTOR

**BRITISH NATIONAL RADIO SCHOOL**

66 ADDISCOMBE ROAD, CROYDON

Phone Addiscombe 3341

## An essential component unique in this country

B9

Seamless, one-piece, metal bellows combining the properties of a compression spring capable of repeated flexing, a packless gland, and a container which can be hermetically sealed. Hydraulically formed by a process unique in this country, they are tough, resilient, with a uniformity of life, performance and reliability unobtainable by any other method.

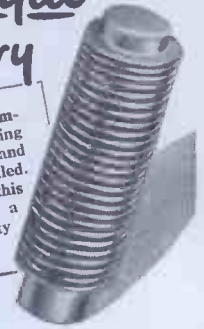

**FOR:** Automatic coolant regulation. Movement for pressure change. Packless gland to seal spindle in high vacua. Reservoir to accept liquid expansion. Dashpot or delay device. Barometric measurement or control. Pressurised couplings where vibration or movement is present. Dust seal to prevent ingress of dirt. Pressure reducing valves. Hydraulic transmission. Distance thermostatic control. Low torque flexible coupling. Pressure sealed rocking movement. Pressurised rotating shaft seals. Aircraft pressurised cabin control. Refrigeration expansion valves. Thermostatic Steam Traps. Pressure amplifiers. Differential pressure measurements. Thermostatic operation of louvre or damper.

Write for List No. V 800-x.

## Drayton 'Hydroflex' METAL BELLOWS

Drayton Regulator & Instrument Co. Ltd., West Drayton, Mdx. • W. Drayton 2611

## Here's the Master POCKET Set!

### THE TRIMMER KIT

which no  
Amateur or Profes-  
sional Radio or Television Engineer can  
afford to be without. Contains:

- I End Trimmer.
- I Side Trimmer.
- I Yaxley Switch Contact Adjuster.
- I Low Capacity Trimmer.
- I Screwdriver.
- I Set of Feeler Gauges.
- I Set of six Box Spanners from I to 8 B.A.
- I Set of four Spanners from 0 to 8 B.A.

Order from— In durable black crackle finish metal case.  
**J. & S. NEWMAN LTD.** 100 Hampstead Rd., N.W.1  
Tel.: Euston 5176



**25/6**  
POST  
FREE

## The VALRADIO Heavy Duty Converter

(Famous since 1937)

Will supply A.C. at standard voltages for numerous applications from D.C. supply voltage ranging from 6-250 volts with wattage outputs from 30-300 watts. Frequency stability  $\frac{1}{2}$  of 1% at 50, 60 or 75 cycles per sec.

Let us bring to your notice a few listed by us in popular demand, others can be considered on receipt of specification. All hereunder incorporate Radio and Low Frequency suppression from interference.

Type	DC Input	AC Output	Wattage Load	Price
230/300-A	200-250 V	200-250 V	220-300	£16- 0-0
230/300/110-A	100-120 V	200-250 V	150-300	£16- 0-0
230/200-A	200-250 V	200-250 V	100-200	£14- 0-0
230/100/110-A	100-120 V	200-250 V	100-200	£14- 0-0
230/200/50-A	50 V	200-250 V	100-200	£16- 0-0
230/110-A	180-270 V	200-250 V	60-110	£10-15-0

Also similar types available to operate from D.C. input voltages of 6, 12, 24, 32 and to order.

All above prices advanced 10% from 1st July 1950.

Literature and terms of business on request to :

**VALRADIO LIMITED**

57, FORTRESS ROAD, LONDON, N.W.5.

Phone : GULiver 5165

## HIGH VOLTAGE SUPPLIES



Model S4/50 Breakdown Tester

- Continuously variable 2-30 KV
- Positive or Negative output
- Available stabilised or unstabilised for breakdown testing
- Input A.C. 115-250 volts, 40-100 cycles

A complete range of Radio Frequency high voltage equipment is available from 2 to 50 KV at 1 mA

**HAZLEHURST DESIGNS LTD.,**  
34a, Pottery Lane, London, W.11.

PARK 6955

**HIVAC**  
THE SCIENTIFIC  
VALVE  
BRITISH MADE

*Pioneers and specialists  
in Small Valves*

SUBMINIATURES  
MINIATURES  
MIDGETS  
GAS TRIODES  
ELECTROMETERS

COLD CATHODE  
TUBES

**HIVAC LTD**

GREENHILL CRESCENT, HARROW-ON-THE-HILL, MIDDX

Telephone : HARrow 2655

## ★ Antenna Theory and Design

By H. Paul Williams, Ph.D., A.M.I.E.E., Sen. M.I.R.E. This important two-volume work gives a complete account of the theoretical basis of antenna design followed by comprehensive guidance on the practical aspects of this work. Both volumes are profusely illustrated.

Vol. I

FOUNDATIONS OF ANTENNA THEORY

142 pages. 21/- net.

Vol. II

THE ELECTRICAL DESIGN OF ANTENNAE

522 pages. 63/- net.

**Pitman**

Parker Street, Kingsway, London, W.C.2

## AMBITIOUS ENGINEERS

### IMPORTANT GUIDE TO SUCCESSFUL ENGINEERING CAREERS



After months of intensive effort, we are pleased to announce that the new edition of our 176-page Handbook, "ENGINEERING OPPORTUNITIES," is now ready for free distribution.

This book is, beyond argument, the finest and most complete Handbook on Successful Electrical Engineering Careers ever compiled. It should be on the bookshelf of every person interested in any phase of Electrical Engineering, whatever his age, position or experience.

This book shows, among other intensely interesting matter, the easiest way of passing B.S.C., A.M. Brit. I.R.E., CITY AND GUILDS, G.P.O., and every other important technical examination, whilst details are given of over 200 Courses in all branches of Engineering. The Electrical Group of Courses includes: Neon Lighting, Power House Design, Radio, Television, Alternating Current, Sound Film Projection, Mains Engineering, Measuring Instruments, Electrical Design, Electricity Supply, Electronic Engineering, General Electrical Engineering, Electrical Installations.

The Handbook also explains the unique advantages of our Employment Dept.

**We Guarantee "NO PASS—NO FEE"**

If you wish to become Technically Qualified you cannot afford to miss reading "ENGINEERING OPPORTUNITIES." In your own interests send for your copy of this enlightening guide to well-paid posts NOW—FREE and post-free. Do not neglect this opportunity of investigating the possibilities within your reach.

BRITISH INSTITUTE OF ENGINEERING TECHNOLOGY  
337B, Shakespeare House,  
17-19 Stratford Place, Oxford St., **BIET**  
London, W.1

# The "ALL METAL WAY" 6d per copy post free

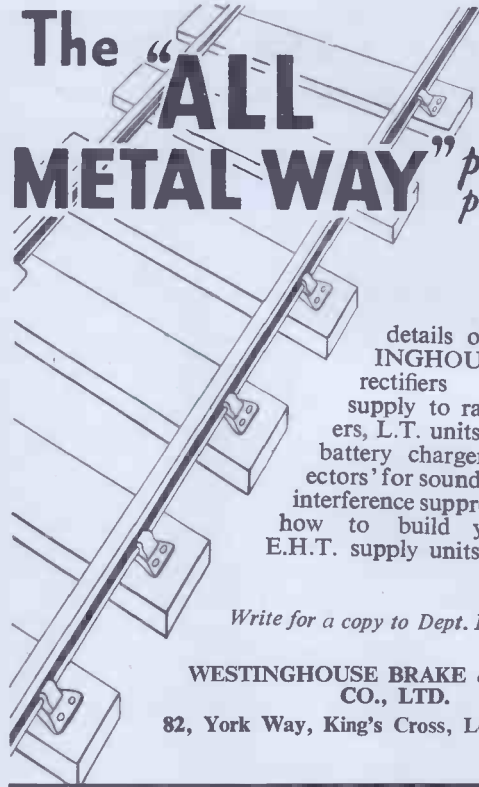

for

details of 'WESTINGHOUSE' metal rectifiers for H.T. supply to radio receivers, L.T. units for small battery chargers, 'Westectors' for sound and vision interference suppression, and how to build your own E.H.T. supply units.

Write for a copy to Dept. Elec. E.8

WESTINGHOUSE BRAKE & SIGNAL CO., LTD.

82, York Way, King's Cross, London, N.1.

## JUST PUBLISHED

The First published design  
for B.B.C. F.M. Reception

# A HOME BUILT FREQUENCY MODULATED RECEIVER

By K. R. STURLEY, Ph.D., M.I.E.E.

Contains full details and wiring diagrams for the construction of a frequency-modulated receiver for reception of the B.B.C.'s new high-fidelity F.M. transmitter at Wrotham (Kent). Included in the booklet is a design for a suitable aerial system and a simple modulated test oscillator for alignment of the I.F. stages.

Obtainable from:—

**ELECTRONIC ENGINEERING**

28 ESSEX STREET, STRAND, LONDON, W.C.2

Price **4/6d.**

Post Free 4/9d.



**MECHANO-ELECTRONIC TRANSDUCER**  
TYPE — 5734

An unique triode valve with a movable element which translates mechanical motion into electrical current variations. Its high sensitivity and wide frequency response render it invaluable as an aid to the measurement of displacement and vibration in all branches of Engineering, Medicine and Physics.

SOME FEATURES :

- Sensitivity 40 volts/degree of deflection.
- Frequency 0 to 12,000 c.p.s.
- Weight 1/16 of an ounce.
- Size 1.3 in. long by 0.33 in. dia.
- Envelope Metal Shell.

This transducer is but one of a wide range of special purpose valves and electronic products produced by RCA on which information will gladly be supplied upon request.

WRITE TO THE ENGINEERING AND SERVICE DIVISION

**RCA PHOTOPHONE LTD.**

AN ASSOCIATE COMPANY OF THE RADIO CORPORATION OF AMERICA  
36 WOODSTOCK GROVE, LONDON W.12.  
Telephone: SHE 1200

**RATCHET AND REVOLUTION COUNTERS**

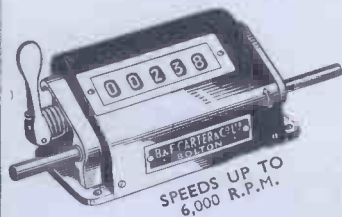

PLEASE SEND FOR LEAFLET NO. 18/6 SHOWING FULL RANGE OF 'ALBION' PRECISION COUNTERS

MEMBERS OF THE BESTEC ORGANISATION

SOLE MAKERS AND PATENTEES :

**B. & F. CARTER & CO. LTD., BOLTON, N.3.**

SPEEDS UP TO 6,000 R.P.M.

**SURPLUS VALVES GUARANTEED**

ILN5.	6/3.	6J7M.	4/9.	43.	6/3.	EF39.	5/6.
IS4.	6/-.	6K7.	4/9.	78.	6/3.	EB34.	5/-.
5Z4M.	4/9.	6K8.	5/9.	807.	5/6.	EF50.	7/-.
5Y3G.	6/3.	6L6C.	8/6.	2X2.	4/9.	EK32.	4/-.
5U4G.	5/-.	6L6M.	8/6.	U18.	6/3.	EF54.	5/-.
6AG7.	5/6.	6Q7.	5/6.	SP41.	3/6.	EC52.	5/-.
6AC7.	5/6.	6N7.	5/6.	SP61.	3/6.	HP4101.	5/6.
6B4.	6/-.	6SK7.	4/9.	SP13A.	4/6.	HP4106.	6/3.
6B8.	5/6.	6V6G.	4/9.	Y63.	6/3.	VR150/30	5/6.
6C5.	5/6.	6X5.	4/9.	KT30.	6/3.	VU111.	4/6.
6C6.	6/3.	7Q7.	6/3.	H63.	6/3.	HL2.	3/6.
6F6G.	5/-.	14F6G.	4/9.	KT44.	5/6.	PP225.	4/6.
6H6.	3/-.	18.	6/3.	KTW61.	4/9.	6SN7.	6/9.
6J5.	4/6.	41.	6/3.	EBC33.	4/9.	VU39.	6/6.
				EL33.	8/6.	IT4.	6/-.

WRITE FOR LISTS OF OVER 500 RADIO LINES

**WILLIAM CARVIS,**  
103, NORTH STREET, LEEDS, 7



*At Last...*  
**A REALLY LIGHTWEIGHT HEADSET**

Suitable for aircrew, police or sound monitoring work, the Amplivox type 1900 light weight headset, weighing only 7 ozs has been developed to provide maximum comfort for the wearer and thus help to lessen the effects of fatigue under working conditions.

The headset comprises two miniature capsule receivers fitted to transparent ear discs with air cushioned ear caps. The double headband is leather covered and self locking for any head size. Standard impedance is 150 ohms, and the frequency response flat within  $\pm 5$  dB over a range 100-4,000 c.p.s. The cord is attached by a removable plug to one side of the headset only.

The type 1900 headset (Patents applied for) has been approved by the Air Ministry and supplied to the British Overseas Airways Corporation and Messrs. Handley Page Ltd.

**AMPLIVOX LTD, 2, BENTINCK ST., W.1**  
(WELBECK 2591-4)



**MAGNETIC RELAYS**

LARGEST STOCK IN GREAT BRITAIN OF RELAYS, KEY SWITCHES AND UNISELECTORS

Government Contractors

RELAYS P.O. 3000 - 600 - HIGH SPEED  
Also 230v. A.C. 50cy.  
ALL NEW EX-MINISTRY GOODS

**JACK DAVIS DEPT. E.E.**  
**30 PERCY STREET, LONDON, W.1.**

Phones : MUSeum 7960 L ANgham 4821

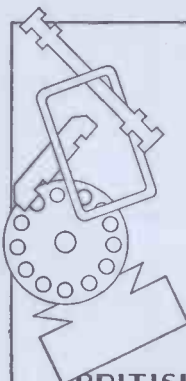

**MICA**

DISCS  
DIAPHRAGMS  
ELEMENT STRIPS  
CONDENSER PLATES  
SPECIAL SHAPES  
RAW MICA  
WASHERS  
etc

BRITISH MICA CO LTD - BEDFORD.



# TRAINING IN ELECTRONICS

RADIO - TELEVISION  
and other INDUSTRIAL  
ELECTRONIC subjects

### HOME STUDY COURSES

- ADVANCED RADIO
- INDUSTRIAL ELECTRONICS
- TELEVISION
- HIGHER MATHEMATICS
- PHYSICS

Obtain a copy of Free Booklet giving full details of these and Daytime Attendance Courses.

Write to Dept: 11

## E.M.I. INSTITUTES

10 PEMBRIDGE SQUARE, NOTTING HILL GATE, LONDON, W.2  
Telephone: BAYwater 5131/2.

Associated with  
"H.M.V."  
MARCONIPHONE  
COLUMBIA  
ETC.

E. 1666

+ SECOND EDITION NOW OUT! 248 PAGES!

## SOUND REPRODUCTION

by G. A. Briggs

REVISED AND ENLARGED, WITH  
10 NEW CHAPTERS AND 193  
ILLUSTRATIONS, INCLUDING 75  
ENTIRELY NEW DIAGRAMS

Greatly enlarged, this fascinating work contains all the principal features from the first edition, additional pages on Cabinet Design, Disc Recording, Needles and Grooves, Pick-ups and Microgrooves and new chapters on the following:—

EXPONENTIAL HORNS AND  
MULTIPLE SPEAKERS - CABINET  
LINING - QUESTIONS AND  
ANSWERS - AIR LOADING - CROSS-  
OVER NETWORKS - DIRECTIONAL  
EFFECTS - MAGNETIC RECORDING  
RIBBON SPEAKERS - NEEDLE  
INSPECTION - SAPPHIRE,  
TUNGSTEN AND DIAMOND

OBTAINABLE FROM RADIO  
DEALERS, BOOKSELLERS OR  
DIRECT FROM THE PUBLISHERS

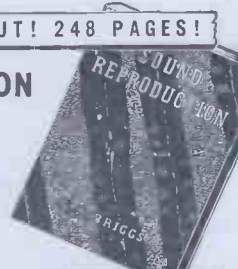

BOUND FULL  
REXINE  
**10/6** (11/-)  
POST FREE

## LOUDSPEAKERS

by G. A. Briggs

3rd Edn. (4th impression)

NOW READY!

The Why and How  
of Good Reproduction

88 PAGES

36 ILLUSTRATIONS

**5/-** (5/3)  
POST FREE

Enjoyment of these books is enhanced by the occasional flashes of humour now expected of Mr. Briggs.

## Wharfedale WIRELESS WORKS,

BRADFORD ROAD, IDLE, BRADFORD, YORKS.

Telephone: Idle 461

Telegrams: "Wharfedel, Idle, Bradford."

### SERVO CONTROL EQUIPMENT



#### MAGSLIPS

Resolvers, Transmitters, Hunters, Receivers, etc., 2" and 3" types.

#### SELSYNS

Power and Phase-Shifting types.

#### INDUCTION MOTORS AND VELODYNES

Send for list and technical details.

Repair facilities for all types of British and American Magslips, Selsyns, test equipment, etc.

#### HOPTON RADIO,

1, Hopton Parade, Streatham High Road, LONDON, S.W.16.

'phone: STReatham 6165

## MELTON METALLURGICAL LABORATORIES LTD.

# Liquid Silver

IMMEDIATE DELIVERY OF GRADES  
FOR METALLIZING

**CERAMICS, MICA,  
GLASS & PLASTICS**

All Enquiries to our NEW ADDRESS—

42, TOWNGATE STREET,  
POOLE, DORSET

Telephone No. Poole 1241

**Varley**  
REGD TRADE MARK

QUALITY RELIABILITY

**MAINS TRANSFORMERS  
A.F. TRANSFORMERS  
SMOOTHING CHOKES  
THERMAL DELAY SWITCHES  
SLIDER RESISTANCES**

*Made by*

**OLIVER PELL CONTROL LTD**  
CAMBRIDGE ROW, BURRAGE ROAD, S.E.18.  
Telephone: Woolwich 1422



**THE  
SERVICE ENGINEER'S  
FIRST CHOICE**

## Electronic ACCESSORIES & COMPONENTS



For Research  
Depts., Labora-  
tories, Colleges,  
etc.  
Send for List.

HOLIDAY & HEMMERDINGER LTD  
74-78, HARDMAN ST., DEANSCATE  
MANCHESTER 3 · TEL. · DEA. 4121/2





**BRAY**  
ELECTRO-CERAMIC INSULATORS & REFRACTORIES  
for the TELECOMMUNICATION, RADIO & ELECTRICAL TRADES.  
manufactured by  
**GEO. BRAY & CO. LTD.**  
LEEDS 2, ENGLAND.  
Telephone 20981 (8 lines) - Telegrams BRAY LEEDS

POTENTIOMETERS  
*by*  
**RELIANCE**

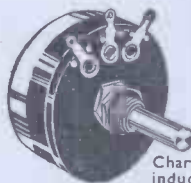

Wire-wound and Composition types. Single, Ganged, Tandem Units.

Characteristics: linear, log., semi-log., non-inductive, etc. Full details on request.

**RELIANCE MFG., CO. (SOUTHWARK), LTD.,**  
Sutherland Road, Higham Hill, Walthamstow, E.17.  
Telephone: Larkswood 3245

**Technical Excellence**

combines with beauty and soundness of DESIGN in the

**OXLEY**

DIFFERENTIAL AIR DIELECTRIC TRIMMER

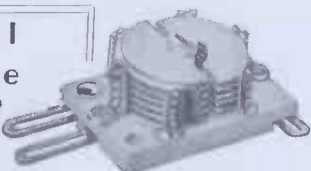

★ Width: 16.5 m/m Length: 25 m/m  
Height:  
1.5 to 8pF—8 m/m  
1.5 to 20pF—12.5 m/m  
2 to 26pF—11.5 m/m  
2 to 32pF—12.5 m/m  
Law: Straight line capacity  
Power Factor: Less than .001  
Insulation: Over 2,000 megohms  
Voltage: 500 D.C.

**OXLEY DEVELOPMENTS CO., LTD.,**  
ULVERSTON, N. LANCs. TEL. ULVERSTON 3306

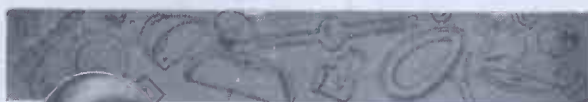

**FOR MOULDED RUBBER PARTS**

Enquiries are invited from the Engineering, Electrical and Motor Industries for special Moulded Parts in Synthetic and Natural Compounds.



THE HABRORO' RUBBER CO., LTD., Market Harborough

**Laboratory Research Workers & Technicians**

A. F. JEFFREE, LTD., ARE NOW ABLE TO OFFER DIRECT COUPLED AMPLIFIERS, SUITABLE FOR USE IN ALL FIELDS OF SCIENTIFIC APPLICATIONS. CARDIOGRAPHY, ENCEPHALOGRAPHS. WIRE STRAIN GAUGES, WIDE BAND AMPLIFIERS, BIOLOGICAL USE, PHOTOMETRY, SPECTRO PHOTOMETRY, NUCLEAR PHYSICS, PULSE CIRCUIT, AND NUL INDICATORS, ETC.

**FEATURES**

Input circuit noise not measurable. Zero Frequency to Megacycles. Inputs: 1, 2, 4, 6, or 8. All electronically mixed to suit any impedance required. True balanced phase splitters. Normal unstabilised power pack. Zero drift over whole amplifier. Not affected by extremes of temperature Gains from 50 to 100,000

Enquiries are invited, write to:

**A. F. JEFFREE, LTD.**  
8, DOVERS GREEN RD., REIGATE,  
SURREY, ENGLAND

**THE SOUND MAGNET**

**Magnetic Tape Recorders**

Three speeds give  $\frac{1}{4}$ ,  $\frac{1}{2}$ , 1 hr. programmes. Radio Quality for 30 minutes without pause. Twin Tracks double above playing times. Powerful 12 watt amplifiers. Use also for Public Address. Portable in leathercloth carrying case. Complete Recorder and playback equipment, less microphone. *Model 50 £50*

Also the latest S.M. TAPE CONVERTOR. For use with existing P.A. systems and amplifiers. *Model C £35*

Manufactured & distributed by:—

**GENERAL LAMINATION PRODUCTS LTD.**

294 Broadway, Bexleyheath,  
Kent.



Partridge Mews

*To your exact Specification*



5 VA to 50 KVA

**TRANSFORMERS—**  
POWER or AUDIO FREQUENCY  
**4 WEEKS DELIVERY**

The acknowledged precision of Partridge transformers is available to you in transformers and chokes to your own specification . . . and in double quick time. Whatever your transformer need, first consult Partridge—the specialists.

★ Note: All Partridge components are now available  
**HERMETICALLY SEALED IN OIL**

**PARTRIDGE**  
TRANSFORMERS LTD

ROEBUCK ROAD, KINGSTON-BY-PASS  
TOLWORTH SURREY  
Telephone ELMbridge 6737-8

INDEX TO ADVERTISERS

Acheson Colloids Ltd. .... 24	Edison Swan Electric Co. Ltd., The .. 16	Painton & Co., Ltd. .... 32
Advance Components Ltd. .... Cover i	E.M.I. Institutes Ltd. .... 42	Parmeko ..... 23
Air Control Installations Ltd. .... 14	Ferranti Ltd. .... 10	Partridge Transformers Ltd. .... 43
Airmec Laboratories Ltd. .... 34	Fielden (Electronics) Ltd. .... 354	Pearce (Pressings) Ltd., William .. 37
All-Power Transformers Ltd. .... 30	Furzehill Laboratories Ltd. .... 23	Pell Control Ltd., Oliver ..... 42
Amplivox Ltd. .... 41	Gardner's Radio Ltd. .... 31	Pitman & Sons Ltd., Sir Isaac .. 39
Antiference Ltd. .... 44	General Electric Co., Ltd., The .. 6	Plessey Co., Ltd. .... 11
Automatic Telephones & Electric Co., Ltd. .... 13	General Lamination Products Ltd. .... 43	Pye Telecommunications Ltd. .... 15
Belling & Lee Ltd. .... 18	Hallam, Sleigh & Cheston Ltd. .... 38	Radiospares Ltd. .... 42
Bray & Co. Ltd., George ..... 43	Harboro' Rubber Co. Ltd., The .. 43	R.C.A. Photophone Ltd. .... 41
British Electric Resistance Co., Ltd. .... 35	Hazlehurst Designs Ltd. .... 39	Reliance Mfg. Co. (Southwark) Ltd. .... 43
British Institute of Engineering Technology ..... 40	Hivac Ltd. .... 39	Sangamo-Weston Ltd. .... Cover iii
British Insulated Callender's Cables Ltd. .... Cover ii	Hogg, F. Livingston ..... 35	Scophony-Baird Ltd. .... 36
British Mica Co. Ltd. .... 41	Holiday & Hemmendinger Ltd. .... 42	Small Electric Motors Ltd. .... 26
British National Radio School, The .. 38	Hopton Radio ..... 42	Standard Telephones & Cables Ltd. .... 17
British N.S.F. Co. Ltd. .... 21	Hunt Ltd., A. H. .... 31	Taylor & Co. Ltd., Armand ..... 36
British Thomson-Houston Co. Ltd., The .. 27	Jeffree Ltd., A. F. .... 43	Telegraph Condenser Co. Ltd., The Cover iv
Builers Ltd. .... 20	Marconi's Wireless Telegraph Co. Ltd. .... 28	Telegraph Construction & Maintenance Co. Ltd., The ..... 32
Carter & Co. Ltd., B. & F. .... 41	Melton Metallurgical Laboratories Ltd. .... 42	Tufnol Ltd. .... 22
Carvis, William ..... 41	Metropolitan-Vickers Electrical Co., Ltd. .... 12	United Insulator Co. Ltd. .... 33
Chapman & Hall Ltd. .... 352	Modern Book Co., The ..... 352	Valradio Ltd. .... 39
Cinema-Television Ltd. .... 25	Muirhead & Co. Ltd. .... 5	Vitavox Ltd. .... 7
Cole Ltd., E. K. .... 3	Mullard Electronic Products Ltd. .... 8	Vortexion Ltd. .... 33
Cosmocord Ltd. .... 26	Nagard Ltd. .... 28	Walter Instruments Ltd. .... 9
Cossor Ltd., A. C. .... 19	National Savings ..... 36	Wayne-Kerr Laboratories Ltd., The .. 34
Darwins Ltd. .... 37	Newman Ltd., J. & S. .... 38	Webb's Radio ..... 37
Davis, Jack ..... 41	Oxley Developments Co., Ltd. .... 43	Westinghouse Brake & Signal Co., Ltd. .... 40
Dawe Instruments Ltd. .... 29		Wharfedale Wireless Works Ltd. .... 42
De La Rue & Co. Ltd., Thomas .. 30		Whiteley Electrical Co. Ltd. .... 3
Drayton Regulator & Instrument Co. Ltd. .... 38		Wiggin & Co., Ltd., Henry ..... 24

**MARKS THE SPOT**

Better television reception—a cleaner picture—less interference on sight and sound, and at lower cost. These are the facts which account for the rapidly increasing number of 'X' type aerials to be seen in both town and country. Enterprising dealers have been quick to see that the 'Antex' means customer satisfaction, enhanced goodwill and extra profits.

*The electrical and mechanical design of the 'Antex' is fully protected. Pat. No. 630795 & Prov. Pat. 12178/49 & Reg. Des. 859630.*

**MODEL XL for London**  
**MODEL XL/B for Midlands**  
 with 7-ft. mast and chimney lashing equipment  
 RETAIL PRICE **£3 . 15 . 0**

**MODEL XW for London**  
**MODEL XW/B for Midlands**  
 with 7-ft. mast and wall mounting bracket  
 RETAIL PRICE **£3 . 0 . 0**

**MODEL XP for London**  
**MODEL XP/B for Midlands**  
 Complete with pole mounting fitting  
 RETAIL PRICE **£2 . 3 . 0**

**ANTIFERENCE**  
*Antex*  
**TELEVISION AERIAL**

**ANTIFERENCE LIMITED · 67 BRYANSTON STREET · LONDON · W.1**