

Electronic Engineering

JUNE 1966

VENNER

PULSE GENERATOR

* Silicon throughout * One or two pulses up to 20V amplitude, + or — with respect to earth * Frequency range 2.5 c/s—2.5 Mc/s * Vernier and 1:2:5 switched control of amplitude, pulse width, frequency, and delay * Separate polarity control for pre-pulse * Pulse width: 100nS to 10mS * Rise time: 10nS * Delay: 100nS to 10mS * Variable tilt for ease of operation * All these features in a portable unit of compact modern design at remarkably low cost.

Ask for full details of this latest addition to the Venner range of transistorised electronic precision instruments.

**VENNER DOUBLE-PULSE
GENERATOR TYPE TSA 628**



VENNER ELECTRONICS LIMITED

Kingston By-Path · New Malden · Surrey · Tel: MALden 2442

Overseas subsidiary: VENNER A.G. BÜRGENZIELWEG 16, 3006 BERNE · SWITZERLAND

VENNER N.V. HELMSTRAAT 3 · DEN HAAG · HOLLAND

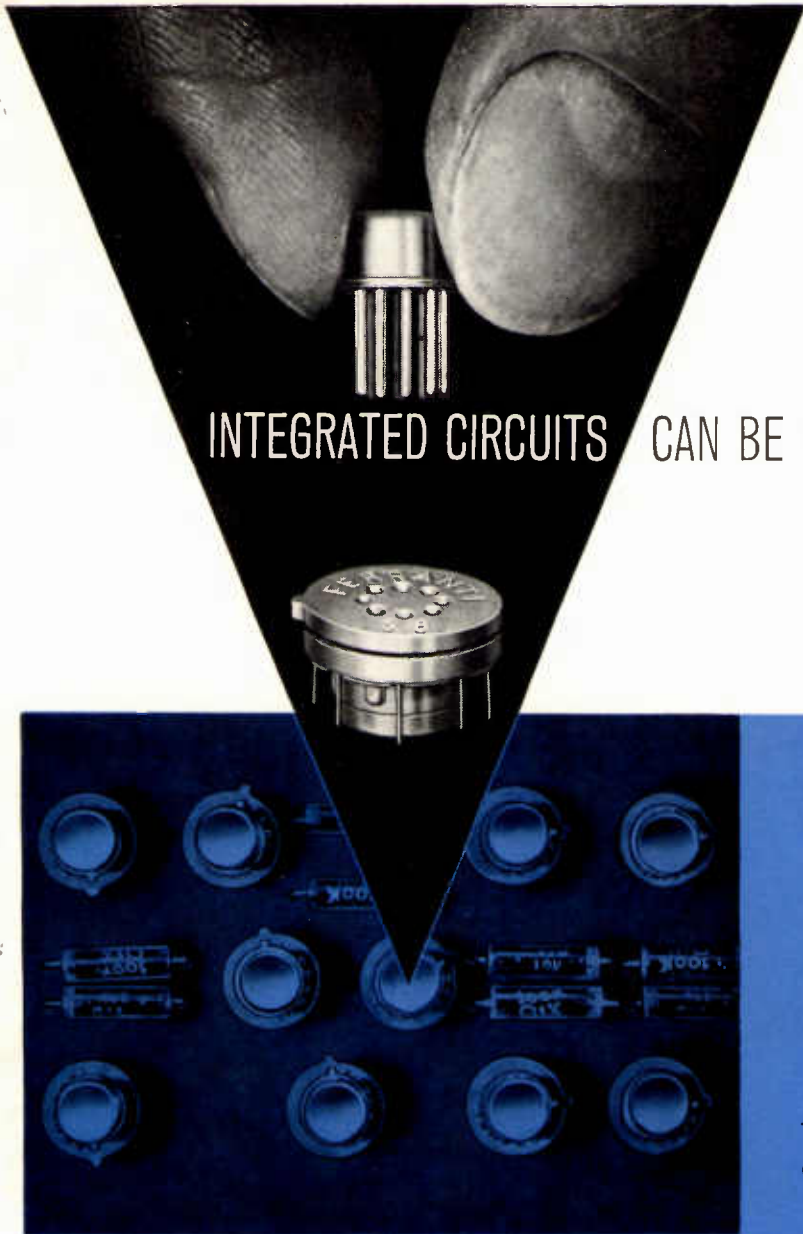

INTEGRATED CIRCUITS CAN BE REPLACED IN SECONDS

with
the
new

FERRANTI S8 CONNECTOR

The FERRANTI S8 Connector has been designed to overcome the problems of replacing quickly and safely integrated circuits in printed circuit boards. In practice the Connector which is moulded in glass-filled nylon, is inserted into the board and the hard gold-plated beryllium copper contacts are wave or hand soldered into the circuit. These contacts incorporate a low-rate spring which closely controls the contact pressure. The S8 Connector accepts all eight-lead integrated circuits enclosed in TO-5 encapsulations.

TYPICAL PERFORMANCE DETAILS OF THE S8 CONNECTOR ARE:-

Insulation Resistance	1 x 10 ⁷ Megohms
Contact Resistance	30 milliohms
Self inductance of each contact	0.01 Microhenry
Capacitance between adjacent contacts	0.2 pf
Insertion force	600 gm
Temperature range	- 55°C to + 125°C
Plating	0.0002 in. (5 microns) minimum hard gold on contacts.

FERRANTI

First into the Future

Full details from: FERRANTI LTD., KINGS CROSS ROAD, DUNDEE, SCOTLAND. Tel: (ODU2) Dundee 87141

Electronic Engineering

Incorporating ELECTRONICS, TELEVISION and SHORT WAVE WORLD

Managing Editor: H. G. FOSTER, M.Sc., M.I.E.E., M.I.E.R.E.

Contents

353	Commentary	
354	A Computer-controlled C.R.T. Display System	by W. Bial
359	Electronic Sterling Invoicing	
360	Analysis of High Speed Fixed Stores Using U-cores	by H. P. A. Salam
366	Remote Control of Television Relay Stations	
367	Thin Film Transistors	by R. P. Howson
370	A Very High Input Impedance Buffer using Field Effect Transistors	by K. Thompson
373	Numerically Controlled Spark Engraving	
374	Swept Frequency Methods of Response Measurement	by J. F. Golding
381	Moderate Speed Data Logging Using Pulse Groups on Magnetic Tape	by J. G. Lang
384	A High-Efficiency Monostable Circuit using Complementary Transistors	by B. D. Rakovich
387	A New Letter Sorting Machine	
388	Tantalum Film Circuits	by P. L. Hawkes
389	Measurement by Short Range Telemetry	
390	A Low-Noise, High-Input Impedance Transistorised Pre-amplifier	by A. Szerlip
392	Circle Diagrams for Representing the Relationship Between the Noise Factor and Source Admittance of a Linear Two Port	by R. Bridgen
394	Design Data for a Third Order Butterworth Filter with Specified Source and Load Resistance	by R. Sill and A. Simeon
397	Octave and One-Third Octave Filters for Sub-sonic Frequencies	by W. Tempest and N. S. Yeoward
399	Self-Monitoring for Data Systems	
400	New Books	
402	New Equipment	
408	Short News Items	
FRANCAIS	411 Nouvelles Réalisations	
	416 Résumés des Principaux Articles	
DEUTSCH	418 Neue Ausrüstungen	
	423 Zusammenfassung der wichtigsten Beiträge	

Classified Advertisements page 165

Index to Advertisers page 171

SUBSCRIPTION RATES

Single copy 3s. 6d. plus 1s. 6d. postage
HOME £2.5.0d. p.a. (3 yrs. £8.0.0d.)
OVERSEAS £2.15.0d. (3 yrs. £7.10.0d.)
CANADA & U.S.A. \$8.00 p.a. (3 yrs. \$22.00)

PUBLISHED MONTHLY on the last Friday of the preceding month by:

MORGAN BROTHERS (PUBLISHERS) LIMITED
 at 28 Essex Street Strand London W.C.2 : Telephone: CENTral 6565
 CABLES (Home and Overseas)—'Lectroning London W.C.2'

ABC MEMBER OF THE AUDIT BUREAU OF CIRCULATIONS

© MORGAN BROTHERS (PUBLISHERS) LTD. 1966

New

Bryans 21000 series plotters.
Simple, versatile and reliable.
Prices from under £300

Bryans 21000 series



High impedance floating input circuits
Linearity better than 0.25%

Sensitivity 1mv/inch to 1v/inch, or 500 μ v/inch to 5mv/inch in potentiometric mode
Zero shift in both axes

Time base optional
Modular design, simple mechanism,
for reliability and long life

Ask for a demonstration from
Bryans Ltd
Willow Lane Mitcham Surrey
Mitcham 5134

for value

REED



RELAYS

REED PUSH-BUTTON SWITCH

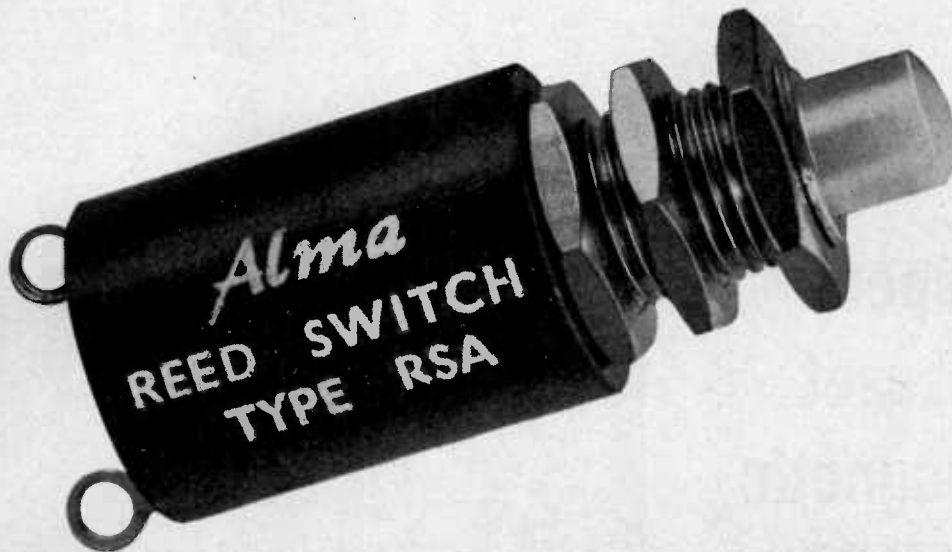

These switches have been designed to provide a clean make and break with a minimum of bounce or spurious contact which is sometimes experienced with conventional switches. An annular magnet is moved over a sealed reed contact by the push button. The switches are ruggedly designed and have positive end stops.

- ★ Available as normally open (push to make) Type RSA, or as normally closed (push to break) Type RSB.
- ★ Ratings 0.5A, 200 Volts or 10 Watts into resistive load.
- ★ Life better than 10^8 operations.

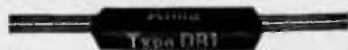

TYPE DR1 Form A

Coil Voltage	2-20V
Coil Power	75mW
Contact Rating	12VA 10W
Contact Resistance	100mΩ
Actuating Time	1m sec.
Dimensions	0.875" long × 0.25" dia.

TWO MINIATURE RELAYS

Using the miniature Hamlin reeds, these relays are offered as complete units.

Other Alma reed relays available both as standard and to special order.

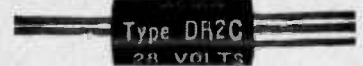

TYPE DR2C Form C

Coil Voltage	2-36V
Coil Power	100mW
Contact Rating	4VA 3W
Contact Resistance	150mΩ
Actuating Time	2m sec.
Dimensions	0.75" long × 0.38" dia.

'SPECIALS' & ASSOCIATED DEVICES TO ORDER—AND BY DESIGN

A wide variety, including mercury-wetted relays, are available to order. In addition, numerous switching devices based on reed relays are being developed by Alma—including, a rotary selector switch, a proximity switch, etc.

Design service: Give us details of your applications and we will design for you reed relays with correctly matched coil and reed characteristics, suitable dimensions, etc. Contact us or ask for one of our representatives to call.

Quality first—Alma's experience in coil winding and precision measurements ensures that you get relays and devices engineered to close tolerances.

ALMA COMPONENTS LIMITED

Park Road . Diss . Norfolk . Telephone: Diss 2287 . Telex: 18162

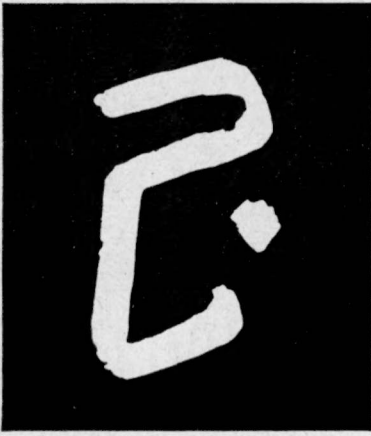

5,000 years of counting

No. 1

Since man first scratched on cave-walls, the quantity 'one' has been indicated by a single stroke. Variations such as the Hieratic symbol (left) have all proved transitory, and our modern figure is the same 'one' the Phoenicians used.

Moral: Once you find the right answer, stick to it. Clients of CI wouldn't change to any other counting system.



High speed quick reset electro-magnetic COUNTERS

Operating at twenty counts a second, this six-figure counter resets by push button or electrically. Other models in this sub-range are four-digit counters capable of twenty-five counts a second. A special feature is that accidental resetting when the counter is running does not harm the mechanism. These models are designed for flush panel mounting.

Energised by dual electro-magnets on a common armature. Balanced escapement mechanism. Jewelled bearings tooled to very fine limits. Nylon moulded working parts for minimal friction. Differential pinion for precise alignment. Large figures for good readability.

In an increasingly diverse field, CI counters help you keep pace with growth and demand.

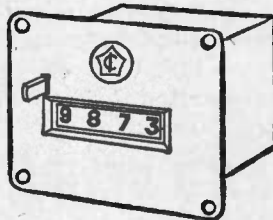
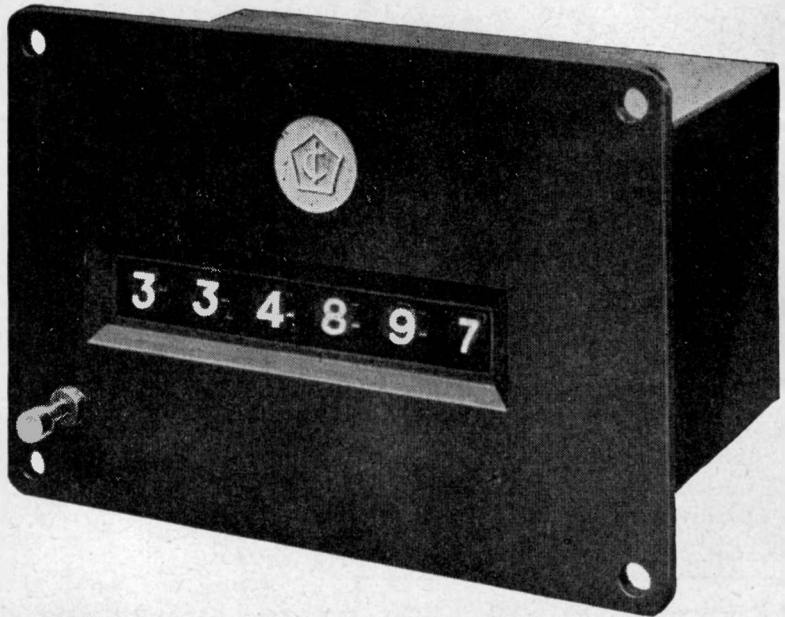

PUSH BUTTON RESET

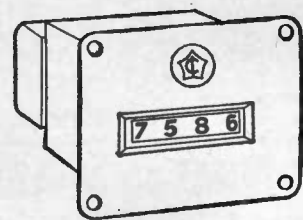

ELECTRIC RESET



Write or telephone for technical information or specific applications

COUNTING INSTRUMENTS LIMITED
Elstree Way, Boreham Wood, Hertfordshire
Telephone ELStree 4151

one of the best
in the world

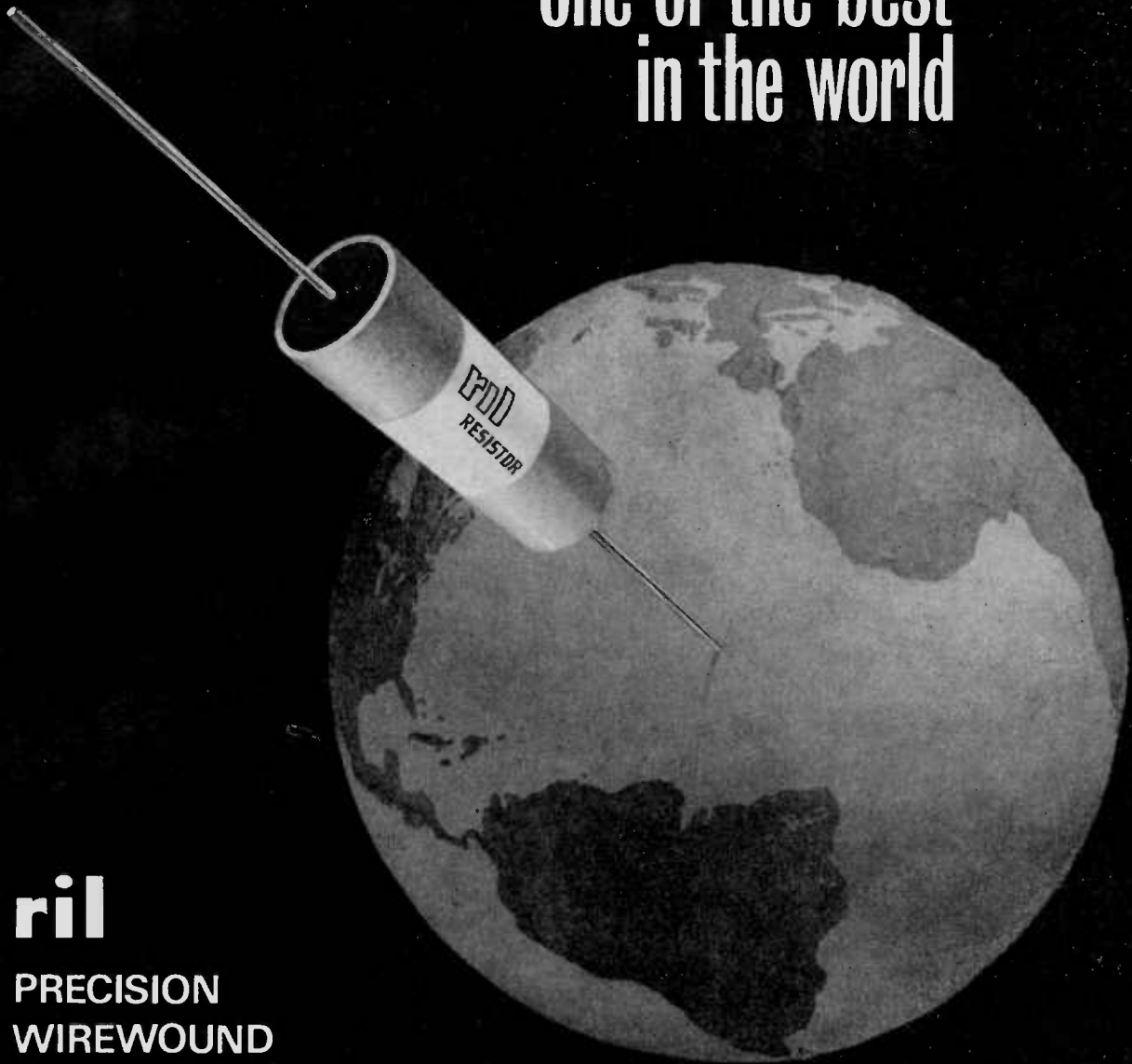

ril

PRECISION
WIREWOUND
RESISTORS

Type approved to DEF 5113 (H2)

“You can rely on Rivlin”

SEE US ON STAND NO. 301



RIVLIN INSTRUMENTS LIMITED

ril

Yorktown Industrial Estate Doman Road Camberley Surrey Telephone: Camberley 21107/8

London Office: 687 FINCHLEY ROAD, LONDON, N.W.2. Telephone: Swiss Cottage 3038

EE 94 009 for further details

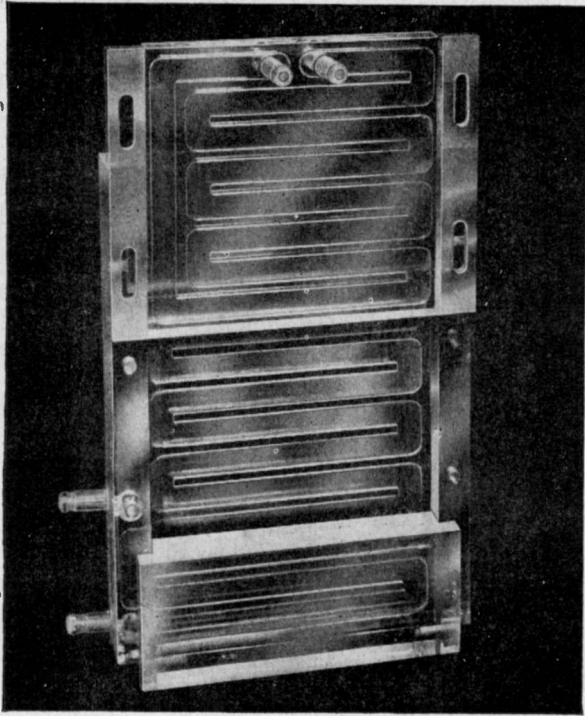

VISIJAR LABORATORIES LIMITED ACRYLIC SPECIALISTS

**Skilled in the Manipulation and Fabrication of
'PERSPEX' IN ALL ITS FORMS**

Craftsmen in the use of 'PERSPEX' always ready to put our ingenuity and years of experience at your service.

Many types of prototype equipment are made for industry, chiefly — Electronics, Space research, Medical and Educational.

We also carry one of the largest stocks of Acrylic in the United Kingdom.

Officially Appointed  Stockists

NATIONAL ACRYLIC CONSULTANTS VISIJAR LABORATORIES LIMITED

PEGASUS ROAD • CROYDON AIRPORT • SURREY • MUN 6341 (5 LINES)

**ONE
STEP
AHEAD
ONE
STEP**



one step ahead of today's demands

GGL work in metal, progress on policies stronger than the materials they work with. Capstan and automatic work, pressings and drawings, components in metal — any metal — come quick and accurate when you deal with GGL. If you are an industrial pace-setter and you need a component supplier to keep pace, better get in touch with GGL.

GGL *The techniques of tomorrow for the needs of today*

Griffiths, Gilbert Lloyd Limited, Empire Works, Park Road, Birmingham. Tel. NOR 6221.

EE 94 010 for further details



All the information you want between two covers

If you are professionally engaged in the electronics industry you should have your own personal copy of Gardners Industrial Catalogue. It contains details of our latest additions—42 Transformers for Transistorised A/F Power Amplifiers, New Audio Line Matching Transformers, besides a comprehensive range of Small Power Transformers, Auto, Isolating and Low Voltage Transformers, Inductors, Saturable Reactors, etc. This publication will be kept up to date with amendments and additions as they are issued. Years of specialisation have given Gardners Transformers a reputation for high performance and reliability.

Write for your copy of Gardners Industrial Catalogue on your company's heading. You will find it packed with the sort of information you require at your finger-tips.

Gardners

GARDNERS TRANSFORMERS

GARDNERS TRANSFORMERS LIMITED, Somerford, Christchurch, Hants. Tel: 1734. Telex 41276 Telegrams: Radiotrans Christchurch Telex.

NOW INTERNATIONAL! PENNY & GILES

RELIABLE CUSTOM-BUILT Precision Potentiometers

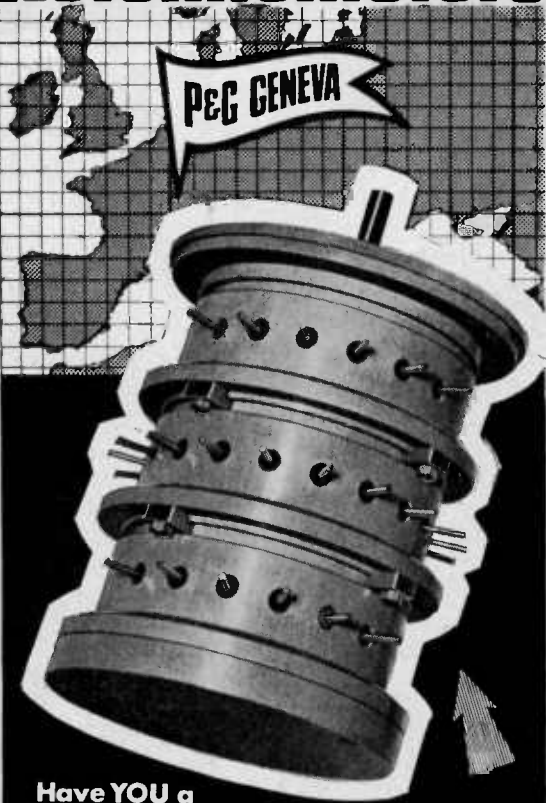

Have YOU a Potentiometer Application Problem?
For example: This 3-Gang Rotary Potentiometer was designed for an Industrial Analogue Computer

ALL MAJOR INDUSTRIES IN THE UNITED KINGDOM SPECIFY PENNY & GILES

- Over 90% of our precision Instruments are custom-built to individual requirements.
- Fully tested and approved to M.O.A., A.R.B., & M.I.L. Specifications.
- Research & Design Laboratories at customers' disposal for particular applications.
- Environmental testing facilities ensure maximum reliability.

OUR CUSTOMERS INCLUDE THE FOLLOWING COMPANIES:

ASSOCIATED ELECTRICAL INDUSTRIES • BRITISH EUROPEAN AIRWAYS • BRITISH OVERSEAS AIRWAYS CORPORATION
ELLIOTT FLIGHT AUTOMATION LTD. • THE ENGLISH ELECTRIC CO. LTD. • FERRANTI LTD. • THE MARCONI CO. LTD.
ROLLS-ROYCE LTD. • SMITHS INDUSTRIES

SEND FOR SPECIFICATIONS AND COLOUR BROCHURE DEPT. E.E.5

HEAD OFFICE: MUDEFORD, CHRISTCHURCH, HANTS, ENGLAND.

PENNY & GILES LTD
CASE 2, 1211 GENÈVE 6, SUISSE

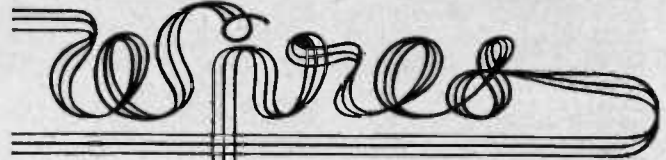

TOPHET 'A'

80/20 NICKEL-CHROME—gives best results in all high temperature applications.

TOPHET 'C'

NICKEL-CHROME-IRON—lower priced but excellent for use at slightly lower temperatures.

CUPRON

COPPER-NICKEL—low temperature coefficient alloy for use at low temperatures.

LOW RESISTANCE ALLOYS

Meets the demand for a series of alloys with resistance between that of copper and Copper-Nickel.

EVANOHM

The best available materials for super precision resistors. Highest specific resistance and lowest temperature coefficient.

★
For complete data on all our resistance alloys and stainless steel wire, write for a copy of our Resistance Handbook

GILBY-BRUNTON LTD
Head Office & Works:
SEAMILL, MUSSELBURGH, SCOTLAND
Telephone: Musselburgh 2369
London Office: 47 WHITEHALL, S.W.1
Telephone: Whitehall 4058

Single Sideband Crystal Filters from K. S. S.



This is designed for use in SSB transmitters to especially maintain excellent characteristics in Temperature and Shock.

• Main Characteristics of SSB Crystal Filters

Type	Center Freq.	5 db Bandwidth min.	60 db Bandwidth max.	Carrier Suppression min.	Insertion Loss max.	In band ripple max.	In & Out Impedance ohms	Operating Temperature Range	Dimensions DJ W H %
KFN-12	455KC	2.4KC	4.2KC	25db	6db	2db	5KΩ	-10 ~ +50°C	64x24x23
	1475KC								
	1756.5KC								
	1945KC								
KFX-12	2121.5KC	2.4KC	4.2KC	25db	6db	2db	5KΩ	-10 ~ +50°C	80x30x30
	2855KC								
	3000KC	2.4KC	60db 5.0 KC	25 db	6db	2db	560Ω	0 ~ 40°C	55x20x23



* For catalog write to:
Kinsekisha Laboratory Ltd
Tel. 429-2111 Cables: "CRYSTAL TOKYO"
17-23, 2-chome. Miyasaka, Setagaya-ku, Tokyo, Japan



How does KODAK LINAGRAPH DIRECT PRINT PAPER help run a railway?

Ask the Eastern Region
of British Rail

On a busy rail network like the Eastern Region of British Rail, time is at a premium. So faults have to be detected *fast*, corrected as quickly.

That's why Eastern Region engineers use oscillograph recordings on Kodak 'Linagraph' Direct Print Paper to investigate the electrical equipment of the Region's multiple unit electric trains.

The tremendous speed with which Kodak 'Linagraph' Direct Print Paper provides an

image without chemical processing (it's practically instantaneous) enables engineers to examine results and make modifications to the test programme while test trains are actually running. Which, of course, means valuable savings in time and money for British Rail.

It could be that Kodak 'Linagraph' Direct Print Paper could help save time and money for you, too. Post the coupon today for full details.

Kodak SERVES INDUSTRY

'Linagraph' and 'Kodak' are registered trade-marks.



Please send full details of Kodak 'Linagraph' Direct Print Paper.

NAME _____

ADDRESS _____

Kodak Limited, Dept. 73, Kodak House,
Kingsway, London, W.C.2.

EE

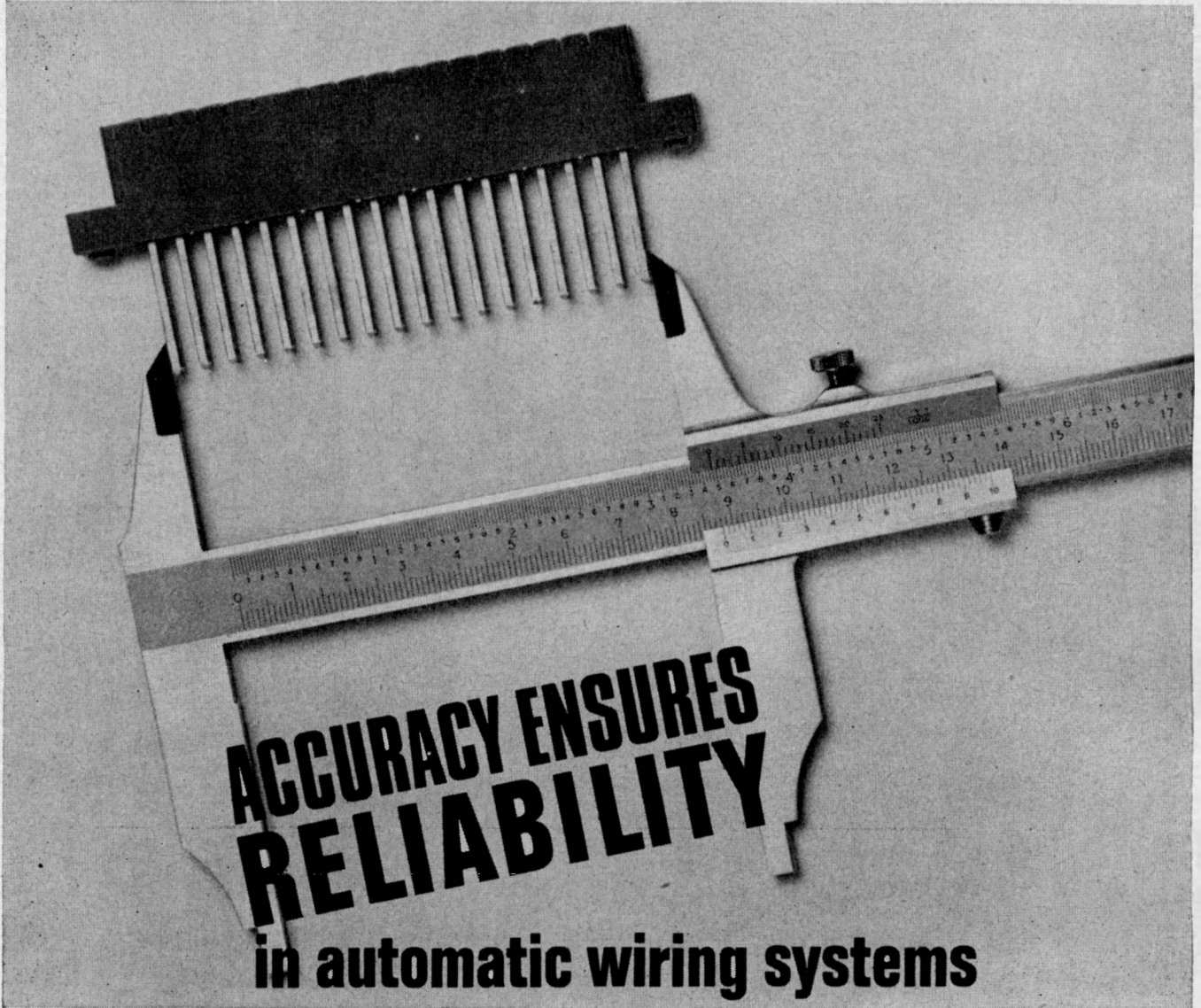

Precision-engineered PW Series Connectors ensure complete reliability for programmed automatic or manual wiring systems. The phosphor bronze contact/wiring pillars are of one-piece fitted in high-strength polycarbonate mouldings. The pillars—accurate to $\cdot015''$ radial tolerance and $\cdot030''$ positional tolerance at tip—withstand over 30 lb axial loading.

Voltage rating—500 v AC RMS. Contact rating—5A. Contact insertion force—average 6 oz per contact pair. Various contact spacings available for single or double sided printed circuit boards.

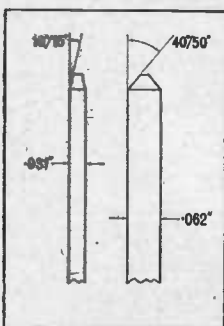

DESIGN FEATURES

Wiring pillar tip chamfers held to close tolerances. Bifurcated contacts give multi-point contact. Minimum contact engagement length $\cdot180''$. Low rate springs accommodate printed circuit boards from $\cdot054''$ to $\cdot072''$ thickness. Unit construction contact spring and wiring pillar. Contact finishes available to suit applications.

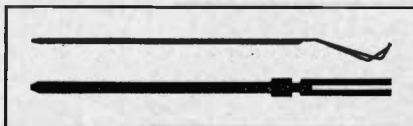

Write for full technical information.

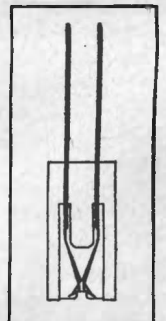

BICC-BURNDY LIMITED

ST. HELENS, LANCS. Telephone: St. Helens 26251

MORE DATA →

MORE ENTRIES →

MORE SECTIONS →

MORE PAGES →

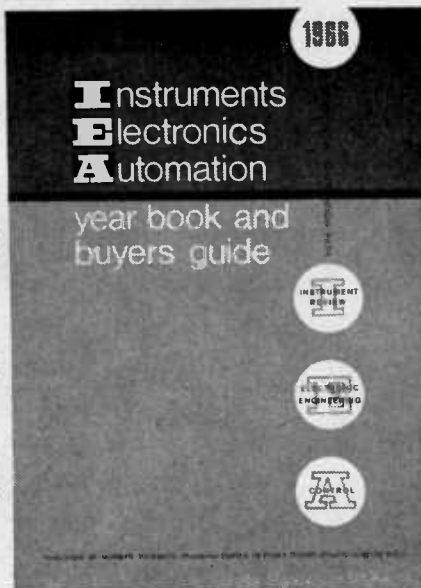

THE SECOND EDITION (1966) of the I.E.A. Year Book and Buyers Guide has been completely revised and IS NOW READY. For technologists and buyers in industry, commerce and research — indeed for all who need to keep abreast of developments in the instruments, electronics, and automation field — this publication is a "must".

Expansion is the keynote of the second edition which contains over 700 pages

BUYERS GUIDE 10,000 new entries included and Product Headings increased to 4,600

MANUFACTURERS ADDRESSES now number 2,700 firms

EQUIPMENT SURVEYS ALL SURVEYS have been revised and brought up to date and three new ones added: Digital Computers · Hygrometers · pH Meters and Electrodes

PLUS TWO NEW SECTIONS British Standard and Defence Specifications
Export Information

CONTENTS

BUYERS GUIDE
Contains over 4,600 product headings relating to Instruments, Electronic and Automation equipment plus 1,500 cross references.

MANUFACTURERS ADDRESSES
2,700 firms with products in the Buyers Guide and Equipment Surveys.

ILLUSTRATED PRODUCTS
100 pages of illustrations and specifications of products listed in the Buyers Guide.

WHO'S WHO
Career details of prominent people in the industry.

WHO BUYS
A guide to people responsible for procuring supplies for public services in the U.K.

BRITISH STANDARD and DEFENCE SPECIFICATIONS
A list of relevant British Standard and Defence Specifications.

EXPORT INFORMATION
Details of Government Services available to exporters.

TRADE NAMES
Trade Names used by firms whose products are included in the Buyers Guide.

ASSOCIATION ADDRESSES
A list of Associations, Institutions, Societies and other bodies with details of their principal officers and main objects.

EQUIPMENT SURVEYS
Provide technical background information and data relating to equipment commercially available in the Instruments, Electronics and Automation industries in the United Kingdom.

Analogue-to-digital Converters
Closed-circuit Television
Digital Computers
Control System Analysers
D.C. Amplifiers for Computers
Electrical Moisture Meters
Electrohydraulic Servo-valves
Electronic Process Controllers
Gas and Liquid Density Gauges
Hydraulic Oils for Power Transmission
Hygrometers
Mass Flowmeters
Miniature Recorders
Optical Galvanometer Recorders
pH Meters and Electrodes
Pneumatic Controllers
Potentiometric Recorders
Pressure Transducers
Radiation Pyrometers
Turbine Flowmeters
Uniselectors
Variable-area Flowmeters.

Instruments, Electronics, Automation Year Book and Buyers Guide.

28 ESSEX STREET, LONDON, W.C.2

A Morgan Brothers Publication.

ORDER YOUR COPY NOW!

**INSTRUMENTS, ELECTRONICS, AUTOMATION
YEAR BOOK AND BUYERS GUIDE**
28 Essex Street, Strand, London, W.C.2 Central 6665

Please send _____ copies at £3.0 each, including postage, to the address below.
Remittance for £ _____ is enclosed.

NAME _____

COMPANY _____

ADDRESS _____

Four new marine radar magnetrons

2000-HOUR GUARANTEE

The greatly improved reliability of transistorised equipment demands greater life from its associated thermionic devices. To meet this demand in the marine radar field, Mullard has now introduced four new long-life magnetrons.

YJ1120 and YJ1121

The first pair of magnetrons in this new release are types YJ1120 and YJ1121, which are not only guaranteed for 2000 hours, but are confidently expected to give excellent service for at least 5000 hours. This long life has been obtained by revolutionary techniques which also result in low heater consumption (6.3V, 600mA), a very useful feature in hybrid systems.

<i>Brief data:</i>	YJ1120	YJ1121
Frequency	9.380 to 9.440Gc/s	9.415 to 9.475Gc/s
R.F. pulse power output (I-pulse = 8A)	25kW	26kW
Pulse voltage (I-pulse = 8A)	8.2kV	—
(I-pulse = 9A)	—	8.3kV
Max. duty factor	0.0015	0.0015

YJ1110 and YJ1111

Also recently introduced by Mullard are the YJ1110 and YJ1111 magnetrons which are designed as long-life plug-in replacements for the universally known and well proved JP9-15 and JP9-15B types, production of which will be continued.

<i>Brief data:</i>	YJ1110	YJ1111
Frequency	9.345 to 9.405Gc/s	9.415 to 9.475Gc/s
R.F. pulse power output (I-pulse = 7.5A)	20kW	20kW
Pulse voltage (I-pulse = 7.5A)	7.8kV	7.8kV
Max. duty factor	0.0015	0.0015

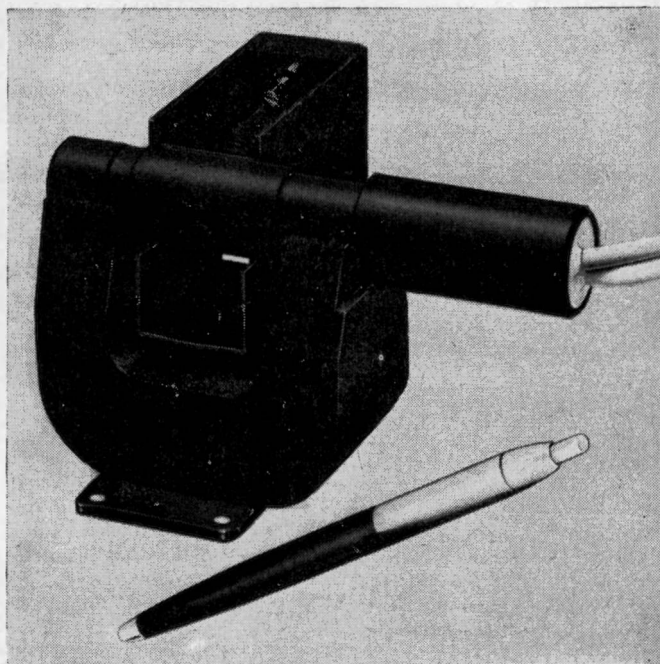

YJ1120 magnetron

Compared to standard magnetrons, all of these long life versions offer particular advantages to companies operating rental schemes — expected average cost per normal running hour is some 50% lower and cost per guaranteed operating hour some 65% lower.

These magnetrons are of packaged construction and, at normal temperatures, can be cooled by natural air flow.

For further details of Mullard YJ1110, YJ1111, YJ1120 and YJ1121 magnetrons, please use the reply card of this journal (see reference opposite).

What's new from Mullard

Competitively Priced Varactor Diode Introduced

Power source for low power
V.H.F. and U.H.F. transmitters

Mullard's latest silicon planar varactor diode, type BAY96, a highly efficient frequency multiplier, has been introduced to meet the growing demand for competitively priced power sources for solid-state v.h.f. and u.h.f. transmitters; power output stages in telemetry equipments and driver stages for microwave harmonic generators are other suitable applications for this device.

The BAY96 has a higher power rating than the now well-known BAY66. Rugged and dependable, the BAY96 is eminently suitable for the most advanced military and civil low power mobile transmitters. Used as a trebler, the BAY96 will provide an 18W output at 450Mc/s from a 30W 150Mc/s source—a typical efficiency of 60%. Used as a doubler, an 8W output at 1Gc/s can be obtained from a 20W 500Mc/s source—the efficiency in this case is 40%. The BAY96 can also be used as a quadrupler, providing 5W at 480Mc/s from a 10W 120Mc/s source—50% efficiency.

The varactor is encapsulated in a low inductance, hermetically sealed, welded, ceramic-metal DO-4 envelope. It is designed to

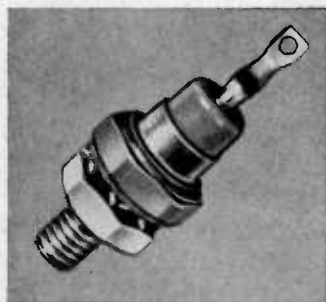

operate over a wide temperature range; maximum junction temperature is 175°C. Low series resistance ensures minimum diode losses and high efficiency.

Brief data:

V_{Rmax}	120V
$P_{tot,max}$ ($T_{case} = 25^{\circ}C$)	20W
$T_{j,max}$	175°C

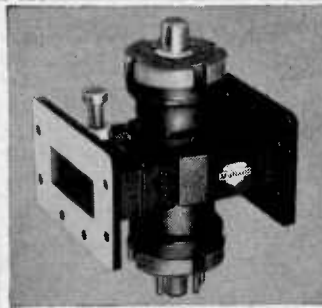

NEW KLYSTRONS GUARANTEED FOR 5000 HOURS

A guaranteed 5000 hour life is offered by Mullard's new type YK1070 series of 1W communications reflex klystrons. Designed for use in the output stages of medium capacity microwave links, all klystrons in this range are mechanically and electrically similar to the VA222 series and can be used as alternatives.

Klystrons in the YK1070 series exhibit excellent stability with 1W output power over a frequency spectrum of 5.925 to 8.1Gc/s. Mechanical tuning is by screw adjustment of the external cavity. Contact cooling allows economies to be made in the cost of the overall system by the elimination of the blower usually required; this feature also improves the overall reliability of the system.

The output connection is by waveguide WR137, i.e. British size 14.

New module
provides
cheap,
simple and
reliable
current
limiting

Another recent addition to the Mullard range of potted modules is a current limiting module type MY5051 which has been designed for use with existing thyristor firing modules and stacks.

The introduction of this module enables either single-phase or three-phase control systems to be built with automatic correction for load current variations or short-circuit conditions as well as to provide slow start facilities for motor controls.

The MY5051 is a cheap reliable and simple module which may be connected in a feedback circuit between a current sensing transformer (or other current sensing device) and a thyristor firing module. The onset of current limit occurs when the input signal to the MY5051 is 2.6V r.m.s. At lower inputs, the MY5051 has little effect on the control circuit but at higher inputs the trigger angle of the thyristor is rapidly increased.

FIVE NEW DOUBLE-DIFFUSED EPITAXIAL TRANSISTORS

Mullard now offers a range of five new '1 amp' n-p-n double-diffused silicon planar transistors which fully meet the requirements for the well-known JEDEC types 2N696, 2N697, 2N1420, 2N1613 and 2N1711, and also complement the performance coverage offered by Mullard's popular BFY50 series. Double-diffused

construction provides these new devices with extremely linear gain/current characteristics and consequently makes them ideal for service in circuits where linearity must be maintained down to low current levels. Another attractive aspect of this range is that all devices are offered at very competitive prices.

The high collector/base voltage ratings of these transistors together with their linear charac-

teristics make these devices an obvious choice for use in d.c. or high frequency amplifiers. Their suitability for industrial high current switching applications is apparent from the high cut-off frequency and low collector/base capacitance quoted. Linear circuit designers will be particularly interested in the detailed specifications prepared for types 2N1613 and 2N1711.

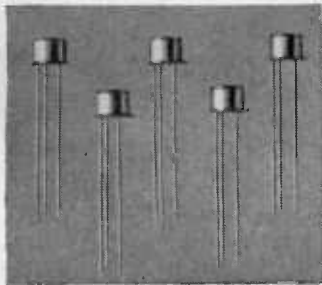

Brief data:	60V	60V	60V	75V	75V
V_{CBO}	2N696	2N697	2N1420	2N1613	2N1711
V_{CEO}	40V	40V	30V	30V	30V
P_{tot}	600mW	600mW	600mW	800mW	800mW
$T_{j,max}$	175°C	175°C	175°C	200°C	200°C
$h_{FE}(150mA)$	20-60	40-120	100-300	40-120	100-300
f_t	40Mc/s	50Mc/s	50Mc/s	60Mc/s	60Mc/s
V_{CESat}	1.5V	1.5V	1.5V	1.5V	1.5V
V_{BESat}	1.3V	1.3V	1.3V	1.3V	1.3V

FURTHER DETAILS of the Mullard products described in this advertisement can be obtained from the address below or through the Reader Information Service of Electronic Engineering using the appropriate code number shown below.

YJ1110, YJ1111, YJ1120,
YJ1121 Magnetrons . EE 94 350
BAY96
Varactor Diode EE 94 351
5 New
Epitaxial Transistors. EE 94 352
YK1070 Series
Klystrons. EE 94 353
MY5051
Potted Module. EE 94 354



Mullard Limited, Mullard House, Torrington Place, London, WC1. Telephone: LANgham 6633



Registered Office:
 PENNINE HOUSE,
 78, SHAW ROAD,
 ROCHDALE, LANCs.

General Secretary:
 MR. W. BIRTWISTLE, M.Inst.E.
 Tel. Rochdale 48759

Est. 1930

Inc. 1935

The Institution of Electronics takes this opportunity to remind you that its
**TWENTY-FIRST ANNUAL ELECTRONICS, INSTRUMENTS,
 CONTROLS and COMPONENTS EXHIBITION and CONVENTION**
 is to be held at
BELLE VUE, MANCHESTER,
 from **SEPTEMBER 27th to OCTOBER 1st inclusive, 1966**

For Conditions of Exhibiting at, or to request that your name be added to the Mailing List of, this the Largest Annual International Electronics Exhibition and Convention held in the United Kingdom, write to the General Secretary, The Institution of Electronics, Pennine House, 78, Shaw Road, Rochdale, Lancs. Catalogue (Post free 4/9d.) will be available from September 12th, Preview (Post free 7d.) available from September 1st.

For Institution Membership Details write to Membership Registrar



CROPICO POTENTIOMETERS

This potentiometer is a medium grade instrument suitable for general laboratory use, such as the calibration of instruments, measurement of resistance, voltage and current, calibration of wattmeters, thermocouple measurements, photoelectric measurements, etc.

The instrument is completely self-contained, having a built-in sensitive spot reflecting-galvanometer, standard cell and supply battery.

The potentiometer has an independent standardizing circuit so that standardization against a standard cell may be effected independently of the setting of the main dial. The circuit incorporates a device which automatically compensates for changes in standard cell voltage due to ambient temperature changes.

		ACCURACY	
THREE RANGES	0 to 1.8 Volts	0.02%	or 0.2mV
	0 to 0.18 Volts	0.03%	or 25 μV
	0 to 0.018 Volts	0.04%	or 3 μV

Delivery prompt

Also Manufacturers of:—VERNIER POTENTIOMETERS, WHEATSTONE BRIDGES, FOR FULL DETAILS REQUEST LEAFLET No. 54 THERMOCOUPLE SWITCHES, KELVIN BRIDGES, RESISTANCE BOXES, ETC.

CROYDON PRECISION INSTRUMENT COMPANY

HAMPTON ROAD · CROYDON · SURREY Telephone THORNTON HEATH 4025 & 4094

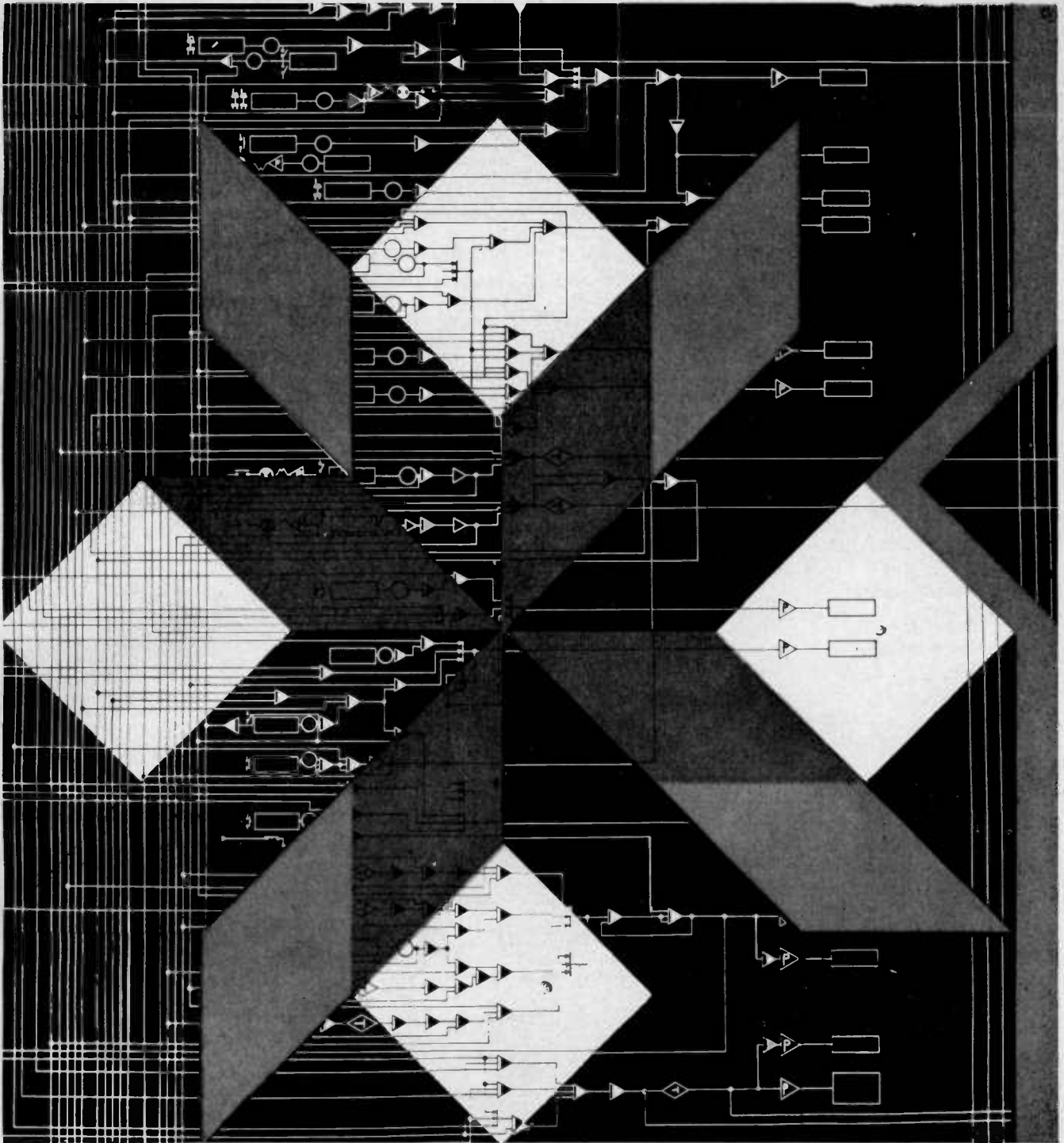

Automation
Tape recording
Programming
Information and data processing
Data transmission

1 MOSA 5 GB *telem*

COMPAGNIE DES COMPTEURS france

C.D.C. (GREAT BRITAIN) Limited
Terminal House - Grosvenor Gardens - London S.W. 1
Telephone : SLOane 8271 - Telex : 23372

A Better Delivery

Four items from the long line of high quality components available QUICKLY from Bourns. Bourns products include the well known TRIMPOT® potentiometers with wirewound, carbon and Palirium® elements; precision potentiometers, relays, time delays, microcomponents and transducers for sensing of pressure, position and

acceleration. Bourns wide range, high quality and rapid delivery will keep you on the right track.

Avoid costly delays and write, phone or telex your order now to Bourns (Trimpot) Ltd.

Use Bourns reliable products and service.

3101
Trimpot® relay
1.0 amp
Double pole
Double throw

Size—
only 0.2" x 0.4" x 0.6"

Operating sensitivity—
160 MW

Temperature range—
-65°C to +125°C

Shock 150G's
11 Milliseconds

Vibration—
40G's to 3000 CPS

Three terminal styles

3250
Trimpot® potentiometer
Humidity proof
—wirewound

Low volume
square shape

1/2" x 1/2" x 3/16"

High temperature—
175°C

Low residual end
resistance—
0.1% or 1.0 ohms

Wiper assembly idles

Standard
Resistances—
10 ohms to 50K ohms

Three terminal styles—
Insulated leads
printed circuit
pins or panel mount

3300
Trimpot® potentiometer
single turn
—wirewound

Smaller than TO 5
transistor size
5/16" diameter x 3/16"

High temperature—
178°C

Excellent shock,
vibration stability

Outstanding humidity
performance

Two printed circuit styles
and Panel Mount

Standard
Resistances—
10 ohms to 20K ohms

3010
Trimpot® potentiometer
High temperature
Humidity proof
—wirewound

Qualified to Mil-R-27208A
Style RT-11

High power—
1.0 watt at 70°C

Excellent shock,
vibration and
acceleration stability

High temperature—
175°C

Sealed against humidity,
liquid and potting compounds

Standard
Resistances—
10 ohms to 100K ohms

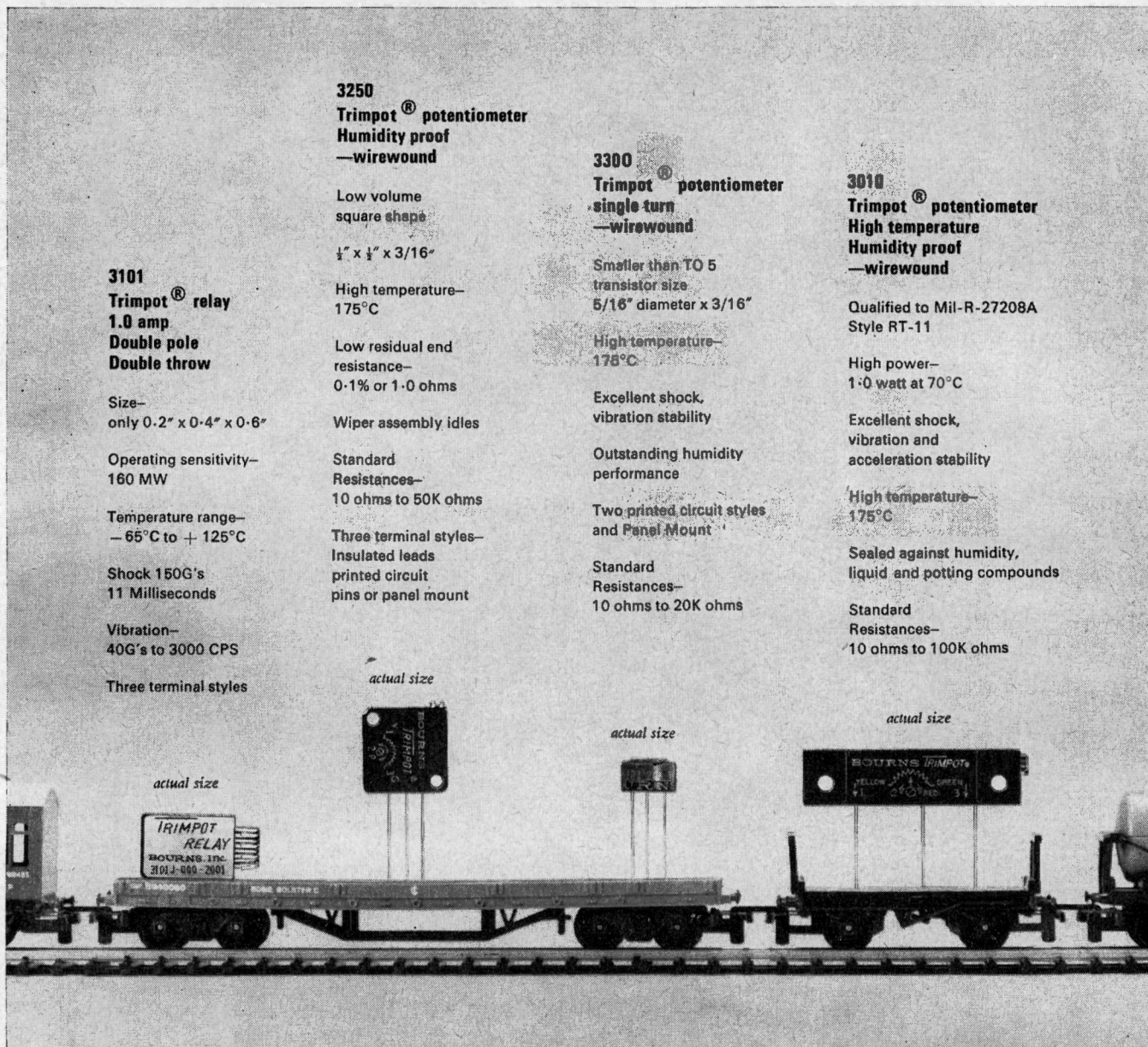

Components for
Commercial
Industrial
and Defence
applications

BOURNS

BOURNS (TRIMPOT) LIMITED
Hodford House, 17/27 High Street,
Hounslow, Middlesex
Tel: Hudson 0111. Telex: 264485

3 more Plug-ins

FOR YOUR
 175A
 OSCILLOSCOPE SYSTEM

 1784A
Strip Chart Recorder

Just push a button to automatically record repetitive waveforms to 30 mc. Cost is 1/20th that of standard photograph.
 Price: £ 340

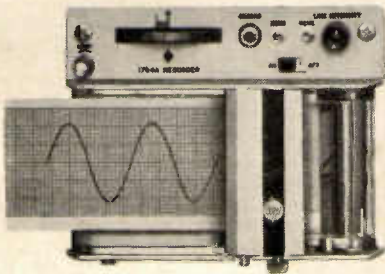

 1750 B
50 mc Dual Trace

Maximum Sensitivity is 50 mV/cm. Simplified triggering insures stable dual trace display.
 Price: £125

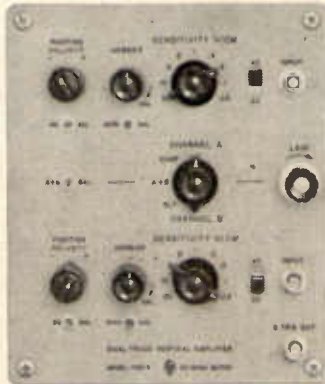



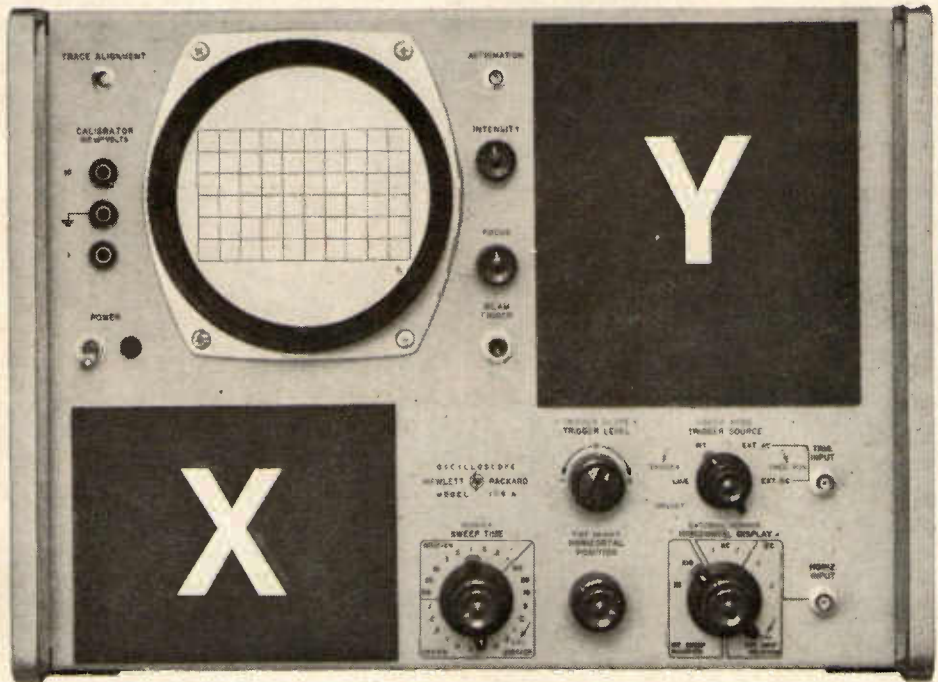





 1755A
High Sensitivity Dual Trace
 With one plug-in: High Frequency (50mc, 10mV/cm) or Low Level (20 mc, 1mV/cm) operation. DC or AC coupled. Simplified triggering as in 1750B.
 Price: £ 253



Y

X

 175A	Oscilloscope	(without plug-ins)	£509
ADDITIONAL PLUG-INS FOR  175A OSCILLOSCOPE			
 1751A	Single Channel Amplifier	50 mc	50 mV/cm
 1752B	High Gain Amplifier	30 mc (or 40 mc)	5 mV/cm (50 mV/cm)
 1754A	Four Channel Amplifier	40 mc	50 mV/cm
 1781B	Sweep Delay Generator	offers four different sweep modes	£ 125
 1782A	Display Scanner	for transferring CRT picture to x-y-recorder	£ 187
 1783A	Time Mark Generator	supplies 10 µsec, 1 µsec, 0.1 µsec markers with 0.5% accuracy	£ 57

Prices are subject to change without notice.

HEWLETT  **PACKARD**
 LIMITED

DALLAS ROAD, BEDFORD, BEDFORD 68052

Headquarters in USA: Palo Alto (Calif.)
 European Headquarters:
 Geneva (Switzerland)
 European Plants: Bedford (England),
 Böblingen (Germany)



SOLENOIDS

Series 390.

Thrust type solenoid for valve operation.



SOLENOIDS

Series 420 (A/C) 425 (D/C)

Miniature thrust type solenoids.



SOLENOIDS

Series 421-428.

A range of AC or DC solenoids in 'U' frames.

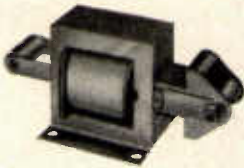

SOLENOIDS

Series 573.

A compact AC solenoid of laminated construction. Pull or thrust versions available.



SOLENOIDS

Series 575 & 576.

Heavy duty AC solenoids. Pull or thrust versions available.

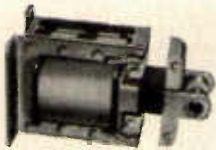

SOLENOIDS

Series 684.

AC solenoids with high force/size ratio. Pull version only.

RS.1014.

There are many factors to be taken into consideration when selecting a solenoid, including stroke, force required, rating, response time and ambient temperature etc. As it is very important to match a solenoid to the duty it is required to perform, why not let our Design and Application Engineers match your requirement from our extensive range. If you require our catalogue, a sample, a quotation—our help in any way make contact with Magnetic Devices now.



M.O.A.—A.R.R.E.—A.R.B. Approved Inspection
G.P.O. & C.E.G.B. Approved Suppliers

MAGNETIC DEVICES LIMITED
NEWMARKET · SUFFOLK · ENGLAND
TEL: NEWMARKET 3461 (10 LINES)

Grams: Magnetic Newmarket Telex 81245

MANUFACTURERS OF RELAYS, TIMERS & CONNECTORS

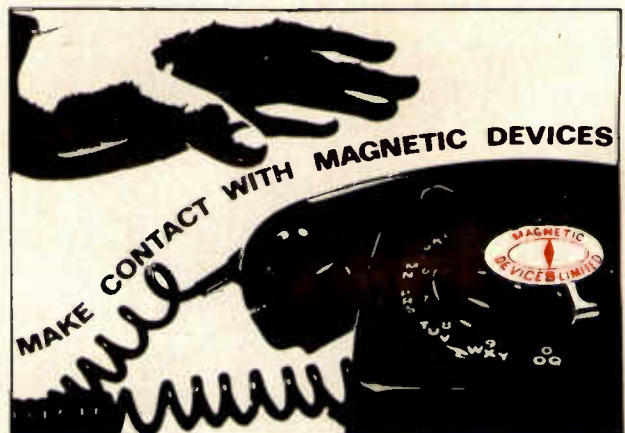

Autronex
gold plating
is available in
8 basic
versions



... Solving your problem
might make it 9

In electronic components, a minute variation in requirements can create the need for a new gold plating process. That's why we have 8 distinct formulations of Autronex[®]. Originally each was a response to a particular plating problem. Today, these same 8 basic formulations are meeting hundreds of requirements. That's a major advantage of working with Sel-Rex. Our scientific approach allows

us to change existing processes and create new ones as needed. Our ability to meet these needs has made Autronex the most widely used process in electronics throughout the world. If you're looking for a means of improving your precious metal plating let us know the details of your application requirements.



SEL-REX (U.K.) LIMITED

Subsidiary of Sel-Rex Corporation

689 Stirling Road, Trading Estate, Slough, Bucks. Telephone: 26649 Telegrams: Eesarex. Slough.

what
do you look for
in an
oscilloscope?



...accuracy?
...reliability?
...low cost?

only **rob and** combine precision and reliability at such low cost



the R050A is a superb instrument of consistent performance

ABRIDGED SPECIFICATION

- Bandwidth:** D.C. - 25Mc/s at 50 mV/cm (DC - 15 Mc/s at 5 mV/cm)
- Operating Modes:** single and dual trace
- Triggering:** advanced circuitry ensures triggering over complete bandwidth
- Signal Delay:** permits viewing of leading edge of pulse
- Time Base:** 23 calibrated sweep speeds from 0.1 microseconds/cm - 2 secs/cm
- Magnifier:** extends range down to calibrated 0.02 microseconds/cm
- Accuracy:** $\pm 3\%$ assured by stabilised EHT and power supplies
- Display:** 6 cm X10 cm high brightness by use of 11.5KV on the CRT
- Versatility:** ensured by a range of standard plug-in-units
- Economy:** prices range from £276-£330 according to choice of plug-in-unit

rob and
 Electronics Limited
 Charwood Works
 Charwood
 Horley, Surrey
 Crawley 20172

DIGITAL MEASUREMENT OF TRUE R.M.S.



Now optional to all d.c. DVM users

Accuracy, versatility, and soundness of construction set the Dynamco DM2140 apart from all other a.c.-d.c. converter systems. *Accuracy* between 30 c/s and 3 Kc/s is 0.025% f.s.d. \pm 0.075% of reading—not under special conditions but for a full year's use over a realistic ambient temperature range of 10-40°C. *Versatility* results from plug-in modular design, and includes options such as mean measurement r.m.s. calibrated for sine wave input, true r.m.s. conversion, and range extension to 1 KV r.m.s. *Soundness of construction* has been confirmed for us by the military, who now include the DM2140 in their CT470 Set.

Ask for a full specification of the Dynamco DM2140 a.c. to d.c. system, designed to convert the world's best d.c. digital voltmeters into the world's best a.c. digital voltmeters.



DYNAMCO Dynamco Instruments Limited *incorporating Digital Measurements*
Salisbury Grove · Mytchett · Aldershot · Hampshire · Telephone Farnborough 44422



LEADS WITH LOW COST DIODES

**HIGH
PERFORMANCE
1-AMP DIODE
FOR
HALF A CROWN**

Made in bulk quantities in the U.K. —a new high-performance 1 amp, 1000V subminiature diode, with void-free injection moulded encapsulation, surge capacity up to 50A. Applications are as endless as supplies. Value is unbeatable at prices down to 2/6d each.

Yet another addition to the world's most used range of semiconductors.

ExpIRience counts!

Full details available on request.



INTERNATIONAL RECTIFIER • HURST GREEN • OXTED
SURREY • TELEPHONE OXTED 3215
TELEX RECTIFIER OXTED 95219



INTERNATIONAL RECTIFIER



163 different Mullard Zener Diodes

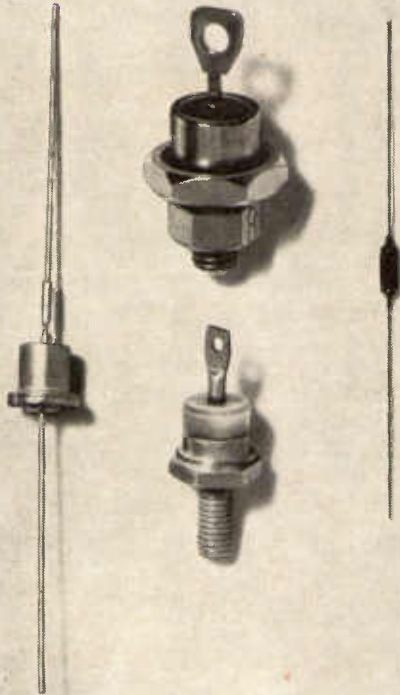

‡ 3.3 to 75V... 0.28 to 75W

‡ 5% tolerance

‡ new low prices

Mullard silicon voltage regulator (Zener) diodes give you $\pm 5\%$ voltage tolerances at prices normally associated with tolerances of $\pm 10\%$ or 20% .

In the wide Mullard range there are 163 different voltage/power ratings—from 3.3 to 75V (E24 log-series values) and 280mW to 75W. They exhibit sharp knee characteristics, low dynamic resistance and low leakage currents.

MULLARD RANGE OF SILICON VOLTAGE REGULATOR (ZENER) DIODES

	Voltage Range	Power Rating	Encapsulation
*BZY91	10 to 75V	75W	DO-5
*BZY93	6.8 to 75V	20W	DO-4
OAZ222-OAZ223	5.6 and 6.2V	10W	DO-4
BZY96	4.7 to 9.1V	1.5W	DO-1
BZY95	10 to 75V	1.5W	DO-1
BZY88	3.3 to 9.1V	0.4W	DO-7
† BZY94	10 to 75V	0.4W	DO-7
BZY78	5.3 typical	0.28W	DO-7

BZY91 series is capable of withstanding peak surges of 4.4kW for a 100 μ s.

**Available with either normal or reverse polarities. † To be released shortly.*

A New Publication Every designer should have his own copy of Mullard's new publication 'Voltage Regulator (Zener) Diodes' which includes detailed considerations of voltage-stabilising, voltage-shifting, voltage-clipping and other circuits. It's free... just write to Mullard for your copy.

Mullard

Mullard Limited, Industrial Markets Division,
Mullard House, Torrington Place, London, W.C.1. LANGHAM 6633.

Vacuum Products
Bulletin No. 4

Now—Another triode ion pump from AEI. Only £258 complete.

81037

Here's a chance to re-think your clean Ultra High Vacuum practice with the P8 a new 8 litres/sec triode ion pump—the latest addition to the AEI range.

Look what you get!

- **Low Cost**—complete station only £258
- **Flexibility**—small, compact; available for glass or metal systems
- **Ultra High Vacuum**—goes below a clean 10^{-11} torr
- **Longevity**—rugged triode element lasts thousands of hours at 10^{-9} torr
- **Versatility**—starts easily; pumps argon; pumps stably
- **Information**—control is pressure indicating to $5 \cdot 10^{-9}$ torr

See how you save!

A triode ion pump gives CLEAN vacuum—no oil, no contaminants. No liquid nitrogen means no supply bills—and no worries about whether you'll get the trap refilled in time. No protection circuits to wire up—no ion gauge to buy—no filaments to replace. To shut down—switch off, unplug, put it in the cupboard and forget about it till you need it again. Tomorrow, next year, whenever you need it again, it will start instantaneously from as high as 50 millitorr and pump down to ultimate—fast!
8 litres/sec too small? AEI has triode ion pumps 25, 120, 300, 600 litres/sec too.

VACUUM PRODUCTS

Write or phone: K. F. Jackson, Vacuum Products Sales, **Scientific Apparatus Department**, Associated Electrical Industries Ltd., Barton Dock Road, Urmston, Manchester. Tel: (061) LONGford 4466 Ext. 385



AEI

ELECTRONICS

THINK
SOLARTRON



SOLARTRON

Integrating Digital Voltmeter LM 1420.2 measures d.c. voltages from 2.5 microvolts to 1000 Volts with an accuracy of 0.05% i.e. ± 1 digit, at a maximum rate of 33 readings per second. Maximum input resistance is > 5000 megohms, both input terminals are fully guarded with an isolation impedance of 10^9 megohms/150pf to earth. Common mode rejection is thus 150dB d.c. and 130dB a.c.

The integrating technique together with optional 30dB filter gives 60dB attenuation of input noise.

Detailed information will be sent on request and Solartron Engineers are available to discuss applications.

LM 1420.2 forms part of a comprehensive range of instruments designed to meet every laboratory and industrial application. These include a True R.M.S. reading a.c. Converter a Mean Sensing a.c. Converter and a Digital Resistance Test Set.

An outstanding feature of the a.c./d.c. versions (shown right) is their completely isolated inputs. AC common mode rejection

as high as 60dB at 50 c/s is achieved. The LM 1420.2 also forms the basis of a low cost compact logger comprising 20, 50 or 100-Channel Scanning Units, Print-Out Units and other Data Logging Modules.

Measurement in the Presence of Noise
Under practical conditions, noise interference is one of the major obstacles to accurate measurement using a digital voltmeter. The LM 1420.2 Integrating Digital Voltmeter employs average reading, which greatly reduces the effects of superimposed interference and the instrument incorporates an isolated and guarded input circuit to eliminate common mode noise. Isolation is maintained even when an earth referenced print-out device is used.

THINK
SOLARTRON

EE 94 032 for further details



NO OTHER LOW-PRICE DIGITAL VOLTMETER

OFFERS...

- 2.5 microvolts – 1000 Volts d.c.
- 10 microvolts on top of 500 Volts peak common mode – even with printer connected
- 10 microvolts d.c. through 10 millivolts of noise
- 1 millivolt d.c. from a 100 megohm source impedance
- Integration minimises super-imposed noise
- 33 conversions per second

SOLARTRON

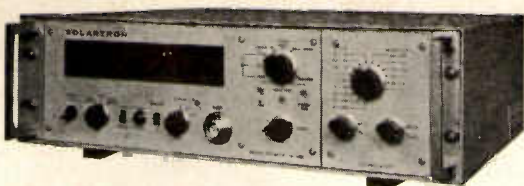

AC/DC Versions of LM 1420.2
LM 1420.2BA True R.M.S. sensing
LM 1420.2BM Mean AC sensing



THE SOLARTRON ELECTRONIC GROUP LTD.

FARNBOROUGH, HANTS, ENGLAND
TEL: FARNBOROUGH (HANTS) 44433
TELEX: 85245 SOLARTRON FARNBOROUGH
CABLES: SOLARTRON, FARNBOROUGH

**A MEMBER OF THE
SCHLUMBERGER GROUP**

M & P S221

- HIGH PERFORMANCE
- HIGH VOLTAGE RECTIFICATION—SMALL PACKAGE
- HIGH QUALITY GLASS ENCAPSULATED DIODES
- HIGH GRADE EPOXY RESIN ENCAPSULATION
- ALL AT LOW COST . . .

... SPECIFY HUGHES CARTRIDGE RECTIFIERS

Type	Max. Inverse Voltage KV	Max. Reverse Current at P.I.V. at 25°C	Max. Forward Voltage Drop at 100mA	Case Size
HSC1	1.0	5μA	2V	.375 dia. x .5"
HSC015	1.5	5μA	3V	.375 dia. x .5"
HSC2	2.0	5μA	4V	.375 dia. x 1"
HSC3	3.0	5μA	6V	.375 dia. x 1"
HSC4	4.0	5μA	8V	.5 dia. x 1"
HSC5	5.0	5μA	10V	.5 dia. x 1.5"
HSC6	6.0	5μA	12V	.5 dia. x 1.5"
HSC7	7.0	5μA	14V	.5 dia. x 2"
HSC8	8.0	5μA	16V	.5 dia. x 2"
HSC9	9.0	5μA	18V	.5 dia. x 2.5"
HSC10	10.0	5μA	20V	.5 dia. x 2.5"
HSC12	12.0	5μA	24V	.5 dia. x 3"
HSC15	15.0	5μA	30V	.55 dia. x 4"
HSC18	18.0	5μA	36V	.55 dia. x 5"
HSC20	20.0	5μA	40V	.55 dia. x 5"
HSC25	25.0	5μA	50V	.55 dia. x 7"
HSC30	30.0	5μA	60V	.55 dia. x 8"

HUGHES CARTRIDGE RECTIFIERS in their standard form are rated at up to 30KV peak inverse voltage with forward currents up to 100mA. The use of high grade glass diodes, welded interconnections, and epoxy encapsulation, ensures a rugged, reliable component. The lead-out wires of tinned nickel can be soldered or welded. Special assemblies such as bridges, multipliers or different mechanical configurations can be designed to suit special applications.

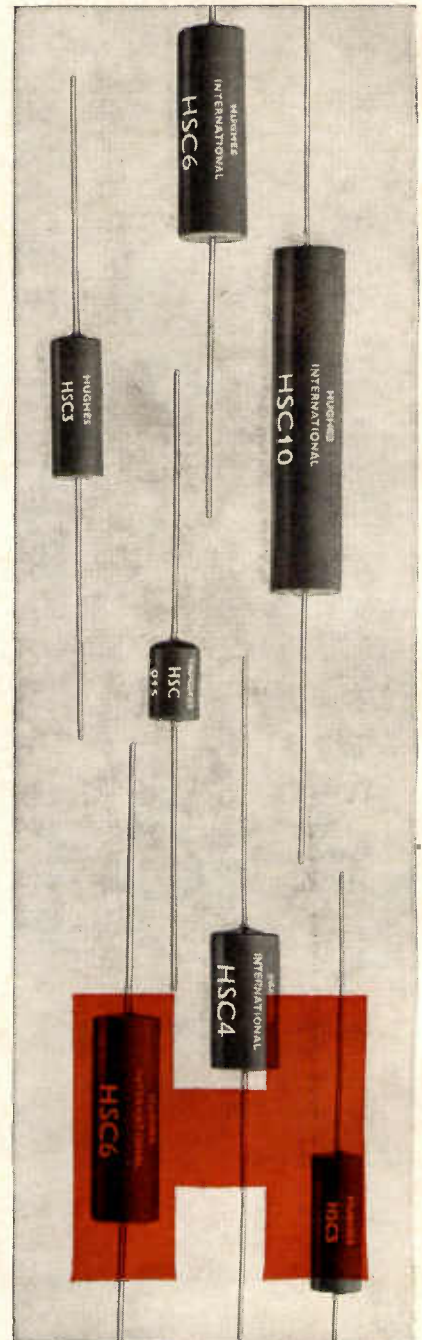

M & P HM 28

HUGHES INTERNATIONAL (U.K.) LTD

GLENROTHES • FIFE • SCOTLAND
 Sales Office: HEATHROW HOUSE, BATH ROAD, CRANFORD, HOUNSLOW, MIDDLESEX.
 Tel: SKYport 9584/5, 9961/2 Telex: 23613

**NOW
HALF
AS
MUCH
FOR YOUR
MONEY**

EE 94 034 for further details

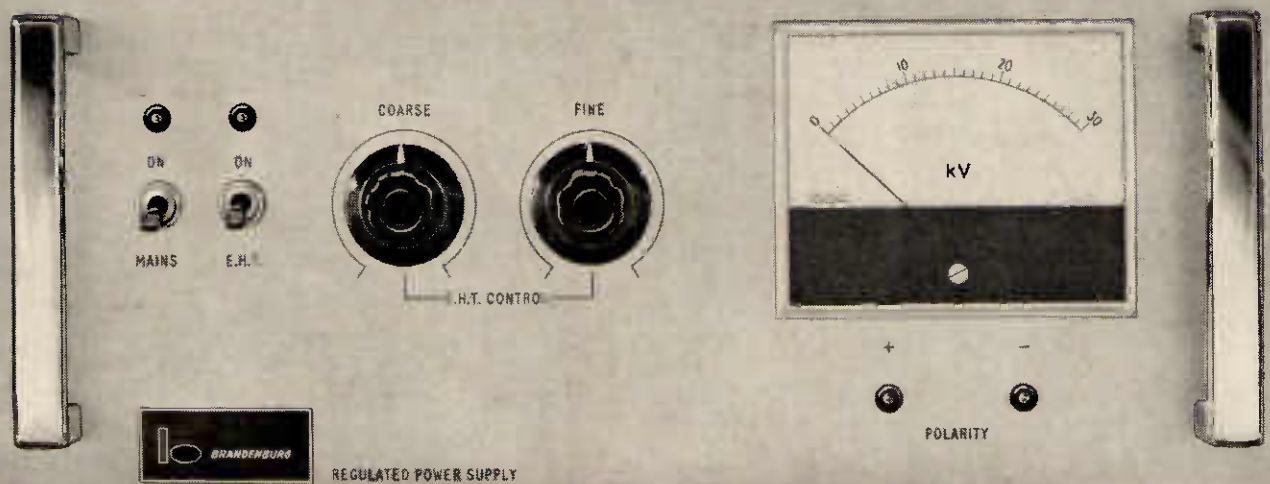

THE NEW
BETA
RANGE FROM
brandenburg
STABILISED HIGH VOLTAGE

FULL DETAILS OVERLEAF

brandenburg

BETA

high voltage power supplies cut panel height by **40%**

The BETA Range of high voltage stabilised power supplies is a completely new development from Brandenburg. Based on unequalled experience of high voltage equipment, the new range combines Brandenburg standards of engineering with new, exclusive features — and packs them into little more than half the volume of previous designs *but has twice the power.*

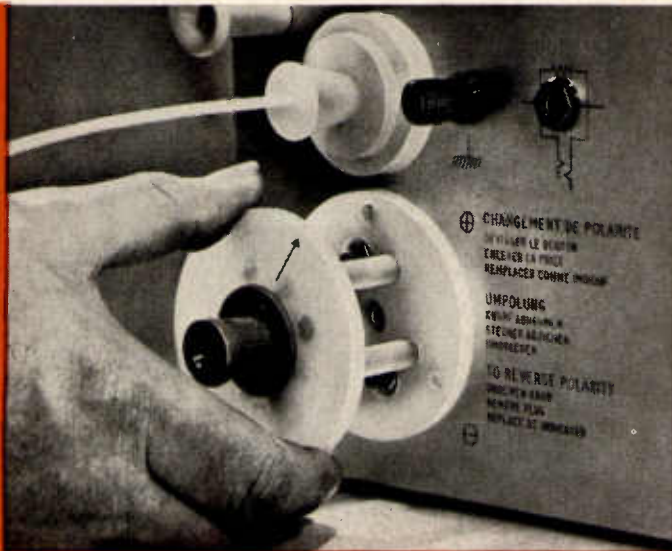

Polarity

Polarity is reversible by the simple changeover of a single plug. This automatically reverses meter and amplifier phase by remote switching, and disconnects EHT for safety during the operation which takes only 15 seconds.

EE 94 035 for further details

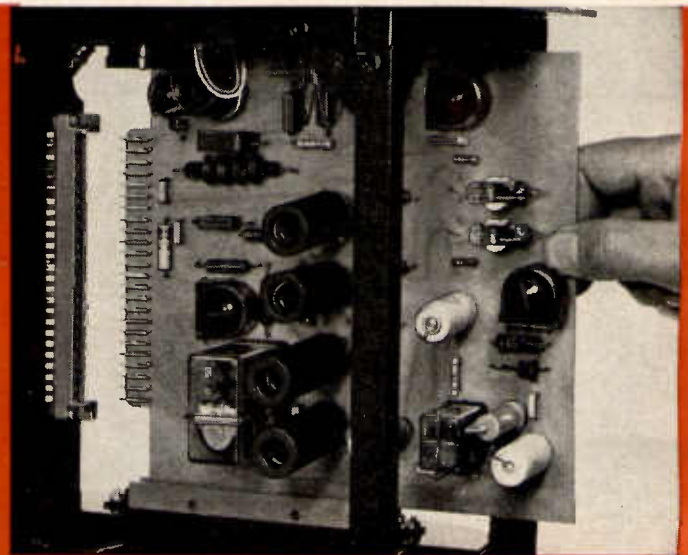

Amplifier

The comparator-amplifier and reference is built as a printed circuit board with edge connector for easy removal.

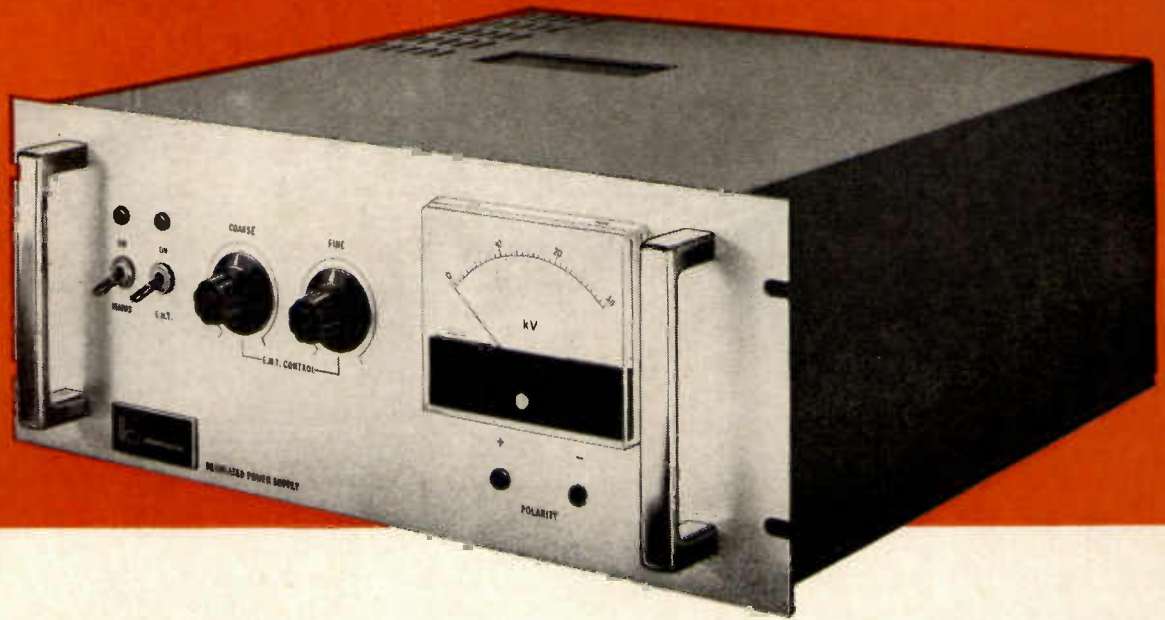

Performance

Despite their compact proportions the BETA Range Models compromise with neither reliability nor specification; they are high quality, general purpose instruments suitable for every industrial use and many laboratory applications. **Ripple 0.1%; Regulation 0.25% at full voltage; stability against +10% and -7½% mains is 0.1%.**

Models Available

Models 705 and 800 are outwardly identical units, sharing the same smart, economical styling. Model 705 gives 2mA at 1.5kV to 15kV; Model 800 gives 1mA at 3kV to 30kV. They are built for rack mounting but their clean, crisp design makes them equally elegant (and extremely practical) on the bench

High Voltage Head

The HV head is most carefully engineered, using many specially moulded polythene components. The main resistor chain and the EHT transformer are both resin encapsulated.

Construction

A rigid, light alloy frame, impeccable wiring, first quality components and careful attention to detail make the BETA Range a significant advance, even against traditional Brandenburg equipment.

Best of all, perhaps, price is held at the same very competitive level; both models cost £150.

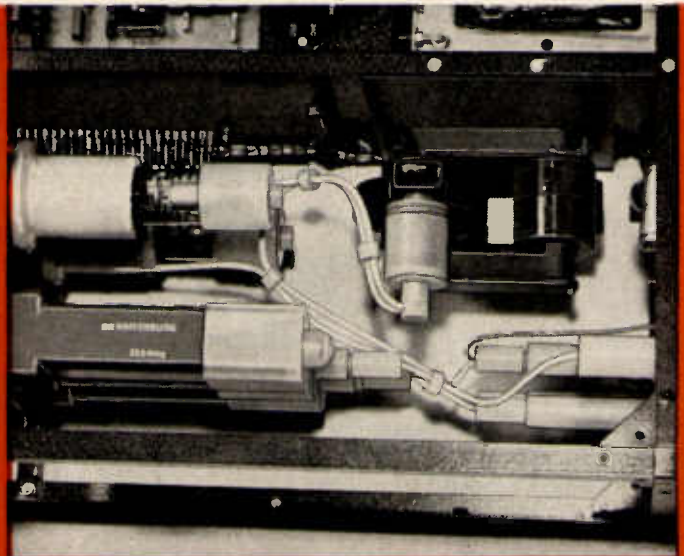

Models 800 and 705 are only the first of the new Brandenburg range and power supplies for other duties will follow. It will always pay you to contact Brandenburg for high voltage stabilised power; Brandenburg are the acknowledged leaders in this field.

Please write for further information on the BETA Range or on any other high voltage power supply:



Brandenburg Limited

139 Sanderstead Road, South Croydon, Surrey
Telephone: Sanderstead 0225

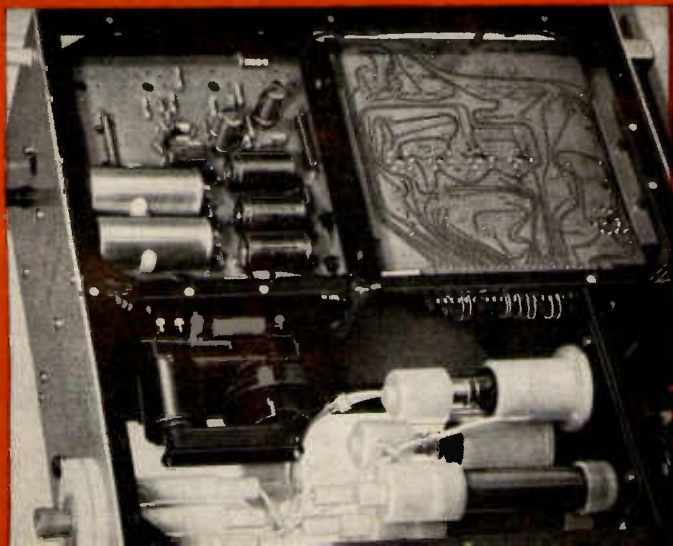

HERE'S HOW...

THE ELECTRONIC INDUSTRY IS USING THESE TWO FAMOUS ULANO FILMS IN ULTRAMINIATURE MASK TECHNOLOGY AND COMPLEX PRINTED CIRCUITRY

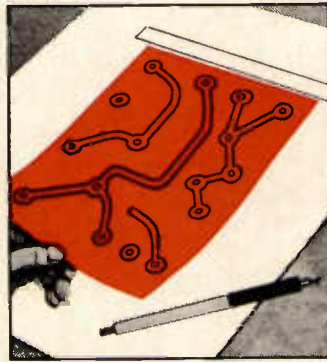

Cut a piece of the desired film large enough to cover area to be masked. Tape it down firmly at the top with dull-side up.



With sharp blade, outline the areas to be masked. Do not cut through the backing sheet. The Ulano Swivel Knife does the job quickly, easily.

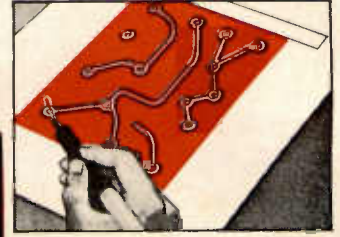

Using the tip of the blade, lift up a corner of the film thus separating it from the backing sheet.

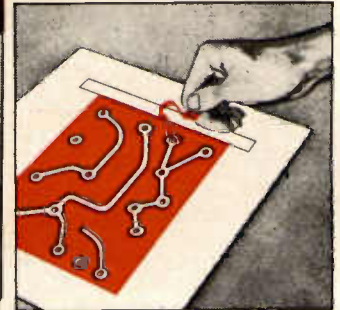

Now carefully peel off the film as outlined leaving a completed mask, positive or negative, that corresponds exactly to the desired pattern.

Ulano

T.M.

RUBYLITH^{T.M.} • AMBERLITH^{T.M.}

HAND CUT MASKING FILMS FOR THE GRAPHIC ARTS

ULANO RUBYLITH... a revolutionary knife cut red film is laminated to a stable transparent plastic backing sheet. The red film is "light safe" so that when contacted to a sensitized emulsion and exposed to a suitable light source, light passes through the cut-out portions only... not through the red film. ■ The polyester backing is absolutely stable...insures perfect register. ■ Special effects such

as crayon tones, paste ups, benday sheets, and opaquing are easily combined with versatile ULANO RUBYLITH.

ULANO AMBERLITH... a companion to Rubyolith serves as a color separation medium used as the master on camera copy board to secure negatives or positives.

A wide variety of Ulano films—in rolls and sheets—is readily available

ulano

NEW YORK • CHICAGO • ZURICH

"Ulano", "Rubyolith", "Amberlith" are registered trade marks of the Ulano Companies.

610 DEAN ST., BROOKLYN, N. Y. 11238
In Europe: ULANO A. G., Untere, Heselbachstrasse No. 22
Kusnacht, Zurich, Switzerland



WRITE TODAY

on your letterhead for free special sample kit 1878

Weir

CLEAR FRONT INDICATING INSTRUMENTS

DESIGNED FOR

MODERN ELECTRONIC EQUIPMENT

Send for Descriptive Literature

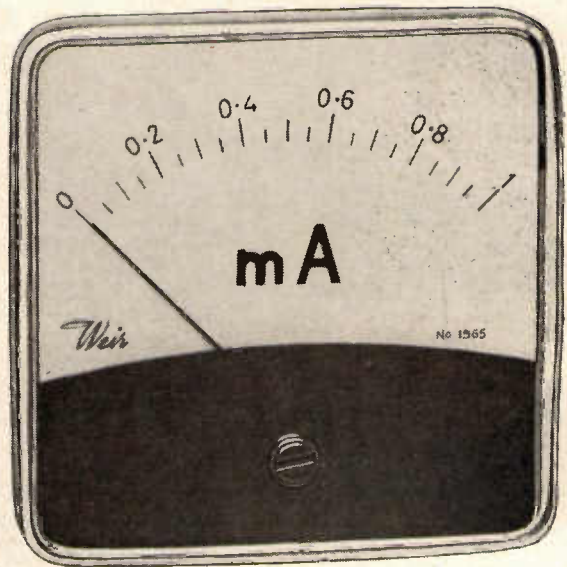

MOVING COIL, MOVING IRON

AND

RECTIFIER TYPES

THE WEIR ELECTRICAL INSTRUMENT CO. LTD., BRADFORD-ON-AVON, WILTSHIRE Tel. 2044-5

EE 94 037 for further details

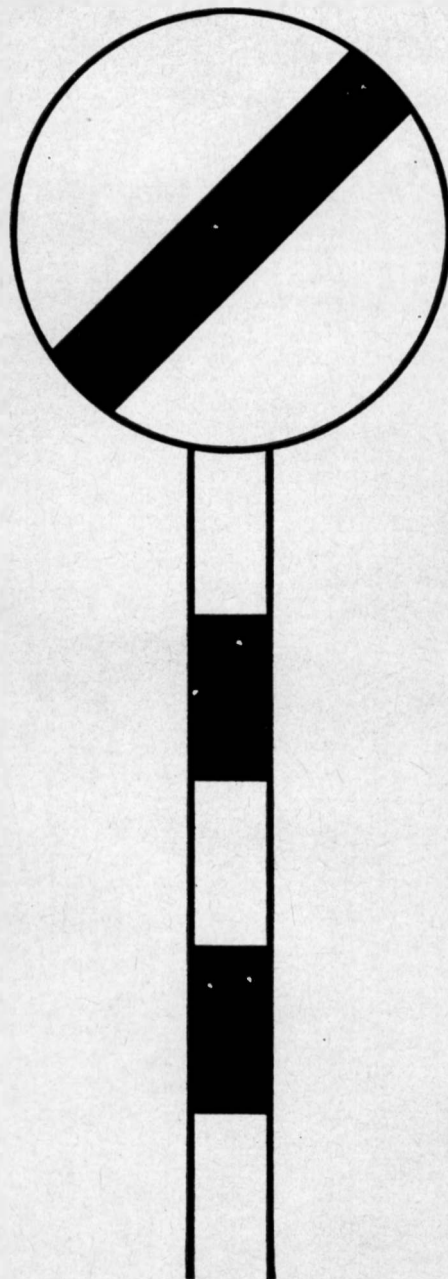

faster to Jo'burg!

- From June BR551 All-Freight Britannias on Africargo services
- Same day arrival Malta, Khartoum, Nairobi and Johannesburg
- Capacity increased to 16 tons ● Fully palletised
- Still 1am Sunday from London



**Firm reservations: British United Cargo Unit
London (Heathrow) Airport Tel: SKYport 4111**

PORTLAND HOUSE, STAG PLACE, LONDON SW1. TELEPHONE: VICTORIA 8121

ANOTHER BRIGHT IDEA FROM M-O V



M-O V introduce the first Dual-trace mesh P.D.A. C.R.T.

M-O V's latest precision instrument C.R.T. is the world's first dual-trace mesh P.D.A. tube. This technique produces new standards in brilliance and sensitivity. A rectangular flat-face tube, the 1300P extends M-O V's wide range of dual-trace precision instrument C.R.T.'s.

The new Dual-trace Tube has all these features:

- 10 kV (Va4) operation for high brightness and writing speed.
- High deflection sensitivities—Sy 5V/cm, Sx 10 V/cm, 1.5kV. Val.
- Deflection blanking.
- Independent astigmatism adjustment.
- Useful scan (each trace)—6 cm x 10 cm.
- Full overlap of traces.
- Rectangular flat face to save panel space 12 cm x 9 cm.
- Spot size 0.35 mm shrunk raster for a current of 5 μ A per beam.

This new tube joins M-O V's other dual-trace precision instrument C.R.T.'s to form the widest range of such tubes in the world



THE M-O VALVE CO LTD

Brook Green Works • Hammersmith • London W6 • Tel. 01. 603. 3431 • Telex 23435



DON'T READ THIS

IF YOU ALREADY USE COSSOR COMMUNICATIONS EQUIPMENT

If you do already use Cossor Communications Equipment then you'll know all the tremendous advantages, and economies, that clear reliable communication can bring to your work. If you don't, then why not contact Cossor for a complete survey of your activities and recommendations for a system?

Cossor have a highly skilled planning division and of course the range of equipment covers every requirement from personal pocket sets to UHF point-to-point links.

COSSOR MEANS COMMUNICATIONS

Cossor Communications Co., Ltd.,

The Pinnacles, Elizabeth Way, Harlow. Tel: Harlow 26862. Telex: 81228. Cables: Cossor, Harlow.

STAND G 207 I.E.A. EXHIBITION

COSSOR



A.C. Power Supplies give you exactly what you need

		
KM2N Output Power 700 watts	PPA2.5 Output Power 2,500 watts	KRF Output Power 1,000 watts
Frequency Range 30 c/s - 5 Kc/s	Frequency Range 50 c/s - 10 Kc/s	Frequency Range 5 Kc/s - 100 Kc/s
Distortion 0.1%	Distortion 3%	Distortion 5%
Voltage Stability ± 0.03%	Regulation 1%	Output Voltage 25 - 100 Volts

Full specification and details of other types on request

Savage A.C. Power Supplies are available for :-

- **1, 2 or 3 PHASE**
OUTPUTS OF
- **35 VA - 35 KVA**
FREQUENCIES OF
- **6 c/s - 100 Kc/s**

**For Industrial applications and processes;
Research; Testing and Calibration**

*Our Engineers will be pleased to advise on all specific problems.
Write or Phone to:*



W. BRYAN SAVAGE Ltd.
Heath Works, Baldock Rd.,
Royston, Herts.

Telephone: 2412/3, 2424, 3466.

Telex: 81174

THE ULTIMATE IN MASS PRODUCTION COIL WINDING

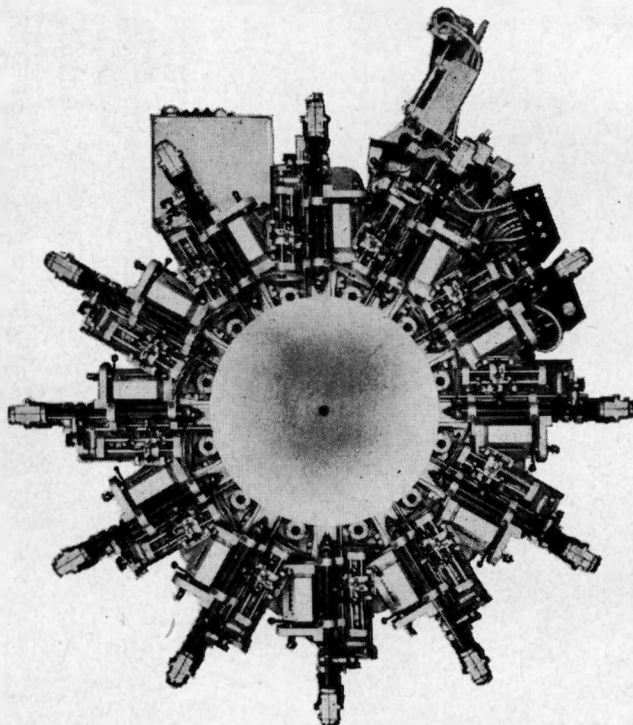

THE AUMANN STAR WINDER

Not just one winding unit, but a combination of twelve separate winding machines; — the Aumann Star Winder is the most productive coil-winding installation available today.

The Star Winder incorporates a rotating indexing table which brings each unit in turn before the operator who merely removes the finished coil and replaces it with an empty bobbin; (wire terminations are automatic, and the wire is never handled). At any time up to ten of the units can be winding simultaneously, while it is also possible to operate them two or three at a time or even singly.

A wide variety of automatic stations are available for taping, cementing, soldering, or twisting, and the fitting of a simple ejection and loading device can make the Star Winder completely automatic.

The Aumann Star Winder is a product of the very highest standards of precision engineering, and is backed by country-wide service. For absolute details of the ultimate in coil-winding, telephone or write to:



R.H. COLE ELECTRONICS LTD.
7/15 LANSDOWNE ROAD · CROYDON · SURREY
TEL: MUNICIPAL 4411

AUMANN

SUD *Electronique* AVIATION

LABORATOIRE DE PHYSIQUE APPLIQUÉE — 12, RUE PASTEUR — 92 — SURESNES, (FRANCE) TÉL. 506.58-24

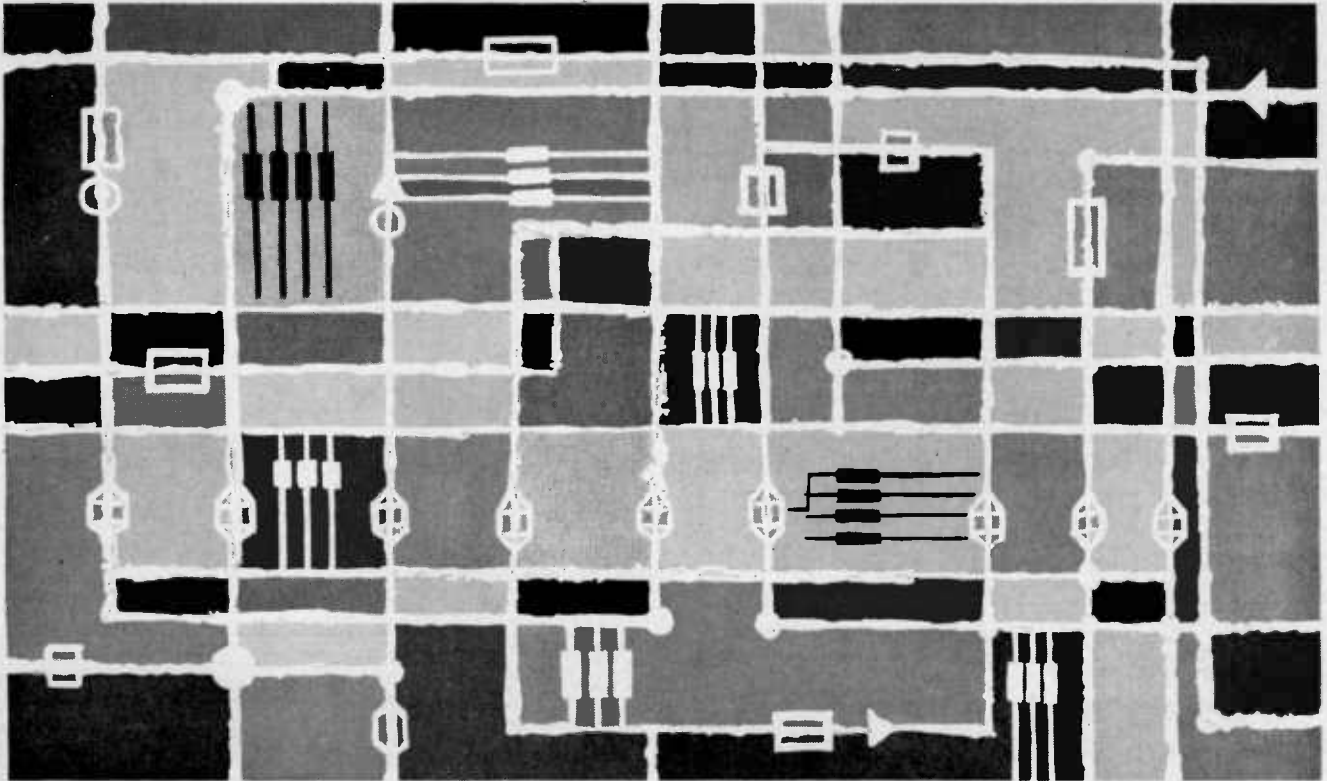

TELEMETERING AND REMOTE CONTROL EQUIPMENT
ANTENNAS
50 AND 400 CPS STATIC INVERTERS
OPTICAL ALTIMETERS
SERVO-CONTROLS
DIGITAL TECHNIQUE
MAGNETOMETERS

EE 94 044 for further details

new

M1310 12 INCH U.V. RECORDER

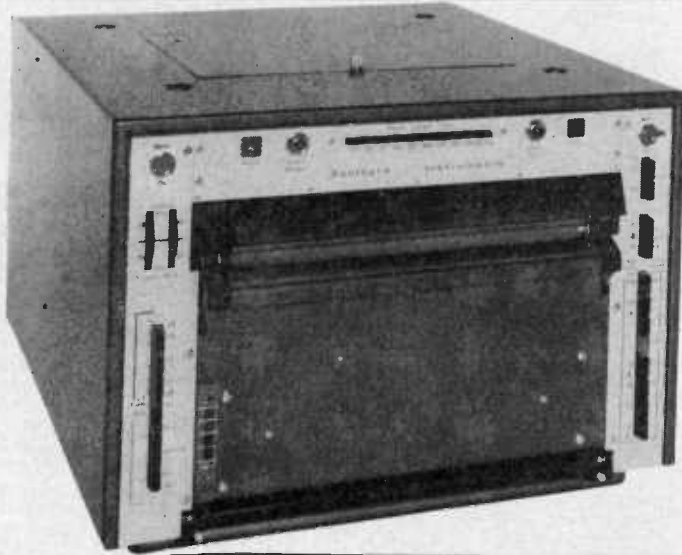

The M1310 U.V. Recorder incorporates many new features PLUS SPEED RANGE OF 0.004 - 25,000 mm/Sec

This instrument offers you versatility and reliability at a very competitive price.

SOUTHERN INSTRUMENTS LIMITED Frimley Road, Camberley, Surrey. Telex 85249. Tel. Camberley 3401 Cables Minrak Camberley.

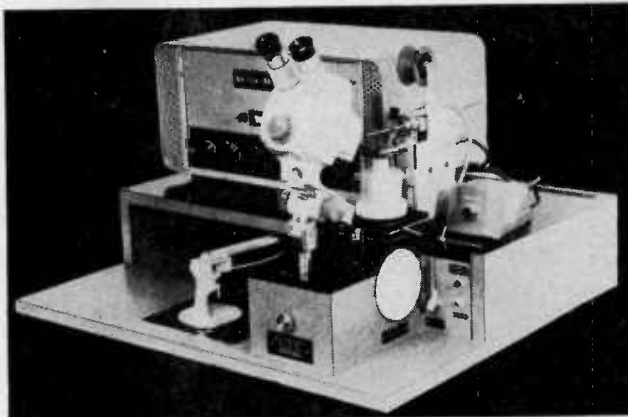

Close-ups of welding tip in position over work-holding chuck. Vacuum chuck above is standard equipment. Mechanical chuck below is optional.

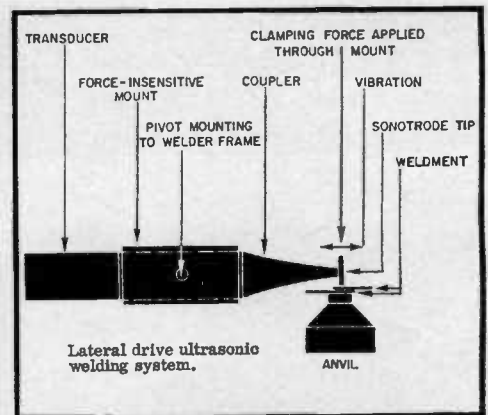

ULTRASONIC MICRO-WIRE BONDING THE MOST ADVANCED WELDING TECHNIQUE FOR MICROCIRCUITRY

From transistors to integrated microcircuits Ultrasonics is a proved production method for lead-wire bonding in mass production.

Kerry's 20 w. W-260-A-welder combines within the one unit all components of wire feed, work manipulation under welding tip, welder head operation and positioning.

Aluminium and gold wires, ranging in size from 0.0005 inch to 0.010 inch diameter, can be welded to both plain and metallised surfaces of silicon and germanium. Copper, nickel, aluminium, gold wires and ribbons can be welded to aluminium, nickel copper, silver, gold, tantalum, chrome, nichrome, platinum and molybdenum films on various glass and ceramic substrates for micro-miniature circuit applications. Such junctions are free of brittle, high-resistance intermetallic compounds, and are characterized by low noise and low ohmic resistance.

- * NO HEAT
- * NO FLUX
- * NO CLEANING
- * NO PURPLE PLAGUE BY REPLACEMENT BY ALUMINIUM WIRE TO SILICON BONDING.

OTHER KERRY ULTRASONIC WELDING EQUIPMENT

Ultrasonic spot, seam, and ring welding equipment is available in a range of sizes and models from 20 watt to 4,000 watt units.



For literature and demonstration please contact
Leaders in ultrasonics

Technical Sales Division Warton Road, London E.15 Phone: Maryland 6611

A member of the Kerry Group of Manufacturing Companies
Factories and Laboratories at Hitchin, Herts and Basildon, Essex.

Broadway/KU 602

EE 94 045 for further details

Cut Piercing Costs 12/- to 15/- in £1 on Short and Medium Runs

BRITISH **WIEDEMANN** TURRET PUNCH PRESSES

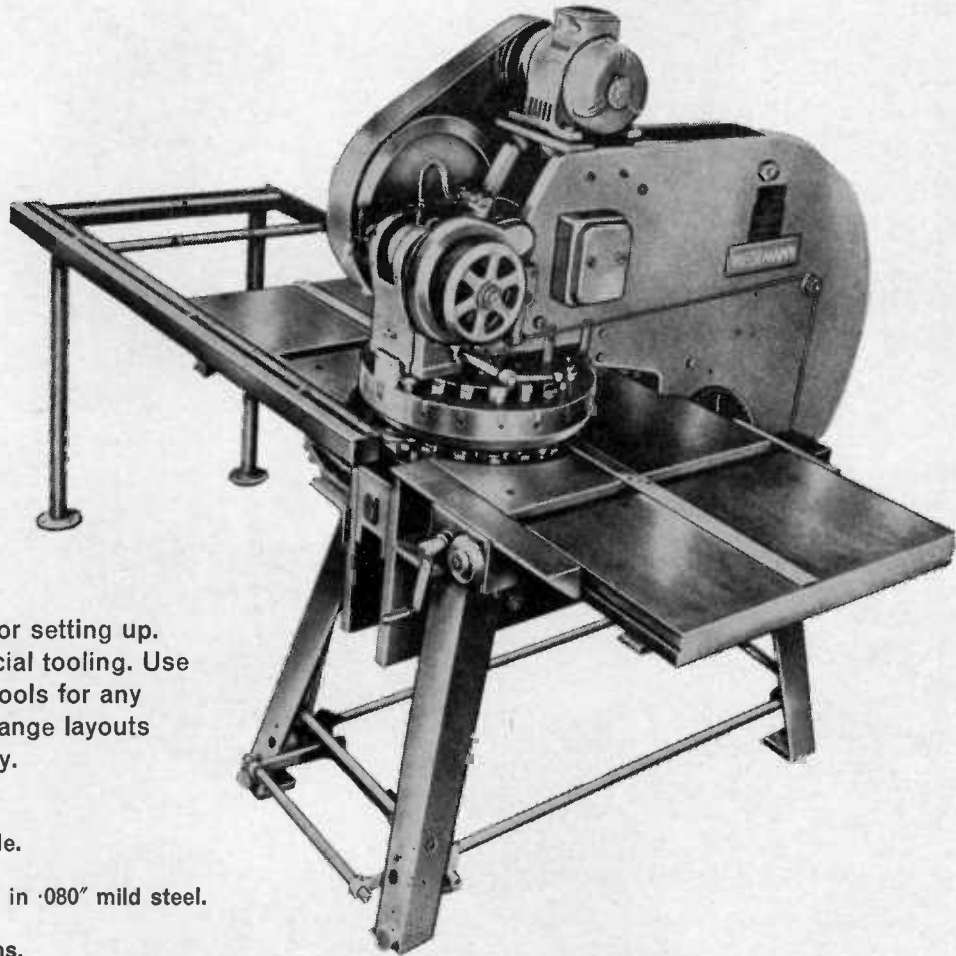

No more laying out or setting up.
No more costly special tooling. Use
the same standard tools for any
layout. Modify or change layouts
quickly, economically.

Model R 41P
With Rack Gauge Table.
Capacity 30,000 lb.
Punches up to 3 1/8" dia. in .080" mild steel.
Throat depth 28".
16, 18 or 20 tool stations.

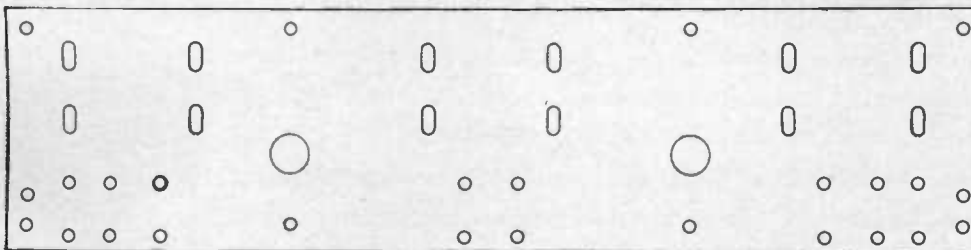

54" x 12" x 1/8" mild steel. Three
standard tools. 40 hits. First
component 20 min. Additional
components 10 min.

There's a Wiedemann press for every short and medium run
piercing job - 6 1/2 to 100 tons capacity: hand, power, automatic

SEE THIS MACHINE IN
OUR SHOWROOMS OR WRITE
FOR BROCHURE EE350



DOWDING & DOLL LTD

17-27 GARRATT LANE, LONDON, SW.18.

TEL: VANDYKE 0181 (8 LINES) TELEX 23182 GRAMS: ACCURATOOL LONDON TELEX

forged...

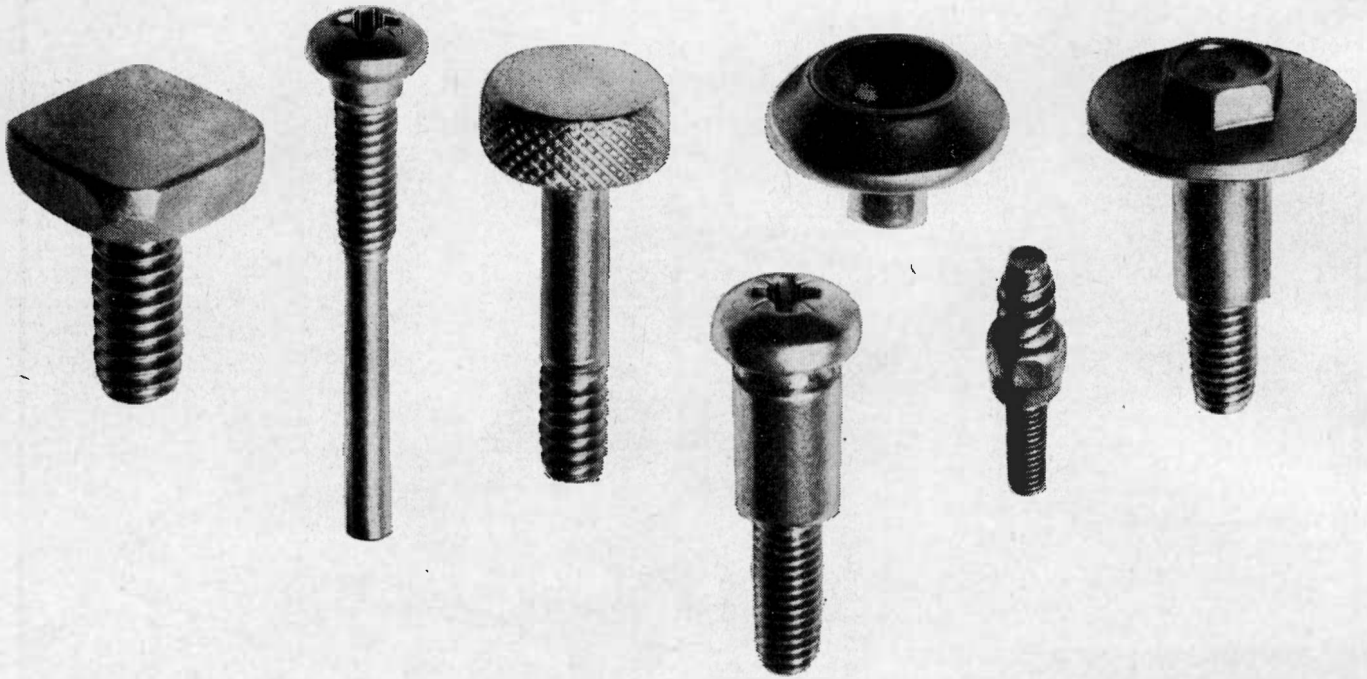

GKN DYNAFLOW®

The new GKN DynafLOW process is a unique combination of cold extrusion with cold heading, for the making of intricate parts. It cuts time, labour, material, *cost*; but it doesn't actually cut the metal. The elimination of turning, milling and other costly secondary operations results in a considerable saving and means improved grain flow. In the extrusion stage, high reductions in cross sectional area are achieved; normally 60% to 70% but up to 90% in softer material, and this coupled with the cold heading process can produce intricate and previously unforgeable products. **GKN DynafLOW can be used to make** large heads (up to 35 unit shank volumes); shoulders; heads with collars; screws in exotic materials; multi-piece items. Extrusions can be round, rectangular, hexagonal or any shape desired, and can be eccentric. **GKN DynafLOW improves products** Besides the extra strength derived from the grain flow and the cold working, DynafLOW often gives improved surface finish over machined items. The process can be used for both fasteners and other precision forgings in a wide variety of material. In a recent application GKN were able to offer a component which saved 49% of the manufacturer's own cost. DynafLOW also improved the product and eliminated surface finish quality problems. **For full details or investigation of particular problems** contact:

GKN Screws & Fasteners Limited, Heath St. Division, Automotive & DynafLOW Product Group, Box 24, Heath St, Birmingham 18. Tel: Smethwick 1441

s/dr/1000

Training Costs

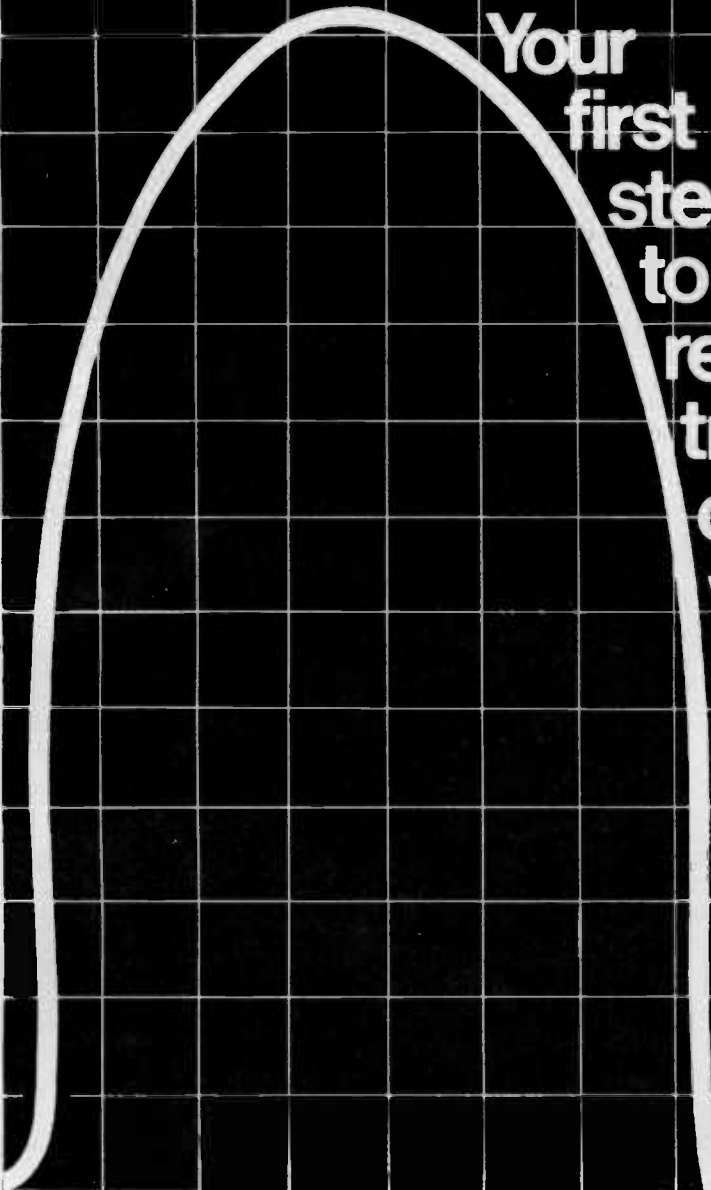

Your
first
step
to
reduce
training
costs
with
greater
efficiency
is to
complete
and return
this
coupon:

Training Systems Limited are Programmed Learning specialists who advise on the most efficient method of training in the Electrical industry.

We create complete integrated training systems to suit your needs.

We are already working for many companies to create tailor made training systems. Programmed Learning has been approved by The Central Training Council.

The coupon will bring you details of how our techniques can help your business.

Name
Company
Address
3
Send to: Times House, Ruislip, Middlesex.



**Training
Systems
Limited**

ADCOLA
PRODUCTS LIMITED
 (Regd. Trade Mark)

**SOLDERING
 EQUIPMENT**

Illustrated

$\frac{7}{8}$ in. DETACHABLE
 BIT SOLDERING
 INSTRUMENT
 L64
 POSITIONED IN
 PROTECTIVE UNIT
 WITH ACCESSORIES
 L700

INSTRUMENTS WITH
 THE CORRECT
 SOLDERING
 TEMPERATURES

ALL VOLT
 RANGES
 6/7 to 230/50
 VOLTS

British & Foreign
 Pats. & Reg.
 designs.

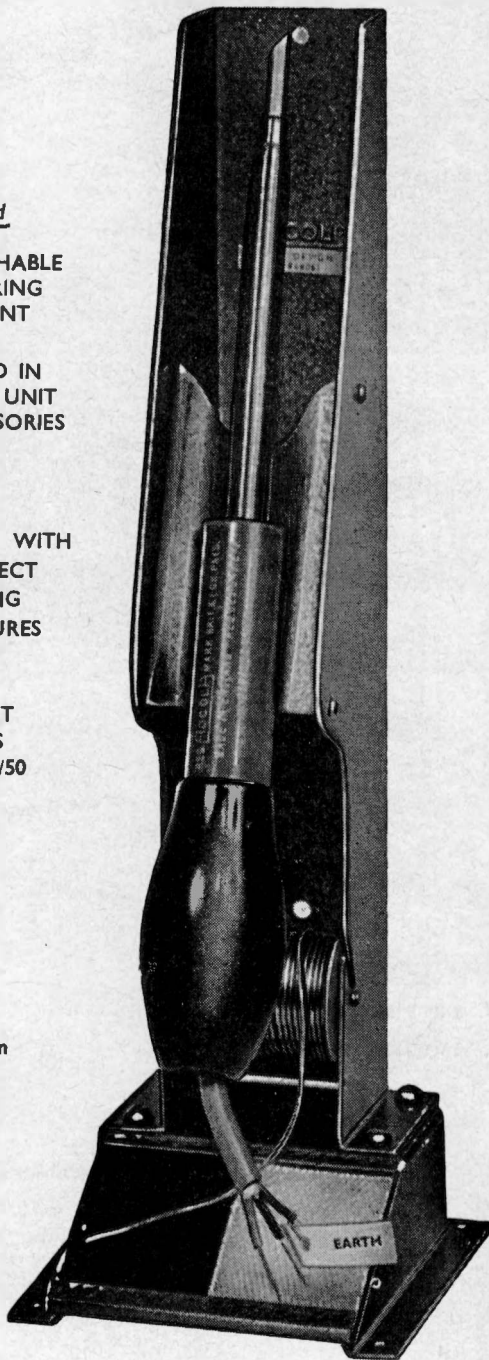

For further information and full illustrated catalogue apply head office.

ADCOLA PRODUCTS LIMITED
 ADCOLA HOUSE, GAUDEN ROAD, CLAPHAM
 LONDON, S.W.4

Telephone: MACaulay 0291-3

Telegrams: SOLJOINT
 LONDON S.W.4

**NEW
 MINIATURE
 RECORDERS**

Providing facilities for
 Multi-channel trace records
 on direct writing paper,
 monochrome and colour
 transparency film, tri-colour
 and monochrome paper.



GRAPHICORDER "70"

- Minimum size and weight
- Quartz Iodine lamp—Instant warm up — minimum current consumption
- Minimised 'g' sensitivity
- 18 recording traces
- 70 mm chart
- Sensitivity — from 2 μ a/cm
- Response — DC to 10 Kc

The Graphicorder '70' is a high resolution, high precision, miniature, multi-channel, galvanometer, oscillograph recorder designed for use where high recording accuracy is required. The design of these instruments is such that research engineers now have available a remarkably compact, reliable and convenient instrument capable of recording accurately and economically in environments never previously considered suitable for oscillograph recorders. An extensive range of galvanometer elements, including those especially developed for flight, torpedo and vehicle performance recording facilitates optimum system design whatever the nature of the parameter or environment.

GRAPHIC INSTRUMENTS (Research) LTD.,
 TROUT ROAD, YIEWSLEY, MIDDLESEX Tel.: WEST DRAYTON 2892

**PLASTIC
 MOULDINGS**
 THERMO-SETTING THERMO-PLASTIC

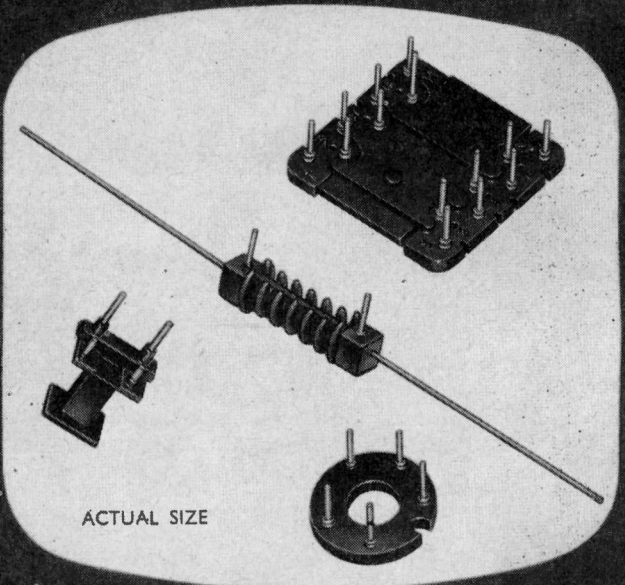

FREDERICK W. EVANS LTD.
 Plastic Works, Long Acre, Birmingham 7.
 Telephone: STD. 021 EAST 3071 (4 Lines)

31.6V ✓ 10c/s to 1Mc/s

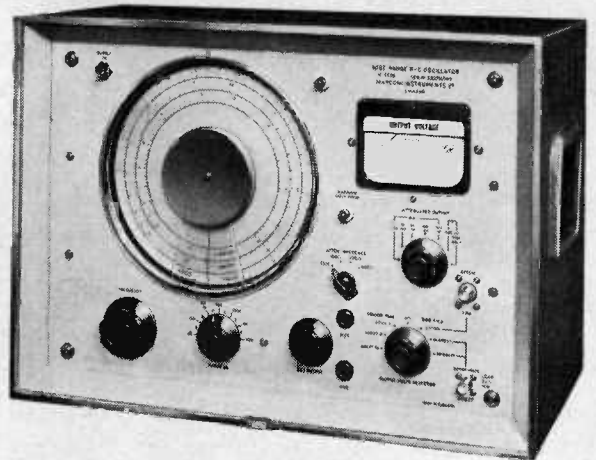
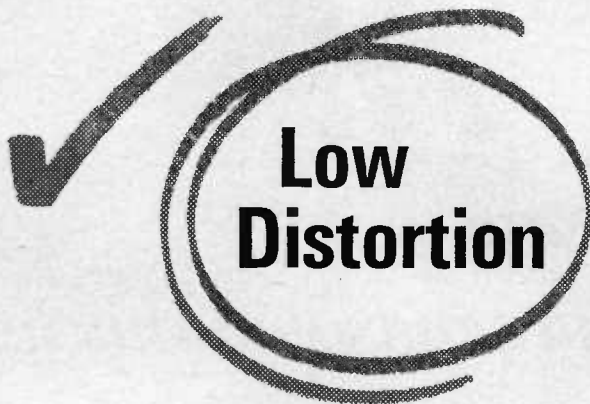

Marconi Instruments Type TF 1370A
**WIDE RANGE
R-C OSCILLATOR**

A new development
in versatile sine-wave/
square-wave generators

- Sine-waves 10 c/s to 10 Mc/s
Square-waves 10 c/s to 100 kc/s
- Distortion less than 0.5% over main part of range
- Decade frequency bands with dual-ratio slow-motion tuning
- High outputs at 4 impedances
- Price — £275
- Accessories include a triple impedance unbalanced-to-balanced transformer, 1 kc/s band-pass filter and x 100 attenuator pad

A GOOD NAME FOR GOOD MEASURE

**MARCONI
INSTRUMENTS**

Please write or telephone for further information.
Also available—Signal Source Calculator (slide rule)

Marconi Instruments Ltd., St. Albans, Herts., England
Tel: St. Albans 59292. Telex 23350

TC 283

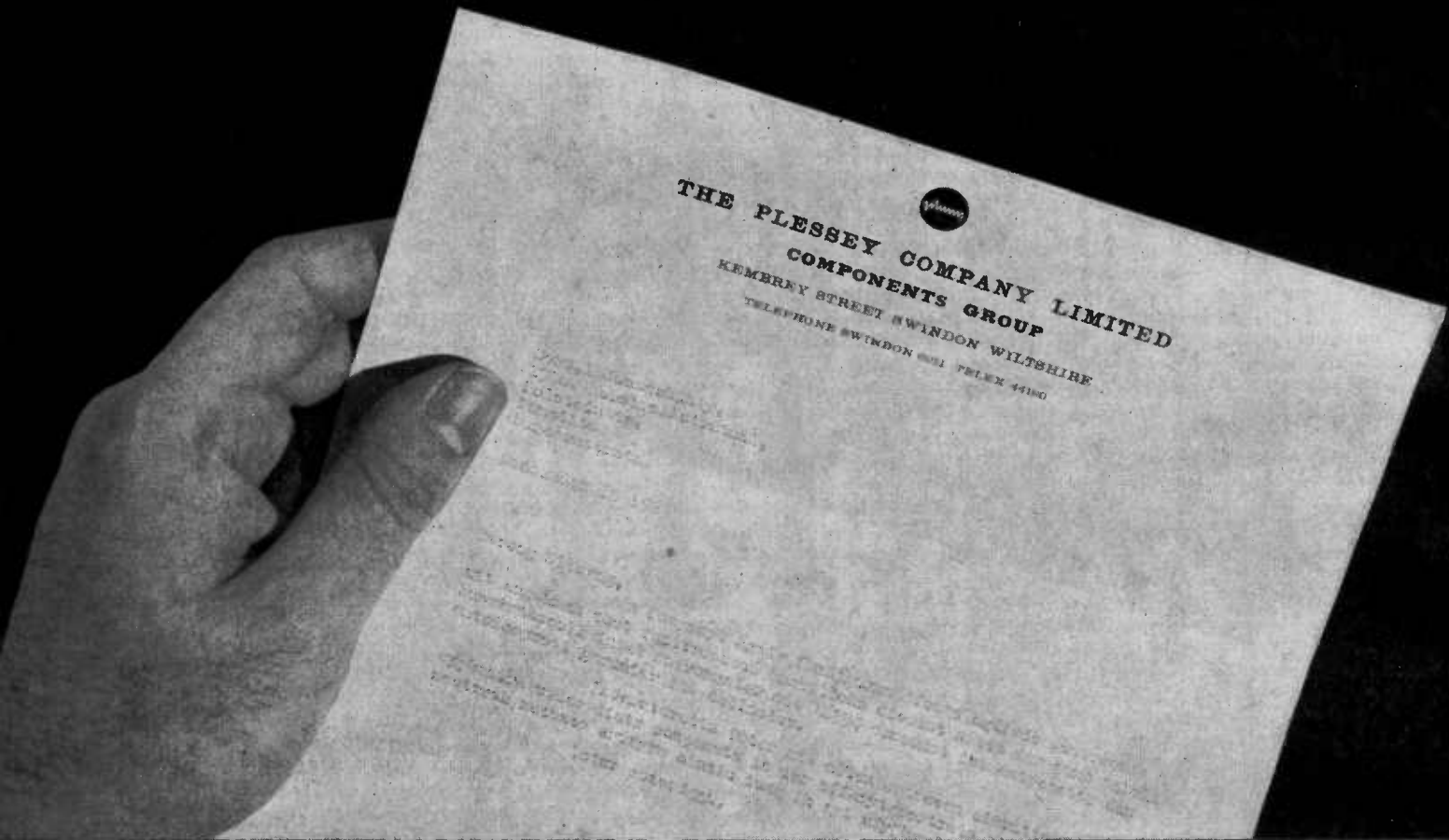

EE 94 053 for further details

The Plessey man who sends you this letter...

Behind every Plessey representative stands the most comprehensive electronic-component capability in the world. In the new Plessey Components Group there are specialised Divisions, modern production plants, development laboratories, 16,000 skilled employees, and more than 40 years of experience. Plessey can meet practically every component requirement for commercial, industrial and military electronic equipment. As well as producing one of the widest ranges of electronic components available, Plessey also offers you the highest

possible component reliability. Incomparable Plessey test facilities include one of Europe's most extensive and up-to-date environmental laboratories. A separate research centre, among the most advanced in Europe, has originated many new components and materials. The expert from Plessey will be happy to tell you about Plessey components the next time he visits you. If there is a particular problem you would like to discuss, or particular components on which you want advance information, just fill out the coupon below, and post it to Plessey.

For more information fill in and post this coupon

Please send me data on the Plessey components ticked below/I would like a Plessey specialist to visit and tell me about them

<input type="checkbox"/> air & plastic dielectric variable capacitors	<input type="checkbox"/> infra-red detectors	<input type="checkbox"/> silicon alloys	<input type="checkbox"/> subminiature valves & neon lamps
<input type="checkbox"/> cast permanent magnets	<input type="checkbox"/> loudspeakers	<input type="checkbox"/> solar cells	<input type="checkbox"/> valveholders & ceramic components
<input type="checkbox"/> ceramic capacitors	<input type="checkbox"/> new subminiature rotary switch	<input type="checkbox"/> new rotary solenoid	_____
<input type="checkbox"/> coil assemblies	<input type="checkbox"/> micro-alloy & micro-alloy diffused transistors	<input type="checkbox"/> solid circuits	Name _____
<input type="checkbox"/> cold cathode tubes	<input type="checkbox"/> miniature silicon rectifiers	<input type="checkbox"/> switches	Title _____
<input type="checkbox"/> diffused silicon rectifiers	<input type="checkbox"/> number tubes	<input type="checkbox"/> tantalum capacitors	Company _____
<input type="checkbox"/> dry reed relay inserts	<input type="checkbox"/> planar switching diodes	<input type="checkbox"/> tape decks	Address _____
<input type="checkbox"/> electrical connectors	<input type="checkbox"/> preformed wiring	<input type="checkbox"/> timing & regulating devices	_____
<input type="checkbox"/> electroluminescent devices & mimic diagrams	<input type="checkbox"/> pick-up cartridges	<input type="checkbox"/> transformers & inductors	_____
<input type="checkbox"/> electrolytic capacitors	<input type="checkbox"/> rectifier stacks	<input type="checkbox"/> transistors	_____
<input type="checkbox"/> ferrite memory cores & matrices	<input type="checkbox"/> relays	<input type="checkbox"/> wound components	_____
<input type="checkbox"/> filters	<input type="checkbox"/> resistors & potentiometers	<input type="checkbox"/> new printed-circuit connectors	Telephone _____

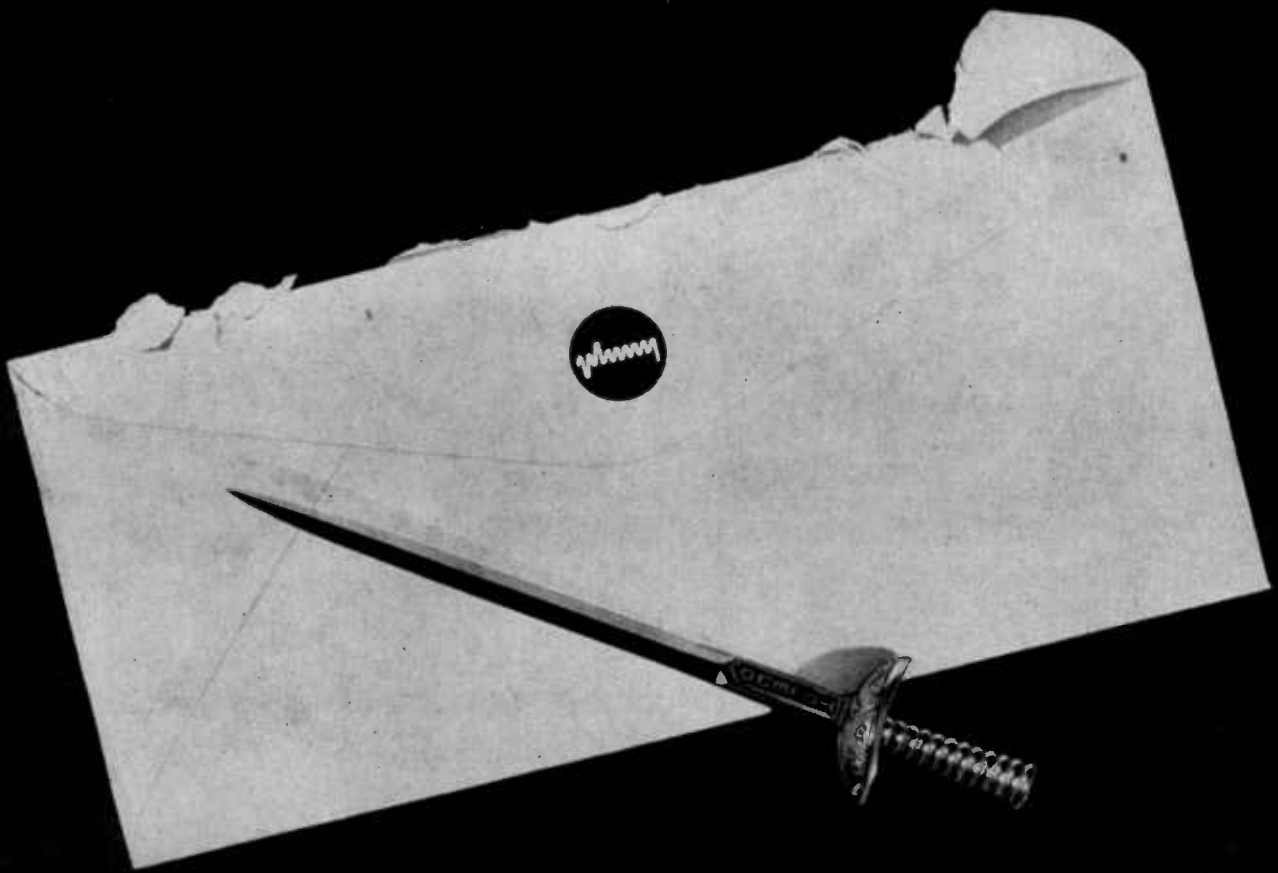

EE 94 054 for further details

*offers you 39 different categories of electronic components.
Here are three of the newest:*

New Sub-miniature Relay

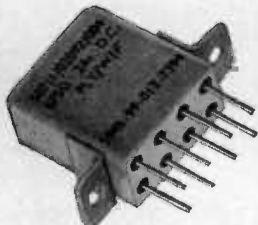

Fully sealed and with a balanced armature and high contact pressures, the new CF Relay operates from -65°C to $+125^{\circ}\text{C}$. Twin gold-plated contacts make it specially suitable for switching in low-level circuits. Contact action: 2-pole changeover. Contact rating: 3 Amps at 28 volts d.c. or 115 volts a.c. 400 c/s 10^4 operations at 3 amps. Standard coil values: 6, 12, 24, 48 and 110 volts d.c. Weight: 14.8 gm max. Size: 22.35 mm x 20.45 mm x 10.18 mm.

New Approved Tantalum Capacitors



The 'Castanet' range of high stability low power factor tantalum capacitors has recently been granted Type Approval by the Forsvarets Teletekniska Laboratorium (military Electronics Laboratory Research Institute of National Defence), Stockholm. With capacitance values from 33-470 μF their stability is exceptionally high over the temperature range -55°C to $+150^{\circ}\text{C}$ and under certain conditions this can be extended to -60°C to $+200^{\circ}\text{C}$. A particular feature of this range is the minimal change of parameters experienced with orientation.

New Rotary Solenoid

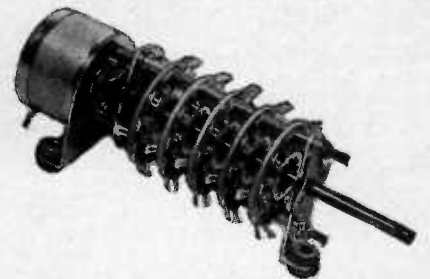

Designed for reliability and long life, this Rotenoid is particularly suited to the operation of multi-bank wafer switches where extra force is often required to overcome initial loads due to high static friction and indexing mechanisms. It will operate at a temperature of 180°C . DC operating range: 2V to 440V dissipation 12W continuous or up to 100W, according to function.

PLESSEY Components Group



The Plessey Company Limited, Kembrey Street, Swindon, Wiltshire. Telephone: Swindon 6211. Telex: 44180

Pat. 110
mono-block
connectors
with
closed entry
contacts



Designed to comply with D.E.F 5325 PAT. 110, these connectors consist of one-piece Diallyl Phthalate moulding with hard gold plated plug pins, socket contacts, and beryllium copper contact clips. Closed entry contact design eliminates the risk of damage to the sockets by test probes. The shells are of passivated cadmium plated steel and the covers and cable clamps are of die-cast aluminium Grade LM6.

ELECTRICAL RATINGS Working voltage: 750 volts DC
Current capacity: 5 amps max per contact

CARR FASTENER CO LTD

the firm with the best connections

Stapleford, Nottingham Telephone: Sandiacre 2661
Sales Offices: Wembley, Sale



the answer is



So many designers and engineers are finding **HENGSTLER** Counters provide the answer to control problems today. You are invited to send for a copy of our latest book which gives all the technical data and general information on our very advanced units, assemblies and systems. Keep ahead with **HENGSTLER**.

Visit our Stand G50 at the
I.E.A. Exhibition



**J. HENGSTLER CO.
GREAT BRITAIN LTD.**

Brooker Road, Waltham
Abbey, Essex.
Phone: Waltham Cross 26166-7-8



NAME _____

ADDRESS _____

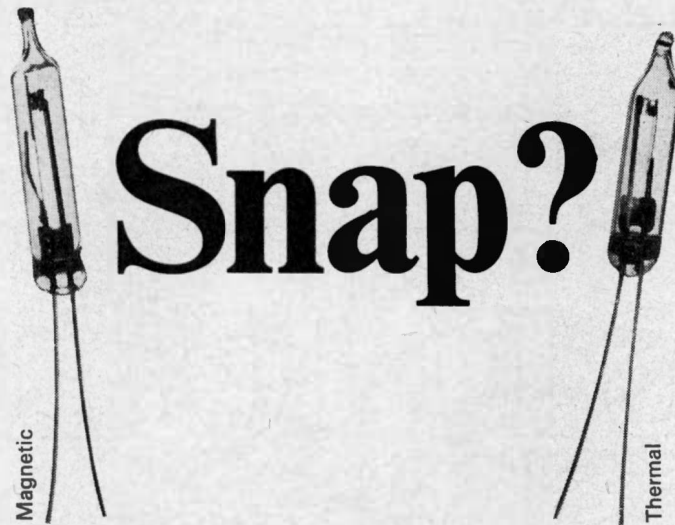

Yes...and no. Both components have a fast snap action; both incorporate silver contacts. They share the same compact, hermetically-sealed 1½" by ⅝" diam. glass envelope, and enjoy the same super efficiency, reliability and low cost—but—their functions are quite different.

Sylvania Magnetic Switch MS700 Series

Hermetically-sealed snap-action switches—activated by permanent or electro-magnets—offering excellent power handling at low cost. Contacts operate in a vacuum, eliminating arcing, extending contact life and providing environmental-free operation.

Contact Data

Arrangement: Normally closed, SPST
 Material: Silver
 Rating: 3 amps at 120V; 1.5 amps at 240V
 Resistance: 60 milliohms

Operational Data

Life expectancy: 100,000 to 1 million cycles depending on type of load
 Switch speed: 4 milliseconds (including bounce)
 Operating frequency: Up to 20 c.p.s.
 Breakdown voltage: In open position 500V a.c.;
 in closed position 1000V a.c.
 Temperature range: -54°C to 200°C

Sylvania Thermo-Break Circuit Protector SB600 Series

Hermetically-sealed snap-action circuit breakers—activated by excess temperature or current—providing the ultimate in snap-blade protection at low cost. Gas-filled enclosure for fast thermal response and long contact life.

Contact Data

Arrangement: Normally closed
 Material: Two silver contacts; one current-carrying, temperature-sensitive prestressed bimetal blade
 Rating: Continuous currents of 10 amps at 120V/240V; fault currents at 28 amps at 120V and 13 amps at 240V.

Thermal Shock

Tested from 26°C to 300°C within a one-second period.

Pressure

Tested to 2,000 p.s.i.

For full details write to



Thorn Special Products Ltd

Great Cambridge Road, Enfield, Middx. HOwARD 2477

A member of the Thorn Electrical Industries Ltd group of companies

TA3142

TSP9

The world's most versatile 1c/s to 16Mc/s solid-state Pulse Generator



made in England

The INTERCONTINENTAL PG-2 Pulse Generator is extremely versatile, ideally suited for a wide range of measuring applications—from testing amplifiers, radar, computers, memory cores, semi-conductors, and A.C. coupled logic circuits to nuclear instrumentation. Panel height is only 3½”.

ADVANTAGES:

- Repetition rate 1 c/s to 16 Mc/s
- Single or double pulse
- Positive or negative and complementary pulse

- One shot pushbutton
- Adjustable offset, delay and width
- No duty cycle limitations
- Linear rise and fall times variable from 12 nanoseconds to 20 milliseconds
- DC coupled output
- Adjustable trigger sensitivity, threshold and slope
- All solid state Price £380

The Intercontinental PG-2 Pulse Generator offers a combination of advantages unobtainable hitherto in any other instrument produced in this country.

Now that it is being made in England by the Instruments Division of Claude Lyons Limited, customers will, of course, benefit in many ways—not the least of which is the elimination of tedious duty-free formalities.



CLAUDE LYONS LTD

Instruments Division, Hoddesdon, Herts.
Tel: Hoddesdon 67161 Telex: 22724.
76 Old Hall Street, Liverpool 3.
Tel: MARitime 1761. Telex: 62181.

*so our
design engineers
went broody...*

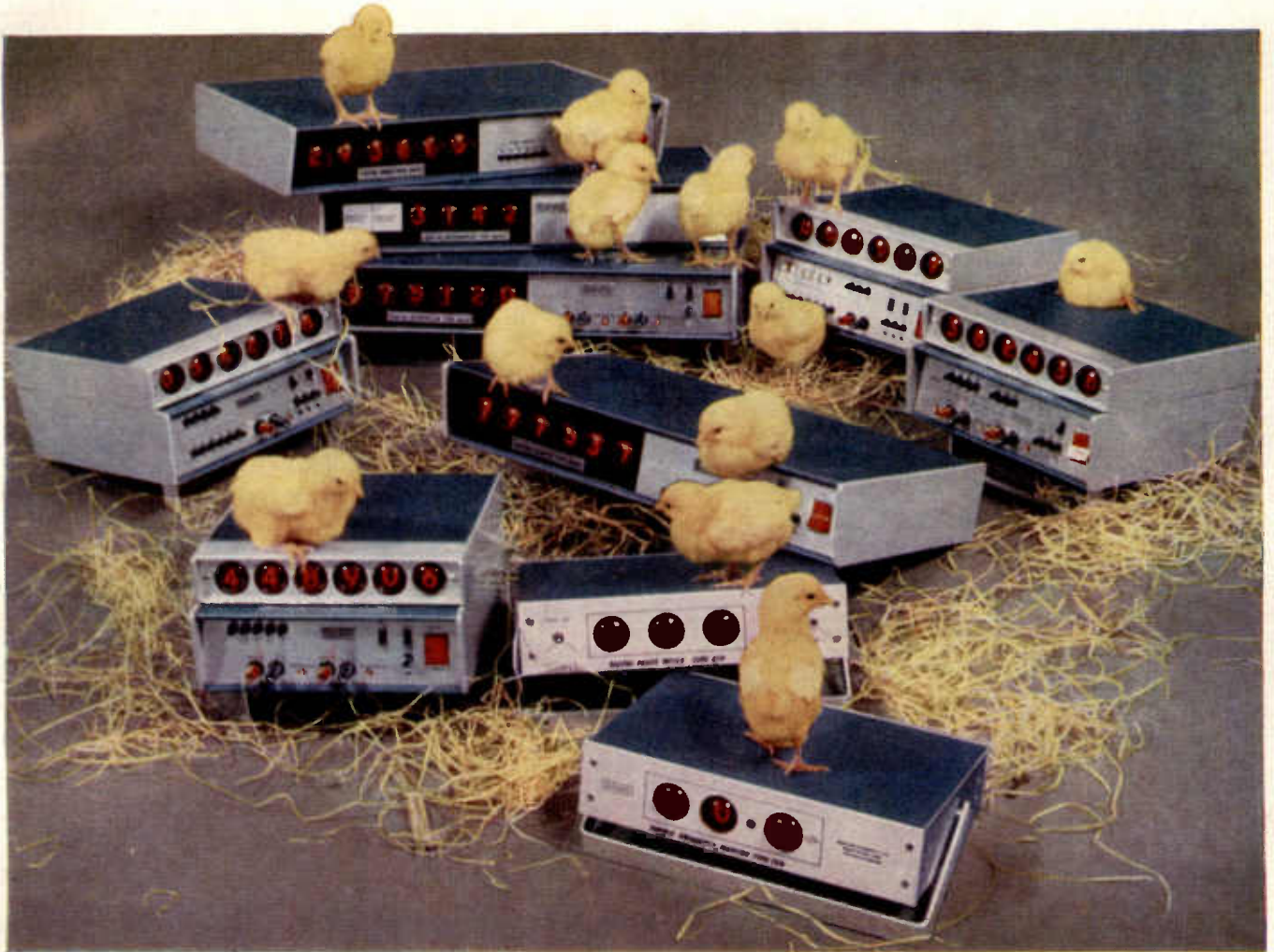

*and
hatched out
a whole new family
of DAWE
digital instruments!*

Tall ones, short ones, fat ones, slim ones—modular construction explains the family resemblance, those elegant good looks, those frank, open, easy to read faces. It also explains the remarkably low cost (for example, the Type 920A 4 digit, 1Mc/s, Frequency Meter and Counter, £113) and the ease with which modified versions can be made up to meet your individual requirements. For a start the range consists of seventeen of the little beauties—counters, timers, tachometers, ratio meters, frequency meters and multiple function units—but like all proud parents we hope to add to our family from time to time!

Full details available from:—

**INSTRUMENT
and digital measurement**

division of **DAWE** INSTRUMENTS LTD.,

WESTERN AVE., LONDON, W3 Tel: ACO rn 6751 A member of the *Simms* group of companies

These two pages list, describe and price the entire current range of Telequipment oscilloscopes. Further details of all the items shown are given in the new Telequipment short form catalogue, a copy of which will be sent on request. All prices apply to the U.K. only.



the full scope of

TELE

SERVISCOPES *

1. S51A—see below
2. MINOR—the *Serviscope Minor—for audio work, low frequency display and training programmes. £23 10s. 0d.
3. S32A—portable *Serviscope capable of fast pulse work normally expected only of far more elaborate instruments. £78.
4. D52—a compact 5" double-beam *Serviscope. Suitable for laboratory applications, yet simple and robust enough for general and industrial use. £99.
5. S52—special purpose 5" *Serviscope for applications involving phase comparison and measurement. £120.
6. S32AR—an inexpensive ready-made instrument for building in as a permanent monitor; panel space in 19" rack. £90.

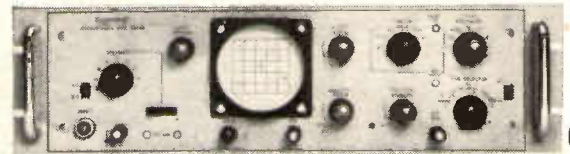
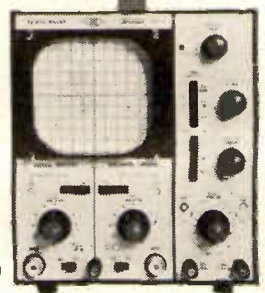
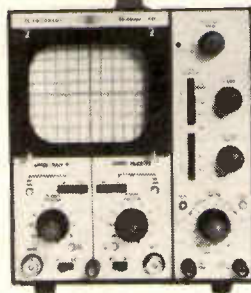
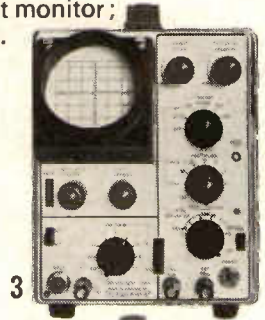
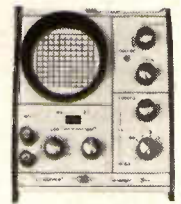

S 51A—portable *Serviscope, ideal for inspection, production control, monitoring and training. £55. Also S51E—educational version. £55. And S51T—special version with d.c.X amplifier facility. £60.

EQUIPMENT

LABORATORY 'SCOPES WITH A COMMON RANGE OF PLUG-INS

7. D43R—a versatile 'scope system in standard 19" rack-mounting form, occupying only 7" of panel space. £125 with type A general purpose amplifiers.

8. S43—portable laboratory 'scope with choice of six plug-in amplifiers. £98 with type A general purpose amplifier.

9. D43—Accurate and versatile, with choice of six plug-in amplifiers. High voltage aluminised PDA tube for high writing speed £125 with type A general purpose amplifiers.

10. D53—advanced laboratory 'scope using the full range of Y amplifiers described below. Signal and sweep delay. Plug-in time base. Rectangular double-beam mesh PDA tube giving superlative readout. £225 with type CD Y amplifiers.

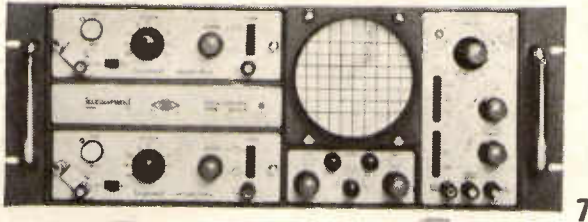

7

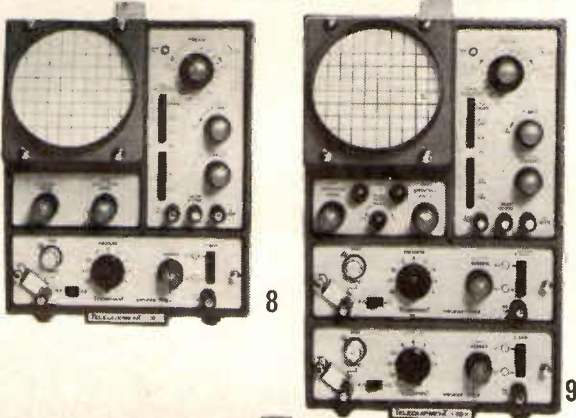

8

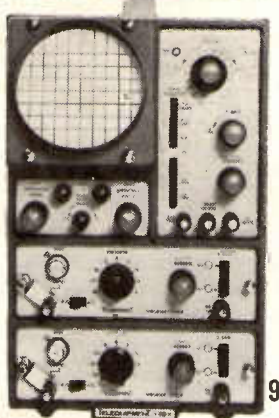

9

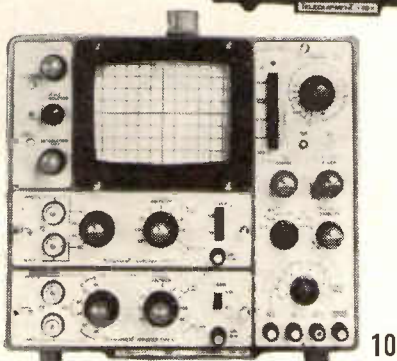

10

PLUG-INS

INTERCHANGEABLE AMPLIFIERS FOR 43/53 SYSTEM

11. General Purpose, Type A—£18.

12. Differential, High Gain, Type B—£32.

Wide Band, Type G—£23. (Not illustrated).

13. Ultra High Gain, Type C—£27.

Type CD—£27.

14. Wide Band, Type H—£32.

Type HD—£32.

Envelope Monitor, Type D—£35. (Not illustrated).

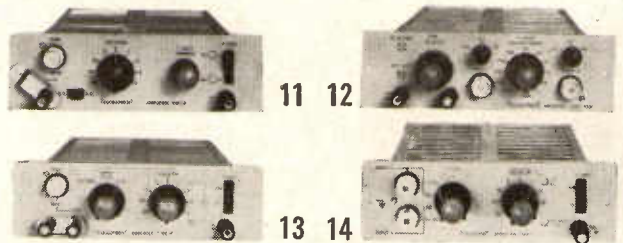

11 12

13 14

a specialised oscilloscope— and full range of accessories

15. D56—Advanced instrument with a 5" double-gun PDA tube. Two identical time bases, versatile triggering facilities, calibrated delay sweep. £295.

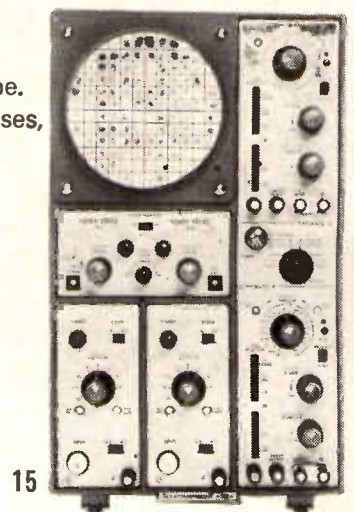

15

Ancillary equipment for the Telequipment range of 'scopes includes cameras, trolleys, probes, calibrators, etc.

*Serviscope is a registered trade mark.

TELEQUIPMENT



Telequipment Limited·Southgate·London N14·Telephone FOX Lane 1166

What happens to Sintox powder after 48 hours at temperatures up to 1600 °C ?

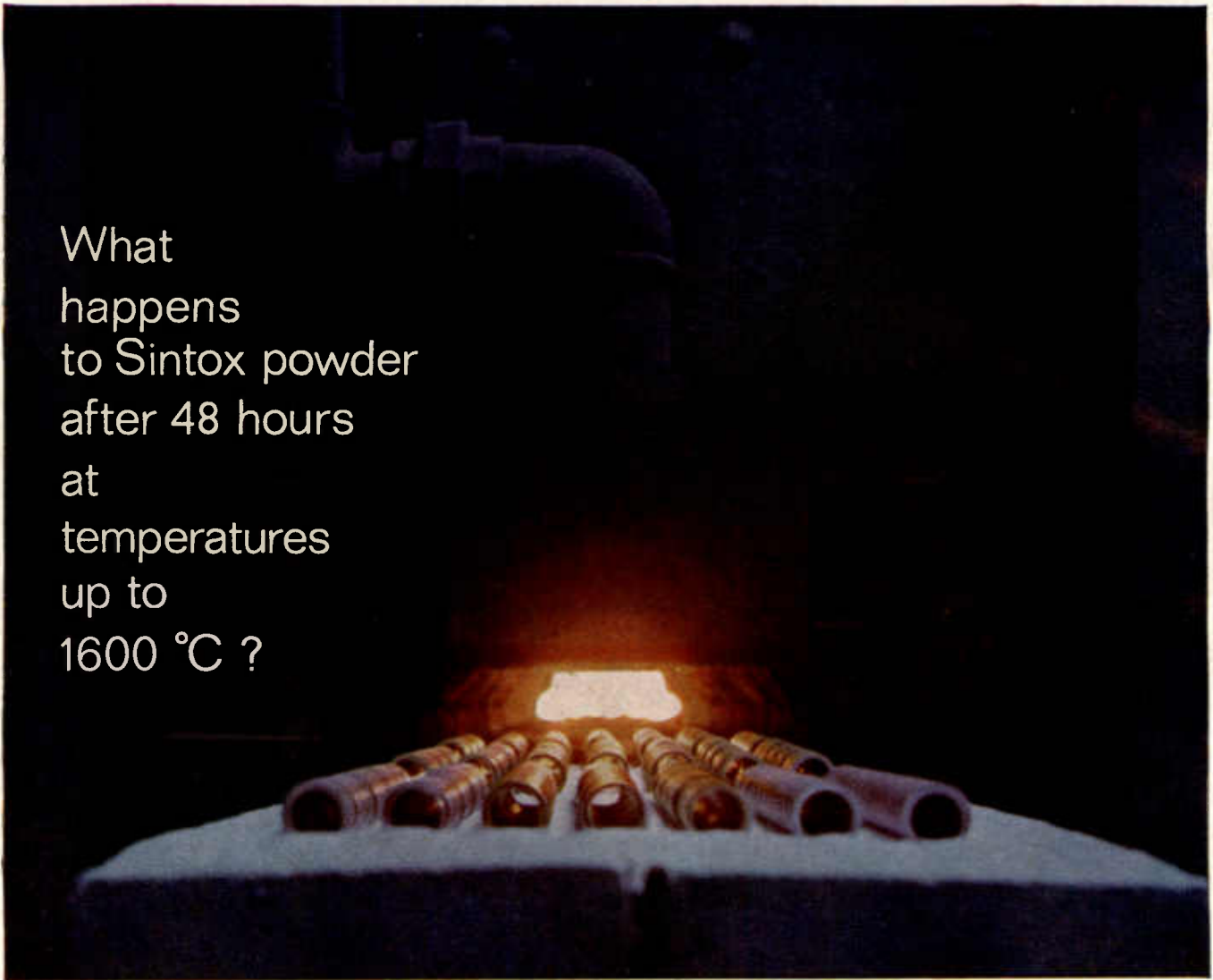

... it becomes a unique engineering ceramics material

All Sintox ceramics start as a free-flowing powder. But no other material can match its combined ease of initial formability and ultimate hardness and strength. As an unfired solid or liquid slip it can be moulded, pressed, extruded, machined and threaded easily. After firing Sintox has a hardness surpassed only by diamond and a compression strength also among the highest of all known materials. It has an as-fired dimensional tolerance of $\pm 2\%$ and can be diamond ground within ± 0.0001 ". It can also be combined in direct metal/ceramic

brazed assemblies. These factors, combined with an extraordinary range of additional high performance properties—including excellent thermal conductivity, the highest dielectric factors, chemical inertness, total impermeability, nuclear stability and RF transparency—make Sintox the most important engineering ceramics development in the world.

Sintox ceramics are high-purity alumina compounds produced in a variety of grades. They are sintered in a critically controlled firing process at up to 1600°C. Recrystallization occurs throughout the entire Sintox body creating a uniform fine-grained structure of controlled density. Ask for comprehensive technical data,

Sintox ... 'only a diamond is harder'
ALUMINA CERAMICS

A PRODUCT OF  SMITHS INDUSTRIES · RUGBY · WARWICKSHIRE

1-40 GHz



with
the complete line
of hp 690 series sweepers

Increased versatility with four independent sweep modes:

Start-Stop sweep — set end-points anywhere in the frequency range on slide rule scale. Sweep up or down frequency range. Markers appear on rf output.

Marker sweep — expand any small area of the major sweep with independent marker sweep function. End points set on error-free digital readouts.

Delta F sweep — a symmetrical sweep about a center frequency, useful for calibrating narrow-band devices.

Manual sweep — permits detailed investigation of a localized area. Ideal for X-Y recordings.

Increased accuracy with PIN diode modulation in "D" models.

Amplitude and pulse modulation functions — including output leveling — are performed through a precision PIN line. Complete isolation of BWO results in elimination of frequency pulling and incidental FM. (All "C" models have grid modulation.)

Summary of Specifications:

Model	Frequency Range	Max. Levelled Power Output	Frequency Accuracy	Price	Model	Frequency Range	Max. Levelled Power Output	Frequency Accuracy	Price
691C	1-2 GHz	≥ 100 mW	+ 1%	£ 1233	694C	8-12.4 GHz	≥ 20 mW	+ 1%	£ 1196
691D	1-2 GHz	≥ 70 mW	+ 10 MHz	£ 1367	HO1-694C	7-12.4 GHz	≥ 10 mW	+ 1%	£ 1310
692C	2-4 GHz	≥ 70 mW	+ 1%	£ 1158	694D	8-12.4 GHz	≥ 30 mW	+ 30 MHz	£ 1328
692D	2-4 GHz	≥ 40 mW	+ 10 MHz	£ 1291	HO1-694D	7-12.4 GHz	≥ 15 mW	+ 40 MHz	£ 1442
HO1-692D	1.7-4.2 GHz	≥ 15 mW	+ 13 MHz	£ 1405	695C	12.4-18 GHz	≥ 40 mW	+ 1%	£ 1348
693C	4-8 GHz	≥ 30 mW	+ 1%	£ 1158	696C	18-26.5 GHz	≥ 10 mW	+ 1%	£ 1728
693D	4-8 GHz	≥ 15 mW	+ 20 MHz	£ 1291	697C	26.5-40 GHz	≥ 5 mW	+ 1%	£ 2488
HO1-693D	3.7-8.3 GHz	≥ 5 mW	+ 25 MHz	£ 1405					

1801

HEWLETT  **PACKARD**
LIMITED

DALLAS ROAD, BEDFORD. Tel: BEDFORD 68052

JUNE 1966

53

Headquarters in USA: Palo Alto (Calif.)
European Headquarters:
Geneva (Switzerland)
European Plants: Bedford (England),
Böblingen (Germany)

ELECTRONIC ENGINEERING

NOW... MICROWAVE POWER FROM A SINGLE DIODE

The gallium arsenide varactor has been long considered a «conventional» microwave device. But now here's news of an exciting new mode of varactor operation that will be of special interest to microwave design engineers.

You can now get microwave energy from a varactor diode using dc power inputs. Sounds impossible? It seemed that way until Sylvania's recent announcement of a new gallium arsenide unit, the D-5540, a reverse breakdown oscillator diode. Sylvania has named this varactor the MOD. (microwave oscillator diode)

The MOD, the first diffused junction GaAs microwave diode of its type, actually can generate microwave power in Ku-band between 12 GHz and 14 GHz with 0.2 to 2 percent efficiency with more than 1 mw output power. The unit is biased in the avalanche breakdown region of the I-V characteristics. Sylvania is now making the D-5540 available in sample quantities as an experimental device.

Horizontal deflection was supplied by the voltage across the 1K series resistor. Voltage was proportionate to the bias current of the diode. The resulting display on the oscilloscope gave the output power of the diode oscillator versus bias current. The output power was displayed as function of V_s , the bias voltage across the test diode.

TENTATIVE CHARACTERISTICS

- Breakdown voltage: 20-40V @ - 10 μ a
- Total capacitance: 0.4-1.5 pf @ 0 volts
- Minimum output as oscillator: 1 milliwatt at 12-14 GHz.
- Maximum power dissipation: 300 milliwatts.
- Maximum reverse current: 10 milliamperes if maximum P_{DISS} is not exceeded.

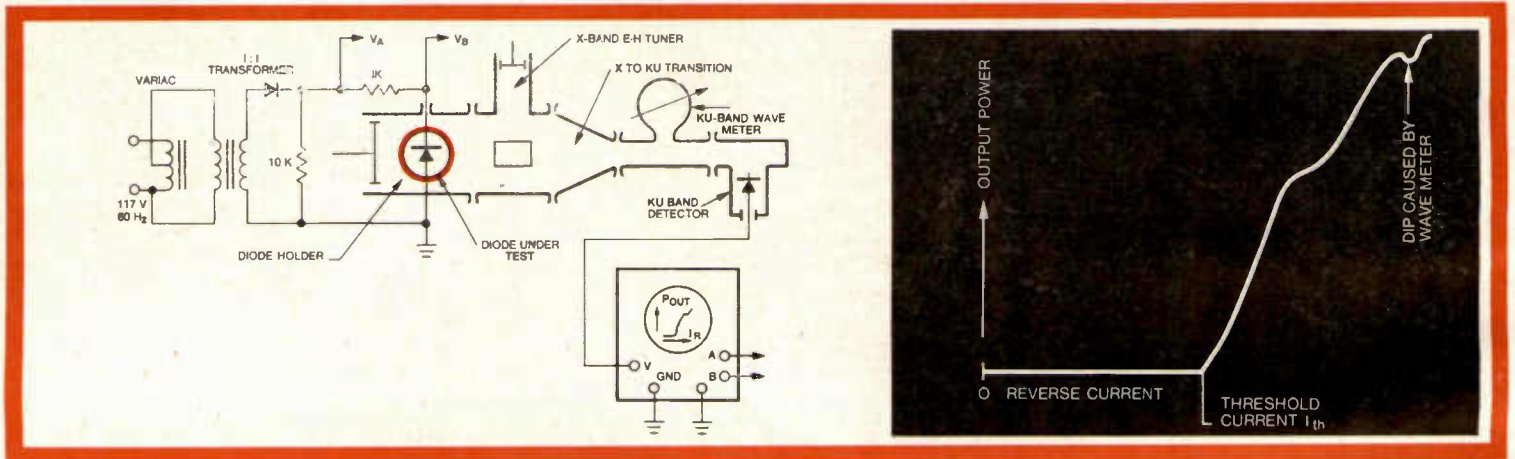

APPLICATIONS

Among the unit's known areas of application are local oscillators for microwave receivers, low-power beacons, signal and noise generators.

Test circuits used by Sylvania for rapid screening of diodes for oscillation and for accurate output power measurements and analysis are shown above. The test diode was driven by a reverse biasing 60 Hz half-sine-wave voltage into the avalanche breakdown. Oscillation of the diode was detected by a crystal detector, the output voltage of which was connected to the vertical deflection of an oscilloscope.

Threshold current (typ): 5 milliamperes (somewhat dependent upon tuning).

For further information ask about the Sylvania type D-5540 MOD diode.

Please contact the authorized Sylvania distributor in your country or write to

SYLVANIA
SUBSIDIARY OF
GENERAL TELEPHONE & ELECTRONICS **GT&E**

European Head Office: 21, rue du Rhône, Geneva, Phone: 26 43 70, Telex: 22649, Cable: Intelgent

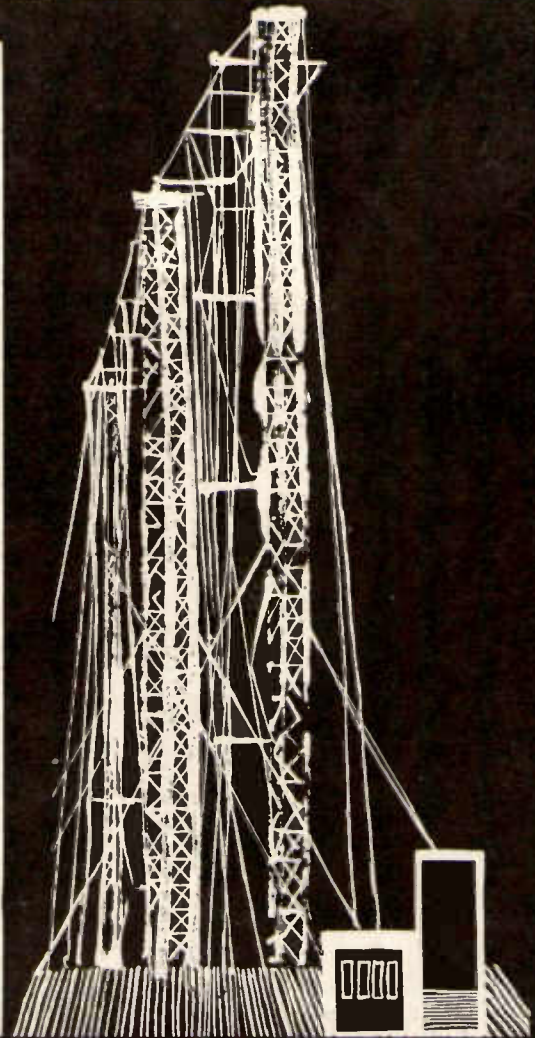

EEV Vacuum Variable Capacitors

English Electric Vacuum Variable Capacitors offer outstanding advantages over air dielectric counterparts for all transmitter applications at frequencies up to 27 Mc/s. These advantages include: ■ Compactness ■ Low self inductance and stray capacitance ■ Direct or remote control ■ Low inertia and torque for servo tuning ■ Freedom from adverse dust and moisture effects ■ Self-healing properties ■ Linear relation between shaft turns and capacitance ■ Any mounting position ■ Voltage rating maintained under adverse ambient conditions ■ Minimal maintenance costs

The standard range employs shaft tuning but most types can be modified for axial pull tuning. EEV will also consider other special design features and alternative capacitance values to suit individual requirements not covered by the standard range. The Capacitors, as well as being the ideal choice for new equipments, are particularly suitable for the modernisation of older transmitters. For full information on all EEV Capacitors, including fixed capacitance types contact Sales Office at the address below.

ENGLISH ELECTRIC VALVE CO LTD AGENTS THROUGHOUT THE WORLD
CHELMSFORD ENGLAND · TELEPHONE: CHELMSFORD 53491 EXTENSION: 318 TELEX: 99103

EEV

AP258

Jackie's a regular pulse-stopper.

How many micro-seconds shall we put you down for?



Jackie works on delay line assembly at Lexor. She makes marvels of miniaturisation: precisely and reliably to specification, as designed by the leading delay line engineers in the country.

'Not that any of us girls'-she says-'mind the men taking most of the credit. But it's fair to say that we're delay line experts too. How about working it in with the sign-off line f'rinstance?'

While we're thinking about it, would you like Jackie to reserve some pulse-stopping time for you?
How many micro-seconds shall we put you down for?

Lexor Britain's leading delay line engineers (and assemblers)

LEXOR ELECTRONICS LIMITED Allesley Old Road, Coventry. Tel: 72614 & 72207



A truly automatic 500 MHz frequency converter

- Automatic frequency measurement to 500 MHz.
- No tuning or interpolation.
- Automatic level-setting.
- Counter accuracy retained.
- Sensitivity 100 mV.
- No ambiguity.

The Racal Auto Frequency Converter type SA.565 affords direct, automatic and continuous frequency measurement to 500 MHz from most 100 MHz counters. An entirely new design concept eliminates measurement ambiguities and offers many unique advantages to the research, development and production engineer.

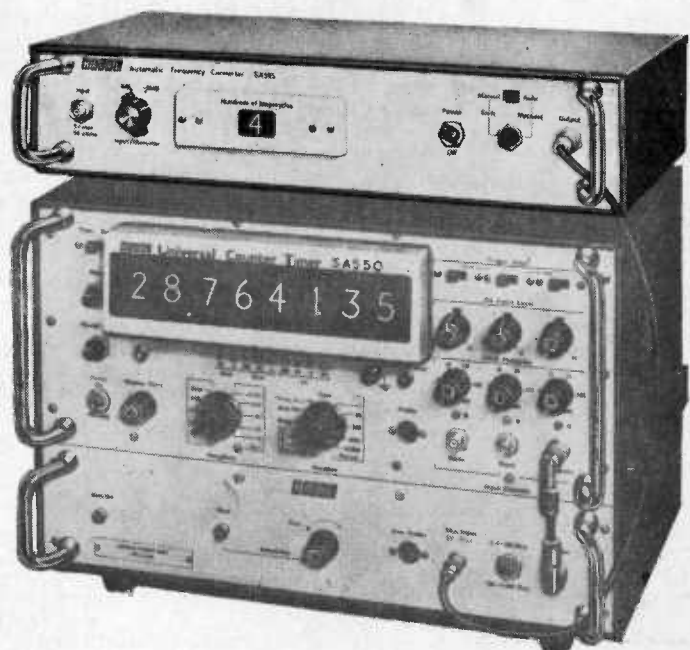

RI/A105

Racal research and development maintains world leadership in Digital Measurement.

RACAL

Write for fuller details to:
Racal Instruments Limited
 Dukes Ride, Crowthorne, Berks.
 Tel: Crowthorne 227213 and 3763.
 Telex: 84166. Cables: Racal, Bracknell.

WHITELEY

OF MANSFIELD

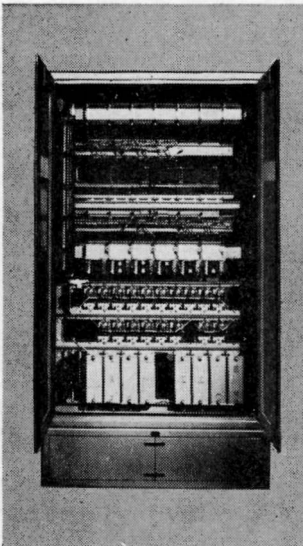
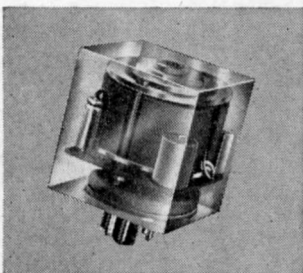
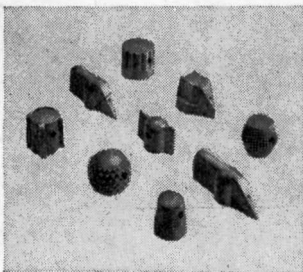
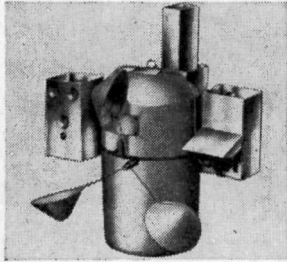

provide a
comprehensive
service for
the design &
manufacture
of electronic
equipment &
components

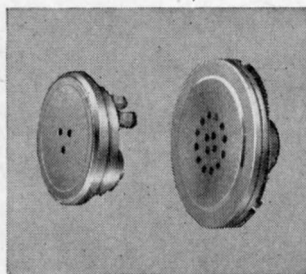

Whiteley Electronic Equipment & Components are designed and precision-built in the Company's own factories. Every operation is strictly controlled, every part is vigorously inspected and tested. Nothing is left to chance—hence Whiteley's enviable reputation.

WHITELEY ELECTRICAL RADIO CO. LTD

MANSFIELD · NOTTS · ENGLAND Tel: Mansfield 1762/5
London Office: 109 KINGSWAY, W.C.2 Tel: HOLborn 3074

WB185



Facit PE 1500 Tape Punch

- 1 Computers
- 2 Data transmission
- 3 Data logging



punched
tape output
up to 150 characters per second
▶ including tapes for TTS

Facit-Odhner Electronics Ltd.

Eastgate Court
Rochester Kent
Telephone: Medway (OME 4) 43485 & 43487
Cable: Facitroc Rochester Kent

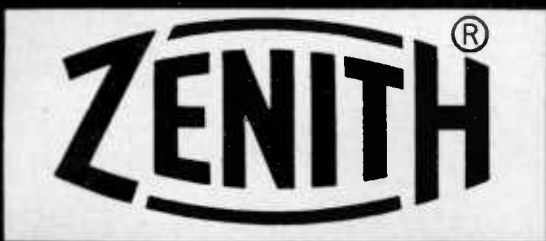

Primary Injection Test Set



This illustration is typical of the 240 volt, 10 kVA equipment having an output of 1000 amperes between zero and 10 volts. A change-over switch allows zero to 240 volts from the VARIAC control at a maximum of 10 kVA. The vernier booster circuit permits adjustment to +10 volts at any setting. Its versatility enables the testing of overload coils, also ammeters and voltmeters in conjunction with the usual external meters.

With a separate potential circuit included, either directional or non-directional over current relays may be tested.

The REPLI-PRINTER



The Mark II Model is now available, re-styled and with a completely new developing unit of the semi-dry type. It can be sited in any convenient place without the drawback of ducting for NH₃ extraction. Paper speeds of 30 ft. per minute are smoothly controlled by a VARIAC speed control unit backed by a 2 kW high pressure mercury discharge tube fed by a constant output transformer. The diaphragm pump maintains the correct level of developer; for cleaning, it is merely necessary to substitute water. Safety thermostats take care of any possible over-heating through extraneous causes.

Secondary Injection Test Set

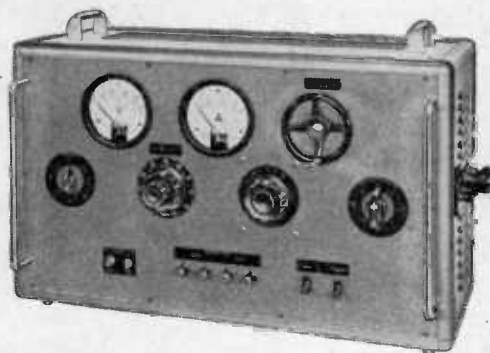

A Current Injection Test Set for secondary injection testing of protective overload and earth fault relays, designed to work with time interval meter. For use on 240 volts A.C. giving 37.5 amperes at 20 volts for a time cycle of 15 minutes per hour. Current adjustment down to 0.5 ampere. Potential circuit 0/200 volts, 2 amperes.

THE ZENITH ELECTRIC COMPANY LIMITED

ZENITH WORKS · VILLIERS ROAD · WILLESDEN GREEN · LONDON N.W.2

Telephone: WILLESDEN 6581/5 Telex: 261778 Telegrams: "VOLTAOHM, LONDON N.W.2"



CARD PRINTERS

SODECO

print

THE SPEED OF SIGHT —
THE SECURITY OF PRINT
NOW ON

CARD



When quality counts — specify **SODECO**

- Why take readings? The count can be permanently printed on a card and if desired on paper tape simultaneously
- Standard card sizes (3¹/₄" or 7³/₈")
- Combinations of one to four channels and up to 20 single-decade elements

Full details are given in leaflet E111 or E112

Agents and licencees for
The United Kingdom:

LANDIS & GYR

Landis & Gyr Ltd.
Victoria Road, North Acton
LONDON W. 3
Tel. ACO 5311

Addresses of representatives in
other European and overseas
countries are available from

SODECO
1211 GENEVA 16 (Switzerland)

new 25 in. MAZDA RIMGUARD PICTURE TUBE



The new *MAZDA CME2501 (A65-11W) has been specially designed to meet the Continental and Home demand for the 25" tube. It is less than one inch longer than the popular 23" tube, but gives 45 sq. in. more picture area. Light transmission is 42%, giving good contrast ratio. EHT working voltage is 13-18 kV and the scanning power requirement similar to the 23" tube. The CME2501 brings you all the advantages of Mazda Rimguard construction with its improved safety factor and lower maintenance costs through ease of cleaning.

*British MAZDA picture tubes are exported under the EDISWAN trademark.



Write for full technical details to:

**Thorn-AEI
Radio Valves & Tubes Limited**



7 Soho Square, London W1.
Tel: GERrard 5233

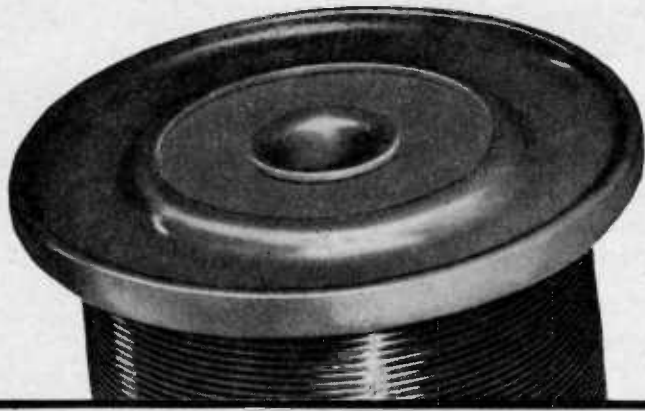

LEWCOS ENAMELLED WIRES

The fine reputation in both oleo-resinous and synthetic enamelled wires, of LEWCOS among manufacturers of electrical equipment justly reflects the high standards observed in their production. The most modern machinery and the latest techniques ensure the continued leadership of LEWCOS products.

THE
LONDON ELECTRIC WIRE
COMPANY & SMITHS LTD.

LEYTON, LONDON, E.10.

A member of the L.E.W. Group

SIMPLE MAGNETIC ECONOMICS BY



for holding light ferrous components—

- 1** With items of considerable length use—
MAGNETIC STRIP BULLETIN NUMBER **M.29**
OR MAGNETIC TAPE BULLETIN NUMBER **M.70**
- 2** For components with large areas use—
MAGNETIC TILES BULLETIN NUMBER **M.49**
- and something entirely new**
- 3** For indicating, planning and charting
(in 4 colours) use—
MAGNETIC PLANNERS BULLETIN NUMBER **M.78**

Full information, on request, from
JAMES NEILL & COMPANY (SHEFFIELD) LIMITED, NAPIER STREET, SHEFFIELD 11.

M.52

EE 94 074 for further details

STANDARD PARTS

For speedy delivery of standard parts
manufactured by
The Carr Fastener Company Limited
and F.T. Products Limited
the smaller quantity user should contact
United-Carr Supplies Limited.

Stocks carried of the well-known range of

CINCH, F.T and DOT

Radio, Electronic and Electrical Components

UNITED-CARR SUPPLIES LTD.

FREDERICK ROAD, STAPLEFORD. Tel. SANDIACRE 2349

DATA SHEETS ON APPLICATION

EE 94 075 for further details

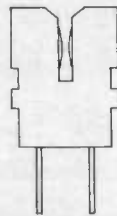

6-35 WAYS
0.20 PITCH

NEW BOY **(baptised in hell fire)**

A bright, welcome newcomer to the UECL range—the series 635 connector. If only you knew what it's been through before emerging on the market. Behind the closed doors of the UECL quality control laboratories, a vast array of demon devices have been at work on it. Sheer torture. And sheer torture was conquered by sheer perfection. Give the new boy a big hand. Order him. Contact us today about this and our other products. Please quote U27EE

**ULTRA
ELECTRONICS
(COMPONENTS)
LIMITED**

TRANSISTOR A.C. MICROVOLT METER

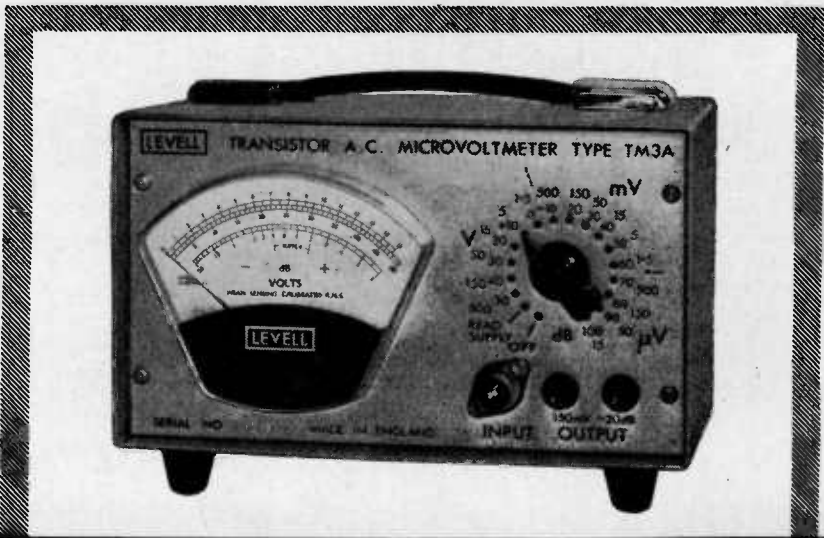

TYPE TM3A

Can be used as an A.C. Voltmeter or A.C. Amplifier. The frequency response extends from 1c/s to 3Mc/s. Sixteen ranges are provided in 10dB steps from 15µV f.s.d. to 500V f.s.d. with selection by a single rotary switch which also has "Off" and "Read Supply" positions. Ideal as an oscilloscope preamplifier as it has a low noise level, low microphony, no hum and is independent of a mains supply.

SPECIFICATION

VOLTMETER RANGES

15µV, 50µV, 150µV 500V .s.d. linear black meter scales.

ACCURACY

± 1.5% ± 1.5% f.s.d. ± 1.5µV at 1kc/s.

dB RANGES

- 100dB to + 50dB in 10dB steps with red meter scale from - 20dB to + 6dB relative to 1mW into 600Ω.

INPUT IMPEDANCE

Above 50mV, > 4.3MΩ and < 20pF, from 1c/s to 3Mc/s.
On 150µV to 50mV, > 5MΩ and < 40 pF, from 100c/s to 100kc/s.
On 15µV to 50µV, > 2MΩ and < 50pF, from 200c/s to 20kc/s.

FREQUENCY RESPONSE

On "mV" and "V" ranges: ± 3dB from 1c/s to 3Mc/s. ± 0.3dB from 4c/s to 1Mc/s.
On 500µV: ± 3dB from 2c/s to 2Mc/s.
On 150µV: ± 3dB from 4c/s to 1Mc/s.
On 50µV: ± 3dB from 8c/s to 500kc/s.
On 15µV: ± 3dB from 20c/s to 200kc/s.

AMPLIFIER OUTPUT

150mV at f.s.d. on the meter corresponding to a gain of 80dB on the 15µV range. Output may be connected to a load of 100kΩ and 50pF with negligible loss of accuracy or frequency response as output impedance is 100Ω in series with 6.4µF.

MAXIMUM INPUT VOLTAGES

On 15µV to 50mV ranges: 250V D.C., 100V A.C. up to 20 kc/s, 30V A.C. above 20kc/s.
On 150mV to 500V ranges: 750V A.C. peak plus D.C.

INPUT NOISE LEVEL

5µV r.m.s. maximum on 15µV range with zero source resistance.
25µV r.m.s. maximum on 50µV range with 100kΩ source resistance.

INPUT COAXIAL SOCKET

Belling Lee L604 is standard fitting but BNC is available on request.

POWER SUPPLY

One type PP9 battery, life 1,000 hours, or A.C. Mains when a LEVELL Power Unit is fitted.

SIZE AND WEIGHT

5" x 7½" x 4½". 4½lbs.

LEVELL

PORTABLE INSTRUMENTS

PRICE **£49**

complete with battery and input lead.

OPTIONAL EXTRAS :

Leather Carrying Case **£4. 10. 0**

A.C. Power Unit **£7. 10. 0**

Fully detailed leaflets are available on our complete range of portable instruments.

LEVELL ELECTRONICS LTD.
Park Road, High Barnet, HERTS. Tel: Barnet 5028



Perfectly soldered in seconds!

... with Fry's specially designed FLOWSOLDER machine. The many joints on a printed circuit board are soldered simultaneously, simply by passing through the crest of the FLOWSOLDER 'wave'; completely free from dross and oxide.

The FLOWSOLDER machine is very simple to use, easy to control, giving a completely trouble-free performance; resulting in considerable savings as unskilled labour can safely be employed to operate the machine. For further details of this unique machine, please write or phone for an appointment to see a demonstration to:

FRY'S METAL FOUNDRIES LTD • FLOWSOLDER DIVISION • WILLOW LANE • MITCHAM • SURREY
TEL. MITCHAM 2248-9



FRY'S automatic soldering machines

HEAD OFFICE: • TANDEM WORKS • MERTON ABBEY • LONDON SW19 • TEL. MITCHAM 4023

AND AT MANCHESTER • GLASGOW • KIDDERMINSTER • DUBLIN

SANKEN SEMICONDUCTORS

PHOTOCONDUCTIVE CELLS

Cadmium Sulphide and
Cadmium Selenide

Watt-Loss Ratings from 100mW
to 1W

Sizes from 6mm to 29mm dia.

Prices
from
1/9
each

SILICON RECTIFIER DIODES

P.R.V. from 200-1400V

R.M.S. Input from 140-980V

Current from 150-750mA

Prices
from
1/6
each

The above components are but a few of the wide range of Sanken Semi-conductors which are available from Photain Controls Ltd. Send today for further details — samples available from stock.

PHOTAIN CONTROLS LTD
Randalls Road, Leatherhead, Surrey.
Telephone: Leatherhead 2776 & 5517.

Tschudin & Heid AG

FROM OUR NEW PUSH-BUTTON SWITCHES PROGRAMME

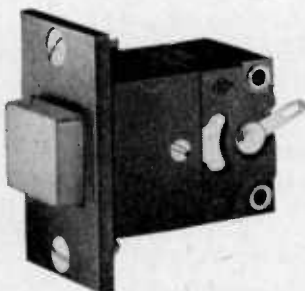

3 A, 250~.

Indicator lamp No.
491, for fastening
from front.



4153 Reinach, Switzerland

4747-A



H.F. CERAMICS & FERRITES

LIGHTNING BRAND HIGH FREQUENCY CERAMICS ANSWER STRICT REQUIREMENTS OF ADVANCED RADIO AND ELECTRONIC TECHNOLOGY

- (1) LOW DIELECTRIC LOSS AT HIGH FREQUENCY.
- (2) ABILITY TO WITHSTAND HIGH TEMPERATURE AND HIGH HUMIDITY.
- (3) HIGH INSULATION RESISTANCE AND MECHANICAL STRENGTH.
- (4) SMALL COEFFICIENT OF EXPANSION.
- (5) HIGH STABILITY UNDER VARIOUS CLIMATIC CONDITIONS, UNDER VIBRATION, IMPACT, RADIATION OR CHEMICAL REACTION.
- (6) PRECISION MADE WITHIN CLOSE TOLERANCES.

Enquiries and orders are cordially invited.

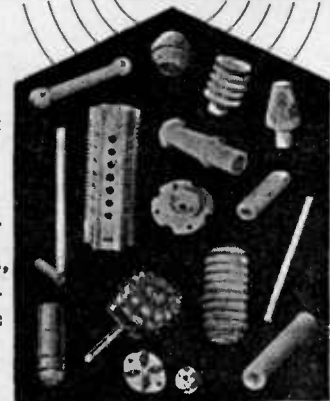

CHINA NATIONAL INSTRUMENTS IMPORT & EXPORT CORP.
SHANGHAI BRANCH

27 Chung Shan Road, E.I., Shanghai. Cable Address: INSTRIMPEX Shanghai

MORE
FACILITIES
EASIER
TO USE

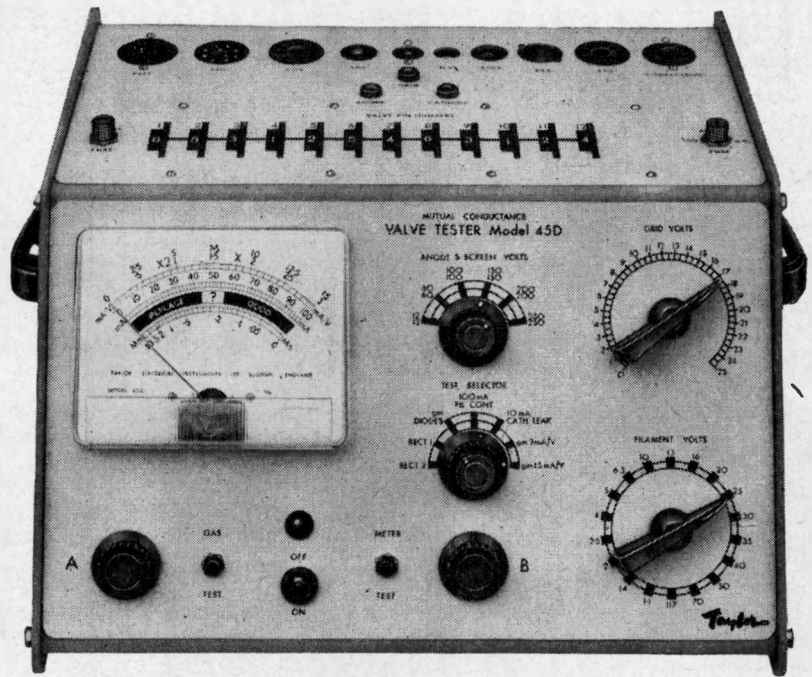

Taylor

Provides rapid mutual conductance measurement on more than 7,000 valves, British, American and Continental, with up to 12 pins and with a maximum power dissipation of 25 watts. Also tests CRTs (including colour TV tubes). *New edge control circuit selector switch connects any valve pin to any electrode.* Checks diodes and rectifiers for emission under normal working conditions with a load test for high current rectifiers. *Tests each section of frequency changer and other multiple valves separately for mutual conductance and emission.* Ten valve bases, including Compactron and Nuvistor types; a B14E base accepts a range of adaptors to cover any obsolete or new base not already incorporated. *Tests most CRTs without removing tube from receiver with adaptor which can be supplied.*

45D

TESTS
OVER

7,000

TYPES

VALVE TESTER

The pace of new techniques in electronic equipment implies constant re-appraisal of test capability. In the new 45D Valve Tester, Taylor research and continued development offers an instrument as advanced as the industry it serves, with more facilities, improved design and easier operation. Write or telephone now for complete information.

IF IT'S TAYLOR MADE, IT'S CLEARLY BETTER



TAYLOR ELECTRICAL INSTRUMENTS LTD. Montrose Avenue, Slough, Bucks.
Phone: Slough 21381 - Grams: Taylins, Slough.



965/5/1

ROTAX-BALDWIN PHOTO-ELECTRIC 200 SERIES ENCODERS



Low-cost Photo-electric encoders are more accurate than mechanical types. They achieve high resolution without the use of gears and so avoid backlash, hysteresis and vibration problems. Of their type the 200 series are the smallest and most compact. ■ Low cost ■ Trouble free ■ Long periods between maintenance. Readily available from stock. We offer you the important economic advantage of being able to choose from a wide range of codes (Gray, B.C.D., Sine etc). Why not contact Rotax?

ROTAX

INSTRUMENTATION DIVISION

ROTAX LIMITED, INSTRUMENTATION DIVISION
WILLESDEN JUNCTION, LONDON, N.W.10. TELEPHONE: ELGAR 7777

ALL IN ONE HAND...

Small dimensions
Excellent electrical properties
Inexpensive
Constant voltage
Adjustable current limiting
Series and parallel connection possible



with the Philips D.C. regulated power supply,
type PE 4818

D.C. output voltage	0.2...35 V
Load current	0...150 mA
Adjustable current limiting	6...180 mA
Stability	< ± 0.2% by ± 10% mains variations
Internal resistance	< 0.3Ω
Hum	< 1 mV

Please request for datasheet EA4-U23



PHILIPS

The M.E.L. Equipment Company Ltd.,
207 Kings Cross Road, London W.C.1,
Telephone TERminus 2877

FERRANTI FIRST AGAIN

ONE MILLION MILLION OHMS

REVERSE IMPEDANCE

Silicon Planar Epitaxial Miniature Diodes

ZS150	ZS151	ZS152	ZS153	ZS154	ZS155
-------	-------	-------	-------	-------	-------

IMMEDIATELY AVAILABLE

SPECIAL FEATURES

- Surface Passivated Structure
- Exceptionally Stable Forward & Reverse Characteristics
- Small Size
- Negligible Leakage Current
- High Conductance

APPLICATIONS

- Magnetic Amplifiers for use at High Temperatures
- Modulators and Demodulators

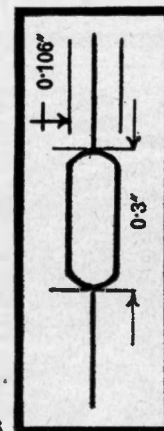

MAXIMUM
DIMENSIONS

RATINGS AND CHARACTERISTICS AT 25°C	ZS 150	ZS 151	ZS 152	ZS 153	ZS 154	ZS 155	UNIT	CONDITIONS
Max. Peak Inverse Voltage	50	100	50	100	50	100	V	
Max. Mean Rectified Current	250	250	250	250	250	250	mA	up to 75°C
Max. Reverse Current at P.I.V.	1*	1*	5	5	100	100	nA	at T=25°C
Max. Reverse Current at P.I.V.	1†	1†	5	5	10	10	µA	at T=150°C
Max. Forward Voltage Drop	1.2	1.2	1.2	1.2	1.2	1.2	V	I _F =200 mA
Max. Forward Recovery Time	10	10	10	10	10	10	nS	I _F =10 mA
Operating and Storage Temperature Range (All Types) -65°C to +200°C								
* Typically 0.1 nA † Typically 100 nA								

FERRANTI

First into the Future

FERRANTI LTD · GEM MILL · CHADDERTON · OLDHAM · LANGS
London Office Telephone: (01) VICToria 6611 Telephone: (061) MAIn 6661

Callins International Limited

Aluminium foil capacitors

- * Hermetically sealed all-plastic encasement.
- * Ultra-Small sizes.
- * Close Tolerance Dimensions.
- * Lead spacing to $\pm 0.015"$
- * High Reliability by close Quality Control. Proven in the exacting U.S. Market.
- * Surprisingly low cost.
- * Fast Delivery.
- * Ratings 3V to 350VDC
- * Cap. Tol. to 100V - 20% + 100%
„ 150V 350V - 20% + 50%

Operating Temp. - 20°C to +65°C
- 20°C to +85°C

Extremely Low Dissipation Factor and D.C. Leakage

Types Available

- Low Voltage Polar type Vertical and Horizontal Mounting 65° and 85°
- Low Voltage Non-Polar type Vertical and Horizontal Mounting 65°C and 85°
- High Voltage Polar type Vertical and Horizontal Mounting 65°C and 85°C

I.E.I. Tantalum Capacitors

- Tantalum Foil 85°C per MIL-C-3965/2/3/13 and/14
- Tantalum Foil 125°C per MIL-C-3965 Super Series 85°C Tantalum Foil High Voltage Tantalum Plain Foil Capacitors per MIL-C-3965
- Tantalum Wet Slug Electrolytic capacitors per MIL-C-3965/4
- Solid Tantalum Dry Slug Electrolytic Capacitors per MIL-C-26655/2

Callins International Limited Shannon Airport, Ireland. Tel: Shannon 61449/61558

See us at the I.E.A. Exhibition at Olympia, London, from 23rd to 28th May, Stand No. 268



IN THE VAST FIELD OF PRINTED CIRCUITRY . . .

YOU CANNOT AFFORD TO IGNORE

- the low production cost of Milclad flexible printed circuits made from the world's widest range of Copper-Clad Polyester and Polyamide substrates.
- the availability now of Pre-preg glass epoxy and Milbond polyester adhesives for all Multilayer designs.
- the prompt delivery to you from stocks held in England and Scotland of the finest quality and most generally specified Glass/Epoxy, Paper/Epoxy, Paper/Phenolic, and flexible polyester copper-clad grades.
- the interested technical sales and service team whose advanced experience is available on call.

OSWALD E. BOLL LTD

4A COMMERCIAL ROAD · WOKING · SURREY

Tel: Woking 61633

WOKING · ZURICH · PARIS · BRUSSELS · HAMBURG · MILAN

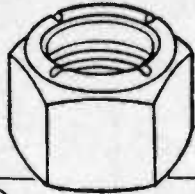
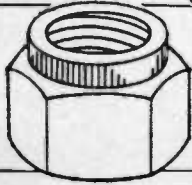
**APPOINTED
STOCKISTS****NYLOC****CLEVELOC**

BEDFORD Randalls Ltd.,
20-22 St. Mary Street, Bedford.
Telephone: Bedford 67488

BELFAST Kennedy & Morrison Ltd.,
12 Library Street, Belfast, 1.
Telephone: Belfast 30231 (5 lines)

BIRKENHEAD
Tom Wallace (Liverpool) Ltd.,
52 Cleveland Street, Birkenhead.
Telephone: Birkenhead 7891-2

BIRMINGHAM G. F. Bridges Ltd.
Humpage Road,
Bordesley Green, Birmingham, 9.
Telephone: Victoria 5511 (10 lines)

G. F. Bridges Ltd.,
Harvills Hawthorne, Hill Top,
West Bromwich.
Telephone: Wednesbury 1748

Thos. Millington & Co. Ltd.
Warstone Lane, Birmingham, 18.
Telephone: Central 8504-5

Telco Ltd., P.O. Box 213,
Wincaster Factory Estate,
Aston Brook Street, Birmingham, 6.
Telephone: Aston Cross 4828

BRISTOL
Woodberry, Chillcott & Co. Ltd.,
Atlas Street, Feeder Road, Bristol, 2.
Telephone: Bristol 70407

CARDIFF John Hall (Tools) Ltd.,
23 Churchill Way, Cardiff.
Telephone: Cardiff 22242 (7 lines)

DUNDEE George Boyd Ltd.,
13-15 Bell Street, Dundee.
Telephone: Dundee 26817

EDINBURGH George Boyd Ltd.,
24 Annandale Street, Edinburgh, 7.
Telephone: Waverley 4771 (5 lines)

D. F. Wishart & Co. Ltd. P.O. Box 74,
18 Picardy Place, Edinburgh, 1.
Telephone: Waverley 7481 (5 lines)

GLASGOW
Land Speight (Engineering) Ltd.
49 St. Vincent Crescent, Glasgow, C.3
Telephone: Central 1082-3

Stephens & Smith (Power Transmission) Ltd.
13 York Street, Glasgow, C.2.
Telephone: City 4051/2

George Boyd Ltd.,
140, Fielden St., Glasgow,
Telephone: BRidgeton 1844 (10 lines)

HULL The Hull Factoring Co. Ltd.,
Bourne House
Anlaby Road, Hull, East Yorkshire.
Telephone: 36725 (3 lines)

LEEDS Alder Hardware Ltd.,
Midland Road,
Balm Road, Leeds, 10.
Telephone: Leeds 75230 and 72724

LIVERPOOL
Tom Wallace (Liverpool) Ltd.,
Hope Street, Liverpool, 1.
Tel: Liverpool Royal 6401 (5 lines)

LONDON
Alder Hardware Ltd.,
Beaconsfield Road,
Springfield Road, Hayes, Middx.
Telephone: Hayes 7766 (10 lines)

Lewis Hunter & Co. Ltd.,
Rippleside Commercial Estate,
Ripple Road, Barking, Essex.
Telephone: Dominion 8298/9

F. Miller & Co. (London) Ltd.,
Rectory Road, Acton, London, W.3.
Telephone: ACOrn 5201 P.B.X.

Telco Ltd., Alma Rd., Enfield, Middx.
Telephone: HOWard 1282

LUTON Randalls (Luton) Ltd.,
Selbourne Road, Luton.
Telephone: Luton 52351

MANCHESTER
J. A. Challiner & Co. Ltd.,
77-83 Downing Street, Manchester, 1.
Telephone: ARDwick 3221-2-3

MIDDLESBROUGH Macnays Ltd.,
P.O. Box 14, Middlesbrough, Yorks.
Tel: Middlesbrough 45111 (7 lines)

POOLE
J. R. Smith & Sons (Structural) Ltd.,
Hamworthy, Poole, Dorset.
Telephone: Poole 1300 (10 lines)

SHEFFIELD
The Needham Engineering Co. Ltd.,
G.P.O. Box No. 23,
Townhead Street, Sheffield, 1.
Telephone: Sheffield 27161 (10 lines)

SLOUGH
F. Miller & Co. (London) Ltd.,
Cambridge Avenue, Slough, Bucks.
Telephone: Slough 25511 (10 lines)

STOCKPORT Delson & Co. Ltd.,
Newby Road, Hazel Grove Ind. Est.,
Stockport, Cheshire.
Telephone: Stepping Hill 1498 (3 lines)

TEDDINGTON H.S.S. Ltd.,
25 Church Road, Teddington, Middx.
Telephone: Teddington Lock 4441-5

WATERLOOVILLE H.S.S. Ltd.,
Jubilee Industria I& Trading Estate,
Waterlooville, Hants.
Telephone: Waterlooville 52941/2

FIRTH CLEVELAND FASTENINGS LTD

Treforest, Pontypridd, Glamorgan Tel: Treforest 2211

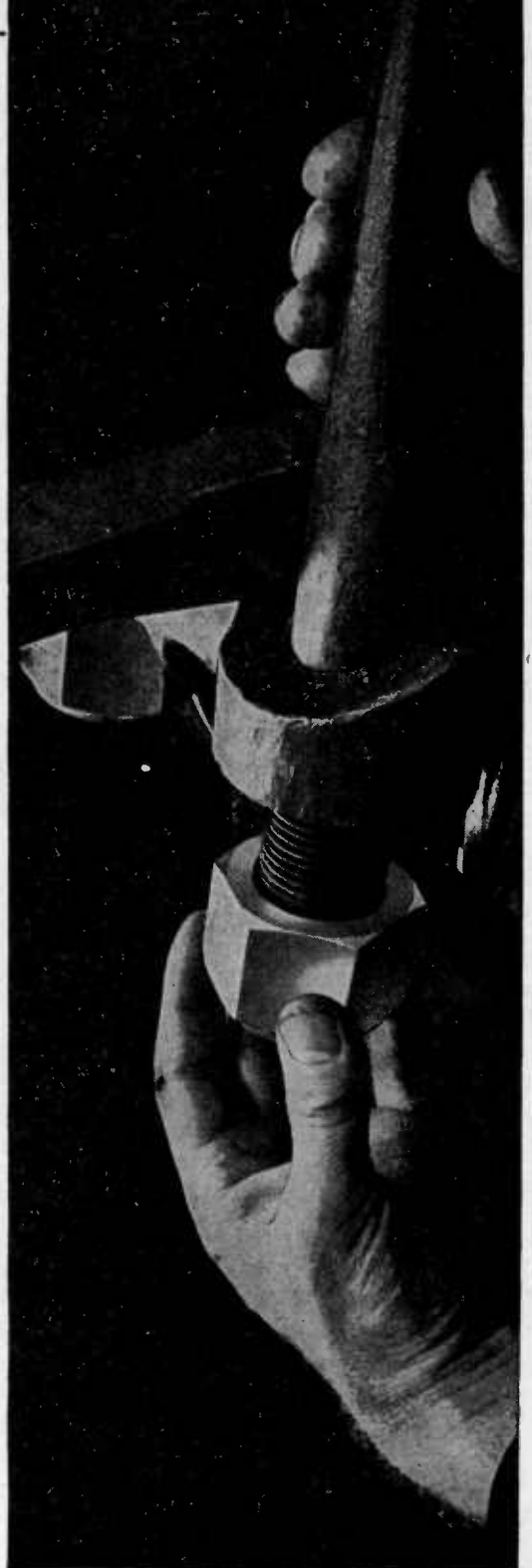
**NYLON INSERT
SELF-LOCKING NUTS****ALL METAL ONE PIECE
SELF-LOCKING NUTS**

M&P N66

Bullers CERAMICS

for the **ELECTRONIC INDUSTRY** (and Electrical Appliance Manufacture)

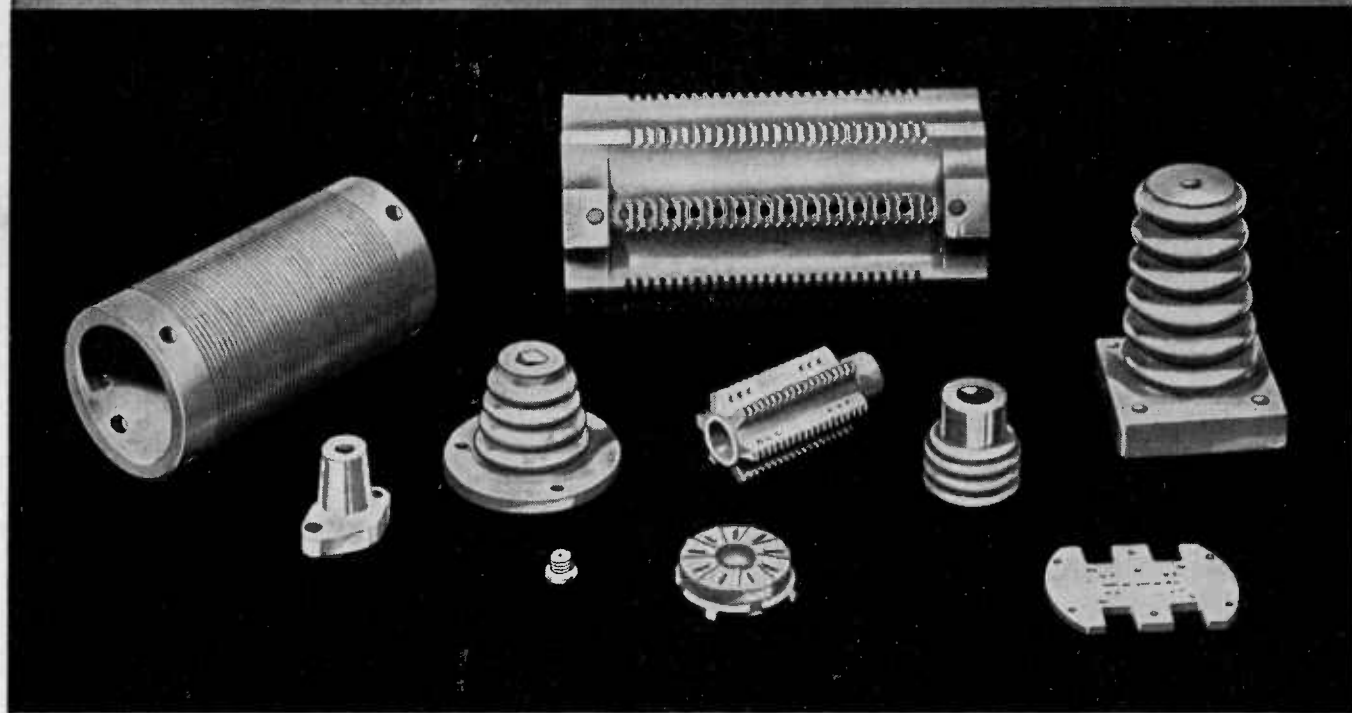

Frequelex—for high frequency insulation.

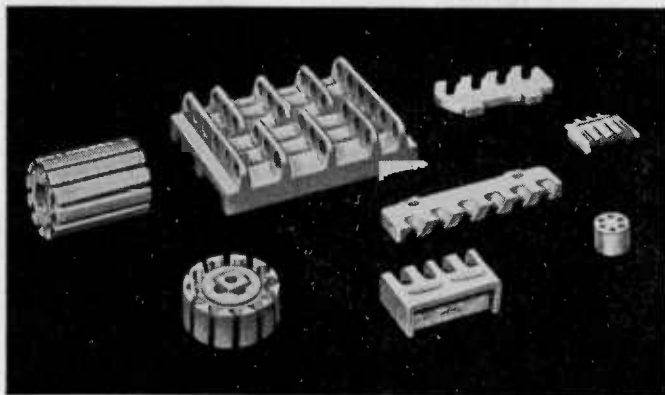

Refractories for high-temperature insulation.

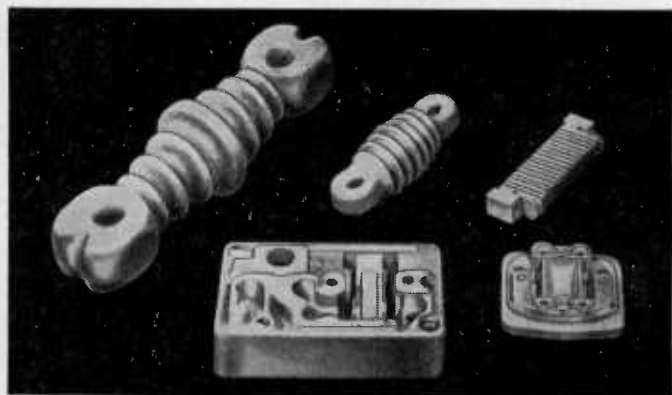

Bullers porcelain for general insulation purposes.

Meticulous care in manufacture, high quality material, with particular attention applied to *dimensional precision and accuracy*, explain the efficiency and ease of assembly when using Bullers die pressed products.

Write today for detailed particulars.

BULLERS LIMITED

Milton. Stoke-on-Trent, Staffs.

Phone: Stoke-on-Trent 54321 (5 lines)

Telegrams & Cables: Bullers, Stoke-on-Trent

London Office: 6 Laurence Pountney Hill, E.C.4.

Phone: MANsion House 9971



Eddystone

Eddystone Radio specialise in the manufacture of communications receivers and have, over the years, gained a high world-wide reputation for the excellence of their products. The diverse range of models offered fall into various categories and naturally there are variations in the capabilities of one receiver compared to another, according to frequency range, price class and the applications envisaged, with the advantage that most requirements can be met.

The total frequency coverage encompassed is

extremely wide—no less than 10 kc/s at one end (in the 850/4) and 870 Mc/s at the other (in the 990S). Some receivers use valves, others transistors, and a high engineering standard is maintained throughout. Other common features are good performance, robust construction and reliability.

A typical example is the Eddystone 990S receiver, which is a recently introduced model for VHF/UHF operation. It can be used separately or as a complete panoramic receiver, in which form it is illustrated below.

Eddystone EPR 29 panoramic receiver

A combination of the 990S receiver and the EP17R display unit, with the necessary accessories. The receiver is transistorised and gives high performance from 230 Mc/s to 870 Mc/s, divided into two ranges, with clear direct-reading scales. FM, video and AM modes of operation are catered for. The display unit operates on the IF output of the receiver and has a maximum scan of one megacycle, with excellent resolution and other characteristics. The whole forms a versatile compact equipment having many applications.

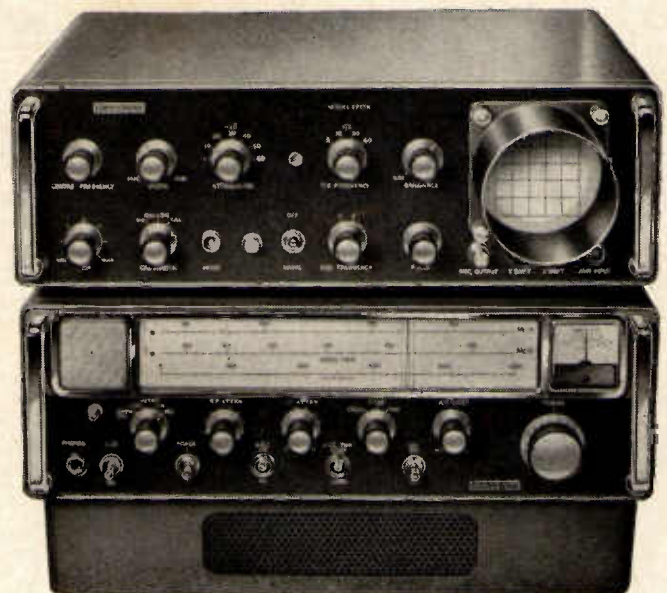

Eddystone Radio Limited

Eddystone Works, Alvechurch Road, Birmingham 31 Telephone: Priory 2231 Cables: Eddystone Birmingham Telex: 33708

LTD/ED15

COUTANT - Europe's top -

GB

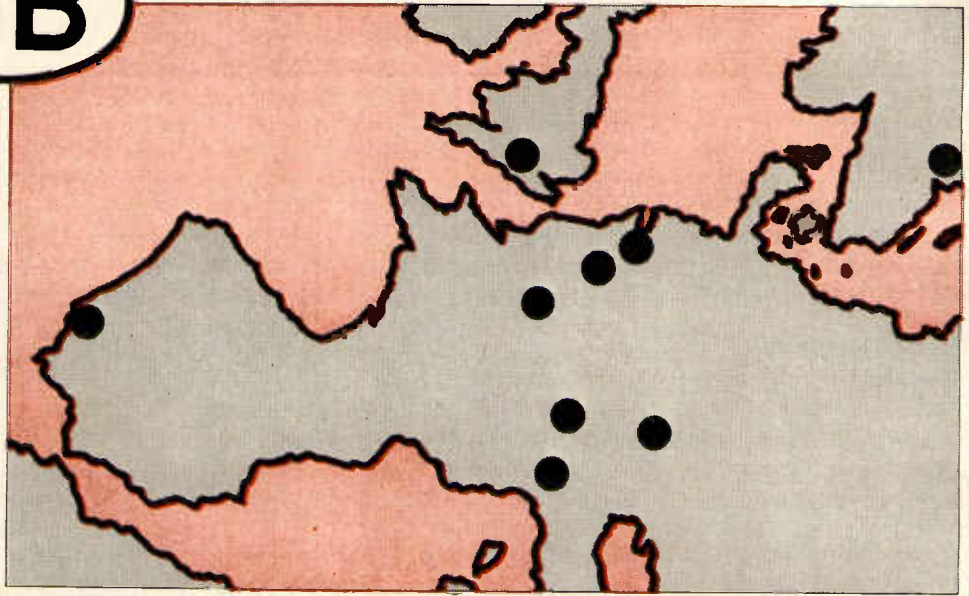

COUTANT INTO EUROPE

Now Coutant Electronics moves into Europe—not just in one or two countries, but right across the Continent you can talk to (and buy direct from) an accredited Coutant Agent—from Helsinki to Lisbon. Further afield you will find CEL agencies in Australasia and in the U.S.: *more to be appointed soon!* FIND OUT NOW ABOUT COUTANT PRECISION PACKAGED POWER FROM YOUR LOCAL AGENT—

BELGIUM: S.A. Gentronics, 80, Chausse de Charleroi, Brussels 6

FINLAND: Oy Control ab., Hitsajankatu 5, Herttoniemi, Helsinki 80

FRANCE: S.E.I.N.A., Rue d'Aguesseau 16, Boulogne-Billancourt, (Seine)

GERMANY: Omni Ray, G.m.b.H., 8 Munchen 19, Nymphenburger Strasse 164, Postfach 25

HOLLAND: Air Parts International N.V., Electronics Dept., Ryswyk (Z.H.), Haagweg 149

ITALY: Applicazioni Elettroniche S.p.A., Viale Monte Grappa 14, Milano

PORTUGAL: Rualdo Lda., Rua de S. Jose, 9-15, Largo da Anunciada 19, 1, Lisboa 2

SWEDEN: ab Elektronik Enheter, Torogatan 24, Enskede

SWITZERLAND: Omni Ray, A.G, Dufourstrasse 56, 8008 Zurich

SOUTH AUSTRALIA: W. E. Beveridge & Co., 204 Cross Road, Unley Park, Adelaide

U.S.A.: Dentronics Inc., 60 Oak Street, Hackensack, New Jersey 07601

selling POWER SUPPLIES

COUTANT FOR PEAK PERFORMANCE

Coutant Electronics' modular power supplies are built with precision, embody the most advanced design techniques and offer you unequalled reliability even when operated continuously at elevated temperatures. A typical specification is given below—and these figures are often bettered substantially in production. For VA per pound weight *and* VA per cu. in. COUTANT specs lead the field.

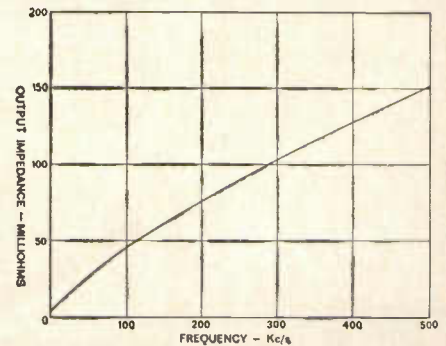

COUTANT for the widest choice

Manufacturing more than 70 different models of power supply unit COUTANT offer the widest and highest performance range in Europe. The 'E' Series offers from ½-amp to 2×30A in 19 versions—7 of which cater for 5-14V output needs. There are 23 standard modules in the high-temperature rated 'K' series—and there are unstabilised versions too. Whatever your application area, there is a COUTANT supply unit to give you best value for money. NOW—VARIABLE UNITS TOO! Recent additions to our range include variable lab. supply units in bench or modular form: current and voltage variable—sub-units remotely programmable and ideal for systems work. FILL IN THE COUPON NOW!

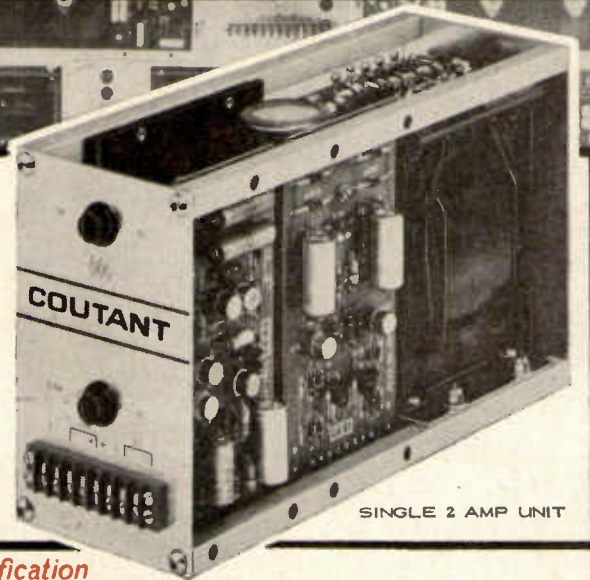

typical basic specification

STAB. RATIO	O/P RESISTANCE	RIPPLE p-p	O/P IMPEDANCE 100 kc/s
< 5000 : 1	< 0.002Ω (< 0.0005Ω ABOVE 5A)	< 200μV	< 0.1Ω



COUTANT ELECTRONICS LIMITED

TRAFFORD ROAD
RICHFIELD INDUSTRIAL ESTATE • READING • BERKSHIRE
Tel: READING 55391-5

electrotech instruments division

EE 94 092 for further details

Sub-Miniature Switches

For Your Every Application

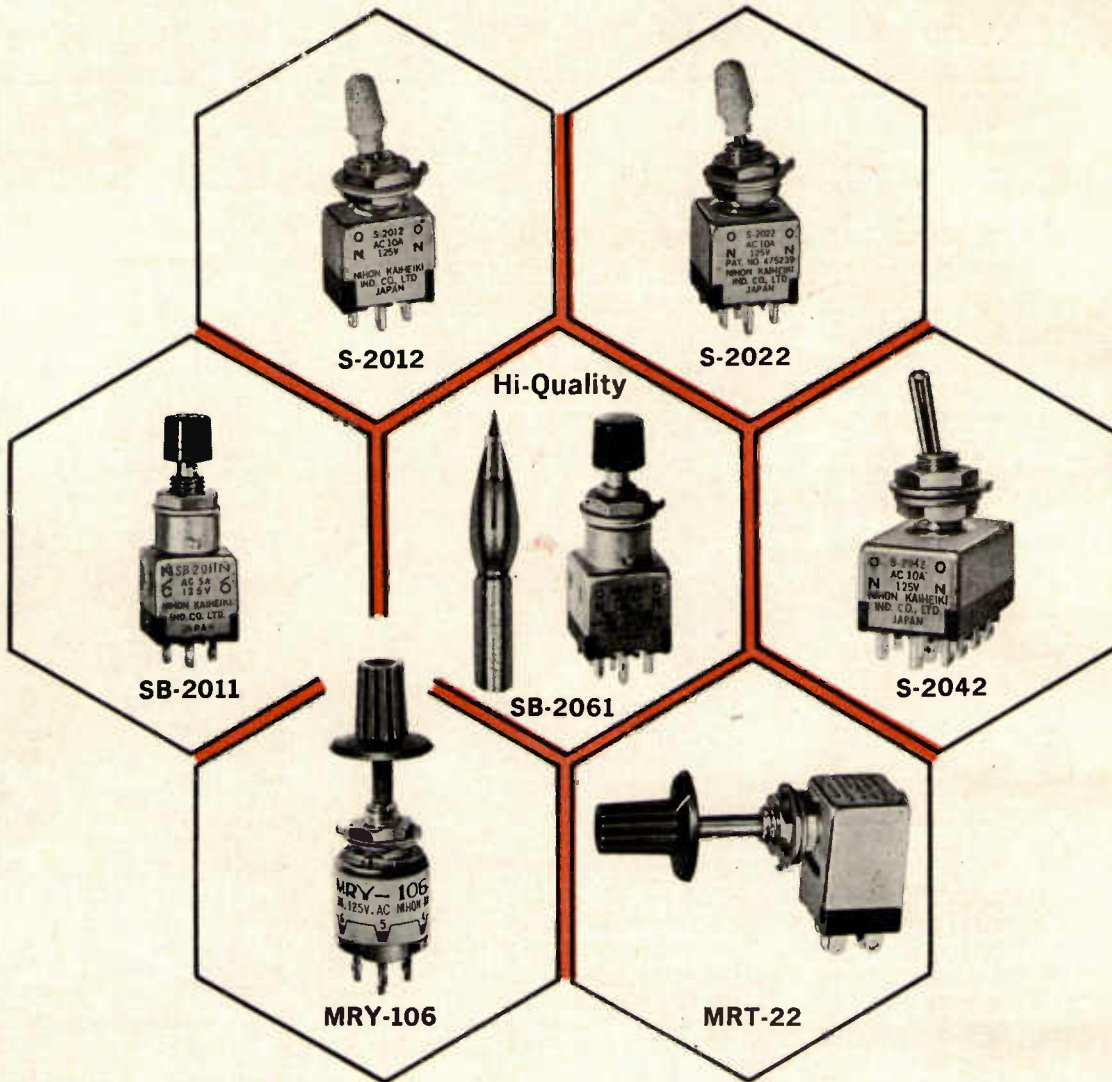

Best Choice for Your Requirements

TYPE	MODEL	CIRCUIT	CAPACITY	CIRCUIT ARRANGEMENT	TYPE	MODEL	CIRCUIT	CAPACITY	CIRCUIT ARRANGEMENT
Toggle Switch	S-2012	SP.DT	10A. 125V. A.C.	ON-ON	Nikaron (Micro Sw)	SM-1	SP.DT	3A. 125V. A.C.	ON-ON (momentary)
	S-2013	SP.DT	5A. 125V. A.C.	ON-OFF-ON		Rotary Switch	MRT-22	DP.DT	6A. 125V. A.C.
	S-2022	DP.DT	10A. 125V. A.C.	ON-ON	MRT-23		DP.DT	6A. 125V. A.C.	ON-OFF-ON
	S-2023	DP.DT	5A. 125V. A.C.	ON-OFF-ON	MRX-108		1 pole	1A. 125V. A.C.	usable position 1-8
	S-2025	DP.DT	6A. 125V. A.C.	ON-Mom. ON	MRX-204		2 poles	1A. 125V. A.C.	usable position 1-4
	S-2042	4P.DT	10A. 125V. A.C.	ON-ON	MRY-106		1 pole	3A. 125V. A.C.	usable position 1-6
	S-2043	4P.DT	5A. 125V. A.C.	ON-OFF-ON	Push-Button Switch	SB-2011	SP.DT	5A. 125V. A.C.	ON-Mom. ON
Power Relay	UMR-2P	DP.DT	3A. 200V. A.C.	ON-ON (Plug-in)		SB-2061	DP.DT	6A. 125V. A.C.	ON-Mom. ON
	UMR-3P	TP.DT	2A. 200V. A.C.	ON-ON (Plug-in)	SB-2085	DP.DT	6A. 125V. A.C.	Push ON Push OFF	

Write for free catalogue

Main Products:

Toggle Switches, Push-Button Switches, Rotary Switches, Micro Switches, See-Saw Switches, Relays, Motor Timers, Rotary Selectors, Etc.



NIHON KAIHEIKI IND. CO., LTD.

Address: 1-5-14, Minami-Magome, Ota-ku, Tokyo, Japan

Tel. Tokyo (772) 3181-5

Cable Address: "NIKKAELECTRO" TOKYO

HIGHEST PERFORMANCE — at the lowest cost!



**Small size
Competitive price**

TYPE PS300
100-5,000 Volts at 20mA, floating
0.005% stable for 10% supply change
Ripple less than 20mV peak to peak
100 ohms output impedance
Overload trip



ONE IN A MILLION

The Drift Monitor enables the stability of Power Supplies from 0.1 Volts to 5kV and 0.1mA to 5 Amps to be measured. It possesses the unique facility of producing a continuous pen recorder trace of input variations with a sensitivity of 0.01% of input for I.A.D. on a 10mA recorder. The Drift Monitor is more than one in a million stable against a 5°C ambient or 10% mains change.



0.001% STABLE E.H.T. SUPPLY

The type 2124 E.H.T. unit has shown that very high stability can be maintained in a production instrument. The 2124 has been in service for over two years with the U.K.A.E.A., Government departments, universities and industry since being shown at the Physics Exhibition in 1964. The 2124 delivers 0.4kV at 3mA, with reversible polarity.



LOW COST GENERAL PURPOSE E.H.T. SUPPLY

Our experience of high stability work has been used to produce an E.H.T. unit of moderate stability at low cost for general purpose use, the PS2, which gives 0.3,000 Volts at 1mA with reversible polarity and 0.05% stability on the bench.

J & P Engineering (Reading) Ltd.

PORTMAN HOUSE · CARDIFF ROAD · READING · BERKS · Reading 52227

Mullard components for Television, Radio & Audio

**world famous
performance**

**world proven
reliability**

Many of the world's leading manufacturers of radio, television and audio equipment are users of Mullard electronic valves, tubes, semiconductors and components. They are served by an international network of Mullard companies, agents and distributors, supported by a complete technical information and advisory service.

There is almost certainly a distributor in your own country even if he is not included in the short list on the opposite page. Please write to us for details and let us know in which field of electronic applications you are particularly interested. We will, in any case, be pleased to see that you receive the Mullard Bulletin, which will keep you informed of our latest developments.

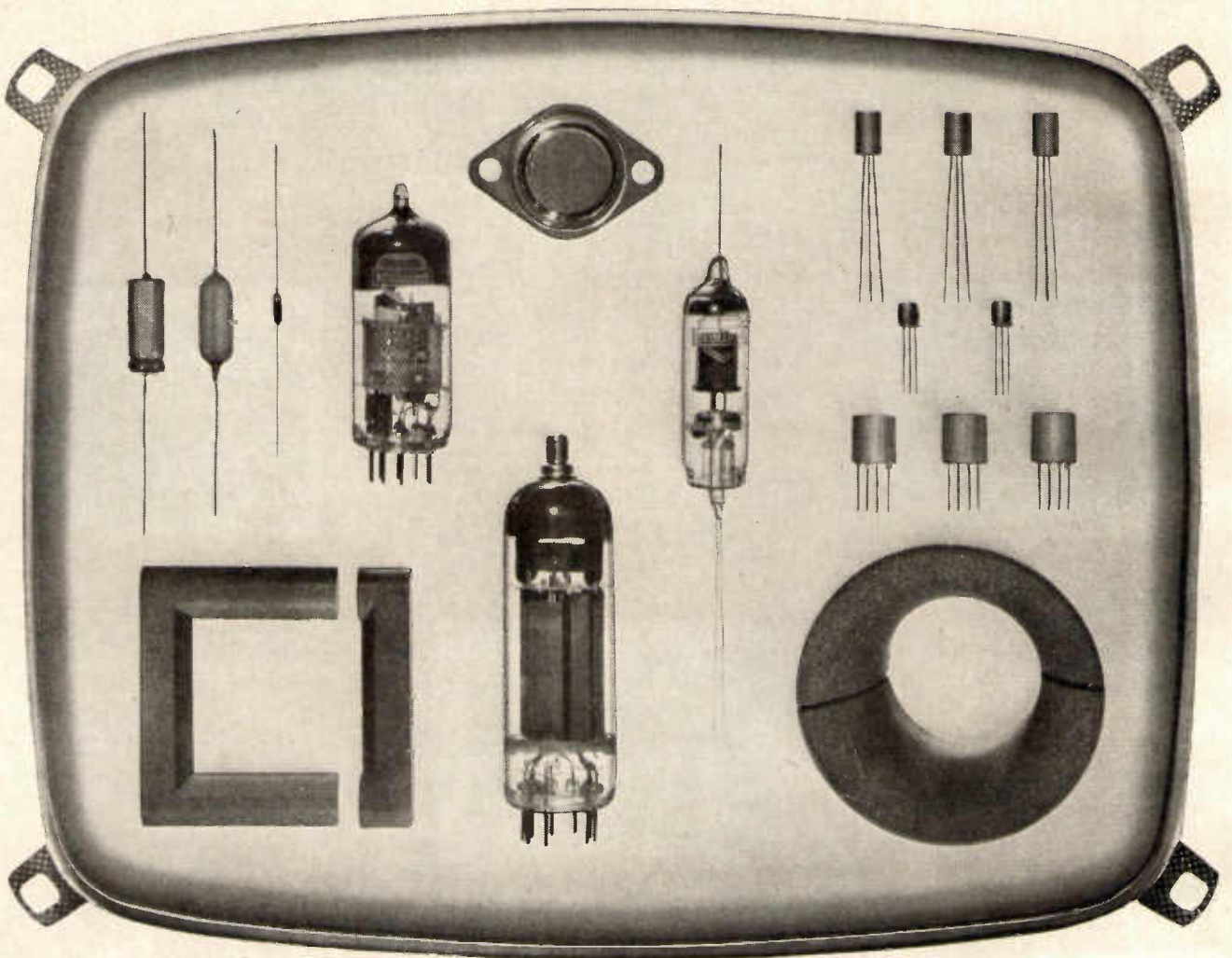

Mullard — makers of Britain's most comprehensive range of electronic components



world wide availability

A short list of important Mullard overseas companies and agents. For information about distribution in other countries, please write to Mullard Limited, London, at the address below.

AUSTRALIA
Mullard-Australia (Pty) Ltd.
Sydney
Tel: 29-2006

DENMARK
Mullard A/S
Bagsværd
Tel: 982666

ITALY
Britelec S.r.L.
Milan
Tel: 68 82 194

NEW ZEALAND
Electronic Development and
Application Co. Ltd. Wellington C3
Tel: 54-039, 54-130

NORWAY
E. Borge Haga A/S
Oslo 5
Tel: 38 03 80

RHODESIA
Rhodesian Electronics (Pvt) Ltd
Bulawayo
Tel: 64477

SOUTH AFRICA
E D A C (Pty) Ltd.
New Doornfontein
Tel: 24-2047

SWEDEN
Svenska Mullard AB
Stockholm No.
Tel: 08/67 01 20 Vaxel

Mullard Limited
Torrington Place, London WC1
Telephone: LANGHAM 6633
Telex: 22281
Cables: Mulletron London WC1

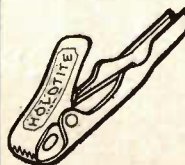
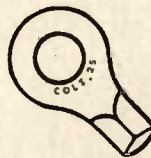
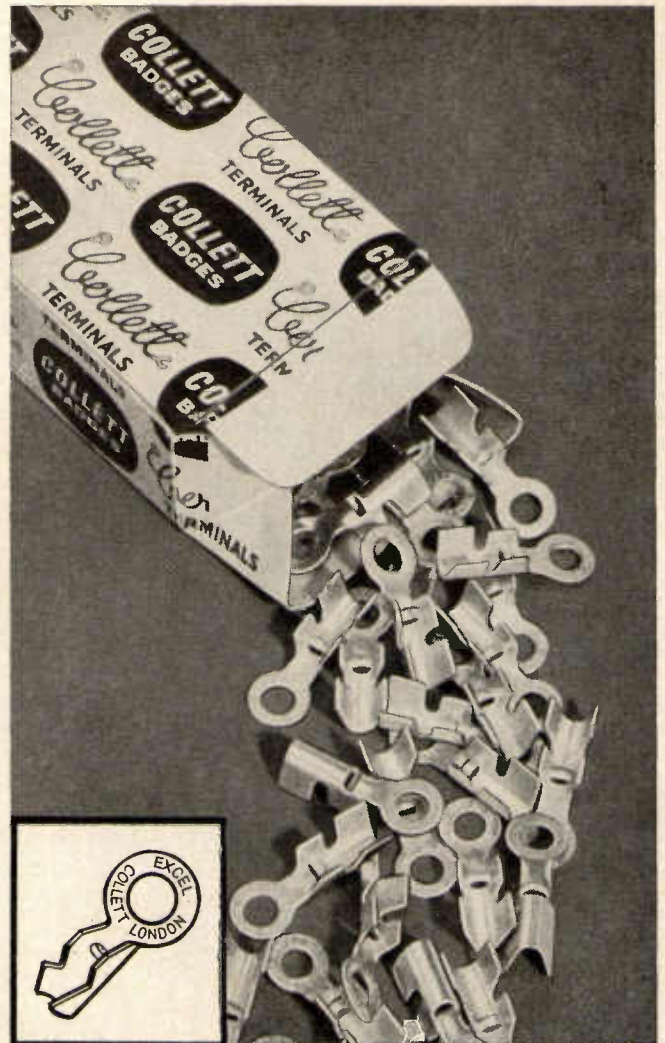

TAKE YOUR PICK!

There are more than 200 different types of solder and solderless terminals, tags and clips to choose from in the famous COLLETT range.

The COLLETT "small quantity" service is particularly valuable to the development engineer. Small boxes of 100 or even 10 of any type of terminal can be ordered from stock. And if none of the standard range is suitable, COLLETT will make up "specials" to meet your own requirements.

Send for fully illustrated catalogue and price list today.

COLLETT TERMINALS

347/349, GOSWELL ROAD
LONDON, E.C.1 · TERMINUS 2584



don't take a chance
on heads



Epsylon have spent many years perfecting the development and production techniques of magnetic recording heads, and the new Series 3 units consequently set new standards in scientific and industrial recording fields.

Ask for details of our complete range. Epsylon magnetic recording heads offer outstanding performance and quality at very competitive prices.

**magnetic
recording
heads by**



A member of the
Stone-Platt Group

EPSYLON
INDUSTRIES LIMITED

Faggs Road, Feltham, Middlesex, England
Telephone: FELtham 5091/5

Electronic People make contact with McMurdo

Adventurous designers with down-to-earth practicality choose McMurdo plugs, sockets and connectors for their reliable performance, quality of construction and budget-conscious prices. If You've got your eyes on a bright future, you'll find the McMurdo data sheets will provide the fuel to put your plans in orbit. If You're a holder of the ELECTRONIC ENGINEERING INDEX, see LJ400 for Connectors and LJ470 for Valve Holders.

The McMurdo range includes: CONNECTORS—rack and panel, line and jumper, printed circuit and audio range. VALVE HOLDERS—Plug-in relay sockets, Decal 10 pin valve holders. Transistor Sockets, Crystal Sockets. VOLTAGE SELECTORS.



McMURDO

ELECTRONIC COMPONENTS

THE McMURDO INSTRUMENT COMPANY LIMITED
RODNEY ROAD · PORTSMOUTH · TEL 35361 · TELEX 86112
NORWAY J. M. Fairing A/S, Lilletorvet 1, OSLO
PERU Estemag Peruana S.A., P.O. Box 2838, LIMA
PHILIPPINES C & C Commercial, P.O. Box 2419, MANILA

BETADUCT

**STRAIGHTFORWARD
P.V.C. DUCTING.**

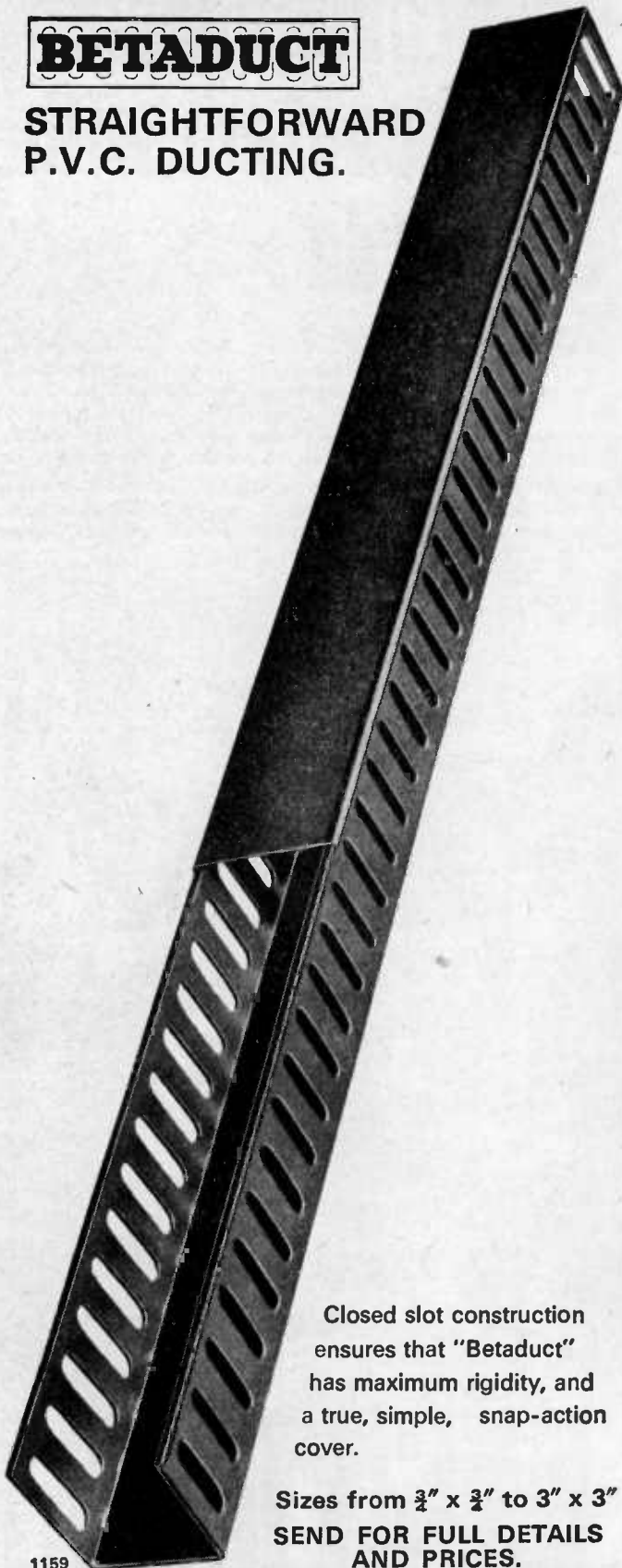

Closed slot construction ensures that "Betaduct" has maximum rigidity, and a true, simple, snap-action cover.

Sizes from $\frac{3}{4}$ " x $\frac{3}{4}$ " to 3" x 3"
**SEND FOR FULL DETAILS
AND PRICES.**

1159

CRITCHLEY BROS. LTD.

BRIMSCOMBE - STROUD - GLOS.

Tel: Brimscombe 2208 (3 lines)

TELEX 43194

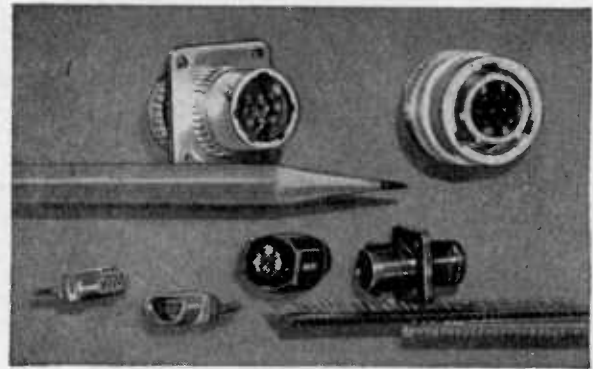

CANNON MICRO MINIATURE CONNECTORS

Circular, Rectangular, Strip Connectors,
Contact densities up to 420 per sq. inch.

**Cannon Electric
(Great Britain) Ltd.,
Lister Road,
Basingstoke, Hants.
Tel: Basingstoke 3171**



CANNON



HLEMCO

THE
CAPACITOR
SPECIALISTS

MICA

CERAMIC

ELECTROLYTIC

PLASTIC FILM

METALLISED

MOULDED

LONDON ELECTRICAL MANUFACTURING COMPANY LIMITED
51 Bridges Place, Parsons Green Lane, London S.W.6. Tel: Renown 7071-6

TAS/LEN 2



Stainless

Solid advantages. Stainless steel fasteners, immune to corrosion in most applications, may cost a little more — but in the end they are the most economical. They last and last, with no need for inspection or maintenance. Even physical damage does not affect their corrosion resistance, and they leave no rust marks when they are removed.

No more difficult decisions—with stainless steel you can be *sure* of good performance. Stainless steel fastener prices are more stable than most; and stainless steel fastening is a potent sales point in itself for all goods sold to the public.

A full range of G.K.N. fasteners is available in stainless steel — Socket Screws, Self-Tappers, Wood Screws, and many others.



GKN SCREWS & FASTENERS LIMITED

Heath Street Division, Box No. 24, Heath Street,
Birmingham 18. (Smethwick 1441).

Fredk. Mountford (Birmingham) Ltd., Fremo Works,
Moseley Street, Birmingham 5. (Midland 7984).



MORGANITE RESISTORS LIMITED

A Member of The Morgan Group of Companies

is proud to receive

THE QUEEN'S AWARD TO INDUSTRY

in recognition of

its export achievements

new Filmet* high stability metal film resistors

The consistent reliability of 'Filmet' metal film resistors has been still further improved by radically new manufacturing methods. Filmet resistors are now being made in our new 'clean' building which reduces chances of microscopic contamination to an absolute minimum. To this is added an uncompromising attitude to quality control which means that 100% inspection is carried out at every stage of manufacture.

Two basic versions of the new Filmet resistor are being made, the FC series is conformally coated with epoxy resin and the FM series is protected by multiple epoxy coatings with a hot moulded outer case. The multiple coated version of the resistor is designed to surpass the requirements of DEF 5115 Style RFG7.

A range of sizes is available covering power ratings up to 1W at 70°C and resistance values from 6Ω to 2.2MΩ. The new Filmet resistors can be produced to a tolerance of 0.1% and temperature coefficients of ± 15 p.p.m. can be obtained.

*Filmet is a registered trademark of Morganite Resistors Limited



Morganite electronic components are 2 steps ahead

new cermet trimming potentiometers

Morganite now offer a range of industrial, professional and military components employing the latest techniques in the manufacture of metal glaze potentiometer tracks developed by the leading U.S. manufacturer of cermet products.

The cermet resistance element is a composition of precious metal and glass which is screen printed and fired on to a ceramic substrate. The element is immune to catastrophic failure and can operate at high temperatures. This enables relatively high power ratings to be achieved in components of extremely small size.

The hard smooth cermet track provides essentially infinite resolution and is impervious to atmospheric corrosion or oxidation. This ensures easy resetting and electrical stability throughout the long working life of the potentiometers.

Cermet trimming potentiometers are available in selected values from 10Ω to 2MΩ and in linear and rotary form.



Morgan

For details of these new professional components please write to:—

MORGANITE RESISTORS LIMITED

Bede Trading Estate, Jarrow, Co. Durham. Telephone Jarrow 897771. Telex 53353

ECONOMICAL COOLING by C&N

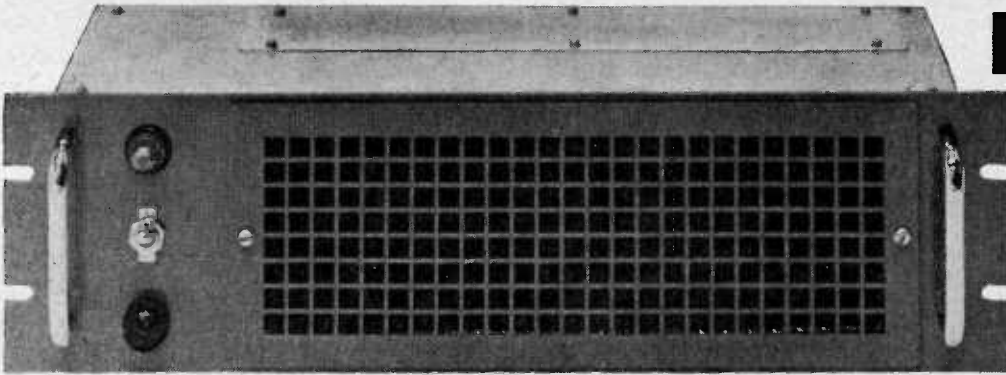

BLOWER UNIT BL 35

Designed for the 19" (482.6 mm) panel user for the ventilation of electronic cabinet and rack assemblies. The BL35 has already proved itself to be one of the most efficient low assembly cost blower units yet made. It is mounted on a standard 19" x 5 1/4" panel with an overall depth of 5 3/8". Chrome plated Dee handles are fitted and the front panel is finished in Dark Grey stoved enamel. The air delivery can be vertical or top and this change can be effected quickly. It is also made to become a vital part of the 7500 system. The BL35 Blower Unit is essential for the proper maintenance of delicate scientific instruments and fully repays its cost. Can we send you details to meet your requirements?

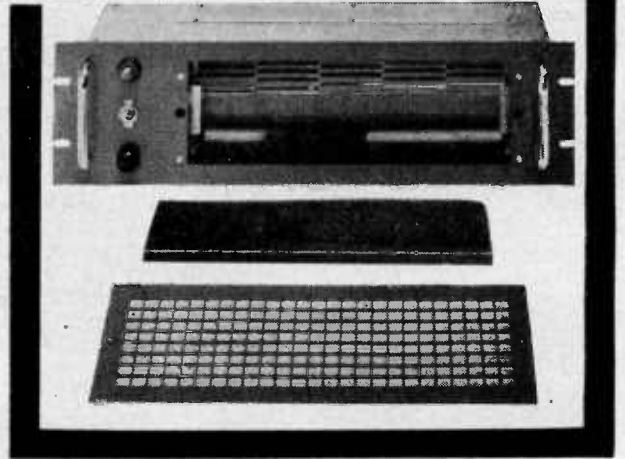

 **C & N ELECTRICAL LTD**

THE GREEN, GOSPORT, HANTS TEL.: GOSPORT 82391/9 TELEX: 86121

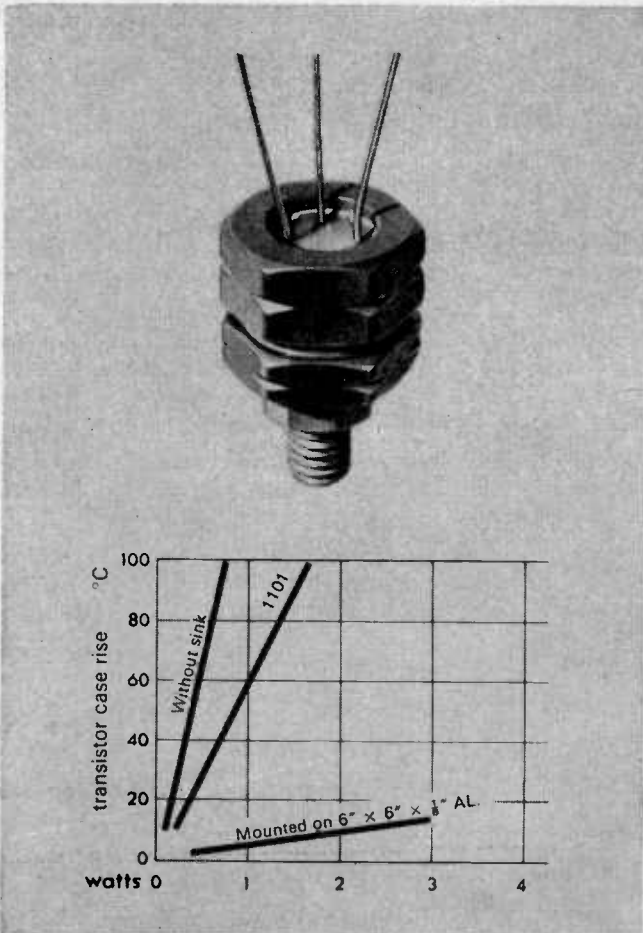

HEAT SINKS for T05 & T018

Positive contact heat sinks for T05 and T018 simplify cooling problems, transistor choice and circuit design.

Made of two part threaded construction the heat sinks are designed to grip the weld flange of the transistor—the area of maximum heat generation; variations in can size do not affect thermal performance. Insulated versions with identical thermal characteristics are available, each tested to 500 VDC.

JERMYN heat sinks cut development and production costs, increase transistor life, improve stability and save space.

 **JERMYN**
Jermyn Industries
Vestry Estate Sevenoaks Kent
Telephone Sevenoaks 56838-48

Manufacturers of every conceivable transistor accessory and stockist distributor for General Electric (U.S.A.)

LADDER

FILTERS

ADVANTAGES

- Fantastic space saving
- Excellent stability with time and temperature
- Single or multiple resonant units

TYPICAL SPECIFICATION

Centre Frequency	300 to 600 kc/s \pm 2 kc/s
Bandwidth	2 to 45 kc/s at 6 db
Insertion Loss	1 to 15 db (dependent on B/W)
Impedance	Either 1200 or 1500 ohms in and out, dependent on B/W
Case Size	8 mm diameter 38 mm long
Operating Temperature Range	-40°C to +85°C
Shape Factor 60/6 db	1.3 : 1 to 2.6 : 1 Dependent on B/W

Curve below shows response of our ladder filter type TL 10 D 16A. Note the outstanding shape factor

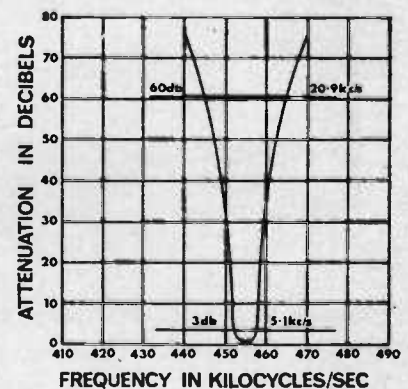

Keep your eye on Brush

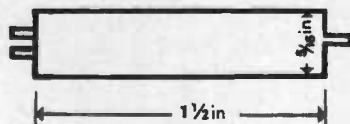

SIZE

This illustrates the typical dimensions for a ladder filter. The case is a plated brass cylinder with glass end seals and pigtail leads. A 1 1/2 inch length will provide sufficient volume to give 80 db stop band rejection.

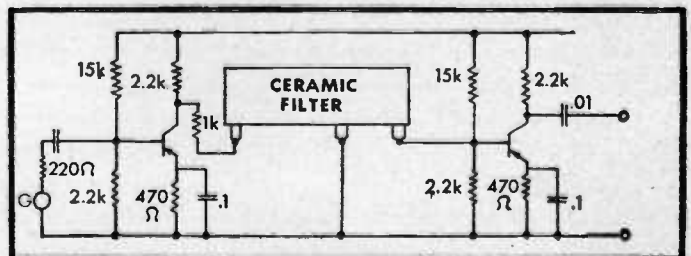

BC BRUSH CLEVITE COMPANY LIMITED

BRUSH CLEVITE COMPANY LTD HYTHE SOUTHAMPTON

PHONE HYTHE 3031 GRAMS BRUDEV HYTHE SOUTHAMPTON TELEX 47687

Plessey can solve your memory store problems...

Because Plessey, leaders in the field of computer memory stores, have the facilities, know-how, problem-solving experience and staff to tackle any application.

★ Plessey leadership in computer-requirement knowledge starts with the experience of engineers who design stores for all applications with the assurance that the production teams can cope with the complex technicalities involved.

★ Plessey Research and Development has produced a complete range of ferrite square-loop cores from '080' to '020' dia., covering switching times down to 1 μ sec as well as low drive, wide temperature cores for special systems.

★ Plessey production facilities cater for all types of applications whether the requirement calls for a specially designed 'one-off' unit or large quantity production.

★ Plessey leadership in test equipment installations *guarantees* that the unrivalled experience of all concerned is concentrated into the finally despatched stores, whatever the specification.

Whatever your requirement for computer memory stores, contact:

The Plessey Company Limited,
Dielectric and Magnetic Division,
Wood Burcote Way, Towcester, Northamptonshire.
Telephone: Towcester 312. Telex 31628

PLESSEY
Components Group





NEW

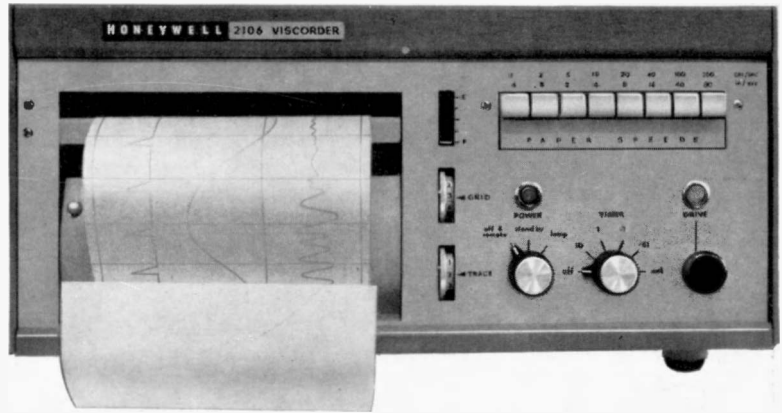

LOW PRICED/HIGH PERFORMANCE Direct Writing Recording Oscillograph

Fresh this month from the production line of Honeywell's Newhouse (Scotland) Factory, comes the new 2106 'Visicorder' Oscillograph—an instrument embracing an extremely high specification within a very low price structure.

One of Honeywell's major introductions at this year's I.E.A. Exhibition, the 2106 offers many features not normally associated with instruments in this price range. The compact unit has a 6 in. wide chart which takes records from 12 channels (plus a further 2 auxiliary channels).

The result of extensive research and development, the 2106 has been designed to cover the most stringent applications but still meet the tight budgets of most research and development establishments. Aware of the practical working problems faced by engineers, Honeywell designers have included many plus features which make the 2106 truly versatile.

No longer will you have to keep the unit running, while not actually recording—the 2106 has a unique facility allowing instant starting of the U.V. Lamp either hot or cold. Capable of recording a multiplicity of variables on the same chart, the 2106 also provides as standard features, grid and timing lines. Other features include:

- Choice of chart speeds—gearboxes available which provide an overall

range of 1 cm./min. [0.4 in./min.] to 300 cm./sec. [120 in./sec.].

- Individual plug-in resistance board for each Galvanometer, enabling a library of input boards with different damping and matching networks to be built up—eliminating tedious and expensive setting-up time.
- A maximum of 2 event markers available.
- Facilities available for mounting of chart latensifier on front panel, thus providing immediate development records.
- Optional record length control prevents paper wastage.
- The 2106 takes up to 150 ft. of paper.
- Absolute running economy—nar-

row paper width can be used, where suitable, down to a minimum of 3 in.

- Writing speed greater than 125 cm./ms. [50,000 in./s.]

A world wide market is forecast for this versatile unit. **Ref No EE 94 850**

... AND WITH THE 2106 ...

...the wide range of new U.K. produced series M Galvanometers ... which can be used with the 2106 and other Honeywell 'Visicorder' Oscillographs.

Series M Galvanometers combine high sensitivity and stability with flat frequency responses going from d.c. to 13,000 c/s. Stability of performance is maintained by heating and thermostatically controlling the temperature of the Galvanometer block.

In these high frequency galvanometers the mirror is not immersed in the damping medium. In consequence the deflection of the light image across the chart is not limited by dispersion of the U.V. light in the fluid.

Any Galvanometer may be inserted or removed in a matter of seconds.

Ref No EE 94 851

1966 INSTRUMENTS ELECTRONIC & AUTOMATION EXHIBITION

REVIEW



H20 COMPUTER MAKES ITS EUROPEAN DEBUT



Highlighting Honeywell's continuing progress in the field of automation—and a major attraction at I.E.A.—is the H20 Digital Control System.

Bringing for the first time usable performance to the low cost computer field, the H20 is designed to provide total system capability—handling the widest range of scientific and industrial applications from relatively simple engineering computations to large multi-programmed, on-line problems.

Reflecting Honeywell's belief that true economy extends beyond the modest initial investment to include generally useful performance, the H20 system incorporates many hardware and programming features seldom found in low cost systems. These features put it on-line fast and give it a real on-the-job power—even for the inexperienced user.

By combining the high performance with low cost the H20 opens the door to applications considered too (either) difficult or too expensive to be undertaken by computer systems of previous generations. It provides a solution today for the control problems of tomorrow.

Ref No EE 94 852

ACCUDATA 104 HITS U.K.— I.E.A. PREVIEW OF NEW d.c. AMPLIFIER RANGE

Honeywell are marketing for the first time in Britain a series of d.c. Amplifiers. Known as the Accudata 104, the range is available in a standard version, giving a gain between 10 to 250, and two other versions, giving gains of $\cdot 1$ to $2\cdot 5$ and $\cdot 4$ to 10

The Amplifiers have excellent noise and drift specifications and are ideal general purpose amplifiers for d.c. excited stained gauges, thermocouples or other signal sources lacking sufficient power to drive a recorder direct. All versions are designed to work with galvanometer recorders and have sufficient output capability to drive even the highest frequency fluid damped galvanometers.

The Accudata 104 is designed to

NEW MULTI-CHANNEL CARRIER AMPLIFIER

Honeywell have increased the operating range of their C.A.51 multi-channel carrier amplifier C.A. The improved instrument is for the benefit of the user who wishes to measure strain, pressure, and other variations from d.c. to 2,000 cycles per second.

It incorporates the following features of this world-proven, British designed instrument: individual plug-in amplifiers giving real power for operating the Honeywell range of Visicorders or any other recording oscillograph.

Ref No EE 94 853

prevent transients from damaging the galvanometer when gain ranges are switched, when the input is open-circuited, or when the unit is turned on or off. A front panel control determines the polarity of connection to the galvanometer, and also enables the output to be shorted for a Zero setting of the galvanometer. Rack and variable adapters are available.

Ref No EE 94 854

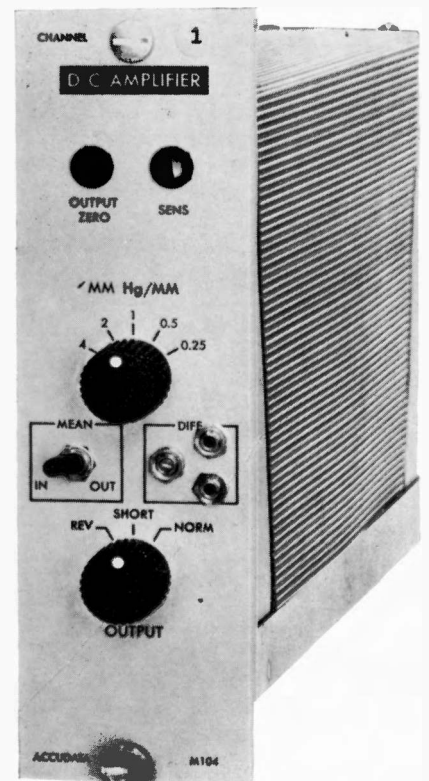



6200—THE SIMPLEST WAY TO ACQUIRE MEDIUM SPEED SYNCHRONOUS OR RANDOM DATA

Systems Engineers working with paper tape machines and paper-to-magnetic tape convertors or with buffers and fast start/stop Recorders had a common complaint—"There just has to be a better way of preparing Computer Compatible Tape."

Now there is . . . the Honeywell 6200. This incremental digital unit records synchronous or asynchronous data with the same ease to produce tape with the proper bit spacing for direct use by a 7 track Computer Tape Handler.

Typical sources of data received by the 6200 include: Data Coding Typewriters; Digital Measuring Instruments (counters, digital frequency meters, time interval meters); and Analogue-to-Digital Convertors (digital volt meters, shaft position encoders, special purpose convertors, punched tape recorders).

More information on this versatile instrument will be available on I.E.A. stand G.205.

Ref No EE 94 855

1966 INSTRUMENTS ELECTRONIC
& AUTOMATION EXHIBITION
REVIEW

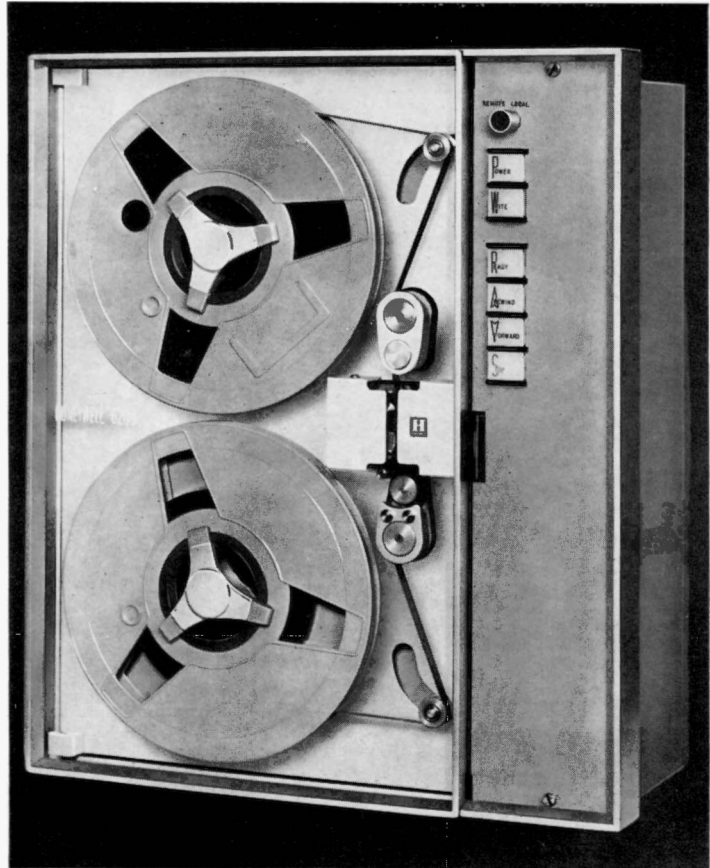

HIGH VOLTAGE d.c. SOURCES

Introduced recently, the Honeywell 6K20 offers the greatest stability of any high voltage d.c. sources in their range available today. They have a guaranteed stability of .005% per hour and .01% stability per day.

The 6K20 have been environmentally tested to operate within specifications at 120°F at 95% relative humidity and designed to function properly up to altitudes of 10,000 ft.

Having a range of 0 to 6,000 volts the 6K20 is designed for the utmost in user convenience. The compact instruments are only 5½ in. high and may be used in a standard relay rack or bench mounted.

Ref No EE 94 856

8100 PORTABLE MAG TAPE RECORDER

Another item at I.E.A. underlying Honeywell's versatility in the Scientific, Medical and Industrial fields, is the new 8100 Portable F.M. Magnetic Tape Recorder/Reproducer.

Designed for a wide range of applications this new instrument weighs only 75 lbs. yet has been designed to meet all requirements demanded by users of compact instrumentation. It will accommodate power supplies in the range 230v 50 c/s; 110v 60 c/s; and 115v 400 c/s; or, alternatively, two 12 volt car batteries. It includes many features normally expected only in large and more expensive laboratory systems.

Although it is essentially a portable instrument, the Honeywell 8100 has a sub-chassis which permits rack-mounting.

Ref No EE 94 857

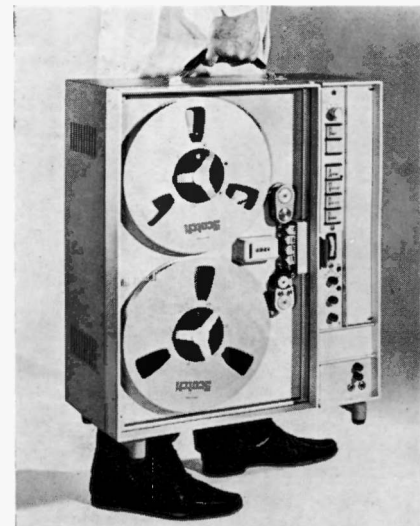



Instrumentation News

TIME DELAY CORRELATOR FIRST I.E.A. SHOWING



Introduced during 1965, the Honeywell 9410 Correlator is designed basically for the investigation of complex natural and man-made physical systems as the name suggests, it embraces the time correlation principle as a means of data reduction. It includes the Auto-Correlator function employed with a single amplitude-time history record and the cross correlation employed with pairs of records.

A typical application is featured above, where the Department of Mechanical Engineering—at University of Aston—are using the 9410 as an important tool in their programme on Automobile Research. Particular attention is being paid by the Department to the detection of rear axle noise and the Correlator will be used specifically to isolate high frequency sounds.

Ref No EE 94 858

Chromatography Integrator Steps Out

Precision Automatic Print out for Gas Chromatograms

Designed to meet the special, exacting requirements of Gas Chromatography, the Honeywell Precision Integrator is self-contained and requires only connection to the mains supply and the chromatograph output.

Among the many important features of the new Integrator is the specially designed Printer which gives the high count range capacity of transfer printers with the simplicity and low cost of the accumulating print. This new printer offers us simple 'drop in' paper loading and immediately visible printout.

The Integrator is fully transistorised and it uses module construction for ease of servicing.

Ref No EE 94 859



Honeywell

INDUSTRIAL PRODUCTS GROUP

Honeywell Controls Limited

Honeywell House Great West Road Brentford Middlesex

Telephone Atlas 9191

HONEYWELL INTERNATIONAL

Sales and service offices in all principal cities of the world.

Manufacturing in United Kingdom, U.S.A., Canada, Netherlands, Germany, France, Japan.

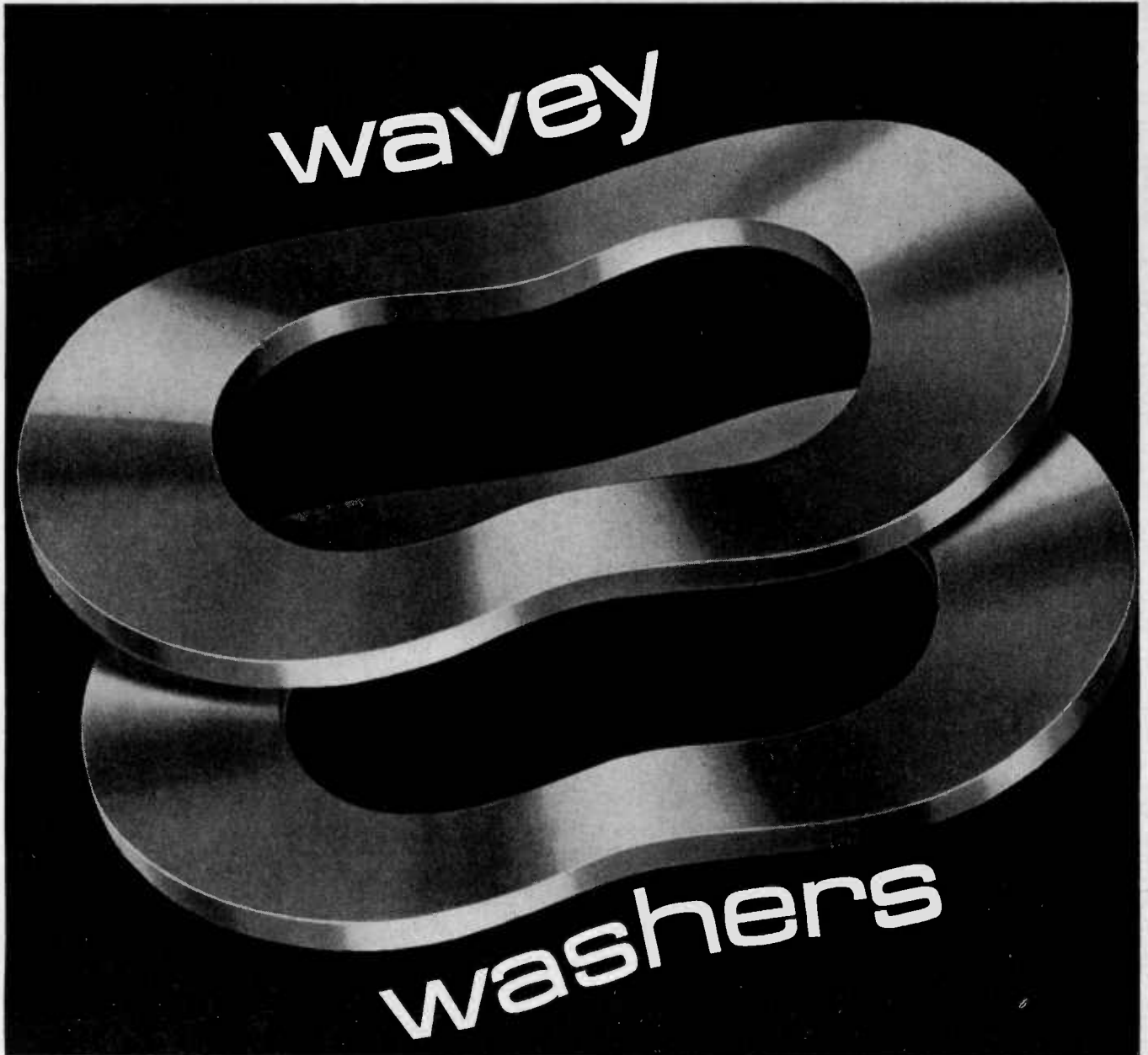

IN STAINLESS STEEL OR BERYLLIUM COPPER

"WAVEY" WASHERS are made from 18/8 Austenitic Stainless Steel (V.P.N. 380 min.) or Beryllium Copper (V.P.N. 350 min.). They have excellent corrosion resistance and a high resistance to permanent set under compression. Supplied for A.I.D. and commercial interests in natural finish and available in a wide range of sizes. A range of leaflets on these and other products is available free and a 40-page booklet on Spring Design at a cost of 4/6d.



Our design and development service is always available for consultation.

wavey washers

THE LEWIS SPRING CO. LTD.

STUDLEY ROAD, REDDITCH, WORCS. Tel: Redditch 3771/6

Grams: Resilient, Redditch. Telex: 33625

London Office: 153-155 MITCHAM ROAD, TOOTING BROADWAY, S.W.17

Tel: BALham 8215/6 Telex: 25520



**Fit
Knitex
R.F. Shields
round your
equipment.**

New Knitex Shields have been developed by KnitMesh Limited for suppression of R.F. interference. Knitex knitted mesh shields are widely used in the electronics industry for numerous similar applications and also for heat exchangers, Air Filters and Vibration Cushions.

Knitex R.F. Shields have a mesh structure of asymmetrical interlocking loops, Knitted into a tube shape, this avoids the zoning patterns caused by the more regularly shaped materials. Their flexibility, resilience, and conductivity depends on the materials used and Silvered Copper, S. Steel, Monel and Aluminium are available to suit each individual customer's requirements.

Write now for complete catalogue and price list of R.F. Shielding Sections, strips, and Silicone Rubber covered with KnitMesh.

INSIST ON KNITMESH



**KnitMesh Limited · Prudential House
Wellesley Road · Croydon · London**
Telephone: MUNicipal 1034 & 1035

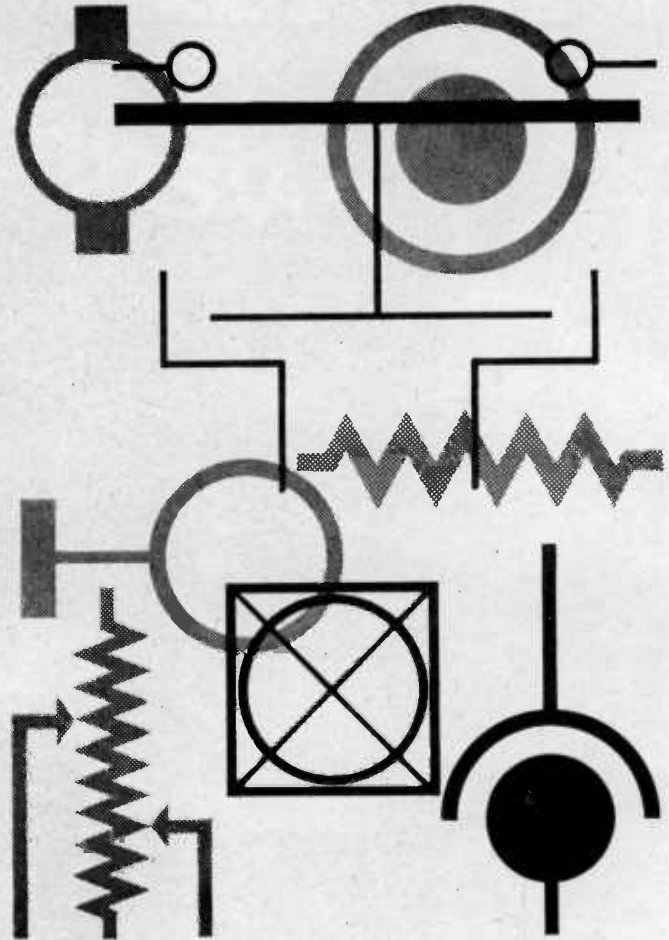

Electrical power and process control for industry

by the
Special Electrical Engineering Division of
The Head Wrightson Machine Co. Ltd.

Head Wrightson offers its services for the design, manufacture and installation of electrical motor controls, electrical and pneumatic instrumentation and electrical power and lighting equipment, to engineers and contractors concerned with industrial plant of any size or type in any industry.

Head Wrightson



Special Electrical Engineering Division,
The Head Wrightson Machine Co. Ltd., Commercial St.,
Middlesbrough, Yorks. Tel: Middlesbrough 43401

TW 1697

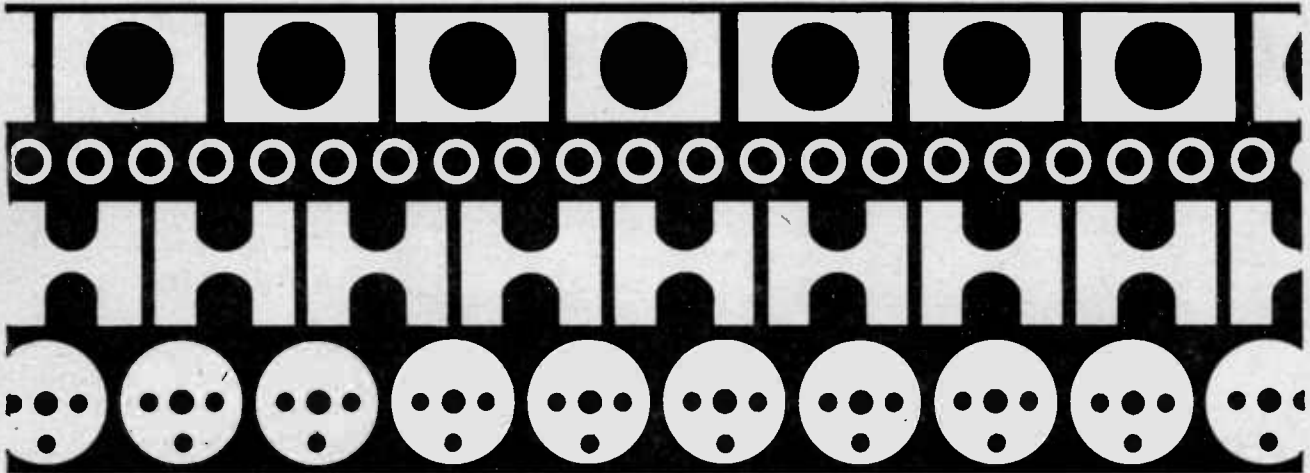

controlled soldering starts with an Enthoven preform

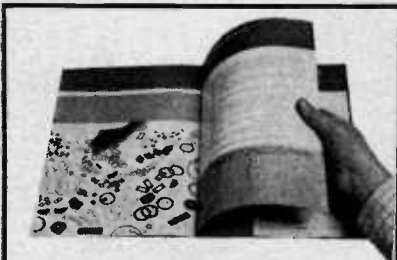

New free booklet describes the complete range of Enthoven Solder products... preforms among them. Ask now for your copy of 'Soldering with Enthoven'.

The right amount of solder, in the right place, every time. The right alloy to suit the surfaces to be joined. The right flux for effective wetting. The right heat-source. Enthoven know about this kind of thing, will give advice, supply preforms—cored or solid. Controlled soldering means economical soldering. Soldering with Enthoven preforms saves solder, time and wastage. Cuts costs. Produces a stronger, cleaner job. Enthoven supply washers, rings, shims and strips in a wide variety of alloys, cored and solid, and design to meet special requirements.

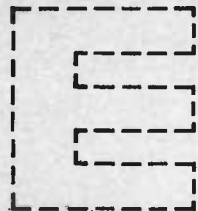

**ENTHOVEN
SOLDERS LIMITED**

Sales Office & Works · Upper Ordnance Wharf · Rotherhithe St · London SE16 · Bermondsey 2014 · Head Office · Dominion Buildings · South Place · London EC2 · Monarch 0391

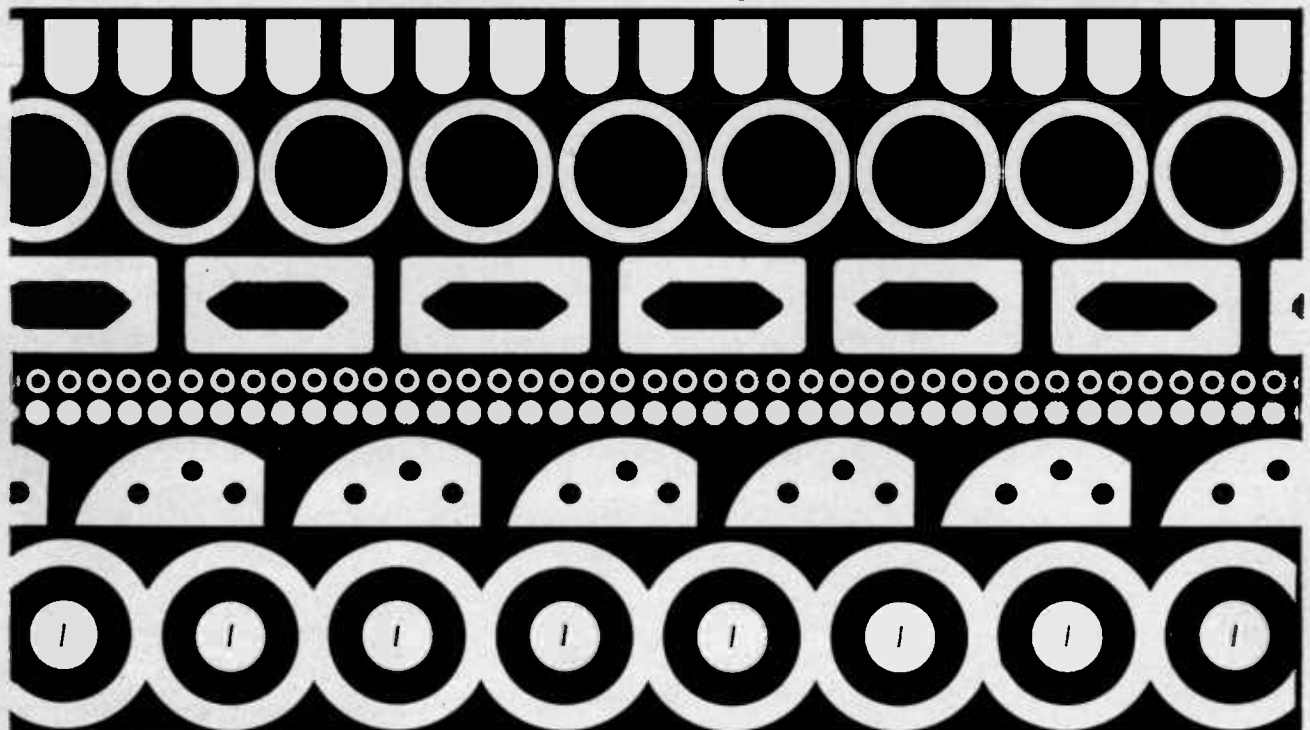

electrosil

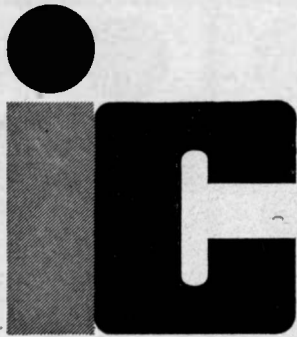

**a
complete
range**

The range of I.C. devices offered by Electrosil gives the widest choice to designers—at truly competitive prices. Much of the range is compatible in both function and pin layout with I.C.'s of other manufacture, an important "second source" feature which allows you to specify with confidence.

Utilogic — Medium speed high level TTL

Utilogic is a low-cost logic form specially developed for the computer and industrial markets. It was the first product which Electrosil introduced to the UK market and was the basis of America's biggest order—2 million circuits for ground support equipment. Utilogic is the best buy in digital monolithic integrated circuits of up to 4 Mc/s clock rate.

- Very high noise immunity, worst case 0.8v.
- High Fan-out—17.
- Capable of withstanding high capacitive loading.
- Bistable element (J-K flip-flop) is not critical of rise-time and fall-time of clock waveform.
- Very competitively priced.

The LU Utilogic Range

LU 300K Dual 3-Input Gate Expander
 LU 305K 6-Input AND Gate
 LU 306K Dual 3-Input AND Gate
 LU 314K 7-Input NOR Gate
 LU 315K Dual 3-Input NOR Gate
 LU 316K Dual 2-Input NOR Gate (Expandable)
 LU 320K J-K Binary Element
 LU 331K Dual 2-Input OR Gate (Expandable)
 LU 332K Dual 3-Input OR Gate

Temperature Ranges for Utilogic IC's

LU RANGE + 10°C to + 55°C
 * SU RANGE — 20°C to + 85°C
 * (Note: type numbers are the same for LU range with the exception of the prefix)
 These temperature ranges can be expanded if reduced fan-out is acceptable.
 ENCAPSULATION: 10-LEAD FLAT PACK OR TO-5.

Inexpensive dual-in-line SP600A

This new package form is easy to use because of its plug-in facility. The first range to appear in this package consists of the SP600A range which comprises a mixture of DTL and TTL. Other ranges will shortly be available in this form.

SP616A Dual 4-Input NAND Gate
 SP620A J-K BISTABLE
 SP631A Quadruple 2-Input Expander
 SP659A Dual 4-Input Buffer/Driver
 SP670A Triple 3-Input NAND Gate
 SP680A Quadruple 2-Input NAND Gate

Wide temperature range DTL

Some examples from the 14-lead flat pack range.
 NE106J Dual 5-Input Gate Expander
 NE112J Dual 3-Input High Fan Out NAND/NOR Gate
 NE116J DUAL 4-Input NAND/NOR Gate
 NE124J RST Binary Element
 NE125J (Master Slave J-K) Bistable Unit
 NE156J Dual 4-Input CLOCK/CAPACITIVE Line Driver
 NE161J One-Shot Multivibrator
 NE170J Triple 3-Input NAND/NOR Gate
 NE180J Quadruple 2-Input NAND/NOR Gate

Temperature Ranges

NE RANGE 0 to + 70°C
 SE RANGE — 55°C to + 125°C
 (Note: type numbers are same as for NE range with the exception of the prefix)
 ENCAPSULATION: 10 or 14 LEAD FLAT PACK OR TO-5.

Linear I.C.

A competitively priced linear range is available to meet all requirements

Electrosil IC's are available

Electrosil currently have a stock of over 10,000 IC's in this Country. All units are competitively priced and available in a variety of packaging configurations. Manufacturers developing prototypes can be assured of continuing supplies advancing to really large production quantities when these are required. A start is being made on production facilities at Sunderland, and in 1966, at least partial manufacture will take place in this Country, strengthening the multi-source availability of Electrosil IC's.

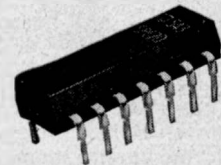

SP600A

**for the ultimate
benefits in**



talk now to



ELECTROSIL LIMITED · MICRO-ELECTRONICS DIVISION · SALES OFFICE · LAKESIDE ESTATE COLNBROOK · SLOUGH · BUCKS · TELEPHONES: COLNBROOK 2198 & 2998 · HEAD OFFICE PALLION · SUNDERLAND · CO. DURHAM

Who leads in
**ELECTRICAL
CONNECTORS?**

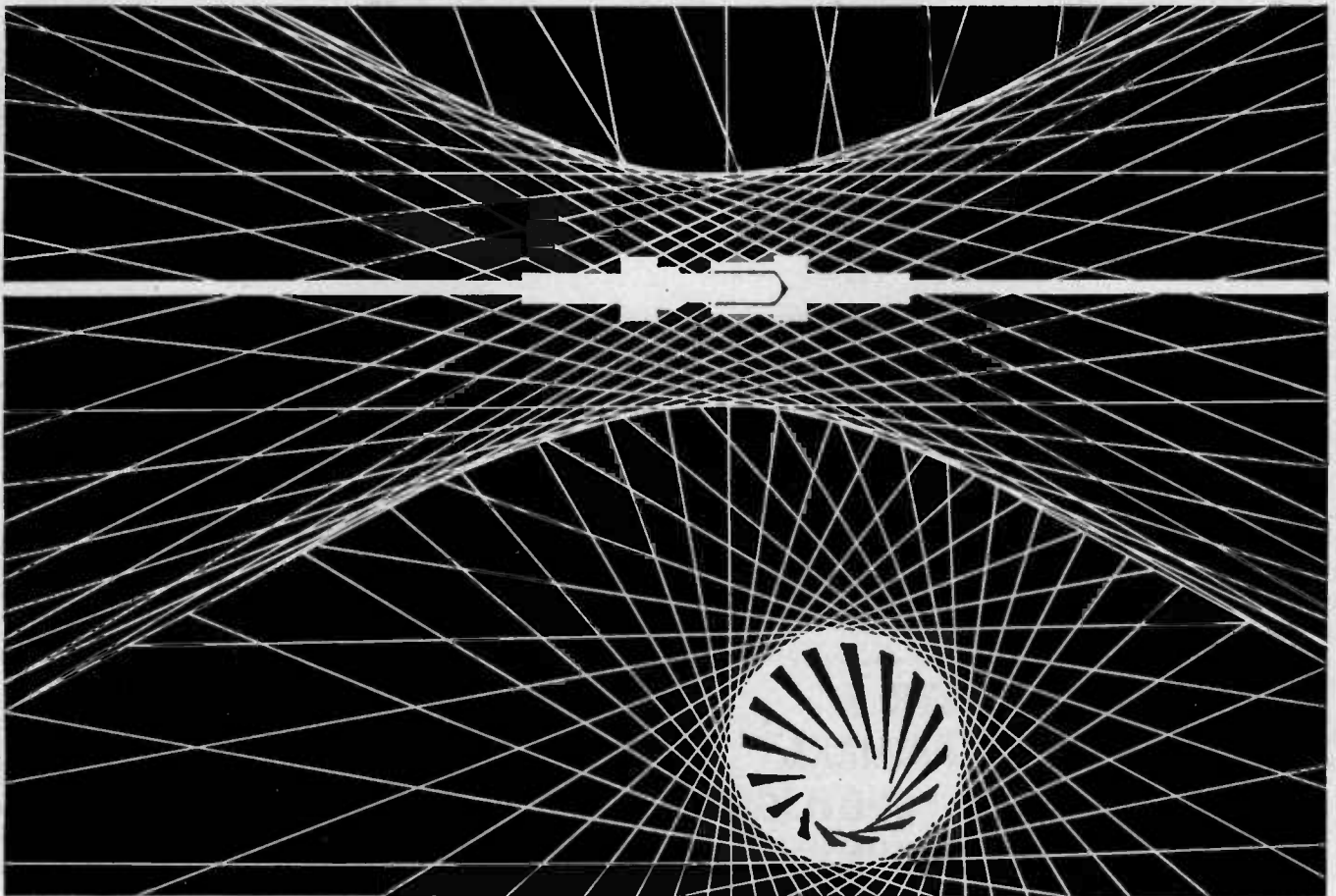

**'Hypertac' is the world's
most efficient connector**

No other electrical connector has all the advantages of 'Hypertac'. The unique laminar hyperboloid design gives maximum contact through a number of wires with low spring rate stresses, to provide

- * Large area contact with low electrical resistance
- * Very low insertion and withdrawal forces
- * Long life
- * High electrical performance

For full information ask for 'Hypertac' leaflet M/284A.

The 'Hypertac' connector is one of the many precision products made by Smiths Industries—the world's largest instrument makers. We also make more pressure gauges than anyone else; magnetic, electrical, electronic and hand tachometers; industrial thermometers; synchronous hour counters; and magnetic particle couplings.

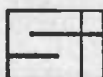

SMITHS INDUSTRIES LIMITED
INDUSTRIAL INSTRUMENT DIVISION

CHRONOS WORKS, NORTH CIRCULAR ROAD, LONDON, N.W.2. TELEPHONE GLADSTONE 6444

EE 94 116 for further details



**INSULATION TEST SET
MODEL 667**

	100 Volts	250 Volts	500 Volts	1,000 Volts
Scale 1	0 to 0.1 Mohm	0 to 0.25 Mohm	0 to 0.5 Mohm	0 to 1 Mohm
Scale 2	0.05 to 1 Mohm	0.125 to 2.5 Mohm	0.25 to 5 Mohm	0.5 to 10 Mohm
Scale 3	1 to 1,000 Mohm	2.5 to 2,500 Mohm	5 to 5,000 Mohm	10 to 10,000 Mohm

**NORMA
VIENNA**

NO MORE CRANKING!

A Portable light weight insulation test suitable for measuring the insulation resistance of all components installations, etc. Cranking is obviated by the utilisation of a transistor converter; the power supply being two 4½ volt dry batteries. The test voltage and range are selected by push buttons which facilitate quick and easy reading of the resistance value.

Delivery EX STOCK

RANGES with push button selection

CROYDON PRECISION INSTRUMENT COMPANY

HAMPTON ROAD · CROYDON · SURREY Telephone THORNTON HEATH 4025 & 4094

**SOLDER WITH A
PRIMAX OR PRIMAXA
SUPER EFFICIENT SPOTLIGHT
SOLDERING GUN**



Distributors: **S. KEMPNER LTD.,**
384 FINCHLEY ROAD · LONDON · N.W.2
Telephone: SW1 2371 & HAM 6365

SOLOG STATIC SWITCHING SYSTEM

DESIGNED & PRODUCED

FOR

COST CONSCIOUS ENGINEERS

BY

D.K. INDUSTRIAL INSTRUMENTATION

● TERMINAL BLOCK CONNECTIONS

● NEON INDICATION

POWER LOGIC UNITS

D.C. LOAD SWITCHING FROM A.C. SUPPLY

A.C. POWER SWITCHING

D.K. INDUSTRIAL INSTRUMENTATION LTD.,
AVEBURY ROAD, WESTCLIFF-ON-SEA.
SOUTHEND 45182

EE 94 118 for further details

EE 94 117 for further details

Telex
25573
for
resistors

FROM RADIO RESISTOR CO LTD

TELEX TO ALL RESISTOR USERS
SO MANY TYPES EACH WITH SPECIFIC APPLICATIONS
IN A VAST RANGE OF OHMIC VALUES
IN PRODUCTION QUANTITIES
INVARIABLY FROM STOCK
QED

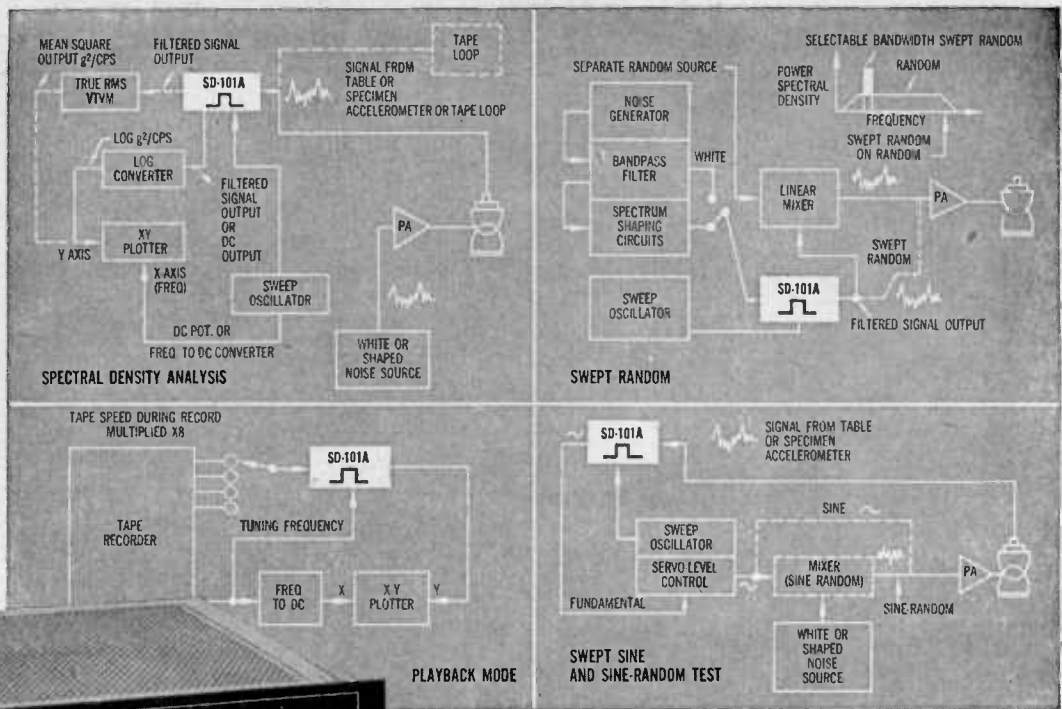

Unique tracking filter analyser converts your vibration console into a data analysis centre

The SD-101A Dynamic Analyzer, available from Spectral Dynamics Corporation of San Diego, is completely compatible with all existing shaker console equipment, giving you complete control and analysis capability. Essentially, the SD-101A provides two modes of operation: (1) a synchronous tracking filter, and (2) a swept filter for analysis of a complex spectrum. In tracking applications, the SD-101A separates the fundamental specimen or shaker response signal from noise and tracks the fundamental over the test frequency range. With the SD-17 Sine Rejection Adapter, the SD-101A provides a random output with the sine wave suppressed for use with Automatic Equalizer/Analyzers for sine random tests. Typical tracking applications of the SD-101A include swept sine wave and sine random testing, data reduction of tape recordings of transmissibility and mechanical impedance measurements. In the swept

mode, you analyze a complex or random signal as a function of frequency. Typical swept applications include power spectral density analysis, harmonic wave analysis and swept random testing.

The SD-101A is a frequency-tuned band-pass filter. The center frequency of a selected pass band is inherently, continuously and precisely tuned to track the frequency from an external sine wave source. The SD-101A does not use internal servo, frequency to DC conversion, or critical phase lock circuits for its unique operation. It uses a patented heterodyne technique which provides positive tracking and is

precisely tuned virtually instantaneously.

Features of the SD-101A include a wide frequency and dynamic range and selectable filters. For a relatively small investment, it greatly extends the capabilities of vibration test equipment that may have cost hundreds of thousands of dollars. The Analyzer is recommended for all kinds of environmental vibration and acoustical testing. The SD-101A may also be applied for general instrumentation and for power spectral density analysis. A demonstration will be arranged at your convenience. Send for free brochure.



SPECTRAL DYNAMICS CORPORATION OF SAN DIEGO

Sole agents in United Kingdom

PYE-LING LIMITED

HEATH WORKS · BALDOCK ROAD · ROYSTON · HERTS
Tel: Royston 2424 Telex: 81174 (Pyeling Royston) Grams: Vibration Royston



AP 55

Are Mecpots too stable?

(unfair to compulsive twiddlers)



Take a Mecpot. Design it into a circuit.
Trim it, then
leave it alone.

What happens?

Your Mecpot
stays rock steady.
Nothing to adjust.
No need to twiddle.

Yet
authoritative psychiatric
research shows that
trimmer-twiddling is
definitely soothing,
relaxing and fine for
the morning after.

Despite all of which you will still want to
specify Mecpots because of all
the other advantages—

Three connection types

Resistance values from
50 to 20,000 ohms

Power rating 1 watt at 20°C,
¼ watt at maximum temperature 85°C

Slipping clutch

20 turns full travel

Prices from 11/3 depending
on quantity

Delivery of most values
ex-stock

Full specification
and samples from
Miniature Electronic
Components Ltd
Copse Road Woking
Surrey
Woking 63621

m-e-c

Trimmer Potentiometers
Wire-wound Resistors
Miniature Switches
Elapsed Time Meters

This is a **Sanken** CdS Photoconductive Cells.

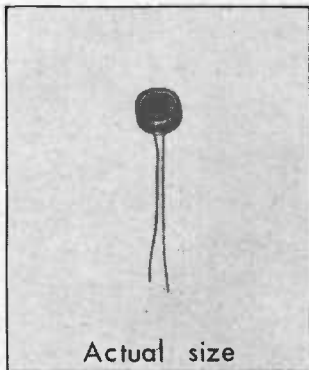

Actual size
SP5 Series, 50mW

.....it is highly sensitive.

.....it is exceptionally reliable.

.....it is money saving.

Available in two types, CdS cells and CdS-CdSe cells from 50mW to 500mW.

Sanken® SANKEN ELECTRIC CO., LTD.

For further information write or call

Photain Controls Limited

RANDALLS ROAD, LEATHERHEAD, SURREY.

Telephone: LEATHERHEAD, 2776

SHEET METAL PUNCHES

Pat. Nos. 619178 & 938098
Quickly punches clean holes in sheet metal up to 16 swg.
100% BRITISH
USED ALL OVER THE WORLD
NOTE NEW ROUND SIZES:
1 1/8" 13/9; 1 1/4" 14/6; 1 1/2" 14/9; 1 3/4" 16/6
Full list of sizes on request.

GRID DIP OSCILLATOR
Model G.D.O.2

For the determination of resonant frequency of tuned circuits. For tuning transmitters without application of power. For determination of coil, mutual and stray inductances and fixed and stray capacitance. Built-in mains pack.

PRICE WITH COILS 1.5-300 Mcs.
15 GNS.

'Q-MAX' (ELECTRONICS) LTD
Napier House, High Holborn, London, W.C.1 Tel: HOLborn 8534

EE 94 131 for further details

RESISTANCE, CAPACITY & INDUCTANCE BOXES

Accuracy at economic prices

Wide selection of units covering the following ranges:—

- Capacity — 10pf to 111µF
- Resistance — 0.1Ω to 100 KΩ
- Inductance — 1 mH to 10 H

Resistance Voltage Dividers and Wheatstone Bridges available

LIONMOUNT & CO. LTD.
Bellevue Rd., New Southgate, London, N.11, England. Tel: Enterprise 7047

★ Foreign AGENCY enquiries welcomed

EE 94 132 for further details

Precision

Photography

HUNTING PHOTOGRAPHIC LIMITED 6, ELSTREE WAY, BOREHAMWOOD, HERTS. Telephone: Elstree 6161.

HIGH PRECISION
Negatives and Positives
Accuracy to ±.001"

ORIGINALS up to 50" x 50"
NEGATIVES up to 40" x 40"
Enlargements, Reductions,
Direct Reversals, Tone,
Line and Combinations

EE 94 133 for further details

0.15" CONTACT PITCH

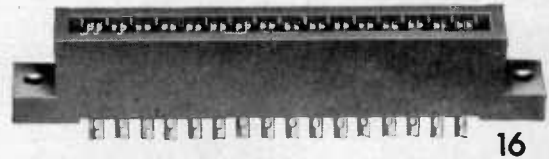

PRINTED CIRCUIT EDGE CONNECTORS

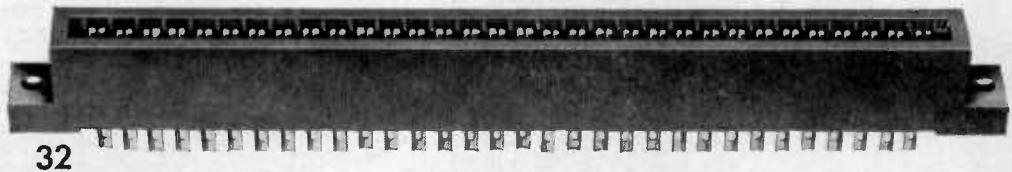

FROM 8 TO 32 CONTACTS
DESIGNED FOR USE WITH 1/16" BOARDS

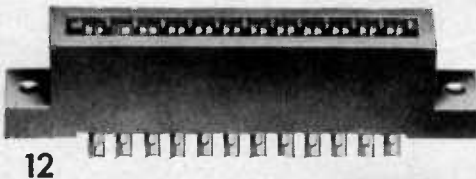

AND
MADE BY

PAINTON

*By the way—
quick delivery!*

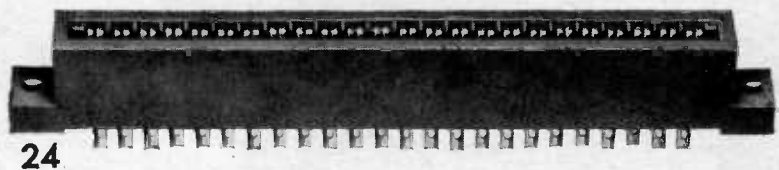

SEND FOR FULL DETAILS

Painton & Co. Limited

KINGSTHORPE, NORTHAMPTON

Tel: 34251 (10 lines) Grams: Ceil. Northampton. Telex 31576

AUSTRALIA Painton (Australia) Pty. Ltd. U.S.A. Painton Inc. ITALY Painton Italiana. SWEDEN Svenska Painton A.B. BENELUX Painton S.A.
GERMANY Painton G.m.b.H.

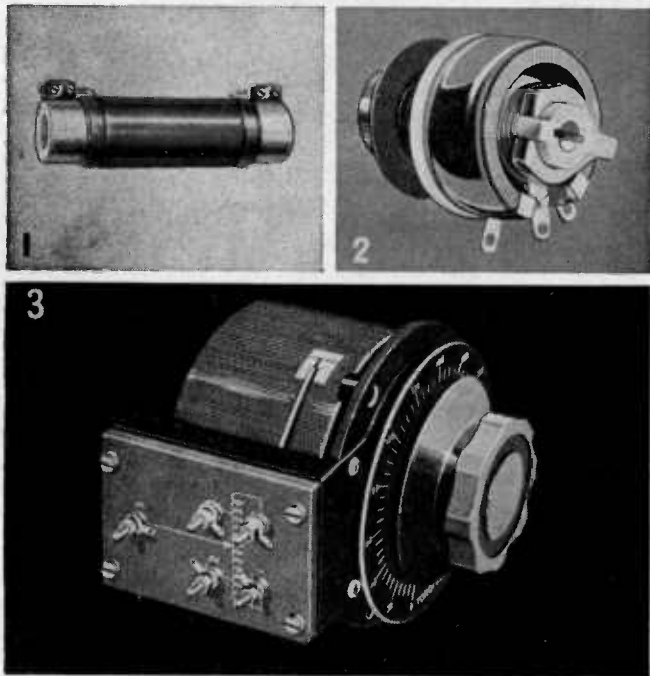
cressall

RESISTORS RHEOSTATS VARIABLE TRANSFORMERS

Examples from the range:

1. CRESSALL VITREOUS ENAMELLED RESISTORS
Wire-wound or corrugated edge wound on a strong ceramic base. Ratings 6 watts - 320 watts.
2. CRESSALL 'TOROSTATS' Toroidally wound vitreous enamelled power rheostats. Ratings 6 watts-1,000 watts.
3. CRESSALL 'TOROVOLTS' A range of variable ratio auto-wound and double-wound transformers. Providing an economical and reliable means of controlling A.C. apparatus with smooth adjustment of output from zero up to full voltage. Double-wound Torovolts have a secondary winding isolated from the input supply and enable variable A.C. outputs to be obtained with complete safety. Outputs, auto-wound models up to 30 A; double-wound units up to 15A. Portable Metered Torovolts are offered for test bench use and incorporate either an auto-wound unit for A.C. outputs or a double-wound torovolt with built-in rectifier for D.C. outputs.

A member of the **expamet** Group

THE CRESSALL MANUFACTURING COMPANY LIMITED
CHESTON ROAD · BIRMINGHAM 7 TELEPHONE: EAST 3571

NEW

DIGITAL

STOP-CLOCKS 661 SERIES



TYPE 661D £92

- ▷ 5 digits in-line display
- ▷ 59 minutes 59.9 seconds in 0.1 seconds
- ▷ remote start:stop on over a mile of cable
- wide range of specifications available

JUST ONE OF THE
digicron RANGE
OF DIGITAL

- time of day clocks
- count down clocks
- batch counters
- counters
- tachometers

**DARANG ELECTRONICS
LIMITED**

Restmor Way Hackbridge Road Hackbridge
Surrey England FRANKLIN 1140

ELECTRONIC ENGINEERING

VOL. 38

No. 460

JUNE 1966

Commentary

"ELECTRONIC ENGINEERING" has now been the title of this journal for 25 years; and what enormous changes have taken place in both the subject and the journal during those years. To review the progress in electronic engineering during that time would be a major undertaking and would require far more space than can be allocated to it here: it may though, be an opportune moment to say a few words about the origin and growth of the journal.

While by no means the oldest of the journals in the radio and electronic field its roots, as indicated by the present volume number*, go back somewhat further than 25 years. In fact it had its inception just over 38 years ago but, during the first thirteen years of its life, it underwent several changes of title, either to indicate a broadening of its scope or to keep abreast of the changing pattern of the industry.

Number 1 Volume 1 appeared in March, 1928, the title at that time being simply *Television*. It claimed, quite rightly, to be the world's first television journal and it was, at that time the official organ of the Television Society. Since *Television* was started only two years after John Logie Baird's historic demonstration to the Royal Institution its founders were undoubtedly men of foresight and optimism and the original editor is to be congratulated on the accuracy of the statement in his first editorial when he said, "... this new branch of science, which bids fair in time to rival wireless broadcasting in importance and popularity". The first issue contained "Greetings to the World's First Television Journal" from a number of eminent men including Sir Oliver Lodge, Sir John Reith, Mr. J. L. Baird and Captain S. R. Mullard. It also contained an article entitled, "Commercial Television—When May We Expect It?"; but perhaps 'commercial' had a somewhat different connotation in those early days! No doubt there are a number of present-day readers of *Electronic Engineering* who can remember the early days of *Television* but to the majority the articles, circuit diagrams and illustrations would appear rather quaint and unreal, while some, viewed in retrospect, are rather amusing; for instance an article published in April 1930 starts "From time to time attempts have been made to use a cathode-ray tube for television purposes". There is, however, one thing which would be appreciated by present readers; the journal cost 6d per copy or 7s 6d per year post free!

The first change of title came in February 1935 and it was in fact more of an addition than a change, for it became *Television and Short Wave World*. Commenting

on this the Editor of the day stated "The reason for this can be explained in a few words—there is not a shadow of doubt but that the future of television lies with short waves and we believe that we can best encourage and assist development by fostering a greater interest in short-wave work." This, again, was a good forecast made at a time when the arguments of mirror-drum versus disk receivers were more avidly debated than those of mechanical versus c.r.t. systems and when a high definition system implied 180 lines! Indeed, a month later than this the Television Committee's recommendation that a 240 line system should be adopted caused considerable consternation among the many who had pinned their faith on mechanical systems.

The next change in title came in October 1939, just after the outbreak of war, and this time it was to *Electronics and Television and Short-Wave World*. The magic word 'electronics' had at last made its appearance. According to the 'editorial' in that issue the change of title was brought about partly to enable the journal to embrace the developments "of a remarkable new industry—that of Electron Engineering" and partly through necessity as television development had come more or less to a standstill with the closing down of the public service due to the war. The Editor also bemoaned the fact that it was necessary to increase the price per copy to 1s 6d! To mark its new scope and to emphasize the advent of war this issue contained an article on "Electrical Activity in the Human Brain" and another on amplifier systems for giving air-raid warnings in factories.

A short time later, in June 1941, the title was finally changed to its present one of *Electronic Engineering*. This was done to "indicate more clearly its widening scope and the trend of its editorial policy", and it was stated that "In its new form, this journal will provide the whole industry, research engineer, factory engineer and student alike with a medium for interchanging ideas and learning the progress which is being made in all parts of the world".

In the past twenty-five years the breadth and scope of the subject of electronic engineering has grown and expanded in a way which even the most optimistic of seers could hardly have foretold. During this time, the editorial content and appearance of *Electronic Engineering* have undergone considerable changes to keep abreast (and often ahead) of current practice; nevertheless, its aims today are very little different from those stated 25 years ago. How well it has succeeded is perhaps for the reader to judge but some measure of its success may be gauged from the fact that *Electronic Engineering* is now circulated and read in some 97 countries throughout the world.

* It is one year older than indicated by the volume number as two years were included in one volume during the war.

A Computer Controlled C.R.T. Display System

By W. Bial*

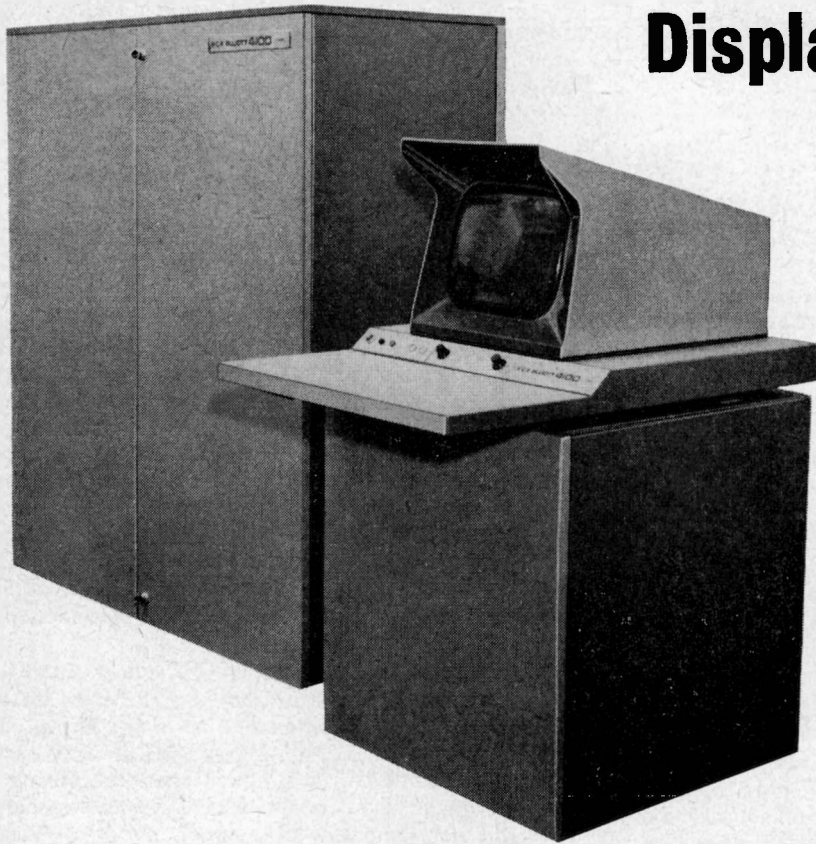

A general description is given of a c.r.t. system intended primarily for the display of output from a digital computer. Details of circuits of particular interest are included

(Voir page 416 pour le résumé en français: Zusammenfassung in deutscher Sprache auf Seite 423)

THE primary use of the display system described here is as a fast output unit for a digital computer. It has been designed mainly to display text and tabulated data rather than graphs or diagrams, and could readily be combined with simple photographic equipment to act as a high-speed printer.

The equipment consists essentially of two parts: the control unit and the display unit (Fig. 1). The control unit receives digital data and control signals from the computer interface and sends busy signals back; it contains digital to analogue convertors, the outputs of which control beam position, and a character generator with a repertoire of up to 256 characters. The display unit contains a magnetically deflected c.r.t. with a screen diameter of up to 24in (corresponding to a picture size of 22in diagonal), together with its e.h.t. supplies, separate pairs of X and Y deflexion amplifiers for main beam positioning and character drawing, and the bright-up circuits. Up to 12 display units may be associated with a control unit; these may be remote from the control unit and are selected by signals from the computer.

* Elliott-Automation Ltd.

Since the control unit is common to several display units which are not necessarily carrying the same picture, the regeneration rate of each display may be as low as 6 frames per second. To avoid flicker a special phosphor is used which gives a substantially constant light output for some 150msec after illumination, followed by a relatively rapid decay.

The picture area is considered as a matrix of 1024×1024 grid points, and hence the precision available is about 0.1 per cent. The main deflexion circuits can move the beam from any grid point to any other in not more than 90 μ sec, with an accuracy of 0.3 per cent. This accuracy figure does not take into account distortions due to the tube and any associated photographic process, but where external measurement is required a co-ordinate drawing facility may be used since displayed co-ordinates will be subject to the same distortions.

The character rate from the computer may be 100 000 characters/second or more. Characters are drawn by superimposing small X and Y deflexions on the (steady) main deflexion, using a secondary, short-range deflexion system so as to obtain the high writing speed without

excessive power consumption. These small deflexion signals are obtained in analogue form from the character generator which also provides bright-up signals; character size and brightness are under computer control.

Much of the system was designed according to conventional engineering practice, but some unusual techniques were developed where speed, reliability or economy seemed to require them. The remainder of this article is concerned with three parts of the system in which novelty is apparent: the digital to analogue converters, the co-ordinate-drawing circuits and the character generator.

The Digital to Analogue Converter

The main digital to analogue converter receives a 10-bit unsigned number from the computer and generates a corresponding analogue signal which drives the associated deflexion amplifiers in the display units. To avoid the necessity for an operational amplifier between each converter and the deflexion amplifiers the conversion is carried out at high power level and consists essentially in switching binary weighted currents into a 16Ω resistor. The range of current in this summing resistor is from 0 to $+0.25A$, giving an output voltage range of 0 to $+4V$ relative to the $-10V$ supply line (Fig. 2).

Each of the ten stages in the converter is essentially a simple long-tailed transistor pair (Fig. 2(a)), arranged so that when the input logic signal V_1 cuts VT_1 off a current equal to V_{ref}/r is switched into the summing resistor R_s . Now as can be seen from the diagram, in the simplified circuit the current actually switched is $(V_{ref} - V_{eb})/r - I_b$.

To reduce I_b to negligible proportions, each transistor in Fig. 2(a) is replaced by a Beneteau pair, taking due precautions to avoid oscillation (omitted from the diagram, for simplicity). Also, a separate very accurate reference supply is used to hold the base of the control transistor

pair, since it is not good practice to take power from a reference supply (Fig. 2(b)).

The error due to V_{eb} can in principle be reduced by passive component compensation, but this is difficult to achieve in practice due to thermal and matching problems. V_{eb} is measurable as the difference between V_{ref} and V_e (Fig. 2(b)), and is applied to a linear differential long-tailed pair using Beneteau pairs B_3 and B_4 (Fig. 2(c)). The current in the tail of B_3 and B_4 is made greater than the

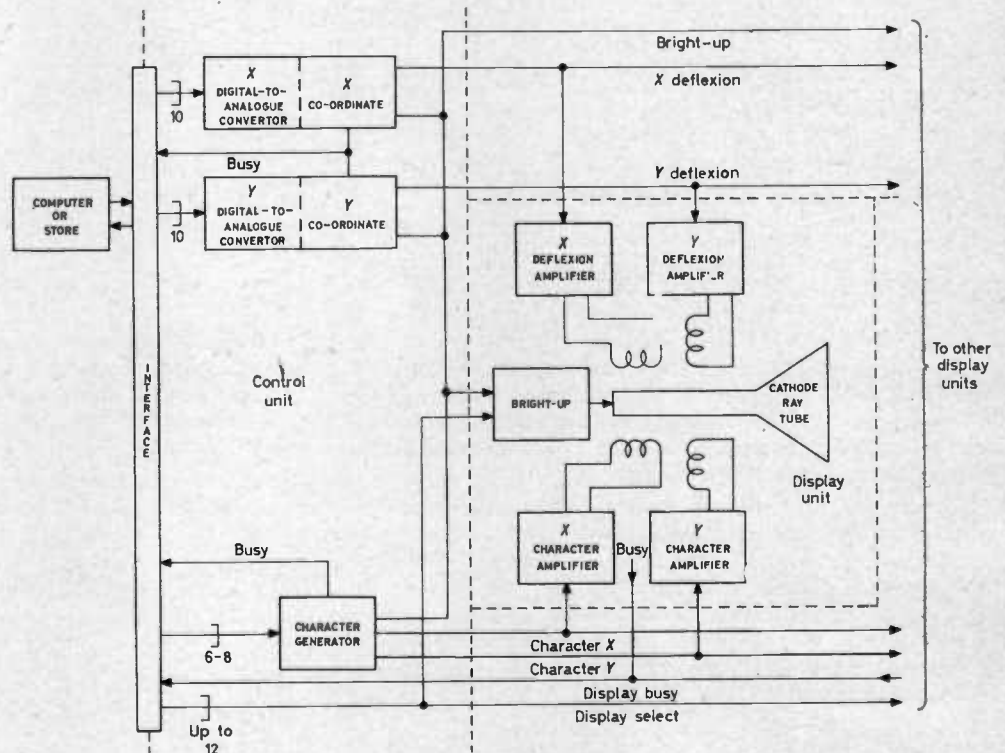

Fig. 1. Display system arrangement

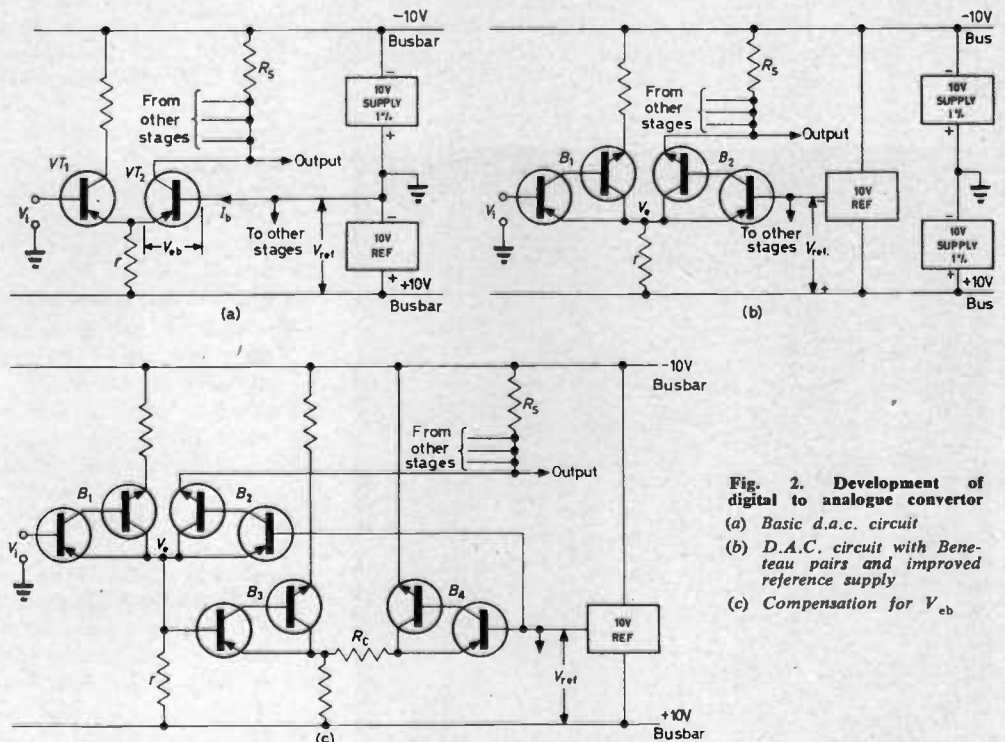

Fig. 2. Development of digital to analogue converter
(a) Basic d.a.c. circuit
(b) D.A.C. circuit with Beneteau pairs and improved reference supply
(c) Compensation for V_{eb}

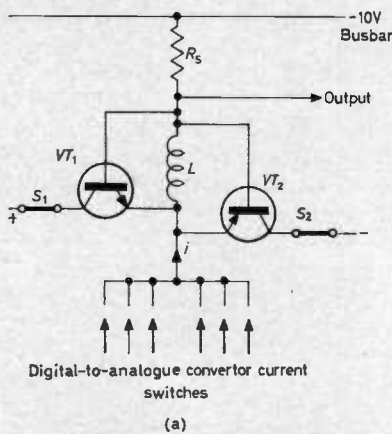
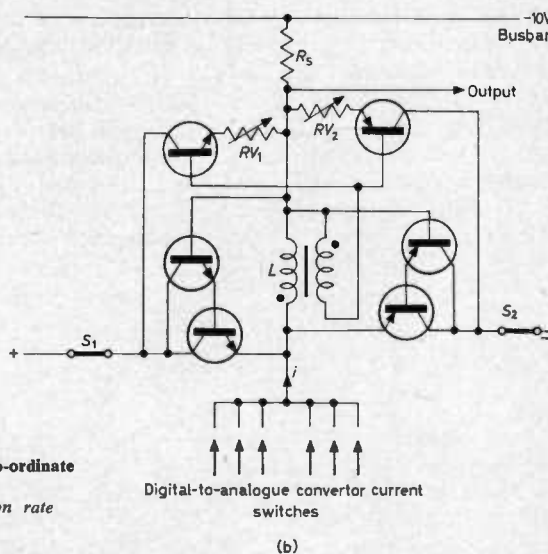

Fig. 3. Generation of ramp voltage for co-ordinate drawing
(a) Basic circuit for linear deflexion rate
(b) Improved version



highest likely compensating current, and the resistor R_0 is chosen so that $R_0 +$ emitter resistance of $B_3 +$ emitter resistance of $B_4 = r$. Due to the differential action, $V_{ref} - V_o = V_{ob}$ appears between B_3 and B_4 emitter junctions, and the collector current of B_4 is thus V_{ob}/r which exactly compensates for the $-V_{ob}/r$ from B_2 .

The ten stages of the convertor are all essentially similar and share the same reference supply and resistor. The highest-current stage (most significant bit) is formed of two identical stages, each handling half the current, to reduce the power rating of this stage and so improve reliability. In the low-order stages less elaborate compensation is used, since the necessary proportional accuracy is less.

Co-ordinate Drawing

If the output of the X and Y digital to analogue convertors is merely used to index the beam from one grid point to another, without bright-up, the acceleration of the beam is unimportant: all that matters is that the beam should settle on the new position as soon as possible.

Fig. 4. A typical display

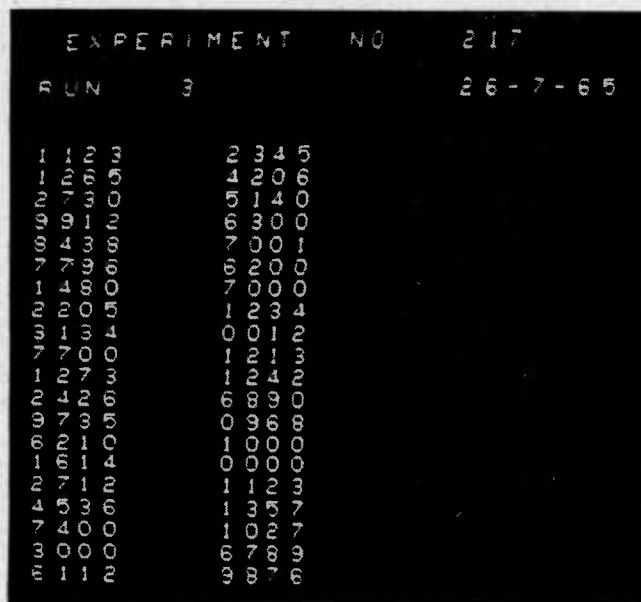

closed (i.e. by a control signal from the computer), that a current i has been established in the circuit (due to the convertor stages), and that V_{out} is steady. Let i change by some increment i' .

The current increment cannot be accepted by L immediately, and therefore flows through VT_1 or VT_2 , according to polarity. The emitter-base voltage drop $\cdot V_{ob}$ is

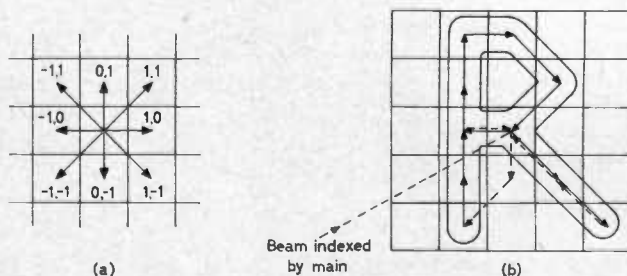

Fig. 5. Formation of graphics
(a) Unit increments
(b) Possible construction for letter R

established across L , and if V_{ob} is assumed independent of i' the current in L will change linearly at a rate given by V_{ob}/L . The current i' is thus transferred linearly from the shunting transistor to L , and when the whole of i' is flowing in L the voltage V_{ob} collapses. The circuit is once again in equilibrium with V_{out} corresponding to $i + i'$ and defining the new beam position.

The linearity of this circuit is adequate for its purpose, but there are certain shortcomings. The base currents of VT_1 and VT_2 flow in R_s , producing a step when S_1 and S_2 are closed or opened. This is overcome by using Darlington pairs for VT_1 and VT_2 and changing the value of L to retain the desired beam traverse rate with the new value of V_{ob} so introduced.

Also, L , whether iron or ferrite cored, will carry eddy currents due to the effect of the applied V_{ob} . These persist during the transition from i to $i + i'$ and appear as a step in R_s . To compensate, a secondary is wound on L , across which a voltage proportional to that across L is induced (Fig. 3(b)). This voltage drives a compensating current in one of the emitter-followers, according to polarity, exact compensation being achieved by adjusting RV_1 and RV_2 for the two directions of drawing.

Character Generator

The choice of a method of drawing graphics on the display was strongly influenced by two criteria: the character set should be easy to change to suit any particular purpose, and the graphics should be reasonably easy to read without operator fatigue. This second criterion implies that a graphic should be of uniform brightness and continuous (i.e. not formed of visibly separate dots).

Graphics are therefore drawn as a series of straight-line increments, each blended into the next (Fig. 4). The origin for each graphic displayed is determined by the main deflexion system, as already explained, and each character is defined by up to 20 increments drawn relatively to that origin. Each increment may be 0 or ± 1 unit in X or Y directions, or both, giving the eight possibilities shown in Fig. 5(a). A graphic is drawn on a 5×5 matrix of unit increments, centred at the local origin, each cell of the matrix containing typically from 2 to 6 grid points in X and Y according to the scaling factor transmitted from the computer. Limited excursions outside the matrix area are possible, for example to draw the descenders of lower-case letters. A possible series of increments for the character R is shown in Fig. 5(b), the dotted lines representing deflexion without bright up.

The character generator consists essentially of a store

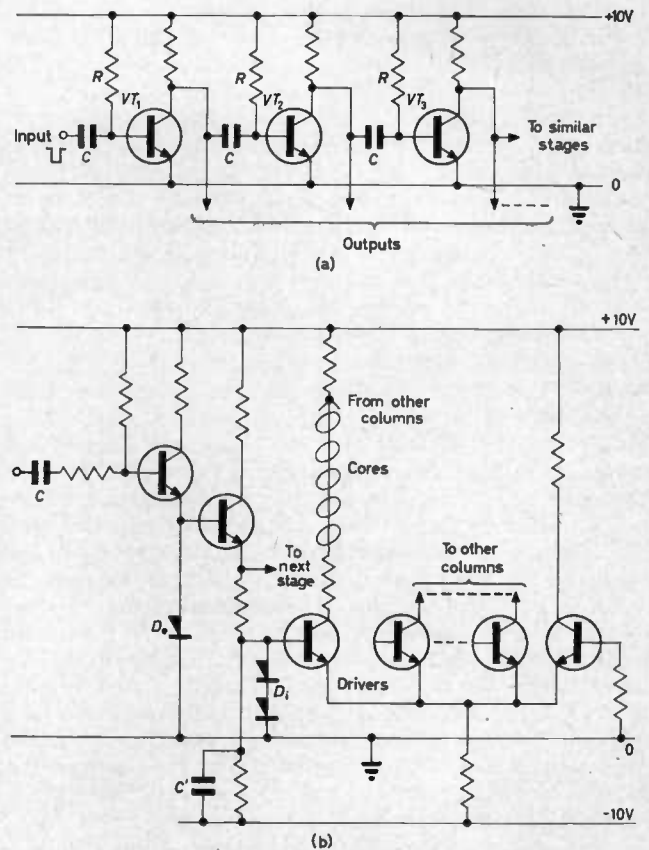
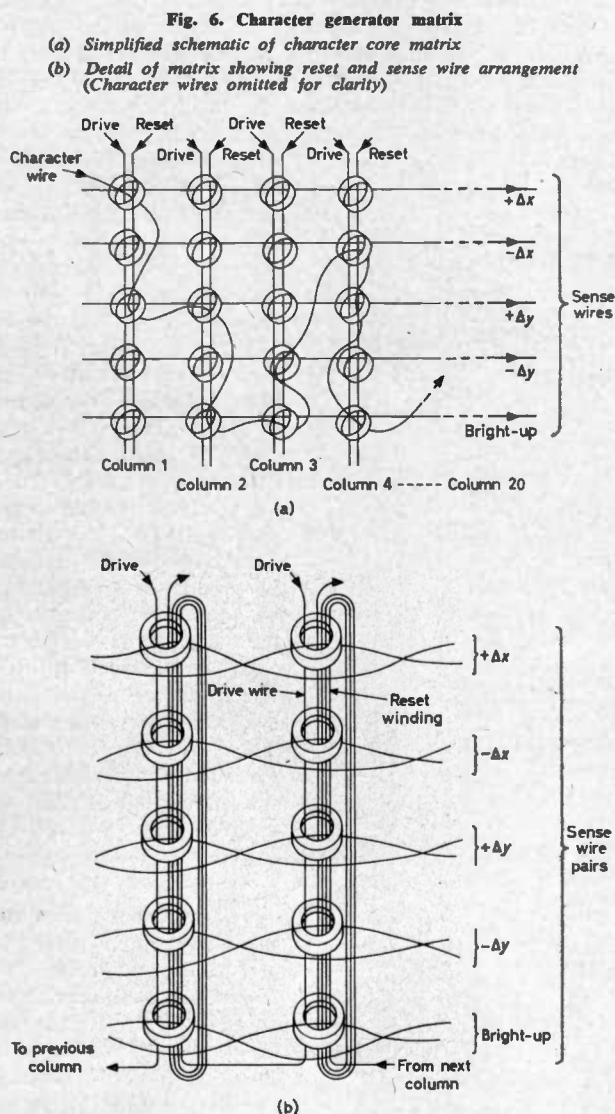

Fig. 7. Sequencer circuits
 (a) Basic differentiator chain
 (b) Detail of one stage with driver circuits

having one location for each character, the content of the location being the set of increments for the graphic. The character code received from the computer acts as an address by means of which a single location is selected, and the increments are read as a time sequence of pulses from which analogue deflexion signals are derived. At a typical running speed of 100 000 characters/second (neglecting main beam indexing), each of the 20 increments must be drawn in $0.5 \mu\text{sec}$.

The increment store in the character generator consists of a matrix of pre-wired cores (Fig. 6). The matrix has 20 columns corresponding to the 20 increments, and 5 rows: one each for $\pm X$ increment, $\pm Y$ increment and bright up. Each column carries a drive wire and a reset winding; each row carries a sense wire. There is also a wire corresponding to each character, selected by the character code from the computer, threaded through up to three cores in each column according to the sequence of increments and bright up required (Fig. 6(a)). Variations of graphic form and the provision of special graphics is simply achieved by choosing an appropriate path for the character wire.

Broadly speaking, the process used is similar to coincident current selection in a conventional core store. The selected character wire carries a steady current throughout the process of drawing the graphic, and the column drive wires are pulsed in turn by signals from a sequencer or commutator circuit. Each core threaded by the character wire will be switched, at least partially, when the corresponding drive wire is pulsed.

It will be clear that fairly large cores must be used to accommodate the many wires that must be threaded

through them. The speed of a ferrite core is proportional to the excess over the coercive force of the drive force per unit path length in the core, and is almost independent of the core material. The drive current required for a given coercive force is proportional to the core diameter, and hence to keep the drive current reasonably low it is necessary to use a low coercive force material. Nominal half-current selection is, in fact, $2/3$ coercive force selection, so the excess drive force, which governs the switching speed, is $1/3$ coercive force. Therefore the switching speed of a large, low coercive force core will be low, and conventional half-current selection would result in very slow operation of the matrix.

It is desirable that the core output should be available within 10 per cent of the $0.5\mu\text{sec}$ time interval of an increment, that is, within 50nsec of the start of the drive pulse. The core actually used has a nominal $4\mu\text{sec}$ access time in half-current operation; even the fastest core materials would not give less than a 150nsec access time.

The difficulty is overcome in the following manner. Coincidence between the character decode current and the sequence pulse produces partial switching of the selected cores in a column: partial because of the short duration of the sequence pulse. A selected core stores this state until reset by the next pulse from the sequencer, which, after driving the next column of cores, is passed through a multi-turn reset winding on the column driven just previously (Fig. 6(b)). The partially switched cores in this column are reset very powerfully, even against the steady decode current, and an extremely fast output pulse appears on the sense wires.

The sequencer is essentially a chain of differentiator

stages, each driving the next, as shown in Fig. 7(a). In the quiescent state all stages are conducting. When a negative-going trigger pulse is applied, VT_1 cuts off for a time determined by RC giving a short positive-going pulse, the trailing edge of which cuts off VT_2 in a similar manner. Thus a sequence of positive-going pulses appears at the collectors. To allow for resetting the 20th column of the matrix the sequence contains 21 pulses.

Certain refinements are necessary (Fig. 7(b)). The diode D_0 in the emitter circuit protects the base emitter junction which, in the simple circuit, will have a 10V reverse potential when the transistor cuts off. The emitter-follower is necessary to prevent distortion of the output pulse due to loading. The base connexion to the driven stage from which the column drive pulse is obtained is tapped down the emitter-follower load resistor so that the driver can be firmly cut off; C' is a speed-up capacitor. The back voltages from the cores are significant and variable, so the driver stages are put into a constant current system with one extra stage to absorb the current when all the drivers are cut off. The bases of the drivers are high impedance points, so to prevent undue variation of base voltage the diodes D_1 are included. As a bonus, these diodes provide a rough temperature compensation for the emitter-follower and driver base-emitter voltages.

The fast output pulse from a sense wire must be held on a bistable for the duration of the increment time interval. To avoid the difficulty of resetting and setting a bistable at the same time the arrangement of the sense wires is somewhat more complicated than the foregoing description suggests. There are, in fact, two sense wires per row, threading alternate cores, each controlling its own bistable.

An additional advantage of separate sense wires is that discrimination is improved: when a core is reset a signal is obtained from the sense wire whether the core has been switched or not; if it has been switched the signal is larger. But if another core is being switched while the first core is being reset the resultant output signal will be lower since the small output pulse due to switching is of opposite polarity to the large pulse on reset, and discrimination between switched and unswitched cores will suffer. The use of alternately threaded sense wires has the effect that a core on a given wire is never being driven while another is being reset (Fig. 6(b)).

The sequence pulses are grouped into alternate sets after threading the cores, and returned to supply through resistors across which will appear time interleaved signals called comb signals.

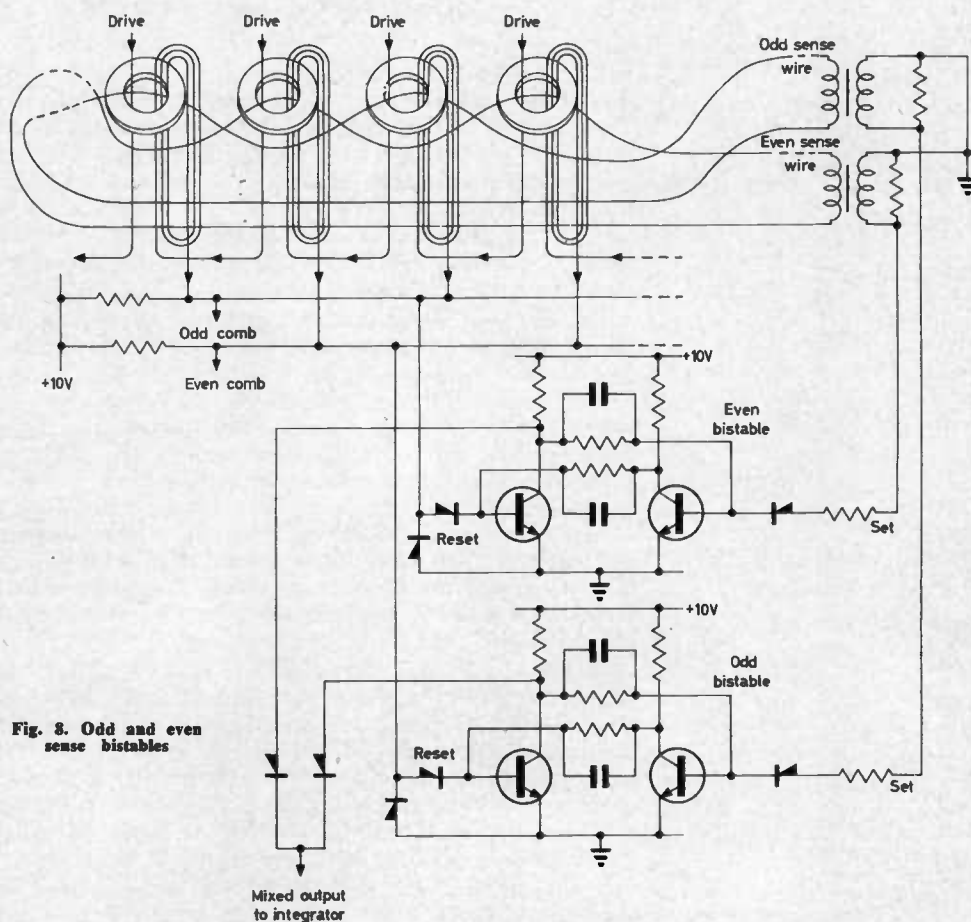

Fig. 8. Odd and even sense bistables

These, the sense wires and the bistables are distinguished as odd and even; the odd bistable is set by the output from the odd sense wire and reset by the even comb signal (Fig. 9). It will be seen that the output from a sense wire when a core on this wire is being switched has the wrong polarity to affect the bistable.

To improve discrimination against spurious signals when unswitched cores are pulsed in the reset direction, a compensating pulse of opposite polarity and similar form is generated on the sense wires. Taking the odd sense wires as examples, these are passed together through a core which is driven into saturation in the appropriate direction by the even comb waveform. This is not shown in Fig. 8.

The outputs of the odd and even bistables for each row are mixed together, so that if the same increment or bright-up condition persists for more than one increment time a quasi steady signal is obtained. The bright-up signal is used in this form to turn the c.r.t. on or off, but the X and Y increment signals are passed to integrators so that discontinuous movement of the beam is avoided.

The circuit for the X increment ΔX is taken as an example; that for ΔY is equivalent. The $+\Delta X$ and $-\Delta X$ signals from the two pairs of row bistables are integrated separately, and their difference is taken and amplified according to the scaling factor specified for the graphic (Fig. 9).

The integrators are reset by transistor switches, represented by S , which are opened when the sequence starts and closed by the 21st sequence pulse. To avoid loading the integrator capacitors and give good d.c. stability the differencing amplifier is a capacitor coupled long-tailed pair with independent emitter feed points, Darling-ton pairs being used to give a high input impedance. The coupling resistor r carries a current proportional to the difference between the $+\Delta X$ and $-\Delta X$ ramp voltages from the integrators, assuming the coupling capacitor is large enough to be negligible, and the value of r therefore determines the sensitivity, since it determines the differential currents in the two collector loads.

There is also a standing component of collector voltage which must be eliminated since it represents an uncontrolled offset of graphic position in the X direction. This standing voltage is taken from P , at which the ramp voltages cancel, and used to form a low impedance supply for the output emitter-follower VT_1 . The base of this transistor is permitted to move symmetrically with respect to the standing voltage by the bias from the constant current source VT_2 .

Scaling under computer control is achieved by switching one or more additional resistors R' into the emitter circuit of VT_1 so as to increase the ramp output without shifting the centroid of the graphic. Deliberate movement of the centroid can be attained by switching the constant current source VT_2 .

The final output is therefore the desired ramp voltages for the graphic, superimposed on an average level suffi-

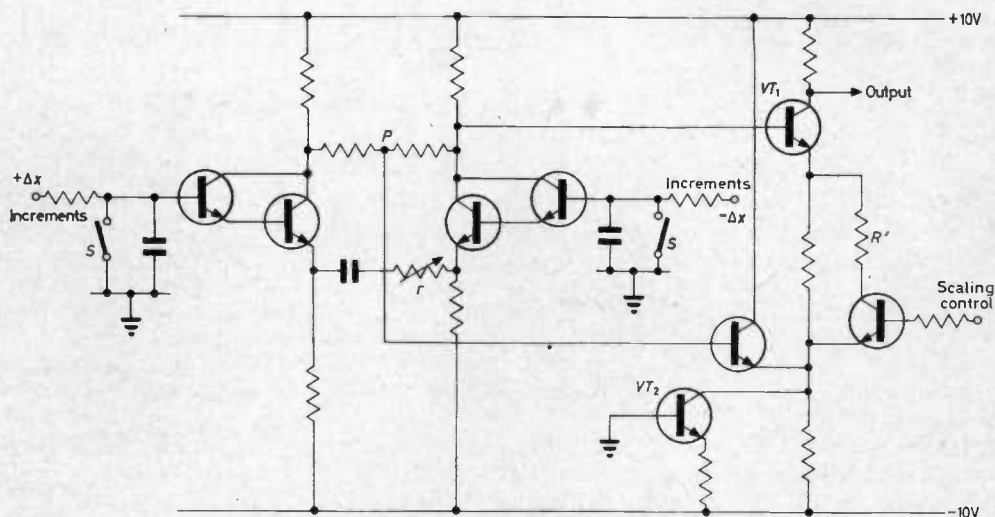

Fig. 9. Graphic increment integration and scaling

cient to take the maximum excursions without cutting off. This output is passed to cable driving circuits and thence to the display units. The remaining circuits are, for the most part, conventional, and will not be discussed here.

All patents, design and commercial rights of the systems and circuits described here are vested in, and the property of, Elliott Automation Ltd. The publication of this description does not confer any rights to use the same.

Acknowledgments

The author wishes to thank his colleagues in the Computing Research Laboratory who assisted in the development of this system. The design of the production version of the equipment was carried out by the E. A. Military Systems Division to whom thanks are also due.

Acknowledgment is also due to Elliott Automation Ltd for permission to publish this article.

Electronic Sterling Invoicing

By installing one Friden 5010 Computyper electronic sterling invoicing machine, Staffordshire Potteries Ltd, of Longton, Stoke-on-Trent, has been able to reduce its invoice office staff by one typist and one comptometer operator—an annual saving of almost one third of the cost of the machine. In addition, invoices are now processed in less than half the time previously taken and invoice errors have dropped dramatically.

The Staffordshire Potteries group is one of the biggest earthenware producers in the U.K. and specializes in mass produced tea and dinner ware. Production of the four companies which constitute the group is centralized at Meir Airport. During the last two years considerable strides have also been made in centralizing and mechanizing the four companies' accounting procedures.

In the past, invoices were computed by comptometer operators and then produced on conventional typewriters. Under this system, it could take anything up to five days after the goods had been despatched to send out an invoice. Using the 5010, one typist—with some checking assistance from another—can do the whole job. No comptometer is needed since the machine automatically performs all calculations and invoices are posted within two days of the despatch of goods.

With this machine, invoice preparation is reduced to a routine typing job. The operator simply types the descriptive part of the invoice and enters the relevant quantities and prices. All extensions, discounts, surcharges, sub-totals and totals are computed and printed automatically by the machine.

Analysis of High Speed Fixed Stores Using U-cores

By H. P. A. Salam*, Ph.D.

The factors affecting the design of wired fixed stores using ferrite U-cores are discussed and several possible sources of noise are listed. The basic equations are evolved for a particular system and it is shown that the signal-to-noise ratio is proportional to the square of the length of the drive wires and to the square of the operating frequency. The engineering of a unit with a 250nsec cycle time is described.

(Voir page 416 pour le résumé en français: Zusammenfassung in deutscher Sprache auf Seite 423)

FIXED stores are widely used in present day computers to store the microprogram sequences needed for the execution of the computer instructions^{1,2}.

They offer the advantage, compared with the use of logical elements, of providing the control information in

The last two of the above factors tend to be the most critical. For a store having, say, 2000 words, many of the existing arrangements, which rely on drive wires printed side by side on a flexible laminate³, would need excessively long read wires. For this reason it is desirable to choose a form of store in which the drive system is essentially three dimensional in nature, such as the Dimond ring⁴ arrangement, or the modified version of it described in this article. This reduces the read wire length from tens of feet to a few feet.

While the delay in the read system can readily be predicted from the length of the read wires and the response of the amplifiers, the maximum speed of operation that can be achieved without exceeding a given noise-to-signal ratio is much more difficult to assess, since it is dependent on many factors. The main purpose of this article is to attempt to list these factors and to show which of them are the most critical.

Description of the Fixed Store

BASIC PRINCIPLE

The principle of the Dimond ring type of fixed store is outlined with reference to Fig. 1. A number of linear ferrite cores are used to couple a set of drive wires with a set of read wires. Each drive wire corresponds to one word, and each read wire to one digit position. Information is stored in a word by threading its drive wire

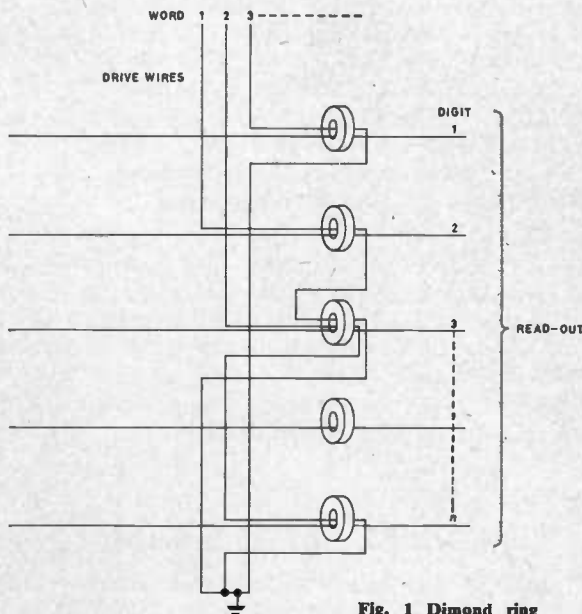

Fig. 1 Dimond ring

an economical and rational way and they enable the design of a computer to proceed independently of the detailed specification of the microprogram. This enables last minute changes in the control to be incorporated easily.

One of the main problems in the design of fixed stores for high speed computers is that of achieving access and cycle times sufficiently short to control effectively the fastest logical circuits available; i.e. to ensure that the fixed store is not dominating the speed of the computer. The factors that limit the speed of the store are:

- The delay in the drive circuits and the length of the drive wires.
- The length of the read wires and the delay in the read amplifiers.
- The stray couplings in the drive and read-out systems, which result in unwanted (noise) signals that increase in magnitude with increase in speed of the store.

* Formerly English Electric-Leo-Marconi Computers Ltd.

PRINCIPAL SYMBOLS*

C_B	= Capacitance per unit length of all wires to earth
C_W	= Capacitance per unit length between drive wire and all adjacent wires
L	= (YL) = Total inductance of drive wire
L'	= Inductance per unit length of drive wire
M_O	= Mutual inductance between a drive wire and a read wire, provided by a core
M_W	= Mutual inductance between a drive wire and any one of the adjacent wires
τ_B	= Rise-time of bar selection drive
t	= time
τ	= Rise-time of stage drive
$V_{(pk)}$	= Peak amplitude of drive voltage
$V_{o(pk)}$	= Peak 'one' output signal at secondary of core
V_B	= Bar selection voltage
V_{N-}	= Negative stage noise voltage
V_{N+}	= Positive stage noise voltage
V_{NB}	= Bar selection noise
x	= Distance from bar switch
Y	= Total length of drive wire

through the cores corresponding to the digit positions for which 'ones' are required in that word.

USE OF U-CORES

In a large store it is impracticable to use only one set of cores, because of the large number of wires, and it is necessary to have many sets with their read outputs commoned by joining them either in parallel² or in series. It is desirable not only to duplicate the sets of cores but also to use pairs of U-cores instead of toroids, since this enables the stored information to be changed much more easily. The arrangement adopted in the

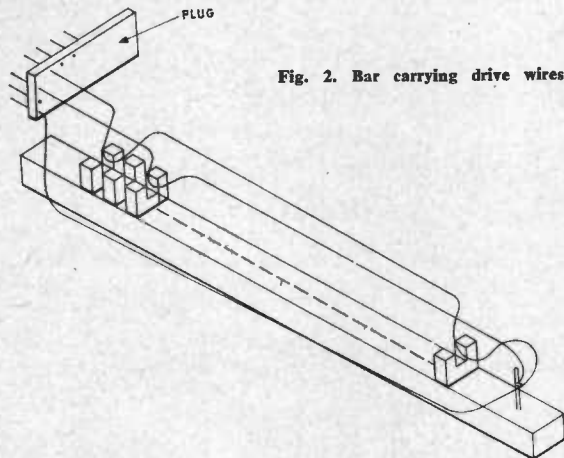
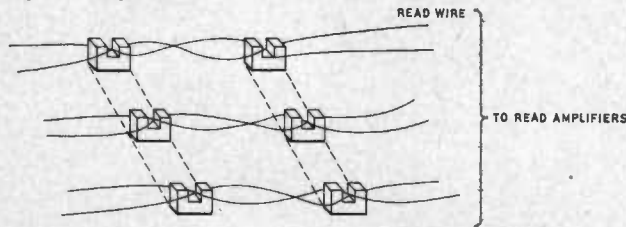

Fig. 2. Bar carrying drive wires

Fig. 3. Arrangement of read wires



250nsec unit that was built is illustrated schematically in Figs. 2, 3 and 4. Fig. 2 shows one of the bars that carry the drive wires, Fig. 3 shows the arrangement of the read wire and Fig. 4 shows the relative positions of the drive and read U-cores. Spacer sheets 0.005in in thickness were used to define the core gap. This defined gap swamps variation in the permeability of the material and makes the output signals relatively insensitive to specks of dust and irregularities on the mating surfaces of the cores. It also reduces the inductance of the cores, and so reduces the propagation delay along the drive wire and along the read wire, both of which behave as delay lines, with the cores acting as lumped inductances.

METHOD OF DRIVING

The driving arrangement is shown in Fig. 5. The microprograms are stored so that as far as possible a complete instruction is contained within a bar, since there is a time penalty in selecting a bar. Once the bar has been selected, by closing the switch to earth, the wires within the bar can be driven in any sequence at the maximum rate of 4Mc/s.

Sources of Noise

Unwanted noise signals can be induced in the read wires of the systems described by:

- (a) Stray magnetic flux in the selected bar.
- (b) Stray currents in the selected bar.

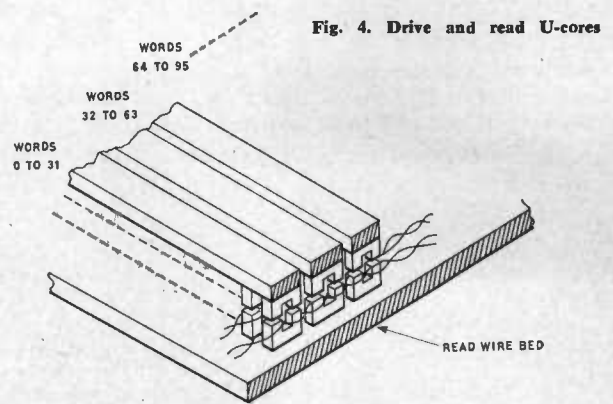

Fig. 4. Drive and read U-cores

- (c) Stray currents in the unselected bars.
 - (d) Crosstalk between the read wires.
- These sources are discussed in turn.

STRAY MAGNETIC FLUX

There are two sources of stray flux:

- (a) Stray flux from a drive wire which is by-passing a core (storing a nought) as illustrated in Fig. 6. Noise so produced can be minimized by making the gap in the core small. With 0.005in gaps the noise is only a few per cent of the signal amplitude.
- (b) Stray flux leaking from one core to an adjacent core. This is a function of the spacing between the cores and the air gap. With a spacing of $\frac{1}{4}$ in it tends to be negligible.

STRAY CURRENTS IN THE SELECTED BAR

The stray couplings within the bar are shown in Fig. 7. The capacitance C_w is that between the driven wire and the immediately adjacent unselected wires. The capacitance C_E is that between the remaining, unselected, wires and earth. The mutual inductance M_w is that between the drive wire and any other wire and is assumed to be independent of the stored information. This approximation is valid for the unit that was constructed, since the air gap made the core inductance very small

Fig. 5. Driving arrangement

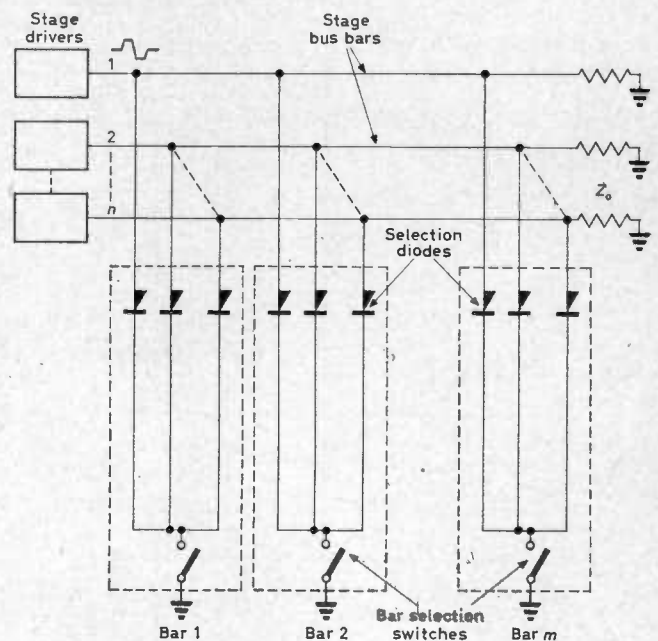

and the nature of the microprogram system was such that the number of 'ones' stored in a word was a small proportion of the total number of bits. A further parameter in Fig. 7 is M_c , the mutual inductance between drive wire and read wire provided by a core.

The stray couplings in the selected bar are responsible for four types of noise:

- (a) Positive stage noise.
- (b) Negative stage noise.
- (c) Back edge noise.
- (d) Bar selection noise.

Positive Stage Noise

This is primarily due to C_w as shown in Fig. 8. When a wire is driven, the signal current passes down the wire, but because of the presence of C_w , a small noise current also flows in the immediately adjacent wires, causing a positive-going, differentiated output from read wires associated with cores linked by these stage wires. The amplitude of this output depends on the rate of change of the selection signal, and also the value of C_w , which is proportional to the length of the wires. This noise

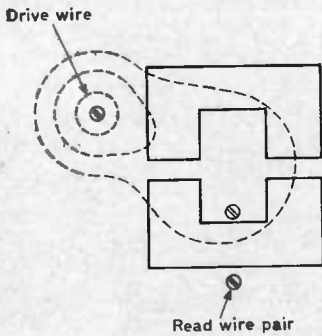

Fig. 6 (left). Stray flux from wire by-passing a core

Fig. 7 (below). Stray couplings within the bar

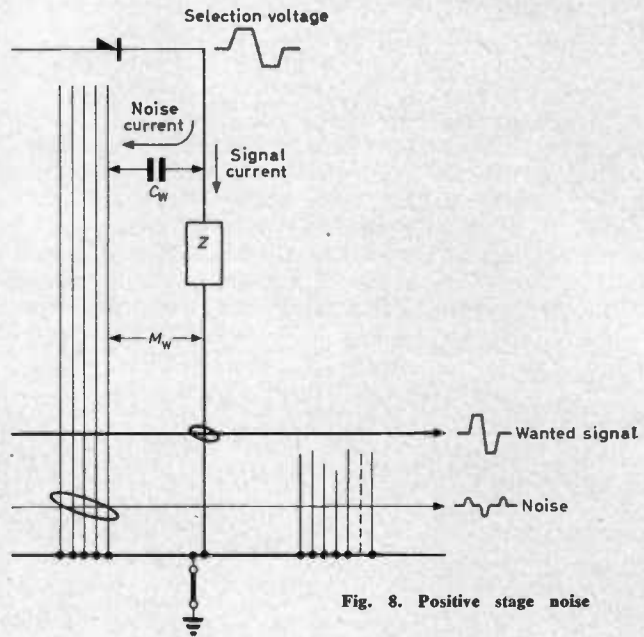
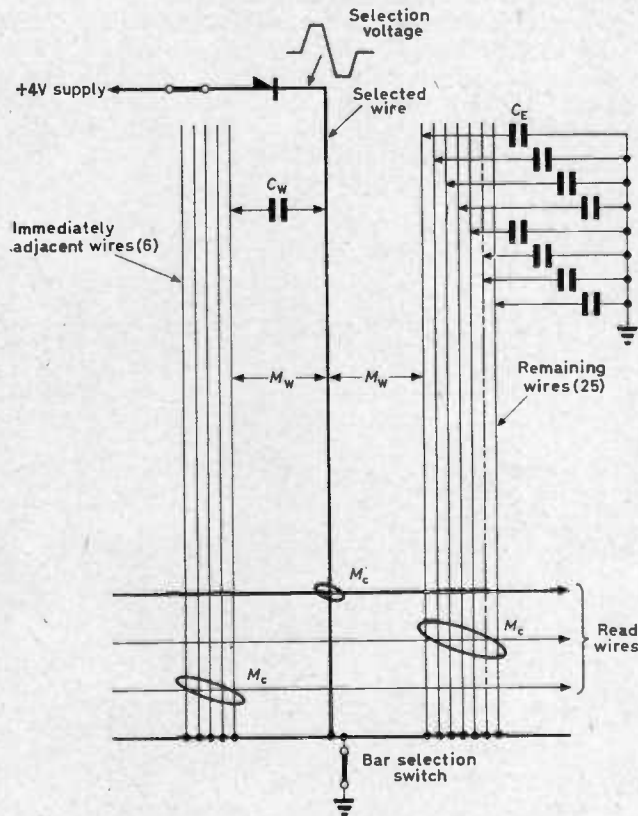

Fig. 8. Positive stage noise

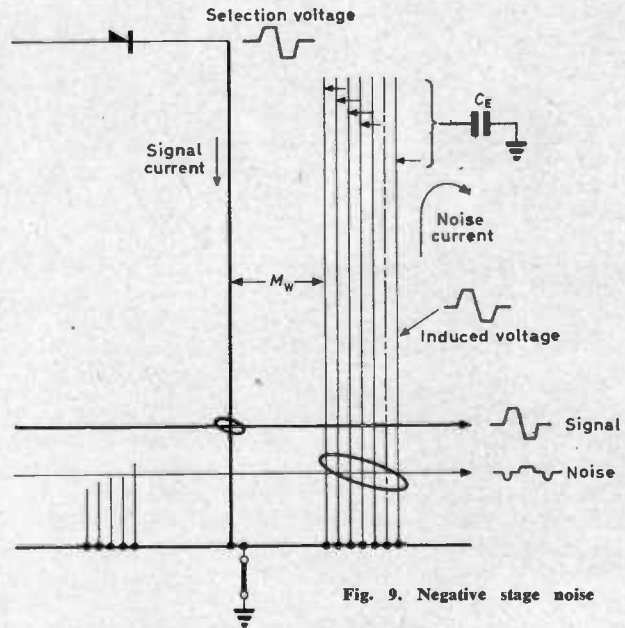

Fig. 9. Negative stage noise

can be minimized by keeping the drive wires as short as possible, and by choosing wire insulation of low dielectric constant.

Negative Stage Noise

The parameters affecting this are shown in Fig. 9.

When the stage wire is selected, a voltage appears across all the unselected wires, due to the mutual inductance M_w . This voltage causes a noise current to flow through them to earth, via C_E . Cores shared by many wires will thus generate a negative-going differentiated output. The noise can be minimized by keeping C_E small, by ensuring that wires are separated from earth by thick insulating material of low dielectric constant.

Back Edge Noise

The causes of this are shown in Fig. 10.

When a drive is applied, the voltage across the selected wire rises to a maximum, falls, and overshoots because

the drive wire is inductive. During the overshoot period, a voltage is induced in the unselected wires which can cause current to flow through the selection diodes to earth, via the bus-bar terminating resistors. This noise can be eliminated entirely by returning the termination resistors to a negative supply instead of earth. This back-biases the diodes and stops them conducting during the overshoot period.

Bar Selection Noise

When a bar is selected by closing the bar selection switch, the capacitance, C_E , of the stage wires to earth is discharged, causing noise currents to flow in all stage wires. The noise generated in this way tends in practice to be larger than either positive or negative stage noises. The remedy used in the model was to switch the bars slowly.

STRAY CURRENTS IN UNSELECTED BARS

There are three types of noise that can arise in the unselected bars. These are referred to as:

- (a) Charging noise
- (b) Diode capacitance noise
- (c) Core-squared noise.

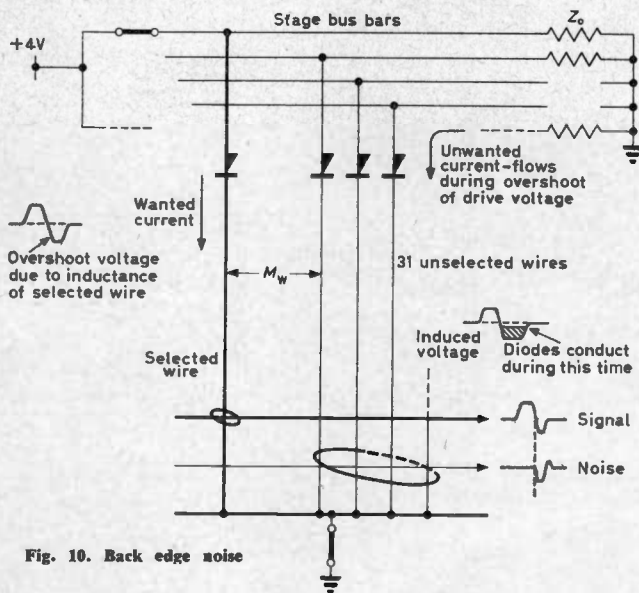

Fig. 10. Back edge noise

Charging Noise

Fig. 11 shows the cause of this noise. Current flows through one diode in each of the unselected bars to charge C_E . This type of noise can be avoided by returning the drive wires to a positive supply voltage equal to, or greater than, the peak drive voltage.

Diode Capacitance Noise

With the unselected bars returned to a positive supply all the associated diodes are cut off. When the stage bus-bar is driven, currents will flow in the unselected bars because of the capacitance of the diodes, in combination with the capacitances of the drive wires to earth as shown in Fig. 12. This is an effect that multiplies with the number of bars. For large fast stores very low capacitance diodes must be used.

Core-Squared Noise

Driving the selected bar causes signal currents to flow along some of the read wires. These currents cause e.m.f.'s and currents to be induced in unselected bars,

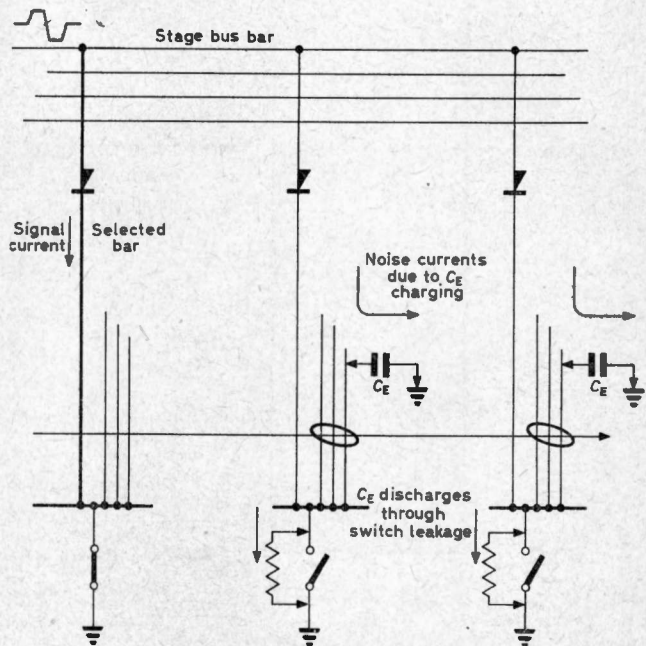

Fig. 11. Charging noise

due to the cores on the read wires. The unwanted currents in the drive wires of the unselected bars induce e.m.f.'s in read wires other than those carrying the true signal currents. This noise could in theory be large if M_0 is large. With an air gap, M_0 is very small and the noise is negligible.

CROSSTALK

The shielding afforded by twisting the read wires is reduced when they link a core, because the twisting has to be opened out to allow the wires to pass round the limb of the core. This results in crosstalk between one read wire and the next. The noise can be kept very small by appropriate spacing of the read wires.

Noise Equations

In practice the most serious types of noise are:
Positive stage noise.

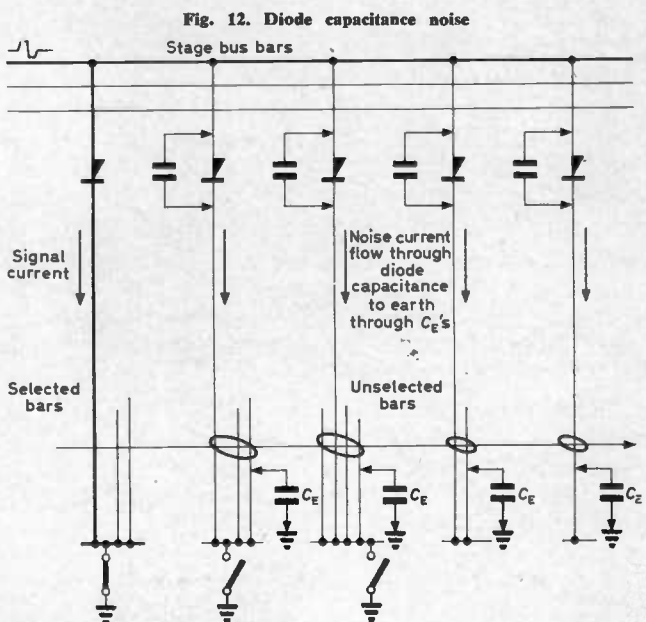

Fig. 12. Diode capacitance noise

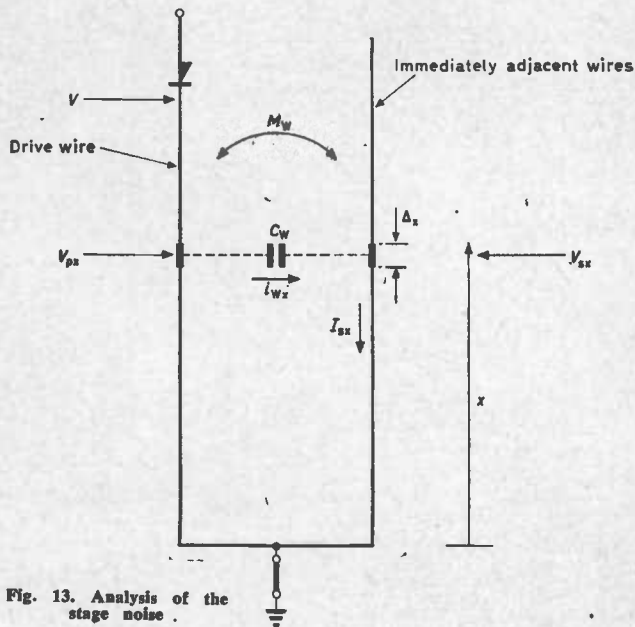

Fig. 13. Analysis of the stage noise.

Negative stage noise.
Bar selection noise.

The other types of noise can be made small by careful design, or in some cases eliminated altogether, and will not be discussed further.

In deriving the noise equations the following assumptions are made.

- (a) The inductance of the drive wire is independent of the number of cores it threads. This is roughly true, provided the number of cores it threads is small and the cores have an air-gap: i.e. the wire inductance swamps the effect of the cores*.
- (b) The signal current is independent of the position along the drive wire; i.e. that the noise current that has leaked away to neighbouring wires is insufficient to detract seriously from the magnitude of the signal current. This must be true if one is to have a workable system with a good signal-to-noise ratio.
- (c) The resistance of the wires is negligible.

EXPRESSION FOR POSITIVE STAGE NOISE

Fig. 13 shows the current i_{wx} flowing from the driven wire to the immediately adjacent wires, for an increment of length Δx , measured at a distance x from the bar switch. This current is given by:

$$i_{wx} = C_w \cdot \Delta x \cdot (d/dt) (v_{dx} - v_{sx}) \dots \dots \dots (1)$$

where C_w is the capacitance per unit length between the driven wire and the adjacent wires.

Taking the length of the drive wire to be Y , the inductance to be L , and neglecting the loading affect of the cores, it can be shown that:

$$v_{dx} - v_{sx} = (1 - (M_w/L)) \cdot (x/Y) \cdot V \dots \dots \dots (2)$$

where M_w is the mutual inductance between the wires and V is the drive voltage. From equations (2) and (1) the total current flowing in the adjacent wires, measured at a point x is obtained:

* A detailed study of positive stage noise has been made by Taub and Kingston for the opposite case, where the inductance of the cores is much higher than the wire inductance*.

$$I_{sx} = \int_x^Y i_{wx} dx$$

$$= \frac{1}{2} [1 - (M_w/L)] \cdot C_w \cdot Y [1 - (x^2/Y^2)] dV/dt \dots (3)$$

from this the positive stage noise output voltage is obtained.

$$V_{N+} = M_C (dI_{sx}/dt)$$

$$= \frac{1}{2} [1 - (M_w/L)] \cdot C_w M_C \cdot Y [1 - (x^2/Y^2)] d^2V/dt^2 \dots \dots \dots (4)$$

It is seen from this equation that the noise is a function of the drive waveshape. The simplest drive that will produce noise of limited amplitude is parabolic. A square or ramp drive results in spikes of infinite amplitude.

Fig. 14(a) shows the waveshape of the front edge of an ideal drive, which it will be assumed is used, consisting of two identical parabolic sections of the form:

$$V = 2V_{(pk)}t^2/\tau^2 \dots \dots \dots (5)$$

joined together. $V_{(pk)}$ is the peak amplitude of the drive and τ is the rise time. Fig. 14(b) shows the second derivative, and therefore the noise, is constant during each of the parabolic sections.

The peak value of the 'one' output signal is given by:

$$V_{o(pk)} = (M_C/L'Y) \cdot V_{(pk)} \dots \dots \dots (6)$$

where $L' = L/Y$ is the drive wire inductance per unit length. From this and equations (4) and (5) the following

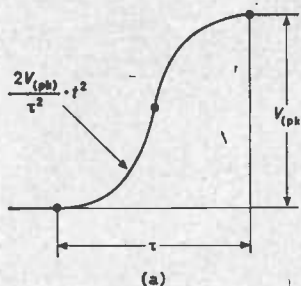

Fig. 14 (a). Ideal drive waveshape

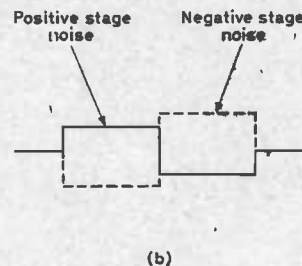

Fig. 14 (b). Noise resulting from ideal drive

expression is obtained for peak noise to peak signal ratio for an ideal drive:

$$\frac{V_{N+(pk)}}{V_{o(pk)}} = 2 [1 - (M_w/L)] \cdot L' C_w Y^2 \cdot [1 - (x/Y)^2] \cdot 1/\tau^2 \dots (7)$$

The first term shows that the noise is dependent on the magnetic coupling between the wires. The second term shows that it is proportional to the square of the total length of the drive wire, as well as the inductance and capacitance per unit length. The third term shows how it varies along the different positions of the wire. The fourth term shows that the noise-to-signal ratio is inversely proportional to the square of the rise time.

EXPRESSIONS FOR NEGATIVE STAGE NOISE

By an analysis similar to the one just carried out it can be shown that the negative stage noise is given by:

$$V_N = -\frac{1}{2} (M_w/L) C_E \cdot M_C Y [1 - (x^2/Y^2)] \cdot d^2V/dt^2 \dots (8)$$

where C_E is the capacitance per unit length between all unselected wires and earth.

The peak noise to peak signal ratio for an ideal drive is:

$$\frac{V_{N-(pk)}}{V_{o(pk)}} = 2 (M_w/L) \cdot L' C_E Y^2 [1 - (x/Y)^2] \cdot 1/\tau^2 \dots (9)$$

The dependence of noise-to-signal ratio on length, posi-

tion, and waveshape is exactly as for the positive stage noise:

EXPRESSION FOR BAR SELECTION NOISE

The bar selection noise is given by:

$$V_{NB} = C_B M_C (Y - x) d^2 V_B / dt^2 \dots\dots\dots (10)$$

where V_B is the bar switching voltage.

The peak noise to peak signal ratio for an ideal bar switching waveform is:

$$\frac{V_{NB(pk)}}{V_{o(pk)}} = 4C_B L' Y^2 [1 - (x/Y)] \cdot (V_{B(pk)}/V) \cdot 1/\tau_B^2 \dots (11)$$

where $V_{B(pk)}$ is the peak value of the bar switching voltage and τ_B is the rise time.

Design Optimization

The analysis just carried out shows that the most serious types of noise, namely positive and negative stage noise and bar noise, are all proportional to the square of the drive wire length. This must therefore be kept as short as possible, by mounting the selection diodes and the bar selection switches on the bars. For a microprogram fixed store in which the microsignals are not coded, the

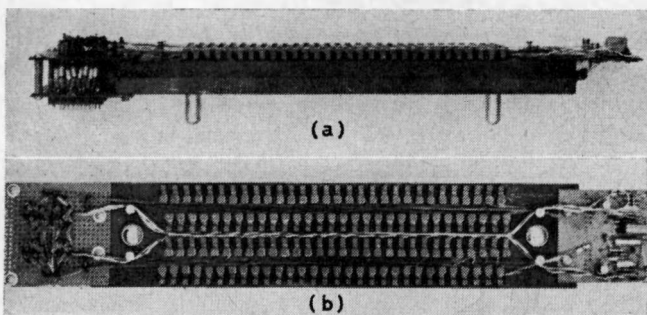

Fig. 15. Bar module

proportion of 'ones' in a word is small and advantage can be taken of this to shorten further the drive wire, by arranging the cores in two rows side by side, with the drive wires running between the rows and calling on the occasional core on either side.

The distributed stray capacitances C_W and C_B must of course be kept small. If enamelled wires are used for the drive conductors, then C_W can only be controlled by choosing the diameter and insulation thickness. If thin printed laminates are used, then it is possible to reduce C_W by staggering the printed conductors in the successive layers, so that they are well spaced from each other. It is even possible to eliminate C_W altogether by putting an earthed screen between each laminate and the next. Unfortunately the steps one can take to reduce C_W in practice have the effect of increasing C_B and therefore negative stage noise. For example, the use of printed laminates results in a set of conductors with a larger peripheral area than a bundle of enamelled wires, and a surrounding of higher dielectric constant. Introducing screening makes matters worse, C_B becomes a multilayer foil capacitor of a 1000pF or so, compared with 50pF for a bundle of fine enamelled wires kept away from earth.

The noise is proportional to the second derivative of the drive voltage, and for a square or trapezoidal drive it consists of large narrow spikes, occurring at the corners of the waveform. It is possible to strobe out such spikes in the reading amplifier, but at high speeds this presents difficulties since the propagation time along the

drive and read wires is variable and is a significant fraction of the cycle time. Thus it would be necessary to adjust the strobing time according to word and bit positions. The strobe would have to coincide with the middle of the signal since the noise can be of either polarity, both for the rise and the fall of the drive. An alternative to relying on strobing is to use a parabolic drive to give minimum noise, thus simplifying the reading system at the expense of complicating the driving system. In practice the parabolic drive can be achieved by using a grounded emitter stage with double Miller feedback between collector and base.

Noise is greatest for cores which are at the bar switch end which are threaded by many drive wires. The performance of a microprogram fixed store can be optimized, therefore, by allocating the most frequently used microsignals to the diode end and the least frequently used ones to the bar switch end.

Performance of the Model

Photographs of the bar module that was used are

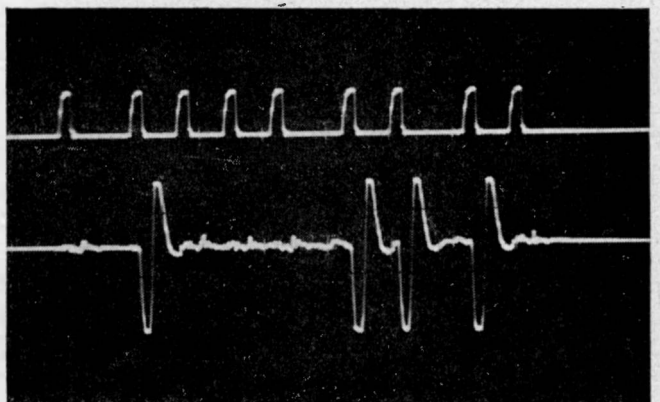

Fig. 16. Read-out signal

shown in Fig. 15. The module holds 64 words of 60 bits each. The 64 words are arranged in two groups of 32, each with its own set of cores and selection switch. Each set of cores is arranged in two rows to keep the wires short. The cores are mounted on a 3/4in block of low-dielectric material. The diodes can be seen mounted on the module at the left-hand end, and the two bar selection switches at the right-hand end. Signals are fed into the module by means of a plug situated next to the diodes.

The model contains seven bar modules, six of which are wired with 42 s.w.g. enamelled wire and the seventh with printed fibre glass laminates 0.003in thick. The pattern threads and by-passes every core and information is stored in the laminate by punching holes in it. The module wired with the laminates is found to give 50 per cent more noise output than a logically identical one using wires. The noise is predominantly negative stage noise.

The cores are stuck on to flexible sheets which are backed by a layer of foam rubber, so as to guarantee pressure between the read cores and the write cores. The read wires are terminated with their characteristic impedance.

The model has been working satisfactorily since it was built in March 1964. Fig. 16 indicates the signal-to-noise ratio that was obtained. The top trace shows the timing pulses for the stage drive, which are 75nsec wide, and the bottom trace shows one of the more noisy outputs. This

was from a core situated at the bar switch end threaded by 50 per cent of the drive wires. The 'one' signal amplitude is 100mV peak-to-peak. The noise is of the order of 10mV peak-to-peak.

Conclusion

Various sources of noise have been listed and the dependence of the more important types of noise on the parameters of the drive wires and the drive waveshape have been analysed for the case where the cores provide a weak coupling. It follows from the analysis that for a given physical size and speed of operation, the factor that limits the permissible number of words in a bar is negative stage noise, since this is a function of C_B , and C_B increases with the number of word wires. The factors that limit the permissible number of bits in a word are positive and negative stage noise and bar noise, since all of these types of noise are proportional to the square of the drive wire length.

Remote Control of Television Relay Stations

Two remote unmanned ITA television relay stations in eastern England are now being supervised and controlled from a single control centre by a system designed, installed and commissioned by G.E.C. (Electronics) Ltd.

The stations, at Great Massingham, near Kings Lynn, Norfolk, and Hameringham, near Horncastle, Lincolnshire, are equipped with G.E.C. Telecode and Teleshift time and frequency division multiplex equipment and are linked by GPO tie lines to a control centre at Belmont, near Louth. Belmont has Europe's tallest cylindrical television mast—its height is 1265ft. The remote control equipment enables engineers at the control centre to control and monitor at each remote station 16 conditions, including switching to standby transmitters, checking the main functions of each station's electronic equipment, monitoring fire alarms, and supervising the starting, stopping and locking out of auxiliary diesel generators.

By means of coloured lights on a mimic diagram the engineers at Belmont are given continuous indications of conditions at each station. They learn of changes and the incident at fault within two seconds, enabling corrective action to be taken immediately.

Basically the system comprises an assembly of standard modules, an arrangement favoured by the ITA engineers. One Teleshift frequency channel from each station is sufficient to carry all the information at present required but if in the future more conditions need to be monitored, or if it becomes necessary to supervise a third remote station from Belmont, it will only be necessary to add extra Teleshift and Telecode modules.

In the event of a mains power failure at either station the Telecode equipment automatically switches to standby 12V batteries which are kept permanently charged by a constant voltage device connected to the mains supply. The batteries can run the Telecode equipment for about two days.

If the G.P.O. tie line to either station fails the remote station continues to operate in accordance with the last signals received from Belmont. At the same time the equipment at the control centre initiates audible and visual warnings of the line fault condition.

The control system is so designed that in addition to carrying control and supervisory signals, the tie line can at the same time be used for voice communications between the control centre and engineers visiting the relay stations.

The equipment at Belmont is based on Telecode and Teleshift f.s.k. multiplex three-state tone signalling systems. This is of modular construction and can accommodate up to 24 standard C.C.I.T.T. frequency division channels spaced at 120c/s intervals through the audio bandwidth.

The Teleshift is operated in conjunction with Telecode

The main factors that limit the number of bars are diode capacitance noise and the signal propagation time along the read wires.

The understanding of the noise phenomena has made it possible to construct a 250nsec unit with very good signal-to-noise ratio.

Acknowledgments

The author wishes to thank Dr. J. M. M. Pinkerton, Director of Research at English Electric-Leo-Marconi Computers Ltd, for permission to publish this work and to thank Mr. M. V. Palmer for his assistance in deriving the noise equations.

REFERENCES

1. WILKES, M. V., RENWICK, W., WHEELER, D. J. The Design of the Control Unit of an Electronic Digital Computer. *Proc. Inst. Elect. Engrs.* 105B, 121 (1958).
2. TAUB, D. M., KINGTON, B. W. The Design of Transformer (Dimond Ring) Read-Only-Stores. *IBM. J.* p. 443 (Sept. 1964).
3. TAUB, D. M. A Short Review of Read-Only Memories. *Proc. Inst. Elect. Engrs.* 110, 157 (1963).
4. DIMOND, T. L. No. 5 Crossbar A.M.A. Translator. *Bell Lab. Rec.* 29, 20 (1951).

modular solid state scanning equipment which uses time division multiplex techniques. This combination can transmit up to 40 conditions on each Teleshift tone channel.

Both of the remote relay stations are equipped with Telecode and Teleshift tone signalling equipment. Whenever a switching change is required—such as to start the diesel generator or change to a standby transmitter—a signal is transmitted from the control centre to the remote station via the GPO tie line, to actuate the appropriate function. A Telecode scanner operating over a separate Teleshift channel continuously passes monitoring signals back to the mimic diagram at Belmont.

Filter modules divide the audio frequency band at 2kc/s so that the lower half of the band can be used for telephone speech while the upper half carries the control and supervisory signals and the telephone ringing circuits.

The Belmont project is the latest in a series of similar installations which G.E.C. has carried out for the ITA and the BBC using rented GPO tie lines or public exchange lines. The company has also recently installed three other systems for ITA. These are controlling relay stations at Scarborough and Richmond Hill (Yorkshire) and Angus (Scotland), using public exchange lines as the transmission media.

The control centre at the transmitting station at Belmont. The console on the wall in front of the operator contains Teleshift and Telecode f.s.k. multiplex signalling equipment and Telecode solid state scanning equipment. The mimic diagram on the door of the console gives a continuous read-out of conditions at two remote unmanned relay stations.

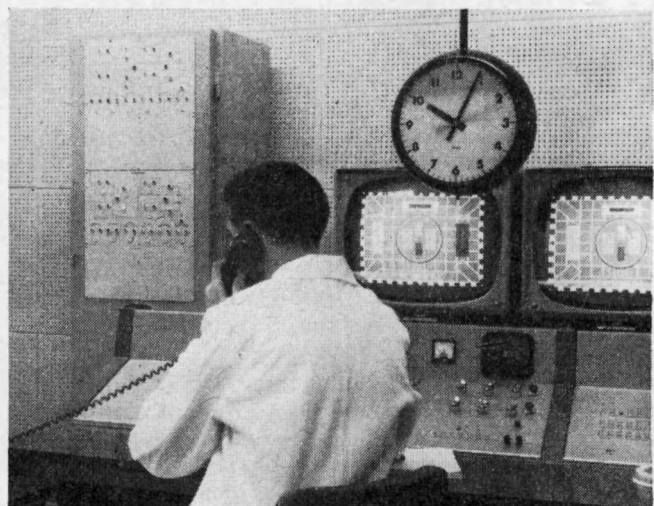

Thin Film Transistors

By R. P. Howson*

Unlike the conventional bipolar transistor a field effect device of thin films evaporated in vacuum can be successfully produced using a variety of semiconducting materials which do not require to be highly crystalline or have their electrical properties precisely controlled. The mode of operation, the technology used and the performance obtained from such devices is reviewed here and the factors in the design of such transistors is considered with respect to the available materials and the geometry used. The possible future of such devices in comparison to their single crystal silicon equivalents is also discussed.

(Voir page 416 pour le résumé en français: Zusammenfassung in deutscher Sprache auf Seite 423)

THE term thin film transistor (t.f.t.) is used to apply to amplifying devices constructed of thin films produced by evaporation in vacuum on to glass or other amorphous substrates. The use of evaporated films to form integrated circuits using nichrome for the resistive element and silicon monoxide as the capacitor dielectric, linked with gold, copper or aluminium electrodes, has demonstrated the versatility of this technique.

A material is typically vaporized in vacuum by resistance heating of a tantalum metal container; at a suitable vacuum pressure of less than 10^{-4} torr the liberated molecules suffer no collisions with the residual gas and travel in straight lines until condensed upon the substrate. The shape of the film required can be obtained by shadow masking during film preparation or etching or machining the completed film, the thickness is controlled by the rate and time of deposition and can be monitored.

The outstanding omission from thin film integrated circuits is an amplifying device prepared by techniques compatible with those used for the rest of the circuit. At the moment encapsulated germanium or silicon devices are soldered into the circuit or unprotected devices attached and the whole unit encapsulated. The availability of an evaporated t.f.t. could expand the usefulness of thin film integrated circuits by making them more reliable and cheaper and would enable an increased complexity of circuit to be undertaken.

Thin film materials generally show properties which are characteristic of their bulk state and also of the peculiar nature of a thin film. The thin film form may exhibit a different structure and has a much larger surface to volume ratio than the bulk. In particular the electrical properties of thin film semiconductors formed by evaporation have proved different as well as being very difficult to control. This is not surprising when the high degree of purity and structural perfection demanded for good property control in these materials is considered. In general deposited films can be either amorphous or micro-crystalline with crystal sizes up to around one micron. The lack of coherent structure given by amorphous materials can be desirable for dielectric and insulator applications where electrical breakdown is required to be high. With semiconductor materials it is desirable that the micro-crystal size should be as large as possible to enable charge carriers to realize the highest mobility without scattering due to grain boundaries.

Solid state amplifying devices generally require close control of the properties of the semiconductors used and therefore it is not surprising that it has not proved pos-

sible to produce a bipolar transistor. The device which has been produced is one which requires the minimum of material property control but with precise control of the geometry of thin layers, this is the field effect transistor (f.e.t.). The operation of a f.e.t. can be understood with reference to a capacitor, one plate of which is a semiconductor and the other metal, called the gate. The

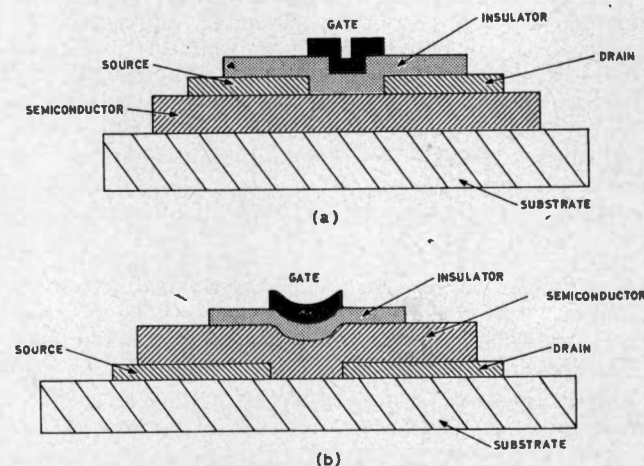

Fig. 1. The fundamental arrangements of electrodes in a t.f.t.

Inversion with respect to the substrate is also possible, making four geometric systems available

application of a potential across the dielectric causes a charge to appear on the interface of the semiconductor and the dielectric and this charge is used to conduct between two electrodes on the semiconductor. The two basic arrangements of electrodes are shown in Fig. 1, inversion of these positions relative to the substrate is of course possible. To attain a satisfactory performance it is necessary that all intrinsic carriers initially present in the semiconductor should be capable of being depleted by a suitable potential applied to the gate. This makes it necessary for the semiconductor to have a low intrinsic charge carrier density and for it to be in thin film form. It is of interest to compare this mode of operation with that of the single crystal silicon field effect transistor, the metal-oxide semiconductor transistor (m.o.s.t.). The difference is that the field attracted charge is of opposite sign to that of the bulk and an inversion layer is formed isolating the surface charge from the bulk, contact is made to a reverse junction formed by diffusion. In this case therefore thin films are not required, although single crystal films grown on sapphire have been used. These films are characterized by being single crystals prepared

* Nottingham Regional College of Technology.

by vapour transport on to a single crystal substrate and are considerably thicker than those obtained by vacuum evaporation on to amorphous substrates.

Performance

Successful t.f.t.'s have been made from several combinations of material; cadmium sulphide and selenide¹, tellurium¹, indium antimonide², lead sulphide³ and tin oxide⁴ have been used as the semiconductor and silicon oxide, magnesium fluoride and anodized aluminium oxide have proved most popular as the dielectric. Conduction due to both electrons and holes has been achieved making operation under positive and negative potentials possible. Despite the many differences in the properties of the materials the best performances obtained from all devices have been similar and all have had similar defects.

The characteristics are those of a pentode valve, the source to drain current, at a constant gate voltage, rises with applied potential reaching a value above which little increase is observed until breakdown occurs. The transconductance is around a few milliamperes per volt with input impedances being almost purely capacitive, the d.c. resistance can be over 1 000MΩ.

Field effect theory predicts this behaviour through considering the charge carriers induced throughout the channel. At some point complete depletion occurs and the semiconductor can then be regarded as an insulator, however sufficient potential appears across that volume for charge carriers to be induced and space charge limited current flow occurs. This point determines the knee of the characteristics.

The current flowing below this given by:

$$i_d = w\mu C/L [V_g - V_o - (V_d/2)] V_d \dots\dots (1)$$

where C is the capacitance per unit area across the dielectric, μ is the mobility of the carriers in the semiconductor film, w is the width of the source and drain electrodes and L is their separation.

V_d is the potential applied to the drain electrode and V_g that to the gate, measured relative to the source.

V_o is a potential representing that necessary to deplete the film of its intrinsic carriers.

At the knee $V_d = V_g - V_o$, i.e. there exists a point in the channel where neither intrinsic or external field effect carriers appear, and the current is constant above that point at a value of:

$$i_d = w\mu C/L [V_g - V_o]^2 \dots\dots\dots (2)$$

The transconductance, g_m , is then:

$$g_m = di_d/dV_g = w\mu C/L [V_g - V_o] \dots\dots (3)$$

and the frequency at which the current gain falls to unity, the gain bandwidth product is:

$$GB = g_m/2\pi C_g = \frac{\mu[V_g - V_o]}{2\pi L^2} \dots\dots\dots (4)$$

C_g is the total gate to source capacitance.

This theory predicts a dependence of the performance determining factors on the source-drain spacing and actual devices use the most narrow that can be produced practically. This is around ten microns along a width of up to one centimetre. These separations are achieved by shadowing the deposition of the source and drain around an extremely thin wire or by electron beam machining or etching through a region defined by photo-lithography. It has been found that etching gives the most satisfactory results, shadowing is difficult to arrange mechanically and gives unreliable results due to the diffusion of the

evaporant into the shadow region and electron beam machining piles up material at the side of the gap area giving a rough surface on to which the dielectric has to be evaporated. More sophisticated etching techniques⁴ enable the gate electrode to be formed by etching as well, which is a great advantage as alignment of the gate electrode with the source drain spacing can be difficult, while overlapping of the gate and source and drain electrodes leads to a greater possibility of dielectric breakdown with increase in gate capacitance. The thickness of the semiconductor film is determined by the material chosen. Those with narrow energy gaps have high intrinsic charge carrier densities and very thin films are used; tellurium and indium antimonide are used at thicknesses of about 100Å. The higher energy gap materials like cadmium sulphide and selenide are essentially insulating when prepared by evaporation on to a hot substrate and have been used at thicknesses up to 5 000Å. The thickness of the dielectric determines the gate capacitance and the transconductance so that thicknesses down to 100Å are used, the thinnest that can be achieved.

Although semiconductors with bulk mobilities from 70 000cm²/V-sec to 200cm²/V-sec have been used the mobility obtained from transconductance measurements is often around the same value of 200cm²/V-sec, suggesting that perhaps a limitation is scattering of the charge carriers by the surface. Similar defects of, at best, a change of V_o with time, and, at worst, a large dependence of the source drain current on the frequency of the applied gate potential occur, especially at low frequencies. This latter effect leads to the characteristics of most t.f.t.'s, when shown on a curve tracer, displaying hysteresis. Life of devices, especially in moist air, is short, and this is generally attributed to the deterioration of the dielectric accompanied on occasions by the film peeling away. Similar effects were initially observed with m.o.s.t. structures, though not so pronounced, and have been attributed to an impure and non-stoichiometric dielectric film, leading to conduction by ions with large direct current leakage and considerable low frequency effects. T.F.T.'s with their more impure dielectrics and greater liability to non-stoichiometry may well be expected to give more pronounced effects, as indeed they do. These effects could also be caused by impurity states in the semiconductor, but it seems unlikely that they could have such long time-constants when narrow energy gap materials are used.

Design

The description of the performance of a t.f.t. given so far is inadequate. The limits to geometric parameters, which determine the performance are given by the intrusion of other conduction mechanisms and the power dissipation capacity. The performance factor of a t.f.t. taking account of these will be better described by an overall voltage amplification factor, A , at a maximum power level. A is then given by: $A = g_m R_L$, where R_L is the maximum load resistance given from the characteristics shown in Fig. 2. R_L is determined by the maximum voltage that can be sustained across the gap before breakdown and the maximum power dissipation of the device.

The points at issue are then the power dissipation of the device with the geometry chosen for it to give high transconductance and load resistance, and the breakdown potentials of the dielectric and semiconductor. Considering the breakdown of the dielectric first: The charge induced per unit area of the gate electrode across the dielectric is $C.V_g$ which, if it is assumed that the breakdown field, E_B , is not a function of thickness, may

be written as proportional to $\epsilon_1 \cdot E_B$ a constant property of the dielectric. It will be assumed henceforth that $C \cdot V_g$ is a constant and that a maximum allowed value of V_g can be changed at will by adjusting the thickness of the dielectric.

The breakdown between source and drain is assumed to be due to space charge limited current. At zero effective bias the semiconductor is assumed to be depleted and insulating and the evidence of the repeatable nature of the breakdown and its non-abrupt appearance suggests that the current through it would probably be caused by injection of carriers by the field across it and be space charge limited. Space charge limited current between the source and drain electrodes is given to a sufficient approximation⁵ by:

$$i = \frac{\epsilon_2 \mu w d}{4\pi} V_d^2 / L^3 \dots\dots\dots (5)$$

where ϵ_2 is the dielectric constant of the semiconductor and d the thickness of the layer.

The dissipation of the power produced in the source-drain gap in the thin film will in general be determined by the substrate, the conductance of heat through a very thin semiconductor film being high. If a line source of heat is considered dissipating into the bulk of the substrate the power dissipation can be represented by:

$$P = B \cdot w \dots\dots\dots (6)$$

where B is a constant characteristic of the material and dimensions of the substrate.

If now the breakdown current limit is fixed at one per cent of the maximum current that can flow and the load resistance is approximated by:

$$R_L = V_{max} / I_{max} \dots\dots\dots (7)$$

(The current at V_{max} is one per cent of I_{max} by the previous condition and can be neglected. I_{max} occurs when $V_d = V_g - V_0$. V_g and V_0 can be made small by a suitable choice of the thickness of the dielectric.)

The operating conditions are then defined as:

$$I_{max} \cdot V_{max} / 4 = B \cdot w$$

and $I_{max} / 100 = \frac{\epsilon_2 \mu w d}{4\pi} V_{max}^2 / L^3$

and the amplification factor, A , is given from equations (3) and (7) by:

$$A = [\pi^2 / B \cdot 2.5 \cdot 10^3]^{1/3} [C \cdot V_g] [\mu / \epsilon_2^2 d^2]^{1/3} L \dots (8)$$

The best performance is then predicted for a semiconductor film with a high mobility and low dielectric constant used as a very thin film. L should be as large as possible consistent with being able to produce breakdown with a reasonable potential. Table 1 shows the bulk

TABLE 1
Properties of Semiconductors for t.f.t.'s

	E_g	μ_p	μ_n	ϵ	$(\mu/\epsilon^2)^{1/3}$
Te	0.33	560	1 100	5	3.5 or 2.8
InAs	0.35	340	30 000	11.5	6.1
InSb	0.17	1 000	70 000	16.8	6.3
GaAs	1.35	400	8 500	13.5	3.6
PbS	0.37	1 000	800	22.5	1.2
PbSe	0.26	1 500	1 500	20.5	1.5
PbTe	0.25	750	1 620	17.5	1.7
HgTe	0.02	160	22 000	—	—
HgSe	0.6	—	18 500	14	2.1
CdS	2.4	—	200	5.9	1.8
CdSe	1.74	—	500	4.3	3.0
Si	1.04	500	1 900	11.8	2.4
Ge	0.63	1 900	3 900	16.0	2.5

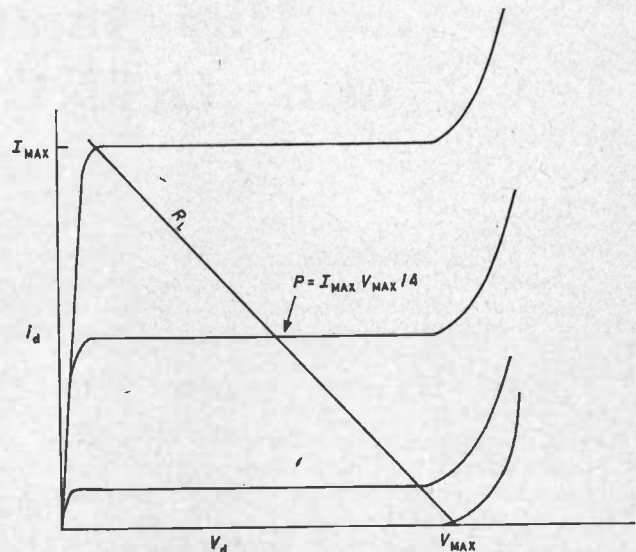

Fig. 2. The source to drain current shown as a function of the drain potential at various gate voltages
The breakdown of the current at high values of the drain potential is shown and the limited load line indicated

values of some semiconductors that have been used and some that have been suggested for t.f.t.'s and the computed performance factor of $[\mu/\epsilon_2^2]^{1/3}$. In the event of the field effect mobility being limited by surface scattering the most acceptable material is that with the lowest dielectric constant and it is interesting to note that this is cadmium selenide, the material which has found greatest acceptance. Lead sulphide with a high dielectric constant is reported as having a low breakdown⁸ as could be expected. Measurements of crystal size with films from cadmium sulphide have shown no falling off with films from 5 000 to 500Å thick, and the smaller thickness is obviously thus preferable for devices, and has proved the better. Comparison with m.o.s.t. devices of silicon show that although the silicon has a high dielectric constant the effective thickness, d , is very low as the conduction channel is defined by depleting a surface layer. This control is denied to thin film properties at the moment.

Conclusion

T.F.T.'s have proved feasible, surprisingly so with the lack of control of material properties present in the evaporation processes used, but have proved unstable. This situation will remain until the processes used are better controlled and the factors controlling the properties of thin films are better understood. It remains, however, that when a device can be made stable using a thin semiconductor film and a high quality dielectric the potential applications for thin film integrated circuits are large. Thin film circuits could thus offer units which could be optimized, using different materials, to be better for an application than the equivalent single crystal one and, used in sophisticated circuits using optimized materials, still be of low cost.

REFERENCES

1. WEIMER, P. K. The Insulated Gate Thin Film Transistor. Physics of Thin Films. Vol. 2, pp. 147-192. Ed. G. Hass and R. E. Thun. (Academic Press, 1964).
2. FRANTZ, V. L. An Indium Antimonide Thin Film Transistor. Proc. Inst. Elect. Electronic Engrs. 53, 760 (1965).
3. PENNEBAKER, W. B. PbS Thin Film Transistors. Solid State Electronics, 8, 509. (1965).
4. KLASSENS, H. A., KOEDMANS, H. A Tin Oxide Field Effect Transistor. Solid State Electronics, 7, 701. (1964).
5. LAMPERT, M. A. Injection Currents in Insulators. Proc. Inst. Elect. Electronic Engrs. 50, 1781. (1961).

A Very High Input Impedance Buffer using Field Effect Transistors

By K. Thompson*, B.Sc.

The circuit described has a very high input impedance of $10^{12}\Omega$ over the range d.c. to 50kc/s and is primarily intended to act as a unity gain buffer, for voltage sensing over $\pm 10V$ in a high impedance analogue simulator. The low output impedance of 1Ω makes it suitable as a feed to many other normal instruments and with a milliammeter produces an excellent, though limited voltage range, valve-voltmeter. It has an input gate standing current as low as any valve circuit ($10^{-10}A$).

(Voir page 416 pour le résumé en français: Zusammenfassung in deutscher Sprache auf Seite 423)

A VERY high input impedance buffer was required to record voltages existing in a dynamic analogue simulator which uses passive high impedance elements. The limited working voltage range required of approximately $\pm 10V$ and accuracy of about ± 0.1 per cent of full scale, made it worth while considering a circuit based on unchopped field effect transistors.

The resultant circuit achieves the high input slope impedance, at d.c., of $10^{12}\Omega$ and low input capacitance of $5 \times 10^{-13}F$ ($10^9M\Omega$ 0.5pF). Since the buffer gain is basi-

cally unity, it is possible to use the output voltage as a screen for the input wiring and thus effectively make it possible to use the very low input capacitance, if required. The steady d.c. drain required by the input transistor is less than $10^{-9}A$ and can be simply trimmed down to $10^{-10}A$, which is similar to the positive ion current in similar good valve circuits¹.

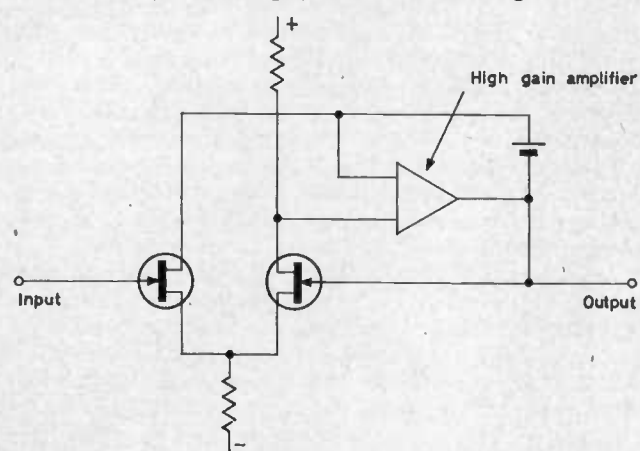

Fig. 1. Basic scheme

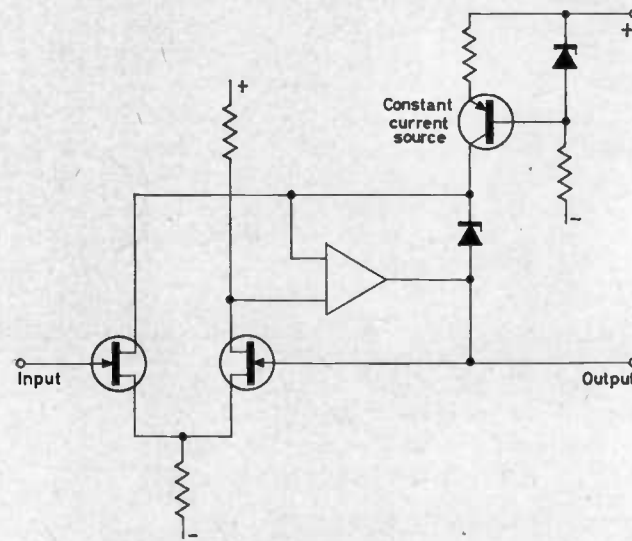

Fig. 2. Basic practical scheme

ally unity, it is possible to use the output voltage as a screen for the input wiring and thus effectively make it possible to use the very low input capacitance, if required. The steady d.c. drain required by the input transistor is less than $10^{-9}A$ and can be simply trimmed down to $10^{-10}A$, which is similar to the positive ion current in similar good valve circuits¹.

Circuit Development

The field effect transistor (f.e.t.) acts similarly to a low voltage pentode valve with large interelectrode capacitance. If the source and drain can be made to follow the input gate potential signal, then the capacitive disadvantage can be mainly removed. The use of a long tail pair of transistors permits almost direct comparison of the feedback potential with the input signal. Fig. 1 shows a possible scheme to augment the above ideas, and which has been used to develop the present circuit. The principle used is to create an active high gain amplifier with unity feedback utilizing the already high input impedance of the field effect transistor input gate to achieve a very high input impedance buffer.

* The University of Liverpool.

It is not practical to connect the drain load of the second field effect transistor directly to the positive voltage rail, due to the low ratio of the transistor mutual conductance to the drain standing current, and also the relatively large variation of the input potential. Two possible schemes were developed to float the input stage and are shown in Fig. 3.

The first scheme (a) should have more development potential if larger input potential variations have to be considered, but the Zener diode internal resistances require a too stringently stable constant current condition for simple use. A practical circuit, shown in Fig. 4, was tried and justified the comments by the high value of the dependence of the output voltage upon the load and the low frequency random noise generated relative to those existing in circuit (b).

Resultant Buffer Circuit

The resultant buffer circuit (b), shown in Fig. 5, was developed from scheme (b) of Fig. 3.

INPUT STAGE

The long-tail pair of field effect transistors has three main connexions to the power supplies. The f.e.t. VT_2

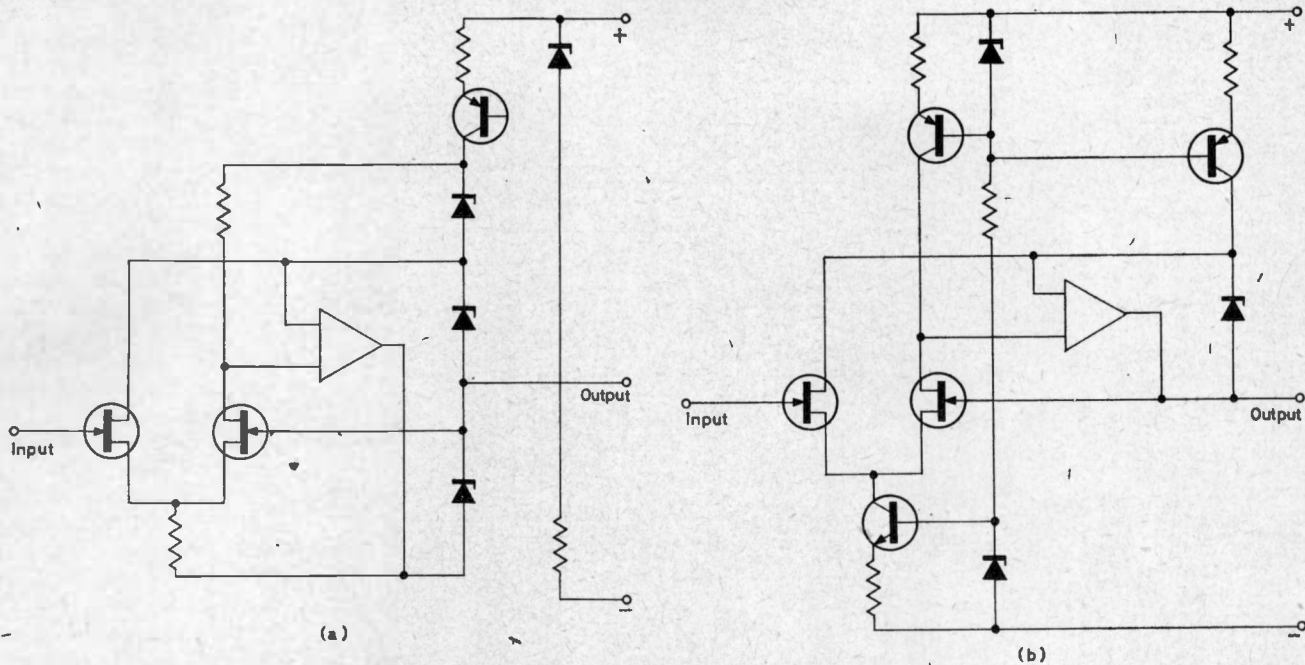

Fig. 3. Two possible buffer arrangements

acts as a source follower to provide a floating voltage for the source of the f.e.t. VT_1 , which has an output controlled floating voltage for its drain supply. The drain load of the f.e.t. VT_2 , however, is based on a constant current source concept from transistor VT_4 . Together with a similar constant current source from transistor VT_3 for the common transistor sources, these should completely maintain a constant potential and current environment for the two input f.e.t.'s VT_1 and VT_2 .

INPUT STAGE THERMAL EFFECTS

Thermal effects are involved in two ways. Firstly, the normal physical environment temperature influence on the input stage. It has already been shown by Richards² that the choice of the gate potential influences the temperature coefficient of f.e.t.'s, also that a gate source potential usually between -0.3 and $-0.8V$ gives a zero temperature coefficient. The low value of mutual conductance g_m of the available f.e.t.'s makes the stage also dependent on the temperature coefficients of the constant current source components. This thermal effect can be reduced by the use of reverse biased diodes in series with the Zener diode. Secondly, the low ratio of mutual conductance g_m to standing current I_d of f.e.t.'s causes a thermal effect

in the constant current transistors due to heat internally generated. If a standing current of $2mA$ is present and the input voltage changes by its maximum amount of $20V$ then a change of heat production takes place in the transistor of $40mW$. This changes the standing current and the f.e.t.'s low mutual conductance ($1mA/V$)

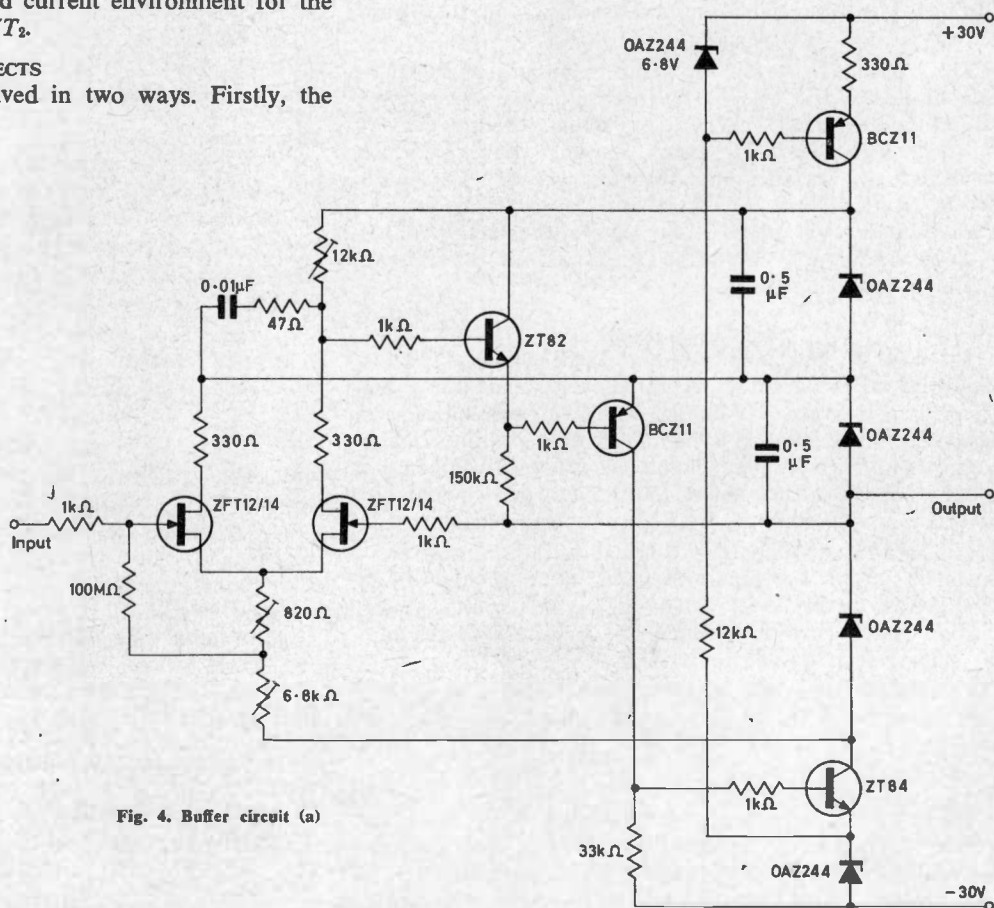

Fig. 4. Buffer circuit (a)

OUTPUT

Output resistance	$< 1\Omega$
Maximum voltage	$> \pm 10V$
Maximum current	$> \pm 10mA$
Frequency range	D.C. to 50kc/s
Low frequency random noise	$< \pm 1mV$

Conclusion

The buffer amplifier described is a very powerful sampling tool within the convenient, though limited, work-

ing range of transistor circuits. Its upper frequency range and voltage accuracy can be extended as transistors are developed further.

Acknowledgment

This work is part of a research project supported by a contract from the Ministry of Public Building and Works.

REFERENCES

1. BROWN, D. E., KANDIAH, K. A Very High Impedance Valve-Voltmeter. *Electronic Engng.* 24, 320 (1952).
2. RICHARDS, J. C. S. Field Effect Transistors in D.C. Amplifiers. *Electronic Engng.* 37, 302 (1965).

Numerically Controlled Spark Micro-Engraving

An advanced form of automated spark micro-engraving for the production of thin-film micro-circuits is now being used at the Paignton, Devon, factory of Standard Telephones and Cables Ltd.

The new machine works on an entirely automatic cycle from a digital punched paper tape programme prepared from a sketch drawn by the circuit design engineer on graph paper. The machine can engrave tracks down to 0.002in wide with a positional accuracy of 0.0003in.

The machines are being used at Paignton either to manufacture photolithographic masters from which further circuits will be made by photo-resist methods, or else to adjust existing thin-film circuit resistor and capacitor values to close limits.

Consequently, STC is now in a position to offer a rapid service in the production of highly reliable, and where required, highly accurate thin-film circuits on a custom-built basis. Typical machine time for cutting, for instance, a pattern of resistors, is about one minute.

A feature is that all the scaled-up draughting processes normally associated with thin-film production are entirely eliminated. Furthermore, masters are stored at actual substrate size, thus drastically reducing storage space.

An important aspect of the use of punched tape is the possibility of tape preparation from a remote location—the digital information can be sent from one place to another over the Telex system.

Another significant feature of the process is that it opens up the possibility of feeding circuit design parameters straight into a computer which in turn will control the action of the micro-engraving machine.

The spark micro-engraving technique is the outcome of a research programme at STL and the micro-positioning co-ordinate table has been engineered by STC's Advanced Production Development Department at Chaseside, New Southgate, London.

The machine, itself, consists of the engraving head and a two axis numerically controlled table.

In order to meet the requirement that the table should be inexpensive, an open loop control system was chosen incorporating a stepping motor as the drive element and precision leadscrews as the reference lengths. One electrical input pulse to the motor drive circuit will cause the motor shaft to make one step of rotation (equivalent to 1.8°). This rotates the leadscrew and hence moves the table the distance of 0.0005in.

The electrical controls for the micro-engraving machine consist of solid state logic circuits, using silicon transistors, giving high reliability and long life. The logic modules are manufactured in STC's own modular construction, 'Ministac.' The control system consists of two registers, one containing the co-ordinate of the actual table position and the other containing the co-ordinate of the position to which the table must move. The motors and position register are pulsed until

the two registers contain identical co-ordinates. This indicates that the table has reached the required position.

The preparation of the tape programme for the micro-engraving machine consists of punching the co-ordinates of the various change points in relation to a suitable origin. The origin must be in the extreme position in each axis to which the table is required to move during the engraving process. This is necessary because the control unit cannot handle negative co-ordinates as would be necessary if the table were to be expected to move past the origin. The origin must also be an easily identified point on the substrate. This is necessary so that the engraving head can be set in relation to the substrate before engraving is commenced.

The table can move in both axes at once, resulting in a motion of 45° to the direction of the axes. Normally, however, the lines are required on the substrates parallel to one of the two axes. In this case only one motor would move at a time. The manual controls which are housed in a small control box enable the operator to move the table to any required position. This is necessary during the setting-up and aligning of the substrate prior to machining. Other controls are provided to set up the values of capacitance resistance and voltage for the two machining conditions. These are housed in a separate control box.

The operation consists of inserting the substrate into the holder on the table top and clamping it with the connexion clamps. These provide mechanical clamping as well as electrical contact for the sparking voltage. The table is moved manually to align the engraving head with the origin. The registers are then set to zero in this position by pressing the "Set-Zero" button. The programme can then be run as required under the tape command, the instructions being related to the origin which has been used for the setting-up purposes.

Automatic probes are provided which enable monitoring of a particular component to be done and the machine to adjust to a particular value automatically. The probes can also be used to give a return path for the engraving voltage, enabling the engraving to be carried out even to areas which are isolated from the connecting clamps. There are two probes on the machine, as this is usually sufficient for all requirements. Each probe has an electromagnet in its base which clamps it to the table top in the position required. The probes are parked above the substrate when not in use in a position very close to the engraving head. When a probe is required at a certain position on the substrate, the table moves the substrate so that the required probe is immediately above that position on the substrate. The probe is then lowered and clamped to the table top in this position. When the adjusting process is completed, the table is returned to the co-ordinate at which the probe was lowered and the probe is raised clear of the substrate. The instructions to raise and lower the probes are included on the programme tape, together with the co-ordinates at which they are to be put down and picked up. The measuring equipment is arranged to stop the adjusting when the correct value has been reached.

Swept Frequency Methods of Response Measurement

By J. F. Golding*

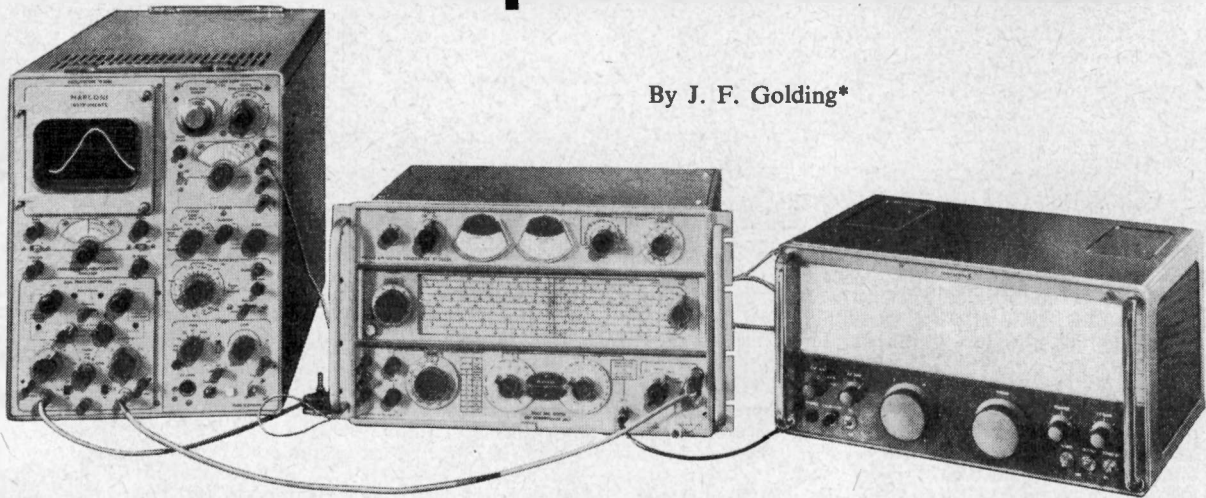

The technique of using a sweep generator and an oscilloscope for displaying frequency/response characteristics of active and passive networks is very well known. This article describes some of the commonly used methods and includes some suggested variations which could help to solve technical difficulties that arise with narrow band measurements.

(Voir page 417 pour le résumé en français: Zusammenfassung in deutscher Sprache auf Seite 424)

Wide Band Sweep Measurements

SO far as this article is concerned, the word response, as applied to a network, is the general term for the ratio between input and output levels; i.e., either gain or loss. Thus, the frequency response characteristic of an amplifier or attenuator is defined as the plot of response against frequency. While this piece of information may seem superfluous it is as well to start by defining terms in order to avoid any ambiguity that could otherwise come later. Also, throughout this article, a sweep generator is taken to mean an oscillator whose frequency is varied automatically in unison with a suitable deflexion voltage for a cathode-ray display.

The principles involved in using a sweep generator and an oscilloscope for displaying the frequency response characteristic are well known. Fig. 1 shows the basic arrangement. A sawtooth generator provides the horizontal deflexion voltage for a cathode-ray display system, and also a frequency sweeping voltage to a swept oscillator; i.e. an oscillator whose tuned circuit contains a voltage-sensitive reactive element. The instantaneous horizontal position of the spot on the c.r.t. screen then corresponds to the instantaneous frequency of the swept oscillator.

The output from this oscillator is applied to the network under test; and the output voltage from the network is rectified and fed to the Y input of the cathode-ray display system. The vertical position of the spot is then a direct function of the network's response at any instant; and as the oscillator frequency is swept through the network's passband the shape of the frequency response characteristic is traced out on the c.r.t. screen.

Incidentally, it is not at all necessary that a sawtooth sweep waveform should be used. A sinewave, or indeed any other shape, will do the job because the instantaneous frequency will still correspond to the instantaneous spot position, but the sawtooth is more usually used because it gives even brilliance over the display and it is normally readily available.

The basic arrangement shown in Fig. 1 is varied to suit particular applications, and later some of the refinements of the technique will be considered; but first the most common and probably one of the earliest general applications—that of wide band receiver alignment—will be dealt with.

ALIGNMENT OSCILLOSCOPE (WOBBULATORS)

The static method of alignment of a narrow-band radio receiver with not more than two i.f. stages is a comparatively simple procedure. A signal is applied at the centre

* Marconi Instruments Ltd.

frequency of the passband, and each stage is tuned in sequence for peak output. Providing the Q and the coupling factor of the tuned circuits are correct, the desired frequency response characteristic is obtained automatically. This can, of course, be checked by tuning the test signal progressively through the receiver's passband and plotting output against frequency.

With a wide band amplifier, such as the i.f. amplifier of a television receiver, the procedure is not quite so simple; for the bandwidth is normally obtained by the use of stagger tuning; i.e. successive i.f. stages are tuned to different frequencies.

Manufacturers of television receivers usually publish details of correct alignment procedure, giving the tuning frequency for each i.f. stage. If the instructions are followed, re-alignment of a receiver is not difficult but for the initial adjustment and for receivers where no approved procedure is available, the obtaining of a desired frequency response characteristic by static measurement can be very laborious. It becomes essential, therefore, to be able to display the characteristic and see the effect of each adjustment as it is made.

A sweep generator to cover these alignment requirements must be capable of frequency excursions of up to 8Mc/s about a centre frequency which is tunable to standard television i.f.'s. (The r.f. stages of television receivers are not normally very selective, and the overall frequency response characteristic is that of the i.f. amplifier.)

Sweep generators for this purpose fall into two classes. There are those which are self-contained, complete with c.r.t. display, and those which take the form of an accessory to an oscilloscope. The first of these is sometimes in the form of a special purpose oscilloscope with provision for limited general purpose use. In either case, however, the requirements of the display section of the system are those of a simple low-speed oscilloscope; and it is the frequency sweep device which warrants the main interest.

When built for this application such instruments are often known as wobblers.

The simplest way of producing the frequency sweep is by applying the sweep modulation directly to the variable oscillator. However, the frequency deviation is rather too large for the conventional types of electronic variable reactors used for frequency modulation. But it is essential that the sweep must be made at a fairly low speed in order to avoid 'ringing' in the amplifier's tuned circuits; and this circumstance rather invites the use of electro-mechanical methods.

In the earliest type of wobbulator an auxiliary tuning capacitor, connected in parallel with the oscillator's tuned circuit, was rotated by means of an electric motor. The law of this capacitor was such that the frequency change was linearly proportional to the angle of rotation. This provided the frequency sweep while the synchronized horizontal deflexion voltage was produced by means of a 360° potentiometer whose slider was also driven by the same motor. The potentiometer was connected across a d.c. voltage source so that a sawtooth voltage was obtained from the slider as it rotated. This system does not strictly conform to the diagram in Fig. 1, although the general principle still applies. It has the disadvantage that the frequency sweep is not variable, and in order to make the displayed characteristic line up with a horizontal scale on the c.r.t. graticule, the horizontal amplitude of the total display must be varied by means of the X amplifier gain.

A more flexible arrangement employs a different type of drive to the auxiliary capacitor. In this the fixed and moving plates of the capacitor are in the form of coaxial cylinders, the moving plates being driven in and out of mesh by means of a moving-coil unit similar to that used in a loudspeaker. The sawtooth voltage is applied to the moving coil via a suitable level control which serves to vary the frequency sweep as required. This system can be conveniently employed in a wobbulator accessory to an oscilloscope, where the sawtooth drive for the sweep generator can be derived from the oscilloscope's time-base.

Although this second electromechanical method is in use in several modern sweep generators, the more usual approach nowadays is that of using a purely electrical

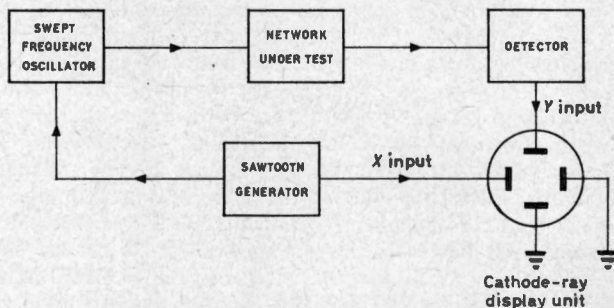

Fig. 1. Basic arrangements of sweep generator

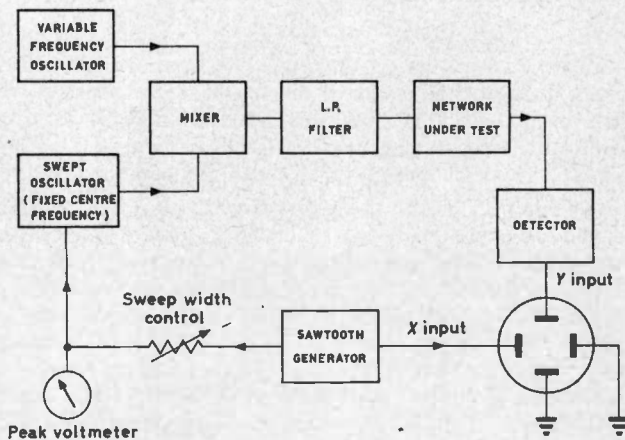

Fig. 2. Beat frequency sweep generator

voltage (or current) controlled reactor. The action of such devices is explained elsewhere, and, in this article only their effect will be considered. There are four main types, viz., the reactance valve or transistor, the variable capacitance diode, the ferrite modulator, and the voltage-sensitive capacitor. In comparison with the electromechanical systems all of these suffer from the disadvantage that the frequency deviation they produce is small in proportion to the oscillator frequency. Overall sweep width, of about a tenth of the centre frequency is the normal maximum, so that, for a sweep of 10Mc/s the oscillator would need to operate at about 100Mc/s centre frequency.

Sweep generators using electrical reactors are, therefore, usually of the beat frequency type utilizing an arrangement similar to that shown in Fig. 2.

The swept oscillator operates at a fixed centre frequency which is a good deal higher than the highest test frequency. Its output is mixed with that of a manually tuned variable frequency oscillator, and the difference frequency

is selected by means of a low-pass filter. The v.f.o. is, of course, tuned to give a difference frequency which sweeps through the passband of the amplifier under test.

The beat frequency system has several advantages over direct modulation of the variable oscillator. It obviously has a greatly extended tuning range, and can be used not only for examination of the i.f. characteristic but also for the display of the frequency response curve of the video amplifier. By tuning the v.f.o. to only slightly more than half the sweep width away from the swept oscillator's centre frequency, the difference frequency can be made to sweep from only a few cycles per second up to the full sweep-width frequency.

A second, and very important, advantage is that the sweep width remains constant as the tuning of the sweep generator is varied. This is not the case when the variable oscillator is swept directly for the following reasons. The sweep width as a percentage of the swept-oscillator centre frequency is roughly half the percentage change of reactance. So, if the voltage-controlled reactor has the same sign as the fixed tuning element of the variable oscillator, the sweep width will be a constant proportion of the centre frequency, varying directly as the oscillator is tuned. If, however, the voltage-controlled reactor has the same sign as the variable element of the tuned circuit the percentage sweep increases as the centre frequency increases, and it is very difficult to calibrate. With the beat frequency system no such difficulty arises because the swept-oscillator centre frequency remains constant.

SWEEP CALIBRATION

So far the means of making the spot on the c.r.t. screen trace out the shape of the frequency response curve have been considered; but this is of no help in making bandwidth measurements unless the horizontal axis of the display can be calibrated in terms of frequency.

The simplest way of doing this is suggested by the second advantage of beat frequency sweep generators. Assuming that the voltage controlled reactor is linear, the sawtooth modulating voltage could be monitored by means of a peak reading voltmeter calibrated directly in frequency as shown in Fig. 2. This meter would indicate the frequency width of the complete display-base-line, and the X sensitivity of the cathode-ray display unit could be adjusted to make the base line fit a linearly divided graticule.

Such a system would be easy to read and give a display very similar to a manually plotted curve on graph paper. The snag is that it would not be very accurate. It would rely, not only on the accuracy of the voltmeter but also on the linearity of the c.r.t. displaying system, and of the voltage controlled reactor. Errors can easily mount up to the order of 30 per cent on bandwidth measurement, with much larger errors over small parts of the characteristic. So obviously a more fundamental means is needed of measuring the frequency at any point on the displayed curve.

One method is by using the calibration of the variable oscillator itself.

The tuning dial is, of course, normally calibrated in terms of centre frequency of the swept output signal. If the action of the voltage controlled reactor is linear and symmetrical the centre frequency is reached when the spot is exactly at the middle of the trace; but even if there is some non-linearity the error will be fairly constant and will not affect the accuracy of the measurement. So the centre line of the graticule can be regarded as the point

on the trace corresponding to the reading of the sweep generator's tuning dial.

As the sweep generator's manual tuning is adjusted the displayed frequency response curve moves across the trace; and one has only to note the readings on the tuning dial at which the relevant points on the curve are coincident with the centre line in order to make the bandwidth measurements.

This method is direct and fundamental and does not rely on the linearity of any part of the system for its accuracy. Nevertheless, it is still not the most satisfactory way of making the measurement; there is unlikely to be sufficient reading discrimination on the tuning dial, and

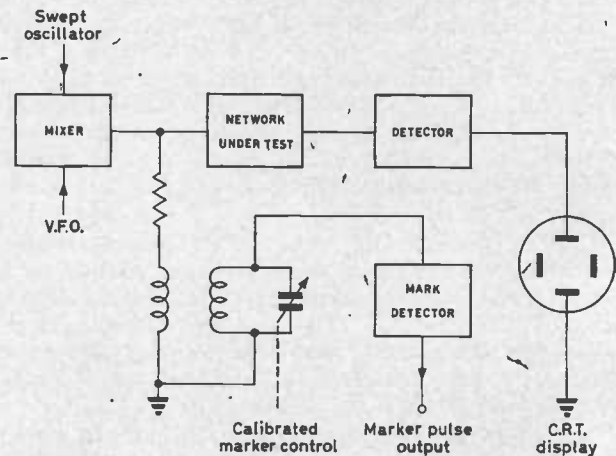

Fig. 3. Absorption type marker generator

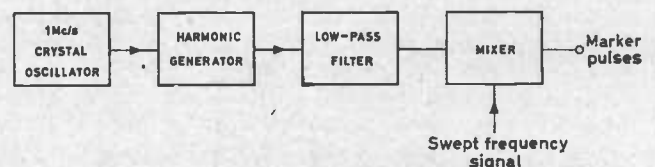

Fig. 4. Crystal controlled heterodyne marker generator

if the sweep generator is to be used while adjustments to the amplifier are being made, a standing calibration is needed that remains visible all the time. Furthermore, this slideback method cannot be used when the centre frequency of the amplifier's passband is less than the sweep width, as for display of the video amplifier characteristic.

FREQUENCY MARKERS

There are several methods of displaying frequency markers on the trace either in the form of sharp vertical 'pips' superimposed on the outline of the displayed characteristic, or as brilliance modulation marks. They are, however, all variations on one of two basic systems; viz., a narrow band absorption wavemeter or a heterodyne wavemeter.

The first of these is very suitable for the introduction of a single marker whose frequency can be set by means of a calibrated dial. Fig. 3 shows a variation of the beat frequency arrangement with the absorption wavemeter introduced. Before application to the network under test, part of the frequency-swept signal is loosely coupled to a high Q tuned circuit. As the signal sweeps through the resonance frequency of this circuit an r.f. pulse is produced. This is rectified and applied either to the Y deflexion system, to give a vertical 'pip', or to the grid or cathode of the c.r.t. to produce a bright or dark spot.

The position of the marker on the trace then corresponds to the resonance frequency of the tuned circuit as indicated by its calibrated control.

The heterodyne method is rather more useful because it enables a number of markers to be displayed simultaneously. Fig. 4 shows an arrangement for producing markers at 1Mc/s intervals originating from a crystal oscillator. The output from a 1Mc/s crystal controlled oscillator is fed to a harmonic generator to produce a spectrum of frequency components at integral multiples of 1Mc/s.

Part of the difference-frequency output from the sweep generator goes to a second mixer, which produces a beat note every time the swept-signal frequency coincides with a harmonic of 1Mc/s. This beat note is rectified to form a d.c. pulse, which is used for the production of either Y amplitude markers or brightness markers. In fact the heterodyne system produces double pulses whose separation depends upon the low frequency response of any network preceding the detector.

The overall width of this double-pulse marker is determined by the cut-off frequency of the low-pass filter interposed between the second mixer and the marker detector. As the swept-signal frequency is approaching a harmonic, the beat note produced is decreasing in frequency. When it falls to the cut-off frequency of the low-pass filter the leading edge of the marker pulse occurs. As the signal passes through zero beat, the output from the marker detector falls momentarily to zero, giving a division in the marker pulse. (If the frequency response characteristic of the marker circuit is sensibly flat down to d.c., this division may be so small as to be imperceptible.) Then, as the swept-signal frequency moves away from the harmonic, the beat frequency increases until it again reaches the filter cut-off where the trailing edge of the marker pulse is produced.

The arrangement described produces marker pips on an absolute scale at 1Mc/s intervals. This enables the operator to measure the bandwidth by adjusting the manual control to bring the displayed characteristic into a convenient position relative to the markers, which can be regarded as fine frequency indicators. Coarse indication of frequency can be obtained from the calibrated dial of the tuning control.

For very wide band measurement—such as frequency response characteristics of oscilloscope Y amplifiers—there is some advantage in making say every fifth marker distinguishable. This can be done very easily by using a separate 5Mc/s crystal oscillator also connected to the harmonic generator. A difference of only a few cycles per second in the coincident harmonics will produce secondary beats which make every fifth marker appear to wobble.

For ease of measurement there is some virtue in including both a heterodyne and an absorption type marker generator, so that precise fixed frequency intervals are indicated with additional provision for a roving marker for interpolation.

Elaborations and variations of these marker generators are used, such as a separate variable oscillator and mixer covering a restricted range to enable a heterodyne-marker comb to be moved independently of the displayed characteristic; but the general principle remains as described.

Narrower Bandwidths

Experience of setting up wide band tuned amplifiers

has shown the advantage of being able to view the frequency response characteristic while making adjustment. That the same philosophy can be applied to tuned amplifiers of medium bandwidth follows naturally. But here it is necessary to be careful about sweep speeds or some misleading displays are likely to be produced.

RINGING

The speed at which oscillation can be made to build up or decay in a resonant circuit is an inverse function of the circuit Q . If, therefore, the test signal is swept through the response band of the tuned circuit too quickly, the oscillation does not have time to build up to its full amplitude by the time the resonance frequency is reached; so the indicated peak response is lower than the true value. Then, as the swept signal frequency moves away from resonance, the voltage across the tuned circuit is unable to follow the shape of the frequency response curve, and at some point breaks away from it and continues to decay exponentially with time, giving the appearance of an asymmetric characteristic. This phenomena is known as ringing, and to avoid it the sweep time must be long compared with the time-constant of the tuned

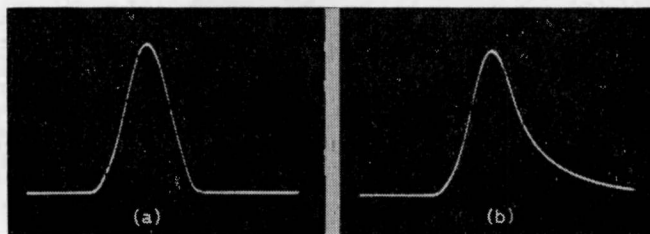

Fig. 5. Displayed response curves showing effect of ringing

circuit. Fig. 5 shows the effect of ringing on the displayed characteristic of a narrow band receiver. In Fig. 5(a) a sweep rate of about 10c/s gives a true outline of the characteristic; in Fig. 5(b) the sweep rate has been increased, producing deformation.

In practice an amplifier normally comprises several tuned circuits. If these all resonate at the same frequency the amplifier behaves much as though it contained a single tuned circuit of increased Q . If the amplifier's selective stages are stagger tuned to give a wide bandwidth some ringing of individual tuned circuits may not be too important unless they are the particular circuits that establish the shape of the skirts of the characteristic.

As a guide to permissible speed, it can be said that, to avoid significant deformation of the displayed response, the highest frequency component of the waveform comprising the displayed response, should be less than 1/100 of the amplifier's 3dB bandwidth. For the conventional in-line tuned amplifier, the shape of the displayed selectivity curve corresponds very roughly to a \sin^2 pulse. So, providing the displayed curve occupies most of the trace, the sweep rate should not exceed 1/200 of the amplifier's bandwidth; i.e., a 10kc/s bandwidth amplifier characteristic can be displayed with a 50c/s sawtooth.

However, if the shape of the selectivity curve is more sophisticated, approximating to a rectangular pulse, the maximum permissible sweep speed will naturally be much lower because this shape contains high order harmonics of the repetition frequency.

SWEPT-FREQUENCY SIGNAL GENERATORS

For measurements on receivers it is an advantage if the

sweep generator has the attributes of a standard signal generator; i.e. an output attenuator at the correct impedance giving a signal of accurately controllable amplitude down to the order of $1\mu\text{V}$.

Apart from television receivers, most receiver bandwidths are within the deviation range of an f.m. signal generator; v.h.f. and u.h.f. signal generators are available which can be frequency modulated to deviations upwards of 100kc/s. For example, a Marconi TF 995A/2M signal generator can be modulated at up to 200kc/s deviation at

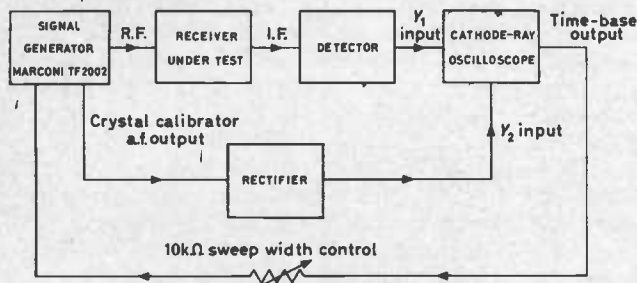

Fig. 6. Method of connecting an f.m. signal generator and oscilloscope for display of frequency/response characteristic

the standard broadcast i.f. of 10.7Mc/s. This is equivalent to a total sweep width of 400kc/s, which is more than adequate for the 240kc/s bandwidth of an f.m. broadcast receiver—one of the widest bandwidths in common use apart from television.

Fig. 6 shows the method of connecting a signal generator and oscilloscope to a receiver in order to display the i.f. or overall frequency response characteristic. The diagram shows an external detector in use; this is necessary for f.m. receivers and may be convenient for a.m. receivers in which the internal detector is not readily accessible. With many a.m. receivers, however, it is possible to make direct connexions to the internal detector so that an external one is unnecessary. But if this is done, care must be taken to be sure that any time-constants in the detector load do not modify the shape of the displayed curve.

For example, if the receiver is fitted with a signal strength meter the Y input to the oscilloscope can be connected in parallel with it. Although this makes connexions very easy, such meters are usually by-passed by a fairly large capacitor, which must either be disconnected or allowed for by keeping the sweep speed so slow that the time-constant of the capacitive detector-load does not modify the displayed characteristics.

This second course can only be taken if (1) the oscilloscope time-base operates at very low speeds—say 5c/s; (2) the external modulation circuit of the signal generator will accept such low frequencies, and (3) the Y amplifier is d.c. coupled. Condition (2) is the one that is usually unfulfilled, so that the operator has the choice of disconnecting the offending capacitor in the receiver or opening up his signal generator and making a d.c. connexion from the time-base output terminal of the oscilloscope to the frequency modulator.

It is not usually possible to display frequency markers when a signal generator is used in this way; but, fortunately f.m. signal generators are usually equipped with a directly calibrated incremental frequency control so that the width of the displayed characteristic can be measured by varying the tuning to bring relevant points on the curve to a central cursor line on the c.r.t. graticules.

F.M. signal generators do not normally operate at frequencies below about 1Mc/s; and, until recently, swept-frequency measurements on receivers in the m.f. and h.f. bands have been restricted to orthodox sweep generators.

The newest of the Marconi signal generators, however, has frequency sweep facilities at centre frequencies tunable from 100kc/s to 70Mc/s. This instrument, type TF 2002, can be frequency swept from an external source, with d.c. coupling to the voltage controlled reactor, so that very low sweep speeds can be used if necessary.

This particular signal generator is also equipped with a built in crystal calibrator giving calibration beats at 10kc/s intervals. When the signal is being frequency swept, the audio output from the crystal calibrator can be rectified and applied to the Y deflexion or Z modulation terminal of the oscilloscope to provide frequency markers. At the comparatively narrow sweep widths used, however, these markers have a very definite double-pulse form with the zero point between the two pulses corresponding to the 10kc/s interval mark. The photograph on page 374 shows this signal generator being used for frequency response curve display on a communicator receiver. Fig. 7 shows the connexions.

At these lower frequencies, receivers are used which have very narrow acceptance bands and crystal controlled local oscillators; e.g., single-sideband and independent-sideband receivers. When making protracted measurements on such receivers with a signal generator the problem of the generator's frequency stability can be quite serious. With a frequency swept signal generator this problem is greatly eased because, unlike the single frequency signal which gradually drifts out of tune, the swept signal is continually traversing the acceptance band and the only effect of a small amount of drift is a movement of the displayed characteristic curve across the oscilloscope trace.

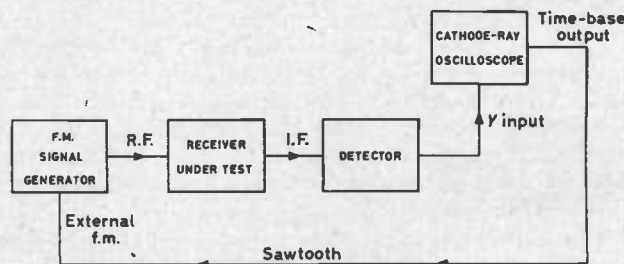

Fig. 7. Connexions for response curve display on communication receiver

Thus the attributes of the frequency swept signal generator can offer advantages for purposes other than actual frequency response measurement or circuit alignment.

F.M. DEMODULATOR RESPONSE

A somewhat specialized case arises in the setting up of f.m. receivers. Important as the shape of the frequency response characteristic is in this type of receiver, the main application of the swept frequency measurement is probably for examination of the demodulator characteristic. For this particular application the dynamic display of the characteristic can be made using an oscilloscope and a frequency modulated signal generator of the type that would normally be used for general tests on the receiver. The method of connecting the test set-up is given in Fig. 8.

It is important that the maximum frequency deviation of the f.m. signal generator shall be large enough to accommodate the whole of the demodulator's response.

For broadcast receivers, designed for 75kc/s maximum deviation 100kc/s deviation from the signal generator is usually sufficient.

In order to test the demodulator under realistic conditions, the test signal applied to it should be at the full limiter voltage and it should also be derived from the correct source impedance. To obtain these conditions, one can hardly do better than to use the i.f. amplifier of the receiver as the connecting network between the signal generator and the demodulator. So the output of the signal generator is fed into the input of the receiver's i.f. amplifier—or, indeed, into the aerial socket if this is more convenient.

However, care must be taken that the displayed demodulator characteristic is not modified by frequency response characteristic of the receiver's tuned amplifiers; and to do so the modulating frequency must be kept as low as conveniently possible, 50c/s being quite satisfactory in normal circumstances. The bandwidth of the receiver must be sufficient to accommodate the multiple f.m. sidebands at much higher modulation frequencies, so all significant sidebands at 50c/s spacing are easily handled.

This usually necessitates modulating the signal generator from an external source; and, in this case, a sine wave source is more convenient than a sawtooth. With sine wave modulation the signal generator's modulation meter indicates the frequency deviation, which is, of course, half the sweep width. The horizontal deflexion on the oscilloscope is obtained by also feeding the output of the modulating oscillator to the external time-base terminal of the oscilloscope, and the total length of the trace then corresponds to twice the f.m. deviation as indicated on the modulation meter. With comparatively restricted frequency sweep, errors due to non-linearity of the f.m. modulator are fairly small and the calibrated graticule of the oscilloscope can safely be used as a frequency scale.

The Y input of the oscilloscope is connected directly to the audio output terminal of the receiver's demodulator. The high input impedance of the oscilloscope is unlikely to affect the operation of the demodulator, so no special precautions are necessary from this point of view.

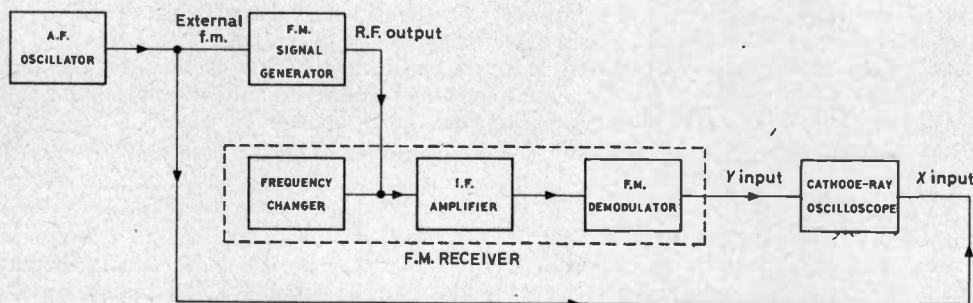

Fig. 8. Connexions for displaying response curve of f.m. demodulator using f.m. signal generator and oscilloscope

To adjust the demodulator, the signal generator is set accurately to the i.f. (or r.f.) centre frequency, and sufficient output is applied to operate the limiter of the receiver. The familiar 'S' shaped demodulator response will then be displayed on the c.r.t. screen; and the demodulator trimming controls can be adjusted to bring it to the centre of the display. If the receiver contains a ratio detector, the normal precautions of replacing the bias capacitor with a suitable voltage source must be taken

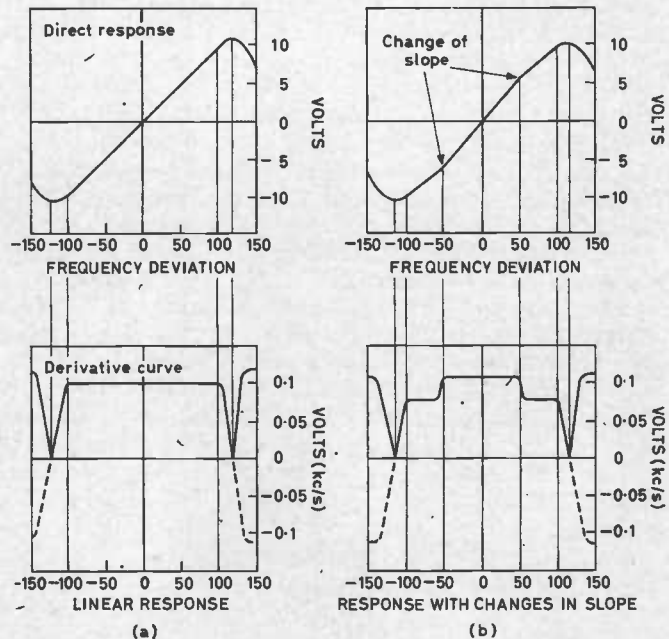

Fig. 9. Direct and derivative f.m. demodulation curves

in the same way as for static methods of measurement.

THE DERIVATIVE CURVE

Providing the f.m. signal generator is suitable it is possible to go a step further and produce a very much more useful display by the use of two superimposed modulating frequencies.

The point of interest is the linearity of the demodulator over the nominally linear part of its characteristic. For a really comprehensive assessment of this performance aspect, a display is required showing the demodulation linearity of the complete receiver circuit. The ideal display is, therefore, that of the derivative of the demodulation curve; or, in other words, a display in which the instantaneous vertical position of the spot is proportional to the instantaneous slope of the demodulation curve. With such a display there is far better discrimination than

with the direct picture of the 'S' shaped curve; for if the demodulator was perfectly linear, the display would take the form of a straight horizontal line, any deviation from this form representing non-linearity.

Fig. 9 shows samples of direct and derivative curves for linear and non-linear demodulation. Note that the vertical locus of the derivative curve falls to zero at the turnover point of the direct curve where the slope is zero.

The correct theoretical curve beyond these zero points

is shown by the dotted lines in the diagram, but, for reasons that will become obvious, the displayed derivative curve takes the shape of the full line in the diagram. However, as the only part of interest is that between the zero points, this does not matter very much.

The connexions for obtaining this display are shown in Fig. 10. A very slow sawtooth voltage (or very low frequency sine wave) is applied to the external modulation terminals of the signal generator and simultaneously to the X deflexion system of the oscilloscope. In the diagram the internal time-base generator is used. This is the actual sweep voltage and its amplitude should be such as to give a frequency sweep which completely accommodates the demodulator characteristic. Its frequency should be below the l.f. response of the receiver's audio amplifier.

Superimposed upon this voltage, by means of transformer T_1 , is an audio frequency voltage (say 1kc/s) of sufficient amplitude to give about 1 per cent of maximum rated deviation.

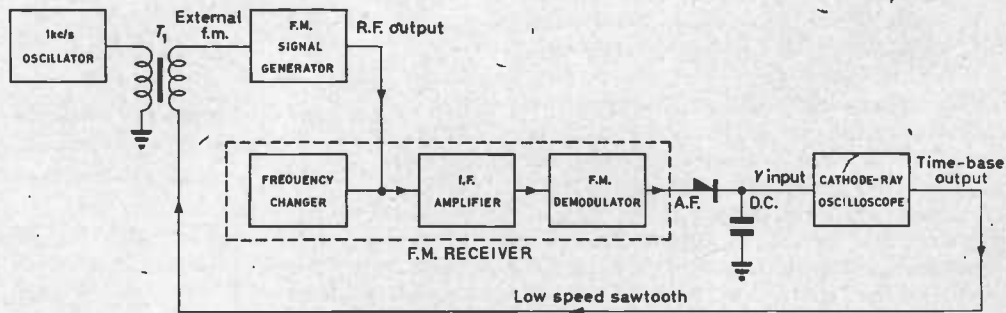

Fig. 11. Connexions for derivative display

The Y input terminal of the oscilloscope is connected via a rectifier to the a.f. output of the receiver, thus utilizing both the gain and the l.f. cut of the audio amplifier. Now the 1kc/s output from the receiver at any instant is directly proportional to the slope of the demodulation curve at the instantaneous input frequency, so that the spot traces out the derivative curve. Any non-linearity is easily detected by aligning the curve with one of the graticule lines on the oscilloscope. Furthermore, the relative magnitude of the non-linearity can be measured by comparing the amplitude of the departure from this line with the mean height of the display from the zero points.

Frequency calibration is best done by a slide back method against the signal generator's incremental frequency control.

RECEIVER SENSITIVITY

Returning to the aspect of using a swept signal to obviate difficulty due to frequency drift, consider as an example, sensitivity measurement of f.m. communication receivers. With this type of receiver, sensitivity is normally defined as the minimum input voltage necessary in order to produce an acceptable signal-to-noise ratio with 30 per cent of the maximum rated deviation.

A mobile communication receiver may have a bandwidth as narrow as 25kc/s at a tuning frequency of the order of 470Mc/s. With a 15kc/s maximum rated deviation, 30 per cent modulation is approximately 5kc/s, so that the signal generator only needs to drift about 6kc/s from the centre frequency before the outer significant sidebands fall outside the receiver's pass-band. This calls for a frequency stability of about 0.00125 per cent for the time to make the measurement.

A good quality valve-operated signal generator is likely to have a drift of 0.002 per cent per ten minutes after about 3 hours warm up, but it would be considerably worse than this when first switched on.

Now, if the sine wave deviation was to be increased (in the arrangement shown in Fig. 10) to 5kc/s, it would certainly distort the derivative curve; but, providing the frequency sweep was slow enough, the height of the curve at the centre frequency would be proportional to the in-tune output of the receiver. Then, if the output from the signal generator is reduced below the limiter level, the receiver noise would appear superimposed on the signal curve. The relative heights of the signal and the noise would be measured against the oscilloscope graticule and the signal generator output adjusted to produce the specified signal-to-noise ratio.

With the measurement made in this way, very much more frequency drift can be tolerated than for the conventional method.

A similar philosophy can be applied to sensitivity measurement of a.m. receivers. In the h.f. band, the only types of receiver with a narrow passband to warrant this type of treatment are single sideband receivers and c.w. telegraphy receivers. With such receivers the signal-to-noise ratio set up is similar to that in Fig. 6. It is essential, however, that the internal detector is used, giving an a.f. output from the c.w. input signal. This is rectified and applied to the Y input of the oscilloscope. For sensitivity measurements it does not matter if the shape of the displayed curve is modified by the frequency response characteristic of the a.f. amplifier; so the external rectifier can be connected between the a.f. output terminals and the Y input of the c.r.o.

The measurement procedure is similar to that for f.m.; i.e., the signal generator output is reduced until noise appears on the trace superimposed on the signal curve.

V.H.F. and u.h.f. d.s.b. a.m. receivers can be tested in a similar way providing the signal generator is of the type that can be amplitude modulated and frequency swept simultaneously.

This article is not intended as a treatise on this type of measurement, and the examples cited have been given a rather broad treatment to illustrate the possibilities of frequency sweep methods. The author is well aware of the fact that the noise level indicated would be that of peak voltage, whereas for normal measurement the signal power is compared with the total noise power in the passband, and it would, therefore, be necessary to correct for this discrepancy. In practice, rather more elaborate methods may be necessary, but the frequency swept signal can often provide a solution to the problem of signal generator drift.

Moderate Speed Data Logging Using Pulse Groups on Magnetic Tape

By J. G. Lang*, A.M.I.E. (Aust.)

A system of pulse frequency modulation recording on magnetic tape is described which is virtually independent of tape speed. Input channels are scanned at a rate of six per second and arranged serially on one track of the tape. This system finds particular application for moderate speed data recording at field sites remote from mains power.

(Voir page 417 pour le résumé en français: Zusammenfassung in deutscher Sprache auf Seite 424)

FOR the purpose of determining the strength and deformation properties of the soil on which a structure is to be built, 'undisturbed' samples of the soil are obtained for laboratory testing. Some of the sampling processes currently used cause considerable disturbance in the soil sample, and are thus inconsistent with the refined laboratory testing and design procedures which follow. Consequently, a research programme has been undertaken with the aim of improving the practice of 'undisturbed' soil sampling by determining the influence of various factors on the quality of the samples obtained.

This programme requires many sets of measurements of torque, thrust, rotational speed, rate of advance, and fluid pressure to be made in the rather adverse conditions of a small-sized drill rig working on a number of isolated outdoor sites. While a scanning rate of about five channels per second is necessary, it is desired that only the minimum of reliable simple recording equipment should be taken into the field. If necessary, this could be supported by more complex equipment in the laboratory to process

the primary field record and automatically produce the punched paper tape required for input to a digital computer.

This article describes those aspects of the system of data recording developed which are considered to be of more general application.

Outline of System

In the field, transducers convert the required physical quantities into voltage signals. These signals are amplified as necessary and converted to signals which are pulse frequency modulated (p.f.m.) within the audio spectrum, using circuits by DeSa and Molyneux¹ and Schwartz². Shaft rotational speed is obtained by electromagnetic pick-up from a finely toothed wheel.

These various transducer signals are then recorded on a tape recorder of quite modest specification by a system which is virtually independent of tape speed. This has two advantages: accidental variations of tape speed do not affect the accuracy of the results, and the tape can be deliberately replayed at a speed slower than that at which it was recorded, thus gaining a factor on real time. A factor of four has been found practical.

* Commonwealth Scientific and Industrial Research Organization, Australia.

Fig. 1. Timing sequence

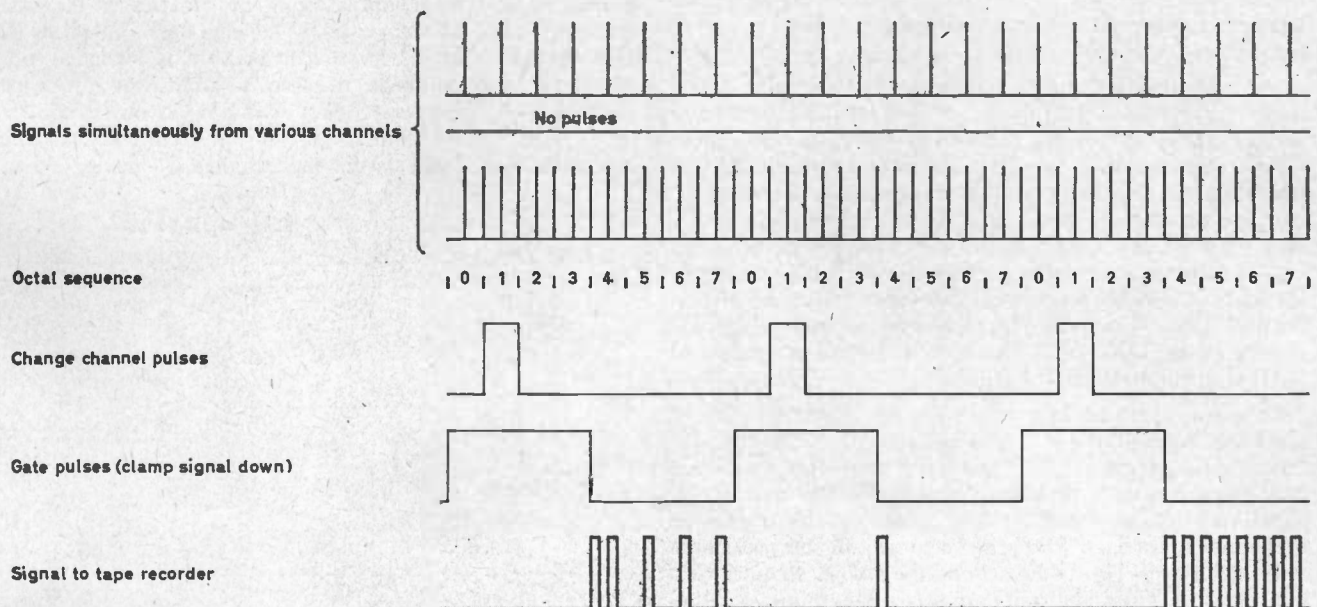

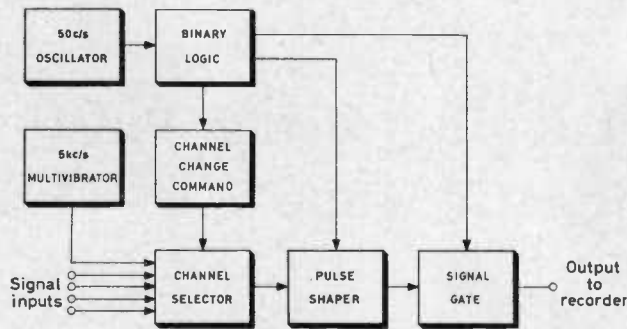

Fig. 2. Arrangement of control unit

Each of the p.f.m. transducer signals is continuously available to the control unit. By means of an electromagnetic rotary switch each of these signal channels is selected in turn. The signal from the selected channel is then gated for a fixed interval and the gated signal fed to the magnetic tape. In the interval during which the gate is closed, a change is made to the next channel. The

Description of Circuits

Fig. 2 shows the logical relations between the various circuits which make up the control system. The timing circuit comprising the oscillator and the binary logic are shown in Fig. 3. Basic timing is from a Wein bridge oscillator with fixed value, high stability components in the positive feedback loop. The circuit has been adapted from one previously described³. An oscillator frequency of 50c/s was chosen because while it was of about the required order, it was also convenient to check by comparison with the supply mains frequency. The frequency stability of the oscillator has been improved by using a voltage regulated supply. Square pulses are developed from the output of the oscillator by an overdriven amplifier and fed to the first of three cascaded binary dividers. To enable the oscillator to be warmed up, but without driving the electromechanical components, the connexion from the amplifier to the first binary is switched (S_{1a} , S_{2a}). The binary dividers together with most of the NOR logic circuits which follow them, have been adapted from the circuits of Flanagan and Molyneux⁴; such circuits being adequate for the speeds

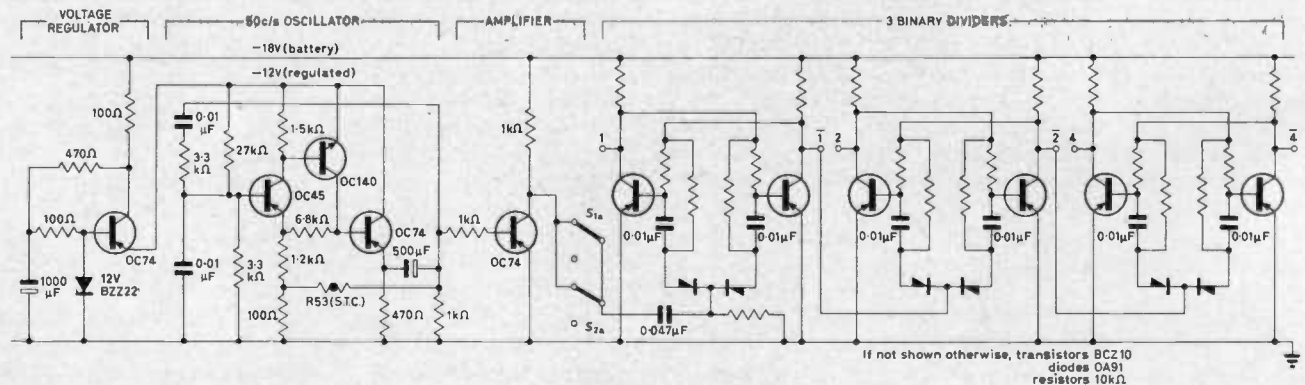

Fig. 3. Timing circuit

recording on the tape thus consists of a group of pulses followed by a gap of equal length with no signal, then a group of pulses from the next channel. Fig. 1 shows this timing sequence. The steps in the octal sequence are 20msec and thus the gating and gap intervals are each 80msec, giving one channel change every 160msec (6.25 per sec).

Once a group of pulses has been recorded, times, frequencies or speeds are no longer critical. The significant value is the count of the number of pulses in that group.

The gap between the groups is a compromise of efficiency for simplicity at two points. During recording, the gap allows time for a channel change by a relatively slow method (electromechanical) and sufficient time for all conditions to stabilize before the recording is made. Secondly, during processing of the tape in the laboratory, the gap allows time for a tape perforator to punch out the count on paper tape. This avoids the complications of providing buffer storage equipment.

In order that the channels may be identified on the recording, one of the channels is reserved for a synchronizing signal from a 5kc/s multivibrator. This frequency is higher than that produced by any of the transducers and thus produces a higher count which can be recognized each time it appears. The other channels in the cycle then fall into place. The counts from the 5kc/s channel also indicate any gross malfunctioning of the timing system.

of operation involved in this system. From the outputs of the three binaries any of the eight 20msec steps in an octal sequence can be developed.

Channel changing is achieved by the circuit shown in Fig. 4. The three inputs from the binaries to the first transistor are all zero only during octal interval 1. During this interval the first transistor is switched off, which in turn switches the second transistor on, thus energizing the reed relay, A. If switch S_{1b} is on, as shown, the 12V supply is connected, via the reed relay, to the rotary solenoid and a channel change is made. When

Fig. 4. Circuit for channel change command pulses

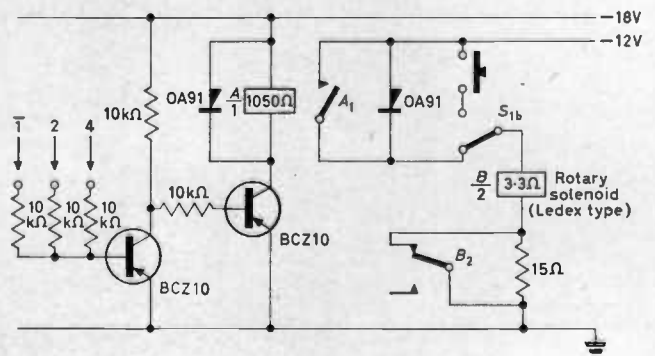

switch S_{1b} is off, the rotary solenoid can be advanced manually using the press-button. The second contact (B_2) fitted to the solenoid enables the current to be reduced after the rotor has advanced and thus reduces the current across the reed relay contacts when they in turn open.

To the first position on the channel selector, Fig. 5, is connected the 5kc/s multivibrator, while the other positions are occupied by the various transducer signals. The output from the channel selector goes to a monostable pulse shaper. This reduces all pulses to a constant shape, irrespective of from which transducer they initiated. A pulse width of $80\mu\text{sec}$ has been adopted, as it has been found that this takes best advantage of the tape recorder used. On replay, these pulses, although somewhat distorted, are still uniform in shape, irrespective of their pulse repetition frequencies, and hence are amenable to processing and counting.

figures of the accumulated count displayed on a digital counter. An audio output of the signal helped the operator to keep in time. Although time-consuming, this method of reduction has its applications when acquisition of more automatic equipment is not justified, but the advantages of the recording system are indicated.

The automatic equipment now used for laboratory processing of the primary tapes comprises a tape recorder (in replay mode), digital counter, timing control unit, punch encoder, and paper tape perforator. The magnetic tape is run at one-quarter of the recording speed. On the arrival of the first pulse of a group the counter gate opens and remains open for an interval which is 20msec longer than the nominal length of the group. This accommodates any variations in tape speeds, or between the timing systems. After the count is completed its value is punched on the paper tape as four binary coded decimal characters

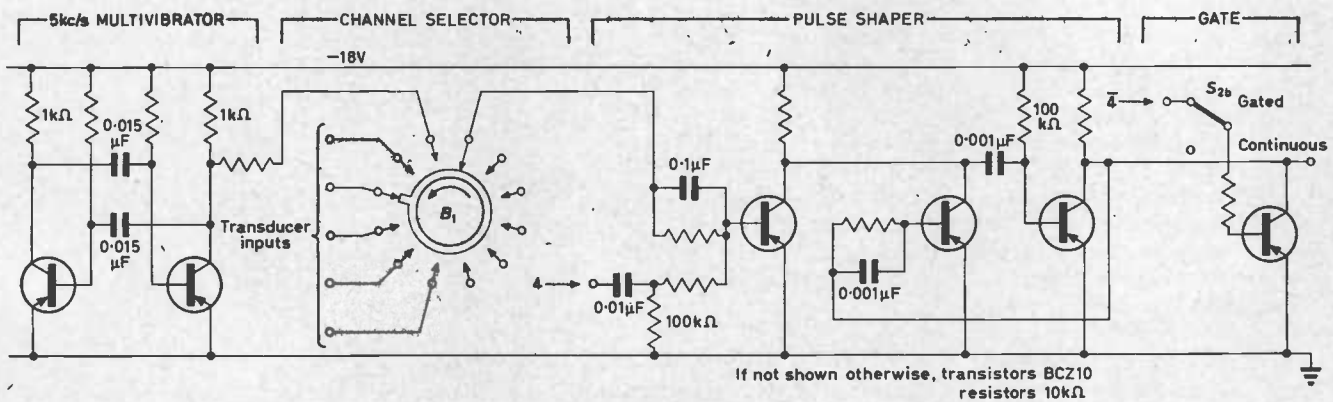

Fig. 5. Signal selection and gating circuit

It will be noted that the pulse shaper has a second input which is capacitively coupled from the third binary. The resulting spike as the gate opens causes a pulse to be recorded right at the beginning of every gated interval. During later processing of the tape this ensures correct synchronization with the gating intervals.

After pulse shaping the signals are gated. The gating circuit is formed by a NOR unit having a common load with the final transistor of the pulse shaper, thus isolating the gating and signal pulses. During intervals 0, 1, 2, 3 a gate closed signal is obtained from the third binary which clamps down the output, preventing the signal from passing to the recorder. During the other half of the gating cycle, in the absence of the gating pulse, the signal pulses can pass to the recorder.

Processing of Magnetic Tape

In the more convenient surroundings of the laboratory, the data tape recorded in the field is later replayed and the number of pulses in each group counted. Two methods have been used.

Initially, while the system was being developed, the procedure was to use two tape recorders to make successive transfers. The primary recording was replayed at one-quarter of the speed at which it was recorded, i.e. 1.875in/sec compared with 7.5in/sec . After reshaping the pulses, the output of this recorder was re-recorded on a second recorder running at 7.5in/sec . Thus a gain of four on real time was obtained by the transfer. After another transfer, the third tape was re-run at one thirty-second of the original speed. At this speed it was found possible to write down, during the gaps, the last three

followed by a fixed character which represents a space. Subsequently the paper tape is fed as data input to an electronic digital computer on which all sorting, checking and reduction of the data is done.

Conclusion

The recording system described has been found to adequately meet the requirements for which it was designed. It is considered to have further applications particularly for recordings in the field at sites remote from power mains.

Three further developments suggest themselves. Firstly, in a system using vibrating wire strain gauges, the gauges could be plucked by a pulse developed at interval 2. Secondly, in a remote unmanned site where power consumption is critical, the NOR logic could be extended to include the channel scanning. Finally, although in the present application the magnetic tape is run during processing at one-quarter of the speed at which it was recorded so as to expand on real time, it would be possible in other circumstances to reverse the speeds to obtain a compression of real time and thus save on processing and computing times.

REFERENCES

1. DE SA, O., MOLYNEUX, L. A Transistor Voltage-to-Frequency Converter. *Electronic Engng.* 34, 468 (1962).
2. SCHWARTZ, J. Unijunction Transistor Simplifies Voltage-to-Frequency Converter. *Electronics*, 36, 56 (25 Oct. 1963).
3. Mullard Reference Manual of Transistor Circuits. 2nd edition. (Mullard Ltd. 1961).
4. FLANAGAN, G., MOLYNEUX, L. A Low Speed Single Supply NOR Logic System. *Electronic Engng.* 36, 460 (1964).

A High-Efficiency Monostable Circuit using Complementary Transistors

By B. D. Rakovich*, Ph.D.

A monostable circuit using complementary transistors and suitable for the generation of rectangular pulses having very short rise- and fall-time is described. The circuit needs power only when triggered thus providing a useful economy in total power consumption when a low duty cycle is required. Another important feature of the circuit is that it provides a means of generating very short rectangular pulses of fairly good shape.

(Voir page 417 pour le résumé en français: Zusammenfassung in deutscher Sprache auf Seite 424)

IN many pulse applications it is often desirable to utilize circuits which economize the power supplied by energy sources. Although conventional collector-or emitter-coupled monostable multivibrators are very simple and reliable circuits for producing rectangular pulses, in some instances they perform this action with very poor efficiency which might be defined as the ratio of the signal energy delivered to the load to the total energy drain of the circuit during one complete cycle of operation. This is particularly true when rectangular pulses with small mark-to-space ratio are required, or when the circuit is triggered only infrequently. In conventional multivibrators one transistor is always conducting and therefore power is wasted for most of the period of input trigger if the duty cycle of the circuit is low.

For this reason, some other possibilities in designing transistor trigger circuits have been investigated in recent years, especially in connexion with the development of satellite electronic systems and computer circuits. It has been demonstrated that by using complementary transistors bistable and monostable trigger circuits can be built in which both transistors are either simultaneously in the 'on' or in the 'off' state. Some interesting papers have been published accounting for these developments¹⁻⁵.

A novel monostable circuit using complementary transistors and capable of producing rectangular pulses with very short rise- and fall-times is dealt with in the following sections. This circuit is derived from a bistable element, based on the original circuit of C. D. Florida⁶, by adding an appropriate timing network. When not triggered, all transistors are cut off and the circuit does not dissipate power, thus providing a useful economy in total power consumption when a low duty cycle is needed. However, owing to the small recharging time-constant of the timing capacitor, the circuit can also be designed with a higher mark-to-space ratio.

Another useful feature of the circuit described is that it can generate very short pulses. During the experiments rectangular pulses of 35nsec were produced, but there is no reason to believe that an even shorter duration could not be obtained.

Description of the Circuit

The circuit to be described is shown in Fig. 1. Transistors VT_1 and VT_2 form the basic monostable circuit and transistor VT_3 is in the output stage. In the absence of trigger pulses all transistors are cut off and the timing capacitor is charged to the supply voltage V_{cc1} . It is worth noting in passing that the biasing voltage V_{cc2} can be left out of the circuit and the resistor R_2 returned to the ground

potential. However, in that case the circuit tends to become free-running at temperatures above 50°C.

After a positive trigger pulse is applied to the collector of transistor VT_1 a regenerative process starts bringing both transistors to saturation in a very short time.

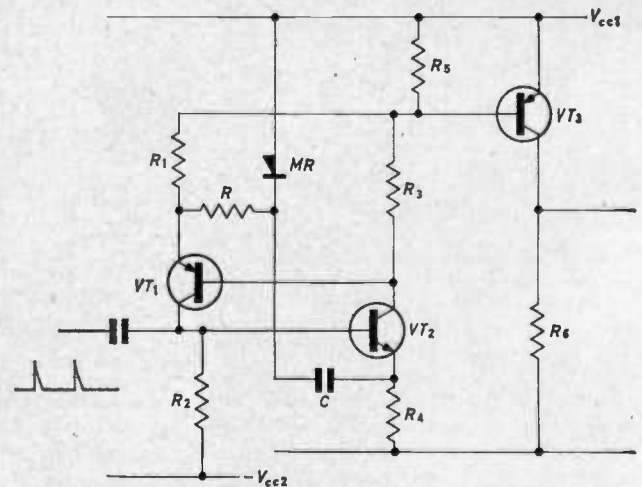

Fig. 1. The monostable circuit

Regeneration will take place if the loop gain of the circuit is greater than unity:

$$\beta_1\beta_2 \frac{R_2R_3}{(R_1 + R_{i2})(R_4 + R_{i1})} > 1 \dots\dots\dots (1)$$

where

$$R_{i1} \approx r_{b1} + (r_{e1} + R_1)(1 + \beta_1) \approx \beta_1 R_1$$

$$R_{i2} \approx r_{b2} + (r_{e2} + R_4)(1 + \beta_2) \approx \beta_2 R_4$$

are the input resistances of VT_1 and VT_2 .

Substituting these expressions in equation (1) and simplifying the result:

$$R_2R_3 > R_1R_4 \dots\dots\dots (2)$$

The foregoing result is derived on the assumption that the positive feedback through the timing network can be neglected during the regenerative action. However, it will be shown in the appendix that owing to the positive feedback through the timing network the circuit can be regenerative even if the inequality (2) is reversed. This second mode of operation is particularly suitable when the circuit is to produce rectangular pulses of very short duration.

After triggering, when the emitter of VT_2 has risen due to the positive voltage drop across R_4 , the cathode of MR will also rise since the voltage across the timing capacitor cannot change instantaneously. Therefore the diode is

* Faculty of Electrical Engineering, Belgrade, Yugoslavia.

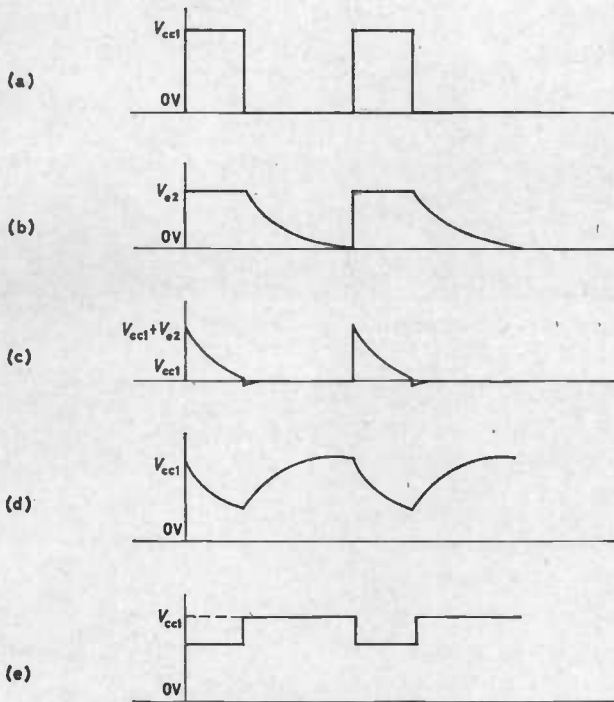

Fig. 2. Waveforms of the circuit

- (a) Collector VT_3
- (b) Emitter VT_2
- (c) Cathode MR
- (d) Capacitor C
- (e) Emitter VT_1

reverse biased and the timing capacitor starts to discharge through R and the rest of the circuit. The quasi-stable state will terminate soon after the discharging current has decreased to the value at which the base currents of VT_1 and VT_2 cannot keep them in saturation. At this moment the loop gain exceeds unity causing VT_1 and VT_2 to turn off by regeneration. The capacitor C recharges through MR and R_4 and the circuit is reverted to its initial condition. The waveshapes at different points of the circuit are shown in Fig. 2.

Calculation of the Pulse Width

The pulse width can be determined by calculating the time taken to desaturate VT_2 . Since the base current at which VT_2 comes out of saturation depends on transistor β , the pulse width will vary considerably with different samples of the transistors when the timing resistor has a relatively high value. However, this variation of the pulse width can be very much reduced if the circuit is designed such that, with β at its lower limit, the pulse terminates just when the diode MR starts conducting. This design technique also very much improves the temperature stability of the generated pulses.

When switching occurs after triggering, the voltage at the emitter of VT_2 will rise to approximately:

$$\Delta V = \frac{V_{oc1} - R_4(i_{b1s} + i_{b2s})}{1 + (R_3/R_4)} \dots \dots \dots (3)$$

where i_{b1s} and i_{b2s} are the base currents of VT_1 and VT_2 . Since the cathode of MR will rise for the same amount, the duration of the quasi-stable state can be calculated as:

$$T = \tau \log (V_{oc1}/\Delta V) \dots \dots \dots (4)$$

where $\tau = CR$ is the discharging time-constant of C .

The simplified model of the basic circuit shown in Fig. 3 can help to determine the value of R_1 which will

ensure the turn off process on the instant the potential across MR reaches zero. If i_{b1} and i_{b2} are base currents and v_{be2} base-to-emitter voltage of VT_2 at the end of the pulse, the following equation can be written:

$$R_2 i_1 - R_2(i_{b1} + i_{b2}) + R_2 i_N - V_{oc2} = R_4 i_2 + R_4(i_{b1} + i_{b2}) - R_4 i_N + v_{be2} \dots \dots \dots (5)$$

where i_N is the discharging current of the timing capacitor.

The currents i_1 and i_2 can readily be derived from Fig. 3 as:

$$i_1 = \frac{V_{oc}' + V_{oc2} - R_2 i_N + R_2(i_{b1} + i_{b2})}{R_1 + R_2} \dots \dots \dots (6)$$

$$i_2 = \frac{V_{oc}' + R_4 i_N - R_4(i_{b1} + i_{b2})}{R_3 + R_4} \dots \dots \dots (7)$$

where

$$V_{oc}' = V_{oc1} - R_5(i_1 + i_2 + i_{b3}) \approx V_{oc1}$$

Substituting equations (6) and (7) into (5) and taking into account that at the end of the pulse $i_N = V_{oc1}/R \exp(T/\tau)$ one obtains after some manipulation:

$$[(V_{oc1}/R) \exp(T/\tau) - i_{b1} - i_{b2}] \sum_{i < j < k} R_i R_j R_k = V_{oc1}(R_1 R_4 - R_2 R_3) + V_{oc2} R_1 (R_3 + R_4) + v_{be2} (R_1 + R_2)(R_3 + R_4) \dots \dots \dots (8)$$

where

$$\sum_{i < j < k} R_i R_j R_k = R_1 R_2 R_3 + R_1 R_2 R_4 + R_1 R_3 R_4 + R_2 R_3 R_4$$

Although the value of R_1 can be calculated from this equation when other circuit parameters are determined or chosen, it is much easier to find it experimentally particularly because base currents are not known accurately.

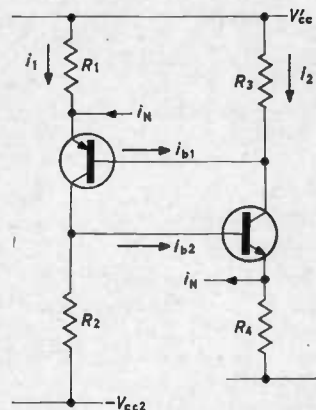
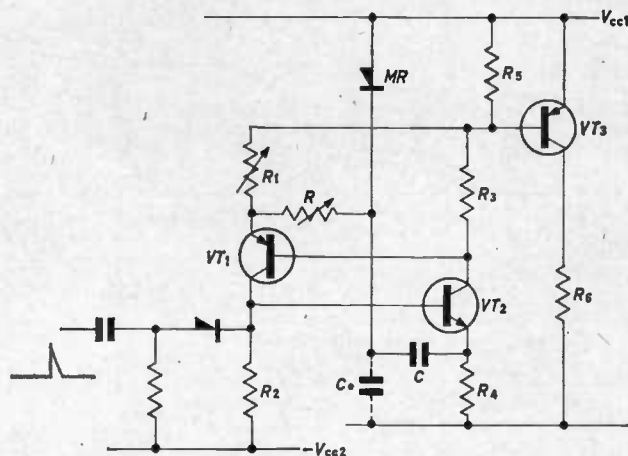

Fig. 3 (right). Circuit for computing the value of R_1

Fig. 4 (below). Experimental circuit



Practical Circuits

The circuit shown in Fig. 4 was used to carry out the experimental study. Two pnp transistors type OC47 were used for VT_1 and VT_3 and one npn transistor type OC140 for VT_2 . Other circuit parameters were as follows: $R_1 = 110\Omega$; $R_2 = 1k\Omega$; $R_3 = 150\Omega$; $R_4 = 1k\Omega$; $R_5 = 33\Omega$; $R_6 = 470\Omega$; $R = 1k\Omega$; $C = 0.47\mu F$; $V_{cc1} = 10V$; $V_{cc2} = -2V$. Pulse width: $1200\mu sec$.

The circuit was constructed and tested with various pairs of OC47 and OC140 transistors used for VT_1 and VT_2 . The measurements were made with the diode OA5 connected and removed from the circuit. It can be seen from Table 1, in which the results of measurements under various conditions are listed, that the stability of the pulse width is considerably improved by diode action. Also, smaller values of the timing resistor help to improve the stability of pulse width.

The sensitivity of pulse width to parameter changes was obtained experimentally by varying one parameter at a time while the others remain fixed. It was found that for $R = 1k\Omega$, a 10 per cent change in any one resistor produces an approximately equal percentage change in pulse width, while a 10 per cent change in supply voltage gives less than 5 per cent change in pulse width.

The variations of the pulse width with temperature were checked over the ambient temperature range of $25^\circ C$ to $65^\circ C$. The experiment was carried out with the timing network outside the oven. Increasing the temperature increases the pulse width due to the changes in I_{co} , the emitter-base voltage and β . The maximum changes of pulse width are inside the limit of 3 per cent if the timing resistor is not higher than $1k\Omega$. Again it was found that the action of the diode MR is essential in reducing the sensitivity of pulse width to temperature changes.

The output pulses, Fig. 5, exhibit short rise- and fall-times of less than $0.2\mu sec$. Rise-time can be shortened to $0.1\mu sec$ by adding a 1000 to $2000pF$ capacitor C_o from the cathode of MR to ground as shown by dashed lines in Fig. 4. This capacitor effectively by-passes R_4 during the regenerative drive thus increasing the loop gain of the circuit.

Since the major switching speed limitations for the circuit are the transistors α cut-off frequencies and collector-to-ground capacitances they can be further reduced by using transistors with α cut-off frequencies which greatly exceed those of OC140 and OC47. With two pnp transistors type BSX29 for VT_1 and VT_3 and one npn transistor type BSX28 for VT_2 rectangular pulses of $1000\mu sec$ width having rise- and fall-times of only $10nsec$ were produced (Fig. 6). Other circuit parameters were as

TABLE 1

TIMING CIRCUIT	CHANGE IN β_1 (per cent)	CHANGE IN β_2 (per cent)	CHANGE IN T WITHOUT MR (per cent)	CHANGE IN T WITH MR (per cent)
$R = 1k\Omega$ $C = 0.47\mu F$	+300	0	+5	+1
$R = 1k\Omega$ $C = 0.47\mu F$	0	+300	+5	+1
$R = 4.7k\Omega$ $C = 0.1\mu F$	+300	0	+25	+3.5
$R = 4.7k\Omega$ $C = 0.1\mu F$	0	+300	+25	+3.5

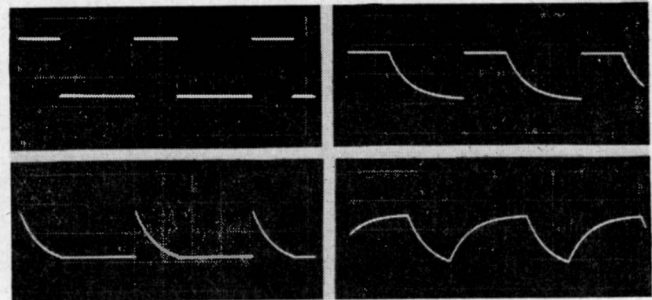

Fig. 5. Output waveforms of the circuit

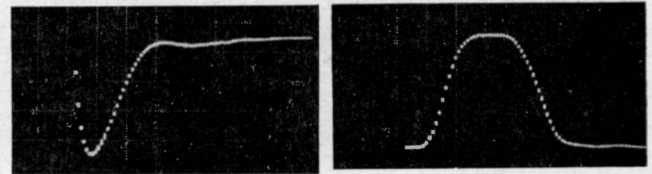

Fig. 6. Turn-on waveform of the $1000\mu sec$ pulse
Horizontal scale: $5nsec/div.$
Vertical scale: $2V/div.$

Fig. 7. The output pulse of $35nsec$
Horizontal scale: $10nsec/div.$
Vertical scale: $2V/div.$

follows: $R_1 = 47\Omega$, $R_2 = 150\Omega$, $R_3 = R_4 = 500\Omega$, $R_5 = 33\Omega$, $R = 1000\Omega$, $C = 0.47\mu F$, $C_o = 820pF$, $V_{cc1} = 8V$, $V_{cc2} = -2V$. Finally, a $35nsec$ output pulse of fairly good rectangular shape with a $10nsec$ rise-time and a $15nsec$ fall-time, which was obtained with $R_1 = 3.3k\Omega$, $R = 200\Omega$, $C = 200pF$ and all other parameters unchanged is shown in Fig. 7. The amplitude of the pulse is $8V$.

Conclusion

In conventional type monostable circuits with two transistors of the same type of conduction one transistor is always in the 'on' state irrespective of the triggering condition. This might be undesirable in those applications where minimum power dissipation is a prime objective and the circuit is designed to perform its action with a low duty cycle. By using complementary transistors, monostable circuits can be built which use power only when they operate thus minimizing the total power drain on the power supply.

In the monostable circuit described in this article three transistors are used in a complementary arrangement which turns itself off when not triggered. The circuit is capable of producing rectangular pulses with rise- and fall-times which depend almost entirely on transistor α cut-off frequencies. With very fast switching transistors rise- and fall-times in the $10nsec$ region can be obtained. This circuit also provides a suitable means of generating very short rectangular pulses of fairly good shape. Finally, due to the loose coupling of the output stage and low static and dynamic output impedances, the circuit can be loaded considerably without causing any noticeable change in the duration of the output pulse.

Acknowledgments

The author would like to acknowledge the help given by Mr. P. Vrbavac and Mr. B. Kovacevic in placing the facilities of the Institute 'Mihailo Pupin' at his disposal during the course of experimental work.

APPENDIX

CIRCUIT WITH SMALLER VALUE OF THE TIMING RESISTOR

If the timing resistor is not large when compared with R_1 in parallel with R_2 the positive feedback through the

timing network must be taken into account when establishing the necessary condition for the regenerative process. The circuit can conveniently be analysed on a negative-resistance basis.

A current-controlled negative resistance characteristic, shown in Fig. 8, has three regions: in the first and the third regions VT_1 and VT_2 are both non-conducting and saturated respectively so that only the active region (segment 2) should be examined. In order that the re-

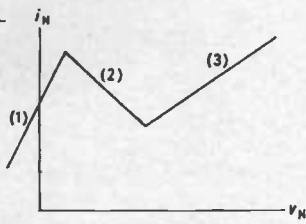

Fig. 8. Current-controlled negative resistance characteristic

generative process can take place a negative resistance must be seen from the timing capacitor terminals. When VT_1 and VT_2 are active the equivalent circuit takes the simplified form shown in Fig. 9. To determine the current i_N the following equations can be written:

$$V_{cc}' - R_1(i_{e1} - i_N) + Ri_N - v_N - R_4[(1 + \beta_2)i_{b2} - i_N] = 0 \quad (9)$$

$$R_1(i_{e1} - i_N) + r_{b1}(1 - \alpha_1)i_{e1} - R_3[\beta_2 i_{b2} - (1 - \alpha_1)i_{e1}] = 0 \quad (10)$$

$$r_{b2}i_{b2} + R_4[(1 + \beta_2)i_{b2} - i_N] - R_2(\alpha_1 i_{e1} - i_{b2}) + V_{cc2} = 0 \quad (11)$$

Eliminating i_{b1} and i_{e1} and simplifying the result by the following reasonable assumptions,

$$\beta_2 \gg 1; \alpha_1 = 1, \beta_2 R_4 \gg (R_2 + r_{b2}):$$

$$v_N = V_{cc}' + \frac{R_1(R_3 + R_4)}{R_1 R_4 - R_2 R_3} V_{cc2} - \left(\frac{\sum_{i < j < k} R_i R_j R_k}{R_1 R_4 - R_2 R_3} - R \right) i_N \quad (12)$$

where

$$\sum_{i < j < k} R_i R_j R_k = R_1 R_2 R_3 + R_1 R_2 R_4 + R_1 R_3 R_4 + R_2 R_3 R_4$$

Thus the following criteria for the negative resistance characteristic are obtained:

$$R_1 R_4 > R_2 R_3 \quad (13)$$

$$\frac{\sum_{i < j < k} R_i R_j R_k}{R_1 R_4 - R_2 R_3} > R \quad (14)$$

Obviously, the inequality (14) does not impose the limitation for the highest value of the timing resistor R for which the criterion (5) is still valid. The upper limit of R can be derived from the condition that after triggering VT_1 and VT_2 must be saturated. Therefore, one may proceed by writing the following expression for the simplified circuit of Fig. 3:

$$Ri_1 + v_{eb1} > Rj_3 \quad (15)$$

where v_{eb1} is emitter-to-base voltage of VT_1 required to just bottom the transistor.

The currents i_1 and i_2 are given by (Fig. 3):

$$i_1 = \frac{V_{cc}' + V_{cc2} - R_2 i_N + R_3(i_{b1} + i_{b2})}{R_1 + R_2} \quad (16)$$

$$i_2 = \frac{V_{cc}' + R_4 i_N - R_4(i_{b1} + i_{b2})}{R_3 + R_4} \quad (17)$$

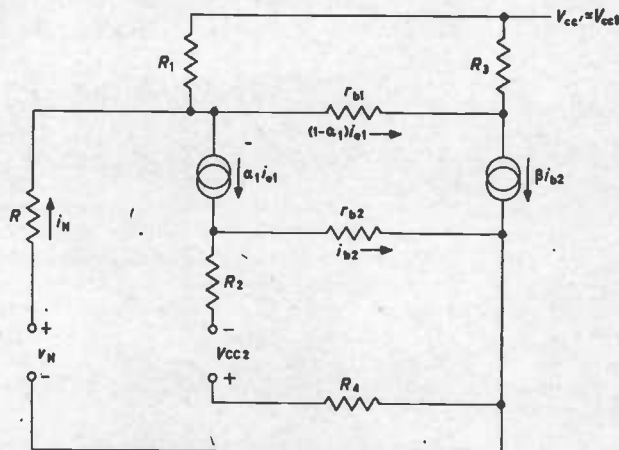

Fig. 9. Active-region equivalent circuit

Solving equations (15) to (17) and taking into account that the maximum value of $i_N \approx V_{cc1}/R$:

$$\left(\sum_{i < j < k} R_i R_j R_k \right) \frac{V_{cc1}}{R} > V_{cc}'(R_1 R_4 - R_2 R_3) + R_1(R_3 + R_4)V_{cc2} + \left(\sum_{i < j < k} R_i R_j R_k \right) (i_{b1} + i_{b2}) + v_{eb1} \quad (18)$$

REFERENCES

- MATTHEWS, R. E., HART, B. L. Transistor Flip-Flop Lamp Drive Unit. *Electronic Engng.* 35, 532 (1962).
- STEIGER, W. A Monostable Transistor Circuit for High-Ratio Frequency Division and Generation of Short Pulses. *Semiconductor Prod.* 4, 30 and 23 (August, September 1961).
- RAKOVIC, B. A PNP-NPN Transistor Multivibrator. *Publ. Electrotech. Fac. Beograd.* No. 40 (in Serbian).
- KLEINBERG, L. L. Monostable Circuits Need Power Only When They Work. *Electronics*, 37, 56 (24 August 1964).
- HEKEMIAN, N. C. PNP-NPN Circuits: New Look at a Familiar Connection. *Electronics*, 35, 42 (23 November 1962).
- FLORIDA, C. D. A New Bistable Element Suitable for Use in Digital Computers. *Electronic Engng.* 30, 71 and 148 (1958).

A New Letter-Sorting Machine

A new letter-sorting machine built by Thrissell Engineering, Bristol, in co-operation with the General Post Office Engineering Department, has been installed at the GPO Norwich Sorting Office and is at present undergoing trials.

Extensive use is made of sub-miniature photoelectric head units on the machine and a number of these have been supplied by Lancashire Dynamic Electronic Products (MI Group) of Rugeley, Staffordshire.

It will be possible, using these machines, to sort letters by county, town and area right down to the last stage of the postman's round.

The first operation in the sorting process is the stamping of each letter with a series of phosphorescent dots. This takes place in an encoding machine: the operator reads the address and prints the appropriate code by pressing a key on a keyboard similar to that of a typewriter.

The letters are transferred from the encoding machine to the sorting machine in batches and from this point the operation is entirely automatic.

An LDEP type OCP 71 sub-miniature photo-electric head first detects letters entering the machine. Then a system of belts takes each letter past another set of photo electric heads that pick up the information from the phosphorescent code dots which show up as bright blue after irradiation by ultraviolet light. The information gained is gated into the logic circuit of the machine by a further set of LDEP type OCP 1 photo-electric heads and stored until each letter, travelling between belts from the bottom towards the top of the machine on five levels, reaches the correct pigeon-hole.

The machine can handle approximately 7000 letters an hour and letters will go on filling each pigeon hole until, at a predetermined level, LDEP type FT 421 subminiature photo-electric head units set off a warning to the operator to empty the pigeon-hole; there are five sets of these heads, one on each level.

Tantalum Film Circuits

By P. L. Hawkes*

The applications of electronic techniques in telephone switching and transmission systems are increasing rapidly. The numerous digital and analogue circuit functions which are specified must be realized in an economical and reliable component form. One promising approach being studied uses 'hybrid' integrated circuits formed by assembling semiconductor devices on to thin film circuits. Tantalum and its compounds are preferred materials for the film R and C elements because a wide range of precise and stable element values can be obtained. The film processing steps are based on the chemical etching and anodic oxidation of sputtered tantalum layers deposited on to flat insulating substrates.

(Voir page 417 pour le résumé en français: Zusammenfassung in deutscher Sprache auf Seite 424)

At the recent symposium on the applications of microelectronics held at Southampton University, one of the papers¹ dealt with the design, physical realization and performance of audio frequency active RC filters using tantalum film circuit elements.

The electrical design of these inductorless filters was carried out at the Advanced Development Laboratories of the A.E.I. Telecommunications Group (Blackheath, London). The thin film circuit 'hardware' was made at the A.E.I. Harlow Research Laboratory. Research and engineering studies of the applicability of microelectronic techniques to components used in electronic telephone and telegraph systems have been under way at Harlow and Blackheath for some years. The expanding telecommunications industry is becoming a major user of solid-state devices and, although space and weight are not often at a premium, the potential reliability and low cost advantages of film and semiconductor integrated circuits are being evaluated for pulse and analogue circuit functions typical of those encountered in electronic transmission apparatus and telephone switching.

The special problems facing the integrated-circuit engineer in this industry include the need to obtain a specified performance characteristic coupled with long-term reliability at the lowest possible cost, and the need for compatibility with the rest of the system and with electro-mechanical devices and equipment. The operating frequencies and power levels cover wide ranges, and while standardized functional modules are required in large numbers, a high proportion of requirements are for 'tailor-made' circuits. A guaranteed source of supply over a period of years is also needed to permit system extensions.

In these circumstances the versatility and low tooling costs and time of 'hybrid' integrated circuits are of particular interest. Inter-connected film resistor and capacitor elements are deposited on a flat glass or ceramic substrate and pre-tested semiconductor devices are assembled on to the resulting thin film networks by soldering or welding.

The active filter circuits described at Southampton are of this type. Some (unpacked) examples are shown in Fig. 1. The fabrication technology adopted uses etched and anodized films of the refractory metal tantalum for both R and C elements in lumped form. Adherent tantalum films are conveniently deposited by cathode sputtering in a low pressure noble gas discharge. Layers in the thickness range 1 000 to 4 000 Å are suitable. The characteristics of tantalum-based film circuits have been examined in recent years by workers at the Bell Telephone Laboratories² and elsewhere. Especially important for audio-frequency applications is the high usable capacitance per unit area of the anodically formed tantalum oxide dielectric. This is typically³ 0.1 μF/cm² for tantalum pentoxide layers 2 000 Å thick. Moreover, the controllable nature of the anodizing step and the uniformity of oxide film thickness allows designs to be based on close (≈ 1 per cent) tolerances of capacitor ratios. Vacuum-deposited gold and gold/chromium films are used for capacitor top electrodes, interconnexions and solderable terminals.

Resistor network geometry is readily fixed by chemical etching of high resistivity sputtered tantalum films through

Fig. 1. Unpackaged examples of active filter circuits

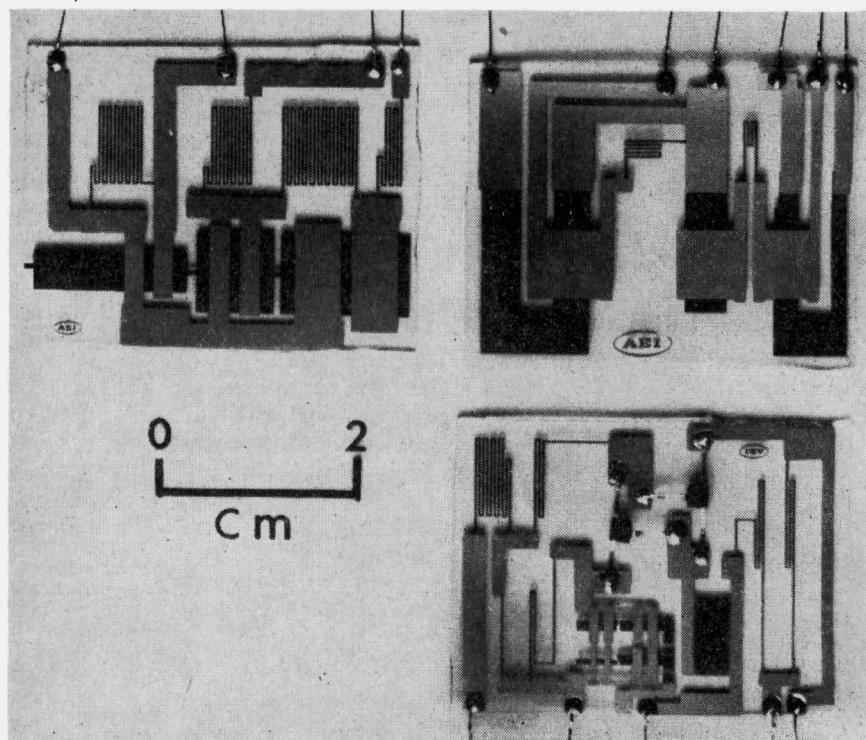

* Associated Electrical Industries Ltd.

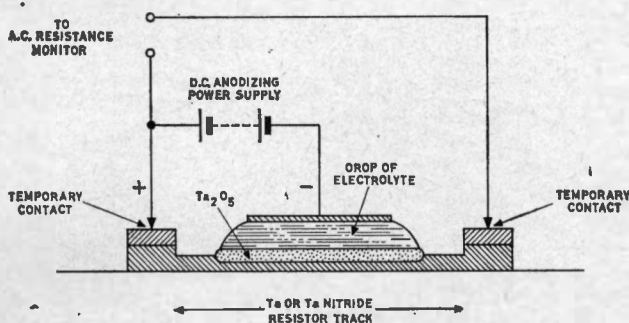

Fig. 2. Adjustment of resistor value by anodic oxidation

photo-resist or screened resist in-contact masks. This permits a wide range of high- and low-value resistors to be formed to reasonably close tolerances of absolute value and ratio from films having a surface resistivity of 50Ω per square with temperature coefficients of resistance of less than $\pm 50 \times 10^{-6}/^\circ\text{C}$. This feature is of particular value in circuit designs bearing both high- and low-value resistors since the temperature and time stabilities of all resistors on a single substrate will be similar.

Anodic oxidation of the surface layers of etched tantalum film resistors (Fig. 2) affords a method of continuously trimming resistors up to selected values and also further enhances the excellent corrosion resistance of tantalum films, thus reducing the complication and cost of circuit packaging. Since the oxide film covers the whole surface of the resistor at a constant thickness no hot-spots are introduced by this trimming method. The resistor trimming feature is useful in several ways. Using

electronic controllers, upward adjustment to within at least 0.1 per cent of the selected value is possible on individual resistors. 'In circuit' adjustment can be carried out and permits compensation of semiconductor or capacitor manufacturing tolerances by resistor adjustment, thereby improving overall circuit yield. For resistor arrays to wider (≈ 5 per cent) tolerances, such as are required in transistor logic networks⁴, individual resistor adjustment is not necessary, one resistor per substrate being monitored while all are anodized.

The above properties are obtainable on a range of electrically insulating substrates including glass, glazed ceramics and oxidized silicon. Depending on the substrate selected and the areas allotted to individual film resistors, power dissipation from tens of milliwatts upwards is attainable with excellent temperature and time stability².

Because of this unique combination of features, tantalum-based film circuits and components are likely to find numerous applications in the realization of future electronic telecommunications systems where they will complement the quite different characteristics of semiconductor devices such as silicon integrated circuits.

REFERENCES

1. DREW, A. J., TARBIN, F. G. A Tantalum Thin Film Active Filter. IEE/IERE Symposium on the Applications of Microelectronics, Southampton University, 21-23 Sept. 1965, IEE Conference Publication No. 14.
2. McLEAN, D. A., SCHWARTZ, N., TIDD, E. D. Tantalum Film Technology. *Proc. Inst. Elect. Electronic Engrs.* 52, 1450 (1964).
3. HAWKES, P. L., TARBIN, F. G. Some Characteristics of Tantalum Film Capacitors. Paper 16, IEE Conference on Components and Materials used in Electronic Engineering, London, Publication No. 12, 1965.
4. HAWKES, P. L. A Study of Tantalum Film Microcircuits for Telecommunications Equipment. IEE/IERE Symposium on Microminaturisation, University of Edinburgh, April 1964.

Measurement by Short Range Telemetry

A system of short-range telemetry has been developed by EMI Electronics Ltd to assist design and research engineers to obtain data from moving parts where normal forms of connexion cannot be made.

In the example illustrated the system is being used to measure strain in a shaft while a varying load is applied, and to measure the temperature of the rotating part of the loading brake. A thermistor is used as the temperature sensor and a $1k\Omega$ strain gauge bridge is used for strain measurement.

The system is based on frequency-modulated sub-carriers which in turn frequency modulate the transmitter carriers. The following modular units are used for the transmitter: A carrier oscillator working in the 27.12Mc/s band, two subcarrier oscillators working in the 22kc/s and 30kc/s IRIG channel frequency bands, and a power transfer module working in the 80kc/s band. These modules are affixed to the rotating shaft. The receiver modules consist of a carrier discriminator, two sub-carrier demodulators, power supplies and a power transfer generator.

The measurement accuracy is

better than 3 per cent of full-scale on both channels. The transmitting equipment will operate in environments between -10° to $+60^\circ\text{C}$, and up to 100 per cent relative humidity, withstanding accelerations of up to 3000g. The receiving equipment is designed for 0°C to 40°C ambient temperature range and up to 65 per cent relative humidity.

Strain and temperature measurement by telemetry

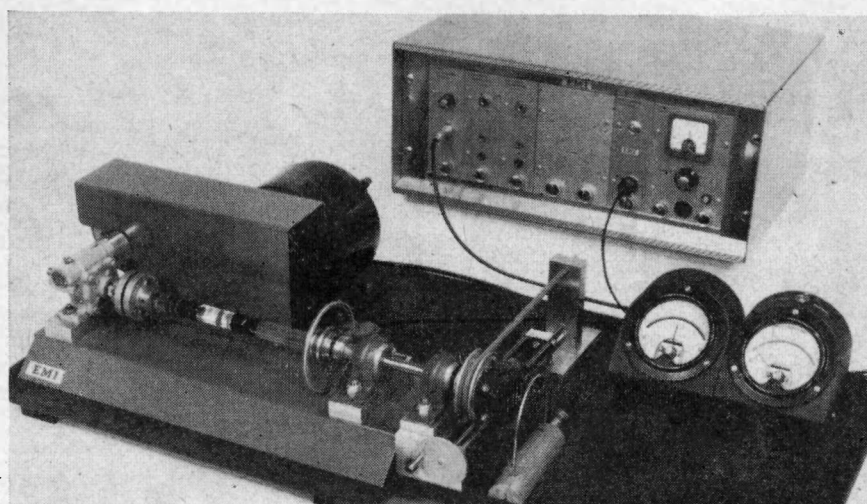

A Low-Noise, High-Input Impedance Transistorized Pre-amplifier

By A. Szerlip*

This article describes a transistorized pre-amplifier which was primarily designed to be used in conjunction with a capacitor microphone. The pre-amplifier has an excellent low-noise performance over the range from 5 to 70kc/s. The advantage of this pre-amplifier is its high-input impedance which allows direct coupling to the capacitor microphone. Because of the direct coupling the sensitivity to variation in microphone bias voltage is sharply reduced in this pre-amplifier and a much greater bandwidth is obtained.

Design considerations for the input stage are discussed. A method for calculating the noise factor of the pre-amplifier is also given.

(Voir page 417 pour le résumé en français: Zusammenfassung in deutscher Sprache auf Seite 424)

FOR an experimental air sonar system the receiving transducer array will consist of capacitor microphones, followed by transistorized pre-amplifiers. This article describes the design of these amplifiers, which were required to have a low-noise figure and a high-input impedance to avoid the necessity for inductive tuning.

It is possible to achieve low-noise amplifier operation, using the new transistors, with noise matching condition greater than 100kΩ. This performance makes the amplifier

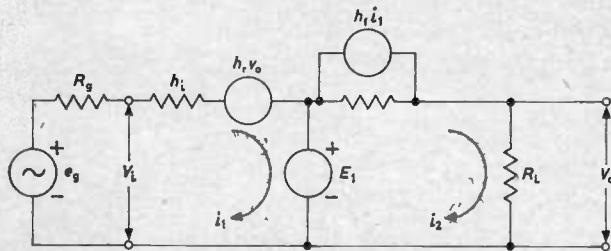

Fig. 1. Common-collector (with collector feedback) h parameter equivalent circuit

ideal for use with capacitor microphones or other high impedance transducers.

Input Stage

The amplifier consists of a high-input impedance stage followed by two stages giving a voltage gain of ten. The input stage is connected in common-collector configuration. In order to increase the input impedance of this stage, negative feedback is applied. The hybrid equivalent circuit of this stage is shown in Fig. 1.

When no feedback is applied to the transistor the input resistance (R_i) is:

$$R_i = \frac{h_i(1 + R_L h_o) - h_r h_i R_L}{(1 + R_L h_o)} \dots \dots \dots (1)$$

When the feedback voltage E_1 is applied the input resistance becomes:

$$R_i = \frac{h_i(1 + R_L h_o) - h_r h_i R_L}{(1 - E_1/v_i)(1 + R_L h_o) - (E_1/v_i) h_r R_L h_o} \dots \dots \dots (2)$$

It will be noted that the numerators of equations (1) and (2) are identical, but the denominator in equation (2) is controlled by the ratio of the feedback to input voltages. As the ratio E_1/v_i approaches unity the input resistance becomes larger and larger until it finally becomes negative.

Once the input resistance is in the negative region any further increase in the value of E_1/v_i will result in the input becoming a smaller negative quantity.

This condition exists in the actual amplifier. Here the

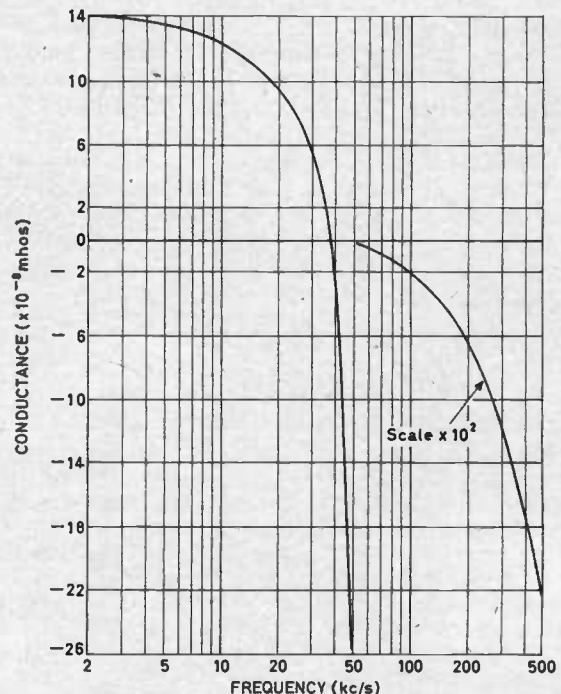

Fig. 2. Amplifier input conductance

ratio of E_1/v_i is a function of the frequency. The resulting input conductance against frequency relationship is shown in Fig. 2. The input reactance is capacitive and also varies with frequency. The input capacitance is about 4pF at a frequency of 100kc/s and then steadily increases with higher frequency. A plot of the resulting input impedance against frequency is shown in Fig. 3.

Noise

The amplifier noise figure, for noise-matched condition, is given in Fig. 4. Also shown on this graph is the required matching impedance for obtaining minimum noise figure. Any deviation from this curve will result in higher noise figures. The noise-matched impedance is obtained as follows:

$$R_i = e_n/i_n \dots \dots \dots (3)$$

* University of Birmingham.

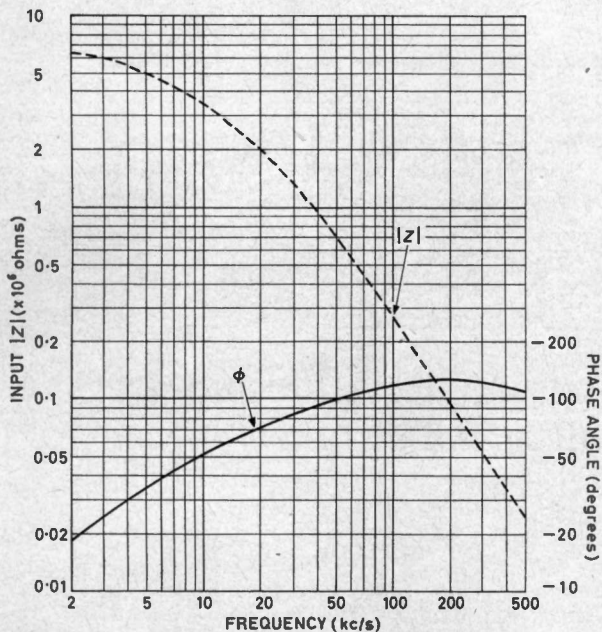

Fig. 3. Amplifier input impedance

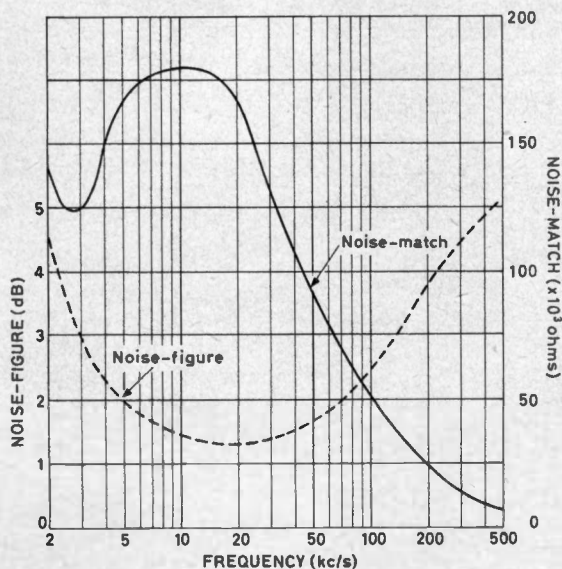

Fig. 4. Noise-figure and noise-match

where R_1 is the input matched condition

e_n is the equivalent noise voltage at the input of the amplifier when this input is short-circuited.

i_n is the equivalent noise current at the input of an amplifier when this input is open-circuited.

It is usual for an amplifier to have one value for the noise-matched condition and a different value for the power-matched case. In this particular amplifier both power-match and noise-match impedances are the same around the frequency of 50kc/s. Below this frequency the power-match impedance is much larger than the noise-match impedance, e.g. at 10kc/s the power-match is 5.6M Ω , while the noise-match is 168k Ω . Above 50kc/s the noise-match impedance is larger than the power-match impedance, e.g. at 300kc/s the noise-match is 18.7k Ω , while the power-match is 5.95k Ω . The formula for calculating the noise factor for different matching conditions is

given below.

$$F = 1 + \frac{1}{4KTf} (i_n^2 R_s + (e_n^2 / R_s) + 2\gamma e_n i_n) \dots (4)$$

where γ is the correlation coefficient between e_n and i_n . The correlation coefficient γ lies between 0 and 1 and is usually very close to 1. Thus for calculations let:

$$\gamma = 1 \dots (5)$$

A plot of e_n and i_n in decibels reference to $1V/(c/s)^{1/2}$ and $1A/(c/s)^{1/2}$ respectively is given in Fig. 5.

The actual circuit for the amplifier is given in Fig. 6. Since no voltage gain is obtained from the first stage the noise figure of the second stage becomes important. For this reason the first two transistors were chosen to be low-noise devices. Two types of low-noise transistors were tried in these stages with reasonably satisfactory results. They were Fairchild BFY 77 and General Electric (U.S.A.) 2N3391A. All the measurements in this article were carried out using 2N3391A transistors. Due to the fact that the gain of the second stage is large the noise figure of the last transistor becomes negligible and adds very little to the overall noise figure.

Performance

The amplifier has an overall dynamic range of 80dB before the distortion becomes significant. The maximum input signal voltage at this distortion level is 5mV. The overall voltage gain of the amplifier is 10. Using a signal generator with 1k Ω internal resistance the output is flat to within 1/2dB from 200c/s to 4Mc/s. The 6dB points are at 33c/s and 5.5Mc/s. The output can be loaded with 1k Ω in parallel with 5 000pF without significantly affecting the output signal.

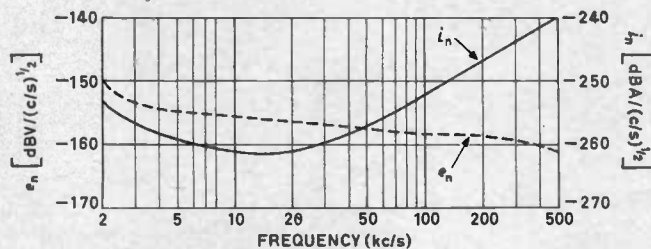
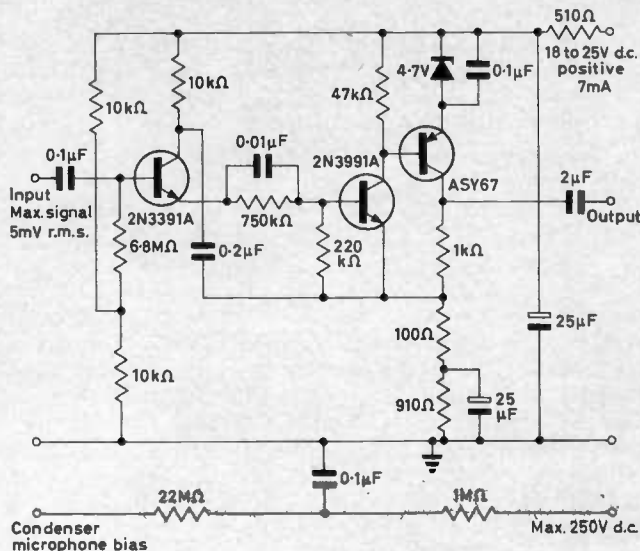

Fig. 5. Equivalent noise voltage and current

Fig. 6. Low-noise, high-input impedance pre-amplifier



The amplifier was designed to provide low-noise performance, a high-input impedance while relatively low cost is maintained. Recent advances in the semiconductor field make low-noise, high-input impedance amplifiers possible with field-effect transistors. Unfortunately, at present these devices are rather expensive and it will probably take some time before they will approach the cost of the 2N3391A transistor. An available commercial pre-amplifier (type 1560-P40) using field-effect transistors has been designed by General Radio Co. Its low noise performance (less than 2dB) is in the frequency range of

200c/s to 10kc/s. Below and above this range the noise figure increases rapidly. Its noise-matched input impedance over these frequencies is in the order of 100kΩ.

BIBLIOGRAPHY

1. SANDERSON, A. E., FULKS, R. G. A Simplified Noise Theory and its Application to the Design of Low-Noise Amplifiers. *I.R.E. Trans. Audio, AU-9*, 106 (July-Aug. 1961).
2. A New Low-Noise Preamplifier. *General Radio Experimenter*, 39, No. 6 (June 1965).
3. Very High Input Impedance Amplifiers. Texas Instruments Ltd. Application Note No. 6.
4. SMITH, D. A., LEWIS, T. M. A. A Buffer Stage for Piezo-Electric Strain Gauges. *Electronic Engng.* 34, 99 (1962).
5. BLASEN, L. The Design of Low Noise, High Input Impedance Amplifier. Fairchild Semiconductor. Application Report AP-14.

Circle Diagrams for Representing the Relationship Between the Noise Factor and Source Admittance of a Linear Two Port

By R. Bridgen*

The contours of constant noise factor in the source admittance plane of a linear two port consist of a set of circles. A unique set of circles can be obtained by suitable normalization of the noise factor and source admittance in terms of four parameters which define the noise properties of the two port device.

Some of the properties of the relationship between noise factor and source admittance are discussed, while finally the significance of the noise defining parameters are considered in terms of a two generator equivalent circuit used to represent the noise.

(Voir page 417 pour le résumé en français: Zusammenfassung in deutscher Sprache auf Seite 424)

WHEN considering the noise performance of transistors or other active two port devices used in the high frequency stages of a receiver, an important con-

admittance plane consists of a system of circles. In addition some of the properties of the relationship between noise factor and source admittance are discussed, while finally

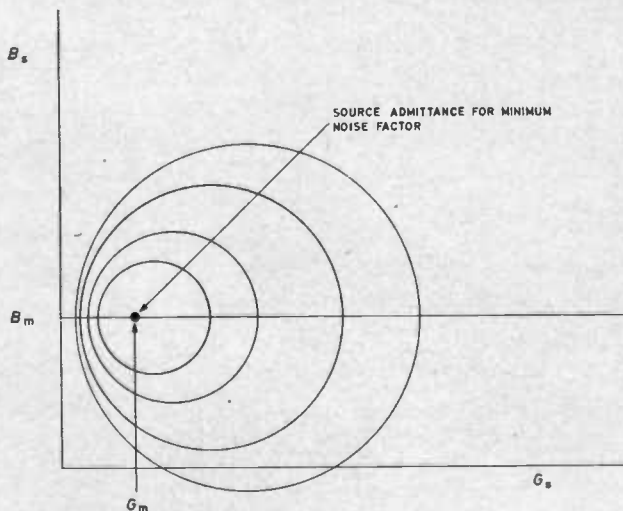

The circles are defined by:

$$\text{Co-ordinates of centre} = \left(G_m + \frac{F - F_m}{2R_n}, B_m \right)$$

$$\text{Radius} = \frac{F - F_m}{2R_n} \sqrt{\left(1 + \frac{4R_n G_m}{F - F_m} \right)}$$

Fig. 1. Contours of constant noise factor

sideration is the way in which the transistors' noise factor varies with the source admittance. This relationship is defined by a unique equation in terms of the source admittance and four noise defining parameters of the two port device.

The main purpose of this article is to draw attention to this equation and to the fact that this equation shows that the contours of constant noise factor in the source

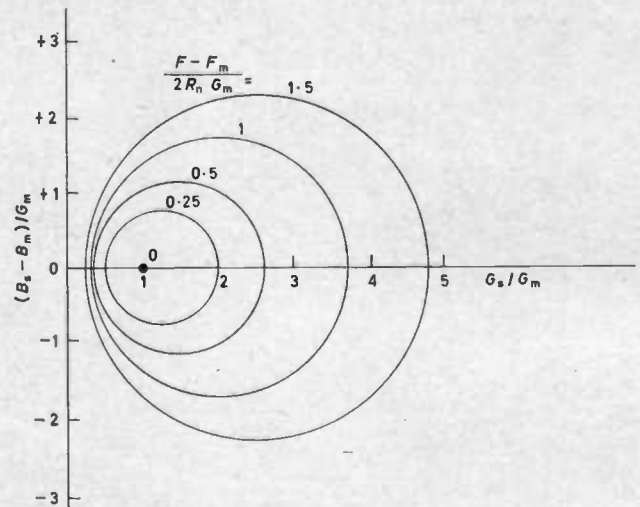

The circles are defined by:

$$\text{Co-ordinates of centre} = \left(1 + \frac{F - F_m}{2R_n G_m}, 0 \right)$$

$$\text{Radius} = \frac{F - F_m}{2R_n G_m} \sqrt{\left(1 + \frac{4R_n G_m}{F - F_m} \right)}$$

Fig. 2. Normalized contours of constant noise factor

the significance of the noise defining parameters is considered in terms of a two generator equivalent circuit used to represent the noise.

The complex consideration of the relationship between the noise-defining parameters and the equivalent circuit of transistors or other active two port devices is not considered.

Variation of Noise Factor with Source Admittance

It has been shown in the literature¹ that the noise per-

* Mullard Ltd.

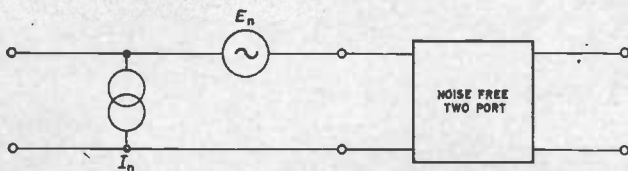

Fig. 3. Representation of noise in a two port by external current and voltage generators
 Note: The power delivered by these two generators cannot, in general, be added arithmetically

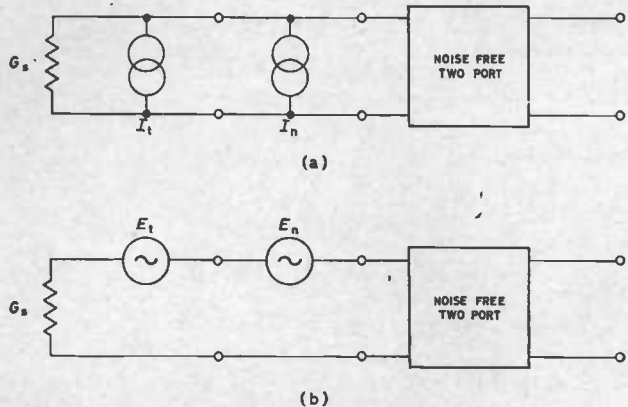

Fig. 4. Approximate representation of noise in a two port when the source admittance is real and (a) very small, or (b) very large

formance of a linear two port can be defined by four parameters: One such set of parameters is the following:

$Y_m = G_m + jB_m$ = Source admittance for minimum noise factor.

F_m = The minimum noise factor.

R_n = A noise-defining parameter with units of resistance.

It has further been shown that the variation of noise factor with source admittance is given by the equation:

$$F = F_m + R_n/G_s |Y_s - Y_m|^2 \dots (1)$$

where F = The noise factor with source admittance Y_s .

$Y_s = G_s + jB_s$ = The source admittance.

This equation shows that the contours of constant noise factor in the source admittance plane are a system of circles as shown in Fig. 1. These curves can be normalized to give a unique set of curves showing the dependance of noise factor on source admittance by expressing the source admittance and noise factor in the form:

$G_s/G_m + j(B_s - B_m)/G_m$ = Normalized source admittance.

$(F - F_m)/2R_n G_m$ = Normalized noise factor.

The normalized curves showing the dependance of noise factor on source admittance are shown in Fig. 2.

THE EFFECT OF SEPARATELY VARYING THE SOURCE SUSCEPTANCE AND CONDUCTANCE ON THE NOISE FACTOR

Examination of the normalized noise factor contours (Fig. 2) shows that when the source susceptance only is varied, the noise factor always passes through a minimum at the same value of the source susceptance regardless of the value of the source conductance, while in addition the noise factor varies symmetrically about the optimum susceptance value.

On the other hand, when only the source conductance is varied, the minimum noise factor for a particular value of source susceptance occurs at the admittance where the horizontal line representing the source susceptance is tangential to the noise factor contours. It will be seen that the value of this optimum conductance does depend upon

the value of the source susceptance. An interesting property of this conductance is that it is the geometric mean of any pair of smaller and larger conductances at which the noise factor has the same value.

THE SIGNIFICANCE OF THE NOISE DEFINING PARAMETERS R_n AND Y_m IN TERMS OF THE TWO GENERATOR EQUIVALENT CIRCUIT USED TO REPRESENT THE NOISE

The noise generated inside a linear two port can be represented by noise voltage and noise current generators connected externally across the input terminals of the noise-free two port as shown in Fig. 3.

When the source admittance is real and has a very low value, the voltage of the noise voltage generator will be much smaller than the thermal noise voltage of the source and can be neglected; when the source admittance is real and large the noise current generator can be neglected. This is shown in Fig. 4 in which generators E_t and I_t represent the thermal noise of the source.

The values of the generators representing the noise in the two port can be related to the noise defining parameters by equating the noise factor obtained from equation (1) with the noise factor calculated from the equivalent circuits of Fig. 4.

SOURCE ADMITTANCE WITH A VERY SMALL REAL VALUE

The noise factor from equation (1) is given by:

$$F_I \approx \frac{R_n |Y_m|^2}{G_s}$$

while calculating from Fig. 4 gives:

$$F_I = \frac{J + I_n^2/4 G_s}{J} \approx I_n^2/4 G_s J$$

where J = Available thermal noise ($=k.T.B$)

Hence $I_n^2 = 4R_n J |Y_m|^2$.

SOURCE ADMITTANCE WITH A VERY SMALL REAL VALUE

In this case the noise factor from equation (1) is given by:

$$F_v \approx R_n G_s$$

and it can be shown that:

$$E_n^2 = 4R_n J$$

THE EFFECT OF CORRELATION ON THE NOISE DEFINING PARAMETERS F_m AND B_m

If there was no correlation between the two generators representing the noise shown in Fig. 3, the noise factor for a particular source admittance could be calculated by simply adding the available noise powers of the two generators.

It can be shown that this leads to the result:

$$F_u = 1 + 2R_n |Y_m| + (R_n/G_s) |Y_s - |Y_m|^2 \dots (2)$$

where F_u = noise factor with source admittance Y_s and with no correlation between the two generators representing the noise.

Thus for this special case the source susceptance for minimum noise factor is zero, while the value of the minimum noise factor is given by:

$$F_{mu} = 1 + 2 R_n |Y_m|$$

The noise performance in this case is defined by only two of the four noise defining parameters normally required.

In the general case some correlation does exist between the two generators; this results in the minimum noise factor occurring at some finite value of source susceptance, and also allows the minimum noise factor to have a different value from its uncorrelated value.

REFERENCE

1. I.R.E. Standards on Methods of Measuring Noise in Linear Two Ports. Proc. Inst. Radio Engrs. p. 60 (1959).

Design Data for a Third Order Butterworth Filter with Specified Source and Load Resistance

By R. Sill*, B.Sc., and A. Simeon*, M.Sc.

The object of this article is to provide a simplified procedure for the design of a practical filter based on the third order Butterworth model. This procedure allows for resistive sources and loads and also accounts for lossy circuit elements which occur in practice. The derivation itself is founded upon the predistortion technique described by Darlington¹. For this particular filter, it was found that suitable circuits were obtained without much loss in gain. Included in this discussion is an example of an inter-stage filter for two transistor amplifiers.

(Voir page 417 pour le résumé en français: Zusammenfassung in deutscher Sprache auf Seite 424)

CONSIDER the circuit of Fig. 1. It is desired to synthesize the transfer impedance, $Z_{12}(s)$, of the form

$$Z_{12}(s) = V_L/I_S = \frac{R_{12}}{s^3 + 2s^2 + 2s + 1}$$

where R_{12} is a scale factor. Note that the denominator of $Z_{12}(s)$ corresponds to the third order Butterworth polynomial.

Observing the pole-zero configuration of $Z_{12}(s)$ shown in Fig. 2, a predistortion $P = s + \alpha$ is performed where $0 < \alpha < 1/2$ and then $Z_{12}(P - \alpha)$ is synthesized. This predistorted transfer impedance is denoted by $Z_{12}'(P)$. Upon

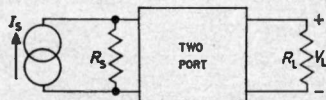

Fig. 1. Configuration of desired filter

restitution a resistor of magnitude $R_s = 1/\alpha C_1$ will be obtained in parallel with the current source I_s . This resistor will occur because the first element in the Butterworth filter in relation to the P plane is a shunt capacitor. The choice of α , therefore, influences the value of R_s , and conversely, the desired R_s can be used to determine the amount of predistortion, α , that is required.

In any reactive Darlington¹ procedure, R_L' is always arbitrary. Usually all impedances are normalized with respect to R_L' in order to simplify computations.

Setting $R_L' = 1$, then, provided all elements are reactive,

$$|Z_{12}'(j\omega)|^2 = R_{11}'(\omega) \dots \dots \dots (*)$$

where $R_{11}'(\omega)$ is the real part of $Z_{11}'(j\omega)$. $Z_{11}'(P)$ is, of course, the driving-point impedance of the network in relation to the P plane.

Returning to the s plane, by the substitution $P = s + \alpha$, it is found that the elements are no longer reactive. Therefore, by the Darlington procedure, the synthesized $Z_{12}'(P)$ results in a terminating resistance other than R_L . However, the resistors introduced by predistortion do not produce finite zeros of transmission and thus all zeros of transmission are still at infinity so that at best, the scale factor, R_{12} , is now less than the R_L obtained in the case of conventional synthesis. Fig. 3 illustrates these steps diagrammatically.

$Z_{12}(s)$ can be written in the following form:

$$Z_{12}(s) = \frac{R_{12}}{[s + 1][(s + 1/2)^2 + 3/4]}$$

Substituting $s = P - \alpha$:

$$Z_{12}'(P) = \frac{R_{12}}{[P + 1 - \alpha][(P + 1/2 - \alpha)^2 + 3/4]}$$

The Darlington method requires the computation of $Z_{11}'(P)$. The value of $Z_{11}'(P)$ as computed by the Gewertz² method is:

$$Z_{11}'(P) = c \left[\frac{2 - 3\alpha}{3 - 12\alpha + 16\alpha^2 - 8\alpha^3} P^2 + \frac{(2 - 3\alpha)^2}{3 - 12\alpha + 16\alpha^2 - 8\alpha^3} P + 1 \right] \frac{1}{P^3 + P^2(2 - 3\alpha) + P(2 - 4\alpha + 3\alpha^2) + 1 - 2\alpha + 2\alpha^2 - \alpha^3}$$

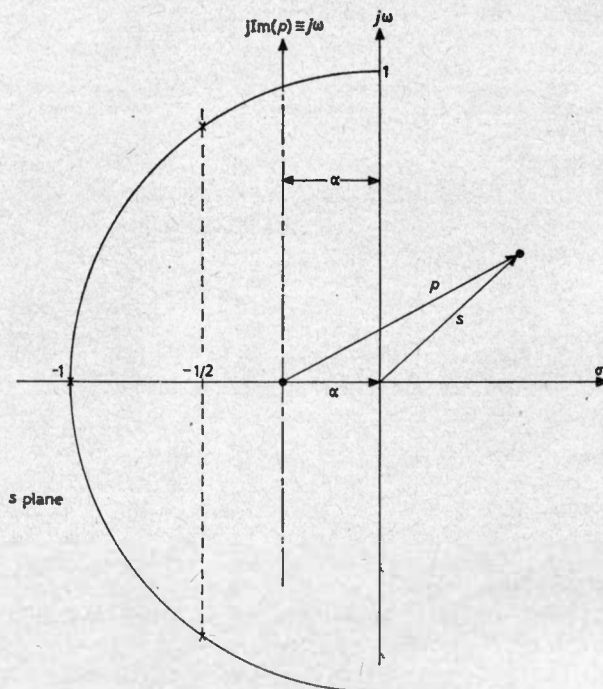

Fig. 2. Predistortion of $Z_{12}(s)$

where $c = \frac{R_{12}^2}{1 - 2\alpha + 2\alpha^2 - \alpha^3}$

Defining $Z_{11}'(P)$ as:

$$Z_{11}'(P) = R_L' \frac{pP^2 + qP + 1}{rP^3 + tP^2 + uP + 1}$$

Then:

$$R_L' = \frac{c}{1 - 2\alpha + 2\alpha^2 - \alpha^3}$$

Because of the freedom of choice of R_{12} , R_L' is arbitrary and can therefore be taken as unity in order to conform with the requirement that equation (*) be satisfied.

Thus:

$$\frac{R_L'}{Z_{11}'(P)} = \frac{rP^3 + tP^2 + uP + 1}{pP^2 + qP + 1}$$

Performing a Cauer³ expansion on this function, one

* The University of Manitoba, Canada.

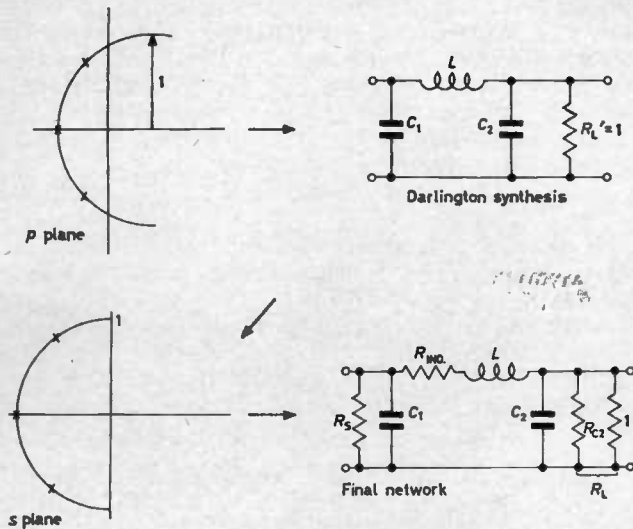

Fig. 3. Synthesis of $Z_{11}(s)$ by predistortion

obtains the network shown in Fig. 4. Computing r , p , and q ,

$$r = \frac{1}{1 - 2\alpha + 2\alpha^2 - \alpha^3}$$

$$p = \frac{2 - 3\alpha}{3 - 12\alpha + 16\alpha^2 - 8\alpha^3}$$

$$q = (2 - 3\alpha)p$$

Then:

$$C_1 = r/p = \frac{3 - 12\alpha + 16\alpha^2 - 8\alpha^3}{(2 - 3\alpha)(1 - 2\alpha + 2\alpha^2 - \alpha^3)}$$

$$L = q = \frac{(2 - 3\alpha)^2}{3 - 12\alpha + 16\alpha^2 - 8\alpha^3}$$

$$C_3 = p/q = \frac{1}{2 - 3\alpha}$$

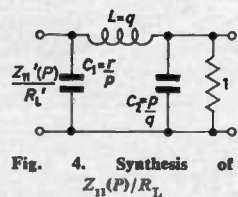

Fig. 4. Synthesis of $Z_{11}(p)/R_L$

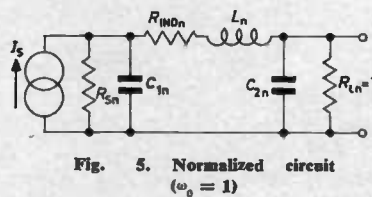

Fig. 5. Normalized circuit ($\omega_0 = 1$)

It has been seen that $R_3 = 1/\alpha C_1$ and with R_L still normalized, $R_L' = 1$.

Thus:

$$R_3 = \frac{1}{\alpha(r/p)} = \frac{(2 - 3\alpha)(1 - 2\alpha + 2\alpha^2 - \alpha^3)}{\alpha(3 - 12\alpha + 16\alpha^2 - 8\alpha^3)}$$

The resistance in series with the inductor with respect to the s plane is then:

$$R_{IND} = \alpha q = \frac{\alpha(2 - 3\alpha)^2}{3 - 12\alpha + 16\alpha^2 - 8\alpha^3}$$

The additional resistance in parallel with C_2 is then found to be:

$$R_{C2} = 1/\alpha C_3 = \frac{(2 - 3\alpha)}{\alpha}$$

Let R_{Ln} be the parallel combination of the 1Ω resistor, R_L , and the resistor R_{C2} . One then has:

$$R_{Ln} = \frac{1}{1/R_{C2} + 1} = \frac{2 - 3\alpha}{2 - 2\alpha}$$

If now all elements are normalized with respect to R_{Ln} ,

and these normalized quantities are denoted by the subscript n , then:

$$R_{Ln} = 1$$

$$R_{Sn} = \frac{(2 - 2\alpha)(1 - 2\alpha + 2\alpha^2 - \alpha^3)}{\alpha(3 - 12\alpha + 16\alpha^2 - 8\alpha^3)}$$

$$R_{INDn} = \frac{\alpha(2 - 3\alpha)(2 - 2\alpha)}{3 - 12\alpha + 16\alpha^2 - 8\alpha^3}$$

$$L_n = \frac{(2 - 2\alpha)(2 - 3\alpha)}{3 - 12\alpha + 16\alpha^2 - 8\alpha^3}$$

$$C_{2n} = \frac{1}{2 - 2\alpha}$$

$$C_{1n} = \frac{3 - 12\alpha + 16\alpha^2 - 8\alpha^3}{(2 - 2\alpha)(1 - 2\alpha + 2\alpha^2 - \alpha^3)}$$

To find R_{12n} apply d.c. and observe that:

$$I_L/I_S = \frac{R_{Sn}}{R_{Sn} + R_{INDn} + 1}$$

However, since $R_{Ln} = 1$, $I_L = V_L$.

Therefore:

$$R_{12n} = \frac{R_{Sn}}{R_{Sn} + R_{INDn} + 1}$$

and so:

$$Z_{12n} = \frac{R_{12n}}{s^3 + 2s^2 + 2s + 1}$$

Adaptation of these normalized quantities to actual

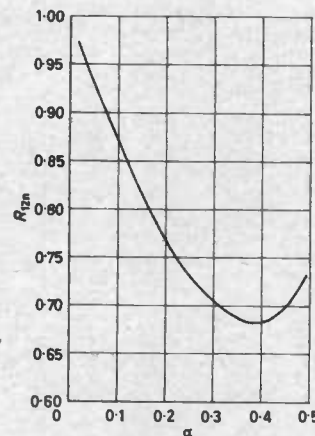

Fig. 6. Plot of R_{12n} versus α

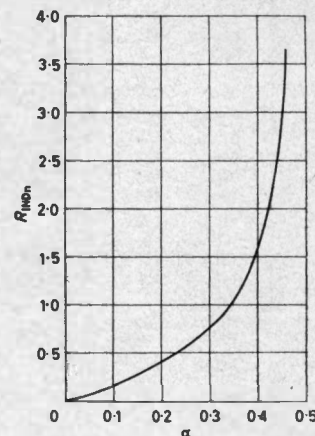

Fig. 7. Plot of R_{INDn} versus α

Fig. 8. Plot of L_n versus α

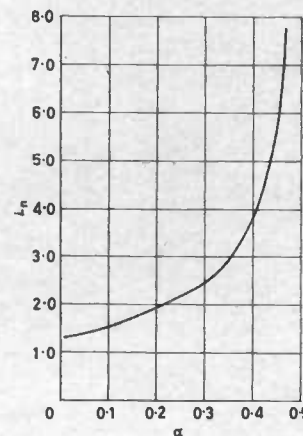
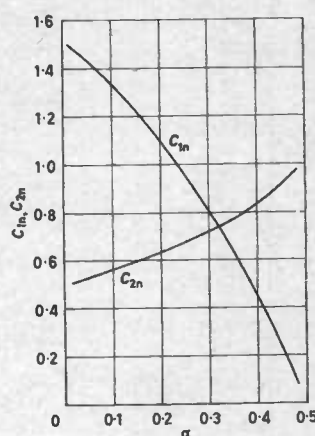

Fig. 9. Plots of C_{1n} and C_{2n} versus α



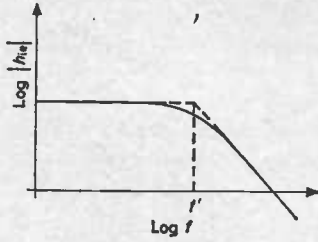
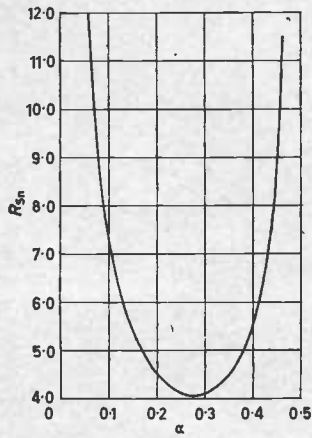

Fig. 10 (left). Plot of R_{Sn} versus α

Fig. 11 (above). Variation of h_{ie} with frequency

desired values is done by substitution into the following formulae:

$$L_{act} = \frac{L_n R_{Lact}}{\omega_{act}}$$

$$C_{act} = \frac{C_n}{R_{Lact} \omega_{act}}$$

and $R_{act} = R_n R_{Lact}$

where ω_{act} is the required cut-off frequency of the filter. The normalized circuit ($\omega_0 = 1$) is shown in Fig. 5. With

TABLE 1

α	R_{INDn}	L_n	C_{1n}	C_{2n}	R_{Sn}	R_{12n}
.01	.013	1.353	1.484	.506	67.351	.985
.02	.027	1.374	1.468	.510	34.036	.970
.03	.041	1.396	1.452	.515	22.945	.956
.04	.056	1.418	1.435	.520	17.410	.942
.05	.072	1.441	1.418	.526	14.098	.929
.06	.087	1.464	1.400	.531	11.897	.916
.07	.104	1.489	1.382	.537	10.333	.903
.08	.121	1.514	1.363	.543	9.167	.891
.09	.138	1.540	1.344	.549	8.266	.878
.10	.156	1.567	1.324	.555	7.552	.867
.11	.175	1.595	1.303	.561	6.973	.855
.12	.194	1.624	1.282	.568	6.497	.844
.13	.215	1.654	1.260	.574	6.100	.833
.14	.236	1.686	1.238	.581	5.766	.823
.15	.257	1.718	1.215	.588	5.482	.813
.16	.280	1.752	1.192	.595	5.240	.803
.17	.304	1.788	1.168	.602	5.033	.794
.18	.328	1.825	1.144	.609	4.854	.785
.19	.354	1.864	1.119	.617	4.702	.776
.20	.380	1.904	1.093	.625	4.571	.768
.21	.408	1.947	1.067	.632	4.460	.759
.22	.438	1.992	1.040	.641	4.366	.752
.23	.469	2.039	1.013	.649	4.289	.744
.24	.501	2.089	.985	.657	4.227	.737
.25	.535	2.142	.957	.666	4.178	.731
.26	.571	2.199	.928	.675	4.143	.724
.27	.610	2.259	.898	.684	4.121	.719
.28	.650	2.323	.868	.694	4.113	.713
.29	.694	2.393	.837	.704	4.117	.708
.30	.740	2.467	.805	.714	4.135	.703
.31	.790	2.549	.773	.724	4.168	.699
.32	.844	2.637	.741	.735	4.216	.695
.33	.902	2.734	.707	.746	4.281	.692
.34	.966	2.842	.673	.757	4.366	.689
.35	1.036	2.961	.638	.769	4.472	.687
.36	1.114	3.096	.603	.781	4.604	.685
.37	1.202	3.248	.567	.793	4.766	.684
.38	1.301	3.424	.529	.806	4.965	.683
.39	1.415	3.628	.492	.819	5.211	.683
.40	1.548	3.870	.453	.833	5.516	.683
.41	1.707	4.163	.413	.847	5.898	.685
.42	1.900	4.525	.372	.862	6.387	.687
.43	2.143	4.985	.330	.877	7.026	.690
.44	2.461	5.594	.288	.892	7.891	.695
.45	2.898	6.441	.243	.909	9.114	.700
.46	3.543	7.704	.198	.925	10.963	.706
.47	4.606	9.800	.151	.943	14.064	.715
.48	6.709	13.978	.102	.961	20.292	.724
.49	12.979	26.489	.052	.980	39.020	.736

the aid of a digital computer, R_{Sn} , R_{INDn} , L_n , L_n , C_{2n} , C_{1n} , and R_{12n} were calculated for different values of α . The results are shown in Table 1. Plots of these quantities against α appear in Figs. 6 to 10 inclusive. It is worthwhile to note that the scale factor R_{12n} is never less than 0.683 and therefore the voltage gain of the filter remains sufficiently high even though the filter is lossy.

Example

In order to show how easily the method can be applied, an interstage filter for two transistor amplifiers will be designed.

The specifications are as follows:
 Filter cut-off frequency = $f_0 = 10\text{kc/s}$.
 Operating point for both transistors: $V_C = 4\text{V}$, $I_C = 5\text{mA}$.
 At the Q-point, the following parameters were measured:
 $h_{ie} = 80$ (1kc/s) $h_{ie} = 800\Omega$ (1kc/s) $C_{b'e} = 3\ 500\text{pF}$.
 Since the load resistance of the filter is related to h_{ie} , the variation of h_{ie} with frequency must be considered.

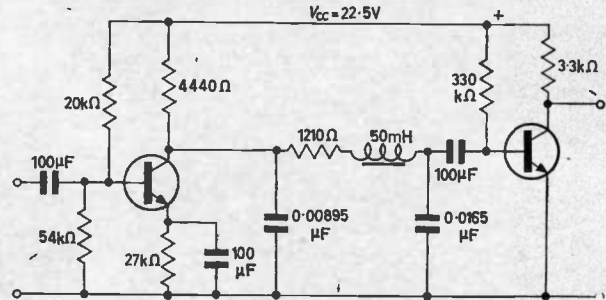

Fig. 12. Completed design

This variation is shown in Fig. 11. f' , the cut-off frequency of h_{ie} , is found from the relation:

$$f' = \frac{1}{R_{b'e} C_{b'e}} \cdot 1/2\pi$$

Since $R_{b'e} \approx h_{ie} R_o$ and $R_o = 26/I_E(\text{mA})$, f' is computed to be 111kc/s. Observe that since $f_0 < 0.1f'$, $C_{b'e}$ does not affect the response of the filter appreciably within the pass-band and thus h_{ie} may be assumed resistive.

With $V_{cc} = 22.5\text{V}$ the second stage was biased at the desired Q-point.

For the filter, $R_{Lact} = h_{ie} = 800\Omega$. The value of any one of the elements in the filter must now be chosen with the restriction that its normalized value falls within the corresponding range for which $0 < \alpha < 1/2$. Although it is more logical to choose the load resistance of the first stage, the value of the inductor is chosen due to the limited variety available, viz. $L_{act} = 50\text{mH}$.

The normalized value of this inductor is found to be 3.93. From Fig. 8, the corresponding value of α is 0.40. From Figs. 7, 9, and 10, it is found that $R_{INDn} = 1.55$, $C_{2n} = 0.83$, $C_{1n} = 0.45$, and $R_{Sn} = 5.55$. The actual values are then $L_{act} = 50\text{mH}$, $C_{1act} = 0.00895\mu\text{F}$, $C_{2act} = 0.0165\mu\text{F}$, $R_{INDact} = 1240\Omega$, and $R_{Sact} = 4\ 440\Omega$.

Since the inductor used has an inherent resistance of 30Ω , a $1\ 210\Omega$ resistor was used in the actual circuit.

The resulting circuit is shown in Fig. 12. The $100\mu\text{F}$ capacitors are necessary for coupling and emitter by-pass. This circuit was built and tested and was found to possess a cut-off frequency within 1 per cent of the designed value.

REFERENCES

- DARLINGTON, S. Synthesis of Reactance 4-Poles Which Produce Prescribed Insertion Loss Characteristics. *J. Math. Phys.* 18, 257 (1939).
- SESHU, S., BALABANIAN, N. Linear Network Analysis, pp. 259-261 (John Wiley & Sons, Inc. 1959).
- VAN VALKENBURG, M. E. Introduction to Modern Network Synthesis. Ch. 5. (John Wiley & Sons Inc. 1962).

Octave and One-Third Octave Filters for Sub-sonic Frequencies

By W. Tempest*, Ph.D., and N. S. Yeowart*, B.Sc.

Circuits have been developed for transistorized active band-pass filters of octave and one-third octave bandwidths. The basic design consists of two stagger-tuned parallel-T feedback amplifiers, and, since no inductors are used, it is suitable for operation at low frequencies. Examples have been constructed with centre frequencies down to 1c/s and give a satisfactory performance.

(Voir page 417 pour le résumé en français: Zusammenfassung in deutscher Sprache auf Seite 424)

IN the measurement and analysis of sound and vibration frequent use is made of band-pass filters, and where fixed frequency filters are employed these are most commonly of either octave or one-third octave bandwidth.

An octave filter is defined as one in which the upper and lower passband limits f_h and f_l are related by $f_h = 2f_l$. The filter is described by its mid-band frequency $f_o = (f_h f_l)^{1/2}$. These definitions lead to the results $f_h = (2)^{1/2} f_o$ and $f_l = (2)^{-1/2} f_o$.

For the case of the one-third octave filter the passbands are such that three adjacent filters make up one octave and for each filter $f_h = (2)^{1/3} f_l$. Hence $f_h = (2)^{1/3} f_o$ and $f_l = (2)^{-1/3} f_o = 0.89 f_o$ where the primed frequencies refer to the passband limits and mid-band frequencies of one-third octave units.

The ideal shape of the passband for most purposes is rectangular, the filter having zero loss between the band limits and zero transmission outside them; however, all practical filters have finite rates of attenuation and the limits of the passband must be defined in some way. One way is to define the limits as the half power frequencies, i.e. the frequencies at which the response is 3dB lower than at the mid-band frequencies. Alternatively, bandwidth can be defined in terms of the power transmission of the filter with a white noise input. In this case the equivalent noise bandwidth is the bandwidth of an ideal (rectangular passband) filter which has the same mid-band frequency and transmits the same power, as the actual filter, with a white noise input.

When filters with mid-band frequencies from about 50c/s upwards are required, very satisfactory units can be constructed using passive elements. However, at frequencies below 50c/s the increasingly large inductors needed make passive filters rather less attractive, and at the same time the performance deteriorates since it is difficult to produce high Q resonant circuits at lower frequencies. The practical lower limit of passive filters seems to be in the region of 15c/s.

For lower frequencies it is therefore necessary to turn to active filters, i.e. amplifiers with frequency dependent feed-

back; such units can be designed without inductors and for this reason are particularly convenient at low frequencies. The most widely used band-pass active filter appears to be that consisting of an amplifier with a parallel-T feedback loop¹, and has a response of the type shown in Fig. 1(a). The Q of the peak in the response can be adjusted by altering the gain of the amplifier. In order to obtain a response closer to the 'ideal' rectangular characteristic it is necessary to use two or more feedback amplifier units, with staggered centre frequencies. In general the best overall response can be obtained by using many stagger tuned filter units, each with a high Q , however, this approach must be regarded with some

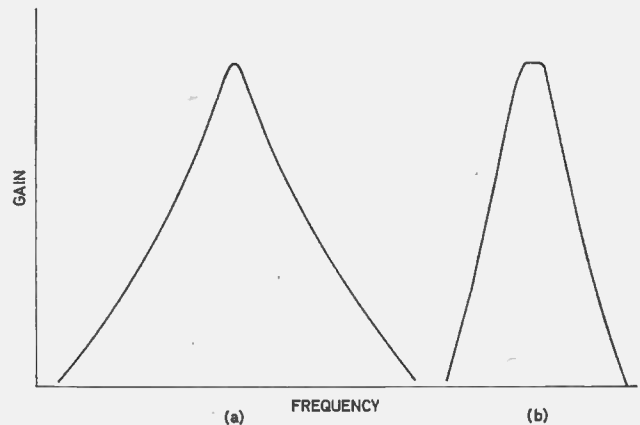
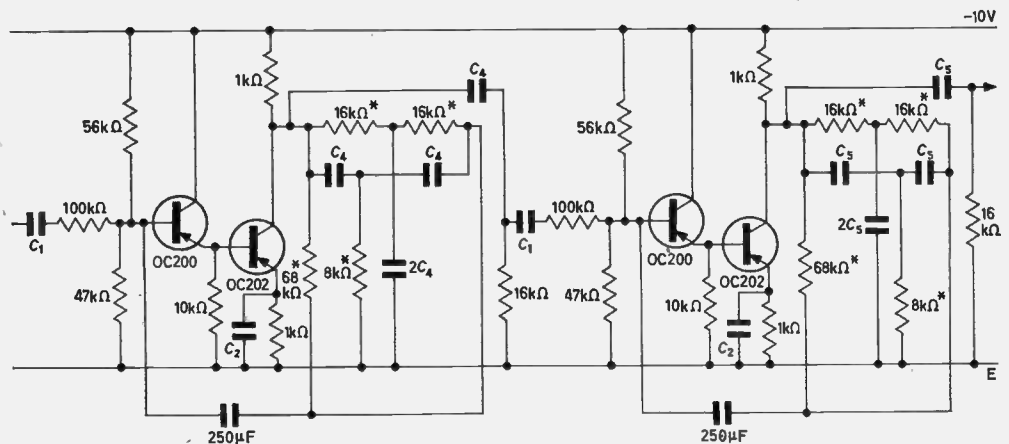

Fig. 1 (a). Response of amplifier with parallel-T feedback loop
(b) Response of two cascaded parallel-T feedback amplifiers with staggered frequencies

Fig. 2. Complete circuit of octave filter



* University of Liverpool.

* = 1 percent tolerance

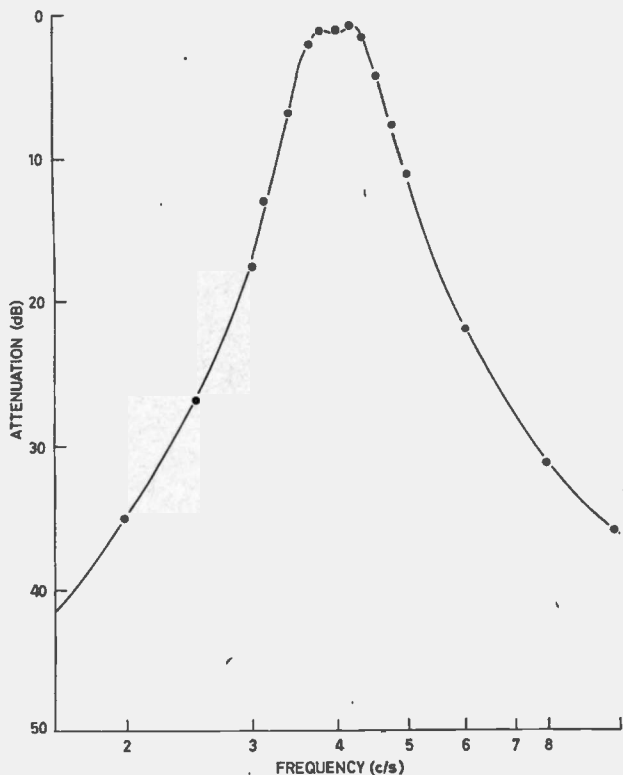

Fig. 5. Measured response of a typical one-third octave filter

2 to 40c/s. No setting-up procedure was used and it was found that the mid-band frequencies were within 3 per cent of nominal and the bandwidths ranged from 22 to 25 per cent (nominal value 23 per cent). A typical measured response curve is shown in Fig. 5. It was found that in some cases the response was slightly asymmetrical due to departures of the Q s of the individual filter sections from their nominal value of 7. This effect was quite small (less than 1dB tilt in the pass-band) but could be corrected by adjusting the value of the resistor shunting the parallel-T in the range 330 to 470k Ω .

Measurements were made of the maximum input levels, output noise level and harmonic distortion of the filters. It was found that output noise was at least 70dB below maximum output signal, the actual output was mostly hum and could no doubt have been improved further by better shielding and power supply filtering. Harmonic distortion could not be measured accurately with the equipment available but was not worse than 80dB below fundamental for a 1V r.m.s. input. Maximum input signal level was 3V r.m.s. for the octave filters.

The overall gain of a typical octave filter was measured for a period of 40 hours. The change in the period was less than 0.1dB. For the filters described here the half-power definition of bandwidth has been used, the equivalent noise power bandwidth was calculated from the measured response curve of one filter and is approximately 12 per cent greater than the half-power bandwidth.

REFERENCE

1. SCOTT, H. H. *Proc. Inst. Radio Engrs.* 26, 226 (1938).

Self-monitoring for Air Data Systems

An air data computer made up from modular sub-units and incorporating a high degree of built-in self-monitoring is currently being proposed by Elliott-Automation to US transport and military aircraft manufacturers. Monitoring of the output of the pressure sensing capsule is already available and specified by ARINC characteristic 545, but an Elliott patented system for the first time provides monitoring of the sensing capsule itself in a simple way.

Monitoring of the pressure capsule is accomplished by using the normal mechanical feedback shaft in the pick-off servo of the main capsule to drive the pick-off on a second capsule mounted alongside with its own independent pressure source. Failure of the primary capsule would therefore produce a signal at the second pick-off and indicate a fault at the monitor amplifier, which is set to operate a warning circuit at a given threshold. In fact, the monitor pick-off is biased by a fixed amount so that certain power and signal line failures would raise a difference voltage in the same way as a difference in capsule displacement.

The monitor can be applied to both static and pitot static capsules and can be bolted on to the transducer frame in a space already available in the existing air data computers.

This new degree of self-monitoring is an optional feature of the Elliott modular air data system, which can be made up to provide a wide variety of autopilot sensors as well as automatic height encoding systems to meet ARINC characteristic 549 Mk 1 and Mk 3. From a range of modules the customer can choose the facilities he requires and have them packed in an ATR case size allowing spare capacity for the addition of further modules, either during the development of a particular aircraft or to up-date the system at a later stage. Modular arrangement also reduces maintenance costs.

The modules have standard size formats, with output gears positioned to mesh automatically with those of neighbouring units. Electrical contacts are made by plugs in the base of each module.

BAC One-Eleven airliners operating with American airlines are already fitted with Elliott 2000 series autopilots as well as modular air data systems, and these can be fitted with encoders required for automatic height reporting. The modular system has also been selected for a large new British military aircraft.

The addition of a monitoring capsule to the pitot transducer in the BAC One-Eleven air data computer raises the integrity of the signals used for autothrottle control to the level required for Category 3 operations.

The Elliott-Automation modular air data system assembled in an ARINC 549 Mk 1 automatic height encoder for secondary radar height reporting. It is in a short 3/8 ATR case. A similar unit to ARINC 549 Mk 3 would be contained in a short 1/2 ATR case.

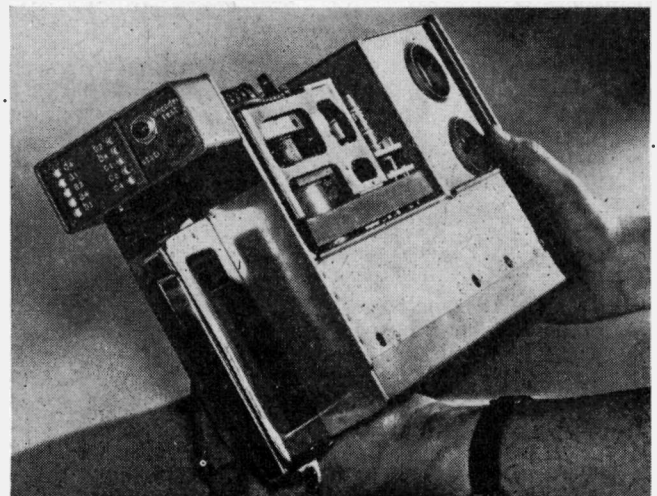

NEW

BOOKS

Signals and Noise in Communication Systems

By H. E. Rowe. 341 pp. Med. 8vo. D. Van Nostrand & Co. Inc. 1965. Price 86s.

A LONE elementary circuit diagram and two very much simplified block diagrams out of a total of some 50 figures indicate that this is essentially a theoretical treatise. A cursory glance through "Signals and Noise in Communication Systems" reveals pages of mathematical equations, thankfully offered without apology, and demonstrates that this is no book for light bedside reading. Yet this outstanding book, directed at the final year undergraduate and post-graduate levels, should become a classical textbook and an invaluable work of reference.

One of the difficulties of reviewing this type of book is that the specialized nature of the topics covered and the advanced mathematical treatments necessarily direct it towards the specialist reader. When the book is well written, well ordered and comprehensive, the temptation is to over-eulogize. The temptation with "Signals and Noise in Communication Systems" is great indeed.

Here is a book which, from the title page to the last question mark on page 334, covers the subject logically and thoroughly without wandering from the point. In this respect it gains as much from what is left out as from what is included.

One of the first things that will strike any reviewer is the exceptional aptness of the title. Mr. Rowe first deals with analysis of non-random signals and introduces the concepts of Fourier integrals and Hilbert transforms. He then applies these to the study of random signals and noise. The use of Hilbert transforms becomes of particular value later when Mr. Rowe deals with such topics as distortion in various amplitude modulation and related systems, and noise in amplitude modulation and in phase and frequency modulation systems.

The remainder of the book is devoted to various forms of modulation in communication systems.

Amplitude modulation is introduced by a mathematical analysis of the response to signals of modulators, demodulators and detectors. Amplitude and phase distortion of signals, vestigial sidebands and noise and amplitude modulation systems complete the chapter.

Spectral analysis of angle-modulated waves with sinusoidal and square-wave modulation and with random modulation provide the opening sections of the chap-

ter on frequency and phase modulation. The spectra are then evaluated both approximately and in the case of Gaussian modulation exactly. A study of the effects of interference and noise completes the chapter.

The final chapter deals with pulse modulation systems and is divided into three principal sections devoted to pulse-amplitude modulation, pulse-position and pulse-duration modulation, and pulse-code modulation systems. The spectra of the modulated signals, the demodulation and the effects of noise, both random and quantizing, are considered.

The emphasis throughout is on the mathematical treatment of the subject and on the more useful methods for computing the spectra of various modulated waves. One of the great assets in a book of this sort is the inclusion of an extensive range of 145 problems.

"Signals and Noise in Communication Systems" is one of the most recent additions to that excellent series issued by the Bell Telephone Laboratories and published by D. Van Nostrand Company Inc. For almost 35 years this series has established itself with some of the most notable contributions to the literature of science and engineering and arises out of the broad investigations of the Bell Telephone Laboratories. "Signals and Noise in Communication Systems" joins a worthy heritage and maintains the highest standards of the series.

R. A. BONES

Principles of Communication Engineering

By J. M. Wozencraft and I. M. Jacobs. 720 pp. Med. 8vo. J. Wiley & Sons. 1965. Price 130s.

IT is generally recognized that a book dealing with the principles of communications should not be cluttered with details of systems and their associated hardware. This book, however, has been taken to the extreme and a more appropriate title would be 'Principles of Communication Theory'. The fundamentals of present-day techniques are given scant attention, for example, pulse-code modulation is dealt with in only five pages whereas undue emphasis is placed on analogue methods such as pulse-position modulation which is covered in approximately 20 pages.

After an introductory chapter explaining the scope of the book the second, entitled "Probability Theory" and extending over 100 pages, covers such topics as randomness, density and distribution functions, and limit theorems.

Chapter 3, which is of similar length, is devoted to random waveforms including filtered input noise, Gaussian processes, correlation functions and power spectra.

Optimum receiver principles are dealt with in Chapter 4 which is concerned mainly with the reception of the signal with additive Gaussian noise and the matched filter receiver. At this juncture the reader may be somewhat surprised to read that "it is common practice to express energy ratios in units of decibels", and to have this statement followed by a table listing ratios such as 1, 10 and 100 with their respective equivalents in decibels.

The fifth chapter "Efficient Signalling for Message Sequences" introduces the concept of n -dimensionality and sphere hardening which is followed by the statement and proof of Shannon's Capacity Theorem. Although this section is dealt with at some length, it is thought that the original papers by Shannon would provide a more lucid exposition to the reader meeting the subject for the first time.

"The Implementation of Coded Systems", Chapter 6, deals with the problems of encoding, parity check codes, decoding and error probability. This is undoubtedly the most valuable chapter and the material is presented in a clear and concise manner.

Chapter 7 introduces the characteristics of some of the more common channels such as random amplitude and phase variations of a fading signal, scattering and diversity effects. It is unfortunate that fundamental principles, in this instance basic definitions of double sideband and single sideband modulation, are covered at such a late stage; any reader attempting to understand the book should at first be fully conversant with these principles.

In the final chapter "Waveform Communications", an attempt is made to present some of the principles employed in modern day systems. The explanation of linear modulation by a complicated mathematical representation suggests that the simple basic facts have been glossed by the trappings of mathematics in order to justify their inclusion. Although the student meeting the subject for the first time may have difficulty understanding this chapter, the experienced reader should find the section on maximum likelihood reception of value. This is followed by twisted modulation (p.p.m.), frequency modulation and the performance of f.m. signals in the presence of weak noise. Pulse code modulation is

explained in an unnecessarily sophisticated way, to quote: "In conventional p.c.m. it is customary to choose the number of quantization intervals to be a power of 2 and to employ a binary antipodal signalling alphabet. The transmitted signal may then be written

$$s_i(t) = \sum_{j=1}^K s_{ij} \phi_j(t); \quad i = 0, 1, \dots, M - 1 \text{ in}$$

which the $\{\phi_j(t)\}$ are an appropriate set of orthonormal functions, $K = \log_2 M$, and the vector $s_i = (s_{i1}, s_{i2} \dots s_{iK})$ represents the number i written in binary form."

This book cannot be recommended to the undergraduate or postgraduate student, for whom it is intended, but it may provide a useful reference for the practising engineer.

J. A. BETTS

Modulation, Noise and Spectral Analysis

By P. F. Panter. 759 pp. Med. 8vo. McGraw-Hill Book Co. 1965. Price £7 16s.

THERE is now a large number of books dealing with the topics of modulation theory and noise and it becomes necessary to consider the comparative merits of a particular book. This book has a lot to offer within its 24 chapters, if one is prepared to pay for it. It is true that liberal use is made of established material, but it is used to build up a coherent picture of a particular topic and points of practical engineering importance are well brought out. The mathematics involved are a little fearsome at times, but there are a few examples worked in the text which are helpful. Each chapter includes a good set of references.

This is the sort of book that should be on any good communication systems engineer's shelf and the self-contained section dealing with his important mathematical tools removes the necessity for constant reference to several sources. It will be equally useful for graduate students in communications, though the instrumentation is somewhat dated.

After a good introductory chapter, the author allots considerable space to a concise but excellent review of the formulation and application of Fourier series and transform theory and good use is made of these tools later in the book. Random signal theory is then dealt with and correlation techniques for dealing with random noise functions are well covered.

Only two chapters are devoted to amplitude modulation, but the important aspects are well treated, including the three methods of single sideband generation and a comparison of signal-to-noise ratio for various methods of detection.

Angle modulation receives much more attention. Ten chapters cover the subject and again the important engineering aspects receive treatment. For example, account is taken of the fact that a frequency modulator normally produces significant amplitude modulation effects also, and the spectral distribution for this

is studied. The treatment of distortion of frequency modulated signals in linear networks covers both the steady state Fourier transform approach, in which the input signal is resolved into its spectral components, each of which is modified by the transfer function, and the dynamic power series approach. This section forms an excellent review of present methods of approach, though it tends to encourage the thought that the brute force use of a digital computer is justified.

Transient response and common channel interference then take up two good chapters, but signal-to-noise improvement is very ordinary material and the chapters on generation and detection of f.m. signals are disappointing, with negligible reference to semiconductor circuits. The section on f.m. ends with useful chapters on application of negative feedback and threshold extension. In this connexion, frequency compressive feedback in phase locked loop demodulators is presented. Apart from the exceptions mentioned these 10 chapters form an excellent presentation of f.m. material.

The remainder of the book is devoted to pulse modulation systems and includes proof of the sampling theorem, a study of the spectra of the various modulated pulse trains and various time-division-multiplex systems. The discussion of instrumentation of t.d.m. systems is rather dated—there are circuits shown employing valves, though t.d.m. has come into its own with the advent of semiconductors—but the sections on crosstalk are good.

The basic concepts of information theory are given excellent coverage, with emphasis on pulse code modulation applications, followed by a chapter on the principles of p.c.m. Whereas so much literature on quantizing noise deals quantitatively only with linear quantizing, this author gives an analysis of the effect of logarithmic compression.

A chapter is included on delta modulation principles and the book ends with an excellent discussion of methods of modulation used in digital data transmission systems and a comparative analysis of modulation systems in relation to Shannon's formula for minimum information capacity.

R. BARRETT

Digest of Literature on Dielectrics Volume 28, 1964

359 pp. Demy 4to. National Academy of Sciences—National Research Council. 1965. Price \$20.00

Better Report Writing 2nd Edition

By W. H. Waldo. 276 pp. Med. 8vo. Chapman and Hall. 1965. Price 8s.

Transistors for Technical Colleges

By L. Barnes. 194 pp. Demy 8vo. Illiffe Books Ltd. 1966. Price 42s.

The Zener diode and the silicon-controlled rectifier are included in this book which deals with semiconductors from the design and application points of view.

It is intended not only for students in technical colleges but for industrial engineers with a limited knowledge of electronics.

Heating with Microwaves Fundamentals, Components and Circuit Technique

By H. Puschner. 320 pp. Med. 8vo. Philips Technical Library. 1966. Price 72s.

The object of this book is to introduce modern microwave appliances for use as dielectric heaters for non-conducting materials. High frequency microwave tubes and their associated circuits together with the measuring techniques are described in detail.

Basic Tables in Electrical Engineering

By G. A. Korn. 370 pp. Med. 8vo. McGraw-Hill Book Co. 1966. Price 32s.

Proceedings of the First Microelectronics Lecture Course Oxford, 1965

Edited by G. W. A. Dummer. 197 pp. Med. 4to. United Trade Press Ltd. 1966. Price £3 3s.

This book contains the 21 papers presented at Clarendon College, Oxford, in July 1965.

The Radio Amateur's Handbook 43rd Edition, 1966

704 pp. Demy 8vo. American Radio Relay League. 1966. Price \$4.00

Waveforms

Edited by B. Chance et al. 785 pp. Demy 8vo. Constable. 1965. Price 26s.

This book is an unabridged and unaltered republication of the work first published by McGraw-Hill in 1949 as Volume 19 in the Massachusetts Institute of Technology Radiation Laboratory series.

Pulse Generators

Edited by G. N. Glasoe and J. V. Lebacqz. 741 pp. Demy 8vo. Constable. 1965. Price 24s.

This book is an unabridged and unaltered republication of the work first published by McGraw-Hill in 1948 as Volume 5 in the Massachusetts Institute of Technology Radiation Laboratory series.

Vacuum Tube Amplifiers

Edited by G. E. Valley and H. Wallman. 743 pp. Demy 8vo. Constable. 1965. Price 24s.

This book is an unabridged and unaltered republication of the work first published by McGraw-Hill in 1948 as Volume 18 in the Massachusetts Institute of Technology Radiation Laboratory series.

Waveguide Handbook

Edited by N. Marcuvitz. 428 pp. Demy 8vo. Constable. 1965. Price 18s.

This book is an unabridged and unaltered republication of the work first published by McGraw-Hill in 1951 as Volume 10 in the Massachusetts Institute of Technology Radiation Laboratory series.

Computing Mechanisms and Linkages

By A. Svoboda. 359 pp. Demy 8vo. Constable. 1965. Price 18s.

This book is an unabridged and unaltered republication of the work first published by McGraw-Hill in 1948 as Volume 27 in the Massachusetts Institute of Technology Radiation Laboratory series.

Automatic Digital Calculators

By A. D. Booth and K. H. V. Booth. 263 pp. Demy 8vo. Butterworths. 1965. Price 52s. 6d.

The third edition of this book, originally published in 1953, now includes information on transistor and tunnel diode circuits, thin film magnetic and cryogenic storage and modern auto-coding systems with particular reference to FORTRAN.

NEW EQUIPMENT

A description, compiled from information supplied by the manufacturers, of new components, accessories and test instruments.

(Voir page 411 pour la traduction en français; Deutsche Übersetzung Seite 418)

INTEGRATED DECADE COUNTER

SGS-Fairchild Ltd, 23 Stonefield Way, Roislip, Middlesex

The C μ L958, which may be used as either a counter or a divider, consists of four cascaded binary triggered flip-flops, modified by a feedback loop to count in the familiar 1-2-4-8 code. Provision is made for clearing and presetting any one of the possible decimal states. The monolithic structure employs only resistors and transistors and is manufactured by the planar epitaxial process.

The device, which is contained in a TO-5 can, has a counting speed guaranteed to be up to at least 2Mc/s and is compatible with other SGS-Fairchild integrated circuit elements. Nominal supply voltage is 3.6 to 4V; operating temperature range, 0 to 75°C.

EE 94 751 for further details

CONTINUOUS INTEGRATOR

Mercury Electronics (Scotland) Ltd,
640 Argyle Street, Glasgow, C.3

(Illustrated right)

This integrator has been designed to provide a suitable instrument for the continuous integration of small signals. It operates satisfactorily with input signals in the range 10mV to 1V, an output signal of one volt being obtained for an input of 1000mV sec.

Two complementary transistors are connected in series with their collectors connected to one side of a capacitor. If the two collector currents are the same no current will enter or leave the capacitor, but if a signal is added to the emitter current of one, its collector current will alter correspondingly and the capacitor will charge (or discharge) accordingly. As these transistors are in the grounded base configuration the collector current is substantially independent of the changing potential, and thus, for a constant input signal the relation between time and the potential across the capacitor exhibits good linearity. In most transistors the collector current is in fact slightly voltage dependent, but the effect is normally only perceptible as a tendency for the baseline to return towards centre when integrating asymmetrical signals over long periods.

For many purposes this acts as a drift correction and indeed it has been found advantageous to reduce the time-constant still further when integrating waveforms

of a few seconds duration, in order to reduce the effect of artefacts. A switch is fitted to the front panel allowing the most useful time-constant to be selected.

Although the instrument was designed primarily for use with the Greer micro-manometer to enable flow dependent pressures to be integrated with respect to time to provide volume tracings, the low signal required for the integrator makes it suitable for operating on inputs derived from densitometers or other signal sources: it may also be used as an averaging device where it is desired to display the mean value of a signal.

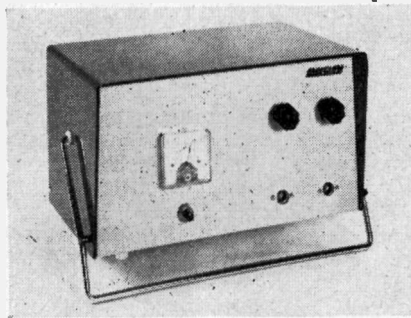

EE 94 752 for further details

RESISTORS

Welwyn Electric Ltd, Bedlington, Northumberland

A completely new range of metal film resistors has been developed by Welwyn Electric Ltd. Designated the 'WELMET' 40-10 series, they have been specifically designed to meet the exacting requirements of the instrument manufacturer, but are suitable for all applications where a high performance/low cost ratio is essential.

The range is available in four grades of temperature coefficient down to $25 \times 10^{-6}/^{\circ}\text{C}$. There are 5 sizes ranging from 0.125W to 2.0W and the ohmic range extends from 1Ω to $30M\Omega$. Standard tolerances of ± 1 per cent and ± 0.5 per cent are offered and closer tolerances are supplied to order.

Typical stability figure after 2000 hours cyclic load at 70°C shows a resistance change of from 0.1 per cent to 0.2 per cent for values below 500k Ω , and from 0.2 per cent to 0.4 per cent for maximum values.

The predicted failure rate over a time period of 25 000 hours is only 0.4 per

cent per 1000h where a 0.5 per cent change is considered a failure. If a change of 1 per cent is acceptable the failure rate drops to 0.02 per cent per 1000h.

The resistors are fully insulated, being protected by a multi-lacquer layer ensuring good climatic performance and a sleeve of irradiated polyolefin which is flame retardant and has a high insulation resistance. The sleeve is non-hygroscopic and is solvent resistant.

EE 94 753 for further details

INCREMENTAL PLOTTERS

Benson-Lehner Ltd, West Quay Road, Southampton

(Illustrated on page 403)

Two new versions of the incremental plotter are now available. One version features a plotting speed of 450 increments per second, and in the other plotter the increment size has been increased to 0.010in. This constitutes an improvement of 50 per cent in plotting speed (from 300 increments per second) and an increase of 100 per cent the former increment size (from 0.005 to 0.010in).

In this latter version, increased increment size results in faster plotting, since the distance covered in each increment movement is doubled. In effect, by plotting 300 increments per second at 0.010in the distance covered is 3in.

With the faster plotting version, 450 increments at 0.005in give a distance of 2 $\frac{1}{2}$ in; of course, the smaller increment size provides more accurate results.

The incremental plotter produces fully annotated plots under on-line computer control, or off-line from punched paper tape or magnetic tape. Typical applications include automatic draughting, plotting weather charts and critical path scheduling.

A feature in the controls of the plotter is the 'joystick control'. This allows the plotting pen to be positioned anywhere on the paper through the use of a single button, which moves either the pen or the paper, or both, depending on whether the desired movement is in the X, Y or XY direction. The speed of movements with the 'joystick control' is either 2 increments per second or 450 increments per second, the latter speed being obtained by completely depressing the button.

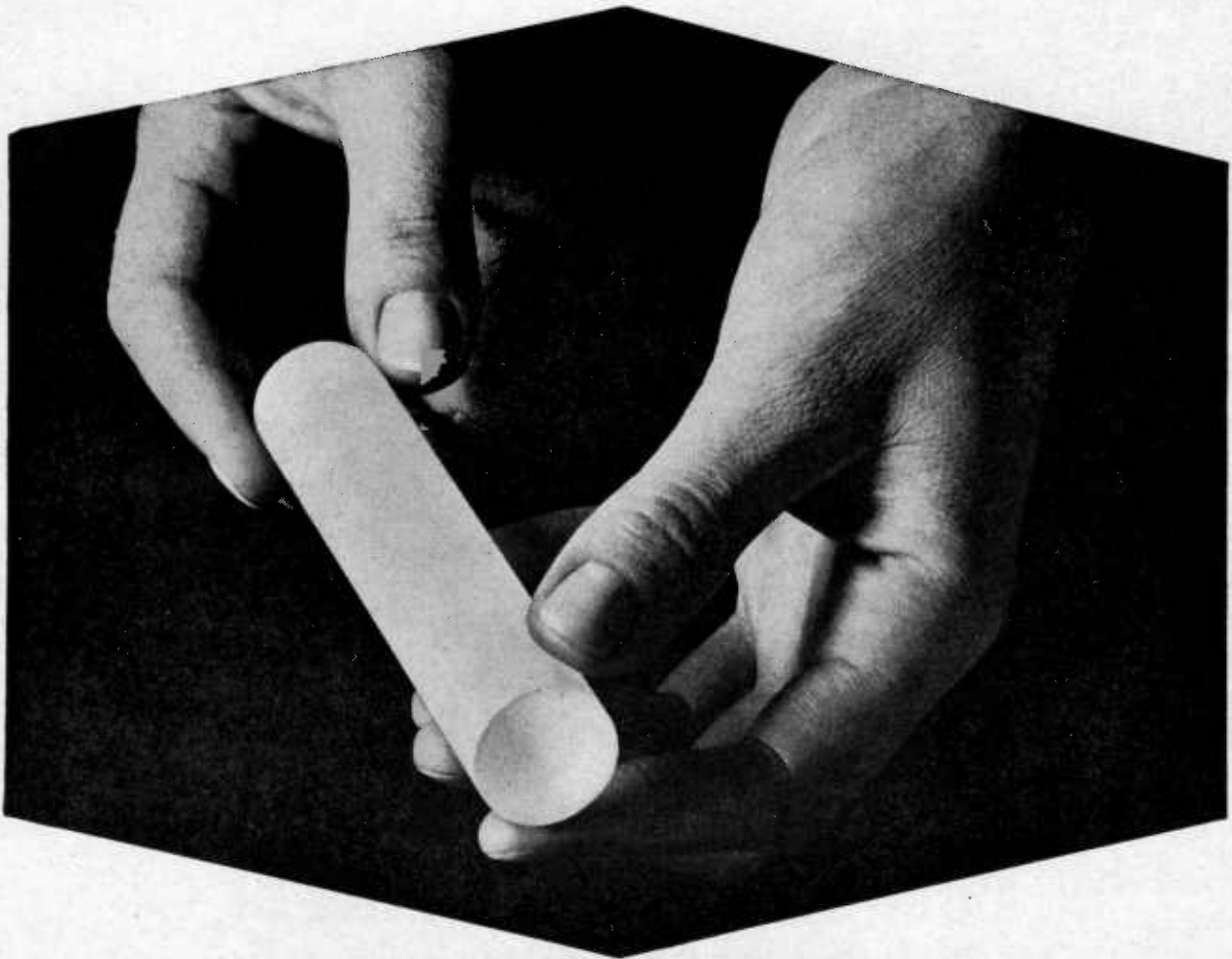

The ultimate in laser rubies

50 per cent of the output energy contained within 0.1×10^{-3} radians per linear inch

In terms of physical properties and performance characteristics the Developmental Quality Laser Ruby now available from Union Carbide Limited is virtually perfect. Produced by the unique Linde process it has a beam divergence which contains 50 per cent of the output energy within 0.1×10^{-3} radians per linear inch of rod and no less than 90 per cent within 0.2×10^{-3} radians per linear inch of rod. Internal scattering is less than one per cent. Dislocation density is negligible. And the fringe count as determined by interferometric analysis is less than 1.5 fringes per linear inch—regardless of rod diameter. Moreover, the homogeneity and hexagonal crystalline structure of the host material approximates to the theoretical ideal. As a result, the Developmental Quality Ruby combines high energy density and spot brightness with

high durability and a long useful life. For applications where the use of a Developmental Quality Ruby would not be justified, Union Carbide supply a number of other high quality rubies, foremost among which are the S.I.Q. and the Standard grade rubies. There are also the revolutionary new low threshold YAG crystals suitable for continuous operation at room temperature. YAG is doped singly with Neodymium or double doped Neodymium and chromium. In addition, the company markets electro-optical crystals for use in modulation, Q-switching, high efficiency frequency doubling, tunable lasers and other critical applications, and electronic sapphire substrates, silicon monoxide and alumina powders. Having been involved in laser research since its inception, and now being among the world's foremost suppliers of lasers

and laser equipment, Union Carbide is in a unique position to advise on the application of synthetic crystals and associated materials. If you are currently engaged upon work in this field a discussion with Union Carbide could save you a great deal of time and quite possibly reduce your development costs by a very considerable margin.

Synthetic Crystals
another practical product of



UNION CARBIDE LIMITED • KEMET DEPARTMENT • 8 GRAFTON STREET • LONDON W1 • MAYFAIR 8100

CHEMICALS • CRYOGENICS • DYNEL FIBRE • ELECTRIC WELDING • ELECTRONICS • FERRO-ALLOYS • FLAME PLATING • PRESTONE CAR POLISH • SILICONES • SUPERALLOYS • UCON LUBRICANTS
The terms Dynel, Kemet, Prestone, Ucon and Union Carbide are registered trade marks of Union Carbide Corporation ECR88



THE MOST COMPREHENSIVE RANGE OF PRECISION MINIATURE D.C. MOTORS IN THE COUNTRY

The Rank Pullin range of D.C. motors—the largest in the United Kingdom—British design—British manufacture. The units are generally designed to comply with specifications EL. 1925, BSG. 100, DTD. 1085C, K. 114A, K. 114D, K. 114E, AVP. 24 and operate over the temperature range -65°C to $+85^{\circ}\text{C}$. Special motors for higher temperature operation can be supplied. Motors can be supplied with round, pinion or splined and threaded output shafts.

Motors in the interservice and P.M. series ranges can be fitted with integral reduction gearheads.

P.M.I. SERIES PERMANENT MAGNET MOTORS
6, 12, 24, 28, 50 and 110 volt D.C. windings available..

INTER-SERVICE PERMANENT MAGNET MOTORS
6, 12, 28, 50 and 110 volt D.C. windings available.

SQUARE-BODIED SHUNT WOUND MOTORS
12, 24 and 50 volt D.C. windings available.

The P.M.I. and P.M.IC D.C. motors can be supplied with an integral centrifugal fan with moulded case thus forming compact high efficiency blower units.



The Rank Organisation, Rank Pullin Controls,
Component Sales, Phoenix Works, Great West Road,
Brentford, Middlesex. Telephone: Isleworth 1212.

USE THIS COUPON TO OBTAIN DETAILED INFORMATION :

Please send me details of your range of D.C. motors

Name

Position

Company

Address

Phone

ELEN.JUNE

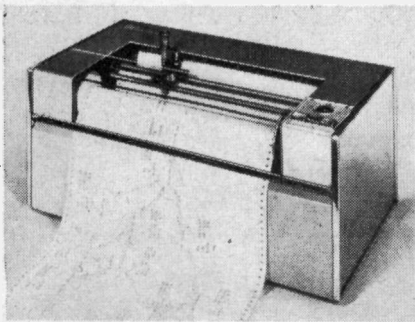

The plotting pen is clearly visible and accessible at all times, thus making it easy to align to a starting point (e.g. graph paper) and giving an unrestricted view of the plots as it develops.

Limit switches safeguard against the loss of data and possible damage by inhibiting the input whenever the paper runs out or the pen is driven off scale. Push-button controls are illuminated in the 'operative' position, positively acknowledging a command.

The tear-off bar permits completed plots to be neatly removed with a minimum of wastage.

EE 94 754 for further details

LINEAR MEASURING SYSTEM

The M.E.L. Equipment Co. Ltd, Manor Royal, Crawley, Sussex

(Illustrated right)

The PE2271 provides a direct measurement of tool position and is not affected by backlash and other machine inaccuracies. It differs from similar systems insofar as it employs a new type of dynamic transducer. The result is that it is accurate, reliable and insensitive to vibration, and is capable of operating at high speeds. Furthermore, there is no physical contact between its stationary and moving elements (there is 15mm clearance between them when mounted on the machine), and—although the system is an optical one—it is not affected by oil films.

The system comprises a linear glass scale having alternating reflecting and non-reflecting lines, the dynamic transducer and a small electronic unit.

The scale is clamped in a metal mounting, and as the glass is harder than steel chippings it can be cleaned without risk of damage. The divisions of the scale are 0.3mm beneath the surface and are comparatively coarse, the combined width of a reflecting and non-reflecting line being 0.64mm.

During machining operations, the glass scale is traversed by the transducer unit. The unit contains a rotating optical system which generates two 7500c/s light signals. One of these is a reference signal which is transmitted directly to a photocell, while the other is a measuring signal which is reflected from the glass scale to another photocell.

The phase relationship of the two photocell outputs varies with the position of the slide, a phase change of 360° representing 0.32mm linear movement.

The output from the photocells is received by a separate unit which converts them into a form suitable for feeding to position indicating or control equipment. The overall resolution of the system is 0.01 or 0.005mm, the required resolution being specified when ordering. Machines fitted with this system can be operated with table speeds as high as 480mm/sec.

An important advantage of the dynamic transducer is that it provides an a.c. output. High amplification is consequently simple, and interference signals are easily filtered out. Also, a comparatively low power light source, with a proportionately longer life, can be employed.

As this type of transducer generates a signal even when it is at rest, it has been possible to incorporate a 'dirty scale warning'. Should the scale become unduly soiled, the signal due to the light reflected from the glass scale becomes

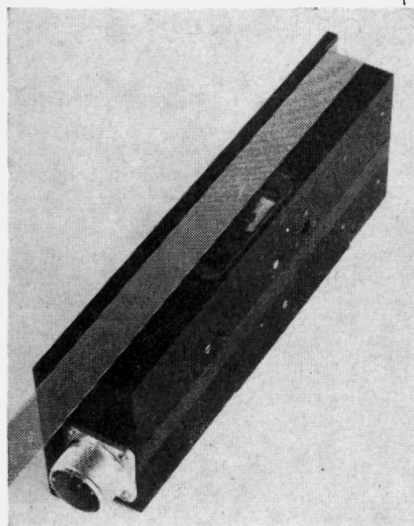

weaker, and this is indicated by a lamp on the associated electronic unit. The lamp lights well before the contamination is heavy enough to cause errors. The space between the transducer and scale is 15mm, and it is possible to clean both the glass scale and the window of the transducer without dismantling. With some machines cleaning can be carried out even during operation.

In the illustration, the glass scale is, for clarity, shown without the metal mounting to which it is normally fitted.

EE 94 755 for further details

PEN RECORDERS

Distributed by: Cybernetics Instrumentation Ltd, 174 Granville Road, London, N.W.2

(Illustrated above right)

This single channel pen recorder has a full-scale pen speed of 0.4sec for 250mm width paper. The zero point can be adjusted to any point on the paper. Chart speed is variable from 1 to 50cm/sec.

The recorders can be supplied with a built-in bridge amplifier stage so that recordings can be made directly from strain gauges, pressure or displacement

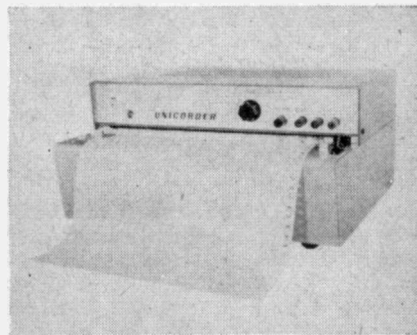

transducers etc without auxiliary equipment. The normal input voltage range is from 10mV to 50V in twelve steps.

Rack mounted, four channel and X-Y plotters are also available.

EE 94 756 for further details

SEALED MERCURY RELAY

Distributed by: Techna (Sales) Ltd, 47 Whitehall, London, S.W.1

(Illustrated below)

A British made hermetically sealed mercury relay is now being distributed by Techna (Sales) Ltd.

The relay is known as Euroswitch-M and employs the principle of breaking the arc on mercury to mercury contacts, thereby resulting in a life expectancy in excess of 10 million operations. Operation is by a plunger action instead of tilting and there are therefore no external moving parts. The mercury container is stainless steel which enables severe shocks due to current surges, arcing, etc, to be withstood.

A current of 25A at 440V a.c., resistive can be disconnected at an operating frequency of up to 2000 per hour. A full range of standard coil voltages is available and the operating power required is only 4W on d.c. voltages and 6VA on a.c. voltages.

The relay will operate within 25° of vertical and due to its construction is virtually unbreakable.

The small size of 1.5in diameter x 3.25in long coupled with absolute reliability and low cost makes this relay ideal for use in dangerous or contaminated atmospheres or for applications where long fault-free life is required.

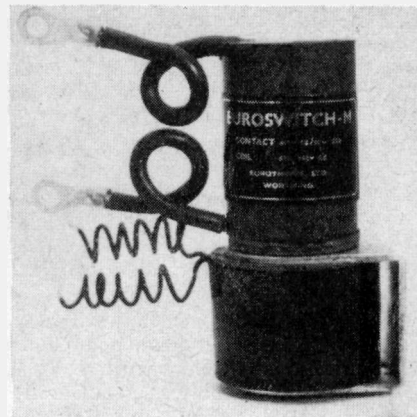

EE 94 757 for further details

FREQUENCY SYNTHESIZER

The Wayne Kerr Co. Ltd, Sycamore Grove,
New Malden, Surrey
(Illustrated below)

An entirely new solid-state instrument announced by Wayne Kerr-Gertsch gives direct digital dial-in and large in-line read-out of any desired synthesized frequency, in 1c/s increments from 5c/s to 50Mc/s and in 10c/s increments from 50Mc/s to 500Mc/s. This extremely wide coverage is achieved entirely on fundamentals. Known as model SSG-1, the instrument combines the high accuracy output voltage calibration of a standard signal generator with traditional Gertsch frequency accuracy; it also gives direct measurement of frequencies from 10kc/s to 1 000Mc/s (to 10Gc/s with ancillary unit).

Accuracy and stability are limited only by a single 1Mc/s master crystal oscillator. With the built-in oscillator, stability is better than 1 in 10^7 per day. Full provision is made for an external standard, when the SSG-1 will produce

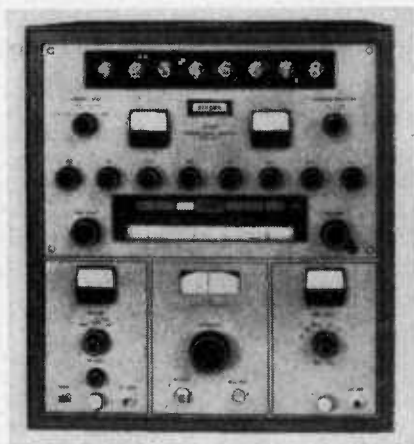

synthesized output frequencies to any limit of stability available from such standard.

Output levels of up to 200mV can be set to 0dBm and adjusted down to -130dBm by a precision 50Ω attenuator. Once the input level to the attenuator is set, an a.g.c. system maintains this level constant throughout the entire frequency range.

The SSG-1 has internal amplitude modulation (400 or 1 000c/s), built-in beat detector and meter, and can be adapted to read peak deviation of frequency-modulated signals. It measures 16in wide, 18in high, 21in deep and weighs approximately 100 lb.

EE 94 758 for further details

EDGE CONNECTORS

Ultra Electronics (Components) Ltd,
Industrial Estate, Long Drive, Greenford,
Middlesex

(Illustrated above right)

A new range of printed wiring edge connectors is being manufactured by Ultra Electronics (Components) Ltd.

Pitched on 0.156in centres, the range consists of 10-, 15- and 22-way connectors, fitted with floating bushes to



accommodate 8 B.A. screws. Contacts are manufactured from phosphor bronze, in UECL's patented bellows action. The mouldings, of diallyl phthalate compound, have a temperature range from -55°C to 110°C.

Contact resistance is 10mΩ maximum, and insulation resistance 5 000MΩ minimum under normal conditions. Nylon polarizing keys can be fitted in any position required.

EE 94 759 for further details

SWEEP GENERATOR

Telonic Industries U.K., The Summit,
2 Castle Hill Terrace, Maidenhead, Berkshire
(Illustrated below)

A new solid-state sweep generator, the model 1001, has been introduced by Telonic Industries. The new instrument features wide frequency range, variable sweep width, high stability, swept or c.w. operation, and a new type of frequency marking system. Range of the new unit is 100kc/s to 20Mc/s.

The width of the instrument's sweep may be varied through three ranges. On wide range, it covers 10kc/s to 20Mc/s, on intermediate range, 1kc/s to 2Mc/s and on narrow range, 100c/s to 200kc/s. The sweeping rate is also variable, continuous from 0.01c/s to 60c/s or may be locked to the 50/60c/s line. Output of the model 1001 is 1V r.m.s. The variable frequency marker output can be fed directly to a frequency counter.

Highly stable power supplies specially designed for the model 1001, combined with temperature compensation in the oscillator, provide a high degree of stability. On a short term basis, stability of the instrument is 500c/s.min⁻¹ and on long term, 5kc/s.h⁻¹.

An important feature of the generator is a new frequency marker system achieved by a deviation-multiplier circuit. The marker is operable in two modes, a 1Mc/s harmonic and a variable type. The harmonic marker is only 10kc/s wide. The variable frequency marker can be selected to be 10kc/s, 1kc/s or 100c/s

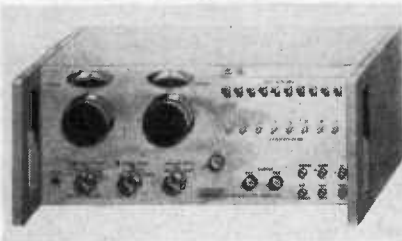

wide. The narrow widths of the markers permit an extremely accurate determination of frequency.

The marker system also includes a 'tilt' control for tilting the marker off vertical when it occurs on a steep slope permitting a more precise reading.

The generator is housed in a 19in wide x 7in high cabinet that may be adapted to rack mounting by the addition of two brackets.

EE 94 760 for further details

PIEZOELECTRIC ACCELEROMETER

Consolidated Electroynamics Division,
Bell & Howell Ltd, 14 Commercial Road,
Woking, Surrey

(Illustrated below)

The Consolidated Electroynamics Division of Bell & Howell Ltd has introduced a small, light weight piezoelectric accelerometer with a 'compliant rod' compression design which mechanically isolates the sensing system from the housing.

This mechanical isolation of the sensing element from the case provides maximum shielding from the blast of rocket engines and thermal transients.



The 4-274 piezoelectric accelerometer is particularly suited to operation in severe humidity because of its all-welded construction. Even with temperature cycling, there is no 'breathing in' of moisture as is found in epoxy-sealed units.

When shunted with a recommended value of capacitance (700pF), the change in sensitivity over the temperature range of -100°F to +300°F is typically less than 8 per cent. The accelerometer's 70kc/s mounted natural frequency allows a frequency response of ±5 per cent from 2c/s to 12kc/s.

EE 94 761 for further details

INTEGRATED CIRCUIT ANALYSER

Distributed by Quantum Engineering Ltd,
31 Queen Anne's Gate, London, S.W.1

(Illustrated on page 405)

The model IC-101 integrated circuit analyser manufactured by Optimized Devices Inc., U.S.A., provides a rapid means for evaluation, testing and analysis of monolithic and discrete component circuits. A slide switch assembly forms a 16 x 9 crosspoint matrix to connect any or all of the device pins to any of the four internal power supplies, four external arbitrary functions or a common point.

The fully-floating, 0 to ±100V,

when other
materials
stop
development

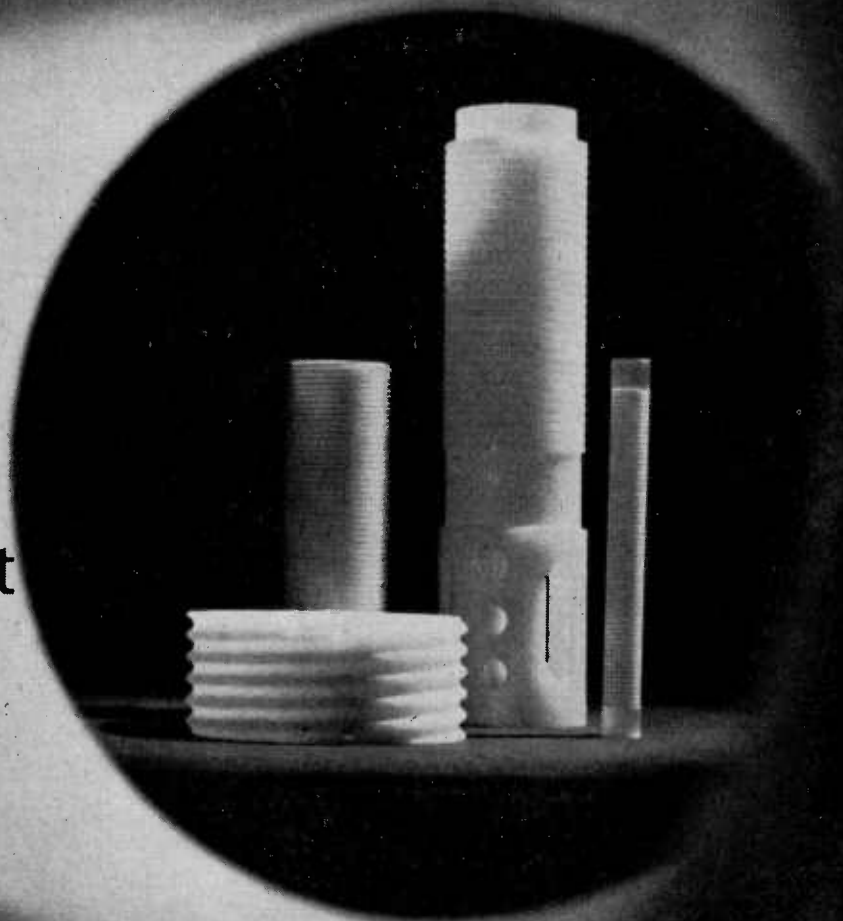

look into **VITREOSIL®**

When a rise in temperature raises a new barrier . . . when corrosion creates a new problem . . . look for the answer in VITREOSIL pure fused silica, which gives chemical stability and product purity at temperatures up to 1050°C. VITREOSIL is adaptable . . . we can machine parts to accurate limits for special applications and moulded parts can be machine-finished where close tolerances are specified.

Full details are available. One of our Technical Representatives will be pleased to call on request.

pure fused silica **VITREOSIL®**

THERMAL SYNDICATE LIMITED

P.O. Box No. 6, WALLSEND, Northumberland. Tel. Wallsend 625311 (8 lines) Telex 53614
9, BERKELEY STREET, LONDON, W.1. Tel. HYDe Park 1711 Telex 63945

SILICA INDUSTRIAL WARE • LABORATORY WARE • OPTICAL COMPONENTS • HIGH TEMPERATURE OXIDE CERAMICS

NEW

PM 3238 ultra-high sensitivity double-beam oscilloscope

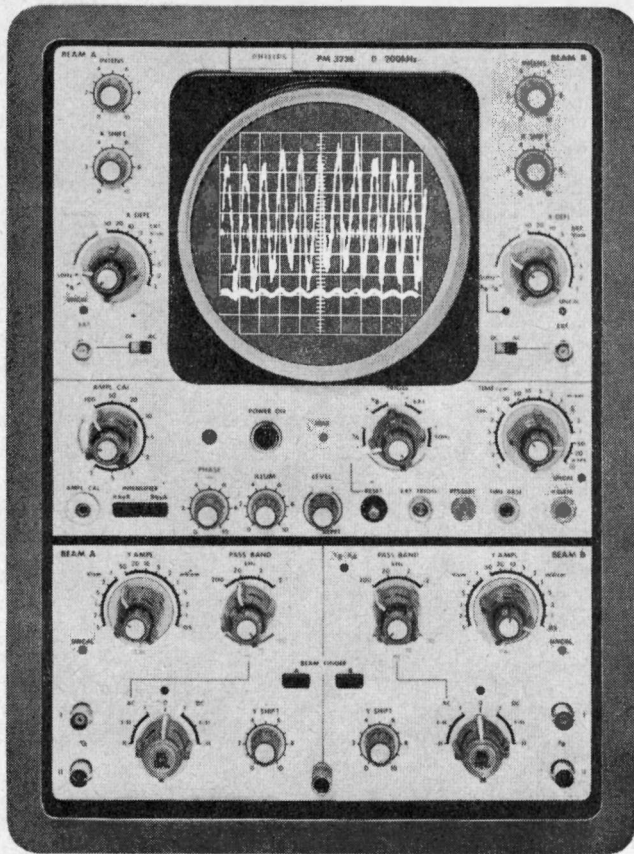

On the oscilloscope screen:
 Lower trace: 7 μ V sinewave, 560 c/s (sensitivity 50 μ V/cm)
 Upper trace: same signal displayed with cascaded amplifier (sensitivity 2.5 μ V/cm, bandwidth 0.5 c/s-20 kc/s)

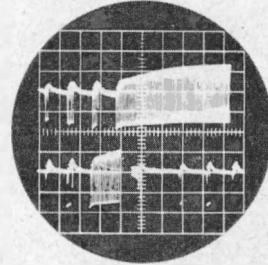

Start of RC generator
 Lower trace: as it would appear on a normal oscilloscope. Upper trace: using restart facilities of PM 3238 time base.

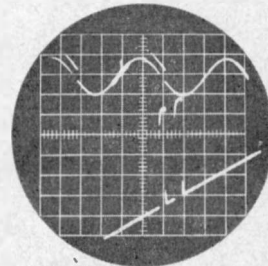

Sinewave with superimposed pulses
 The intensified part of the upper trace is shown magnified in the lower.

Bandwidth

DC - 200 kc/s

Sensitivity

50 μ V/cm

Common mode rejection

50,000 : 1

13 cm (5 in) CRT with full 10x10 cm display area for both guns ● Twin differential vertical amplifiers with sensitivity from 50 μ V/cm to 5 V/cm ● Very high common mode rejection factor ● Recorder output with independent shift control for each vertical channel ● Y-amplifiers can be cascaded via recorder output giving approx. 2½ μ V/cm sensitivity ● Filters for rejecting HF and/or LF noise ●

Servo system for DC balance ● Comprehensive triggering including DC and singleshot ● Full sensitivity "X-Y" facilities on one beam ● Twin horizontal amplifiers ● Independent X signal sources ● Independent X expansion ● Facilities for identification of the expanded portion of one trace by intensification of the other ● Facility for driving both "X" deflection systems from the Xa amplifier ● Wide range

of sweep speeds extending from 5 μ s/cm down to 5 s/cm ● Beam finder for quick trace location and adjustment ● Quick reset to start of sweep, from mid sweep ● Power output socket from the stabilized supplies for use with user-built accessories ● Comprehensive set of accessories available, including special "siamesed" low noise differential probe cables.

PHILIPS
 electronic measuring instruments



For the U.K.:
 Philips Electronics and Control
 The M.E.L. Equipment Company Ltd.,
 Manor Royal, Crawley, Sussex.
 Tel. Crawley 28787.

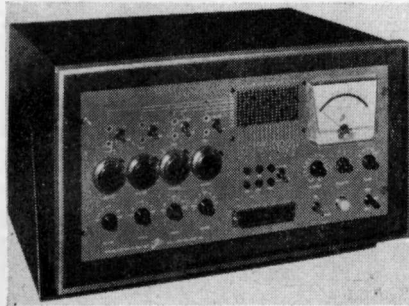

± 0.1 per cent resolution, power supplies using silicon transistor operational amplifiers mounted on glass-based plug-in circuit boards, are set quite independently for polarity, range and voltage by switches and 1000-division, direct-reading dials.

A self-contained, 5-range, mirror-scaled, 1 per cent accuracy voltmeter may be switched to any device pin for voltage measurement with respect to a common point. Current measurement facilities are provided.

Other features included are: inputs for external power and signal sources, connected to the test specimen via the switch matrix; monitoring of the device lead voltage, individual power supply voltage and current, and total ground current by external meters, for example, by a d.v.m. with data logging equipment; monitoring device pin signals by counters, oscilloscopes, etc. Front panel sockets are provided for the insertion of resistors to simulate constant-current operation, supply and common-ground impedances and for series-connexion of supplies via components, for example, relays or inductors, to check correct external circuit operation.

Dual (Kelvin) connexions at the test specimen adaptor eliminate measurement errors due to contact and lead voltage drop, especially in probe tests.

The analyser is supplied in a bench case, mounted for ease in use in a swivelling stand which can be locked in any position. When removed from the cabinet, the unit may be installed in a 19in rack.

EE 94 762 for further details

TEMPERATURE CONTROLLER

Clarke Chapman & Co. Ltd, (Electronics Division), Team Valley, Gateshead, Co. Durham
(Illustrated below)

This accurate but inexpensive proportional temperature controller can control up to three hundred different points with an accuracy within $\pm 1^\circ\text{C}$ over a temperature range of 0 to 1000°C . Control is proportional and the proportional band can be set from 3 per cent to 300 per cent. Push-button selection

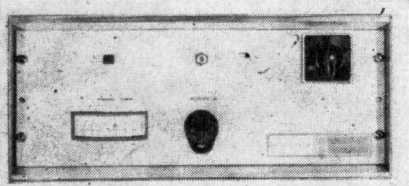

allows the temperature of each point to be monitored on an edge-scale moving-coil instrument. If desired, points which are not being controlled can also be monitored.

Each control loop circuit is contained in a small, panel mounted, dust proof, plug-in module and will handle electric heater loads or can be used in conjunction with electro-pneumatic convertors.

It is envisaged that the controller will find its main application in process foundries, plastics, rubber, chemicals, synthetic fibres and other industries where inexpensive multi-point heat control is needed. Another model is available giving accuracy to within $\pm 0.1^\circ\text{C}$.

EE 94 763 for further details

ELECTRONIC MULTIMETER

O.P. Instruments Ltd, 246 Sutton Common Road, Sutton, Surrey

(Illustrated below)

This direct current reading instrument has been designed as a low cost complement to the standard multimeter, having an input resistance exceeding $100\text{M}\Omega$ on all voltage ranges, and reading voltage

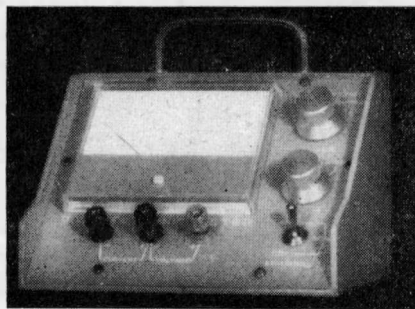

and current on sixteen ranges. The full scale voltage ranges cover 333mV to 1kV , and current ranges cover 333nA to 1mA .

The meter dial is inclined at 45° , and has a large scale for easy reading. The ranges are organized for optimum accuracy distribution.

Small size ($7\frac{1}{2} \times 5\frac{1}{2} \times 5\text{in}$), and battery operation enhance portability, there being direct external access to the long lasting 3V Bijou battery.

The transistor amplification provides high sensitivity, excellent electrical stability, and full protection against overload and polarity reversal.

With an external rectifying probe the instrument will measure r.m.s. calibrated peak alternating voltages.

EE 94 764 for further details

L.F. SIGNAL GENERATOR

Taylor Electrical Instruments, Montrose Avenue, Slough, Buckinghamshire

(Illustrated above right)

This new l.f. oscillator, model 192A, is a versatile instrument designed for general test purposes, but it has a performance which also makes it suitable for use as a general purpose laboratory signal generator.



It has been designed to provide a sinusoidal or square waveform over the frequency range of 10c/s to 100kc/s in four frequency bands, the wave shape required being selected by the waveform switch. The maximum sine wave voltage at the output terminals is 25V r.m.s. with an output impedance of 68Ω at 25mV rising to approximately $10\text{k}\Omega$ at maximum output.

The instrument thus provides a convenient source of low power for checking the frequency and transient response of amplifiers, transformers, loudspeakers etc.

A conventional Wien bridge circuit is incorporated which is thermistor stabilized to provide a constant amplitude at all frequencies. The square wave facility is provided by feeding the output from the bridge circuit into a Schmitt trigger circuit which clips and shapes the sine wave to provide a square wave output. The circuit is designed so that this same stage forms a voltage amplifier in the sine wave position.

EE 94 765 for further details

COUNTER-TIMER

Radun Controls Ltd, White Street, Caerphilly, Glamorgan

(Illustrated below)

The model 152 computing counter is a general purpose low cost electronic counter of increased versatility.

Designed for industrial or laboratory applications in the frequency range of 1c/s to 250kc/s , the counter employs transistorized circuits throughout, having a four in-line long life number tube display. A counter model 153 with an overflow indicator is also available.

Besides performing the normal functions of most pre-settable counters such



as: measuring frequency, period, time interval or frequency division and batching, the counter also measures and displays: speed or rate of flow directly in appropriate units such as rev/min, gal/min or ft/min and ratios of two frequencies or rates directly or normalized.

By the use of a fully variable four decade time-base, an input signal can be sampled for periods varying from 100 μ sec to 1sec in 100 μ sec steps, or by the use of a $\times 10$ multiplier from 1msec to 10sec in 1msec steps, thereby providing a simple method for converting frequencies into practical units. For tachometer or flow metering applications, machine or transducer characteristics can be automatically compensated to give a display directly in desired units. Likewise, through the use of a second input signal channel and variable time-base, the ratios of two frequencies or speeds can be normalized.

Subsidiary features include: a 10kc/s crystal source with dividers to provide outputs from 100 μ sec to 10sec in decade steps; self-contained test facilities; a display which can be blanked out until a counter is complete or alternatively continuously displayed; a display period adjustable from 0.3 to 6sec or 'locked up' for a one shot display; output signals comprising closure of a pair of relay contacts at the end of a count and which can be used for an external control function; print-out facility in the form of direct decimal outputs expressed in terms of a voltage level.

EE 94766 for further details

COATING PLANT

Balzars High Vacuum Ltd, Northbridge Road, Berkhamsted, Hertfordshire

(Illustrated below)

This new coating plant, the BA 360 is suitable for small production or research work in the field of optical or electronic thin films.

The unit is compact and versatile, the



vertical double-walled stainless steel vacuum chamber, having an internal diameter of 360mm and internal height of 390mm; pumping is effected by a semi-automatic single lever operated pumping unit. With a pumping speed of 650 litres per second, the empty and clean plant can be evacuated to 1×10^{-5} torr in approximately five minutes and by including a deep cooled baffle and Meissner trap, pressures as low as 5×10^{-7} torr can be achieved in less than 15 minutes.

As a research and development unit it has the advantage that new processes developed can readily be transferred to the larger production models—the BA. 510 and BA. 710.

The accessories available for these larger models—glow discharge equipment, electron beam evaporation, deep-cooled baffles, thickness measuring equipment, servo-controlled gas inlet valve, simultaneous evaporation from two sources, rotary cage, etc., are also available for this smaller unit.

EE 94767 for further details



MICROWAVE POWER METER

W. H. Sanders (Electronics) Ltd, Gunns Wood Road, Stevenage, Hertfordshire

(Illustrated above)

This new power meter is designed to indicate directly microwave power up to 10mW, and offers considerable flexibility in operation. The meter is used with a broad-band microwave head which will cover the frequency range appropriate to the waveguide size (2.6 to 12.4Gc/s) with a maximum v.s.w.r. of 1.5. Thermistors or bolometers are used in the measuring heads as sensing elements. Matched pairs of thermistors are used for temperature compensation, but where this facility is not necessary single elements can be employed. All elements, which operate at a resistance of 200 Ω , may be replaced by the operator.

The instrument is fully portable and operates either from the mains or internal batteries with no degradation in the accuracy of 3 per cent f.s.d.

EE 94768 for further details

ULTRASONIC GENERATORS

Radyne Ltd, Wokingham, Berkshire

(Illustrated above right)

The increasing industrial demands for

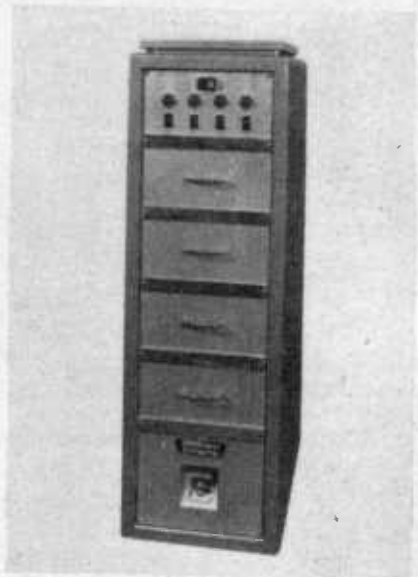

large ultrasonic cleaning equipment has prompted a new design approach for generators and transducers and Radyne Ltd has developed an assembly in which unlimited power outputs are provided by the use of a module generator supply. Consisting of a power supply, control panel and multiple 1kW module units the system enables custom built generators to be easily produced.

Each module generator supplies power to an immersible or bulkhead transducer unit and large areas can be irradiated by multiple transducer assemblies. Individual or group control is facilitated by means of separate switching.

A two-unit console and a four-unit console form the basic system. The generator modules are plugged into the consoles and are based on the Radyne s.c.r. inverter circuit. Associated transducers use the Radyne Magnatrac elements providing a fully industrialized system. The consoles can either be air cooled, or water cooled in a completely sealed case for stringent industrial operation.

EE 94769 for further details

TRANSFER FUNCTION ANALYSER

Smiths Industries Ltd, Aviation Division, Kelvin House, Wembley Park Drive, Wembley, Middlesex

(Illustrated on page 407)

Combining a sine-wave generator and analyser in a single unit, a new transfer function analyser is available from the Aviation Division of Smiths Industries Ltd. The instrument operates in the sub-audio frequency range, from 24c/s down to 1c/min.

Read-out of the analyser is in eight ranges, from 50mV to 150V full-scale deflexion. The generator outputs have a maximum figure of 10V and the output impedance is 10 Ω . Overall accuracy of the instrument is ± 2 per cent in amplitude and $\pm 1^\circ$ in phase.

The generator has two output channels one of which may be varied through 360° in relation to the other. This permits a

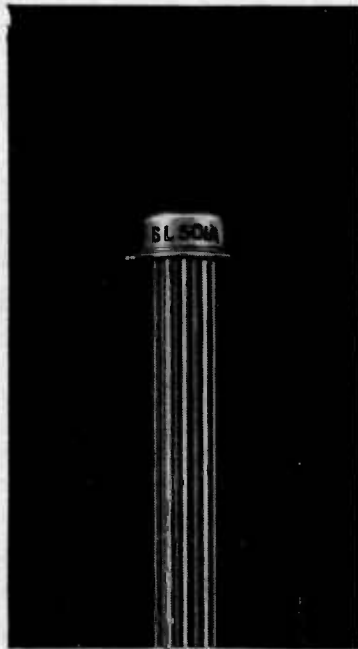

the
SL500 series
is the
most advanced
solid circuit
wideband
amplifier series
in the world

VERY BRIEFLY

CURRENT GAIN
26dB

BANDWIDTH
100 Mc/s

INTERNAL AGC
40dB.RANGE

INTERNAL
SUPPLY LINE
DECOUPLING

a completely British product originated by the Allen Clark Research Centre, Caswell.

*Write for full details of this and other
amplifier ranges*

PLESSEY Components Group

Semiconductors Limited



Cheney Manor, Swindon, Wilts. Tel: Semiconductors Sales, Swindon 6251

AUTOMATIC PLANCHET COUNTER

- 24 or 40 PLANCHET POSITIONS
- PRINT-OUT OF TIME, COUNTS, AND SAMPLE NUMBER
- PRE-SET FOR COUNTS, OR TIME

The ASS-13 assemblage illustrated handles 40-1" dia. planchets. A conversion set is available to enable it to accommodate 24-2" dia. planchets.

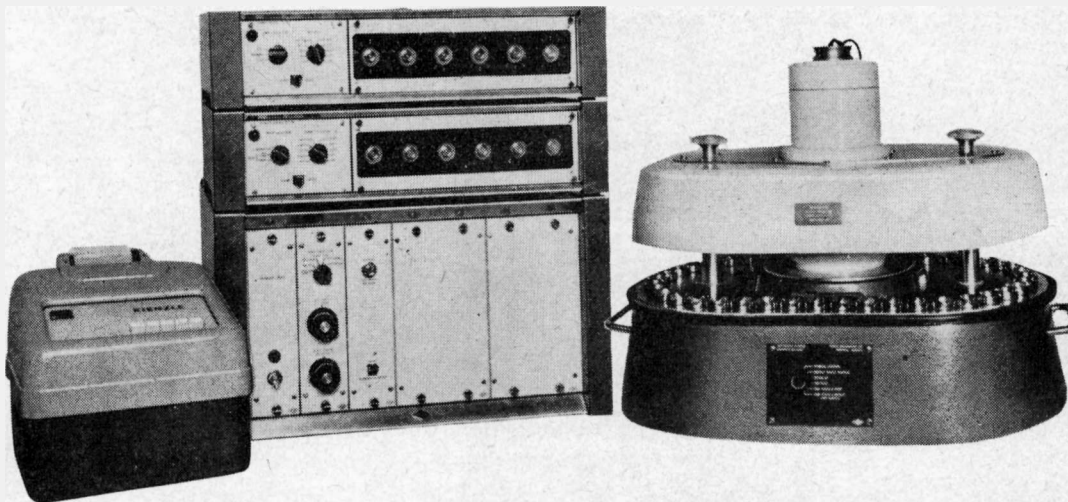

The windowless scintillation detector has a background of about 12-15 cpm and an efficiency of 90-100% for C-14 in a 2 pi arrangement ignoring self absorption.

The various modes of counting include the following facilities:

Manual.

Automatic counting in sequence continuously or stopping at the last planchet.

Repeat counting of an individual sample.

Repeat counting on the last planchet.

Stopping at a selected planchet.

Alternative systems may include low background anti-coincidence detectors, sodium iodide crystal detectors and proportional counters.



PANAX EQUIPMENT LIMITED

Holmethorpe Industrial Estate, Redhill, Surrey. Tel: Redhill 63511

frequency response to be read off in polar co-ordinates as an alternative to the normal cartesian presentation.

In addition to direct low frequency signals, modulated signals having a 400c/s carrier may be generated and analysed. Choice of carrier or direct working is independent for the analyser section and for each generator output.

Both the generator output and analyser input terminals are floating on both direct and carrier working. This gives the user complete freedom to inject and measure signals in any part of a circuit.

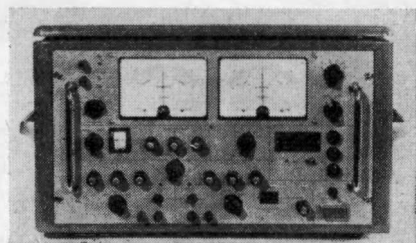

EE 94 770 for further details

SINTERED SILVER MICA CAPACITORS

London Electrical Manufacturing Co. Ltd,
Bridges Place, Parson Green Lane,
London, S.W.6

(Illustrated below)

Using mica blade sizes of 25mm by 15mm in a sintered construction, LEMCO has increased its range of sintered silver mica capacitors.

Pure silvered ruby-mica plates are stacked, subjected to intense compression and fired, bonding the plates into a stable robust block. End wires are soldered on using special solders to maintain the highest possible Q.

To suit most applications these capacitors are available in moulded, synthetic resin insulated, or wax finish and are intended for professional applications.

Prolonged life tests have shown these capacitors to be extremely stable under all forms of environmental stress, and to offer a low temperature coefficient.

Capacitances from 5 000pF to 0.05 μ F are available with operating voltages of 200 and 350V d.c.

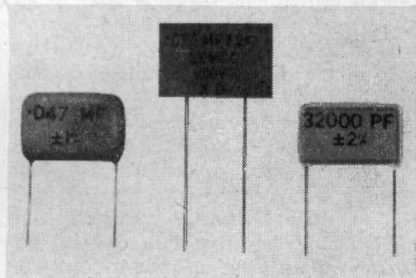

EE 94 771 for further details

MICROCIRCUIT BOARDS

Harrison Reproduction Co. Ltd,
164 Lynchford Road, Farnborough, Hampshire
(Illustrated above right)

A new and advanced method of pro-

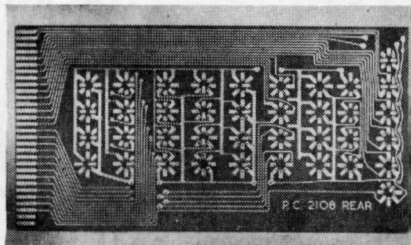

ducing through-plated hole circuit boards has been developed for use in micro-circuits. Produced by Harrison Reproduction Equipment Ltd (Movitex Group) the boards are the equivalent in micro-circuits of the use of printed circuit boards in transistorized assemblies.

The new technique allows circuit lines to be reduced down to four thousandth's of an inch wide with four thousandth's of an inch separation. Holes are through plated down to 15 thousandth's of an inch diameter. It is believed to be the first time that such fine tolerance and compactness has been available in the U.K. on a production basis.

Harrisons are using a new combination of processes for deposition, plating, etching and bonding of copper to glass fibre. Epoxy bonded glass fibre forms the base of the boards with copper circuit lines and holes, completed with a variety of finishes, including tin dispersions and gold plating. Bond strength has been checked and tested and is claimed to be comparable with ordinary circuit boards. The working temperature range is from -55°C to 100°C .

EE 94 772 for further details

DIGITAL VOLTMETER

Fenlow Electronics Ltd, Springfield Lane,
Weybridge, Surrey

(Illustrated below)

The Fenlow digital voltmeter type 301A is a precision instrument using a new strobe locked integration technique. The oscillator which produces pulses to be counted during the signal and reference integration periods is servo controlled to be 20 000 times the mains frequency by means of an early and late strobe principle often used in radar tracking systems. The effect of the strobe locked integration is to reduce the effects of series mode signals (without the use of filters) by about 100 times over fixed integration period systems when the mains frequency deviates, as it does during winter.

The input and integrator amplifiers make use of field effect transistors for chopping thus reducing the drift and

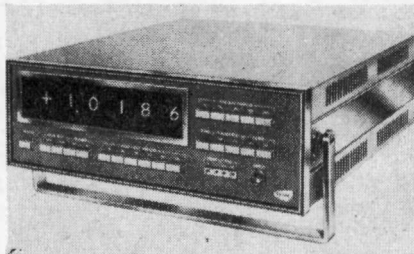

giving very low input currents and high input impedance.

The whole of the input system is floating permitting differential operation even when used for driving a printer. The instrument contains a programme unit facilitating operation from external commands.

Five voltage ranges are provided, covering 0 to 100mV up to 0 to 1kV.

EE 94 773 for further details

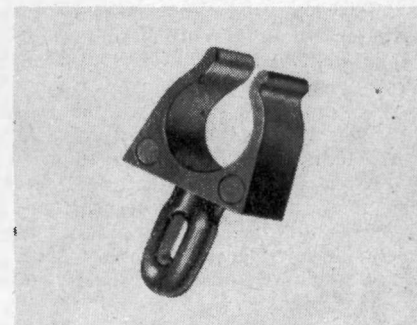

TRANSISTOR CLIP

Jermyn Industries, Vestry Estate, Vestry Road,
Sevenoaks, Kent

(Illustrated above)

A plastic clip has been introduced by Jermyn Industries Ltd which is fixed into position by simply pushing it into a $\frac{1}{16}$ in diameter hole. The clip holds a diameter range from 0.189in to 0.235in and is thus suitable for transistors such as the OC200. Made of nylon A100 which has a melting point greater than 210°C , the clip is suitable for flow soldering techniques, since, unlike other clips in polythene, it is completely unaffected by the solder flowing over it.

EE 94 774 for further details

PSOPHOMETER

Laboratoire Electro-Acoustique, 5, Rue Jules
Parent, Rueil (S & O), France

(Illustrated below)

This unit is designed for absolute background noise level measurements and consists of a calibrated amplifier, a psophometric filter and a measuring instrument.

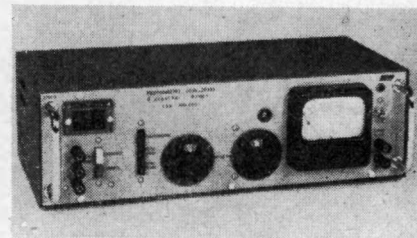

Input is by balanced transformer with an impedance greater than $5k\Omega$ and sensitivity is -115dB to $+15\text{dB}$ with attenuators providing 10dB and 1dB steps. Interchangeable filters are provided and silicon transistors are employed throughout.

Instruments are available for both radio-broadcasting and telephony.

EE 94 775 for further details

SHORT NEWS ITEMS

The Control and Automation Division of the Institution of Electrical Engineers is to hold a conference entitled, "Integrated Process Control Applications in Industry" at the University of Manchester on 26 to 29 September.

This conference, which will be residential, is being supported by the U.K. Automation Council and the Ministry of Technology, and the object is to provide managers, process designers and engineers with an appreciation of the potentialities of modern control techniques and their place in today's industry. Topics will include alternative methods of control, control equipment available, applications in process industries and economies achievable. The concept will be introduced of the degree of integrated control which can vary from simple manual control to computer controlled systems. Existing installations will be used to illustrate the levels of integrated control appropriate to different economic and technical situations.

Further details are obtainable from the Secretary, The Institution of Electrical Engineers, Savoy Place, London, W.C.2.

The Ministry of Technology has placed a contract valued at £15 000 to extend the SIRAIID service, operated by the British Scientific Instruments Research Association, which advises industrial and other customers—at home and overseas—in the selection of instruments and industrial control equipment.

This contract will enable BSIRA, which has already earmarked approximately £25 000 for the service this year, to develop SIRAIID in general and also to make available to all users of measurement and control equipment a special service formerly limited to members of the Association. This service which is operated from the Association's Headquarters at Chislehurst, Kent entails a detailed analysis of the customers' requirements and the instruments involved.

The British Acoustical Society has been formed as the result of the studies carried out by a committee set up in 1963.

The Society's interests will embrace all aspects of sound, hearing and vibration, including ultrasonic activities such as the detection of flaws in solids and of shoals of fish in the sea. Such currently important problems as the noise of aircraft and traffic, industrial

noise, noise in dwellings and the design of better public and concert halls will be studied with due regard to intelligibility and musical aspects. The Society will also actively sponsor the furthering of teaching and research in acoustics.

The Chairman is Dr. A. J. King and the Vice-Chairman is Professor E. J. Richards who are respectively the Chairman of the Acoustics Group of the Institute of Physics and Physical Society and the President of the Society of Acoustic Technology.

The Joint Honorary Secretaries are Dr. P. Lord, Dept. of Pure and Applied Physics, Royal College of Advanced Technology, Salford, Lancashire, and Dr. R. N. B. Stephens, Dept. of Physics, Imperial College, South Kensington, London, S.W.7.

Nippon Electric Co. Ltd (NEC) has been awarded a contract to build an experimental earth station for satellite telecommunications at Ahmedabad, Gujarat State, India.

The contract was officially signed in March this year by the International Telecommunications Union (ITU) acting as the executive agency of the United Nations Development Programme which will provide the funds needed for the construction of the earth station. NEC won the contract at an international bidding held in Geneva, Switzerland, in September 1965.

The contract calls for the provision of a complete set including a transmitter and receiver with a 14m diameter parabolic antenna, as well as installation of the equipment.

The Centre National D'Etudes des Telecommunications (C.N.E.T.) of the Compagnie Generale d'Electricite of France (C.G.E.) has carried out experiments on circular waveguides for the transmission of 100 000 telephone channels or 12 television channels over a distance of 1 500 metres.

As a result the French Post Office has decided to co-operate with Cables de Lyon, a branch of C.G.E., in the installation of an experimental circuit, 5km long, in the Paris area.

The Post Office has placed a contract valued at £2½M to £3M with Submarine Cables Ltd for the supply of three submarine telephone cables with the largest capacity of any sea cables in the world to be laid during this year and next. The

cables, each of which will carry 480 circuits, will be from Hampshire to St. Helier, Jersey; Yorkshire to Norway; and East Anglia to the Netherlands.

The first of these on which work will be done will be the cable to Norway of which the shore end in Britain will be at Cayton Bay, near Scarborough. The Danish cable ship "Peter Faber" will be laying two cables, one for speech and the second an earth cable.

The speech cable, the Norwegian end of which will be at Kristiansand, will be 450 miles (386 nautical miles) long and will have a repeater at approximately every eight and a half miles, 53 in all. The repeaters will be transistorized, and these will be the first cables in the world to use transistorized repeaters on a large scale. The only other international submarine cable known to use transistorized repeaters is between the U.K. and Belgium. It has two such repeaters, installed in 1964.

The present cable linking Britain and Norway has only 36 circuits.

The shore-ends of the Jersey cable at Hengistbury Head and St. Helier are planned to be laid this October, and those of the Covehithe (near Lowestoft) to Katwijk (Netherlands) cable in April next year.

All the main sea sections of the cables will probably be laid by the Post Office cableship "Monarch".

The cost will be borne pro-rata by the British, Norwegian and Dutch Administrations.

The Telecommunications Division of Elliott-Automation is now producing a fully-transistorized transmitter-receiver equipment, designed to operate at the ultra-high-frequencies required by British police forces. The equipment can be located in a police station or police control centre to provide a radio link with policemen on the beat.

It can also be used, with the addition of a channelling unit, to transmit and receive information between data link termini and, at the same time, to provide a voice channel for speech communication. This application is of particular importance in connexion with data processing systems, as the equipment can be used to link a computer with offices or industrial plants several miles away.

The transmitter-receiver is designed for either simplex or duplex operation and meets GPO specification W 6457. Full modulation corresponds to a deviation of 25kc/s, but this can easily

be adapted to foreign 50kc/s requirements by the substitution of a filter.

To provide the performance necessary for police communication, a receiver sensitivity of 0.5 μ V at the threshold of limiting, a low overall receiver noise of 8dB and a transmitter power of 8W have been included in the design. Transmit and receive frequencies, in the range 450 to 470Mc/s, are pre-selected by plug-in crystals.

The British Standards Institution has issued a Specification B.S.4009 "An artificial mastoid for the calibration of bone vibrators used in hearing aids and audiometers". It specifies the basic features of an artificial mastoid for use in the objective calibration of bone vibrators over the approximate frequency range 250 to 4000c/s. The dimensions, finish and composition of the components of the artificial mastoid are specified in detail.

The primary purpose of the standard is to ensure that the comparisons between the response characteristics of bone vibrators of similar pattern carried out on the artificial mastoid shall reproduce closely the comparisons which would obtain on human mastoids with the same vibrators.

Copies of B.S.4009 may be obtained from the British Standards Institution, Sales Branch, 2 Park Street, London, W.1. Price 4s. 6d. each (Postage will be charged to non-subscribers).

English Electric-Leo-Marconi Computers Ltd has completed the design of a large central computer, designated System 4-75, for simultaneous operation by 200 users.

The system which will be available in June 1968 has been designed for universities, research centres, Government departments and commercial firms. The user feeds to the computer, through a terminal or console in his own office, the data which he wants processed. The computer instantly accepts the job, does the calculations and sends the answer back in a few seconds. Distance between the terminal and the computer is not critical—it can be hundreds of miles apart or in adjoining rooms.

An automatic telegram centre has been installed at the Scandinavian Airlines System's Headquarters (SAS) at Stockholm.

Designed jointly by SAS and the Swedish Remington Rand Company the equipment includes a UNIVAC 418 computer and can cope with over 5 million telecommunications messages annually.

Advanced logic design permits the computer to receive and forward messages simultaneously on some 60 lines. If all the lines are busy, messages are

temporarily stored on magnetic drum before transmission. The computer has a 16 384-word core memory, which can be extended to some 65 000 words. The magnetic drum accommodates nearly 790 000 alphanumerical characters with an average access time of 8.5msec.

The installation includes a high-speed printer that operates at a maximum speed of 600 lines/min, a card reader that reads 600 cards/min, and a magnetic tape unit with a data transfer rate of 23 741 characters/sec. The communications system is provided with external specified index, which guarantees that all information will arrive at the proper location in the central processing unit.

The British Radio Valve Manufacturers' Association (BVA) and the Electronic Valves and Semi-Conductor Manufacturers' Association (VASCA) announce that the total sterling value of sales of British radio valves, tubes and semiconductor devices for 1965 shows an increase over those for 1964 as follows:

	1965	1964
Valves and tubes	£46.1M	£48.3M
Semiconductor devices	£28.1M	£23.7M
	£74.2M	£72.0M

The figures for the last quarter of 1965 were:

Valves and tubes	£13.7M
Semiconductor devices	£ 7.5M
	£21.2M

Of the total for 1965, according to figures previously released, export sales reached the record level of £13 320 466.

The Royal Netherlands Navy has placed an order worth over £100 000 with Elliott-Automation for a new type of naval tactical training simulator which will reproduce faithfully complex tactical situations under realistic war-like conditions.

The simulator incorporates the operations rooms of two ships and reproduces for the crews under training all the information about surface, underwater and airborne targets they would receive under service conditions. The movements of a complete convoy can be simulated, if required, reproducing at will all the problems facing naval escort ships under conditions of search and attack. Great flexibility in the planning of exercises is provided for.

The simulator incorporates an Elliott 920B digital computer.

The Bagneux Research Centre of the Compagnie Française Thomson-Houston has recently introduced a new radar system known as BEARN for the automatic tracking of missiles.

For a missile not equipped with a

responder and travelling at about 15 times the speed of sound, the range of BEARN exceeds 200km. With a responder, the range extends to 400km.

The new radar system is largely transistorized and uses digital techniques for data handling.

Its antenna of 4m diameter is of the Cassegrain type.

Plessey Radar Ltd, part of the Plessey Electronics Group, has signed an agreement with the Compagnie Générale de Télégraphique Sans Fil of France (CSF) for the manufacture and sale of the CSF T1 450 scan conversion bright display and its peripheral equipment.

The agreement gives Plessey exclusive rights in the UK, together with non-exclusive rights in certain other parts of the world. It also provides for the mutual exchange of information concerning improvements in design and performance.

This agreement enables Plessey to offer bright displays with their civil and military radar and data handling systems.

The Ministry of Technology has placed a £106 500 research contract with the Imperial College of Science and Technology for a three-year programme of work on a general purpose Compiler Processor for digital computers.

The contract aims at providing a general tool for the translation of any language for use by any computer. As the processor programme will itself be written in one of the languages it can process, once it has been coded by hand on one machine it can be used to transfer itself on to another. The scheme is a generalization of work done at Manchester University on the Compiler.

The Thames Radio has been brought into operation as part of the Post Office Radiotelephone service for ships using the port of London.

With aerials near Sevenoaks it will cover an area roughly from Tower Bridge to beyond Canvey Island, including the Medway. It will be available to handle telephone calls with ships at anchor, in port, or anywhere in the Thames area.

The service operates on v.h.f., f.m. using the common calling and answering frequencies. Channel 16, 156.8Mc/s, for establishing communication in either direction, after which the working frequencies are used—ship transmits on 157.35Mc/s and Thames Radio on 161.95Mc/s.

Cossor Electronics Ltd has received an order valued at approximately

£500 000 from the Ministry of Aviation for the supply of eight ground secondary surveillance radar interrogator systems.

This order follows those already received for installations at London Airport, Ash and Ventnor.

The standard installation of this equipment is dual channel, in the sense that two interrogator/receivers are provided, either of which may be coupled to one aerial. Servo control equipment for synchronizing the s.s.r. aerial to the primary radar is also duplicated. A single-channel installation omits the standby interrogator/receiver and servo control equipment.

When completed, these installations will provide s.s.r. cover for the major part of the UK Airways System.

The first of three British built and operated earth stations to be used to send and receive military communications under the Anglo-American Initial Defence Communications Satellite Project, announced on 2 February this year, has now been erected at the Ministry of Aviation Signals Research and Development Establishment at Christchurch.

Designed and manufactured by The Marconi Co. Ltd for the Ministry of Aviation, this first station was delivered to SRDE only one year after the placing of the contract and opened on 4 May.

The second and third stations have been completed and will shortly be delivered to overseas sites.

The Society of Instrument Technology is organizing a three-day conference at St. Andrews on 20 to 22 September, 1967 on the subject of "On-line Measurement and Inspection and their Impact on Quality" as its contribution to the National Quality and Reliability Year.

The conference will cover three main spheres:

- (a) Composition and Analysis
- (b) Physical Properties and Chemical Techniques
- (c) Detection of Defects

It is intended that the papers presented will be compact and incisive to allow adequate discussion and good coverage of the subject. Offers of papers of about 1000 words which can be presented in about 10 minutes are requested.

Summaries (100/200 words) of papers, for consideration, should be forwarded by 31 August 1966 to: The Secretary, Society of Instrument Technology, 20 Peel Street, London, W.8.

The Process and General Industries Division, Stafford, of English Electric's Electrical Products Group has been awarded a contract worth approximately

£350 000 by the Ministry of Aviation, to supply equipment for fatigue testing the forward fuselage section of the BAC/Sud-Aviation "Concord" in accordance with a special test procedure developed by the Royal Aircraft Establishment, Farnborough.

Known as 'convective' testing, the procedure simulates the alternate heating and cooling effects that take place during flight and this thermal cycling is intended to operate continuously for a period of about five years.

The contract covers two air systems, heating and refrigeration plant, process control equipment and two English Electric Leo Marconi KDF7 digital computers, for installation at Farnborough. Considerable emphasis has been placed on the reliability of the test facility, as it is designed to operate largely unattended, and separate computers are to be used for control and monitoring.

The British Standards Institution has published B.S.4010 entitled, "Guide to the specification of magnetic cores for use in coincident current matrix stores".

This guide is intended to help manufacturers of matrix stores in the purchasing of magnetic cores, and it defines terms used to specify the properties of magnetic cores intended for use in coincident-current matrix stores having a nominal 2:1 selection ratio. Measuring methods and conditions of test, and recommendations for the specification of cores and the correct presentation of core performance data are also given in the guide.

The guide which is substantially in agreement with international proposals on the subject, is divided into five parts covering the description of current pulses; description of core responses; derived core characteristics; test requirements; specification of cores and presentation of information.

Copies of B.S.4010 may be obtained from the BSI Sales Branch, 2 Park Street, London W.1. Price 12/6 each. (Postage 1/- extra will be charged to non-subscribers.)

The M.E.L. Equipment Co. Ltd is to supply the Post Office with specially developed units for delaying low frequency signals in radio telephony equipment which is to be supplied to the GPO.

The delay units, type YL2109, are made by the M.E.L. Equipment Co. Ltd and work in conjunction with G.E.C./GPO Lincompex (linked compressor expander) equipment. The method of transmission involves the separation of the amplitude and frequency information in the speech signal. This can introduce a difference of as much as 8msec between the amplitude and frequency information signals. The M.E.L. devices are used to delay one of the

two signals in order to restore their original time relationship.

Each delay unit comprises, in effect a 'modulator', magnetostrictive wire delay line and 'demodulator'. A voltage-controlled multivibrator converts speech frequency information into a frequency modulated pulse train. This is delayed by the delay line (a standard YL2108 digital delay module) and then reconverted to the same form as the original speech signal.

The dynamic range of the delay units is 55dB, and performance over the telephone speech band (200 to 3200c/s) is flat within plus or minus 1dB. Overall distortion and linearity are better than 1 per cent.

Ultra Electronics Ltd, London, are to supply their fully-transistorized u.h.f. emergency and standby communications system (type D403P) for the Phantom aircraft on order from the McDonnell Aircraft Corporation, Missouri to be delivered to the British armed forces.

The D403P system is a further development of the D403M at present in production for the Royal Air Force and Navy, and has received full approval of the Ministry of Aviation.

The Flight Simulator Division of Redifon Ltd has received orders totalling £1½M from the U.K. and \$1½M from the United States for flight simulators.

The United Kingdom order is from the Ministry of Aviation for three Phantom Digital Flight Simulators, two for the Royal Air Force and one for the Royal Navy. Each of these simulators includes a digital computer for the operational flight trainer and a second digital computer for the tactical simulation. Each simulator is provided with the Redifon Three Axes Motion System and a Colour Visual System which permits the pilot to make his visual approaches and landings at his base. In addition, each system includes a 64ft² terrain model so that the pilot may gain experience and training in the ground attack mode. The tactical section includes full simulation of the weapons system and the aircraft operational radars using the Redifon Land Mass Multi-Colour System.

The two digital computers used with each simulator complex are identical and they use the latest silicon integrated microcircuits.

The American order comes from Western Airlines of Los Angeles for a flight simulator to train the crews of their new 737 Fleet, and the civil training centre of Flight Safety Inc. of La Guardia. The latter has just signed a contract with Redifon for three simulators, namely a DC-9, Lear Jet and King Air, and this contract includes an option for a further simulator for the Jet Commander.

FAST ACCURATE THIN FILM MEASUREMENT

TALYSTEP, a new instrument for the measurement of the thickness of thin film deposits, has been developed by RTH. Send the coupon for full details.



THE RANK ORGANISATION
RANK TAYLOR HOBSON
 LEICESTER HOUSE, LEE CIRCLE,
 LEICESTER *Tel: Leicester 23801*

TALYSTEP	
(Please tick the appropriate square)	
Send me detailed literature	<input type="checkbox"/>
Ask a sales engineer to call	<input type="checkbox"/>
Arrange a demonstration in your Leicester showroom	<input type="checkbox"/>
Arrange a demonstration at the following address	<input type="checkbox"/>
NAME _____	
POSITION _____	
COMPANY _____	
ADDRESS _____	
PHONE _____	ELEN/JUN

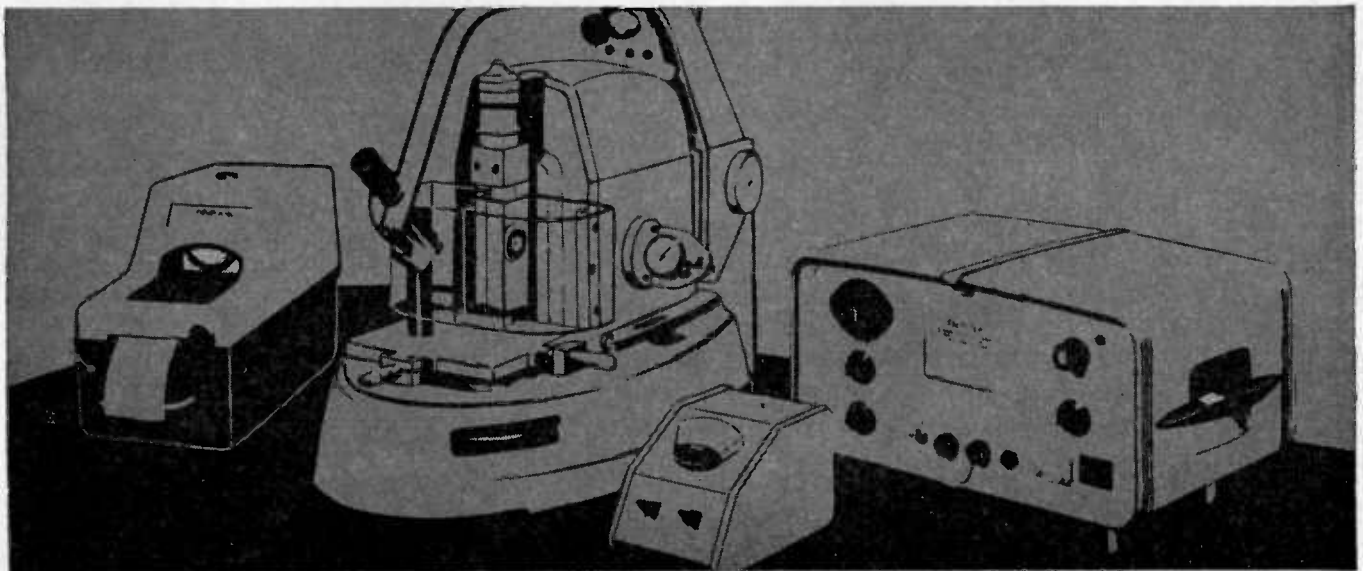



Our range of epoxy resins is complete.

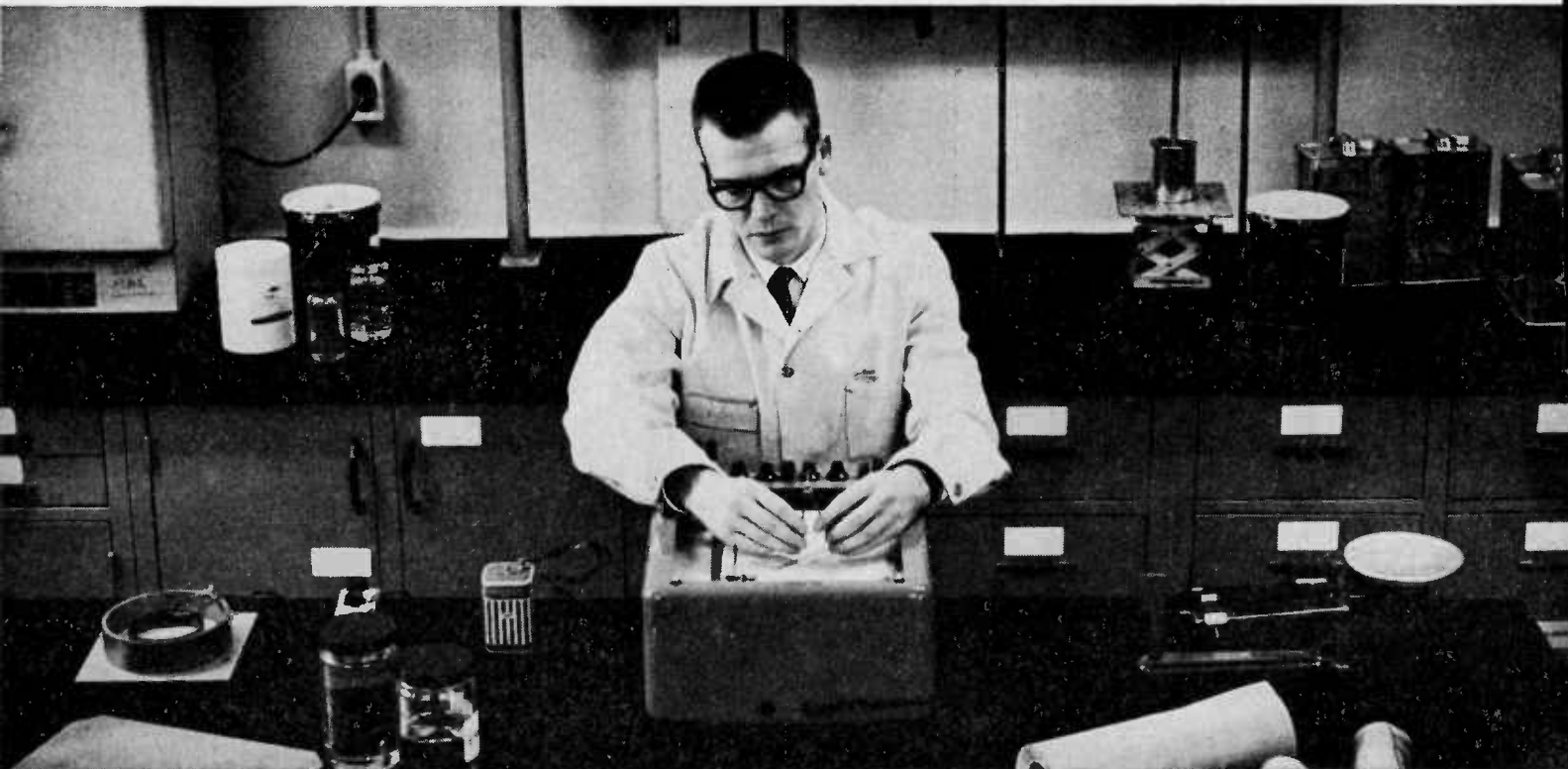

And so is our technical assistance.

EE 94 128 for further details

Whatever your application, you can get the epoxy resin you need from Dow, including liquid systems for electrical applications, road coating, lacquers, laminating and adhesives; solid systems for paint coatings; novolac based resins for improvement of heat stabil-

ity, heat distortion temperatures, chemical resistance and gel time; flexible resins for elongation and flexibility; and flame retardant brominated resins. And, in addition to making the most and finest epoxy resins, we will be happy to

help you solve your technical problems. Dow Chemical Company (U.K.) Ltd., 105 Wigmore Street, London, W.1. Tel: WELbeck 4441 or St. Ann's House, Parsonage Green, Wilmslow, Cheshire. Tel: Wilmslow 2851.

* Trademark of The Dow Chemical Company



NOUVELLES Réalisations

Traduction des pages 402 à 407

Une description basée sur des renseignements fournis par les fabricants de nouveaux organes, accessoires et instruments d'essai

COMPTEUR DE DÉCADES INTÉGRÉ

SGS-Fairchild Ltd, 23 Stonefield Way, Ruislip, Middlesex

Le CuL 958, qui peut être utilisé soit comme compteur soit comme diviseur, se compose de quatre basculeurs à déclenchement binaire en cascade, modifié par un circuit de réaction pour le comptage dans le code familial de 1-2-8. On peut également effacer et préréglér n'importe lequel des états décimaux possibles. La structure monolithique n'emploie que des résistances et des transistors et elle est construite suivant le procédé planaire épitaxial.

Le compteur de décades, qui est contenu dans un boîtier TO-5 a une vitesse de comptage garantie d'au moins 2 MHz et il est pleinement compatible avec d'autres éléments à circuit intégré SGS-Fairchild. La tension d'alimentation nominale est de 3,6 à 4 V; la gamme de température de fonctionnement est de 0 à 75° C.

EE 94 751 pour plus amples renseignements

INTÉGRATEUR CONTINU

Mercury Electronics (Scotland) Ltd,
640 Argyle Street, Glasgow, C.3

(Illustration à la page 402)

Cet intégrateur a été conçu pour constituer un instrument approprié pour l'intégration continue de petits signaux. Il fonctionne parfaitement avec des signaux d'entrée dans la gamme de 10 mV à 1 V, un signal de sortie de 1 volt étant obtenu pour une entrée de 1 000 mV/sec.

Deux transistors complémentaires sont reliés en série, leur collecteur étant reliés à l'un des côtés d'un condensateur. Si les deux courants au collecteur sont les mêmes, aucun courant n'entrera ou ne quittera le condensateur, mais si un signal est ajouté au courant à l'émetteur de l'un deux, son courant au collecteur sera modifié de façon correspondante et le condensateur sera chargé (ou déchargé) en conséquence. Etant donné que ces transistors sont dans la configuration à base à la masse, le courant au collecteur est sensiblement indépendant du changement de potentiel; ainsi, pour un signal d'entrée constant, le rapport entre le temps et le potentiel à travers le con-

densateur accusera une bonne linéarité. Dans la plupart des transistors, le courant au collecteur est, en fait, dépendant dans une certaine mesure de la tension, mais l'effet n'est normalement perceptible que sous forme d'une tendance de la ligne de base à retourner vers le centre pendant l'intégration de signaux asymétriques durant de longues périodes.

Pour plusieurs buts, cet effet agit comme correcteur de dérive et il a, en fait, été trouvé avantageux de réduire la constante de temps d'avantage lorsqu'on intègre des formes d'onde d'une durée de quelques secondes, de manière à réduire l'effet d'artifices. Le panneau frontal est muni d'un commutateur qui permet de choisir la constante de temps la plus utile.

Bien que l'instrument ait été principalement conçu pour pouvoir être utilisé avec le micromanomètre Greer, pour permettre l'intégration de pressions dépendant du flux par rapport au temps afin d'obtenir des tracés de volume, le faible signal requis pour l'intégrateur le rend approprié pour le fonctionnement sur entrées provenant de densitomètres ou d'autres sources de signaux; il peut être utilisé également comme dispositif de calcul de moyennes lorsqu'on veut indiquer la valeur moyenne d'un signal.

EE 94 752 pour plus amples renseignements

RÉSISTANCES

Welwyn Electric Ltd, Bedlington,
Northumberland

Une série entièrement nouvelle de résistances à film métallique a été réalisée par la société Welwyn Electric Ltd. Désignée sous le nom de série "Welmet" 40-10, elle a été spécifiquement conçue pour répondre aux conditions rigoureuses du fabricant d'instruments, mais elle peut être utilisée pour toutes les applications exigeant une performance élevée et un rapport de coût réduit.

La nouvelle série est prévue pour quatre grades de coefficients de température jusqu'à 25×10^{-60} C. Il existe cinq formats allant de 0,125 W à 2,0 W et la gamme ohmique s'étend de 1 Ω à

30 M Ω . Des tolérances normales de $\pm 1\%$ et de $\pm 0,5\%$ sont offertes et des tolérances plus serrées peuvent être étudiées sur demande.

Les chiffres de stabilité caractéristiques, après 2000 heures de charge cyclique à 70° C, indiquent un changement de résistance de 0,1% à 0,2% pour des valeurs au-dessous de 500 k Ω , et de 0,2% à 0,4% pour des valeurs maxima.

Le taux de panne prévu pendant une période de temps de 25 000 heures n'est que de 0,04% par 1 000 h lorsqu'un changement de 0,5% est considéré comme une panne. Si un changement de 1% est admissible, le taux de panne tombe à 0,02% par 1 000 h.

Ces résistances sont entièrement isolées, étant protégées par une couche de laque qui leur assure une bonne performance climatique et un revêtement de polyoflin irradié qui retarde l'action du feu et a une résistance d'isolement élevée. Le revêtement est non-hygroscopique et résistant aux solvants.

EE 94 753 pour plus amples renseignements

MATÉRIEL DE REPORT DIFFÉRENTIEL

Benson-Lehner Ltd, West Quay Road,
Southampton

(Illustration à la page 403)

Il existe maintenant deux nouvelles versions du matériel de report différentiel. La vitesse de report de l'un de ces modèles est de 450 additions par seconde, et dans l'autre modèle la dimension différentielle a été portée à 0,010 pouce. Cette augmentation constitue une amélioration de 50% de la vitesse de report (à partir de 300 additions par seconde) et une augmentation de 100% de l'ancienne dimension différentielle (de 0,005 à 0,010 pouce).

Dans ce dernier modèle, la dimension différentielle accrue augmente la vitesse de report puisque la distance couverte par chaque mouvement d'addition est doublée. En effet, en reportant 300 additions par seconde à 0,010 pouce la distance couverte est de 3 pouces.

Avec le modèle de report plus rapide, 450 additions à 0,005 pouce donnent une distance de 2,25 pouces; évidemment

la dimension différentielle plus réduite donne des résultats plus précis.

Le matériel de report différentiel produit des données entièrement annotées sous contrôle de calculatrice en ligne, ou hors ligne à partir de bandes de papier perforé ou de bandes magnétiques. Les applications caractéristiques comprennent le report automatique, le report de diagramme atmosphérique et les programmes de parcours critique.

Les commandes de l'équipement de report se distinguent par la commande à levier. Cette dernière permet de placer la plume de report à n'importe quel point du diagramme par l'emploi d'un seul bouton qui déplace soit la plume soit le papier, selon que le déplacement voulu est dans la direction X, Y ou XY.

La vitesse des mouvements de la commande à levier est soit de deux additions par seconde soit de 450 additions par seconde, cette dernière vitesse étant obtenue en relâchant complètement le bouton.

La plume de report est toujours clairement visible et accessible, permettant ainsi de s'aligner facilement à un point de départ (par exemple le diagramme) et donnant une vue sans restriction du développement du report.

Des interrupteurs de limite empêchent la perte de données ainsi que tout endommagement en retenant l'entrée lorsque le papier s'achève ou lorsque la plume s'écarte de son parcours normal. Des commandes à bouton-poussoir sont éclairées dans la position de fonctionnement, accusant ainsi positivement toute commande reçue.

La barre de déchirement permet d'enlever complètement les reports avec un minimum de gaspillage.

EE 94 754 pour plus amples enseignements

SYSTÈME DE MESURE LINÉAIRE

The M.E.L. Equipment Co. Ltd, Manor Royal, Crawley, Sussex

(Illustration à la page 403)

Le système PE2271 permet la mesure directe de la position d'outils et il est insensible au jeu et à d'autres imprécisions mécaniques. Il diffère de systèmes analogues par son emploi d'un nouveau type de transducteur dynamique. Il en résulte un système précis, sûr et insensible aux vibrations, pouvant fonctionner à des vitesses élevées. En outre, il n'y a aucun contact physique entre ses éléments stationnaires et mobiles (il y a un espace de 15 mm entre ces éléments lorsqu'ils sont montés sur la machine), et bien qu'il s'agisse d'un système optique, il n'est pas affecté par les films à huile.

Le système comprend une échelle de verre linéaire à lignes réfléchissantes et non réfléchissantes, un transducteur dynamique et un petit élément électronique.

L'échelle est fixée dans un montage métallique, et étant donné que le verre est plus dur que les éclats d'acier il peut être nettoyé sans risque d'endom-

agement. Les divisions de l'échelle sont à 0,3 mm sous la surface et elles sont relativement approximatives, la largeur combinée d'une ligne réfléchissante et non réfléchissante étant de 0,64 mm.

Durant les opérations d'usinage, l'échelle de verre est traversée par l'élément transducteur. Cet élément contient un système optique rotatif qui produit deux signaux lumineux de 7500 Hz. L'un de ces signaux est un signal de référence transmis directement à une cellule photo-électrique, tandis que l'autre signal est un signal de mesure réfléchi par l'échelle de verre à une autre cellule photoélectrique.

Le rapport de phase des deux sorties des cellules photoélectriques varie en fonction de la position de la diapositive, un changement de phase de 360° représentant un mouvement linéaire de 0,32 mm. La sortie des cellules photoélectriques est reçue par un élément à part qui convertit cette sortie en une forme appropriée pour sa transmission à un matériel de commande ou d'indication de position. La résolution globale du système est de 0,01 ou 0,005 mm, la résolution voulue étant spécifiée à la commande. Les machines munies de ce système peuvent être utilisées à des vitesses de table allant jusqu'à 480 mm/sec.

Un avantage important du transducteur dynamique est le fait qu'il fournit une sortie de courant alternatif. L'amplification élevée est par conséquent simple, et les signaux d'interférence sont facilement filtrés. On peut également employer une source lumineuse comparativement faible avec une durée de vie proportionnellement plus longue.

Etant donné que ce type de transducteur produit un signal même lorsqu'il est au repos, il a été possible d'incorporer un signal "d'échelle souillée". En effet, lorsque l'échelle est souillée, le signal dû à la lumière réfléchie de l'échelle de verre devient plus faible et cet affaiblissement est indiqué par une lampe sur l'élément électronique connexe. La lampe s'allume bien avant que la contamination devienne assez forte pour pouvoir causer des erreurs. L'espace entre le transducteur et l'échelle est de 15 mm, et on peut nettoyer tant l'échelle de verre que la fenêtre du transducteur sans les démonter. Avec certaines machines, le nettoyage peut s'effectuer même en cours d'utilisation.

L'échelle de verre que l'on voit dans notre gravure a été dépourvue, pour plus de clarté, du montage métallique auquel elle est normalement fixée.

EE 94 755 pour plus amples renseignements

ENREGISTREURS À PLUME

Distributeurs: Cybernetics Instrumentation Ltd, 174 Granville Road, London, N.W.2

(Illustration à la page 403)

Cet enregistreur à plume univoie a une vitesse d'avance de la plume totale de 0,4 sec pour une largeur de papier de 250 mm. Le réglage de zéro peut

s'effectuer à n'importe quel point du papier. La vitesse du diagramme varie entre 1 et 50 cm/pouce.

Ces enregistreurs peuvent être fournis avec étage d'amplificateur à pont incorporé pour pouvoir effectuer des enregistrements directs à partir d'extensomètres, de transducteurs de pression ou de déplacement, etc. sans équipement auxiliaire. La gamme de tension d'entrée normale s'étend de 10 mV à 50 V en douze plots.

Des enregistreurs à quatre voies, pour montage sur châssis et à dispositifs de report X-Y peuvent être fournis également.

EE 94 756 pour plus amples renseignements

RELAIS AU MERCURE SCELLÉ

Distributeurs: Techna (Sales) Ltd, 47 Whitehall, London, S.W.1

(Illustration à la page 403)

Un relais au mercure hermétiquement scellé et de fabrication britannique est maintenant distribué par la société Techna (Sales) Ltd.

Ce relais porte le nom de Euroswitch-M et s'inspire du principe de la coupure d'arc sur contacts de mercure à mercure, ce qui donne une durée de vie dépassant 10 millions d'opérations. Le fonctionnement s'effectue par action à plongeur plutôt qu'à bascule et il n'y a donc pas de pièce mobile extérieure. Le récipient à mercure est en acier inoxydable ce qui lui permet de résister à des chocs sévères dûs aux pointes de courant, aux décharges extérieures, etc.

Un courant résistif alternatif de 25 A à 440 V peut être débranché à une vitesse de fonctionnement allant jusqu'à 2000 par heure. Une gamme complète de tension de bobine standard est prévue et la puissance d'utilisation requise n'est que de 4 W sur tension continue et de 6 VA sur tensions alternatives.

Le relais peut être utilisé dans 25° d'arc vertical et en raison de sa construction il est virtuellement incassable.

Son faible encombrement, soit 3,81 cm de diamètre × 8,25 cm de longueur, allié à une fiabilité absolue et à un prix réduit en font le relais idéal pour l'emploi dans les atmosphères dangereuses ou contaminées ou pour les applications exigeant une longue durée de vie sans défauts.

EE 94 757 pour plus amples renseignements

SYNTHÉTISEUR DE FRÉQUENCE

The Wayne Kerr Co. Ltd, Sycamore Grove, Malden, Surrey

(Illustration à la page 404)

Il s'agit d'un instrument entièrement nouveau et constitué de corps solides mis au point par la société Wayne Kerr-Gertsch et donnant des indications numériques directes de n'importe quelle fréquence synthétisée voulue, par incréments de 1 Hz, de 5 Hz à 50 MHz, et par incréments de 10 Hz, de 50 MHz à 500 MHz. Cette gamme extrêmement étendue est entièrement obtenue sur les fréquences fondamentales. L'instrument, modèle SSG-1, allie l'étalonnage de

haute précision de la tension de sortie d'un générateur de signaux standard à la précision de fréquence traditionnelle des appareils Gertsch; il effectue également la mesure directe de fréquence de 10 kHz à 1000 MHz (et jusqu'à 10 GHz avec l'appareil auxiliaire).

La précision et la stabilité ne sont limitées que par un seul oscillateur à cristal principal de 1 MHz. Avec l'oscillateur incorporé, la stabilité est supérieure à 1 dans 10⁷ par jour. On peut incorporer un étalon extérieur et le synthétiseur SSG-1 produira alors des fréquences de sortie synthétisées jusqu'à n'importe quelle limite de stabilité pouvant être obtenue d'un tel étalon.

Des niveaux de sortie pouvant atteindre 200 mV peuvent être fixés à 0 dBm et réglés jusqu'à -130 dBm par un atténuateur de précision de 50 Ω. Une fois réglé le niveau d'entrée vers l'atténuateur, un système anti-fading maintient ce niveau constant sur toute la gamme de fréquence.

Le synthétiseur SSG-1 comporte la modulation d'amplitude interne (400 ou 1000 Hz), un détecteur de battements incorporé et un instrument de mesure, et il peut être adapté pour lire la déviation de pointe de signaux modulés en fréquence. Il mesure 40,64 cm de large × 45,7 cm de haut × 53,3 cm de profondeur et son poids est d'environ 45,3 kg.

EE 94 758 pour plus amples renseignements

CONNECTEURS PAR LA TRANCHE

Ultra Electronics (Components) Ltd,
Industrial Estate, Long Drive, Greenford,
Middlesex

(Illustration à la page 404)

La société Ultra Electronics (Components) Ltd. fabrique une nouvelle gamme de connecteurs par la tranche à bobinage imprimé.

Cette gamme à entr'axe de 3,96 mm se compose de connecteurs à 10, 15 et 22 directions, munis de bagues flottantes pour recevoir les vis de 2,2 mm. Les contacts sont en bronze phosphoreux à action de soufflet breveté. Les moulages en phthalate diallyle ont une gamme de température de -55° C à 110° C.

La résistance de contact maxima est de 10 mΩ et la résistance à l'isolement minimum est de 5000 mΩ dans des conditions normales. Des clefs de polarisation en nylon peuvent être montées dans n'importe quelle position voulue.

EE 94 759 pour plus amples renseignements

GÉNÉRATEUR DE BALAYAGE

Telonic Industries U.K., The Summit,
2 Castle Hill Terrace, Maidenhead, Berkshire

(Illustration à la page 404)

Un nouveau générateur de balayage constitué de corps solides, le modèle 1001, a été introduit par la société Telonic Industries. Ce nouvel instrument comporte une gamme de fréquence étendue, une largeur de balayage variable, une stabilité élevée, le fonc-

tionnement par balayage ou ondes entretenues et un nouveau type de système marqueur de fréquence. La gamme du nouveau générateur va de 100 kHz à 20 MHz.

La largeur du balayage de l'instrument peut être variée à travers trois gammes. Sur la gamme étendue, elle va de 10 kHz à 20 MHz, sur la gamme intermédiaire, elle va de 1 kHz à 2 MHz et sur la gamme étroite de 100 Hz à 200 kHz. Le taux de balayage est également variable; il est continu de 0,01 Hz à 60 Hz où il peut être verrouillé jusqu'à la ligne de 50/60 Hz. La sortie du modèle 1001 est de 1 V efficace. La sortie du marqueur de fréquence variable peut être transmise directement à un compteur de fréquence.

Des blocs d'alimentation à stabilité élevée, spécialement conçus pour le modèle 1001, combinés à la compensation de température dans l'oscillateur, fournissent un degré élevé de stabilité. La stabilité à court terme de l'instrument est de 500 Hz/min et à long terme de 5 kHz/h.

Une caractéristique importante du générateur est le nouveau système marqueur de fréquence réalisé par un circuit multiplicateur de déviation. Ce marqueur est utilisable en deux modes: le mode à harmoniques de 1 MHz et le mode variable. La largeur du marqueur d'harmoniques n'est que 10 kHz. Le marqueur de fréquence variable peut être choisi à une largeur de 10 kHz, 1 kHz ou 100 Hz. Les largeurs étroites des marqueurs permettent une détermination extrêmement précise de la fréquence.

Le système marqueur comprend en outre une commande de bascule pour faire basculer le marqueur par rapport à la verticale lorsqu'il se trouve sur une pente abrupte permettant une lecture plus précise.

Le générateur est logé dans un coffret mesurant 48,2 cm de large × 17,78 cm de haut pouvant être adapté au montage sur bâti en lui ajoutant deux supports.

EE 94 760 pour plus amples renseignements

ACCÉLÉROMÈTRE PIÉZOÉLECTRIQUE

Consolidated Electrodynamics Division,
Bell & Howell Ltd, 14 Commercial Road,
Woking, Surrey

(Illustration à la page 404)

La Consolidated Electrodynamics Division de la société Bell & Howell Ltd. a réalisé un accéléromètre piézoélectrique d'un poids et d'un encombrement réduits avec compression par "tige" qui isole mécaniquement le système sensible du logement.

Cet isolement mécanique de l'élément sensible du coffret assure une protection maxima contre les bouffées de vents des moteurs à fusées et des phénomènes transitoires thermiques.

L'accéléromètre piézoélectrique 4-274 est particulièrement indiqué pour l'utilisation dans des conditions d'humidité élevée en raison de sa construction entièrement soudée. Même avec le

cyclage de température, il ne se produit aucun "soufflage", d'humidité comme cela se produit dans les éléments à scellement d'époxyde.

Lorsque le changement de sensibilité dans la gamme de température de -100° F à +300° F est mis en dérivation avec une valeur recommandée de capacité (700 pF), il est caractéristiquement inférieur à 8 %. La fréquence naturelle montée de 70 kHz de l'accéléromètre permet une réponse de fréquence de ±5 % de 2 Hz à 12 kHz.

EE 94 761 pour plus amples renseignements

ANALYSEUR DE CIRCUIT INTÉGRÉ

Distributeurs: Quantum Engineering Ltd,
31 Queen Anne's Gate, London, S.W.1

(Illustration à la page 405)

L'analyseur de circuit intégré, modèle IC-101, construit par la société Optimized Devices Inc, U.S.A., constitue un moyen rapide pour évaluer, contrôler et analyser les circuits monolithiques et à composants multiples. L'assemblage à commutateurs glissants forme une matrice de 16 × 19 reliant n'importe lesquels ou la totalité des broches à n'importe lequel des quatre blocs d'alimentation interne, à n'importe laquelle des quatre fonctions arbitraires extérieures ou à un point commun.

Les blocs d'alimentation entièrement flottants de 0 à ±100 V et à résolution de ±0,1 %, utilisant des amplificateurs opérationnels à transistors au silicium montés sur plaquette de circuit imprimé à fiche et à base de verre sont réglés de manière entièrement indépendante en ce qui concerne la polarité, la gamme et la tension par des commutateurs et des échelles à lecture directe et à 1000 division.

Le voltmètre autonome à 5 gammes et à échelle à miroir d'une précision de 1 % peut être commuté à n'importe quelle broche de dispositif pour la mesure de tension par rapport à un point commun. Il peut également mesurer le courant.

L'analyseur comprend en outre des entrées pour sources de puissance extérieure et de signaux, reliés au circuit soumis à l'essai au moyen de la matrice à commutateurs; le contrôle de la tension de charge, la tension et le courant individuels d'alimentation, et le courant de terre total par instrument de mesure extérieure, par exemple, par un dispositif de concentration de données; le contrôle de signaux de compteurs d'oscilloscopes etc. Les douilles du panneau frontal sont prévues pour l'introduction de résistances simulant le fonctionnement au courant constant, d'impédances d'alimentation et pour la connexion en série d'alimentations au moyen de composants, par exemple des relais ou des inducteurs, pour vérifier le fonctionnement correct des circuits externes.

Des connexions doubles (Kelvin) placées sur l'adaptateur du circuit soumis à l'essai éliminent les erreurs de mesure dues aux contacts et à la chute

de tension particulièrement au cours des essais.

L'analyseur est fourni dans un coffret fourni sur support pivotant pouvant être fixé dans n'importe quelle position. Lorsqu'il est retiré de son coffret, l'analyseur peut être installé sur bâti de 48,2 cm.

EE 94 762 pour plus amples renseignements

CONTRÔLEUR DE TEMPÉRATURE

Clarke Chapman & Co. Ltd, (Electronics Division), Team Valley, Gateshead, Co. Durham
(Illustration à la page 405)

Ce contrôleur de température proportionnel, précis mais peu coûteux, peut contrôler jusqu'à 300 points différents avec une précision de $\pm 1^\circ \text{C}$ près dans une gamme de température de 0 à 1000° C. Le contrôle est proportionnel et la bande proportionnelle peut être réglée de 3 % à 300 %. La sélection par bouton-poussoir permet de contrôler la température de chaque point sur un instrument à cadre mobile et à échelle sur la tranche. Si nécessaire, on peut également contrôler des points qui ne sont pas surveillés.

Chacun des circuits de contrôle est contenu dans un petit module à fiches monté sur panneau et à l'épreuve de la poussière et peut effectuer le contrôle de charge de chauffe électrique ou être utilisé en liaison avec des convertisseurs électro-pneumatiques.

On pense que le contrôleur trouvera son application principale dans les fonderies de processus, les matières plastiques, le caoutchouc, les matières chimiques, les fibres synthétiques et d'autres industries exigeant un contrôle thermique à plusieurs points et peu coûteux. Il existe un autre modèle donnant une précision de $\pm 0,1^\circ \text{C}$ près.

EE 94 763 pour plus amples renseignements

MULTIMÈTRE ÉLECTRONIQUE

O.P. Instruments Ltd, 246 Sutton Common Road, Sutton, Surrey

(Illustration à la page 405)

Cet instrument de lecture du courant continu a été conçu comme complément à bas prix du multimètre standard. Sa résistance d'entrée dépasse 100 M Ω sur toutes les gammes de tension et il comporte une tension et un courant d'indication sur 16 gammes. Les gammes de tension complète vont de 333 mV à 1 kV, et les gammes de courant vont de 333 nA à 1 mA.

Le cadran de l'instrument de mesure est incliné à 45° et il a une grande échelle pour faciliter la lecture. Les gammes sont disposées de façon à fournir une distribution d'un précision optimum.

Le format réduit (19,68 cm \times 13,97 cm \times 12,7 cm) et le fonctionnement sur batterie augmentent la portabilité du multimètre; on peut avoir accès direct par l'extérieur à la batterie de longue durée de 3 V.

L'amplification par transistor assure une sensibilité élevée, une excellente stabilité électrique et une pleine protec-

tion contre les surcharges et les inversions de polarité.

Grâce à la sonde de redressement extérieur, l'instrument peut mesurer des tensions alternatives de pointe étalonnées en valeur efficace.

EE 94 764 pour plus amples renseignements

GÉNÉRATEUR DE SIGNAUX B.F.

Taylor Electrical Instruments, Montrose Avenue, Slough, Buckinghamshire

(Illustration à la page 405)

Ce nouvel oscillateur B.F., modèle 192A, est un instrument d'une grande souplesse d'emploi pour le contrôle général, mais il a une performance qui le rend également approprié pour l'emploi comme générateur de signaux de laboratoire à usage universel.

Il a été conçu pour fournir une forme d'onde sinusoïdale ou carrée dans la gamme de fréquence de 10 Hz à 100 kHz dans quatre bandes de fréquence, la forme d'onde voulue étant choisie par le commutateur de forme d'onde. La tension d'onde sinusoïdale maxima aux bornes de sortie est de 25 V efficaces avec une impédance de sortie de 68 Ω à 25 mV montant jusqu'à environ 10 k Ω à la sortie maxima.

Cet instrument constitue donc une source de faible puissance pour le contrôle de la fréquence et de la réponse transitoire d'amplificateurs, de transformateurs, de haut-parleurs, etc.

Un circuit à pont de Wien classique est incorporé au générateur. Ce circuit est stabilisé par thermistors pour fournir une amplitude constante à toutes les fréquences. On obtient des ondes carrées en injectant la sortie du circuit à pont de Wien dans un circuit de déclenchement Schmitt qui fixe et façonne l'onde sinusoïdale pour fournir une sortie d'onde carrées. Le circuit a été conçu de manière à ce que le même étage constitue un amplificateur de tension dans la position d'onde sinusoïdale.

EE 94 765 pour plus amples renseignements

COMPTEUR-MINUTERIE

Radun Controls Ltd, White Street, Caerphilly, Glamorgan

(Illustration à la page 405)

Le compteur à calculer, modèle 152, est un appareil électronique universel à bas prix d'une grande souplesse d'emploi.

Conçu pour les applications industrielles ou de laboratoire dans la gamme de fréquence de 1 Hz à 250 kHz, ce compteur est entièrement muni de circuits transistorisés et fournit un affichage en ligne à quatre chiffres par tube de longue durée. Il existe également un modèle 153 avec indicateur supplémentaire.

Ce compteur exécute non seulement les fonctions normales de la plupart des compteurs pré-réglables, à savoir la mesure de fréquence, de périodes, d'intervalles de temps ou la division de fréquence, mais il mesure et affiche également la vitesse ou le taux du flux directement dans les valeurs appropriées

telles que tours/min, gallons/min ou pieds/min et les rapports de deux fréquences ou les taux directs ou normalisés.

Par l'emploi d'un base de temps à quatre décades entièrement variable, un signal d'entrée peut être échantillonné pendant des périodes variant de 100 μsec à 1 sec en plots de 100 μsec , ou par l'emploi d'un multiplicateur $\times 10$ de 1 msec à 10 sec en plots de 1 msec, fournissant ainsi une méthode simple pour convertir les fréquences en valeurs pratiques. Pour les applications tachymétriques ou de mesure de flux, les caractéristiques de machine ou de transducteur peuvent être compensées automatiquement pour fournir un affichage direct en valeurs voulues. De même, par l'emploi d'un deuxième canal de signaux d'entrée et d'une base de temps variable, les rapports de deux fréquences ou vitesses peuvent être normalisés.

L'appareil comporte en outre, une source de cristal de 10 kHz avec diviseurs fournissant des sorties de 100 μsec à 10 sec en plots de décades; un dispositif de contrôle autonome; un affichage pouvant être effacé jusqu'à ce qu'un comptage soit complet ou, en variante, affiché de manière continue; une période d'affichage réglable de 0,3 à 6 sec ou "verrouillée" pour affichage d'un coup; des signaux de sortie comportant la fermeture d'une paire de contacts de relais à la fin d'un comptage et pouvant être utilisée pour une fonction de contrôle extérieur; l'impression sous forme de sorties décimales directes exprimées en fonction d'un niveau de tension.

EE 94 766 pour plus amples renseignements

INSTALLATION DE REVÊTEMENT

Balzars High Vacuum Ltd, Northbridge Road, Berkhamsted, Hertfordshire

(Illustration à la page 406)

Ce nouveau matériel de revêtement, modèle BA 360, convient pour la production sur une faible échelle ou les travaux de recherche dans le domaine des films minces électroniques ou optiques.

C'est un appareil compact et d'une grande souplesse d'emploi, la chambre à vide verticale en acier inoxydable à double mur ayant un diamètre intérieur de 360 mm et une hauteur intérieure de 390 mm; le pompage s'effectue par une pompe semi-automatique à levier unique. Avec une vitesse de pompage de 650 litres par seconde, l'installation vide et propre peut être évacuée jusqu'à 1×10^{-5} torr en environ cinq minutes et, en ajoutant une trappe de Meissner à refroidissement profond, on peut obtenir des pressions minima de 5×10^{-7} torr en moins de 15 minutes.

En tant qu'élément de recherche et de mise au point, il a l'avantage de permettre le transfert rapide de nouveaux procédés aux grands modèles de production, le BA.510 et le BA.710.

Les accessoires prévus pour ces grands modèles sont: équipement de décharge

incandescent; évaporation de faisceau électronique; chicanes à refroidissement profond; équipement de mesure d'épaisseur; valve d'entrée de gaz servo-commandé; évaporation simultanée de deux sources; cage rotative, etc. Ces accessoires peuvent être obtenus également pour le BA. 360.

EE 94 767 pour plus amples renseignements

INSTRUMENT DE MESURE DE PUISSANCE À MICROONDES

W. H. Sanders (Electronics) Ltd,
Cunnels Wood Road, Stevenage, Hertfordshire
(Illustration à la page 406)

Ce nouvel instrument de mesure de puissance a été conçu pour indiquer directement la puissance en microondes jusqu'à 10 mW et il présente une grande souplesse de fonctionnement. Il est employé avec une tête microondes à large bande couvrant la gamme de fréquence appropriée à la grandeur du guide d'onde (2,6 à 12,4 GHz) avec un taux d'ondes stationnaires de 1,5. Des thermistors ou des bolomètres sont utilisés dans les têtes de mesure comme éléments sensibles. Des paires équilibrées de thermistors sont utilisées pour la compensation de température, mais lorsque cette facilité n'est pas nécessaire, des éléments simples peuvent être employés. Tous les éléments, qui fonctionnent à une résistance de 200 Ω , peuvent être remplacés par l'opérateur.

L'instrument est entièrement portable et fonctionne soit sur courant secteur soit sur batterie intérieure sans dégradation aucune de la précision de 3 % de déviation sur la totalité de l'échelle.

EE 94 768 pour plus amples renseignements

GÉNÉRATEURS À ULTRASONS

Radyne Ltd, Wokingham, Berkshire
(Illustration à la page 406)

La demande industrielle croissante de matériel de grand format pour le nettoyage par ultrasons a donné lieu à une nouvelle conception de la réalisation des générateurs et des transducteurs. La société Radyne Ltd a ainsi mis au point un appareil fournissant des sorties de puissance illimitées par l'emploi d'un générateur modulaire. Ce système qui se compose d'un bloc d'alimentation d'un panneau de commande et de modules multiples de 1 kW permet de produire facilement des générateurs construits suivant les spécifications des clients.

Chaque générateur modulaire fournit la puissance à un transducteur immerisible ou de cloison et des surfaces étendues peuvent être irradiées par des assemblages de transducteurs multiples. La commande individuelle ou par groupes est facilitée par la commutation à part.

Une console à deux éléments et une autre console à quatre éléments constituent le système de base. Les modules générateurs sont branchés aux consoles et basés sur le circuit inverseur Radyne.

Les transducteurs connexes utilisent les éléments Radyne Magnatrak qui constituent un système entièrement industrialisé. Les consoles peuvent être soit à refroidissement par air soit à refroidissement par eau dans un coffret complètement scellé pour le fonctionnement industriel le plus rigoureux.

EE 94 769 pour plus amples renseignements

ANALYSEUR DE FONCTION DE TRANSFERT

Smiths Industries Ltd, Aviation Division,
Kelvin House, Wembley Park Drive, Wembley,
Middlesex

(Illustration à la page 407)

Combinant en un seul appareil un générateur d'onde sinusoïdale et un analyseur, la division d'aviation de la société Smiths Industries Ltd. a réalisé un nouvel analyseur de fonction. Cet instrument fonctionne dans la gamme de fréquences sub-acoustiques de 24 cycles/secondes jusqu'à 1 cycle/minute.

La lecture de l'analyseur se fait en huit gammes, de 50 mV à 150 V de déviation sur la totalité de l'échelle. Les sorties du générateur ont une valeur maxima de 10 V et l'impédance de sortie est de 10 Ω . La précision globale de l'instrument est de ± 2 % en amplitude et de ± 1 % en phase.

Le générateur a deux canaux de sortie dont l'un peut être varié à travers 360° par rapport à l'autre. On peut ainsi lire la réponse de fréquence en coordonnées polaires en variante à la présentation cartésienne normale.

En plus des signaux directs de basse fréquence, des signaux modulés à fréquence porteuse de 400 Hz peuvent être produits et analysés. Le choix de la porteuse ou de la tension directe est indépendant pour la section de l'analyseur et pour chaque sortie de générateur.

Tant les bornes de sortie du générateur que les bornes d'entrée de l'analyseur sont flottantes sur tension continue et tension porteuse. L'utilisateur peut ainsi injecter et mesurer librement des signaux dans n'importe quelle partie d'un circuit.

EE 94 770 pour plus amples renseignements

CONDENSATEURS AU MICA ARGENTÉ AGGLOMÉRÉS

London Electrical Manufacturing Co. Ltd,
Bridges Place, Parson Green Lane,
London, S.W.6

(Illustration à la page 407)

La société LEMCO a enrichi sa gamme de condensateurs au mica argenté agglomérés en utilisant des lames de mica de 25 mm \times 15 mm de construction agglomérée.

Pour réaliser ces condensateurs des plaques de mica argenté pur sont entassées, soumises à une compression intense puis agglomérées en un bloc stable et robuste. Les fils d'extrémité sont soudés à l'aide de soudure spéciale pour maintenir le facteur de qualité le plus élevé possible.

Pour répondre à la plupart des appli-

cations, ces condensateurs sont fournis sous forme moulée et isolés à la résine synthétique ou à la cire et ils sont prévus pour les applications professionnelles.

Des essais de longue durée de vie ont montré que ces condensateurs sont extrêmement stables dans les conditions d'environnement les plus ardues et offrent un faible coefficient de température.

Des capacités de 5000 pF à 0,05 μ F sont prévues avec des tensions de fonctionnement de 200 et de 350 Vc.c.

EE 94 771 pour plus amples renseignements

PLAQUETTES DE MICROCIRCUITS

Harrison Reproduction Co. Ltd,
164 Lynchford Road, Farnborough, Hampshire
(Illustration à la page 407)

Une nouvelle méthode perfectionnée de production de plaquettes à perforations doublées a été mise au point pour l'emploi dans les microcircuits. Ces plaquettes, produites par la société Harrison Reproduction Equipment Ltd (Motivex Group) représente l'équivalent dans les microcircuits de l'emploi de plaquettes à circuit imprimé dans les assemblages transistorisés.

La nouvelle technique permet de réduire les lignes de circuit à une largeur de quatre millièmes de pouce avec un espacement de quatre millièmes de pouce. Les perforations sont cadmiées jusqu'à un diamètre de quinze millièmes de pouce. Il y a lieu de penser que c'est la première fois qu'on ait pu réaliser des tolérances aussi fines et une telle capacité sur une base de production au Royaume-Uni.

La société Harrison emploie une nouvelle combinaison de processus pour le dépôt, le revêtement, la gravure et l'agglomération du cuivre à la fibre de verre. La fibre de verre agglomérée à l'époxyde constitue la base de ces plaquettes avec lignes et perforations de circuit en cuivre, complétés par une variété de revêtements comprenant l'étain et l'or. La force de liaison a été contrôlée et elle est comparable à celle des plaquettes de circuit ordinaire. La gamme de température de fonctionnement va de -55° C à 100° C.

EE 94 772 pour plus amples renseignements

VOLTMÈTRE NUMÉRIQUE

Fenlow Electronics Ltd, Springfield Lane,
Weybridge, Surrey

(Illustration à la page 407)

Le voltmètre numérique Fenlow, type 301A, est un instrument de précision utilisant une nouvelle technique d'intégration stroboscopique. L'oscillateur qui produit les impulsions devant être comptées pendant le signal et les périodes d'intégration de référence est à commande asservie pour pouvoir atteindre 20 000 fois la fréquence de secteur au moyen d'un principe stroboscopique fréquemment utilisé dans les systèmes de repérage de radar. L'effet de l'intégration stroboscopique est de réduire les effets des signaux de mode en série (sans employer de filtres) d'environ 100 fois

par rapport au système à périodes d'intégration fixe lorsque la fréquence de secteur fluctue, comme c'est le cas en hiver.

Les amplificateurs d'entrée et intégrateurs utilisent des transistors à effet de champ pour la modulation, réduisant ainsi la dérive et produisant des courants d'entrée très faibles et une impédance d'entrée élevée.

L'ensemble du système d'entrée est flottant ce qui permet le fonctionnement différentiel même lorsqu'il est utilisé pour entraîner un imprimeur. L'instrument contient un élément à programme qui facilite le fonctionnement à partir de commandes extérieures.

Cinq gammes de tension sont prévues allant de 0 à 100 mV jusqu'à 0 à 1 kV.

EE 94 773 pour plus amples renseignements

PINCE POUR TRANSISTOR

Jermyn Industries, Vestry Estate, Vestry Road,
Sevenoaks, Kent

(Illustration à la page 407)

Une pince en matière plastique a été mise au point par la société Jermyn Industries Ltd. Cette pince est fixée à la position voulue par simple pression dans une ouverture d'un diamètre de 0,31 cm. Le diamètre de la pince varie de 0,189 pouce à 0,235 pouce et il convient donc pour des transistors tels que le OC200. Faite en nylon A 100 dont le point de fusion est supérieur à 210° C, cette pince peut être utilisée pour les techniques de soudage de flux puisque, contrairement aux autres pinces en polythène, elle est complètement insensible à la soudure coulant sur elle.

EE 94 774 pour plus amples renseignements

PSOPHOMÈTRE

Laboratoire Electro-Acoustique, 5, Rue Jules
Parent, Rueil (S & O), France

(Illustration à la page 407)

Cet appareil a été conçu pour la mesure absolue du niveau de bruit de fond et il se compose d'un amplificateur étalonné, d'un filtre psophométrique et d'un instrument de mesure.

L'entrée s'effectue par transformateur équilibré dont l'impédance est supérieure à 5 k Ω et dont la sensibilité s'étend de -115 dB à +15 dB, avec des atténuateurs fournissant des plots de 10 dB et 1 dB. L'appareil est muni de filtres interchangeable et il est entièrement équipé de transistors au silicium.

Il existe, en outre, des instruments de ce genre tant pour la radiodiffusion que pour la téléphonie.

EE 94 775 pour plus amples renseignements

Résumés des Principaux Articles

Un système d'affichage cathodique commandé par calculatrice par W. Bial

Résumé de l'article
aux pages 354 à 359

Cet article décrit d'une manière générale un système à tube cathodique principalement conçu pour l'affichage des résultats d'une calculatrice numérique. Des détails de circuits d'intérêt particulier sont fournis.

Analyse des réservoirs fixes à action rapide et à noyaux en U par H. P. A. Salam

Résumé de l'article
aux pages 360 à 366

Les facteurs entrant en ligne de compte dans la conception des réservoirs fixes bobinés à noyaux de ferrite en U sont examinés et plusieurs sources éventuelles de bruit sont indiquées. Des équations de base sont développées pour un système particulier et il est démontré que le rapport signal/bruit est proportionnel au carré de la longueur des fils d'entraînement et au carré de la fréquence de fonctionnement. La construction d'un élément avec un temps de cycle de 250 nanosecondes est décrit.

Transistors à film mince par R. P. Howson

Résumé de l'article
aux pages 367 à 369

Contrairement au transistor bipolaire ordinaire un dispositif à effet de champ comportant des films minces évaporés sous vide peut être produit avec succès à l'aide d'une variété de matériaux semi-conducteurs qui n'ont pas besoin d'être hautement cristallins où dont il n'est pas nécessaire de contrôler avec précision les propriétés électriques. Le mode de fonctionnement, la technologie utilisée et la performance obtenue avec ces dispositifs est analysé dans cet article qui étudie les facteurs essentiels de la conception de ces transistors par rapport aux matériaux existants et à la géométrie utilisée. L'auteur examine également l'avenir éventuel de ces dispositifs par rapport à leurs équivalents au silicium à cristal unique.

Un circuit intermédiaire d'impédance à entrée très élevée utilisant des transistors à effet de champ par K. Thompson

Résumé de l'article
aux pages 370 à 373

L'impédance d'entrée très élevée de 10¹³ ohms dans la gamme du courant continu à 50KHz est principalement prévue pour faire fonction de tampon à gain unitaire, pour la perception de tensions de ± 10 volts dans un simulateur analogique à impédance élevée. Son impédance à faible sortie de 1 ohm lui permet d'alimenter de nombreux autres instruments normaux et, avec un milliampèremètre, il produit un voltmètre électronique excellent bien que d'une gamme de tension limitée. Le courant constant de porte d'entrée est aussi faible que celui de n'importe quel circuit à lampes (10⁻¹³ ampères).

Mesure de réponse par les méthodes de balayage de fréquence par J. F. Golding

Résumé de l'article
aux pages 374 à 380

La technique consistant à utiliser un générateur de balayage et un oscilloscope pour afficher les caractéristiques de fréquence/réponse de réseaux actifs et passifs est bien connue. Cet article décrit certaines des méthodes communément utilisées et indique quelques variantes pouvant permettre de résoudre les difficultés techniques découlant de la mesure à bande étroite.

Système à vitesse moyenne pour l'enregistrement en série de données à partir de plusieurs canaux par J. G. Lang

Résumé de l'article
aux pages 381 à 383

Il s'agit ici d'un système d'enregistrement à modulation de fréquence par impulsions sur bande magnétique qui est pratiquement indépendant de la vitesse de la bande. Les canaux d'entrée sont balayés à la vitesse de six par seconde et disposés en série sur une piste de la bande. Ce système trouve une application particulière pour l'enregistrement de données à vitesse moyenne à des emplacements éloignés de la puissance secteur.

Un circuit monostable de haute efficacité utilisant des transistors complémentaires par B. D. Rakovich

Résumé de l'article
aux pages 384 à 387

L'auteur décrit un circuit monostable à transistors complémentaires permettant de produire des impulsions rectangulaires à temps de montée et de chute très réduits. Le circuit ne doit être alimenté que lorsqu'il est déclenché, ce qui représente une économie considérable dans la consommation totale de courant lorsqu'un cycle à faible régime est utilisé. Ce circuit se caractérise également par le fait qu'il constitue un moyen de produire de très courtes impulsions rectangulaires dont la forme est assez bonne.

Circuits à film de tantale par P. L. Hawkes

Résumé de l'article
aux pages 388 à 389

Les applications de l'électronique dans les systèmes de transmission et de commutation téléphonique augmentent rapidement. Les nombreuses fonctions de circuit numérique et analogique pouvant être prévues doivent être réalisées de manière économique et comprendre des composants sûrs. L'une des méthodes envisagées utilise des méthodes hybrides formées par l'assemblage de dispositifs semi-conducteurs sur les circuits à films minces.

Le tantale et ses composants sont les matériaux préférés pour les éléments R et C du film car ils permettent d'obtenir une gamme étendue de valeurs d'éléments précises et stables. Le traitement du film est basé sur la gravure chimique et l'oxydation anodique de couches de tantale déposées sur les couches sous-jacentes plates et isolées.

Préamplificateur transistorisé à impédance à entrée élevée et à faible bruit par A. Szerlip

Résumé de l'article
aux pages 390 à 391

Cet article décrit un préamplificateur transistorisé conçu initialement pour l'emploi avec un microphone à condensateur. Le préamplificateur a une excellente performance à faible bruit dans la gamme de 5 à 70KHz. L'avantage de cet amplificateur est son impédance à entrée élevée qui permet le couplage direct au microphone. En raison du couplage direct, la sensibilité aux variations dans les tensions de polarisation de microphones est nettement réduite dans ce préamplificateur et on obtient une largeur de bande beaucoup plus étendue.

L'article examine des considérations de réalisation de l'étage d'entrée. Il indique également une méthode pour calculer le facteur de bruit du préamplificateur.

Dessin schématique circulaire pour représenter le rapport entre le facteur de bruit et l'admittance de source d'un dispositif linéaire à deux orifices par R. Bridgen

Résumé de l'article
aux pages 392 à 393

Les contours du facteur de bruit constant dans le plan d'admittance de source d'un dispositif linéaire à deux orifices consistent en une série de cercles. On peut obtenir un ensemble particulier de cercles en normalisant le facteur de bruit et l'admittance de source en termes de quatre paramètres qui définissent les propriétés de bruit du dispositif à deux orifices.

Certaines des propriétés du rapport entre le facteur de bruit et l'admittance de source sont examinées. Enfin, l'importance des paramètres de définition du bruit est étudié en fonction d'un circuit équivalant à deux générateurs utilisés pour représenter le bruit.

Données de réalisation d'un filtre Butterworth du troisième ordre avec source spécifiée et résistance de charge par R. Sill et A. Simeon

Résumé de l'article
aux pages 394 à 396

Le but de cet article est d'indiquer une méthode simplifiée pour l'étude d'un filtre pratique basé sur le modèle Butterworth du troisième ordre. Cette méthode prévoit des sources et des charges résistives et tient compte également des éléments de circuits à pertes qui se produisent dans la réalité. La dérivation elle-même est fondée sur la technique de prédistorsion décrite par Darlington.

Dans le cas de ce filtre particulier il a été constaté que des circuits appropriés ont pu être obtenus sans grande perte de gain.

Les auteurs donnent également un exemple de filtre à inter-étages pour deux amplificateurs à transistors.

Filtres à une octave et à un tiers d'octave pour les fréquences sub-soniques par W. Tempest et N. S. Yeowart

Résumé de l'article
aux pages 397 à 399

On a réalisé des circuits pour des filtres transistorisés à passebande active de largeurs de bande d'une octave et d'une octave et d'un tiers d'octave. Le dessin de base se compose de deux amplificateurs à réaction à parallèle T et à accord échelonné. Vu que l'appareil n'emploie pas d'inducteur, il peut être utilisé aux basses fréquences. Des modèles ont été construits avec des fréquences centrales d'un minimum de 1Hz et donnant une performance satisfaisante.

NEUE AUSRÜSTUNGEN

Übersetzung der Seiten 402 bis 407

Beschreibung neuer Bauelemente, Zubehörteile und Prüfgeräte auf Grund der von Herstellern gemachten Angaben.

Integrierter Dekadenzähler

SGS-Fairchild Ltd, 23 Stonefield Way, Ruilip, Middlesex

Der als Zähler oder Teiler anwendbare μ L958 besteht aus vier binärgetriggerten Flip-flops in Kaskade, die durch eine Rückführungsschleife auf Zählen im bekannten 1-2-4-8-Code modifiziert werden. Einrichtungen für Löschen und Vorgabe jedes der möglichen Dezimalzustände sind vorhanden. Die monolithische Struktur hat nur Widerstände und Transistoren; sie wird im Planar-Epitaxial-Verfahren hergestellt.

Das in ein TO-5-Gehäuse eingebaute Element hat eine Zählgeschwindigkeit, die mit mindestens 2 MHz garantiert ist, und ist mit anderen integrierten Schaltungselementen von SGS-Fairchild kompatibel. Die Nennspeisespannung ist 3,6 ... 4 V, der Betriebstemperaturbereich 0 ... 75°C.

EE 94 751 für weitere Einzelheiten

Kontinuierlicher Integrator

Mercury Electronics (Scotland) Ltd, 640 Argyle Street, Glasgow, C.3

(Abbildung Seite 402)

Dieser Integrator wurde als geeignetes Instrument für kontinuierliche Integration kleiner Signale entwickelt. Er arbeitet zufriedenstellend mit Eingangssignalen im Bereich von 10 mV ... 1 V und gibt ein Ausgangssignal von 1 V für einen Eingang von 1000 mVs.

Zwei Komplementärtransistoren sind in Serie geschaltet, und ihre Kollektoren liegen an einer Seite eines Kondensators. Bei identischen Kollektorströmen fließt kein Strom in oder aus dem Kondensator. Beaufschlagung des Emittersstroms des einen Transistors mit einem Signal ändert jedoch seinen Kollektorstrom entsprechend, und der Kondensator wird daher aufgeladen oder entladen. Da die Transistoren in Basisschaltung arbeiten, ist der Kollektorstrom im wesentlichen unabhängig von der Potentialänderung, und daher ist die Beziehung zwischen Zeit und Potential am Kondensator für

ein konstantes Eingangssignal linear. Tatsächlich ist aber der Kollektorstrom in den meisten Transistoren ein wenig spannungsabhängig, aber dieser Effekt ist üblicherweise nur erkennbar als Tendenz der Grundlinie, nach der Mitte zurückzuwandern, wenn asymmetrische Signale langfristig integriert werden.

Für viele Zwecke wirkt das als Driftkorrektur, und wenn Wellenformen von ein paar Sekunden Dauer integriert werden, hat es sich tatsächlich als vorteilhaft erwiesen, die Zeitkonstante noch weiter zu reduzieren, um den Einfluss von Artefakten zu reduzieren. Ein Schalter an der Frontplatte gestattet Einstellung der nützlichsten Zeitkonstante.

Trotzdem das Gerät in erster Linie für Anwendung mit dem Greer-Mikromanometer für die Integration stromabhängiger Drücke mit Bezug auf Zeit zur Erstellung von Volumendaten entwickelt wurde, ist es durch die für den Integrator benötigten kleinen Signale für Arbeiten mit Eingangssignalen von Densitometern oder ähnlichen Signalquellen geeignet. Es kann auch dort zur Bildung von Durchschnittswerten herangezogen werden, wo die Darstellung des Mittelwertes eines Signals wünschenswert ist.

EE 94 752 für weitere Einzelheiten

Widerstände

Welwyn Electric Ltd, Bedlington, Northumberland

Welwyn Electric Ltd hat völlig neue Metallschichtwiderstände entwickelt, die als WELMET-Baureihe 40-10 angeboten werden. Sie genügen voll den anspruchsvollen Forderungen der Hersteller von Messgeräten, sind jedoch für alle Anwendungen geeignet, für die hohe Leistung bei niedrigen Preisen erforderlich ist.

Die neuen Widerstände kommen in vier Temperaturbeiwertklassen bis zu $25 \times 10^{-6}/^{\circ}\text{C}$ herunter. Es gibt fünf Größen von 0,125 W bis zu 2,0 W und

Widerstandswerte von 1 Ω bis zu 30 M Ω . Standardtoleranzen sind ± 1 Prozent, aber $\pm 0,5$ Prozent wird auch angeboten, und engere Toleranzen sind gegen Sonderauftrag lieferbar.

Typische Stabilitätswerte sind nach 2 000 Stunden zyklischer Belastung bei 70°C Widerstandsänderungen von 0,1 bis 0,2 Prozent für Widerstände unter 500 k Ω und von 0,2 bis 0,4 Prozent für die Höchstwerte.

Für Zeitspannen von 25 000 Stunden ist die vorausgesagte Ausfallrate 0,04 Prozent/1 000 h, wenn Änderungen von 0,5 Prozent als Versagen betrachtet wird. Wenn eine Änderung von 1 Prozent zulässig ist, fällt die Ausfallrate auf 0,02 Prozent/1 000 h.

Die Widerstände sind vollisoliert. Sie werden durch eine Mehrschicht, die gute Klimaeigenschaften sichert, und eine Hülle aus bestrahltem Polyolefin, das flammenhindernd ist und einen hohen Isolationswiderstand hat, geschützt. Die Hülle ist unhygroskopisch und lösungsfest.

EE 94 753 für weitere Einzelheiten

Inkrementaler Schreiber

Benson-Lehner Ltd, West Quay Road, Southampton

(Abbildung Seite 403)

Den inkrementalen Schreiber gibt es jetzt in zwei neuen Ausführungen. In einer Ausführung wird mit 450 Inkrementen/Sekunde geschrieben, und in der anderen wurde die Inkrementgröße auf 0,254 mm erhöht. Damit wurde eine Verbesserung der Schreibgeschwindigkeit um 50 Prozent (von 300 Inkrementen/Sekunde) und eine Erhöhung der Inkrementgröße um 100 Prozent (von 0,127 mm auf 0,254 mm) erreicht.

Die erhöhte Inkrementgröße im letzteren Modell gestattet schnelleres Schreiben, da die durch jede inkrementale Bewegung zurückgelegte Entfernung verdoppelt ist. Die beim Schreiben mit 300 Inkrementen von je 0,254 mm pro

Sekunde durchlaufene Entfernung beträgt 76,2 mm.

Das Modell mit der schnelleren Schreibgeschwindigkeit durchläuft bei 450 Inkrementen von 0,127 mm je Sekunde 57,1 mm, gibt aber durch die kleineren Inkremente genauere Ergebnisse.

Der inkrementale Schreiber erzeugt unter direkter Prozessrechnersteuerung oder von Lochstreifen oder Magnetbändern komplett gekennzeichnete Kurvenzüge. Typische Anwendungsbeispiele sind automatisches Zeichnen und Erstellen von Wetterkarten und Netzwerken für Planung des kritischen Weges.

Die "Knüppelsteuerung" ist ein charakteristisches Bedienelement des Schreibers. Die Schreibfeder kann mittels eines einzigen Bedienelementes, das entweder Schreibfeder oder Registrierpapier oder beide bewegt, wenn die gewünschte Bewegung in X-, Y- oder XY-Richtung erfolgen soll, beliebig auf dem Registrierpapier positioniert werden. Die mit der "Knüppelsteuerung" erreichbare Bewegungsgeschwindigkeit ist entweder 2 Inkremente/Sek. oder 450 Inkremente/Sek; letztere Geschwindigkeit wird durch volles Durchdrücken des Bedienelementes eingestellt.

Die Schreibfeder ist völlig sichtbar und immer zugänglich, was Einstellen des Startpunktes (z.B. auf Koordinatenpapier) erleichtert und unbeschränkte Beobachtung des entstehenden Linienzuges ermöglicht. Drucktasten leuchten in der Betriebsstellung auf, so dass der Steuerbefehl positiv betätigt wird.

Eine Abreissvorrichtung gestattet saubere Entfernung vollständiger Aufzeichnungen mit geringstem Abfall.

EE 94 754 für weitere Einzelheiten

Lineares Messsystem

The M.E.L. Equipment Co. Ltd, Manor Royal, Crawley, Sussex

(Abbildung Seite 403)

Die Ausrüstung PE 2271 gestattet direktes Messen der Werkzeugposition und wird nicht durch Spiel und andere Ungenauigkeiten der Maschine beeinflusst. Sie unterscheidet sich von anderen Systemen durch Anwendung eines dynamischen Messwandlers neuer Art und ist daher genau, zuverlässig, unempfindlich gegen Schwingungen und kann mit hohen Geschwindigkeiten betrieben werden. Ausserdem bestehen zwischen den ortsfesten und beweglichen Elementen keine Berührungspunkte (sie haben nach Einbau 15 mm Abstand), und das System wird nicht durch Ölfilme beeinflusst, trotzdem es nach optischen Prinzipien arbeitet.

Das System besteht aus einer linearen Glasskala mit abwechselnden reflektierenden und nichtreflektierenden Linien, einem dynamischen Messwandler und einem kleinen elektronischen Gerät.

Die Skala ist in einen Metallträger

gespannt; Stahlspäne können ohne Beschädigungsgefahr weggewischt werden, da das Glas härter ist als die Späne. Die verhältnismässig grobe Teilung liegt 0,3 mm unter der Oberfläche, wobei eine reflektierende und eine nichtreflektierende Linie zusammen 0,64 mm breit sind.

Während des Bearbeitungsvorgangs läuft der Messwandlerkopf über die Glasskala. Ein in diesem Kopf enthaltenes rotierendes optisches System erzeugt zwei 7500-Hz-Lichtsignale, von denen eins ein Bezugssignal ist und direkt in eine Fotozelle gestrahlt wird, während das andere ein Messsignal ist, das von der Skala in eine weitere Fotozelle reflektiert wird.

Die Phasenbeziehung zwischen den Ausgängen der beiden Fotozellen schwankt mit der Position des Schlittens, wobei eine Phasenänderung um 360° einem linearen Weg von 0,32 mm entspricht. Der Ausgang der Fotozellen wird in ein getrenntes Gerät eingegeben, das sie in eine für Speisung des Positionsreglers oder Steuersystems geeignete Form umsetzt. Es gibt System-Gesamtauflösungen von 0,01 oder 0,005 mm, zwischen denen man bei Bestellung wählen muss. Mit diesem System ausgerüstete Maschinen sind mit Tischgeschwindigkeiten bis zu 480 mm/s fahrbar.

Ein wesentlicher Vorteil des Messwandlers ist die Abgabe eines Wechselstromsignals. Hohe Verstärkung ist deshalb verhältnismässig einfach, und Störsignale können leicht ausgefiltert werden. Ausserdem sind nur schwache Lichtquellen mit einer proportional längeren Lebensdauer erforderlich.

Da Messwandler dieser Art selbst bei Stillstand ein Signal abgeben, kann man eine Warnung "Schmutzige Skala" vorsehen. Bei übermässiger Beschmutzung der Skala wird das von der letzteren reflektierte Licht ein schwächeres Signal hervorrufen, was sich durch eine Lampe in einem elektronischen Zusatzgerät anzeigen lässt. Die Lampe leuchtet auf, bevor die Verschmutzung Fehler hervorrufen könnte. Der Abstand zwischen Wandler und Skala ist 15 mm, so dass es möglich ist, die Glasskala und das Fenster des Wandlers ohne Ausbau zu säubern. Bei einigen Maschinen kann das Reinigen sogar während des Arbeitsablaufs erfolgen.

Zur klareren Darstellung ist die Glasskala in der Abbildung ohne den Metallträger gezeigt, auf den sie üblicherweise gespannt wird.

EE 94 755 für weitere Einzelheiten

Messschreiber

Vertrieb: Cybernetics Instrumentation Ltd, 174 Granville Road, London, N.W.2

(Abbildung Seite 403)

Die Schreibgeschwindigkeit dieses Einkanalsschreibers beträgt bei Vollablenkung über das 250 mm breite Papier

0,4 s. Der Nullpunkt kann auf jeden Punkt auf dem Papier eingeregelt werden. Der Papiervorschub ist zwischen 1 und 50 cm/min einstellbar.

Die Schreiber können mit eingebautem Brückenvorverstärker für direkten Anschluss an Dehnstreifen, Druck- und Weggeber usw. ohne Zusatzausrüstung geliefert werden. Der normale Messumfang ist 10 mV ... 50 V in 12 Bereichen.

Es gibt auch Ausführungen für Gestelleinbau, als Vierkanalgerät und X-Y-Schreiber.

EE 94 756 für weitere Einzelheiten

Abgedichtetes Quecksilberrelais

Vertrieb: Techna (Sales) Ltd, 47 Whitehall, London, S.W.1

(Abbildung Seite 403)

Techna (Sales) Ltd vertreibt neuerdings ein in Grossbritannien hergestelltes, hermetisch dichtes Quecksilberrelais.

Das mit Euroswitch-M bezeichnete Relais arbeitet nach dem Prinzip des Lichtbogenlöschens an Quecksilber-Quecksilberkontakten, was eine Lebenserwartung von über 10 Millionen Schaltspielen zulässt. Statt des Kippens findet eine Kolbenaktion statt, und es gibt daher keine extern sich bewegenden Teile. Der Quecksilberbehälter besteht aus rostfreiem Stahl, kann also durch Stromstösse, Lichtbogen usw. hervorgerufene schwere Belastungen aushalten.

Bei rein ohmscher Belastung kann ein Strom von 25 A, 440 V mit einer Betriebshäufigkeit von 2000 pro Stunde abgeschaltet werden. Für Standardspannungen ist eine volle Spulenauswahl lieferbar; die für Betätigung erforderliche Leistung ist bei Gleichspannungen nur 4 W, bei Wechselspannungen 6 VA.

Das Relais kann innerhalb 25° von der Vertikallage arbeiten und ist durch seine Bauart praktisch unzerbrechbar.

Wegen seiner kleinen Abmessungen (38,1 mm Durchmesser und 82,6 mm Länge), absoluten Zuverlässigkeit und günstigen Preislage eignet sich dieses Relais ideal für Einsatz in gefährlicher oder vergifteter Atmosphäre oder wo lange, fehlerfreie Lebensdauer erforderlich ist.

EE 94 757 für weitere Einzelheiten

Frequenzgenerator

The Wayne Kerr Co. Ltd, Sycamore Grove, Malden, Surrey

(Abbildung Seite 404)

Ein völlig neues, von Wayne Kerr-Gertsch angekündigtes Festkörperinstrument hat digitale Einstellung sowie grosse Einzeilenanzeige jeder gewünschten synthetisierten Frequenz in 1-Hz-Inkrementen von 5 Hz bis zu 50 MHz und in 10-Hz-Inkrementen von 50 MHz bis zu 500 MHz. Der sehr grosse Frequenzumfang wird ausschliesslich mit Grundfrequenzen erreicht. Das als Modell SSG-1 bezeichnete Instrument

kombiniert die hochgenaue Eichung der Ausgangsspannung eines Standardmessenders mit der traditionellen Frequenzgenauigkeit von Gertsch; es gestattet ausserdem direktes Messen von Frequenzen zwischen 10 kHz und 1 GHz (bis zu 10 GHz mit Zusatz).

Genauigkeit und Konstanz werden nur durch die des 1-MHz-Quarz-Steueroszillators begrenzt. Mit dem eingebauten Oszillator ist die Stabilität besser als 1×10^{-7} pro Tag. Ausserdem kann ein externes Normal angeschlossen werden; der SSG-1 erzeugt in diesem Fall Ausgangsfrequenzen innerhalb jeder von einem solchen Normal bestimmten Konstanz.

Ausgangspegel bis zu 200 mV können auf 0 dB eingestellt und mittels eines 50- Ω -Präzisionsabschwächers bis zu -130 dBm heruntergeregelt werden. Wenn der Eingangspiegel zum Abschwächer eingestellt ist, wird er durch Verstärkungsautomatik über den ganzen Frequenzbereich konstant gehalten.

Der SSG-1 hat interne Amplitudenmodulation (400 oder 1000 Hz), eingebauten Schwebungsdetektor und Messgerät; er kann auch für die Anzeige des Spitzenhubes frequenzmodulierter Signale angepasst werden. Die Abmessungen sind 406 mm breit, 457 mm hoch und 533 mm tief, das Gewicht etwa 45 kg.

EE 94 758 für weitere Einzelheiten

Steckerleisten

Ultra Electronics (Components) Ltd,
Industrial Estate, Long Drive, Greenford,
Middlesex

(Abbildung Seite 404)

Steckerleisten für gedruckte Schaltungen werden in neuer Ausführung von Ultra Electronics (Components) Ltd angekündigt.

Das Programm besteht aus 10-, 15- und 22poligen Steckerleisten mit 3,96 mm Rastermass und Gleitbüchsen für Schrauben mit dem englischen 8BA-Gewinde. Die aus Phosphorbronze erstellten Kontakte sind nach dem UECL patentierten Balgprinzip ausgeführt. Die aus Diallylphthalat gepressten Leisten haben einen Arbeitstemperaturbereich von $-55^{\circ}\text{C} \dots +110^{\circ}\text{C}$.

Der maximale Kontaktwiderstand ist $10 \text{ m}\Omega$, der Isolationswiderstand unter normalen Bedingungen mindestens $5 \text{ G}\Omega$. Nylon-Führungsnippel können in jeder Position vorgesehen werden.

EE 94 759 für weitere Einzelheiten

Wobbler

Telonic Industries U.K., The Summit,
2 Castle Hill Terrace, Maidenhead, Berkshire

(Abbildung Seite 404)

Telonic Industries hat einen neuen Festkörperwobbler Modell 1001 eingeführt. Das neue Gerät hat einen grossen

Frequenzbereich, veränderlichen Wobbelhub, hohe Stabilität, Wobbel- oder Dauerstrichbetrieb und ein neues Frequenzmarkensystem. Der Bereich des neuen Instruments ist 100 kHz...20 MHz.

Der Wobbelhub kann durch drei Bereiche verändert werden: einen breiten Bereich von 10 kHz...20 MHz, einen Zwischenbereich von 1 kHz...2 MHz und einen engen Bereich von 100 Hz...200 kHz. Die Wobbelgeschwindigkeit ist ebenfalls veränderlich, und zwar kontinuierlich von 0,01...60 Hz oder mit dem 50-Hz- oder 60-Hz-Netz synchronisiert. Die Ausgangsspannung des Modells 1001 ist $1 V_{eff}$. Der Ausgang des Frequenzmarkengebers kann direkt einem Frequenzzähler zugeführt werden.

Besonders für Modell 1001 entwickelte hochkonstante Stromversorgungen gewährleisten zusammen mit der Temperaturkompensation im Oszillator hohe Stabilität. Die kurzfristige Stabilität des Gerätes ist 500 Hz/min, die langfristige 5 kHz/h.

Ein durch eine Hubervielfältigerschaltung erreichtes neues Frequenzmarkensystem ist ein wichtiges Merkmal des Generators. Der Markengeber hat zwei Betriebsarten: eine mit Harmonischen von 1 MHz und eine veränderliche. Die harmonischen Marken sind nur 10 kHz breit. Die veränderlichen Frequenzmarken können 10 kHz, 1 kHz oder 100 Hz breit eingestellt werden. Die engen Markenbreiten gestatten äusserst genaue Frequenzbestimmung.

Das Markierungssystem hat auch ein Bedienungsorgan, das Schrägstellen der Marken von der Vertikalen gestattet, so dass genaueres Ablesen bei stark geneigter Wellenfront ermöglicht wird.

Der Generator ist in einem 483 mm (19") breiten, 178 mm hohen Gehäuse untergebracht, das durch Nachrüsten mit zwei Befestigungsteilen für Gestelleinbau geeignet ist.

EE 94 760 für weitere Einzelheiten

Piezoelektrischer Beschleunigungsmesser

Consolidated Electrodynamics Division,
Bell & Howell Ltd, 14 Commercial Road,
Woking, Surrey

(Abbildung Seite 404)

Der von der Abteilung Consolidated Electrodynamics der Bell & Howell Ltd eingeführte kleine, leichte piezoelektrische Beschleunigungsmesser ist in Kompressionskonstruktion mit einem federnden Stab ausgeführt; das Fühlersystem ist also mechanisch vom Gehäuse isoliert.

Durch die mechanische Isolation des Fühlerelementes vom Gehäuse wird maximaler Schutz gegen den Luftdruck von Raketentriebwerken und thermische Sprünge erreicht.

Der piezoelektrische Beschleuniger 4-274 eignet sich auf Grund seiner ganz geschweissten Bauart besonders für Einsatz bei sehr hoher Feuchtigkeit. Selbst bei periodischer Temperatur-

änderung findet kein "Einatmen" von Feuchtigkeit statt, wie es bei epoxyd-gekapselten Gebern auftreten kann.

Die Empfindlichkeitsänderung beträgt bei Parallelschaltung des empfohlenen Kapazitätswertes (700 pF) weniger als 8 Prozent über den Temperaturbereich $-73^{\circ}\text{C} \dots +149^{\circ}\text{C}$. Der Beschleunigungsmesser hat in eingebautem Zustand eine Eigenfrequenz von 70 kHz, was einen Frequenzgang von ± 5 Prozent zwischen 2 Hz und 12 kHz gestattet.

EE 94 761 für weitere Einzelheiten

Analysator für integrierte Schaltungen

Vertrieb: Quantum Engineering Ltd,
31 Queen Anne's Gate, London, S.W.1

(Abbildung Seite 405)

Der von Optimized Devices Inc in U.S.A. hergestellte Analysator für integrierte Schaltungen gestattet schnelle Beurteilung, Testen und Analyse monolithischer Schaltungen und solcher mit diskreten Bauelementen. Ein Schiebeshalterzusammenbau bildet eine Matrize mit 16×9 Kreuzpunkten für das Verbinden jeder beliebigen oder aller Anschlussstifte der Bausteine mit jeder beliebigen der vier internen Stromquellen, vier beliebigen externen Funktionen oder einem gemeinsamen Punkt.

Die völlig erdfreien Stromversorgungen geben $0 \dots \pm 100 \text{ V}$ mit $\pm 0,1$ Prozent Auflösung ab, haben siliziumtransistorbestückte Funktionsverstärker auf Glasfaser-Einsteckdruckschaltungen und können ganz getrennt mittels Schalter und direktanzeigender 1000teiliger Skalen auf Polarität, Bereich und Spannung eingestellt werden.

Ein eingebautes Voltmeter der Güteklasse 1 mit Spiegelskala und fünf Bereichen kann für Spannungsmessungen in bezug auf einen gemeinsamen Punkt an jeden Anschlussstift des Bausteins gelegt werden. Strommessungen kann man auch durchführen.

Weitere Merkmale sind unter anderem: über die Schaltmatrize mit dem Prüfling verbindbare Eingänge für externe Strom- und Signalquellen; Überwachung der Spannungen an den Bausteinzuleitungen, der einzelnen Stromquellenspannungen und -ströme sowie des gesamten Erdstroms mittels externer Messgeräte, z.B. eines Digitalvoltmeters mit Datenerfassungseinrichtung; Überwachung der Bausteinanschlussstifte mittels Zähler, Oszillografen usw. Frontplattenbüchsen gestatten Einfügen von Widerständen für die Simulation von Betrieb mit konstantem Strom, Impedanzen des Netzanschlusses und der Gemeinschaftserde sowie Serienschaltung von Stromquellen mit Hilfe von Bauelementen, wie z.B. Relais oder Spulen, zur Prüfung des korrekten Funktionierens externer Schaltungen.

Kelvin-Zweifachverbindungen am Prüfling-Zwischenstück beseitigen durch Kontakt und Spannungsabfall in den Zuleitungen vor allem bei Messungen mit Sonden auftretende Messfehler.

Der Analysator wird für leichtere Bedienung in einem Tischgehäuse auf einem Schwenkstand geliefert, der in jeder Position feststellbar ist. Nach Entfernung aus dem Gehäuse lässt sich das Gerät in ein 19"-Gestell einbauen.

EE 94 762 für weitere Einzelheiten

Temperaturregler

Clarke Chapman & Co. Ltd. (Electronics Division), Team Valley, Gateshead, Co. Durham
(Abbildung Seite 405)

Dieser genaue, doch preisgünstige proportionalwirkende Temperaturregler kann bis zu 300 verschiedene Punkte im Temperaturbereich 0...1000°C mit $\pm 1^\circ\text{C}$ Unsicherheit regeln. Die Regelung erfolgt proportional, und der Proportionalbereich ist zwischen 3 und 300 Prozent einstellbar. Drucktastenwahl gestattet Überwachung der Temperatur jedes Messpunktes auf einem Profil-Drehpulsmessgerät. Auf Wunsch können auch nichtgeregelte Messpunkte überwacht werden.

Jede Regelkreisschaltung ist in einen kleinen Einsteckmodul für Schaltfeldmontage eingebaut und kann entweder elektrische Heizerlasten oder elektro-pneumatische Wandler steuern.

Es wird angenommen, dass der Regler seine Hauptanwendung in den Verfahren der Gessereien, Chemie, Kunststoff- und Gummiwerken, Chemiefasern und anderen Industrien finden wird, wo eine billige Mehrfachregelung der Temperatur benötigt wird. Andere Modelle sind mit einer Regelunsicherheit von $\pm 0,1^\circ\text{C}$ lieferbar.

EE 94 763 für weitere Einzelheiten

Elektronischer Mehrfachmesser

O.P. Instruments Ltd, 246 Sutton Common Road, Sutton, Surrey
(Abbildung Seite 405)

Dieses gleichstromanzeigende Instrument wurde als billige Ergänzung des Standard-Mehrfachmessers entwickelt und hat für alle Spannungsbereiche einen Eingangswiderstand von über 100 M Ω . Die Anzeige von Spannung und Strom erfolgt in sechzehn Bereichen; die Skalenendwerte der Spannungsbereiche liegen zwischen 333 mV und 1 kV, die der Strombereiche zwischen 333 nA und 1 mA.

Die für bequemes Ablesen ausgelegte Grosskala des Messgerätes ist 45° geneigt. Die Bereiche wurden für optimale Genauigkeitsverteilung angeordnet.

Kleine Abmessungen (197 x 140 x 127 mm) und Batteriebetrieb machen es leichter tragbar; die 3-V-Trockendauerbatterien sind direkt von aussen zugänglich.

Transistorverstärkung gibt hohe Empfindlichkeit, ausgezeichnete elektrische

Stabilität und vollen Schutz gegen Überlastung und Polaritätsumkehr.

Mit einem externen Gleichrichter-taster kann das Instrument effektive Spitzenwerte von Wechselspannungen anzeigen.

EE 94 764 für weitere Einzelheiten

NF-Messender

Taylor Electrical Instruments, Montrose Avenue, Slough, Buckinghamshire
(Abbildung Seite 405)

Der neue NF-Oszillator 192A ist ein vielseitiges Gerät für allgemeine Testzwecke, dessen Leistung ihn jedoch auch für Allgemeineinsatz als Messender im Labor geeignet macht.

Das Gerät wurde für Abgabe von Sinus- oder Rechteckwellen im Frequenzbereich 10 Hz ... 100 kHz in vier Teilbereichen ausgelegt; die gewünschte Wellenform wird durch einen Schalter eingestellt. Bei Sinuswellenabgabe ist die Höchstspannung an den Ausgangsklemmen 25 V_{eff} mit 68 Ω Ausgangsimpedanz bei 25 mV, die bei Höchstspannung auf 10 k Ω ansteigt.

Das Gerät stellt daher eine zweckmässige Quelle niedriger Leistung zur Kontrolle des Frequenzganges und der Einschwingvorgänge von Verstärkern, Übertragern, Lautsprechern usw. dar.

Eine eingebaute, konventionelle Wien-Brückenschaltung ist thermistorstabilisiert und gibt bei allen Frequenzen eine konstante Amplitude ab. Die Rechteckwellenform wird durch Speisung des Brückenschaltungsausgangs in eine Schmitt-Triggerschaltung erzeugt, die die Sinuswellenform abkapt und in eine Rechteckwelle formt. Die Schaltung ist so ausgelegt, dass sie bei Einstellen des Sinuswellenausgangs als Spannungsverstärker arbeitet.

EE 94 765 für weitere Einzelheiten

Zähler-Zeitmesser

Radun Controls Ltd, White Street, Caerphilly, Glamorgan

(Abbildung Seite 405)

Der Rechen-Zähler 152 ist ein preisgünstiger elektronischer Mehrzweckzähler mit grösserer Vielseitigkeit.

Das für Anwendung im Werk und Labor entworfene Gerät hat einen Frequenzbereich von 1 Hz ... 250 kHz, ist volltransistorisiert und gibt eine einzeilige, vierstellige Anzeige auf Langlebensdauer-Zählröhren. Ein Zählermodell 153 mit Überschussanzeige ist ebenfalls lieferbar.

Ausser den von den meisten Vorkontrollzählern ausführbaren Funktionen, z.B. Messen von Frequenzen, Perioden, Zeitintervallen oder Frequenzteilung und Abzählen von Partien, kann dieser Zähler auch die folgenden messen und anzeigen: Geschwindigkeit oder Durchsatz direkt in geeigneten Einheiten, z.B.

als UPM, 1/min oder m/min sowie das Verhältnis zweier Frequenzen oder Raten, und zwar direkt oder normiert.

Durch Verwendung einer vollvariablen Vierdekaden-Zeitbasis kann das Eingangssignal für Perioden von 100 μs bis zu 1 s in 100- μs -Schritten abgetastet werden; bei Einsatz eines $\times 10$ -Vervielfachers sind die Perioden zwischen 1 ms und 10 s in 1-ms-Schritten einstellbar. Daraus ergibt sich eine einfache Methode zur Umsetzung von Frequenzen in praktische Einheiten. Bei Drehzahl- und Durchflussmessungen lassen sich die Kenndaten automatisch kompensieren, so dass die Anzeige direkt in den gewünschten Einheiten erfolgt. In gleicher Weise gestattet die Verwendung des zweiten Eingangskanals und der variablen Zeitbasis das Normalisieren der Verhältnisse von zwei Frequenzen oder Geschwindigkeiten.

Zusätzliche Merkmale sind u.a.: eine 10-kHz-Kristallquelle mit Teilern zur Abgabe von Ausgängen von 100 μs bis zu 10 s in Dekadenschritten; komplette Testeinrichtungen; eine Anzeige mit Austastung bis zur Beendigung der Zählung oder kontinuierlicher Darstellung; von 0,3 ... 6 s regelbare Anzeigephasen und Einmalanzeige; Ausgangssignale durch Schliessen von Relaiskontakten nach Beendigung der Zählung, die man gegebenenfalls für externe Steuerfunktionen benutzen kann; Ausdrucken in direkter Dezimalform oder als Spannungspegel.

EE 94 766 für weitere Einzelheiten

Beschichtungsausrüstung

Balzers High Vacuum Ltd, Northbridge Road, Berkhamsted, Hertfordshire

(Abbildung Seite 406)

Die neue Beschichtungsausrüstung BA.360 ist für die Erstellung optischer oder elektronischer Dünnschichten in Kleinserien oder für Forschungsarbeiten geeignet.

Die Ausrüstung ist kompakt und vielseitig; die vertikale, doppelwandige Vakuumkammer aus rostfreiem Stahl hat einen Innendurchmesser von 360 mm und eine interne Höhe von 390 mm; das Pumpen erfolgt mittels einer halbautomatischen Einhebelpumpe. Die leere und saubere Anlage kann mit 650 l/s Pumpgeschwindigkeit in etwa 5 Minuten auf 1×10^{-5} Torr evakuiert werden; bei Verwendung einer tiefgekühlten Prallplatte und eines Meissner-Schlusses können Drücke bis zu 5×10^{-7} Torr herunter in unter 15 Minuten erreicht werden.

In Forschung und Entwicklung hat die Ausrüstung den Vorteil, dass neu entwickelte Prozesse ohne Schwierigkeiten auf die Modelle BA.510 und BA.710 für Massenproduktion übertragen werden können.

Das für die grösseren Modelle lieferbare Zubehör, z.B. Glimmentladungsein-

richtungen, Elektronenstrahlverdampfung, tiefgekühlte Prallplatten, Dickemesser, servoregelte Gaseinlassventile, gleichzeitiges Verdampfen von zwei Quellen, Drehkäfig usw., gibt es auch für die neue Ausrüstung.

EE 94 767 für weitere Einzelheiten

Mikrowellen-Leistungsmesser

W. H. Sanders (Electronics) Ltd,
Gunners Wood Road, Stevenage, Hertfordshire
(Abbildung Seite 406)

Der neue Leistungsmesser ist für Direktanzeige von Mikrowellenleistung bis zu 10 mW ausgelegt und im Betrieb sehr vielseitig. Das Messgerät wird mit einem Mikrowellenvorverstärker, der den dem Hohlleiter entsprechenden Frequenzbereich (2,6...12,4 GHz) mit einem maximalen Stehwellenverhältnis von 1,5 überstreicht, eingesetzt. Thermistoren und Bolometer finden als Tastelemente in den Messköpfen Verwendung. Für die Temperaturkompensation verwendet man gepaarte Thermistoren; wenn keine Kompensation erforderlich ist, können aber Einzelelemente benutzt werden. Alle Elemente, die mit 200 Ω Widerstand betrieben werden, können durch das Bedienungspersonal ausgewechselt werden.

Das Gerät ist bequem tragbar und kann entweder ans Netz angeschlossen oder ohne Verschlechterung der Messunsicherheit von 3 Prozent des Skalenendwertes mit internen Batterien betrieben werden.

EE 94 768 für weitere Einzelheiten

Ultraschallgenerator

Radyne Ltd, Wokingham, Berkshire
(Abbildung Seite 406)

Der wachsende Bedarf an grossen Ultraschall-Reinigungsanlagen hat zu neuen Konstruktionsgesichtspunkten für Generatoren und Schwinger geführt, und Radyne Ltd hat durch Entwicklung von Generatormoduln Anlagen unbegrenzter Ausgangsleistung geschaffen. Sie bestehen aus einem Speisegerät, Steuerfeld und mehreren 1-kW-Moduln, so dass die Systeme leicht auf die Anforderungen der Kunden zugeschnitten werden können.

Jeder Generatormodul gibt Energie an einen Tauch- oder Schottschwinger ab, und Grossflächen werden durch Mehrfachschwingergruppen bestrahlt, Einzel- oder Gruppenkontrolle wird durch getrenntes Schalten erleichtert.

Konsolen mit zwei oder vier Einheiten bilden das Grundsystem. Die Generatormoduln beruhen auf der Radyne-Thyristor-Wechselrichterschaltung und werden in die Konsolen eingeschoben. Die zugehörigen Schwinger sind mit Radyne-Magnatrack-Elementen ausgerüstet und vervollständigen das Baukastensystem. Die Konsolen können ent-

weder luftgekühlt oder—für sehr harte industrielle Bedingungen—in einem dichten Gehäuse wassergekühlt werden.

EE 94 769 für weitere Einzelheiten

Übertragungsfunktion-Analysator

Smiths Industries Ltd, Aviation Division,
Kelvin House, Wembley Park Drive, Wembley,
Middlesex

(Abbildung Seite 407)

Der vom Geschäftsbereich Luftfahrt der Smith Industries Ltd angekündigte neue Übertragungsfunktion-Analysator vereint einen Sinuswellengeber und einen Analysator in einem Gerät. Das Instrument arbeitet im Tiefstfrequenzbereich von 24 Hz bis zu 1 Periode/Min herunter.

Die Analysatoranzeige erfolgt in acht Bereichen mit Endwerten von 50 mV bis zu 150 V. Der Generatorausgang hat einen Höchstpegel von 10 V und eine Ausgangsimpedanz von 10 Ω . Die Gesamtgenauigkeit des Gerätes ist ± 2 Prozent der Amplitude und $\pm 1^\circ$ der Phase.

Einer der beiden Ausgangskanäle des Generators kann in bezug auf den anderen um bis zu 360° verschoben werden. Der Frequenzgang lässt sich daher—als Alternative zur Darstellung in den normalen kartesischen Koordinaten—in Polarkoordinaten darstellen.

Ausser den direkten Tiefstfrequenzsignalen können modulierte Signale auf einem 400-Hz-Träger erzeugt und analysiert werden. Die Wahl der Arbeitsweise—direkt oder Träger—erfolgt unabhängig für den Analysatorteil und jeden der Generatorausgänge.

Sowohl für direkten wie auch Trägerfrequenzbetrieb sind die Ausgangsklemmen des Generators und Eingangsklemmen des Analysators erdfrei. Dadurch steht es dem Anwender völlig frei, Signale in jedem beliebigen Teil der Schaltung aufzudrücken oder zu messen.

EE 94 770 für weitere Einzelheiten

Gesinterte Silber-Glimmerkondensatoren

London Electrical Manufacturing Co. Ltd,
Bridges Place, Parson Green Lane,
London, S.W.6

(Abbildung Seite 407)

LEMCO hat durch Verwendung von 25×15 mm-Glimmerplättchen in gesinteter Form das Spektrum ihrer Silber-Glimmerkondensatoren erweitert.

Reinversilberte Rotglimmerplättchen werden gestapelt und unter starkem Druck erhitzt, bis die Plättchen in einen stabilen widerstandsfähigen Block gebondert sind. Enddrähte werden mit Speziallot angelötet, um das höchstmögliche Q aufrechtzuerhalten.

Um allen Anwendungsmöglichkeiten gerecht zu werden, sind diese Kondensa-

toren entweder umpresst, mit Kunstharz isoliert oder mit Wachs überzogen lieferbar. Sie sind für professionelle Verwendungszwecke bestimmt.

Ausgedehnte Lebensdauertests haben gezeigt, dass diese Kondensatoren in allen Umweltbedingungen äusserst konstant sind und einen niedrigen Temperaturbeiwert haben.

Kapazitäten von 5000 pF bis zu 0,05 μ F sind für Betriebsspannungen von 220 und 350 V—lieferbar.

EE 94 771 für weitere Einzelheiten

Mikroschaltungs-Leiterplatten

Harrison Reproduction Co. Ltd,
164 Lynchford Road, Farnborough, Hampshire
(Abbildung Seite 407)

Ein neues und fortschrittliches Verfahren zum Durchplattieren von Löchern in Leiterplatten wurde für Mikroschaltungen entwickelt. Die von Harrison Reproduction Equipment Ltd (Movitex-Gruppe) hergestellten Leiterplatten finden die gleiche Anwendung für Mikroschaltungen wie Druckplatten für transistorisierte Schaltungen.

Die neue Technik gestattet, Leitern von nur 0,1 mm Breite mit 0,1 mm Abstand zu erstellen. Löcher bis zu 0,38 mm Durchmesser herunter können nunmehr durchplattiert werden. Die Firma glaubt, dass diese engen Toleranzen und kompakten Abmessungen in England erstmalig aus der Fertigung lieferbar sind.

Harrison wendet eine neue Kombination von Verfahren für Niederschlag, Plattieren, Ätzen und Bondern von Kupfer zu Glasfasern an. Mit Epoxyharz verarbeitete Glasfasern bilden die Basis der mit Schaltungsleitern und Löchern versehenen Platten, deren Oberfläche auf die verschiedensten Weisen behandelt werden kann, u.a. mit Zinn dispersion und Vergoldung. Die Bindefestigkeit wurde getestet und erprobt; es wird angegeben, dass sie der herkömmlicher Druckplatten entspricht. Der Betriebstemperaturbereich ist $-55^\circ\text{C} \dots +100^\circ\text{C}$.

EE 94 772 für weitere Einzelheiten

Digitalvoltmeter

Fenlow Electronics Ltd, Springfield Lane,
Weybridge, Surrey

(Abbildung Seite 407)

Das Fenlow-Digitalvoltmeter 301A ist ein Präzisionsinstrument in neuer Integrationstechnik mit mitlaufenden Auswertimpulsen. Der Oszillator, der während der Signal- und Referenzintegrationsperioden die zu zählenden Impulse abgibt, wird durch vor- und nachlaufende Auswertimpulse auf 20 000 mal die Netzfrequenz eingeregelt, ein Prinzip, das oft in Radarnachlaufsystemen Anwendung findet. Die durch Auswertimpulse eingerastete Integration reduziert den Einfluss der Serientakt-

signale ohne Einsatz von Filtern um ungefähr 100 mal gegenüber Systemen mit Festintegrationsperiode bei Netzfrequenzabweichungen, wie sie im Winter vorkommen.

Vorverstärker und Integratorschaltung sind für die Zerhacker mit Feldeffekttransistoren bestückt, was die Drift reduziert und niedrige Eingangsströme und hohe Eingangsimpedanz ergibt.

Das ganze Eingangssystem ist erdfrei und gestattet Differentialbetrieb selbst wenn ein Druckwerk getrieben wird. Das Gerät enthält einen Programmteil zur Erleichterung des Betriebs mittels externer Befehle.

Fünf Spannungsbereiche sind vorhanden, von 0...100 mV bis zu 0...1 kV.

EE 94 773 für weitere Einzelheiten

Transistorklammer

Jermyn Industries, Vestry Estate, Vestry Road, Sevenoaks, Kent

(Abbildung Seite 407)

Eine von Jermyn Industries eingeführte Plastik-Klammer wird einfach durch Eindrücken in ein 3,2 mm Loch positioniert und kann Durchmesser von 4,8 bis 6 mm festklemmen. Sie ist somit für Transistoren wie z.B. den OC200 geeignet. Die aus Nylon A100 hergestellte Klammer hat einen Schmelzpunkt, der über 210°C liegt, und ist daher im Gegensatz zu anderen Klammern aus Polyäthylen für das Lötwellenverfahren geeignet, da sie nicht durch das über sie fließende Lot angegriffen wird.

EE 94 774 für weitere Einzelheiten

Psophometer

Laboratoire Electro-Acoustique, 5, Rue Jules Parent, Rueil (S & O), Frankreich

(Abbildung Seite 407)

Dieses Gerät wurde für das Messen des absoluten Hintergrundgeräuschpegels entwickelt und besteht aus einem geeichten Verstärker, einem psophometrischen Filter und einem Messgerät.

Im Eingang liegt ein symmetrischer Übertrager, dessen Impedanz grösser ist als 5 k Ω ; die Empfindlichkeit ist -115 dB... +15 dB mit Abschwächern für 10 dB in 1-dB-Stufen. Auswechselbare Filter sind vorhanden, und das Gerät ist durchgehend mit Silizium-Transistoren bestückt.

Geräte sind sowohl für Rundfunk als auch Fernsprechdienst lieferbar.

EE 94 775 für weitere Einzelheiten

Zusammenfassung der wichtigsten Beiträge

Ein computergesteuertes Oszillografendarstellungssystem von W. Bial

Zusammenfassung des Beitrages auf Seite 354-359

Es wird eine allgemeine Beschreibung eines Oszillografensystems gegeben, das in erster Linie für die Darstellung der Ausgabe eines Digitalrechners gedacht ist. Schaltungseinzelheiten von besonderem Interesse werden besprochen.

Analyse eines Schnellfestspeichers mit U-Kernen von H. P. A. Salam

Zusammenfassung des Beitrages auf Seite 360-366

Die den Entwurf von verdrahteten Festspeichern mit U-Ferritkernen beeinflussenden Faktoren werden besprochen. Die für ein spezielles System geltenden Grundgleichungen werden entwickelt, und es wird gezeigt, dass der Signalabstand dem Quadrat der Länge des Steuerdrahtes und dem Quadrat der Betriebsfrequenz proportional ist. Die Konstruktion eines Speichers mit 250 Nanosekunden Zykluszeit wird beschrieben.

Dünnschichttransistoren von R. P. Howson

Zusammenfassung des Beitrages auf Seite 367-369

Ein im Vakuum aufgedampftes Feldeffektelement aus Dünnschichten kann—ungleich dem herkömmlichen bipolaren Transistor—erfolgreich aus den verschiedensten Halbleiterelementen hergestellt werden, die weder hochkristallin zu sein, noch einer präzisen Kontrolle ihrer elektrischen Eigenschaften zu unterliegen brauchen. Die Arbeitsweise, Technologie und Eigenschaften solcher Elemente werden untersucht und die die Konstruktion solcher Transistoren beeinflussenden Faktoren in bezug auf greifbare Materialien und die benutzte Geometrie besprochen. Ferner wird die voraussichtliche Zukunft solcher Elemente im Vergleich mit ihrem Einkristall-Siliziumäquivalent betrachtet.

Eine Trennstufe mit sehr hoher Eingangsimpedanz und Feldeffekt-Transistoren von K. Thompson

Zusammenfassung des Beitrages auf Seite 370-373

Die sehr hohe Eingangsimpedanz von $10^{13}\Omega$ für den Frequenzbereich 0...50 kHz ist in erster Linie als Trennstufe mit 1:1 Verstärkung für das Abtasten von Spannungen über ± 10 V in einem hochohmigen Analogsimulator gedacht. Durch die niedrige Ausgangsimpedanz von 1Ω ist sie als Treiber vieler anderer normaler Instrumente geeignet und bildet mit einem Milliampereometer ein Röhrenvoltmeter mit allerdings begrenztem Spannungsbereich. Sie hat einen Eingangsgateruhestrom, der so niedrig wie der jeder Röhrenschaltung ist (10^{-10}).

Messen des Frequenzganges mittels Frequenzwobblung von J. F. Golding

Zusammenfassung des Beitrages auf Seite 374-380

Das Verfahren, nach dem ein Wobbler und ein Oszillograf zur Darstellung des Frequenzganges aktiver und passiver Netzwerke eingesetzt werden, ist überall bekannt. Der Beitrag beschreibt die üblicherweise benutzten Methoden und bringt einige vorgeschlagene Abwandlungen, die zur Lösung der bei Schmalbandmessungen auftretenden technischen Schwierigkeiten beitragen können.

Ein System für die Serienaufzeichnung von Daten von mehreren Kanälen mit mässiger Geschwindigkeit von J. G. Lang

Zusammenfassung des Beitrages auf Seite 381-383

Ein System für die impulsfrequenzmodulierte Aufzeichnung auf Magnetband, das von der Bandgeschwindigkeit praktisch unabhängig ist, wird beschrieben. Eingangskanäle werden mit einer Geschwindigkeit von sechs Kanälen pro Sekunde abgetastet und die Information serienmässig auf eine Spur des Magnetbandes übertragen. Das System hat besonders im Aussendienst Anwendungsmöglichkeiten, wo Daten mit mässiger Geschwindigkeit und vom Netz entfernt registriert werden sollen.

Eine monostabile Hochleistungsschaltung mit Komplementär-Transistoren von B. D. Rakovich

Zusammenfassung des Beitrages auf Seite 384-387

Eine beschriebene monostabile Schaltung mit Komplementär-Transistoren ist für die Erzeugung von Rechteckimpulsen mit sehr kurzer Anstiegs- und Abfallzeit geeignet. Die Schaltung nimmt nur Energie auf, wenn sie getriggert wird, und führt zu einer nützlichen Einsparung bei der Gesamtenergieaufnahme, wenn ein niedriges Tastverhältnis gewünscht wird. Eine weitere wichtige Eigenschaft der Schaltung ist, dass sie sehr kurze Rechteckimpulse recht guter Form erzeugen kann.

Tantalfilmschaltungen von P. L. Hawkes

Zusammenfassung des Beitrages auf Seite 388-389

Elektronische Verfahren finden in immer schneller wachsendem Masse beim Schalten und in der Übertragung von Fernsprechkverkehr Anwendung. Die zahlreichen vorgeschriebenen digitalen und analogen Schaltungsfunktionen müssen durch Bauelemente in wirtschaftlicher und zuverlässiger Form realisiert werden. Eine erfolgversprechende Methode, die zur Zeit untersucht wird, sieht Anwendung integrierter Hybrid-Schaltungen vor, für die Dünnschichtschaltungen mit Halbleitern bestückt werden. Tantal und seine Verbindungen werden als Werkstoffe für die R- und C-Filmelemente vorgezogen, da sie Fertigung in einer grossen Auswahl genauer und konstanter Werte ermöglichen. Die Verfahrensstufen der Filmherstellung beruhen auf chemischem Ätzen und automatischer Oxydation der auf flache, isolierende Träger aufgespritzten Tantalschichten.

Rauscharmer Transistor-Vorverstärker mit hoher Eingangsimpedanz von A. Szerlip

Zusammenfassung des Beitrages auf Seite 390-391

Der Beitrag beschreibt einen transistorisierten Vorverstärker, der in erster Linie für Einsatz mit einem Kondensatormikrofon entwickelt wurde. Der Vorverstärker hat im Bereich 5...70 kHz ausgezeichnete rauscharme Eigenschaften. Sein Vorteil liegt in seiner hohen Eingangsimpedanz, die direkten Anschluss des Kondensatormikrofons gestattet. Durch die direkte Ankopplung wird die Empfindlichkeit dieses Vorverstärkers gegen Schwankungen der Mikrofonvorspannung stark reduziert und eine viel grössere Bandbreite erzielt.

Konstruktionsüberlegungen für die Eingangsstufe werden besprochen und Methoden zur Berechnung des Rauschfaktors des Vorverstärkers gegeben.

Kreisdiagramme zur Darstellung der Beziehung zwischen Rauschfaktor und Quellenadmittanz eines linearen Vierpols von R. Bridgen

Zusammenfassung des Beitrages auf Seite 392-393

Die Konturen konstanter Rauschfaktoren in der Quellenadmittanzebene eines linearen Vierpols bestehen aus einer Reihe von Kreisen. Durch geeignetes Normalisieren des Rauschfaktors und der Quellenadmittanz in Form von vier Parametern, die die Rauscheigenschaften des Vierpols definieren, kann eine eindeutige Reihe von Kreisen erreicht werden.

Einige Eigenschaften der Beziehung zwischen Rauschfaktor und Quellenadmittanz werden besprochen und abschliessend die Bedeutung der das Rauschen definierenden Parameter in Form einer Zwei-Generator-Ersatzschaltung, die das Rauschen darstellt, in Betracht gezogen.

Entwurfsdaten für ein Butterworth-Filter dritter Ordnung mit vorgeschriebener Quelle und Belastungswiderstand von R. Sill und A. Simon

Zusammenfassung des Beitrages auf Seite 394-396

Es ist beabsichtigt, in diesem Beitrag ein vereinfachtes Verfahren für den Entwurf eines praktischen Filters, das auf dem Butterworth-Modell dritter Ordnung beruht, zu beschreiben. Dieses Verfahren berücksichtigt rein ohmsche Quellen sowie Abschlüsse und stellt verlustreiche Schaltungselemente, die in der Praxis vorkommen, in Rechnung. Die Ableitung selbst beruht auf der von Darlington beschriebenen Vorverzerrungsmethode.

Für dieses besondere Filter konnten geeignete Schaltungen ohne grosse Verstärkungsminderung entworfen werden.

In die Diskussion einbegriffen ist das Beispiel eines Zwischenstufenfilters für zwei Transistorverstärker.

Oktaven- und Terzfilter für Unterhörfrequenzen von W. Tempest und N. S. Yeowart

Zusammenfassung des Beitrages auf Seite 397-399

Schaltungen für transistorisierte aktive Bandfilter mit Oktaven- und Terzbandbreite wurden entwickelt. Die Grundschaltung besteht aus zwei gestaffelt abgestimmten Doppel-T-Verstärkern mit Rückkopplung, die ohne Spulen gebaut und daher für niedrige Frequenzen geeignet sind. Muster mit Mittenfrequenzen bis zu 1 Hz herunter wurden gebaut und funktionierten zufriedenstellend.

ADVANCE

PULSE GENERATORS

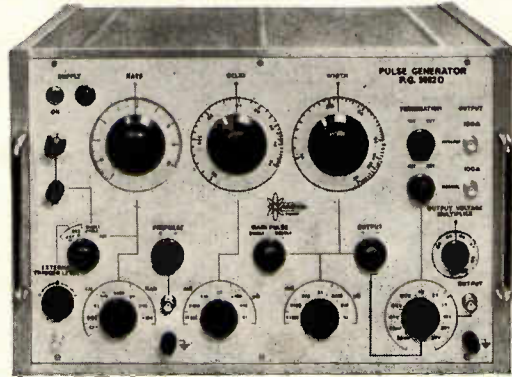

DOUBLE PULSE GENERATOR PG5002D

The Pulse Generator PG5002D is a fully calibrated instrument with a wide range of facilities which make it extremely flexible in operation.

Main Pulse

Width: Continuously variable 0.1 μ S to 1 Sec.
Delay: Continuously variable 0.2 μ S to 2 Sec. *Rise Time:* 12 nanosecs. up to 2V. Above 2V dependent on load capacitance. *Repetition Rate:* From internal oscillator, 0.1 c/s to 1 Mc/s. (Doubled in double pulse mode). *Amplitude and Output Impedance:* 8mV to 2V, 100 Ω ; 2V to 50V, 250 to 2500 Ω . *Polarity:* Positive or negative going from earth.

Prepulse

Width: 0.2 μ S approx. *Amplitude:* 15V minimum, positive or negative. *Rise Time:* 0.035 μ S approx. *Repetition Rate:* As set for main pulse.

External triggering

Repetition Rate: 0.1 c/s to 2.5 Mc/s approx. *Impedance presented to external source:* 1M Ω in parallel with 30 pF.

Operating Temperature Range

0 to +40°C.

PRICE £290 nett, ex Works

EE 94 137 for further details

Advance Pulse Generators are widely used in Research and Industry because they offer fully calibrated control of frequency, delay, pulse widths and amplitude.

The range includes transistorised instruments with single and double pulse outputs which are *true positive or negative with respect to earth*, and a versatile square wave generator with very fast rise times (less than 1 nanosecond) over a wide, fully calibrated frequency range of 9 Kc/s to 100 Mc/s.

If you are interested in Pulse Generators and would like to know more about the Advance range, please fill in the coupon or telephone for further information.



**ADVANCE
ELECTRONICS
LIMITED**

Instrument Division, Roebuck Rd, Hainault, Ilford, Essex. Tel: 01-500 1000

TO: ADVANCE ELECTRONICS LTD
ROEBUCK ROAD, HAINAULT, ILFORD, ESSEX.

- Please send full specifications of Advance Pulse Generators.
 We have a specific application in mind which we would like to discuss with a technical representative.

NAME

COMPANY

ADDRESS

TELEPHONE No:

Highlights from TOTAL PLANAR



This prototype hearing aid amplifier, developed by SGS-Fairchild Applications Laboratories using the HA10 hearing aid package, delivers a power output of 0.4mW into a load of 1000Ω when operated from a 1.5V supply; battery drain is 2-1mA.

BETTER HEARING AIDS WITH HA10 PACKAGE

Using only a fraction of the space taken by conventional types, the new SGS-Fairchild Hearing Aid package HA10 makes possible considerable savings in component costs and offers greater possibilities for designers to improve stability in amplifiers. The package is intended for use in hearing aids or in any other application where a small, stable, low-level audio-amplifier is required. It consists of four n-p-n silicon Planar transistors—three BC127 and one BC128—selected to provide optimum performance in each stage. A recommended circuit is available.

These high-gain, low-level, low-noise transistors, when used in the recommended circuit, give very stable performance regardless of falling-off in battery voltage or variations in temperature; in fact battery voltage can fall very appreciably with virtually no effect on the performance. With their narrow spread of V_{BE} (matched V_{BE} design), these devices are far more stable than anything else available because the design is centred on characteristics only obtainable with Planar construction. As d.c. coupling is used in circuits utilising these transistors, overall savings in components can be made as compared with circuits using ordinary transistors. Space savings are also significant; apart

from the fact that less component space is needed, the devices take only one-tenth of the space of conventional hearing-aid transistors.

Added to the financial advantages inherent in such space saving is the resultant reduction in size of the completed amplifier; this opens up useful new design possibilities. For example, it gives designers the opportunity to develop a hearing aid capable of being mounted completely in the ear—the stability of the amplifier allowing the use of a smaller battery than usual to give normal hearing-aid battery life. Such an instrument, virtually invisible when worn, has great cosmetic attraction, particularly to women.

Reader Information Service Number EE 94 550

TOTAL PLANAR	military
	professional
	industrial
	consumer

LET US KNOW —

* or contact your local distributor
(see classified section of this journal)

TOTAL PLANAR brings the benefits of silicon Planar performance to all electronic equipment designs. Let us know the type of equipment you are designing and we will send you a Planar Selector listing the devices most suitable for your requirements.

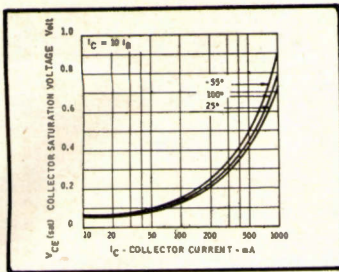

The low saturation voltage of the C426 is maintained over a current range of up to 1A.

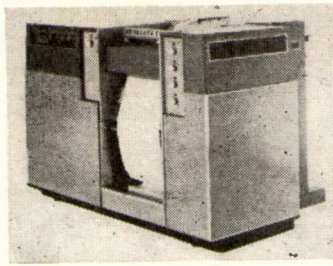

The SGS-Fairchild BFX34 is useful in solving interface problems between the computer central processor and peripheral equipment

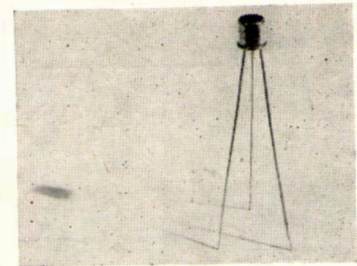

The C400, which eliminates the need for expensive "end of life" tolerancing, is contained in a TO-18 encapsulation.

NPN AMPLIFIER/SWITCH FOR INDUSTRIAL APPLICATIONS

A medium-power high-current industrial addition to SGS-Fairchild's range of semiconductors, the C426 is an n-p-n epitaxial silicon Planar transistor for amplifier circuits in the 1 to 500mA range, and for switching circuits in the 10mA to 1A range.

As the curve above shows, the low saturation voltage is maintained over a current range of up to 1A. A further curve, appearing in the C426 data sheet shows that the current gain of the amplifier is maintained over the current range: 1mA to 1A.

These parameters combine to make the C426 an ideal transistor for use in relay and lamp drivers and high current bistable circuits where lamps or relays are driven directly by cross-coupled transistors. The wide current range and high cut-off frequency of this transistor combine to make it useful in linear-power output stages and current and voltage stabilisers, where the high frequency response of the transistor permits lower-value smoothing capacitors to be used.

For a high-current transistor of this type the turn-on and turn-off times are exceptionally short; this suits it for use in blocking oscillators and low-power d.c./d.c. converters and in high-level logic circuits. It is also suitable for use in a driver stage for a power output device such as the SGS-Fairchild C434 Power Switch Transistor.

V_{CEO} is 30V min., V_{CO} (sat) is 0.76V at 1A, h_{FE} is 70 at 150mA and t_{off} is 0.4 μ s at 150mA. The device is contained in a TO-5 can.

Reader Information Service Number **EE 94 551**

INTERFACE PROBLEMS EASED IN COMPUTER DESIGN

An all-Planar epitaxial n-p-n power device, the BFX34, has been added to the SGS-Fairchild Professional range. Encapsulated in a TO-5 can, the BFX34 is ideal for use in high-speed high-current switches for operation in the 5 to 10A region. Saturation voltage is typically 0.4V at 2A, and h_{FE} typically 100 at 500mA. The guaranteed high minimum V_{CEO} of 55V makes the BFX34 an excellent performer in various power supply applications, in relay drivers, power amplifiers, computer read-out circuitry and in machine-tool control electronics. The device is also of great assistance in solving computing equipment interface problems.

Reader Information Service Number **EE 94 552**

C400 OBIVIATES END-OF-LIFE TOLERANCING

Having a wide variety of cost reducing applications in most industrial electronic equipment where power supplies of up to 28V are used in inter-stage low-frequency amplifiers and in industrial choppers, the C400 general purpose amplifier and switch features a nearly constant high gain over a current range from 1 to 250mA.

This device, which is made to meet the specific needs of the designer of industrial electronic equipment, has an assured 30V collector to emitter rating (60V in switching circuits); it eliminates the need for expensive end-of-life tolerancing, and has better-than-germanium bottoming voltage typically 0.05V at 10mA and 0.28V at 250mA.

Reader Information Service Number **EE 94 553**

PLANAR SCR'S BRING MAJOR SAVINGS

Described as a big step forward in the techniques of controlled rectification, the availability of all-Planar silicon controlled rectifiers brings major savings to circuit design work and manufacturer's component and assembly costs.

By virtue of their Planar structure these devices are extremely sensitive, having a turn-on time of 1 μ s and a turn-off time of 13 μ s—requiring only 1% of the gate power of an ordinary SCR for triggering. Yet, because of the very low leakage current there is no danger of the Planar SCR firing accidentally, so high temperature operation requires no voltage derating.

The complex and costly circuits needed for conventional triggering are thus not now necessary; this results in less work for designers and the use of fewer com-

ponents, ensuring a reduction in the number of equipment assembly operations.

All-Planar silicon controlled rectifiers are particularly suitable for use with power supply regulations, aircraft power supply inverters, machine tool control systems, servomechanisms, capacitive discharge or artificial-line type modulators (in radar and telecommunications) cathode ray tube deflection circuits, phase control circuits, time delay circuits, ring counters and many other similar applications.

The devices are available, as additions to the SGS-Fairchild Professional range of Planar semiconductors, in two current ratings: 2.2 and 8A. Each current rating is made with four different voltage ratings.

Reader Information Service Number **EE 94 554**



SGS-Fairchild Limited 23 Stonefield Way Ruislip Middlesex
Viking 2141 Micrologic RLP 22194

POTENTIOMETER PROBLEM?

THEN COLVERN IS THE ANSWER!

Only one of our wirewound potentiometers is illustrated, but with over 50 different types in constant production there is one to suit most applications. Send us details of your requirements.

SEE YOUR ELECTRONIC ENGINEERING INDEX LIBRARY, FOR FULL TECHNICAL DATA

COLVERN
LIMITED

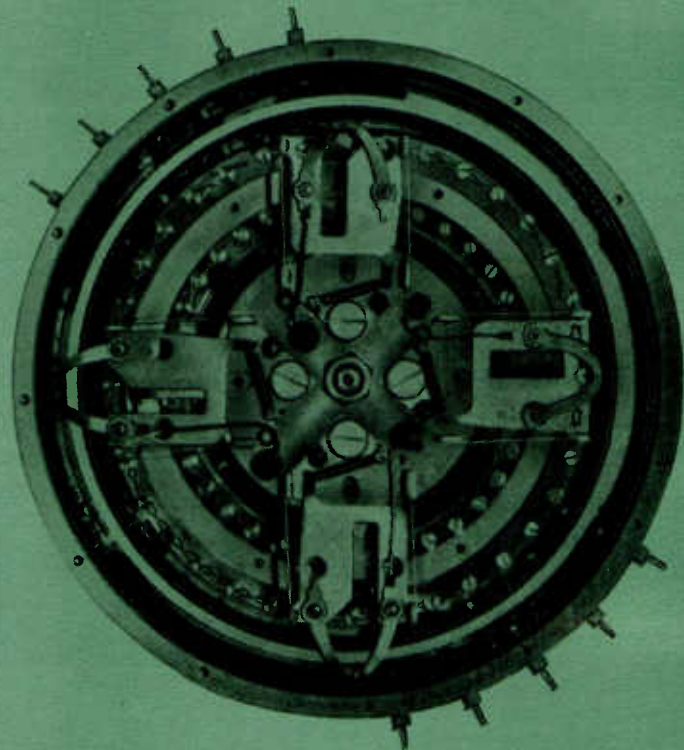

Spring Gardens, Romford, Essex, England.

Telephone: ROMFORD 62222 (PBX) Telex: 23984

New...
two further additions to
the British-made 
range of miniature plug-in
relays

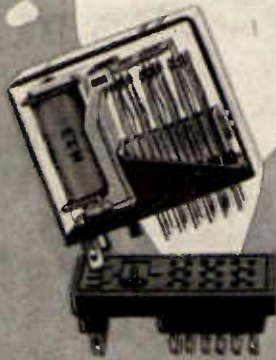

VP6.CAB.26

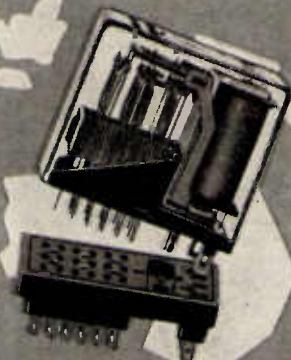

VP8.MAB.26

used and approved
throughout the world

The world-renowned Varley range of miniature plug-in relays now includes:

V.P.6. (6 C/O Contacts).

V.P.8. (8 N/O Contacts).

V.P.8. (8 N/C Contacts).

Fine Silver or Gold Alloy.

Rated at 1 amp. 30 watts. 100 volts.

V.P.6. 5A. (6 C/O Contacts).

V.P.8. 5A. (8 N/O Contacts).

V.P.8. 5A. (8 N/C Contacts).

Fine Silver.

Rated at 5 amps. 100 watts. 220 volts.

All contacts and conductive materials are gold flashed to extend shelf life and ensure socket contact and solderability

Ex-stock deliveries— from the largest range of plug-in relays in the U.K.

Write for details to:

OLIVER PELL CONTROL LTD

CAMBRIDGE ROW · BURRAGE ROAD · WOOLWICH · LONDON SE18 · WOOLWICH 1422

TA 4289

Teltron Ltd. manufacture educational apparatus for studies in atomic physics. To produce equipment such as electron analysis tubes at low cost, the ability to apply heat exactly where it is wanted and control it precisely is essential. Outgassing, during the evacuation of these tubes, requires close temperature control and is carried out in a gas heated high vacuum baking oven. Specially designed gas burner rigs are used for cutting and sealing the tubes once the electron gun has been inserted.

Gas and electron tubes

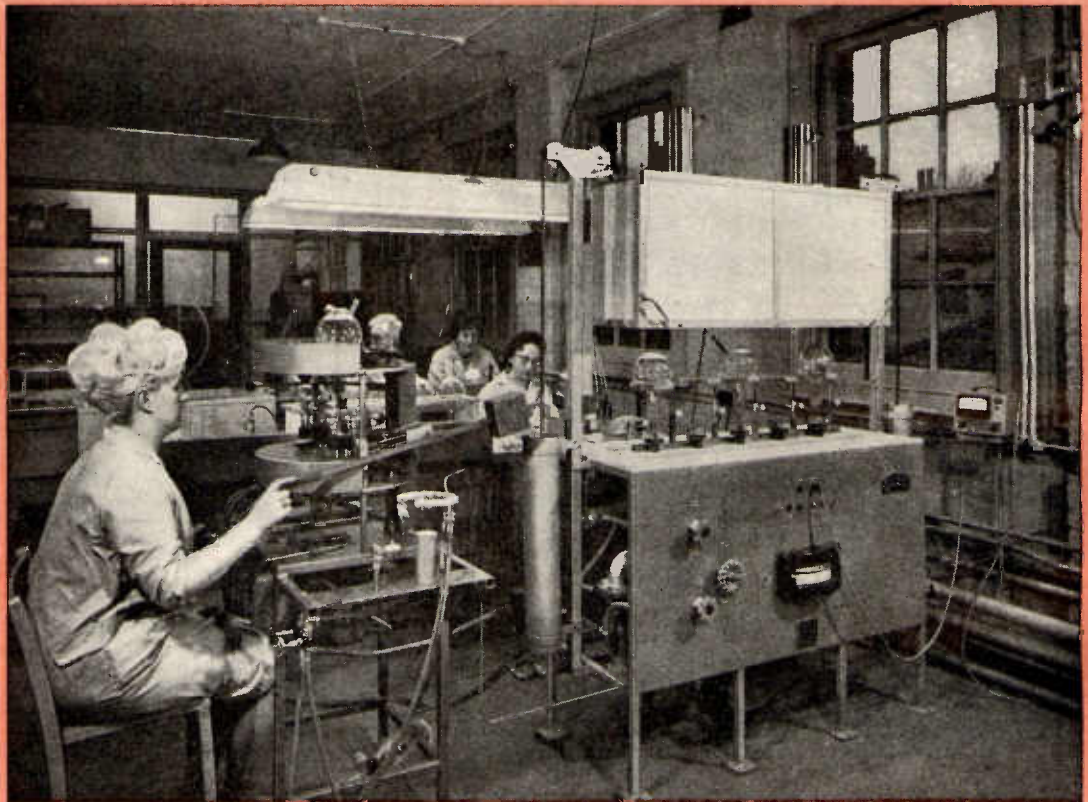

With the cover raised, three electron analysis tubes are positioned on the base of the high vacuum baking oven. The cutting and sealing equipment can be seen on the left.

For free technical advice on your industrial heating problems, a letter or phone call to the Industrial Gas Officer of your Gas Board will bring you the services of a qualified Industrial Gas Engineer, backed by the full technical resources of the gas industry.

HIGH SPEED GAS





FOR SALE
HOUSING SUITABLE
FOR
TWO FAMILIES

Solving the housing problem

In the same housing, you can now have shielded r.f. signal and d.c. power circuits, in any combination. COAXICON sub-miniature coaxial connectors are interchangeable with Series 'M' pin-and-socket connectors in standard size cavities. Featuring the unique single crimp technique, COAXICON connectors are applied by simultaneous crimping of centre conductor, outer braid and ferrule. Both application and assembly are speedy

and simple. Connectors snap into the housings and lock by built-in retention springs; yet they can be removed instantly if the need arises. Standard Series 'M' housings with from 14 to 104 ways can accommodate mixed coaxial and pin-and-socket connections.

AMP Creative Analysis is freely available to examine your circuitry and advise you how to improve wiring layouts and assembly costs.

**AMP brings automation
to circuit assembly**

AMP

Aircraft-Marine Products (Great Britain) Limited

TERMINAL HOUSE STANMORE MIDDX TEL: STOnegrove 6341

USA AUSTRALIA BELGIUM CANADA FRANCE GERMANY HOLLAND ITALY JAPAN MEXICO PUERTO RICO SPAIN

COAXICON IS A TRADE MARK OF AMP INCORPORATED

AP384

KELVIN

-FIRST NAME IN RECORDING

From Kelvin comes an ever-widening range of instruments—bench, portable, panel-mounted and miniature. So tell us your application or problem. We'll have the answer.

SERVOSCRIBE RECORDER

With its chopper amplifier, servo-action and great versatility the 'Servoscribe' is designed to record electrical values and outputs from transducers used in all branches of industry as well as for laboratory applications, etc. Intended as a bench instrument, the Servoscribe may be used in the vertical position. There are eleven measuring ranges and 6 chart speeds.

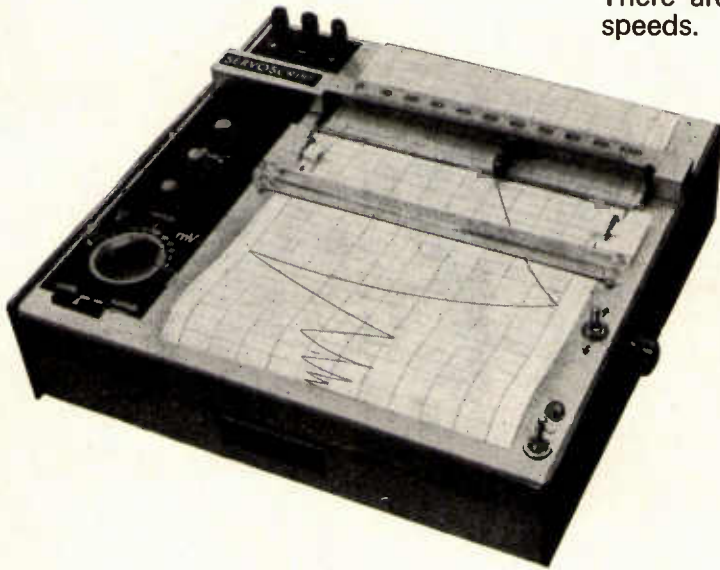

- * 11 fixed input ranges
- * Maximum sensitivity 50 $\mu\text{V}/\text{cm}$.
- * Accuracy $\pm 0.5\%$ of full scale
- * Response 1 sec. approximately
- * 6 Chart speeds 1 cm/sec. to 3 cm/hr.
- * Variable zero suppression and scale expansion

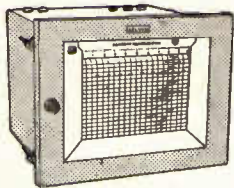

SINGLE AND MULTIPOINT POTENTIOMETRIC RECORDERS

Designed to record and indicate millivolt input signals as derived from thermocouples, resistance thermometers, strain gauges and other transducers. Null balance type measuring system. Sealed reservoir capillary used for single-point recording and multi-colour symbol or numeric identification for multi-point recording. Up to 12 variables clearly presented on one chart. Input selected by sealed switches. Manual or automatic range changing facilities.

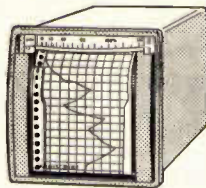

'MINISCRIBE' RECORDERS

Miniscribe 'D'. For measuring and recording D.C. and A.C. currents and voltages, temperatures or other electrical inputs.
Miniscribe 'B'. Has bi-metal movement based on the thermal action of currents. They are used in cases where the average of a current value, over fixed periods, has to be recorded.
Miniscribe 'Z'. Records the start and end of events when these are indicated by the opening and closing of switches such as occur in machine tools and other industrial applications.

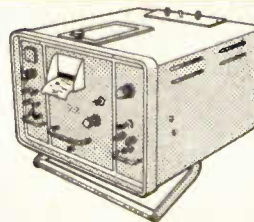

DIRECT WRITING 2 - CHANNEL TRANSIENT RECORDERS AND AMPLIFIERS

Single, 2 and 4 channel recorders for up to 90 cycles per second response (150 c.p.s.—3 d.b.). Unique suspension of the coil permits the use of these recorders under the most arduous conditions; they can be used on moving vehicles, trains or ships.



'MULTISCRIP'T' RECORDERS

Multi-range A.C. and D.C. Combines the advantages of portable multi-range instruments with that of inkless recording. A battery drive version is available. The selected measuring range is automatically recorded with the recorded value for measuring and recording voltages and currents.

KELVIN

KELVIN ELECTRONICS COMPANY

A DIVISION OF SMITHS INDUSTRIES LIMITED

Kelvin House, Wembley Park Drive, Wembley, Middlesex. Telephone: Wembley 8888. Grams: Keeco Wembley Telex: 25366.

☐ KEC 2742

BSY38 – BSY39 *practical, economical silicon planar epitaxials for high speed logic*

Mullard BSY38 and BSY39 silicon planar epitaxial transistors are designed to meet *economically* and *practically* the needs of high speed logic, of 20ns typical propagation delay. Features of these two n-p-n transistors are low saturation voltage, small desaturation time, high f_T at low voltage, small depletion capacitance and narrow spreads on current gain and input voltage. Encapsulation is TO-18. Both types are in large quantity production and are available for immediate delivery.

Further details of these and other devices can be obtained from:

Mullard Limited, Industrial Markets Division,
Mullard House, Torrington Place, London WC1.

Here are brief specifications :
TYPES BSY38, BSY39

V_{CB} (max)	($I_E=0mA$)	+20	V
V_{CE} (max)	(cut-off)	+15	V
I_{CM} (max)		200	mA
P_{tot} (max)	($T_{amb}=25^\circ C$)	300	mW
h_{FE}	($I_C=10mA$) BSY38 BSY39	39 to 60 40 to 120	
f_T (typ)	($V_{CB}=2V, I_C=10mA$)	350	Mc/s
t_s	($I_C=I_B=I_{BM}=10mA$)	8	ns
V_{CE} (sat)	($I_C=10mA, I_B=1mA$)	<250	mV
C_{tc}	($V_{CB}=5V, I_E=0, f=1Mc/s$)	<5	pF

LANgham 6633. Telex : 22281.

Mullard

Si

planar

The resources of AEI Electronics
Semiconductor Bulletin No. 12

New low cost encapsulated thyristor trigger unit for all inductive and resistive loads

Precise balance between phases in 3-phase applications

The latest addition to AEI Electronics' range of low cost, encapsulated thyristor trigger circuits (the type UFC4-A) has been designed for all loads—inductive and resistive. It can be used with every type of AEI thyristor up to CR50 Series, and with CR 70 and CR100 Series when 80mA gate current is selected. It provides sufficient power to fire two thyristors, and when used with an AEI type PT4 pulse transformer, the UFC4-A will fire paired thyristors in inverse-parallel, parallel, series or shorted bridge connection. Components of the circuit are selected so that the spread of firing angle for a given value of control resistance will not be greater than $\pm 15\%$. Applications in which the encapsulated UFC4-A trigger units offers important advantages include vibrator control, oven and hotplate control, lamp dimming, D.C. motor speed regulation, and time delay relay actuation. An applications report giving details of both single and 3-phase circuits is available on request.

SPECIFICATION

Output

Pulse amplitude into open circuit 8.4 volts
Pulse source impedance 35 Ohms
*Pulse duration 20/u.sec.

Multiple pulse output for firing angles less than 90° .
Single pulse output for firing angles greater than 90° .

*This may be increased by the addition of a capacitor connection between pins 2 and 4, e.g. $0.47/\mu\text{F}$ gives pulse duration of $60/\mu\text{sec}$.

Control

Firing angle control range 20° to 160°

Supply

Supply voltage range (50 c/s) 200 to 250 volts
Mains dropper resistor (5% 10W) 6.8K Ohms

Temperature

Operating temperature range -55°C to $+100^\circ\text{C}$

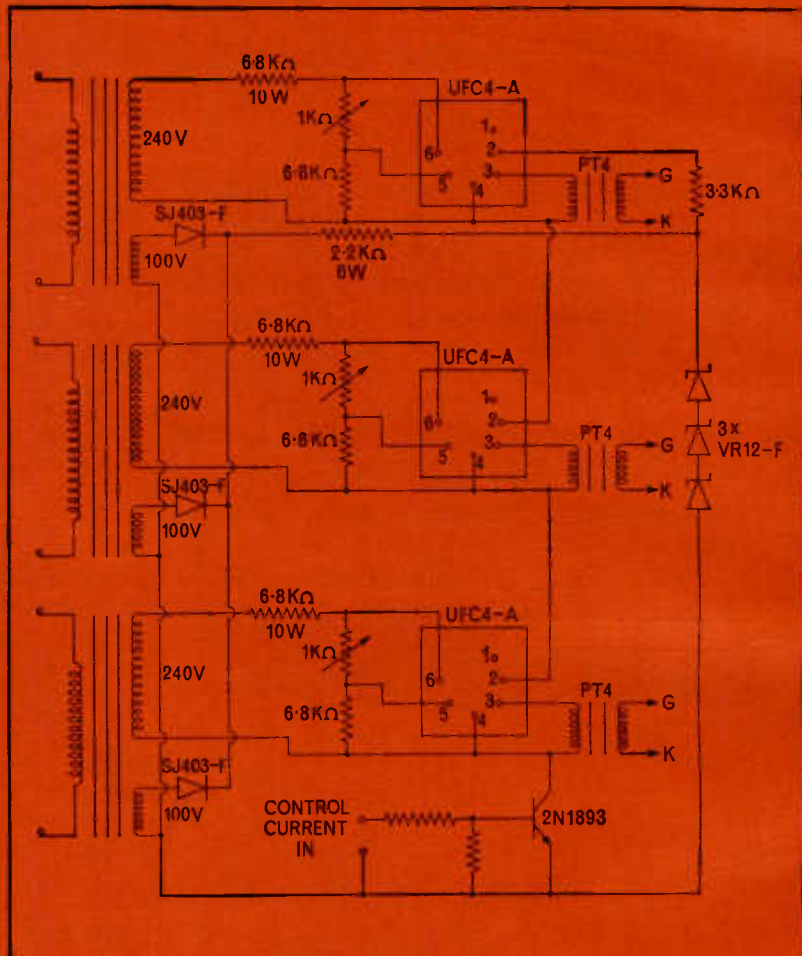

A THREE PHASE FIRING CIRCUIT USING UFC4-A



Dependability of AEI Semiconductors now predicted in monthly reliability reports

By maintaining a system of continuous testing, and issuing regular reports, AEI has made it possible for users of their semiconductors to ascertain the reliability of these devices with a high degree of confidence.

Today there are few applications in which a designer will willingly use semiconductors of unknown reliability. In fact many general industrial applications of these devices now call for the same standards of guaranteed reliability as aerospace applications. And this has created a problem. For in aerospace applications reliability is sufficiently important to justify a premium that would seldom be acceptable to an industrial user.

The semiconductor manufacturer's problem has, therefore, been to devise a method of testing which will enable him to guarantee the reliability of his industrial semiconductors—without increasing their cost in the process. AEI have perfected a method of doing this, and now offer evidence of their excellent long-term reliability of their devices.

The basis of the test procedure is quality control. For it is an axiom of economical semiconductor production that dependability should be "built-in", not "tested-in". So most raw materials and component parts are purchased from suppliers approved by the M.O.A.

Tests made after encapsulation include process tests to which every device is subjected, quality appraisal applied to each basic device group every week, and regular long-term reliability tests carried out on selected batches.

The process tests include high temperature storage, exposure to tropical humidity, shock tests and measurement of the electrical characteristics. Long term reliability tests are carried out on samples of 20-25 devices covering shelf life at room temperature, high temperature life non-operating, moisture resistance cycling and low temperature life.

As the test procedures and compilation of reports are being carried out as a continuous operation, users of AEI semiconductors will always be able to ascertain the operational reliability of the devices they are employing.

Write now for copies of the first reports which cover:

- 1 GENERAL PROCEDURES,
- 2 GERMANIUM JUNCTION RECTIFIERS
- 3 5, 10 and 15 AMP THYRISTORS.
- 4 GERMANIUM POINT CONTACT DIODES

AEI

SEMICONDUCTORS

Associated Electrical Industries Ltd.,
Semiconductor Dept., Carholme Road,
Lincoln, or your nearest AEI office.

EE 94 146 for further details



Mackie, pioneers for more than 80 years in the manufacture of power conversion and generating equipment, now offer a range of transistorized Static Inverters giving outputs up to 500VA, at 50Hz, 400Hz, and 1,000Hz, square or sine wave. Compact and of robust construction Mackie Static Inverters have been designed as alternatives to the already well established Mackie low-voltage rotary converters.

Enquiries are welcomed for Research and Development projects on specific units to meet customers' requirements.

Mackie also design and produce 400Hz, and 1,000Hz, Alternator Sets and G.P.O. type Dynamotors for all industrial applications.

Below: Inverter producing 400 Hz. $\pm 1.5\%$ < 2% distortion, 140 W (-40° C to $+85^{\circ}$ C). Provision for phase-locked synchronizing take-over

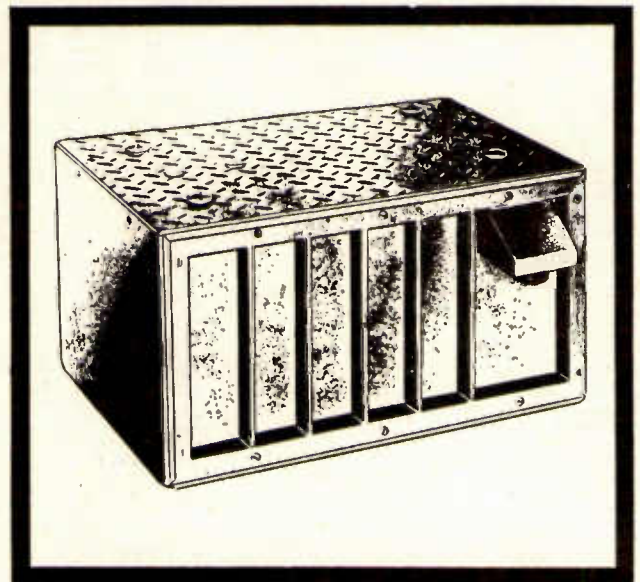

mackie

W. MACKIE & CO. LTD., WILLOW LANE, MITCHAM, SURREY
Telephone: Mitcham 0951-6 Telegrams: Mackie Croydon Surrey Telex: 264041

introducing...

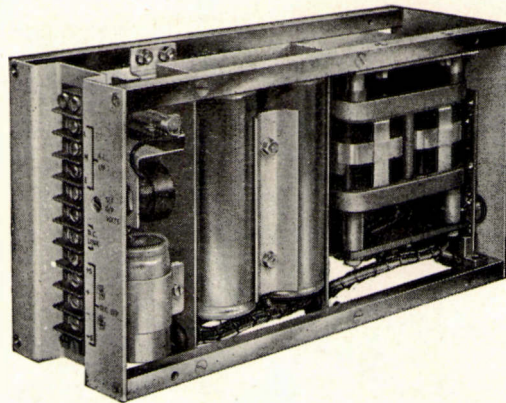

a new range of

ADVANCE



ELECTRONICS

**MODULAR
POWER
SUPPLIES**

- MODULAR CONSTRUCTION ■ FULLY TRANSISTORISED ■ ALL-SILICON SEMI-CONDUCTORS ■ AUTO RESET OVERLOAD PROTECTION ■ C-CORE TRANSFORMERS
- COMPETITIVE PRICE AND QUICK DELIVERY

Advance research engineers, applying the latest techniques to an old problem, have created a new concept in electronic design – a range of low-cost, compact and versatile modular power supplies engineered to meet the exacting requirements of many modern – and future – applications from technical education to advanced computer design.

Silicon semiconductors are used throughout to permit operation up to 60°C. All models have very low output impedance and high stability against mains changes, together with automatic reset overload protection. These power supplies offer a wide range of voltages and output currents and can be used in series or parallel for higher power requirements. They are principally intended for incorporation into customers' own equipment.

Write today for further details to:



**ADVANCE
ELECTRONICS
LIMITED**

Type No.	Voltage Range	Current Rating	Price
PM1	4-7V or 8-15V	1 Amp	£25
PM2	15-30V	1 Amp	£28
PM3	30-50V	1 Amp	£31
PM4	4-7V or 8-15V	3 Amp	£31
PM5	15-30V	3 Amp	£37
PM6	30-50V	3 Amp	£43
PM7	4-7V or 8-15V	5 Amp	£40
PM8	15-30V	5 Amp	£50
PM9	30-50V	5 Amp	£60
PM10	4-7V or 8-15V	10 Amp	£52
PM11	15-30V	10 Amp	£70
PM12	30-50V	10 Amp	£88

Volstat Division, Roebuck Rd, Hainault, Ilford, Essex, Tel: 01-500 1000



Thinking about CONNECTIONS AND CABLES

Single or Multi-way?
Plain or Screened?
High or Low-voltage?
D.C. to S.H.F.!
A wide range backed by our
"By Return" Delivery Service.
Good Reasons why you
should — specify Radiospares



Radiospares Ltd.

4-8 MAPLE STREET · LONDON W.1 · ENGLAND
TELEPHONE: EUSon 7232 (8 lines)
TELEGRAMS AND CABLES: RADOSPERES, LONDON, W.1.

RS3.

A 100 Mc/s Direct Reading Counter...

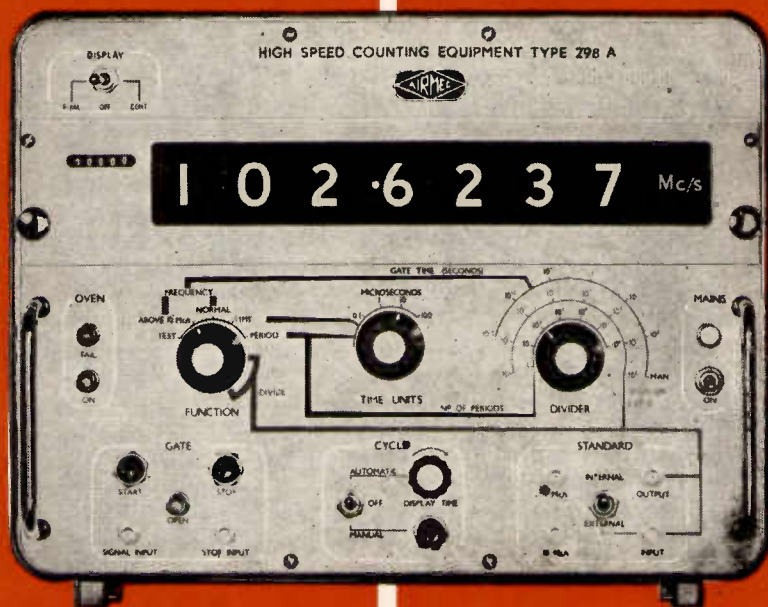

The Airmec High Speed Counter Type 298A is a fully transistorised instrument using a standard oscillator incorporating an AT cut crystal. This is installed in a temperature-controlled oven, and has a short term stability of the order of ± 5 parts in 10^6 .

The indicator is a large 8-figure in-line display showing both the units of measurement and the decimal point, combined with a 5-digit resettable electro-mechanical counter.

- Frequency measurement up to 100 Mc/s without frequency changing
- Time and period measurement from 1 μ s. to 10^8 seconds
- 12 digit display
- Display memory circuit
- Provides a range of standard frequency outputs
- Divider facilities 10^{-1} to 10^{-8}
- Variable pulse group outputs
- Self-checking facilities
- Connection for external frequency standard

This instrument is part of the comprehensive range of high quality electronic instruments produced by Airmec for use in laboratories and workshops.

Airmec High Speed Counter Type 298A

...plus frequency extension to 500 Mc/s & recording facilities

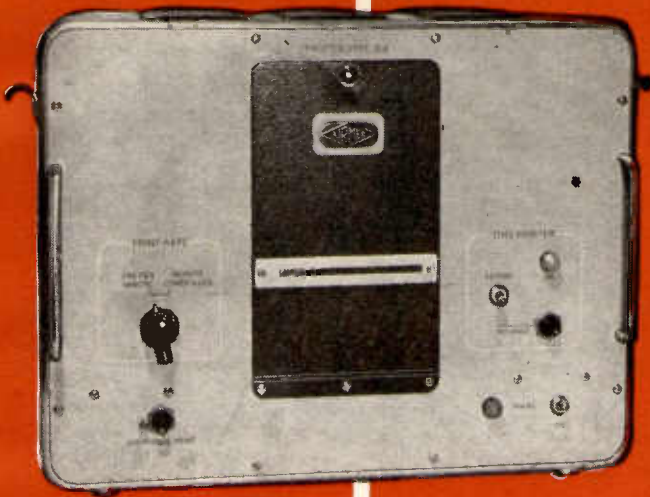

The Airmec Printer Type 316 is designed for operation with the High Speed Counter 298A to provide a permanent timed record of readings. The count values, together with the time of reading, are printed simultaneously on a 4" wide paper roll with a capacity of 7000 entries.

Each printing takes approximately 3 seconds. The frequency of printing can be continuously varied from once every 5 seconds to once every 10 seconds, or alternatively set at once a minute or once every quarter of an hour.



The Airmec Frequency Converter Type 362 extends to 500 Mc/s the frequency range of counters with a nominal 100 Mc/s limit. Input frequencies in the range 90-500 Mc/s are converted to the 10-100 Mc/s range. Input frequencies from 10-100 Mc/s are amplified with a gain of 10, and the converter can be used to increase the sensitivity of a counter from 100 mV (r.m.s.) to 10 mV. Converters to 10 Gc/s shortly available.

Printer Type 316 | Frequency Changer Type 362



Airmec for peak performance consistently

LABORATORY INSTRUMENTS DIVISION—

High Speed Counters, Signal Generators, Oscilloscopes, Wave Analysers,
Phase Meters, Valve Voltmeters etc:

AIRMEC LIMITED · HIGH WYCOMBE · BUCKS · ENGLAND

TELEPHONE: HIGH WYCOMBE 21201 (10 LINES)

AP 279B

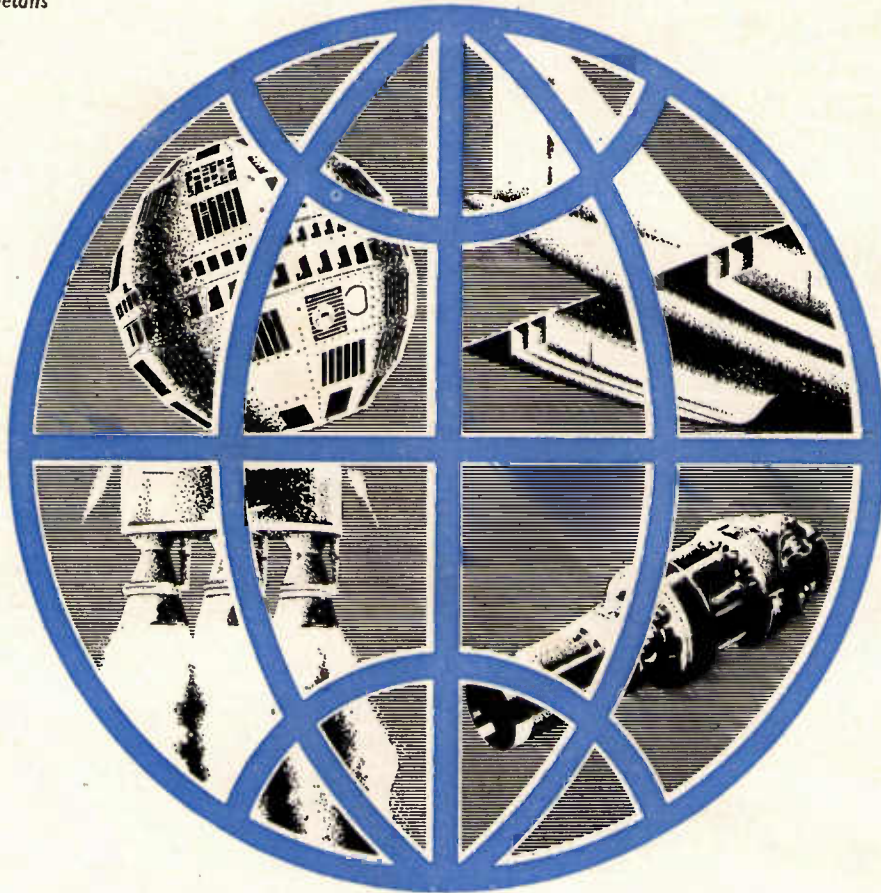

DEADLINE / TODAY

**In the data systems world of nanoseconds,
tomorrow is a century away.**

Benson-Lehner assist you in meeting your deadline today through their range of Redcor Amplifiers, which have long been recognised as the forerunners in the field of solid state circuitry, reliable under circumstances of continued performance. □ It is people, however, who will

ultimately be responsible for the success of your operation. □ The Benson-Lehner engineers form a dedicated group prepared to cope with any emergency, fully capable to assist you in meeting your deadline—today!

Redcor D.C. Differential Amplifiers are precision engineered for applications in varying strain gauge, thermocouple, resistive transducer and multiplexing operations. □ Individually numbered personal copies of our new Amplifier Applications Manual are available to members of research and engineering laboratories on request.

- Fast Recovery Time from 20 volt differential or common mode overload.
- High common mode rejection with wide bandwidth.
- High Input impedance—1000 megohms.
- Line unbalance—0-1000 ohms either line.
- No guard shield—so no third wire.
- Variable gain—10-1000.
- Variable bandwidth unaffected by gain change.

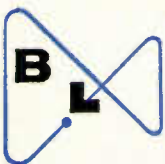
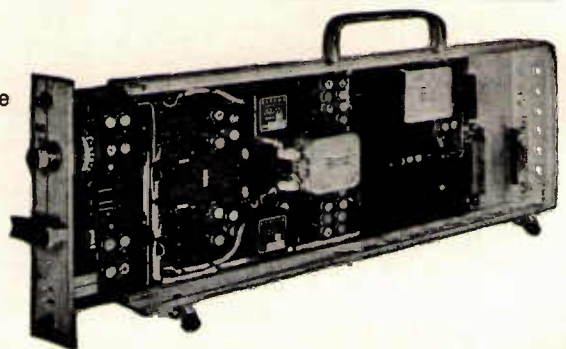

For full details of how BENSON-LEHNER can help you in the data systems field, telephone SOUTHAMPTON 27831, or write to: DIGITAL SYSTEMS DIVISION

benson-lehner LTD / WEST QUAY ROAD / SOUTHAMPTON
For information on:— D. C. AMPLIFIERS / A/D CONVERTERS / MULTIPLEXERS

TRANSISTOR TESTING DOWN TO NANO AMPS with the Type TT164

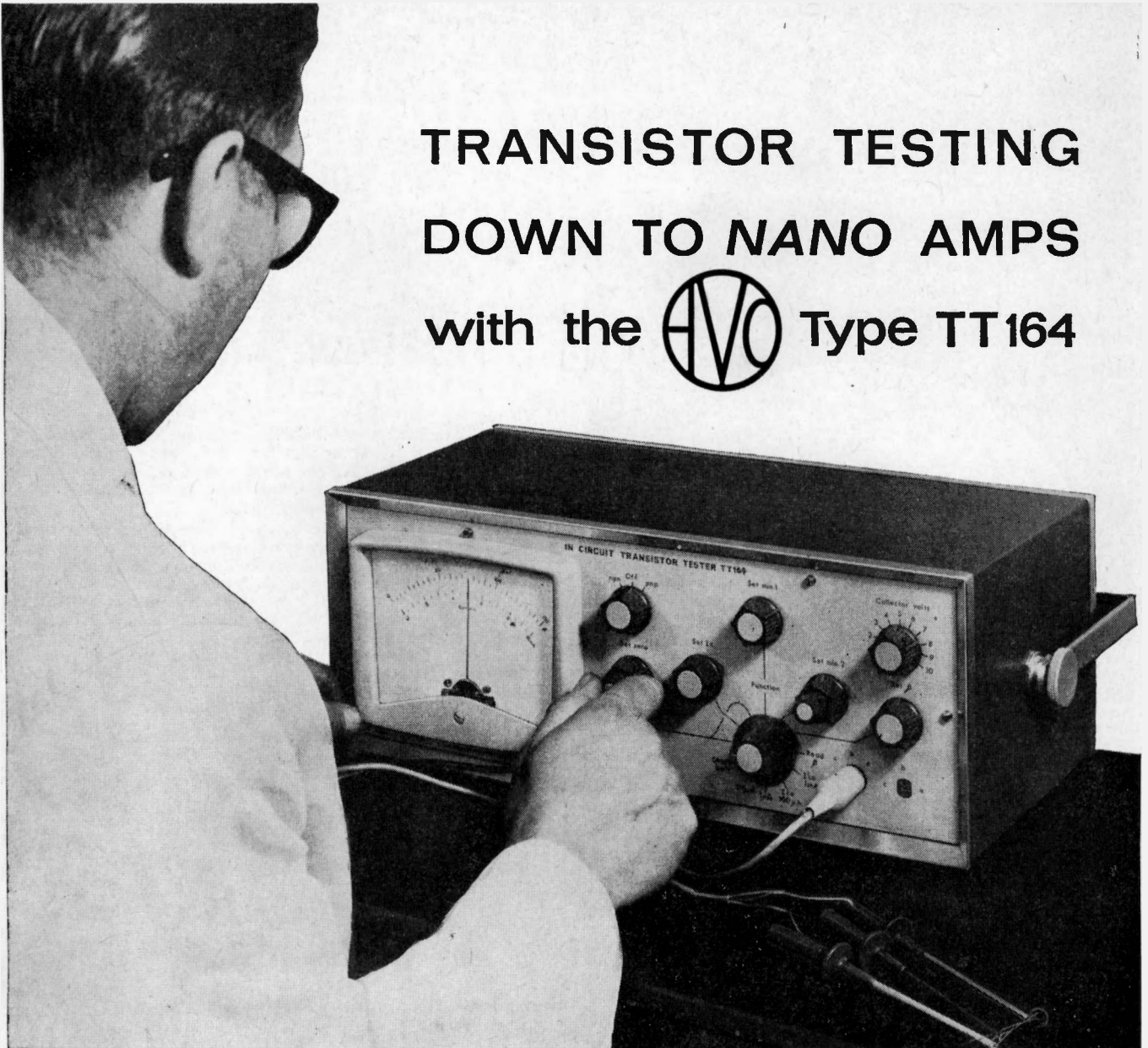

The new Avo In-Circuit Transistor Tester Type TT 164 enables medium power p.n.p. or n.p.n. transistors to be tested simply and quickly. There is no involved setting up, and carefully designed circuits balance out the shunting effect of components connected to the transistor under test.

Introduced to meet the requirements for a direct-reading instrument that is simple to operate, the Type TT 164 — replacing its successful predecessor, the Type TT 162 — is also able to measure (out of circuit) very small leakage currents down to a first indication of 10 nano Amps (300nA f.s.d.).

A battery check facility ensures that supply voltages do not fall below the limit required for satisfactory operation. Overload protection is provided by an internal circuit limitation.

COLLECTOR VOLTAGE:

(In-circuit and Out-of-circuit)

0—10V continuously variable.

COLLECTOR CURRENT:

(In-circuit and Out-of-circuit)

0—10mA continuously variable, and in additive steps of 10mA up to approx. 30mA.

CURRENT GAIN (Beta):

(In-circuit and Out-of-circuit)

0—150 and 0—300 \pm 5% between $\frac{1}{2}$ f.s.d. where external base loading is above 400 Ω .

LEAKAGE CURRENT I_{co}:

(Out-of-circuit only)

0—300nA, 0—3 μ A.
0—100 μ A and 0—1mA f.s.d.



New descriptive literature now available on request.

AVO LTD

AVOCET HOUSE • ARCHCLIFFE ROAD • DOVER • KENT

Telephone: Dover 2626



The Finest Photocells from.....

Moririca A Mark of Quality

It senses.....Sharply.
It stands.....Constantly.
It lastsEternally.

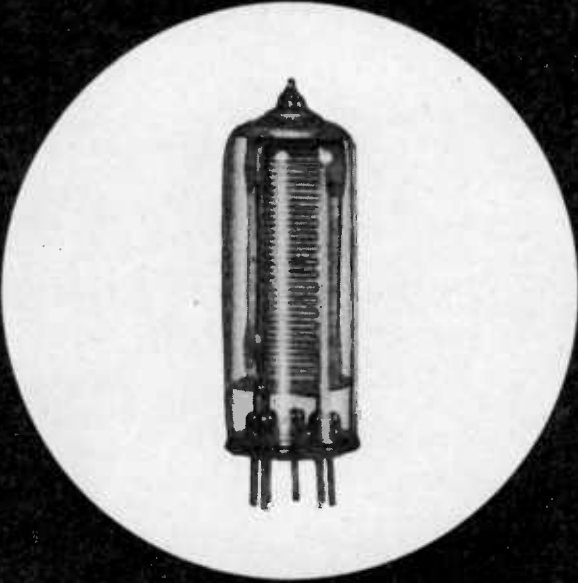

Outstanding characteristics

Dark resistance	Above 5 M Ω
Light resistance at 50 Lx (2700°K)	Below 4 k Ω
Max. voltage	400 V AC. DC.
Max. dissipation	300 mW
Max. ambient temp.	70 °C.

Main products:

- Cadmium Sulfide Photoconductive Cell
- Cadmium Selenide Photoconductive Cell
- Selenium Photocell

Customer designed cells available according to spec.

- Luminance meter
- Automatic Light Switch

MORI PHYSICS & CHEMISTRY LAB. CO., LTD.

205 Tozuka-machi, Tozuka-ku, Yokohama, Japan
Cable Add: MORIRIKA YOKOHAMA

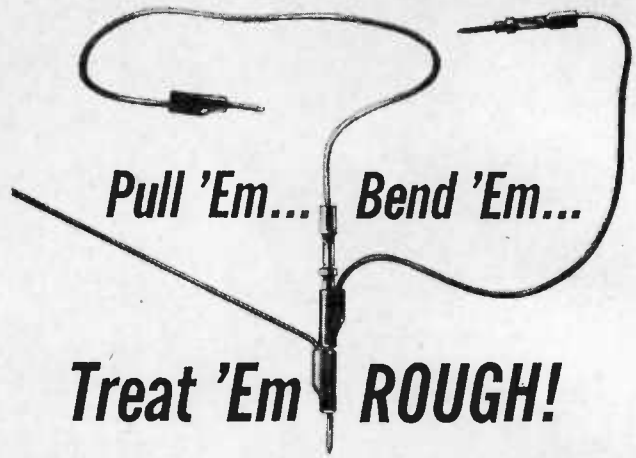

No half-way performance here! These miniature plugs and jacks from CAMBION® are made to do a man's job. Plugs are attached to wire to stay by means of Mil type four-point crimp. Completely flexible, plug can be bent up to 90 degrees — maintain 100% perfect contact — tens of thousands of cycles.

Exceptionally versatile, CAMBION Plugs and Jacks are ready for instant use in countless test board applications, breadboard set-ups, computer circuits and for production equipment or wherever .040" plugs and jacks and plug-jack terminations are used. Cage jack principle permits solid contact with low contact resistance. CAMBION Plugs and Jacks permit self-stacking for multiconnection at a single point. Made to meet international specifications, CAMBION Plugs and Jacks provide unlimited applications for prototype and production.

Cambion Electronic Products Limited, Dept. 306, Castleton, Nr. Sheffield.

CAMBION®

Standardise on CAMBION... the Guaranteed Electronic Components.

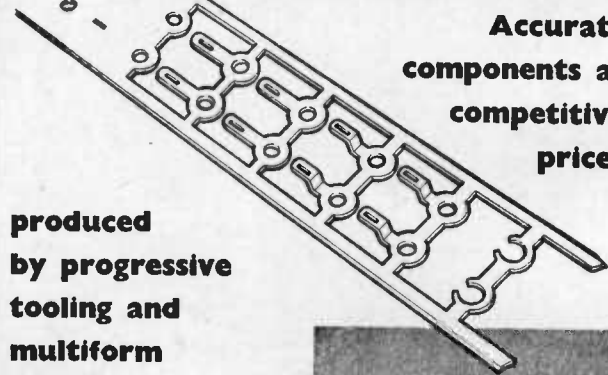
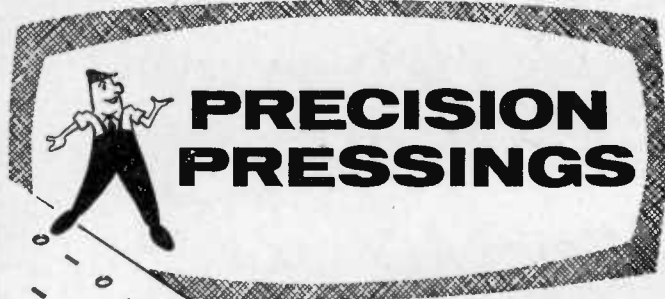

Accurate components at competitive prices

produced by progressive tooling and multiform methods.

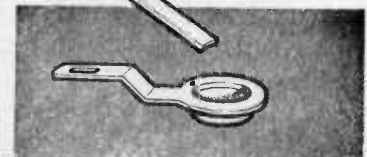

JOHN SMITH LTD.

209, SPON LANE, WEST BROMWICH, STAFFS.
TELEPHONE: WES 2516 (3 lines)
WOODS LANE, CRADLEY HEATH, STAFFS.
TELEPHONE: CR 69283 (3 lines)

EE 94 155 for further details

silicon and germanium transistor selection

(an unbiased appraisal by a manufacturer of *both*!)

Many designers are being stampeded into rejecting germanium transistors by biased commercial interests. In common with other manufacturers of both germanium and silicon transistors we find this disturbing. There are sound technical reasons for selecting each for various applications. Neither gives an all-purpose answer to every problem.

Selection considerations

After twenty years of development there are really only two significant commercial methods of manufacture – diffused and alloyed junctions, and two materials – silicon and germanium. Today characteristics other than cost can be decisive in transistor selection. This table recaps the main considerations.

Silicon preferable for

- 1 Extra high temperatures
- 2 Extra low leakage currents
- 3 N.P.N. circuitry

Germanium preferable for

- 1 Extra low saturation voltage
- 2 Extra low forward voltage
- 3 Extra low temperatures
- 4 Extra high frequency
- 5 P.N.P. circuitry

Forward voltage difference

When low forward voltage is essential the difference between silicon and germanium devices is critical. The graph shows the additional voltage lost across the junction with a silicon device.

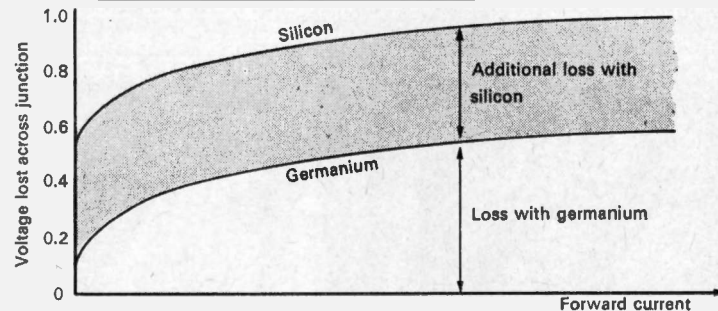

Transistor Coding Systems

Even when it has been decided to use a silicon or germanium transistor for each specific job, further confusion can arise from the multiplicity of numbering codes. Apart from each manufacturer having his own code system there are two independent codes, the American and European. Their significance is as follows.

American — E.I.A or J.E.D.E.C

Standard specification registered with Joint Electron Device Engineering Council. Numerals are awarded in chronological order, and have no indication of device characteristics.

Code: 2N + numerals.

European — Pro-Electron

Standard specification registered with Pro-electron, Luxembourg.

Code for industrial types:

1st letter = type + 2nd letter = function + 3rd letter and 2 digits = serial number
A = Germanium B = Silicon C = audio S = switch

Newmarket House Code

Germanium code: NKT + 3 digits or less. First digit denotes function.

1 = rf (pnp), 2 = af (pnp), 3 = IP (pnp), 4 = P (pnp), 6 = vhf (pnp), 7 = af (npn)

Silicon code: NKT + 5 digits. First digit denotes polarity and construction.

Second digit frequency cut off. Third digit current gain. Fourth digit voltage rating. Fifth digit serial number.

Send for booklet

All this and a lot more useful information is contained in a small booklet entitled 'Silicon and Germanium Transistor Selection' published by Newmarket. Send for your free copy.

Newmarket
TRANSISTORS LIMITED

Newmarket Transistors Limited,
Exning Road, Newmarket, Suffolk
Telephone Newmarket 3381

Denmark Oskar Pade 4, Ingersvej, Charlottenlund, Copenhagen
Finland Inetssto Pluton, Kirstink 8A, Helsinki 51
Sweden Forslid & Co A.B. Rådmanngatan 58, Stockholm
Norway H. Meltzer & Co Rådhusgaten 17, Oslo 1
Canada Musimart of Canada Ltd, 970 McEachran Ave. Montreal 8

Startronic

POWER SUPPLIES

- ★ N.A.T.O. CATALOGUED
- ★ Type approved components
- ★ Tropicalised meters & switches
- ★ Ambient temperature 55°C



MODEL 119.S TWIN 0-30v., 0.5A

MODEL	N.A.T.O. CATALOGUE No	OUTPUT
119.S	6110-99-945-8802	TWIN 0-30v., 0.5A
125.S	6110-99-945-8801	TWIN 0-30v., 2.0A
127.S	6110-99-945-8800	SINGLE 0-30v., 2.0A

STARTRONIC LTD., 117a-119a MALDEN ROAD, NEW MALDEN, SURREY. Tel: MALden 0186

MASSIVE STOCKS

Authorised Stockist for
SIDAL BELGIAN
Aluminium



H. ROLLET & CO. LTD.

No Quantity too Small — Branches in most major Cities

Independent stockists · Since 1896

BRASS
COPPER
BRONZE
ALLOYS
ALUMINIUM
STAINLESS STEEL
NYLON P.T.F.E.

ROD
BAR
SHEET
TUBE
STRIP
WIRE

3000 Standard Stock Sizes

KSM

PULSE GENERATOR T 15 TRANSISTORISED

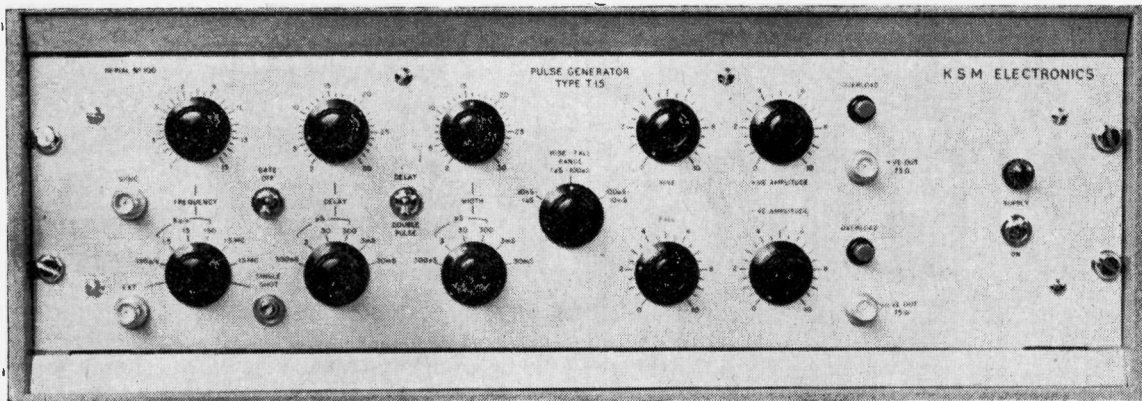

- Internal Oscillator 15 c/s—15 Mc/s
- Pulse Width 30 nS—30 mS
- Delay 30 nS—30 mS
- Pulse Amplitude 10 V into 50 Ohms
- Single or Double Pulse Output
- Simultaneous Positive & Negative Pulses
- Variable Linear Rise & Fall Times
- Single Shot Push Button
- Overload Protection
- Dimensions: 19½" wide × 7¼" deep × 7¼" high
- Weight: 20 lbs.

POSITIVE PULSE

NEGATIVE
PULSE

DOUBLE PULSES

GATED PULSES

OUTPUT WAVEFORMS

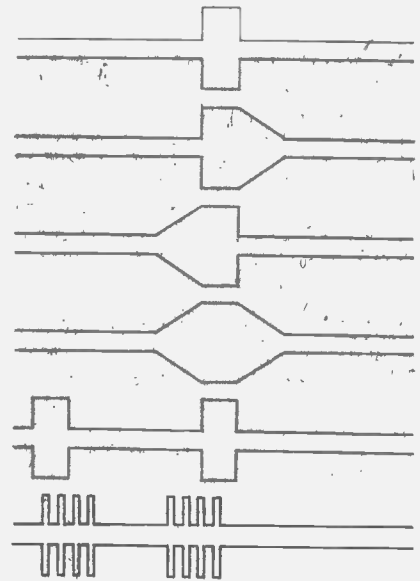

The Pulse Generator model T15 is an all solid state instrument which has been designed to be extremely compact utilising printed circuit boards and high quality components. Although extremely compact this instrument has great versatility; it provides single or double pulses with simultaneous positive and negative polarity. Pulse widths and delays from 30 nanoseconds to 30 milliseconds are available. The rise and fall times of the output pulses can be independently controlled from 10 nanoseconds to 10 milliseconds. The internal oscillator has a range of 15 c/s to 15 M/cs. Pulse widths up to nearly 100% duty cycle can be obtained. The output amplitude of both output pulses can be independently varied up to 10 volts peak into 50 ohms.

The unit can be triggered from its own internal oscillator, internal single shot push button, or from an external waveform. Gated and sweep frequency operation can be obtained using external signals.

KSM ELECTRONICS LTD.
139 FONTHILL ROAD, LONDON, N.4

TEL.: ARCHWAY 6160



CAPACITORS

FOR

**ELECTRONIC
ENGINEERING**

RADIO and TELEVISION

**PHOTO-FLASH
EQUIPMENT**

**FLUORESCENT LIGHTING
BALLAST UNITS**

**START/RUN MOTOR
CONTROL**

**POWER FACTOR
CORRECTION**

*'Frakolyt' Capacitors for Printed Circuits to
DIN and VDE Specifications*

Further information and leaflets from:—

NEOFLEX LTD.

115a CRICKLEWOOD BROADWAY, LONDON, N.W.2.

Telephone: GLAdstone 0074-5. Telex 25853.

for

HUGHES

HUGHES AIRCRAFT COMPANY

PRECISION MICRO-MINIATURE WELDING

consult

HIRST ^{ELECTRIC}

Hirst Electric Industries Ltd. are the distributors in the U.K. for the extensive range of precision micro-miniature welding equipment manufactured by Hughes Aircraft Company of California. Now all your welding equipment needs can be met by HIRST—the specialists in Resistance Welding. Outstanding in the unique range of Hughes equipment is the MCW MICROCIRCUIT WELDER. It is available in two forms—model EL parallel gap welding system for welding external leads of integrated circuit packages to printed circuit boards etc., and the IL thin film bonding system for bonding internal leads to thin films as in semiconductors and film resistors.

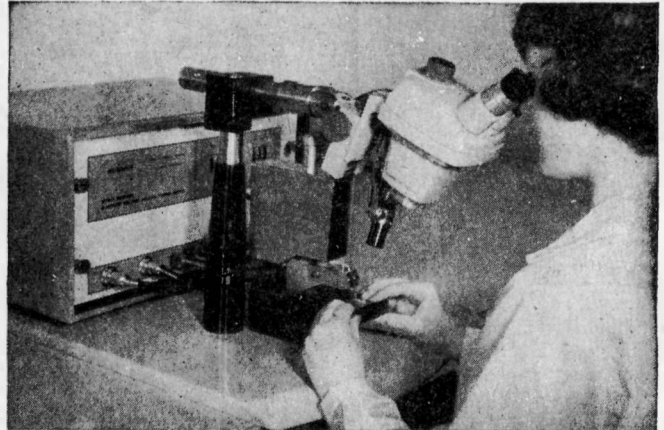

Hughes MCW Systems incorporate either the VTA66 parallel gap head (EL) or the VTA90 head (IL) with complete optical systems, and a range of interchangeable components—constant voltage power supplies, baseplates, bus-bars, substrate holders etc. is available to make up a complete system designed to suit any specialised application.



FOR COMPLETE INFORMATION ON
HUGHES WELDING EQUIPMENT GET IN TOUCH WITH

HIRST

ELECTRIC INDUSTRIES LTD.

MANUFACTURING ELECTRICAL ENGINEERS

GATWICK ROAD, CRAWLEY, SUSSEX. CRAWLEY 25721-5

(formerly Hirst Electronic Ltd.)

QUARTZ STABILITY

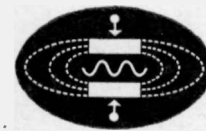
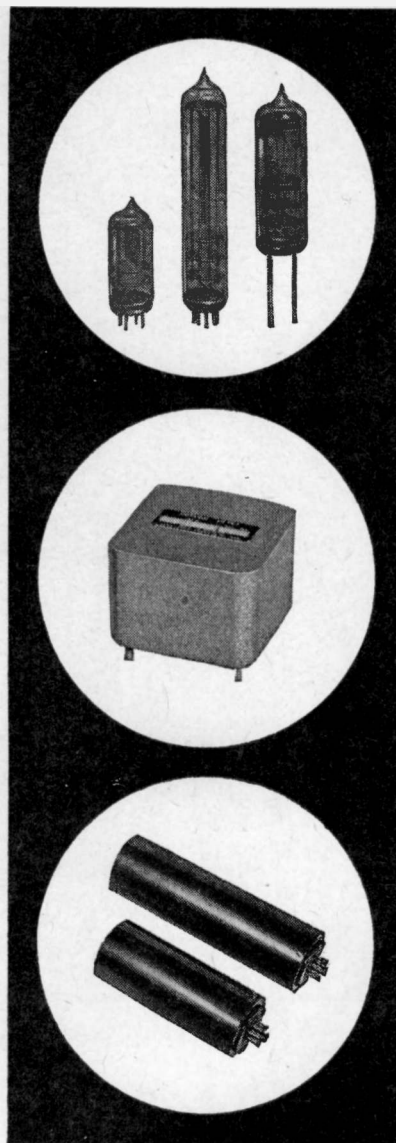
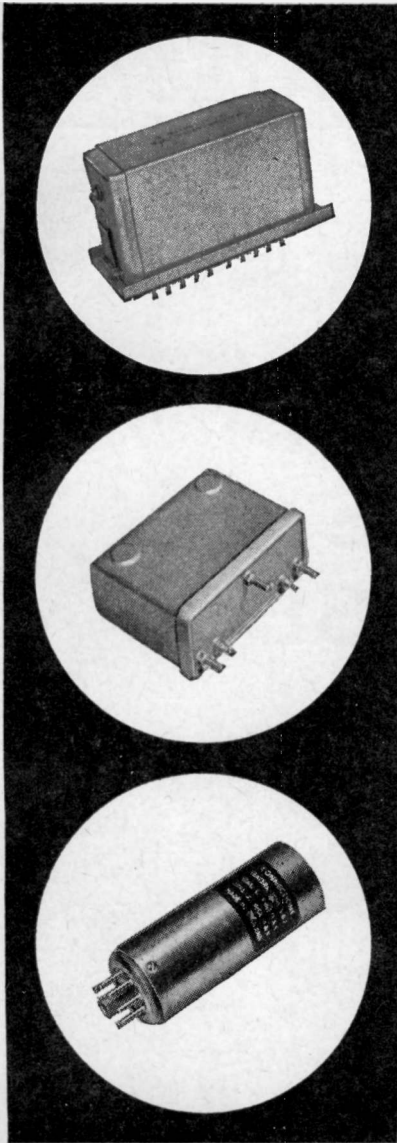

crystals

Marconi have more than twenty years' experience in the manufacture of high quality quartz crystals. A wide range of crystals can be supplied from 1 kc/s upwards. Special low aging types are available at 5 Mc/s and 2.5 Mc/s for use in high stability oscillators.

crystal filters

A selection of crystal filters, both s.s.b and bandpass, are available. New designs are constantly being added to the range and can be produced to meet special requirements.

crystal ovens

Marconi crystal ovens accommodate various types of crystals. Models are available which can accommodate up to ten crystals. Outstanding in the range is the Marconi 'change of state' oven which needs no thermostat and has a switching differential of $\pm 0.0014^{\circ}\text{C}$.

Marconi specialized components are designed and manufactured only when the precision and high performance required is otherwise unobtainable. The Specialized Components catalogue lists the full range.

Marconi specialized components

The Marconi Company Limited, Specialized Components Division, Billericay Works, Radford Crescent, Billericay, Essex, England. Telephone: Billericay 3431

LTD/FS4

READ ANY GOOD BOOKS LATELY?

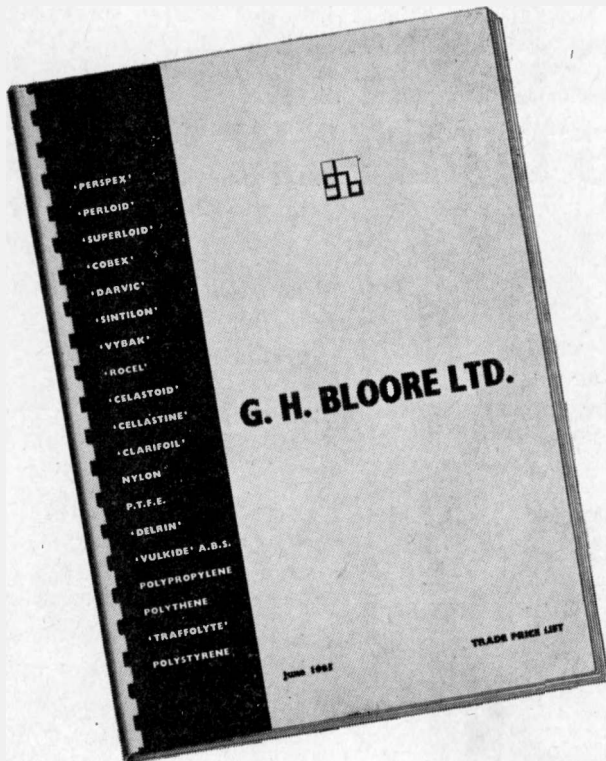

DON'T MISS THESE

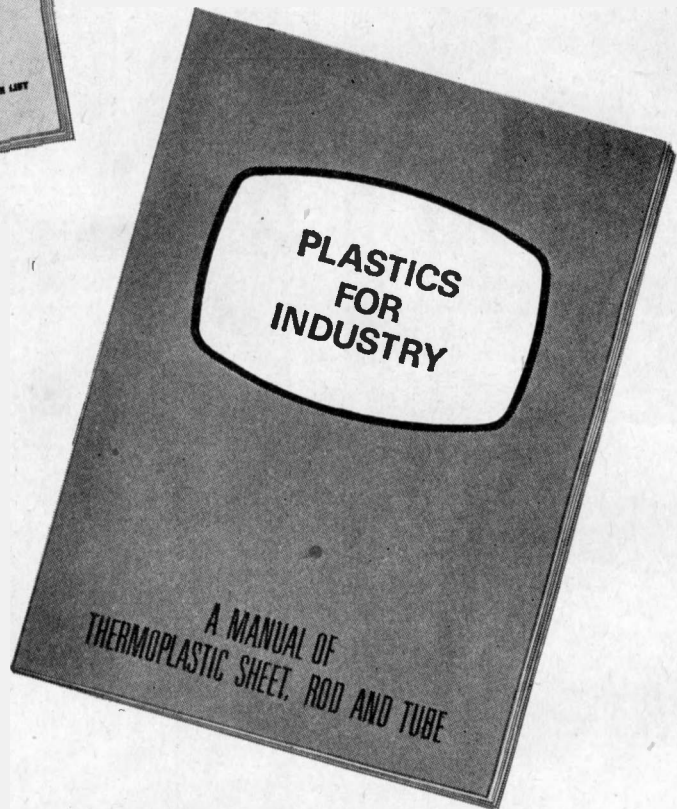

Our new book "Plastics for Industry" has been specially written by our Technical Service Manager, Y. W. Rayden B.Sc., to provide you with the latest, detailed guide available on the use of plastics in modern industry, research and development. The comprehensive catalogue contains a complete list of our wide range of materials. We shall be delighted to send these to you on application with our compliments.

PRODUCED BY

G. H. BLOORE LTD.

Head Office:
Honeypot Lane, Stanmore, Middlesex. EDGWARE 2391.
London Office:
26 Laycock Street, Islington, N.1. CANONBURY 5242.
Midland Region:
Lawley Street, Birmingham 4. ASTON CROSS 4187.
Western Region:
18 Forest Road, Kingswood, Bristol. BRISTOL 674065.

TO: G. H. BLOORE LTD.

Please send me your new book and/or catalogue.

NAME.....

COMPANY.....

ADDRESS.....

EEI



ULANO EUROPEAN TECHNICAL CENTER FOR GRAPHIC ARTS

Ulano's technical center in Switzerland is headed by the very capable Mr. Henri Kunz. He is qualified by his many years of experience in the Screen Process and Graphic Arts fields. Demonstrations and technical seminars are held in many languages throughout the year. Complete laboratory facilities have been installed to provide demonstrations of the complete Ulano line. Large stocks of all famous Ulano films are available for immediate delivery to all parts of the world.

You are invited to contact Mr. Henri Kunz at ULANO A.G., Untere, Heslibachstrasse No. 22, Kusunacht-8700, Switzerland, Telephone 905959. It is our pleasure to serve you.



**DO YOU USE
SCREEN PROCESSING**
IN THE PRODUCTION OF
**COMPLEX
PRINTED
CIRCUITRY?**

TWO NEW PRESENSITIZED FILMS TO SPEED PRODUCTION - LOWER COSTS

Ulano
T.M.



WRITE TODAY
on your letterhead
for free special
sample kit
number 5473

HI-FI RED HEAVY-DUTY INDUSTRY PROVED

Presensitized photo film used by many leading electronic firms for clean, sharp, tough, durable, almost indestructible screens of unmatched quality. Adheres tightly to wire, silk, nylon and dacron.

PREP® PRESENSITIZED FOTO FILM

.002 Polyester support guarantees good register. Does not require a dark room. Very good resolution—suitable for halftones. Excellent adhesion to silk, nylon, dacron and metal mesh. Tough, strong emulsion—good for machine printing and long runs.

J. ULANO & COMPANY, INC.

610 Dean Street, Brooklyn, N. Y. 11238, U.S.A.

Cable address: "UlanoFilm"

In Europe: ULANO A.G., Untere, Heslibachstrasse No. 22
Kusunacht, Zurich, Switzerland

SERCEL CRYSTAL FREQUENCY STANDARDS

NEW HIGH-STABILITY

Type=	SF.2000-12-T	SF.100-12-T	SF.100-12
Quartz Crystal (c/s)	2 Mc/s A-T cut	102400 c/s	102400 c/s
Type of Oven	Proportional Regulator	Bi-metal (55°C)	without oven
Output Frequencies	1 Mc/s—100-10-1 Kc/s and 100-10-1 c/s	800-400-100-50 c/s	800-400-100-50 c/s
Stability (in Temp.)	$\pm 1 \times 10^{-8}$ from 0° to 40°C	$\pm 4 \times 10^{-8}$ from 0° to 45°C	$\pm 2 \times 10^{-8}$ from 15° to 45°C
Stability (in Time)	$\pm 1 \times 10^{-8}$ per 24 hours		
Ambient Range	0°C to +60°C	0°C to +60°C	0°C to +60°C
D.C. Supply	12V ± 2V	12V ± 2V	12V ± 2V
Current Consumption	300 to 450 ma.	80 to 235 ma.	65 ma.
Square Wave Output	8V peak-to-peak	8V peak-to-peak	8V peak-to-peak
Output Impedance	500 Ohms	500 Ohms	500 Ohms

THESE STANDARDS ARE ALSO AVAILABLE AS 'MILITARY TYPES' WITH AN AMBIENT TEMPERATURE FROM -40°C TO +70°C, AND FOR 26V ± 4V D.C. SUPPLY. DESIGNED TO REPLACE FORK-TYPE STANDARDS, THESE COMPACT TRANSISTORISED STANDARDS HAVE A WATERPROOF HOUSING 92mm HIGH BY 73mm DIA. WITH PLUG-IN BASE. THE OSCILLATOR IS MOUNTED IN THE AXIS OF THE HOUSING AND THE FREQUENCY DIVIDING DECADES CONSIST OF ANNULAR PRINTED CIRCUITS STACKED IN TIERS. THE CONSTRUCTION PERMITS EASY ACCESS TO ANY PART AND ENSURES VERY GOOD LONG TERM RELIABILITY.

BRITEC LIMITED

17, CHARING CROSS ROAD, LONDON, W.C.2

TELEPHONE: WHITEHALL 3070

I.E.A. EXHIBITION
STAND N312A
OLYMPIA

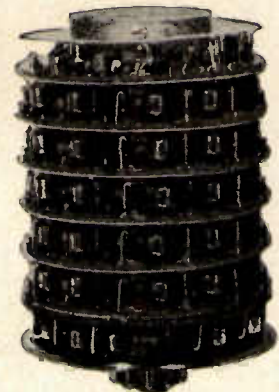

EE 94 164 for further details

these are the 5 best ac stabilisers at ANY price

so what more do you want for

£104.0.0 | £150.0.0 | £84.0.0 | £144.0.0 £144.0.0

These Servomex A.C. Stabilisers are de-luxe instruments yet cost no more than ordinary commercial quality. They are true RMS instruments — they *have* to be to reach the new precision 0.1% — any rectifier measuring device being upset by distorted waveform of the supply voltage, or of the load current. Compare these outstanding features : Accuracy $\pm 0.1\%$. Speed about 60V sec. True RMS sensing—immune to waveshape changes. Temperature compensated. Continuous servo — no creeping towards balance and no noise. *Send for Data Sheets.*



AC2 MK III
2/4 KVA for
rack mounting or bench use.
(Wooden ends £4 extra)

AC7 MK II
7/14 KVA for
rack mounting or bench use.
(Wooden ends £4 extra)

AC2 MK IIIA
Unmetered, bench or shelf
mounted, easleat access
for servicing

AC7 Industrial
Dust proof, hose proof. Can be wheeled or
operated anywhere. Alternative cases.

SERVOMEX

SERVOMEX CONTROLS LIMITED CROWBOROUGH SUSSEX CROWBOROUGH 1247

Industry chooses TRANSITRON HLTTL

why?

because HLTTL offers:



The most advanced range of universal logic circuits available



Combined performance not possible in any other form of monolithic digital circuit—

High Noise Immunity	800mV
High Fan Out	15 min
High counting speed	20 Mc/s Min
Low propagation delay	10 nSec max
High capacitive line driving capability	300 pF



A completely compatible and full comprehensive range of integrated logic circuits including—

Gates: Single and Multiple NAND/NOR and NAND-OR plus expanders
 Flip Flops: Gated 2 phase, Charge Storage and Master Slave types
 Also Line, Lamp and Clock Drivers



Package versatility—

14 or 22 lead ceramic-glass flat packs
 14 lead ceramic-glass dual in-line plug-in packs
 8 or 12 lead low height TO-5 packages

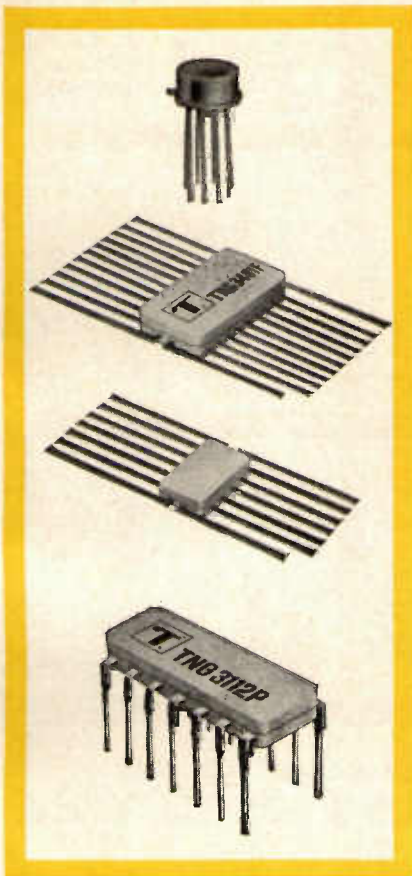

T

TRANSITRON ELECTRONIC LIMITED

Gardner Road · Maidenhead · Berkshire · Telephone: 26371 STD OMA-8 Telex: 84335
 ASSOCIATE COMPANIES IN PARIS AND MUNICH

Representatives in: Amsterdam · Copenhagen · Milan · Oslo · Stockholm · Vienna · West Berlin · Zurich

Terry's put life into springs

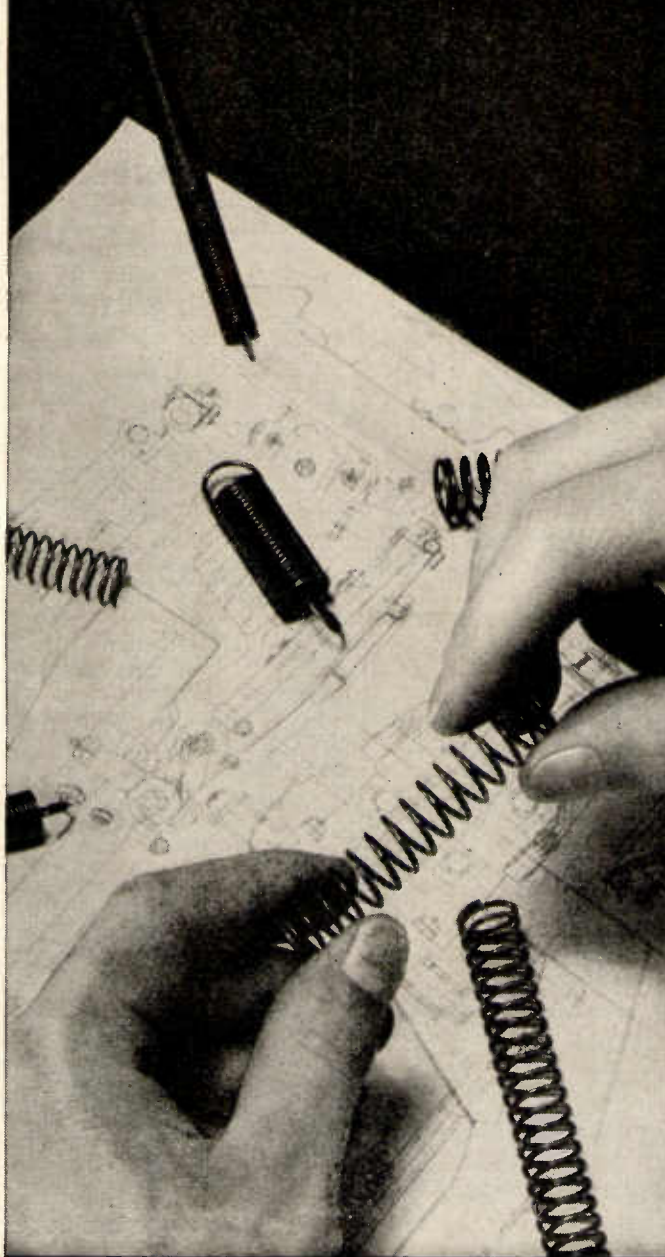

—and success into your experiments

A better spring for every experiment is always at hand with Terry's fine range of boxed assortments. You pick the spring you want, when you want it. And even if the spring you want isn't yet in existence, Terry's have the answer for that too. Their team of designers and research men have had years of experience in solving spring and presswork problems of all kinds, and they've never yet failed to come up with a brilliant solution. They're always at your service. No problem is too small or too big—as long as it's to do with springs, wireforms and presswork.



Light expansion springs
packed in boxes of three dozen assorted. No. 753 13/6. Also in stainless steel — No. 1468.



Light compression springs
packed in boxes of one gross. No. 757 20/-. Also available in stainless steel — No. 1469.



Assorted springs
packed in boxes of one gross. A complete service kit. No. 1217 50/-.



Spring design and calculations
11th edition — 12/6 post free.

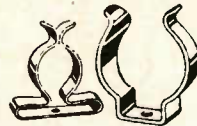

Tool clips
In hardened and tempered steel. Sizes from 1/4" to 2".



Wire circlips
in sizes from 1/8" to 5/8" — immediate delivery from stock.

- * All prices quoted subject to trade discount.
- * Full range available on request.

TERRY'S

work wonders with springs

**HERBERT TERRY & SONS
LIMITED**
REDDITCH · WORCS



Terry's hose clips
with security worm drive. Sample and price list free.



Terry's retaining pins
replace the split pin. Spring grip on side holds firm. Top ring for easy removal. Sizes from 3/8" to 1 1/4".

STORAGE

**is data storage your problem?
MEL delay modules are the perfect
low cost answer!**

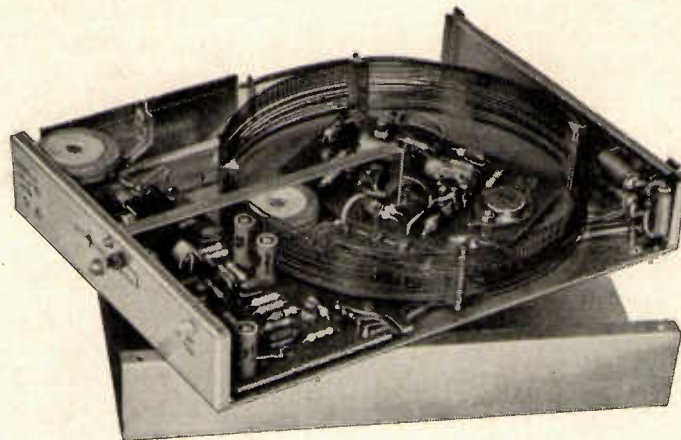

If data storage is your problem, there is a really low cost solution with M.E.L. wire delay lines. Covering a wide range of applications, they are already used extensively in small computers, business machines, telephone exchanges, machine tool control systems. Here's why ...

You can store up to 1,000 bits in an M.E.L. wire delay line. They come complete with their own read/write electronics, tailored to meet specific delay requirements and adjustable over $20\mu\text{S}$.

The delay range covers from $100\mu\text{S}$ at 400kc/s pulse rate to 3.2mS at 250kc/s.

They are compatible with the wide range of M.E.L. digital sub-assemblies, and provide an output for n.p.n. or p.n.p. devices.

They are immediately available.

For delays which need a broad bandwidth—as in communications work—M.E.L. produce a range of custom-built quartz delay lines featuring long delay times and high storage capacity.

Find out how your data storage problems can be solved inexpensively—contact M.E.L. now!



The M.E.L. Equipment Company Ltd

Electronics and Control Division

Manor Royal Crawley Sussex Tel: Crawley 28787

NEW CONSTANT CURRENT POWER SUPPLY

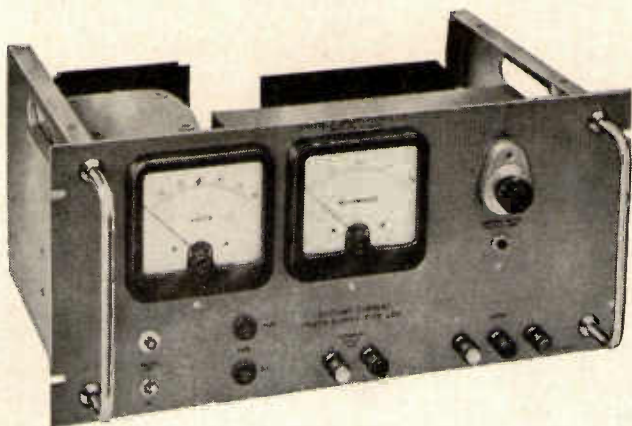

- Built-in precision sensing resistor.
- High resolution output current control.
- High stability and accuracy of setting.
- Separate, large scale metering for output voltage and current.
- Unit is suitable for 19" panel mounting or can be fitted into an instrument case for laboratory use.

HATFIELD BALUN

HATFIELD INSTRUMENTS LTD., Dept. E.E.,

BURRINGTON WAY, PLYMOUTH, DEVON.

Telephone: Plymouth 72773/4

Telegrams: Sigjen Plymouth.

TYPE L.E. 606

The unit type L.E. 606 is a fully protected power supply, which has been applied to the testing of devices such as Submerged Repeaters.

Specification details, below, are for the Standard Model, but units with different voltage and current ranges can be supplied to order.

A most important feature is the completely foolproof Protection Circuit. A system of zener diode gates and latching relays make it impossible to set the output greater than 5 volts above the voltage in use, without using the release button. Further, if the equipment is switched off, and another load value or current setting used, the output voltage will be limited to the first 5 volt step and the resetting button must be used before a new voltage level can be reached.

Brief Specification

INPUT:

200 to 250 V. 50 c/s.

OUTPUT:

Output current variable by means of 10 turn control over the range: 56 to 200 m.A. d.c.

STABILITY:

$\pm 0.25\%$ for a $\pm 10\%$ change of nominal input voltage. $\pm 0.5\%$ for a $\pm 20\%$ change in load resistance.

NOISE & RIPPLE:

5mV. R.M.S. max.

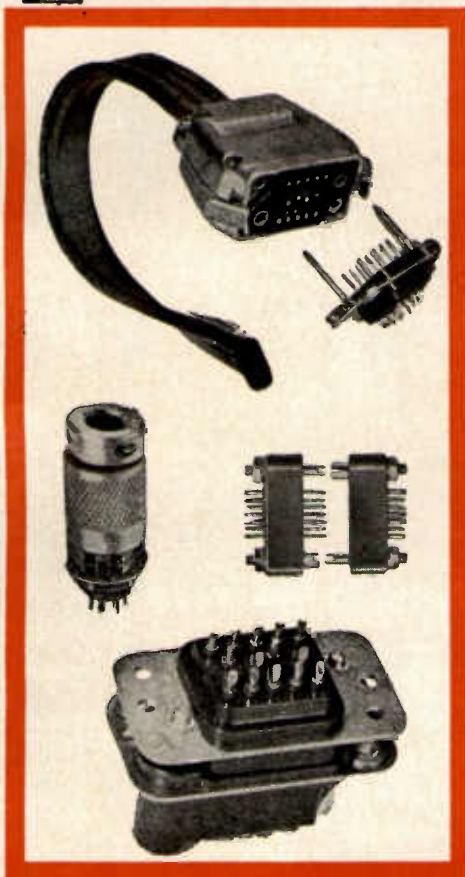
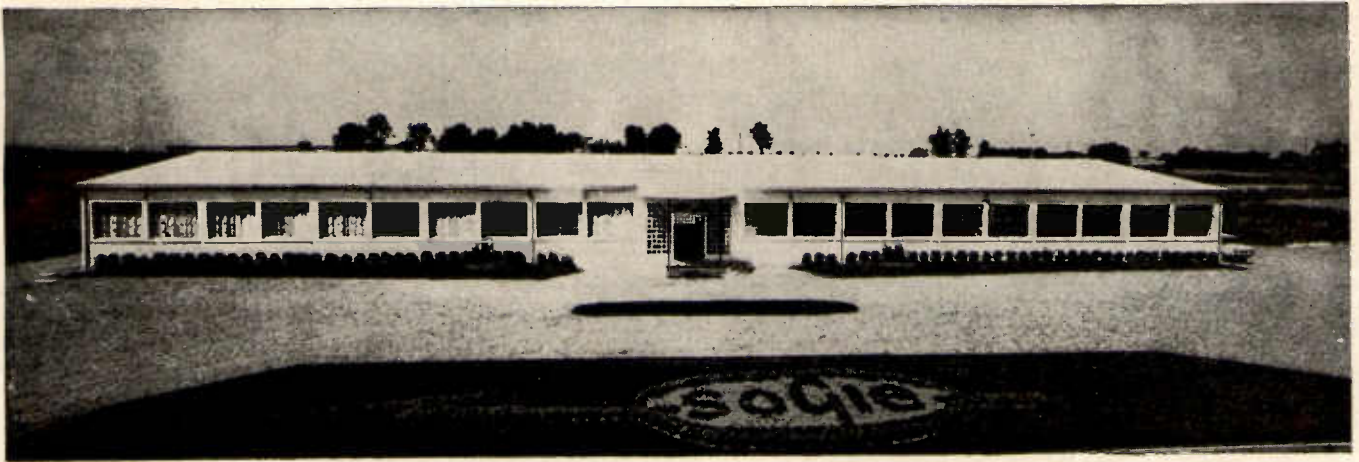

AN
ULTRA-MODERN
FACTORY PRODUCING
ELECTRICAL
CONNECTORS

CUSTOM DESIGN WORK

● SOCIÉTÉ GÉNÉRALE
POUR L'INDUSTRIE
ÉLECTRONIQUE

305, RUE DE BELLEVILLE
PARIS

TÉL : 205 25-61 — 205 41-48

PLANT LOCATED AT CHATEAURENAULT

CELDIS LD., 4 TRAFFORD ROAD RICHEFIELD ESTATE, READING, BERKSHIRE

We pay our people to work for you—

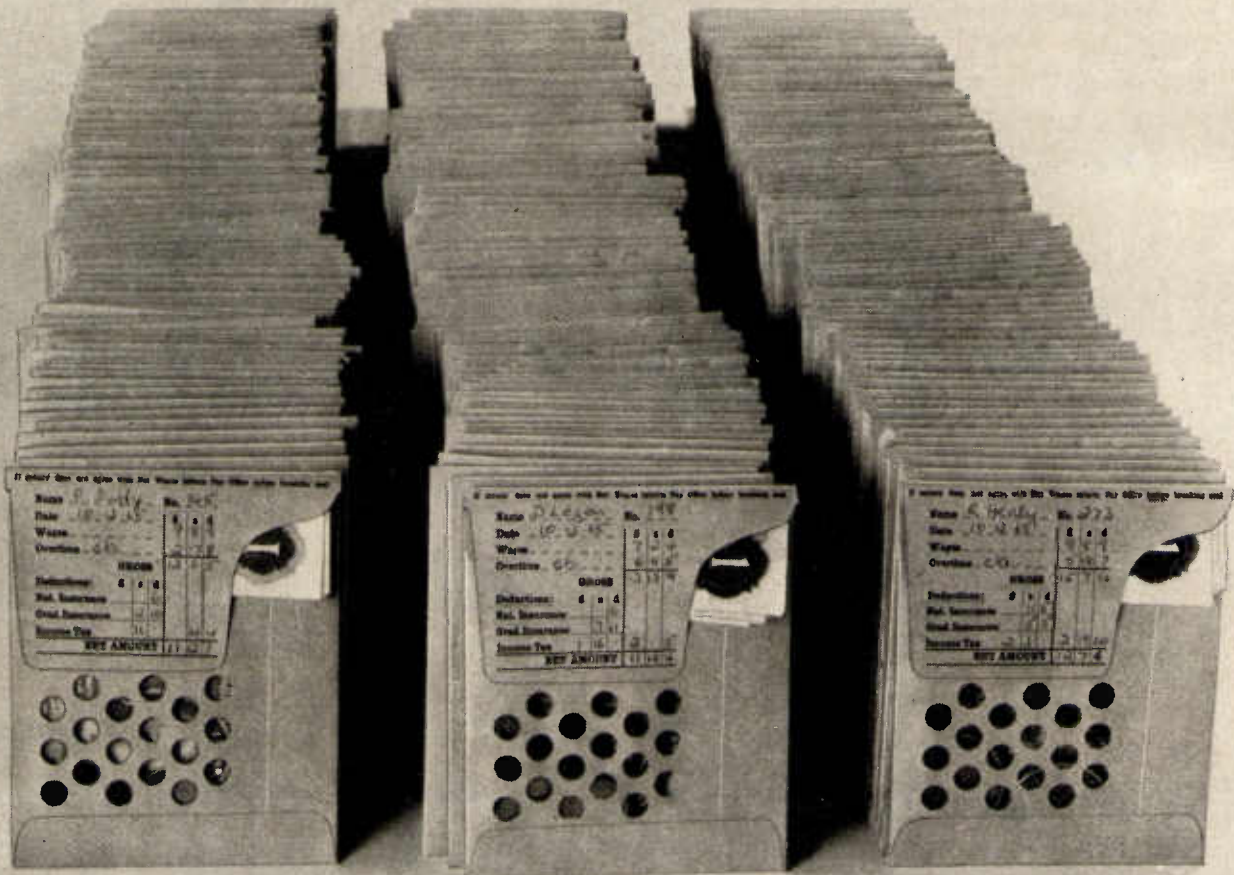

we supply factory and know-how too!

Production problems? Diversification difficulties? Target date doldrums?

Lumber the lot on Broxlea—the *specialist* subcontractors to the British Electronics Industry. (At one time or another, everybody who's anybody in the business has!)

Our factory just outside London has space for your work *now*. It is fully equipped to assemble all kinds of electronic and telecommunications equipment. Particularly wiring, cable-forming and pre-formed wiring systems.

Our own supervisory engineers are fully qualified and highly experienced. If you prefer, however, your own staff can supervise every operation on the spot.

Enough talking. May we *show* you the comprehensive facilities we have to offer? Please 'phone, telegram or write our Managing Director (Mr Leslie Izzard) and arrange a visit at any time that suits you.

BROXLEA

The largest company exclusively engaged in subcontracting
for the Electronics and Communications Industry.

Broxlea Limited (MoA approved) Broxbourne, Herts. Hoddesdon 64455



by Bradley

A new concept in Instrument Cases specially designed for your laboratory-made test gear or for your short production runs. Modern, distinctive styling with the following attractive features:

- Adjustable chassis height.
- Pierced diecast side frames allow for mounting of sub-assemblies.
- Side, top and bottom plates, removable for assembly or servicing.
- Etched aluminium panel suitable for engraving or printing.
- Durable and attractive finish, black P.V.C. bonded on to steel sheet.
- Supplied in kit form, complete in every detail.
- Range of sizes available.

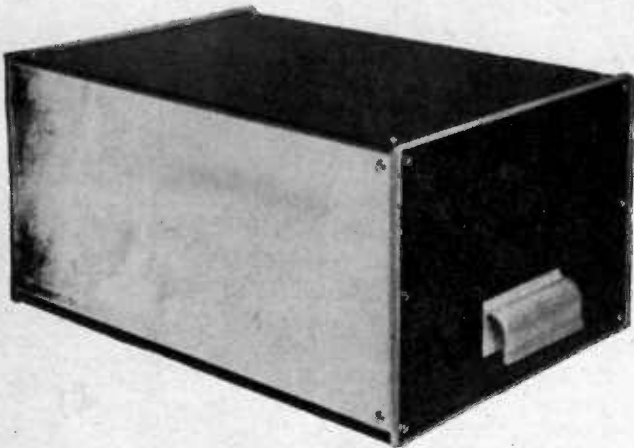

For details and the addresses of your nearest Casekit distributor contact:



G & E BRADLEY LIMITED
ELECTRAL HOUSE, NEASDEN LANE, LONDON N.W.10
TELEPHONE: DOLLIS HILL 7811
TELEGRAMS: BRADELEC LONDON NW10. TELEX 25583

potentiometers

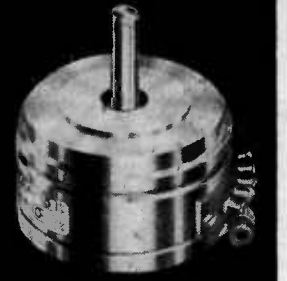
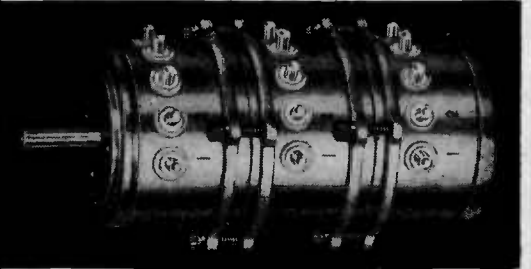

robust high quality precision potentiometers

Metal cased; will maintain their accuracy under severe environmental conditions. Models available covering a resistance range from 0.25 to 200K ohms, with a resistance tolerance of $\pm 5\%$. Standard independent linearity $\pm 0.5\%$ and $\pm 0.3\%$, or to special order $\pm 0.2\%$ and $\pm 0.15\%$. Mounting by 3 tapped holes in face, or by clamping ring and circlip. Up to six units may be ganged on one shaft. Write for leaflets giving full technical specification of complete range.

Salford Electrical Instruments Limited
Peel Works, Barton Lane, Eccles, Manchester
Tel: Eccles 5081
Telex: 66711

London Sales Office:
Brook Green, Hammersmith W.6
Telephone: 01-603 9292



A Subsidiary of The
General Electric Company
Ltd of England

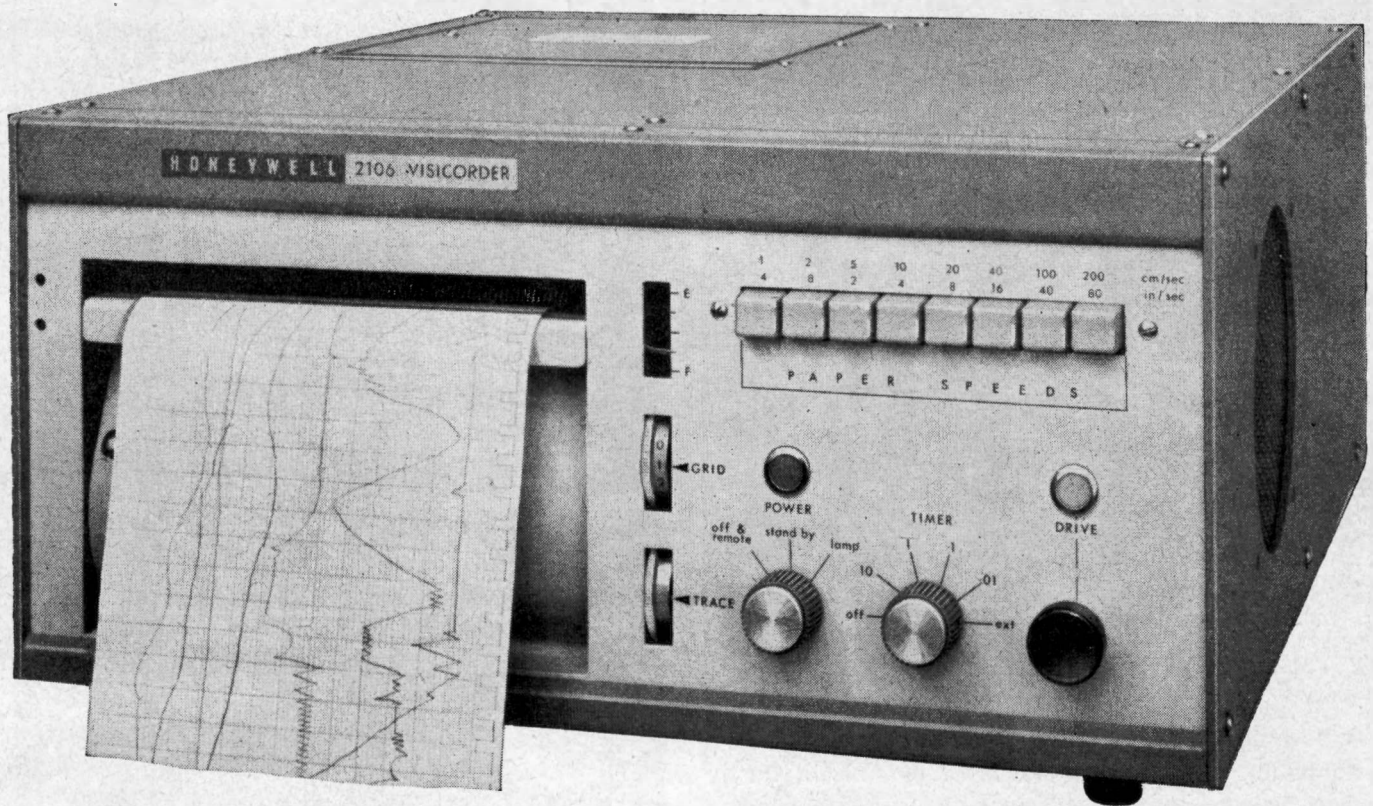

12 + 2

Channels on the new **2106 Visicorder** recording oscillograph

- 12 Channels + 2 Auxiliary
- Improved Galvanometer Range 0—13000 c/s
- Chart speeds up to 300 cm/s (120 in/sec)
- Temperature controlled magnet block
- Automatic record length control
- Plug-in resistor board for each galvanometer
- High spec—Low cost
- Immediate lamp start—hot or cold

Full width electronic time and grid lines ; remote control ; 6" paper ; latensifier ; event marker ; bench or rack mounting ; writing speed over 125 cm/msec (50000 in/sec) ; individual galvanometer connections. Designed and manufactured in Great Britain. For further information please write or 'phone Honeywell Controls Limited, Industrial Products Group, Great West Road, Brentford, Middlesex. Atlas 9191.

Honeywell

Honeywell International Sales and service offices in all principal cities of the world. Manufacturing in U.K., U.S.A., Canada, Netherlands, Germany, France, Japan.

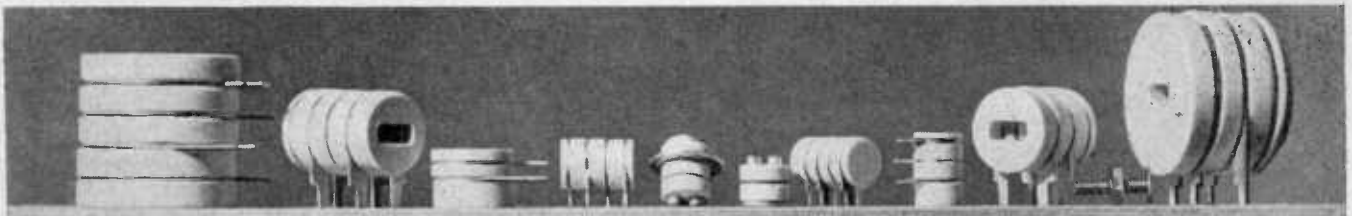

Do the tough jobs with

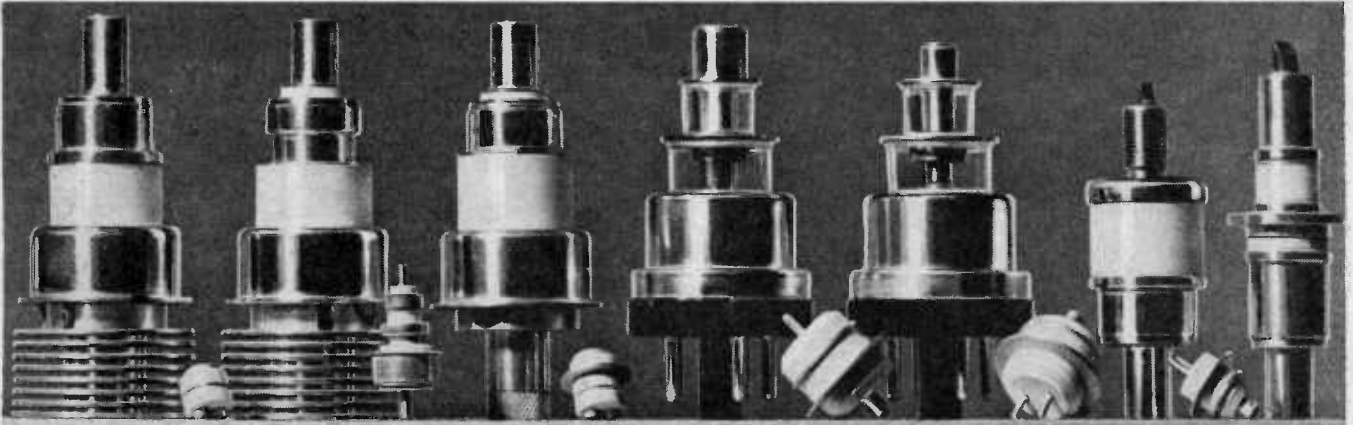

metal-ceramic planar tubes from

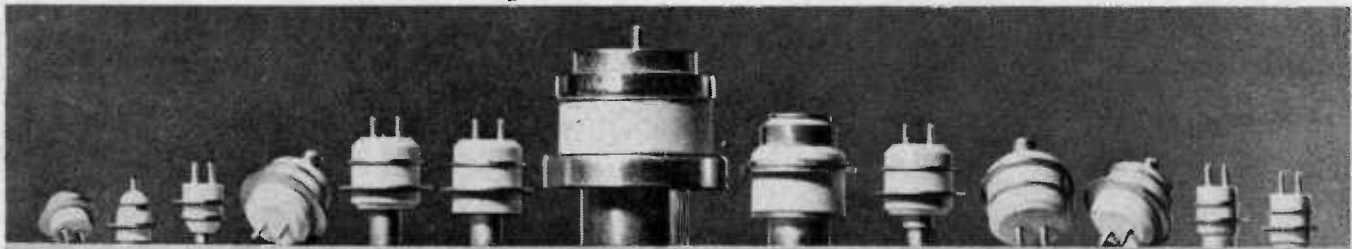

General Electric Company of U.S.A.

From DC to 10 gc, ceramic triodes are often the most practical way to achieve small size and weight... at low cost... without sacrificing performance. Sometimes they're the only way.

These tubes, from General Electric Company, U.S.A.*, are of planar construction; terminals are integral parts of the structure.

As a result, these tubes rate *high* in power output (milliwatts to 5 KW peak). *Low* in noise (fractions of a db at low frequency). *High* in gain and *wide* in band (gain-band width products up to 5000 mc).

And when it comes to performance under adverse conditions, ceramic tubes from General Electric, U.S.A., are unsurpassed.

They tolerate temperatures as low as -55°C or as high as 400°C . These tubes withstand impact shocks of up to 600 G's for 3-5 M.Sec., RMS vibration up to 48 G's (100-2000 cps, 3 min. each planel. And they've tolerated nuclear radiation of 10^{18} NVT total integrated dose.

For full information on the whole line—only a fifth of it is listed here—contact International General Electric Company of New York, Ltd., 296 High Holborn, London, W.C.1, or General Electric Company, Dept. EC-66-03, 159 Madison Ave., New York, N.Y. 10016, U.S.A.

*GENERAL ELECTRIC COMPANY, U.S.A., IS NOT CONNECTED WITH THE BRITISH COMPANY OF A SIMILAR NAME.

Classification	Type	Maximum Ratings		Typical Application	Useful Frequencies Extend to**
		Plate Dissipation (Watts)	Current (milliamperes)		
Triode (Class A Operation)	7077	1.0	$I_k = 10$	Low-noise UHF Amp.	3000 mc
	7768	5.5	$I_k = 30$	Low-noise VHF Amp.	3000 mc
	Y-1032	0.6	$I_k = 10$	Low- μ , Low-plate-voltage Osc., Amp. or Mult.	3000 mc
Triode (Class B or C Operation)	6897	100.0*	$I_k = 125$	UHF Power Amp. Osc. or Freq. Mult.	3000 mc
	7486	1.0	$I_k = 10$	UH - Power Amp. Osc. or Freq. Mult.	3000 mc
	7913	5.5	$I_k = 30$	UHF Power Amp. Osc. or Freq. Mult.	3000 mc
Triode (Pulse Operation)	6442	7.5*	$I_p = 2500$ $I_q = 1250$	Pulsed Oscillator or Amp.	6000 mc
	7815	100.0*	$I_p = 3000$ $I_q = 1500$	Pulsed Oscillator or Amp.	3000 mc
	7910	1.5	$I_p = 600$	Pulsed Oscilla'or	7500 mc
	7911	6.5	$I_p = 2500$	Pulsed Oscillator or Amp.	6000 mc

*At this dissipation level, anode cooling is usually necessary to prevent exceeding maximum permissible seal temperature.

**The frequency listed is one at which significant application data are available or expected. It does not represent an absolute frequency limit.

GENERAL ELECTRIC COMPANY OF U.S.A.



CHANGE OVER TO **ETHER**

Two new general purpose miniature relays have been added to the Ether range. Designed for printed circuit or chassis mounting, they are compact, reliable and inexpensive.

Two-pole changeover types are rated at 2 amps; single pole double make-and-break types at 3 amps (240V a.c. or 24V d.c.)

Standard coil voltage: 6, 12, 18 and 24V d.c.

Maximum operating power: 1 watt.

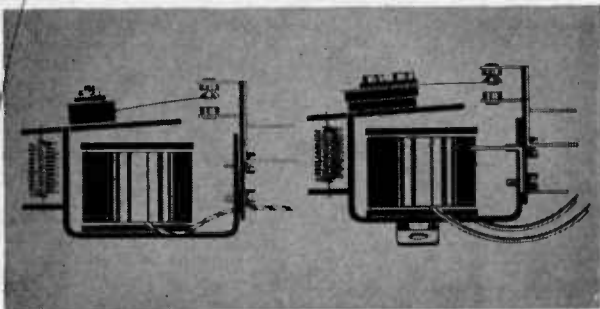

Write for full details to:

ETHER LIMITED
GENERAL PRODUCTS DIVISION
 CAXTON WAY · STEVENAGE · HERTS
 Telephone: Stevenage 4422 - 16 lines

NEW FROM

VERO

THE "BOTLEY" RANGE OF

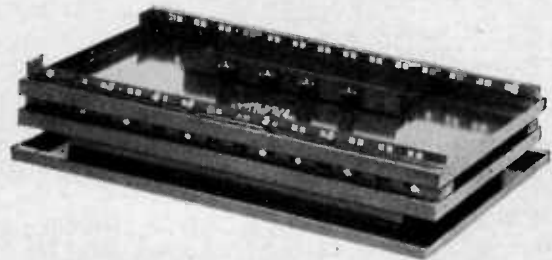

PACK-FLAT CASES

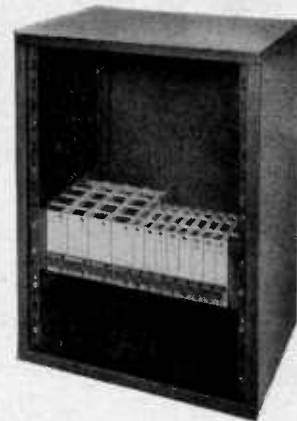

... requiring minimum amount of storage space ... convenient for packing and travel ... easily assembled with just a screw-driver ...

Send for competitive price details to

VERO ELECTRONICS
 LTD

INDUSTRIAL ESTATE, CHANDLERS FORD, HANTS.
 Tel: CHANDLER'S FORD 2921/2/3 Telex: 47551

BRANCHES AND AGENTS THROUGHOUT THE WORLD

LIVINGSTON SPOTLIGHTS...

**F. W. BELL
HALL EFFECT
GAUSSMETER
MODEL 110A**

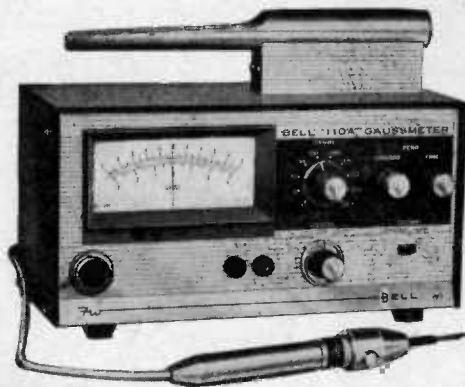

- * 1 gauss full scale sensitivity
- * Portable and battery operated
- * Price £204 (including probe)*

The Model 110A is a fully portable gaussmeter operating from either mains or internal batteries. Sensitivity is 1 Gauss to 30 Kilogauss full scale, accuracy is $\pm 2\%$ of f.s. up to 10,000 Gauss and the instrument is self calibrating. The price of £204 excludes duty but includes the cost of the YA-147 transverse probe (illustrated), which enables accurate measurements of magnetic flux to be made within air gaps 0.020" wide. Several general or special purpose probes are also available.

Applications include geomagnetic field plotting, inspection of meters, vibration pick-ups, DC motors, magnets, tachometers, relays, solenoids, or magnetic tape. The Bell 110A provides a degree of accuracy, sensitivity and customer convenience not offered by more conventional flux measuring techniques, and is ideal for use in Educational Establishments, Research Laboratories and all companies engaged in the manufacturing or testing of magnetic materials.

F. W. Bell pioneered the commercial development of Hall Effect applications and has gained an international reputation for its range of magnetic equipment consisting of gaussmeters, Hall Effect devices, magnets and magnetic sorting and inspection systems.

* Duty remission is normally granted.



- Please send Bell 110A data sheet.
 Please send Bell short form catalogue covering full range.

NAME

ADDRESS



LIVINGSTON LABORATORIES LIMITED
 Livingston House, Greycaines Road,
 North Watford, Herts. Tel: Watford 44344

a new range of series stabilizer modules by GRENSON

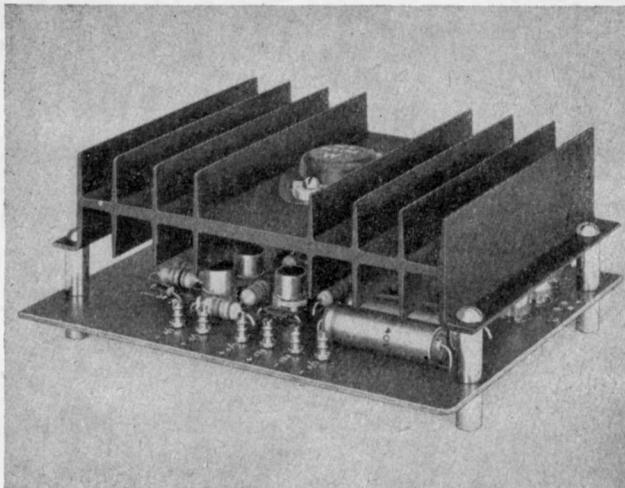

The module illustrated is the 1 Amp. unit from our new range of variable series stabilizers. The output voltage is variable in the range 6-30 V at currents from 0-1 Amp. and provision is made for remote sensing of the reference voltage as well as remote programming of the output voltage. The module is fully protected against accidental overloads and short circuits by an electronic trip circuit which can be preset to operate at any current within the range 100 mA-1.2 A and which resets automatically on removal of the overload.

Brief specification: Max current 1.0 Amp. O/P Voltage 6-30 V (variable). Min. I/P Voltage-(O/P + 4 V) Effective resistance < 0.01 ohm. Control ratio 1000 : 1.

GRENSON ELECTRONICS LIMITED.
Station Avenue, Tile Hill, Coventry. Tel: Tile Hill 65632

K 30 KV GROUP high voltage DC power supplies

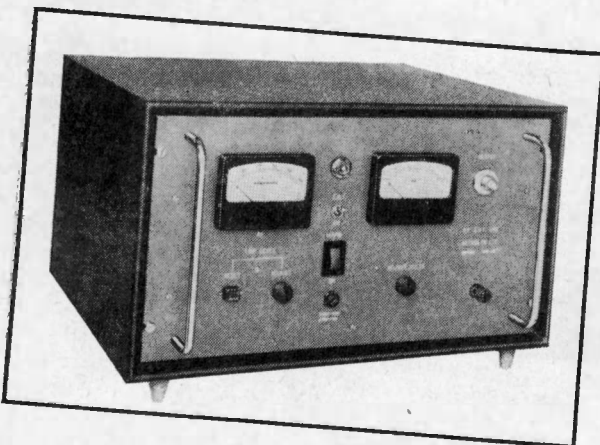

Model H3005	2-30kV	500µA	*Variable trip 100µA to 500µA
Model H301	2-30kV	1mA	*Variable trip 200µA to 1mA
Model H302	2-30kV	2mA	*Variable trip 400µA to 2mA

*Variable trip circuit is set by front panel 'Adjust' knob. The maximum working current is indicated on the current meter by pushing the reset button. Overload trip will operate if current exceeds the indicated maximum working current.

Specification
Regulation: Better than 0.2% zero to full load and ±10% mains
Ripple: Less than 0.1% at full output.
Polarity: Reversible
Panel mounting units with cover instead of case can be supplied to special order.

Kilovolts Limited
high voltage engineers
41 Lodge Road Croydon Surrey THOrnton Heath 8856-7

**NEW
SUBMINIATURE TWO-POLE
CHANGE-OVER RELAY
BUILT ORIGINALLY FOR
MILITARY USE**

NOW AT A COMMERCIAL PRICE!

The new Clare-Elliott Type CF relay is a commercial version of the Type F relay, created originally for military use. It offers the engineer a new subminiature two-pole change-over relay having high sensitivity and absolute reliability at low cost! Type CF is immediately available with 12, 24 and 48 volt coils and wire end terminations as standard.

Outstanding characteristics

SENSITIVITY:	300 milliwatts approx.	
OPERATE TIME:	5 milliseconds max. (including bounce)	
RELEASE TIME:	5 milliseconds max. (including bounce)	
MECHANICAL LIFE:	10,000,000 operations before failure when tested at speeds up to 30 cps.	
TEMPERATURES:	-40°C to +85°C.	
CONTACT RATING:	28 V d.c. Resistive 3 amps 115 V a.c. Resistive 1 amp 28 V d.c. Inductive (100 m.H.) 1 amp	10 ⁶ Operations

For full technical specification, please write to:

CLARE-ELLIOTT LTD
AIRCRAFT RELAY DIVISION

70 DUDDEN HILL LANE • LONDON NW10
Willesden 8070  A Member of the Elliott-Automation Group

**Full
data**

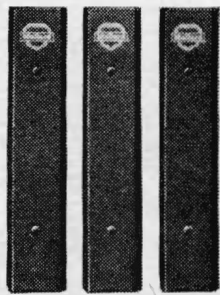

**on all
Mullard
products**

The Mullard Technical Handbook contains Data Sheets on all Mullard semiconductors, valves, tubes, electronic and magnetic components in current production.

Available on a subscription basis, this six volume loose-leaf publication is kept perpetually up-to-date by the issue of supplementary data sheets. Subscribers automatically receive the revised sheets as they are introduced.

The information includes ratings, characteristics, recommended operating conditions and performance figures for various applications, and curves and outline diagrams.

Mullard

MULLARD LIMITED · MULLARD HOUSE · TORRINGTON PLACE · LONDON WC1

Please send me full details and subscription rates of the Mullard Technical Handbook Service.

NAME _____

ADDRESS _____

springs and pressings for the electronic industry

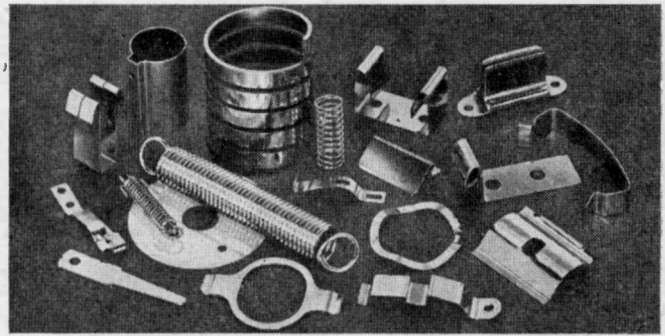

Made to your individual requirements from Beryllium Copper, Nickel Silver, Stainless Steel, Phosphor Bronze, Tantalum, Spring Steel etc.

Write or phone for further details to:

LITCHFIELD BROTHERS LTD.
HEAGE FIRS, NETHER HEAGE, DERBY, ENGLAND TEL: AMBERGATE 435/6/7



individually
tested
vitreous enamel
wirewound
RESISTORS

Proved reliability-qualification approval
embraces RCSC types RWV4J-K & L, 1 Ω to 100K Ω

CGS resistors offer you highest standard of quality and performance at extremely competitive prices, due to specialisation, an efficient production organisation and selective buying of raw materials. Up to 100 of any RCSC type resistors are available from stock. Leading manufacturers, GPO, Ministry of Aviation, Admiralty, and NATO are among the many users of CGS resistors. RCSC type approved to DEF 5111-1, manufactured under EID and ARB approved inspection conditions.

For price list, catalogue and stock list write or phone: **THE C.G.S. RESISTANCE CO. LTD.**
Marsh Lane, Gosport Street, Lympington, Hants. Tel: Lympington 2811

EE 94 194 for further details

ONE MILLIVOLT FULL SCALE TO 1,200 Mc/s



Frequency Range

10kc/s to 1,200 Mc/s
—useful to 2,500 Mc/s

Voltage Ranges

8 ranges, 1mV.—3V. full scale

Accuracy

±3%, (± 0.25 db), 10 kc/s—100 Mc/s
±5%, (± 0.45 db), 100 —700 Mc/s
±10%, (± 0.9 db), 700 — 1,000 Mc/s
+22% ($-0 + 1.75$ db), 1 — 1.2 Gc/s
—0 + 3 db, 1.2 — 1.5 Gc/s

Stability

No zero reset required over 8 hours, except on most sensitive range.

Response

RMS to 30mV; peak calibrated in terms of RMS above 30mV; with 100:1 divider RMS-responsive to 3V.

Input Impedance

High Impedance—2 pf. and 150 K Ω :
also 50 Ω termination adaptor
(other values on request).

Features

Temperature compensated probe.
Linear scale on all ranges.
D.C. recorder output—1.5V. at 0.5mA.
Taut-band mirror scaled 6" galvanometer.

Accessories Supplied

Probe with high-impedance tip, 50 Ω .
BNC termination adaptor, output plug.

Accessories Available

100:1 capacitive voltage divider, BNC, N or GR terminations, type N 'Tee' adaptor.



MILLIVAC TYPE MV-28B R.F. MICROVOLT METER

Price £230 net.

Delivery Normally Ex Stock



CLAUDE LYONS

Claude Lyons Limited, Instruments Division
Valley Works, Hoddesdon, Herts. Tel: Hoddesdon 67161. Telex: 22724.
76 Old Hall Street, Liverpool 3. Tel: MARitime 1761. Telex: 62181.

Wherever you are, a phone call or a cable will get you information about electronic systems and components from:

Norden

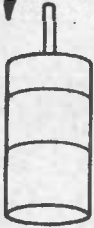

Brush and magnetic encoders

Codes: V-scan binary, binary-decimal, Gray, latitude-longitude binary-decimal, beacon altitude, incremental. Total counts: 100 to 1,000,000. Used in major U.S. missile and weapons systems, data processing, machine tool positioning.

Gyro

RI1000 low-cost, rate-integrating gyro.

Integrated circuits

Power amplifiers up to 40 watts. Sense, differential and error amplifiers, master dice bread-boards.

Pressure ratio indicating systems

Monitor thrust of high-performance jet engines.

Radar systems

Multi-mode radar systems for treetop or high-altitude flight, terminal navigation and all-weather landing.

Pilot display systems

Head-up horizontal display systems for aircraft.

Hamilton Standard



MicroCircuit Pack

Low-cost hermetically sealed modules permit interconnection of integrated and thin-film hybrid circuits, on up to 10 discrete wafers with maximum of 360 interconnections. Standard modules available for evaluation.

Static inverters

Wide variety of specially designed models with 25va to 10kva output, 1-3 phases, various wave forms. Ask for representative list.

Helicopter stabilization systems

Flight control systems combining autopilot and amplifier-coupler in one package. Also stability augmentation equipment for light helicopters.

Vector

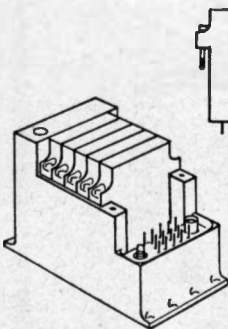

Telecommunications systems

Complete analog and digital data acquisition and processing systems for aircraft, satellites, missiles, manned space vehicles and ground test stations.

Telemetry components and subsystems

Signal conditioners; subcarrier oscillators; calibrators; analog-to-digital and digital-to-analog converters; multiplexers; modulators; commutators;

power supplies; synchronizers; simulators; discriminators; VHF/UHF FM, PM and Beacon transmitters; airborne receivers, power amplifiers, frequency multipliers.

Solid state components

Power amplifier, silicon small signal (including radiation hardened) and differential transistors; Tempistors* (temperature compensating resistors).



For name of nearest local representative in Europe, write or call Paris, 225 80.48. Cable "Unitedair" Paris, France. Elsewhere in the world, write or call United Aircraft International, USA (203) 565-4321. Cable "Unitedair" East Hartford, Connecticut, USA.

United Aircraft International

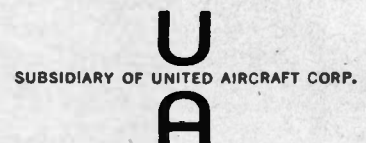

OVERSEAS REPRESENTATIVE FOR: PRATT & WHITNEY AIRCRAFT • HAMILTON STANDARD • SIKORSKY AIRCRAFT • NORDEN • UNITED TECHNOLOGY CENTER • VECTOR • UNITED AIRCRAFT OF CANADA LIMITED
REPRESENTATIVE FOR NORDEN, HAMILTON STANDARD, AND VECTOR PRODUCTS: UNITED AIRCRAFT INTERNATIONAL, SARL, 39 AVENUE PIERRE 1^{er} DE SERBIE, PARIS 8^e, FRANCE

This Gordos Dry Reed switch

EE 94 197 for further details

is precisely the

- right size
- right rating
- right contact resistance
- right speed
- right sensitivity
- right life expectancy

and the

- right price

for someone's circuit

Gordos Dry Reed Switches offer reliability, stability, high insulation resistance, fast operating speed, long life, small size and low cost.

Two basic designs: centre gap type for coil operation and off-set gap types for magnet operation.

Three main contact materials: diffused gold, Di-met and rhodium.

There are Gordos switches for dry circuit conditions, for inductive loads. Switches with close differentials. Switches having very low dynamic noise, bounce and thermal EMF. In fact switches for every application.

Gordos reeds are fitted to the complete B & R range of dry reed relays. Please send for the new Gordos Technical Manual and for details of all the new reed relays.

B & R Relays Ltd
Temple Fields Harlow Essex
Telephone Harlow 25231/4
Telex 81140

B&R GORDOS

Sole UK agents for
Gordos Corporation of USA

One of the other 49 types
will be precisely right for you

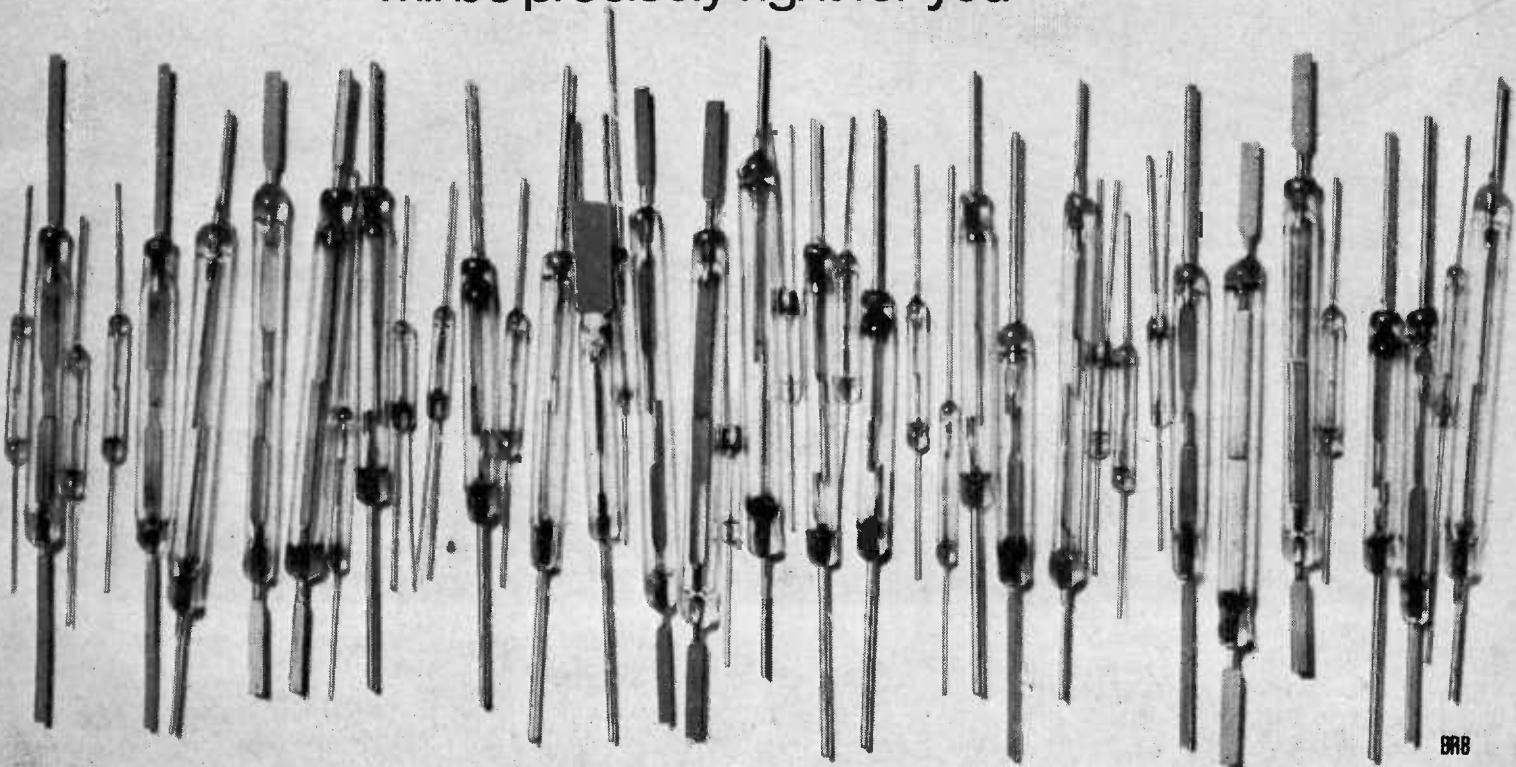

most versatile rf sweep generator

JERROLD 900C

- Sweep widths from 10kc to 400mc
- Frequency range 500kc to 1,200mc

Here is the ultimate instrument for all your IF, VHF, and UHF sweep requirements. Famous for its stability and built-in convenience: Crystal-controlled harmonic markers: variable-gain dc or ac-coupled scope



preamplifier; precision turret attenuator from zero to 50db in 10db steps, plug-in rf detector (for remote use), rf output meter and provisions for inserting external markers. Write for complete technical data.



JERROLD
ELECTRONICS
CORPORATION

Systems Engineering Svc. Ltd., 35-39 South Ealing Rd.
Ealing, London W5, Great Britain

Sweep Generators • Amplifiers • Precision Attenuators • Comparators

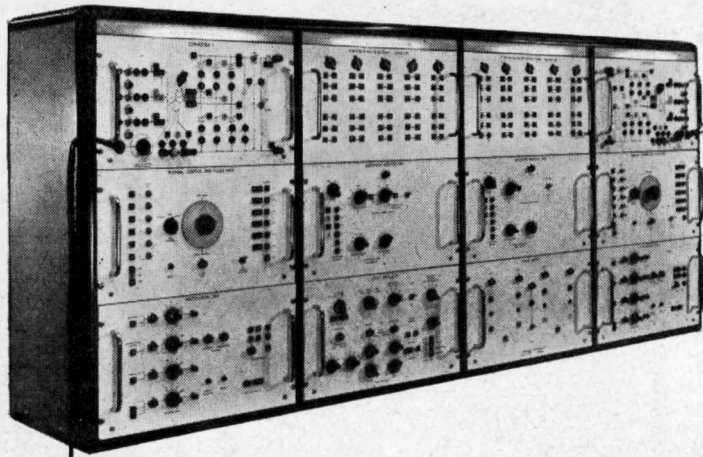

HIGH VOLTAGE D.C. SYSTEM MODEL

- Two three-phase bridge S.C.R. Converters with a bypass S.C.R.
- Transmission line simulators.
- Manual or Automatic Control.
- Protection Circuits.
- Automatic Fault Simulator.
- Full monitoring facilities.
- Completely transistorised.

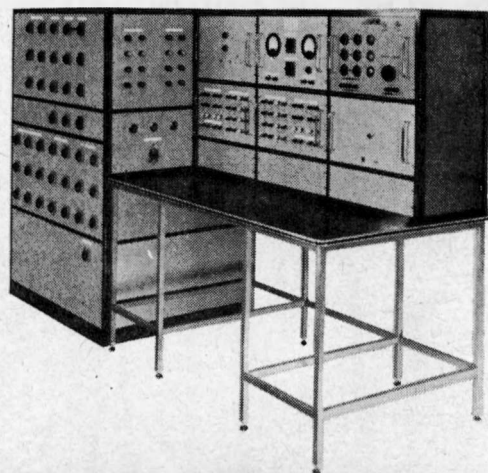

for education & research

PROTECTIVE TEST BENCH

- 440V 3-phase source.
- Short-term rating 120A.
- Variable source reactors.
- Variable line reactors.
- Point-on-Wave Switching.
- Current and Voltage transformers.
- Safety interlocks.

F. C. ROBINSON & PARTNERS LIMITED

Works & Northern Sales; Councillor Lane,
Cheadle, Cheshire; Tel. GATley 6611 (3 lines)

Southern Sales & Export; Davies House,
181 Arthur Road, Wimbledon, London S.W.19 Tel. Wim 6386



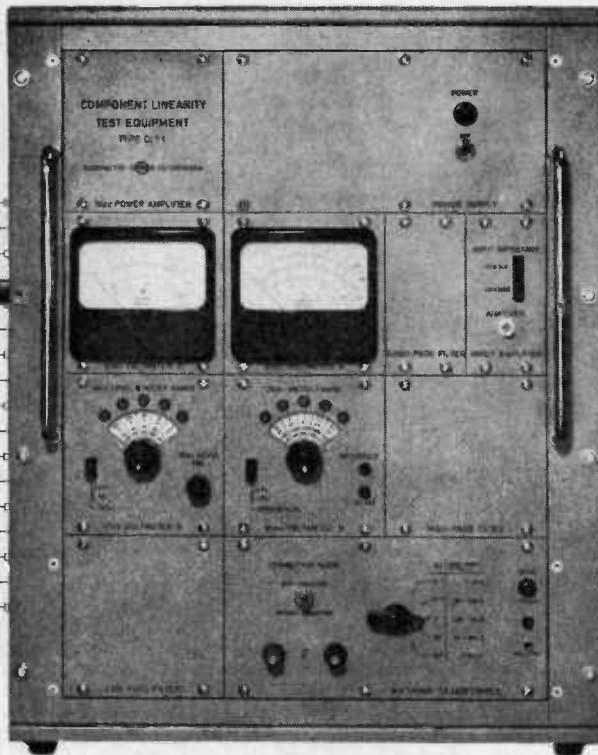

COMPONENT LINEARITY TEST EQUIPMENT TYPE CLT1

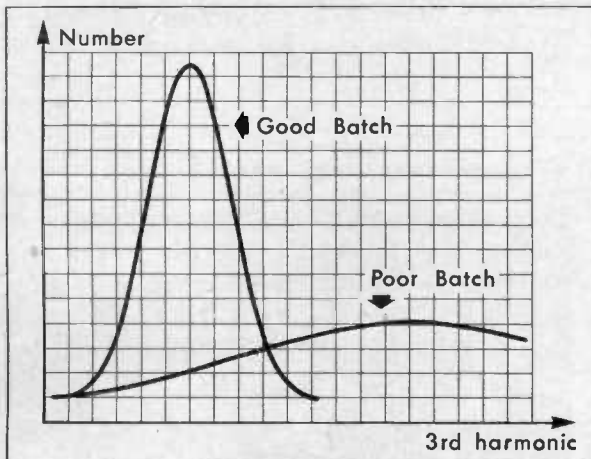

The Component Linearity Test Equipment, type CLT1, is intended for investigation of the non-linearity of nominally linear components, such as resistors and capacitors. It is especially suited for

- Reliability investigations
- Quality control of component manufacture
- Acceptance testing of components.

The working principle of the equipment is a determination of the non-linearity of a component by a selective measurement of the 3rd harmonic signal, generated in the component, when a pure 10 kc voltage is applied to it.

Typical defects causing non-linearity:

Carbon Film Resistors ▶ Poor contact between connecting lead and cap ▶ Poor contact between cap and carbon film ▶ Inhomogeneous spots in carbon film ▶ Traces of carbon film left in the grooves ▶ Longitudinal grooves in the ceramic.

Capacitors ▶ Poor contact between metal electrode and terminal ▶ Iron oxide in mica or iron particles in paper, polystyrene film, etc. ▶ Small movements due to electrostatic forces.

For Great Britain:
Livingstone Laboratories Ltd., 31 Camden Road, London NW1

Special Features:

- Wide impedance range of components: from less than 1Ω to above $100 M\Omega$.
- 1 VA delivered to the component under test within impedance range 3Ω to $300 k\Omega$.
- Max. 10 kc test voltage : 560 V.
- 3rd harmonic as much as 150-160 dB below the fundamental can be measured.
- Short response time makes possible measurements of 10 to 20 components per second.
- No sensitivity to hum.
- Steady meter deflection.

RADIOMETER A/S, 72 EMDRUPVEJ, COPENHAGEN NV, DENMARK

RADIOMETER
COPENHAGEN





How 'low-down' are you?

If, by the time you read it, this copy is dog-eared, well-thumbed and several weeks late we would diagnose the trouble as "keep itis". This is a common failing among technical men when they get their hands on Electronic Engineering.

The sensible remedy is to take your own copy regularly each month. Then when the company copy arrives on your desk you can initial it with a flourish and a knowing air and pass it on quite happy in the knowledge that you have already read it.

U.K. £2.5.0 per year (£6.0.0 for three years)
Overseas £2.15.0 per year (£7.10.0 for three years)

The Circulation Manager
ELECTRONIC ENGINEERING
28 Essex Street
Strand,
London, W.C.1,
England.

Please send me Electronic Engineering each month starting with theissue for one year/three years.
Remittance of.....is enclosed.
Name
Address
Company
Signed

NEW STANDARD CASES from OLSON

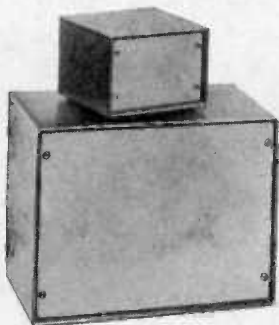

- Advanced design
- High quality
- Rigid construction
- Made in various sizes
- Low price

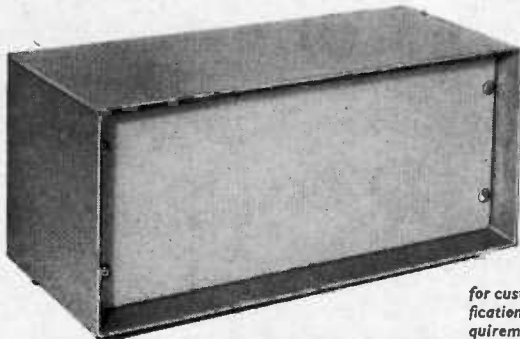
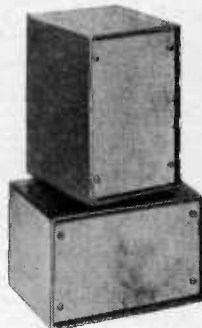

Quotations gladly given for customers own specifications and special requirements.

WRITE FOR FURTHER DETAILS TO
OLSON ELECTRONICS LIMITED
54, Myddiecon Street, LONDON, E.C.1 Telephone: TERminus 8081

FM VHF SIGNAL GENERATOR

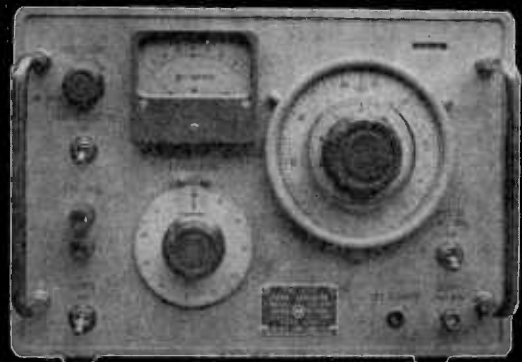

Model MSG-276

●USE:
For testing FM receivers and tuners in the VHF range 75 to 110 Mc and the standard 10.7 Mc I-F circuits.

FEATURES:

- No bond switching required. ■ Output level is automatically controlled.
- Smooth piston type attenuator — 0 to 100 dB in range. ■ Equipped with meter for indicating frequency deviation. ■ Built-in crystal calibrator with a magic eye type for accurate frequency settings. ■ Compact construction.

● Catalog sheet on request:



MEGURO DENPA SOKKI K.K.
(Meguro Electronic Instrument Co., Ltd.)
5-1, 2-chome, Chuo-cho, Meguro-ku, Tokyo, Japan
TEL: 711-7191-7 Cables: MEGURO DENPA TOKYO

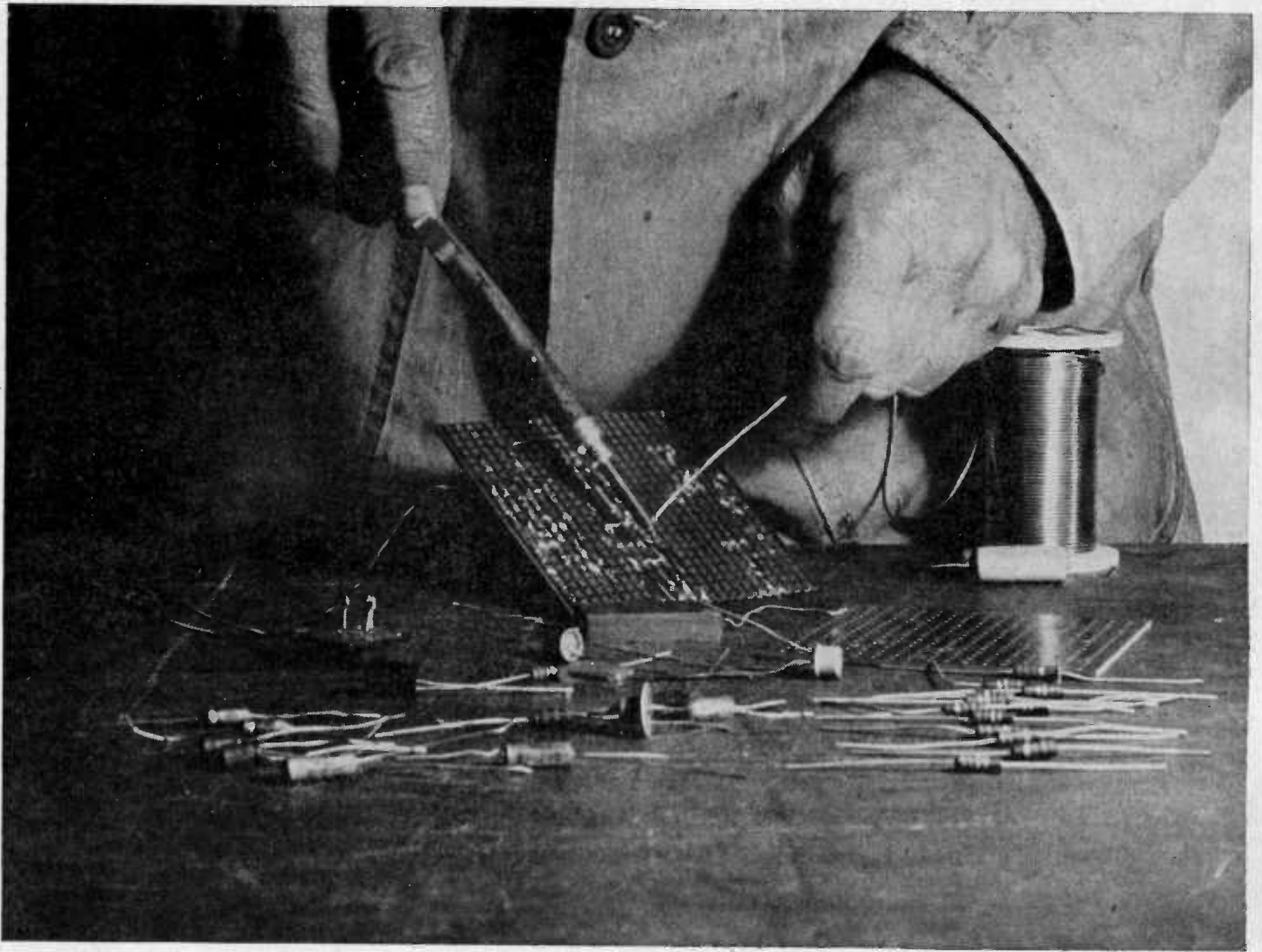

Ready sometime

TOTAL CAPABILITY IN MICROELECTRONICS



Ready made

From the widest based microelectronics organisation in Europe, familiar with all aspects of microelectronic technology, comes a broad range of circuits—including integrated circuits, thin film circuits and Minilog packaged circuits ■ Elliott-Automation Microelectronics provides a total capability in microelectronics—backed by experience in all forms of interconnections . . . supported by skilled applications advice. Elliott-Automation Microelectronics means the best in ready-made circuits and accessories—economically.

INTEGRATED CIRCUITS / THIN FILM CIRCUITS / MINILOG PACKAGED CIRCUITS / MICROELECTRONICS ACCESSORIES

If you have a problem in Microelectronics—share it with us.



Elliott-Automation Microelectronics Limited

MICROELECTRONICS SALES DIVISION • GLENROTHES • FIFE • SCOTLAND • TEL: GLENROTHES 3272

London Office
Tel: ELS 2040 (ext 628)
or ELS 2040 (ext 205)

Bristol Office
Tel: Bristol 25915

Birmingham Office
Tel: Birchfield 5863

Manchester Office
Tel: Bramhall 5000

Newcastle Office
Tel: Newcastle 21273



Professional components

Pirelli Applicazioni Elettroniche

Piazza Duca d'Aosta, 3
Milano

Agent for United Kingdom:
BAY & CO. (United Kingdom) Ltd.
Pirelli House - 343/345 Euston Road
London N.W. 1 - Phone EUSton 3131

Glass-AMP

Rectifiers, glass encapsulated D07,
for voltage up to 1500 V and rectified
current up to 1 A at 100°C
Controlled avalanche rectifiers
for up to 600 V and rectified
current of 1 A at 75°C
Voltage regulator diodes
from 10 to 200 V - 1 W

Flangeless rectifiers

Meeting MIL-S-19500/155 U.S.NAVY
requirements (200-600 V, 1 A at 100°C)
For industrial purposes (100-800 V,
1 A at 25°C)
Controlled avalanche rectifiers
(200-600 V, 2 A at 25°C)

Bridge rectifiers

For voltages from 50 to 600 V
Rectified current: up to 3 A at 50°C

Tantalum capacitors

Meeting MIL-C-26655
and CCTU-02-12-A specifications
Voltages from 6 to 35 V
Capacitance from 0.0047 to 330 μF

Professional fixed composition resistors

Meeting MIL-R-11 specification
1/4, 1/2, 1 and 2 Watts types
Tolerance: ± 5, ± 10 and ± 20%

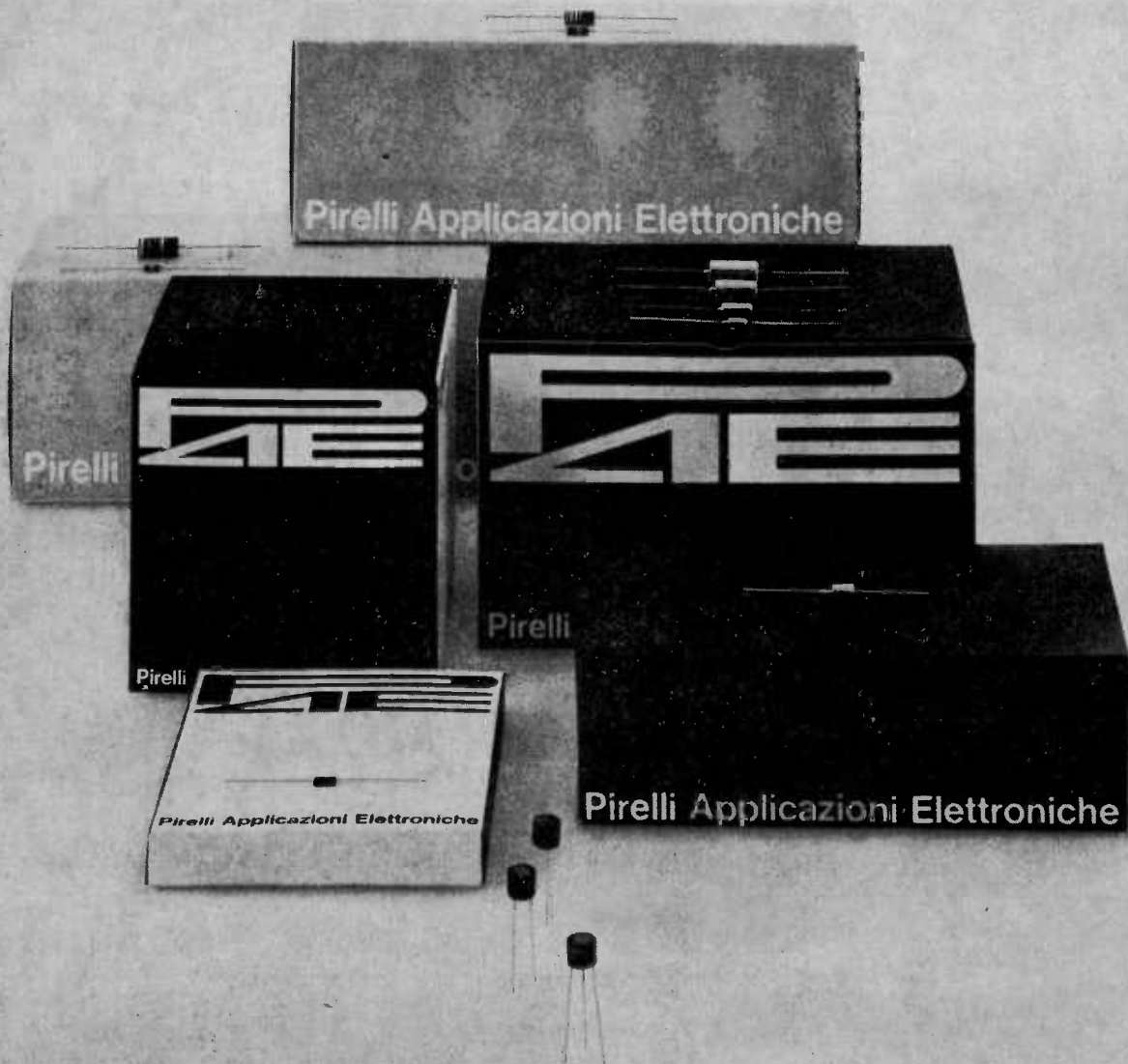

DESIGN: MASSIMO VIGNELLI, UNIMARK

CLASSIFIED ADVERTISEMENTS

RUN-ON AND SEMI-DISPLAYED The charge for these advertisements is 6s. per line of approximately 6 words, (Minimum 24s.) for Run-on advertisements. For Semi-displayed advertisements the charge is 72s. per single column inch. Use of Box Number 3s. extra. Copy is required by 14th of the month for insertion in the next issue.

FULLY DISPLAYED (With border rules, larger type faces and blocks if required). The charge is 72s. per single column inch—minimum 3 inches. Eighth page £13 0s. 0d. Quarter page £25 0s. 0d. Half page £48 0s. 0d. Full page £94 0s. 0d. Use of Box Number 3s. Blocks must be supplied mounted. Copy is required by 5th of the month (if proofs are wanted), or by 10th of the month (without proofs) for insertion in next issue.

Advertisements for publication and replies to box numbers should be addressed to:

Classified Advertisement Dept., "Electronic Engineering", 28 Essex Street, Strand, London, W.C.2. CENTRAL 6565

OFFICIAL APPOINTMENTS

THE UNIVERSITY OF SHEFFIELD

PHYSICS OR ELECTRONICS TECHNICIAN

Physics or Electronics Technician required to join electronics team in Department of Obstetrics and Gynaecology at Jessop Hospital for Women to help service existing research apparatus and build new apparatus for clinical research projects. Experience of circuit construction techniques an advantage. Salary £660—£935 per annum with basic qualification. Allowance for approved higher qualification. Five day week. Write to the Bursar, (Ref. B.3), The University, Sheffield, 10.

W 8310

ST. BARTHOLOMEW'S HOSPITAL

SENIOR PHYSICIST OR ELECTRONIC ENGINEER

Senior Physicist or Electronic Engineer, preferably with Linear Accelerator or Microwave experience required to work in the Physics Section of the Radiotherapy Department in conjunction with the Department of Medical Electronics. The work will involve machine operation, development and research. Salary within the scale £1,833—£2,276. Applications with the names of two referees should be addressed to the Clerk to the Governors, St. Bartholomew's Hospital, London, E.C.1. quoting reference no. ASC/13.

W 8290

UNIVERSITY OF CAMBRIDGE

CAVENDISH LABORATORY

Applications are invited for the post of SENIOR RESEARCH ASSISTANT in the Mullard Radio Astronomy Observatory from 1st October, 1966. Experience in electronics essential. Candidates should hold a degree or H.N.C. in Electrical Engineering or Applied Physics, or an equivalent qualification. Starting salary will be either in the range £1,400×£85—£1,995 or £1,740×£85—£2,505, according to age, experience and qualifications. Applications should be addressed to The Secretary, Department of Physics, Cavendish Laboratory, Free School Lane, Cambridge.

W 8294

UNIVERSITY OF MANCHESTER

(FACULTY OF TECHNOLOGY)

LECTURER OR ASSISTANT LECTURER

Applications are invited for the post as LECTURER or ASSISTANT LECTURER in High Voltage Engineering. The selected candidate will join an active and rapidly expanding team engaged in studying a wide range of High Voltage Engineering and Physics Problems. He will be expected to supervise research and participate in the running of a postgraduate M.Sc. course in High Voltage Insulation. Applicants with research interests and/or Industrial Experience in Electrostatic Field Problems and/or High Voltage Discharge Phenomena or in the properties of dielectric materials would be particularly suited for this appointment.

Commencing salary according to qualifications and experience in the appropriate scale:

Assistant Lecturer: £1,105×£75—£1,180×£80

—£1,340 per annum.

Lecturer: £1,470×£90—£2,010×£85

—£2,180×£90—£2,630 per annum.

Federated Superannuation System for Universities. Conditions of appointment and application forms are obtainable from the Registrar, University of Manchester Institute of Science and Technology, Sackville Street, Manchester 1 to whom completed forms should be returned by Saturday, 11th June, 1966.

W 8308

WESTMINSTER HOSPITAL

ELECTRONICS TECHNICIAN

Electronic Technician required. Duties involve maintenance of 6 MeV Linear Accelerator and 2 MeV van de Graaff, and also design and construction of electromedical apparatus. Qualifications City and Guilds, O.N.C. or H.N.C. Grading as Technician (£771—£913) or Senior Technician (£943—£1,181) as appropriate. Applications stating age, qualifications and experience, with names of two referees to Chief Physicist, Westminster Hospital, S.W.1.

W 8311

ROYAL MILITARY COLLEGE OF SCIENCE

SHRIVENHAM, SWINDON, WILTS.

EXPERIMENTAL OFFICER

Applications are invited for two Experimental Officer posts in the ELECTRONICS BRANCH of the Royal Military College of Science.

Duties:

Supervision of laboratory classes, development of experiments and helping in research.

Qualifications:

Appropriate H.N.C., Pass Degree or equivalent with experience in electronics, telecommunications or radar.

Some experience in the field of microwaves essential for one of the posts.

Age:

Applicants must be at least 26 years of age for appointment in Experimental Officer grade but lower age acceptable for Assistant Experimental Officer grade at a lower salary.

Salary:

Within the incremental scale: £1,365×6 annual increments to £1,734 p.a. Opportunities of working for higher qualifications and for promotion to the Grade of Senior Experimental Officer in the salary scale of £1,977×5 annual increments to £2,411.

Accommodation:

Temporary single accommodation in the Officer's Mess or the possibility of a married quarter.

Requests for application forms should be addressed to the C.E.P.O., Royal Military College of Science, Shrivenham, Swindon, Wilts. (Please quote reference CR.1225/9).

W 8302

THE UNIVERSITY OF LIVERPOOL

DEPARTMENT OF PHYSICS

Applications are invited from suitably qualified people to fill the following vacancies.

A-A senior post in the salary range £1,250 to £1,850 per annum to assist with the installation, commissioning and modification of electronic, analogue and digital, data handling equipment for ultimate connection to a computer. (The person appointed will have a good opportunity for obtaining experience of on-line computers.) A knowledge of digital equipment is necessary and related experience will be an advantage. A degree or equivalent qualification is necessary.

B-Posts as GRADE II TECHNICIANS in the salary range £660—£935 per annum, to wire and perform limited tests on electronic circuits. Related experience is necessary and some knowledge of electrical circuits will be an advantage. There is a superannuation scheme and a five day week.

Applications, quoting reference No. 50 A or B, should be made on the appropriate form, which may be obtained from the Registrar, The University, Liverpool 3.

W 8300

WESTMINSTER HOSPITAL

DEPARTMENT OF CLINICAL MEASUREMENT

Electronics Technician required for design and development work. The Department is concerned with service to patients and research in various fields including Cardiology and Cardiac Surgery and applied Physiology in Respiratory and Renal Diseases. Salary in the range of £805—£1,025+£45 or £55 London Weighting.

Application with the names of two referees to the Hospital Secretary, Westminster Children's Hospital, Udhall Street, S.W.1.

W 8312

MINISTRY OF AVIATION

MAIN GRADE ENGINEERS

Mechanical, Aeronautical and Electrical/Electronic Engineers are required for posts in London and the regions, covering a wide range of duties, namely, Experimental, Research and Development, Production, Inspection, and Cost Estimating, in the Aeronautical, Electronic and Allied fields, including Engines, Airframes, Fuel Systems, Guided Weapons, Radar, Radio, Telecommunications, and Navigational Aids.

QUALIFICATIONS: A.M.I.Mech.E., A.M.I.E.E., A.F.R.Ac.S., A.M.I.Prod.E., A.M.I.E.R.E., and a recognised engineering apprenticeship.

SALARY (national): £1,606—£2,152. Salary increased for officers serving in London.

Prospects of permanent pensionable appointments. APPLICATION FORMS from Ministry of Aviation, S.M.(Eng.) 3, Savoy Hill House, Savoy Hill, London, W.C.1., quoting HB/2H/2.

W 8296

COMMUNICATIONS

ELECTRONIC SECURITY DEPARTMENT

Vacancies in N.W. London Laboratories for (i) SCIENTIFIC OFFICERS and SENIOR SCIENTIFIC OFFICERS for research in Telecommunications Engineering. Experience in, or sufficient flexibility to adapt to, one of the following fields of research is required:

Computer and other Data Processing (both Analogue and Digital) for application to Telecommunications; Micro-miniature Techniques; Signal Analysis; Acoustics; Speech Analysis and Perception; Audio-frequency or Pulse Transmission.

QUALIFICATIONS: 1st or 2nd class honours degree, Dip. Tech., or equivalent or higher qualification in Electronic Engineering or Physics and, for S.S.O., at least 3 years' post-graduate experience.

SALARY: S.O. £971—£1,639;

S.S.O. (minimum age 26) £1,809—£2,220.

(ii) EXPERIMENTAL OFFICERS and ASSISTANT EXPERIMENTAL OFFICERS to undertake experimental work in Electronics or Telecommunications in support of research programmes in the above-mentioned fields.

QUALIFICATIONS: Degree, Dip. Tech., H.N.C., or equivalent in Engineering Physics. Under 22, minimum qualification is 2 G.C.E. 'A' levels in Science and/or Maths. subjects.

SALARY: A.E.O. £608 (at 18)—£848 (at 22)—£1,067 (at 26 or over)—£1,293; E.O. (minimum age 26) £1,420—£1,799.

Prospects of permanent pensionable appointments. Successful candidates will be appointed to the Royal Naval Scientific Service and be seconded to the Communications—Electronic Security Department. APPLICATIONS TO: Communications—Electronic Security Department, 8 Palmer Street, London, S.W.1

W 8305

MEDICAL RESEARCH COUNCIL

TECHNICAL OFFICERS OR JUNIOR TECHNICAL OFFICERS

Two Technical Officers or Junior Technical Officers are required to take part in evaluation trials of sophisticated patient monitoring equipment. Duties will include the installation, maintenance and modification of equipment, training of hospital staff, and the design and construction of prototype units. The work will be centred at the Division of Biomedical Engineering, Medical Research Council Laboratories, Hampstead, London, N.W.3., but applicants must be prepared to travel and to spend some nights away from home. Applicants should have experience in semiconductor electronics and electromechanical devices. Previous association with medical or biological research would be an advantage. Formal qualifications for Technical Officer or Junior Technical Officer are university degree, H.N.C. or the old-style Final City and Guilds in Telecommunications. Appointments on the Senior Technician scale might be considered for applicants of adequate experience but not in possession of the appropriate qualifications. The appointment will be for three years. Salary within a range of £865 (age 23) to £1,868 according to qualifications and experience. Application form obtainable from Personnel Officer, National Institute for Medical Research, Mill Hill, London, N.W.7. Telephone Mill Hill 3666.

W 8301

DISTRIBUTORS



leading distributors in the United Kingdom for **SGS-FAIRCHILD** Total Planar diodes, transistors and microcircuits



The D-T-V Group
126 Hamilton Road London SE27
Phone Gipsy Hill 6166

Electrical Equipment (NI) Co Ltd
Kelvin House 51 & 53 Adelaide Street
Belfast 2 Phone Belfast 26222
Cable Elequip Belfast

A C Farnell Ltd
81 Kirkstall Road Leeds 3
Phone Leeds 35111

Hawnt & Co Ltd
112-114 Pritchett Street Birmingham 6
Phone Aston Cross 4301/9

Hird-Brown Ltd
Flash Street Bolton Lancashire
Phone Bolton 27311
Cable Electronics Bolton

Morris, Warden & Co Ltd
Morden House 10 Royal Crescent
Glasgow C3 Phone Douglas 8671
Cable Morden Glasgow

Quarndon Electronics
(Semiconductors) Ltd
Slack Lane Derby
Phone Derby 46695 Telex 37163

SASCO-Stewart
Aeronautical Supply Co Ltd
PO Box No 20 Gatwick Road Crawley
Sussex Phone Crawley 28700
Cable Sasco Crawley Telex 87131

Sasco Scottish Branch Office
Factory 13B Carbrain Industrial Estate
Cumbernauld Glasgow
Phone Cumbernauld 25601 Telex 778104

Sasco Hitchin Branch Office
Hunting Gate
Wilbury Way Hitchin Herts
Phone Hitchin 2242 Telex 82283



SITUATIONS VACANT

CENTRAL ELECTRICITY GENERATING BOARD

SOUTH WESTERN REGION

SOUTH WALES DIVISION

Vacancy No. 89/E/66

4th ASSISTANT ENGINEER TESTING, EFFICIENCY, MONITORING & STATISTICS SECTION GENERATION SERVICES DEPARTMENT, DIVISIONAL HEADQUARTERS, CARDIFF

Applications are invited for the superannuable N.J.B. appointment of 4TH ASSISTANT ENGINEER, Testing, Efficiency, Monitoring & Statistics Section, Generation Services Department, Divisional Headquarters, Cardiff.

Salary: Grade II, Scales 8/10
£1,235—£1,575+£60 per annum.

An engineer with a sound practical knowledge of electronics is required to take charge of instrumentation, which in addition to temperature, pressure and flow sensing devices includes automatic data logging, digital voltmeters and other electronic equipment associated with the testing of power station plant.

The successful candidate will be responsible for calibration, maintenance and installation of testing equipment and will be in charge of a small testing and efficiency laboratory and workshop.

Applicants should possess H.N.C. or equivalent qualifications and practical experience in this field will be of the utmost importance.

Special application forms obtainable from the Central Electricity Generating Board, Personnel Department, Twyn-y-Fedwen Road, Gabalfa, Cardiff, to be returned by the 3rd June, 1966. W 8315

INSTRUMENT HIRE THE LIVINGSTON WAY...

Why put up with ageing equipment when without investing valuable capital you can hire tip-top specialised instruments at attractive rates? Instruments now available include Tektronix 'scopes, pulse generators, counters, frequency meters, differential and digital voltmeters, FM/AM signal generators, digitally set high voltage power supplies, spectrum analysers, low distortion oscillators and distortion meters.

Write or telephone for full details of available range and terms to:

Instrument Hire Division
Livingston Laboratories Limited



Livingston House,
Greycaines Road,
North Watford, Herts.
Telephone:
Watford 44344

W 8287

CANADA

We are in touch with several Companies interested in capable and ambitious men Write to:

Major ENgagements Ltd.,
Sheepy Parva,
Atherstone, Warwickshire.

W 8288

ELECTRONICS ENGINEER

required to stimulate and guide the progressive application of electronics to film laboratory processes. He will have responsibility for the development and maintenance of equipment ranging from logical microcircuitry to colour C.C.T.V. Experience which is not narrowly electronic and qualification to degree standard are desirable. Reply stating age, qualifications and brief experience to

Personnel Manager,
TECHNICOLOR LIMITED,
Bath Road,
Harmondsworth, Middlesex.

W 8309

INTERMEDIATE ELECTRONIC ENGINEER

For small laboratory to S. W. London. H.N.C. standard or knowledge and experience to similar level. Required for circuit design and development of small transistorised instruments.

Contributory pension scheme available and canteen facilities.

Apply to Chief of Research.

Box No. W 8292.

c/o Electronic Engineering.

A PRACTICAL ECONOMIST

English Electric require a SENIOR ECONOMIST to augment the staff of their Economic Intelligence Department carrying out work to provide essential economic background information for the trading operations of its Product Divisions.

Qualities required include an analytical mind, and an approach to business based on practical application of such economic information. The applicant should preferably have a good Degree in Economics and at least five years experience in allied work, such as industrial market research.

The Company is looking for a man who has already acquired experience and is now seeking the chance to put this to greater use in a wider field.

This appointment could provide to a suitably trained man an excellent opportunity to carry out a very satisfying job and one in which it can quickly be seen how the economic information provided is being applied.

The appointment is tenable in London and applicants are asked to give full career details, which will be treated in strict confidence.

All applications will be acknowledged and further information given to a preliminary short list of candidates who will be invited to attend for personal interview.

Please send full career details, quoting EE.0516.E to the Chief Staff Officer, English Electric Company Limited, Strand, London, W.C.2. W 8293

EDUCATIONAL

THE UNIVERSITY OF ASTON IN BIRMINGHAM (designate)

DEPARTMENT OF ELECTRICAL ENGINEERING

ONE-YEAR GRADUATE COURSE LEADING TO A MASTER'S DEGREE IN ELECTRICAL ENGINEERING

OCTOBER 1966 to SEPTEMBER 1967

A graduate course leading to a Master's degree is being offered in electrical engineering. The course will be of one year duration. It will consist of six months of lectures, tutorials and laboratory work, followed by six months of project work in a chosen specialist field. One third of the lecture work will consist of mathematics and electrical engineering materials. The remaining time will be devoted to one specialist option selected from the following:

1. Communication Systems
2. Design of Pulse and Digital Circuits and Systems
3. Control Systems
4. Electrical Machines
5. Electrical Power Systems Engineering

Applications form and further particulars may be obtained from:—

The Head of the Department of Electrical Engineering (ref. M.Sc.),
The College of Advanced Technology,
Gosta Green,
Birmingham 4.

W 8291

PROPOSED UNIVERSITY OF BRADFORD
(Bradford Institute of Technology)

M.Sc. COURSES
POWDER TECHNOLOGY
AUTOMATION IN CHEMICAL ENGINEERING
CHEMICAL ENGINEERING
Suitably qualified students may be eligible for the tenure of Science Research Council advanced course studentships.
Further particulars can be obtained from the Registrar, Bradford Institute of Technology, Bradford 7. W 8147

NORTHERN POLYTECHNIC

HOLLOWAY, N.7 NORTH 6767

DEPARTMENT OF PHYSICS

PART-TIME COURSES IN APPLIED PHYSICS
HIGHER NATIONAL CERTIFICATE

A.1 Friday 9.30 - 1, 2 - 5, 6 - 9
A.2 Wednesday 9.30 - 1, 2 - 5, 6 - 9
ENDORSEMENT COURSE for L.Inst.P.
Electrical and electronic measurement techniques.

A.3 Thursday 10 - 1, 2 - 5, 6 - 9
GRAD.INST.P PART II
Tuesday 10 - 1, 2 - 5, 6 - 9

2-year course:
1966 - 67 Electronics Properties of Matter
1967 - 68 Optics and Thermodynamics Nuclear and atomic physics, Electricity and magnetism.
Enquiries to Head of Department of Physics. W 8298

BOROUGH POLYTECHNIC

BOROUGH ROAD, LONDON, S.E.1.

DEPARTMENT OF ELECTRICAL AND ELECTRONIC ENGINEERING

A COURSE OF LECTURES ON DIGITAL CIRCUIT TECHNIQUES
will be held from 20th June to 24th June, 1966 from 9.30 a.m. to 3.30 p.m. each day.
Further particulars and an application form available on request. W 8304

SERVICE

"TELECOMM" HIRE SERVICE offers Radio Microphones and VHF Radio-Telephones on a weekly hire basis. Radio Communications Co., 16 Abbey Street, Crewkerne, Somerset. Phone: 662. W 8279

AIRTRONICS LTD., for coil winding, assembly and wiring of electronic equipment, transistorised sub-units. Sheet Metal Work. 3A, Waterland Road, London, S.E.13. Telephone: Lee Green 1706. W 370

ELECTRONICON LTD. From drawing board to production with minimum delay. Let us be your research, development, design and prototype department. Pilot production runs a speciality. 176, Lythalls Lane, Coventry. Tel. Nuneaton 2353. W 372

CAPACITY AVAILABLE

EXTRA PRODUCTION FACILITIES: Skilled workers + floor space + expert supervision + extra production facilities for you. See page 140. W 374

MANUFACTURERS OF ELECTRONIC EQUIPMENT. Can we assist you by manufacturing Control Panels, Assemblies, Sub. Assemblies. Long or short runs. Quality guaranteed. Rock & Taylor Ltd., Hayes Lane Trading Estate, Lye, Worcs. Tele:—Lye 2807/2822. W 375

FAST SERVICE for coil winding and electronic assembly. Prototypes and quantity. Injection moulding. **ELECTRICOLE LIMITED.** 2-14 Shortlands, Hammersmith, London, W.6. RIV 9924. W 376

TENDER

SALE BY TENDER

By Instructions from the Receiver for the Debenture Holders R.G. Lovatt Esq., Messrs. Peat, Marwick, Mitchell & Co., Chartered Accountants, Albion Street, Hanley, Stoke-on-Trent, Staffordshire.
re: **ELECTRONIC CIRCUITS LTD.**
IMPORTANT SALE BY TENDER OF VALUABLE PATENTS, ELECTRONIC EQUIPMENT, STOCK IN-TRADE, CARRYING CASES, AND PACKING MATERIALS.
CHARLES BUTTERS & SONS have been instructed to Catalogue the above and remove for convenience of viewing to Trinity Buildings, Trinity Street, Hanley, Stoke-on-Trent, Staffordshire, including:
PROVISIONAL PATENTS—"SOUND RECORDING AND REPRODUCING APPARATUS FOR CINEMATOGRAPH", and "IMPROVEMENTS IN OR RELATING TO HIGH MEASURING INSTRUMENTS".
STOCK-IN-TRADE—Over 11,000 Electrolytic Capacitors—1,000 to 10/uf and 150 to 6 VW. 19,000 P.F. Capacitors, 2,500 Assorted Resistors mostly 5% high stability, 220—30HM 9"×4" Speakers, 150 New Carrying Cases 160 Power Transistors OC 26, 200 low power ditto NKT 713, 275, 214, 212, 85—BSR Record replay leads (MNI 55) 400 Self-oscillating Erase Heads, 750 Westinghouse Rectifiers (12 volt 1½amp) 3,500 AB Slider switches, 3,400 Stanley Palmer rotary switches, 500 Fractional H.P. motors, 90 Transistorised switching and amplifying chassis, 33 new Amplifiers, 100 Motorised striped 8 m.m. cine film Capstans, Large assortment of various other Capacitors and Transistors.
EQUIPMENT & PACKING MATERIALS—Oscilloscope-Hartley Electromotives Ltd. (Double beam 13A) Tool Post Grinder Kit in box with wheels and spindles, Moulding machine, 6" Saw Bench, Minolta AP-8 Projector, Workbench 5'×2' 6" with HK 1" Electric Drill and Engineer's Vice 4" jaw. Large quantity of corrugated Cardboard (mostly to make up boxes 15"×8"×8").
On display for inspection on Wednesday, Thursday and Friday the 15th 16th and 17th June, 1966 from 11 a.m. to 4 p.m.
Completed Tenders to be returned to the Offices by first post on Monday 27th June, 1966.
Catalogues and Form of Tenders available on request to the Offices, Trinity Buildings, Trinity Street, Hanley, Stoke-on-Trent, Staffordshire. Telephones: Stoke-on-Trent 21328/9. W 8303

SITUATIONS VACANT CONTINUED

ELECTRONIC ENGINEERS

Automation Electronics

A new Automation Electronics Section is being formed to apply modern electronic circuit techniques in the evaluation and application of process control schemes based on advanced mathematical methods developed by associated sections employing the latest digital and analogue computers. Openings exist for electronic engineers at all levels of experience.

Electronic Control of High Voltage D.C. Power Transmission

Electronic engineers of graduate or H.N.C. standard with some experience of transistor circuits are required for the expansion of the Control Systems Laboratory responsible for research into the control of A.C./D.C. convertors for high voltage D.C. power transmission.

Electronic Instrumentation

Electronic engineers of graduate or H.N.C. standard are required for the development of specialised instruments for use in research in ultra high vacuum, plasma and solid state physics and other such fields.

Engineers interested in any of the above vacancies are invited to write in confidence with full career details, quoting EE 906.C, to:

Dr. R. J. Benzie, Manager, Nelson Research Laboratories, c/o Directorate of Personnel, English Electric House, Strand, London, W.C.2.

'ENGLISH ELECTRIC'

NELSON RESEARCH LABORATORIES

W 8299



UNITED KINGDOM ATOMIC ENERGY AUTHORITY ENGINEERING GROUP
Risley, Nr. Warrington, Lancs.

require

INSTRUMENT DESIGN ENGINEERS

There are vacancies for young professionally qualified engineers or physicists who wish to make their career in the field of measurement and systems engineering design for nuclear reactors, special chemical process plant and experimental assemblies.

The problems encountered present a challenge to imaginative and energetic young men of suitable education and background and offer a variety of work unequalled in other fields of instrument design.

Considerable use is made of advanced electronics in both measurement, control, computation and data processing and candidates should have reached an adequate standard of education in a discipline which includes one or more of these activities. Preferred disciplines are those of Physics with Electronics or Electrical Engineering with Electronics but candidates of other disciplines who have equivalent training and suitable experience will be considered.

Qualifications required are:

A degree in Physics or Electronics or Electrical Engineering or Graduate Membership of the I.E.R.E. or I.E.E.

Salary:

£825 at age 20 - £1,540 at age 34 - £1,750 (Scales are at present under review).

Housing:

Married men living beyond daily travelling distance will be eligible for housing or assisted house purchase.

Suitable qualified young men are invited to write for an application form quoting ESO/467/266/HJD/J43 to the:—

Closing Staff Officer, Room E.359,
Date: U.K.A.E.A.,
13th June, Engineering Group Headquarters,
1966. Risley, Warrington, Lancs.

W 8306

£20 a week while you train as a Computer Systems Engineer!

I.C.T. has immediate vacancies for Computer Systems Engineers in Central and Greater London. Salary during the 6-months' course will be at least £20 a week plus travel or accommodation and expenses. Apply NOW if you are aged 23-30 and have one of the following:

- ONC or HNC Electronics or Electrical
- City and Guilds Telecommunications or Electronic Servicing
- RAF, RN, or REME radar experience
- Industrial experience in Transistors or Pulse Techniques

QUALIFY IN 6 MONTHS As a Computer Systems Engineer you will either join a team servicing Atlas and Orion computers, or become responsible for a customer's I.C.T. 1900 installation working without supervision.

UP TO £1,400 CAN BE REACHED Computer Systems Engineers in London can reach £1,400 p.a., with £52 p.a. travel allowance for Central London, 3 weeks' holiday, up to £10 a week extra for shifts, and a real chance of promotion.



Phone **PUTney 7262 (Ext. 333)**
or write, quoting **ESO 6**, to

Mr. E. J. Reeves, International Computers
and Tabulators Limited,
85-91 Upper Richmond Road, London, SW15

CVS-190

UNIVERSITY OF NEWCASTLE UPON TYNE DEPARTMENT OF CHEMICAL ENGINEERING

Applications are invited for the post of Electronics Engineer to work with a research team studying the effects of electrical discharges upon the course of chemical reactions. This project is supported by the Science Research Council and the person appointed should be able to design and construct electrical generating equipment for producing D.C., A.C. and R.F. Discharges and be able to advise on related problems including the development of methods for power factor measurement.

Candidates should be graduate electrical engineers or hold a University Diploma in Electronics. The salary, which is subject to review, will be within the range £265-£2,270 p.a. together with F.S.S.U. benefits. Applications (three copies) stating age, qualifications and experience should be sent to Professor J. D. Thornton, Department of Chemical Engineering, The University of Newcastle upon Tyne, Newcastle upon Tyne, 1, within two weeks of the appearance of this advertisement. W 8314

SERVICE

Why not export to France?

This announcement is particularly addressed to Directors of small but expanding British Companies whose foresight now could lead to sizeable French export trade in the very near future.

An independent British Sales Engineer, resident many years in Paris is seeking contact with more electronic component manufacturers wishing to assess sales outlets in France. Surveys of competition, prices, market potential etc. Direct customer assistance or active representation on commission basis can also be offered when required. Please write Box No. W 8295, c/o Electronic Engineering.

ELECTRONICS AT UXBRIDGE

We need

CIRCUIT DESIGN ENGINEERS
MICROCIRCUIT PACKAGING ENGINEERS
COMPONENT APPRAISAL ENGINEERS

We use

TRANSISTOR & DIODE LOGIC CIRCUITS
THIN FILM TECHNIQUES
SOLID STATE MONOLITHIC MICROCIRCUITS

We design and make

DIGITAL CALCULATING EQUIPMENT
SPECIALISED COMPONENTS FOR OUR OWN USE

We offer

NEW LABORATORIES overlooking the Buckinghamshire countryside.

FULL SOCIAL AMENITIES

SECURE EMPLOYMENT in an expanding Company.

Please apply to

Personnel Manager,
BELL PUNCH CO. LTD.,
THE ISLAND, UXBRIDGE, MIDDX.

Tel: Uxbridge 38211

(A Control Systems Company)

W 8264

EPSYLON INDUSTRIES

invite applications for a

SENIOR PROJECT ENGINEER

with experience of Industrial Electronics and Automation applications covering a wide range of instrumentation and control problems, using solid state digital and analogue techniques.

Applicants should be able to prepare design studies and be responsible for customer liaison and Contract negotiations.

Apply by letter for an Application Form to:

The Secretary



A member of the
Stone-Platt Group

EPSYLON INDUSTRIES LIMITED

Faggs Road, Feltham, Middlesex, England
Telephone: FELtham 5091/5

W2889



Harwell

MICROWAVE ENGINEER OR PHYSICIST

An engineer or physicist with experience in high power microwave systems or high power microwave valves is required for work in connection with a large linear accelerator at the Atomic Energy Research Establishment, Harwell. Knowledge of electron linear accelerators and electron optics would be an asset but is not essential. The successful candidate will work in association with a small team of engineers and will be responsible for the scientific aspects of the operation of, and of modifications to, the accelerator and its associated equipment and will be expected to collaborate with industry in aspects of the design and specification of new accelerators.

The appointment will be made in the Scientific Officer or Senior Scientific Officer grades, and applicants should have a first class or good second class honours degree (or equivalent). Suitable applicants who are not qualified for the Scientific Officer Class may, however, be considered for appointment in the Experimental Officer Class.

The starting salary will be within the range £995-£2,310 (Scientific Officer or Senior Scientific Officer), depending on the applicant's experience. The starting salary for an Experimental Officer Class appointment will be within the range £800-£1,860.

Superannuation scheme. Housing.

Please write for further information and application forms to Personnel Department (A514842), A.E.R.E., Harwell, Didcot, Berks. W 8313

STAFF PROBLEMS?

*Take a Classified
Advertisement in*

Electronic Engineering

And solve your problems

Apply for rates to:—

Electronic Engineering

ADVERTISEMENT DEPARTMENT
28 ESSEX STREET, STRAND
LONDON, W.C.2

TEL. : CEN 6565

ROLLS-ROYCE
AND ASSOCIATES LIMITED

**NUCLEAR
PROPULSION**

require ELECTRICAL AND ELECTRONICS ENGINEERS

The Company's continuing expansion in the design and development of nuclear plant for the Royal Navy demands the recruitment of the following ENGINEERING STAFF:—

Electronic Engineers

For design and development work in the fields of AC, DC and pulse amplifiers, non linear circuits and power supplies.

Electrical Engineers

For design and development work on the control and protection of equipment associated with the Reactor Plant.

The duties of some of these engineers will involve periods on Sites to assist in the investigation and solution of design problems encountered during initial commissioning of the equipment.

The work is of a varied and challenging nature and applicants should be of graduate standard with experience of similar work.

Attractive salaries and conditions of service will be negotiated at interviews to be held in Derby.

Working conditions are excellent in modern offices on the outskirts of the town. The Company will make a generous contribution towards out of pocket expenses and will give consideration to housing assistance.

Applications should be sent to the

**Staff Manager,
Rolls-Royce & Associates Ltd.,
P.O. Box 31, DERBY**

W 8297

minitest IS PROVING ITSELF EVERYWHERE



... IN THE FIELD



Small instrument... fits in the pocket... tip-top performance. It's the Salford Minitest, a highly sensitive test meter for the measurement of A.C. and D.C. volts, current and resistance. Wherever there's a measuring job to do — you can rely on the Minitest. The clarity of the scale is exceptional and the knife edge pointer ensures accurate reading. Housed in a tough Melamine cover, the movement is built into a pressed steel case which effectively screens it from external magnetic fields.



... IN THE LAB



... IN THE TROUBLE SHOOTER'S HANDS

MINITEST	D.C. Amps	D.C. Volts	A.C. Volts
	0 - 1 Amp.	0 - 1,000	0 - 1,000
	0 - 100 mA.	0 - 250	0 - 250
	0 - 10 mA.	0 - 100	0 - 100
0 - 2,000 Ohms	0 - 1 mA.	0 - 25	0 - 25
0 - 200,000	0 - 1 mA.	0 - 10	0 - 10
0 - 20 Megohms	0 - 50 uA.	0 - 2.5	0 - 2.5

TRADE PRICE ONLY £7-17-6
(with leather case £8-12-6)

All ranges are selected by a single twelve-position rotary switch. A separate slide switch is provided to change over from A.C. to D.C. ranges. **IMMEDIATE DELIVERY.**

At your finger-tips with the Minitest:-

- * D.C. sensitivity 20,000 ohms per volt
- * A.C. sensitivity 2,000 ohms per volt
- * D.C. accuracy $\pm 2\frac{1}{2}\%$ F.S.D.
- * A.C. accuracy $\pm 2\frac{3}{4}\%$ F.S.D.
- * A.C. accuracy maintained up to 20 kc/s
- * Additional decibel scale
- * Small size $5\frac{1}{2}'' \times 3\frac{3}{4}'' \times 2\frac{1}{4}''$
- * Weight 18 ozs. * 20 ranges.

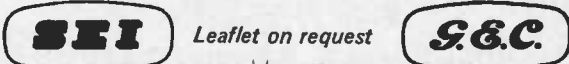

SALFORD ELECTRICAL INSTRUMENTS LIMITED
Peel Works, Barton Lane, Eccles, Manchester. Tel: ECCies 5081

London Sales Office: Brook Green · Hammersmith W6 Tel: 01-603 9292
A Subsidiary of THE GENERAL ELECTRIC COMPANY LTD OF ENGLAND

100,000 REASONS WHY YOU NEED THIS CATALOGUE



over 100,000 different types of British and American Plugs, Sockets and Connectors available

EX-STOCK FOR IMMEDIATE EXPRESS DELIVERY

Standard Circular, Miniature Circular, Pygmy, Audio, Electrical, Miniature, Sub-miniature, Radio Frequency, Accessories: by AMPHENOL, BELLING LEE, BENDIX, BUGGIE, BULGIN, CANNON, CONTINENTAL, ELECTRO METHODS ETHER, FILMS & EQUIP., GREENPAR, HUBBELL, IGRANIC, JONES, KINGS, MAGNETIC DEVICES, McMURDO, NIPHAN, P.E.T., PLESSEY, PAINTON, PYE, PYLE, SUPERFLEXIT, THORN, TRANSRADIO, WINCHESTER; Large stocks held under their INTER SERVICE reference numbers.

All are listed in this 24 page fully illustrated catalogue.

SEND FOR YOUR COPY NOW!

LIND-AIR ELECTRONICS LTD
(CONNECTORS DIVISION)

53 Tottenham Court Road, London, W.1

Telephone: LANgham 3653 (10 lines) Telex: 27931

INDEX TO ADVERTISERS (continued from previous page)

K		O		Société Générale Pour L'industrie Electronique	139
K.S.M. Electronics Ltd.	129	Oliver Pell Control Ltd.	113	Sodeco Sté des Compteurs de Geneve	60
Kelvin Electronics Co.	116	Olson Electronic Ltd.	160	Solartron Electronic Group Ltd.	26, 27
Kempner, S., Ltd.	94			Southern Instruments Ltd.	38
Kerry's (Ultrasonics) Ltd.	38	P		Spectral Ltd.	152
Kilovolts Ltd.	146	Painton & Co. Ltd.	107	Startronic Ltd.	128
Kinsekisha Laboratory Ltd.	8	Panax Equipment Ltd.	102	Sud-Aviation	37
Knitmesh Ltd.	90	Penny & Giles Ltd.	8	Sylvania International S.A.	54
Kodak Ltd.	9, 147	Philips, N. V., Eindhoven	68		
		Philips, N. V., Gloeilampenfabrieken	100	T	
L		Photain Controls Ltd.	66	Taylor Electrical Instruments Ltd.	67
Levell Electronics Ltd.	64	Pitman, Sir Isaac, & Sons Ltd.	152	Telequipment Ltd.	50, 51
Lewis Spring Co. Ltd.	89	Plessey Co. Ltd.	44, 45, 88	Terry, Herbert, & Sons Ltd.	136
Lexor Electronics Ltd.	56	Pye-Ling Ltd.	96	Thermal Syndicate Ltd.	99
Lind-Air Electronics Ltd.	170			Thorn-A.E.I. Radio Valves & Tubes Ltd.	61
Lionmount & Co. Ltd.	106	Q		Thorn Special Products Ltd.	47
Litchfield Brothers Ltd.	154	Q-Max (Electronics) Ltd.	106	Training Systems Ltd.	41
Livingston Laboratories Ltd.	145	Quartz Crystal Co. Ltd.	148	Transitron Ltd.	135
London Electric Wire Co. Ltd.	62			Tachudin Und Heid	66
London Electrical Manufacturing Co. Ltd.	82			Tufnol Ltd.	151
Lyons, Claude, Ltd.	48, 155				
		R		U	
M		Racal Instruments Ltd.	57	Ulano AG (J. Ulano & Co., Inc.)	32, 133
M.E.L. Equipment Co. Ltd.	137	Radio Resistor Co. Ltd.	95	Ultra Electronics (Components) Ltd.	63
M.O. Valve Co. Ltd.	34	Radiometer A/S	159	Union Carbide Ltd.	97
Mackie, W., & Co. Ltd.	119	Radiospares Ltd.	121	United Aircraft International	156
Magnetic Devices Ltd.	18	Rank Pullin Controls Ltd.	98	United-Carr Supplies Ltd.	62
Marconi Co. Ltd.	131	Rank Taylor Hobson	103		
Marconi Instruments Ltd.	43	Rivlin Instruments Ltd.	5	V	
Meguro Electronic Instrument Co. Ltd.	160	Roband Electronics Ltd.	20, 21	Venner Electronics Ltd.	Cover i
McMurdo Instrument Co. Ltd.	81	Robinson, F. C., & Partners Ltd.	158	Vero Electronics Ltd.	144
Minialature Electronic Components Ltd.	105	Rollet, H., & Co. Ltd.	128	Visijar Laboratories Ltd.	6
Morganite Resistors Ltd.	84, 85	Rotax Ltd.	68	Vitality Bulbs Ltd.	148
Mori Physics & Chemical Laboratory Co. Ltd.	126				
Mullard Ltd.	12, 13, 24, 78, 79, 117, 154	S		W	
		S.G.S. Fairchild Ltd.	110, 111	Weir Electrical Instrument Co. Ltd.	32
		Salford Electrical Instruments Ltd.	141, 170	Westinghouse Brake & Signal Co. Ltd.	Cover iii
		Sanken Electric Co. Ltd.	106	Whiteley Electrical Radio Co. Ltd.	58
		Sankyo Seiki Manufacturing Co. Ltd.	148		
		Sel-Rex (U.K.) Ltd.	19	Z	
		Semiconductors Ltd.	101	Zenith Electric Co. Ltd.	59
		Servomex Controls Ltd.	134		
		Smith, John Ltd.	126		
		Smiths Industries Ltd.	52, 93		

99.999+%



Alloys prepared as ingot, wire, rod or foil.
Also available—antimony and tellurium (lead content less than .001%) for thermo-electric applications.

ASSOCIATED LEAD



MANUFACTURERS LIMITED
Clements House, 14 Gresham Street, London, E.C.2.
Crescent House, Newcastle upon Tyne 1.
Lead Works Lane, Chester.

EE 94 212 for further details

Printed in Great Britain by The Press at Coombelands, Ltd., Addlestone, Surrey, for the Proprietors, Morgan Brothers (Publishers) Ltd. 28, Essex Street, Strand, W.C.2.
Registered for Transmission by Canadian Magazine Post.

When it's a question of **SEMICONDUCTORS**

WESTINGHOUSE
IS THE POWER BEHIND THEM!

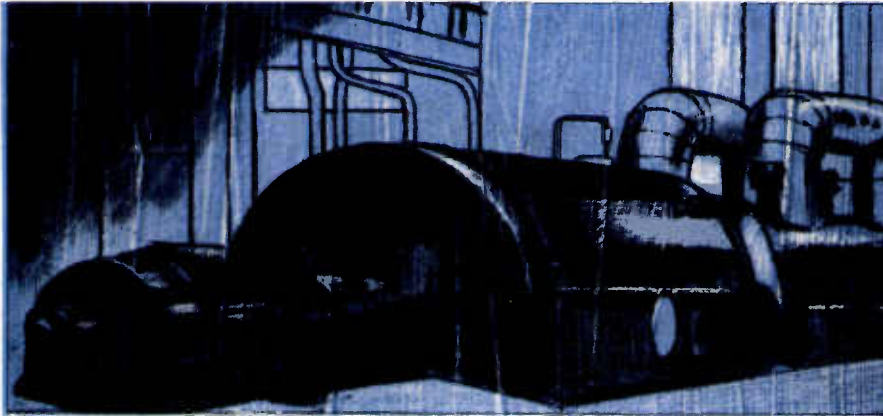

WESTINGHOUSE not only make very good semiconductors—they also make the widest range. That's why such a variety of industries use them. The Westinghouse range includes devices for the smallest electronic application to the largest industrial plant.

A special compression bonding technique in manufacture eliminates thermal fatigue to give improved performance and greater reliability. Trouble-free, instant in action—that's Westinghouse Semi-

conductors. And they're backed by over 40 years experience in rectifier design and development. What more could you ask?

Write for a copy of our abridged SEMICONDUCTOR brochure showing the Westinghouse range of Silicon Diodes, Thyristors and Rectifier Assemblies.

Dept. E.E.6/66 **WESTINGHOUSE BRAKE AND SIGNAL COMPANY LIMITED**
 82 York Way, King's Cross, London N.1
 Terminus 6432 Telex 2-3225

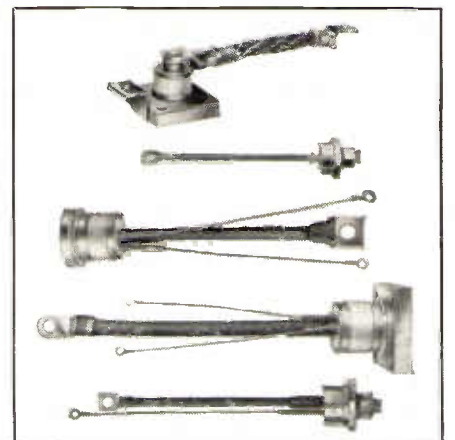

* **The Westinghouse brochure** gives abridged information about: Silicon Diodes ranging from 200mA to 300A at 100 to 1800V and Thyristors from 500mA to 250A, 25V to 1200V according to type.

R.F. SHIELDED ENCLOSURES - MANY VARIATIONS WITH MODULAR UNITS

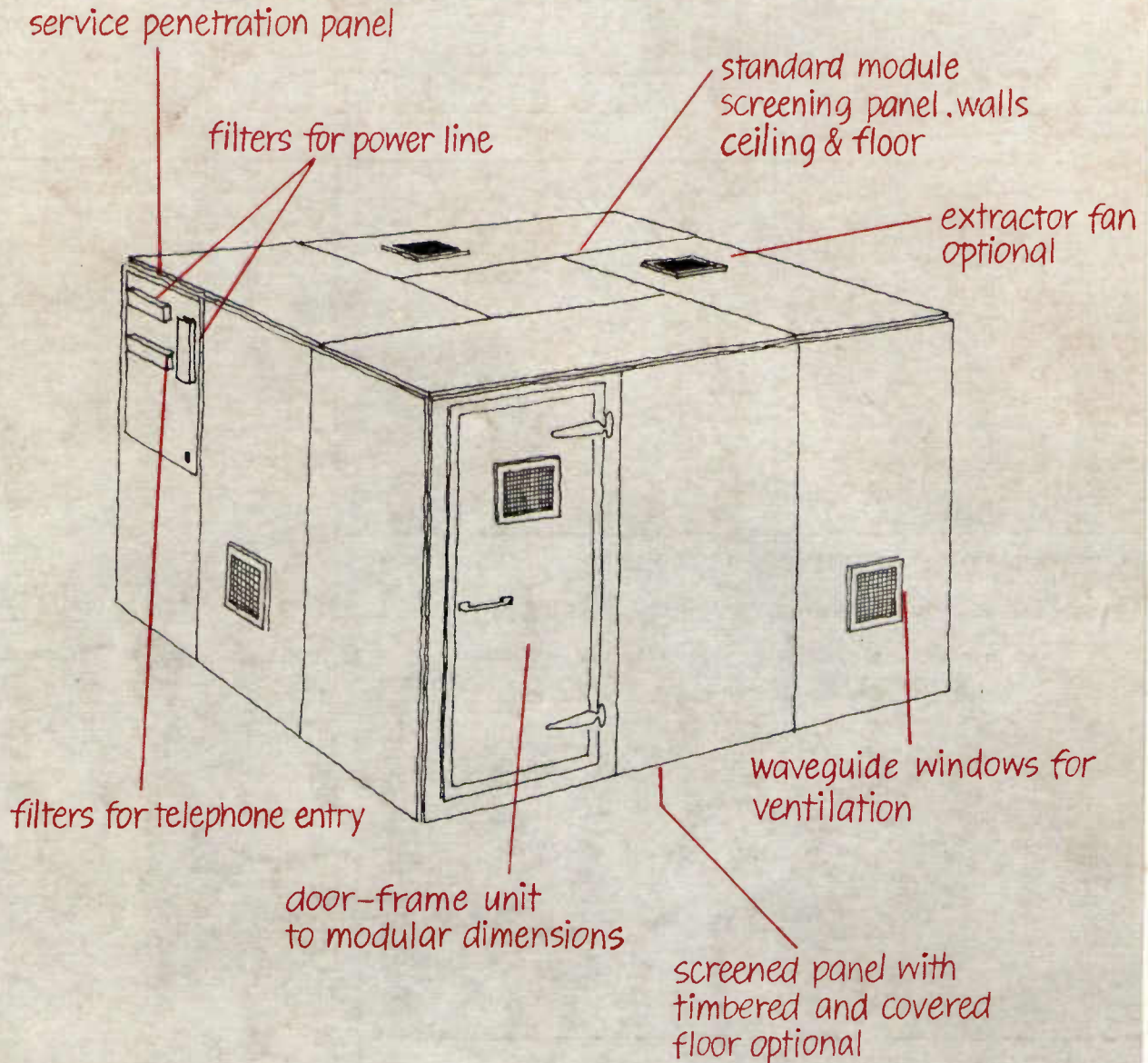

Belling-Lee are official consultants on radio frequency interference suppression and shielded enclosures to the British and Overseas Defence Services.

easily assembled room provides high r.f. attenuation over a wide frequency range. Typical performance: -100dB, 100 kc/s (100 Hz) to 10 Gc/s (10 MHz).

BELLING-LEE

 r.f. shielded enclosures

Write for leaflets F11-16 or telephone Miss Woolgar at Enfield 5393 Ext. 27

Belling & Lee Limited • Great Cambridge Road • Enfield • Middlesex • Telephone: Enfield 5393 • Telex: 263265