

# Electronic Engineering

Incorporating ... ELECTRONICS, TELEVISION & SHORT WAVE WORLD

VOL. 20 No. 242

APRIL 1948

PRICE 2/-

A black and white photograph of a Mazda valve, a cylindrical component with a glass top, placed on a chessboard. The chessboard is tilted, showing a diamond pattern of light and dark squares. Several red chess pieces, including pawns and a knight, are scattered around the valve. The valve has the text 'MAZDA VALVE' and 'MADE IN ENGLAND' printed on it. The background is dark, and the lighting creates a strong shadow of the valve and pieces on the board.

KING OF THE SET

## MAZDA

RADIO VALVES AND CATHODE RAY TUBES

THE EDISON SWAN ELECTRIC CO. LTD.,  
155, CHARING CROSS ROAD, LONDON, W.C.2.

# Virtually Distortionless

## A.D/47 AMPLIFIER

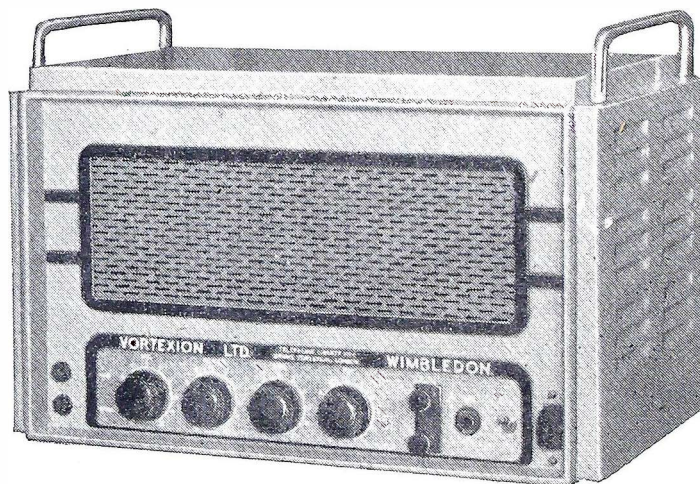
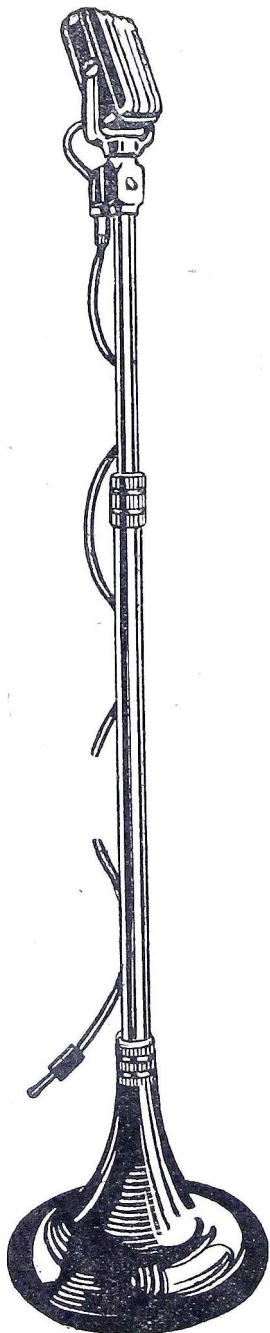

This is a 10-valve amplifier for recording and play-back purposes for which we claim an overall distortion of only 0.01 per cent., as measured on a distortion factor meter at middle frequencies for a 10-watt output.

The internal noise and amplitude distortion are thus negligible and the response is flat plus or minus nothing from 50 to 20,000 c/s and a maximum of .5 db down at 20 c/s.

A triple-screened input transformer for  $7\frac{1}{2}$  to 15 ohms is provided and the amplifier is push-pull throughout, terminating in cathode-follower triodes with additional feedback. The input needed for 15 watts output is only 0.7 millivolt on microphone and 7 millivolts on gramophone. The output transformer can be switched from 15 ohms to 2,000 ohms, for recording purposes, the measured damping factor being 40 times in each case.

Built-in switched record compensation networks are provided for each listening level on the front panel, together with overload indicator switch, scratch compensation control and fuse. All inputs and outputs are at the rear of the chassis.

Send for full details of Amplifier type AD/47.

*Vortexion*  
LIMITED

257/261 THE BROADWAY,  
WIMBLEDON, LONDON,  
S.W.19

Telephones : LIBerty 2814 and 6242/3.

Telegrams : "VORTEXION, WIMBLE, LONDON."

## CLASSIFIED ANNOUNCEMENTS

The charge for these advertisements is twelve words or less 5/- and 4d. for every additional word. Box number 2/- extra, except in the case of advertisements in "Situations Wanted" when it is added free of charge. A remittance must accompany the advertisement. Replies to box numbers should be addressed to: Morgan Bros. (Publishers) Ltd., 28, Essex Street, Strand, London, W.C.2 and marked "Electronic Engineering." Advertisements must be received before the 10th of the month for insertion in the following issue.

### SITUATIONS VACANT

Vacancies advertised are restricted to persons or employees excepted from the provisions of the Control of Employment Order, 1947.

**FERRANTI LIMITED** require for Vacuum Physics Laboratory Physicists or Engineers, graduates or with equivalent qualifications, preferably with experience of electronic vacuum work or U.H.F. valves. Applications from Personnel Manager, Ferranti Limited, Ferry Road Edinburgh, 5.

**TRAUGHTSMEN** required for jig and tool drawing office. Must be familiar with electronic equipment construction. Manchester area. Apply, giving full particulars of experience, qualifications and salary required, to Box 213, E.E.

**ENGINEERS** required for employment on development of radar, communication and electronic equipment. Applicants must possess a degree in engineering or its equivalent. Salary £400 to £600 annum, according to qualifications. Reply, stating age, experience, training and qualifications, etc., to Cossor Radar Ltd., Wren Mill, Chadderton, Nr. Oldham, Lancs.

**SIGNER-DRAUGHTSMAN** required for factory northern area. Must be conversant with radar and radio equipment construction. Reply, stating age, details of experience, training and salary required, to Box 214, E.E.

**SENIOR RADIO DEVELOPMENT ENGINEER** required by the South Western Division of a leading radio Company. Candidates should have had practical experience in radar work and be capable of controlling teams developing radar and atomic energy electronic equipment. Commencing salary will be £600 upwards, according to qualifications and experience. Housing accommodation is likely to be made available in the near future to the person appointed. Full details should be submitted immediately.

The Company is also appointing a Junior Development Engineer (Inter. B.Sc. or equivalent). Candidates for this post must have had practical experience in radar and communications equipment design. The commencing salary will be £350/£400, with every prospect and facility for advancement. Full details of qualifications and previous experience in writing to Box 212, E.E.

**ENGINEERS** required for employment on mechanical design of radar, communication and electronic equipment. Applicants must possess a degree in engineering or its equivalent, and be capable of producing designs suitable for small and mass scale production. Writing age, details of experience, training and qualifications, etc., to Cossor Radar Ltd., Wren Mill, Chadderton, Nr. Oldham, Lancs.

**DEVELOPMENT ENGINEERS** required by radio manufacturers in Essex for work on centimetric waves. Candidates should possess a University Degree, preferably with telecommunications as a subject. Age 25-35. Salary according to age and experience. Apply, quoting Ref. 91, to Box 215, E.E.

**RESEARCH DEPARTMENT** of Instrument-making in N.E. London, requires graduate in physics or engineering with good communications experience, particularly in acoustics and electronics, including the design of amplifiers for outputs up to 2 KW. Write, giving age, experience and salary required, to Box 224, E.E.

**RADIO SENIOR** Assembly Foreman required, Manchester area, must be capable of controlling male and female labour, experienced in assembly belt layout and familiar with A.I.D. requirements. Apply, stating age, experience and salary required, to Box 223, E.E.

**SENIOR RADIO** Development Engineers, with experience of light electrical engineering, required by radio manufacturer. Suitable applicants would be required to travel abroad and knowledge of languages and commercial experience would be an advantage. State full details of experience, age and salary required to Box 222, E.E.

**RADIO MANUFACTURERS**, West London district, have vacancies for Senior Development Engineers and Laboratory Assistants for work on design and development of telecommunication equipment and broadcast receivers. For the senior posts, at least five years' practical experience in this class of work is essential. Write, stating age, qualifications, experience and salary required, to Box 229, E.E.

**A LARGE MANUFACTURING** Company in the South of England requires an electrical engineer and physicist to take charge of microwave development work. Suitable applicants must have experience of this work and adequate technical knowledge. Reply, stating qualifications, experience, age and salary required, to Box 230, E.E.

**REQUIRED MACHINE SHOP** Superintendent by Radar and Radio Company, Manchester area; must be capable of supervising the production of components for assembly lines. Knowledge of machine, press and fitting operations essential. Apply, giving full particulars of experience and salary, etc., to Box 228, E.E.

**PLANNING ENGINEERS** required by Radar and Electronic Equipment Company, Manchester area; must have served general engineering apprenticeship and be capable of developing and planning all machine shop, fitting and assembly operations. Apply, stating age, experience and salary required, to Box 227, E.E.

**TRANSFORMER DEPARTMENT** Superintendent required by Radar and Radio Equipment Company, North Manchester area; must be capable of controlling labour, be conversant with all operations of coil winding, impregnation and assembly. Reply, giving details of age, experience and salary required, to Box 226, E.E.

**SENIOR RADIO ENGINEER** required for large industrial concern operating in the Middle East. Applicants should have had at least seven years' experience in technical installation, operation and maintenance of M/F, H/F, and VHF communication transmitters, superhet receivers and high-speed W/T systems. A knowledge of carrier current technique advantageous. Age not over 35, Secondary School education. Attractive salary plus generous allowance in local currency. Free passage out and home, medical attention, kit allowance and furnished bachelor accommodation. Write, giving age and full particulars of qualifications and experience, quoting Department F.96, to Box 1076 at 191, Gresham House, E.C.2.

**ASSISTANT PHYSICIST**, preferably with some electronic knowledge, required for work on waveguide systems. Mathematical and academic qualifications essential, practical experience and mechanical ability an advantage. Age 20 to 30. Salary, £350 to £450 per annum. Write Box N. 5862, A.K. Advtg., 212a, Shaftesbury Avenue, W.C.2.

**ASSISTANT ELECTRONIC ENGINEER** required for Radar laboratory. Mathematical qualifications and some previous experience necessary. Age 20 to 30. Salary, £350 to £450 per annum. Write Box N. 5866, A.K. Advtg., 212a, Shaftesbury Avenue, W.C.2.

**E.M.I. INSTITUTES** (associated with H.M.V., Marconiophone, etc.) require a Lecturer in Radio Communications. Science degree (or equivalent) and good practical outlook essential. Commencing salary about £300, according to age, qualifications and experience. Cost-of-living bonus 29s. 6d. extra per week in addition to superannuation benefits. Apply giving fullest possible particulars to Principal, E.M.I. Institutes, 43, Grove Park Road; London, W.4.

**LEADING COMPONENT** Manufacturers require the services of a graduate radio engineer to carry out research and development programmes in connection with electronic components, fuses and suppressors. Good background in general physics and some inventive ability essential. Salary will be in accordance with qualifications and experience but will not exceed £500 per annum. Give full details of age, education and experience. Box 232, E.E.

**DEPUTY DIVISION HEAD** required for laboratory responsible for development of carrier current telephone and multi-channel telegraph equipment. Replies from those with suitable experience should give qualifications and salary expected. Permanent and pensionable position with good prospects. Box 233, E.E.

**SIEMENS BROTHERS & CO., LTD.**, Ref. 235, Woolwich, S.E.18, invite applications for posts as Senior Engineers in the line telephone transmission laboratory. Suitably qualified applicants only should write, stating details of experience and salary required.

**SUPERINTENDENT** required to take charge of radar and radio assembly department, Electronic Equipment Company, Manchester area; must be familiar with A.I.D. requirements, and capable of controlling labour on track and bench assembly. Reply, giving full particulars of age, experience, qualifications and salary required, to Box 225, E.E.

**PHILIPS' MITCHAM WORKS** have vacancies in their domestic receiver development laboratories for technical assistants. Applicants should be between the ages of 20 and 30, and be graduates (engineering with radio or telecommunications) of a recognised University or hold qualifications exempting from I.E.E. examination. The work will involve a study of the problems of mass production of components and complete receivers, and successful candidates will be expected to work with a minimum of supervision, and to take responsibility for the preparation of receivers and associated components for production. Some experience of production is an advantage. Salary according to qualifications. Write for application form to the Personnel Manager, Mitcham Works, Ltd., New Road, Mitcham Junction, Surrey, quoting reference "C.I."

**VALVES AND ELECTRONIC VACUUM TUBES.** Production Engineer required to take charge of small production unit. Experience on similar work essential. Good salary and prospects for experienced man. Apply Personnel Manager, Ferranti, Ferry Road, Edinburgh.

**THE RESEARCH LABORATORIES** of Elliott Brothers (London) Limited have a vacancy for an experienced electronic circuit research engineer. Applicants must have qualifications of degree standard and research experience of general circuit techniques, preferably those relating to pulse methods. The successful applicant will be required to take charge of small groups concerned with advanced circuit techniques. Age 25-30. Salary, £500 to £800, according to qualifications. Application to be made to the Research Director, Research Laboratories of Elliott Brothers (London) Limited, Elstree Way, Borehamwood, Herts.

**E.M.I. ENGINEERING** Development Limited, Hayes, Middlesex, invite applications from junior and intermediate engineers, age 25 to 30, with engineering degree or the equivalent, and practical design experience. Specific vacancies on radar development include the following work: (a) design of 30-100 Mc.I.F. amplifiers; (b) transformers for higher frequency power supply; (c) special problems on radar presentation. There are several other interesting vacancies for physicists and engineers. Inclusive salary £400 to £550, according to age and qualifications. Write, giving full details and interests, to Personnel Department.

**RADIO ENGINEER**, preferably aged 25-30, with an Honours degree or equivalent qualifications, and with experience in circuitry and advanced development work, is required for research in the field of telecommunications. Apply by letter only to The Director, Research Laboratories of the General Electric Co., Ltd., North Wembley, Middlesex, stating age, academic record and experience.

**RADIO SERVICE ENGINEERS** for works and field, primarily in London area, well-known company, excellent prospects. Applicants should have comprehensive knowledge radio servicing and minimum of two/three years retail or industrial experience in repair work. 5-day, 44-hour week. Wages according to experience and at prevailing levels. Apply, stating age, full details experience, wages required. Box 241, E.E.

**ELECTRONIC DEVELOPMENT ENGINEER.** Well-known North London firm requires good engineers interested in electronic design and instrument work. Sound theoretical knowledge and wide experience of low-frequency circuits in particular are essential. Vacancies for senior assistants with academic qualifications, commencing salary up to £500 per annum and junior with Nat. Cert., Inter. B.Sc., or C. and G. III Commencing salary up to £350 per annum. Write, stating qualifications, experience, age and salary required, to Box 242, E.E.

**DRAUGHTSMEN.** North London firm requires good draughtsmen. (a) Designer with sound training and wide experience, including instrument and tool work for preference, commencing salary up to £475 per annum. (b) Young man with initiative and preferably some knowledge of electrical layout and circuit diagrams. (A.E.S.D. rate.) Much interesting development work for the right men. Write, stating qualifications, experience, age and salary required, to Box 243, E.E.

**INDEX TO ADVERTISERS**

SEE PAGE 32

## CLASSIFIED ANNOUNCEMENTS (Cont'd.)

**TECHNICAL ASSISTANT** required for radio and lines project section. Age 21-26 years. Experience in communication and radio engineering essential, together with ability to write descriptions of such equipment. Minimum qualifications City and Guilds Radio, Part 3. Apply in writing to E.T.E. Ltd. (Radio Laboratory), Brathway Road, Wandsworth, London, S.W.18, stating experience, age and salary required.

**ASSISTANT (TECHNICAL)** required for cathode-ray tube department. Must have technical knowledge and be prepared to do practical work. Some knowledge and experience of electronic tube and high vacuum technique desirable. Apply Personnel Department, The Edison Swan Electric Co., Ltd., Cosmos Works, Brimsdown, Enfield, giving full particulars, age, etc.

**RADIO ENGINEERS** required for design and test of latest type radio transmitters and receivers. Technical standard preferably up to City and Guilds final, or equivalent. Opening offers good prospects. London area. Apply in confidence giving age, details of education, experience and salary required to Box 247, E.E.

**THE MULLARD RADIO VALVE CO.** require designer draughtsman for special purpose machinery in connection with electric lamps and radio valves. Only those men capable of seeing jobs through to conclusion need apply. Jig and tool draughtsmen should note that their experience is not sufficient to warrant application for one of these positions. Good salary and prospects for the right men. Apply in the first instance to the Works Personnel Officer, The Mullard Radio Valve Co., Ltd., New Road, Mitcham Junction, Surrey, for a form of application and quote the reference "J.A."

**OFFICE JUNIOR** wanted for the Head Office of this journal; good opportunity for alert youth or girl leaving school; hours 9.30 to 5, no Saturdays. Written applications to Staff Manager, Morgan Brothers (Publishers) Limited, 28 Essex Street, London, W.C.2.

**ELECTRICAL COMPONENTS MANUFACTURERS** require young man with good electrical training, preferably with Higher National Certificate or equivalent, for development work on television components. Write giving full details and stating remuneration required to Box 248, E.E.

**ASSISTANT ENGINEER** for laboratory development of radio communication receivers. University degree or equivalent and industrial experience of receiver measurements essential. Applicants should state salary required. Apply Ref. 715, Siemens Brothers and Co., Ltd., Woolwich, S.E.18.

**LOW POWER** radio transmitter design engineer required. Qualifications engineering or physics degree or equivalent and industrial experience of transmitter design. Salary according to qualifications and experience. Pensionable position on permanent staff. Box 249, E.E.

**ASSISTANT ENGINEER** for design and development of subscribers telephone instruments required. Applicants should have university degree or equivalent and have had previous experience of acoustic measurements. Salary will be paid in accordance with experience and qualifications. Box 250, E.E.

## SITUATIONS WANTED

**LIGHT ELECTRO-MECHANICAL** Engineer would advise in the design of relays, motors, etc., and all electro-magnetic equipment. Also acoustics and industrial electronics. University and industrial qualifications. Box 234, E.E.

**RADIO ENGINEER**, extensive practical experience, seeks progressive responsible position, London area. Conversant telephone, telegraph equipment, domestic receivers, other radio electrical fields. Accustomed controlling staff. Box 240, E.E.

**DEVELOPMENT ENGINEER**, 35, B.Sc.(Eng.), wide experience in audio technique and electronics, now in London, seeks position involving development or research in or near country. Box 239, E.E.

**ENGINEER**, 33, City and Guilds Final Grade in Telecommunications and Technical Electricity, now studying for Higher National Certificate, seeks change. Box 238, E.E.

**ENGINEER**, Oxford Graduate with ten years' experience of light current engineering, seeks executive position in London area or south-east where initiative and administrative ability are essential additions to a wide technical background. Box 236, E.E.

**ENGINEER**, Bristol area, prepared to act as part-time technical representative or agent. Box 235, E.E.

**RADIO AND ELECTRONIC** Engineer, desiring change, requires position of responsibility, fully experienced in television and radio frequency heating. Box 237, E.E.

**ROYAL AIR FORCE** Technical Signals (Radar) Officer, 7 years' experience of airborne and ground communication and radar equipments; single (26), available soon. Seeks progressive position, good prospects essential. Hard work and long hours no object with reasonable salary. Box 231, E.E.

**PHYSICIST**, B.Sc., F.Inst.P. 38, experienced in electronic engineering and vacuum practice, is available for research in thermionics, vacuum physics applications, or instruments. Box 221, E.E.

## BUSINESS OPPORTUNITIES

**GENTLEMAN**, opening business New Zealand shortly, desires agencies for industrial goods, radio and electrical components, etc. Write West, 46, Boileau Road, Barnes, S.W.13 (Phone: RIVERSIDE 1044).

## EDUCATIONAL

**COMPLETE CORRESPONDENCE COURSE** covering Amateur and C. and G.I. Examinations, consisting of 12 lessons. Send for particulars. Everyman's Correspondence College, 72, St. Stephen's House, Westminster, S.W.1.

## SERVICE

**FACILITIES AVAILABLE** for radio assembly work on amplifiers, radar and small radio chassis. Prompt deliveries, first-class work. Write R. T. M. C. Ltd., 141, Little Ealing Lane, W.5 (EALING 6962).

**LOUDSPEAKERS**—We carry on. Sinclair Speakers, 12, Pembroke Street, N.1.

**LOUDSPEAKER** repairs, British, American, any make, moderate prices.—Sinclair Speakers, 12, Pembroke Street, N.1.

**FACTORY HAS TECHNICAL** Staff and capacity available for manufacturing scientific or other articles in glass. Box 163, E.E.

**TELEVISION ENGINEERS.** Here is something you cannot manage without. Wide band television pattern Generator. The only way to check vision and sound receivers satisfactorily. Full details apply W. B. Martin, Television Engineers, 206-208, Lower Parliament Street, Nottingham.

## MISCELLANEOUS

**WE WILL BUY** at your price used radios, amplifiers, converters, test meters, motors, pick-ups, speakers, etc., radio and electrical accessories. Write, phone or call, University Radio Ltd., 22, Lisle Street, London, W.C.2. GERrard 4447.

**WEBB'S** Radio Map of the World enables you to locate any station heard. Size 40 in. by 30 in. 2-colour heavy Art Paper, 4/6, post 6d. Limited supply on Linen, 10/6, post 6d.—Webb's Radio, 14, Soho Street, London, W.1. Phone GERrard 2089.

**MORSE** Practice Equipment for Class-room or Individual Tuition. Keys Audio Oscillators for both battery or main operation. Webb's Radio, 14, Soho Street, London, W.1. Phone: GERrard 2089.

**PHOTOGRAPHY.** We specialise in advertising and catalogue-photography, and in series photographs for instruction sheets. Our pictures tell the story. Behr Photography, 44, Temple Fortune Lane, M.W.11 (SPEEdwell 4298).

## FOR SALE

**COPPER WIRES**, enamelled, tinned, litz, cotton, silk covered. All gauges. B.A. screws, nuts, washers, soldering tags, eyelets. Ebonite and laminated Bakelite panels, tubes, coil formers. Tufnol rod. Flexes, permanent detectors, earphones, etc. List S.A.E. Trade supplied. Post Radio Supplies, 33, Bourne Gardens, London, E.4.

**EX-R.A.F.** Loran Indicators with 5 in. electrostatic c.r.t. with time base. 26 valves including 6SN7, 6H6, 6SJ7 and calibrated 100 Kc. crystal, suitable for conversion to oscillograph, £10. Box 220, E.E.

**IN STOCK.** Rectifiers, Accumulator Chargers Rotary Converters, P.A. Amplifiers, Mikes, Mains Transformers, Speakers of most types, Test Meters, etc. Special Transformers quoted for.—University Radio, Ltd., 22, Lisle Street, London, W.C.2. GERrard 4447.

**MASTS.** First-class aerial masts, new, unused and crated. A.M. type 23. 78 feet high when erected. A few are offered at 17 gns. each, carr. paid nearest railway station in G.B. for quick sale. Telephone TUDOR 5277 or write BM/RXBF, London, W.C.1.

**THE MORDAUNT DUPLEX REPRODUCER**, as used in the ENOCK instrument, is now available separately. Folded horn bass unit and new high note reflector of original design, giving exceptionally smooth response from 40-20,000 c.p.s. Even distribution over a wide angle. Reproduction has an "atmosphere" and realism hitherto unattainable. Price (ex works), 98 Gns. Please send for full particulars, or better still, let us arrange for a demonstration. Joseph Enock Ltd., 273a, High Street, Brentford, Middlesex (EALING 8103).

**TEST METERS**, Triplett, 10-5,000 volt A.C./D.C. 10-500 mA D.C., 3,000-250,000 ohms resistance. Government surplus, £5 10s. Ball-type microphones, 15 ohms coil, £5 2s. 6d. Hand M.C. Microphones with 40 yards screened lead and jack plug, £4 10s. Cabinets, car radio, pierced for speaker, few only, 12s. 6d. Speakers, P.M., 2½ in., 18s. Tuning Condensers, twin 400 pf with spindle 1 in. long, ¾ in. dia., 5s. Twin 480 pf with 2½ in. drive drum, 7s. 6d. Small Mica Condensers, 0.01-0.0005 mfd, parcel of 50 for 10s. 6d; High Voltage Condensers, 0.01 mfd, 5,000 v., 1s. 6d.; 0.02 mfd., 8,000 v., 2s. 6d.; 1 mfd., 1,200 v., 3s. 6d.; 0.1 mfd., 2,500 v., 1s. 3d.; 0.25 mfd., 2,000 v., 1s. 3d.; 0.1 mfd., 1,200 v., 1s.; 2 mfd., 1,000 v., 3s. 6d.; 4 mfd., 1,000 v., 6s. EA50 valve holders, 3s. per dozen. Heavy Duty Chokes, 250 ohm, 150 mA, 12s. 6d.; 150 ohm, 200 mA, 14s. 6d.; 2,000 ohm, 300 mA, 16s. 6d.; 100 ohm, 500 mA, 22s. 6d.; 100 ohm, 700 mA, 35s. Vibrators, 6 volt 4-pin UX, 8s. 6d. Flexible insulated shaft couplings, ¼ in. spindles, 1s. 3d. Write for list of these and many other bargains, Joseph Enock Ltd., 273a, High Street, Brentford, Middlesex (EALING 8103).

**A DIAMOND STYLUS**, due to its permanence, never changes its shape and is therefore the only possible solution where consistent, high quality reproduction is required. This is only one of the reasons why the ENOCK pick-up is capable of such an unusually fine performance. Light-weight moving coil. Weight at needle point, ¼ oz. Price £33 13s. 9d., including tax. Full particulars from Joseph Enock Limited, 273a, High Street, Brentford, Middlesex (EALING 8103).

**NEW ARMOUR MAGNETIC** Steel Recording Wire on standard spools, in maker's sealed tins. 60 minutes' speech or 30 minutes' music playing time. £3. Harris, Strouds, Pangbourne, Berks.

**EVERSHED** 500 v. Bridge-Megger, 4-dial plus Varley test, £35. Also Wee-Meggers (in leather case), 500 v., £8 10s.; 250 v., £7 10s. Generator-driven ohmmeters, 0-5 or 0-10,000, £3 15s. "Megger" ohmmeter, battery model, 2-range, 0-1,000, 0-200K., £5. Box 244, E.E.

**VALVES**, 1T4, 6s 6d.; 3A5, 10s.; 813, 110s. All new, boxed. Box 245, E.E.

**JOURNAL APPLIED PHYSICS** from October, 1930, to December, 1942, less February, 1940, June, October, November and December, 1941. 34 copies, immaculate, £4. Cambridge-Grassot Fluxmeter, used once only, £20 Box 246, E.E.

## WANTED

**I WILL BUY** a metal detector to detect at 10 feet below ground. Write to Felix Rovira S., P.O. Box 1305, Caracas, Venezuela.

**HILL & CHURCHILL,**  
Booksellers LTD.

**SWANAGE, DORSET**

**ENGLISH & AMERICAN  
BOOKS IN STOCK ON**

**RADIO AND  
TELECOMMUNICATION**

Catalogue on Application

# MERCURY VAPOUR RECTIFIERS WITH AN ASSURED

# Long Life

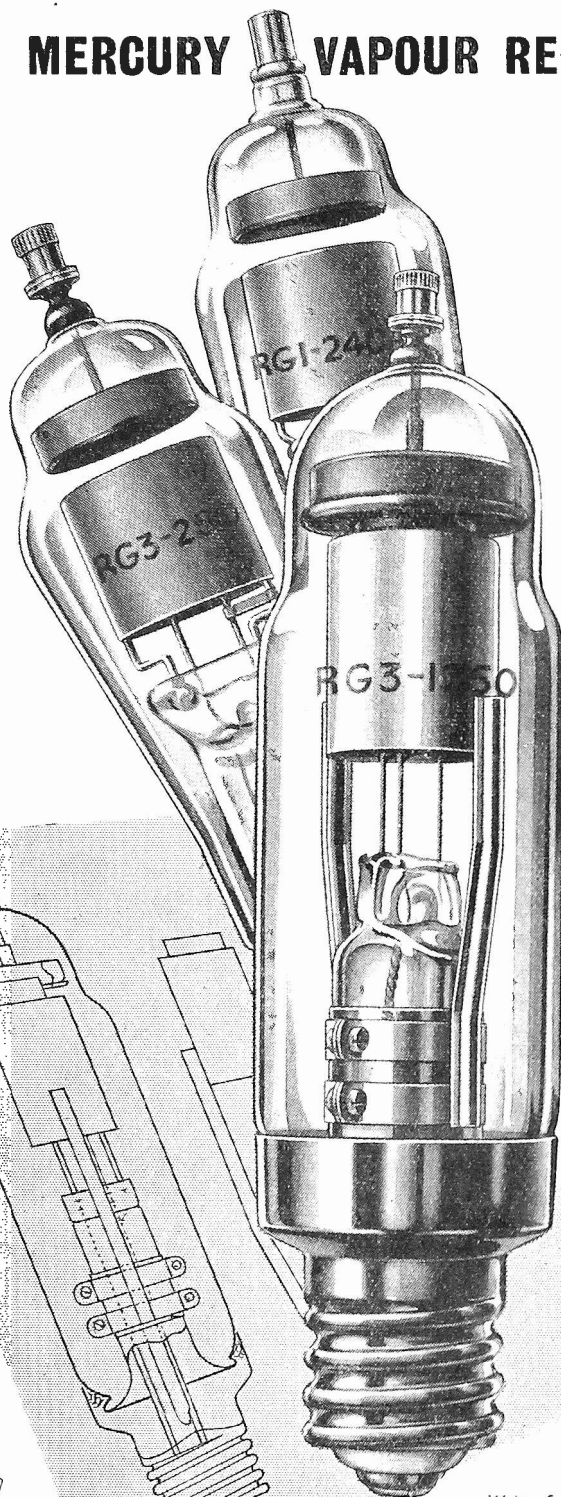

These three Mullard rectifiers owe their reputation for dependability to closely controlled manufacturing processes. Below are some of the reasons why more and more designers are specifying the "RG" range.

**Stable Emission.** The special double spiral filaments are so designed that the emissive coating is firmly keyed to the wire.

**Long Life.** The use of zirconium to eliminate "foreign" gases reduces positive ion bombardment of the cathode.

**High Voltage Tests.** All valves are subjected to rigorous back-arc tests.

**RG1-240A**

Peak Inverse Voltage - - - 4,700 V max.  
 Mean Anode Current - - - 250 mA max.  
 Two Valves in a Single-Phase Full-Wave Circuit  
 will give 1,500 Volts at 500 mA.  
 Filament Voltage - - - - 4.0 V  
 Filament Current - - - - 2.7 A

**RG3-250**

Peak Inverse Voltage - - - 10,000 V max.  
 Mean Anode Current - - - 250 mA max.  
 Two Valves in a Single-Phase Full-Wave Circuit  
 will give 3,150 Volts at 500 mA.  
 Filament Voltage - - - - 2.5 V  
 Filament Current - - - - 5.0 A

**RG3-1250**

Peak Inverse Voltage - - - 13,000 V max.  
 Mean Anode Current - - - 1.25 A max.  
 Two Valves in a Single-Phase Full-Wave Circuit  
 will give 4,140 Volts at 2.5 amps.  
 Filament Voltage - - - - 4.0 V  
 Filament Current - - - - 7.0 A

Write for  
 technical data  
 on these and  
 other Mullard  
 valves

# Mullard

**THERMIONIC VALVES & ELECTRON TUBES**

THE MULLARD WIRELESS SERVICE CO. LTD., TRANSMITTING & INDUSTRIAL VALVE DEPT., CENTURY HOUSE, SHAFTESBURY AVENUE, LONDON, W.C.2



1948  
 OLYMPIA &  
 EARLS COURT  
 MAY 3-14

**SEE OUR EXHIBIT**

Stand No. H.45



# MAZDA

for

# DEPENDABILITY

## SP61\*



### RATING :

Heater Voltage	....	....	....	....	6.3
Heater Current (amps)	....	....	....	....	0.6
Maximum Anode Voltage	....	....	....	....	250
Maximum Screen Voltage	....	....	....	....	250
‡ Mutual Conductance (ma/V)	....	....	....	....	8.5

‡ Taken at  $V_a=200$ ;  $V_s=200$ ;  $V_g=1.5$

### GENERAL :

The SP61 is a high slope screened H.F. Pentode designed for use on A.C. mains in the H.F. and I.F. stages of a Television receiver.

Other uses are:

1. Video amplifier in circuits where the capacity across the output load is low.
2. Frequency changer in conjunction with a separate oscillator valve such as the P61.
3. Certain classes of audio amplification work where gains of over 150 can be realised.

The valve is fully metallised and is fitted with a Mazda octal base.

\* Also made with 4v. heater and known as SP41

LIST PRICE 10/6 (plus 3/5d. purchase tax)

## P61†



### RATING :

Heater Voltage	....	....	....	....	6.3
Heater Current (amps)	....	....	....	....	0.6
Maximum Anode Voltage	....	....	....	....	250
§ Mutual Conductance (ma/V)	....	....	....	....	8.0
§ Amplification Factor	....	....	....	....	17
Maximum Peak Anode Current (mA)	....	....	....	....	30
Maximum Anode Dissipation (watts)	....	....	....	....	4.0

§ Taken at  $V_a=100$ ;  $V_g=0$

### GENERAL :

The P61 is a triode and has been primarily designed for use as an oscillator in television receivers. It may also be used as an oscillator in all-wave receivers where a single valve frequency changer is not employed.

The valve is fully metallised and is fitted with a Mazda octal base.

† Also made with 4v. heater and known as P41

LIST PRICE 9/6 (plus 3/1d. purchase tax)

## THE EDISON SWAN ELECTRIC COMPANY LIMITED

RADIO DIVISION

## 155 CHARING CROSS ROAD, LONDON, W.C.2

**SPRING LOADED TERMINALS**

*A Positive CONNECTION WITHOUT SOLDER - SIMPLY PRESS & RELEASE*



**PAINTON**

PAINTON & CO. LTD · KINGSTHORPE · NORTHAMPTON · ENGLAND

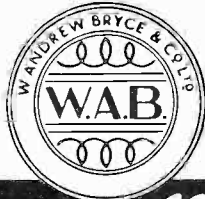

*Hermetically Sealed*

**TRANSFORMERS**

W.A.B. Hermetically Sealed Transformers were developed during the war to meet the requirements of the Services for a unit which would operate continuously under conditions of high relative humidity and high ambient temperature.

A patented method of internal construction ensures that the weight of the Transformer is taken directly on the fixing bushes and not on the case, thus preventing a risk of damage to the sealing of the case when the unit is subjected to mechanical shock.

All Transformers in this range are so constructed that they can be used for either chassis or baseboard mounting.

**W. ANDREW BRYCE & CO. LTD.**  
**SHENLEY ROAD, BOREHAM WOOD, HERTS**

Telephone: ELStree 1870, 1875 and 1117

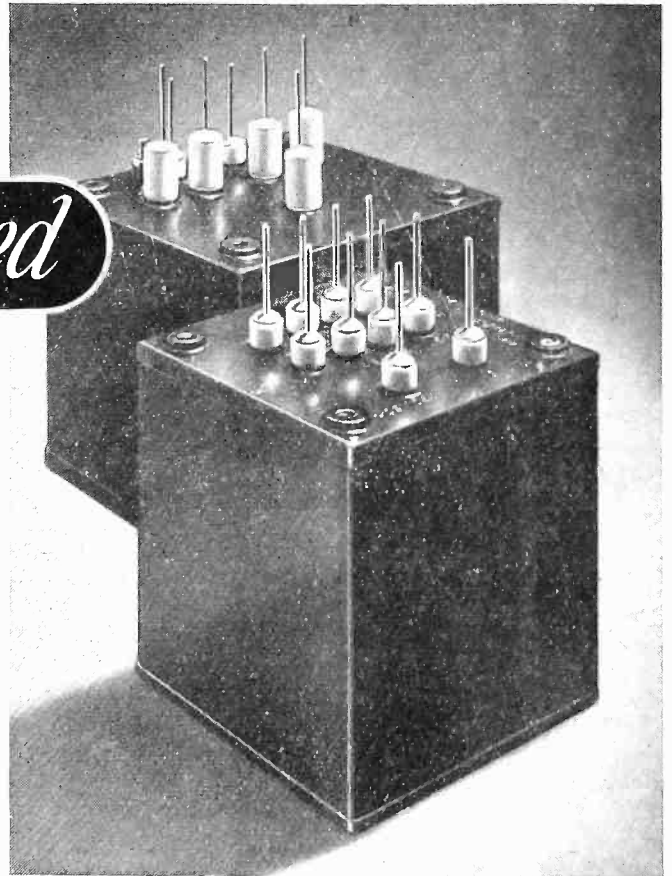

# Are you building the "E.E." Televisor?

## IF SO

### TELE-RADIO (1943) LTD.

CAN supply the following brand new Components straight from the manufacturers as specified in "E.E." for the Home Built Televisor

	each				each		
	£	s.	d.		£	s.	d.
C.R. Tube GEC 6501	12	10	3	TCC MICA DISC CM30			
Mazda Pen 45	13	11		CP58QO .1mfd	15	0	6
Mazda T.41	13	11		CE19P 8mfd	4	6	6
GEC KT45/Pen.46	1	3	3	CE29L 30mfd	6	6	6
Cossor 45IU	19	11		CE37P 32mfd	10	0	6
EF50 (12/6) new, boxed and guaranteed	1	3	3	CE30B 20 by 12v.	2	6	6
Mullard EBC33	12	7		CP47N .5mfd	3	0	0
Mullard EA50	13	11		CP33N .02mfd	1	9	9
Mullard EL33/KT61	13	11		CE26L 16mfd	4	9	9
Belling & Lee P & S L604 comp.	3	3		CC30A 2pf	1	4	4
Belling & Lee P & S L1107 comp.	2	9½		CP31N .005mfd	1	8	8
Home Built Televisor Booklet	2	6		CP37N .1mfd	2	3	3
9 in. CRT Masks, Black or White	10	0		TYPE62 1mfd	6	6	6
12 in. CRT Masks, Black or White	15	0		" Picopack " 1mfd 350v CE30N	2	6	6
Complete chassis assembly with all screens and gantries				CM20 .001mfd	1	9	9
and with all valve holder holes punched out	7	10	0	Aladdin Coil Formers (complete)			10

Haynes transformers are steadily being supplied but delivery is still from 4-6 weeks. Complete Set including EHT, Line Output, Focus Coil and Scanning Coil ... .. £8 0s. 6d.

Send for complete price list, as we can supply the majority of items from stock.

PHONES :—AMB 5393—PAD 6116/5606

**TELE-RADIO (1943) LTD., 177a EDGWARE RD., PADDINGTON, W.2.**

## TOROIDAL POTENTIOMETERS 10-1000 WATTS

Ceramic Insulation only—and approved for  
Tropical conditions.  
Complete Ceramic Rings for strength.  
Approved by all Government Departments.  
Reasonable Delivery.

Specialists in ALL TYPES OF TOROIDAL WINDINGS

**P. X. FOX LIMITED**

**HORSFORTH • YORKSHIRE • ENGLAND**

Telephone : Horsforth 2831

Telegrams : Toroidal, Leeds

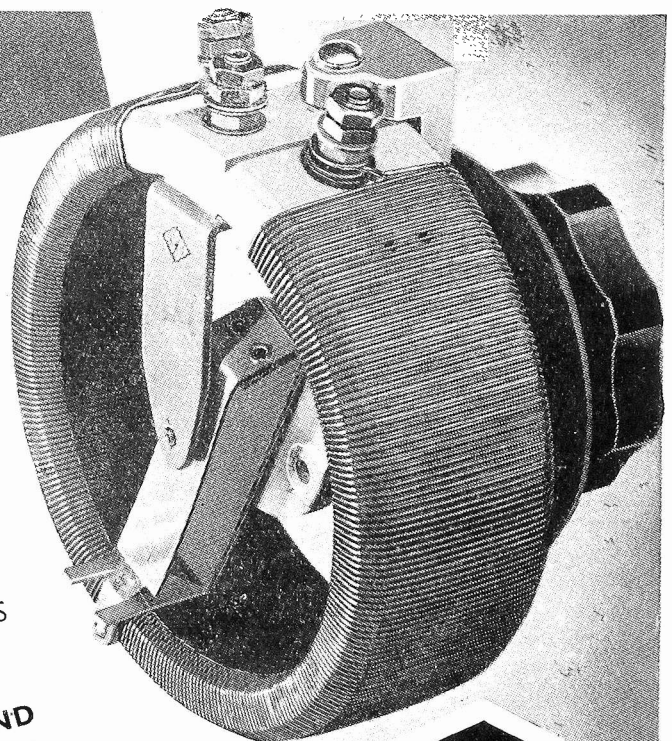



**NEW DESIGNS**

in the range of

**U.I.C**

*High Stability*

**CAPACITORS**

**1**

**LEAD-THROUGH "HI-LOAD" CAPACITOR**

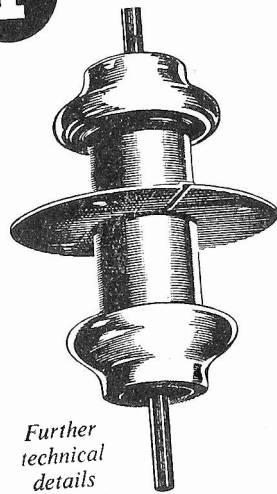

*Further technical details furnished on request*

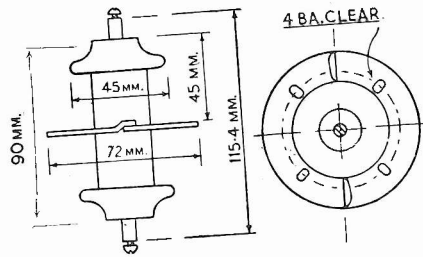

This new Ceramic "Hi-Load" Capacitor has been specially designed as H.T. or Heater By-Pass and Lead-Through Capacitor. Although very small in dimensions the capacitor has a capacitance of 1,000 pF and it is rated at 40 KVA R.F. with a maximum R.F. current of 20 amps. The sturdy rod forming the lead-through connection is capable of handling all normal currents. The high rating also makes the capacitor suitable as a tank capacitor.

**UNITED INSULATOR CO. LTD. OAKCROFT RD. TOLWORTH SURBITON SURREY**

Telephone: Elmbridge 5241 (6 lines)

Telegrams: Calanel, Surbiton

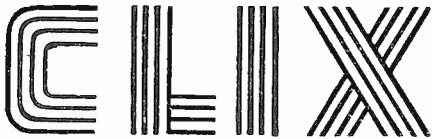

**RADIO, TELEVISION and ELECTRONIC COMPONENTS**

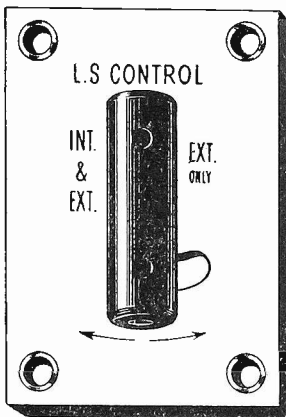

**LOUDSPEAKER CONTROL PANEL**  
CAT. No. LSC 398/0

**GRAM-JACK PANELS**  
CAT. No. GJP/O

This panel is designed for inclusion in radio receivers and extension circuits where series or parallel speaker points must be individually controlled.

Positive On/Off switch action.  
Speaker or P.U. plug readily removed from panel.

*Clix Components are adequately protected by British and Foreign Patents*

**BRITISH MECHANICAL PRODUCTIONS LTD.**

21 BRUTON STREET, BERKELEY SQUARE, LONDON, W.1.

Telephone: MAYfair 5543



Announcing... SIX ENTIRELY NEW

## ELECTRONIC INSTRUMENTS

by CINEMA-TELEVISION LIMITED

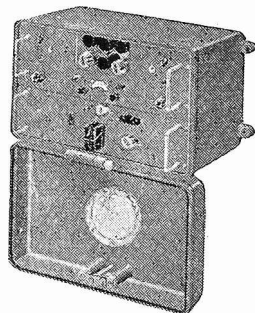

### INDUSTRIAL ELECTRONIC METAL DETECTOR

An automatic inspection equipment for the detection of ferrous and non-ferrous metal particles of all kinds in non-metallic substances such as foodstuffs, plastics, textiles, tobacco, timber, pharmaceutical products, etc.

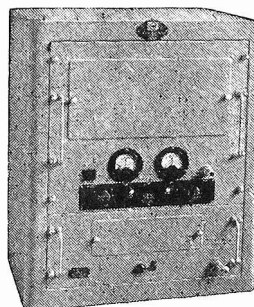

### STANDARD ELECTRONIC COUNTER

A high speed electronic counter of particular appeal to the industrialist. Facilities are provided for batching, selective counting etc., the maximum counting-speed for the equipment being 30,000 per minute.

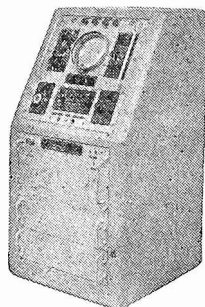

### UNIVERSAL OSCILLOSCOPE

A unique instrument meeting fully the requirements of the serious users of oscilloscopes for laboratory and industrial purposes, arranged to permit readily the assembly of suitable units to fulfil every application. Complete range of units is available, e.g. stabilised time base, A.C. and D.C. amplifiers, 5 beam switch unit etc.

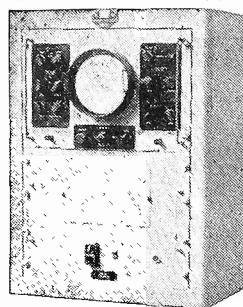

### LABORATORY OSCILLOSCOPE

A high grade 6" screen oscilloscope expressly designed for laboratory use, incorporating hard valve linear time base, 3 megacycle "Y" amplifier and 1 megacycle "X" amplifier. Cupboard and trolley are available if required.

### DEMONSTRATION OSCILLOSCOPE FOR LECTURE PURPOSES

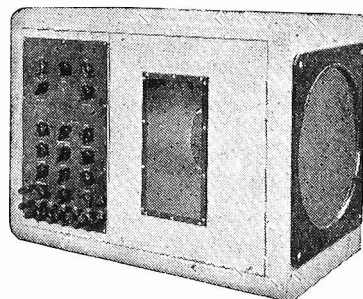

Demonstrator and student alike will acclaim the features of this equipment — 15" tube with glare removing filter, 2 beam switch for simultaneous delineation of two recurrent wave forms, or their "addition" to produce a single resultant trace. Provision is made for setting up from rear of instrument

### PROCESS TIMER

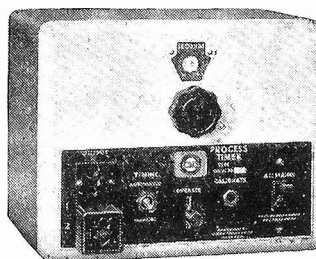

A compact instrument, from the "CINTEL" range, providing simple and accurate electrical control for scientific and industrial processes of every kind. The timing range extends from 0.25 to 90 seconds.



Reg. Trade Mark

**CINEMA-TELEVISION LTD.,**  
INCORPORATING BAIRD TELEVISION LIMITED  
WORSLEY BRIDGE RD., LONDON, S.E.26

Telephone: HITHer Green 4600

Suppliers to ADMIRALTY, MINISTRY OF AIRCRAFT PRODUCTION, MINISTRY OF SUPPLY, ARMAMENT RESEARCH, etc. Manufacturers of Scientific Instruments and Photo-electric cells.

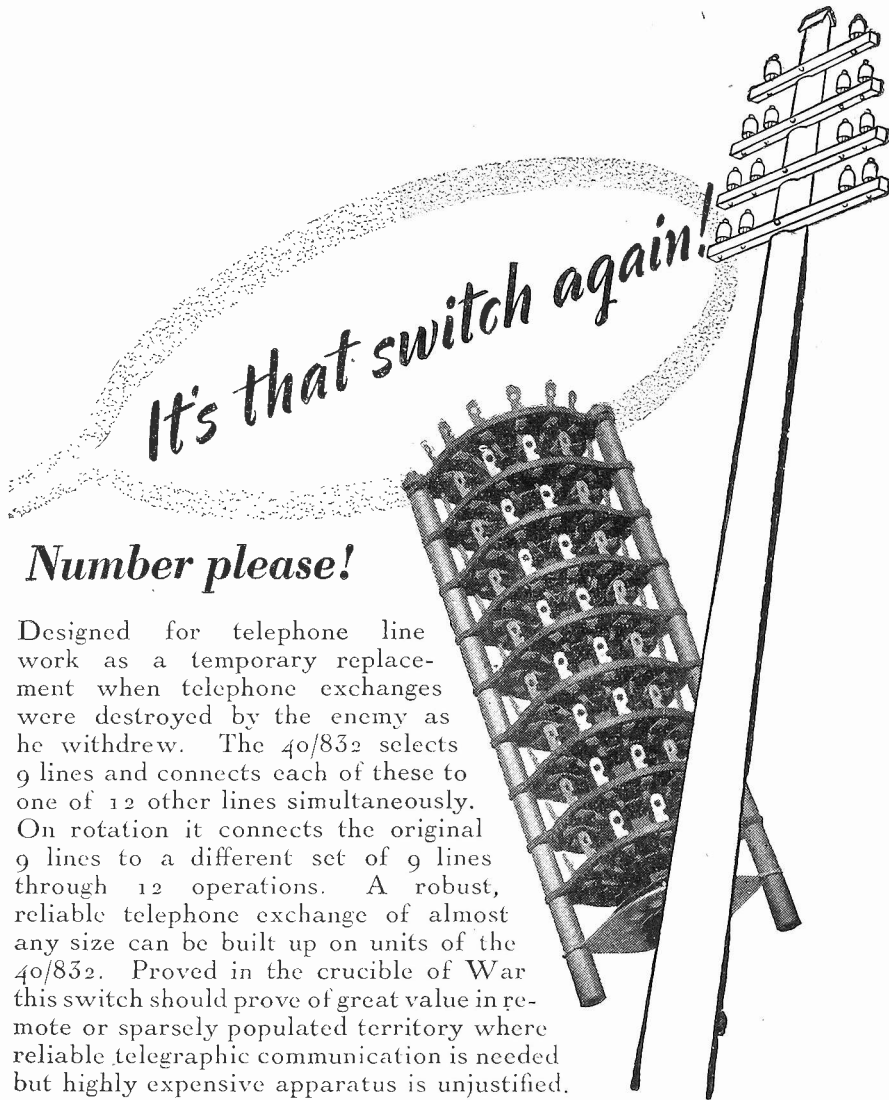

**Number please!**

Designed for telephone line work as a temporary replacement when telephone exchanges were destroyed by the enemy as he withdrew. The 40/832 selects 9 lines and connects each of these to one of 12 other lines simultaneously. On rotation it connects the original 9 lines to a different set of 9 lines through 12 operations. A robust, reliable telephone exchange of almost any size can be built up on units of the 40/832. Proved in the crucible of War this switch should prove of great value in remote or sparsely populated territory where reliable telegraphic communication is needed but highly expensive apparatus is unjustified.

WALTER INSTRUMENTS LIMITED, GARTH ROAD, LOWER MORDEN, SURREY. TELEPHONE: DERWENT 4421 - 2 - 3

**WALTER Type 40**

made for



ONE OF OVER 2000

ASSEMBLIES

C.R.C.15R

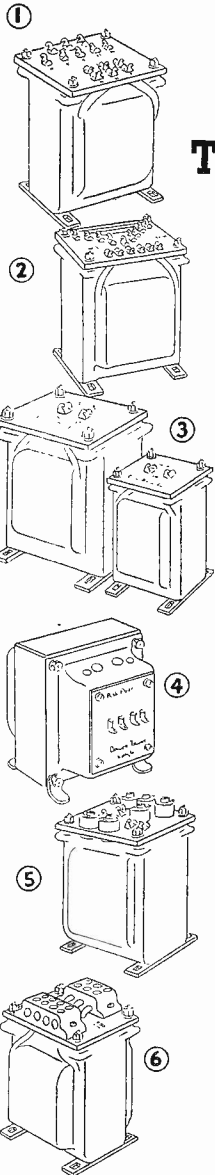

## SIX TRANSFORMERS & CHOKES

Representing  
a range of

# 141

types

For Immediate or Prompt Delivery

- 1 Somerford MAINS POWER TRANSFORMERS—66 types.
- 2 Somerford OUTPUT TRANSFORMERS—8 types.
- 3 Somerford SMOOTHING-CHOKES—42 types.
- 4 Somerford DRIVER TRANSFORMERS—9 types.
- 5 Somerford E.H.T. TRANSFORMERS—5 types.
- 6 Somerford AUTO (voltage change) TRANSFORMERS—11 types.

These six Transformers and Chokes fulfil every normal Laboratory, Radio and Industrial requirement. But should unusual needs demand a special design, this can easily be made and delivered within a few weeks.

All these Transformers and Chokes are made to meet the requirements of all relevant Government Specifications.

The name Gardners is synonymous with the highest standard of material and workmanship.

# GARDNERS

## SOMERFORD TRANSFORMERS

Write for List and Specifications to  
**GARDNERS RADIO LIMITED**  
Somerford, Christchurch, Hants.

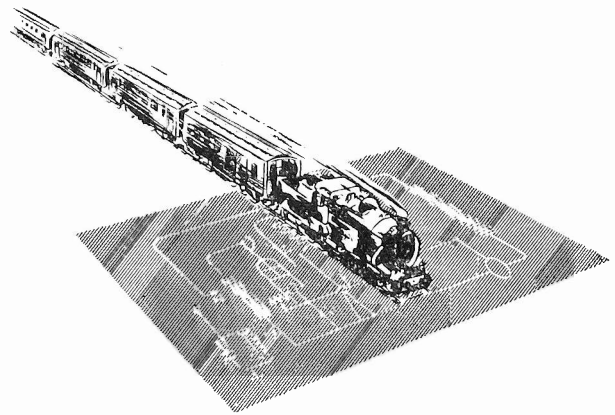

For all points North, South,  
East and West . . .

Intricate point-to-point wiring jobs are effectively accomplished with *Hamofil* Connecting Wires. Specially designed for efficient, economical wiring of electrical, radio and electronic apparatus, *Hamofil* is available in solid and stranded tinned copper conductors, with rubber insulation in seven plain colours.

★ *Hamofil* "Push Back"—a popular and inexpensive grade—permits the cotton braiding to be slid back along the wire to facilitate joining or soldering. In seven colours and their combinations.

*Hamofil* is available with the following conductors:—1/22, 1/19, 7/33 and 14/36 s.w.g.

# HAMOFIL

connecting wires

Full details on request

De La Rue Insulation Limited

IMPERIAL HOUSE,  
84/86 REGENT STREET, LONDON, W.1

Telephone: Regent 2901 Telegrams: Delinsul, Piccy, London

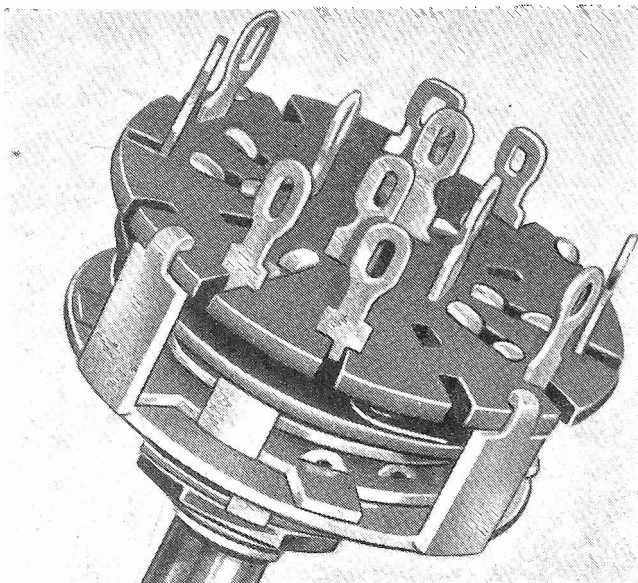

*It's really quite tiny*

Designed for use in midget radio receivers and other apparatus where space is limited, the AB—Type M-1 is ideally suitable for such tasks as wave-band and meter switching, etc. Small though it is, features such as heavily silver-plated brass stator contacts and rotor contacts of a special alloy, also heavily silver-plated, combine to give very low contact resistance, noiseless operation and long life.

Available in all popular switching combinations.

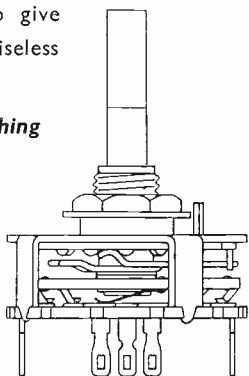

**AB TYPE M-1  
MINIATURE  
ROTARY SWITCH**

**AB Metal Products Ltd., Great South-West Road, Feltham, Middlesex  
Hounslow 6256 Feltham 2865**

“OAK” WAFER SWITCHES, SINGLE OR MULTI-BANK •  
TOGGLE SWITCHES FOR ALL PURPOSES • PUSH-PULL  
SWITCHES • ROTARY SWITCHES

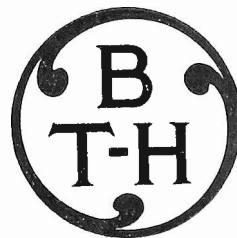

## PHOTO-ELECTRIC RELAYS



THE BTH Company has had many years' experience in the development and manufacture of Photo-electric Relays and their application to industrial processes.

including :

- LIQUID LEVEL CONTROL
- TEMPERATURE CONTROL
- LIGHTING CONTROL
- DIMENSIONAL CONTROL
- REGISTER CONTROL
- WEIGHING
- COUNTING
- BURGLAR ALARMS
- ETC. ETC.



The BTH Company also makes a wide range of Electronic Apparatus associated with power equipment for all purposes

**BTH RUGBY**

THE BRITISH THOMSON-HOUSTON COMPANY LIMITED, RUGBY, ENGLAND  
A.3749N

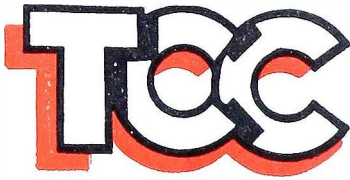

# DRY ELECTROLYTICS

SINGLE, DUAL and TRIPLE CAPACITORS in the now famous "MICROPACK" and "LECTROPACK" All-aluminium constructions

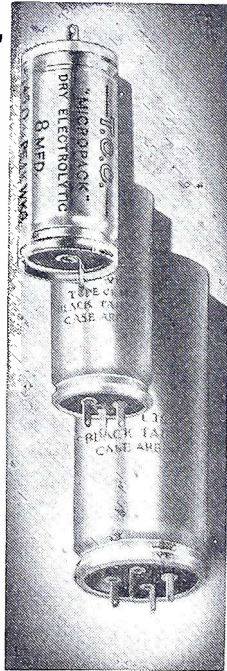

## "MICROPACK" AND "LECTROPACK" SINGLE SECTION CAPACITORS

Capacitance Mfds.	Peak Wkg. Volts	Dim'n's Inches L D	Type No.	Retail Price Each	Capacitance Mfds.	Peak Wkg. Volts	Dim'n's Inches L D	Type No.	Retail Price Each
50	12	1 1/2 x 1/2	CE32B	2/9	8	200	1 1/2 x 1/2	CE18G	3/3
1000	12	2 1/2 x 1/2	CE10B	8/6	16	200	1 1/2 x 1/2	CE24G	4/-
2000	12	2 3/4 x 1/2	CE23B	12/-	24	200	2 1/2 x 1/2	CE25G	4/6
					32	200	2 3/4 x 1/2	CE26G	5/6
25	25	1 1/2 x 1/2	CE32C	2/9	2	350	1 1/2 x 1/2	CE17L	3/-
50	25	1 1/2 x 1/2	CE18C	3/-	4	350	1 1/2 x 1/2	CE18L	3/3
500	25	2 1/2 x 1/2	CE10C	8/6	8	350	2 1/2 x 1/2	CE11L	3/9
1000	25	2 3/4 x 1/2	CE23C	12/-	16	350	2 3/4 x 1/2	CE26L	4/9
					30	350	2 3/4 x 1/2	CE29L	6/6
12	50	1 1/2 x 1/2	CE32D	2/9	40	350	2 3/4 x 1/2	CE10L	7/6
25	50	1 1/2 x 1/2	CE18D	3/-					
50	50	1 1/2 x 1/2	CE24D	4/-	1	450	1 1/2 x 1/2	CE32P	2/9
100	50	2 1/2 x 1/2	CE26D	5/6	2	450	1 1/2 x 1/2	CE18P	3/3
250	50	2 3/4 x 1/2	CE10D	8/6	4	450	2 1/2 x 1/2	CE11P	3/9
500	50	2 3/4 x 1/2	CE23D	12/-	8	450	2 1/2 x 1/2	CE19P	4/6
					16	450	2 1/2 x 1/2	CE29P	6/-
250	100	2 3/4 x 1/2	CE23E	12/-	24	450	2 3/4 x 1/2	CE10P	7/6
					32	450	2 3/4 x 1/2	CE37P	10/-
8	150	1 1/2 x 1/2	CE18F	3/-					
16	150	2 1/2 x 1/2	CE11F	3/3	4	500	2 3/4 x 1/2	CE13P	4/9
32	150	2 3/4 x 1/2	CE19F	4/6	8	500	2 3/4 x 1/2	CE10P	6/6
					16	500	2 3/4 x 1/2	CE14P	9/6
2	200	1 1/2 x 1/2	CE31G	2/9					
4	200	1 1/2 x 1/2	CE32G	3/-					

## "LECTROPACK" DUAL SECTION CAPACITORS

16-16	150	2 3/4 x 1/2	1	CE34F	6/-	*16-16	350	2 3/4 x 1/2	1	CE34L	8/6
20-20	150	2 3/4 x 1/2	1	CE35F	6/6	24-8	350	2 3/4 x 1/2	1	CE28L	8/6
*32-24	150	2 3/4 x 1/2	1	CE34F	7/6	24-16	350	2 3/4 x 1/2	1	CE28L	9/-
*50-30	150	2 3/4 x 1/2	1	CE35F	8/6	30-30	350	4 1/2 x 1/2	1	CE37L	12/-
						32-16	350	4 1/2 x 1/2	1	CE37L	11/-
16-16	275	2 3/4 x 1/2	1	CE27H	7/-						
25-25	275	2 3/4 x 1/2	1	CE28H	9/-	4-4	450	2 3/4 x 1/2	1	CE34P	6/-
						8-8	450	2 3/4 x 1/2	1	CE27P	7/6
8-8	350	2 3/4 x 1/2	1	CE35L	6/-	16-8	450	2 3/4 x 1/2	1	CE28P	9/-
16-8	350	2 3/4 x 1/2	1	CE27L	7/6	16-16	450	4 1/2 x 1/2	1	CE37P	11/-
16-16	350	2 3/4 x 1/2	1	CE28L	9/-	24-16	450	4 1/2 x 1/2	1	CE37P	12/-

\* Etched Foil Construction.

## "LECTROPACK" TRIPLE SECTION CAPACITORS

30-10-10	350	4 3/4 x 1/2	1	CE39L	12/6	8-8-8	450	3 1/2 x 1/2	1	CE38P	11/-
8-4-4	450	2 3/4 x 1/2	1	CE10P	10/-	16-8-8	450	4 1/2 x 1/2	1	CE39P	12/6

**LEADERSHIP** T.C.C. "MICROPACK" and "LECTROPACK" electrolytics have established themselves among discriminating dealers and service engineers as first choice for all condenser replacement purposes.

**RELIABILITY** Hermetic sealing, "ALL-ALUMINIUM" construction and conservative rating ensure reliability of performance.

**RANGE** The above tables show only an abridged version of the extensive ranges featured in List No. 123 (available on request). There are T.C.C. replacements available for all purposes from American midgets to television receivers or public-address equipment.

T.C.C. Lists Nos. 123 & 132 showing extensive ranges of Paper, Mica, Ceramic & Electrolytic Capacitors are available on request. Send 2½d. Stamp.

**THE TELEGRAPH CONDENSER CO., LTD.**

RADIO DIVISION

NORTH ACTON · LONDON · W · 3

TELEPHONE: ACORN 0061

WHEN THE PROBLEM IS  
TEMPERATURE CONTROL  
THE ANSWER IS . . . . .



★ Ask us for appropriate literature—  
SUNVIC CONTROLS LIMITED  
10, Essex Street, Strand, London, W. C. 2.

ELEKTRON A8 unsuperheated.  
Mag. X 300

We are exhibiting at the BRITISH INDUSTRIES FAIR, Olympia, Stand No. C. 50

TAS/SC. 202

# RM

## Radio Feeder

### 483

Designed to supply radio signals to all classes of amplifiers. Three wavebands. Output, 5 volts across 680 K-ohms. Three valves: 6K8G, 6K7G, 6Q7G. Price: £12 12s., plus £4 1s. 10d. purchase tax.

*Send for full particulars*

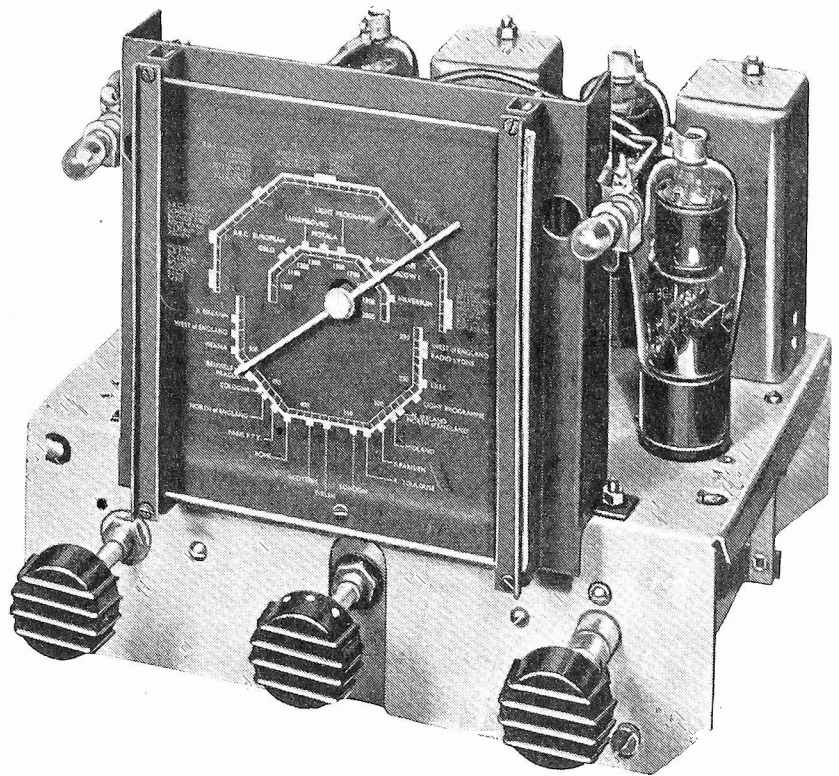

R. M. ELECTRIC LTD., TEAM VALLEY, GATESHEAD, 11.

## — ALL-POWER —

### CONSTANT VOLTAGE POWER SUPPLIES

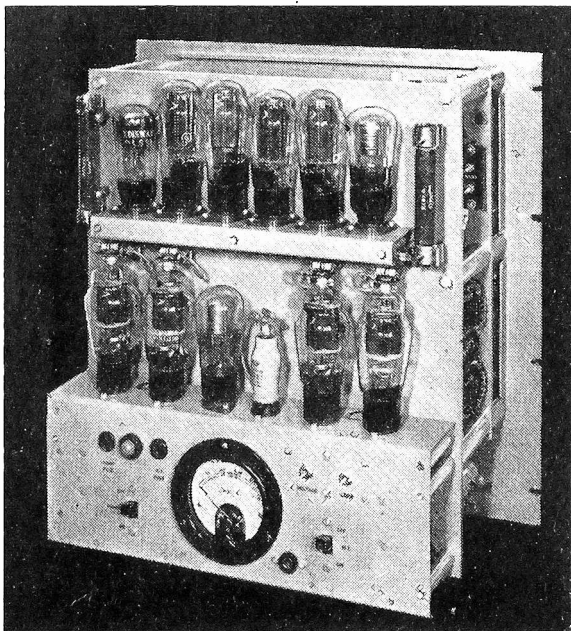

#### SPECIAL LABORATORY UNITS

This forward mounting Rack Unit, illustrated with cover removed, provides a constant output voltage of 300 D.C. at any current up to 600 mA. The output impedance is a fraction of an Ohm, and the residual output ripple is less than 2 mV.

This is only one of the many special Power Supply Units we are making to customers' requirements.

**ALL-POWER TRANSFORMERS LTD.**  
8a, Gladstone Road, Wimbledon, S.W.19

Tel. : LIBerty 3303



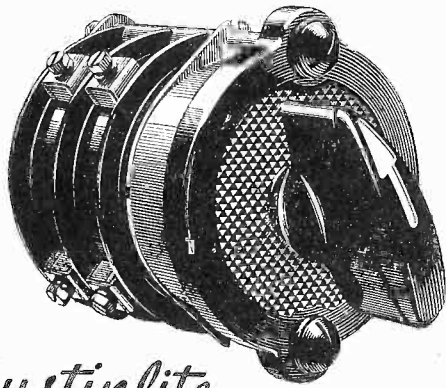

## Austinlite ROTARY SWITCH

A new, heavy-duty 30 amp. switch of robust construction suitable for multi-circuit operations and capable of giving a long and trouble-free life. Can be built up into 1, 2, 3, 4 or 5-cell units providing a large range of contact combinations. Send for folder giving full particulars.

Made by  
**AUSTINLITE LTD.**  
(Department J.)  
**LIGHTHOUSE WORKS**  
SMETHWICK  
BIRMINGHAM



(Proprietors: CHANCE BROTHERS LTD.)

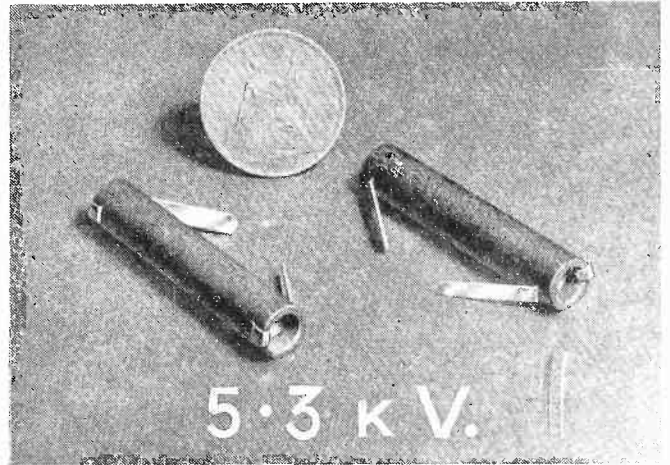

from two rectifiers each only  $2\frac{1}{2}$  ins. long,  $\times \frac{7}{16}$  in. diameter.

An outstanding advance in metal rectifier design has resulted in such a great reduction in size and weight that the 36EHT rectifiers can be soldered directly into the receiver wiring. The two units type 36EHT45 illustrated will deliver 5.3 kV output in a voltage doubler circuit fed with line flyback pulses from a television line output transformer.

## WESTINGHOUSE WESTALITE 36 EHT. RECTIFIERS

Write for Data Sheet No. 60 to Dept. E. Engr. 4, Westinghouse Brake & Signal Co. Ltd., 82 York Way, King's Cross, London, N.I.

# “Cyldon”

MICA DIELECTRIC TRIMMER Capacitors

Type No. 10

Type No. 1 P

Type No. 193

**SYDNEY S. BIRD & Sons, Ltd.**

CAMBRIDGE ARTERIAL ROAD, ENFIELD, MIDD.

Phone: Enfield 2071-2 Grams: Capacity, Enfield.

## TELCON<sub>RF</sub> CABLES

for all Television  
and Radio Requirements

CABLE CHARACTERISTICS

CODE	Zo.	CAPACITY	ATTENUATION
K12SM	60-	24 $\mu$ F	At 1 Mc/s 1.2 db/100Ft
	75	per foot.	„ 10 „ 3.0 „ „ „
	ohms.		„ 50 „ 6.0 „ „ „

OVERALL DIAMETER:— .250"

TYPE:—Screened Balanced Twin Flexible,  
P.V.C. Sheathed.

Further details of this and other  
R.F. Cables on application.

**THE TELEGRAPH CONSTRUCTION & MAINTENANCE CO. LTD.**

Founded 1864

Head Office: 22 OLD BROAD ST., LONDON, E.C.2. Tel: LONdon Wall 3141

Enquiries to TELCON WORKS, GREENWICH, S.E.10. Tel: Greenwich 1040

*They used a NEW material...*

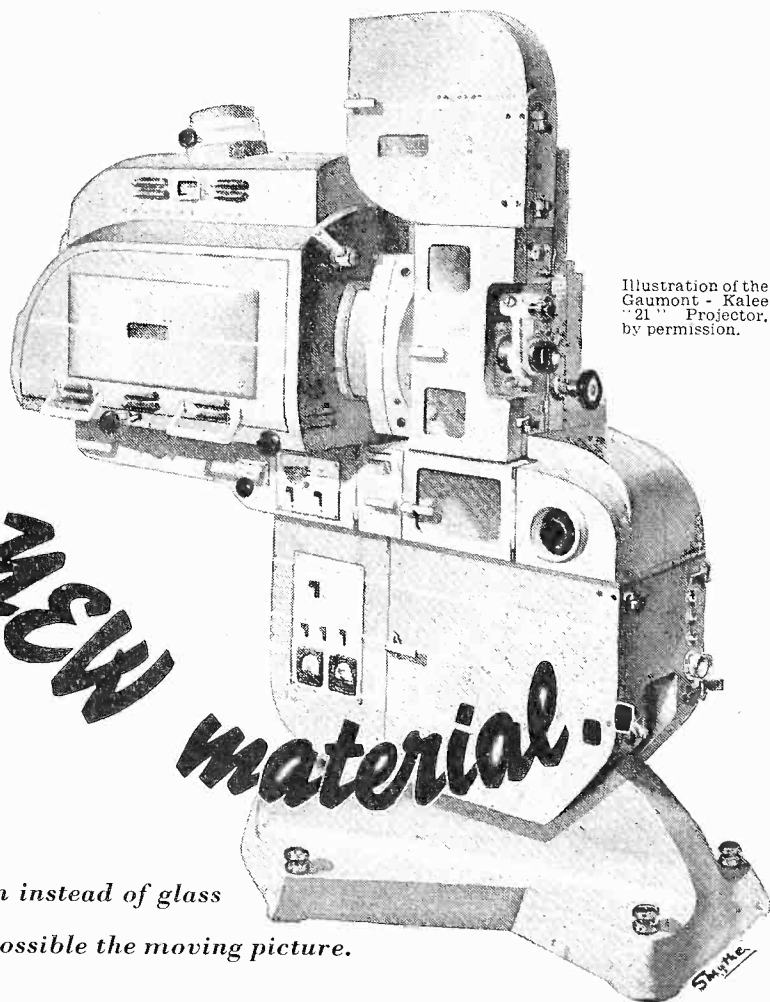
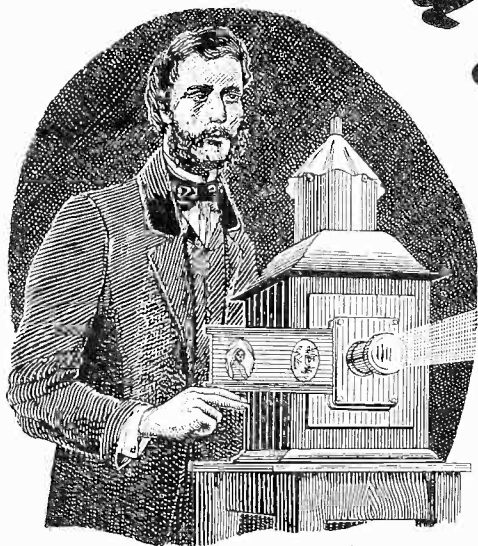

Illustration of the Gaumont - Kalee "21" Projector, by permission.

*... film instead of glass made possible the moving picture.*

Similarly, engineers are using TUFNOL, a comparatively new material, with advantage to improve their products and plant. In practically every industry TUFNOL has proved to be the solution to tricky problems—as improved gear wheels,

textile bobbins, aircraft pulleys, chemical trays and electrical insulators to name only a few of the thousands of different uses. Can TUFNOL improve your products or plant? Write for fuller details or ask for one of our technical staff to call on you.

- TUFNOL . . . a comparatively new material. Made in the forms of sheets, tubes, rods, bars, angles and channels.

- For quantity production, some components can be moulded to shape during manufacture.

- Light in weight, strong, electrical insulator, resists corrosion, unaffected by water, oil or petrol. Does not warp. Is not attacked by rodents or termites.

- Can be machined easily and accurately.

**TUFNOL**  
*The Engineer's Material*

An ELLISON Product made by **TUFNOL LTD** Perry Barr Birmingham 22B

# Electronic Engineering

EDITORIAL, ADVERTISING AND PUBLISHING OFFICES, 28, ESSEX STREET, STRAND, W.C.2.

TELEPHONE: CENTRAL 6565 (10 LINES)

MANAGING EDITOR: G. PARR, M.I.E.E.

TELEGRAMS: LECTRONING, ESTRAND, LONDON

Monthly (published last Friday of preceding month) 2/- net. Subscription Rate: Post Paid 12 months 26/-.

Vol. 20. No. 242

## CONTENTS

April, 1948

<b>The Detection of Cracks by X-Rays and Gamma Rays</b> ... .. By C. Croxson, B.Sc., F.Inst.P. ... .. 106	<b>The Cathode-Follower—Part 4</b> ... .. 126 By E. Parker, M.A. (Oxon) A.M.I.E.E.
<b>A Direct Reading Indicator for Electronic Counters</b> ... .. By G. T. Baker, M.Sc. ... .. 112	<b>New Cathode-Ray Engine Analyser</b> ... .. 130 By J. H. Jupe, A.M.I.E.E.
<b>The R.C.M.F. Exhibition</b> ... .. 114	<b>Correspondence—The Synchrodyne</b> ... .. 132
<b>25 Years of Component Making</b> ... .. 118 (Belling & Lee's Jubilee)	<b>April Meetings</b> ... .. 133
<b>High Vacuum Pumps—Part 4</b> ... .. 122 By R. Neumann, Dipl.Ing., A.M.I.Mech.E.	<b>Book Reviews</b> ... .. 134
<b>Magic Eye Tubes as Polarity Indicators</b> ... .. 125	<b>Abstracts of Electronic Literature</b> ... .. 136

## American Radio

### Some facts and figures

**M**R. BOND GEDDES, Vice-President and General Manager of the American Radio Manufacturers' Association, recently gave evidence before a House of Representatives' Committee on the state of the American radio industry. A summary of his statement is given here.\* The figures given show the rapid expansion of the American radio industry in the years immediately following the war, and will be interesting news to many engaged in the corresponding industry in Britain.

The American R.M.A. comprises about 325 principal manufacturers of all types of radio and electronic equipment, including 193 set makers (as compared with 57 pre-war), and of these about 65 are major firms.

The factory employment is estimated at 300,000, and in addition there are 1,500 radio distributors and wholesalers and 35,000-50,000 dealers. With 40,000-50,000 servicemen, the total industry employs about half a million. The average hourly wage for all types of labour, skilled and unskilled is now \$1.19 (4s. 6d.) against \$0.68 (2s. 8d.) pre-war.

Radio business in America is composed mainly of scores of small parts suppliers and set makers on a modest scale. It is highly competitive, to the point of being "cut-throat," and only about 50 of the 290 manufacturers in the Association in 1927 have survived. Conditions to-day are at their competitive peak, owing to the entrance of many new firms into the business.

Radio set ownership among the American people is estimated (according to the F.C.C. Report) at 73,000,000. There is at least one radio in 91 per cent. of homes, and the average home ownership is two sets.

In 1947 the industry had a record production of 18 million sets of all types compared with the previous

record of 16 million in 1946, the first post-war year of full production. The estimated value of this production is \$1,271,100,000 or about £251,300,000.

#### F.M.

A year ago the F.C.C. predicted that there would be more than 700 F.M. stations on the air by the end of 1947. Actually there are 379 stations in operation. Largely as a result of the inability to secure network music on F.M. broadcast programmes, the industry's 1947 production was only 1,150,000 receivers, or less than half the anticipated figure.

#### Television

The production of television receivers in the last five years has totalled 183,000, but nearly all this quantity has been produced in 1947. Estimates give a total of 500,000 receivers to be made in 1948, with a value of nearly \$250,000,000. The rapid growth of post-war television is shown by the following figures:

### PAPER SALVAGE

The need for salvage is once more vital and help must be given now. Every engineer can help in the drive for waste paper.

Here are some of the sources of paper salvage with which engineers are directly concerned:—

- Obsolete textbooks
- Periodicals
- Old catalogues
- Reprints of papers
- Lecture note-books

Make an effort to go through your files in the office and at home and put out waste paper for collection.

Your local salvage organisation will collect it—don't delay.

Year	Sets made	Value in dollars
1943	1342	(Millions) 0.427
1941	389	0.152
1942	953	0.176
1946	5367	2.050
1947	175,000	102.000

\* Reproduced with acknowledgements to *Radio News* magazine, March 1948.

# The Detection of Cracks

by X-Rays and Gamma Rays

By C. CROXSON, B.Sc., F.Inst.P.\*

Based on a lecture given at a Symposium on "Methods of Crack Detection," July, 1947, arranged by the Industrial Radiology Group of the Institute of Physics.

**T**HE applications of radiology surveyed in this paper cover a remarkably wide field, embracing metals and non-metals, magnetic and non-magnetic metals and alloys, and thicknesses ranging from a few hundredths of an inch in spot welds to 4 in. or more of steel, and equivalent thicknesses of other materials. The results are, unlike those of some other methods, not affected by looseness of structure in metallic castings or by inhomogeneities in the material, and the method can be used both for the investigation of cracks which are visible on the surface and also for the detection of those which are wholly internal. The most common applications are probably to steel castings and welds, in thicknesses ranging from  $\frac{1}{2}$  in. to 2 in.

In view of this wide field, no more than passing mention can be made of many defects which, though not strictly cracks, have crack-like characteristics; these include laminations in rolled plates, lack of fusion in welds, fish eyes in welds, badly fitting rivets, fine gaps between the walls of containers and their contents, microporosity in magnesium alloy castings, and dendritic formations in steel and non-ferrous alloys. Some of the crack-like appearances which have been seen in radiographs are shown in Fig. 1, and none of these is a genuine crack.†

## Geometrical Characteristics of Cracks

One outstanding characteristic of cracks is their great diversity; another is that they tend to emerge nearly normal to the surface when not wholly internal. The emergence is often obscured in castings by the surface layer of scale: in steel forgings a crack may be so fine as to be invisible even on a polished surface, viewed with a hand lens. The ends

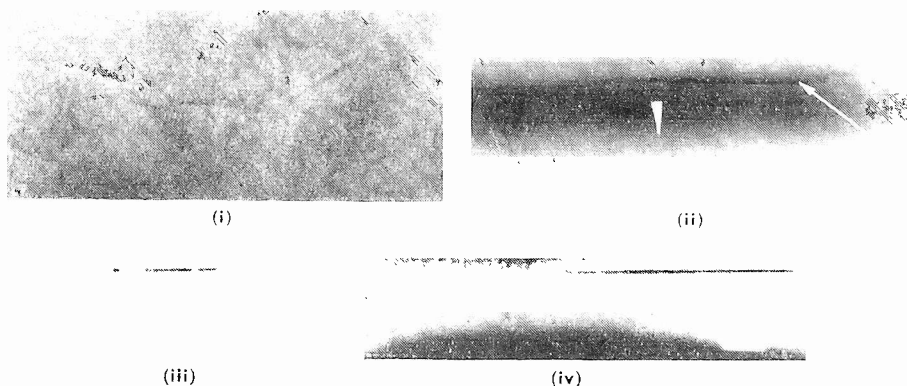

Fig. 1. Radiographs of some crack-like defects

- (i) Dendritic structure in cast tin-bronze (gamma rays)
- (ii) Internal flaws in steel forging (X-rays)
- (iii) Lack of fusion in weld (X-rays)
- (iv) Small pipe in  $1\frac{1}{4}$  in. dia. gunmetal rod (X-rays)

of a crack taper to disappearance, which is a useful fact in radiographic interpretation.

The liability of a crack to extend is one reason why the defect is regarded so seriously. Repair was formerly considered to be unsafe but it is nowadays a commonplace under radiographic supervision. Radiography may, of course, prove a suspected crack to be nothing more than a shallow surface defect.

## General Radiographic Technique

There is very little published work on the radiography of cracks, and much more investigation is needed. One rather discouraging factor is the difficulty of assessing the mechanical significance of a crack by correlating radiographic results with practical experience. This, however, need not prevent systematic work on technique.

The radiographic conditions are clearly much the same as for the recording of fine detail but are modified by the geometry of the crack, which may not inaptly be described as "length without breadth." The controlling factors in producing a good radiograph are contrast and definition. Little need be said about the former except that

high contrast is secured by reducing the tube voltage as much as possible without prolonging the exposure time unreasonably, and provided that adequate protection can be given against the effects of scattered radiation. Gamma rays are equivalent as regards contrast to very high voltage X-rays and are of comparatively low sensitivity for flaw detection especially for thicknesses below one inch of steel.

Sharp definition is achieved by placing the film as close as possible to the specimen, by ensuring good contact between film and intensifying screens, and by choosing a distance between the focus of the X-ray tube and the specimen such that the penumbra is imperceptible. Experimental work at Woolwich has shown that penumbral unsharpness is not so detrimental as might be supposed when one considers the small width of a crack, and a slight broadening of a fine image by penumbra may even enhance its perceptibility. The penumbral width need not be reduced below 0.01 in., a value which is readily attainable: incidentally, tube distances can often be reduced without loss of diagnostic value from those normally employed especially in the

\* Armament Research Department, Ministry of Supply.

† All the radiographs in this paper are reproduced as they appear in the original films, that is, they are so-called radiographic "negatives."

radiography of thin specimens.

It has been found, on the other hand, that graininess in the photographic film is very detrimental and breaks up the image so that the latter becomes merged in the background. The experiments have shown a progressive improvement in sensitivity as the graininess is reduced, other factors being maintained constant, and for critical radiography the use of fine grain high contrast film with metal intensifying screens is essential. For maximum sensitivity, the film should be exposed to a density of about 2 reached by development for 3 or 4 minutes in a standard MQ developer. The pronounced graininess of gamma radiographs is probably at least as serious a factor as the inherently low contrast of gamma rays in producing the lower sensitivity as compared with X-ray radiographs.

Projective enlargement has been introduced in Germany to overcome the effects of grain. The method, as shown in Fig. 2, is to project an enlarged radiographic image on to the film by placing the film a considerable distance from the object, so that the image details are large compared with the grain. Berthold<sup>1</sup> states that an appreciable improvement results from an enlargement of 2 or more. While this is true for standard film, the author has found that no added resolution can be perceived by projective enlargement on to fine detail film, even when using an X-ray tube with a focus of only 0.3 mm. diameter. There appears therefore to be little advantage in projective enlargement, provided that fine grain films are used.

When the above conditions are observed, radiography is undoubtedly a very sensitive method of detection if the crack is oriented in line with the rays. The factor of orientation was investigated by Warren<sup>2</sup> for artificial "cracks" in steel 1 in. thick using X-rays, and some additional results have since been published by Berthold.<sup>3</sup> Warren found that the angular deviation through which a crack remains discernible depends on its width, and is in fact practically proportional to the width. Paradoxically, with a "deep" crack ( $\frac{1}{4}$  in.) such that the oblique view is a band of sensible width the depth dimension does not appear to enter into the discernibility, which is, however, sensitive to change of angle. With a shallow

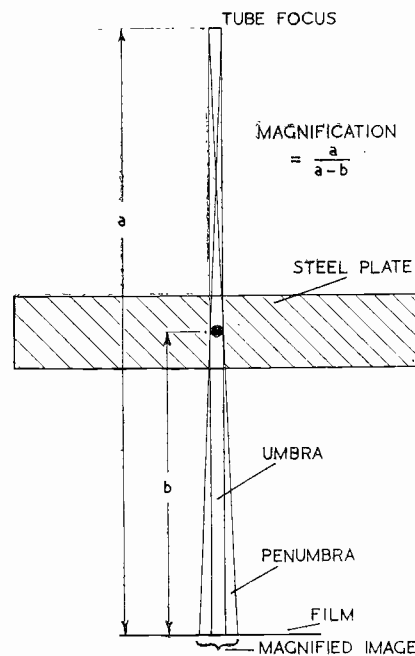

Fig. 2. Projective enlargement to minimise the effects of graininess

crack ( $1/16$ th in.) such that a change in the projected width of the trace is not noticeable to general observation, the discernibility is unaffected by change of angle and the intensity of the image is proportional, not to the width, but to the cross-section of the crack. This fact is attributed to the inability of the unaided eye to distinguish between the two elements of width and intensity when the image is very fine. It follows that the radiographic appearance is not a dependable guide in estimating the probable depth or width; a crack 0.005 in. wide and  $1/16$ th in. deep looks much the same as a crack 0.001 in. wide and  $\frac{1}{4}$  in. deep in a radiograph. Berthold's results<sup>3</sup> for cracks  $\frac{1}{4}$  in. deep in  $1\frac{1}{2}$  in. of steel show that a crack 0.01 in. wide can be seen when inclined as much as  $30^\circ$  to the X-ray beam, and this partially explains the ready detection of relatively broad cracks such as hot tears.

Very little information is available as to the dimensions of the smallest cracks which can be detected. Certainly cracks a few thousandths of an inch, that is 10 microns or less, in width can be found in steel up to about  $\frac{1}{2}$  in. in thickness. The criterion, however, is not entirely a dimensional one, so much depends on orientation and on variation in direction as the crack wanders through the metal; what really matters is whether the radio-

logical method is successful in practice. For this purpose the applications to metal castings, forgings and welds will be briefly surveyed in turn.

### Metal Castings

Perhaps the commonest type of crack occurring in castings is the hot tear, which in a large casting may extend to a length of two feet or more. Hot tears usually break through to the surface over some part of their length, but it is frequently found that they do not penetrate the surface skin of metal, and thus escape detection by visual surface examination; an example of this is shown in Fig. 3.

The direction of a hot tear can generally be inferred with sufficient accuracy and so long as there is accessibility to the part for which examination is required, little difficulty is to be anticipated either in detecting or diagnosing the defect. The problem of accessibility is illustrated in Fig. 4, and the examination of this casting was only possible by the use of gamma rays. The practical question is perhaps not so much to detect a crack as to find its full extent, and to ensure a sound repair by excavating and welding. Excavation of a crack without radiological verification is a common but a most unsatisfactory practice. The ends of a crack in a rough excavation are easily burred over by a chipping tool when, as shown in Fig. 5 there may be serious unsuspected cracks left in the metal. Furthermore one crack may be successfully cleared only to leave other completely separate cracks buried at a greater depth in the metal wall. In the majority of castings dealt with in the author's experience the radiographs have shown further excavation to be necessary, although apparently clear to surface examination.

If a broad, deep crack is oriented very obliquely to the X-ray beam a pseudo-multiple appearance may result from the changes in direction as it wanders through the metal, only the portions which are in line with the rays (or nearly so) giving a trace on the film. This changing direction partially explains the difficulty often experienced in the interpretation of stereoscopic radiographs: the two exposures forming the stereoscopic pair record different portions of the crack (see Fig. 6), and it is little wonder that these will not combine to give a three-dimensional result. In spite of this,

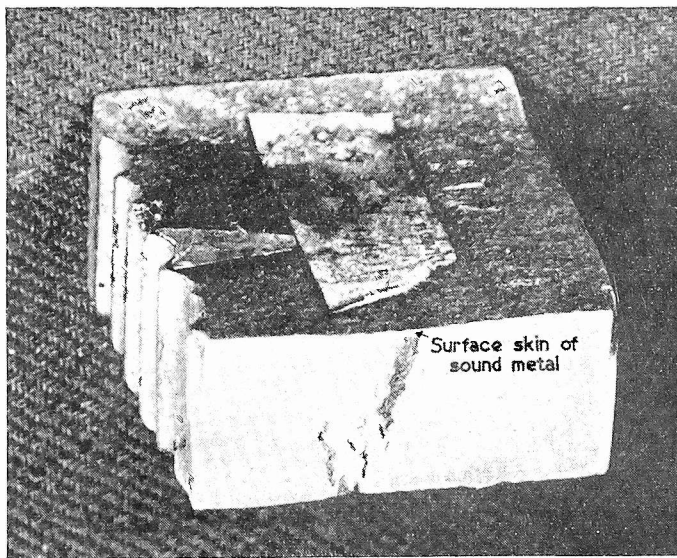
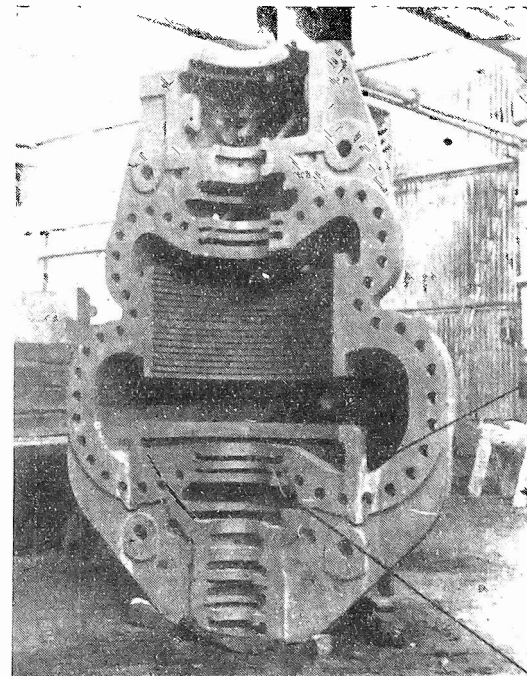

Fig. 3. Photograph of typical hot tears in portion of steel casting  $\frac{1}{8}$  in. thick



Upper surface of weld in this angle

To lower surface of weld

however, tube-shift exposures made on a single film can be used to locate and find the depth of a crack with sufficient accuracy to determine the best method of excavation. This has been done on many occasions with gamma rays, using fast salt screens, the exposure time with a 240 mgm. source of radium being of the order of 5 minutes for  $1\frac{1}{2}$  in. of steel.

Another type of defect found in steel castings is intercrystalline cracking. As a casting defect this is fortunately rare: fortunate because such cracking has a serious effect on the strength of the material and also because cracks of this kind can, at a first glance, be mistaken for relatively harmless shrinkage porosity.

A defect occasionally found, chiefly in non-ferrous alloys, may be conveniently described as a "negative" crack. This is formed by a crack becoming filled with solder, lead paint, or other dense material and thus producing a light instead of a dark image in the radiographic film: an example is shown in Fig. 7.

Two instances will serve to illustrate the application of radiography to castings. The first concerns a turbine casting in which a crack had been found during machining, and which was returned to the foundry and repaired without the aid of radiography. On return to the engineering firm it failed a second time on water pressure test. Radiography disclosed an extensive and

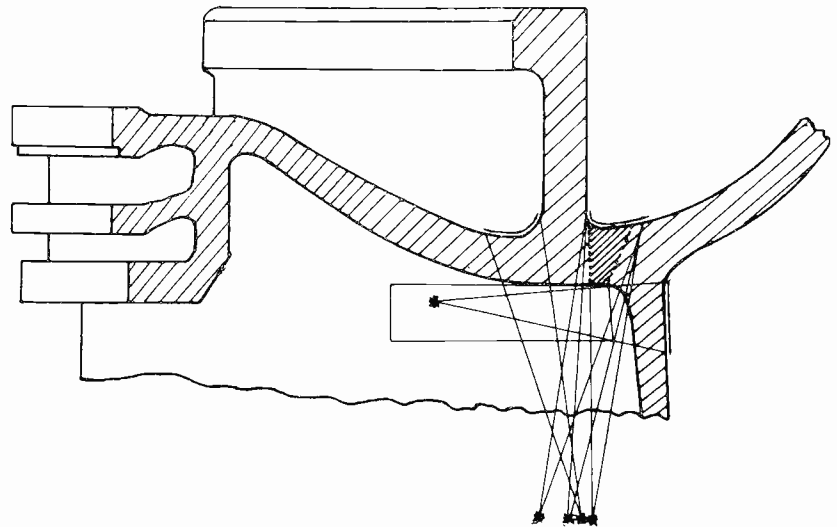

Fig. 4. H.P. turbine casting, and sketch showing section of welded region after removal of cracks

complex system of cracks but the casting, almost fully machined and very expensive was ultimately satisfactorily repaired and passed into service.

The second example concerns some particularly vital castings which after ten years' service, were all found to be cracked. The replacement castings in store, and new ones specially made to the same design, were then examined and found to be cracked in the same regions. The completely redesigned component was thoroughly vetted by radiography of the pilot casting and more than 70 castings of the new

type, each weighing about 10 tons, have since given yeoman service at a critical period in our history.

It can be stated that suspected cracks, unsuspected cracks, and incompletely excavated cracks, have been detected or located by means of X-rays or gamma rays and satisfactorily repaired in literally hundreds of the heaviest and most valuable steel castings. In the author's opinion the radiological method is reliable and indeed invaluable as applied to castings, and he has never heard of an authentic instance of a crack in a casting being missed by X-rays and subse-

quently disclosed by failure of the casting.

**Forgings and Processed Materials**

Compared with hot tears cracks in forgings are usually short, straight, planar and very fine. They may arise consequent on heat treatment, they may be due to local concentrations of stress (notch effect) or to corrosion, fatigue, stress corrosion and so on. In general a crack in a forging involves rejection, and repair by welding is not permissible because it may not be possible to follow up with the required heat treatment.

The problem is mostly to determine whether a more or less faint surface mark is a genuine crack or a shallow defect of little or no significance. Owing to the small width and depth radiography is necessary for detection. It would be assumed that the crack emerges normally to the surface, and if it is not detected on this assumption the area must be searched by means of successive exposures in which the inclination of the rays is varied in steps of about 5° on either side of the normal. The appearance of a crack will change markedly with a small shift of the X-ray tube while that of a forged-out inclusion remains almost unaltered.

The changing width of the image of an approximately plane, deep crack with the position of the X-ray tube enables, very often, a surprisingly accurate estimate of depth to be made, but it is impossible to be certain what accuracy is being attained in a particular specimen without sectioning the material. The table below gives some actual results obtained with six cracks in a forged steel tube, 1 3/8 in. wall, which was subsequently sectioned.

No. of Crack	DEPTH		WIDTH	
	From Radiograph	From Section	From Radiograph	From Section
1	.06	.05	.008	.011
2	.06	.04	.007	.010
3	.08	.07	.007	.010
4	.11	.10	.003 <sub>7</sub>	.004 <sub>5</sub>
5	.07	.08	.004	.005
6	.18	.17	.003	.004

Snowflakes are well known defects most commonly found in alloy steel forgings. They are in general wholly internal and of very varying direction. When they occur, as they usually do, in considerable numbers there is every prospect of detecting a substantial proportion of them if

the radiographic technique is good. Nevertheless, radiography of itself can scarcely be relied upon to give a complete picture.

Bare mention only can be made of

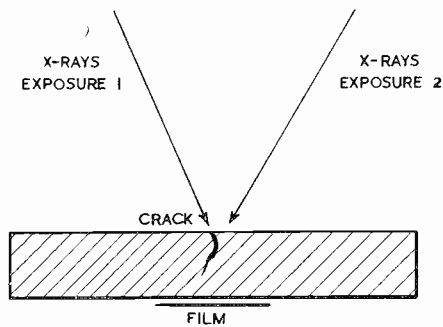

Fig. 6. Sketch illustrating how the different portions of a wandering crack are recorded in a stereoscopic pair of radiographs

cracks in riveted plates for the detection of which no special technique is required, and of corrosion defects in the inner surfaces of boilers and the like. Access to both sides of the material is essential and may be difficult, but the non-destructive value of the method is lost if the suspected area has to be cut out before the examination can proceed. It is usually possible, however, to find a radiographer small enough and sufficiently altruistic to crawl through a man-hole and set up the necessary exposures.

Some of the most difficult problems in radiography are the examinations of cylindrical rods or pipes, and circumferential butt welds of small diameter. The examination of a restricted area is fairly straightforward, but a 100

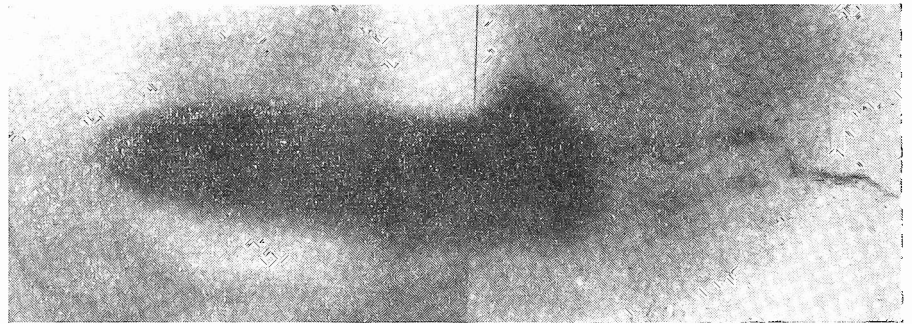
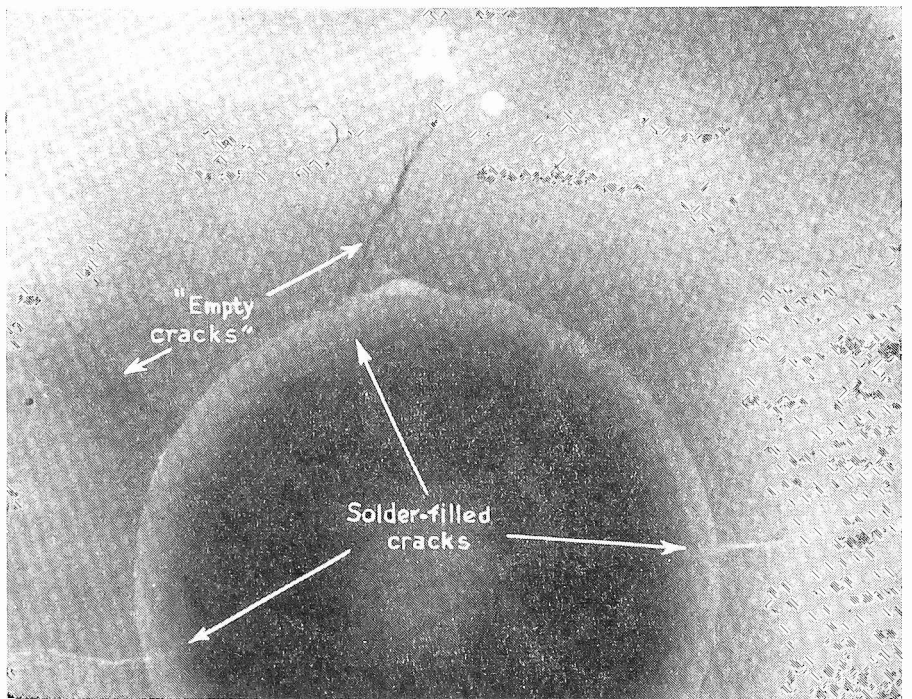

Fig. 5 (above). Composite radiograph (gamma rays) showing hot tears not completely removed by large excavation in centre

Fig. 7 (below). Radiograph (X-rays) showing normal and solder-filled cracks in cast bronze



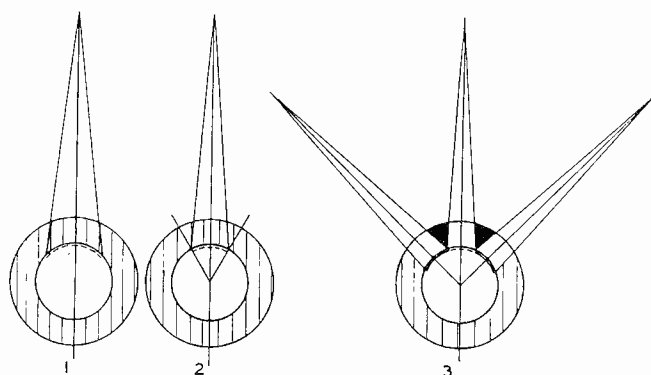

Fig. 8. Limiting factors in the radiography of pipes and cylinders

- (1) Increase of thickness with increasing obliquity of X-rays
- (2) Decreasing sensitivity with increase of angle between the rays and the normal to the metal surface
- (3) Large parts of metal not examined unless considerable overlap allowed

per cent. examination of a specimen of small diameter relatively to the wall thickness is often required and this is much more difficult. A full treatment of the problem is outside the scope of this paper, but briefly there are three factors which restrict the application of X-rays to the radiography of a metal wall which is convex to the X-ray tube (see Fig. 8):—

(i) The increasing thickness of metal to be penetrated as the obliquity of the radiation increases towards the edges of the field.

(ii) The decreasing sensitivity as the angle between the direction of irradiation and the normal to the surface increases, the crack being assumed radial.

(iii) The large amount of overlap required between adjacent exposures to cover the whole periphery, especially of a thick walled specimen of small diameter.

Analysis shows that (ii) is the major factor, and if high sensitivity is to be attained only a very small sector can be covered per exposure. The maximum length of arc on the inner surface is given by

$$l = 0.35 (d - t)r / (d + r)$$

where  $r$  is the internal radius,  $t$  the wall thickness, and  $d$  the source-to-film distance. For a tube of 4 in. external diameter and  $\frac{1}{2}$  in. wall thickness the length must not exceed approximately  $\frac{1}{2}$  an inch to ensure the detection of a radial crack 0.001 in. in width. Thus about twenty exposures would be required to cover the whole periphery which is quite impracticable. Insofar as there is any departure from this technique so are the results inferior to those attainable with a flat plate. Two methods are known in which these disadvantages may be overcome:—

(1) *Panoramic Rotational Radiographs.*

This method was described by

Warren<sup>2</sup> in 1935, and was also subsequently referred to by Berthold<sup>3</sup>; it is shown diagrammatically in Fig. 9. A film is placed round the whole of the inner periphery in close contact with the metal surface. The rays pass through a slit  $\frac{1}{2}$  mm. wide in a lead plate placed close to the cylinder, and between it and the X-ray tube: the cylinder is kept in continuous rotation during the exposure. This is a sensitive and easily applied method, but the exposure times are necessarily long, as each element of the cylinder is only exposed for a small fraction of the total time.

(2) *Film round the outside of a cylinder, source of rays inside.*

This method can be used for cylinders of a foot or more in diameter into which an X-ray tube can be inserted. Long anode tubes have a limited application for this purpose and a tube operating at 250 kV with a focus smaller than  $\frac{1}{2}$  mm. would be most useful. Extensive use is now made of gamma rays, and small radon seeds of high intensity and  $\frac{1}{2}$  mm. or less in width will give sharp definition in pipes down to 3 in. diameter; the poor contrast results, however, in a loss of sensitivity especially in wall thicknesses below 1 in. of steel. The length of pipe which can be examined per exposure is much restricted with a small source-to-film distance, but this is of little consequence in the examination of butt welded joints.<sup>4</sup> This common application has the disadvantage that root cracks are on the inner surface, that is the surface remote from the film, which is the worst position for detection. On the other hand the set-up is a good one for detecting lack of side fusion in a weld with V or U joint preparation.

Scattered radiation must receive due and respectful attention and one of the many curious effects of

scatter, this time a beneficent one, is known in the A.R.D. as the stencil effect. Where a defect emerges on the film side of a thick specimen the radiographic image is partially built up by a wash of soft, scattered radiation falling upon the final cracked layer from widely differing directions and giving a considerably enhanced image if the film is in close contact with the cracked surface. This ultra sensitivity rapidly decreases to normal value for a defect embedded  $\frac{1}{8}$  to  $\frac{1}{4}$  in. below the surface. Neff<sup>5</sup> pointed out that in general increased contrast results from placing the film up to an inch or so away from the metal surface. This does not hold, however, for an emergent defect on the inner surface because of the stencil effect and it is preferable to use a flexible cassette or wrapper with the film wedged in close contact with the surface as shown in Fig. 10 rather than a metal cassette placed along a chord—suitable precautions being taken, of course, to avoid pressure marks.

It will be seen that the radiography of fine cracks in forgings requires very good technique. The method is considered to be a reliable one in the hands of an experienced radiologist but it may not always be possible to give a definite diagnosis.

### Welds

Much of the foregoing applies to welds and the radiography of all grade I welds in pressure vessels and the like is now required by inspecting authorities. Since cracking is the defect most likely to cause failure if present, its detection was taken to form the basis of a specification prepared for another Service Department in 1941. This specification covered technique and acceptance limits for radiographic examination of fusion welded pressure vessels. It is understood that somewhat similar recommendations for general industrial use has already been published by another authority concerned with welding.<sup>6</sup>

The surfaces of grade I welds are as a rule ground smooth and therefore critical radiography is possible; this is also true of welded repairs in high-grade castings. Radiography is also used for the examination of fillet welds in fabricated structures. The difficulty with these is the rapid change of thickness in the metal section and there is also the difficulty of detecting lack of fusion and



cracks situated along the toes (see Fig. 11).

These cracks are mostly similar in character to hot tears in castings and are readily detected in butt welded joints. In the repair of a casting it may be necessary to fill an excavation in the form of a slot in the wall, and cracks tend to occur in the first run of welding bridging the gap in the metal; it is preferable therefore in radiographing the repair to place the film adjacent to the side where the original first run of welding was made; (incidentally, it is better to avoid piercing the wall during the excavation if at all possible). Failure occasionally occurs by the "springing" of a weld when cold, and such a crack tends to be fine, so that fine-grain high-contrast film should be used for such an examination.

The application of X-rays to spot welds has been described in a comprehensive series of papers by McMaster and his co-workers.<sup>6</sup> The low voltages (10 to 40 KV) and short focus-film distances employed for the radiography of the very thin material give rise to a rather specialised technique, but the detection and interpretation of the cracks appear to be readily achieved, and stereoscopic methods have been used with success even in these small thicknesses.

The most difficult problem with welds is the detection of short fine cracks occurring as root cracks, basal cracks, crater cracks, and cracks associated with inclusions. These are difficult not only because of their shortness, but because of their random orientation which makes detection very uncertain; and it is sometimes, in a thin weld, almost impossible to distinguish between a small crack and a slag "stringer." This is a limitation which must be accepted, but it seems questionable whether it is a really serious one. When it is remembered that the radiography of welded boiler drums has been in operation for about 15 years without any failure, so far as is known, and remembering the radiography of the Boulder Dam pipe line in America and of many welded bridge structures and the like in Europe the practical value of the method can hardly be doubted.<sup>7</sup>

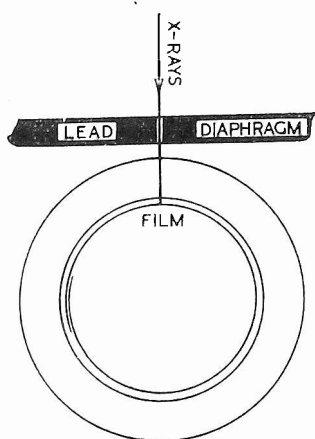

Fig. 9. Sketch illustrating the method of producing a Panoramic Rotational Radiograph

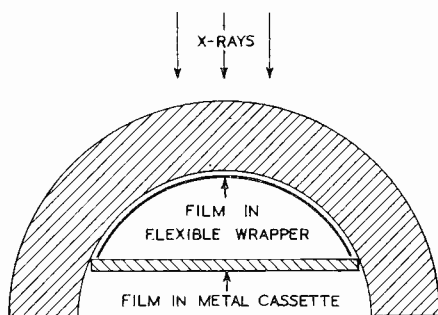

Fig. 10. Sketch illustrating the alternatives of flat or curved films in the radiography of a cylinder

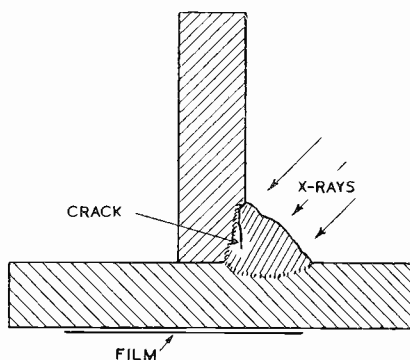

Fig. 11. Crack in toe of fillet weld. Note changing thickness of metal across the welded corner

**Conclusions**

The main points which have emerged from this brief survey are as follows:—

(1) The basic principles of radiographic technique are known, but much more investigation is necessary to find how the discernibility of cracks varies in materials of different thicknesses and densities.

(2) The circumferential radiography of tubes and cylinders, an

important industrial application, needs more attention than is perhaps generally realised and a thorough knowledge of technique is required especially for pipes and cylinders of small diameter.

(3) The radiological method can be considered sound and reliable with relatively few limitations. Limitations there must be since there are limits to what X-rays can reveal, but the practical criterion is whether it is possible for potentially serious cracks to escape detection by radiology. To this the author would say no in the case of hot tears and cracks in castings; also in forgings provided that good technique is used. In welds it is possible that small cracks would escape detection but these would appear to be of little practical significance.

(4) The increasingly widespread opinion that gamma rays are in all circumstances an efficient and a simple substitute for X-rays should be corrected before it becomes firmly established in industrial circles. The chief value of the gamma ray method is that it can be used to give a general picture in positions which are inaccessible to X-ray apparatus. There ought to be no doubt whatever that X-rays should be used for preference on every occasion when a critical examination is required.

(5) Finally, some of the most interesting applications of X-rays for the radiologist are to the various crack-like defects mentioned in the introduction. Further discussion of these must be deferred, but it can be said that radiological methods have been successfully used in the detection of all the defects enumerated.

**Acknowledgements**

Grateful acknowledgement is made by the author to his colleagues, in particular to Mr. W. J. Wiltshire, G.M., and Mr. J. W. Avery, for contributions to the subject matter and for helpful criticism and advice.

The paper is published by permission of the Chief Scientist, Ministry of Supply.

**References**

- <sup>1</sup> Berthold and Vaupel. *Aluminium*. 1943. 127.
- <sup>2</sup> Warren. *B.J.R.*, 8. 1935. 235.
- <sup>3</sup> Berthold. *Atlas der zerstörungsfreien Prüfverfahren* 1937.
- <sup>4</sup> Dawson. *J.Sci.Inst.* 23. 1946. 138.
- <sup>5</sup> Neef. *Zeit. f. tech. Phys.* 6. 1925. 208.
- <sup>6</sup> McMaster and others. *Welding J.* 25. 1946. 707, 851. 26. 1947. 121, etc.
- <sup>7</sup> Rhoades. *Welding J.* 26. 1947. 497.

# A Direct Reading Indicator for Electronic Counters

By G. T. BAKER, M.Sc.\*

**E**LECTRONIC counters are being applied to an increasing number of industrial functions. Two fundamental requirements of such counters, as distinct from their laboratory equivalents, are robustness and ease of reading. In most applications, a binary indication would be a serious disadvantage, and some form of decade counter is essential. Of the several types of decade available, that constructed from four "scale-of-two" stages<sup>1</sup> is probably the most suitable. A counting rate of, say, 50 Kc/s. is ample for most industrial requirements, and if sufficient positive and bias potentials are allowed, this circuit can be constructed with wide tolerance components, and is stable over a considerable range of operating conditions.

Indication is, however, more difficult on this circuit than on others. The four neon tubes arrangement<sup>1</sup> is simple, but leads to errors when used by a semi-skilled operator on

\* Automatic Telephone and Electric Co., Ltd.

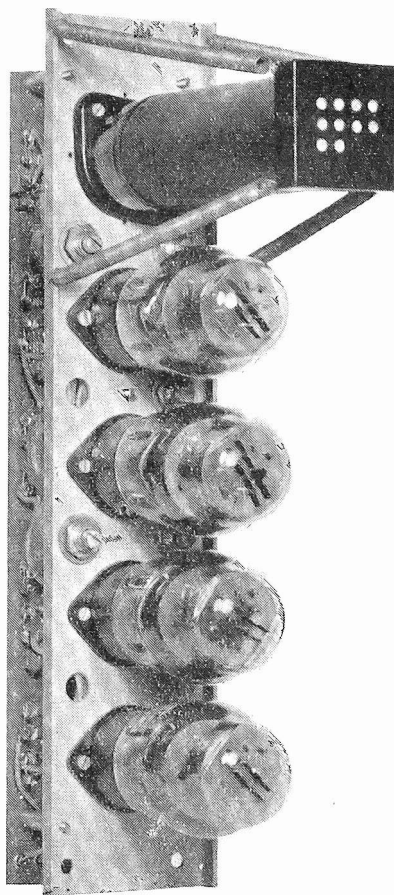

Fig. 4. Typical decade with indicator in position

repetition work. Grosdoff<sup>2</sup> shows a system using ten neon tubes, one for each integer. Like the current summation arrangements, this system is somewhat marginal, and involves a control over the plate potentials which nullifies one of the main advantages of the circuit.

Regener<sup>3</sup> discloses a method whereby the count is indicated by the position of the spot on a cathode-ray tube. This he uses in conjunction with a ring-type counter, but the same instrument applies more readily to the  $4 \times 2S$  type of decade. The following notes describe a simple and robust indicator, which can be read with such speed and certainty as to make it very suitable for industrial instruments.

In Fig. 1, each of the vertical elements represents a binary stage, the short thick strokes indicating the anodes. It is assumed that the four lower valves are conducting in the resting or zero position. Deflection plates  $X_2$  and  $Y_2$  of the tube are virtually at the full positive potential, but plates  $X_1$  and  $Y_1$  being connected to conducting load resistors, are more negative by an amount  $V$ . This potential across each pair of plates displaces the spot upwards and to the left, i.e., to the position occupied by "0" in Fig. 2.

When the counter receives the first impulse, conduction is transposed in the first stage, and  $X_1$  and  $X_2$  are now at the same potential. The spot moves into a neutral or undeflected position horizontally, thus indicating "1." The next impulse restores the potential on  $X_1$ , but also transposes the second stage. The potentiometers forming the load resistors are so adjusted that the potential on the  $X_2$  plate is equal to  $2V$ . Consequently this plate is now the more negative by an amount  $V$ , and the spot moves an equal distance to the right to indicate "2." The third impulse

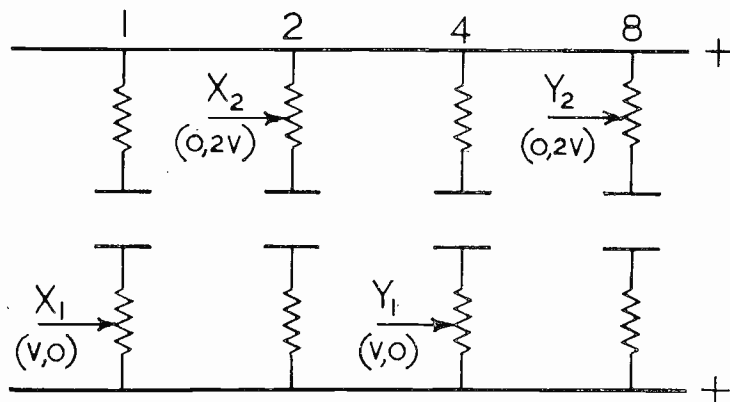

Fig. 1. (above) Plate connexions

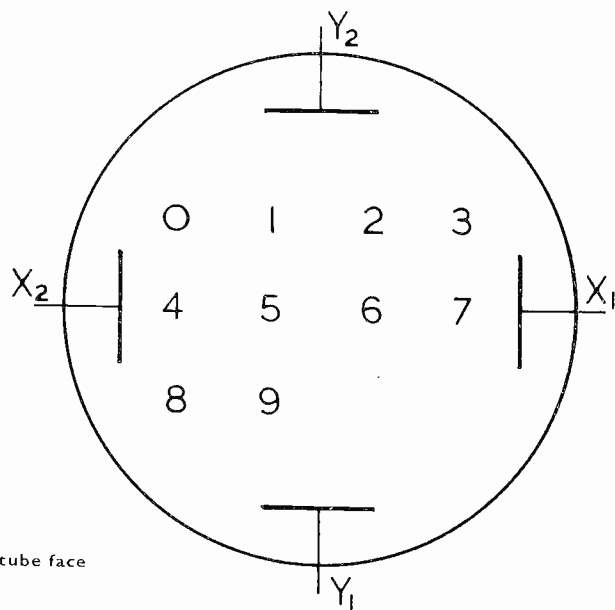

Fig. 2. (right) Layout of scale for tube face

again transposes the first stage to remove the potential  $V$  from  $X_1$ .  $X_2$  is now more negative by  $2V$ , and the spot moves one step further to the right to indicate "3."

On the fourth impulse, the third binary stage is actuated, and the negative potential  $V$  is removed from  $Y_1$ . The spot drops to the vertical mid-position, but since the first two stages have been reset, the horizontal displacement is similar to "0," and the spot indicates the integer "4." Further impulses re-operate the first two stages as before, and the spot moves horizontally to "5," "6" and "7." At the eighth impulse, the third stage restores, but the operation of the last stage produces a potential  $2V$  upon  $Y_2$ , making this plate the more negative by  $V$ . The spot drops one step below the mid-position and the locating of "8" and "9" will be obvious. At the tenth impulse the system re-sets to zero.

It will be noted that Fig. 2 shows the scale symmetrical about a vertical axis whereas the above description suggests that the frame should be displaced to the right. The symmetry is achieved by providing a standing potential upon  $X_1$ , which can be obtained by connecting the plate to a potential divider system as shown in Fig. 3. Resistances  $R_1$  and  $R_2$  are so chosen that the system is displaced one half step to the left, i.e., the potentials applied to plate  $X_1$  are not  $V$  and zero but  $1.5V$  and  $0.5V$ . To reduce the wattage, and so economise on the control potentiometers, it is advisable to make these of high resistance, e.g., 2 megohm, and to bridge the potentiometers by a fixed resistors equal to the required anode load. In this case, the positive side of the  $X_1$  potentiometer is connected to the shift divider system of Fig. 3, and the deflection plate is connected directly to the sliding arm.

The type of scale depends on the finish of the instrument. A simple method is to draw the figures on a piece of tracing cloth or detail paper, and to gum this on the face of the tube. The spot shines through and illuminates the integer corresponding to the state of the count. It is an advantage to draw each character in reverse and to attach the scale so that the figures touch the screen. The unwanted numbers are less obtrusive and the contrast is increased. A somewhat more elaborate arrangement uses a small metal cap or mask to hold the

tracing cloth against the face of the tube. Holes correspond to the position of the integers, and the body of the tube is coated with black paint to exclude back light. (Fig. 4).

The beam should be de-focused somewhat to illuminate the body of the character, and to prolong the life of the screen. When designing an instrument incorporating this type of indicator, it is desirable to have a separate control on the beam, either by a toggle switch or a push button. This can act either by disconnecting the positive supply to the tube or by applying a more negative potential to the grid or brilliance electrode. In some cases the beam control can be effected automatically, e.g., in timing instruments, the key controlling the timing cycle can also control the tube illumination. With these precautions, it is possible to use a fairly high beam current and to dispense with adjustable values for the

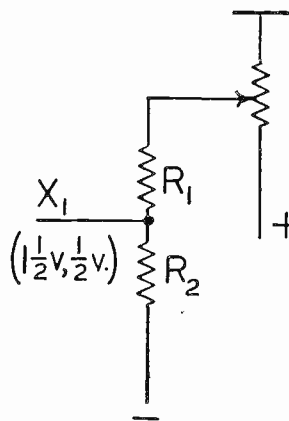

Fig. 3. Arrangement of shift circuit

focusing and brilliancy potentials, since a wide tolerance can be permitted. When a number of decades are conjoined to form a multi-digit counter, a single divider chain is sufficient to provide the intermediate potentials for all the tubes.

The tubes can be of the small monitoring type. A quite effective scale is obtained on an inch diameter screen, the character size and separation being approximately equal to that of a 2.5 in. straight scale. Efficient operation of the decade counter requires some 400-500 volts, which is sufficient to operate a small tube. The indicator should therefore add but little to complexity of the circuit.

References

- 1 Potter, *Electronics*, June 1944, p.110.
- 2 Grosdoff, *R.C.A. Rev.*, Sept. 1946, p.438.
- 3 Regener, *Rev. Sci. Inst.*, May 1946, p.185.

Printed Circuits

THE illustrations below show successive stages in making an amplifier from a printed circuit.

—M. Lorant.

Stearite plate after drilling and firing.

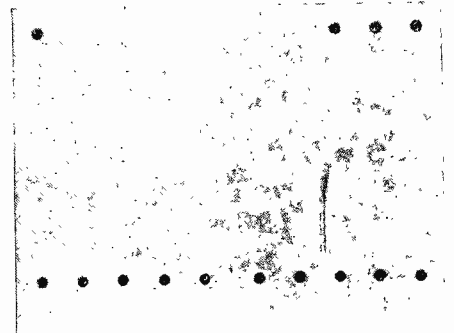
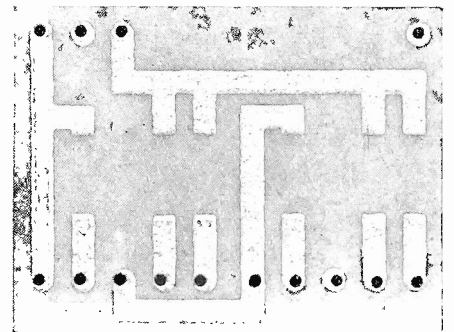
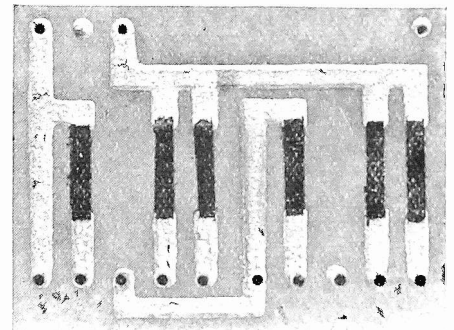

Plate with circuit wiring deposited



Resistor strips added



Miniature valves soldered direct to the wiring, making a 2-stage amplifier

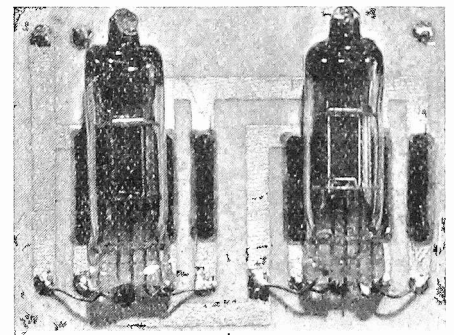

# The R.C.M.F. Exhibition

The fifth annual exhibition of British Radio, Television, and Electronic Components was held at Grosvenor House, Park Lane, on March 2-4, 1948. A selection of the newer and more important exhibits is given below. Further information can be obtained from the firms named.

## Aerials

The "Arnine" aerial is a folded dipole which, together with its supporting insulators, is embedded in polythene. This firm also exhibited aerials suitable for car radio and television.

—*Antiference, Ltd.*

67, Bryanston Street, W.1.

## Attenuators

Variable and fixed attenuators, screened and unscreened, with stud switching and one-hole fixing. Dials calibrated in db. can be supplied. Slider type heavy-duty faders will dissipate over 1 KW and work at 125°C.

—*Painton & Co.*

Kingsthorpe, Northampton.

## Cabinets

Instrument cases, standard rack and panel assemblies.

—*Alfred Imhof, Ltd.*

New Oxford Street, W.C.1.

—*Labgear, Ltd.*

Fair Street, Cambridge.

—*Weymouth Mnfg. Co., Ltd.*

Crescent Street, Weymouth.

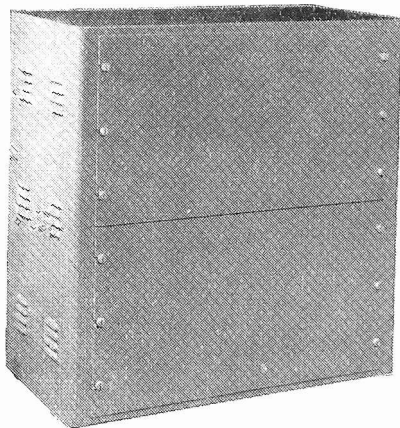

2-panel instrument case by Imhof

## Capacitors

Silvered mica capacitors of small size in a wide range of specifications and tolerances, with unusual stability.

—*Stability Radio Components, Ltd.*

Central Street, E.C.1.

A range of silvered ceramic capacitors is shown by *Fulham Electrical Components, Ltd.*, an associate of the *London Electrical Mnfg. Co., Ltd.*

459, Fulham Road, S.W.10.

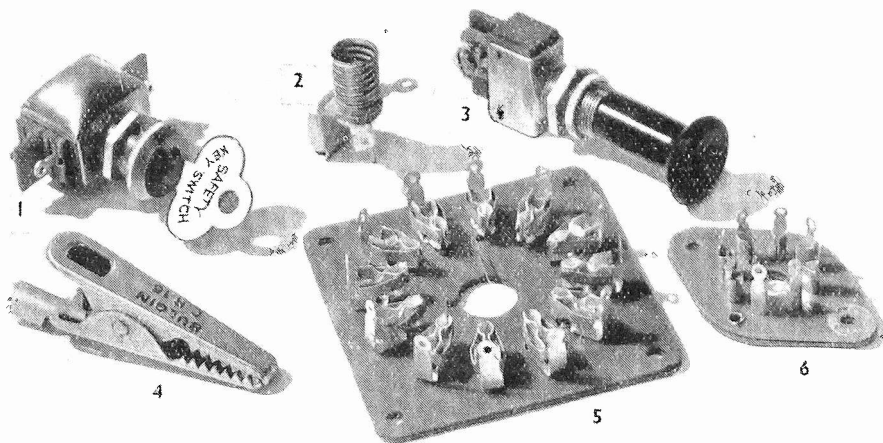

Some of the new Bulgin components: 1. Key switch. 2. Clip-on lamp socket. 3. Push switch for dashboards. 4. Large crocodile clip with identifying disk. 5. Cathode ray tube socket. 6. Valve socket.

—*A. F. Bulgin & Co., Barking*

Silvered mica capacitors, including twin capacitors for use as end-plates in I.F. transformers, and lead-through capacitors for bypassing in television receivers up to 300 pF (see illustration).

—*United Insulator Co., Ltd.*

Toutley Works, Wokingham.

## Tubular Paper

Paper capacitors for fluorescent lighting, and hermetically sealed types for tropical use.

—*Ferranti, Ltd.*

Hollinwood, Lanes.

Complete range in aluminium containers or wax-dipped bakelite tubes.

—*Static Condenser Co., Ltd.*

Oakcroft Road, Tolworth.

## Metallised Paper

A special range of miniature metallised paper capacitors possessing self-healing properties.

—*A. H. Hunt, Ltd.*

Garratt Lane, S.W.18.

A new addition to the "Cathod-ray" range of capacitors is a 0.0005  $\mu$ F type rated at 25 KV for

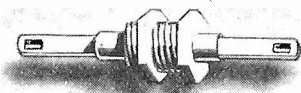

Lead-through capacitor—*United Insulator Co.*

use in projection-type television receivers.

—*Telegraph Condenser Co., Ltd.*

North Acton, W.3.

## Capacitors—Pre-set and Variable

Air-dielectric and "postage-stamp" trimmers in strips up to six units.

—*Wingrove & Rogers, Ltd.*

Broadway Court, Broadway, S.W.1.

Complete range of variable transmitting capacitors and trimmers.

—*S. Bird & Sons (Cyldon), Ltd.*

Cambridge Road, Enfield.

New range of variable capacitors for transmitters, etc.

—*Labgear, Ltd.*

A capacitor designed for use in high Q circuits. Its lightness and small size make it suitable either for use within a coil can, or for fixing on the chassis, in conjunction with the mounting plate. Two sizes: 2.8 pF. and 3.30 pF.

—*Mullard Wireless Service, Ltd.*

Century House, W.C.2.

## Electrolytic Capacitors

In addition to standard types in aluminium cans, with neoprene seals, special types for A.C. starters can be supplied.

—*Daly (Condensers), Ltd.*

The Green, W.5.

"Drilitic" dry electrolytic capacitors can now be supplied in metal cans or tubular cases. A full range

is available of comparatively small dimensions.

—*Dubilier Condenser Co., Ltd.*  
N. Acton, W.3.

**Cathode Ray Tube Accessories**

Holder and sockets are supplied by *Belling & Lee, Ltd.*, *Carr Fastener Co., Ltd.*, and *Messrs. British Mechanical Productions, Ltd.*, (Clx). Shields from *Magnetic & Electrical Alloys, Ltd.*, and *Telegraph Construction & Maintenance, Ltd.* Masks for television and other purposes from *Long & Hambly, Ltd.*, *High Wycombe.*

**Coil Packs**

A new 3-band midget coil pack, and an 8-range band-spread coil pack with wave-band scale lamp switching.

—*Weymouth Radio Mfg. Co.*

**E.H.T. Rectifiers**

A new range of high-voltage metal rectifiers has been specially developed to meet the growing demand for a small, compact metal rectifier to provide E.H.T. in many forms of equipment where the current demand is unlikely to exceed about 0.5 mA. D.C.

Rectifiers Type 36EHT are tubular in construction; the outside diameter is 7/16 in. throughout the range. Tag connectors are provided at the ends, in place of the more usual nut and bolt connectors.

Type 36EHT rectifiers are particularly suitable for use in voltage multiplying circuits such as voltage doublers, triplers, etc., owing to their small size and low forward resistance, and they will operate very effectively as pulse rectifiers to derive E.H.T. from the flyback pulse, which occurs at the line scanning output transformer of a television receiver.

—*Westinghouse Brake & Signal Co., Ltd.*  
York Way, N.1.

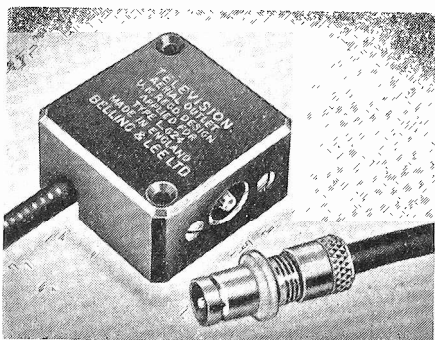

New television outlet box—*Belling & Lee*

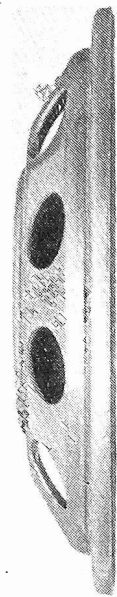

**Disk Loudspeaker**

An entirely new form of design is shown in the "Disc" loudspeaker manufactured by the *British Communication Corporation*. It is claimed to be both weight-saving and space-saving and comparable in performance with any other high-quality speaker. The thickness of the 5 in. model is only 7/8 in., and that of the 2 1/2 in. model 5/8 in. The 5 in. model handles 3 W peak and the 2 1/2 in. model 1/2 W peak. The magnet is of Alcomax, with a cadmium-plated pot housing. The chassis is of stamped hard aluminium.

—*British Communications Corporation.*  
Gordon Avenue, Stanmore.

**Gramophone Motors**

A new type of record player in which a record placed on the turntable is automatically played on closing the lid of the cabinet. The pickup runs on a tracking rod to give true tracking, and is prevented from damage by an interlock which prevents the motor from starting when no record is on the turntable.

—*Garrard Engineering Co.*  
Swindon, Wilts.

**Hearing Aids**

A special range of miniature components for hearing aids.

—*E. Shipton & Co.*  
Ferndown, Northwood Hills.

**H.F. Cables**

In addition to feeders for domestic radio and television receivers, two Telcothane insulated transmission lines have been introduced with

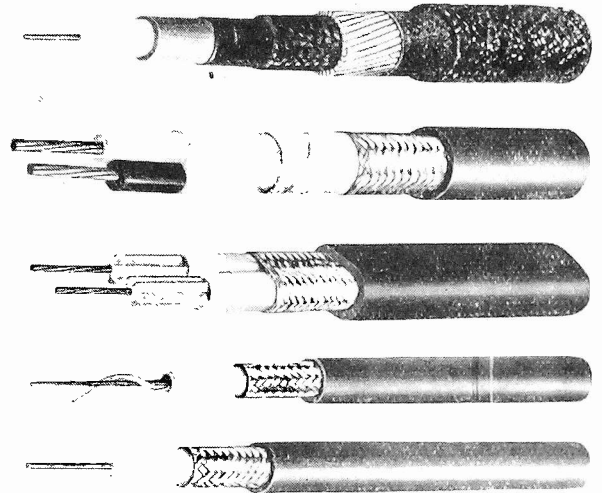

Left: The "Disc" loudspeaker, described in col. i.  
Above: Types of low loss polythene cable exhibited by *B. I. Callender's Cables Ltd.*—72 Fleet Street, E.C.4.

surge impedance of 300 ohm and 150 ohm.

Special double-screened and anti-microphonic cables are also to be seen.

—*Telegraph Construction Co.*,  
22, Old Broad Street, E.C.2.

**Metals**

The same firm is able to give good delivery of Telcon thermostatic bimetals, which are employed in delay switches, instrument temperature compensating devices and other components.

**Magnets**

Sintered Alnico magnets are identical with the cast metal, but permit small complex shapes to be readily moulded.

Sintered and drawn tungsten and molybdenum wire is also available.

—*Murex, Ltd.*, Rainham, Essex.

**Pick-ups**

The Ferranti Ribbon gramophone pick-up is a precision instrument designed to reproduce lateral recordings of standard groove shape with the highest fidelity, and with negligible groove wear.

To enable rapid and accurate control of the pick-up to be obtained without fear of damage due to momentary lapses, an automatic placing mechanism is provided in the base. The pick-up may be placed on, or removed from, a 10 in. or 12 in. record simply by pressing the appropriate button.

—*Ferranti, Ltd.*

Also shown: 3 types of pick-up, the "Concert" moving-coil with linear response from 40-16,000 c/s..

the "Ferrocoil" with higher output and a response from 50-12,500 c/s., and the "Ribbon," a pick-up having exceptionally light weight in the moving system.

—*Truvox Engineering Co., Exhibition Grounds, Wembley.*

#### Plugs and Connectors

A new 2-pin plug L.607PG suitable for L.336 balanced twin feeder carries two "O.Z." contacts and a removable "fouling pin" to prevent insertion into a 2 amp. mains socket. Reversible or non-reversible when used with the appropriate sockets. The socket panel carries two sockets and either 1 slot or 2 slots to take the "fouling pin."

A co-axial outlet box will be available for our new range of television and car radio co-axial plugs and sockets, all of which are now in production. They include single and twin right-angle, line coupling and through chassis connectors, the standard plug and chassis socket and a modified version for larger diameter.

—*Belling & Lee, Ltd.*

#### Temperature Indicators

A new item shown for the first time, is a Multicore Kit for determining bit temperatures. Of special interest to planning engineers and works managers, this kit comprises five different Multicore Indicator Wires which melt at temperatures recommended for the appropriate Ersin Multicore alloys and enables it to be determined simply whether or not a soldering iron has the requisite bit temperature. Previously, such tests could be undertaken only with expensive pyrometers of special design.

—*Multicore Solders, Ltd., Albmarmarle Street, W.1.*

#### Vibrators

A new synchronous vibrator and vibrator power pack which have been specially designed to ensure low current consumption for 2 volt working.

The power pack, which has been designed as a self-contained replaceable unit is extremely small and measures only 4 in. by 4 in. by 2½ in. high and provides an H.T. supply of 90 V, 10 milliamps and a negative bias of 6 V. This can, of course, be varied to suit customers' specific requirements with an upper limit of 6 watts D.C. energy.

—*The Plessey Co., Ltd., Ilford.*

## Measuring and Test Instruments

#### Signal Generator.

The Signal Generator Type B.4 is an entirely new substandard signal generator designed to cover two frequency ranges:

Model A, 100 Kc/s. to 70 Mc/s. and Model B, 30 Kc/s. to 30 Mc/s. Both the modulation depth and the carrier output of the instrument are monitored by a crystal voltmeter.

The generator, which is small in size and light in weight, may also be externally modulated. Radiation is negligible—less than 1  $\mu$ V at all frequencies.

#### Audio Generator Type F.

This instrument is a particularly flexible power source at audio frequencies for measurements on the frequency characteristics of transformers, filters, transmission lines, amplifiers and loudspeakers. The

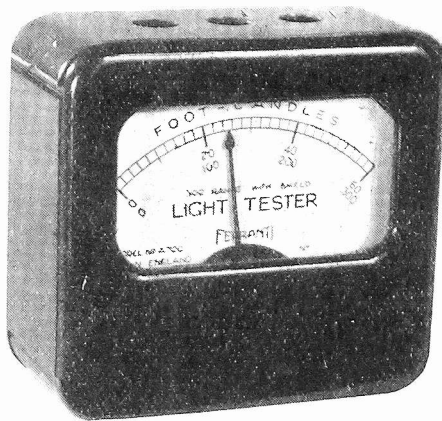

Ferranti Light Tester. The instrument employs a selenium cell and has 2 ranges—0-60 ft. candles without shield, and 0-300 ft. candles with shield.

frequency scale approximates to logarithmic and a high quality drive is provided. The output is monitored by a rectifier type output meter.

The use of a well-designed negative feedback network gives the instrument an almost level response over the complete range 100 cycles to 10,000 cycles.

—*Advance Components, Ltd., Shernhall Street, E.17.*

#### Four New Dawe Instruments

The following new instruments shown by Dawe Instruments, Ltd.

(1) A combined stroboscope and flash unit for industrial high speed analysis and photography.

(2) Sound level measurements over the full range of hearing.

(3) Resistance-tuned oscillators extending to 0.1 c/s.

(4) An electronic tachometer which requires no connection with the device under measurement.

—*Harlequin Avenue, Brentford.*

#### Resistance and Capacity Bridge

A small portable bridge designed for the quick checking, with fair accuracy, of resistors and capacitors including electrolytics. It consists of a pair of ratio-arms and a number of standard resistors and condensers selected by a switch. The bridge is balanced by variation of the ratio arms, a calibrated potentiometer. Provision is also incorporated for checking the leakage of electrolytic condensers. The leakage current is arranged to charge a condenser which after an interval discharges through a neon tube. The rate of flashing of the neon is then a measure of the leakage current of the condenser under test.

#### "Q" Meters

These two instruments operate on an entirely new principle which eliminates the "injection" resistance and they are capable of a high degree of accuracy up to extremely high frequencies. They cover the whole of the frequency range where the "Q" of coils is likely to be required, capacity can also be measured and with a simple calculation loss measurements of dielectrics may also be carried out. The low frequency model covers the range 25 Kc/s. to 50 Mc/s. and the high frequency model 15 Mc/s. to 150 Mc/s. In both instruments the degree of error is constant at all frequencies except at the extreme high frequency end.

—*Salford Electrical Instruments, Ltd., Salford, Lancs.*

#### Pick-up Test Oscilloscope

This equipment has been designed for the production testing of gramophone pick-ups. An output from a low-frequency oscillator covering the spectrum 0-10 Kc/s. is fed to the pick-up under test, and the response curve from the pick-up is traced on a cathode-ray tube. In order to get a continuous picture the oscillator is deviated at a recurrence frequency of 1 c/s., and a tube with the necessary after-glow is provided. A jig for mounting the test sample is supplied.

The low frequency oscillator, which is of the beat frequency type, carries a frequency calibration. The variable oscillator of the B.F.O. is driven by a synchronous motor, but

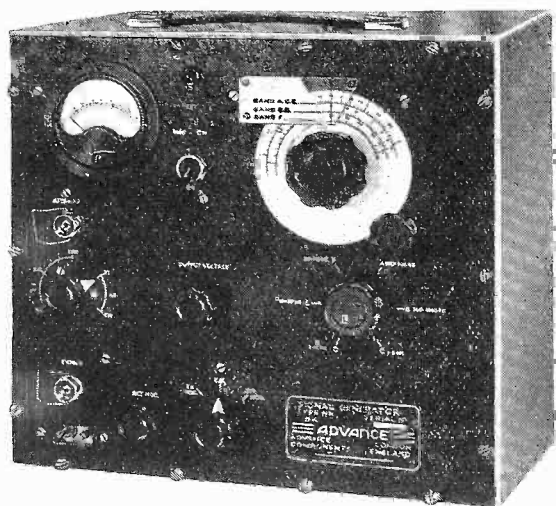

"Advance" Signal Generator with six waveband ranges, Type B.4

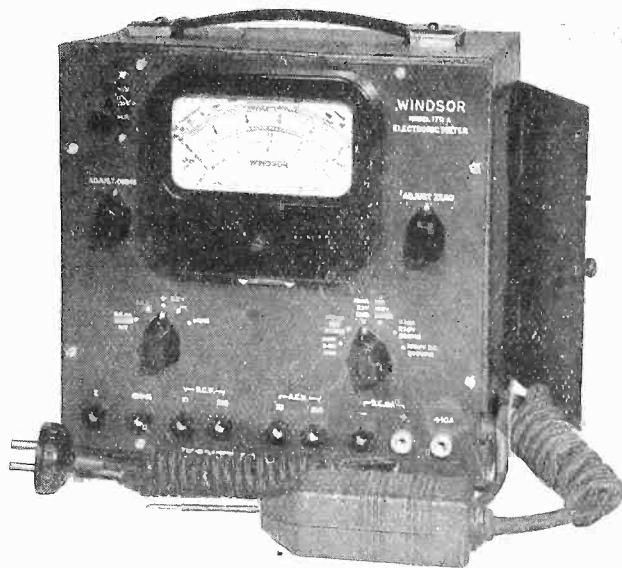

Taylor "Windsor" Valve Voltmeter for universal measurements

a friction device is provided with a manual control to enable the oscillator to be set at any frequency in the spectrum. Provision for viewing the wave-form from the pick-up is given by a built-in time base.

—The Plessey Co., Ltd.

**Electronic Meter**

This instrument is an A.C. mains-operated valve voltmeter enabling readings to be taken of A.C. voltages from 0.1 to 250 volts at frequencies up to 200 Mc/s. and up to 2,500 volts at audio frequencies.

D.C. voltage measurements from 50 millivolts to 10,000 volts are available and the input impedance on D.C. volt ranges is 10 megohms on the lower ranges and 100 megohms on the higher ranges.

Resistance measurements can also be made from 1 ohm to 2,000 megohms in six ranges and D.C. current measurements are available from 2 microamps to 10 amperes.

Model 170A. Provisional price £22 10s.

**Combined Electronic Meter and Universal Multi-Range Voltmeter**

This instrument has the same specification as the Model 170A but in addition the instrument can be used as a Universal Meter having a sensitivity of 10,000 ohms per volt D.C. and 1,000 ohms per volt A.C.

Model 180A. Provisional price £27 10s.

**Wobblulator Model 55A**

Curve tracing facilities are provided by this unit which is used with a signal generator and C.R. oscillograph such as the Taylor 65B and 30A respectively. The mean fre-

quency of the wobblated oscillator is 4 Mc/s. with directly calibrated incremental tuning of  $\pm 25$  Kc/s. for bandwidth measurement. A continuously variable amplitude of frequency sweep is provided by a potentiometer feeding the reactor valve which is controlled by the time base voltage from the C.R. oscillograph. The dimensions are  $12\frac{1}{2}$  in.  $\times$   $8\frac{1}{2}$  in.  $\times$  6 in.

Price £14 14s.

—Taylor Electrical Instruments, Ltd.

Further items are unavoidably held over and will be described later.

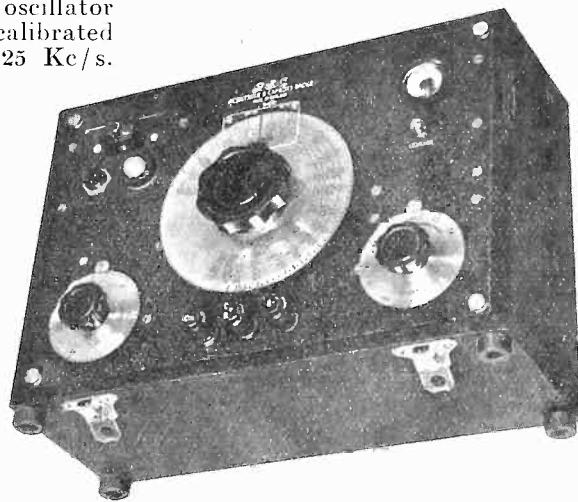

G.E.C. Resistance-Capacity Bridge

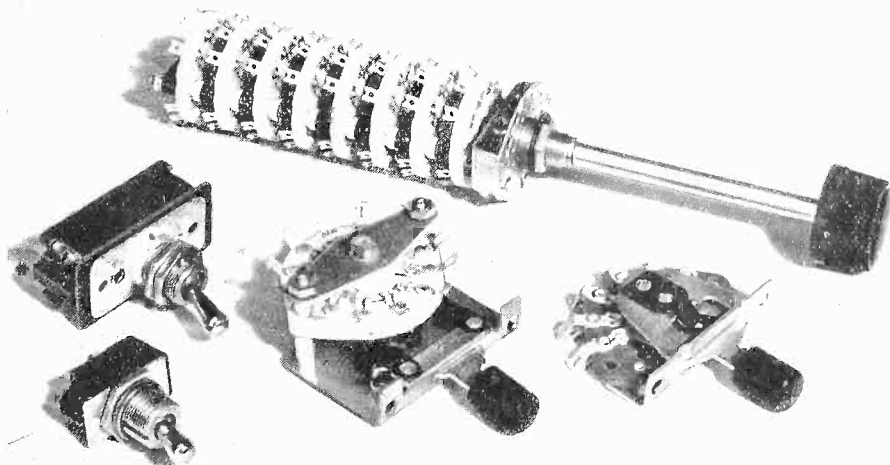

New "Oak" rotary switches of small diameter, with ceramic wafers. The toggle switches are Cutler-Hammer type made under licence. British N.S.F. Co. Ltd., Keighley, Yorks.

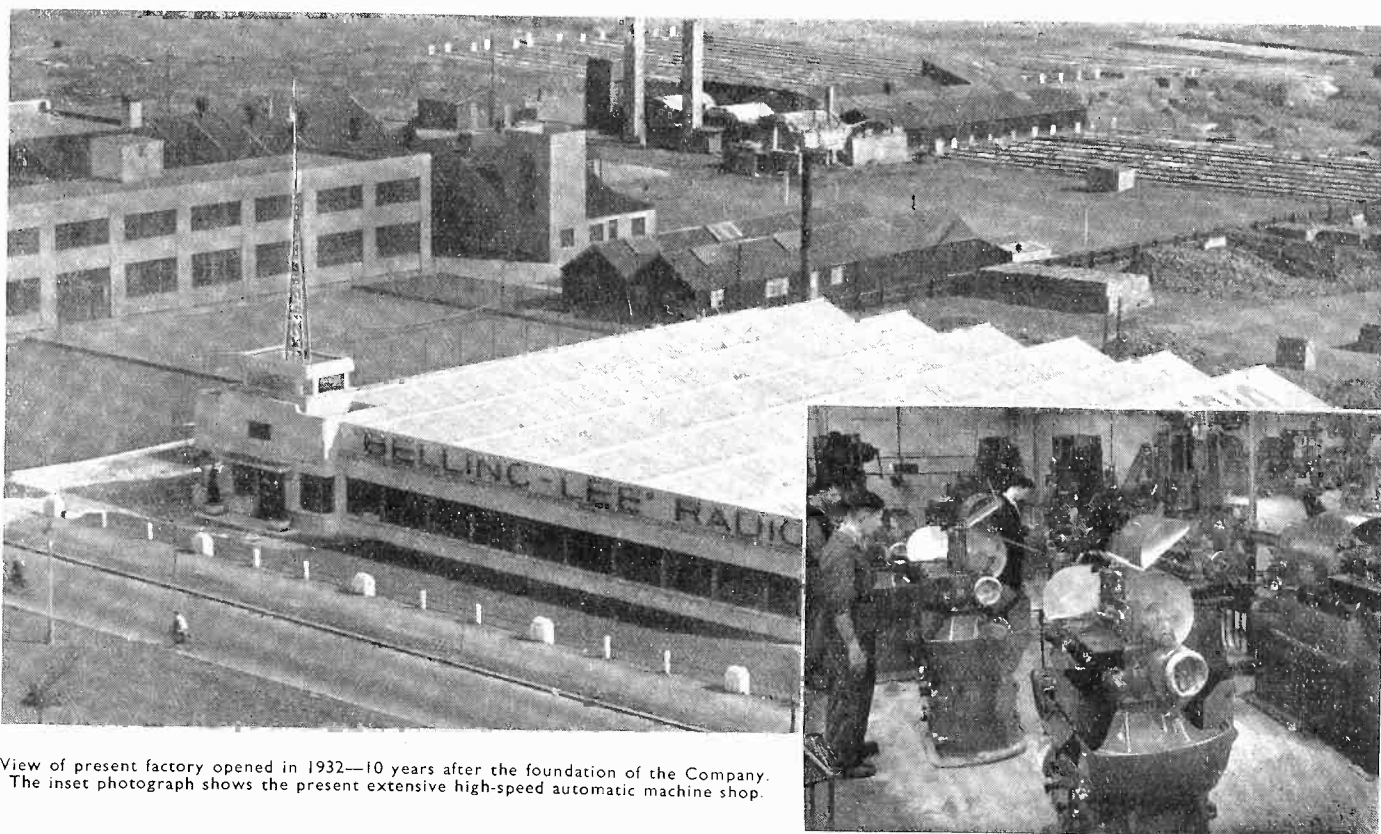

View of present factory opened in 1932—10 years after the foundation of the Company. The inset photograph shows the present extensive high-speed automatic machine shop.

## 25 Years of Component Making

### Belling & Lee Silver Jubilee

**B**ELLING & LEE, LTD., now embarking on their second quarter-century in the radio and electrical industry was first registered as a company in 1922. The British Broadcasting Company had also started in the November of that year, and for the first two years of its existence the firm of "Belling-Lee" made radio receivers in a small factory of 2,000 square feet at Queensway, Ponders End.

The pitfalls of receiver manufacture in the early days soon convinced the small company that a "safe" line in receivers was required, and a simple crystal set was produced and sold at 25s., the production being 300 sets per week.

One by one the components were designed and tooled for making in the factory, until the only components purchased outside were the aerial and earth terminals. Then, in 1924, a combination of ideas produced the first indicating terminal with a head that did not come off and an engraved marking on it. A

further improvement in 1925 produced the terminal which made the name of "Belling-Lee" as component manufacturers—the "B" type, with non-removable head and non-rotating indications.

At 9d. each these were in enormous demand in the home constructor market, some sets having as many as 20 terminals with different labels. The "B" type terminal has persisted to the present day with only minor modifications, and is still a best-selling line.

Other small components followed in quick succession—fuseholders and fuses, wander plugs, multi-contact plugs, and special valveholders.

In 1933 the problem of interference in radio reception was becoming acute and development of interference suppressors was undertaken. One thing led to another, and from the simple suppressor unit mounted on a meter board came a complete noise reduction service with anti-interference aerials as well as suppressors. An improved anti-inter-

ference aerial, the "Eliminoise" was marketed in 1936 and later came the "Skyrod," a vertical rod aerial of neat appearance and superior effective height.

The same year (1937) saw the beginning of television broadcasting, and with the additional designs of television dipoles the firm in 1939 had reached a position where aerials were the largest part of the manufacture, with smaller components as a steady and useful background.

In 1932 the company had outgrown its works in Queensway, having already covered four separate factory premises, and it moved to a new modern factory on the Cambridge Arterial Road covering 22,000 sq. ft. At the outbreak of war in 1939 this new factory was turned over entirely to war material and components for radar and Service radio equipment, and the output of small components became astronomical. Even the original moulded terminal exceeded its records of home constructor days,



and many of the well-known types of component were exported to the U.S. Signal Corps.

Extensions to the factory were added until the present area covers over 60,000 sq. ft. In this area is one of the largest plating plants in the country, capable of finishing single aerial sections of 25 ft. in length. The plant includes polythene moulding presses, pressure die-casting and glass moulding machines, and high-speed automatic presses producing 36,000 valveholder contacts an hour. The normal complement of the production units is 16,000,000 piece parts.

The organisation not only produces aerials and equipment but also installs them, with teams of skilled riggers and construction technicians

The illustration below shows old and new developments of the "B" type terminal and its modern counterparts in high voltage glass hermetic seals, the original meter-board suppressor and the well-known dipole and reflector Viewrod. The twin safety fuseholder is a 1929 design practically unaltered; the multi-connector is typical of a range including 5, 7 and 10 pin types with panel pins or socket. These incorporate the O-Z low contact resistance, heavy current construction plug pin, and finally the new valveholder for B8A type valves

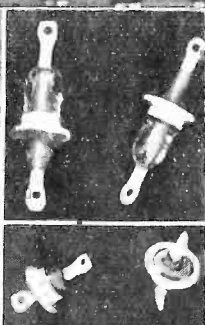
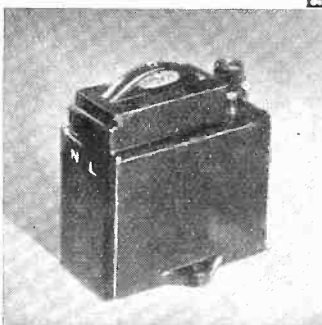
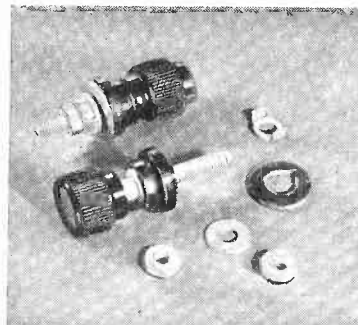
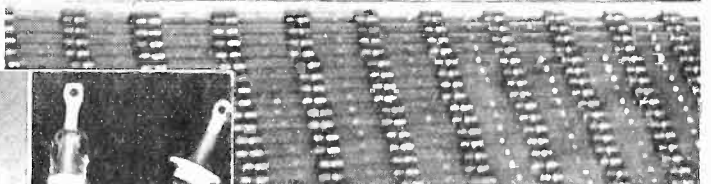

Soldering ends of fuse wire to caps. Note how the wire is threaded through a succession of fuse tubes

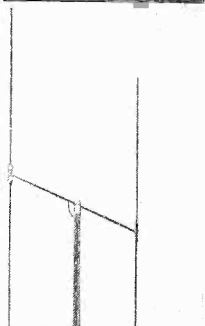
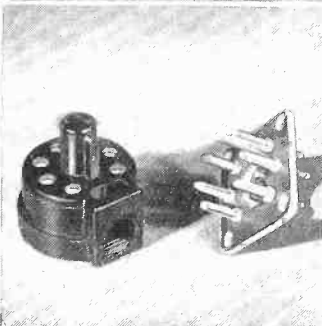
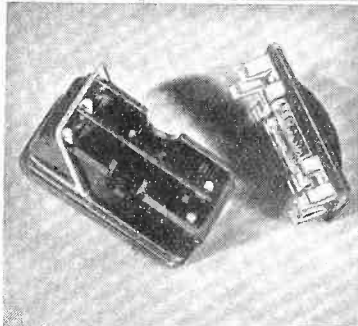

backed by a technical service department of high standard. The research department, in addition to carrying out development work, has a range of standard equipment for testing and checking under carefully controlled conditions and can simulate tropical or arctic surroundings if required.

**Fuses**

Fuses are manufactured to B.S. Specification with ratings from 50 mA to 20 A. As shown in the illustration, after the glass tubes have been fitted with caps bored to receive the wire, it is threaded through a number of tubes in turn, soldered to the caps and the surplus is then trimmed off. For the lower current fuses wire of as small a diameter as .001 in. is successfully employed.

A special form of construction is used in the "Magnickel" fuse which is designed to provide delay action on heavy overloads of short duration. This fuse employs a fine nickel filament to which a special

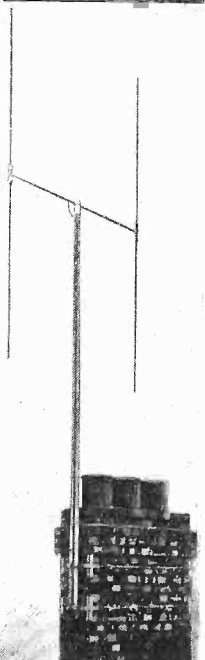
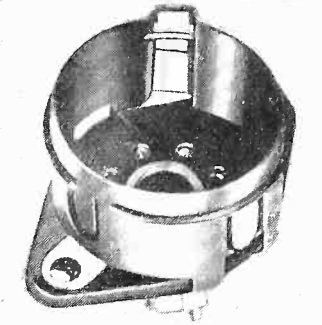
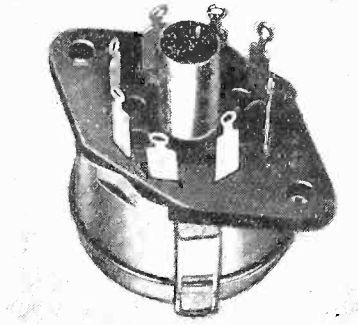

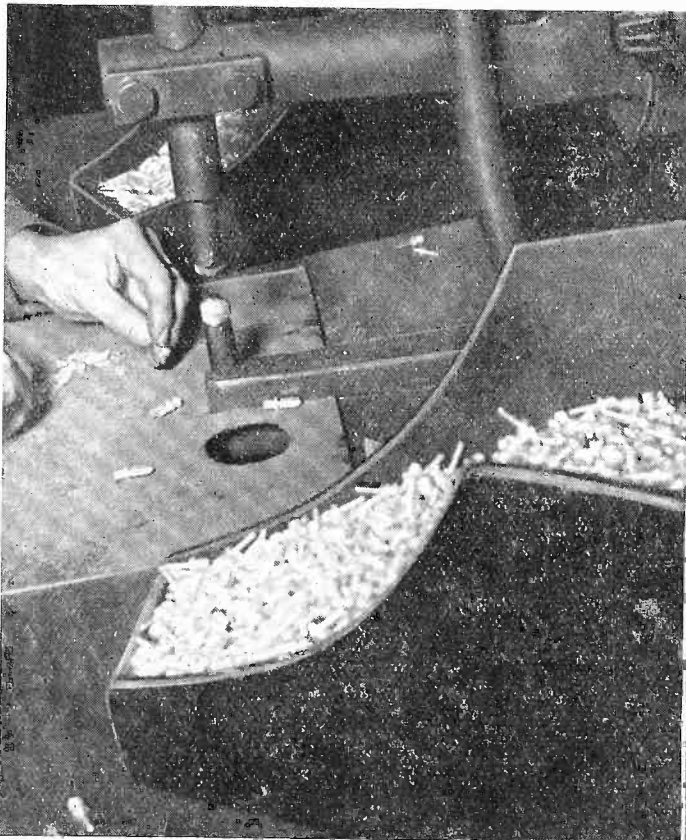

Welding leaf contacts into O-Z plugs

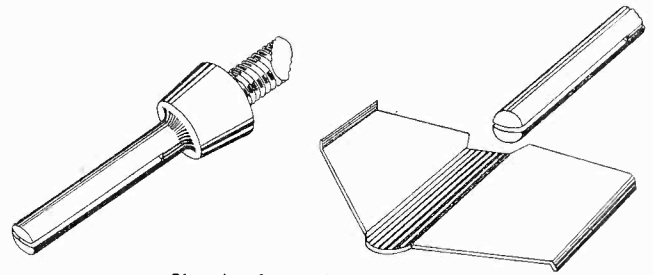

Showing formation of O-Z plug

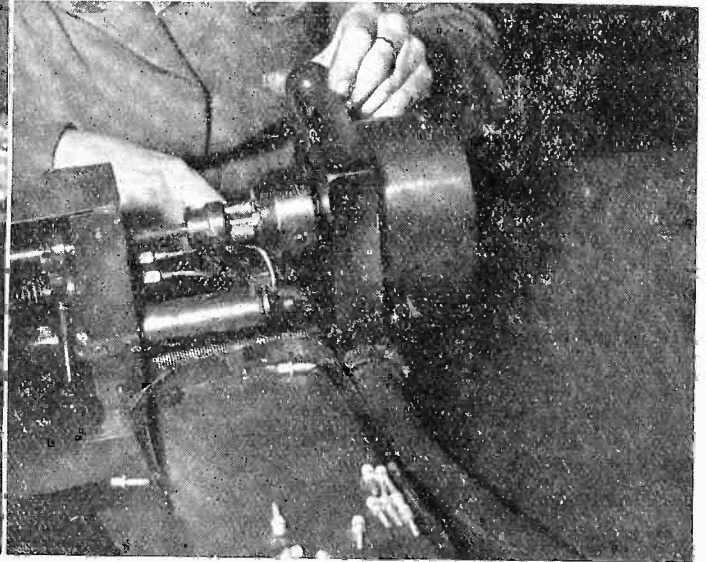

Rolling the leaf into shape after welding

Below : Aerial packing department, seen through a row of aerials ready for packing

—Behr-Hunot photos

magnesium deposit is attached. When an overload persists the magnesium ignites and ruptures the nickel fuse wire. On a 75 per cent. overload which is maintained it will blow within a minute.

#### O-Z Plugs

The problem of making good contact between a split plug and a socket has always presented difficulties, especially where a good contact area is required. The type of plug known as O-Z was developed and patented with the object of ensuring good contact in sockets of varying dimensions and depths. It is formed from a slotted plug into which is welded a phosphor-bronze leaf contact which is afterwards formed into a Z-shaped curve. The springiness of the leaf enables the plug to fit securely into a cylindrical socket and gives exceedingly low contact resistance. It is thus possible to carry heavier currents without overheating; for example, a slotted plug of  $\frac{1}{8}$  in. nominal diameter would be rated at 2 amperes, whereas an O-Z plug of the same diameter would be under-rated at 5 amperes.



It is the intention of the company to employ this type of plug throughout the range of components, and it is at present available in four sizes.

The photographs show the formation of the contact spring from the flat leaf, the principle of assembly being shown in the diagram.

#### Thermal Cut-outs

Among the later developments are thermal cut-outs for small motor protection and delay switches for rectifier heating. Applications for these delay switches have been found in fluorescent lighting and in electric train door control, and cut-outs are frequently used in circuits where an ordinary fuse is liable to blow on a momentary surge.

The thermal cut-out is assembled from over 25 piece parts under motion study conditions in a little over a minute. The switch itself contains a bimetallic element inserted in a mechanical toggle-link action which gives a quick break on overload. A follow-through contact ensures that the movement has accelerated to maximum speed at the moment of breaking circuit, and the

same toggle action ensures quick make on resetting the cut-out.

Each switch is tested on an electronic timer and is then tested in a temperature-controlled oven with its individual thermocouple. This accurate control enables a cut-out to be made with the precision of a high-grade instrument at a cost which permits its use in relatively low-priced machines. An important advantage of the device is that it provides a double safeguard if mounted near the windings of machines, as the switch can be thermally operated by the temperature of the winding in addition to overload current.

**Aerials**

The standard H-type television aerial, which is widely used in the reception area, is shown in the illus-

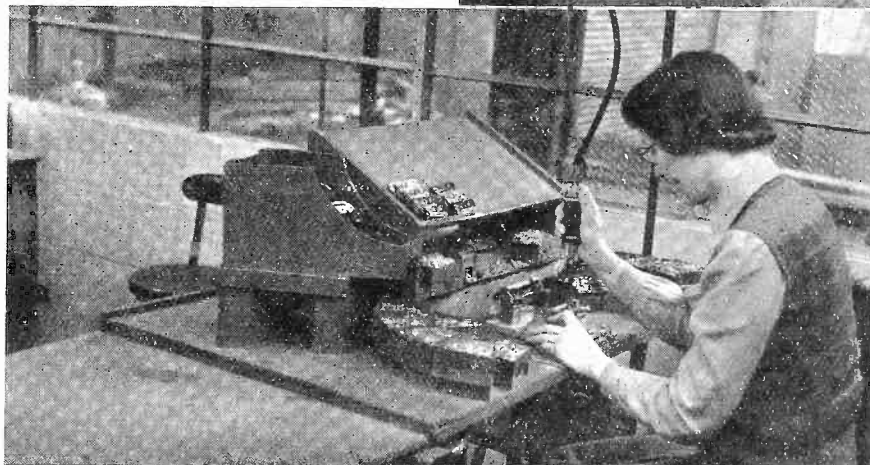
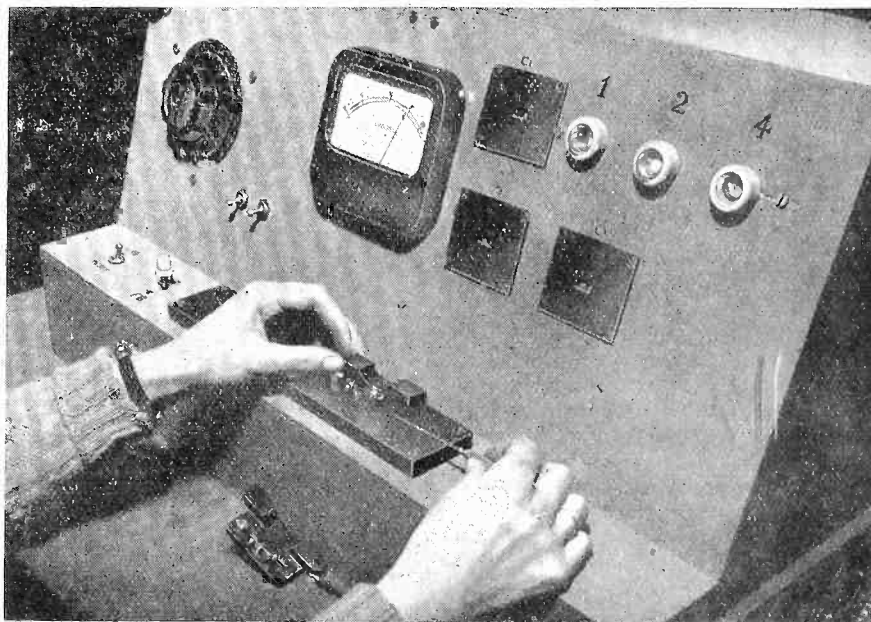

**The Manufacture of Thermal Cut-outs**

An electronic timer for controlling cut-out operation on current overload in a fixed time. The panels C1 C2 C3 are electronic counters in seconds and neon lamps indicate eights of seconds

Centre: A motion-studied layout for cut-out assembly employing pneumatic spanner for speed and uniformity of nut tightening

Each cut-out is tested with an individual thermocouple in one of the small ovens shown below

—Behr-Hunot photos

tration being packed for dispatch. A recent addition to the range is the "inverted-V" television aerial, which can be installed in a loft as well as outside the building. The appearance of what is considered by some as an unsightly rod is avoided, but the range of the V-aerial is restricted to 5 miles from the station when indoors and 10 miles outdoors.

Other Belling-Lee activities in aerial construction cover airborne radar and radio aerials, matching units and filters, and pre-fab. aerials for the new housing programme. There is also a complete aerial kit for amateur transmitters.

**Acknowledgement**

The photographs illustrating this article were taken by permission of Belling-Lee, Ltd., who also supplied the information on which the article is based.



# High Vacuum Pumps

## Their History and Development

By R. NEUMANN, Dipl. Ing., A.M.I.Mech.E.

Part 4 — Diffusion Pump Design

THERE exists an enormous number of different designs of diffusion pumps and only very few typical examples can be dealt with here. Perhaps the best way of approach is to discuss briefly the different elements of design and then to give a few illustrations of pumps actually manufactured or having special features which might be useful in future development.

The principal parts of an ordinary diffusion pump are the boiler or evaporator with its heating appliance, the tube leading from the boiler to the pump chamber, the diffusion slit or nozzle, the condensating or cooling arrangement, the connexions from the recipient to the pump chamber and from the latter to the backing pump. Certain accessories as the cold traps necessary with mercury pumps for obtaining very high vacua and the baffles required mainly in oil pumps shall be dealt with separately.

In many cases the evaporator is simply formed by the lowest part of the cylindrical pump chamber, but frequently—especially in pumps made of glass or quartz—the evaporator has the form of a bulb so that the boiling surface is increased. This enlargement of the boiling surface is also employed in some all-metal pumps, e.g., if they are of the fractionating type. In Hickman's horizontal design the boiler is a more or less V-shaped annex fastened lengthwise to the pump chamber. In a recent design developed by the National Research Corporation the boiler acts on the fire tube principle.<sup>101\*</sup> It consists of a short horizontal or vertical tube mounted underneath the U-shaped pumping chamber and connected to it by a vapour uptake and a return flow pipe. In some cases it is gas-heated. But in general—except

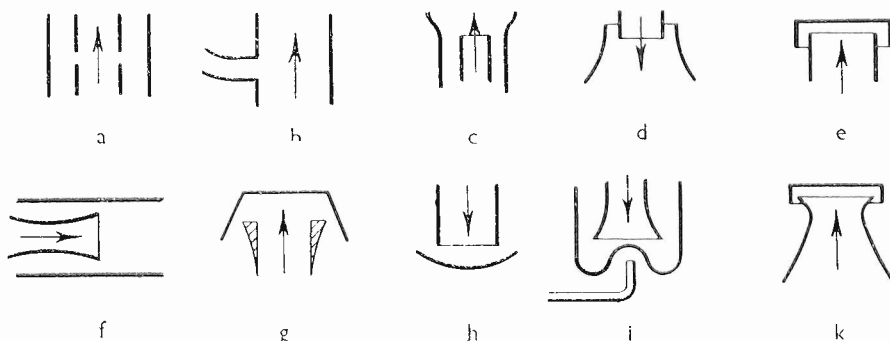

Fig. 20. Typical nozzles of diffusion pumps

a Gaede's slit. b Williams' orifice. c Langmuir's nozzle. d Langmuir's "goose-neck" nozzle. e Langmuir's "umbrella" nozzle. f Crawford's nozzle. g Kaye's design. h Pillow's design. i Brill's design. k Embree jet.

for small laboratory pumps—electrical heating is preferably used as the current may be readily adjusted to the requirements of operation and may be easily measured. The exact adjustment of the temperature of the boiler is the more important with oil diffusion pumps as there is a comparatively narrow range between the temperature at which vapour production for efficient working of the pump is obtained and the temperature at which cracking takes place.

Cylindrical or flat heating units are most generally applied, but also various other arrangements have been proposed, i.e., mercury arc heating,<sup>102</sup> induction heating,<sup>103</sup> the latter also with high frequency current. To increase the speed of starting the pump the boiler may be heated for a short period with excess heat.<sup>104</sup>

Small and light electric heating elements with a minimum heat capacity are recommended by Hickman, e.g., nichrome wire windings on split mica circles, preferably immersed in the pump fluid. With synthetic oils used in fractionating pumps the optimal depth of the liquid is 3-5 mm., not higher as the quantity of decomposition products liberated is proportional to the quantity of pump filling, and not too shallow lest a vapour layer would isolate the liquid from the very hot wall and decomposition would be accelerated.

The natural flow of the vapour from the horizontal surface of the working fluid in the boiler is upwards. In the first designs of diffusion pumps, Gaede's as well as Langmuir's, this upward flow was not deflected and the vapour flowed in a vertical tube to the diffusion slit or the orifice. Considerations of design showed that a downwards flow of the vapour has some advantages in avoiding the extra work spent for taking care of falling drops of condensed fluid. This led first to the "goose neck" type of pump in which the tube, leading from the boiler to the pump chamber, is shaped like an inverted U and then to the "umbrella" or "mushroom" type in which the vapour is led upwards in a central tube and deflected by a cowl at its upper end. This design is the one most commonly used in modern pumps, specially in those of metal construction, but is also used to a large extent in glass pumps, although for these either the original undeflected flow or a more or less horizontal flow is frequently met with. For fractionating pumps Hickman prefers the horizontal design as the boiler area is independent of the jet diameter, as the precise distribution of the heat input can be more easily regulated, as the arrangement of the boiler underneath the pump chamber leaves two free ends, one for the small fore-vacuum and one for the large fine-vacuum connec-

\* National Research Corporation of Boston and Cambridge, U.S.A., and Daniel Varney, Ltd., of Hillington, Glasgow, and 6, Cromwell Place, London, have now formed conjointly British American Research, Ltd., who are producing all the National Research Corporation's products in Daniel Varney's Glasgow Works.

Siegbahn's molecular pumps mentioned in the February issue are manufactured by LKB-Produktorfabriksaktiebolag, Stockholm.

tion, and as the fractionating unit may thus serve as a straight pipe between the mechanical pump and the vessel to be exhausted.

As we saw, the narrow diffusion slit used in Gaede's first design was soon discarded. In the mushroom type an annular nozzle is formed by the upper end or the sides of the uptake tube and the cylindrical or conical inner surface of the cowl. Where the sides of the cowl are made conical, use is made of a principle first proposed by Crawford<sup>109</sup> who applied the experiences gained in steam turbine designs by Laval to the shaping of the nozzle of the diffusion pump. This divergent nozzle causes the vapour to leave the admitting tube as a nearly parallel jet of very high speed. Various proposals were made to make these nozzles adjustable.<sup>109</sup> But it may be safely stated that, in spite of Gaede's objections to its theory, the ordinary divergent nozzle—either circular or annular—is now the one most widely accepted, though it has not quite replaced the cowl with cylindrical side walls.

A recent development of the annular divergent nozzle is the Embree jet<sup>110</sup> extensively used in the pumps of Distillation Products Inc. It is a mushroom nozzle in which the vapour is allowed to expand towards the centre of the pump. With such a jet a Ho-coefficient of over 30 per cent. has been obtained. Fig. 20 gives a comparison of some typical kinds of nozzles used in diffusion pumps.

For the condensing or cooling systems natural or enforced air cooling and water cooling are employed. While in small glass type diffusion pumps natural air cooling may be sufficient, for larger type pumps a small electric fan or a gentle stream of air from a laboratory line may be used for providing the necessary circulation of the cooling medium. This stream of air is preferably directed towards the outer wall of the pump near the jet. The cooling action may be improved by copper wire coiled and looped around the tubes on small glass pumps, or by cooling ribs on metal pumps (e.g., VMF series, Distillation Products Inc.)<sup>87</sup>

For water cooling, either only the outer walls of the pump chamber, or also the inner parts of the nozzle or its opposite walls, are cooled.<sup>71, 110a</sup> Jacket cooling with or without a spiral water channel (e.g., Metrovac) or special cooling

tubes wound around the walls of the pump chamber (Dist. Prod. Inc., Litton) are employed in the various designs. In Bancroft's design these are hard welded to the condenser tube.<sup>111</sup>

According to a proposal by Krämer the cooler may be arranged as a self-contained vessel, its walls contacting the walls of the pump. Preferably it consists of two half cylindrical parts, surrounding the pump and flanged together.<sup>112</sup>

The connexion between pump chamber and the vessel to be evacuated should be as short as possible and of largest possible cross-section. If shutters cannot be avoided, they must be of a type with least possible obstruction to gas flow. The same applies also to the connexion to the fore-pump, although to a lesser degree.

Perhaps the simplest design suitable for a mercury pump used in connection with mercury arc rectifiers and therefore requiring a final pressure of not much less than  $10^{-3}$  mm. Hg is shown in Fig. 21 (Brown Boveri).<sup>113</sup> The "slit" is here replaced by the orifice of the high vacuum admission pipe in a similar manner as in Williams's design.<sup>114</sup> Other designs by Brown Boveri<sup>115</sup> show concentric uptake tubes and may be considered as predecessors to the fractionating pumps later developed. A specially compact pump in which the central tube and the diffusion jets can easily be removed for inspection and cleaning was designed by van der Poel (Philips) and is shown in Fig. 22.<sup>116</sup>

The same advantageous feature is incorporated in Kaye's pump (Fig. 23).<sup>117</sup> Kaye's design is used in the series of mercury diffusion pumps manufactured by W. Edwards & Co., and a typical example of this pump is shown in Fig. 24. While these latter pumps are the principal representatives of mercury diffusion metal pumps in this country, oil diffusion metal pumps are mainly manufactured by Metropolitan-Vickers Electrical Co.<sup>118</sup> Fig. 25 shows a section of a two-stage pump. The pump for higher suction speeds shown in Fig. 26 uses a smaller two-stage pump as a "booster." A similar booster is also used in Edwards' Type 120, which until recently was the largest capacity pump (180 l/s) available here according to manufacturers' catalogues. It has now been replaced

Fig. 23. Kaye's diffusion pump

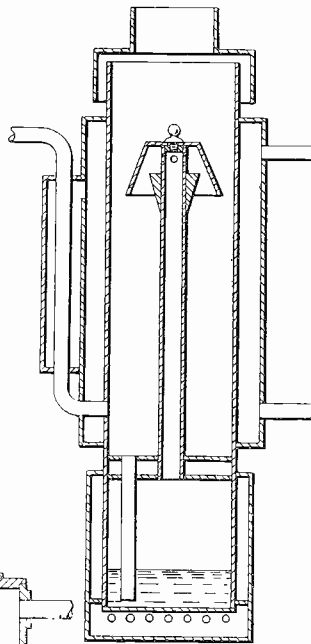

Fig. 21. Brown Boveri's Mercury diffusion pump

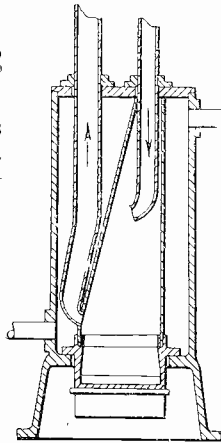
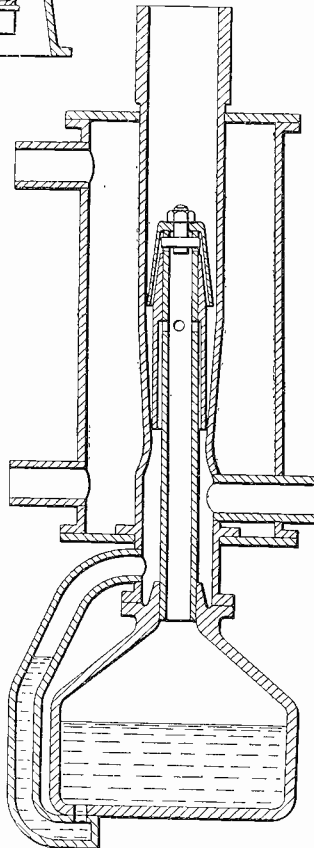

Fig. 22. Philips' diffusion pump



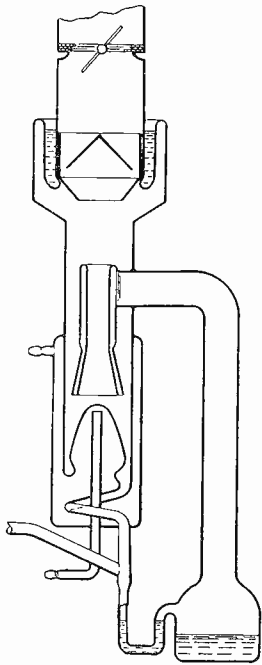

Fig. 29. Bull's high-speed pump

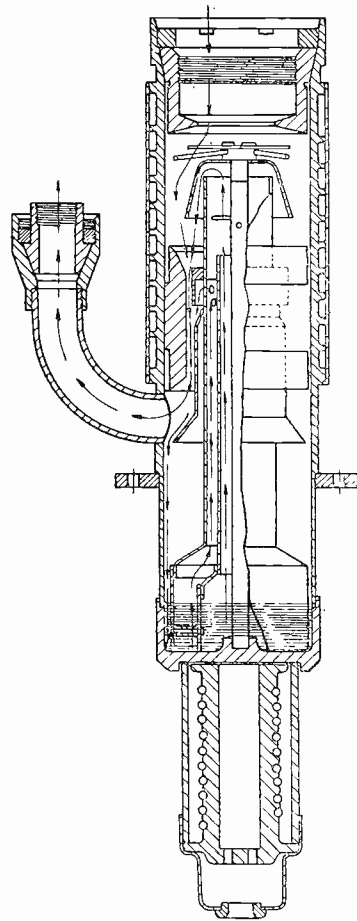

Fig. 25 (centre left). Metropolitan-Vickers' 2-stage oil diffusion pump, Type O.3B.

Fig. 26 (centre, below). Metropolitan-Vickers' pump Type O.4B.

Fig. 28 (above). Westinghouse oil booster pump

Fig. 27 (below). Metropolitan-Vickers' pump, Type O.83B, with baffle

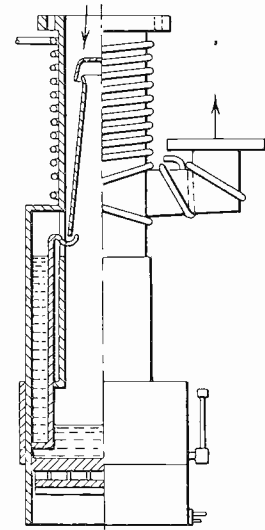
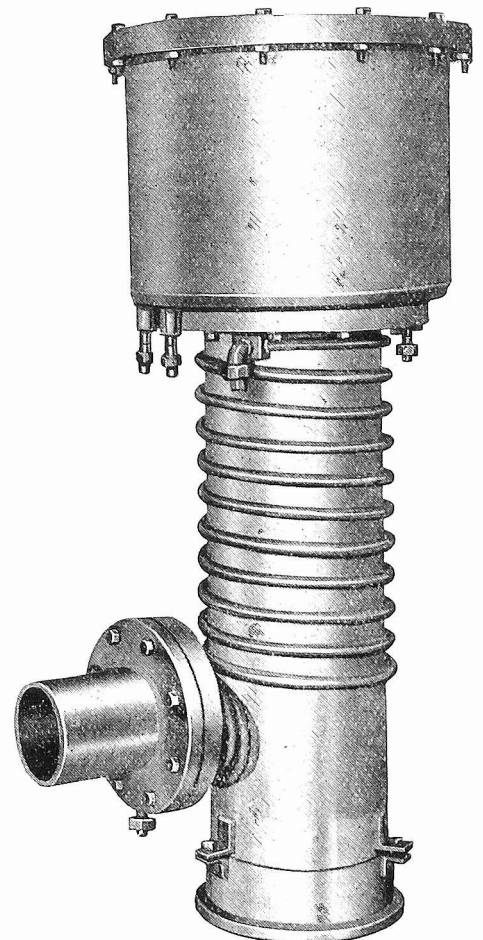
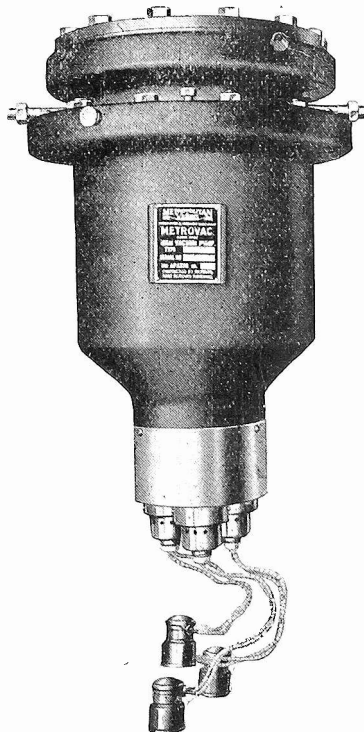
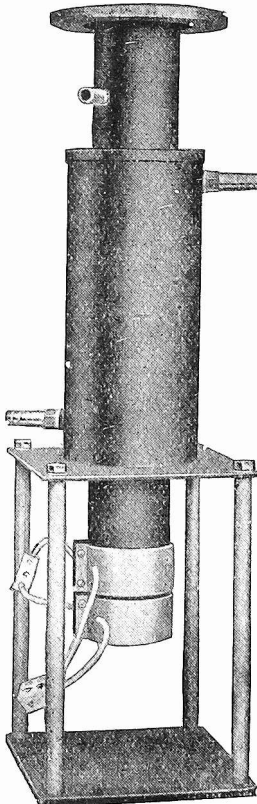

Fig. 24. Edwards' mercury diffusion pump



by the pump 6MD500 working without a booster and attaining a pumping speed of 500 l/s over a wide pressure range. This is a Hg diffusion pump. The Metrovick oil diffusion pump shown in Fig. 26 and working with a booster is now replaced by one of the models exhibited for the first time at the Physical Society's 31st Exhibition of Scientific Instruments and Apparatus, April, 1947. The types 0203B, 083B, 063B and 043B with diameters of 20 in., 8 in., 6 in., 4 in. and speeds of approximately 3,500, 500, 300 and 120 l/sec. at  $10^{-4}$  mm. Hg were exhibited. Of these the type 083B is shown in Fig. 27.

While it is quite customary to use the combination of box pump and single diffusion pump as main pumping outfit, booster pumps between these two units are frequently applied for obtaining larger speeds. They may operate against exhaust pressures as high as 2 mm. for oil diffusion pumps and 25 mm. for mercury diffusion pumps. The maximum exhaust pressure of a

diffusion pump should be as high as possible as the efficiency and speed of the box pump increases with increasing intake pressure.

A 6 in. booster oil diffusion pump was, for instance, developed by Westinghouse for use on the atomic bomb project, for which about the largest pumps so far designed have been built, especially for the separation of isotopes. The booster is built with an electrically heated expanded boiler with large evaporating and heater contact surface. Fins welded to the boiler platter facilitate the heat transfer. A single jet is used which best prevents back streaming of air molecules. An external oil return leads the condensed oil back to the boiler. The booster weighs about 150 pounds.<sup>119</sup> Fig. 28 shows a section through this booster pump.

A high speed mercury diffusion pump designed by Bull with annular Crawford nozzle and condenser with inside and outside water cooling is shown in Fig. 29.<sup>120</sup> Inside and outside water cooling is also used in the design of P. Alexander.<sup>11</sup>

(To be concluded)

References

<sup>104</sup> Olive, *Chem. & Metallurg. Engg.* Oct., Nov. 1943.  
<sup>105</sup> Jones & Russell, *Phys. Rev.* 10, 301, 1917.  
 German Pat. 357360, 359368, 390652.  
 British Pat. 380471, 380780.  
<sup>106</sup> German Pat. 365620, 469447.  
 Rissik, *Mercury Arc Current Converters*, London, 1935, p. 123.  
<sup>107</sup> German Pat. 590979.  
<sup>108</sup> Crawford, *Phys. Ref.* 10, 556, 1917.  
<sup>109</sup> German Pat. 385662, 1921, & Ref. 71.  
<sup>110</sup> U.S.A. Patent 2150976, and Ref. 96.  
 See also Baumgartner, *et al.*, *Helv. Phys. Acta* 15, 332, 1942.  
<sup>110a</sup> Bull & Klemperer, *J. Sci. Instr.*, 20, 179, 1943.  
<sup>111</sup> British Pat. 438915, 1934.  
<sup>112</sup> German Pat. 458100, 1926.  
<sup>113</sup> Fleming, *Mercury Arc Rectifiers*, p. 8 (see also Brit. Pat. 138745, 1919 (Western Electric Co.).  
<sup>114</sup> Williams, *Phys. Rev.* 7, 583, 1916.  
<sup>115</sup> Ger. Pat. 460795, 1920; 474547, 1925.  
<sup>116</sup> Germ. Pat. 502771, 1924.  
<sup>117</sup> Backhurst & Kaye, *Phys. Mag.* 47, 918, 1924; Kaye, *Phys. Mag.* 1, 349, 1926  
<sup>118</sup> and Ref. 6. (Brit. Pat.) 346293, 1930, and 407593, 1933 (Burch & Bancroft).  
<sup>119</sup> Colaiaco & Hopper, *Westinghouse Engineer*, 6, 193, 1945; Brit. Pat. 565455, 1943.  
<sup>120</sup> Brit. Pat. 552898, 1941; Bull & Klemperer, *J. Sci. Instr.*, 20, 179, 1943.

## Magic Eye Tubes as Polarity Indicators

THE use of electron-tube tuning indicators for balance or null detectors is well known. For instrument work, however, a balance indicator capable of greater precision is frequently desired. By means of a special circuit M. L. Greenough has adapted a conventional "magic eye" tube of the variable shadow angle type, such as the 6E5, 6U5, and 6N5, to furnish a polarity-sensitive indication. Although this circuit was developed for instrument application it may be of value for adapting a conventional tuning eye to balance indication in FM discriminators.

The obvious method of making the "magic eye" tube polarity-responsive is to bias the deflection grid to produce some arbitrarily chosen reference angle, which is marked on the scale over the tube. Positive or negative signals then cause an increase or a decrease of this

shadow angle. The disadvantages of instability of the reference angle, which is greatly dependent upon the supply voltages, and parallax of observation may be

avoided by repeatedly switching the signal on and off at a rate fast enough to prevent visible flicker. By this means two shadow angles are maintained on the tube screen itself. One corresponding to zero input, appears half the time, and during the remaining time the angle is that due to the amplitude of the applied signal. Zero signal input is indicated when the edges of these angles coincide.

Typical patterns are obtained for positive zero, and negative signals. There appears to be a half-illuminated angular sector whose width is proportional to the deflection signal, and which lies on one or the other side of a reference line as determined by signal polarity. The switching voltage is conveniently obtained from an L.T. winding on the transformer, as shown in the diagram.—*National Bureau of Standards Technical Bulletin.*

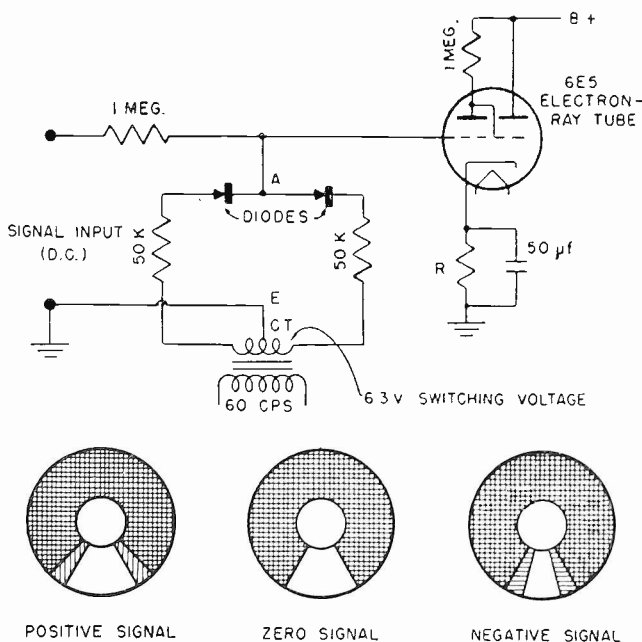

# The Cathode-Follower

By E. PARKER, M.A., A.M.I.E.E.

Part 4 — Appendices

Appendices I and II are mainly of theoretical interest, but the remainder contain results of considerable practical value. Except that Appendix V must follow Appendix IV, the appendices can be read in any order; they refer exclusively to the linear or "idealised" theory of Sections 1-9.

## APPENDIX I.

The Principal Formulae Expressed in terms of  $R_a$ .

FOR the sake of completeness the principal formulae of Sections 1 to 5, inclusive, are re-stated below in terms of  $R_a$ . As mentioned in Section 1, the writer believes them to be less convenient than the forms given in the main text. Each " $R_a$ " form is, of course, obtained from the corresponding " $R_m$ " form (whose number is given in brackets) by the substitutions  $R_m = 1/g_m = R_a/\mu$ . The Basic Triode Equation:

$$I = \frac{V_a + \mu V_i}{R_a} \dots (1.1)$$

The "Degenerate" Triode Equation:

$$I = D \times \frac{V_{ht} + \mu V_i}{R_a} \dots (2.2)$$

where  $D = \frac{R_a}{R_a + (\mu + 1)R_c} \dots (2.3)$

$$\approx \frac{R_a}{R_a + \mu R_c} \dots (2.4)$$

The Cathode-Follower Current Equations:

$$I = \frac{V_{ht} + \mu V_i}{R_a + (\mu + 1)R_c} \dots (3.2)$$

$$\approx \frac{V_{ht} + \mu V_i}{R_a + \mu R_c} \dots (3.3)$$

and  $\Delta I \approx \frac{\mu \Delta V_i}{R_a + \mu R_c} \dots (3.4)$

The Cathode-Follower Voltage Equations:

$$V_o = \frac{R_c}{R_a + (\mu + 1)R_c} (V_{ht} + \mu V_i) \dots (4.1)$$

$$\approx \frac{R_c}{R_a + \mu R_c} (V_{ht} + \mu V_i) \dots (4.2)$$

and  $\Delta V_o \approx \frac{\mu R_c}{R_a + \mu R_c} \Delta V_i \dots (4.5)$

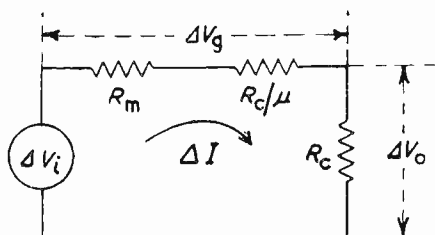

Fig. 24. Equivalent potentiometer

## APPENDIX II

Further Consideration of the Equivalent Circuits

### A.2.1. The Exact Equivalent Circuits

The exact equivalent circuits, like the approximate equivalent circuits (see paragraph 5.2) are obtained most directly from Equation (2.1), which, with a slight notational change, can be written:

$$I.R_m = V_i + V_{ht}/\mu - (\mu + 1)V_o/\mu$$

(It will be recalled that this was a fundamental relationship derived directly from the basic triode Equation (1.2).) Re-arranging, the above equation becomes:

$$\frac{\mu}{\mu + 1} V_i + \frac{1}{\mu + 1} V_{ht} = \frac{\mu}{\mu + 1} R_m \cdot I \dots (A.2.1)$$

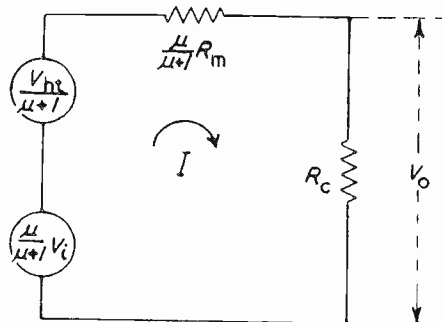

Fig. 22. Equivalent D.C. circuit of cathode follower

The exact equivalent D.C. circuit is therefore as shown in Fig. 22. The corresponding exact a.c. equation is:

$$\Delta V_o = \frac{\mu}{\mu + 1} \Delta V_i - \frac{\mu}{\mu + 1} R_m \cdot \Delta I \dots (A.2.2)$$

and the exact equivalent a.c. circuit is that shown in Fig. 23. In particular, the exact output impedance is  $[\mu/(\mu + 1)]R_m$  and the exact inherent amplification (amplification under "no load" conditions) is  $\mu/(\mu + 1)$ . This last result has been found previously in paragraph 4.3.1.

The above expression:

$$[\mu/(\mu + 1)]R_m$$

for the exact output impedance may

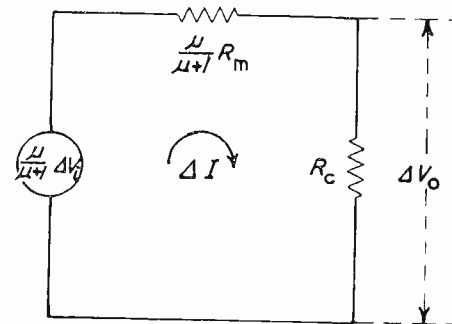

Fig. 23. Equivalent A.C. circuit of cathode follower

be re-written as  $1/(1/R_m + 1/R_a)$ —set  $\mu R_m$  for  $R_a$  and work backwards—which shows that the exact output impedance is equal to the mutual resistance  $R_m$  in parallel with the anode resistance  $R_a$ . (Compare the approximate result given in paragraph 5.6.) The exact statement corresponding to the last sentence of paragraph 5.6 is that the output impedance of the stage as a whole is  $Z$ , where:

$$\frac{1}{Z} = \frac{1}{R_m} + \frac{1}{R_a} + \frac{1}{R_c}$$

These accurate expressions involving  $R_a$  are, of course, mainly of academic interest since  $1/R_a$  is almost always negligible compared with  $1/R_m$ . The results of paragraph 5.6 are the practical ones.

### A.2.2. The Equivalent Potentiometer

An alternative way of writing Equation (A.2.2) is as follows:—

$$[(\mu + 1)/\mu] \Delta V_o = \Delta V_i - R_m \cdot \Delta I$$

or, re-arranging,

$$\Delta V_o = \Delta V_i - R_m \Delta I \quad \Delta V_o/\mu.$$

Writing  $R_c \cdot \Delta I$  for  $\Delta V_o$  in the right-hand side only gives immediately:

$$\Delta V_o = \Delta V_i - (R_m + R_c/\mu) \Delta I$$

which establishes the alternative equivalent circuit of Fig. 24. This is not an equivalent circuit in the usual sense of the term since the "internal impedance," viz.,  $R_m + R_c/\mu$ , is not independent of the load but it does give some in-



formation that cannot easily be derived from the conventional equivalent circuit of Fig. 23. The significant difference between the two circuits is that the "input voltage" in the circuit of Fig. 24 appears explicitly as  $\Delta V_i$  without any multiplying factor (which it does not in the circuit of Fig. 23), so that the voltage across the "internal impedance" of the new circuit is precisely  $\Delta V_i - \Delta V_o$ , i.e.,  $\Delta V_g$ . In other words, the new circuit relates  $\Delta V_i$ ,  $\Delta V_g$ ,  $\Delta V_o$ , in the manner of a simple potentiometer, a relationship which is sometimes very convenient. For example, it can be used to provide an alternative proof of the results of Section 7 on maximum input and outputs (see paragraph A.2.3 below). To distinguish it from the circuit of Fig. 23 the circuit of Fig. 24 will be called the "Equivalent Potentiometer."

A.2.2.1. It should be noted in connection with the last paragraph that the equivalent circuit of Fig. 9, which also appears to have  $\Delta V_i$  and  $\Delta V_o$  at the ends of its internal impedance, does not (in general) have  $\Delta V_g$  across this impedance since the  $\Delta V_o$  there is only approximate. Comparison between Figs. 9 and 24 shows, in fact, that this will be so only if  $R_c/\mu \ll R_m$ , i.e., if  $R_c \ll R_a$ .

**A.2.3. Example. The Results of Section 7 Proved by Use of the Equivalent Potentiometer**

Let the  $\Delta$  appearing in Fig. 24 denote the change from cut-off to the grid current point on the characteristic. Then clearly  $\Delta I = I_m$ ,  $\Delta V_o = V_m$  and  $\Delta V_g = V_{ht}/\mu$  (the "idealised" grid-base,  $V_{GB}$ ), while  $\Delta V_i$  is the maximum permissible peak-to-peak input voltage. Fig. 24 then becomes Fig. 25, and from the latter it follows that

$$I_m = (V_{ht}/\mu)(R_m + R_c/\mu)$$

which equals  $V_m/(R_a + R_c)$ , and that

$$V_m = [R_c/(R_m + R_c/\mu)] [V_{ht}/\mu]$$

which equals  $[R_c/(R_a + R_c)] V_{ht}$ .

The maximum peak-to-peak input voltage is  $V_m + V_{ht}/\mu$ . These are the previously established results of Section 7.

**A.2.4. The Equivalent Potentiometer Established Verbally**

The reasoning which established the equivalent potentiometer can be put into almost completely verbal

form as follows. Let an (incremental) input voltage  $\Delta V_i$  produce a change  $\Delta I$  in output current. This causes a rise  $R_c \Delta I$  in cathode voltage, which, in effect, directly reduces the input voltage by an amount  $R_c \Delta I$ . It also has an indirect effect, in that it causes a drop  $R_c \Delta I$  in the anode voltage, and this, by the definition of  $\mu$ , is equivalent to a change  $R_c \Delta I/\mu$  in the grid voltage. Hence the effective input voltage is

$$\Delta V_i - R_c \Delta I - R_c \Delta I/\mu,$$

and this expression times  $g_m$  must therefore equal  $\Delta I$ . Replacing  $g_m$  by  $1/R_m$  then leads immediately to the result  $\Delta V_i = (R_c + R_c/\mu + R_m) \Delta I$  which establishes the circuit of Fig. 24.

If the last equation is multiplied through by  $\mu/(\mu + 1)$ , the exact equivalent a.c. circuit of Fig. 23 is also established.

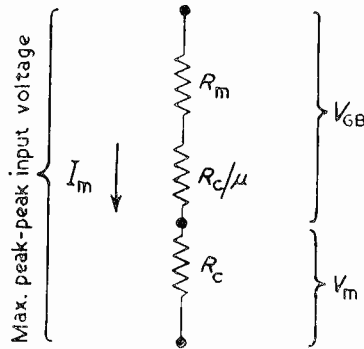

Fig. 25. Mnemonic circuit (exact) for maximum input and output in terms of  $V_{GB}$  ( $=V_{ht}/\mu$ )

**APPENDIX III**

**The Case  $R_c \ll R_a$**

**A.3.1. Maximum Outputs**

The results of Section 7 on maximum outputs are capable of some simplification when  $R_c$  is much less than  $R_a$ . This includes the important case of a cathode-follower feeding a low impedance transmission line. For Equations (7.2) and (7.1) become, respectively,  $I \cong V_{ht}/R_a$ , which equals  $I_1$  (from Section 8), and  $V_m \cong (R_c/R_a)V_{ht}$  which equals  $I_1 R_c$ . In words, the maximum output current is practically independent of  $R_c$  and equal to  $I_1$ , for all values of  $R_c \ll R_a$ , while the maximum output voltage increases directly with  $R_c$ . Geometrically (refer to Fig. 26), the  $R_c$ -lines for values of  $R_c \ll R_a$  make only small angles with the current axis and so the maximum output currents differ little from  $I_1$  while the maximum

output voltages are proportional to  $R_c$ . These results are, of course, self-evident when it is recalled that with small values of  $R_c$  there can be no appreciable change in the anode voltage.

From the equation  $V_m \cong I_1 R_c$  of the previous paragraph it is possible, however, to write down a very convenient expression for  $V_m$  in terms of the "idealised" grid-base,  $V_{GB}$  (see Fig. 26), of the valve. For, from this figure,  $I_1 = g_m V_{GB} = V_{GB}/R_m$  and so

$$V_m \cong \frac{R_c}{R_m} \times V_{GB} \dots \dots \dots (A.3.1)$$

**A.3.2. Maximum Peak-to-Peak Input**

The input necessary to swing the valve from its "idealised" cut-off point to its full output is greater than  $V_m$  by the grid-base itself (see Fig. 26), i.e., the maximum peak-to-peak input voltage is  $V_m + V_{GB}$  which is equal approximately to:

$$\left(\frac{R_c}{R_m} + 1\right) V_{GB} \dots \dots \dots (A.3.2)$$

**A.3.3. Conclusions**

Equations (A.3.1) and (A.3.2) can be remembered from the simple mnemonic circuit of Fig. 27 which is what Fig. 25 becomes under the condition  $R_c \ll \mu R_m$  of the present appendix. But an even simpler statement of the results (A.3.1) and (A.3.2) is the following:

*A cathode-follower with a cathode resistance equal to  $N \times R_m$  and yet small compared with  $R_a$  has an effective grid-base  $(N + 1) \times V_{GB}$  and a maximum output voltage  $N \times V_{GB}$ .*

It follows further that the gain is  $N/(N + 1)$  but this result holds whether  $R_c$  is small compared with  $R_a$  or not. It was, in fact, proved in paragraph 4.3.

A.3.4. It will be seen from Fig. 26 that the peak-to-peak input necessary to swing the valve from true cut-off to full current exceeds  $(N + 1)V_{GB}$  by an amount  $AA'$ . But if the valve is worked only on the linear part of its characteristic,  $(N + 1)V_{GB}$  remains a very good approximation to the input swing required, while the peak-to-peak outputs will in this case be less than  $V_m$ ,  $I_m$  by the minimum d.c. cathode voltage and current, respectively, that the condition of linear working will permit.

APPENDIX IV

The Voltage Across  $R_m$  in the Approximate Equivalent A.C. Circuit of Fig. 9.

This voltage has the very important property that:

*Its product with the mutual conductance is equal to  $\Delta I$  (A.4.1)*

In other words, it is the "effective input voltage" to the valve. The proof of the statement (A.4.1) is self-evident since from the circuit of Fig. 9 the "voltage across  $R_m$ " is  $R_m \Delta I$  and this multiplied by  $g_m$  is  $\Delta I$ .

The actual value of the "effective input voltage" in terms of the true input voltage  $\Delta V_i$  follows at once from Fig. 9. It is  $R_m / (R_c + R_m)$  times  $\Delta V_i$ . Mathematically, of course, this is exactly the same result as was found in Section 2 where the input voltage was supposed unaltered by degeneration but where the *mutual conductance* was supposed reduced to an effective value  $R_m / (R_c + R_m)$  times  $g_m$ . The change of viewpoint regarding the equivalent circuit itself should also be noted. In section 5 the "voltage across  $R_m$ " was the voltage uselessly dropped across the internal impedance of the cathode-follower, while the voltage across  $R_c$  was the useful "output" voltage. Now, the "voltage across  $R_m$ " is regarded as the significant voltage and the voltage across  $R_c$  is ignored. The reason for the new viewpoint is as follows. When the equivalent circuit of Section 5 had been established, the basic theory of the cathode-follower was essentially complete and there was no need for a theorem about the effective input voltage, but when the value of the current through the valve is required for its own sake (i.e., not as a step on the way to finding the cathode voltage), as in the next appendix, the theorem (A.4.1) is very convenient. It is, in other words, a useful corollary to cathode-follower theory rather than a fundamental part of it.

It should be noted that although the "voltage across  $R_m$ " has been shown to be the "effective input voltage" to the valve, this is not the same thing as saying that it is the grid voltage  $\Delta V_g$ . It is  $\Delta V_g$  modified to take into account the change in anode voltage that has occurred. Only if  $R_c \ll R_m$  (see para. A.2.2.1) is it the actual grid voltage  $\Delta V_g$ .

A similar theorem clearly exists in connexion with the approximate equivalent D.C. circuit of Figure 8.

APPENDIX V

The Tetrode or Pentode Amplifier with Cathode Degeneration

A.5.1. Introduction

A great deal of the theory of the cathode-follower can clearly be applied to a tetrode amplifier with cathode degeneration, since such a valve is, of necessity, a cathode-follower at the same time. (The term "tetrode" is to be taken to include "pentode" in the present appendix.) When the cathode current has been found by cathode-follower theory it is only necessary to know the division of this current between the anode and screen, and the anode current and stage gain are then known.

For this simple extension of cathode-follower theory to be valid, it is necessary to make the assumption (a customary one) that the anode resistance of a tetrode is very large. The external anode load can then be supposed zero so far as the cathode current is concerned. It is also convenient (though not essential) to assume a fixed screen voltage relative to H.T. negative. With these assumptions, the "grid input"/"cathode output" relationships of the valve clearly obey cathode-follower rules exactly, and in particular the equivalent circuits and their associated formulae can be used with only notational changes.

There is, however, a simpler and more elegant approach making the same assumptions but using the "effective input voltage" theorem of the previous appendix. This theorem holds for a tetrode just as it did for a triode provided that  $R_m$  is now defined specifically as the grid-cathode transresistance. (In a triode the grid-cathode and grid-anode transresistances were the same so that the distinction never had to be made.) In the tetrode case the theorem can be stated most conveniently as follows:

*The "voltage across  $R_m$ " is the "effective input voltage" to the valve and, in particular, its product with the grid-anode transconductance is equal to the anode current.*

This is illustrated in Fig. 28 where the symbol  $g_m'$  is introduced to represent the grid-anode transconductance. The corresponding D.C. circuit is shown in Fig. 29 (see para. A.5 for explanation of symbols). The rigorous proof of the foregoing statements is left to the reader, as also is the proof of some of the miscellaneous examples which follow.

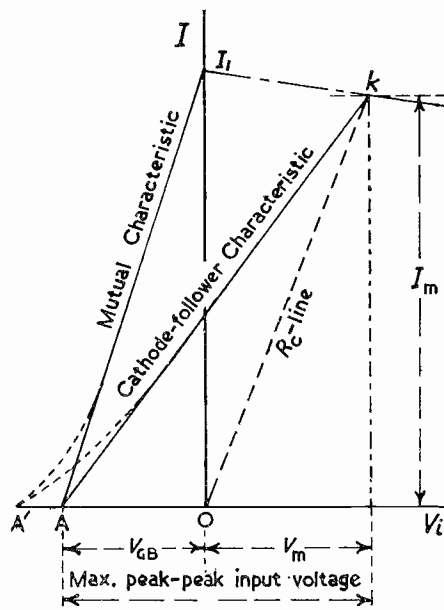

Fig. 26 Illustrating the case where  $R_c$  is 'much less than  $R_a$ '

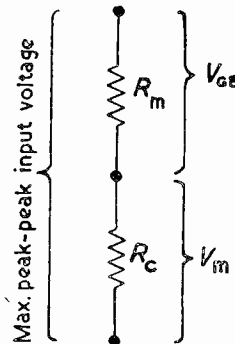

Fig. 27 Mnemonic circuit for maximum input and output voltages in terms of  $V_{GB}$  when  $R_c \ll R_a$

Multiply by  $g_m'$  for anode current (A.C.)

"Effective input voltage"

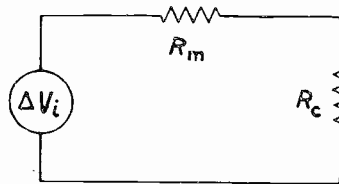

Fig. 28 Approximate equivalent circuit for tetrode or pentode amplifier with cathode degeneration

Multiply by  $g_m$  for anode current (D.C.)

"Effective input voltage"

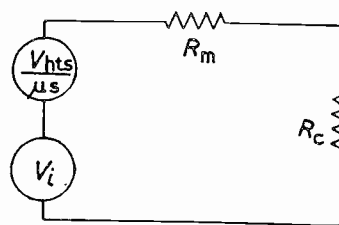

Fig. 29 Approximate equivalent D.C. circuit to the above

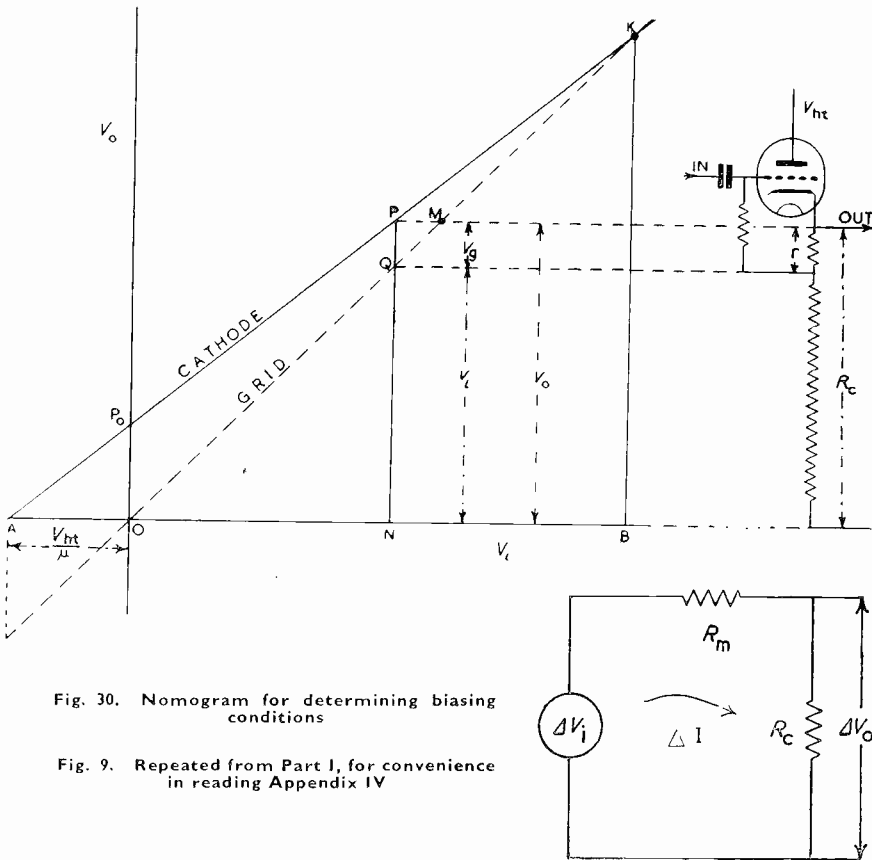

Fig. 30. Nomogram for determining biasing conditions  
 Fig. 9. Repeated from Part I, for convenience in reading Appendix IV

In practice,  $R_m$  can, of course, be taken as either the grid-cathode or grid-anode transresistance unless a very accurate result is required.

**A.5.2. The Stage Gain**

Fig. 28 shows that the "effective input voltage" is  $R_m / (R_m + R_c)$  of the actual input voltage, from which it follows that the stage gain also is  $R_m / (R_m + R_c)$  of what it would have been without degeneration. In the notation of paragraph A.3.3, the stage gain is reduced by a factor  $1 / (N + 1)$ . If the anode load resistance is  $R_L$ , the stage gain is, in full,  $g_m R_L \times R_m / (R_m + R_c)$ .

**A.5.3. The Stage Gain when  $R_c \gg R_m$ .**

In this case, the last formula of the preceding paragraph becomes  $g_m R_L \times R_m / R_c$ , approximately. This can be written as  $(R_L / R_c) \times g_m / g_m$  (where  $g_m$  is the grid-cathode transconductance) which is  $R_L / R_c \times$  the ratio of the anode current to the cathode voltage. This result could have been obtained by recalling that when  $R_c \gg R_m$  the cathode voltage follows the grid voltage almost exactly so that the stage gain is, in effect, the anode voltage divided by the cathode voltage.

If the screen current can be neglected, the expression for the stage gain simplifies still further to  $R_L / R_c$ .

**A.5.4. Maximum Anode Current and Input Voltage when  $R_c \ll R_a$**

The results of Appendix III applied to a tetrode amplifier with cathode degeneration give that the maximum available anode current remains unaffected (to a first approximation) by the introduction of a cathode resistance small compared with  $R_a$ , while the maximum permissible A.C. input is increased by a factor  $N + 1$  (where  $R_c = NR_m$ ).

**A.5.5. Maximum Anode Current and Input Voltage for any  $R_c$ .**

The anode current equation of a tetrode has the form (cf. Equation (1.1)).

$$I_a = \frac{V_s + \mu_s V_g}{R_s} \dots \dots \dots (A.5.1)$$

where  $V_s$  is the D.C. voltage of the screen relative to the cathode. It has this form because the anode current in a tetrode depends on the grid and screen voltages in just the same way as the anode current in a triode depends on the grid and anode

voltages. In the above equation  $R_s$  is the "screen voltage/anode current transresistance" and may be found from the published characteristics as the screen voltage divided by the corresponding anode current at  $V_g = 0$ . The constant  $\mu_s$  is the "grid/screen amplification factor" and is the ratio of any screen voltage to the corresponding (idealised) grid-base.

If the screen current can be neglected, the maximum available valve current (i.e., cathode or anode current) can easily be shown to be

$$I_m = \frac{V_{hts}}{R_s + R_c} \dots \dots \dots (A.5.2)$$

where  $V_{hts}$  is the D.C. voltage of the screen relative to H.T. negative. (This result is obtained most simply by an argument exactly analogous to that of paragraph 7.4.) The corresponding value of  $V_m$  is  $[R_c / (R_s + R_c)] V_{hts}$ , which is therefore the maximum permissible positive input voltage. ( $V_m$  must no longer be described as the maximum output voltage since the output is now being taken from the anode, not from the cathode.)

**A.5.5.1.** If the screen current cannot be neglected, a modification of the same argument shows that the above equation for  $I_m$  still holds provided that  $R_c$  is replaced by  $R_c / \lambda$ , and that the equation for  $V_m$  still holds if  $R_s$  is replaced by  $\lambda R_s$ , where  $\lambda$  is the ratio of the anode current to the cathode current.

**A.5.5.2. Maximum Permissible Anode Load.** The value of  $I_m$  given in Equation (A.5.2) above will not be realisable in practice if the anode supply voltage  $V_{ht}$  is so low or the anode load resistance  $R_L$  so large that the anode "bottoms" before this current is reached. An (approximate) necessary condition for the realisability of this value of  $I_m$  is clearly  $(R_L + R_c) I_m < V_{ht}$ . For linear working, the difference between these two quantities (i.e., the anode-to-cathode voltage) should not be allowed to fall below a certain figure (often about 80 volts). If  $V_{ht} = V_{hts}$ , the above condition becomes (by Equation (A.5.2)) simply  $R_L < R_s$ . Corresponding conditions taking the screen current into account can be worked out if required.

(Continued on p. 131)

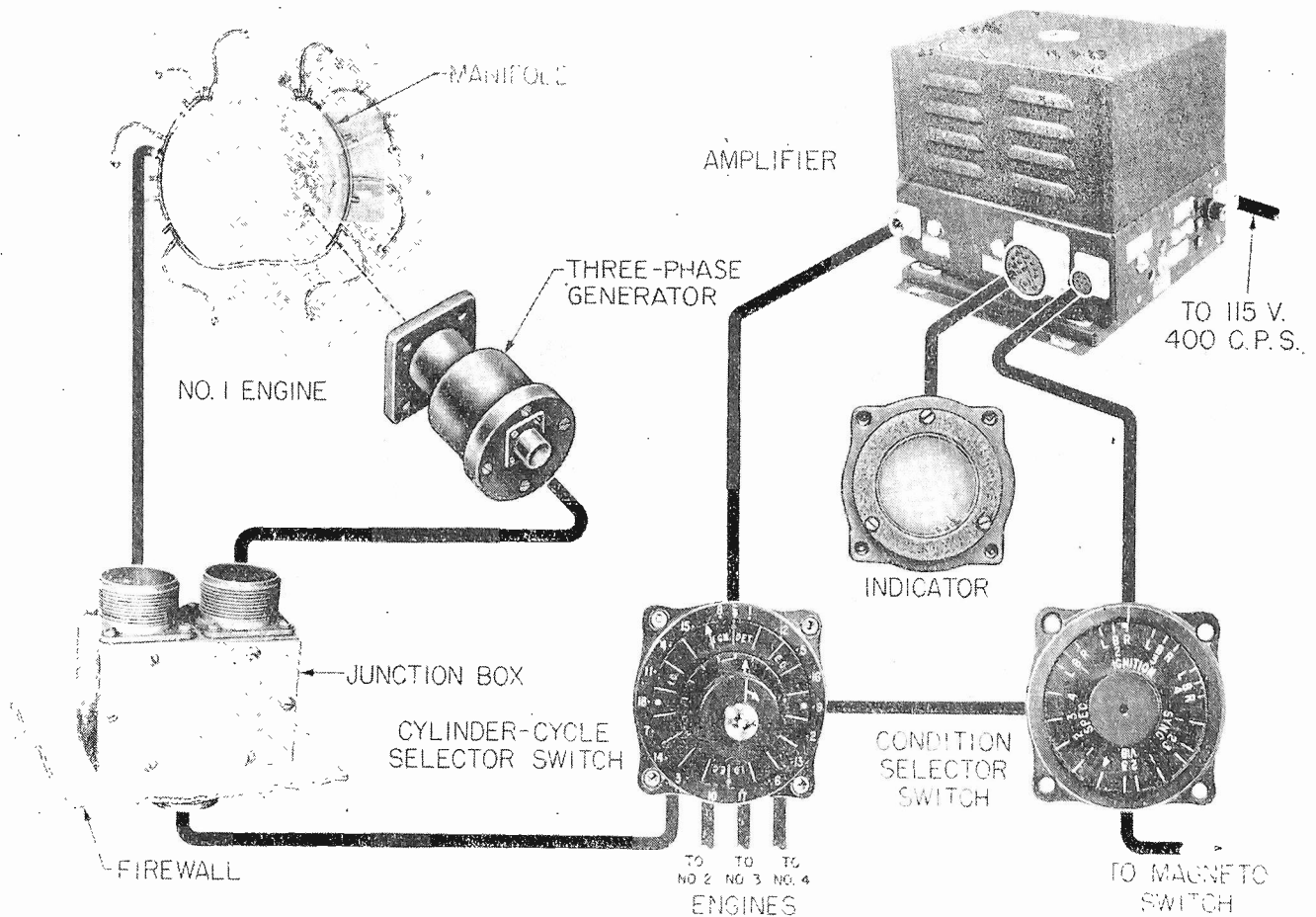

Fig. 1. Diagram of the complete analyser system

## A New Cathode-Ray Engine Analyser

By JOHN H. JUPE, A.M.I.E.E.

**T**HE application of the cathode-ray tube to the analysis of internal combustion engine problems is not new, but the engine analyser of the American Sperry Gyroscope Company is believed to be the first instance of this type of analysis being made the basis of a standard flight instrument for aircraft.

Although the design is broad enough to permit the presentation of various aspects of the aircraft's performance the primary purpose of the equipment, as developed, is to present traces related to the engine ignition system and to the mechanical vibration associated with individual cylinders.

To display traces representing the ignition system the varying voltage at the magneto switch in the primary circuit is applied directly

to the vertical deflection circuit of the cathode-ray tube, though care is taken to ensure that the analyser cannot vary the performance of the ignition system.

For vibration traces, magnetostriction pickup units are screwed into each cylinder and the voltages generated are applied to the vertical deflection plates, after amplification.

Of particular interest is the method of synchronising the oscilloscope time-base with the engine so that variation in the speed of the latter does not change the display conditions. It is done by driving a small three-phase generator from the auxiliary tachometer drive of the engine so that the output voltage alternates synchronously with the engine rotation. This voltage is used to trigger the cathode-ray tube time-base and the sweep can

be initiated just before the firing of any desired cylinder.

Fig. 1 shows a diagram of the complete analyser system.

### Ignition Patterns

Fig. 2 illustrates a typical normal pattern for the engine and ignition named and consists of two damped high frequency oscillations superimposed on a low frequency oscillation. The trace is started when the contact-breaker points separate. The firing of the charge accompanies the arc associated with the first high frequency burst and the second oscillation arises because of the electrical reaction of the ignition system. The voltage developed by this is smaller but by that time there are highly ionised gases between the sparking plug points and so a second discharge can easily occur.

## The Cathode-Follower

(Continued from p. 129)

### APPENDIX VI A Note on Biasing

#### A.6.1. General.

A common way of giving the input signal to a cathode-follower a positive bias with respect to H.T. negative is to return the grid-leak of the valve to a tapping on the cathode resistance (see the circuit part of Fig. 30). The position of the tapping-point on the cathode resistance and the position of the working-point on the characteristic are related as follows.

Let  $P$  be the working-point on the cathode-follower voltage characteristic and let the ordinate  $PQN$  be drawn as shown (in the graph of Fig. 30). Then by the theory of Section 6,  $PQ/QN$  is equal to the (numerical) value of the ratio  $V_g/V_i$  at this working-point. But since there is no current in the grid-leak,  $V_g/V_i$  is (numerically) the ratio into which the cathode resistance is divided by the tapping-point. Hence this latter ratio is equal to  $PQ/QN$  whose value can be measured from the graph.

This method of determining the tapping-point corresponding to a given working-point is illustrated in Fig. 30 where the circuit symbol for the cathode-resistance  $R_c$  has been drawn equal in length to the ordinate  $PN$  and in the position shown, while horizontal lines have been drawn through  $P$  and  $Q$  cutting this symbol at the cathode terminal and the tapping point respectively.

Clearly a cathode-follower current characteristic with its associated  $R_c$ -line will serve equally well in this construction since the current graph differs only from the voltage graph in having a different vertical scale.

#### A.6.2. Mid-point Biasing

In Fig. 30, if  $AP = PK$ , then  $NP = \frac{1}{2}BK = \frac{1}{2}V_m$ , and  $QP = PM = \frac{1}{2}AO = \frac{1}{2}V_{ht}/\mu$ . Hence  $QP/NP = \Gamma_{ht}/\mu V_m = (R_a + R_c)/\mu R_c$ , from Eq. (7.1). But from what has been said above,  $QP/NP = r/R_c$  (Fig. 30). Hence  $r = (R_a + R_c)/\mu = R_m + R_c/\mu$

This, then, is the condition for mid-point biasing. If  $R_c \ll R_a$ , the condition reduces to  $r = R_m$ .

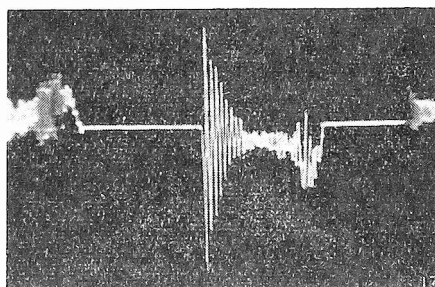

Fig. 2. Normal pattern at 1,700 r.p.m. Wright "Cyclone 18" engine. No capacitor in magneto secondary circuit

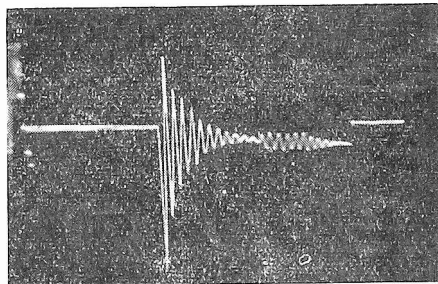

Fig. 3. Fouled sparking plug

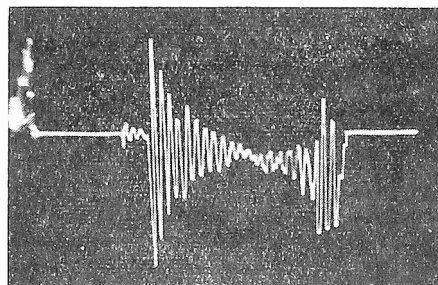

Fig. 4. Magneto mis-timed. (Method 1)

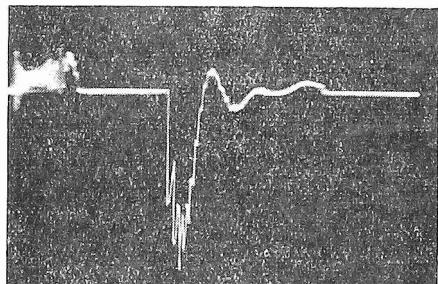

Fig 5. Open circuited secondary

An ignition pattern due to a fouled sparking plug is illustrated in Fig. 3. It appears as a pattern which varies in a dancing manner between perfectly normal and a trace with the second oscillation almost obliterated (the sign of a short circuited secondary or short circuit to frame). Magnetos mis-timed can be shown on the analyser by two methods. In method 1, shown in Fig. 4, there is dependence on an induced pattern picked up from the advanced plug when the single pattern from the retarded one is being displayed. The induced pattern, shown quite clearly in the oscillogram, is a small oscillation before the start of the main pattern, the distance between them being proportional to the angular mis-timing.

The second method of detecting mistiming depends on the fact that if two normal patterns are displayed simultaneously they must be perfectly superimposed if the two sparking plugs fire at precisely the same instant.

Other distinct ignition patterns include small and large plug gaps, open circuited secondary (Fig. 5), short circuited primary capacitor and engine "hunting," even if only slight.

#### Vibration Patterns

The normal vibration pattern shows the four main engine noises as four large-amplitude spaced pips corresponding to:

1. The exhaust valve closing.
2. Fuel being injected.
3. The inlet valve closing.
4. Combustion.

If there are any spurious mechanical effects their presence will be shown by additional pips.

If a valve is seating badly its corresponding pip will be missing or much reduced in amplitude, while incorrect valve timing will be betrayed by the pip being displaced to the left or right of its normal position.

Two switches incorporate all the analyser controls; a Condition Selector to choose the engine, magneto and kind of pattern (vibration or ignition) to be examined; and a Cylinder Selector to choose the individual cylinder or sparking plug and portion of the engine cycle. A push button in the middle of the Cylinder Selector can be used to display the patterns of all cylinders simultaneously, in a row and starting with any particular cylinder.

The analyser is built for operation at 115 volts, 100 c/s., draws 0.6 ampere and has 13 valves in the amplifier. The oscilloscope tube is 3 in. in diameter, fluoresces green and has medium afterglow.

For ignition patterns only in a 4-engined machine, the total analyser weight is only 38 lb. without cables, but if vibration patterns are wanted the weight increases to 112 lb.

# The Synchrondyne — Correspondence

## Communication Receivers

DEAR SIR,—I have studied the articles on the Synchrondyne receiver in March, July, August and September issues of *ELECTRONIC ENGINEERING*. I have a great interest in that subject, especially since I have started working on the problem of selective demodulation before I had the chance to get acquainted with the publications. I admit that I did not get far before the articles made clear to me the advantages of the discriminative properties of the synchronised oscillator.

In the last article in the September issue of *ELECTRONIC ENGINEERING* you leave as an unsolved question to be solved by the reader the use of the Synchrondyne principle in a communication receiver. I have worked out this type of a receiver and I should like to notify you about the innovations employed in it.

The main difference between the "High Sensitivity Circuit" as described in the article and my design, which I call the Super-Synchrondyne Communication Receiver, lies in the voltage amplification prior to demodulation. As already the name of my design shows, the R.F. amplification stages are replaced by the mixer and I.F. amplifier of a superhet type. I found that this arrangement has the following advantages:

1. The rate of voltage amplifications per stage is much higher than in case of a periodic R.F. amplification. I presume that the voltage gain of the A.F. part is limited to the value which can be obtained by two pentode stages, since higher amplification requires expensive screening and precautions against parasitic oscillations. Therefore I believe that the I.F. stages of a sensitive receiver give us the most economic voltage amplification.

2. Standard mixer stage will permit the reception of all frequency bands.

3. The parameters of the synchronised oscillator can be fixed since it is working on a constant frequency. Its synchronising and discriminative action will not depend upon the frequency of the received signal. Furthermore, the fact that the synchronised oscillator works on a fixed frequency is also very helpful in suppressing the tuning-in "howl."

4. In order to increase the frequency discrimination of the receiver the synchronising element of the oscillator may be coupled to the I.F. amplifier through a high selectivity circuit, which elements will have fixed values.

You will probably object to the point that the I.F. amplification will bring a frequency discrimination in the signal part, while you intend to concentrate it only on the demodulator circuit. Theoretically it is certainly true, but in practice the highest modulating frequency of an A.M. transmitter is 9 Kc/s., so if the I.F. channel will pass a 20 Kc/s. band it will not influence the fidelity of the receiver to any extent. At the same time this small frequency discrimination of the I.F. amplifier would be sufficient to keep the strong signals of local stations from overloading the amplifier.

A further innovation in my design is the arrangement of the ring demodulator as illustrated in the diagram. The values of L and C are chosen so that the demodulator circuit can be regarded as a parallel resonant circuit tuned to I.F. if viewed from the last I.F. tank circuit, to which it is coupled. At the same time it behaves like two series resonant circuits in parallel if viewed from the oscillator side. This arrangement of the ring demodulator means a high impedance coupler to the last I.F. stage.

The task of the oscillator voltage is to switch on and off the rectifiers. The smaller the voltage drop on the circuit impedance as compared with the drop on the rectifier internal resistance the more efficiently is the oscillator voltage used. In the arrangement as described above the current of the oscillator passes through the low impedance of the series resonant circuit and the internal resistance of the rectifier and the voltage drop on the last is much higher than in the case of an untuned circuit. The relatively small loading of the I.F. amplifier and efficient use of oscillator voltage are the advantages of the here described tuned ring demodulator.

In my design I took advantage of a relatively simple selectivity control of a receiver using the synchrondyne demodulation system. I placed several m-derived low pass filters with different cut-off frequencies in the A.F. part of the

receiver and by simply switching one of them I got the required selectivity of the receiver. This way of controlling the selectivity seems to me to be one of the great advantages of the synchrondyne system since they are accomplished by much simpler means and the selectivity curve approached nearer the ideal rectangle form than in a normal communication receiver using detector demodulation.—Yours faithfully,

EDWIN LANGBERG.

Prague.

## Patent Note

DEAR SIR,—In the February issue of *ELECTRONIC ENGINEERING* we note in Dr. Tucker's article the suggestion of using a "reactor valve." It does not appear to be generally known that this circuit is a British invention, being the subject of Patents 443,423 and 450,136, owned by this company, and we should be obliged if you would print a note pointing this out in your next issue.—Yours faithfully,

D.P. MURPHY RADIO, LIMITED.

(G.F. HAWKINS)

Electronics Division.

## Correction

In Fig. 6 of the article on The Synchrondyne (page 54, February issue), C and R should be connected to earth and not to the feedback circuit as shown.

## Television Bandwidth

SIR,—With regard to correspondence in your February issue on the subject of Television Bandwidth.

We are under the impression that the British system uses an aspect ratio of 5:4 for the picture. Therefore, the aspect ratio of the transmitted raster, including horizontal and vertical blanking, is 5.882:4.301, assuming 15 per cent. horizontal blanking and 7 per cent. vertical blanking.

Now, using this aspect ratio in the accepted bandwidth formula:  $(FRP)/2$  where  $l$  = number of lines (405),  $R$  = aspect ratio (5.882:4.301),  $P$  = picture frequency (25).  

$$\text{Bandwidth} = \frac{1}{2}(164025 \times 1.367 \times 25)$$

$$= 2.802 \text{ Mc/s.}$$

This is the bandwidth required to transmit a picture containing 377 lines with an aspect ratio of 5:4, assuming equal horizontal and vertical definition.—Yours faithfully,

J. E. RICH, L. F. ODELL.

Nightingale Lane, S.W.12.

# APRIL MEETINGS

## Institution of Electrical Engineers

All meetings are held at the Institution of Electrical Engineers, Savoy Place, London, W.C.2.

### Ordinary Meeting

Date: April 22. Time: 5.30 p.m.  
The Thirty-Ninth Kelvin Lecture:  
"The Nervous System as an Electrical Instrument."  
By: B. H. C. Matthews, C.B.E., M.A., Sc.D., F.R.S.

### Radio Section

Convention on "Scientific Radio."  
Date: April 7.

### Subjects:

"Standards and Measurements."  
"Propagation."

Date: April 8.

### Subjects:

"Radio Noise."  
"Radio Physics."

Date: April 13. Time: 5.30 p.m.  
Discussion on: "Future Trends in the Design of Receiving Aerials."  
Opened by: E. M. Lee, B.Sc.

### Installation Section

Date: April 15. Time: 5.30 p.m.  
Lecture: "The Flash Tube and its Applications."  
By: J. N. Aldington, B.Sc., Ph.D., and A. J. Meadowcroft.

### Informal Meeting

Date: April 26. Time: 5.30 p.m.  
Discussion on "Industrial Applications of Photo-Electric Cells."  
Opened by: F. Baxendale, B.Sc. (Eng.).  
The Secretary: I.E.E., Savoy Place, W.C.2.

### Cambridge Radio Group

Date: April 6. Time: 6 p.m.  
Held at: Cambridge Technical College.  
Lecture: "Television Camera Tubes."  
By: F. H. Townsend.  
Date: April 27. Time: 8.15 p.m.  
Held at: Cavendish Laboratory.  
Lecture: "Tropospheric Propagation."  
By: H. G. Booker.

Hon. Secretary: J. E. Curran, University Engineering Laboratory, Trumpington Street, Cambridge.

### North-Western Radio Group

Date: April 7. Time 6.30 p.m.  
Held at: Engineers' Club, Albert Square, Manchester.  
Lecture: "Pulse Communication."  
By: D. Cooke, B.A., Z. Jelonek, A. J. Oxford, B.Sc., E. Fitch, B.Sc.

Asst. Secretary: A. L. Green, 241 Brantingham Road, Chorlton-cum-Hardy, Manchester 2.

### North-Eastern Centre

Date: April 5. Time: 6.30 p.m.  
Held at: Neville Hall, Newcastle-on-Tyne.  
Lecture: "The Design and Construction of a New Electron Microscope."  
By: M. E. Haine, B.Sc.

Hon. Secretary: E. C. Rippon, c/o C. A. Parsons and Co., Ltd., Hepton Works, Newcastle-on-Tyne, 6.

## Institute of Physics

### Electronics Group

Date: April 20. Time: 5.30 p.m.  
Held at: The Institute of Physics, 47 Belgrave Square, S.W.1.

Lecture: "Long-Wave Infra-Red Detectors."  
By: C. J. Milner, M.A., Ph.D.,  
Hon. Secretary: A. J. Maddock,  
B.S.I.R.A., "Sira," Southill Road,  
Elmstead Woods, Chislehurst, Kent.

### Electron Microscopy Group

Date: April 6 and 7.  
Spring Conference.  
Held at: The Physics Department, King's College, W.C.2.  
Hon. Secretary: Dr. V. E. Coslett,  
Cavendish Laboratory, Cambridge.

### X-Ray Analysis Group

Date: April 13 and 14.  
Conference.  
Held at: The Royal Institution, Albemarle Street, W.1.  
Hon. Secretary: J. N. Kellar,  
A.Inst.P., Cavendish Laboratory,  
Cambridge.

### Scottish Branch

Date: April 13. Time: 7 p.m.  
Held at: The Department of Natural Philosophy of the University, Glasgow.  
Lecture: "Electronics in Peace and War."  
By: Sir Robert Watson-Watt, C.B., F.R.S.  
Hon. Secretary: J. M. A. Lenihan,  
F.Inst.P., Natural Philosophy Department,  
The University, Glasgow, 2.

### Manchester and District Branch

Date: April 30. Time: 7 p.m.  
Held at: New Physics Theatre, The University, Manchester.  
Branch Annual Meeting followed by:  
Lecture: "Superconductivity."  
By: Dr. D. Shoenberg.  
Hon. Secretary: Dr. F. A. Vick,  
Physics Department, The University,  
Manchester, 13.

## British Sound Recording Association

All meetings are held at the Royal Society of Arts, John Adam Street, London W.C.2.

Date: April 23. Time: 7 p.m.  
Lecture: "Quality Factors in Film Recording."  
By: B. C. Sewell.

Hon. Secretary: R. W. Lowden,  
Napoleon Avenue, Farnborough.

## British Kinematograph Society

Date: April 14. Time: 7.15 p.m.  
Held at: The Gaumont-British Theatre, Film House, Wardour Street, W.1.  
Lecture: "Colour Vision and the Film Industry."  
By: W. D. Wright, A.R.C.S., D.Sc.  
Secretary: R. Howard Cricks, Dean House, 2 Dean Street, London, W.1.

## The Television Society

Meetings will be held at The Cinematograph Exhibitors' Association, 161 Shaftesbury Avenue, London, W.C.2.

### Programme Group

Date: April 21. Time: 7 p.m.  
Lecture: "Production Problems in Television Outside Broadcasts."  
By: C. I. Orr-Ewing, O.B.E., B.A., A.M.I.E.E.  
Lecture Secretary: T. M. C. Lance,  
25 Albemarle Road, Beckenham,  
Kent.

### Constructors' Group

Date: April 14. Time: 7 p.m.  
Lecture: "Radio Frequency E.H.T. Supplies."  
By: K. G. Macleod.  
Group Secretary: A. E. Sarson, 22 Union Road, Bromley, Kent.

## Institution of Electronics

Date: April 30. Time: 6.30 p.m.  
Held at: Reynolds Hall, College of Technology, Manchester.  
Lecture: "The Application of Electronics to Vibration Research."  
By: D. M. Corke (de Havilland Propellers, Ltd.).  
Hon. Secretary: Leslie F. Berry, 105 Birch Avenue, Chadderton, Lancs.

### Brit. I.R.E.

#### London Section

All meetings are held at the London School of Hygiene and Tropical Medicine, Keppel Street, London, W.C.1.  
Date: April 8. Time: 6 p.m.  
Lecture: "High Fidelity Recording and Reproduction."  
By: W. S. Barrell and G. F. Dutton, Ph.D.  
The Publications Officer, 9 Bedford Square, London, W.C.1.

#### North-Eastern Section

Date: April 14. Time: 6 p.m.  
Held at: Neville Hall, Westgate Road, Newcastle-on-Tyne.  
Lecture: "The Pulse Signal."  
By: Prof. M. G. Say, Ph.D., M.Sc.  
Secretary: M. A. Boardman, 20 Princes Avenue, Gosforth.

#### North Western Section

Date: April 8. Time: 6.15 p.m.  
Held at: The College of Technology (Reynolds Hall), Manchester.  
Lecture: "Factors Governing the Performance of I.F. Amplifiers."  
By: H. Stibbe and K. G. Lockyer.  
Hon. Secretary: B. E. P. Ritson, 38 Parswood Court, East Didsbury, Manchester, 20.

#### Scottish Section

Date: April 21. Time: 6.45 p.m.  
Held at: The Institution of Engineers and Shipbuilders in Scotland, Elm-bank Crescent, Glasgow, C.2.  
Lecture: "The Physical Applications of Micro-Waves."  
By: J. B. Birks, B.A.  
Local Secretary: A. M. Turnbull, 68 Lauderdale Gardens, Glasgow, W.2.

Recently Published

# MICRO-WAVES AND WAVE GUIDES

H. M. BARLOW, B.Sc.(ENG.), Ph.D.

Professor of Electrical Engineering  
University College, London

122 pages with 70 figures

15s. net

CONTENTS: Features of Micro-Wave Equipment—Transmission Line Elements as the Essential Framework of a Wave Guide—Synthesis of Wave-Guide Modes from Plane Waves—Fundamental Equations of the Electro-Magnetic Field—Analysis of Propagation in Rectangular Guides—Analysis of Propagation in Cylindrical Guides—The Coaxial Line as a Wave Guide—Micro-Wave Technique, Measurements and Applications.

CONSTABLE &amp; Co., Ltd.

10 ORANGE ST., LONDON, W.C.2

## THESE ARE IN STOCK

- RADIO ENGINEERING** — New Third Edition—by F. E. Terman. 42s. Postage 9d.
- RADAR SYSTEM ENGINEERING**, by The M.I.T. 45s. Postage 9d.
- F-M SIMPLIFIED**, by Milton S. Kiver. 33s. Postage 9d.
- RADIO VALVE DATA POCKET BOOK**, by F. J. Camm. 5s. Postage 3d.
- TELEVISION**, by Zworykin & Morton. 42s. Postage 9d.
- ELEMENTS OF RADIO SERVICING**, by Marcus & Levy. 27s. Postage 9d.
- RADIO DATA CHARTS**, by R. T. Beatty. 7s. 6d. Postage 6d.
- THE CATHODE RAY OSCILLOGRAPH IN INDUSTRY**, by W. Wilson. 18s. Postage 6d.
- RADIO RECEIVER CIRCUITS HANDBOOK**, by F. M. Squire. 6s. Postage 4d.
- HIGH VACUUM TECHNIQUE**, by J. Yarwood. 12s. 6d. Postage 4d.
- ELECTRONIC CIRCUITS AND TUBES**, by Cruft Electronics Staff. 45s. Postage 10d.
- A HANDBOOK OF TELECOMMUNICATION**, by B. S. Cohen. 30s. Postage 9d.

We have the finest selection of British and American Radio books. Complete list on application

### THE MODERN BOOK COMPANY

(Dept. E.2)

19-23, Praed Street, LONDON, W.2.

## Radio Technik, Theorie und Praxis

(Radio Technique, Theory and Practice), 216 pages. By Dr. J. Durrwang, (B. Wepf and Cie., Basel, Switzerland, 1947.)

WRITTEN for the serious minded amateur and service man, this book makes interesting reading. Although written in German, the English reader who masters this language will find it sometimes difficult to understand certain passages of the text, because the way of expressing a thought in Swiss-German is different from the German the English reader is used to.

The subject of the book is divided in 18 chapters the general headings of which are:

Fundamentals of A.C. and D.C. theory; capacitors; inductors; resonance; electron valves; rectifiers; principles of electro-acoustics; L.F. amplifiers; electro-acoustic transformers; principles of Wireless Telephony; H.F. generators (transmitters); transmission aerials and transmission; radiation; operation of receivers; television technique; ultra-short, decimetre, and centimetre waves.

The author shows with great skill how a very good insight into the problems and phenomena of radio can be given without resorting to the use of mathematical formulae, and introduces mechanical models when explaining electrical phenomena. He clearly has a deep knowledge of technical matters in addition to teaching experience.

There are but a few minor slips which may be pointed out here, not so much to criticise as for the benefit of the English reader who perhaps might take them in unawares.

On p. 22 the terms alternating voltage (*Wechselspannung*) and alternating current (*Wechselstrom*) are used rather loosely. On p. 32, some unnecessary complication is introduced by using the same letter "e" once for a voltage and then for the charge of a capacitor. The alternating current in Fig. 32 is designated by the letter "J" whereas it is "I" in Fig. 33a and in the text and "i" in Fig. 33a. The transformer coils are marked once S<sub>1</sub> for the primary and S<sub>2</sub> for the secondary (Fig. 35) and then P and S respectively in Fig. 36.

In the elaboration of the formula for the inductive voltage on page 40 the formula should read correctly:

$$e = -k \frac{d}{dt} F_0 \sin \omega t$$

The wording of line 9 from the bottom of page 52 is incorrect and conveys to the reader the erroneous idea that the oscillator circuit (*Schwingkreis*) is D, whereas in fact the author should have written "... so wird der Verlustfaktor D des Schwingkreises ..."

Inconsequence of symbolism may also be found in the formula on p. 64 for the mutual conductance S (*Steilheit*) viz:

# BOOK

$$S = \frac{\Delta J_A}{\Delta E_a} \text{ while in Fig. 58 the same}$$

quantity is written  $S = \frac{\Delta J}{\Delta V}$ . (Incidentally, the "J" should be "I").

For enlightenment of the English reader the Barkhausen formula  $S.d.R_i = 1$  on p. 66 reads in English and American textbooks  $g_m.R_a = \mu$ .

"Fadingausgleich" on p. 73, in German textbooks "*Schwundausgleich*," is "A.V.C."

On p. 87 the statement about overtones is incomplete as the author omits to point out that the difference between, for instance, the "c" as played on the piano and the same sound as produced on a clarinet, is not only a matter of different amplitudes, but also of a different sound spectrum of the harmonics.

W. SUMMER

## Electrical Engineering

By W. Purse, M.I.E.E., M.I.Mech.E. 104 pp. (Southern Editorial Syndicate) 5s.

THIS little book reviews, for all young people contemplating an electrical engineering career, the many different branches they can enter, the types of training that will be necessary and the prospects they may hope to find.

In a long chapter on Foundation Studies, the author emphasises the importance of joining the Institution of Electrical Engineers and eventually qualifying for Associate Membership. He then refers to the courses offered at some of the Universities and Technical Colleges, and their cost. The most valuable part of this chapter, if not indeed of the whole book, is that devoted to Works Training. Full information is given about the system of apprentice training available in the works of most of the large electrical engineering firms. There is also an account of the training facilities offered by the Post Office and the B.B.C. This information will be found most helpful to students, parents, teachers and all who are called upon to advise young people in their preparation for entry into any branch of electrical engineering.

The reader is guided as to which branch to adopt by a chapter devoted to a description of the classes of engineers required in communications, generation, transmission, distribution, transport, mining, electrical installation, contracting, consulting engineering, technical journalism and teaching. The author advises his reader to aim high, and to make sure of promotion by



# REVIEWS

keeping himself in the "electrical public eye."

Mr. Purse is justly proud of the developments of the past and confident of even greater improvements and inventions in the future. Every youthful aspirant to electrical engineering is bound to feel some of what the author calls "unrestrained enthusiasm for my profession," and moreover he will find in this book a guide to the achievement of his goal.

M. J. BUTT

## Microwave Technique

Published by the Radio Society of Great Britain, Price 2s.

IN some 54 pages this booklet gives an admirable introduction to the principles and practice of radio techniques used in the frequency range 3,000-30,000 Mc/s. The characteristics of resonant cavities, wave-guides, disc seal grounded-grid triode valves, velocity modulation valves such as the reflex klystron oscillator and the travelling wave amplifier tube, magnetrons and crystal valves are briefly but clearly described. Block schematics of typical S.H.F. transmitters and receivers for communication purposes are given and directional aerials such as the paraboloid reflector, horn and slot types are referred to. The final chapter discusses the measurement of frequency, power and standing wave ratio. A useful bibliography is included. The booklet represents good value and is confidently recommended to the amateur who is a newcomer to the field of micro-wave radio.

W. J. BRAY

## High Frequency Measuring Techniques Using Transmission Lines

By E. N. Phillips, W. G. Sterns, N. J. Gamara (Research Staff, Collins Radio, Iowa, U.S.A.)  
Published by John F. Rider, New York.

THIS pamphlet of some 58 pages describes the use of a slotted coaxial transmission line with a travelling probe for the measurement of wave-length, impedance, velocity of propagation and attenuation in the U.H.F. range. A collection is given of the formulae required to convert from the standing wave ratio and probe position data derived from the line to the quantity it is desired to measure, together with many numerical examples illustrating the application of the formulae and the accuracy obtainable in practice. Although somewhat special-

ised in character and limited in scope the booklet can be recommended to those concerned with this particular phase of U.H.F. measurement technique.

W. J. BRAY

## Electro-Technology for National Certificate—Vol. I

By H. Teasdale and E. C. Walton. 325 pp. 193 figs. (The English Universities Press Ltd. 9s. 6d. net).

THIS is the first of a set of three volumes intended for the use of students preparing for the Ordinary National Certificate in Electrical Engineering, the course for which is normally taken by part-time instruction over a period of three years. The authors explain that the subject matter in the three volumes is arranged to correspond very roughly with the work done in the three years of the course.

It is somewhat difficult adequately to review volume one without a knowledge of the contents of the other volumes but it can be stated at once that the standard set is in many respects higher than would be normally expected from a first year student.

The contents include chapters on the electric circuit, resistance, electrical energy and its conversion into heat, electro-chemistry, accumulators, magnetic fields, motor and dynamo effects, electrostatics. The presentation of the subject matter is clear and logical. There are specimen numerical examples worked out and included in the text and an excellent selection of examples at the end of each chapter. As will have been noted the subject of indicating instruments is not dealt with as a separate chapter but the working and description of various types are treated in the appropriate chapter; thus the moving coil and moving iron instruments appear in the chapter dealing with motor and dynamo effects. This method of approach has much to recommend it.

The reviewer has, in his opinion, one major criticism to offer which concerns the frequent appearance of photographs of apparatus that have little or no educational value. To give only a few examples: on page 125 is a picture of a carbon filament lamp, on page 118 are two illustrations of arc furnaces with sensibly no detail, on page 131 a porcelain fuse-holder and on pages 58 and 59 photographs of variable resistors which the student will himself handle in the laboratory. The majority of these photographs might well be omitted which would effect a decrease in the bulk of the book and possibly the price, and incidentally produce a saving in paper.

There is nothing but praise for the production of the book, the line diagrams being excellent and the appearance of the next volume will be eagerly awaited.

W. H. DATE

## H. K. LEWIS & Co. Ltd.

### LENDING LIBRARY

Scientific and Technical  
Annual Subscription from

**ONE GUINEA**

*Prospectus post free on request*

New Scientific and Technical Books and new editions are always available

Bi-monthly list of new books and new editions sent post free to subscribers regularly

### THE LIBRARY CATALOGUE

*Revised to December, 1943*

containing Classified Index of Authors and Subjects. Demy 8vo. pp. viii + 928  
To Subscribers - - 12s. 6d. net  
To Non-subscribers - - 25s. net

(Postage 8d.)

*Supplement, 1944 to December, 1946*

To Subscribers - - 2s. 6d. net

To Non-subscribers - - 5s. net

(Postage 4d.)

**LONDON: H. K. LEWIS & Co. Ltd.**

136 GOWER STREET, W.C.1

Telephone: EUSton 4282

### IMPORTANT BOOKS

## TELEVISION SIMPLY EXPLAINED

By R. W. HALLOWS,

T.D., M.A. (Cantab), M.I.E.E.

Foreword by

Com. A. B. CAMPBELL, R.D.

Crown 8vo 198 pages 97 figures

16 plates 9s. 6d. net

*Just Published*

## ELECTRONICS TODAY & TOMORROW

By JOHN MILLS,

Sometime Member of Technical Staff

Bell Telephone Laboratories

Lg Post 8vo 178 pages 13s. 6d. net.

**CHAPMAN & HALL, LTD.**

37-39 Essex Street, London, W.C.2.

# ABSTRACTS OF ELECTRONIC LITERATURE

## MEASUREMENT

### Recorder and Timer for Short Intervals

(W. H. Bliss)

Designed to meet the needs of nucleonic research, this interval timer measures and records intervals up to 16 microseconds with an accuracy of 0.25 microsecond. Intervals to be measured may occur at random and be widely separated.

—*Electronics*, November, 1947, p.127.

### Visual Photometer for After-glow tests on C.R.T. Screens

(W. G. White)

The photometer described was developed to enable a quick check on the decay characteristics of cathode-ray tube screens to be made. The method employed is to measure with a stop-watch the time taken for the screen brightness to decay from one level to another. In the design, more importance has been attached to the convenience of testing by semi-skilled factory operators than to high accuracy. The low field brightness of the photometer and imperfect colour matching both tend to increase the variability of the measurements, but this limitation is kept within reasonable bounds by the novel arrangement of a swinging neutral filter which ensures the same level of brightness for both the initial and final balance. The results of statistical tests are given from which the coefficient of variation is shown to be of the order of 16 per cent. for each of four screens tested.

—*Jour. Sci. Inst.*, January, 1948, p.1.

### An Improved Intermodulation Measuring System

(G. W. Read and R. R. Scoville)

This paper describes a new intermodulation analyser of improved design and also a two-signal generator for use with the analyser. The equipment is intended for measuring distortion in audio-frequency systems by means of paired signals which may be selected in several combinations from 40 to 12,000 cycles per second. This equipment has been found to be particularly useful in determining optimum processing conditions for variable-density recording, but is also useful in any field where audio-frequencies are employed.

—*Jour. S. M. P. E.*, February, 1948, p.162.

### Portable Ultrasonic Thickness Gauge

(N. G. Branson)

The "Audigauge" described is stated to differ from other thickness-measuring equipment in that it is portable

and uses an audible signal to indicate resonance. A frequency-modulated oscillator provides an audible indication of plate current peaks when the oscillator is tuned to the fundamental or harmonic thickness resonance of the material under test. The indicating dial shows steel thickness directly; and the thickness of empty or full pipes and tanks, or metal sheets is measured quickly to a claimed accuracy of 1 per cent.

—*Electronics*, January, 1948, p.88.\*

### A Photo-electric method for determining colour balance of 16mm. Kodachrome Duplicating Printers

(P. S. Aex)

It has been necessary in the past to control the colour balance and exposure of 16 mm. duplicating printers by making actual test prints at frequent intervals. A large amount of footage could be risked during the time required for processing the test prints. A method is described by which it is possible to check the balance of the printer instantly by means of tri-colour readings with a photonic cell.

—*Jour. S.M.P.E.*, November, 1947, p.425.

## C. R. TUBES

### Improvements in the Construction of C.R. Tubes

(J. de Gier and A. P. van Rooy)

The use of flat glass base with chrome iron pins has long been known in the manufacture of radio valves. By applying this construction to cathode-ray tubes more space has become available and it has thus been possible to introduce some improvements of an electron-optical nature without having to make the tube any larger. Furthermore, a new technique has been developed for the mounting of the electrodes which ensures better centring. As a result a sharper light spot is obtained, particularly at the edge of the screen. These improvements have been incorporated in a new oscillograph tube, type DG 7-3, which also has an electric screening that prevents the two pairs of deflecting plates affecting each other electrically at high frequencies.

—*Philips Technical Review*, Vol. 9, No. 6, p.180.

### The Optics of Three-Electrode Electron Guns

(S. G. Ellis)

This paper is concerned primarily with the electron guns employed in electron microscopy. The position of the image of the cathode, the magnification, and the divergence of the beam

leaving the anode are calculated for a three-electrode electron gun with plane electrodes and circular apertures both for zero and battery bias. The simplifying assumption is made that the electrostatic lenses are thin. The results are compared with the experiments of Johannson. The extension of the results to the gun used in the transmission electron microscope is considered with the aid of electrolytic trough measurements. The case of a gun biased by a cathode resistor is also discussed.

—*J. App. Phys.*, October, 1947, p.879.\*

### Producing Curves on an Oscilloscope

(H. E. Webking)

Stepping circuit switches grid voltage after each characteristic curve is traced on cathode-ray oscilloscope. In this way a complete family of curves is automatically produced. Equipment makes possible rapid and detailed studies of all factors affecting tube operation.

—*Electronics*, November, 1947, p.129.

## THERMIONIC DEVICES

### The i, V Characteristics of the Coating of Oxide Cathodes During Short-time Thermionic Emission

(R. Loosjes and H. J. Vink)

The potential differences existing across an oxide coating during short-time emission (condenser discharge with an "RC-time" of  $10^{-4}$  sec.) were measured.

For this purpose a new measuring method was worked out. Using this method it was found that at current densities of about 5-10 A/cm<sup>2</sup> remarkably high potential differences exist across the oxide coating (50-200 V) at the normal working temperatures (900-1,100° K) at which the experiments were carried out.

—*Philips Research Reports*, June, 1947, p.190.

### An Improved Method for coupling valves at Ultra-short waves

(A. van Weel)

A method for coupling two electron valves, or one valve with an antenna is described, by which method the difficulties to the finite inductance of the internal electrode leads of a valve can be eliminated up to very high frequencies. In addition to this the new system provides a very simple way to realise matching of the valve impedance.

—*Philips Research Reports*, April, 1947, p.126.

\* Abstracts supplied by the courtesy of Metropolitan-Vickers Electrical Co. Ltd. Trafford Park, Manchester

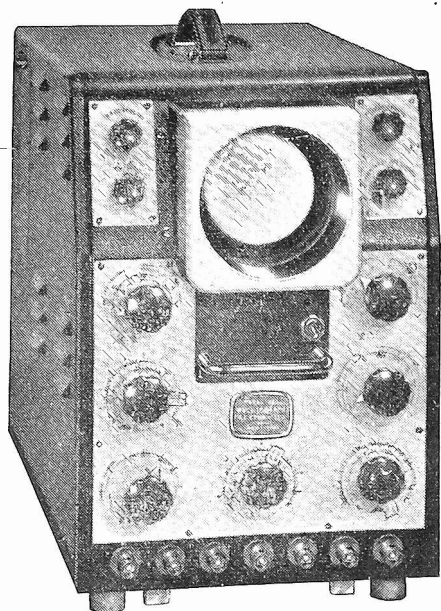

# COSSOR *Announce*

The Model 1035 is a general purpose Oscillograph, consisting of a Double Beam Tube Unit, Time Base, Y Deflection Amplifiers and internal Power Supplies. The two traces are presented over the full area of a flat screen tube of 90mm. internal diameter and operating at 2 kv. Signals are normally fed via the Amplifiers, with provision for input voltage calibration. The Time Base is designed for repetitive, triggered, or single stroke operation, and time measurement is provided by a directly calibrated Shift Control. For photographic recording, Model 1035 and Model 1049 have provision for the attachment of a Camera. Model 1428, which may be operated either manually or by motor drive. A similar camera, Model 427, is also available for use with Model 339 Oscillograph.

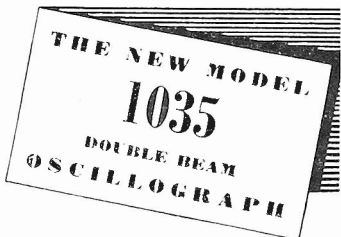

### MODEL 1049

#### INDUSTRIAL OSCILLOGRAPH

is designed specifically for industrial use where the main interest is in the observation and measurement of low frequency phenomena. Its presentation is generally similar to that of Model 1035 and a comprehensive specification includes 4 kv. tube operation for transient recording.

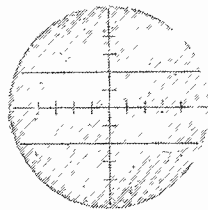

*Further details on application to :*

A.C.COSSOR LTD., INSTRUMENT DEPT., Highbury, LONDON, N.5

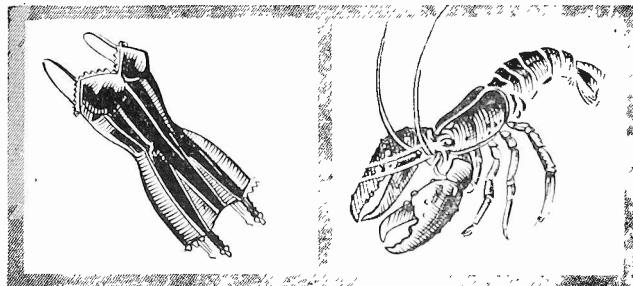

ON CONTAINERS. . .

Ever considered how important containers are to so many Industries ? Just look at these containers and imagine what would happen if there were no such things.

Dwell upon madam's temper if she was denied the exquisite pleasure of encasing her figure in armour; what indeed would be lost to the world of gourmets if lobster a la what you please vanished from the a la carte; think of all the funny tales which never would have been if bangers were just a shapeless mass and not their customary disciplined, delectable selves. Above all, think how the further progress of Electronics would have been halted if the new Parmeko Mercury series in their seamless containers had never been developed to operate under any abnormal conditions . . .

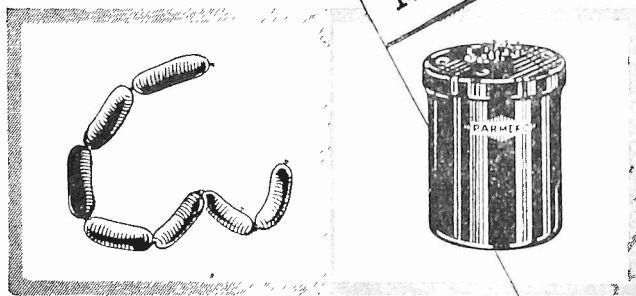

PARMEKO OF LEICESTER  
Makers of Transformers.



**STABLE**  
up to

Resistors produced by the cracked carbon process remain stable to  $\pm 1\%$  of initial value.

Tolerances  $\pm 1\%$   $\pm 2\%$   $\pm 5\%$   
Low temperature co-efficient.

**Welwyn**  
carbon resistor

WELWYN ELECTRICAL LABORATORIES LTD.

Welwyn Garden City, Herts. Telephone: Welwyn Garden 3816-8.

### Examining the effectiveness of electrostatic screens

To test the effectiveness of a transformer screen, measure the capacity between primary and H.T. secondary; then connect the Neutral terminal of the Bridge to the transformer screen or frame, and the capacity should virtually disappear. This test can be used to determine the existence of an electrostatic screen which may have been connected internally to the frame of the transformer.

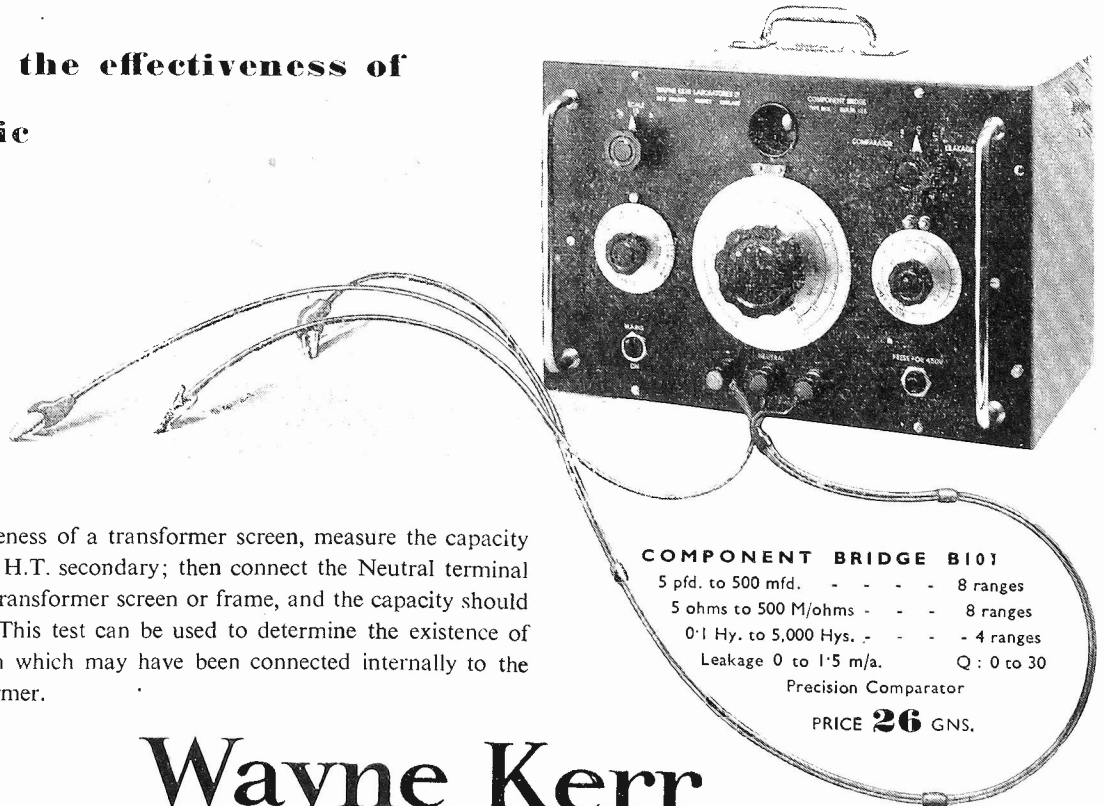

**COMPONENT BRIDGE B101**  
5 pfd. to 500 mfd. - - - - 8 ranges  
5 ohms to 500 M/ohms - - - 8 ranges  
0.1 Hy. to 5,000 Hys. - - - 4 ranges  
Leakage 0 to 1.5 m/a. Q: 0 to 30  
Precision Comparator  
PRICE **26** GNS.

# Wayne Kerr

WAYNE KERR LABORATORIES LIMITED., NEW MALDEN, SURREY · · TELEPHONE MALDEN 2202

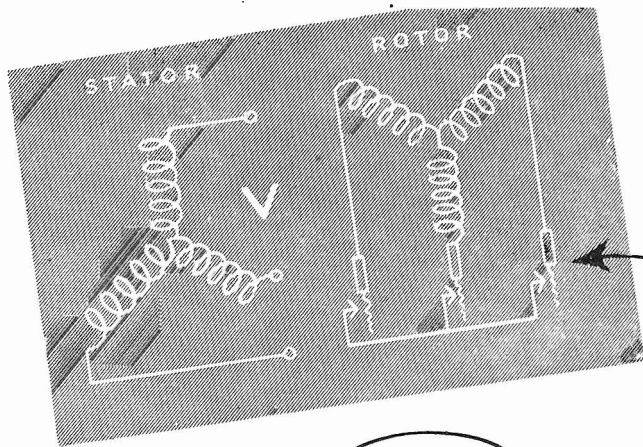

A.C. Polyphase Wound Rotor — Rotor Rheostat

## FOR EVERY PHASE OF ELECTRICAL WORK

The British Electric Resistance Co. Ltd. can answer the multitude of resistance problems that beset the electrical circuit designer. For twenty years Berco resistances have been giving reliable and steadfast service, and the Berco range is designed to meet every requirement. Berco engineers are specialists in resistance design and their knowledge is at your disposal.



**RESISTANCES**

**THE BRITISH ELECTRIC RESISTANCE CO. LTD.,** Queensway, Ponders End, Middlesex  
 Telephone: Howard 1492. Telegrams: Vitrohm, Enfield.

BR2032-TH

**PARK RADIO OF MANOR PARK,**  
 676/8, ROMFORD ROAD,  
 LONDON, E.C.12.

Manufacture and supply:

COMPLETE SET OF CHASSIS WORK  
 £7 10s. 0d.

FOCUS COIL AND HOUSING  
 £1 17s. 6d.

for the

**ELECTRONIC ENGINEERING  
 TELEVISOR**

Trade orders to:

HARRIS AND RUSSELL LTD.,  
 80, TOTTENHAM COURT ROAD,  
 LONDON, W.1.

## Transformers & Chokes

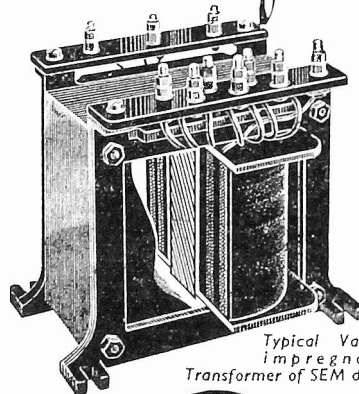

Typical Vacuum impregnated Transformer of SEM design

SEM transformers and smoothing chokes ranging from 10 VA to 10 KVA incorporating such features as:—

- Silent operation,
- High electrical efficiency and
- Over-load reserve power,
- Robust Construction, etc.



**SMALL ELECTRIC MOTORS LTD.** have specialised for over 30 years in making electrical machinery and equipment and are experienced in the design and manufacture of the above products. BECKENHAM, KENT, ENGLAND. Phone: BECKenham 0066 & 1152

Reg. London Office:

Terminal House, 52 Grosvenor Gdns. S.W.1. Phone: SLOane 0411

**PUT IT ON  
OUR PLATE!**

At British N.S.F. switches are lived morning, noon and night. The result is that your switch problems are likely to come easy to us. We are also able, when standard types would not be suitable, to place unique resources at your disposal for special needs.

But whether standard or special, all OAK switches embody the OAK equalised pressure, double-contact clip and the OAK floating rotor. These features maintain a mechanical and electrical efficiency that gives long life and trouble-free operation.

Other N.S.F. Products include Paper Capacitors, Silvered Mica Capacitors, Wire Wound Resistors, and Potentiometers.



**OAK**

**WITH THE EXCLUSIVE DOUBLE  
CONTACT & FLOATING ROTOR  
SWITCHES**

**BRITISH N.S.F. CO. LTD.** Head Office & Export Sales: **KEIGHLEY, YORKSHIRE**  
London Office: 9 Stratford Place, W.1. Telephone: MAYfair 4234

## **DIODE VOLTMETER** NORMAL MODEL TYPE 281B

**VOLTAGE RANGE**—Scale A, 0—1.5 v.; Scale B, 0—5 v.; Scale C, 0—15, 0—50 and 0—150 v.

**FREQUENCY RANGE**—50 c/sec. to 250 Mc/sec.

**ACCURACY**— $\pm 2$  per cent. F.S.D. on all ranges.

**INPUT IMPEDANCE**—4 megohms shunted by 14 pF. No D.C. path between terminals. Up to 300 volts D.C. may be super-imposed on the A.C. input.

**ZERO SETTING**—The zero is set on the 1.5 v. range and thereafter remains precisely set on all other ranges.

**STABILITY**—Zero and deflection sensitivity unaffected by normal fluctuations of mains voltage.

**CALIBRATION**—Peak-reading meter operating on negative half-wave of input, calibrated in terms of R.M.S. value assuming sinusoidal waveform.

**PROTECTION**—Application of over-voltage to the input terminals cannot damage the instrument.

**CONSTRUCTION**—Grey painted louvred metal case with engraved black crystalline finish panel. Lifting bars protect the panel.

**IMMEDIATE DELIVERY**

**PRICE £50**

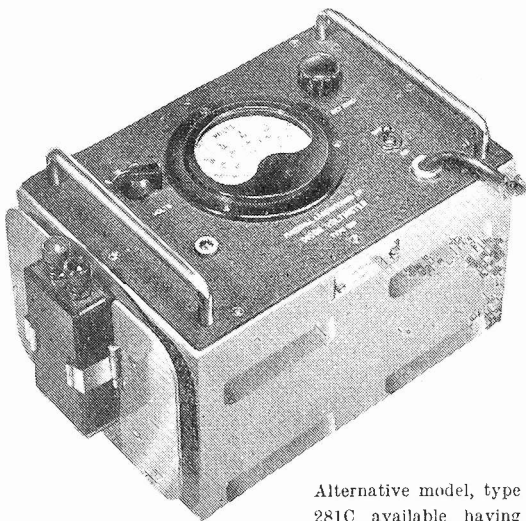

Alternative model, type 281C, available, having additional D.C. voltage range to 300 volts.

*Furzehill*

**LABORATORIES LTD.**

**BOREHAM WOOD, HERTS.**

TELEPHONE: ELSTREE 1137



## A matter of Balance...

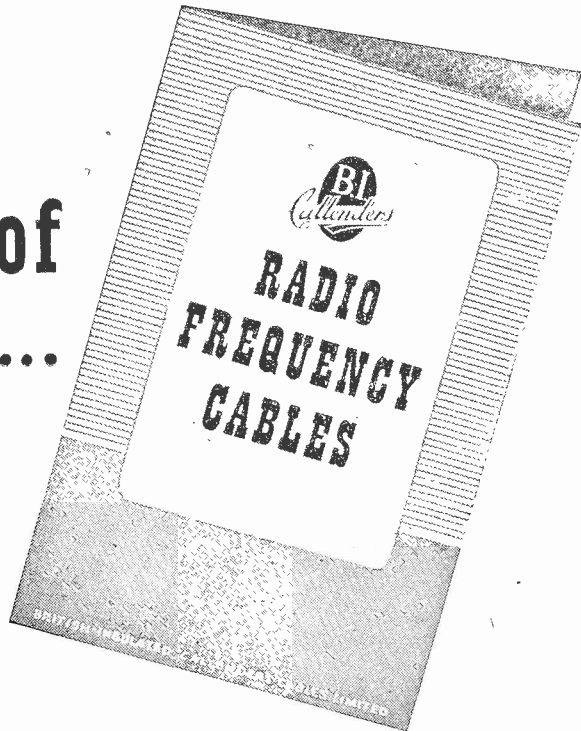

High fidelity in radio and television is a matter of precise balance in the circuit. A matter too, of knowing that B.I. Callender's manufacture types of low-loss radio frequency cables in standard ranges covering all telecommunications and electronic requirements involving frequencies up to, and even higher than 3,000 Mc/s.

This publication contains useful technical information and details of the standard radio frequency cables made by B.I. Callender's. Write to-day for free copy of Publication No. 223.



## RADIO FREQUENCY CABLES

BRITISH INSULATED CALLENDER'S CABLES LIMITED  
NORFOLK HOUSE, NORFOLK STREET, LONDON, W.C.2

## TELEVISION EQUIPMENT

We have been fortunate to secure a small quantity of Vision Tuners made by **PYE, CAMBRIDGE**, having greater fidelity than that normally required for the Vision Signal Bandwidth. These are supplied completely aligned and tested, brand new and **FULLY GUARANTEED**.

**4RF VISION TUNER**, close coupled coils, each section fully enclosed and decoupled. Diode and Video Amp. wired in for High Frequency Response, acceptance better than 3 Mcs. ALL MULLARD EF50 valves used. Silver Plated Brass Chassis. 6 valves. Price **£8 : 0 : 0**

**5RF VISION TUNER**, as above but for high gain and giving excellent results outside London. Special local/distance input, Contrast Control. 7 valves. Price **£12 : 12 : 0**

**5RF VISION RECEIVER** with Sync Separator and Time Bases completely wired in and tested. Steel Cabinet. Price **£22 : 0 : 0**

**4RF SOUND AND VISION RECEIVER** with built-in Power Supply with 8 in. speaker, 19 valves, for use with Magnetic or Electrostatic Tubes. 14 days delivery. Basic unit made by RGD, Sound receiver made by International Electronic Corp. Ltd. Price **£34 : 0 : 0**

**SOUND ADAPTOR** for use with any Radio having 6.3 v. valves, built on Silver Plated Brass Chassis, 4 valves. Price **£5 : 5 : 0**

We hold in stock, High Voltage Transformers, Slug Tuned Coils, Rectifiers, Condensers, Cathode Ray Tubes including Electrostatic types, small Vision Receivers Kits from 13 gns. up to complete 16 valve kits at 32 gns. Catalogue available on request.

### ADAMS RADIO

**ELECTRON HOUSE, 655, FULHAM RD, S.W.6**

Phone : RENown 4178

Tube Station : Walham Green

## PHOTO-ELECTRIC CELLS

Se/Te on gold-alloy, supersensitive to light, gas-filled, permanent, operate a relay by light, either direct or through one-valve amplifier, also reproduce speech and music, etc., perfectly from sound track of films; large tube 3½ in. from glass top to valve pin base, 1 in. dia., 35/-; same type, 2½ in. long, 30/-; small tube, 2 in. from top to terminal base, ¾ in. dia., 28/-; miniature cell, glass top to cap base, 1 in. overall, ½ in. dia., thin flex leads, 25/-; all cells operate on 40-100 volts. Wiring diagrams for relay and film sound amplifier free.

### PRECISION OPTICAL SYSTEM

For sound film, producing very fine line of light from 6 or 12 volt 1 amp. lamp, for scanning film sound track direct into photo-cell, metal tube 1½ in. long, ⅝ in. dia., ⅜ in. focus, 52/- Full directions free.

**CEFA INSTRUMENTS, 38a York St., TWICKENHAM, Mdx.**

Tel. No.: POPesgrove 6597

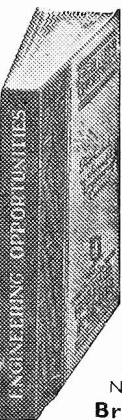

## AMBITIOUS ENGINEERS

Have you had Your Copy of

"Engineering Opportunities" ?

Whatever your age or experience—you must read this highly informative guide to the best paid Engineering posts. It contains particulars of A.M.I.C.E., A.M.I.Mech.E., A.M.I.E.E., A.M.I.M.I., A.M.Brit.I.R.E., and other important Engineering Examinations, and outlines home-study courses in all branches of Civil, Mechanical, Electrical, Automobile, Radio and Aeronautical Engineering, Government Employment, Draughtsmanship, Building and Plastics, Matriculation etc. **WE GUARANTEE—"NO PASS—NO FEE"** If you are earning less than £10 a week you cannot afford to miss reading "Engineering Opportunities." It tells you everything you want to know to secure your future. Write for your copy of this enlightening guide to well-paid posts NOW—FREE and without obligation.

**British Institute of Engineering Technology**  
337E, SHAKESPEARE HOUSE, 17, 18, 19, STRATFORD PLACE, LONDON, W.1

Your particular  
**COIL**  
problems solved!

Here's how we can help you! We design and plan to one standard only—perfection in performance.

Considering the fact that our organisation is under the control of men who know the latest trends in circuit design and are capable of interpreting your particular needs, the ultimate result can only be that standard.

We are manufacturers of coils of all types—to your specification, designed to meet your particular requirements, in bulk, or to a limited number.

Your enquiries are cordially invited! Telephone Mr F. W. Pigott—he is the principal and available to discuss and deal with your problems from start to finish.

RADIO • TELEVISION • ELECTRONICS • INDUSTRIAL APPLICATIONS

**BROUGHTON PRODUCTS LTD**  
REGISTERED OFFICE & WORKS  
WOODCOTE RD · WALLINGTON · SURREY  
TELEPHONES · WALLINGTON 7739/1889



SELENIUM  
PHOTO-CELLS

Best  
in the  
World

A product of

**EVANS ELECTROSELENIUM LTD.**  
Harlow Essex

The exceptional response of EEL cells with their high and uniform standard of performance in Colorimeters, Reflectometers, Photometers, etc., gives them a thousand applications in the industrial world.

For the accurate standardisation of colours in the paint, plastics, cloth dyeing and paper industries, for the precise measurement of density and gravity of liquid for the chemical trades, for the automatic action of relays in the electrical trades—all these applications are now ripe for development thanks to the research and craftsmanship that have made EEL cells available to the world in sufficient quantities.



# VACUUM EQUIPMENTS

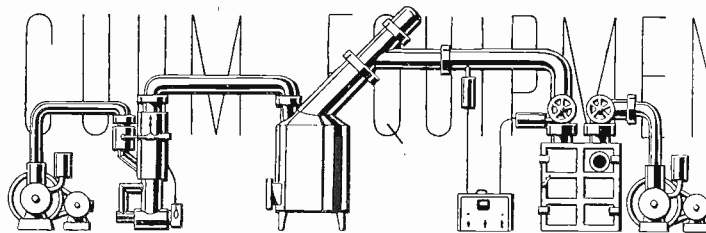

## FROM ONE MILLIONTH DOWN TO LESS THAN ONE BILLIONTH OF AN ATMOSPHERE

We specialise in the design, manufacture and installation of High Vacuum Gauges, Valves, Diffusion Pumps, Furnaces, Coating equipment and dehydration units.

High Vacuum from  $10^{-3}$  to  $10^{-7}$  mm. is our business and unique experience acquired in a world-wide field is available willingly to all those who plan and engineer in this rapidly developing field of science.

For instance, here are three useful high vacuum testing instruments available for quick delivery.

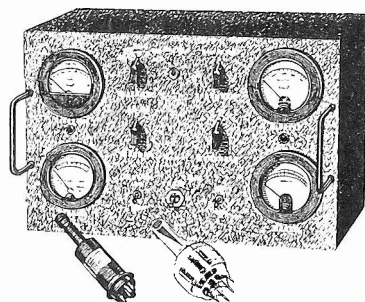

### THE B.A.R. THERMOCOUPLE-IONISATION GAUGE CONTROL

The newly developed Thermocouple-Ionisation Gauge Control, complete with Thermocouple and Ionisation Gauges, covers the pressure range from  $2 \times 10^{-7}$  mm. to 1 mm. Hg operation is dependable and simple. Full-scale meter deflection occurs at 1 mm. and 5, 1.0, 0.1 and 0.01 microns. The unit is removable from its cabinet for incorporation in a central panel.

**THE B.A.R. ALPHATRON** is an ionisation-type vacuum gauge using the ionising power of alpha particles from a radium source to measure total pressure of any gas, vapour or mixed atmosphere from 1 micron to 10 mm. Hg. with instantaneous linear response. The B.A.R. Alpatron is quickly available from batches now in production.

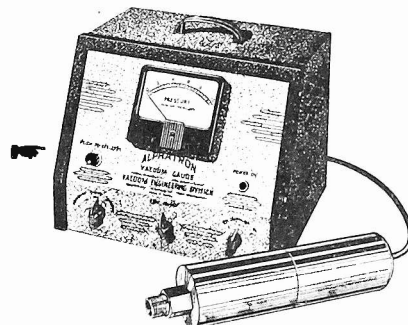

### THE B.A.R. THERMOCOUPLE GAUGE CONTROL

is a light, portable instrument that may be carried to any part of a plant or system for vacuum testing. It is compact, rugged, and built throughout to withstand hard industrial use. Operating from any 115-volt, 50/60-cycle outlet, this unit gives pressure indications over a continuous range from 1 to 1,000 microns Hg. These pressures are read directly on the microammeter which is calibrated both in microns and microamperes. By means of increased filament current and special calibration, the unit will indicate pressures up to 2 mm. Hg. The gauge is undamaged by operation at atmospheric pressure.

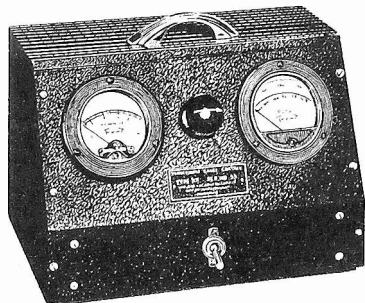

# BRITISH AMERICAN RESEARCH LTD

DESIGNERS AND MANUFACTURERS OF HIGH VACUUM GAUGES · VALVES · SEALS  
 DIFFUSION PUMPS · STILLS · FURNACES · COATING EQUIPMENT AND DEHYDRATION PLANT  
 BLOCK E2 · HILLINGTON NORTH · GLASGOW S. W.



## THE MICANITE & INSULATORS CO. LTD.

Empire Works, Blackhorse Lane, Walthamstow, London, E.17

*Manufacturers of MICANITE (Built-up Mica Insulation). Fabricated and Processed MICA. PAXOLIN Laminated Materials. EMPIRE Varnished Insulating Cloths and Tapes. HIGH-VOLTAGE BUSHINGS and TERMINALS. Distributors of Micoflex-Duratube sleeveings*

# POINTERS FOR DESIGNERS



## CATHODE RAY TUBES

The G.E.C. range of electrostatic industrial cathode ray tubes includes four screen sizes down to 1 1/2" diameter. Widely used in measuring and similar instruments, their outstanding features include:—

- Brilliant screen traces and undistorted frequency response over a wide range.
- Screens for photographic recording or for producing sustained images, when specially ordered.

Electrostatic tubes for the maintenance of G.E.C. Television sets are also available. Other types will be in production shortly.

Detailed technical data sheets are available upon request.

**Osram**  
PHOTO CELLS

**G.E.C.**  
CATHODE RAY TUBES

**Osram**  
VALVES

# CONSISTENTLY *Accurate*



Each type is available in single or multi-range versions, and either an Industrial Model with First Grade Accuracy or a Precision Model with Sub-Standard Accuracy can be supplied. The movement is carefully shielded against extraneous magnetic fields. The case is of cast alloy with all black finish, carrying handle and resilient rubber feet.

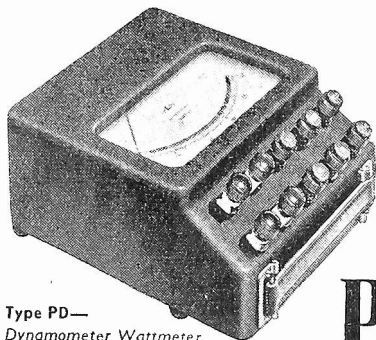

Type PD—  
Dynamometer Wattmeter

Also available:

- Type PC—Moving Coil.
- „ PR—Rectifier, Moving Coil.
- „ PI—Moving Iron.

- SUSTAINED ACCURACY
- 
- GOOD DAMPING
- 
- ROBUST CONSTRUCTION
- 
- MODERN APPEARANCE

## PULLIN PORTABLE PATTERN INSTRUMENTS

MEASURING INSTRUMENTS (PULLIN) LTD  
Dept. E, Electric Works, Winchester Street, Acton, W.3. Acorn 4651/4.

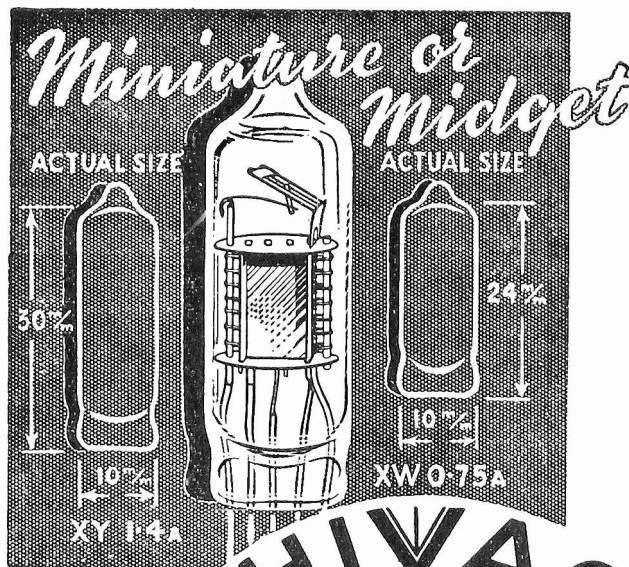

NEW TYPES FOR  
MIDGET RECEIVERS  
HEARING AIDS  
METEOROLOGICAL  
INSTRUMENTS  
ETC.

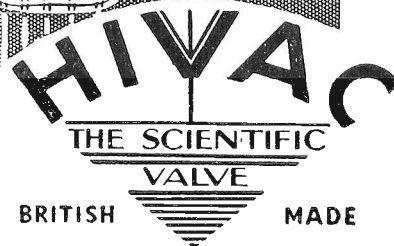

HIVAC LIMITED Greenhill Crescent, Phone HARROW  
Harrow on the Hill, Middx. O895

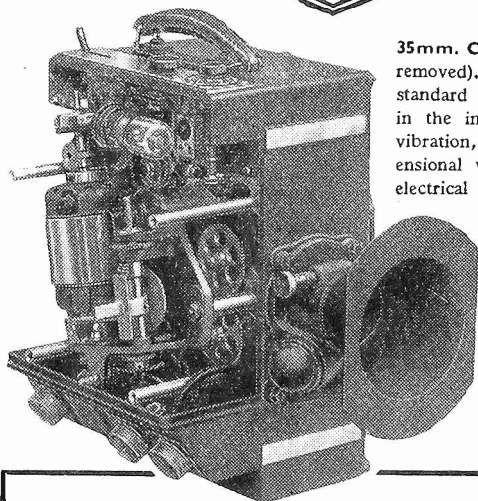

35mm. Camera (cover removed). Used with standard oscillograph, in the investigation of vibration, stresses, dimensional variations and electrical phenomena.

*Design, Development and Manufacture of  
Optical Mechanical Electrical Instruments*

AVIMO LTD, TAUNTON, ENGLAND. Tel. 3634. Grams, 'Avimo'

## A "Laboratory" INSTRUMENT... but NOT Laboratory" Price!

The 'Advance' Type E Signal Generator places an instrument of laboratory class within the financial scope of every radio service engineer and experimenter.

The discerning engineer will appreciate its accuracy and stability, its exceptionally wide range which covers all frequencies required for radio and television receivers and its accurate attenuating system which enables sensitivity measurements to be made on highly sensitive receivers up to 60 Mc/s. Send for fully descriptive pamphlet.

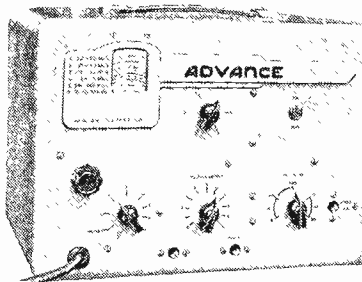

- Range: 100 Kc/s—60 Mc/s on fundamentals (up to 120 Mc/s on Second Harmonic).
- Accuracy: Guaranteed within  $\pm 1\%$
- Attenuation: Constant impedance system embodying a matched 75 ohms transmission line.
- Stray Field: Less than 3 microvolts at 60 megacycles.
- Illuminated Dial: Total scale length 30"
- Power Supply: 110-210-230-250 volts.
- Dimensions: 13" x 10 1/2" x 7 1/2" deep.
- Weight: 15 lbs.

The



ADVANCE COMPONENTS LTD., Back Road, Shernhall Street,  
Walthamstow, London, E.17. Telephone: LARKSWOOD 4366/7.

WHERE EXTREME ACCURACY IS REQUIRED

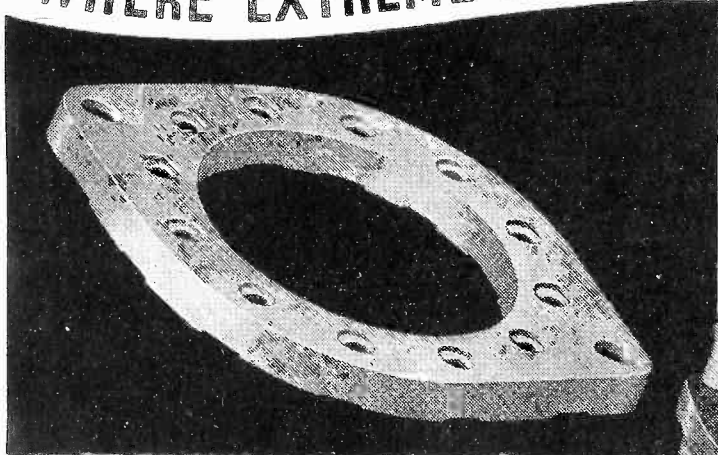

Made in Three Principal Materials

**FREQUELEX**

An insulating material of Low Di-electric Loss, for Coil Formers, Aerial Insulators, Valve Holders, etc.

**PERMALEX**

A High Permittivity Material. For the construction of Condensers of the smallest possible dimensions.

**TEMPLEX**

A Condenser material of medium permittivity. For the construction of Condensers having a constant capacity at all temperatures.

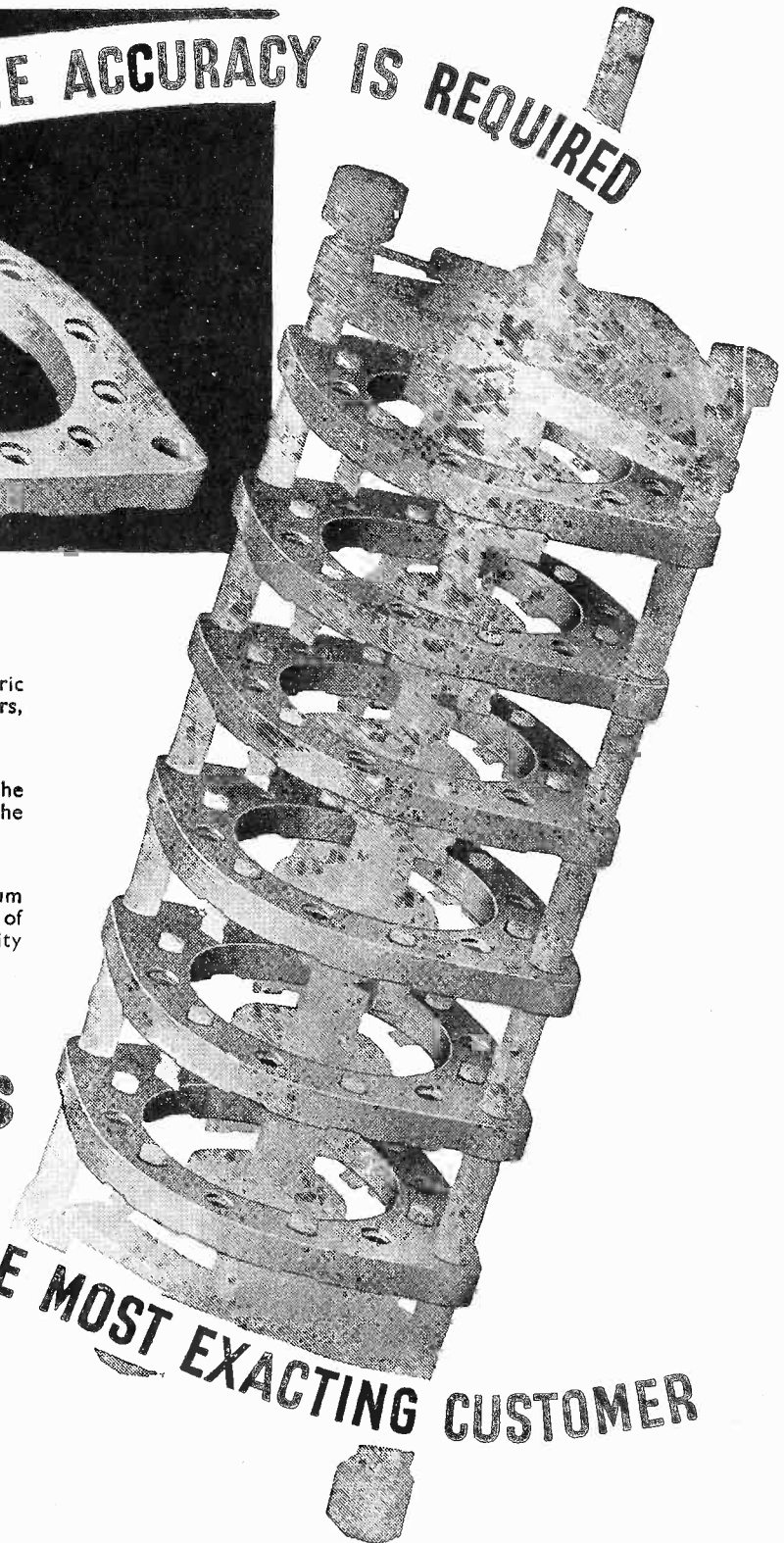

**Bullers**

CAN SATISFY THE MOST EXACTING CUSTOMER



**BULLERS LOW LOSS CERAMICS**

BULLERS LTD., 6, Laurence Pountney Hill, London, E.C.4.  
Telegrams: "Bullers, Cannon, London."

Phone: Mansion House 9971 (3 lines)

# R·R

## PRODUCTS

*Transformers . Amplifiers  
Electrical Control Gear  
Electronic Development &  
Manufacturing for Industry*

TELEPHONE BRADFORD 24902

**R.R. DEVELOPMENT LABORATORIES LTD  
BARNARD RD . BRADFORD , YORKSHIRE**

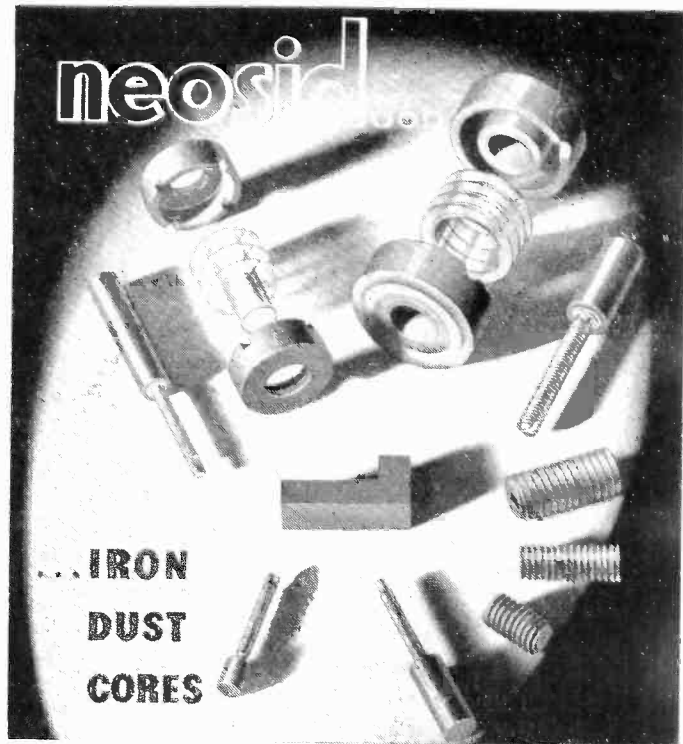

**neosid Limited**

High Performance-Strength-Stability.  
Close electrical and mechanical tolerances Grades to suit various applications  
23-25 Hyde Way, Welwyn Garden,  
Tel: Welwyn Garden 925 City, Herts.

E.E.O.

**TRANSFORMERS  
CHOKES  
MAGNETIC  
AMPLIFIERS**

*OPEN, CANNED OR  
HERMETICALLY SEALED*

**ASSOCIATED ELECTRONIC  
ENGINEERS LTD.**

**DALSTON GARDENS, STANMORE,  
MIDDLESEX.**

TELEPHONE: WORDSWORTH 4474-5-6 TELEGRAMS: ELECTRONIC, STAMMORE

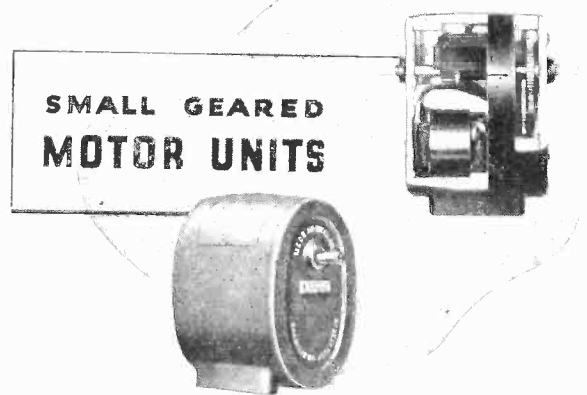

The Drayton "R.Q." is a 25-watt motor unit geared to a final shaft, to which may be fitted eccentrics, arms or cranks, gears, links or pulleys for actuating valves or dampers, movements, switchgear or other devices.

Unidirectional or reversing with or without self-switching, for 100/110 or 200/250 volts A.C.

Both types are fitted with an auxiliary two-way switch actuated by movement of the final shaft, for operating auxiliary gear such as fan motors, pumps, interlocking devices, etc.

**FINAL SHAFT SPEEDS**

Reversing Max 600 R.P.M. 27 min. per rev.  
Unidirectional Max 280 R.P.M. 60 min. per rev.

TORQUE: Reversing 60 in. lbs. max.  
Unidirectional 37 in. lbs. max.

Send for List 302-1/M

**for**

OPERATING VALVES,  
DAMPERS OR RHEOSTATS,  
CINEMA PROJECTORS,  
ROTATING SCREENS,  
ILLUMINATED SIGNS,  
SMALL WORKING MODELS,  
GENEVA MOVEMENTS FOR  
DRUM-TYPE SWITCHES,  
ROCKING BATHS, WORK  
MOVEMENT, SOLDERING  
AND WELDING FIXTURES,  
CONTINUOUS TURNING,  
FEED OF LIGHT STRIP  
UNDER PROCESS.

RQ4) Drayton Regulator & Instrument Co., Ltd., West Drayton, Mdx.

# R.F. ATTENUATOR

## TYPE D-239

**T**HIS small compact attenuator is characterized by a relatively high insertion loss and outstanding accuracy of attenuation at high frequencies. Wire wound resistance elements ensure accuracy, good stability and freedom from noise. It can be used as a bench instrument or for incorporation in other apparatus where its small size is a considerable asset. Two types, giving alternative values of total attenuation, are available.

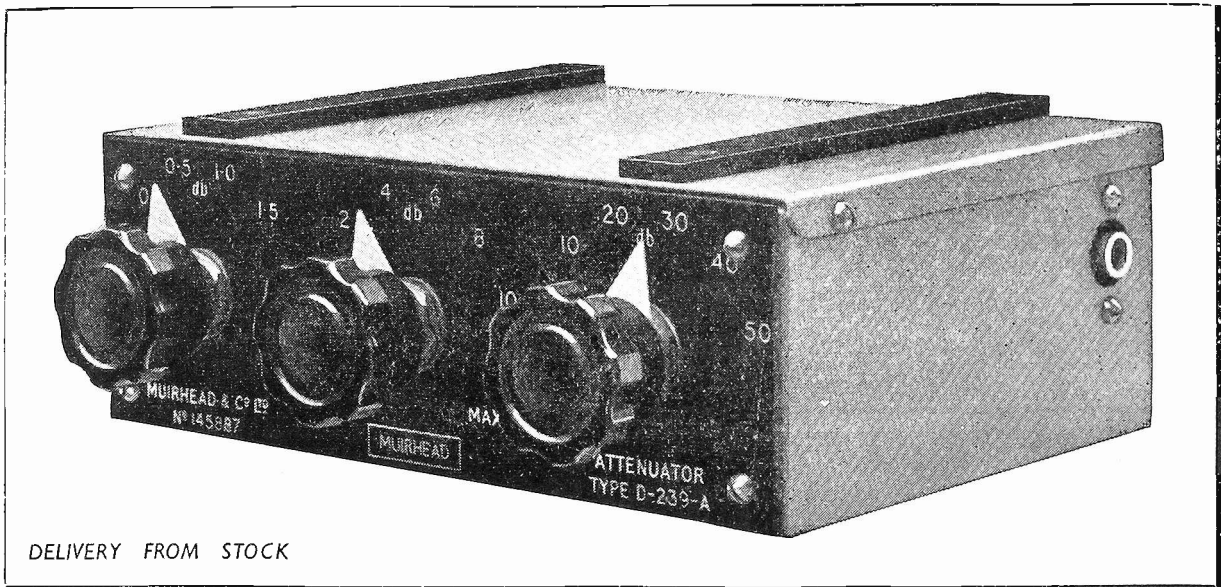

### BRIEF SPECIFICATION

ATTENUATION RANGE: { TYPE D-239-A : 0-61.5 db variable in steps of 0.5 db.  
 TYPE D-239-B : 0-80 db variable in steps of 1 db.

CHARACTERISTIC IMPEDANCE: 75 ohms ("T"-network).

PERFORMANCE : At frequencies up to 5 Mc/s and for any setting of the switches the error in attenuation will not exceed  $\pm 0.2$  db. Reasonable accuracy is maintained up to 10 Mc/s.

TERMINATIONS : Coaxial connectors.

INPUT : 3 volts maximum.

DIMENSIONS :  $6\frac{1}{2}'' \times 2\frac{3}{8}'' \times 5\frac{1}{2}''$ .

WEIGHT :  $2\frac{1}{2}$  lbs.

Manufactured to a design of the Radio Branch of the Post Office Engineering Department.

Full details are given in Bulletin B-562-A, a copy of which will be sent on request.

# MUIRHEAD

Muirhead & Co., Limited, Elmers End, Beckenham, Kent. Telephone: Beckenham 0041-2

FOR OVER 60 YEARS DESIGNERS AND MAKERS OF PRECISION INSTRUMENTS

**ALEC DAVIS SUPPLIES LTD.****18, TOTTENHAM COURT ROAD,  
LONDON, W.1.**

Tel.: MUSeum 4539

Tel.: MUSeum 4539

**STOCK LINES****ATKINS DUST-CORED COILS.** Single "Spire-Nut" fixing. Size  $1\frac{1}{2}$  in. long by  $\frac{1}{2}$  in. dia.

Range 1. 800/2000 metres, Tracking freqs. 150, 200, 250 kc/s. Padder 200 pF, Trimmer 60 pF.

Range 2. 200/450 metres, Tracking freqs. 605, 1025, 1350 kc/s. Padder 450 pF. Trimmer 75 pF.

Range 3. 16/47 metres, Tracking freqs. 7.04, 12.57, 16.8 Mc/s. Padder 5000 pF, Trimmer 50 pF. In three types Aerial, H.F. or Osc. All at 3/7 each.

**ATKINS STANDARD 456 kc/s I.F.'s** for use with the above or similar coils. End or side permeability tuning. Per pair 16/6.**WRIGHT & WEAIRE P COILS**, all ranges, all types, 3/-.**J.B. SQUAREPLANE DRIVE.** Oblong clockface type drive, ratio 8-1. Scale  $4\frac{1}{8}$  in. by  $3\frac{1}{2}$  in., printed two wavebands and station names. Bronze-finished escutcheon with glass. Price 11/6.**J.B. FULL VISION DRIVE.** Simple, reliable friction drive. Ratio 8-1. Scale size  $7\frac{1}{8}$  in. by  $3\frac{1}{2}$  in. Printed three wavebands and station names. Supplied with bronze-finished escutcheon and glass. Price 11/9.**GOODMAN** celebrated twin cone 12 in. P.M. Speaker for high quality reproduction. 15 ohm speech-coil. Price £8 8s. 0d.**CELESTION** 5 in. speaker. Weight 1 lb. 3 ohm speech coil. Price £1 3s. 6d.  
" 3½ in. speaker. Weight ½ lb. 3 ohm speech coil. Price £1 9s. 6d.**VALRADIO** 200 watt D.C./A.C. non-rotary converter. Size 14½ in. by 6 in. by 6 in. Weight 18 lb. Specially designed for television and radio receivers. Efficiency over 80 per cent. on full load. £14.**SURPLUS EQUIPMENT AT SURPLUS PRICES — STOCKISTS OF VALVES, BATTERIES, COMPONENTS AND TEST EQUIPMENT.**

Business Hours—9 a.m. - 5.30 p.m. Mon./Fri., 9 a.m. - 1 p.m. Sat.

**SURPLUS****METERS:** 0.5 amp. Sangamo Western Thermo-couple meters, 2 in. square face type. New and boxed. 7/6 (Post 6d.).

5 mA Metropolitan Vickers moving coil meter, 2 in. square face type. New and boxed. 7/6 (Post 6d.).

**CONDENSERS:** Bakelite cased high voltage condensers. Postage 3d. extra.2 Mfd. 200 volt d.c. wkg. Size  $1\frac{1}{8}$  in. dia. by  $3\frac{1}{4}$  in. long. 1/-.

.1 .. 2500 .. .. .. 1 in. .. 3½ in. .. 8d.

.1 .. 1500 .. .. .. 1 in. .. 2½ in. .. 6d.

.1 .. 600 .. .. .. ½ in. .. 2½ in. .. 6d.

.03 .. 2500 .. .. .. 1 in. .. 2½ in. .. 6d.

.01 .. 5000 .. .. .. 1 in. .. 2½ in. .. 6d.

.01 .. 3000 .. .. .. 1 in. .. 2½ in. .. 6d.

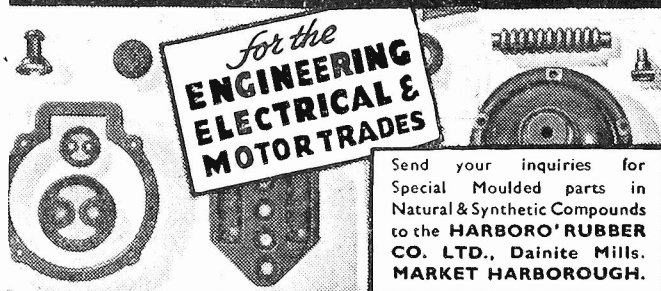
**MISCELLANEOUS:****EXIDE** new and unused accumulators in moulded case. Size 2½ in. square by 6½ in. high—2 volt type. 7/6 (Postage 1/-).**INERT CELLS**, 15 volt type. Size 9 in. by 1 in. by 3 in. 1/6 (Postage 6d.). Set of four 15 volt cells in sealed can 5/- (Postage 1/-).**PLESSEY** 5 in. electrodynamic speaker with 4 ohm. speech coil. Complete with transformer for 4500 ohm. load. All brand new, a real bargain for those in need of an extension speaker. 19/6 (Post 1/-).**SANTON** 30 amp. rotary double pole on/off switch—new and boxed. Price 7/6 (Postage 9d.).**Dainite  
MOULDED RUBBER PARTS**

*For the  
ENGINEERING  
ELECTRICAL &  
MOTOR TRADES*

Send your inquiries for Special Moulded parts in Natural & Synthetic Compounds to the **HARBORO' RUBBER CO. LTD., Dainite Mills, MARKET HARBOROUGH.**

**BRAY CERAMIC INSULATORS**

for L.F. and H.F. Components; also capacitor dielectrics



made by  
**GEO. BRAY & CO., LTD. LEEDS, 2**  
Established 1863 Phone Leeds 20981

**LOWEST EVER  
attenuation & capacitance****CO-AX CABLES  
for RADIO FREQUENCIES**

LOW ATTEN. TYPES	IMPED. OHMS.	ATTEN db/100ft. at 100 Mc/s.	LOADING K.W.	O.D.
A1	74	1.7	0.11	0.36"
A2	74	1.3	0.24	0.44"
† A34	73	0.6	1.5	0.88"

LOW CAPAC. TYPES	CAPAC. mmf/ft.	IMPED. OHMS.	ATTEN db/100ft. 100 Mc/s.	O.D.
C 1	7.3	150	2.5	0.36"
* PC 1	10.2	132	3.1	0.36"
C 11	6.3	173	3.2	0.36"
C 2	6.3	171	2.15	0.44"
C 22	5.5	184	2.8	0.44"
C 3	5.4	197	1.9	0.64"
C 33	4.8	220	2.4	0.64"
C 44	4.1	252	2.1	1.03"

† Bending Radius 5"  
\* Photocell Cable.**TRANSRADIO LTD. 138A CROMWELL ROAD, LONDON, S.W.7.**



**Varley**  
REGD. TRADE MARK

**THERMAL DELAY SWITCHES**  
*Protect Your Radio Equipment*

4 VOLT • 5 VOLT • 6.3 VOLT HEATERS

**OLIVER PELL CONTROL LTD**  
Telephone: WOOLWICH 1422  
CAMBRIDGE ROW • WOOLWICH S.E.18

**HIGH FIDELITY**

much improved version of our Corner Cabinet now available, in either whitewood or walnut veneer. Full details on request. Our Feeder Units and Amplifiers are now available from stock. prototype miniature H.I. Fl. receiver and amplifier using button base valves is in course of development and will soon be demonstrated in our showrooms. Components for the Synchrodyne are available from stock. Our Price List covering components for High Fidelity equipment will be forwarded on request.

**ROGERS DEVELOPMENTS CO.,**  
Macclesfield Street, Shaftesbury Avenue, London, W.1.  
GER. 3057/8256

AND NOW  
**A.C./D.C.**

**20-25 WATT UNIVERSAL AMPLIFIER-U885**

Similar to our 30-watt A.C. model and fitted with latest control panel carrying mic., gram. and special 3-position switch providing either change-over or mixer circuit for gram. and mic. Three-stage high-gain type having 4 valves in parallel push-pull in output stage, a total of 10 valves.

**TRIX**  
*Quality SOUND EQUIPMENT*



**THE TRIX ELECTRICAL CO. LTD.**  
1-5 MAPLE PLACE • TOTTENHAM COURT ROAD • LONDON, W.1.  
TELEPHONE: MUSEUM 5817. GRAMS & CABLES: TRIXADIO, WESOD, LONDON.

**RANGE OF PRECISION BUILT**  
transformers & chokes are specified by engineers who require accuracy and reliability to Tropical Standards.

TYPE APPROVED BY THE ROYAL AIRCRAFT ESTABLISHMENT

Retail stockists: Berry's (Short Wave) Ltd. 25, High Holborn, London, W.1.

**R.T.S. ELECTRONICS, LTD. • KING STREET, EXETER.**  
Telephone: Exeter 2132. Cables & Grams: "Television," Exeter.

**WE OFFER**

A large range of used and new Test Equipment, Converters, Recorders, Amplifiers, Motors, Transformers, etc. All guaranteed and at very attractive prices.

We buy good modern used equipment of all types for spot cash.

**UNIVERSITY RADIO LTD.**  
22 LISLE STREET, LONDON, W.G.2.  
Tel.: GER 4447 and GER 8582.

**Sinclair**  
**SPEAKERS**  
LONDON & ELSTREE



Manufacturers of  
LOUDSPEAKERS  
LAMINATIONS  
SCREENS IN RADIOMETAL  
PERMALLOY  
SILICON ALLOYS

**ELECTRICAL SOUND & TELEVISION PATENTS LTD.**  
12 PEMBROKE STREET, LONDON, N.1. — TERMINUS 4355  
2/4 MANOR WAY, BOREHAM WOOD, HERTS.—ELSTREE 2138

**CLYDESDALE**  
**The Radioman's Shop**  
For Bargains in Ex-Services Electronic Equipment



**BRAND NEW EX-U.S. NAVY AN/APA-1 AIRCRAFT RADAR EQUIPMENT**  
Comprising CATHODE-RAY INDICATOR (Adjustable case with 38PI C.R.T. and leads. Overall length 24 in. base 12 in.) with 11 valves (7-65N7G's, 16H6, 6G6G, 2X2/879, 6X5GT, plus other V.H.F. components, complete in case 12 in. by 7 1/2 in. by 7 in.) CONTROL UNIT (8 in. by 2 1/2 in. by 2 1/2 in.). All finished black crackle, for 110/115v., 400/2400 c/s. with INSTRUCTION BOOK. Packed in wooden case, Carriage paid, Clydesdale's Price. Each **£4 17s. 7d.**

**BRAND NEW SET OF PLUGS FOR AN/APA-1.**  
Post free. Per set **7s. 6d.**

**BRAND NEW EX-U.S.N. SA-4A/APA-1 Antenna Switch.** A motor-driven aerial switch, input 24v., with all necessary co-axial plugs, etc. Post free. Each **14s. 0d.**

**BRAND NEW EX-R.N. A.P.W. 7336 INDICATOR UNIT.** (A self-contained cathode-ray indicator less power unit with V.C.R. 97 C.R.T. in mu-metal screen. 7 valves, 4-EF50's 3-EB34's, etc., in metal case 18 in. by 8 1/2 in. by 7 1/2 in. Carriage Paid. Each **£4 17s. 6d.**

Staff "Hams" GM3BI and GM3ASM

Send now for New Illustrated List. Please print name and address.

**CLYDESDALE SUPPLY CO. LTD.**  
2 BRIDGE STREET, GLASGOW, C.5 Phone SOUTH 2706, 9  
Visit our Branches in Scotland, England and Northern Ireland

# POTENTIOMETERS

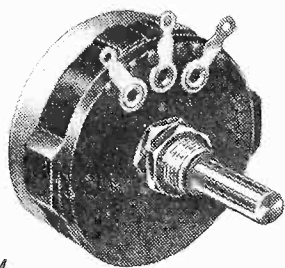

by  
**RELIANCE**

**THE TYPE T.W.** Continuous Wire-Wound  
Rating Ranges  
5 Watts Max. { 5-100,000 Ω Max. (linear)  
(linear) {  
3 Watts Max. { 50- 50,000 Ω Max. (graded)  
(graded) { 100- 10,000 Ω Non-inductive

**Characteristics:** Linear, tapered, graded-log., semi-log., inverse log., non-inductive, etc.

Full details from  
**RELIANCE**  
Manufacturing Co., (Southwark) Ltd.  
Sutherland Rd. Higham Hill, Walthamstow E.17  
Telephone: Larkwood 3245

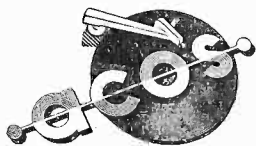

## NEW G.P.12 CRYSTAL PICK-UP

with permanent sapphire stylus

—was fully described in *The Wireless World's* recent article "Crystal Pick-ups—Basis of Design for Fidelity Reproduction."

This remarkable pick-up, which represents the ultimate in high-fidelity reproduction, is now available in limited quantities through your radio dealer, price 96/- incl. P.T.

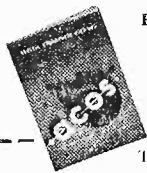

**FREE ILLUSTRATED FOLDER** describing this new pick-up may be obtained by returning the coupon below.

TO COSMOCORD LTD.  
ENFIELD, MIDDX.

Please send folder of ACOS Pick-ups.

NAME .....

ADDRESS .....

E.E.

## INDEX TO ADVERTISERS

A.B. Metal Products, Ltd.	11
Adams Radio	22
Advance Components, Ltd.	26
All-Power Transformers, Ltd.	14
Associated Electronic Engineers, Ltd.	28
Avimo, Ltd.	26
Bird & Sons, Ltd., Sydney S.	15
Bray and Co., Ltd., George	30
British American Research, Ltd.	23
British Electric Resistance Co., Ltd.	19
British Institute of Engineering Technology	22
British Insulated Callender's Cables, Ltd.	21
British Mechanical Productions, Ltd.	7
British N.S.F. Co., Ltd.	20
British Thomson-Houston Co., Ltd.	11
Broughton Products, Ltd.	22
Bryce & Co., Ltd., W. Andrew	5
Bullers, Ltd.	27
Cefa Instruments	22
Chance Bros., Ltd.	15
Chapman & Hall, Ltd.	143
Cinema-Television, Ltd.	8
Clydesdale Supply Co., Ltd.	31
Constable & Co., Ltd.	142
Cosmocord, Ltd.	32
Cossor, Ltd., A. C.	17
Davis Supplies, Ltd., Alec.	30
De La Rue Insulation, Ltd.	10
Drayton Regulator & Instrument Co., Ltd.	28
Edison Swan Electric Co., Ltd. 4 & Front Cover	
Electrical Sound & Television Patents, Ltd.	31
Evans Electroelenium, Ltd.	22
Fox, Ltd., P. X.	6
Furzehill Laboratories, Ltd.	20
Gardners Radio, Ltd.	10
General Electric Co., Ltd.	25
Harboro' Rubber Co., Ltd.	30
Hill & Churchill, Ltd.	2
Hivac, Ltd.	26
Leland Instruments, Ltd.	Cover iii
Lewis, Ltd., H. K.	143
Measuring Instruments (Pullin), Ltd.	26
Melton Metallurgical Laboratories, Ltd.	32
Micanite & Insulators, Ltd.	24
Modern Book Co.	142
Mulrhead & Co., Ltd.	29
Mullard Wireless Service Co., Ltd.	3
Neosid, Ltd.	28
Painton & Co., Ltd.	5
Park Radio of Manor Park	19
Parmeko of Leicester	17
Partridge Transformers, Ltd.	32
Pell Control, Ltd., Oliver	31
R. R. Development Laboratories, Ltd.	28
R. M. Electric, Ltd.	14
R.T.S. Electronics, Ltd.	31
Reliance Manufacturing Co. (Southwark), Ltd.	32
Rogers Developments Co.	31
Small Electric Motors, Ltd.	19
Sunvic Controls, Ltd.	13
Telegraph Condenser Co., Ltd.	12
Telegraph Construction & Maintenance Co., Ltd.	15
Tele-Radio (1943), Ltd.	6
Transradio, Ltd.	30
Trix Electrical Co., Ltd.	31
Tufnol, Ltd.	16
United Insulator Co., Ltd.	7
University Radio, Ltd.	31
Vortexion, Ltd.	Cover ii
Walter Instruments, Ltd.	9
Wayne-Kerr Laboratories, Ltd.	18
Webbs Radio	Cover iv
Welwyn Electrical Laboratories, Ltd.	18
Westinghouse Brake & Signal Co., Ltd.	15

# Partridge News

## THE NEW PARTRIDGE MANUAL

The completely revised post-war edition of this new Manual, now available, contains:—

Many useful circuits including New 15 watt high quality amplifier with 40 db of negative feedback over three stages. Also articles on Sound Reinforcing and Public Address, Acoustical Problems, Cross-over networks, etc. A useful appendix is included consisting of six selected design charts.

Price 5/- Post Free.

### AVAILABLE STOCK

A comprehensive range of mains and audio components is now available from stock, and we can despatch small quantities of these per return. We would stress that before ordering you send for our list detailing these components. Our stock range now covers almost all normal requirements, and by availing yourself of this service you will save the inevitable delay in the production of a special component. We shall be pleased to send you our stock list upon receipt of your address.

Telephone:



Abbey 2244

**PARTRIDGE**  
**TRANSFORMERS LTD**  
76-8, PETTY FRANCE, LONDON, S.W.1

**MELTON**

**METALLURGICAL**

**LABORATORIES LTD.**

# Liquid Silver

Platinum & Gold  
Solutions  
For Metallising.  
Mica Ceramic  
Quartz etc.

Low Melting  
Point Solder and  
Non - Corrosive  
Liquid Flux (A.I.D. Approved)

IPSWICH ROAD  
TRADING ESTATE  
SLOUGH, BUCKS.

'Phone: Slough 20992

Agents for Australia:

A. S. HARRISON & CO. PTY. LTD.  
85 CLARENCE STREET, SYDNEY

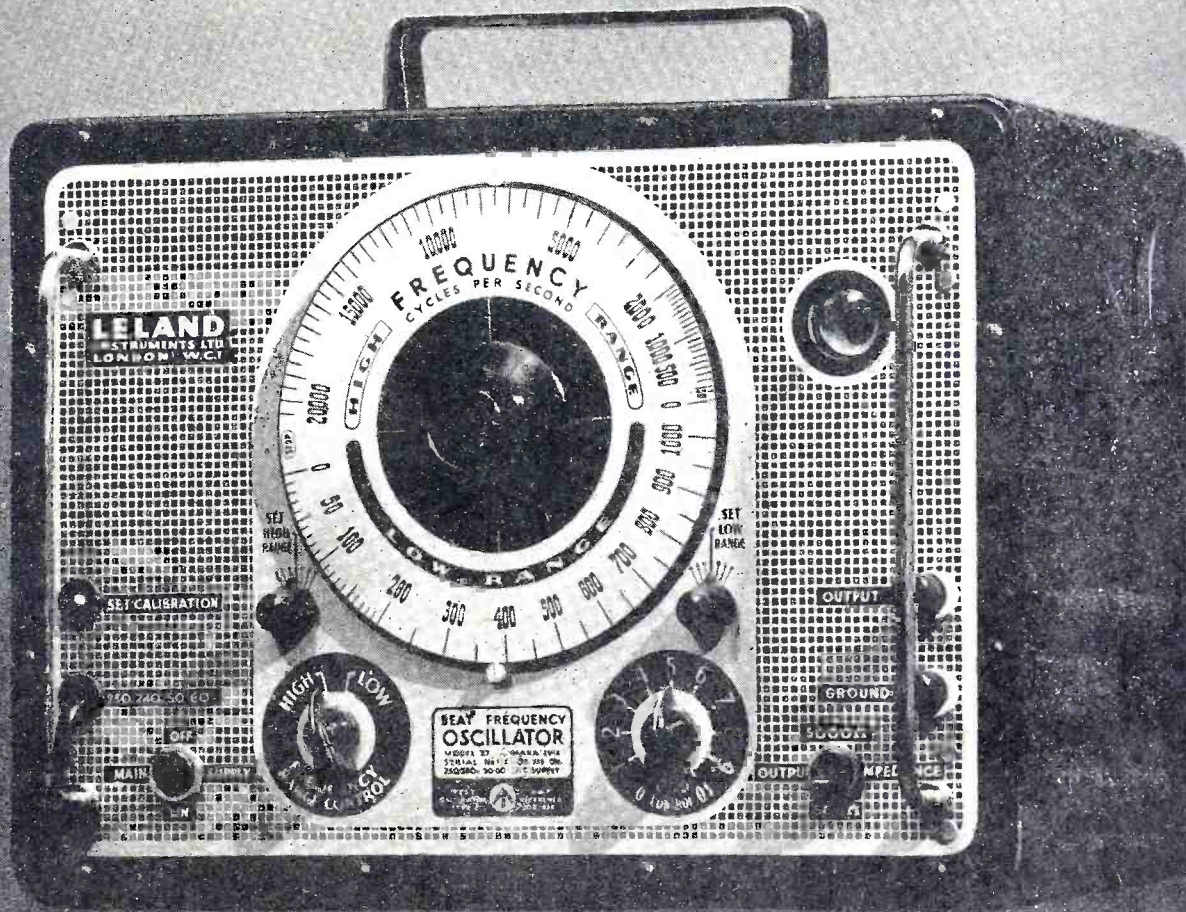

# BEAT FREQUENCY OSCILLATOR Model 27 MARK IVB

A compact portable mains-driven oscillator, providing an output signal of low distortion at frequencies between 10 and 20,000 cycles per second in two ranges, particularly designed to permit good frequency discrimination at the low end of the scale.

This instrument is a variant of the Model 27 Beat Frequency Oscillator which was originally produced for the R.A.F.

- ★ Two ranges cover from 10 to 1,000 cycles and from 50 to 20,000 cycles per second with separate zero setting controls.
- ★ Calibration of the frequency scales is to an accuracy of plus or minus two per cent, and there is provision for beating the oscillator against the mains frequency.
- ★ Outputs up to 25 volts and 8 volts approximately may be obtained across the 5,000 ohms and 500 ohms output terminals respectively by means of a switch.
- ★ Chassis and components, panel and case are finished throughout to semi-tropical specification.
- ★ You are invited to write for the data sheet on Model 27 which gives the instrument's full specification, and also for technical information on other instruments in the ranges of CLOUGH-BREngle, BOONTON, BALLANTINE, FERRIS, MFRVYN and MIDGLEY-HARMER.

**LELAND**  
**INSTRUMENTS LTD.**  
*Electronic Engineers & Consultants*  
**TELEPHONE: CHANCERY 8765 and 8766**

**21 JOHN STREET • BEDFORD ROW • LONDON W.C.1**

# Webb's

for  
**DIVERSITY**  
of  
**STOCK**

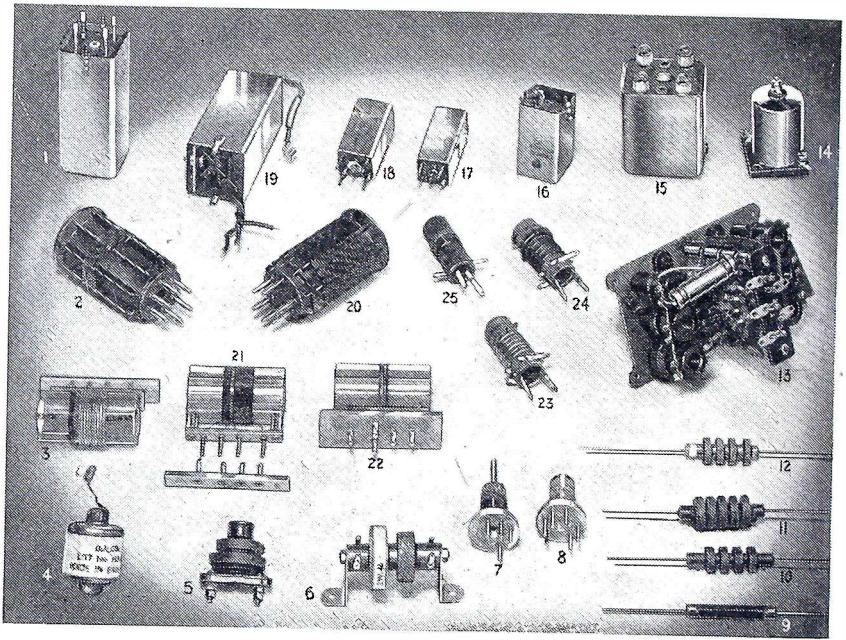

## Inductances

**1. Wearite** I.F. Transformer Nos. 501/2. Size  $1\frac{3}{8}$  in. sq. by  $3\frac{1}{2}$  in. high, 450-470 Kc/s. No. 501 has critical coupling with flying lead. No. 502 has close coupling for diode input—no flying lead. Both types .. .. 10 0

**2 & 20. Eddystone** No. 959 6-pin interchangeable coils. Three winding coils adaptable to most circuits. Tuning range with 160 pf allowing for average circuit capacities:—

6 BB 33.3 to 21.4 Mc/s	5 0	6 W 3.95 to 1.8 Mc/s	5 3
6 LB 25 to 11.5 Mc/s	5 0	6 P 2000 to 924 Kc/s	5 9
6 Y 13.6 to 6.4 Mc/s	5 0	6 G 1153 to 590 Kc/s	5 9
6 R 7.3 to 3.2 Mc/s..	5 3	6 BR 612 to 300 Kc/s	6 6
		6 GY 300 to 150 Kc/s	6 6

**3, 21 & 22. Denco** interchangeable coils on low-loss ribbed polystyrene formers 2 in.  $1\frac{3}{8}$  in. dia.

Range 1.	..	1 to 2 Mc/s (tuned 100 pf)
.. 2.	..	2 to 4.5 Mc/s (tuned 100 pf)
.. 3.	..	4 to 9 Mc/s (tuned 100 pf)
.. 4.	..	7 to 19 Mc/s (tuned 100 pf)
.. 5.	..	16 to 34 Mc/s (tuned 100 pf)
.. 6.	..	30 to 60 Mc/s (tuned 50 pf)
.. 7.	..	50 to 90 Mc/s (tuned 50 pf)
.. 8.	..	70 to 125 Mc/s (tuned 50 pf)

Full details on request.

**4. Bulgin** "Skeleton" general purpose H.F. Choke. All-wave type .. .. 6 6

**5. Eddystone** No. 1066 All-wave Choke. One hole fixing. Inductance 17.9 millihenries .. .. 4 0

**6. Bulgin** Quench coil. Two winding unit for super regeneration .. .. 5 6

**7 & 8. Denco** "Maxi-Q" Plug-in coils (Octal based). In eight ranges covering from 850 Kc/s to 130 Mc/s. Each range available in four types for all purposes. "Blue," 4/0; "Yellow," 4/0; "Red," 4/0; "Green," 5/0. (Coding

as for Denco interchangeable coils also shown in this advertisement).

"Maxi-Q" unwound formers with cores .. .. 2 3

**9. Eddystone** No. 1011 U.H.F. Choke 120/25 Mc/s. Inductance 5.6 microhenries .. .. 1 9

**10. Eddystone** No. 1010 S.W. Choke. 60/1.5 Mc/s. Inductance 1.25 millihenries .. .. 2 6

**11. Eddystone** No. 1022. Transmitting S.W. Choke. 60/1.5 Mc/s. Inductance 1.5 millihenries carries 250 milliamps .. .. 3 0

**12. Denco** 2.6 millihenry general purpose S.W. Choke on polystyrene former .. .. 2 3

**13. Wearite** Coil pack series 600. Three ranges, Superhet coil assembly.

In two types:

Type No. 605B. 16/50 metres, 200/550 metres, 800/2,000 metres.

Type No. 606B. 13/35 metres, 34/120 metres, 200/550 metres. Both types, price each .. .. £2 2 0

**14. Varley** No. BP26. "Nicore" H.F. Choke, screened general purpose H.F. Choke .. .. 7 6

**15. Eddystone** No. 645 I.F. Transformers. 450/465 Kc/s. Litz wound and permeability tuned, plated brass case gives efficient screening. Band-width for a pair of transformers is 5 Kc/s at 20 dB down. Two stages (three transformers) gives band-width of 5 Kc/s at 30 dB down .. .. 19 6

**16. Denco** Midget I.F. Transformers, available in frequencies for 465 Kc/s and 3 Mc/s .. .. each 10 0

**17. Wearite** Midget I.F. Transformers, available in frequencies 465 Kc/s, 1.6, 2.1 and 4.8 Mc/s each .. 10 6

**18. Labgear** I.F. Midget Transformers, 465 Kc/s, each 9 6

### WEBB'S Radio

14, SOHO STREET, OXFORD STREET, LONDON, W.1

Telephone: GERrard 2089.

Shop hours: 9 a.m.—5.15 p.m. Sats. 9 a.m.—1 p.m.