

Electronic Engineering

INCORPORATING ELECTRONICS, TELEVISION AND SHORT WAVE WORLD

PRINCIPAL CONTENTS

The Waveform Monitor — *C.R. Tube Equipment*
Synchrodyne Receiver Design — Part 2
An Application of Motion Study
Design of Acoustic Horns — *Reference Sheet*
Electrical Analogue Computing — Part 4

Pages 299 and 300 are missing

2/- SEPT., 1947

V WIREMOUNTING
BRITISH PATENT No 578290



**FOR
FREQUENCY
SUB-STANDARDS**

TYPE JCF/200, 100 KC/S
Available from stock adjusted to $\pm 0.01\%$
Higher accuracies supplied to special order
PRICES ON APPLICATION

G.E.C. QUARTZ CRYSTAL UNITS

FOR STABLE FREQUENCY GENERATION

FEATURES

Low temperature coefficient—less than 2 in 10^6 per degree Centigrade. Patented nodal suspension. Mounted in vacuum; performance independent of climatic conditions. Exceptionally high Q value. High stability. Small size, 3 in. by $\frac{3}{8}$ in. overall, excluding pins. Fits standard miniature deaf-aid valve socket.

The type JCF/200 unit illustrated above is representative of the wide range of vacuum-type units available for low and medium frequencies.

● VISIT OUR STAND NO. 75 RADIOLYMPIA

SALFORD ELECTRICAL INSTRUMENTS LTD.
PEEL WORKS SALFORD 3
Phone: BLA. 6688 (6 lines) Grams & Cables "Sparkless, Manchester"

Proprietors, THE GENERAL ELECTRIC CO. LTD. England.

TELEPHONE :
CENTRAL 6565
(10 LINES)

Electronic Engineering

INCORPORATING TELEVISION AND SHORT WAVE WORLD

TELEGRAMS:
ELECTRONING
ESTRAND
LONDON

MANAGING EDITOR G. PARR, M.I.E.E.

EDITORIAL, ADVERTISING AND PUBLISHING OFFICES, 28, ESSEX STREET, STRAND, W.C.2.

Monthly (published last day of preceding month) 2/- net. Subscription Rate: Post Paid to any part of the World—12 months, 26/-. Registered for Transmission by Canadian Magazine Post.

Vol. XIX. No. 235

CONTENTS

September, 1947

The Waveform Monitor—C.R. Tube Equipment By H. L. Mansford	272	The Physics of Industrial Diathermy By A. W. Lay, A.M.I.E.E., F.Inst.P.	290
The Design of a Synchrodyne Receiver—Part 2 By D. G. Tucker, Ph.D., and J. F. Ridgway	276	Notes from the Industry	295
An application of Motion Study By H. Barry, A.M.I.P.E.	278	The Manchester Electronics Exhibition	296
The Series Trimming of Crystal Resonators By M.P. Johnson	281	A Nomogram for the Sum of Two Squares By H. B. Morton, B.A., and J. W. Whitehead, B.Sc.	298
Electronic Switching	282	International Exhibition of Measuring Instruments—Stockholm—1947	299
Electrical Analogue Computing—Part 4 By D. G. Mynall, B.Sc., A.M.I.E.E.	283	Book Reviews	300
The Design of Acoustic Exponential Horns	286	Correspondence	302
The Thermistor in Biological Research By B. L. Andrew, B.Sc.	288	September Meetings	302
		Abstracts of Electronic Literature	304

Radiolympia

THE high spot of the year for the radio industry will be reached in a month's time, when the fifteenth National Radio Exhibition opens at Olympia.

There are many, and not necessarily professional radio men, who can boast that they have not missed a single year. Their reminiscences should be listened to with respect, for they give the landmarks in the enormously rapid expansion of an industry which was able to export £8,000,000 worth of equipment in 1946.

And what landmarks some of them were! The first all-mains receiver—the Rice Kellogg loudspeaker—the first pentode, and before that, the double-ended screen-grid valve—push-pull—A.V.C.—automatic tuning—and television, the first demonstration of which took place just outside Olympia for some reason. Old stagers can

amuse themselves by assigning dates to these epoch-making inventions which are now commonplace.

Truly, it is time for the industry to have its own museum where we could renew acquaintance with the wonderful contraptions of the twenties and say "D'you remember?" as we walk round the stands. Some newcomers would be surprised to find the crystal detector in the first showcase and again in the latest exhibits!

Overshadowing all the memories of past excitements is the memory of the blight on the last exhibition before the war when a few aimless wanderers pretended to look at the stands while the gloom deepened until the lights went out altogether and the end of an era had arrived.

Although the gloom has not entirely departed, the survivors are determined that the first post-war exhibition will show that even under present handi-

caps the radio industry is flourishing.

This Radiolympia will be more than a show of post-war radio receivers. It is the opportunity of demonstrating how the industry has expanded and ramified in all directions. Electronics, radar, navigation aids, H.F. heating, are all part of present-day developments and will be seen by many of the public for the first time.

Overseas buyers are specially welcome, and an Export Centre will cater for their requirements. They are asked to write to the Secretary of the Radio Industry Council at 59 Russell Square, W.C.1, for details of the facilities available, and a special booklet is being circulated through official channels.

The first post-war exhibition is also the first radio exhibition at which this publication is represented, and all readers and friends will be welcome at Stand 216 in the National Hall.

The Waveform Monitor

A Cathode-ray Tube Equipment for the Measurement of Voltage and Time

By H. L. MANSFORD, B.Sc., A.C.G.I.*

THE Waveform Monitor Type G302 is an example of laboratory test equipment, redesigned to give the degree of portability and ruggedness required for Naval Radar Service. In addition to the normal functions of a cathode-ray oscillograph, this instrument provides for the accurate measurement of D.C. and A.C. potentials by the use of a null method, which allows the amplifier (D.C. coupled) and C.R.T. to indicate, by 'Y' axis deflections, balance of the input signal potential against another derived from and measured by the instrument.

The block schematic of Fig. 1 gives an introduction to the circuits. Before considering how they work, it is necessary to state briefly what they do:

The 'Y' axis deflecting potentials are given by a balanced D.C. coupled amplifier, which will operate from a single input, or if desired, from two inputs, in which case the deflection is proportional to the difference of the two inputs. The type of circuit used is based on what is generally referred to as the "long-tailed pair" and owes its inception to the late A. D. Blumlein.† A circuit of this type, also used for the 'X' axis amplifier and for the synchronising 'window' has the valuable ability of amplifying only that part of the input signal which may be required for use on the C.R.T. screen or following circuits. The 'Y' axis amplifier serves to provide a variable gain, to convert unbalanced signal potentials to balanced deflection potentials, and to provide for the mixing of signals. If desired, input 1 may be connected direct to the

grid of the first valve, as distinct from the A.C. connexion with grid condenser and shunt grid leak, so that the load across the source is only the valve input impedance plus the stray circuit capacities. This "no-load voltmeter" feature is particularly useful for work on high impedance A.C. networks such as those found on frequency dividers or counters.

'X' axis deflections, normally provided by the timebase circuits to give either triggered or alternatively continuous but synchronous operation, are also controlled by D.C. shift potentiometers, which give a calibration for the measurement of time intervals on waveforms.

The 'X' axis amplifier serves to convert the unbalanced saw-tooth waveform from the timebase generator, to balanced potentials for the 'X' plates. It also provides a variable gain so that either the whole of the trace may be contained within the C.R.T. screen area or a trace variable up to eight times as long may be 'windowed,' when seven-eighths is off the screen and the magnified one-eighth may be chosen from any part of the whole by the use of either the 'X Shift' or the 'Time' control.

The timebase generator circuits are a modified form of the "Sanatron," which make use of a feed-back capacity connected between the anode and grid of a valve.

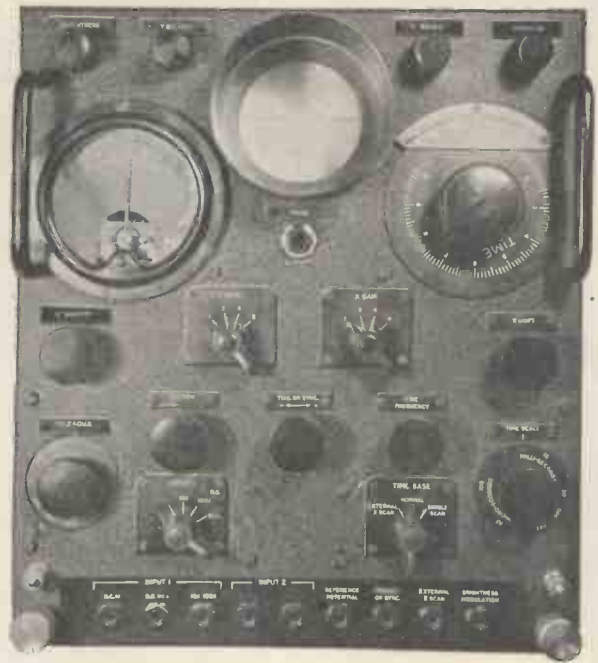

Front panel of
Waveform
Monitor.

The basic circuit is frequently referred to as a Miller integrator, but it may be attributed to the late A. D. Blumlein.* A description of the general and a particular form of this circuit is contained in later pages of this article. This particular circuit may be triggered by a rising potential provided by the 'window' circuit. If the circuit is switched to the free-running position ('Normal') the triggering pulse serves as a synchronising pulse. The 'Time Scale' switch gives a selection of capacity values, making the time of fall of the saw-tooth variable in steps over the ranges, indicated (50 mS. to 3 μ S).

The set-up of the instrument provides for each of these times to correspond to the length of trace ('X' axis timebase sweep) covered by a full-scale rotation of the 'Time' dial. Under triggered conditions the full trace is some 20 per cent. in excess of this amplitude. In order to achieve synchronisation for 'Normal' working, the 'Fine Frequency' control gives a variable curtailment to the period of sweep without altering the sweep velocity. The timebase generator may be stopped to allow potentials from an external source to be introduced to the 'X' axis amplifier.

The function of the 'window' circuit is three-fold. It controls the

* Electrical & Musical Industries Ltd.

† British Patent Specification No. 482,740.

* British Patent Specification No. 580,527.

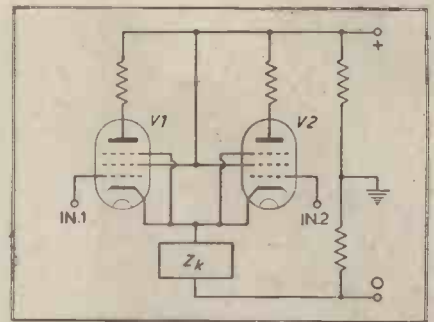
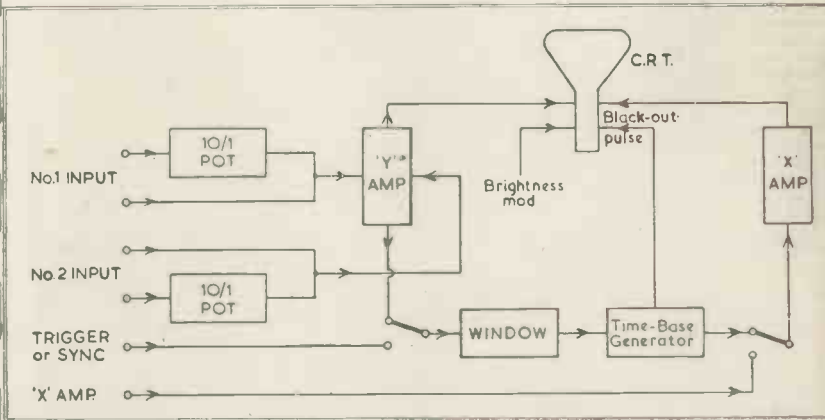

Fig. 1 (left). Schematic of Monitor circuits.

Fig. 2 (above). Basic amplifier circuit using "long-tailed pair."

synchronising or triggering waveform, by providing gain and by controlling the phase of the triggering waveform relative to that being viewed; also it serves to reject from the input to the timebase generator the unwanted potentials which arise as a result of the comparatively high A.C. impedance of the whole circuit about earth.

With the combined functions of the various sections of the main circuit in mind, these and other sections may be studied in greater detail.

As the basic principle underlying the working of the 'Y' amplifier, the 'X' axis amplifier and the 'window' is the same, this principle will be expounded with the aid of Fig. 2.

Fig. 2 shows a 'long-tailed pair' of valves sharing the common cathode circuit impedance Z_k . Consider the circuit balanced, that is, anode resistances, valve currents and grid potentials equal. The value of the impedance Z_k is chosen to fix the current to allow the valves to work remote from grid current. Each grid may be considered to be at chassis potential initially.

Consider now a signal, balanced about earth, between inputs 1 and 2, the mean grid potential remaining as before. The change in V_1 current balances the change in V_2 current so that the cathode potential remains unchanged, and there is no feedback into either grid circuit. The gain is as if the cathode circuit potential were held. Anode circuit signals balance and have the inverse phase to the respective grids.

Consider Z_k to be a current-fixing circuit, which means that it has an almost infinite A.C. impedance, but a workably low value of D.C. impedance. (The anode-cathode impedance of a pentode approximates to this requirement when used above the 'knee').

As an alternative to the balanced input signal, assume a change at V_1 grid only, with V_2 grid remaining at chassis potential. With V_1 grid potential raised, the anode and cathode currents increase. As Z_k current is to be unchanged, V_k cathode and anode currents must be reduced. This change in V_2 current is brought about by added bias from a rise in the cathode potential of both valves, from which it follows that the full rise in V_1 grid potential does not appear between V_1 grid and cathode. If V_1 and V_2 are alike and linear in operation, the change of bias between each grid and cathode is of the same amplitude, but of opposite sign. The effect on the anode and cathode currents is the same as if the applied signal were balanced between the grids. It should be noted that with V_1 and V_2 cathode potential raised, each valve suffers a small reduction of potential between screen grid and cathode, so the mean bias on the valves is reduced to retain the cathode current value. This is a second-order effect.

If the increase of V_1 grid potential is continued until V_1 cathode current equals that passed by Z_k , V_2 current becomes zero (it is lowered to cut off by the rise in cathode potential) and a limit is reached. Added positive cathode swing does not affect V_2 , or its anode circuit. Also if V_1

current should increase further the current in Z_k would have to change. Instead, V_1 cathode potential rises and maintains the bias on V_1 to provide only the current required by Z_k , leaving V_1 anode current fixed at its upper limit. V_1 cathode can follow the grid in the positive direction until the reduction in screen-grid to cathode potential leads the valve into the positive grid current region. This sets an upper limit on the positive input swing.

If V_1 grid is given a negative-going swing from the balance potential, V_1 current drops as that in V_2 increases until V_1 current is zero. Further negative grid swing for V_1 is not limited by the circuit. However, V_1 and V_2 anode currents are limited as before, but now V_2 anode current is at its maximum.

Reference to Fig. 3 should make the operation and use of these limits clearer. Consider this waveform applied to the grid of V_1 (Fig. 2). The period A_1 to A_2 makes a cycle. On the positive-going swing A_1 , B_1 , the valve V_1 starts to pass current at potential v_1 . From v_1 to v_2 its current increases. At v_2 , its current is at a maximum as V_2 current is now zero. From v_2 to B_1 , the anode currents are unchanged. Not until v_2 is reached again on the negative-going swing C_1 , D_1 will any change take place, when V_1 current falls to zero again, as v_1 is reached. The remainder of the cycle D_1 to A_2 is lost to the anode circuits. Only that part between v_1 and v_2 has significance, and this part—if the valve characteristics are linear—is amplified faithfully as a balanced signal in the anode circuits, so that the input signal is 'windowed,' only those parts falling between v_1 and v_2 showing on the C.R.T. or following circuits.

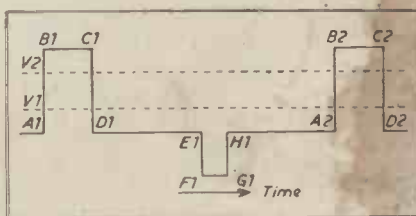

Fig. 3. Waveform illustrating action of "window."

With the same V_1 grid potentials, a change may be made in the selection of the part of the waveforms to be 'windowed' by a fresh choice of V_2 grid potential. By making V_2 grid potential variable, in effect the two lines v_1 and v_2 on Fig. 3 may be moved up or down so as to cover or 'window' the required parts of the waveform.

Fig. 4 shows a sinusoidal wave form at Input 1 and (below) the corresponding anode current waveform. Here the combination of gain and 'windowing' shows as a conversion from sinusoidal to a trapezoidal waveform.

So far the amplitude of the input waveform acceptable by the window has been shown as fixed. A common method of providing control is to allow for controlled variations in the current passed by Z_k . This has the disadvantage of changing the mean value of the two anode potentials, making the method unsuitable for supplying deflecting potentials for a cathode-ray tube. A satisfactory variation in the opening of the 'window' is achieved by the use of negative feedback in V_1 and V_2 cathode circuits. An additional variable cathode resistance in the individual cathode leads provides for a variable amount of cathode following, which allows a larger part of the input swing to be viewed at the 'window' while providing for the acceptance of a larger input signal amplitude. The feed-back gives in addition a valuable improvement to the linearity of the amplifier.

Fig. 5 shows how its variation of effective cathode resistance is achieved. The valves may be given a balanced signal at Inputs 1 and 2, for the purpose of explaining the action of the control. The two cathodes are connected if the 'Y' Gain Control resistance is reduced to zero value. The circuit then behaves, as that of Fig. 2 under balanced conditions. Each cathode acts as a source of A.C., feeding current to a common junction point, where the current balance provides for no excursion of potential. If now the cathodes are separated by a resistance element, the two sources of A.C. are separated. Equal and opposite cathode excursions occur, so providing for less grid to cathode swing on each valve, with a consequent reduction of gain. The mid-point of the resistance joining the cathodes has no potential swing, whatever the value of this resistance, so it may be

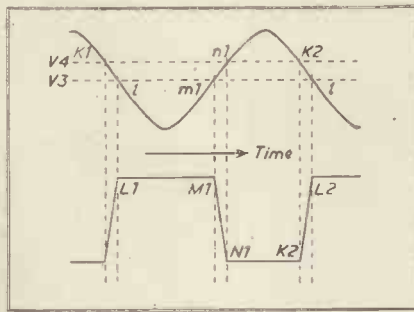

Fig. 4. Trapezoidal waveform of anode current with sinusoidal input.

considered as earthy as the slider of the 'Balance' potentiometer, which is another point where the alternating currents balance. The mean (D.C.) potentials of these two points are not the same, but for the purposes of A.C. working they may be considered as being connected, as with the dotted line (Fig. 5b). This leaves half the gain control resistance in parallel with R_{19} , and half in parallel with R_{20} . With the balanced input signal the variation of gain by the control of the effective cathode resistance should now be clear. The working of the same circuit with an unbalanced input (Input 2 earthy) is less obvious, but it is hoped that with the explanation of the working of Fig. 2 circuit in mind, it will be seen that the gain control is equally effective.

An alternative method of deriving the circuit of Fig. 5b is shown in Fig. 5c. (I) shows the variable feedback resistances, and a 'tail' resistance common to both cathode circuits. Here variations of feedback cause variations of grid bias. (II) shows the equivalent π network where only A.C. flows in the variable resistance, so that bias changes are avoided. (III) is derived from (II) in order to lead to the conversion back to the T-form shown in (IV) which gives the advantages gained by (II), but with a single major resistance for the 'tail,' and the added advantage of the differential control of cathode resistance provided by 'Balance,' (Fig. 5b) the use of which is referred to later.

A balanced and an unbalanced condition with one earthy grid have been considered. A third and important condition of input is given by providing the same signal to the grids simultaneously. It is evident that a slight increase of current in each valve will cause its cathode potential to rise. Efficient cathode following takes place accompanied by any small

change of anode current required by Z_k , and as these changes are in phase there is no associated C.R.T. spot deflection.

'Y' Axis Amplifier

The schematic circuit of Fig. 5a of the 'Y' axis amplifier can be studied with the working of the basic circuit of Fig. 2 as a background. Like valves and balanced conditions can be assumed. The anode and screen-grid currents for V_1 and V_2 are supplied by the cathode currents of V_3 and V_4 . V_1 and V_2 work as before so that their anode and screen grid currents are balanced. The balanced potentials applied to V_3 and V_4 grids maintain balanced cathode currents, leaving their common cathode circuit potential unchanged. In this way the upper pair of valves on the ladder (V_3 and V_4) can work as a balanced pair without cathode feed-back, and the full gain is available. The value of the anode resistance chosen for the lower pair is fixed by the mean bias required by the upper pair. Circuit modifications removing this limitation can be provided if required.* The main advantage of this novel circuit is the simplicity of the D.C. coupling between the stages. For an amplifier associated with a cathode-ray tube, where H.T. up to possibly 1 KV has to be provided, there is the added feature that the one H.T. source may serve the two purposes of supplying both C.R.T. and amplifier.

The practical circuit used in the 'Y' axis amplifier to be described is almost as simple as the schematic. Grid and anode "stoppers" have been added to stop the generation of parasitic H.F. No decoupling condensers are required as the signal currents balance, and the 'Y' plates will tolerate the H.T. ripple, when it is applied to both in the same phase.

Considerations governing the choice of circuit potentials and valve types are of interest. The maximum anode swing of V_3 and V_4 is somewhat greater than that required to deflect the spot to the edge of the screen, in order to keep the sensitivity reasonably constant over the whole screen. Anode resistance values are a compromise between H.F. response on the one hand and current (power) requirements on the other. As the 'Y' plate sensitivity is greater than the 'X' plate sensitivity, and the mean 'X' and 'Y' plate potentials must be the same, some resistance common

* British Patent Specification No. 579,685.

to the two anode circuits (V_3 and V_4) is included. Because V_1 and V_2 at times swing to anode current cut-off, V_3 and V_4 at these times swing to zero bias. This is a condition which may be held indefinitely and each valve must therefore remain within its current and wattage rating. In the instrument illustrated, American 807 valves are used for V_3 and V_4 . Anode current swing is from zero to 100 mA.

With reference to H.T. positive, the mean and the lowest anode potential for V_3 and V_4 is fixed by the C.R.T. plate swing required. The design potential for their common cathode circuit is taken an adequate amount below this.

Valves and currents for V_1 and V_2 can now be chosen. These two give but little gain. They provide for gain control by variable cathode feedback. Their main function, however, is to accept large grid swings without loading the signal source by grid current. The instrument illustrated will accommodate a positive excursion of V_1 grid of 250 volts above the balance potential when the spot or timebase trace is centred on the C.R.T. screen. The value of this feature will be discussed later when the measurement of this input potential is described. For the greater part of this excursion V_2 current is cut off, leaving V_1 to cathode follow at constant current. An upper limit of swing is reached as the cathode potential of V_1 approaches that of its screen grid. A high screen grid to cathode potential is therefore chosen for the balanced condition, and the anode and screen-grid currents are restricted to limit the dissipation to the rated value. With the mean anode current value fixed, the value of the anode resistances follows, as the bias for the upper pair of valves has already been determined.

It is evident that the current passed by the upper pair of valves is to be greatly in excess of that most suited to the lower pair. The excess current is bled from the cathodes of V_3 and V_4 by an adequate impedance made up of stabiliser valves and the circuits associated with the time base generator. This is a power economy feature.

The value of the impedance Z can now be assessed. Use is made of a pentode with resistance between the cathode and H.T. negative line. A potentiometer provides a suitable grid potential. This is a practical example of the use of negative feedback in the cathode circuit to increase the anode impedance.

Fig. 5. Y-axis Amplifier.

(a) Method of varying the "window" opening by altering the effective cathode resistance.

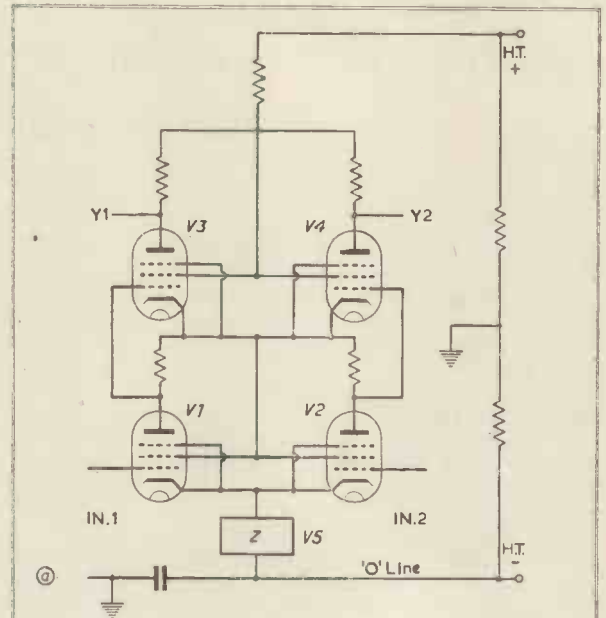

(b) The mid-point of the resistance joining the cathodes has no potential swing and for A.C. working can be considered as connected to the mid-point of the Balance potentiometer.

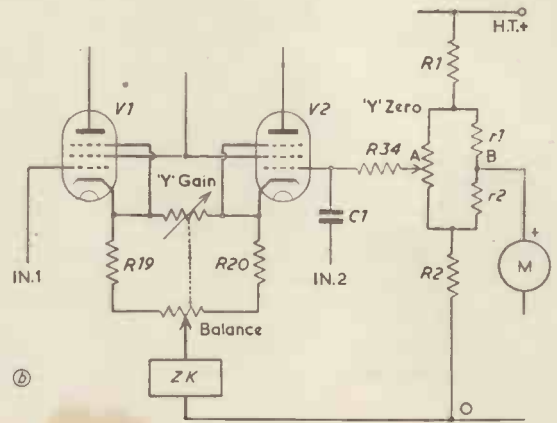

(c) An alternative method of deriving the circuit of Fig. 5b.

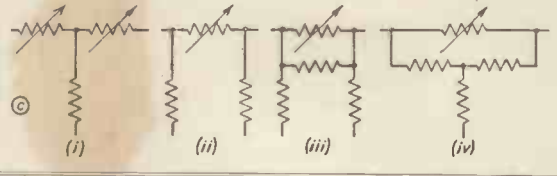

Further reference will be made to the 'Y' axis amplifier when the method of measuring the input potential has been discussed.

The method of voltage measurement requires that all the circuits associated with the 'Y' axis amplifier and C.R.T., which must also include the power supplies and the remainder of the circuits in the instrument, shall float to the extent that their D.C. potential about earth can be controlled by a potentiometer. This potentiometer

impedance is by no means negligible.

Fig. 5a shows the schematic 'Y' axis amplifier. In the practical circuit hum exists between the circuit and chassis. Input 1 circuit and hence V_1 grid are referred back to chassis potential. By referring Input 2 circuit and V_2 grid back to chassis potential also, these hum potentials are applied to both grids (relative to the circuit) and are rejected by the feedback.

(To be continued)

The Design of a Synchrodyne Receiver

Part 2—Some Suitable Designs

By D. G. TUCKER, Ph.D., and J. F. RIDGWAY *

IN Part 1 of this article the basic principles of design of a Synchrodyne receiver were discussed, and it now remains to give some actual designs which can be made up to suit various requirements. All the designs given (which are for the medium-wave broadcast band) have been tried out by the authors and made to work satisfactorily, but it is quite possible that they can be improved by careful thought and experiment. In setting up these circuits it is important to bear in mind the various considerations regarding synchronisation, oscillator discrimination and linearity discussed in Part 1.

The circuits need not be discussed in much detail, as the diagrams should be sufficiently explicit. Particulars of the sensitivities to be expected are given below, together with some hints on adjustment. Three main circuits are shown:—

(a) The basic circuit shown in the preliminary article, using a Cowan demodulator with a cathode-follower input; this is a low-sensitivity receiver.

(b) A high-sensitivity circuit using two R.F. valve stages and a ring demodulator.

(c) A very simple receiver of medium sensitivity and less perfect performance, using a triode-hexode valve for demodulation.

The Basic Circuit

Fig. 1 shows details of this. As given, the sensitivity is low, a signal strength of about 50 mV being required to give good results. However, an additional R.F. stage is easily added, using the circuit of Fig. 2, and this should enable signals of about 2 mV to be satisfactorily received.

The feedback resistance R_8 is the oscillator amplitude adjustment. This should be set so that oscillations are produced without any input signal, and the voltage developed across R_7 should be about 2 volts.

The synchronising control R_6 should be set at maximum if normally only fairly weak signals are received, but for very strong signals (say over 100 mV at the input of Fig. 1), a lower

FIG. 1. BASIC CIRCUIT. Component Values.

- R_1 not critical, say 1,000 Ω potentiometer.
- R_2 300 Ω
- R_3 5,000 Ω
- R_4 2,500 Ω
- R_5 2,500 Ω
- R_6 10,000 Ω potentiometer
- R_7 250 Ω
- R_8 250,000 Ω variable
- R_9 10,000 Ω
- R_{10} 20,000 Ω
- R_{11} 200 Ω
- C_1 0.05 μ F not critical
- C_2 0.05 μ F " "
- C_3 0.005 μ F " "
- C_4 500 μ F variable
- C_5 0.05 μ F not critical
- C_6 0.05 μ F " "
- W_1 Silicon crystal
- W_2 Germanium crystal rectifiers or DI diodes.
- T_1 Tuned winding 100 μ H
Grid winding 10 μ H
Demod. winding 1 μ H
Dust or air-core
- V_1 Valves type
- V_2 SP41 or equiv.

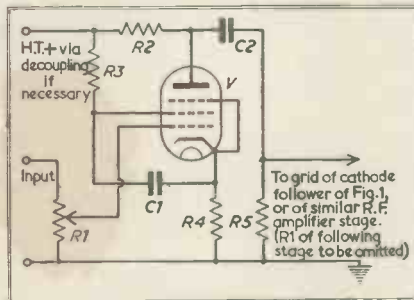
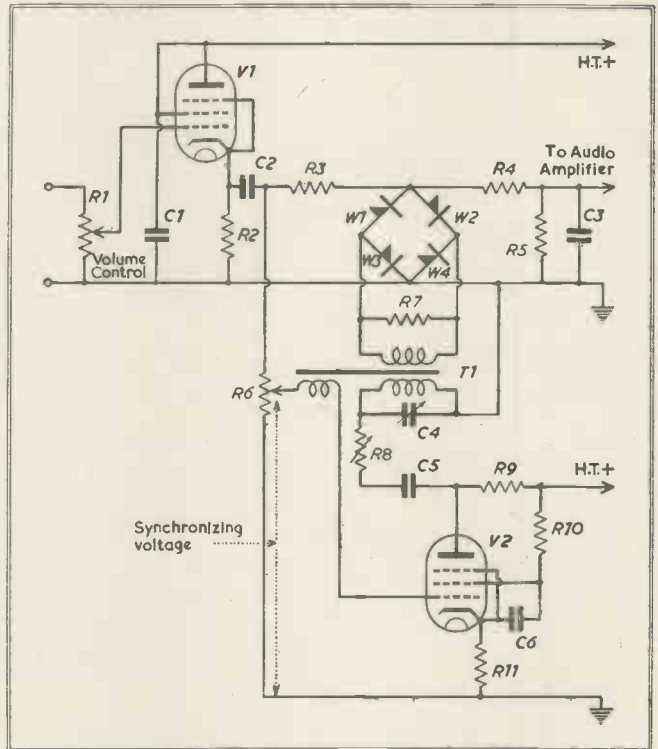

FIG. 2. ADDITIONAL R.F. STAGE. Component Values.

- R_1 not critical, say 1,000 Ω , potentiometer
- R_2 10,000 Ω
- R_3 20,000 Ω
- R_4 200 Ω
- R_5 100,000 Ω
- C_1 0.05 μ F, not critical
- C_2 0.05 μ F " "
- V SP41 or equivalent

setting will be desirable. If on weak signals, however, the discrimination against other signals is not good enough, R_6 may be turned down.

The audio output* from the basic circuit is only about 1 mV when the input signal is 50 mV.

In the preliminary article, a low-pass filter was shown in the output. This has been found to be unnecessary in most practical cases, as the audio stages do not transmit the supersonic frequencies which the filter is intended to remove. The condenser C_3 has some filtering action. If, however, trouble is experienced with supersonic signals becoming demodulated in the audio stages due to their slight non-linearity, a filter may be fitted, according to the circuit shown in Fig. 3. The loss-frequency characteristic is shown in Fig. 4; with just the basic filter (L , C_1 and C_2), the loss rises smoothly with frequency. Should there be present an interfering signal rather too close in frequency for this simple filter to be effective, C_3 may be used, giving a peaked response as shown. To design the filter, we use a parameter m thus:—

$$\text{Frequency of peak} = \frac{1}{\sqrt{1 - m^2}}$$

× cut-off frequency (thus $m < 1$)

* P.O. Research Station, Dollis Hill.

* In all cases quoted, a 30 per cent. modulation of the input signal is assumed.

$$L = mL_0$$

$$C_1 = C_2 = mC_0$$

$$C_3 = \frac{1 - m^2}{2m} C_0$$

where L_0 and C_0 are the values for the untuned case.

If R is the impedance in which the filter works, and f_c is the cut-off frequency, then $L_0 = R/\pi f_c$ and $C_0 = 1/2\pi f_c R$.

High-sensitivity Circuit

Fig. 5 shows a circuit which can receive signals down to 10 μ V. A two-stage R.F. amplifier is used with input tuning ganged to the oscillator tuning control. The input tuning is advisable when low-level signals are to be received, in case there are strong signals also present which might overload the amplifier. Overall negative feedback is provided, and this can be varied by adjustment of R_9 , which therefore serves as a volume control.

With an input signal of only 10 μ V, the audio voltage at the secondary of T_3 is about 60 mV with the volume control at maximum setting. For stronger input signals, audio voltages up to about 1 volt are permissible.

The oscillator circuit is the same as before, except that only 1 volt is required across the modulator winding of T_1 .

Simple Receiver Using Triode-Hexode

Fig. 6 shows a circuit which has been designed for maximum simplicity. It can receive an input signal down to about 10 mV, and with this input voltage gives an audio output from the triode-hexode of about 1 volt. The oscillator must be adjusted by means of R_{10} to oscillate with a grid amplitude of 7-10 volts when there is no input signal. The discrimination against unwanted stations is not as good as in the previous circuits, but is probably adequate for ordinary purposes. The input volume control should be used to maintain a signal voltage of about 0.3-0.5 volt across R_5 .

Conclusions

The three designs of receiver described in this article should have given the reader an adequate illustration of the way in which a synchrodyne receiver may be built up to meet varying requirements. It is hoped, therefore, that readers will be able to prepare modified designs, if necessary, to suit their own individual requirements as to sensitivity, discrimination and simplicity. There is also ample scope for experiment in the application of the principle to short-wave and communication-type receivers.

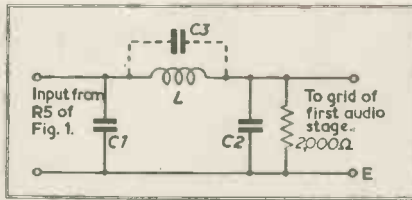

FIG. 3. LOW-PASS FILTER.

For cut-off at 10 Kc/s. in circuit of Fig. 1, with L untuned, $L = 64$ mH, $C_1 = C_2 = 0.008$ μ F.

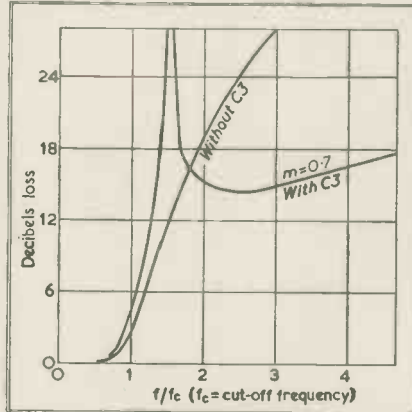

Fig. 4. Loss-frequency Characteristics

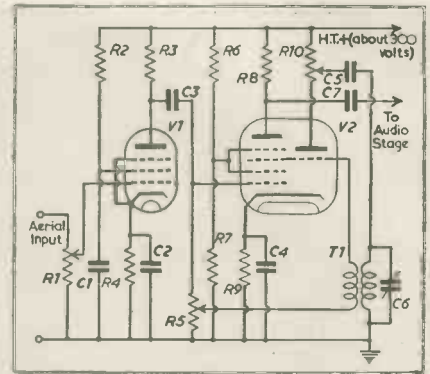

FIG. 6. SIMPLE RECEIVER USING TRIODE-HEXODE VALVE.

Component Values.

- R_1 Not critical, about 1,000 ohms potentiometer
- R_2 30,000 ohms
- R_3 10,000 ohms
- R_4 300 ohms
- R_5 10,000 ohms potentiometer
- R_6 25,000 ohms
- R_7 30,000 ohms
- R_8 10,000 ohms
- R_9 200 ohms
- R_{10} 50,000 ohms potentiometer
- C_1 0.05 μ F not critical
- C_2 0.1 μ F " "
- C_3 0.05 μ F " "
- C_4 0.1 μ F " "
- C_5 0.05 μ F " "
- C_6 500 μ F variable
- C_7 About 0.1 μ F

- V_1 Valve type SP 41 or equivalent
- V_2 Valve type ECH 35
- T_1 Tuned winding 100 μ H
- Grid winding 10 μ H

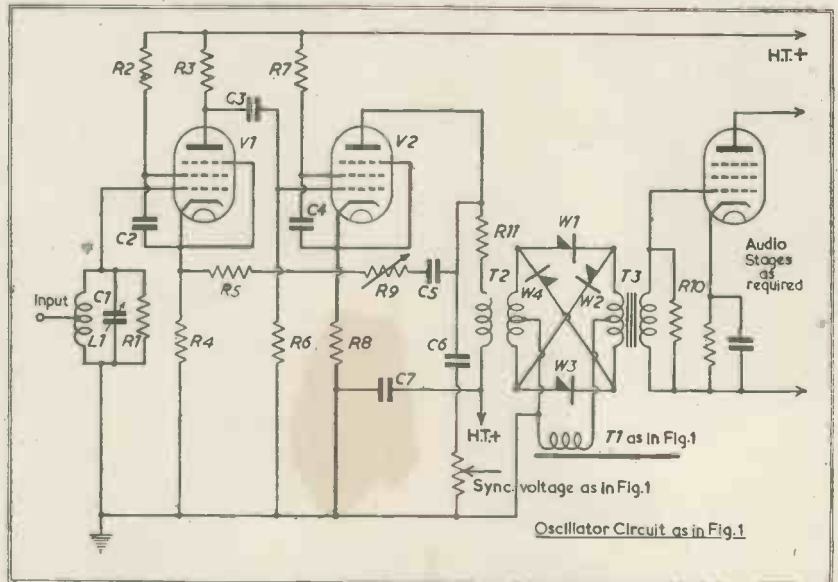

FIG. 5. HIGH-GAIN RECEIVER USING RING TYPE DEMODULATOR.

- R_1 as required
- R_2 20,000 Ω
- R_3 10,000 Ω
- R_4 200 Ω
- R_5 10,000 Ω
- R_6 100,000 Ω
- R_7 20,000 Ω
- R_8 200 Ω
- R_9 Volume control, 250,000 Ω
- R_{10} 200,000 Ω
- R_{11} 5,000 Ω
- V_1 Valve type SP41
- V_2 or equivalent
- C_1 500 μ F variable ganged to oscillator tuning condenser.

- C_2 0.05 μ F, not critical
- C_3 " " "
- C_4 " " "
- C_5 " " "
- C_6 " " "
- C_7 " " "
- L_1 100 μ H, tap at midpoint
- W_1 as in Fig. 1
- T_2 Preferably on small dust core (say T6 type)
- Anode winding about 7 mH
- Demod. winding in two balanced halves, about 1 mH total. Turns ratio 2.5 : 1.
- T_3 Any good audio-frequency input transformer, step-up about 1 : 10. Primary in two balanced halves, total about 10 Henries.

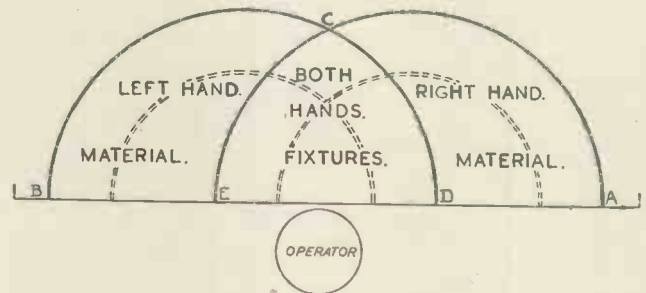

Fig. 1 (left).—Diagram illustrating the principle of minimum movement. Above: Components arranged according to this principle.

(By courtesy of Metropolitan-Vickers)

An Application of Motion Study

By HENRY BARRY, A.M.I.P.E.*



MOTION Study is the scientific study of the movements involved in performing an operation and the development of methods to eliminate all unnecessary or time-wasting movements.

The technique was pioneered by an American engineer, Frank B. Gilbreth, in the latter half of the last century and in all his investigations he was assisted by his wife, Dr. Lilian B. Gilbreth, a psychologist, this combination of engineer and psychologist being of great importance in the development of Motion Study.

The modern technique has as its aim not only the elimination of unnecessary movements, but also the rhythm of movement, balance of posture, conditions of work-place and the psychological study of the individual operator, without whose willing co-operation maximum output cannot be achieved.

While it is true that Motion Study is a technique demanding a high standard of specialisation to achieve maximum results, the simple laws of Motion Economy can, and should be, practised by all shop supervision.

Motion Economy may be described as a summary of certain features that detailed observation show tend to occur. These features are:—

1. Minimum movements.

Tools, materials, machine controls,

etc., should be placed within the area of easiest reach (see Fig. 1).

BCD is the arc described by the left hand using the shoulder as a centre.

ACE is the arc described by the right hand using the shoulder as a centre.

ECD is the overlap of BCD and ACE which is the easiest area for both hands.

The dotted arcs are formed by using the elbow as a centre and are for movements requiring the hand and forearm.

2. Symmetrical movements.

As far as possible all movements should be symmetrical about an imaginary line through the centre of the body.

3. Simultaneous movements.

Where possible make the hand movements simultaneous by using double fixtures if necessary.

4. Rhythmic movement.

Aim at establishing a rhythm. Delay caused by faulty material or tools out of position results in loss of output.

5. Habitual movements.

Take advantage of the human tendency to form habits. It is just as easy to form good habits as bad. If Motion Economy principles are employed, good habits can be introduced before bad habits have been formed. Therefore, always place tools and materials in the correct relative position.

It is unfortunate that, in the past, undue emphasis has been laid on the value of Motion Study for assembly operations. While the field is certainly a fruitful one, the technique can be applied in many other directions with equally good results.

To illustrate this viewpoint, the operation chosen for description in this article is the loading and unloading of components before and after an internal grinding operation.

The carbon resistance ring, the component under discussion, is an element of the stack incorporated in an automatic carbon pile regulator, a type of which is shown in Fig. 2.

These regulators are now extensively used in applications where voltage or current must be controlled within close limits.

In the automatic regulator, pressure is usually applied to the pile by means of a spring and the pressure is opposed by that provided by a solenoid so that, under normal working conditions the pile is subjected to a differential pressure. The solenoid is connected to an appropriate part of the circuit, so as to respond to any variations in the voltage or current. These variations are reflected through the pressure device on to the pile and give use to such changes in its resistance as to compensate for the variation and maintain the voltage or current within the specified limits.

Before assembly, the carbon rings

* Morgan Crucible Co., Ltd.

composing the pile require to be accurately ground internally and externally, which calls for skilled handling if excessive breakage is to be avoided.

The operation prior to internal grinding is external grinding. This is done by loading the rings on a mandrel (see Fig. 3) and passing through a centreless grinder. The rings are then unloaded from the rods and placed in boxes ready for transport to the next operation.

Old Method

The method in use prior to the Motion Study investigation was as follows:—

1. The rings arrived on the internal grinding site, loose in a box.
2. They were then stacked on rods in pile formation and in a vertical position.
3. A suitable number of rings were loaded into a work-holder. The holder was of mild steel, circular in shape with a screwed flange top, on which a knurled circular cap was screwed; the bottom of the holder had two flats to allow of holding in a vice to facilitate the screwing down of the cap.

4. The holder was held in an internal grinder and the rings ground.

5. Holder Unloaded. This is the reverse operation of loading of holders, i.e., unscrewing cap, removal of rings and disposing of ground rings on to rods in a vertical position.

The time cycle of the grinding operation was two holders per minute and to ensure that the grinding machine operator was fully supplied with holders, it required two full-time operators and one operator part time, totalling two-and-a-half operators per machine for the loading.

New Method

Based on Motion Study principles, the first approach to the problem was to eliminate the hand tightening of the work holder.

A new holder was designed (see Fig. 4.A), consisting essentially of a cylinder with a spring-loaded sleeve at the bottom of the bore. When loaded with rings a loose cap (see Fig. 7.A) is placed on the top of the holder, so arranged that there is a clearance between the top face of the holder and the underside of the cap. On the inner face of the chuck jaws of

the grinding machine is machined a taper of the same angle as the taper on the outer edge of the loose cap, (see Fig. 7.A). When the loaded holder with cap is placed in the machine and chuck jaws close, the two taper surfaces impinge and pressure is transmitted through the rings to the spring at the bottom of the holder which is put into compression and the rings to be ground are held between spring pressure and the spigot on the underside of the cap.

By this means the machine is doing the tightening of the work-holder instead of the operator, which means saving of time and considerable reduction of operator fatigue. The second approach to the problem was to avoid the undoing of the mandrels immediately after the centreless grinding operation, so as to utilise the already orderly disposal of the rings to assist in the loading operation for internal grinding.

This was achieved by incorporating in the set-up a fixture for loosening the hexagon nuts on the grinding mandrels. This consists of a mechanical device operating through

Fig. 2 (upper right).—Automatic current regulator with carbon pile element. Fig. 3 (lower right).—Carbon rings and mandrel for assembly.

Comparison Table showing the improvement made by Motion Study

OLD METHOD			NEW METHOD		
2 Loading Operators 1 Machinist		Hand	1 Loading Operator 1 Machinist		Hand
} Additionally part-time service of operator for general use.					
Op.	Operator A	Hand	Op.	Operator A	Hand
1	Load rings on peg	R.H.	1	Pick up 2 mandrels and place in jig	Both
2	Pick up holder	L.H.	2	Turn handle to loosen nuts	R.H.
3	Remove peg from stand and put peg in holder	R.H.	3	Remove 2 mandrels and put in collets	Both
4	Withdraw peg and place in stand	R.H.	4	Remove 2 loose nuts and discard	"
5	Pick up and screw on cap	R.H.	5	Place 2 holders on studs	"
6	Change holder from L.H. to R.H.	R.H.	6	Load rings on to 2 studs	"
7	Pass loaded holder to Operator B	R.H.	7	Load and remove 2 holders and place for machine	"
Operator B			Machine Rings		
8	Pick up and place holder in vice	L.H.	8	Pick up 2 holders and place on studs	"
9	Tighten vice	R.H.	9	Remove 2 piles of rings	"
10	Tighten cap	R.H.	10	Discard 2 piles of rings	"
11	Loosen vice	R.H.			
12	Remove holder and place for machine	R.H.			
Machine Rings					
13	Pick up and place holder in vice	R.H.			
14	Tighten vice	R.H.			
15	Loosen cap	R.H.			
16	Loosen vice	R.H.			
17	Remove holder and hand to Operator A	L.H.			
Operator A					
18	Receive holder in R.H. and change to L.H.	R.H.			
19	Remove cap and place on bench	R.H.			
20	Pick up peg and insert in holder	R.H.			
21	Withdraw loaded peg from holder	R.H.			
22	Place holder on bench	L.H.			
23	Remove rings from peg and discard	L.H.			
24	Put peg in stand	R.H.			
1 Holder loaded and unloaded			2 Holders loaded and unloaded		

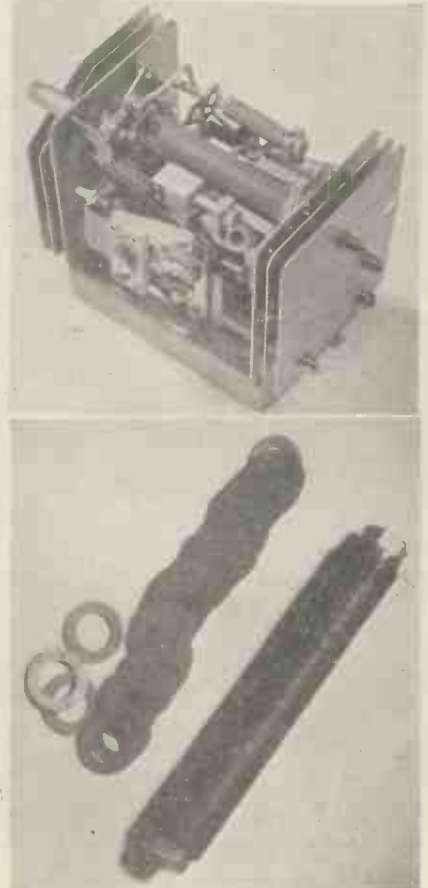

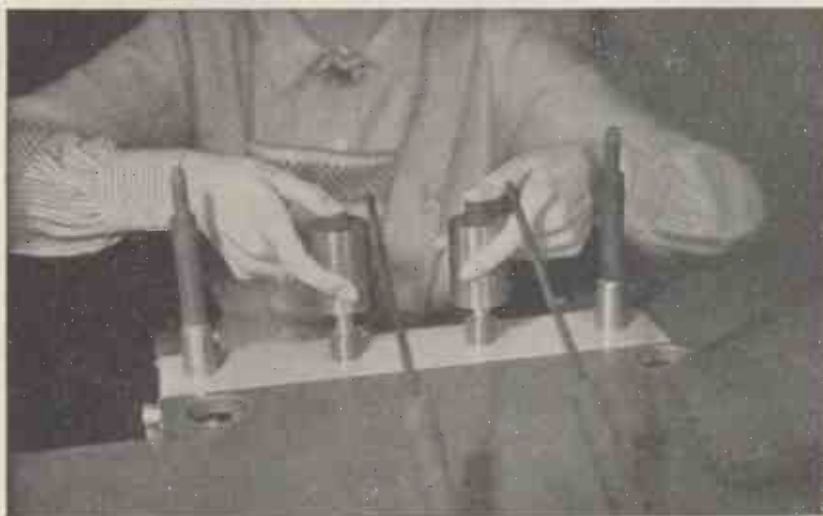

Figs. 4 (top), 5 (centre) and 6 (bottom).—Three stages in the assembly of carbon rings for grinding.

gears with four open-sided hexagons. The two inner locations are free to turn, one clockwise and one anti-clockwise, and the two outer locations are fixed. By placing two mandrels into position it is possible by three turns of a small handle to loosen the nuts sufficiently to enable them to be removed by hand. This device is not shown in the photographs, but the position of the handle can be seen in Fig. 6.C.

Two boxes were then incorporated, one on each side of the operator, to receive the mandrels direct from the centress grinding.

The operation sequence is now:—

1. Pick up two loaded mandrels (one in each hand), place in fixture and loosen nuts by turning handle three times which brings open side of hexagon locations uppermost for ease of removal of mandrels.

2. Remove mandrels and place in two spring loaded hexagon collets (see Fig. 4.B).

3. Remove loosened nuts and washers (one with each hand) and dispose by drop delivery in downward path of movement of hands.

4. Place one holder on each of the two studs (see Fig. 4.A). These studs have two diameters. The top part of the stud has a diameter smaller than the bore of the carbon ring and the bottom part, a diameter larger than the bore of the carbon ring. The length of the smaller diameter is such that it corresponds to the cumulative thickness of the number of rings it is desired to load into the grinding holder.

5. Load carbon rings (two hands simultaneously) by taking rings from loaded mandrels.

6. Load rings into holders by drawing holders upwards (see Fig. 5).

7. Place holders on side ready for grinding operator (see Fig. 6). The holder is picked up by grinding operator who puts on loose cap, grinds the rings and returns holder.

To Remove Rings from Holder

1. Pick up two holders (one in each hand).

2. Drop holders over studs (see Fig. 5). Because of the stepped diameter of the studs, the ground rings remain on the top portion of the studs while the holder drops to lower portion, clear of the rings.

3. Remove rings (one batch in each hand).

4. Disposal of rings by dropping on to disposal rods.

The cycle is then repeated.

(Continued on p. 282).

The Series Trimming of Crystal Resonators

By

M. P. JOHNSON,
E.E. (Toronto) A.M.I.E.E.

IN this note formulæ are derived to determine the amount of series inductance or capacitance required for a given deviation from the crystal resonant frequency, f_r . Other formulæ are derived to show the stability that may be expected from such trimming and a theoretical calculation is compared with a practical result. Formulæ are derived on the condition that the combined reactance of the crystal and its series trimming reactance is zero at a frequency slightly below or above the crystal resonant frequency.

The crystal reactance curve is shown in Fig. 1. From this it is seen that the reactance is negative below resonance, and positive immediately above resonance. Thus for trimming below resonance a positive, effectively inductive, reactance is required, while for trimming above resonance a negative, effectively capacitive, reactance is required.

The crystal equivalent circuit is shown in Fig. 2 between points 1 and 2, and the trimming reactance between 2 and 3.

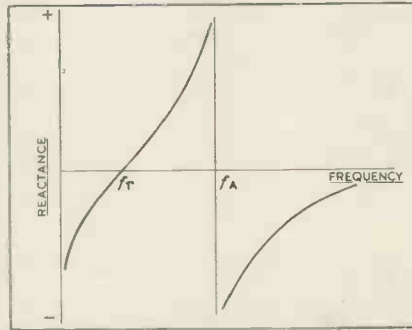

Fig. 1. Crystal reactance curve.

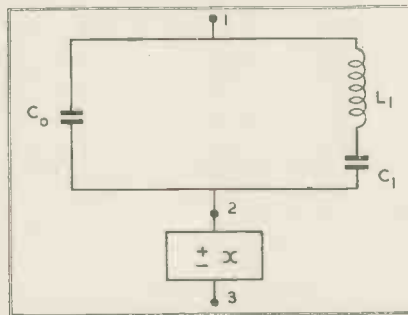

Fig. 2. Crystal equivalent circuit.

Let the roots of this equation be ω_1^2 and ω_2^2 ; then it follows that:

$$\omega_2 = \omega_r \omega_0 / \omega_1 \dots \dots \dots (5)$$

Thus, as would be expected from the crystal reactance curve, inductive trimming produces two points of zero reactance. If one of these is chosen to occur just below f_r the other may be found approximately from Equation (5) and will usually occur at frequency much higher than f_a . Crystals trimmed in this manner are, for oscillator purposes, usually operated at the lower value of these two roots.

The deviation below, f_r , may also be approximated in the following manner:

Let $\omega = \omega_r - \delta$ then where δ is small compared with ω_r : $(\omega/\omega_r)^2 = 1 - 2\delta/\omega_r$, and since $(\omega_a/\omega_r)^2 = 1 + C_1/C_0$, substituting in Equation (3b) and equating X_{1-3} to zero for resonance, yields:

$$\frac{\delta}{\omega_r} + \omega L = 0 \dots \dots \dots (6)$$

$$-\omega C_1 \frac{2\delta C_0}{\omega_r C_1} + 1$$

But $C_1 = i/\omega_r^2 L_1$ and $\delta/\omega_r = \Delta f/f_r$.

Hence Equation (6) may be written:

$$\frac{2\Delta f}{f_r} - \frac{L}{L_1} \left(1 - \frac{2\Delta f}{f_r} \right) \left(\frac{2\Delta f C_0}{f_r C_1} + 1 \right) = 0 \dots (7)$$

Equations (8) and (9) are obtained from (7) by omitting the terms whose coefficient is $(\Delta f/f_r)^2$

$$L = \frac{2(\Delta f/f_r)L_1}{1 - \frac{2\Delta f}{f^2} \left(1 - \frac{C_0}{C_1} \right)} \dots \dots \dots (8)$$

$$\frac{\Delta f}{f_r} = \frac{\frac{1}{2}(L/L_1)}{1 + \frac{L}{L_1} \left(1 - \frac{C_0}{C_1} \right)} \dots \dots \dots (9)$$

Where $L/L_1(1 - (C_0/C_1))$ is small compared with unity, Eq. (9) may be written $\Delta f/f_r = \frac{1}{2}(L/L_1)$, from which it follows that

$$\frac{d\Delta f}{f_r} = \frac{1}{2} \frac{L}{L_1} \frac{dL}{L} = \frac{dL}{L} \frac{\Delta f}{f_r} \dots \dots \dots (10)$$

Capacitive Trimming

By writing $\pm X = -1/\omega C$ in Equation (3a) and equating the result to zero, the resonant frequency of the combination is found to be:

$$\omega = \sqrt{\frac{1}{L_1 C_1} \left(1 + \frac{C_1}{C + C_0} \right)}$$

Since $C_1/(C + C_0) \ll 1$,

$$\omega = \sqrt{\frac{1}{L_1 C_1} \left(1 + \frac{C_1}{2(C + C_0)} \right)} \dots \dots \dots (11)$$

The frequency of the combination is thus greater than the resonant frequency of the crystal by an amount:

$$\frac{\Delta f}{f_r} = \frac{(\omega - \omega_r)/\omega_r}{1} = \frac{C_1}{2(C + C_0)} \dots \dots \dots (12)$$

and

$$C = \frac{C_1}{2\Delta f/f_r} - C_0 \dots \dots \dots (13)$$

From differentiation of Equation (12) it follows that:

$$\frac{d\Delta f}{f_r} = \frac{\Delta f}{f_r} \frac{dC}{C + C_0} \dots \dots \dots (14)$$

Let $f_r = \omega_r/2\pi$, the crystal resonant frequency

$$\omega_r^2 = 1/L_1 C_1 \dots \dots \dots (1)$$

and $f_a = \omega_a/2\pi$, the crystal anti-resonant frequency

$$\omega_a^2 = \frac{1}{L_1 (C_1 + C_0)} \dots \dots \dots (2)$$

Let X_{1-3} = reactance between points 1 and 3.

$$-\frac{1}{\omega C_0} \left(\omega L_1 - \frac{1}{\omega C_1} \right)$$

$$\text{Then } X_{1-3} = \frac{1}{\omega L_1} \left(\frac{C_0 + C_1}{C_1 C_0} \right) \pm x \dots (3a)$$

$$= \frac{1}{\omega C_0} \frac{1 - (\omega/\omega_r)^2}{(\omega/\omega_r)^2 - (\omega_a/\omega_r)^2} \pm x \dots (3b)$$

Inductive Trimming

In this case where L is the inductive trimming $\pm X = +\omega L$. By substituting $+\omega L$ for $\pm X$, ω_0^2 for $\frac{1}{LC_0}$

and equating X_{1-3} to zero the following equation is derived from (3b):

$$\omega^4 - \omega^2(\omega_0^2 + \omega_a^2) + \omega_r^2 \omega_0^2 = 0 \dots (4)$$

which in most practical cases approximates to:

$$\frac{d\Delta f}{f_r} = \frac{\Delta f}{f_r} \frac{dC}{C} \dots\dots\dots (15)$$

Example.

The use of these formulæ may be demonstrated by considering a particular 5° X-cut bar crystal whose constants are:

$$L_1 = 269 \text{ henries} \quad C_1 = 0.0378 \text{ pF.}$$

$$C_0 = 4.72 \text{ pF.} \quad f_r = 50 \text{ Kc/s.} - 51 \text{ parts in } 10^6 \text{ (measured).}$$

From Equation (13), the series trimming condenser required to bring the resonant frequency of the combination to exactly 50 Kc/s. is:

$$C = \frac{0.0378}{2 \times 51} \times 10^6 - 4.72 = 366 \text{ pF.}$$

The value of *C* was determined experimentally as 363 pF.

Assume that this crystal is temperature controlled to ± 0.1° C., and that its temperature coefficient is 4 parts in 10⁷ per 1° C., at the controlled temperature. Let it also be assumed that the temperature coefficient of the condenser is 100 parts in 10⁶ per 1° C., and that it is subject to a temperature variation of ± 10° C. The frequency variation due to the crystal would ± 0.1 × 4 × 10⁻⁷ = ± 4 parts in 10⁶. The frequency variation due to the condenser would be from Equation (15):

$$\frac{d\Delta f}{f_r} = \pm \frac{51 \times 10 \times 100}{10^6 \times 10^6}$$

$$= \pm 5 \text{ parts in } 10^8.$$

As this is larger than the variation of the crystal with temperature, it might be well to consider temperature compensating the condenser.

Conclusion

Little difficulty should be experienced in trimming crystals which have their unwanted resonances well removed from the main resonance. During some experimental work on crystal oscillators it was found possible to trim a particular crystal to the extent of ± 100 parts in 10⁶ with little degradation of the oscillator performance although excessive trimming will radically alter the shape of the reactance curve and lower the *Q* of the combination.

The author is grateful to the General Electric Co., Ltd., for permission to publish this note.

Electronic Switching

(Communication from E.M.I. Laboratories)

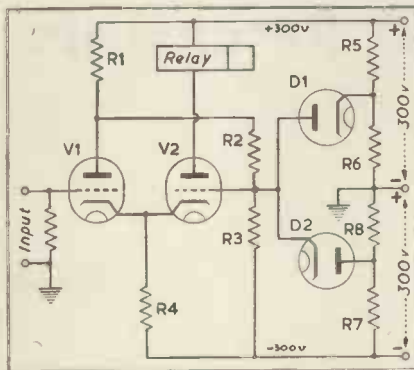

THE so-called "electronic switch" has a large number of applications, not all of which are in precision equipment. The switch is frequently in the form of a trigger relay, and is used for such purposes as counting, switching, and so on. With most arrangements sensitivity of operation demands the use of components with extremely close tolerances, and such a design does not tend towards stability of operation since ageing of valves and temperature changes, etc., will all have pronounced effects. The circuit shown in the figure has the advantage that it provides good sensitivity combined with a high degree of stability against variations of working conditions, such as changes in valve characteristics, values of components or fluctuations in the power source.

Referring to the diagram, a cathode-coupled pair of valves, *V*₁ and *V*₂, form the basis of the trigger circuit, with a D.C. connexion between the anode of *V*₁ and the grid of *V*₂ completing the feedback loop. Such a circuit has, as is known, two states of equilibrium, *i.e.*, with either *V*₁ or *V*₂ conducting and with either *V*₂ or *V*₁ cut-off. The idea is to provide two diodes to set the upper and lower limits of the potential swing on the grid of *V*₂, and, simultaneously, by circuit design, to attempt to cause a large potential swing to occur on this grid between the two stable conditions, considerably larger than that which is actually necessary to cause the circuit action to take place.

With the values shown the voltage swing on the grid of *V*₂ would be, in the absence of the limiting diodes *D*₁ and *D*₂ of the order of 75 volts. Using valves with an amplification factor of 20 or so, 10 volts change is enough to cause the trigger action to occur, and thus a large safety factor

is established which allows variations of about 15 per cent. in the values of any or all of *R*₁, *R*₂, *R*₃ and *R*₄. In order to keep the actual grid voltage swing of *V*₂ within reasonable limits, two diodes, *D*₁ and *D*₂, are provided to set upper and lower potential stops at, say, ± 10 volts.

In theory, since the grid of *V*₂ has applied to it limited potentials which are predetermined by the two diodes, the circuit is bound to operate in a stable manner provided the anode of *V*₁ performs potential excursions sufficient to cause the limiting grid conditions to be reached. It does not matter if the anode of *V*₁ swings beyond this minimum range, and it is, in fact, made to do so.

The sensitivity of the circuit can be adjusted by the potentiometers *R*₅, *R*₆ and *R*₇, *R*₈.

Owing to the very large degree of degeneration introduced by the common cathode resistor *R*₃, the current passed by whichever valve is conducting is largely independent of the valve, so that valve ageing has little effect until emission almost entirely fails.

An Application of Motion Study

(continued from p. 280)

Thus, with the same machine cycle time of two holders per minute, the new method requires only one operator instead of two-and-a-half operators with the old method.

The advantages of the new method over the old are clearly illustrated in the detailed operation chart shown on the page.

A high degree of flatness in the disks is important in order to keep the movement of the pressure device to a minimum, particularly in the design of the automatic regulator in which the closeness of the control limits is dependent on the smallness of this movement over a pressure range of 0 to 6 lb. The change in length of a pile can be restricted to approximately 0.00025 in. per element.

While the simplicity of this method of ohmic adjustment in itself would make a strong claim for the use of these piles, the absence of radio interference due to the continuously unbroken circuit has further contributed to their very extensive use.

The illustrations in this article are used by permission of The Morgan Crucible Co., Ltd., in whose works at Battersea the carbon resistance rings are made.

Electrical Analogue Computing

By D. J. MYNALL, B.Sc., A.M.I.E.E.*

Part 4.—Pure Electronic Systems

THE units which have been described so far, suffice to allow the description of an example illustrating the special possibilities offered by electronic analogue computing.

Specialised applications may be imagined, but it has been thought more valuable to describe a possibility taken from the field of apparatus of general application, such as simultaneous linear equation solvers, algebraic equation solvers and differential analysers.

Of the array of possibilities, the way in which a simple differential analyser may be set up and operated has been chosen for description. The example is restricted to the solution of linear differential equations with constant coefficients, but is sufficient to bring out the main features of the method. In the light of the example, it is fairly clear how, by making use of multiplying, dividing and functional transformation units, the method can be extended to differential equations of other types.

Simple Electronic Analogue Differential Analyser

Suppose that it is desired to solve the equation

$(D^4 + aD^3 + bD^2 + cD + d)y = f(x)$, where D is the usual symbol representing differentiation with respect to the independent variable, x , and a, b, c and d are constants.

As is usual in analogue differential analyser practice (see, for example, Reference 18), a number of integrating units are connected together in such a fashion that the relation between two quantities in the system is subject to the restraint implied by the differential equation.

In an example of the type under consideration, it is possible to use time integrators (thus avoiding the more complicated consistent integrator) if the independent variable, x , is chosen to vary linearly with time. Assuming, for the sake of formal simplicity, that one unit of time is equivalent to one unit of the basic quantity in the system, the time variable, t , may be substituted for x ,

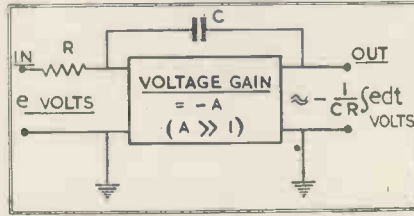

Fig. 27. Voltage integrator employing the feedback principle (Blumlein integrator). Repeated from Part 3, p. 261

and the practical problem becomes one of determining the time-behaviour of y when the circuit is allowed to operate.

Direct current has been chosen as the basic quantity.

A suitable form of integrating unit is one similar to Fig. 27, with the difference that the resistor R is transferred to the output side. The input terminal then presents

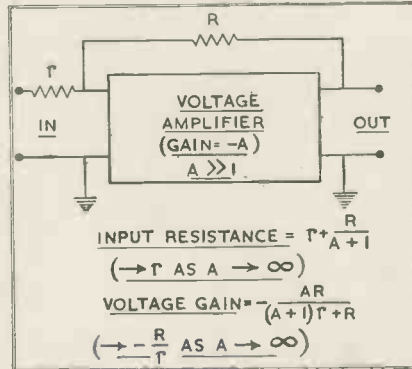

Fig. 6. Feedback amplifier. Repeated from Part 1, p. 180.

effectively zero impedance to earth, and the current which flows in the output resistor when it is connected to earth (or to the effective earth presented by the input terminal of another unit) is substantially equal

to $-\frac{1}{RC} \int i dt$, where i is the input current.

The first step in setting up the circuit is as shown in Fig. 29. Four time integrators (corresponding in number to the order of the equation) are connected in cascade. For simplicity, the "live" connexions only are shown, the integrations being effected in the direction indicated by the usual arrow-head symbolism. Each complete integrator consists of an arrow-head block, containing the feedback condenser and high gain amplifier, and an output resistor. The output resistors are shown explicitly for reasons which appear later.

In practice, it is convenient to speak of output conductance (rather than resistance), since the scale factors of the integrators are proportional to these conductances.

For simplicity, all the integrators may be assumed to be identical (though this is not essential), the output conductances each being equal to g . The value chosen for g settles the scale factor (ω , say) for each integrator, so that an input current i results in an output current $-\omega \int i dt$. Conversely, an output current i is the

result of an input current $-\left(\frac{i dt}{\omega}\right)$

Thus, in Fig. 29, if it be assumed

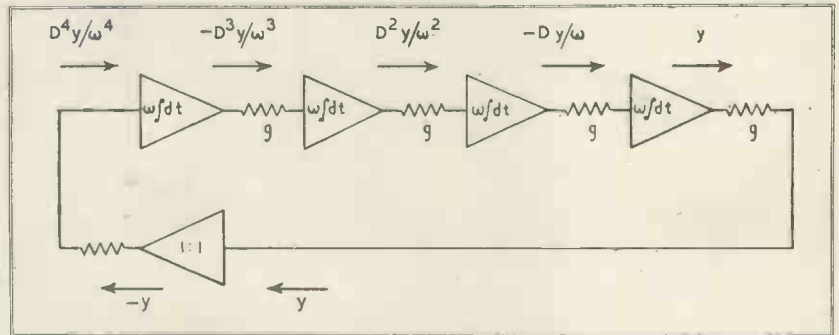

Fig. 29. Initial stage in the assembly of electronic units to solve a linear differential equation with constant coefficients.

* Precision Circuits Section, Electronics Engineering Department, British Thomson-Houston Co., Ltd.

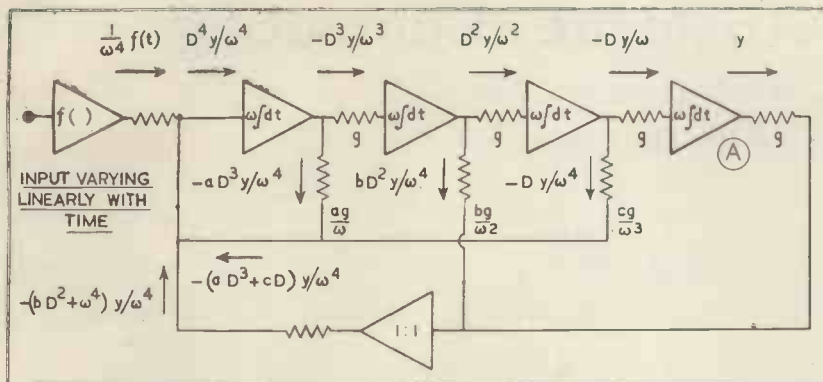

Fig. 30. Final stage in the assembly of electronic units to solve a linear differential equation with constant coefficients

that a current y flows from the integrator on the right of the diagram, the currents in the other parts of the circuit may be written down as shown, proceeding backwards over each integrator in turn.

Suppose now that the circuit is closed in a loop by a 1:1 sign-reversing current amplifier (device similar to Fig. 6, but with the resistor r on the output side). Then the current $-y$ must be identical with $D^4 y / \omega^4$. That is to say, y must obey the differential equation $(D^4 + \omega^4)y = 0$.

If g be chosen so that $\omega^4 = d$, the equation becomes $(D^4 + d)y = 0$, and it is evident that a first step has been made towards setting up the complete equation.

Fig. 30 shows the system completed so as to introduce the remaining constants a , b and c , and the "driving" function, $f(t)$.

Currents $-aD^3 y / \omega^4$, $-bD^2 y / \omega^4$, $-cDy / \omega^4$ and $f(t)$ have been added to the current $-y$. The first three are obtained merely by adding three more conductances as shown. Remembering that the input terminal of the right-hand integrator, for example, is at earth potential, the voltage on the other end of the conductance g is $-Dy / \omega g$. The current required to introduce the constant c can therefore be obtained by connecting a conductance cg / ω^3 to the input terminal of the left-hand integrator. The other constants are introduced similarly. When the sign of the current is not correct, as in the instance of the constant b , it is fed instead to the sign-reversing amplifier. $f(t)$ may, in general, be generated by using a functional transformation unit excited by a linearly rising voltage, though it may be generated directly if it happens to be simple to do this.

Operation of the Analyser

So far, it has been shown how an electronic system may be set up so as to contain, when energised, a current having a time variation which is mathematically analogous to one of the infinite number of solutions of the equation which the system represents. In order to make use of the system, it is necessary to be able to set in the desired boundary conditions and to switch it into operation in a controlled fashion. Further, the result must be made available to the operator.

It is practicable to add an electronic switch to each integrator so that it can either be held passive or released for operation, and also to arrange that the initial current into each integrator at the moment of release is adjustable to any desired value within the range of the unit. In the present example, this means that the first four differential coefficients of y , when $t = 0$, constitute the boundary conditions which may be set in arbitrarily. Other arrangements of units may be designed to solve the same equation, and, in general, result in a different array of boundary conditions. The method of building up the system given in the example was chosen because it is also applicable to similar equations of any other order and the boundary conditions are in a generally useful form.

Display of the result may be readily achieved by applying the voltage at the point A (Fig. 30), amplified if necessary, to the Y-plates of a cathode-ray tube, while, at the same time, a linear voltage sweep is applied to the X-plates and the beam current is switched on. A "graph" of the solution is thus generated.

By alternately holding and releasing the integrators and the display system, at regular intervals, the solution can be continually repeated.

Special Feature of Electronic Approach

Since the whole system is electronic, it is easy to arrange that the solution for any particular set-up is traced out in a time of the order of a few milliseconds. It is practicable, for example, to repeat the whole process (including the time for restoring the circuit to the "initial" state) at 50 cycles per second.

This rate of repetition is above optical flicker frequency and an apparently steady trace is seen on the screen of the cathode-ray tube.

A feature of considerable practical importance arising from this method of working is that the effect of altering any of the boundary conditions or constants in the equation, or of varying the form of $f(t)$, can be followed instantly and continuously. Families of solutions can be run through in the course of a few minutes.

This system has not yet been built up into a calibrated instrument, but the initial development shows that it has considerable promise.

There is a number of possible lines of development of this simple system. In order to deal with non-linear differential equations, for example, multiplying and dividing units will, in general, be required, and an indication of the type of high speed units which might be developed for this purpose is, while somewhat conjectural, perhaps not without interest.

Electronic Multiplication and Division

The examples of possible methods of electronic multiplication and division described here are not by any means exhaustive, but are offered as suggestive of one feasible line of attack.

In order to achieve the highest possible speed of operation, it is desirable to use direct voltage or current as the basic quantity, so as to avoid the artificial upper speed limit consequent upon the use of alternating quantities or any "chopping" process.

Functional transformations of the logarithmic and square law types offer possible solutions.

The logarithmic attack is fairly obvious. Any number of input voltages may be individually converted to voltages which are proportional to their logarithms to a common base. Addition of the transformed quantities may then be used to build up a voltage proportional to the logarithm of a continued product of the input voltages. An inverse (exponential) trans-

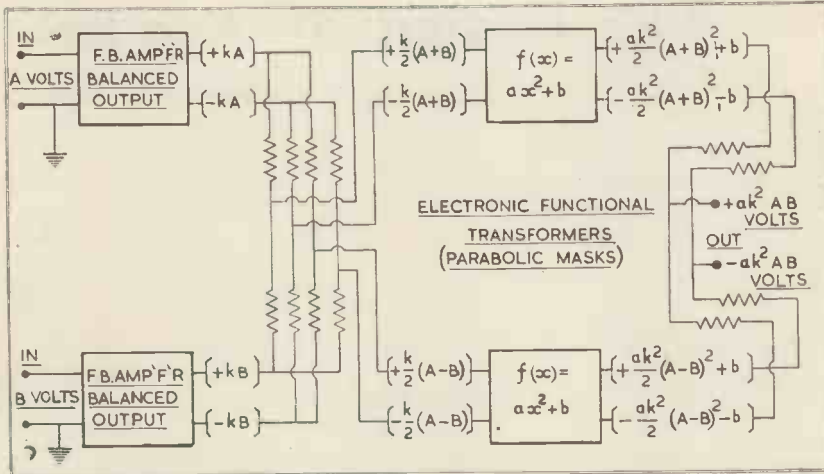

Fig. 31. Example of the use of electronic functional units to perform electronic multiplication.

formation of the resultant quantity would then give a voltage directly representing the continued product. Reversal of the sign of any of the logarithmic quantities would cause it to appear as a divisor in the overall result, thus giving a method of dealing, when necessary, with quotients in which both dividend and divisor are continued products. The weakness of this approach, characteristic of logarithmic methods, is that none of the variables may range through zero.

An interesting possibility, which is free from the disability just quoted, is to use two functional transformers to multiply by the method of quarter squares. The basis of this method is the identity

$$A \cdot B = \frac{(A + B)^2}{4} - \frac{(A - B)^2}{4}$$

Given two voltages A and B , the operations indicated on the right-hand side of the identity may be performed by an assembly such as that indicated in Fig. 31.

The amplifiers with balanced outputs which would normally be used to feed the independent variable to the X-plates of the two functional transforming units are, in this example, cross-coupled on the output side by resistors, so as to provide a fresh set of balanced voltages, which are proportional to the sum and difference, respectively, of the input variables. The transformation $y = ax^2 + b$, where a and b are constants, is then imposed on each of the derived voltages. The balanced voltages appearing on the Y-plates of the two squaring units are also cross-coupled to provide a difference voltage, thus completing the schedule of operations

and giving an output voltage proportional to the product of the input voltages.

Following up the same line of thought, it will be obvious that the quotient A/B could be formed by first transforming B into its reciprocal and then multiplying the result, $1/B$, into A .

A rather more elegant approach to the problem of division, provided that the problem of overall stability proves to be amenable to a satisfactory practical solution, is as indicated in Fig. 32. The multiplying unit of Fig. 31 is used in an inverted fashion, by means of a feedback connexion, and it is thus unnecessary to introduce a third functional transformation unit. The divisor, B , enters as one of the multiplier input voltages and is

multiplied into the output voltage, Z , of a high-gain amplifier. This amplifier is supplied with an input which is proportional to the difference of the output of the multiplier and the voltage, A , representing the dividend. That is to say, the amplifier input is proportional to $BZ - A$. Now, by raising the gain in the feedback link (and taking appropriate precautions to preserve the stability of the system), it should be practicable to reduce the amplifier input to a quantity which differs from zero by a negligible amount under all conditions of input within the range of the unit. This is, of course, the usual feedback approximation, the result being that BZ may be regarded as equal to A to a sufficient order of accuracy. Thus, $Z = A/B$, and is the desired quotient.

Acknowledgements

An attempt has been made to gather together examples of electrical computing methods both interesting in themselves and useful in demonstrating how units may be designed on logical principles to fit together in larger systems.

In an article of this nature, the writer's task is chiefly one of systematisation, and he would like to acknowledge a debt to colleagues (both in the B.T.H. Co. and in other establishments) for the benefit of discussions which have provided a great deal of the matter and helped to form the viewpoints. Thanks are also due to the Directors of the B.T.H. Co., Ltd., for permission to present the article for publication.

¹⁴ Bush, V., and Caldwell, S. H.: "A New Type of Differential Analyser," *Journal of the Franklin Institute*, Oct., 1945.

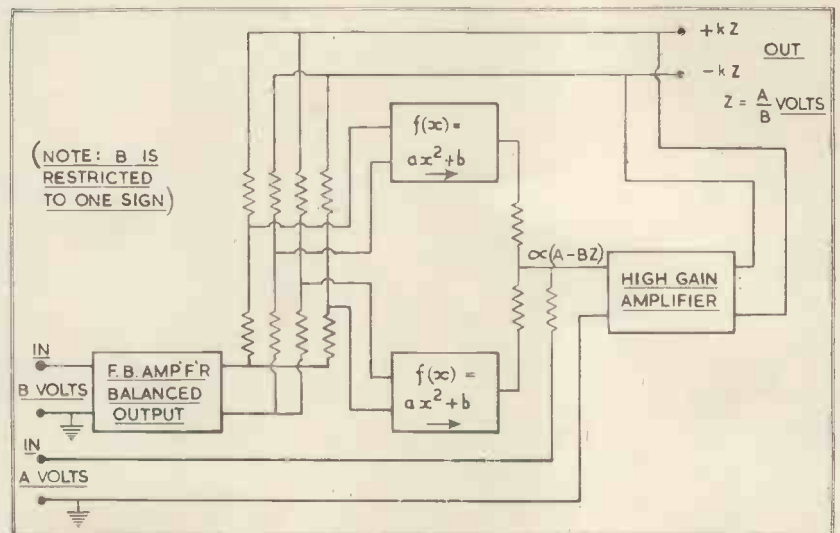

Fig. 32. Example of the use of electronic functional units to perform electronic division.

The Design of Acoustic

Data Sheets on Horns of Square

THE type of horn used chiefly in public address installations to secure efficient transfer of acoustic power from the diaphragm of a loudspeaker to the air outside the speaker, is in effect an acoustic transformer which matches the impedance of the driving source to the value of outside air. These data sheets have been prepared with the object of eliminating or reducing the calculations involved in the design of an exponential horn to suit particular requirements.

If there is no practical limit to the size of the horn (this might occur in a cinema) there are two features which decide its dimensions, namely, the lower cut-off frequency required and the size of the diaphragm of the driving loudspeaker. The initial cross-sectional area of a horn is sometimes made equal to that of the diaphragm of the driving loudspeaker and is sometimes smaller so as to form a pressure or throat chamber. The curves given apply to the expansion from the smallest cross-sectional area of the throat to the mouth. Alternatively, the problem of design may take the form in which the maximum possible mouth area or the maximum possible length are fixed and information about the lowest frequency which can be successfully transmitted is required. The curves that will be deduced will enable both types of problem to be solved and will, in addition, give the values of the ordinates required in constructing the horn.

An exponential horn is one which obeys the formula:

$$A = A_0 e^{mx} \dots (1)$$

in which A_0 = initial throat area,
 A = area of cross-section at a distance x from the throat.
 and m = a factor determining the rate of expansion of the horn.

For a horn of square cross-section it follows that:

$$\sqrt{A} = \sqrt{A_0} e^{mx/2}$$

$$i.e., l = l_0 e^{mx/2} \dots (2)$$

where l_0 and l are respectively the side of the cross-section at the throat and at a distance x from the throat. Similarly, for a horn of circular cross-section:

$$d = d_0 e^{mx/2} \dots (3)$$

Exponential horns transmit readily all frequencies down to a certain (cut-off) value below which there is (theoretically) no transmission at all. This cut-off frequency is decided (a) by the dimensions of the mouth and

(b) by the rate of expansion.* If the circumference of the mouth, no matter what its shape, is denoted by s , then we have:

$$s = 4l \dots (4)$$

for a square-section horn and

$$s = \pi d \dots (5)$$

for a horn of circular cross-section. The theoretical cut-off frequency is that value for which the wavelength is equal to half the circumference of the mouth. Hence:

$$\lambda = \frac{1}{2}s \dots (6)$$

$$\text{from which } f = 2c/s \dots (7)$$

where f = cut-off frequency,
 c = velocity of propagation of sound in air = 1,100 ft. per sec. approximately,
 and s = circumference of the mouth.

Combining (4) and (7)

$$l = c/2f \dots (8)$$

For a cut-off frequency of 50 c/s. then $l = 11$ ft.

Combining (3) and (7):

$$d = 2c/\pi f \dots (9)$$

so that, to obtain transmission down to 50 c/s.

$$d = \frac{2 \times 1,100}{3.142 \times 50} = 14 \text{ ft.}$$

It is evident from these two calcu-

lations that a horn required to transmit frequencies as low as 50 c/s. will be rather too large for domestic use. Expressions (8) and (9) are plotted in Fig. 1, which enables the side (or diameter) of the final opening to be found for any cut-off frequency between 50 c/s. and 200 c/s. The values given by the graph are approximate only; practical cut-off frequencies are likely to be 20 per cent. higher* than the theoretical ones. The rate of expansion of a horn also has some bearing on the value of the cut-off frequency. In order to obtain a certain value of cut-off frequency not only should the final opening be adequate (as defined above) but m should also be less than a certain critical value defined by the relationship:

$$m \leq \frac{4\pi}{\lambda} \left(= \frac{2\omega}{c} = \frac{4\pi c}{f} \right)$$

Thus for $f = 50$ c/s. ($\lambda = 22$ ft.)

$$m \leq \frac{4 \times 3.142}{22} = .5714.$$

Maximum values of m for other values of cut-off frequency are given in Fig. 1.

* "Radio Engineering Handbook" edited by Keith Henney, p. 897.

* "Modern Acoustics" by A. H. Davis, p. 48.

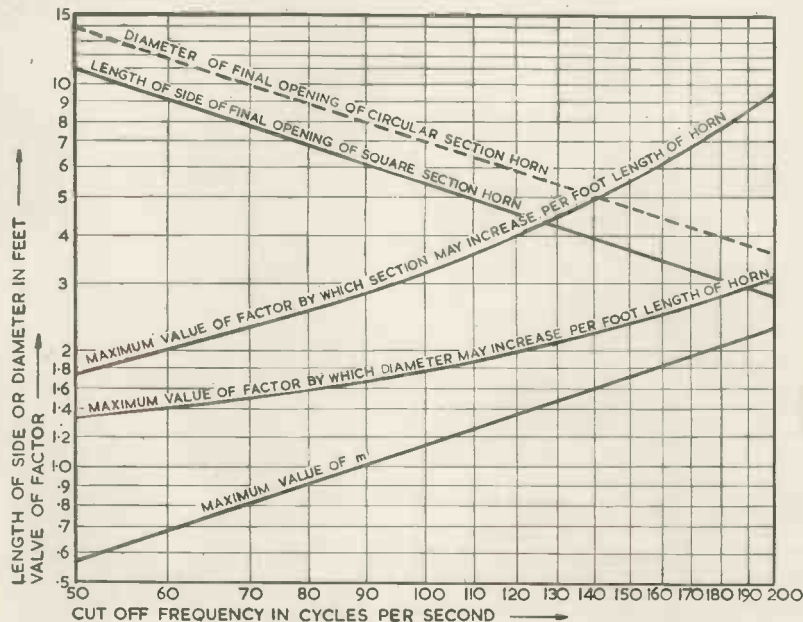

Fig. 1. Length of side and the factor against cut-off frequency.

Exponential Horns and Circular Cross Section

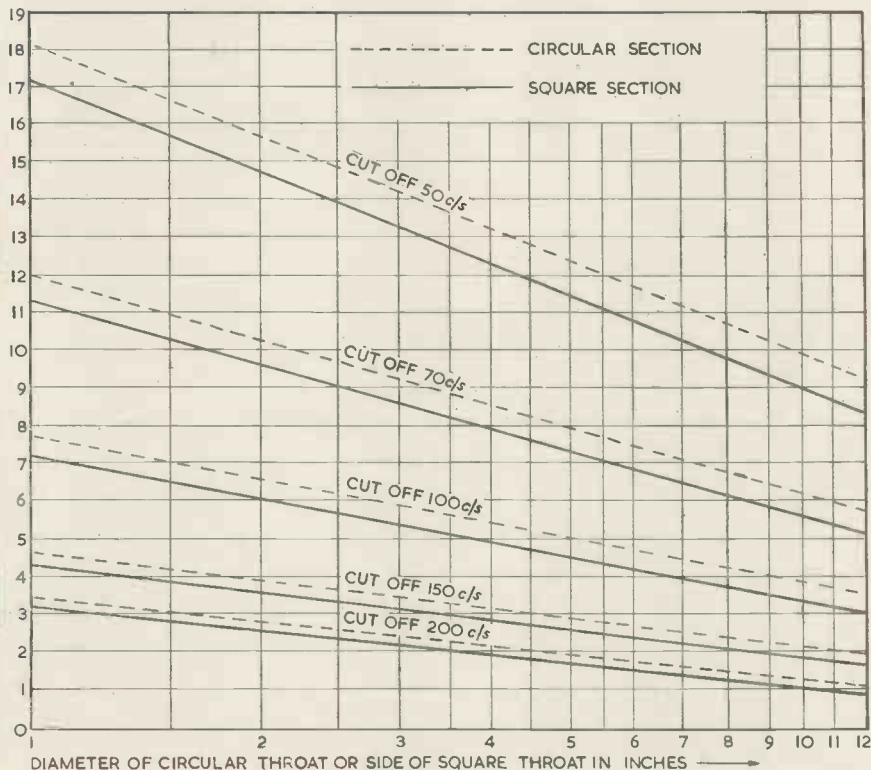
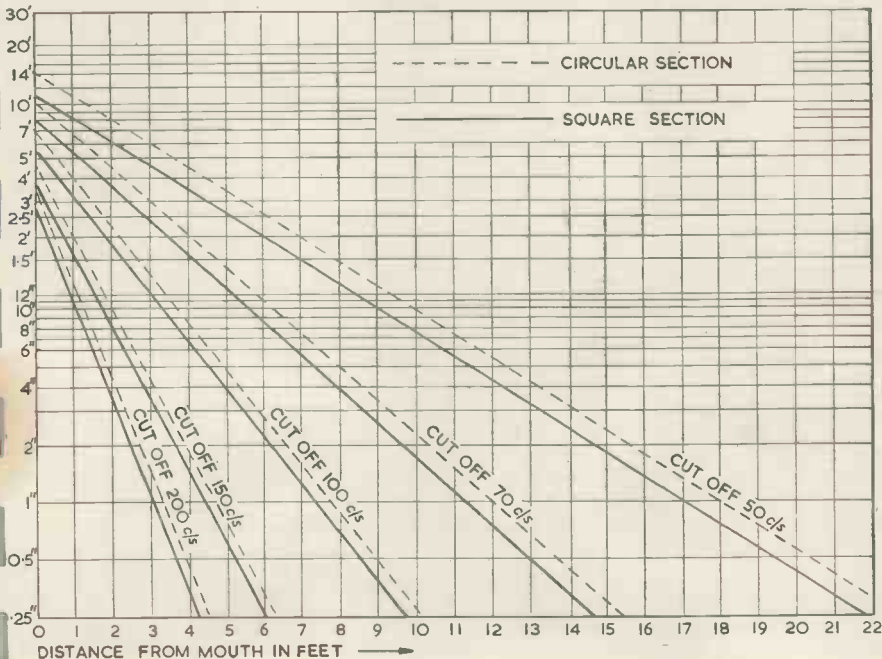

Fig. 2 (above). (Fig. 3 below).



For a 50 c/s. horn

$$A = A_0(e^m)^x = A_0(e^{.5714})^x = A_0 1.77^x \quad (11)$$

If $x = 1$, $A = 1.77A_0$, so that for each foot of length the area of cross-section should not increase by more than 1.77 times. The maximum values of this factor (equal to e^m) have been evaluated for other cut-off frequencies and are indicated by a curve in Fig. 1. For a 50 c/s. horn of square cross-section:

$$l' = l_0 e^{m^2/2} = l_0(e^{.2857})^x = l_0 1.33^x \quad (12)$$

so that each side of the horn should not increase by more than 1.33 times per foot length of horn. 1.33 is, of course, the square root of 1.77. This same expression (12) applies also to the diameter of horns of circular section. The maximum value of this factor (equal to $e^{m/2}$) by which side or diameter may increase per foot length of horn is also indicated in Fig. 1.

If the dimensions of the final opening and the maximum rate of expansion are fixed, the length of the horn depends only on the dimensions of the initial opening. This may be shown as follows: From (1):

$$A_f = A_0 e^{ml'}$$

In which A_f = area of cross-section of final opening and l' = length of the horn. Thus:

$$A_f/A_0 = e^{ml'}$$

from which $l' = 1/m \log_e A_f/A_0$.

Similarly, it may be shown that

$$l' = 2/m \log_e l_f/l_0 \quad (13)$$

$$\text{and } l' = 2/m \log_e d_f/d_0 \quad (14)$$

Since l_f (or d_f) and m are fixed by the cut-off frequency once this has been decided l' depends only on the value of l_0 (or d_0). The curves of Expressions (13) and (14) are plotted in Fig. 2. In plotting these the maximum values of m (obtained from Fig. 1) were used. From this diagram if the initial opening is a square of 4 in. side then a 50 c/s. horn will need to be at least 12' 4" long. The final curves, those of Fig. 3, were prepared to facilitate rapid determination of the values of the ordinates required in constructing horns. They were plotted from expressions (2) and (3), the dimensions of the final opening and the values of m being chosen (from Fig. 2) for cut-off frequencies of 50, 70, 100, 150 and 200 c/s. It should not be forgotten that Figs. 1, 2 and 3 were prepared from formulae resulting from analyses in which a number of simplifying assumptions were made. Accordingly, the results given by the curves are approximate.

The Thermistor in Biological Research

By B. L. ANDREW, B.Sc.*

THE combination of small physical size with a high negative temperature coefficient of resistance makes the thermistor† of great potential use in some biological investigations. Used as a resistance thermometer it has applications where there is a requirement for remote indication of temperature, small size of sensitive element and a rapid response to changes in temperature.

Used in conjunction with an electronic relay it can provide good thermostatic control of baths (the study of the isolated organs of warm-blooded animals usually requires good thermostatic control of the fluid bathing the organ) or may be made to regulate the body temperature of warm-blooded animals whose natural temperature control has been disturbed by anaesthesia. Certain anaesthetics such as Urethane so impair the temperature regulating mechanisms that the body temperature falls to within a few degrees Centigrade of the environmental temperature. The small size of the thermistor is of value here as it permits it to be inserted into the animal.

A further application lies in the recording of skin temperature. The skin temperature is of importance clinically in some neurological connexions and it is usually plotted by means of a thermocouple junction

Fig. 1.—Arrangements for accurate measurement of temperature.

Fig. 2 (below)—Simplified form of circuit.

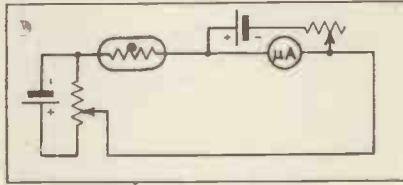
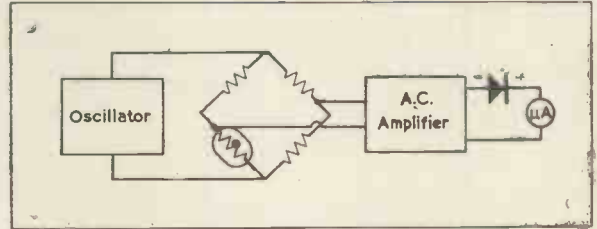

and a sensitive galvanometer. It is not claimed that the thermistor is any real improvement on the thermocouple except that it is more sensitive and so requires a less delicate (and costly) measuring instrument.

A further possible application lies in the recording of respiration rhythms since the thermistor can have such a small thermal capacity that it will indicate the temperature changes synchronous with respiration if placed in air passages.

Circuits

It must be borne in mind that the current flowing through the thermistor will raise the temperature of the

element above the environmental temperature. The magnitude of this temperature difference depends, of course, on the power dissipated, the size of the thermistor, and the properties of the environment. By the use of sufficiently small currents through the thermistor this temperature difference may be made negligible. An arrangement suitable for the accurate measurement of temperature is shown in Fig. 1. For less accurate work the circuit shown in Fig. 2 may be used.

The temperature-resistance characteristic of a type F thermistor (Standard Telephones & Cables, Ltd.) over the range 25° C. — 45° C. is shown in Fig. 3.

The circuit of an electronic relay found suitable to work with a Type F thermistor of 2,000 ohms resistance is shown in Fig. 4. This unit when tested with a small Burn-Dale bath provided with stirrer maintained the temperature at 37° C. ± 0.2°. If the stirrer was switched off the control

* Physiology Dept., University College. St. Andrews University.

† Rosenberg. *Electronic Engineering*, 1947. XIX. p. 185.

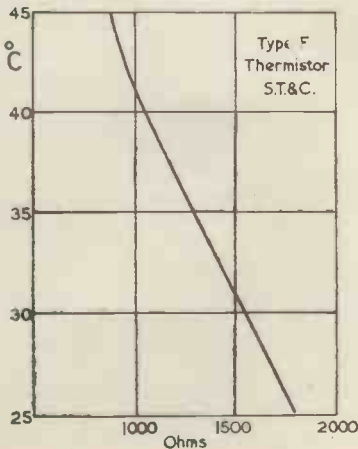
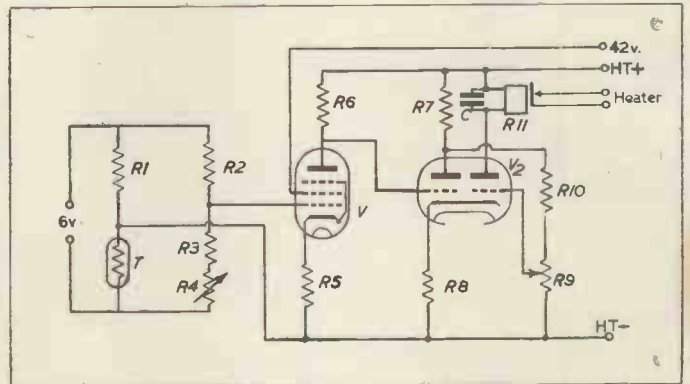

Fig. 3 (left)—Temperature resistance characteristic for Type F thermistor. (Standard Telephones and Cables Ltd.)

Fig. 4.—Relay circuit for use with Type F thermistor



- R₁ 4.7k Ω
- R₂ 4.7k Ω
- R₃ 900 Ω
- R₄ 1,000 Ω variable
- R₅ 600 Ω

- R₆ 200k Ω
- R₇ 2.5k Ω
- R₈ 20k Ω
- R₉ 500k Ω variable
- R₁₀ 500k Ω

- R₁₁ Relay 2,000 Ω
- V EF50 (Mullard)
- V₂ ECC31 (Mullard)
- C₁ 50μf 50v. working

T Thermistor 2,000 Ω at 20°C.

worsened to $\pm 0.5^\circ \text{C}$. The total anode current at 200 volts H.T. was 6 mA or at 300 volts H.T. 9 mA. The unit is sensitive to changes in H.T. so the power supplies must be stabilised. A change of H.T. from 310 to 300 volts produced a change in the thermostat temperature of 0.8°C . During the first ten minutes after switching on the thermostat temperature shifts slightly, perhaps $\frac{1}{4}^\circ \text{C}$.

Operation

The circuit may be considered in three parts:

First, a bridge circuit made up by R_1, R_2, R_3, R_4 and the thermistor. The bridge circuit is supplied from a 6 volt dry battery. The variable resistance R_4 is the "Set Temperature" control and is provided with a dial marked off in degrees Centigrade. This is calibrated by trial.

Second, a high gain amplifier stage which is fed by the out-of-balance potential from the bridge.

Third, a double-triode stage directly coupled to the amplifier valve. The two triodes have a common cathode load and the second triode is biased by means of potentiometer R_0 . The anode current of the first triode passes through part of the biasing potential divider for the second triode. As a result, when one triode is conducting the other is cut off. The potential of the grid of the first triode determines which triode conducts.

The potentiometer R_0 is adjusted so that the change-over from one condition to the other is achieved with a minimum change of thermistor resistance. A way of setting this control is to insert a 0-10 milliammeter in each anode lead to the double-triode and then adjust R_0 until the two triodes exchange rôles for minimum movement of R_4 .

In the anode lead of the second triode is a relay which controls the current to the heating system. A second relay operated by the first may be necessary if large currents are to be broken. A spark quench resistance and capacitance should be connected across the contacts of the relay if a D.C. supply is used for the heater circuit. If it is desired to have an indication of the temperature of the bath or animal a 0-1 milliammeter inserted in the anode lead to V_1 may be calibrated in terms of temperature. The calibration will only apply for a particular setting of R_4 .



A Console for Sound Installation

THE console shown above was designed by Audix (B.B.), Ltd., for sound installation in theatres, public halls, etc., and has unique facilities. On either side are four 20-watt power amplifiers supplying different halls; each amplifier has a gain control for setting the operating power level. The centre panel provides for mixing and monitoring the programmes.

There are five input lines accommodating the following programmes: Two gramophone turntables, one local microphone, one radio; the fifth is used for a remote programme which may be supplied from another mixer panel located in the theatre. These inputs are fed through independent preamplifiers followed by cathode follower stages having outputs of 0.5 V at 600 ohms. At this point the lines are either put direct through to the amplifiers or into the mixed position. The input circuit to each amplifier is brought to a selector switch on the front panel; it can be set to take any of the five programmes or the mixed programme.

A peak level meter is provided for visual programme monitoring, which can be put across any line by a selector switch. Similarly, aural monitoring is available from a 3.0 watt amplifier and loudspeaker.

It is of interest to note that the mixing and fading controls are at high impedance and make use of commercial carbon potentiometers. This practice is now being developed in America even for broadcast studio equipment, on the basis that carbon potentiometers require less attention than conventional faders, and are economical in replacement. As the control is placed at a fairly high level there is no trouble due to noise.

The design of the amplifier is such that the overall response on the mixer channel and power amplifier is flat within 2 db. from 60 to 12,000 c/s., and the harmonic distortion is within 3 per cent. measured at any point between 80 and 8,000 c/s. at the power output rating of 20 watts.

The information and photograph have been supplied by Messrs. Audix, of Sheldrake House, London, S.E.5.

The Physics of Industrial Diathermy—Part 2

By A. W. LAY, A.M.I.E.E., F.Inst.P.*

THE heating effect of high-frequency fields applied to industrial materials of a polar nature will depend upon several factors, governed by boundary conditions which will be specific for a given set of conditions.

Only the general case will be considered here. The main factors upon which the heating effect will depend, apart from frequency (already outlined) are:

- (1) Specific resistance of the material $1/\sigma$
- (2) Specific heat s in calories per gram per degree $^{\circ}\text{C}$.
- (3) Density, m , in grams per cubic cm.
- (4) The shape of the material in the field.
- (5) Cooling effects of convection and radiation.
- (6) The thermal conductivity k calories per sq. cm. per sec.

degrees C. per cm.

- (7) The heat diffusivity $h = k/m.s.$

The specific heat s will depend upon the physical state of the material, which at any instant may be partly solid, partly liquid, and partly gaseous; but the variation of the specific heat with the physical state of matter is a subject too wide to be detailed here.

For the same reason only the Stefan-Boltzmann law of radiation will be mentioned, which in its simple form gives the radiation from a hot body as

$$\Phi = \alpha T^4 \quad (19)$$

where Φ is the energy emitted per second per sq. cm. from a full radiator at an absolute temperature T , and α is a constant which has been found to be equal to 5.32×10^{-5} ergs, approximately, or 5.32×10^{-12} watts per sq. cm. of radiating surface.

Referring now to the elemental cube shown in Fig. 5b, this has three pairs of parallel sides perpendicular to the Z, X and Y axes respectively. These sides are represented by dx , dy , and dz .

Let H be the rate at which heat is being generated in gram-calories per sec. per cu. cm. in the element by the thermogenic action of the H.F. field, as explained in Part 1. Then

Fig. 5b. Diagram to illustrate heat conduction through a cube.

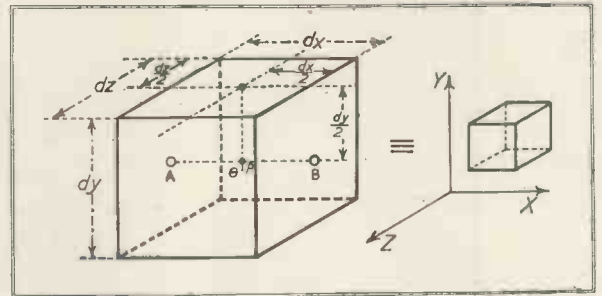

in the short interval of time dt , if Q_0 is the amount of heat in calories, we have:

$$Q_0 = H \, dy \, dz \, dx \, dt \quad (20)$$

If θ is the temperature at the point p in the element, then the increment Q_1 of the heat stored in time dt is:

$$Q_1 = s.m. \left(\frac{\partial \theta}{\partial t} \right) dy \, dz \, dx \, dt \quad (20A)$$

Now the temperature gradient at p is $(\partial \theta / \partial x)_p$, and at A it will be:

$$\left(\frac{\partial \theta}{\partial x} \right)_A = \left(\frac{\partial \theta}{\partial x} \right)_p - \left[\frac{\partial}{\partial x} \left(\frac{\partial \theta}{\partial x} \right) \right] \frac{dx}{2} \quad (20B)$$

At the opposite plane B the gradient will be:

$$\left(\frac{\partial \theta}{\partial x} \right)_B = \left(\frac{\partial \theta}{\partial x} \right)_p + \left[\frac{\partial}{\partial x} \left(\frac{\partial \theta}{\partial x} \right) \right] \frac{dx}{2} \quad (21)$$

The flow of heat through the element will also depend on the conductivity k , already defined, and hence the quantity of heat Q_2 flowing out of the face at "A" will, in the time interval dt , be:

$$Q_2 = k \left(\frac{\partial \theta}{\partial x} \right) dy \, dz \, dt \quad (22)$$

because the temperature will be higher at the point p than it is at A.

By similar reasoning, for the temperature at B we have:

$$\left(\frac{\partial \theta}{\partial x} \right)_B = \left(\frac{\partial \theta}{\partial x} \right)_p + \left[\frac{\partial}{\partial x} \left(\frac{\partial \theta}{\partial x} \right) \right] \frac{dx}{2} \quad (23)$$

Since by convention the gradient is increasing in the X-direction from the point p , the temperature will be higher at B than it is at p , and consequently we have for Q_3 , the heat flowing from p out through B:

$$Q_3 = -k \left(\frac{\partial \theta}{\partial x} \right) dy \, dz \, dt \quad (23A)$$

Similarly, for the faces perpendicular to the X-axis we have:

$$Q_4 = k \left(\frac{\partial \theta}{\partial y} \right) dx \, dz \, dt \quad (23B)$$

and

$$Q_5 = -k \left(\frac{\partial \theta}{\partial y} \right) dx \, dz \, dt \quad (23C)$$

and, finally, for those perpendicular to the Y-axis:

$$Q_6 = k \left(\frac{\partial \theta}{\partial z} \right) dx \, dy \, dt \quad (23D)$$

and

$$Q_7 = -k \left(\frac{\partial \theta}{\partial z} \right) dx \, dy \, dt \quad (23E)$$

By the law of Conservation of Energy, which is "The total amount of energy stored in an isolated system remains unchanged while internal changes may occur," we then have:

$$Q_0 = Q_1 + Q_2 + Q_3 + \dots + Q_7 \quad (23F)$$

and hence by substitution: \dots (23G)

$$H \, dy \, dz \, dx \, dt = s.m. \left(\frac{\partial \theta}{\partial t} \right) dy \, dz \, dx \, dt$$

$$+ k \, dy \, dz \, dt \left[\left(\frac{\partial \theta}{\partial x} \right)_p - \left(\frac{\partial}{\partial x} \left(\frac{\partial \theta}{\partial x} \right) \right) \frac{dx}{2} \right]$$

$$- k \, dy \, dz \, dt \left[\left(\frac{\partial \theta}{\partial x} \right)_p + \left(\frac{\partial}{\partial x} \left(\frac{\partial \theta}{\partial x} \right) \right) \frac{dx}{2} \right]$$

$$+ k \, dy \, dz \, dt \left[\left(\frac{\partial \theta}{\partial x} \right)_p - \left(\frac{\partial}{\partial x} \left(\frac{\partial \theta}{\partial x} \right) \right) \frac{dx}{2} \right]$$

$$- k \, dy \, dz \, dt \left[\left(\frac{\partial \theta}{\partial x} \right)_p + \left(\frac{\partial}{\partial x} \left(\frac{\partial \theta}{\partial x} \right) \right) \frac{dx}{2} \right]$$

$$+ k \, dy \, dz \, dt \left[\left(\frac{\partial \theta}{\partial x} \right)_p - \left(\frac{\partial}{\partial x} \left(\frac{\partial \theta}{\partial x} \right) \right) \frac{dx}{2} \right]$$

$$- k \, dy \, dz \, dt \left[\left(\frac{\partial \theta}{\partial x} \right)_p + \left(\frac{\partial}{\partial x} \left(\frac{\partial \theta}{\partial x} \right) \right) \frac{dx}{2} \right]$$

$$+ k \, dy \, dz \, dt \left[\left(\frac{\partial \theta}{\partial x} \right)_p - \left(\frac{\partial}{\partial x} \left(\frac{\partial \theta}{\partial x} \right) \right) \frac{dx}{2} \right]$$

$$- k \, dy \, dz \, dt \left[\left(\frac{\partial \theta}{\partial x} \right)_p + \left(\frac{\partial}{\partial x} \left(\frac{\partial \theta}{\partial x} \right) \right) \frac{dx}{2} \right]$$

By cancellation and subtraction this produces:

$$H = s.m. \left(\frac{\partial \theta}{\partial t} \right) - k \frac{\partial}{\partial x} \left(\frac{\partial \theta}{\partial x} \right) - k \frac{\partial}{\partial y} \left(\frac{\partial \theta}{\partial y} \right) - k \frac{\partial}{\partial z} \left(\frac{\partial \theta}{\partial z} \right)$$

$$= s.m. \left(\frac{\partial \theta}{\partial t} \right) - k \left(\frac{\partial^2 \theta}{\partial x^2} + \frac{\partial^2 \theta}{\partial y^2} + \frac{\partial^2 \theta}{\partial z^2} \right)$$

$$\text{or } \frac{\partial \theta}{\partial t} = \frac{k}{s.m.} \left(\frac{\partial^2 \theta}{\partial x^2} + \frac{\partial^2 \theta}{\partial y^2} + \frac{\partial^2 \theta}{\partial z^2} \right) + \frac{H}{s.m.} \quad (24)$$

$$= h \nabla^2 \theta + H/sm \quad (24A)$$

* Marconi Research Dept.

If a good thermal conducting system, such as metal plates, is brought into contact with the body, heat will then be lost by conduction. This conducting system may also facilitate heat loss by radiation.

In conclusion it must be borne in mind that the thermogenic, or heating effect is mainly dependent on dipole activity under the influence of radio frequency fields; also that only polar materials lend themselves to the technique of industrial high-frequency heating.

Engineering Considerations

The connexion between theory and practice lies mainly in the dielectric constant ϵ which has been shown to vary considerably not only between polar and non-polar materials, but also in materials of the former type in which the high-frequency heating engineer is mainly interested.

From what has been written already it will be understood that a dielectric such as a plastic may be characterised by displacement and loss currents which flow into a given volume of the material under given conditions.

The power absorbed in heating the material is given by the equation:
 $W = E^2 \sigma$ (26)
 where E is the rms. value of the applied field.

The following reasoning may be more familiar:

Suppose that a condenser plate type of applicator is used to apply the high frequency energy to the material to be heated, and that the material is placed between the plates and in contact with them.

A leaky condenser is thus created, which is equivalent to a capacity and resistor in parallel. (Fig. 6.)

From this the power factor = $\cos \theta = \sin (90 - \theta)$ and for small angles ($\theta < 15^\circ$) the tan of the loss angle = $(90 - \theta)$. Hence the power factor = $\tan (90 - \theta) = E/x_c$. If R_p is the pure resistance and i_r the power component of the current I then

$i_r = E/R_p$ (27)

$i_c = E/X_c$ (27A)

and P.F. = X_c/R_p (27B) and hence

$R_p = X_c/P.F.$ (27C)

$X_c = 10^9/2\pi fc$ (28)

where C is in microfarads, and $C\mu F = 2.248 AK/10^9 D$ (28A)

A is the area of one side of one plate in square inches, and D is the distance between the plate in ins., K is the dielectric constant, (or permittivity) of the material.

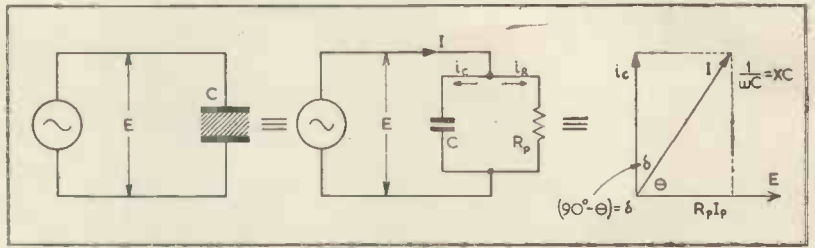

Fig. 6. Equivalent circuit of leaky condenser.

In practice the power factor is measured by a Q meter, and for most polar plastics is between 0.005 to 0.2.

Now the power, P , consumed = $i_r^2 R_p$ (29)
 and $E = i_r R_p$ (30)

From these equations and measurements we can calculate the frequency, and voltage E , and by knowing these suitable applicators can be designed. These will be considerably influenced by frequency, which will depend upon the characteristics of the material.

The problem of power now arises. We start by considering this in gram calories. From the physics of heat it is well known that:

$H' = sm (\delta T) v$ (31)

where s is the specific heat of the material in calories per gram per degree C., m is the density in grams per C.C., δT is the change from the ambient temperature of the room to the final temperature necessary in the heating process, and v is the volume in cubic cms. Knowing H' we can convert to watts thus:

$P \text{ watts} = \frac{4.187 sm (\delta T) v}{t}$ (32)

where t is the time in seconds. If we substitute v cu. ft. for cu. cms., minutes for seconds and temperature degrees Fahrenheit for Centigrade then:

$P \text{ watts} = \frac{0.637 sm (\delta T) v}{t}$ (33)

A convenient practical formula for calculating the power required in watts/min. is:

$H = \frac{Ms (\delta T) 10^9}{56.9}$ (34)

where M is the weight of the material in lbs., the other symbols remaining as before.

If the volume of the material is known in cu. ft., for example, if the load is wood to be glued, or heat processed, the following formula gives the power required in kilowatts per cu. ft. of wood.

$P = 7.35 \times 10^{-13} f.K.V.^2 \cos \theta$... (35)
 K is the dielectric constant, which, in

the case of wood depends on the moisture content, and so also does the power factor of this material.

The specific heat s of wood may be calculated as follows:

$s = \frac{a + 32.4}{a + 100}$ (35)

where a is the percentage moisture content. This may be readily measured by a moisture meter. If, for example, the moisture content is 15% then $s = 0.412$.

Now if H' represents the quantity of heat required in B.Th.U. W is the weight of the material in lbs. and T is the temperature rise in degrees F., then

$H' = W.S.T.$ (37)

and since 1 KW = 3.413 B.Th.U. per hour, then

B.Th.U. per min. = $\frac{3.413P}{60}$... (38)

A preliminary estimate for general purposes may be formed from the familiar equation:

$P = \frac{EI \cos \theta}{1,000}$ KW (39)

when the power or loss factor of the plastic is known, since $I = E/Z$ and for capacitance the impedance

$Z = \frac{1}{2\pi fC}$ ohms, hence by substitution

$P = \frac{2\pi fCE^2 \cos \theta}{1,000}$ KW (40)

where E is the voltage gradient across the material. In practice this gradient may vary from 1,000 to 5,000 volts per in. and these must be multiplied by $\sqrt{2}$ to obtain peak values for which the applicators must be insulated.

As stated, the frequency f will depend very much on the nature of the load such as the loss factor and the rate of heating; but f will also influence the voltage gradient E across the material. For example,

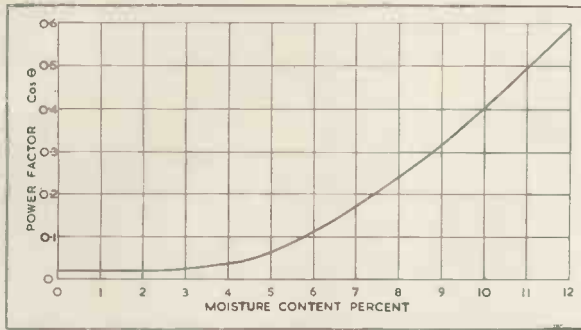

Fig. 7. Curve relating average power factor of wood against moisture content.—J. W. Taylor.

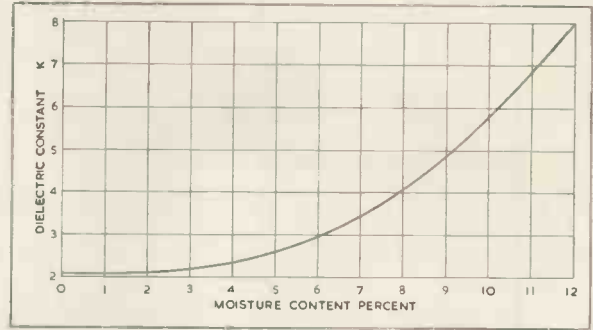

Fig. 8. Curve relating average dielectric constant of wood against moisture content.—J. W. Taylor.

supposing that the power required is 6.0 KW, that the equations (27) to (27C) are used, that $C = 150$ pF and the power factor is, say, 0.05 at $f = 60$ c/s., E becomes 2.05×10^6 peak volts across the applicators, which is not practical nor would the time period be economical.

If, however, the frequency is 10 Mc/s. then E becomes 3,900 peak volts, and the heating period is proportionately reduced.

It may be instructive to take a practical example of the application of industrial diathermy applied to a wood-glueing process by this technique.

For this purpose the average physical characteristics of wood can be taken, as these will vary considerably with different woods.

Let the average value of specific heat $s = 0.66$ calorie per gram per degree C. m , the density, 0.54 gram per cu. cm. k the average thermal conductivity = 0.00036 calorie per sq. cm. per sec. for 1.0° C. per cm. temperature gradient, and for diffusivity, $h = \frac{k}{sm}$, by assigning the

above average values we get 0.00104 as the average diffusivity for wood.

For copper the value is 1.33; hence by comparison with copper and other good thermal conductors, wood may be considered as a poor thermal conductor.

From this it follows that when heat is applied to wooden bodies by means of hot presses, as used in orthodox manufacturing processes, there is a steep temperature gradient from the face of the wood which is in contact with the hot press towards the centre of the body; but as the thermal conductivity of wood is low, most of the heat will be absorbed in thin layers of the wood adjacent to the press face.

This means that considerable heating time would be necessary before

the central region of the body were raised to a temperature comparable with the outer layers. There is also a limit to which the temperature gradient between the outer face and the centre of wood may be raised, since wood scorches at about 205° C. (or 400° F.). These limiting factors, however, cease to be troublesome if use is made of the thermogenic properties of high-frequency current technique in the heating process.

Experimental investigation has shown that the power factor and dielectric constant of wood rises exponentially in value when it contains a moisture content greater than about 4 per cent. (see Figs. 7 and 8). For example, pitch pine has a dielectric constant of 2.3 and a power factor of 0.04 when the moisture content is 4 per cent., whereas the values are 9.0 and 0.5 respectively at 12 per cent. moisture content.

From this it follows, as experiments have proved, that the rate of heat generation increases as the moisture is removed by the exudation of vapour from the wood. Heat is then lost by convection, and, furthermore, the resistance of the wood increases.

In consequence of the change in the dielectric during the heating process the problem of maintaining the applicator system in tune requires attention.

In the practical case the high-frequency applicators take the form of parallel plates and between these and in contact with them the wood and glue forms the dielectric of the simple condenser thus constituted.

Figs. 9, 10, 11 and 12 from J. Taylor, of the American Society of Mechanical Engineers, give an idea of relative costs.

When loaded with wood and glue the electrical nature of the load may be stated briefly as follows:

It is equivalent to a resistance and capacity in parallel, and we have

from a well-known law for parallel impedance:

$$Z = \frac{Z_1 \times Z_2}{Z_1 + Z_2} = \frac{R \times \frac{1}{j\omega C}}{R + \frac{1}{j\omega C}} = \frac{R}{j\omega CR + 1}$$

Rationalising the denominator yields:

$$\frac{R(1 - j\omega CR)}{1 + \omega^2 C^2 R^2} \dots \dots \dots (41)$$

$$\frac{R}{1 + \omega^2 C^2 R^2} \dots \dots \dots (42)$$

is the resistive component, and

$$\frac{-j\omega CR}{1 + \omega^2 C^2 R^2} \dots \dots \dots (43)$$

is the capacitive reactance. This may be transformed to an effective resistance R_e , and an effective capacity C_e in series

$$= R_e - \frac{j}{\omega C_e} \dots \dots \dots (44)$$

By equating the resistive and capacitive components for the parallel and equivalent series circuits we have:

$$R_e = \frac{R}{1 + \omega^2 C^2 R^2} \dots \dots \dots (45)$$

and $\frac{1}{\omega C_e} = \frac{1}{\omega C} \frac{1 + \omega^2 C^2 R^2}{1 + \omega^2 C^2 R^2}$

hence $1 + \omega^2 C^2 R^2 = \omega^2 C_e R^2$

and $C_e = \frac{1}{\omega^2 C R^2} = \frac{1}{\omega^2 C R^2} + C$

$$= C \left(1 + \frac{1}{\omega^2 C^2 R^2} \right) \dots \dots \dots (46)$$

From Equations (45) and (46) it will be seen that effective resistance and capacity of the applicator system are respectively smaller and greater than either of these components separately.

The total current I_t supplied to the

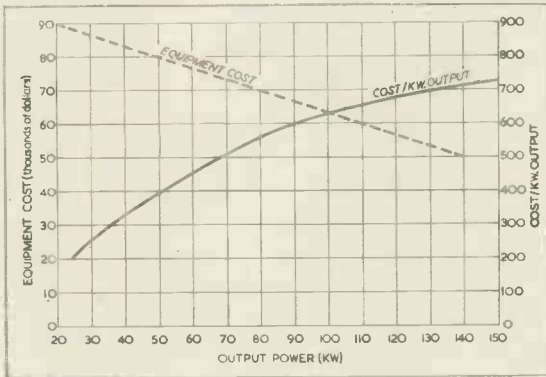

Figs. 9 and 10. Equipment and operating costs for varying output power.—J. W. Taylor.

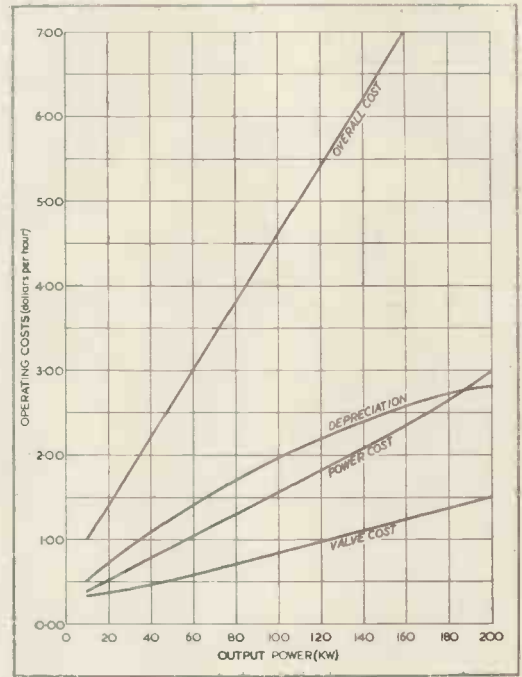

system = $i_R + i_c$, where these are respectively the working and capacitive components of I_t . If f is the working frequency in c/s., R the resistance of the wood, C the electrical capacity of the loaded applicators, X_c the capacitive reactance, then the total power P required may be calculated from a given set of conditions according to the nature and dimensions of the load and applicators.

The Formula (33) indicates that in order to be strictly accurate, s , and the equations which involve this factor, would have to be corrected for incremental variation of moisture content; but for the practical case average values will suffice.

The power P in watts = $i_p R_p \dots$ (47)

and hence i_p may be found also $E = i_p R_p \dots$ (48)

where E is the r.m.s. voltage across the load.

Knowing $\omega = 2\pi f$, C and E the capacitive component $I_c = \omega C E$ (49) may be found. The total current vector I is given by voltage \times admittance.

$$= E \sqrt{\frac{1}{R^2} + \omega^2 C^2} \dots \dots \dots (50)$$

$$\text{and } \tan \theta = R\omega C \approx \frac{I}{R_0 \omega C_0} \dots \dots (51)$$

It will be appreciated that there will be losses in the applicator system due to the following causes:

1. Electro-magnetic radiation.
2. Thermal conduction from the plates.
3. Thermal radiation.
4. Convection due to exuded vapour from the wood.
5. Electrical resistance of the applicator system.

By efficient screening E.M. radiation can be reduced to a negligible proportion, and the electrical losses due to resistance can be kept low by good design.

Of the thermal losses those due to radiation are given by the Stefan-Boltzmann law:

Watts per sq. in. of surface = $36.8 \times 10^{-12} \times K (T^4 - T_0^4)$ (52)

where T_0 is the original, or laboratory, temperature and T is the final temperature of the body. For wood K may be taken as 0.9. The losses from convection will be considerable during the early part of the heating period due to the exudation of vapour as the water content of the wood vaporises with rising temperature. These losses will diminish as the moisture is thus removed from the wood. For the same reason the resistance of the wood will rise and consequently the wattage dissipation $I^2 R$ in the wood becomes less for a fixed voltage across the applicators.

The losses due to conduction will depend upon the design of the applicator system. If the system is a good thermal conductor these will be high if the wood is in direct contact with the work, in which case there will be a tendency for the faces of the wood adjacent to the plates to lose some of their heat from the outer layers. This may be avoided by interposing thin layers of thermal insulation of low power factor between the plates and the wood.

For practical purposes thin layers of dry wood will suffice. The total losses of energy, as enumerated above,

should not exceed 20 per cent. in an applicator system of good design.

An important practical consideration is the working frequency to be chosen for H.F. equipment, which involves a compromise between antagonistic factors.

The higher the frequency the more rapid the acceleration of the setting of the glues, or the removal of moisture from the wood; but the higher the frequency the smaller the volume of wood which may be treated in one charge of the applicator. This is governed by the electrical capacity which may be permitted at a given frequency; since sufficient inductance must be allowed to provide the necessary voltage gradient across the work.

A good compromise for wood work is a frequency in the range from 1.0 to 5.0 Mc/s.

If the time factor of the operating cycle may be increased, then a larger volume of work per applicator charge may be treated at a lower frequency. For example, 0.5 Mc/s. may not be unreasonable for certain purposes; but frequencies up to 300 Mc/s. are used for some plastics.

The Power Generator

If η is the H.F./D.C. conversion efficiency of the oscillator and allowing 15 per cent. for losses the B.Th.U. available for useful work

from (38) are :

$$= \frac{3.413 \times P \times \eta \times 0.85}{60} \dots (53)$$

η may be 65 to 75 per cent. in power oscillators of good design.

The technique of designing high-frequency generators and coupling systems is considered to be sufficiently well known as to need no consideration here.

Should the practical requirement be such that the lengths of the wood are such a fraction of the working wavelength as to render the voltage distribution along the applicator plates non-uniform, and thus produce standing waves of potential, the heating of the wood will not be uniform and consideration will have to be given to the problem of distributing plates.

This can be solved by the application of well-known radio frequency technique.

The following calculation is given by the way of example of a practical problem :

Let the length, l , of the wood be 60 in.
 Let the width, w , of the wood be 10 in.
 Let the thickness, d , of the wood be 1.0 in.
 Then $A = 600$ sq. in. and the volume $v = 600$ cu. in. Suppose that

the initial moisture content is 8 per cent. and hence the dielectric constant K and power factor P.F. become 3.2 and 0.25 respectively. Applying d and K to Equation (28) we have :

$$C_{\mu F} = \frac{2,248 \times 600}{10^{10}} = 1.34 \times 10^{-4} \mu F$$

Suppose that the frequency chosen is 2×10^6 c/s., then

$$X_c = \frac{1}{2\pi f C} = \frac{1}{6.28 \times 2 \times 10^6 \times 1.34 \times 10^{-10}} = 594 \text{ ohms}$$

P.F. = $X_c / R_p = \frac{548}{548} = 1$
 hence $R_p = \frac{548}{0.25} = 2,376$ ohms

From Equation (33) for the power, P in watts = $\frac{0.637 \times sP \times \delta t \times v}{\text{time (min.)}}$

Let the time cycle be stipulated as 2 min. and suppose that the initial temperature of the wood is 80° F. and the glue sets at a temperature of 280° F. at the end of the time cycle, then t the temperature rise in 2 min. is 200° F. Take 0.3 as average for sP , applying these values to Equation (11) yields :

$$P = \frac{0.637 \times 0.3 \times 200 \times 600}{2} = 11,500 \text{ watts}$$

A check on this is obtained from

Equation 40. To this value add 15 per cent. for losses = 1,740 watts. Hence the total H.F. power required to be delivered from the generator = 11,500 + 1,740 = 13,240 watts, say, 13½ KW.

The power component i_p of the total current

$$= i_p^2 R_p = P \dots (53A)$$

hence $i_p = \sqrt{\frac{P}{R_p}} = \sqrt{\frac{11,500}{2,376}} = 2.2$

For V r.m.s. across the applicators we have $i_p R_p = 5,300 = 7,500$ volts peak. This is the working voltage for which the applicator system must be insulated.

The working frequency of 2×10^6 c/s. has been chosen to indicate the influence of comparatively low frequency on the insulation problem.

The capacitive component $I_c = \omega C V = 2\pi \times 2 \times 10^6 \times 1.34 \times 10^{-10} \times 5.3 \times 10^3 = 8.95A$. and the total current I_t fed to the loaded applicators, neglecting useless losses, is given as $I_t = \text{admittance} \times \text{volts}$,

$$I_t = V \left(\frac{1}{R_p} + j\omega C \right) = V \sqrt{\left(\frac{1}{R_p} \right)^2 + \omega^2 C^2}$$

= 9.194, say, 9.2 amps.
 as a check on the power factor chosen we have $\cos \theta =$

$$\frac{I_R}{I_t} = \frac{1}{1 + \omega^2 C^2 R_p^2} = 0.244 \text{ or } 0.25 \text{ approx.}$$

(To be continued)

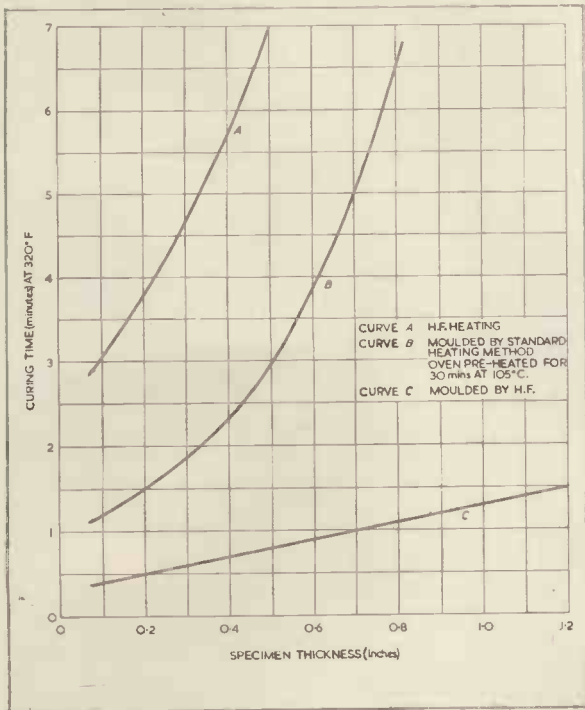
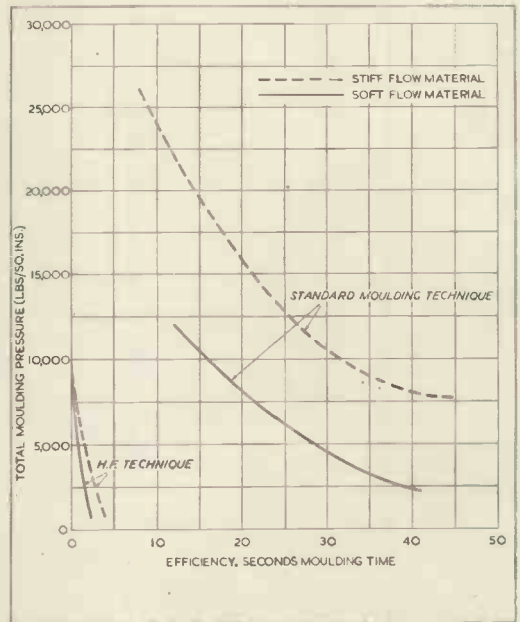

Fig. 11 (left). Optimum time of moulding specimens at different thicknesses, of flour and fabric filled phenolic moulding materials.

Fig. 12 (right). Wood flour filled phenolic moulding material. Test cup closing time at 320° F.



NOTES FROM THE INDUSTRY

Airmec International Inc.

The Board of Radio & Television Trust, Ltd., announce that they have formed a corporation in the U.S.A. under the above title. The directors are Mr. L. D. Bennett, Mr. R. W. Cotton (president) and Mr. H. R. Kent, and the offices are at 347 Madison Avenue, New York 17.

British Electronic Products, Ltd.

Mr. R. J. F. Howard, late of the Mullard Organisation, and until recently in charge of the Development Laboratory of the Industrial Electronics Section of the English Electric Company has joined the staff of British Electronic Products, Ltd., as chief engineer. Mr. B. F. Townsend has also joined the staff in the Engineering Department. The firm's address is Moxley Rd., Bilston, Staffs.

The Practical Training of Engineers

A report recommending the further development of schemes of practical training for professional electrical engineers is published by The Institution of Electrical Engineers. The report has been prepared by a Joint Committee consisting of representatives of The British Electrical and Allied Manufacturers' Association, The Radio Industry Council and The Institution of Electrical Engineers. Copies may be obtained, price 1s. post free, from the Secretary of The Institution of Electrical Engineers, Savoy Place, London, W.C.2.

The Nickel Bulletin, July 1947

Among the many abstracts given in the July issue of The Nickel Bulletin there is a wealth of data on Electro-deposition, ranging from the Technique of heavy nickel plating, Electro-polishing; apparatus and technique, to Electrolytic Lapping and Brush Polishing. The Nickel Bulletin is obtainable free of charge from the Mond Nickel Company, Limited, Grosvenor House, Park Lane, London.

General Accessories Co.

In the note on the B9G valveholders made by this company (May, 1947, issue) the war-time address was inadvertently given. The present address of General Accessories is 21 Bruton Street, W.1.

Price Correction

The price given in the advertisement of Taylor Electrical Instruments, Ltd., p. xvi, July issue, should be £15 15s. and not £19 19s.

Literature Received

The 1948 Catalogue issued by the Mail Order Supply Co., is now available to any reader on application to the firm's offices at 24 New Road, Stepney. The catalogue contains details of a number of Government surplus receivers in addition to a wide range of components and instruments.

Multicore Solders, Ltd., of Mellier House, 23 Albemarle Street, W.1, manufacturers of Ersin Multicore three-core solder, have recently issued a new edition of the publication "For those who seek the finest cored solder in the world." This brochure contains many interesting details of soldering processes in the radio, telephone and lamp industries, in which Ersin Multicore solder is employed. Amongst the technical tables incorporated are ones giving melting points and recommended bit temperatures of the more popular alloys; a table showing the length per lb. in ft. obtained for each gauge of each alloy, and metric and inch comparative tables of S.W.G.'s. Details are also given of Ersin Multicore size 1 and 2 cartons.

The Belling-Lee 1947 catalogue of electrical components and accessories is specifically intended for the use of engineer designers in the electronic and engineering industries and is not available for general trade distribution. Full details and dimensioned drawings of the well-known Belling-Lee components are given, and the catalogue is a model of a well-produced informative publication.

The special requirements of photographs and drawings to be successfully transmitted by Phototelegraphy are given in a leaflet issued by Cable & Wireless, Ltd., Electra House, Victoria Embankment, W.C.2. As an example of the cost, an illustration up to 150 sq. cms. in area can be sent to New York for £5.

"Short Delivery Standards" is the title of catalogue No. 27 issued by Brookhirst Switchgear, Ltd., which gives particulars of a range of batch-produced standard equipments which become available for delivery at regular intervals. The items include small start-stop switches and control units for machine tools. Inquiries should be addressed to the Company at Northgate Works, Chester.

Mond Nickel Fellowships

From previously announced details of the Mond Nickel Fellowships the impression has been gained that these are for training personnel for research in industry. This is not the object, as the main intention is to assist persons capable of appreciating and applying the results of research rather than to encourage research itself.

Potential applicants for Research Fellowships should obtain full details from the Secretary of the Fellowship Committee, The Mond Nickel Company, Grosvenor House, Park Lane, W.1.

Marconi Instrumentation

A new technical publication under this title has been issued by Marconi Instruments, Ltd., St. Albans. The first number contains notes on Power Factor, Loss Angle and Magnification; Aspects of Electro-surgery, and Monitoring for Signal Generators. The Technical Editor is E. D. Hart, M.A. Users of Marconi instruments are invited to contribute novel or experimental notes as a basis for future articles.

Hire Purchase of Taylor Instruments

From June 1, Taylor Instruments, Ltd., offer hire purchase terms on their instruments. Some typical rates are:

Circuit Analyser, 30s. down and 11 payments of 30s.

Universal Meter, £1 18s. 10d. down and 11 payments of £1 18s. 2d.

Universal Meter (Junior), 14s. 10d. down and 11 payments of 14s. 4d.

E.R.A. Publications

The following technical reports have been issued by the British Electrical and Allied Industries Research Association:

"Variation of Capacitance & Power Factor of Low-temperature-coefficient Ceramics with Temperature" (7s.).

"Radio Interference in Ships (Tests on Aquitania)" (2s.).

Copies can be obtained from the Association at Thorncroft Manor, Dorking Road, Leatherhead, Surrey.

E. G. Acheson, Ltd.

A new company has been registered to take over the business of E. G. Acheson, Ltd., from June 30, 1947. This will be known as Acheson Colloids, Ltd., and the address will be the same as before: 9 Gayfere Street, S.W.1.



Manchester Electronics Exhibition

Some items seen at the Second Electronics Exhibition organised by the Institute of Electronics North-West Branch in July.

THE second exhibition of electronic devices arranged by the Institution of Electronics North-West Branch was held in Manchester on July 22 and 23 in collaboration with leading firms in the industry. The Great Hall of the Manchester College of Technology provided ample space for the stands without overcrowding and in addition there was an exhibition of scientific films in the adjoining Reynolds Hall.

The opinion was expressed that this exhibition should become a permanent annual event in the North-West and ultimately provide an equivalent to the Physical Society's Exhibition in London. Under the chairmanship of Dr. J. A. Darbyshire (Ferranti, Ltd.), the organising Committee are to be congratulated on the efficiency of the arrangements and success of the Exhibition.

The secretary is Mr. L. F. Berry, 105 Birch Avenue, Chadderton, Lancs., who will be pleased to answer inquiries about future plans.

Exhibits

Many of the instruments and apparatus shown had already been seen at previous exhibitions in London, and only a few of the more noteworthy items can be listed here. Further information can be obtained from the manufacturers at the addresses given.

Vacuum Pumps

The DR1 pump is a two-stage, oil-immersed, vane type with helical reduction gearing incorporated in it to permit of direct driving by an electric motor with a nominal speed of 1,425 r.p.m., pump and motor being mounted together on a cast-iron bed-plate and the drive being transmitted through a flexible coupling.

Pumping speed at 0.5 mm. Hg., 0.80 litres/sec., 1.7 ft. 3/min.

Pumping speed at 0.1 mm. Hg. 0.67 litres/sec., 1.42 ft. 3/min.

Pumping speed at 0.02 mm. Hg., 0.332 litres/sec., 0.68 ft. 3/min.

The "Metrovac" Oil Condensation Pump Type 03B operates on the condensation principle and employs Apiezon low vapour-pressure oil as the working fluid. The body of the pump and the water jacket are constructed from a non-corrodible alloy, while the oil reservoir below is made of copper to provide high heat conductivity.

Limiting pressure: Below 10^{-6} mm. Hg.

Speed: 30 litres/sec. at pressures between 10^{-3} mm. Hg. and 10^{-6} mm. Hg. on the high vacuum side.

Metropolitan-Vickers Electrical Co. Ltd.,

*Mosley Road Works,
Trafford Park, Manchester, 17.*

Vacuum Gauges

Pirani vacuum gauges giving pressure indication in two ranges. Standard models for high sensitivity vacuum leak detection are available. Other gauges include the Philips cold-cathode ionisation gauge with a range of 5×10^{-3} mm. to 10^{-5} mm. Hg., an ionisation gauge and control unit, and a vacuum switch (Type V.S.1) for isolating plant until the required degree of vacuum has been attained. The range is from 15 mm. Hg. to 500 mm. Hg., and the electrical control circuit will handle 2 A at 600 V to 10 A at 125 V.

A combined water-flow switch and flow indicator gives water-cooled plant protection against water failure and gives a direct reading of flow rate.

*W. Edwards and Co.,
Kangley Bridge Road,
Lower Sydenham, S.E. 26.*

New Oscilloscopes

The Model 1049 Industrial Oscilloscope is designed specifically for the industrial user whose main interest lies in the measurement of low frequency phenomena. It consists of a double-beam tube unit, time base, D.C. amplifiers and internal power supplies.

The trace is presented on a flat screen double-beam tube normally operating at 2 KV, with provision for

4 KV operation for transient recording. Signals are normally fed via the amplifiers, with provision for input voltage calibration.

The time base is designed for repetitive, triggered or single stroke operation and is D.C. coupled throughout.

Time measurement is provided by a directly calibrated control with time scale ranges from 1.5 sec. to 150 microseconds.

Stabilisation against mains variations up to ± 10 per cent. is provided for the amplifiers and cathode-ray tube supplies and long-period stability is reached within 5 to 10 min. from switching on.

The Model 1035 is a general purpose oscillograph, consisting of a double-beam tube unit, time base, Y-deflection amplifiers and internal power supplies.

The traces are presented on a flat screen double-beam tube operating at 2 KV and signals are normally fed via the amplifiers, with provision for input voltage calibration.

The time base is designed for repetitive, triggered or single stroke operation and time measurement is provided by a directly calibrated shift control operated in a similar manner to the Y-voltage calibration.

*A. C. Cossor, Ltd.
Highbury Grove, N.5.*

The Mullard Cathode-ray Oscillograph Type E.800 has been specifically designed to meet industrial, biological and other requirements in the low frequency spectrum. Mains input 100-150 V and 200-250 V 50 c/s. Amplifier response (2 db. loss) 0.1-40,000 c/s. Amplifier sensitivity (max. gain) 1 mV rms./cm. Time base frequency range 0.25-16,000 c/s.

A Frequency Meter shown by Salford Electrical Instrument Co. (General Electric Co. Ltd.), covering 120 c/s to 45 Kc/s. in four ranges.



The Cathode-ray Oscillograph Type E.805 is similar in general design and layout to the above instrument, but covers a higher frequency band. Amplifier response (2 db. loss). 2 c/s.-2 Mc/s. Amplifier response at 5 Mc/s. 27 per cent. Amplifier sensitivity (max. gain) 5 mV rms./cm. Time base frequency range 5 c/s.-150 Kc/s.

*Mullard Wireless Service Co.,
Century House, London, W.C.2.*

Electronic Voltage Regulation

In addition to the regulation of voltage in A.C. and D.C. generators, the thyatron voltage regulator can also be used for speed control and the accurate adjustment of tension or alignment during reeling.

Speed regulation can be obtained over a range of 10:1, the initial speed setting being given by a simple rheostat mounted near the motor. Once set, the running speed will be maintained within very close limits under all conditions of load, and a regulation of ± 0.1 per cent. is readily obtained.

In thyatron control of voltage, a portion of the alternator voltage is rectified and supplied to the arms of a bridge containing non-linear resistances. The output from the

bridge is amplified and applied to the grids of two thyatrons which control the feed current of the exciter. A change of 0.5 per cent. in the alternator voltage will change the field current by nearly 100 per cent., and the limits regulation will thus not exceed ± 0.25 per cent.

Thyatron control of speed was demonstrated at the stand and further particulars can be obtained from booklet AG.768 issued by

*The British Thomson-Houston Co.,
Rugby.*

Crater Lamp

The Type M.A.C.4 is a mercury-argon filled three-electrode tube which gives a light output proportional to the current passing through it. The anode is a fine metallic rod, the tip of which is visible through a small hole in the cap which surrounds and screens the assembly. The glow is concentrated at the tip of the anode rod, light being emitted through the aperture in the cap.

Characteristics:

Heater rating, 4 volts, .3 amp.

Striking voltage, 100 volts maximum.

Anode voltage, 200 volts minimum

Volt drop, 20 volts (approx.).

Basing: English 5 pin.

*Ferranti, Ltd.,
Electronic Sales Dept.,
Gem Mill, Chadderton, Lancs.*

Special Batteries

Dry batteries used in conjunction with deaf-aid equipment, portable wireless, etc. Special batteries used to operate lifeboat wireless transmitters. The batteries are activated by piercing a diaphragm and thus allowing the electrolyte to fill the dry-charged cells.

Meteorological balloon batteries used with Radio-Sonde apparatus. The batteries exhibited are the prototypes developed for this important service, and are ultra light-weight design.

Special batteries for use in bore-hole equipment to operate electronic recorders. The apparatus is used in boring operations (for oil, etc.) and the batteries have to withstand high temperatures and pressures.

*The Chloride Electrical Storage
Co., Ltd.,
Exide Works, Clifton Junction,
Near Manchester.*

The photograph heading this article shows the Chloride Co.'s stand at the exhibition, designed to harmonise with the Grand Hall interior.

Right: Met-Vick
Condensation
Pump, Type 03B.
(see col. 11 of previous
page.)

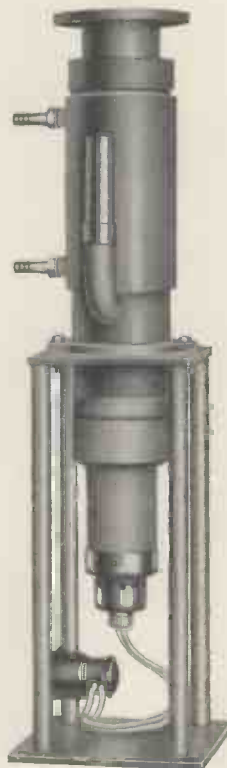

A Nomogram for Calculating the Sum of Two Squares

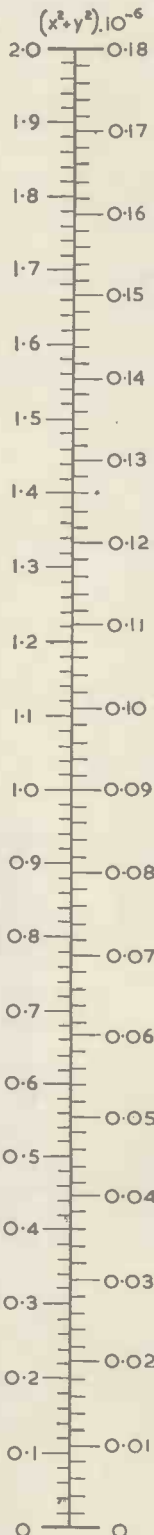

(For explanation see adjoining column)

REVIEWS

Induction Heating

"Heat Treater." Chapman and Hall, London, 1947. Price 10s. 6d. 147 pp. 104 figures and photographs.

Normally a reviewer has a rooted objection to anonymous technical work. In this instance however the pen name "Heat Treater" provides a clue to the standing of the author. It can only be assumed that he is a practical user of induction heating equipment and that he is writing primarily for the practical production engineer.

The first chapter deals with the production improvements made possible by induction heating. Following this there is a first principle explanation of induction heating theory, which is unfortunately, greatly reduced in usefulness by such omissions as the practical values for the constants given in various formulae. The next chapter on "Choice of Frequency Equipment" is primarily written to assist prospective users to select the most suitable equipment for the operation which they wish to undertake. The various types of equipment used to supply high frequency alternating currents are described very briefly. These descriptions cover motor generator, spark gap and valve oscillator sets. The readers of this journal will be disappointed that the author has dismissed the theory of valve oscillators in the following single sentence "The direct current from the rectifiers feeds the oscillator valve, which in turn charges the condenser, the discharge from which provides the high frequency current for the inductor."

The second half of the book deals with hardening technique, internal hardening, assembly processes and other miscellaneous applications. This section of the book is obviously written with considerably more authority than parts of the earlier chapters. As a practical discussion intended primarily for production engineers the latter half of the book can be thoroughly recommended.

It would not be proper to discuss the book in question without some mention of an earlier work "High Frequency Induction Heating" by F. W. Curtis. (McGraw-Hill 1944). The second half of the present work covers almost exactly the same ground as that dealt with by Mr. Curtis and many of the same illustrations are used. A detailed review of this section could not be other than a close repeat of the review on Mr. Curtis' book in *Electronic Engineering*, October, 1946. Unlike the earlier work "Heat Treater" gives no final chapter on dielectric heating, he does however include some references which are almost entirely confined to the applications of induction heating. Mention should be made in the next edition of the classical electrical papers dealing with the theory.

C. E. TIBBS

The Photographic Recording of Cathode Ray Tube Traces

R. J. Hercock, B.Sc., A.R.I.C., A.Inst.P., F.R.P.S. Ilford Technical Monograph No. 1.

Photographic recording with the cathode ray oscillograph is becoming increasingly important in scientific work, but the technique is somewhat specialised and investigators have been handicapped by the lack of practical information on the subject. Messrs. Ilford Ltd. are therefore to be congratulated for producing this helpful little book.

As might be expected it deals mainly with the emulsion and processing aspects of the subject and more space might usefully have been devoted to a discussion of the camera lens as this is a vital factor in the recording of C.R. traces by external photography.

It is not generally realised that by careful attention to the photographic technique writing speeds of the order of those normally associated with the high voltage continuously evacuated oscillograph can be recorded successfully with the 5-10 KV sealed-off glass tube type and this point might have been emphasised more definitely. In this connexion some examples of actual oscillograms would increase the value of the book.

Apart from these points the reviewer has only minor comments to make. In one or two cases his experience is at variance with that of the author as, for example, over the merits of intensification and type of intensifier for optimum results.

The book should be extremely useful to those engaged in cathode ray oscillography and its value is enhanced by the inclusion of a comprehensive bibliography.

W. NETHERCOT

Photoelectric Cells

A. Sommer. D.Phil. Methuen and Co., Ltd. 5s.

This book is an addition to the well known series of "Monographs on Physical Subjects," and will be of great interest to all who deal with the photo-emissive photo-cell, to which its treatment is entirely devoted.

During the last decade, a new type of photo-electric cathode, viz. the antimony—caesium photo-surface, has yielded a very definite improvement in attainable sensitivity, and it is important to note that an account of such cathodes is given in Chapter 3 of this monograph. The author has excised the mathematical complexities with which the subject matter can so readily be endowed, but the treatment throughout is commendably sound and well balanced. Although a monograph of this size can hardly compete with the extensive treatise of Hughes and Dubridge, the reviewer has no hesitation in recommending it.

S. R.

BOOKS

TELEPHONE :
EUSTON 4282 (5 lines)

Books on all branches of RADIO and ELECTRICAL ENGINEERING

A good selection always available. Books reviewed or mentioned in this Journal can be supplied. If not in stock, they will be obtained from the Publishers when available.

Continental and American works unobtainable in this country can be secured in the shortest possible time.

SECOND-HAND BOOKS : 140 Gower Street, W.C.1.

Large stock always available. Books sought for and reported free of charge. Large or small collections bought.

LENDING LIBRARY

SCIENTIFIC AND TECHNICAL

Annual Subscription from One Guinea

Prospectus post free on request.

Bi-monthly List of New Books and New Editions post free to subscribers regularly.

THE LIBRARY CATALOGUE

revised to December 1943, containing Classified Index of Authors and Subjects.

Demy 8vo. Pp. viii + 928.

To subscribers, 12s. 6d. net

To non-subscribers, 25s. net

} Postage 8d.

SUPPLEMENT, 1944 to December 1946. Demy 8vo. Pp. viii + 168.

To subscribers, 2s. 6d. net

To non-subscribers, 5s. net

} Postage 4d.

H. K. LEWIS & Co. Ltd.

LONDON : 136 GOWER STREET, W.C.1

IMPORTANT BOOKS

RADIO TELEGRAPHY AND TELEPHONY

By R. L. DUNCAN and C. E. DREW

SECOND EDITION

9" x 6" 1,046 pages 51s. net

RADIO FREQUENCY MEASUREMENTS BY BRIDGE AND RESONANCE METHODS

By L. HARTSHORN,

D.Sc., A.R.C.S., D.I.C.

Demy 8vo. 265 pages. 99 illustrations. 21s. net.

TIME BASES

(SCANNING GENERATORS)

Their design & development with Notes on the Cathode Ray Tube.

By O. S. PUCKLE,

M.B.E., M.I.E.E.

Demy 8vo. 204 pages. 124 figures. 16s. net.

! (POSTAGE EXTRA)

CHAPMAN & HALL, LTD.

37, Essex Street, London, W.C.2.

CORRESPONDENCE

Identification of Frequencies

Dear Sir,

The method for the Identification of Harmonically Related Frequencies described by Mr. L. M. Moore in the April issue has been, I believe, widely used. However, in view of the fact that this is one of the first publications on the method, I would like to emphasise the author's warning of possible errors.

A few years back I had occasion to spend quite a considerable time on the measurement of frequencies about 120 Mc/s, and for this purpose I was using a heterodyne wavemeter, the range of which was about 20 to 60 Mc/s.

I found that unless the coupling of the oscillator of unknown frequency to the wavemeter was extremely slack then it was quite easy to make mistakes. In fact it was found advisable to reduce coupling so that the stronger beats could just be heard and no more. The following table will show that if a large number of readings were taken then incorrect beating at one end of the range could be as loud as correct beating at the other end. If only the 3 at the top of the range were used then the strength of the beats could easily be misleading as the 5th and 3rd harmonics had no great difference in intensity.

Naturally after the first mistake additional care can be taken, but until one is sure of correct coupling, it is possible to make an error which can delay further progress.

Yours faithfully,

W. BRODIE.

Dennistoun,
Glasgow, E.1.

Wavemeter Frequency	Harmonic	Unknown Frequency
f_1	n	f_0
60	2	f_0
48	5	$2f_0$
40	3	f_0
34.3	7	$2f_0$
30	4	f_0
26.7	9	$2f_0$
24	5	f_0

Cri du Coeur

Dear Sir,

May we trespass on your courtesy to the extent of asking you to publish the following paragraph as an item of news in the literary columns of your journal.

THIS IS NOT AN ATTEMPT TO OBTAIN FREE PUBLICITY. We have paid for announcements in the advertisement columns of various media without the slightest success. The reason is that large manufacturers never consult the adver-

tising columns of their trade papers when in search of additional orders.

Notwithstanding this, we think you will agree that many of your readers would be keenly interested to learn from your editorial columns, that a new and extensive avenue of trade is at their disposal—if they care to take advantage of it.

WHO WANTS MORE ORDERS?

A Birmingham firm of repute who is engaged in the marketing of huge quantities of ex-Government stock, has available a large sales' organisation controlled by experts who have bought and sold miscellaneous merchandise to the value of many millions sterling.

Any manufacturer who wishes to devote his energies exclusively to production and to relegate the distribution to a separate undertaking is invited to send details of any specialities in popular demand that can be sold, in large quantities direct to the public by mail order or other general publicity methods. Substantial supplies of suitable lines will be bought outright regularly and sold direct to the consumer for manufacturers who contact Haviland and Company, 1 Rutland Road, Bearwood, Smethwick.

Your kind co-operation will be greatly appreciated by,

Yours faithfully,

Haviland and Company.

SEPTEMBER MEETINGS

The Institute of Physics

Conference on Electron Microscopy

To be held at the University of Leeds on 16th and 17th September.

Date: September 16. Time: 10 a.m.

Lecture: "Studies on Collagen and Muscle Structure."

By: Dr. R. Reed and Dr. K. M. Rudall.

Lecture: "The preparation of Bacteria for Electron Microscopy."

By: Dr. E. Grieger, Dr. V. E. Cosslett, Mr. G. R. Crowe, and Dr. C. F. Robinow.

Lecture: "The virus in the plant cell."

By: Dr. F. M. L. Sheffield.

Time: 2.15 p.m.

Lecture: "Some notes on manipulation and methods."

By: Dr. A. E. J. Vickers.

Lecture: "The E.M.3 microscope."

By: Mr. R. Page.

Date: September 17. Time: 10 a.m.

Discussion: "The effect of temperature and other conditions on the quality of electron micrographs."

Opened by: Dr. V. E. Cosslett and Dr. I. Dawson.

Time: 11.30 a.m.

Discussion on Photographic Problems.

Time: 2.15-4.30 p.m.

Demonstrations (including the new Met. Vick Electron Microscope).

Hon. Secretary: Dr. V. E. Cosslett, Cavendish Laboratory, Cambridge.

Electron Jubilee Celebrations

Celebrations to mark the fiftieth anniversary of the discovery of the Electron by Sir Joseph J. Thomson will be held in London on September 25th and 26th, 1947. These celebrations are organised by The Institute of Physics and The Physical Society in association with The Institution of Electrical Engineers.

On September 25th at 7.30 p.m. at The Central Hall, Westminster, a public lecture entitled "The Electron Liberated" will be given by Sir Clifford Paterson, F.R.S.

On September 26th, at 3 p.m. at the Science Museum, South Kensington, the official opening of a public exhibition will take place. The exhibition illustrates the great influence of the discovery upon the life and industry of the community, and will remain open for at least three months.

In addition, a number of scientific lectures are being arranged for the members of the three organising bodies.

Tickets for Sir Clifford Paterson's lecture and a handbook of the exhibition (price 1s. 2d. post free) are available upon application to The Secretary, The Institute of Physics, 47 Belgrave Square, London, S.W.1.

Institution of Electronics

N.W. England Section.

Date: September 5. Time: 6.30 p.m.
Held at: Reynolds Hall, College of Technology, Manchester.

Lecture: "Recent Developments in the Application of Electronics to Heavy Engineering."

By: Dr. W. Wilson.

Hon. Secretary: L. F. Berry, 105 Birch Avenue, Chadderton, Lancs.

The Television Society

Date: September 23. Time: 5.30 p.m.
Informal Meeting and Reunion at the I.E.E.

Hon. Secretary: G. Parr, 68 Compton Road, London, N.21.

British Sound Recording Association

Date: September 26.

Lecture: Sound and its Relation to Recording.

By: Dr. L. E. C. Hughes.

Hon. Secretary: R. W. Lowden, 3a, Pembroke Buildings, Camberley, Surrey.

North-West Kent Amateur Radio Society

Future meetings will be held on the first Friday and not the last Friday in the month at Aylesbury Road School at 8 p.m. The next meeting will be on September 5 when G8DN will give a light talk on his experiences during the war.

Hon. Secretary: L. Gregory, 18, Upper Park Road Bromley, Kent.



CELESTION



CELESTION LTD

KINGSTON-ON-THAMES · SURREY
TELEPHONE, KINGSTON 5656-7-8-9

Model P2VO. A 2½" diameter Speaker, weighing only 3½ ozs. designed for small personal radios.

Model P84. An 18" diameter Speaker with a peak power handling capacity of 40 Watts; suitable for public address purposes.

ABSTRACTS OF ELECTRONIC LITERATURE

C. R. TUBES

Improved Cathode-Ray Tubes with Metal-backed Luminescent Screens

(D. W. Epstein and L. Pensak)

Considerably improved cathode-ray tubes result from the application of a light-reflecting, electron-pervious, thin metallic layer on the beam side of the luminescent screen. Observations and measurements on such tubes, using aluminium for backing, show that under appropriate conditions such tubes possess many advantages over similar conventional tubes. These are: (1) Improved efficiency of conversion of electron beam energy into useful light—in other words, more useful light output for a given beam power input. 2. Elimination of ion spot—thus making other, generally less direct, means for eliminating the ion spot unnecessary. (3) Improved contrast. (4) Elimination of secondary emission restrictions, thus permitting the use of high voltages and screen materials with poor secondary emission.

—*R.C.A. Review*, March, 1946, p. 5.

A Linear Time Base of Wide Range

(D. F. Gibbs and W. A. H. Rushton)

An oscillograph time base originally developed for work on the electrophysiology of nerves is described. Special features are the flexibility, linearity, and the wide range of sweep speeds available, very slow speeds being obtained without the use of large condensers or resistors. A sweep voltage of 350 is available, which was applied directly to the X-plates of an oscillograph.

—*Jour. Sci. Inst.*, November, 1946, p. 270.

ELECTRON OPTICS

Conditions for Extending the Resolution Limit of the Electron Microscope

(V. E. Cosslett)

The theoretical limit of resolution of a magnetic electron microscope for a maximum field strength of 10,000 oersteds and an accelerating potential of 50-60 KV is 10-12A and this figure is within reach in practice. To reduce the figure to 5A a microscope operating at a voltage of about 1,000 KV and a focal length of 8-10 mm. must be constructed. The higher resolving power may also be achieved by improving the pole piece materials so that saturation fields of the order of 20,000 oersteds may be achieved or by the correction of magnetic electron lenses, leading to lower values of aberration coefficients than those of present lenses. The possibilities of achieving these conditions are discussed with reference to practical limitations which are likely to restrict the design of such instruments.

—*Jour. Sci. Inst.*, February, 1947, p.40*

CIRCUITS

Superheterodyne Frequency Conversion using phase-reversal Modulation

(E. W. Herold)

The paper describes an improved method of frequency-conversion as utilised in superheterodyne reception. The principle is to reverse the phase of the signal output periodically at a rate which differs from the signal frequency by the intermediate frequency. This may be done either by continuous variation of phase or by continuous variation of tube transconductance from positive to negative. The result is a conversion transconductance which is twice as high as had before been believed ideal. Furthermore, if the phase-reversal rate is made by any integral multiple of an applied local-oscillator frequency, equally good conversion is obtained at a harmonic of the local oscillator without spurious responses at any other harmonic than the one chosen. An electron tube with a multi-humped characteristic has been devised as a means to this end, since the transconductance characteristic will then vary from positive to negative as the control voltage is varied. An analysis of such a tube is carried out in detail including the fluctuation noise.

The analysis shows that the new construction method doubles the conversion gain possible in a tube with a given maximum transconductance. In an ideal case with no second-stage noise, the signal-to-noise ratio is as good as with the same tube used as an amplifier; even in practical cases, the mixer is only 10 per cent. to 20 per cent. poorer than the amplifier. This is in contrast with conventional mixer methods in which the signal-to-noise ratio is from two to three times poorer than when the same tube is used as an amplifier.

Conversion at a harmonic may also be achieved with high gain, but it is found that the signal-to-noise ratio is not favourable as with fundamental operation.

—*Proc. I.R.E.*, April, 1946, p. 184P.

Annales de Radioelectricité

The January issue (Vol. 2 No. 7) of this publication, which is issued by the Associated French Radio Companies, 79 Boulevard Haussmann, Paris, contains the following articles:

The calculation of multiplex radio-telephone links in the ultra-short wavelength.

Practical limitations of the power and output in klystrons.

Glass in the radio industry (including glass base technique).

Speech transmission in noisy surroundings.

THERMIONIC DEVICES

A Megavoltmeter for Induction Electron Accelerators

(W. F. Westendorp)

A direct reading megavoltmeter is discussed for showing the electron voltage to which the induction electron accelerator is adjusted in correlation to the operating voltage of the machine and the phase of the orbit shift circuit. A description and circuit diagram of the instrument is given, together with a method of calibration. The megavoltmeter is applicable to all betatrons, and with minor modifications is applicable also to the synchrotron.

—*Rev. Sci. Inst.*, June, 1946, p. 215.*

Magnetron Cathodes

(M. A. Pomerantz)

Conditions under which magnetron cathodes operate are investigated. Phenomena causing sparking and other effects which shorten the life of a magnetron cathode are considered, and a list given of essential features of a cathode that will withstand the drastic conditions to which magnetrons are subjected. Reference is made to a new type of cathode, the "sinthor," that appears to fulfil the requirements satisfactorily. This comprises a body of thorium oxide which may be heated in various ways.

—*Proc. I.R.E.*, November, 1946, p. 90.*

A Magnetron Oscillator with a Series Field Winding

(L. H. Ford)

A description is given of an experimental investigation of a continuous-wave magnetron oscillator, the magnetic field for which is provided by an electromagnet energised by the anode current of the valve. Oscillations can be readily obtained, and they persist over a wide range of anode voltages. With a two-segment-anode valve oscillations take place at the fundamental frequency of a lecher-wire circuit connected to the valve. With a four-segment-anode valve, oscillations at the fundamental frequency of such a circuit are observed at low anode voltages, but as the voltage is increased oscillations at 3, 5, 7 . . . times the fundamental frequency appears successively. The range of frequency covered by the experiments was 40-750 Mc/s (λ , 7.5 m. to 40 cm.). During oscillation the anode current assumes the value necessary to provide the optimum magnetic field, and, within limits, the number of turns on the electromagnet and the magnitude of the filament current do not affect the action of the oscillator. The operational stability is good, and the danger from an excessive anode current is largely removed.

—*Jour. I.E.E.*, Part 3 January, 1947, p. 60.

* Abstracts supplied by the courtesy of Metropolitan-Vickers Electrical Co. Ltd. Trafford Park, Manchester

Valve maintained TUNING FORK TYPE A-339

INCORPORATING
OUR TUNING FORK,
TYPE A-340-A

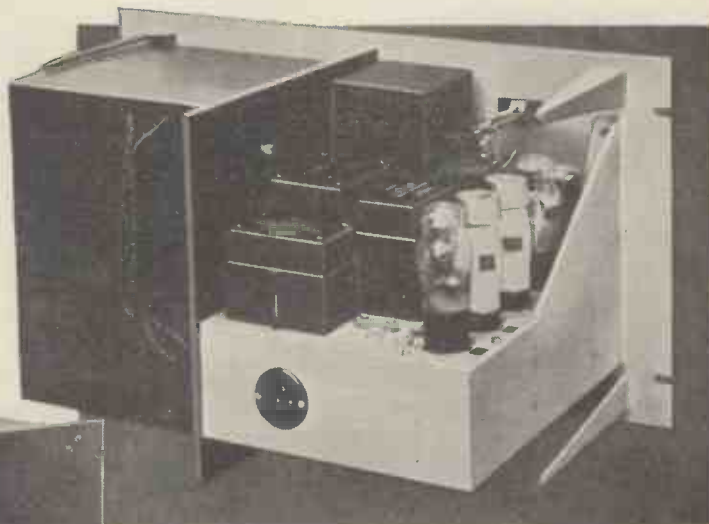

An audio-frequency standard of precision accuracy, small dimensions and reasonable price.

Bulletin B-522-A, giving full particulars of this instrument will be supplied on request.

S P E C I F I C A T I O N

GENERAL. Low temperature coefficient tuning fork, hermetically sealed and temperature controlled. Special negative feedback circuit.

FREQUENCY. Standard frequencies are 500, 1000 and 4000 c/s — intermediate frequencies can be supplied to special order.

DIMENSIONS. Both types 19 in. × 10½ in. × 10½ in. deep.

SUPPLIES. Type A-339-A, A.C. MAINS
Type A-339-B, BATTERIES

POWER OUTPUT. Type A-339-A
1 watt into 600 ohms for 2% distortion.
Type A-339-B
½ watt into 600 ohms for 2% distortion.

MUIRHEAD

Muirhead & Co., Limited, Elmers End, Beckenham, Kent. Telephone: Beckenham 0041-2

FOR OVER 60 YEARS DESIGNERS AND MAKERS OF PRECISION INSTRUMENTS

"Laboratory" INSTRUMENT... but NOT "Laboratory" Price!

The newest addition to the "Advance" range of Signal Generators places an instrument of laboratory class within the financial scope of every radio service engineer and experimenter.

The discerning engineer will appreciate its accuracy and stability, its exceptionally wide range which covers all frequencies required for radio and television receivers and its accurate attenuating system which enables sensitivity measurements to be made on highly sensitive receivers up to 60 Mc/s. Send for fully descriptive pamphlet.



Price 19 Gns.

Range: 100 Kc/s—60 Mc/s on fundamentals (up to 120 Mc/s on Second Harmonic).

Accuracy: Guaranteed within $\pm 1\%$

Attenuation: Constant impedance system embodying a matched 75 ohms transmission line.

Stray Field: Less than 3 microvolts at 60 megacycles.

Illuminated Dial: Total scale length 30"

Power Supply: 110-210-230-250 volts.

Dimensions: 13" x 10 1/2" x 7 1/2" deep.

Weight: 15 lbs.

The



ADVANCE COMPONENTS LTD., Back Road, Shernhall, Street, Walthamstow, London, E.17. Telephone: LARKSWOOD 4366/7

"UNO"

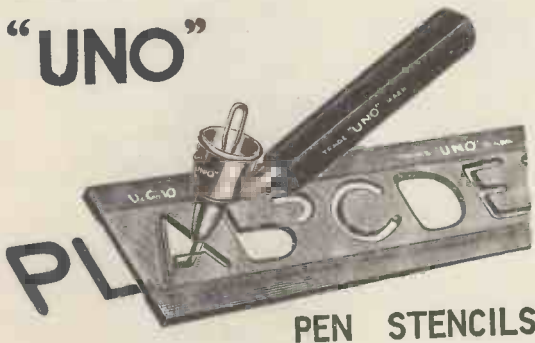

PEN STENCILS

UNO Water-proof Drawing Ink



STENCILS FOR ELECTRICAL (SYMBOLS 6/- EACH



AND

Everything for the Drawing Office

A. WEST & PARTNERS LTD.
36 BROADWAY, WESTMINSTER, S.W.1

Which Switch is the right switch?

... is it Rotary or Pushbutton or Slider? Is it wanted for circuit selection, band selection, tap switching? Is it for a new design or in quantities for a well proved circuit?

Whatever it is — the answer is always OAK!

The basic design of all Oak switches is one of strength and efficient functioning, including such exclusive features as the double-contact clip and the floating rotor, ensuring self-alignment of each section.



OAK SWITCHES

BRITISH N.S.F. CO. LTD., Keighley, Yorkshire (Sole Licensees of OAK Manufacturing Co., Chicago)
A. B. METAL PRODUCTS LTD., Feltham, Middx. (Sub-Licensees of N.S.F.)
The only Manufacturers of OAK Switches under Patent Nos. 478391 & 478392

AERIAL COAXIAL CONNECTOR A NEW BURGoyNE DEVELOPMENT

for ...

Efficient
Watertight
Coaxial Cable
Connections



THIS new Coaxial Cable Connector provides both commercial and amateur users with a means of making efficient watertight coaxial cable connections for aials. It also serves as centre insulator for a half wave doublet.

The Burgoyne Connector is made of aluminium with steatite insulation, and has two forged steel eyebolts equipped with convenient soldering connections.

A bottle of weatherproof cement with a piece of 1/2 in. outside diameter rubber tubing, plus the necessary assembly screws, are supplied with each connector. The assembled connector weighs only 12 ounces.

Amateurs, and all listeners requiring perfect reception will welcome the Burgoyne Connector because it eliminates the necessity for crude, inefficient coaxial cable connections, thus saving them time and trouble due to the inroads of weather on home-made connections. Professional operators will find that it provides a quick, well-engineered means of doing an essential job.

24/6

Trade Enquiries invited.

Sole Distributors for the U.K.

M. O. S. Mail Order Supply Co., 24 New Road, LONDON, E.1
Stepney Green 2760 & 3906

Careers in Electronics

There is vast scope for ambitious men and women in the new fields opened up by Electronic Science. The Correspondence and College Courses provided by E.M.I. Institutes which cover recognised diplomas such as the City and Guilds, etc. are written and supervised by E.M.I. ★ scientists who are specialists in Electronic Science. Here are some of the careers for which you can be trained:

- SERVICE ENGINEERING
-
- OPERATING
-
- DESIGN AND DEVELOPMENT
-
- TECHNICAL SALESMANSHIP
-
- TEACHING

- TELEVISION and RADIO.
- COMMUNICATION ENGINEERING—Land, Sea and Air.
- RADAR.
- NAVIGATIONAL AIDS.
- INDUSTRIAL ELECTRONIC APPLICATIONS.
- MEDICAL EQUIPMENT.
- AUDIO-FREQUENCY, INCLUDING FILMS, etc.

VISIT US ON
STAND 212
NATIONAL
HALL,
RADIO
OLYMPIA



Also short Courses for Executives, Amateurs, Schoolboys, etc.
For full details apply to your local "H.M.V." Radio dealer or direct to:—
Principal: PROFESSOR H. F. TREWMAN, M.A. (Cantab), M.I.E.E.,
M.I.Mech.E., M.Brit.I.R.E.

E.M.I. INSTITUTES LTD.

Dept. 11, 43 GROVE PARK ROAD, CHISWICK, LONDON, W.4

★ The E.M.I. Group includes "H.M.V.", Marconiphone and other important electronic interests.

E.3a

Electro-static screening
to be provided HERE...

THE electro-conductive properties and the opacity of the graphite film deposited on glass surfaces by 'dag' colloidal graphite render it a highly suitable medium for the screening of electronic valves and tubes. This is only one of the many uses of 'dag' in the electrical industry. Your problems in the provision of electrically conducting coating on plastic and other materials can be solved by 'dag.' Technical information is available on request. When writing please quote E64

Engineering and Marine Exhibition,
Olympia, Stand C. Section 4,
Gallery, Grand Hall.

dag
REGD. TRADE MARK
COLLOIDAL
GRAPHITE

WILL DO IT



ACHESON COLLOIDS LIMITED • 9 GAYFERE STREET • WESTMINSTER • S.W.1



FOR THE DETECTION AND MEASUREMENT OF "IONISING RADIATIONS"

External search unit which is connected to the instrument by a flexible cable.

the setting of the sensitivity control. A full description of its principle and uses will be sent on request.

IN the presence of ionising rays the Baldwin Radium Detector produces through a miniature moving coil loudspeaker audible impulses of approximately 800 c.p.s. In the absence of other than cosmic rays, the number of audible impulses may be reduced to a few only per minute, according to

BALDWIN

RADIUM DETECTOR

BALDWIN INSTRUMENT COMPANY LIMITED
GRAND BUILDINGS, TRAFALGAR SQUARE, LONDON, W.C.2
Telephone: WHitehall 3736 Works: Dartford, Kent

DAWE UNIVERSAL IMPEDANCE BRIDGE



Meet us at
RADIOLYMPIA
OCT 1-11

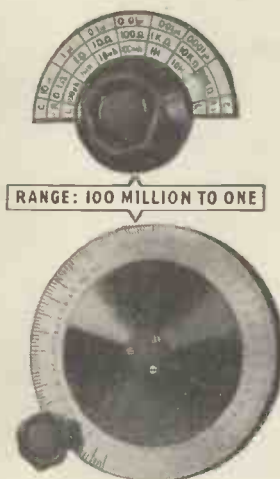

RANGE: 100 MILLION TO ONE

All laboratories using electrical equipment will find a ready use for this Bridge, which is self-contained, portable, direct-reading and sufficiently accurate for most routine measurements.

INDUCTANCE : 1 μ H - 100 Hy
CAPACITY : 1 pF - 100 mfd
RESISTANCE : .001 Ω - 1 M Ω
POWER FACTOR : .002 - 1.0
Q FACTOR : .02 - 1,000

The bridge includes built-in standards, batteries, a 1,000-cycle tone source for a-c measurements, a zero-centre galvanometer null indicator for d-c and terminals for head-phones for 1,000-cycle null detection.

DAWE INSTRUMENTS LTD., HARLEQUIN AVENUE, GREAT WEST ROAD, BRENTFORD, MIDDIX: EALING 1850

★ THE TREND OF MODERN ELECTRONICS ★



THE PINT VALVE

HALF-PINT GLASS

IN THE



BRIMAR

BVA

VALVES

Bantam Range

STANDARD TELEPHONES AND CABLES LIMITED · FOOTSCRAY · KENT

When the aim is

ACCURACY

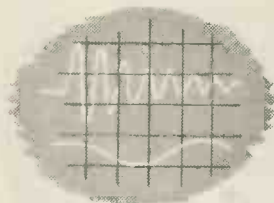

the Instrument is

COSSOR

● An important section of the Cossor Organisation is devoted to the production of electronic indicating and recording equipment of the highest calibre, designed to fulfil the most critical of current scientific demands. Enquiries relating to problems arising in recording indicating and monitoring where effects can be made available as a voltage, should be addressed to: A. C. COSSOR LTD., Instrument Dept., Highbury, London, N.5.

A. C. COSSOR LTD
INSTRUMENTS DEPT.

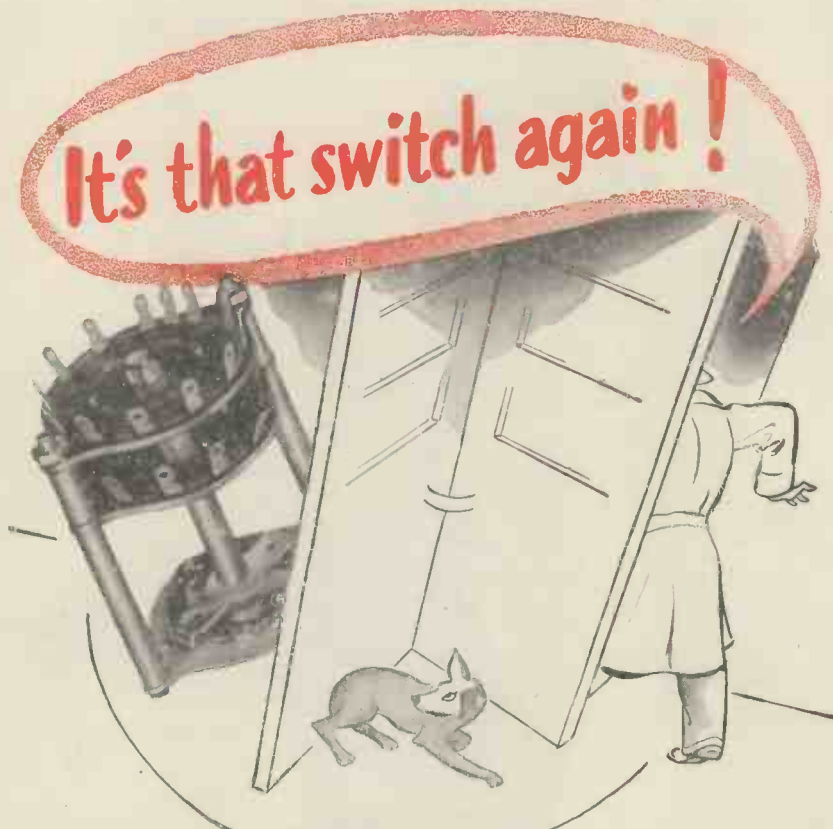

One at a time, please.

This switch is continuously rotatable and provides on its two wafers twelve positions for two poles. Its special feature is that as each contact is selected the remaining eleven are shorted out so that the adjacent capacity in the circuit does not influence the selected circuit in use for the test. Both wafers of the switch operate exactly in step to enable both ends of the component under test to be brought into the circuit.

WALTER INSTRUMENTS LIMITED, GARTH ROAD, LOWER MORDEN, SURREY. TELEPHONE: DERWENT 4421-2-3

WALTER Type 40

made for

Life

1241

THE SWITCH OF OVER 2000 ASSEMBLIES
C.R.C.20

YOU CAN'T STOP A MAN WITH A GOOD IDEA



“Hurrah! I’ve got a new *angle* on it— it might be made of rubber! Must speak to Lorival about it!”

RUBBER OR PLASTICS?

- ★ *While each material possesses its own characteristics, in many applications one is as suitable as the other, and in these times of scarcity it is as well to have this in mind. Firms in need of components, complete articles or packaging should seek our advice, which is based upon wide experience and specialized knowledge. We produce articles in rubber and ebonite as well as plastics, and our service includes design and manufacture.*



LORIVAL PLASTICS

UNITED EBONITE AND LORIVAL LIMITED, LITTLE LEVER, NEAR BOLTON, LANCs



We at Rediffusion try to be modest, but we really must tell you this story. A man came in to see us the other day—said he had an airport and that he wanted some wireless for it. So we asked him why he had come to us and he replied that he liked our up-and-coming youthfulness, and that when up-and-coming youth enters a business like the communications field—well, they've just got to be good. "Youth!" we exclaimed, "We've been turning out first-class communications gear for over ten years." "That's young enough for my money," he replied, "When can I have delivery?"

Here's a picture of our Redifon G40, a 500/800 watts M.C.W. and Telephony transmitter which is suitable for ground/aircraft communications services, Navigational Radio Beacons for airways and sea routes, and broadcasting on medium and short waves.



Redifon RADIO

Communications Division
REDIFFUSION LTD., BROOMHILL ROAD, S.W.18
 Designers and Manufacturers of Radio Communication and Industrial Electronic Equipment. Scientific RC102

- H.T. SUPPLIES**
to small receiving and large transmitting valves.
- L.T. CHARGERS**
And trickle chargers of all types.
- H.F. APPLICATIONS**
Detection, A.V.C., modulation and demodulation. Frequencies up to 1500kC.
- MEASURING INSTRUMENTS**
Units for use with all types of measuring instrument from 100 μ A upwards.

WESTINGHOUSE **WESTALITE RECTIFIERS**

Write or details to Dept. E.E., WESTINGHOUSE BRAKE & SIGNAL CO. LTD., 82, York Way, King's Cross, London, N.1.

Here's your new record library!



1955

Every record enthusiast needs this new lightweight portable IM RAK. Holds up to 50 records, 10in. and 12 in., yet requires little more space than a medium-sized table lamp. Every record easy to get at. Every division individually numbered. Records held firmly in position, by resilient sprung steel divisions specially covered with plastic material, and each record cushioned at points of contact. Finished in a wide choice of gay modern colours. And as your record library grows you can add on new racks, just like a unit book-case. Available now at most good record shops. Price 29/6d. plus 6/5d. purchase tax. Optional dustproof plastic cover 7/9d. plus 1/3d. purchase tax.

For details of your nearest supplier write to Alfred Imhof Ltd., 112, New Oxford Street, London, W.C.1. Museum 5944.



MADE BY THE MAKERS OF THE FAMOUS IM LONG-PLAYING NEEDLES.



The World's largest
manufacturing, marketing and
contracting group concerned
with electrical transmission
and distribution, radio and
telecommunication equip-
ment.

BRITISH INSULATED CALLENDER'S CABLES LIMITED
NORFOLK HOUSE, NORFOLK STREET, LONDON, W.C.2

WHERE THEY USE BAKELITE LAMINATED



Chassis of television receiver, type V.114, by Murphy Radio Ltd., showing components which rely on Bakelite materials for insulation.

No. 6—TELEVISION RECEIVER, Type V.114, by Murphy Radio Ltd

BAKELITE Laminated is used by leading radio and television manufacturers for general and special-purpose insulating jobs because it combines a large number of essential properties. It has high strength-to-weight ratio . . . is uniform in structure . . . can be punched and machined to fine limits using ordinary

tools. In service it gives excellent electrical properties . . . has low moisture absorption, good dimensional stability and resists heat, oil, acids and most chemicals. It is available in sheets up to 4 inches thick, and rods and tubes.

TREFOIL
BAKELITE  **PLASTICS**

REGD. TRADE MARKS

Essential Materials for Essential Work

BAKELITE LIMITED · 18 GROSVENOR GARDENS · LONDON · S.W. 1

MARCONI Mastery of Measurement

makes its Communications Test Gear the instinctive choice of the Radio Engineer.

FOR IMMEDIATE DELIVERY

VARIABLE ATTENUATOR

TYPE TF 338B

This instrument is a continuously variable attenuator of sensibly constant input impedance suitable for audio frequency measurements. The decibel scale is virtually linear and the internal elements are screened from external fields by the metal panel and case. Further particulars of this typically dependable Marconi instrument on request.

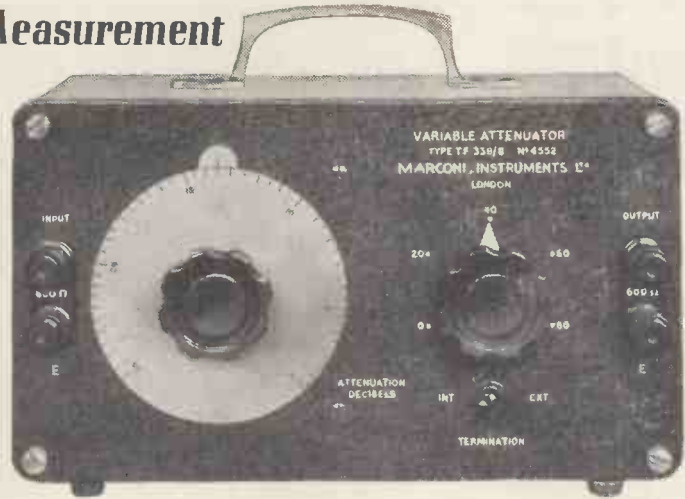

Brief Specification of Variable Attenuator:
 Range: 0-105dB in steps
 Input Impedance: 600 ohms

See us at **RADIOLYMPIA**
 STAND NO. 226



MARCONI INSTRUMENTS LTD

ST. ALBANS, HERTFORDSHIRE Phone: St. Albans 6161/5

Northern Office: 30 ALBION STREET, HULL. Hull 16144

Western Office: 10 PORTVIEW ROAD, AVONMOUTH, BRISTOL. Avonmouth 438

Southern Office: 109 EATON SQUARE, LONDON, S.W.1 Sloane 8615

NIFE All Steel Batteries



- Containers, Terminals and even the Plates are made of steel and practically indestructible.
- Active material totally enclosed.
- Completely inert on open circuit and does not suffer from local action and standing loss.
- No corrosive fumes.
- Alkaline electrolyte non-corrosive to all cell parts, including terminals.

That's why there is **MORE LIFE** in a **NIFE**

Now available for all purposes except private radio and private cars.

NIFE BATTERIES LIMITED • REDDITCH • WORCS.

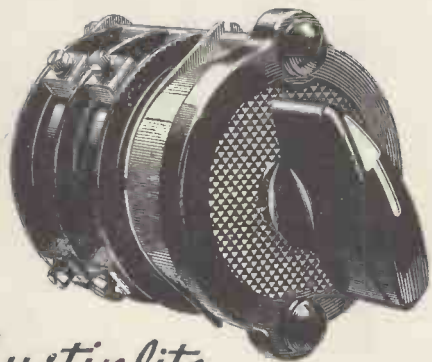

Austinlite
ROTARY SWITCH

A new, heavy-duty 30 amp. switch of robust construction suitable for multi-circuit operations and capable of giving a long and trouble-free life. Can be built up into 1, 2, 3, 4 or 5-cell units providing a large range of contact combinations. Send for folder giving full particulars.

Made by
AUSTINLITE LTD.
(Department 3).
LIGHTHOUSE WORKS
SMETHWICK
BIRMINGHAM

Chance

PRODUCT

(Proprietors: CHANCE BROTHERS LTD.)

MORE POWER AT LESS COST WITH THE *NEW*

MULLARD **SILICA** TECHNIQUE

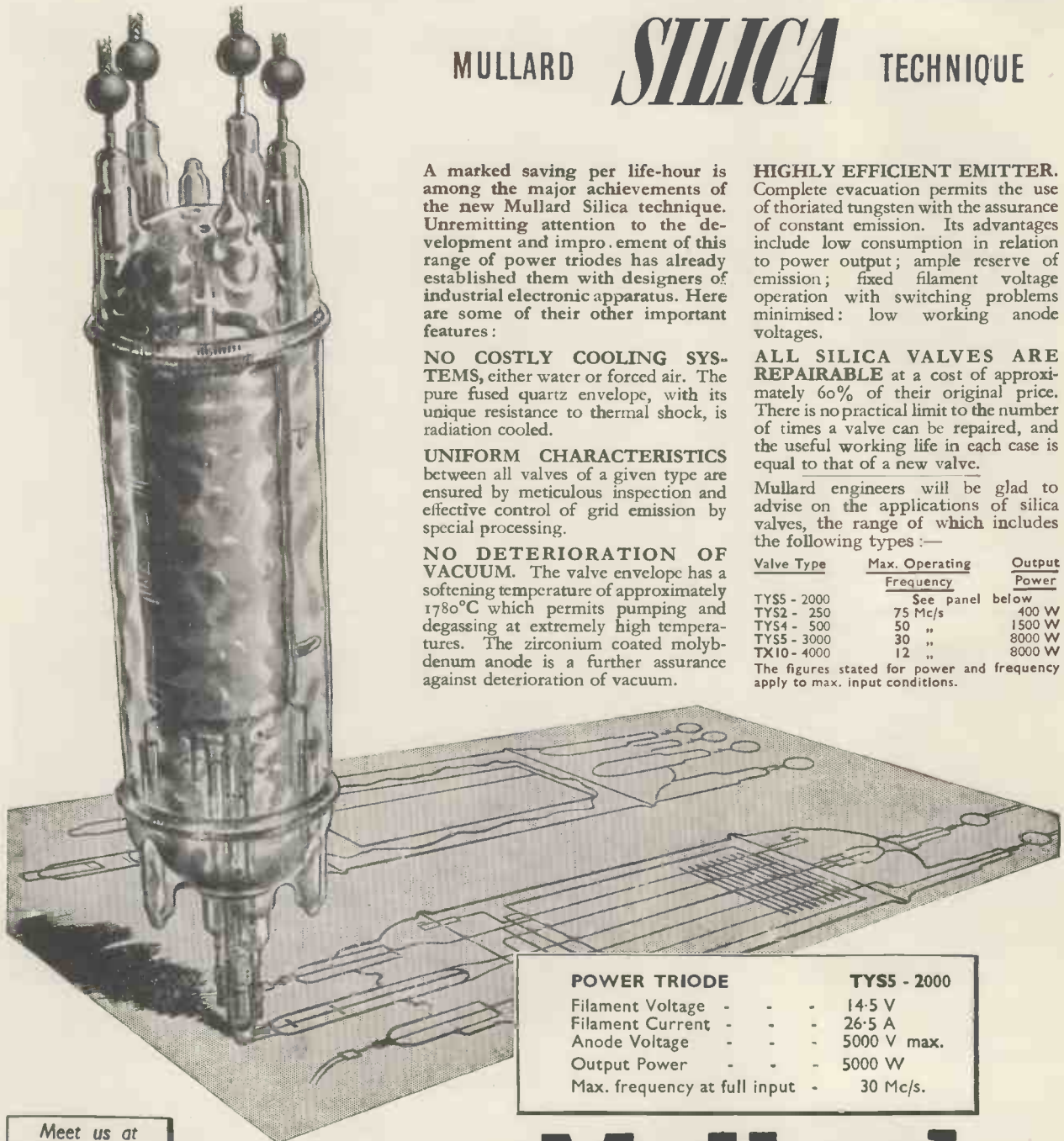

A marked saving per life-hour is among the major achievements of the new Mullard Silica technique. Unremitting attention to the development and improvement of this range of power triodes has already established them with designers of industrial electronic apparatus. Here are some of their other important features:

NO COSTLY COOLING SYSTEMS, either water or forced air. The pure fused quartz envelope, with its unique resistance to thermal shock, is radiation cooled.

UNIFORM CHARACTERISTICS between all valves of a given type are ensured by meticulous inspection and effective control of grid emission by special processing.

NO DETERIORATION OF VACUUM. The valve envelope has a softening temperature of approximately 1780°C which permits pumping and degassing at extremely high temperatures. The zirconium coated molybdenum anode is a further assurance against deterioration of vacuum.

HIGHLY EFFICIENT EMITTER. Complete evacuation permits the use of thoriated tungsten with the assurance of constant emission. Its advantages include low consumption in relation to power output; ample reserve of emission; fixed filament voltage operation with switching problems minimised: low working anode voltages.

ALL SILICA VALVES ARE REPAIRABLE at a cost of approximately 60% of their original price. There is no practical limit to the number of times a valve can be repaired, and the useful working life in each case is equal to that of a new valve.

Mullard engineers will be glad to advise on the applications of silica valves, the range of which includes the following types:—

Valve Type	Max. Operating Frequency	Output Power
TY55 - 2000	See panel below	
TY52 - 250	75 Mc/s	400 W
TY54 - 500	50 "	1500 W
TY55 - 3000	30 "	8000 W
TX10 - 4000	12 "	8000 W

The figures stated for power and frequency apply to max. input conditions.

POWER TRIODE

Filament Voltage	- - -	14.5 V
Filament Current	- - -	26.5 A
Anode Voltage	- - -	5000 V max.
Output Power	- - -	5000 W
Max. frequency at full input	- - -	30 Mc/s.

TY55 - 2000

Meet us at
RADIOLYMPIA
OCT 1-11

Mullard
THE MASTER VALVE



THE MULLARD WIRELESS SERVICE CO. LTD., TRANSMITTING & INDUSTRIAL VALVE DEPT., CENTURY HOUSE, SHAFTESBURY AVENUE, LONDON, W.C.2

PLOTTING THE COURSE IN TOMORROW'S WORLD

In the world of tomorrow, as in the world of yesterday and today, Marconi's will carry forward the tradition of meticulous workmanship in wireless communications apparatus.

New problems have been met as they have arisen by a team of experts with all the experience of a pioneer organisation behind them. Still newer problems are now arising in a post-war world. These too will be handled with the same resourceful skill. Whatever the demands of a new age — you know where you are with Marconi.

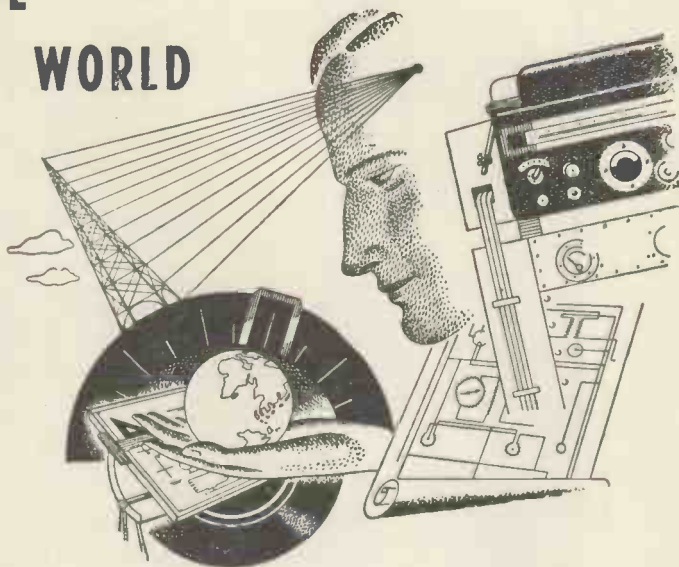

Marconi

THE GREATEST NAME IN WIRELESS



MARCONI'S WIRELESS TELEGRAPH COMPANY LTD · THE MARCONI INTERNATIONAL MARINE COMMUNICATION COMPANY LTD · MARCONI HOUSE, CHELMSFORD, ESSEX



RHODIUM IN TELE-COMMUNICATION ENGINEERING

Rhodium offers many technical advantages to the tele-communication engineer.

The Johnson Matthey organisation provides a consultative service backed by a processing unit equipped to handle specialised apparatus or quantity produced components.

One of the specialised services of

Johnson Matthey

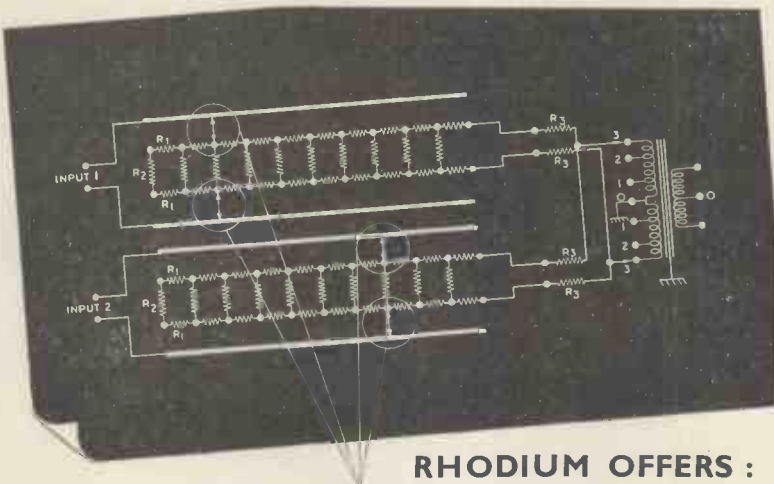

Data Sheet No. 2053 gives further information of our services in this field.

RHODIUM OFFERS :

- Freedom from contact noise.
- Low contact resistance.
- Low contact pressure.
- Constant contact performance.
- Long contact life.
- Simplified contact design.

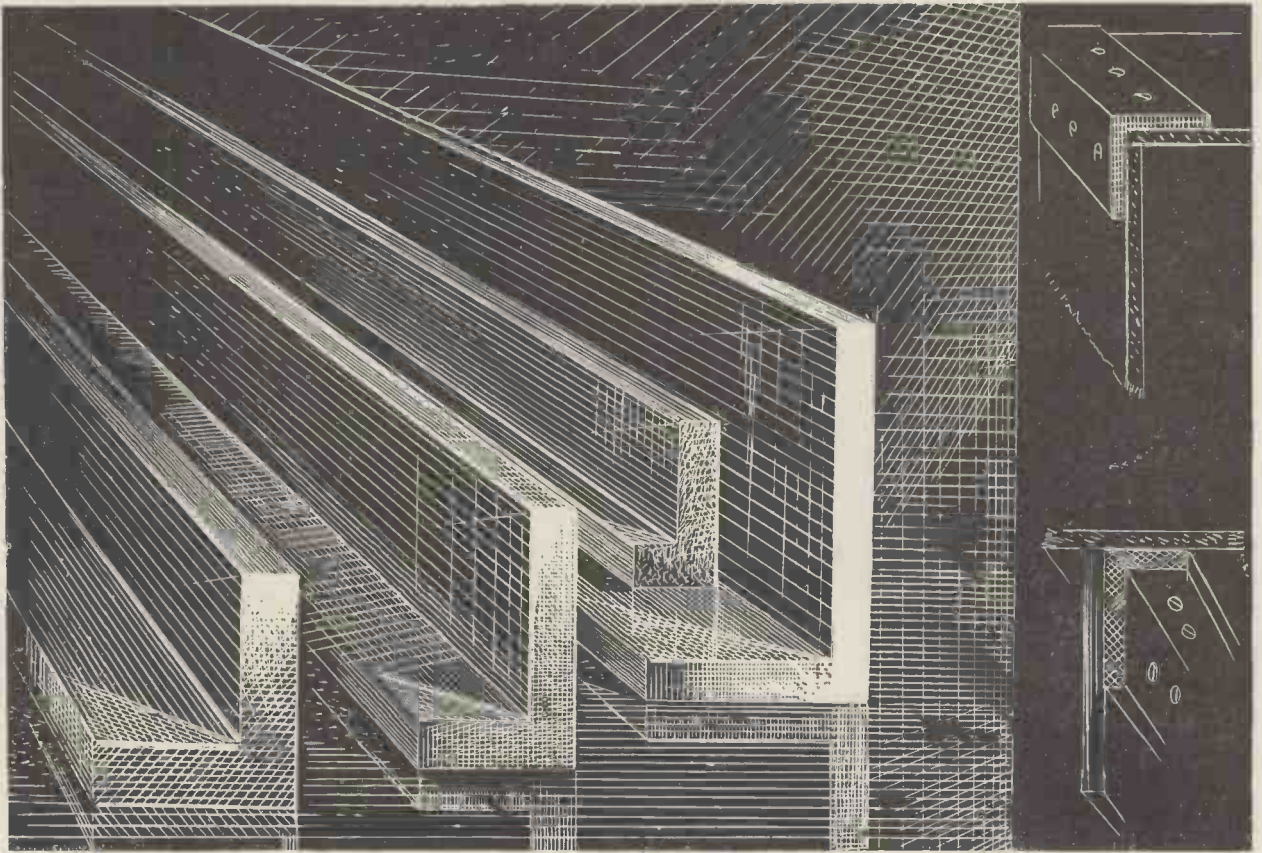

this is TUFNOL ANGLE

a material for engineers

Angle Tufnol provides a convenient way of fixing two sheets of Tufnol at right angles to one another, and may be used as brackets or small right-angle parts. Like other forms of Tufnol — sheets, tubes, rods, bars and channels—it is light yet mechanically strong, it is a good electrical insulator, it resists corrosion and can be machined easily.

Angle Tufnol is made in lengths of approximately 48" and with sides of from $\frac{1}{4}$ " x $\frac{3}{8}$ " up to $5\frac{7}{8}$ " x $5\frac{7}{8}$ " and thicknesses of from $\frac{1}{16}$ " up to $\frac{3}{8}$ ".

An ELLISON Product
TUFNOL LTD
 PERRY BARR BIRMINGHAM 22B



5 mmf/ft

NEW LOW LEVELS in capacity and attenuation of CO-AX Cables mean new possibilities in electronic equipment design both for the war effort and for the post-war electronic age.

Write for characteristics

BASICALLY BETTER AIR-SPACED

CO-AX LOW LOSS CABLES
TRANSRADIO LTD. 16 THE HIGHWAY-BEACONSFIELD-6-BUCKS.



THE "FLUXITE QUINS" AT WORK

'With FLUXITE, I'm an ace
 At soldering things in place
 Don't look alarmed
 Our set's not harmed
 I want to hear more bass !'

For all **SOLDERING** work—you need **FLUXITE**—the paste flux—with which even dirty metals are soldered and "tinned." For the jointing of lead—without solder; and the "running" of white metal bearings—without "tinning" the bearing.

It is suitable for **ALL METALS**—excepting **ALUMINIUM**—and can be used with safety on **ELECTRICAL** and other sensitive apparatus.

With Fluxite joints can be "wiped" successfully, that are impossible by any other method

Used for over 30 years in Government Works, and by leading Engineers and Manufacturers, OF ALL IRONMONGERS—**IN TINS**—10d., 1/6 and 3/-.



The "Fluxite Gun" puts Fluxite where you want it by a simple pressure. Price 1/6, or filled 2/6

ALL MECHANICS WILL HAVE

FLUXITE

IT SIMPLIFIES ALL SOLDERING

Write for Leaflets on **CASE HARDENING STEEL** and **TEMPERING TOOLS** with **FLUXITE** also on "WIPED JOINTS." Price 1d. each.

FLUXITE LTD. (Dept. T.V.) Bermondsey St., London, S.E.1

TELCON^{RF} CABLES
 for all Television and Radio Requirements

CABLE CHARACTERISTICS

CODE	Z ₀	CAPACITY	ATTENUATION
PT29M	68	21.5 μμ F	At 1Mc/s 0.16 db/100Ft
	74 ohms	per foot	" 10 " 0.52 " " "
			" 100 " 1.7 " " "

DIAMETER:—0.330 ins. TYPE:—"TELCO" Dielectric Flexible. PVC Sheath

Further details of this and other R.F. Cables on application

THE TELEGRAPH CONSTRUCTION & MAINTENANCE CO. LTD.
 Founded 1864
 Head Office: 22 OLD BROAD ST., LONDON, E.C.2. Tel: LONDON Wall 3143
 Enquiries to TELCON WORKS, GREENWICH, S.E.10. Tel: Greenwich 1040



BEAT FREQUENCY OSCILLATORS

LELAND INSTRUMENTS LTD

—for priority requirements only, at present. Write for particulars stating frequency range required.
 21, JOHN STREET, BEDFORD ROW, LONDON W.C1
 TELEPHONE: CHANCERY 8765

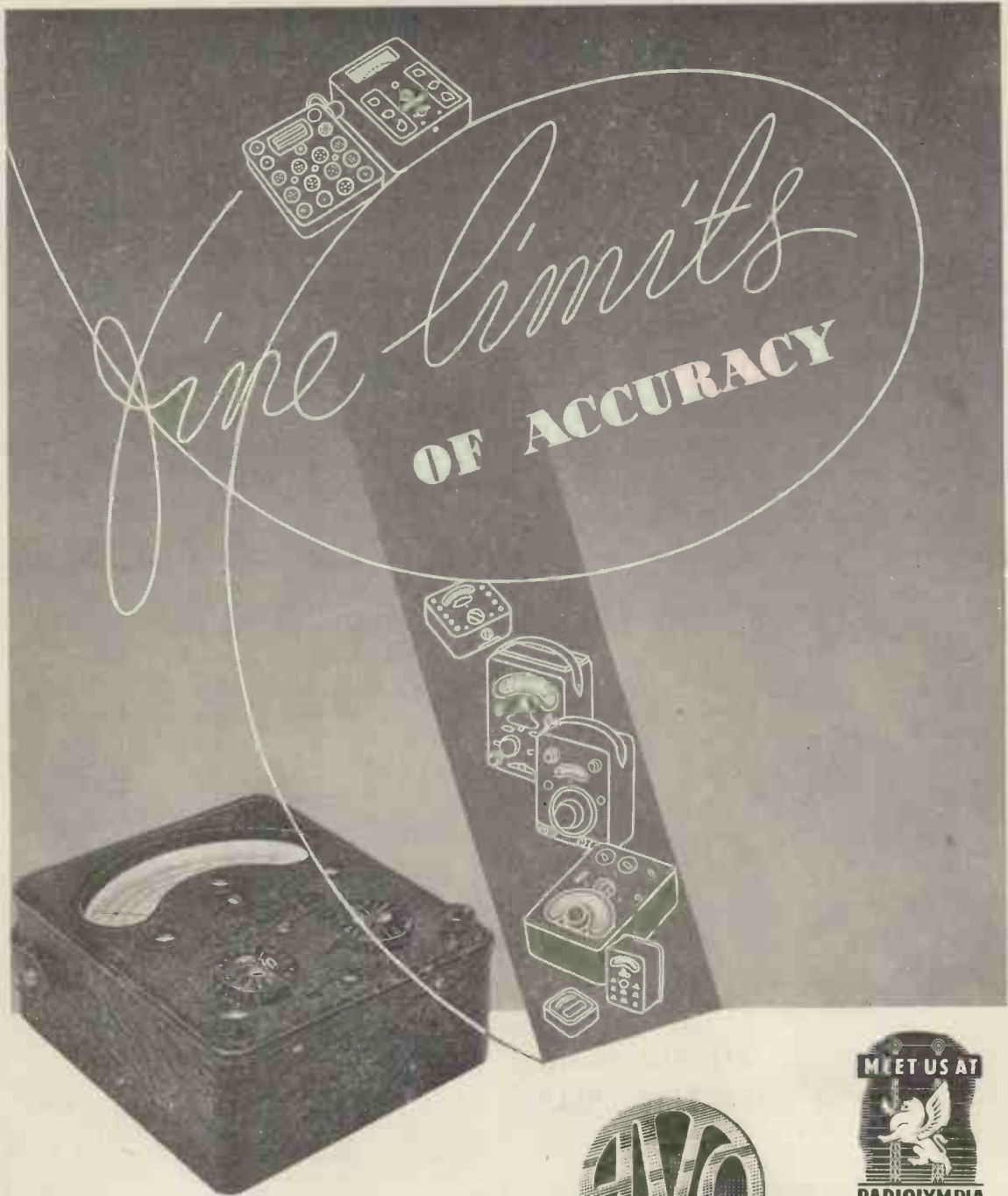

The 50-range Model 7 Universal AvoMeter, the pioneer of the comprehensive range of "Avo" precision Instruments, is the world's most widely used combination electrical measuring instrument. Fully descriptive pamphlet available on application to the Sole Proprietors and Manufacturers:—



Electrical Measuring Instruments

THE AUTOMATIC COIL WINDER & ELECTRICAL EQUIPMENT CO., LTD.
 WINDER HOUSE · DOUGLAS STREET · LONDON · S.W.1 TELEPHONE: VICTORIA 3404/9

WHY

IRON POWDER?

To improve the performance of inductances; to permit a smaller coil to be used and thereby to decrease manufacturing costs; to vary easily the inductance of coils by means of movable powder-iron cores; to pre-set fixed inductances to accurate limits.



WHY

CARBONYL IRON POWDER?

Because the carbonyl process produces a powder with the appropriate characteristics required by core-makers. Because each particle is spherical and the powder has therefore a high packing density, and is easily insulated. Because no heat treatment at high temperatures after pressing is required.

WHY

TWO GRADES?

Because two grades cover the majority of requirements. *Grade ME* is very fine and hard, spherical and remarkably uniform; primarily suitable where electromagnetic losses are required to be very small, and especially for high-frequency applications. *Grade MC* is also fine and spherical but is softer and therefore more easily compressible. Useful in cases where higher permeabilities are required. Further information freely given on request.

The Mond Nickel Company, Limited

Grosvenor House, Park Lane, London, W.1

13B/M/1



SELENIUM PHOTO ELECTRIC CELLS

FOR LIGHTMETERS, EXPOSURE METERS, COLOUR METERS, DENSITOMETERS, REFLECTOMETERS, LABORATORY AND SCIENTIFIC INSTRUMENTS OF ALL KINDS.

INVITATION

You are cordially invited to bring us any problem in connection with Selenium Photo Electric Cells and their application.

MEGATRON LTD. (Laboratories)

115a, Fonthill Road, LONDON, N.4. ARChway 3739.

SMALL GEARED MOTOR UNITS

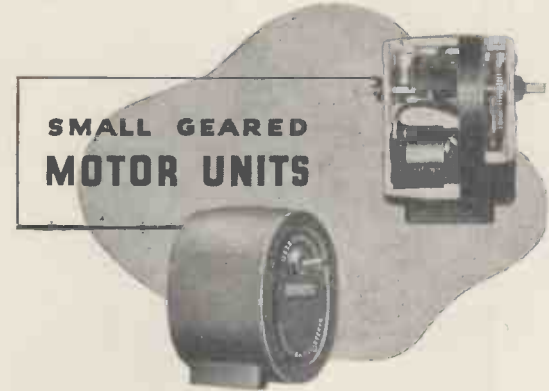

The Drayton "R.Q." is a 25-watt motor unit geared to a final shaft, to which may be fitted eccentrics, arms or cranks, gears, links or pulleys for actuating valves or dampers, movements, switchgear or other devices.

Unidirectional or reversing, with or without self-switching, for 100/110 or 200/250 volts A.C.

Both types are fitted with an auxiliary two-way switch actuated by movement of the final shaft, for operating auxiliary gear such as fan motors, pumps, interlocking devices, etc.

FINAL SHAFT SPEEDS

Reversing Max 600 R.P.M. 27 min. per rev.
Unidirectional Max 280 R.P.M. 60 min. per rev.

TORQUE: Reversing 60lbs. in. max.
Unidirectional 37lbs. in. max.

Send for List 302-1/M

(RQ4) Drayton Regulator & Instrument Co., Ltd., West Drayton, Mdx.

for

OPERATING VALVES
DAMPERS, RHEOSTATS,
CINEMA PROJECTORS,
ROTATING SCREENS,
ILLUMINATED SIGNS,
SMALL WORKING
MODELS,
GENEVA MOVEMENTS
DRUM-TYPE SWITCHES,
ROCKING BATHS, WORK
MOVEMENT, SOLDERING
& WELDING FIXTURES,
CONTINUOUS TURNING,
FEED OF LIGHT STRIP
UNDER PROCESS.

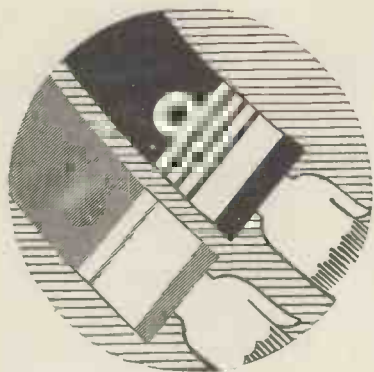

Sleevings

**TO BRITISH ADMIRALTY
AND AIR MINISTRY
SPECIFICATIONS**

Distinctive markings denoting rank! In Delaflex Sleeveings the function of every lead in the most elaborate circuit can be clearly recorded. A wide range of single colours, stripes and multiple colours is available in the various grades, viz., Varnished Cotton, Varnished Art. Silk and Rolled Silk. Produced in bore diameters from 0.5mm.

FULL DETAILS ON REQUEST

Delaflex
INSULATING SLEEVINGS

DE LA RUE INSULATION LIMITED
Imperial House, Regent Street, London, W.1, England
Tele: Regent 2901 Telegrams: Delinsul, Piccy, London

PARMIETKO TRANSFORMERS



* TELEPHONE - LEICESTER 32287

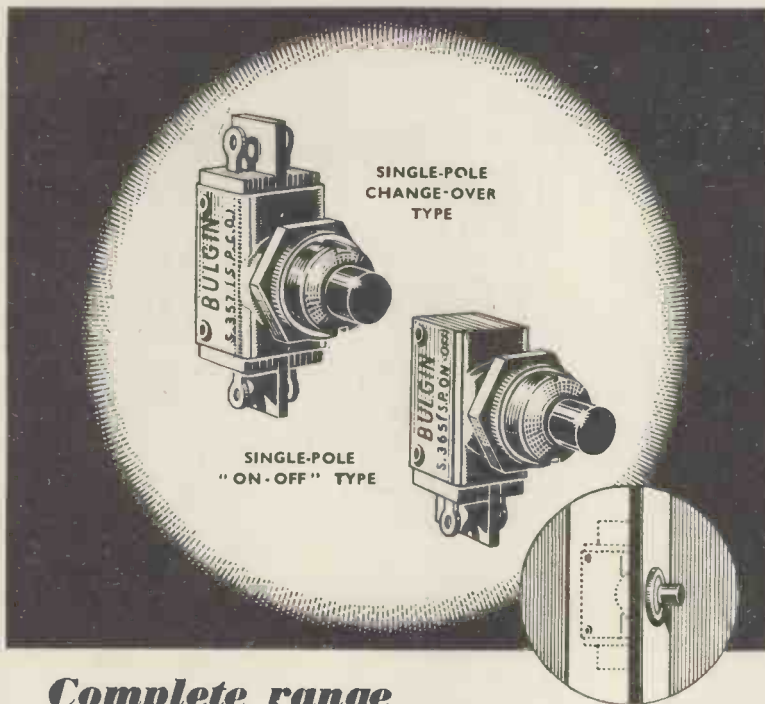

Complete range of press switches

High quality Bulgin switches especially suitable for refrigerators and other equipment where circuit is required on opening or closing of the apparatus. S. 365 is a single-pole, 3 amp. toggle lever switch with push-"On" position, circuit being maintained whilst the knob is depressed. On release of pressure the switch returns to "Off" position. For 250 V. A.C. or D.C. circuits; max. test voltage 1,000 *peak*. Fixing by single 15/32" diam. hole for panels up to 3/16"; solder tags for connection. Other types available are:—

S.357 S.P.C.O., 250V. 2A., biased to one position.

S.358 S.P., ON-OFF, 250V. 3A., biased to "OFF," 6 B.A. terminal connections.

S.359 S.P., ON-OFF, 250V., 3A., biased to "ON," 6 B.A. terminal connections.

S.366 S.P., ON-OFF, 250V., 3A., biased to "ON," tag connections.

"The Choice of Critics"

BULGIN

A. F. BULGIN & CO. LTD. · BYE-PASS-RD. · BARKING

Telephone: RIPpleway 3474 (5 lines).

HILL & CHURCHILL,
Booksellers **LTD.**
SWANAGE, DORSET

ENGLISH & AMERICAN
BOOKS IN STOCK ON
RADIO AND
TELECOMMUNICATION

Catalogue on Application

THE ROMAC MODEL 126
"Personal" RECEIVER



The Romac Personal Receiver is an entirely new departure in portable radio. The shoulder strap method of carrying has ingeniously been used to provide an "invisible" aerial. This convenient feature is exclusive to Romac models.

Price £17 3s. 8d. Plus £3 16s. 4d. P. Tax.
Complete with 1 H.T. and 2 L.T. Batteries.

Home and Export Enquiries should be directed to:
ROMAC RADIO CORPN. LTD.
THE HYDE · HENDON · LONDON, N.W.9
Tel. No.: COLindale 5401 (Three lines).

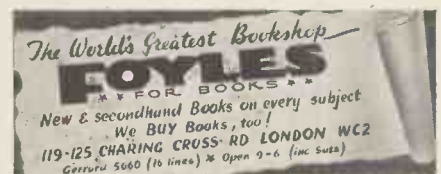

NEW DUAL TESTSCOPE

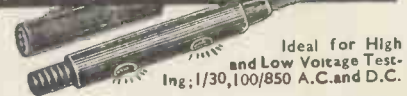

Ideal for High
and Low Voltage Test-
ing: 1/30, 100/850 A.C. and D.C.

Send for interesting leaflet L24 on
Electrical and Radio Testing, from all Dealers or direct.

RUNBAKEN · MANCHESTER · I

**R.R. DEVELOPMENT
LABORATORIES LTD**

Electronic
Engineering
Specialists
83, BARNARD RD - BRADFORD

CLASSIFIED ANNOUNCEMENTS

The charge for miscellaneous advertisements on this page is 12 words or less, 5/- and 4d. for every additional word. Box numbers count as four words, plus 1/- extra for replies. Remittance should accompany advertisement. Cheques and P.O.'s payable to Morgan Brothers (Publishers) Limited, 28 Essex Street, Strand, London, W.C.2. Replies to box numbers should be addressed as above, marked "Elec. Engg." Press date: 10th of month for following issue.

FOR SALE

IN STOCK. Rectifiers, Accumulator Chargers, Rotary Converters, P.A. Amplifiers, Mikes, Mains transformers, Speakers of most types, Test Meters, etc. Special Transformers quoted for.—University Radio, Ltd., 22, Lisle Street, London, W.C.2. GER. 4447.

EX-R.A.F. Loran sets with 5-in. electrostatic C.R.T., with time base. 26 valves, including 6SN7, 6H6, 6J7, and calibrated 100 kc. crystal. Suitable for conversion to oscilloscope, £10. Apply Box 050, "Elec. Engg."

SURPLUS TO CONTRACT. Large quantity Wire and Laminations for disposal at cost. Gauges 40 to 17 S.C., S.C.C., Enamel, etc. Lam. sizes MEA 24A, 26A, 29A, 59A, 15A and 4. £500 lots. GERARD 6632. K. S., 161, Wardour Street, W.1.

WIRE RECORDER, unrepeatable, one only. Completely portable, mike, etc., for receiving, playback, wipe-out. Incorporating supersonic bias. Best offer ever £85. Box 104, "Elec. Engg."

FOR SALE. Brand new Marconi U.S.W. Signal generator, type T.F.390G. As delivered from Marconi. In full working order. Apply Box 100, "Elec. Engg."

LOUDSPEAKERS

LOUDSPEAKERS—We carry on. Sinclair Speakers, 12, Pembroke Street, N.1.

LOUDSPEAKER repairs, British, American, any make, moderate prices.—Sinclair Speakers, 12, Pembroke Street, N.1.

MISCELLANEOUS

ALL GUARANTEED brand new 3/029 twin flat electric cable, braided and compounded, 250 volt. Best make, both V.I.R. and P.V.C. Special sample offer £2 per 100 yards C.W.O. Trade supplied. Indispensable in garages, workshops, foundries, farms and everywhere where electricity is used. Large discounts for quantities. Also large stocks of Aeroplane, automobile, flexibles, ignition, lighting, multicore, radio, screened, starter cables at exceptionally keen prices. Write for list and give details of requirements to Box 2159, G.T.C. 82/94 Seymour Place, London, W.1, Addington 3456.

WE WILL BUY at your price used radios, amplifiers, converters, test meters, motors, pick-ups, speakers, etc., radio and electrical accessories. Write, phone or call. University Radio Ltd., 22, Lisle Street, London, W.C.2. GER. 4447.

HOTOGRAPHY BY BEHR will show your product at its best. Ask for illustrated list. 44, Temple Fortune Lane, London, N.W.11. SPEdwell 4298.

MONOMARKS. Permanent London Address. Letters redirected. Confidential. 5/- p.a. Royal Patronage. Write Monomark BCM/MON04S, W.C.1.

WEBB'S Radio Map of the World enables you to locate any station heard. Size 40 in. by 30 in. 2-colour pavy Art Paper, 4/6, post 6d. Limited supply on linen, 10/6, post 6d.—Webb's Radio, 14, Soho Street, London, W.1. 'Phone: GERard 2089.

MORSE Practice Equipment for Class-room or Individual Tuition. Keys Audio Oscillators for both Battery or main operation. Webb's Radio, 14, Soho Street, London, W.1. 'Phone: GERard 2089.

ELICITY and Leak "Point One" Amplifiers. Now from stock. Literature and demonstrations on request. J. P. Short, 87a, Upper Richmond Road, S.W.15. 'Phone: PUTney 1665.

COPPER WIRE. Enamelled, tinned, cotton, silk-covered, 16-46 S.W.G.; screws, nuts, washers, soldering tags, eyelets, rivets, ebonite and laminated bakelite panels, coil formers, covered wires, flexes, crystals, permanent detectors, earphones, etc. List available. Trade supplied. Post Radio Supplies, 33, Bourne Gardens, London, E.4.

THE PROPRIETORS of British Patent No. 557,675, relating to Improved Device for Measuring Force Electrically, are desirous of entering into arrangements by way of licence or otherwise on reasonable terms for the purpose of exploiting the same and ensuring its full development and practical working in this country. Interested parties who desire a copy of the Patent Specification and further particulars, should apply to E. Matthews of 14/18, Holborn, London, E.C.1.

ELECTRICAL AND RADIO apparatus and precision instrument making to specification. Prototypes and experimental gear, etc. Inquiries invited. Box 109, "Elec. Engg."

PUBLIC APPOINTMENTS

THE AIR MINISTRY has vacancies for a number of Male Civilian Instructors in the following trades:—

Radar Mechanics (Air)
Radar Mechanics (Ground)
Wireless Mechanic
Wireless Operator Mechanic
Wireless Electrical Mechanic
Wireless Operator
Wireless/Teleprinter Operator
Teleprinter Operator.

Preference will be given to former R.A.F. instructors and tradesmen and any other ex-servicemen possessing the requisite experience. The posts available are at the R.A.F. Radio Schools at Compton Bassett and Yatesbury in Wiltshire, at Cranwell, Lincs, and Hedsford, Staffs.

Successful applicants will be engaged on a temporary non-pensionable basis only, but will be guaranteed employment for three years subject (after a probationary period of three months) to efficiency and conduct being satisfactory. Inclusive rates of pay are as follows:—

Civilian Instructor, Class I: £400 by £15 to £460 per annum.
Civilian Instructor, Class II: £350 by £15 to £410 per annum.

Application should be made to the Appointments or Local Offices of the Ministry of Labour and National Service, from whom further particulars may be obtained.

THE CIVIL SERVICE COMMISSIONERS invite applications for the post of Senior Principal Scientific Officer in the Radio Department of the Royal Aircraft Establishment, Farnborough, Hants, under the Ministry of Supply.

Candidates should be British subjects, born on or before 1st August, 1915. They should have a first- or second-class Honours Degree in Physics or Mathematics and must also produce evidence of outstanding attainments and research experience in the field of radio frequency devices and phenomena. A wide knowledge is required of current researches on propagation, circuit design, radiators, etc., at all frequencies from very long wavelengths to centrimetric wavelengths, together with ability to carry out and direct further theoretical and practical investigations.

The successful candidate will be required to take charge of a section carrying out research on fundamental problems arising from the other sections of the Radio Department which are engaged on developments in the fields of communications, navigational aids, remote control, tracking and telemetering, radio components and materials for the Royal Air Force, the Naval Air Arm, etc., and to act as consultant to these sections. The appointment is permanent with superannuation benefits under the Federated Superannuation System for Universities and carries salary on the inclusive scale £1,320, rising by annual increments of £50 to £1,520, less provincial differentiation varying from £80 at the minimum to £85 at the maximum. Rates for women are somewhat lower.

Forms of application are obtainable from the Secretary, Civil Service Commission, Scientific Adviser's Branch, 27, Grosvenor Square, London, W.1, quoting No. 1962, to whom completed application forms should be returned not later than 18th September, 1947.

SITUATIONS VACANT

TELECOMMUNICATION ENGINEERS wanted by large company in south-east London for development work on audio and carrier frequency equipment. Preferably Honours graduates in communication engineering or in physics, with at least two years' experience in telecommunication laboratory. Sound theoretical training essential. Salary according to qualifications and experience. Reply to Box 079, "Elec. Engg."

FERRANTI LIMITED require for Vacuum Physics Laboratory Physicists or Engineers, graduates or with equivalent qualifications, preferably with experience of electronic vacuum work or U.H.F. valves. Application forms from Personnel Manager, Ferranti Limited, Ferry Road, Edinburgh, 5.

DEVELOPMENT AND RESEARCH Engineer required by radio manufacturers S.E. London district with commercial radio and television experience. Apply in strict confidence stating age, qualifications and experience to Box 077, "Elec. Engg."

DRAUGHTSMAN, with some experience in light electrical engineering, required for work on prototype equipment in connection with television transmitters. Apply by letter only, stating age, qualifications and experience, to the Director, Research Laboratories of the General Electric Co., Ltd., North Wembley, Middlesex.

ELECTRONIC ENGINEER with degree and 5/10 years' experience in the designing and development of cathode ray tubes, valves and other electronic devices. Experience in electron-optical investigations especially desirable. The post offers ample scope in a broad field of activity. Apply, stating age, full details of experience and salary required, to Box No. 102, "Elec. Engg."

ELECTRONIC ENGINEER, degree standard, and some years' experience in vacuum physics and thermionics for development work on transmitting valves and cathode ray tubes. Good opening for junior engineer who wishes to widen experience and improve position. Apply, stating age, full details of experience and salary required, to Box 101, "Elec. Engg."

ST. DUNSTAN'S require physicist or electrical engineer with honours degree for research work on electronic guiding and reading aids for blind people. In addition to a sound theoretical knowledge, applicant should preferably have some experience in circuit techniques. Initial salary in the region of £400 p.a. according to qualifications, with F.S.S.U. Reply to: St. Dunstan's Research Department, 8 Hinde Street, W.1.

PHYSICIST REQUIRED for research and development work. Good Honours Degree and experience in electronics essential. Excellent working conditions. 5-day week. Applications in writing to The Secretary, Boulton Paul Aircraft, Ltd., Wolverhampton.

APPLICATIONS are invited for the position of Senior Engineer to take charge of a laboratory, principally engaged upon the design and development of electronic devices. Applicants should hold first-class honours degree in Engineering or Science and have had at least six years' development experience. Salary range, £700 to £900 per annum, according to qualifications and experience. Applications should be addressed to the Personnel Manager, Airmec Laboratories, Cressex, High Wycombe, Bucks.

DRAUGHTSMEN with experience of production drawing in connection with commercial radio and allied apparatus required by large light engineering concern in the East London area. Write, stating age, experience and salary required, to Box No. 111, "Elec. Engg."

DRAUGHTSMEN. Senior Development Draughtsman, with experience on the design for mass-production of commercial radio and allied apparatus, required by large manufacturer in the East London area. Applicants should state age, experience and salary required to Box No. 110, "Elec. Engg."

SENIOR ESTIMATORS required for production estimating in a large engineering company engaged in the radio component industry. Suitable men must be capable of complete breakdown of prices. Write, stating age, experience and salary required, to Box 099, "Elec. Engg."

THE DECCA NAVIGATOR CO., LTD., require a Development Engineer for design and layout of mobile and static ground transmitting stations. Previous experience essential. Salary will be based on qualifications and experience. Applications, in the first instance, should be in writing addressed The Decca Navigator Co., Ltd., 1/3, Brixton Road, London, S.W.9. Please quote reference S.E.

SENIOR DESIGN-DRAUGHTSMAN, with production experience of radio required by a progressive radio factory, North-West London. Permanent post to suitable applicant. Reply, stating details of experience, age and salary required to Box 112, "Elec. Engg."

CLASSIFIED ANNOUNCEMENTS (CONT.)

RESEARCH AND DEVELOPMENT Division of London firm requires Engineer with experience on the electrical and mechanical design of small servo mechanisms. Write, stating age, experience and salary required, to Box 096, "Elec. Engg."

THE FOLLOWING VACANCIES exist in a South London firm:—

- (a) Radio Engineer capable of design of audio-frequency equipment, knowledge of high power amplification essential, experience of acoustic problems desirable.
- (b) Engineer for maintenance of all laboratory test gear and calibration of all meters, knowledge of bridge measurements desirable.
- (c) Electrical Tester for routine production testing of electronic equipment, experience in fault-finding essential. If capabilities warrant suitable applicant would be given charge of section.
- (d) Panel Wiremen (or women) capable of working directly from theoretical circuit diagrams.

Apply, giving particulars of age, experience, qualifications and salary required, to Box 098, "Elec. Engg."

ELECTRONIC ASSISTANT for construction and maintenance of amplifiers, oscilloscopes and other laboratory equipment. Apply in writing to the Personnel Office, De Havilland Engine Co., Ltd., Stonegrove, Edgware, Middlesex.

UNIVERSITY COLLEGE OF SWANSEA. The Council of the College invites applications for the post of Laboratory Assistant in the Department of Engineering, who will be required to act as Steward in the engineering laboratories. Experience in radio construction work would be an advantage. Wages, £5 per week, rising by annual increments of 5s. per week, to a maximum weekly wage of £6. Applications, stating age and experience, together with copies of two recent testimonials, should be forwarded to the Registrar, University College, Singleton Park, Swansea.

UNIVERSITY COLLEGE OF SWANSEA. The Council invites applications for an Assistant Lecturer in the Department of Engineering. Salary, £450 per annum. Qualifications in electrical engineering and radio are essential. Further particulars may be obtained from the Registrar, University College, Singleton Park, Swansea, by whom applications must be received without delay.

PHYSICS OR ELECTRICAL Engineering Graduate, preferably under 25, required for research and development work on centimetre wave receivers, with special reference to crystal mixers. Apply by letter only, stating age and qualifications, to the Director, Research Laboratories of the General Electric Co., Ltd., North Wembley, Middlesex.

TEST GEAR SUPERINTENDENT required for expanding radio component factory, Suburban Surrey. Qualifications: Degree or equivalent. Previous experience in mechanised testing desirable. Salary, £500 per annum, upwards, according to qualifications and experience. Box 085, "Elec. Engg."

ADVERTISER, Manchester area, desires to contact young man with some knowledge of physics and electronic experimental work, physiological research. State experience and remuneration expected. Telephone Sale 5378. Box 095, "Elec. Engg."

IMPORTANT GROUP of Companies entering new field requires the services of a fully qualified radio receiver designer. Applicant must have experience in the latest techniques in short-wave communication receiver design. Apply Box 094, "Elec. Engg."

GLASS BLOWER for vacuum physics laboratory. Experience hand glass blowing or machine glass work. Good salary and prospects. Apply Personnel Manager, Ferranti, Edinburgh, 5.

RADIO DEVELOPMENT ENGINEER (senior), salary £450 to £600 per annum, required by modern radio manufacturers in West London area. Preference given if experienced in receiver design work. Write full particulars to Box 093, "Elec. Engg."

LARGE ENGINEERING company in London requires senior mechanical draughtsmen with experience on the design of light mechanisms. Must be able to work with minimum supervision on interesting new developments. Good practical and technical experience essential. Write, stating age, experience and salary required, to Box 092, "Elec. Engg."

DRAUGHTSMEN and Engineers with experience of the design of radio components and allied components, required by large engineering concern in East London area. Write, stating age, experience and salary required, to Box 091, "Elec. Engg."

CARRIER TELEPHONY Development Engineer required, Manchester area, for work on centimetric carrier telephony equipment. Salary, £550 to £650 per annum, according to qualifications. Reply, giving full particulars, to Cossor Radar Limited, Chadderton, Nr. Oldham.

DRAUGHTSMEN required for development and jig and tool D.O.'s, familiar with electronic equipment construction, Oldham area. Apply, giving full particulars of experience, qualifications and salary required, to Box 090, "Elec. Engg."

DRAUGHTSMEN DESIGNERS required by engineering organisation in West London. First-class senior mechanical and electrical design draughtsmen wanted, preferably with experience in radio and radar drafting. Salaries up to £500. A minimum of five years' drafting experience essential. Interesting work and excellent working conditions. Applications will be treated in strict confidence. Apply, giving age, fullest details of experience, etc., to Chief Draughtsman, Box 088, "Elec. Engg."

COIL ROOM SUPERVISOR required by radio manufacturer. Experience in R.F. coils winding and light assembly work essential. Knowledge of coil test an advantage. Opportunity if willing to learn conveyor assembly. Good salary and prospects for right man. Write full particulars, experience, salary required, etc., to Box 087, "Elec. Engg."

YOUNG MAN required to start as laboratory assistant. Preference given to one with desire to undertake private study in radio theory and with useful service experience in radar. Box 084, "Elec. Engg."

CHIEF OF TEST required for organisation specialising in electronic measuring instruments. Sound theoretical training essential and at least three years' experience in a technical executive position in a telecommunication factory. Write, stating age, experience and salary required, to Box 103, "Elec. Engg."

DEVELOPMENT ENGINEER required for laboratory investigation and measurements in connection with development of cables for radio frequencies. University degree or equivalent. Salary up to £400 per annum. Apply Personnel Manager, Standard Telephones and Cables Limited, North Woolwich, E.16.

TELECOMMUNICATIONS ENGINEER required by Standard Telephones and Cables Limited, North Woolwich, E.16, for the design and development of radio frequency testing equipment for carrier telephone and television cables. Applicants should possess an honours degree in engineering or physics and have had experience on comparable work. Salary up to £450 per annum according to qualifications and experience. Apply Personnel Manager.

A TECHNICAL PUBLISHER can offer a senior position to a technically trained man with a good knowledge of the radio and electrical industry. Age 30-35. Knowledge of advertising desirable but not essential. First-class references to names well known in the industry must be given. State salary required. Box 105, "Elec. Engg."

ENGINEER, 27-35 years, with first-class all-round technical knowledge and education, also sound commercial outlook and experience, required for sales promotion of electronic equipment in Great Britain and Europe. Products manufactured U.S.A. for European market will also become available in this country and include radio transmission, radar and special electronic apparatus for research. Reply in confidence, giving full particulars age, education, experience and salary required. Box 107, "Elec. Engg."

THE DECCA NAVIGATOR CO., LTD., requires Technical Assistants for: (A) Design and development work on mobile and static ground transmitting stations. Previous experience of station, transmitter, power supply and control circuit design essential; and (B) circuit design and development work. Previous experience of circuit design essential. Mathematics to degree standard desirable. Salaries will be based on qualifications and experience. Applications in the first instance should be to the Decca Navigator Co., Ltd., r-3, Brixton Road, London, S.W.9. Quoting reference "S.E.1" for (A) and "S.E.2" for (B).

SITUATIONS WANTED

ADAPTABLE ex-R.A.F. Technical Signals Officer (25), single, with 9 years' experience in ground and air radio equipments, also some commercial service, research and technical correspondence work, seeks progressive post in radio industry. Moderate salary acceptable initially if hard work and initiative are rewarded. Own car. Box 083, "Elec. Engg."

WELL-KNOWN RADIO ENGINEER, M.I.E.E. desires another managerial post in industry or with a Trade Association, etc., in which his abilities and knowledge of the industry can be used to the full. Experience of radio, radar, television and electronic instrument development and production. A good responsible post with real prospects is required. Box 086, "Elec. Engg."

WELL-KNOWN ENGINEER, age 41, over 20 years' experience high executive positions radio engineering England, America, Continent, available immediately in London area. Box 086, "Elec. Engg."

A.M.I.E.E., etc. (32) requires high executive position with scope, radio or light electrical organisation preferably overseas. Twelve years' experience administration, production, design. Experience in organising new factories. Box 089, "Elec. Engg."

A POSITION as Executive i/c Development Technical Assistant to management sought by physicist, 29, B.Sc., A.Inst.P., Grad. I.E.E. Prospect essential. Experience light electrical and high vacuum, including five years mass-production. Box 097 "Elec. Engg."

TEST GEAR ENGINEER, 30, A.M.Brit.I.R. with scope, radio or light electrical organisation preferably overseas. Experience in design of test and measuring equipment, also production of all types of radio equipment, seeks responsible position. Box 100, "Elec. Engg."

ARMY RADIO MECH. INSTRUCTOR, 22, keen amateur, well educated, requires progressive post Demob. January. Box 103, "Elec. Engg."

TUITION

A.M.I.E.E. Examinations. Electrical engineering lecturer (B.Sc. (Eng.) Hons. A.M.I.E.E.) specialises in private individual tuition. Vacancies for April 19 exam. Personal or correspondence. Box 052, "Elec. Engg."

SPEECH DISABILITY: Mr. H. V. Hemery consults at Wigmore Hall Studios, Wigmore Street, W.1.

A.M.I.E.E., City and Guilds, etc., on "NO PASS NO FEE" terms. Over 95 per cent. successes. Full details of modern courses in all branches Electrical Technology send for our 112-page handbook—FREE and post free. B.I.E.T. (Dept. 337B), 17, Stratford Place, London, W.1.

TO
Chief Buyers
of
INDUSTRIAL
ORGANISATIONS



TELE-RADIO (1943) LTD. for high grade radio and electronic components. Suppliers to the Government, Services, Universities and Training Colleges, Local Authorities (for own use), Industrial Organisations, etc. Buyers requiring components in a hurry will find it quicker and more economical to phone PADDINGTON 6116 (quoting official order number). Goods can be despatched usually same day.

TELE-RADIO DEVELOPMENT LTD. Suppliers to the Government of communication and electronic prototypes. Ample facilities available for development and construction where imaginative design and highest grade workmanship are of paramount importance.

Specialists in miniaturisation.

Catalogue 6d. Post Free

TELE-RADIO (1943) LTD.,
177 Edgware Road,
LONDON, W. 2.

Telephone: PADDINGTON 6116-5606

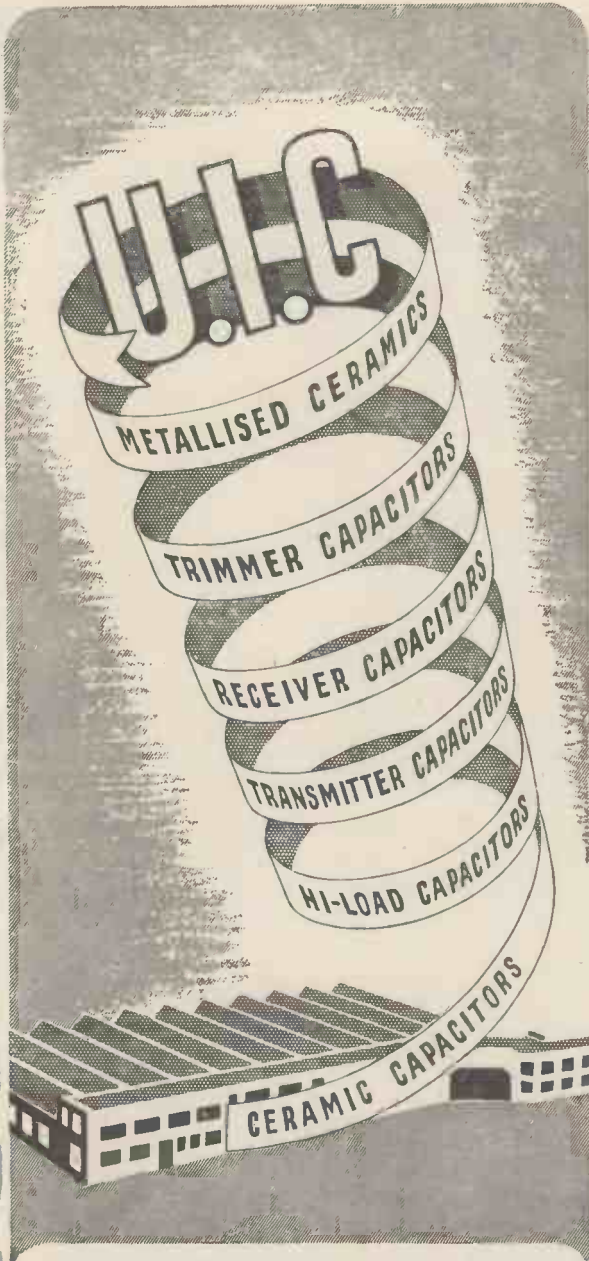

UNITED INSULATOR CO. LTD.

OAKCROFT RD., TOLWORTH, SURBITON, SURREY

Telephone: Elmbridge 5241

Telegrams: Calanel, Surbiton

Unsurpassed

In

Ceramics

BELLING-LEE 'QUIZ' (No. 9)

Answers to some of the questions we are continually asked by letter and telephone



Q. 25. If an aerial has been up for several years, will it need overhaul?

A. 25. Belling-Lee aerials, both Skyrod and *television, are normally made of steel, zinc plated and "passivated" to improve corrosion resistance. Even under ideal conditions you couldn't expect much zinc to be left after six or seven years. These aerials are normally fixed directly in the sulphurous fumes from chimneys, and subjected to all weathers, the very conditions which accelerate corrosion.

When we point out that steel bridges, lamp posts and park railings are all painted regularly and tell people that their aerials cannot last for ever, they seem surprised.

It is much more necessary to protect a slender steel tube subjected to far worse conditions. Our recommendation is to have the aerial lowered once a year, certainly not less than once in two years, giving the

whole thing, together with its lashings and brackets, a good coating of paint, bitumastic if possible. At the same time examine the feeder for chafing where it goes round corners, over gutters, etc. If you are within the Greater London area, the Belling-Lee installation department will quote you for this service.

Q. 26. Will a Skyrod aerial in an exposed coastal position withstand South-West gales?

A. 26. We know of many Skyrods in such locations, right on the sea front or on cliff tops, but no case has been reported to us of one breaking off through wind. We do know of a very few cases where a "Skyrod," through neglect, has rusted badly and bent over. Generally speaking, a steel rod will stand up to a lot of punishment. In Enfield there is a Belling-Lee communication dipole on the roof of the police station. A land mine came down across the road, demolishing a church and many houses, but the dipole was undamaged. It is surprising the number of vertical aerials standing on chimney stacks in Berlin, where the chimney stack is all that remains of the premises.

* VIEWROD (Regd. Trade Mark) U.K. Patent 519883, 526587, 520628
L 502L (As illustrated) less mast £5 12s. 6d.
L 336 Feeder, extra 7½d. per yard.

BELLING & LEE LTD
CAMBRIDGE ARTERIAL ROAD, ENFIELD, MIDDX



The Research Engineer knows that the best speaker for any set is one that offers complete reliability plus true tonal fidelity. After exhaustive tests his advice is always the same —fit Rola and relax !

ROLA SPEAKERS
THEIR QUALITY SPEAKS FOR ITSELF

BRITISH ROLA LTD., 8 UPPER GROSVENOR STREET, LONDON, W.1