

Electronic Engineering

INCORPORATING ELECTRONICS, TELEVISION AND SHORT WAVE WORLD

PRINCIPAL CONTENTS

British Army Radio Photographs
High Frequency Therapy
Dust Cored Coils — Part 2
Fluorescent Lamps
Input Admittance Compensation

2/- SEPT., 1943

GE CALLOY RADIO CORES

An All-British product—the result of extensive research and development carried out during the last 15 years.

MAIN ADVANTAGES

- Greater magnification
- Higher selectivity
- Small size
- Reduced costs
- Robust construction
- Simple adjustment
- Non-rusting

SALFORD ELECTRICAL INSTRUMENTS LTD.

PEEL WORKS, SALFORD, 3. Telephones: BLAckfriars 6688 (6 lines). Telegrams and Cables: "Sparkless, Manchester"

PROPRIETORS: THE GENERAL ELECTRIC Co. Ltd., OF ENGLAND

Going one better

IN COMMUNICATIONS



To-day, wherever Bullers Low Loss Ceramics are used, reception is clearer and better than ever before.

Years of research in Bullers Laboratories have developed these materials to such a high level of efficiency that Dielectric Loss is virtually eliminated. Bullers Ceramics are now playing a vital part in maintaining communications under all conditions.

BULLERS LIMITED

THE HALL, OATLANDS DRIVE, WEYBRIDGE, SURREY
 Telephone: Walton-on-Thames 2451
 Manchester Office: 196 Deansgate, Manchester

Made in Three Principal Materials:

FREQUELEX. An Insulating material of Low Dielectric Loss. For Coil Formers, Aerial Insulators, Valve Holders, etc.

PERMALEX. A High Permittivity Material. For the construction of Condensers of the smallest possible dimensions.

TEMPLEX. A material of medium permittivity. For the construction of Condensers having a constant capacity at all temperatures.

Bullers

LOW LOSS CERAMICS



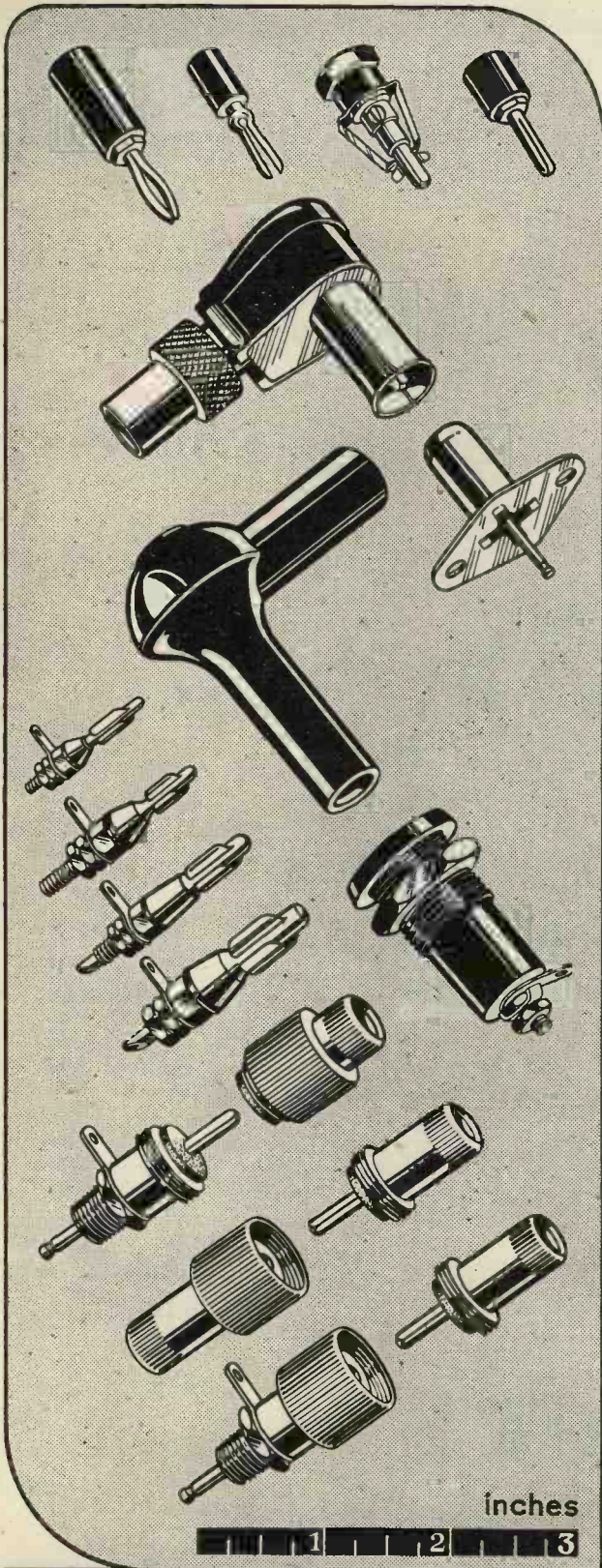

BELLING & LEE LTD
 CAMBRIDGE ARTERIAL ROAD, ENFIELD, MIDDX

**TUCKER
 EYELETS**

AND TAGS.

GEO. TUCKER EYELET CO. LTD.
 WALSALL ROAD, BIRMINGHAM, 22
 Phone: BIRchfields 5024

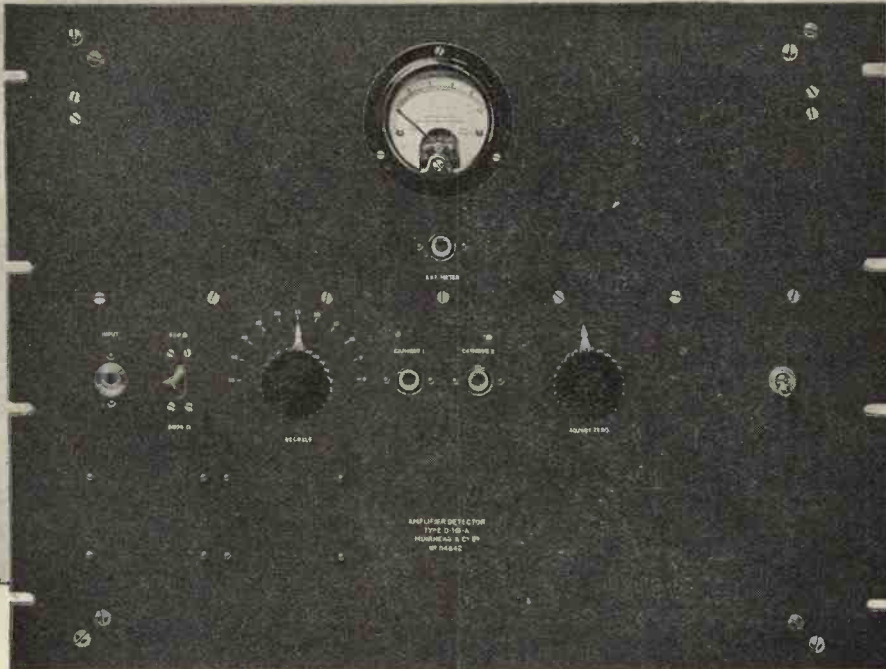

AMPLIFIER-DETECTOR TYPE D-161-A

This Amplifier-Detector is recommended as a balance detector for A.C. bridges and similar equipment operating in noisy surroundings or at other than audio frequencies.

Ample gain is available for the most sensitive measurements and the indicating meter is automatically protected from damage by excessive input voltages.

BRIEF SPECIFICATION

VOLTAGE SENSITIVITY: 5 microvolts for 600 ohms input impedance.

FREQUENCY

CHARACTERISTIC: Flat within 3 db from 40 c.p.s. to 20 kc/s.

INPUT CONTROL: 50 db in 10 steps of 5 db.

INPUT TRANSFORMERS: Two balanced and screened input transformers having primary impedances of 600 ohms and 6,000 ohms respectively selected by a switch. (Other values can be supplied to order.)

AMPLIFIER: High gain resistance-capacitance coupled amplifier with stabilized anode supply.

POWER SUPPLY: 200 to 250 V 50 c.p.s.

DIMENSIONS: 19" x 10½" x 7" for mounting on standard telephone rack.

WRITE FOR BULLETIN B-551-A

MUIRHEAD

MUIRHEAD & COMPANY LTD., ELMERS END, BECKENHAM, KENT. TEL. BECKENHAM 0041-2.

FOR OVER 60 YEARS DESIGNERS AND MAKERS OF PRECISION INSTRUMENTS

COMMUNICATIONS, DEPEND....

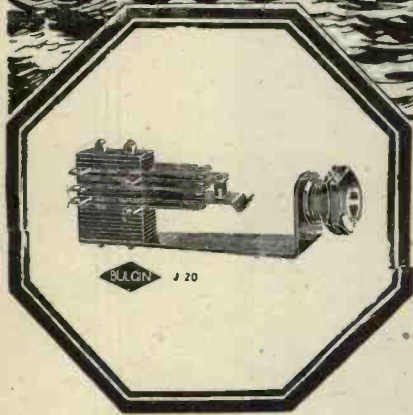
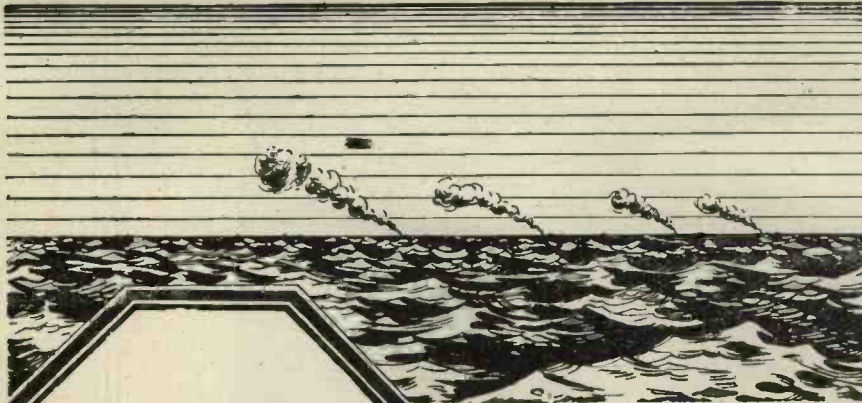

ON SMALL PARTS....

In countless instances quite intricate pieces of apparatus are wholly dependent on the proved reputation and reliability of their component parts.

All products from the House of Bulgin are pre-eminent for superior design and workmanship, and every article bearing our Trade Mark has to pass exacting and exhaustive tests during the course of its production.

We ask the kind indulgence of the public on delivery until peaceful conditions return.

The Choice of Critics

BULGIN

FOR

JACKS

A large and comprehensive range of Jacks, standard to B.S.S. 666, fixing with single $\frac{3}{8}$ " hole to panels 0.036—0.250" thick; single-, double-, and triple-pole, with and without switching. Only $2\frac{1}{4}$ " rear depth. 'Panel-area' taken up = $\frac{9}{16}$ " \times $\frac{3}{4}$ " average. Best bakelite insulation, nickel-silver leaves, silver switching-contacts.

"The Choice of Critics"

BULGIN

REGISTERED • TRADE • MARK

A. F. BULGIN & CO. LTD., BY-PASS RD., BARKING, ESSEX

Tel. Rippleway 3474 (4 lines)

★
MOLYBDENUM

the

**material
for
High
Temperature
Work**

★
VACTITE

are the makers
of
**WIRES, RODS
& TAPES**

for
**Lamps, Valves
and Furnaces**

exact to Specifications.



VACTITE WIRE CO. LTD.
19 QUEEN ANNE'S GATE, WESTMINSTER, S.W. 1
TELEPHONE: WHITENALL 2552

There are

THOUSANDS OF USES

for



METAL RECTIFIERS

Electronic devices need a supply of reliable D.C. power if they are to be operated efficiently. Westinghouse have 17 years experience in the design and production of reliable and efficient rectifiers, and can supply the unit for your job.

Supplies available against priority orders only
Westinghouse Brake & Signal Co., Ltd.
 Pew Hill House, Chippenham, Wilts.

STABILITY
in all your Electrical Instruments

Advance

CONSTANT VOLTAGE TRANSFORMERS

ADVANCE COMPONENTS LTD.
 BACK RD. SHERNHALL ST. LONDON, E.17. Tel: LARKSwood 4566-7

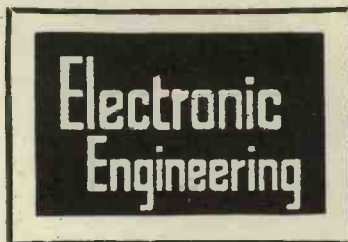

SEPTEMBER, 1943

Volume XVI.

No. 187.

CONTENTS

	PAGE
Editorial	139
British Army Radio	140
High Frequency Therapy	142
Input Admittance Compensation	145
A Monoscope for Testing C.R. Tubes	148
September Meetings	148
Dust Cored Coils—Part 2	149
Fluorescent Lamps	154
Supersonics	158
Matrix Algebra—Part I	160
A Resistance, Inductance and Capacitance Tester	162
Television After the War	164
Short-time Contact from Slow Moving Gears	165
Characteristics of Decibel Meters	166
Electronic Music Group Notice	167
Lubrication of Mechanisms and Automatic Devices	167
Notes from the Industry	168
Abstracts of Electronic Literature	170
Patents Record	172
Book Reviews	174

CONDITIONS OF SALE—This periodical is sold subject to the following conditions, namely, that it shall not without the written consent of the publishers first given, be lent, re-sold, hired out or otherwise disposed of by way of Trade except at the full retail price of 2/- and that it shall not be lent, re-sold, hired out or otherwise disposed of in a mutilated condition or in any unauthorised cover by way of Trade, or affixed to or as part of any publication or advertising, literary or pictorial matter whatsoever.

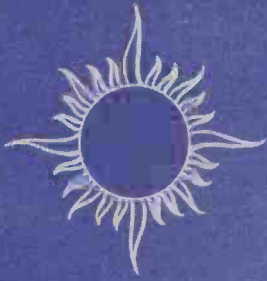

SYMBOLS OF PRECISION

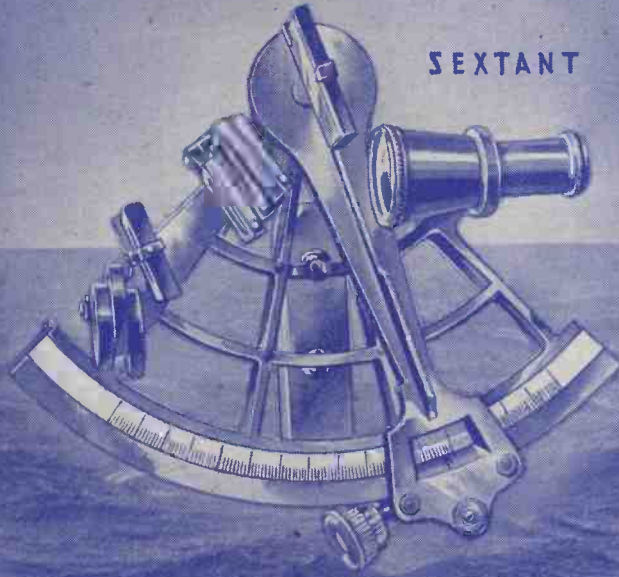

SEXTANT



MAZDA

RADIO VALVES

THE EDISON SWAN ELECTRIC CO. LTD.



155, CHARING CROSS RD., LONDON, W.C.2

For full particulars write to Technical Service Department

Electronic Engineering

PROPRIETORS:
HULTON PRESS LTD.,

EDITOR
G. PARR.

EDITORIAL, ADVERTISING AND PUBLISHING OFFICES, 43-44, SHOE LANE, LONDON, E.C.4

TELEPHONE:
CENTRAL 7400

Monthly (published last day of preceding month) 2/- net. Subscription Rates: Post Paid to any part of the World—3 months, 6/6; 6 months, 13/-; 12 months, 26/-. Registered for Transmission by Canadian Magazine Post.

TELEGRAMS:
HULTONPRES LUD
LONDON.

Boosting

READERS of the American technical journals which continue to reach this country will have noticed the enterprising way in which the advertisements have been adapted to make the utmost of the present manufacturing position.

Raw material suppliers, component makers, and wholesalers are all hinting at the new and wonderful developments which will be released to the post-war world as a direct result of the work which has been done over the past few years.

Mysterious suggestions are made about the adaptation of Radar experience to future needs—new words are coined ("electroneer it!")—the housewife is told that the electron tube will mind her baby in the post-war Utopia—and 'men of electronics' will be able to pick their own industry.

These advertisements are presumably intended for the technical reader and not for the general public. This is just as well, as the man in the street might gather from reading them a confused idea of houses heated electronically, domestic walkie-talkies, or radio-location adapted to finding lost collar studs.

The technical reader, on the other hand, will appreciate exactly how many developments are directly

attributable to war requirements. If he has read through the technical literature of 1937—1939 he will probably have found most of the new devices foreshadowed or even described in an experimental form, and will realise that their present state of perfection is due to an intensive speeding-up of development under abnormal conditions.

The technical man may also ask himself how much of the experience gained in manufacturing highly specialised war equipment can be applied to the different requirements of a competitive peace-time market.

It is certainly not in the interests of the electronic industry of this

country to play down the developments which have taken place as a result of the war stimulus—in fact it would do well to take a leaf out of the technical journals referred to. But it is suggested that the boosting of electronics as such, regardless of the special applications to which it is best adapted, is not in the interest of the industry.

To the radio dealer it tends to create an impression that the sale of electronic devices is to prove a panacea for post-war trade difficulties, and he may overlook the fact that the sale of special apparatus will involve him in an outlay of time and trouble that he is not prepared to give.

The industrial user may become suspicious if he is invited by all to become electronically-minded, and may even decide that the old fashioned levers and strings are better than an expensive box of tricks.

That there is a vast field for electronics there is no doubt, but it will have to be entered with due care and considerable preparation, and our own trade journals will be doing a service by pointing this out.

This month's postscript will be found on p. 161.

SALVAGE

Catalogues, Instruction Sheets, and Circuit Diagrams which are collected and filed for reference, mount up to a surprisingly large quantity in a comparatively short space of time.

There are probably catalogues in your files which are now out of date together with obsolete circuit diagrams. These would play a vital part in the war effort as paper salvage helps to make munitions.

Will you help by sorting your files at the earliest opportunity and all you can to the salvage sack?

British Army Radio

Views taken at the Army Exhibition in Oxford Street, W.

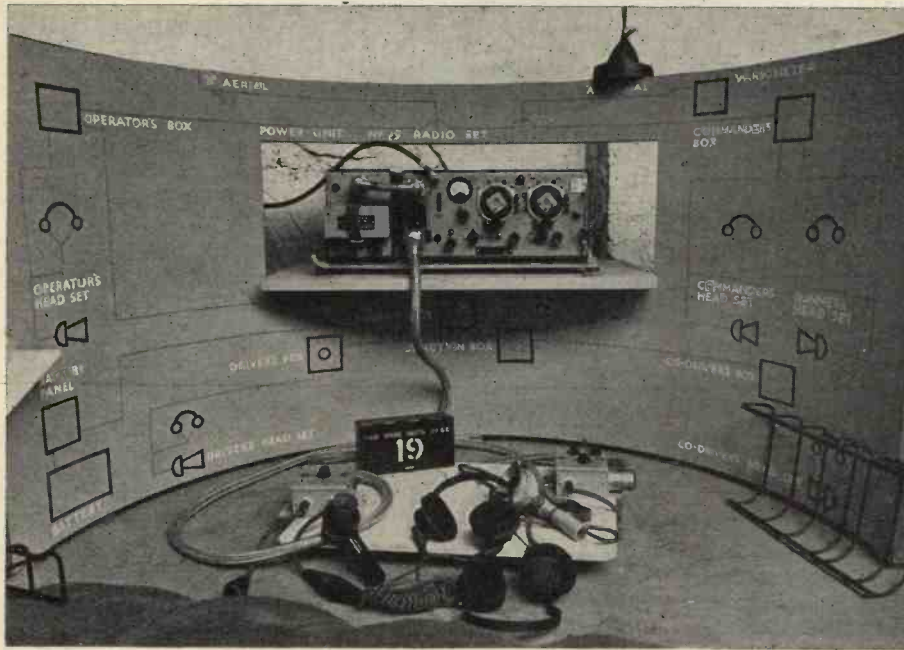

Type 19 Tank Set.

A 15-valve set for three-fold communication: tank—commander; tank—tank; intercomm. in tanks. The aerial is specially sprung to avoid damage by overhead obstructions and the phones are fitted with snatch plugs for quick getaway by the crew.

The display panel shows the layout of the circuit.

The Army Exhibition, which was opened in July last, covers every phase of army life and maintenance in the field, and has attracted large crowds. These photographs were taken in the Radio Communications Section, and are reproduced by permission of the War Office and M.O.I.

Type 21 Transceiver.

For communication between gun batteries, or between batteries and H.Q.

Adopted in succession to the Type 11, it operates from a 6.0 v. accumulator.

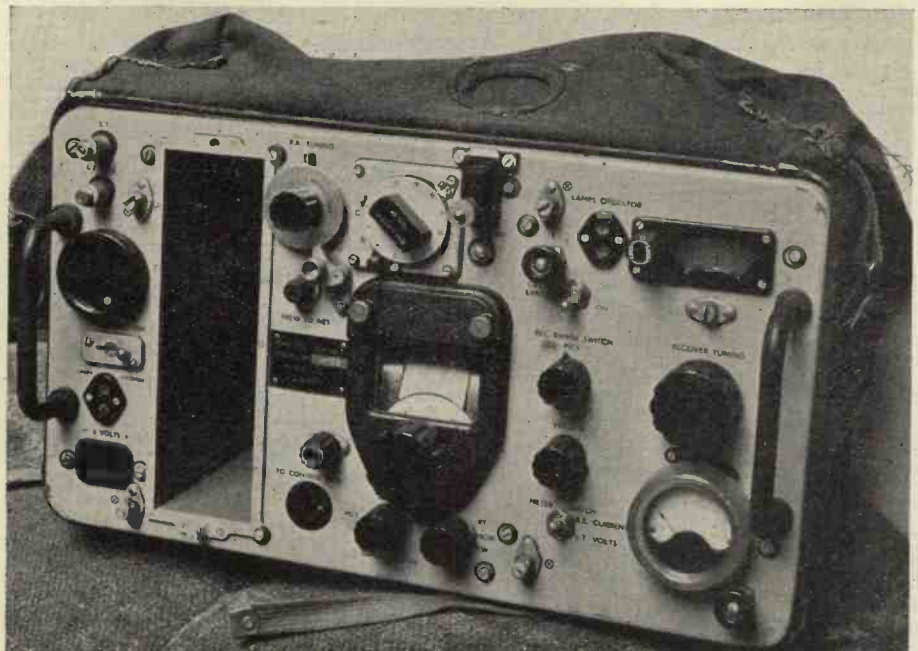



No. 18 Pack Set.

A 7-valve set used by infantry battalions for Morse or radio telephony. The transmitter, receiver, and batteries are mounted in a single case to form a one-man load of 35 lbs., carried on the back.

Type 38 'Personal' Set.

A light transceiver fitted with head phones and laryngaphone for use by paratroops and communication between platoons. It is operated from the dry battery seen at the side.

The carbon-type laryngaphone is shown in the close-up.



Note:

The Exhibition is remaining open till the end of September

High Frequency Therapy

by W. D. OLIPHANT, B.Sc., F.Inst.P. *

Although many articles and papers have appeared on the clinical aspects of electricity in medicine, few have treated the phenomena from the physical viewpoint. The following articles are intended to provide a link between the physical basis and the practical applications of the subject.

Introduction

THE application of electricity to medicine has its origin in the discoveries of Galvani, a physician of Bologna, in the year 1786. In his experiments on electrical discharges and currents he employed, as an extremely sensitive galvanoscope, the lower limbs of a frog, and, by allowing the current to traverse the crural nerve longitudinally, he produced violent muscular contractions when the circuit was made or broken. By increasing the repetition frequency of application a continuous contraction resembling tetanus was produced. About a century later, in 1890 to be precise, Arsène D'Arsonval, experimenting at the Collège de France in Paris, demonstrated conclusively that as the frequency of the applied alternating current increased then the nerve and muscular stimulation effects became progressively weaker until at a frequency of about 10,000 cycles per second such effects were non-existent. Following on this discovery D'Arsonval, with the assistance of a fellow worker, completed a circuit comprising a lamp and generator by joining hands and allowing the resulting current to flow through their arms. The lamp, which required a current of the order of 1 ampere, was lit to full brilliance and the experimenters experienced not a muscular sensation, but a sensation of deep-seated heating in the wrists. Further investigations followed on this heating effect and we attribute to D'Arsonval the origin of diathermotherapy—the science of tissue heating by the direct application of high frequency currents.

Many other investigators entered the field and up to about 1939 over one thousand papers had been published and about a score of text-books written. It is unfortunate, however, that these publications deal largely with clinical investigations and from a scientific view-point must be regarded as of a qualitative nature. The subject is still open to a full and rigorous quantitative investigation before definite conclusions can be made. It is proposed in this series of articles to outline briefly the various physical principles involved; to indicate suitable fields for scientific investigation; to describe the apparatus required and

to give some account of the clinical achievements so far obtained.

Production of Heat by H.F. Currents

In D'Arsonval's experiments it was the heating effect of an h.f. current which received attention and which was soon found to have important curative effects in the human body. Certain investigators went so far as to state that specific action took place at certain critical frequencies and that the heat produced was of no consequence. Whether or not such specific action does in fact take place is still a matter for careful investigation and at the moment it forms a popular subject for controversy. Let us for the moment, then, concentrate on the heating effect which is at any rate a definite phenomenon, but which may or may not in all cases be the root cause of curative action.

At high frequencies, matter may be heated by three types of current, namely (1) conduction current, (2) displacement current and (3) convection current. The particular type of current responsible in a given case will depend on the nature of the substance being treated and on the mode of application of the electrodes which connect the generator to the substance. We shall deal with each type of current in turn.

1. Conduction Current

As the name implies, a conduction current is one which flows in a substance (usually termed a conductor) which is directly connected between a pair of electrodes. By the electronic theory of conduction we define the current flowing as a migration of the free electrons which are present in the substance. Such a flow is brought about by the influence of the applied electric field which accelerates and thereby imparts to the electrons a drift velocity. This drift velocity is superimposed on the inherent random agitation velocities, and, by the simple process of collisions, electrons lose kinetic energy which appears in the form of heat.

The quantity of heat (Q) in calories produced by a current of i amperes flowing through a conductor of resistance r ohms in time t seconds is given by the basic equation,

$$Q = \frac{i^2 r t}{J} \dots \dots (1)$$

where J = Joule's equivalent
= 4.2 joules per calorie.

The quantity of heat produced is thus proportional to the square of the current, to the resistance and to the duration of current flow.

The resulting rise in temperature (θ) is dependent on the mass (m) of the substance and on its specific heat (c) which is a function of its atomic structure. The basic equation relating these quantities is,

$$Q = m.c.\theta. \dots \dots (2)$$

The quantity of heat given by equation (1) must, however, be corrected for thermal radiation, thermal conduction and thermal convection, before the actual temperature rise can be calculated from equation (2). When we come to consider the actual heating of an organ or tissue in the human body it may be readily appreciated how thermal conduction and convection considerably modify the possible temperature rise—the blood stream alone contributing no small convection cooling effect.

From equation (1) we see that a knowledge of the resistance of the substance is essential and as bodies may be of all shapes and sizes we must regard all substances in terms of their specific resistance (ρ) or specific conductance (σ), both being defined in terms of a standard unit cube of the substance.

The problem of conductive heat generation is further complicated by the fact that the resistance is not a constant, but varies both with increase in temperature and with increase in frequency. The effect of temperature on the resistance of a conductor is well known and is governed by the thermal coefficient of resistance. Within limits the increase in resistance may be taken as a linear function of temperature, but the effect on our present problem is negligible. The variation of resistance with frequency on the other hand can contribute a very marked effect especially at very high frequencies. The phenomenon is known as "skin effect" and relates to the manner in which the current concentrates on the outer surface of the conductor in preference to distributing itself uniformly throughout the entire section. This is due to the fact that the inductive reactance of an imaginary elemental filament of the conductor situated on the outer surface is less than that of one situated at the centre. In dealing with this effect as applied to bodily organs and

tissues, we see that the configuration of the organ itself as well as the proximity effects due to currents flowing in adjacent organs renders the effect incalculable.

In general, the human body may be regarded (under this present heading) as an agglomeration of conductive paths of all shapes and sizes and any attempt to resolve it into some simple equivalent circuit would be extremely difficult. We may, however, consider two very simple practical cases of electrode connexions to a complex substance made up of slabs of material of different conductivity. These are shown in Fig. 1.

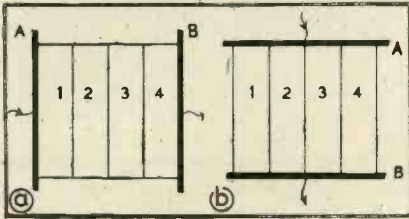

Fig. 1.

We will assume that the conductivity increases progressively from slab 1 to slab 4, that is to say the resistance of slab 1 is greater than slab 2 and so on. In Fig. 1(a) the electrodes A and B are placed in such a manner that they contact the outer faces of slabs 1 and 4. In this arrangement the transverse current will be the same in each slab, and so by equation (1) it follows that the maximum heating effect will take place in slab 1 as it possesses the highest resistance. Consider now Fig. 1(b). In this case the electrodes A and B are placed in contact with the edges of the slabs and so the current will be different in each slab.

Equation (1) may however be rewritten in the form

$$Q = \frac{e^2 t}{r} \dots \dots (3)$$

where e = applied potential difference between A and B.

It thus follows that the maximum heating effect will now take place in the slab of least resistance or greatest conductivity, namely, slab 4. Thus by suitable disposition of the electrodes relative to the body under treatment, we are more or less able to bring about the maximum heating effect where we wish it.

In the foregoing argument, the conduction currents have been brought about by direct contact of the substance with the electrodes. These conduction currents could equally well have been brought about by electro-magnetic induction, the electrodes now being replaced by a coil through which is passing a high frequency current. It is well known that a con-

ductor placed in the alternating magnetic field of such a coil will have voltages induced in it which in turn will produce what are commonly known as eddy currents.

Displacement Current

We have just seen how the possibility of establishing a conduction current is dependent on the presence of free electrons in the structure of the conducting medium, these electrons migrating unidirectionally from atom to atom on applying a potential difference across the ends of the material. In the case of a dielectric, or non-conductor, the number of free electrons is extremely small and so our applied potential difference will only produce a negligible conduction current. It will, however, produce what is known as a displacement current; a transient current which is only apparent while the potential difference is changing. Accepting the fact that a current is brought about by a flow of electrons and realising the fact that we have now no free electrons, then our current must be produced by electron orbital displacement in the atomic structure of the material itself. Fig. 2 shows the mechanism of this effect.

In Fig. 2 we consider a very simple atomic structure comprising the nucleus and one electron which is traversing a circular orbit about the nucleus. In Fig. 2 (a) the electrodes A and B are capable of producing an electric field which is coplanar with that of the orbit whose original position is indicated by (1). On applying a potential difference in such a manner that electrode A becomes positive, we have the orbit displaced to position (2). In Fig. 2(b) the electrodes are so placed that the electric field is normal to the orbital plane and we will get a displacement from position (1) to position (2) as shown. In either case, the net effect when considering the substance as a whole will be for a displacement of the electron orbits giving rise to a resultant transient current—transient because the current is manifest only during orbital displacement. If now we apply an alternating potential difference across AB, we will have produced in the dielectric an alternating displacement current whose value will increase with increase in frequency. This displacement current as in the case of the conduction current already considered, will produce a heating effect in

the dielectric. The heating of a dielectric when exposed to a high frequency field is not a simple matter and it is proposed to deal with it in greater detail in the next article of this series. It will involve us in a study of Debye's dipole theory and will also pave the way for a future discussion on the much debated question of specific action of ultra-high frequency currents and fields.

It might be mentioned in passing that dielectric breakdown is brought about by increasing the electric field strength to such a value that the electron is virtually torn away from its orbit and thus is free to form a conduction current—the so-called breakdown current.

Convection Current

The passage of positive or negative ions in a liquid or a gas constitutes a convection current as also does the passage of electrons *in vacuo* in such a device as the radio valve. As in the case of ordinary conduction currents the heating effect in the actual medium is dependent on its conductivity—secondary heating effects at the electrodes being ignored.

Heat Transference Phenomena

In this introductory article it is logical that we should consider some of the factors which govern our problem on the thermal side as such factors will play a vital part in the successful application of heat treatment.

Equation (2) tells us just how much heat is required to raise the temperature of a body of mass m and specific heat c through θ degrees of temperature. The unit of heat quantity is defined as the quantity of heat which is required to raise the temperature of unit mass of water by one degree. In the C.G.S. system of units, when the mass is in grams and for the centigrade temperature scale, quantity of heat is given in calories (or gram-calories).

The specific heat (or as it is sometimes called the thermal capacity per unit mass) of a substance is defined as the ratio of the quantity of heat required to raise the temperature of any mass of the given substance by one degree, to the quantity of heat re-

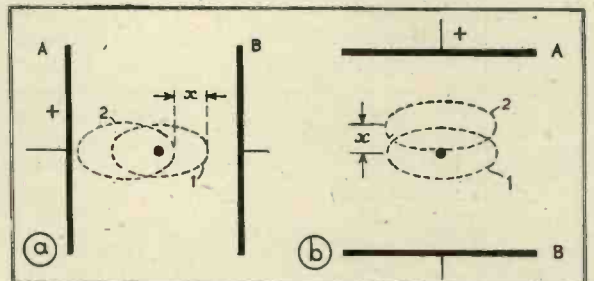

Fig. 2.

quired to raise the same mass of water through one degree. In precise thermal investigations we find that the calorie, or unit of heat quantity, varies with temperature due to the anomalous thermal behaviour of water, and consequently the specific heat of a substance, by the above definition, will also vary with temperature. The general expression for specific heat is given by

$$C = \frac{1}{m} \cdot \frac{dQ}{d\theta} \dots \dots (4)$$

It must be borne in mind that when a substance changes state, that is from a solid to a liquid or from a liquid to a gas or vapour, the specific heat in general varies considerably.

Having increased the quantity of heat in a body by raising its temperature, that heat may be carried away from the body again in three ways, namely, by thermal conduction, convection or radiation or by a combination of all three. The factors governing these phenomena will now be considered.

1. Thermal Conduction

It is a matter of common experience that heat is transmitted through a body from a region of high temperature to a region of lower temperature. The heat is here said to be conducted through the material and the transference is dependent on direct contact with the temperature sources. In arriving at an expression for the quantity of heat which is conducted through the material, it is customary to consider a small portion of an otherwise infinite and uniform slab of the material. The slab of thickness d is subjected to a high temperature T_1 and a low temperature T_2 as shown in Fig. 3.

If now we plot a graph across the section representing the temperature at any point in the section we obtain the line AA' whose zero axis is represented by OO'. In general this line

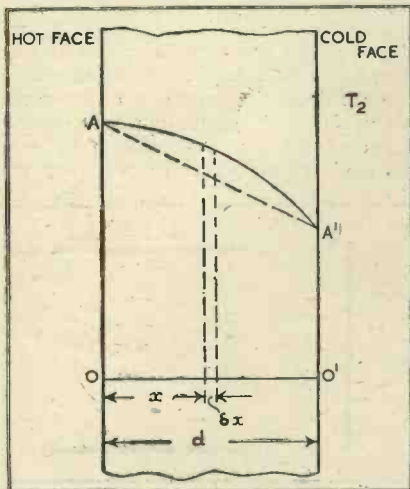

Fig. 3.

may be curved as shown, but in most cases it may be taken as linear to give us a mean condition. The gradient of this line, dT/dx , is known as the temperature gradient and for linear distribution of temperature would be given as

$$\frac{T_1 - T_2}{d}$$

It is found that the quantity of heat passing through the slab is proportional to (1) the temperature gradient dT/dx , (2) the area A through which the heat flows and (3) the time t during which flow takes place. We can thus write down an expression for the quantity involved as

$$Q = K.A.t \cdot \frac{dT}{dx} \dots \dots (5)$$

The factor K is known as the coefficient of thermal conductivity and is formally defined as the rate of flow of heat per unit area per unit temperature gradient. Different substances have different values of K and in general metals are good conductors of heat, while non-metals are poor conductors. Liquids are, as a rule, not good conductors of heat, while gases are extremely poor.

The process of heat conduction just described is a steady state phenomenon and is governed by the temperature gradient. There is, however, a transient process which takes place during the establishment of the temperature gradient, and this is governed by the speed with which a temperature wave will travel across the section. This speed is dependent not only upon the thermal conductivity of the substance, but also on the amount of heat which is necessary to raise an elemental volume of the substance to the required temperature; in other words to the density (ρ) and specific heat (c) of the substance. This phenomenon is known as thermal diffusion and the diffusivity of temperature (or as it is sometimes called the thermometric conductivity) is given by the factor k wherein

$$k = \frac{K}{\rho.c} \dots \dots (6)$$

It is this factor which determines the speed with which temperature changes will take place within the substance of a body, while the thermal conductivity (K) defines the rate at which heat is transmitted through the substance once a stable set of temperature conditions has been reached.

2. Thermal Convection

In thermal convection the quantity of heat involved in the transference process is actually conveyed by particles of the material itself, these particles being set in motion as a result of thermal reduction in their density. The quantity of heat thus being con-

veyed is dependent on the specific heat of the substance and on the rate of flow of the particles. In the human body it is the blood stream which provides a potent means of organ cooling by the principle of thermal convection. The heat is actually transmitted from the organ to the blood by conduction, and is then carried away by forced convection by the blood. As is well known, an increase in body temperature is associated with an increase in the blood flow and with dilation of the blood vessels. The viscosity of the blood is also lowered and so we have a very great cooling effect produced.

3. Thermal Radiation and Absorption

In radiation, heat is conveyed from one body to another without the aid of an intervening conductive medium. The former body is said to radiate heat with a resulting fall in temperature, while the latter is said to absorb heat with consequent rise in temperature. In general a substance which is a good radiator of heat is also a good absorber. In either case the ability for transference of heat is dependent on the nature of the surface of the substance. The surface emissivity of a body is defined as the quantity of heat radiated from unit surface area in unit time for unit temperature excess between the body and the surrounding medium or space. The emissive power of a surface is the ratio of the radiation emitted per unit area in unit time to the radiation emitted per unit area in the same time under the same temperature conditions of a perfect black body. The emissive power of a perfect black body is taken as unity.

The absorptive power of a body is defined as the ratio of the radiation actually absorbed by the body to the total incident radiation, and obviously this ratio cannot exceed unity. Again, the perfect black body is the ideal absorptive medium when all incident radiation is wholly absorbed.

In general, when radiation is incident on matter, part will be reflected, part will be absorbed and part will be transmitted through the body. Substances which readily transmit thermal radiation are known as diathermanous substances—they are thermally transparent; while substances which do not readily transmit thermal radiation are termed adiathermanous. In conclusion it might be stated that thermal radiation is electromagnetic in character, and occupies a definite place in the electromagnetic spectrum, coming between light and radio waves. Such radiation, therefore, behaves in exactly the same way as light and radio waves, and all the well known optical phenomena may be repeated with the longer heat waves.

(To be continued.)

Input Admittance Compensation

By C. E. LOCKHART

The application of some of the results derived from the articles on The Cathode Follower to the compensation of input admittance of amplifiers

This article can be usefully filed with the Data Sheets given in the February and June issues.

IN the majority of H.F. Pentode amplifying valves a large proportion of the input loss is due to the feed back effect of the cathode lead inductance (the screen grid inductance reduces the input loss). An interesting application of the negative input resistance produced by a capacitive cathode load is the use of such a load to neutralise the input losses introduced both by the cathode lead inductance and electron inertia effects.

Input Resistance

If we simplify the intricate network of electrode lead inductances, capacities and mutuals¹ to the circuit shown in Fig. 1, where an ordinary pentode amplifier has in its cathode lead an inductance L_c and a resistance R_c in parallel with a condenser C_c , the input admittance given by expression (81) on p. 376, Vol. xv., is modified to:

$$\frac{1}{R_1} \approx \frac{\omega^2 C_{gc}^2 R_c + \omega C_{gc} L_c (1 - \omega C_c R_c) + g(L_c - R_c^2 C_c) + (1/R_g)[1 + gR_c + \omega^2 R_c^2 (C_c + C_{gc})^2]}{(1 + gR_c)^2 + \omega^2 R_c^2 (C_c + C_{gc})^2} \dots (1)$$

provided

$$\begin{aligned} \omega^2 C_c L_c &<< 1 & \omega^2 (C_{gc} R_c + gL_c)^2 &<< 1 \\ \omega^2 C_{gc} L_c &<< 1 & gR_g &>> 1 \\ \mu &>> 1 & R_g R_c &R_a >> Z \end{aligned}$$

where R_a is the anode A.C. resistance of the valve as a triode and

$$Z = j\omega L_c + \frac{R_c}{1 + j\omega p_0}$$

is the impedance of the cathode load circuit. ($p_0 = \omega C_c R_c$). If in addition $\omega C_{gc} L_c (1 - \omega C_c R_c)$ can be neglected in Eq. (1).

$$\frac{1}{R_1} \approx \frac{\omega^2 C_{gc} [C_{gc} R_c + g(L_c - R_c^2 C_c)]}{(1 + gR_c)^2 + \omega^2 R_c^2 (C_c + C_{gc})^2} + \frac{1}{R_g} \frac{1 + gR_c + \omega^2 R_c^2 (C_c + C_{gc})^2}{(1 + gR_c)^2 + \omega^2 R_c^2 (C_c + C_{gc})^2} \dots (2)$$

at frequencies when $\omega^2 R_c^2 (C_c + C_{gc})^2 \ll 1$ expression (2) is further simplified to:

$$\frac{1}{R_1} \approx \frac{\omega^2 C_{gc} [C_{gc} R_c + g(L_c - R_c^2 C_c)]}{(1 + gR_c)^2} + \frac{1}{R_g (1 + gR_c)} \dots (3)$$

The first term of expression (3) represents the loss introduced by the reactances, while the second term re-

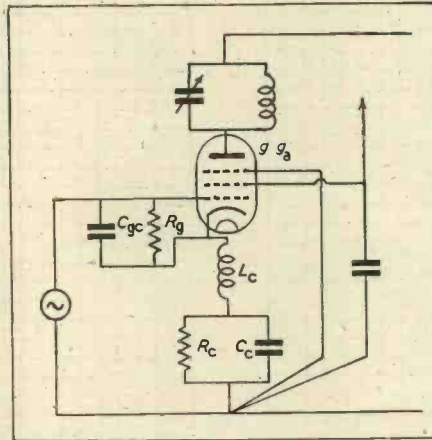

Fig. 1.

presents the normal input loss produced by the resistance R_c (due to electron inertia effects and dielectric losses) reduced by the cathode feed back.

If we make $R_c = 0$ then

$$\frac{1}{R_1'} \approx g\omega^2 C_{gc} L_c + \frac{1}{R_g} \dots (4)$$

an expression already given by Strutt and by Ferris². In expression (4) R_1' represents the total input resistance of the pentode Fig. 1 with $R_c = 0$ at a frequency of $\omega/2\pi$ c/s. and a cathode current mutual conductance g amps./volt.

If the resistance R_c is primarily due to electron inertia effects then

$$1/R_c = g\omega^2 s \dots (5)$$

where s is a factor depending on electron transit times.^{3,4}

From equations (3) and (4) it will be seen that the loss introduced by both L_c and R_g can be compensated by a suitable choice of R_c and C_c , and that this compensation will be approximately independent of frequency over a considerable frequency range.

When it is desired to vary the gain of the amplifier by the application of bias to the control grid only, the problem is usually not so much to neutralise the input resistance as to keep it as constant as possible with the changes in "g." If R_g is mainly due to electron inertia effects then

$$\frac{1}{R_1} \approx \frac{\omega^2 C_{gc}^2 R_c + g\omega^2 [C_{gc}(L_c - R_c^2 C_c) + s(1 + gR_c)]}{(1 + gR_c)^2} \dots (6)$$

when g is reduced to zero.

$$\frac{1}{R_{10}} = \omega^2 C_{gc0}^2 R_c \dots (7)$$

where C_{gc0} is the value of C_{gc} when $g = 0$.

It is possible to find a value of R_c and C_c which will make the input resistance with $g = 0$ equal to the input resistance at the operating bias, i.e., at a cathode current effective mutual conductance of $g/(1 + gR_c)$ or an anode current effective mutual conductance of $g_a/(1 + gR_c)$. The required value of R_c is obtained by equating (6) and (7).

The resulting equation is, however, of little practical interest as the value of L_c is rarely known by the user unless it is predominantly external to the valve.

If, however, the input loss is mainly due to L_c then we can make the approximation:

$$g\omega^2 C_{gc} L_c + \frac{1}{R_g} \approx g\omega^2 C_{gc} L_c + \frac{1}{R_g} (1 + gR_c)$$

then combining (3) and (4) we have

$$\frac{1}{R_1} \approx \frac{\omega^2 C_{gc} R_c (C_{gc} - gR_c C_c) + 1/R_g}{(1 + gR_c)^2} \dots (8)$$

where the value of R_1' is generally available. By then equating (7) and (8) we obtain the required value of R_c , which is given in full on the next page (Eq. 10), but in many cases the simplified expression:

$$R_c \approx [g\omega^2 R_1' C_{gc0} (2C_{gc0} + C_c)]^{-1/2} \dots (9)$$

will be sufficiently accurate.

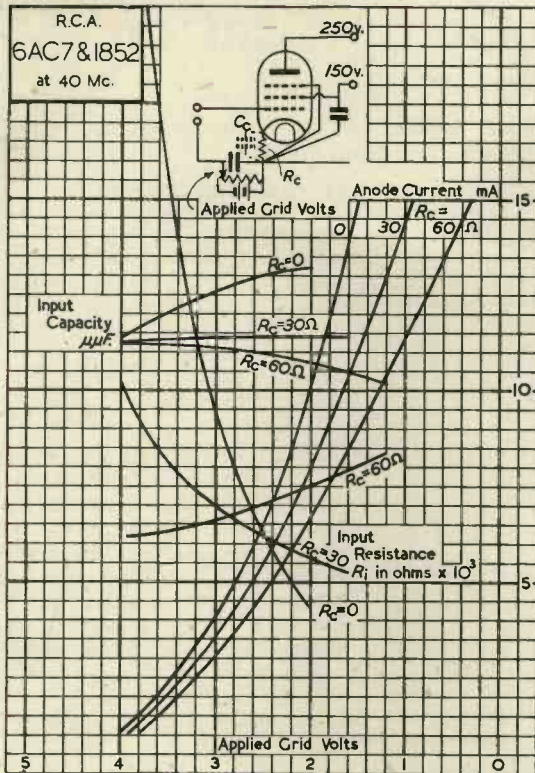

Fig. 2.

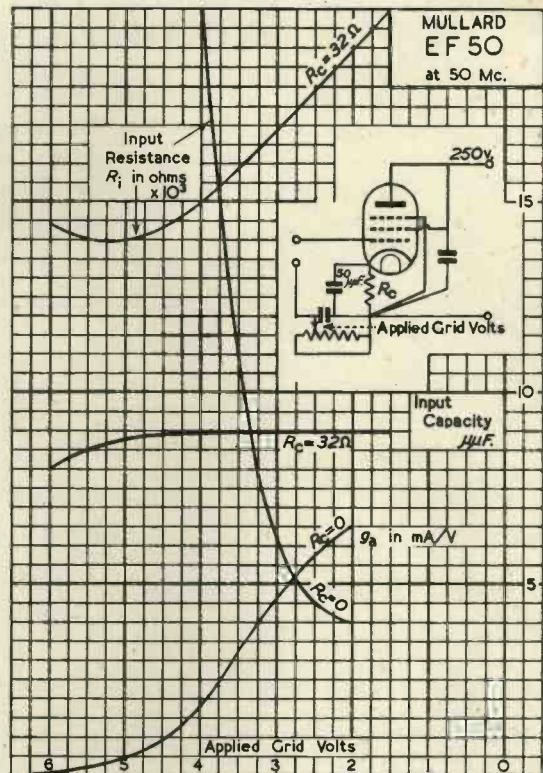

Fig. 3.

$$R_c \approx \frac{\frac{\Delta C_{gc}}{g} + \sqrt{\left(\frac{\Delta C_{gc}}{g}\right)^2 + \frac{C_c(1 + \Delta C_{gc}/C_{gco}) + 2C_{gco}}{g\omega^2 R_1' C_{gco}}}}{2C_{gco} + C_c(1 + \Delta C_{gc}/C_{gco})} \quad (10)$$

at frequencies when $\omega^2 R_c^2 (C_c + C_{gc})^2 \cdot (1 + gR_c) \Delta C_{gc}$

$$R_c \approx \frac{\Delta C_{gc}}{g \cdot C_{gco}} \quad (13)$$

From equations (4) and (5) it will be seen that $1/g^2 \omega^2 R_1' \approx C_{gc} L_c + s$ so that the required value of R_c is sensibly independent of frequency.

In the above expressions C_{gc} is the working grid-to-cathode capacity and $\Delta C_{gc} = C_{gc} - C_{gco}$ is the change in capacity due to biasing the control grid. The accuracy of the above analysis is limited by the fact that the input resistance due to electron inertia effects, is partly due to the transit time in the grid-to-screen space, for this reason it is preferable to make ΔC_{gc} equal to the total change in the control grid capacity, rather than the change in control grid to cathode capacity.

From the foregoing it will be seen that by a suitable choice of values of R_c and C_c it is possible to make the input resistance R_1 either rise, remain reasonably constant, or fall with the application of bias. This effect is well illustrated for the case of the RCA 6AC7/1852 in Fig. 2. A value of R_c of about 45 ohms would have given the most constant input resistance, this being of the order of 7,000 ohms.

The mutual conductance for this value of R_c is reduced to the order of 2/3 of its normal value. While this

loss in mutual conductance can to some extent, be reduced by using larger value of C_c and lower value of R_c , this may however result in a less constant value of R_1 in the intermediate bias range.

Input Capacity

With the same assumptions as were made for equations (1) to (3) and with normal values of R_x and L_c , the cathode lead inductance has a negligible effect on the input capacity. The value of the input capacity is then given by

$$C_1 \approx C_{gc} + C_{gc} \frac{1 + gR_c + \omega^2 R_c^2 (C_c + C_{gc})^2}{(1 + gR_c)^2 + \omega^2 R_c^2 (C_c + C_{gc})^2} \quad (11)$$

By a suitable choice of the value of R_c it is possible to keep the change in input capacity with the application of bias to the control grid as small as possible.

This value of R_c is given by

$$R_c \approx \frac{\frac{\Delta C_{gc}}{C_{gco}} - 1 + \sqrt{\left(1 - \frac{\Delta C_{gc}}{C_{gco}}\right)^2 + 4 \frac{\Delta C_{gc}}{C_{gco}} \left[1 - \frac{\omega^2 \Delta C_{gc}}{g^2 C_{gco}} (C_{gco} + \Delta C_{gc} + C_c)\right]}}{2 \left[g - \frac{\omega^2 \Delta C_{gc}}{g \cdot C_{gco}} (C_{gco} + \Delta C_{gc} + C_c) \right]} \quad (12)$$

The effect of different values of R_c on the input capacity is illustrated for the case of the RCA 6AC7/1852 in Fig. 2, and for one value of R_c and C_c for the Mullard EF 50 in Fig. 3.

In general the optimum value of R_c for resistance variation compensation is not the optimum value for capacity variation compensation, but a reasonable compromise can almost always be obtained.

Control by Simultaneous Bias

The method described above of reducing the variation of input admittance with the application of bias to the control grid, becomes extravagant in the case of multi-stage amplifiers (such as television receivers), due to the resulting reduction in the amplification obtainable. In such applica-

tions it is preferable to control gain

by applying simultaneously a biasing voltage to the control grid and to the suppressor grid.

The compensation is now obtained due to the fact that the application of a negative voltage to the suppressor grid increases both the input admittance and the input capacity. (See Fig. 4.) By a suitable choice of the fraction of the suppressor grid voltage that is applied to the control grid it is possible to keep both the input admittance and the input capacity reasonably constant without any inherent loss of amplification. Fig. 5 illustrates the effect of combined bias application to the performance of the Mazda S.P.41. For comparative purposes Fig. 6 shows the effect of normal control grid bias on the performance of the same valve.

REFERENCES

- 1 "Causes of Increase of Admittance of Modern H.F. Amplifier Tubes on Short Waves." M. G. O. Strutt and A. van der Ziel, *Proc. I.R.E.*, August, 1938.
- 2 "Input Resistance of Vacuum Tubes as U.H.F. Amplifiers." W. R. Ferris, *Proc. I.R.E.*, January, 1936.
- 3 "Analysis of Effect of Space Charge on Grid Impedance." D. O. North, *Proc. I.R.E.*, January, 1936.
- 4 "Operation of Electron Tubes at High Frequencies." H. Rothe, *Proc. I.R.E.*, July, 1940.
- 5 "New Television Amplifier Receiving Tubes." A. F. Kauzmann, *R.C.A. Review*, January, 1939.
- 6 "The Gain Control of R.F. Amplifiers." C. E. Lockhart. *TELEVISION & S. W. WORLD.* August 1940.

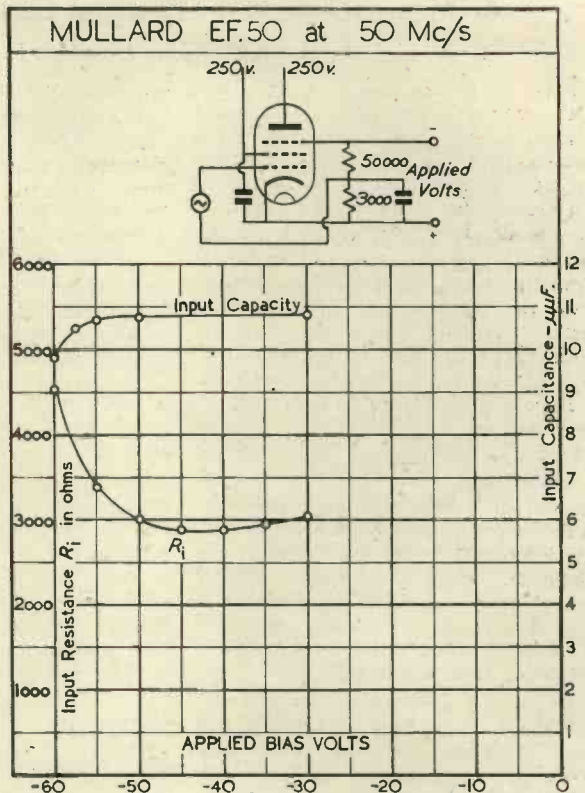

Fig. 4.

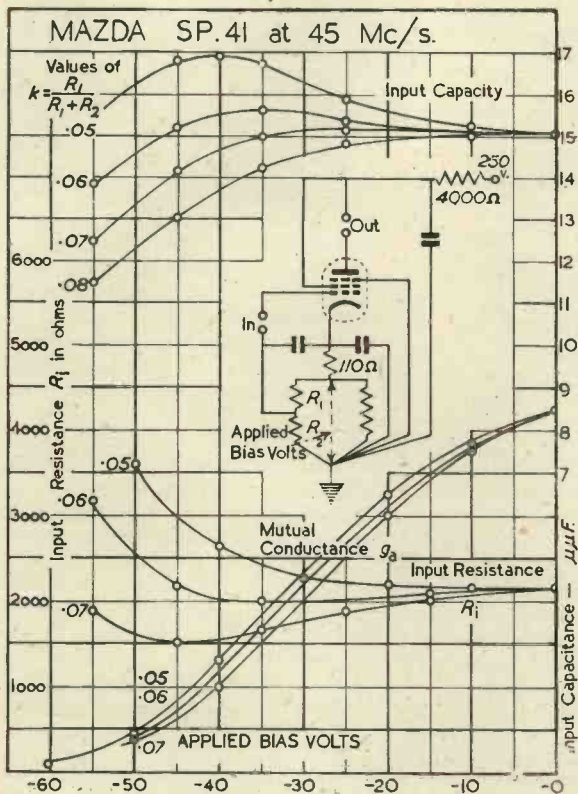

Fig. 5.

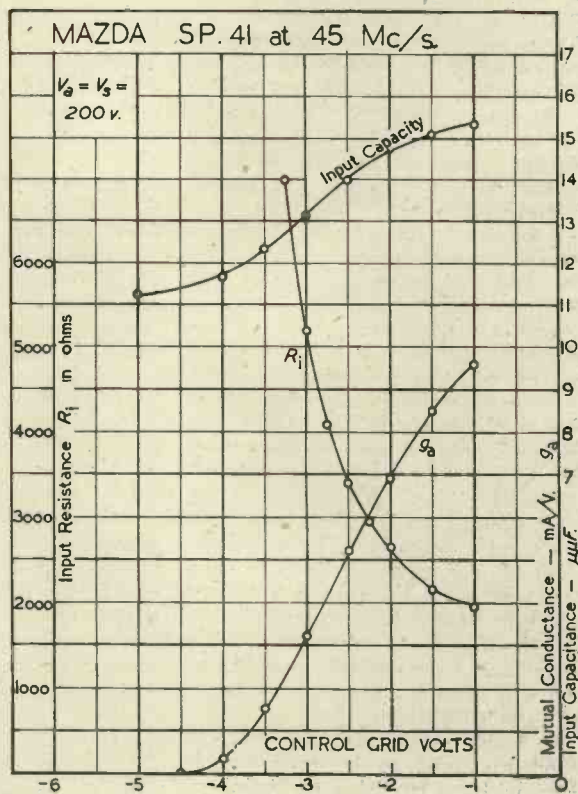

Fig. 6

A Monoscope for Testing C.R.-Tubes

By W. Ehrenberg, Ph.D., F.Inst.P. and G. P. Newton*

IT is, as a rule, not easy to gauge the performance of a cathode-ray tube for television reception. On the one hand, the information concerning the constructional elements, as spot size, screen colour and saturation, etc., is rarely complete, and in any case it is difficult to visualise in all detail the quality of a picture resulting from the co-operation of these elements. On the other hand an appreciable uncertainty is introduced in the judgment of a tube on the basis of its performance in a television receiver, by the continuous change of picture and the varying quality of the signal transmitted. The most convincing test of a tube would be based on its reproduction of a fixed picture, suitably chosen with regard to detail and gradation, and derived from a signal equivalent to the best television signals transmitted. It is the object of this note to describe a new method of producing such a signal.

It is well known that television signals can be produced by imaging the patch scanned on the fluorescent screen of a cathode-ray tube on to a transparent picture, and allowing the light transmitted to fall on to a photo-electric cell, the output of which is fed into an amplifier. Only a small amount of the light emitted by the cathode-ray tube can actually be utilised owing to the nature of the optical system required, and the quality of the signal obtained depends critically on the design and setting of this system. This method is, however, flexible with regard to the picture transmitted.

By placing a transparent picture inside the cathode-ray tube on the glass base, and thus in optical contact with the fluorescent screen, this flexibility is lost but the light output of the tube itself is modulated when the screen is scanned with an unmodulated beam. No optical system is then required in order to obtain the signal. The photocell can be placed close to the screen. The light falling on to the photo-cell is increased by a factor of 20 to 40, and the apparatus is greatly simplified. An ordinary photograph is, of course, unsuitable for inclusion inside a cathode-ray tube, as the tube is subjected to a very severe heat treatment during the process of evacuation. But the following process has been found to give a suitable heat-proof and perfectly graded picture.

The inside of the plane base of the cathode-ray tube to be processed is coated with an emulsion consisting of

* Research Laboratories, Electric and Musical Industries, Ltd.

one part black Indian ink to two parts photo-engraving glue sensitised with ammonium dichromate.* The emulsion is applied free from bubbles—about 1 c.c. per 30 sq. cms. surface—and dried in a horizontal position in a dark room. The film formed is exposed by projecting a negative on to it through the glass base. By the action of the light the glue is made insoluble, the stronger the light the greater the depth of the film affected. With a 100 watt projector a picture of 2" x 2.5" requires an exposure of about eight hours. The film is developed in hot water, which removes most of the glue, and a clear, well-graded picture is left. This consists of carbon particles bound in a small amount of glue which, after drying, is transformed wholly into carbon by baking in vacuo; a slight increase in density results from this treatment. The signal amplitude is proportional to the difference in transmission between highlights and shadows. The transmission in the highlights should therefore be high; the details in them should just be visible. The picture is quite robust and easily withstands application of the fluorescent screen and processing of the tube.

The following data relating to a particular tube will give an idea of the performance of this "Fluorescent Monoscope." The tube has a 2" x 2.5" ZnS-Ag screen, and the gun is both focused and scanned magnetically. It operates at 10kv. and 60 microamps and produces about 3 microamps signal in a photocell of about 5 cm. diameter placed at a distance of 5 cms. from the screen. The picture is reproduced through a wide band amplifier embodying a circuit for compensation of the time lag of the monoscope screen. Since the spot can be finely focused and gradation of the signal from the photocell is as good as the gradation of the original picture, quality is, in practice, limited only by the amplifier, which gives a signal very much above noise-level, as the gain required is comparatively low. Resolution tests on the receiving tube are actually not limited by the definition obtained by the monoscope and amplifier arrangement, but can be extended by varying the size of the picture reproduced. The technique described has other possible applications. It can, e.g., be used for placing a scale on a monitor tube in contact with the screen.

* Albumenoid Products Company Ltd., Aberdeen, Scotland, prepared to the manufacturer's directions for process work on copper.

† Another tube run at 20kv. and at a higher current gave more than ten times this output.

SEPTEMBER MEETINGS

Brit. I.R.E.

The annual general meeting of the above will be held on September 3, at 6.15 p.m., at the Institution of Structural Engineers, 11 Upper Belgrave Street, London, S.W.1.

The meeting will be followed by an address by Sir Stafford Cripps, K.C., M.P.

Institution of Electronics

A meeting of the N.W. England Section of the Institution of Electronics will be held at the Reynolds Hall, College of Technology, Manchester, on September 10, at 6.30 p.m. Mr. Leslie F. Berry will give a lecture on the "Manufacture of Wireless Receiving Valves."

Tickets of admission may be obtained from the Hon. Secretary, 14 Heywood Avenue, Austerlands, Oldham.

Paper on Photocells

At a joint meeting with the Manchester branch of the Institute of Physics in July last, a paper was read on "Photo-Cells" by Dr. A. Sommer (of Messrs. Cinema-Television).

He demonstrated how, on the basis of Einstein's theory, it can be predicted what types of substance are likely to be photo-electrically sensitive. The main conditions are: (1) high absorption coefficient for visible light; (2) low ionisation energy; (3) low work function; (4) specific resistance of the order of a semi-conductor. These conditions are best fulfilled by alkali metals in certain combinations.

After giving examples of suitable photo-electric layers for various light sources, the speaker then compared the merits of vacuum, gas-filled and multiplier cells. The multiplier cell is a great improvement in cases where very small signals of high frequency have to be detected and is therefore particularly suited for television transmission.

A full report of the paper will be given in "Science Forum," the official publication of the Institution.

The current issue contains the following articles:—

"Beam Tetrode Theory." By S. Rodda, B.Sc., F.Inst.P.

"Glass to Metal Seals." By Alex. Hickson.

"Measurement of Thermionic Emission." By D. Besso, B.A.

Non-members may obtain copies on application to the General Secretary, Mr. A. H. Hayes, 64, Winifred Road, Coulsdon, Surrey.

Dust Cored Coils

Part II. Analysis of Losses

By V. G. WELSBY, B.Sc. (Eng.)*

Equivalent Circuit of Coil

In order to obtain a clearer understanding of the way in which the impedance, measured across the terminals of an inductance coil, will vary with the frequency of the applied voltage, it is convenient to consider an equivalent circuit composed of pure reactances and resistances, whose impedance can be made identical with that of the coil by a suitable choice of values for the circuit elements. One simple form of such an equivalent circuit consists of an ideal inductance in series with three resistances. One resistance will be constant and equal to the D.C. resistance of the winding and the other two, both of which will vary with frequency, represent the power losses in the winding and in the magnetic core, produced by the alternating magnetic field. This circuit is shown in Fig. 2.1.(a). R_{dc} is the D.C. resistance and R_w and R_m represent the A.C. losses in the winding and the core respectively. For a more exact representation of the coil, the distributed capacitance of the winding and the dielectric losses in the insulation must be taken into account. It is

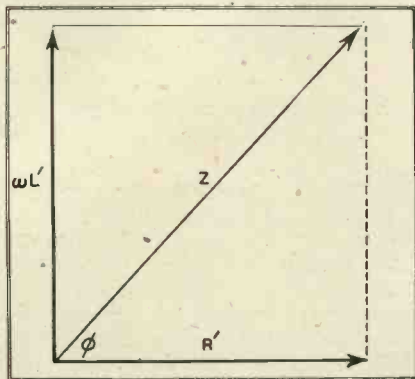

Fig. 2.2. To illustrate loss angle.

usually sufficiently accurate to consider these as a lumped capacitance C and conductance G shunted across the terminals as shown in Fig. 2.1.(b). It should be noted that the circuit of Fig. 2.1.(b) is not the only equivalent which could be developed, but it happens to be the most suitable one for the present purpose. For example, the loss resistances associated with the magnetic field could be re-

garded as shunted across the ideal inductance, as shown in Fig. 2.1.(c), instead of being placed in series. (The values of L , R_w and R_m , of course, would not then be the same as those for the series circuit.) Such an equivalent circuit is, in fact, often used when dealing with the design of transformers. Returning to the circuit of Fig. 2.1.(b) and reducing it to its simplest form, the arrangement shown in Fig. 2.1.(d) is obtained, in which the three loss resistances are lumped together and referred to as the "loss resistance" R .

$$\text{So that } R = R_{dc} + R_w + R_m \dots (1)$$

The next step is to obtain an expression for the impedance measured across the terminals in terms of the components of the equivalent circuit. Calling this impedance Z and using the usual vector notation, it can be shown¹ that

$$Z = j\omega L' + R' \dots (2)$$

$$\text{Where } L' = \frac{L(1 - \omega^2 LC) - CR^2}{(1 - \omega^2 LC)^2 + 2GR + G^2(R^2 + \omega^2 L^2) + \omega^2 C^2 R^2} \dots (3)$$

$$\text{and } R' = \frac{R + G(R^2 + \omega^2 L^2)}{(1 - \omega^2 LC)^2 + 2GR + G^2(R^2 + \omega^2 L^2) + \omega^2 C^2 R^2} \dots (4)$$

[$\omega = 2\pi f$ where f is the frequency.]

As they stand, these equations are cumbersome, but by making certain justifiable assumptions, they may be simplified considerably. For example, it is possible by careful design to keep G , C and R so small that the terms involving these quantities in the denominators of the above expressions can be neglected in comparison with the term $(1 - \omega^2 LC)$. This can only be done, however, if $(1 - \omega^2 LC)$ is not very much less than unity, *i.e.*, if the testing frequency does not approach the critical frequency at which the inductance of the coil resonates with its own self-capacitance. As will be shown later, this condition will normally be fulfilled so that, making the above assumption, and also neglecting the third order products CR^2 and GR^2 in the numerators, the following simplified equations are obtained:—

$$\left\{ \begin{aligned} L' &= \frac{L}{1 - \omega^2 LC} \dots (5) \\ R' &= \frac{R + G\omega^2 L^2}{(1 - \omega^2 LC)^2} \dots (6) \end{aligned} \right.$$

Definition of "Q"

The numerical ratio of the reactive component of the impedance of a coil to its effective resistance is called the "magnification"* of the coil and is denoted by the letter Q .

$$\text{So that } Q = \frac{\omega L'}{R'} \dots (7)$$

It may be mentioned in passing that the reciprocal of this ratio is sometimes loosely referred to as the "power factor" of the coil. Strictly speaking, the power factor is defined as the cosine of the "loss angle" ϕ (Fig. 2.2.) so that

$$\text{power factor} = \cos \phi = \frac{R'}{\sqrt{R'^2 + \omega^2 L'^2}} \dots (8)$$

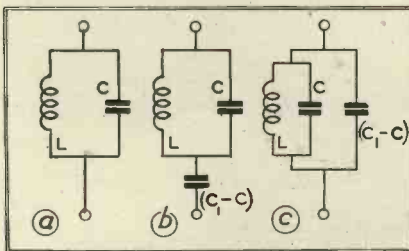

Fig. 2.3. Effect of self capacitance.

For coils of the type to which this article refers, however, the error in-

involved in taking $\cos \phi = \frac{R'}{\omega L'} = \frac{1}{Q}$ is very small.

Core Power Factor

The so-called "core power factor" is sometimes used as a method of specifying the allowable core loss resistance. The term is rather misleading, because, as it is usually defined, it is not a core constant, but depends

* The term "magnification" originates from the fact that if a low-loss condenser is placed in series with the coil and adjusted to resonance at the testing frequency, the voltage developed across the coil will be that applied to the resonant circuit magnified in the ratio $\omega L'/R'$

* P. O. Research Station.

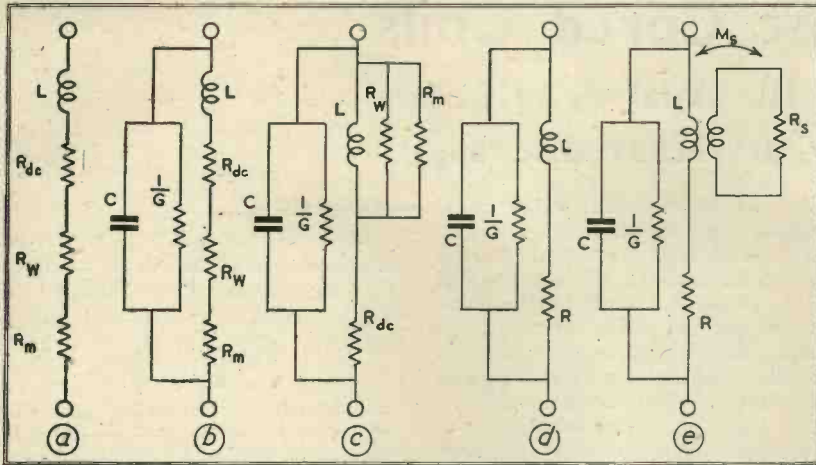

Fig. 2.1. Equivalent circuit of Coil.

on the type of winding used. Provided the winding details and the testing frequency are stated, however, the "core power factor" does provide a convenient method of comparison between various samples of the same type of core. The factor is obtained by measuring the effective resistance of a coil with and without the core in position, and then taking the ratio of the difference of these two results to the measured reactance of the coil with the core in. Very approximately, this process gives the

value of $\frac{R_m}{\omega L'}$. Since the specified

frequency is usually chosen so that it is well below the self-resonant frequency, $\omega L'$ is nearly equal to ωL . Thus the core power factor is roughly

equal to $\frac{R_m}{\omega L}$.

Effect of Self Capacitance

$$Q = \frac{\omega L'}{R'} = \frac{\omega L(1 - \omega^2 LC)}{R + G\omega^2 L^2} \dots (9)$$

Neglecting the dielectric loss, this can be written as

$$Q = \frac{\omega L}{R} (1 - \omega^2 LC) \dots (10)$$

$$= \frac{\omega L}{R} [1 - (f/f_r)^2] = Q_0 [1 - (f/f_r)^2] \dots (11)$$

Where f_r is the self-resonant frequency. $Q_0 (= \frac{\omega L}{R})$ may be regarded as the "true Q" as determined

by the losses in the coil. The

"apparent Q" ($= \frac{\omega L'}{R'}$) as measured

at the terminals is reduced by the factor $[1 - (f/f_r)^2]$. It will be seen that the reduction of Q due to self capacitance depends only on the ratio of the testing frequency to the self-resonant frequency. This reduction may be considerable and increases rapidly as the self-resonant frequency is approached. Wherever possible, the self-capacitance is kept sufficiently low to ensure that f/f_r does not exceed about 1/5. Apart from the reduction of Q_0 , self-capacitance causes the apparent inductance L' of the coil to increase in the same ratio so that

$$L' = \frac{L}{1 - (f/f_r)^2} \dots (12)$$

This effect causes difficulties in circuits such as wave filters in which all the reactance values must be accurately adjusted and independent of frequency. Equation 9 shows that the reactance of a low-loss coil is the same as if the coil were regarded merely as an ideal inductance L shunted by the self-capacitance C . (Fig. 2.3.(a).) Suppose that the coil is intended for use in a resonant circuit with a tuning condenser of capacitance C_1 . Where parallel resonance is required, the effect of self-capacitance (assuming it to be constant over the working frequency range) can be nullified by reducing the tuning condenser value to $(C_1 - C)$. (Fig. 2.3.(c).) The same method can be applied to a series circuit (Fig. 2.3.(b)), but here, although the resonant frequency is correct, the impedance of the circuit at any other frequency

is not. To sum up, the self-capacitance of a coil must be kept as low as possible (by sectionalising the winding and keeping the dimensions small) because:—

- (a) It reduces the Q.
- (b) It makes the apparent inductance vary with frequency.

The upper limit to the practicable working frequency range of a coil is often set by the magnitude of the self-capacitance of the winding rather than by the power losses in the core.

Effect of Screening Can

A current flowing in any coil will produce an external magnetic field surrounding the coil. This external field may be a disadvantage and it is often necessary to surround the coil by a metallic screen in order to prevent stray magnetic coupling with other neighbouring components. Circulating currents are induced in the screen, setting up an opposing field, so that the resultant field strength outside the screen may be made very small. It will be appreciated that the existence of these circulating currents must result in the dissipation of energy, with a corresponding increase in the apparent resistance of the coil. The power loss will be determined by the following factors:

- (a) The ratio of the external flux to the total flux in the coil.
- (b) The relative size of coil and screen.
- (c) The shape and thickness of the screen.
- (d) The specific resistance of the screen material.

The screen loss can be represented in the equivalent circuit by a resistance R_s and inductance L_s coupled to the coil by a mutual inductance M_s , as shown in Fig. 2.1.(e). The addition of the screen may also modify the apparent self-capacitance of the coil, but this effect should normally be small. Except in a few simple cases, the exact calculation of the screen loss is too involved to be practicable, and screen design is usually carried out more or less by trial and error. The addition of a screen will change both the effective inductance and effective resistance of the coil and both these effects may have to be taken into account. For example, where an accurately adjusted inductance is required, the final adjustment may have to be carried out after the screen is fitted, through a suitable hole provided for this purpose in the screen. The most

troublesome effect is the increase in effective resistance, resulting in a reduction of Q, particularly in the case of solenoid coils which have a relatively large external field. The reduction of Q will be a maximum when the screen fits closely round the coil and will decrease as the screen is made larger, so that the final design must be a compromise in which the available space is used in the best manner². The losses can be reduced by using materials of low specific resistance such as copper, but it does not follow that better results will necessarily be obtained by increasing the screen thickness. This is because at high frequencies, the circulating currents tend to concentrate near the inner surface of the screen, so that metal near the outer surface may be practically ineffective.

Eddy Current Losses in the Winding

In addition to the energy dissipated in the D.C. resistance of the winding, there will be a power loss due to eddy currents flowing in the wire. This can be split up into two parts:—

- (a) "Skin effect."
- (b) "Proximity effect."

So that $R_w = R_s + R_p$.

Where R_s and R_p are the components of the wire loss resistance due to skin effect and proximity effect respectively.

"Skin effect" is the term applied to the inherent rise in the resistance of a wire with frequency. It is due to circulating currents induced in the wire by its own magnetic field, and takes place irrespective of whether the wire is straight or wound into a coil. The direction of the circulating currents is such that they oppose the main current near the centre of the wire and augment it near the surface, so that the total resultant current tends to be concentrated near the surface of the wire. This decreases the effective cross-sectional area of the wire and increases its resistance. When the wire is wound into a coil an additional loss is caused by the fact that the current flowing in each turn induces eddy currents in the turns lying adjacent to it. This is known as the "proximity effect." Skin effect can be reduced by the use of stranded wire in which all the strands are insulated. A special type of stranded wire, known as "Litz" wire is available for this purpose. It is made up by twisting three strands together; then taking three of these triple strands and twisting them together, and so on.

Such a construction ensures that each strand passes alternately between the surface and the centre of the wire throughout its length, thus taking an equal share of the current. "Litz" wire has a bad space factor so that the reduction of skin effect tends to be counteracted by the increased D.C. resistance. Also, in the multi-layer windings usually used in dust-cored coils, the proximity effect is large compared with the skin effect, so that good results can be obtained with simple stranded wire. Proximity effect can be reduced by using finely stranded wire and spacing the turns as far apart as possible. The final choice of wire in each case will clearly be a compromise between D.C. resistance and eddy current resistance.

The wire loss resistance can be expressed as

$$R_w = k_n f^2 L_n \dots\dots\dots (13)$$

Where L_n is the inductance of the coil "in air" (i.e., without the magnetic core in position). The value of the wire eddy current factor k_n for a given coil depends on the type of wire used, and it can be shown³ that

$$k_n \propto \frac{d^n}{D^3}$$

Where the coil is wound with stranded wire of overall diameter D made up of n strands each of diameter d . To a first approximation, for the frequency ranges and types of wire suitable for dust cored coils, k_n is independent of frequency. As the frequency is raised indefinitely, however, k_n tends to fall, and Table I shows the limiting values of the frequency f , for various sizes of strand, above which this effect becomes important.

Magnetic Losses in the Core

For the present purpose, the core losses can be split up into three components, each of which can be identified and investigated experimentally. The three components are closely inter-related, so that any variation of one must affect the other two, but for dust-cored coils under normal working conditions they may be treated as though they were completely inde-

pendent without appreciable errors being introduced.

(a) Eddy Current Loss

It can be shown⁴ that, for a given core, the component of the loss resistance due to eddy currents can be expressed as

$$R_e = F_e f^2 L \dots\dots\dots (14)$$

Where F_e is known as the eddy current factor of the core. At normal working frequencies the value of F_e is independent of frequency, but as the frequency is increased indefinitely, both the inductance and the eddy current factor will start to decrease, owing to the fact that the eddy currents in the core particles set up a magnetic field in opposition to the main field, thus reducing the effective permeability of the core.

The flux tends to be concentrated near the surface of the particles so that the centre of each particle is shielded and becomes partly ineffective. This effect, which is known as "eddy current shielding" or "magnetic skin effect," is not usually important at frequencies below the upper limit which is set by other considerations (such as self-capacitance).

(b) Hysteresis Loss

At the low flux-densities dealt with in dust core technique, R_e can be taken as independent of the flux density.

It has already been mentioned that the main importance of this loss is the fact that it introduces a resistance component which varies with flux density⁵, and therefore with the current flowing in the coil. When such a coil forms part of a transmission circuit, the variation of resistance with current causes distortion of the signal waveform. This type of distortion is intolerable in some types of circuit, with the result that coils, which are quite satisfactory as far as the Q value is concerned, have to be rejected on account of hysteresis distortion. In some cases, in fact, the use of dust-cored coils is completely ruled out, and relatively cumbersome air-cored coils of lower Q have to be

[†] The inductance also changes with flux density as a result of Hysteresis, but to a much smaller extent.

TABLE I

S.W.G.	d (cms)	f_1	S.W.G.	d (cms)	f_1
46	.0061	10 Mc/s	32	.0273	520 Kc/s
44	.0081	6 Mc/s	30	.0316	400 Kc/s
42	.0102	3.8 Mc/s	28	.0376	280 Kc/s
40	.0121	2.6 Mc/s	26	.0458	190 Kc/s
38	.0152	1.7 Mc/s	24	.0560	125 Kc/s
36	.0192	1.1 Mc/s	22	.0712	80 Kc/s
34	.0233	720 Kc/s	20	.0915	47 Kc/s

* The original 'Litz' wire was plaited but the term is now generally used for the type of wire described.

used. The component of the loss resistance due to hysteresis is given by

$$R_h = F_h I f L^{3/2} \dots\dots\dots (15)$$

Where I is the r.m.s. value of the sinusoidal current† in the coil and F_h is a constant for the core (at low flux densities). F_h is defined as the "hysteresis factor," and its value is used as a guide to the amount of hysteresis distortion produced in the coil for a given current. The characteristic type of waveform distortion produced is shown diagrammatically in an exaggerated form in Fig. 2.5.

The first point to be noticed is that, since the successive half-waves are symmetrical, the distorted wave can be represented by the addition to the original fundamental frequency of a series of odd harmonics. Also, since there are no abrupt changes, the amplitude of the harmonics will fall rapidly with ascending order, so that the third harmonic will have a greater amplitude than any of the higher harmonics. As a result, the ratio of the amplitude of the third harmonic to that of the fundamental is usually taken as a measure of the hysteresis distortion present. It has been shown[‡] theoretically that the third harmonic c.m.f., E_3 should be given by

$$E_3 = 0.6 R_h I \\ = 0.6 F_h I f L^{3/2} P^2 \dots\dots\dots (16)$$

If E_1 is the P.D. across the coil at the fundamental frequency, then:—

$$E_3 = 2\pi f I L \\ \text{so that } \frac{E_3}{E_1} = \frac{0.6}{2\pi} F_h I \sqrt{L} \dots\dots\dots (17)$$

Experimental results have consistently indicated a slightly different value for the numerical coefficient, but the error is certainly less than 30 per cent.

(c) Residual Loss*

The choice of the term "residual loss" for the third source of power loss is an unfortunate one, because in some modern core materials it forms a considerable proportion of the total core losses. Its existence is an experimental fact, but its exact physical significance is still not clearly understood. It will merely be stated here that there is a component of the loss resistance which can be expressed as

$$R_c = F_c I f L \dots\dots\dots (18)$$

Where F_c is a constant for a given

† Owing to the waveform distortion already mentioned, it follows that slightly different results will be obtained if a sinusoidal voltage is impressed on the coil, producing a distorted current wave. This effect is negligible with good dust-core materials.

* In some literature on the subject the German term "Nachwirkung" is used instead of residual loss. It is also sometimes referred to as "secondary magnetic effect."

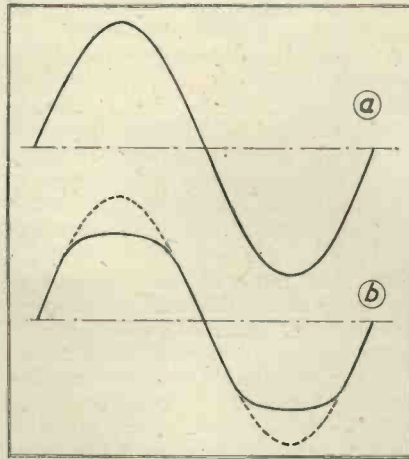

Fig. 2.5. Waveform distortion due to hysteresis.

coil over its normal working frequency range. R_c is independent of the flux density and so does not cause signal distortion. Since, like the hysteresis resistance, residual loss is proportional to frequency, it is usually associated with the latter and may be considered as a residual "hysteresis loss" which takes place at zero flux density.

$$\text{So that } (R_h + R_c) = f L (F_c + F_h I \sqrt{L}) \dots\dots\dots (19)$$

Dielectric Loss

We have been concerned mainly with losses due to the magnetic field, but it must not be forgotten that there are also losses associated with the electrostatic field in the insulating materials. Generally, the magnitude of these losses is such that they are swamped by the magnetic losses, but it will be shown later that they may become important as sources of error when a detailed experimental analysis of the core losses is attempted. Briefly, the total dielectric loss may be split up as follows:

- (a) In the insulation of the wire.

- (b) In the bobbin on which it is wound.
- (c) In the insulation separating the core particles.

These losses are mentioned here merely because, although they should be negligible, they may become important and cause confusing results if any of the insulating material becomes faulty.

Experimental Analysis of Losses

The various sources of power loss are shown diagrammatically in Fig. 2.4. The screen loss can be obtained quite simply by measurements made with and without the screen, so that it need not be considered further. The self-capacitance can be measured and its effect calculated. The dielectric losses will be neglected at this stage. The total core loss resistance can be written as:

$$R_m = R_c + R_h + R_e \dots\dots\dots (20)$$

$$= f L [F_c f + (F_e + F_h I \sqrt{L})] \dots\dots\dots (21)$$

The values of the loss coefficients can then be determined as follows: First of all a series of measurements is made of R_m for various values of frequency, but at constant current.

Then if $\frac{R_m}{fL}$ is plotted against f , a

straight line should be obtained (Fig. 2.6.(a)), with a slope of F_e and an intercept of $(F_c + F_h I \sqrt{L})$. Next, another series of measurements is made, at constant frequency with varying

values of current. If $\frac{R_m}{fL^2}$ is plotted

against I , a straight line will again be obtained (Fig. 2.6.(b)), this time with a slope of F_h . This value of $F_h I \sqrt{L}$ can then be used to evaluate $F_h I \sqrt{L}$ for the current used in the first series of measurements, so enabling F_c to be determined.

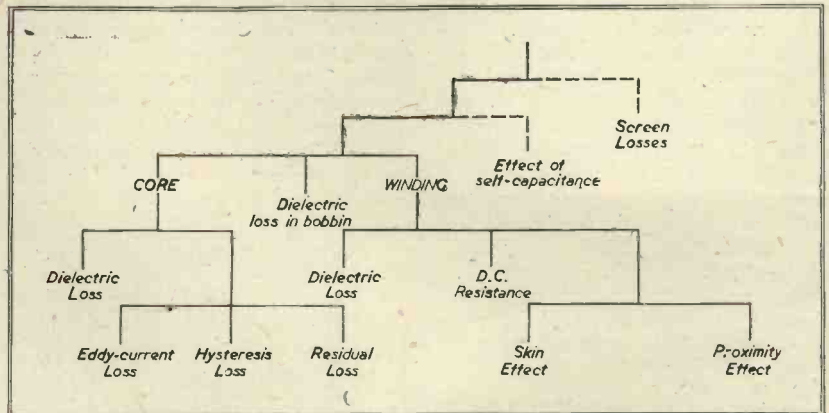

Fig. 2.4. Table showing various sources of power loss.

The first serious practical difficulty which arises is that although the total resistance due to core and wire losses ($R_m + R_w$) can be obtained quite easily, it is not so easy to separate these two components. To a first approximation, the wire loss resistance with core can be expressed as

$$R_w = k_m f^2 L \dots\dots\dots (22)$$

(core)

Where k_m is a constant.

$$\text{So that } R_m + R_w = (R - R_{dc}) = fL[(F_e + k_m)f + (F_c + F_h \sqrt{L})] \dots\dots\dots (23)$$

If now the graphical method just described is carried out with $(R - R_{dc})$ instead of R_m , it will be seen that the slope of the curve of Fig. 2.6.(a) will be increased to $(F_e + k_m)$, but that the values of the other factors will be unchanged. It would appear at first sight that the value of k_m could be obtained quite easily by measuring the impedance of the coil without the core. Unfortunately, however, the removal of the core modifies the flux distribution in the coil and alters the wire loss resistance R_w in a manner which is difficult to predict. This change is best

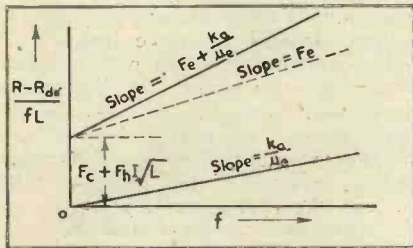

Fig. 2.7. Determination of eddy current loss coefficient.

regarded, for the purpose of the present discussion, as a source of error which must be kept as small as possible, and the assumption made that the wire loss resistance is the same for the coil with and without the core. This assumption is well justified when calculating the predicted Q value for a coil from its loss factors, because the error is small compared with the magnitude of the total losses. Care must be taken, however, when making measurements to determine the absolute value of F_e , to ensure that the wire eddy current losses are kept as small as possible, so that the change when the core is inserted is negligible compared with the core eddy current loss.

Total eddy current resistance with core—

$$R_e + R_w = f^2 L(F_e + k_m) \dots\dots\dots (24)$$

(core)

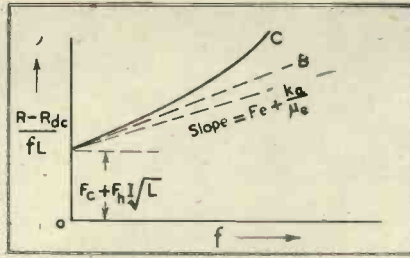

Fig. 2.8. Showing effect of dielectric losses on the curve of Fig. 2.7. Curve B includes loss due to constant component of G, while curve C includes total dielectric losses.

Eddy current resistance without core—

$$R_w = k_a f^2 L_a \dots\dots\dots (25)$$

$$\text{Difference} = f^2 L(F_e + k_m) - k_a f^2 L_a = f^2 L[F_e + (k_m - k_a / \mu_0)] \dots\dots\dots (26)$$

(Since $L = \mu_0 L_a$)

Then, making the above assumption, we can write $(k_m = k_a / \mu_0)$ so that the difference reduces to $f^2 L F_e$, and the total resistance with the core can be expressed as

$$(R - R_{dc}) = fL[(F_e + k_a / \mu_0)f + (F_c + F_h \sqrt{L})] \dots\dots\dots (27)$$

The method of evaluating F_e is then to plot $\frac{R - R_{dc}}{fL}$ against f for the test

coil with and without the core in position, the value of F_e then being obtained from the difference of the slopes of these curves. This is illustrated graphically in Fig. 2.7.

Errors Due to Dielectric Losses

$$R' = \frac{R + G\omega^2 L^2}{1 - \omega^2 LC} \dots\dots\dots (28)$$

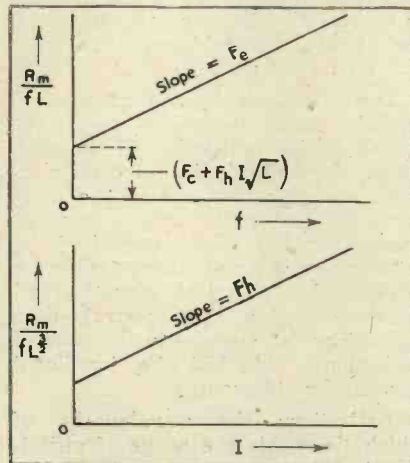

Fig. 2.6 (a) and (b). Determination of loss coefficients.

So that the dielectric losses introduce an additional resistance R_d in series with R ,

$$\text{where } R_d = G \cdot 4\pi^2 f^2 L^2 \dots\dots\dots (29)$$

It is found experimentally that G can be considered as made up of two components, one being constant and the other directly proportional to frequency. The relative magnitudes of these two components depend to a great extent on the design of the coil and in general it is safe to assume that the losses which they represent will have little effect on the Q of a dust cored coil unless unusually large inductance values are contemplated. The dielectric loss, however, introduces another source of error when evaluating F_e .

$$\text{Suppose } G = a + \beta f \dots\dots\dots (30)$$

$$\text{So that } R_d = f^2 L(4\pi^2 a L + 4\pi^2 \beta f L) \dots\dots\dots (31)$$

Thus the second term will cause the curve of Fig. 2.6.(a) to deviate from a straight line in such a way that its effect can easily be detected and allowed for if necessary. (See Fig. 2.8.) The first term, on the other hand, merely increases the slope of the straight line and may cause an appreciable error in the value of F_e . It will be noticed, however, that this error is proportional to L and can be reduced to negligible proportions by making L sufficiently small.

Importance of Loss Analysis

It can now be seen that the loss coefficients F_e, F_h, F_c can all be evaluated from a limited number of impedance measurements. Once this has been done, the core loss resistance can be estimated to a reasonable degree of accuracy for any coil wound on the core under consideration. The prediction of the wire eddy current coefficient k_m is more difficult, particularly at higher frequencies and with cores of low effective permeability, where k_m may be of the same order as F_e . To overcome this difficulty, the author has developed a graphical method of presenting the results of Q measurements made on test coils wound with a few representative types of wire. This method, which will be dealt with in Part 3, enables the predicted performance with other types of wire to be estimated for the core under test.

BIBLIOGRAPHY

- 1 V. E. LEGG. B.S.T.J., January, 1936.
- 2 For a more exhaustive treatment of screen design see BOGLE, Journal I.E.E., September, 1940, p. 299.
- 3 BUCHHOLZ. Archiv fur Elektrotechnik, 1929, p. 360 BUTTERWORTH. Exp. Wireless, 1926, pp. 203, 309, 417, 483.
- 4 V. E. LEGG. loc. cit.
- 5 E. PETERSON. B.S.T.J., July, 1928.



Modern fluorescent lamps installed in a factory.

Fluorescence

A Survey of Old and New

By R. NEUMAN

FOR many years the development of luminosity and of luminous efficiency of lighting sources seemed to have come to an end with the advent of the gas-filled coiled-coil tungsten lamp. But an impetus was given to new development by adapting quite a different principle of light production to the requirements of general illumination. It was the time-honoured principle of producing light by electrical discharges through gases or vapours.

The progress thus brought about may well be expressed in Dr. C. C. Paterson's words: "A limit in the yield of light from incandescent solids had already been reached, and here were gaseous sources of light giving upwards of three times the amount of light for the same electricity costs!"

It was, however, a somewhat complicated way that led from the Geissler tube and its predecessors to the latest sources of light. In order to get a better understanding of this way it might be useful to recall some of the underlying principles concerning light production and discharge phenomena.^{1, 2, 3, 4, 5, 6}

Basic principles.—As is well known, according to present views on atomic structure electromagnetic waves in the visible range and its neighbouring ranges of ultraviolet and infra-red are produced if one or more electrons lose part of their kinetic energy by returning from a higher state of excitation

to a lower one. The wave length or the frequency of the oscillation thus produced depend on the initial and final states of excitation and these are conditioned by the energy input which caused the electron to attain the respective excitation potential. This latter value is usually measured in electron-volts, *i.e.*, the potential difference through which the electron would have to travel in order to acquire the respective energy. If the exciting energy is gradually raised a critical potential is reached, the so-called ionisation potential, and the electron leaves the atom, *i.e.*, ionisation takes place enabling the electron to move freely in space and changing the hitherto neutral atom to a positively charged ion.

As we saw, it is the excitation potential which determines the wave length of the oscillations of the electrons. As the orbits in which the electrons are able to move in the atom have different radii quite a few different oscillations characterised by different wave lengths are possible for a particular chemical element and these determine the spectral lines emitted by the element in the state of excitation or absorbed when irradiated from an outside source.

Oscillations the wavelengths of which lie within the range of visibility (*i.e.*, between 3,800 and 7,200Å), form only a very small part of the whole range of electromagnetic waves,

the lengths of which extend from the 6,000 km of an ordinary a.c. supply system through the wave lengths of radio communication to mainly heat producing waves of the infra-red region and then beyond the visible range through the near and far ultra-violet regions to the regions of X-rays, radium rays and cosmic rays. As will be seen the first as well as the last, the ordinary a.c. supply and the cosmic rays, will play their part in the light sources to be described below.⁷

While the atoms and monatomic molecules are characterised by line spectra of different wave lengths forming series which arrange themselves to regular bands only in the higher states of excitation, the multi-atomic molecules and especially the chemical compounds show these bands or a continuous spectrum even with small excitation. The spectral intensity may vary considerably in the different ranges of wavelengths depending on excitation, pressure, temperature, etc.

Excitation may be caused by the application of an electric field leading to collisions between electrons, ions, atoms or molecules. It may also be caused by the impact of light quanta or photons on either of them. It depends mainly on the nature of such impacts and the materials concerned whether the character of the collision is more of an elastic or inelastic nature. In the former case all the impact energy will be absorbed, in the

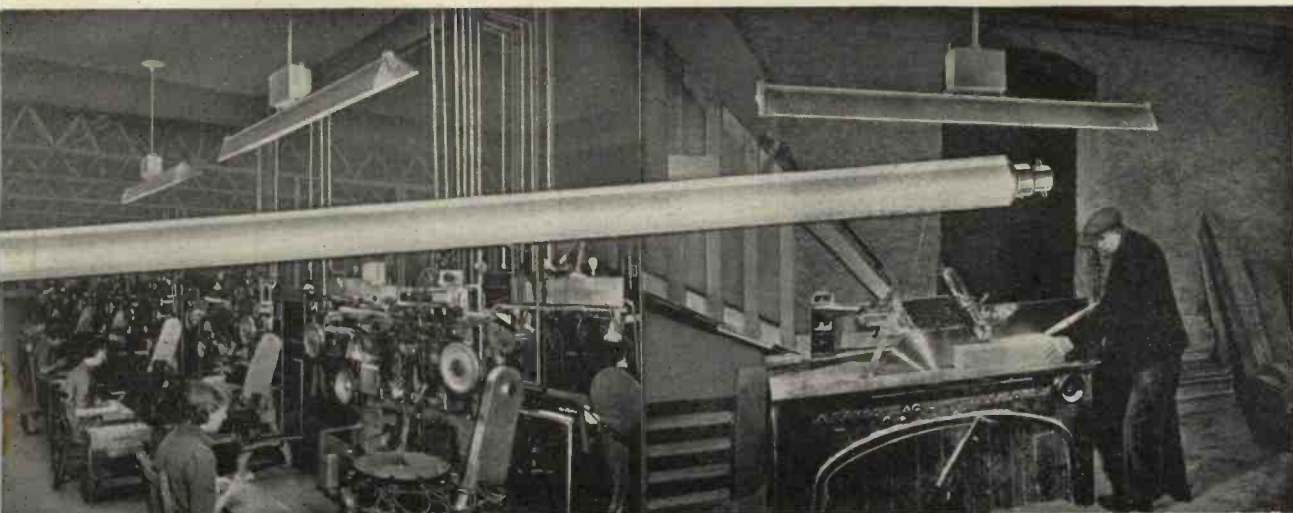

(By courtesy of The Edison Swan Electric Co.)

nt Lamps

Recent Developments

NN, Dipl. Ing.

latter case at least part of the energy is re-emitted in the form of some kind of radiation. The frequency of this re-emission will—according to a law first stated by Stokes and in keeping with the laws of thermodynamics—always be smaller than the frequency of the exciting radiation. Thus a transformation of frequency occurs and it depends largely on the exciting frequency and on the materials used for bringing about this frequency transformation how large the amount of re-emitted energy will be. Fortunately there exist quite a number of materials (*fluorescent materials*) which are able to re-emit the whole or nearly the whole of the irradiated light quanta, thus working with an efficiency of approximately 100 per cent. as regards the quantum yield. The efficiency as regards the energy concerned depends on the ratio of irradiated and re-emitted frequencies.*

It is by no means necessary that the exciting radiation works at a wave length within the visible range, although visible radiation may be re-emitted.

While the electron which is still united with the atom and is excited so as to be enabled to emit electromagnetic radiation is responsible for the production of light, the electron which has left the atom due to an increased excitation which exceeds the ionisation potential (in other words the electron enabled to move freely in

space) is instrumental in effecting the two forms of electrical discharge, the glow discharge and the arc discharge. Here we are specially interested in discharges occurring within an evacuated or gas- or vapour-filled tube fitted at each end with suitable electrodes to which a d.c. or a.c. voltage is applied.

Historical Digression.—As we have spoken of a “time-honoured principle” a brief historical survey of the early development of this kind of tube may not be out of place in this connexion.

According to P. F. Mottelay⁹ it was Otto von Guericke of “Magdeburg hemispheres” fame who designed the first frictional electrical machine and “heard the first sound and saw the first light in artificially excited electricity.” But his electrical experiments carried out in 1660 with a sulphur ball and described in his book “*Experimenta Nova (ut vocantur) Magdeburgica de Vacuo Spatio.*” 1672, were not made in vacuo as the title of the book might suggest. It was a few years later (1675) that the first electrical discharge *in vacuo* was observed and described by the French astronomer Jean Piccard. It occurred when a mercury barometer was transported from the Observatory to the Porte St. Michel. In the same year Newton replaced Guericke’s sulphur ball by a glass globe. In the nineties of the 17th century Robert Boyle noticed the fact that the attractive forces of a rubbed piece of amber are

also effective *in vacuo*. But it was Francis Hauksbee who described in his “*Physico-mechanical experiments on various subjects*” (2nd Edition 1719) the following “Experiment concerning the Production of a considerable Light, upon a slight Attrition of a Glass Globe exhausted of its Air”:

“I Took a Glass Globe of about nine Inches Diameter, and exhausted the Air out of it; then, having turned a Cock, which prevented the Return of the Air, I took it from the Pump. The Globe being thus secured, I fixed it to a Machine, which gave it a swift Motion with its Axis perpendicular to the Horizon: And then applying my naked Hand (expanded) to the Surface of it, the Result was, That in a very little time a considerable Light was produced.

“And as I moved my Hand from one Place to another (that the moist Effluvia, which very readily condense on the Glass, might, as near as I could, be thrown off from every part of it) by this means the Light improv’d; and so continu’d to increase, till Words in Capital Letter became legible by it, as has been observed by Spectators.

“Nay, I have found the Light produced to be so great, that a large Print might without much difficulty be read by it: And at the same time, the Room, which was large and wide, became sensibly enlightened, and the Wall was visible at the remotest distance, which was at least ten Foot.”



One of Geissler's ornamental discharge tubes.

Hauksbee's experiments were carried out in Gresham College before the members of the Royal Society, of which he was a fellow and curator, between 1705 and 1713, in which year he died, and accounts of them are to be found in the Philosophical Transactions of 1705 and following years. In spite of some disparaging remarks Priestley made about him we must consider him as a highly successful experimenter and his evacuated globe as one of the main predecessors of our present day gas discharge lamps. It may be mentioned that he made also experiments with what he called "mercury phosphor," *i.e.*, the appearance of light phenomena when air is blown through mercury in an evacuated container, and with the behaviour of phosphorescent material in such a container.

Johann Heinrich Winkler in 1742 and 1743 made experiments with electric discharges through evacuated tubes and was the first to shape them so that luminous letters were formed.

The use of metal electrodes inside the tube is a much later accomplishment. Faraday, in his researches on gas discharges published 1838, used sphere gaps placed inside the evacuated recipient, and describes as "dark discharge" what is called the "Faraday dark space" to-day, *i.e.*, the space between positive and negative column in a glow discharge.

John Peter Gassiot, who in 1852 discovered the striations in the positive column of the glow discharge, used evacuated tubes with platinum electrodes and remarks in a paper read before the British Association in 1854 "if the wires are sealed into small (thermometer) straight tubing neither terminal appears to be heated, but the discharge takes place, filling the entire tube with a brilliant clear white light."

In the same year Heinrich Geissler founded his workshop at Bonn, where since 1856 so many "Geissler-tubes" were made and distributed throughout the world. Geissler himself was not a scientist, but a mechanic and glass blower, but his work was so much appreciated that an honorary doctor's degree was conferred upon him in 1868. The scientific work on these tubes is connected with the names of Plücker, Hittorf, Becquerel, Crookes, Warburg, Goldstein and J. J. and G. P. Thomson.¹⁰

Basic Principles (continued).—The glow discharge is based on ionisation by collision and liberation of the electrons of the cathode by the impact of ions. It is characterised by a high cathode drop and only a very small current as most of the electrons move at random within the tube. The potential difference at which the glow discharge starts is to a large extent dependent on the kind of gas or vapour contained in the tube, on its pressure, on the length and form of the tube and on the kind of electrodes used. As will be described later there are still other considerations by which the start of the glow discharge may be influenced.¹

The arc discharge sets in if a thermionic emission is started at the cathode so that the liberation of electrons by ion impact on the cathode may decrease. The cathode drop is thus diminished to about one tenth of the value it has with ordinary glow

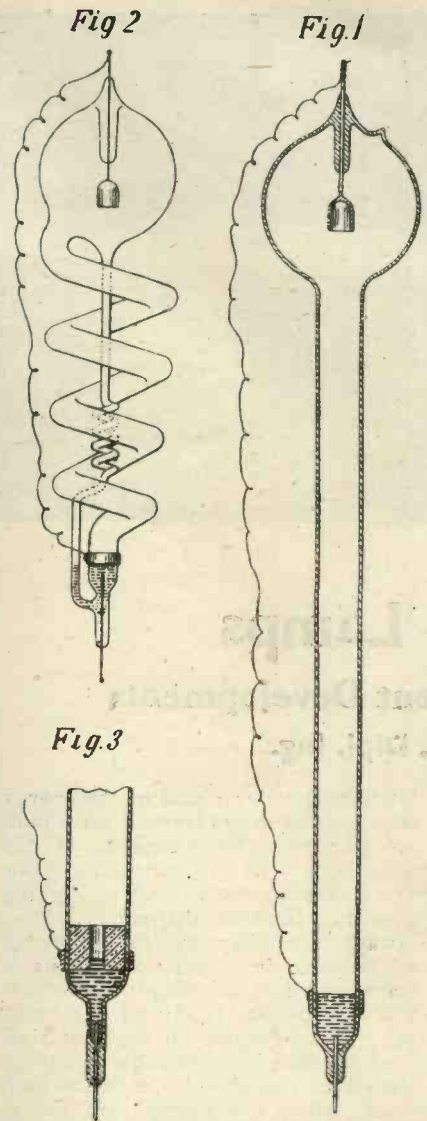

Drawing from P. Cooper Hewitt's specification No. 11,562 of 1900 showing (Fig. 1) a tubular lamp with mercury pool electrode, and (Fig. 2) a lamp with return tube for the condensed mercury vapour. This specification was considerably amended to conform with a decision of the Law Officer, 1907, and mainly covered the use of a mercury pool cathode.

discharge and the large number of electrons now emitted and travelling through the tube to the other electrode forms the current of the arc discharge.⁸

As is well known the arc discharge has a negative characteristic, *i.e.*, the voltage decreases with increasing cur-

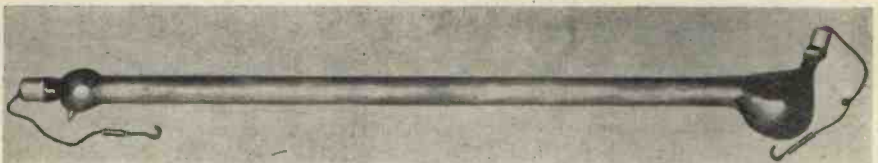

Early form of Cooper Hewitt mercury vapour lamp which had to be tilted to start the discharge. (From the Edison Swan Lamp Museum)

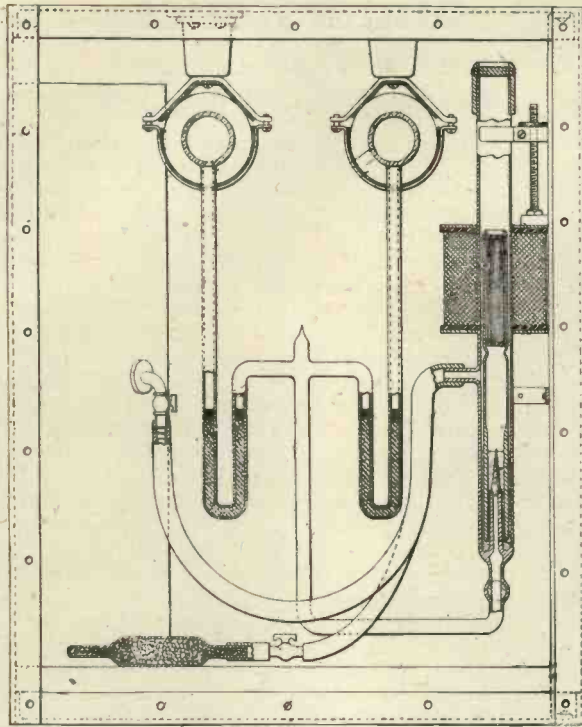

Drawings from the Moore Electrical Co.'s patent No. 9916 of 1906 showing an electro-magnetically operated valve for controlling the pressure of gas in the discharge tube. The tank on the left contains nitrogen or other gas, and the discharge tube is seen in section at the top of the casing.

rent. Thus in order to prevent the current from increasing to such values which would be detrimental to the tube and its electrodes an ohmic resistance or a choking coil must be connected in series to the tube with d.c. or a.c. supply respectively unless the source of current itself is working with a falling characteristic. We shall deal with the arc discharge and with the means for stabilising it more fully later on.

Previous Discharge Lamps.—The first discharge tubes to be produced commercially and not merely for physical experiments (e.g., Arons, 1892) were the mercury arc lamps of Cooper Hewitt and the Moore light, the latter mainly used for decorative lighting. They were very different not only in their working principle and in shape, but also with regard to the electrodes used, the kind of gas or vapour filling and the voltage required for their operation. In the Cooper Hewitt lamp, working with arc discharge, the cathode consists of liquid mercury and the filling consists of mercury vapour. A more or less complicated mechanism was required for striking the arc, the simplest being that of tilting the tube and thus initiating a spark discharge between the cathode and an auxiliary anode. This lamp is still in extensive use, but mainly for special purposes, e.g.,

photographic and medical lamps. As for these purposes the very intensive mercury resonance line of 2,537A is specially valuable on account of its high chemical activity, and as this line is absorbed by ordinary glass but not by quartz, the containers must be made of quartz and the dimensions of the tube are restricted by the price of this material.

On the other hand the Moore light and its descendants, e.g., the neon tubes, are working with glow discharge only and therefore with cold solid metal cathodes. The main contribution of Moore was his "breathing valve" for adjusting the vacuum. As the cathode drop of these lamps is comparatively high it is desirable to extend the tubes to great lengths in order to improve their efficiency. Thus a high operating voltage is required. The kind of filling depends on the colour desired for decorative and advertising purposes. It was in this kind of tube that fluorescent materials were used for the first time commercially by Koch and by Claude as "frequency transformers" in light sources," although as far back as 1857 Becquerel introduced luminescent materials inside the discharge tubes and even proposed to cover part of the inside walls with such materials fixed to them by some glue."

(To be continued.)

The First Primary Cell ?

Some years ago it was reported by Dr. Koenig of the Iraq Museum that an expedition from Baghdad had unearthed a peculiar jar at Khujut Rabu'a, near the Kirkut railway. This jar, of which a sketch is given, was made of clay, about 14 cm. high and 3.3 cm. maximum diameter. Inside it was a copper cylinder 10 cm. long by 2.6 diameter, closed at its lower end. The upper end was fitted with an asphaltum plug through which passed an iron rod approximately 1 cm. diameter. The end of this rod, when found, was eroded to the shape shown.

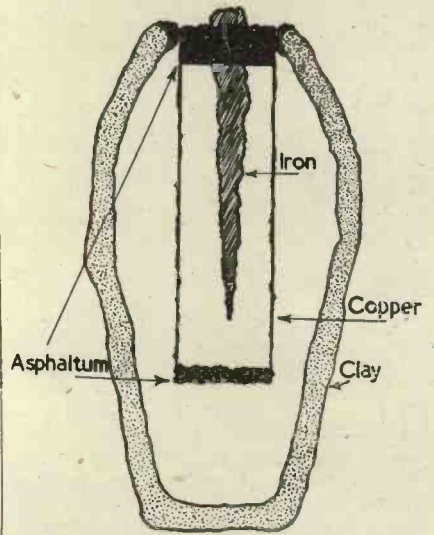

It was pointed out that an assembly of this nature could only fulfil the purpose of a primary cell, and was probably used by silversmiths of Baghdad for electro-gilding—a jealously guarded trade secret. Similar vases have been found near 'Tel' Omar and their probable date is 250 B.C. to A.D. 224.

References to "Fluorescent Lamps"

- 1 C. C. Paterson, Colour and Colour Rendering, *G.E.C. Journal* 10, p. 172, London, 1939.
- 2 A. V. Engel and M. Steenbeck, *Elektrische Gasentladungen*, Berlin, 1931 and 1934.
- 3 W. Uytterhoven, *Elektrische Gasentladungslampen* Berlin, 1938.
- 4 D. Gabor, *Electric Discharges at Low Pressures, Electronics, Television and Short Wave World*, 12 London, 1939.
- 5 J. A. Crowther, *Ions, Electrons and Ionizing Radiations*, London, 1934.
- 6 V. J. Francis and H. G. Jenkins, *Electric Discharge Lamps* (G.E.C., Ltd.), London, 1941.
- 7 M. Pirani, Conditions favouring the Start of an Arc Discharge between Cold Activated Electrodes at 50 Cycles per Second, *Proceedings of the Physical Society* 55, p. 24, London, 1943.
- 8 E. Iax, M. Pirani and R. Rompe, Die Probleme der technischen Lichterzeugung, *Naturwissenschaften* 23, p. 393, Berlin, 1935.
- 9 P. F. Mottelay, *Bibliographical History of Electricity and Magnetism*, London, 1922.
- 10 J. J. and G. P. Thomson, *Conduction of Electricity through Gases*, Cambridge, 1928 and 1933.
- 11 H. G. Jenkins, Fluorescent Lighting, *Journal Roy. Soc. Arts* 90, p. 282, London, 1942.
- 12 A. Claude, L'éclairage par luminescence, *Bull. Soc. Franc. des Electr.* 9, p. 307, Paris, 1930.
- 13 A. E. Becquerel, *La Lumière, ses causes et ses effets*, Paris 1867-68 and *Ann. de phys. et de chim.* 5me série 55, p. 93, Paris, 1859.

Supersonics

By W. P. BOLLINGER

Abstracted from Q.S.T.—May, 1943

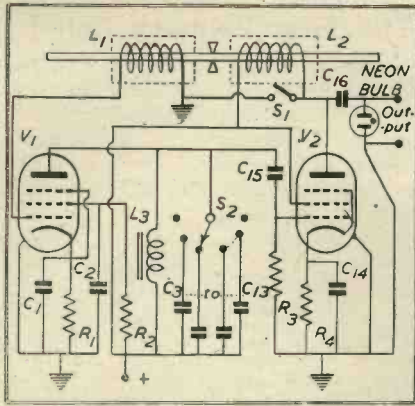

Fig. 2. Magnetostriction-oscillator circuit.

- C₁ 10 μfd. 25-volt.
- C₂ 0.01 μfd. 400-volt.
- C₃ 22 μfd.
- C₄ 100 μfd.
- C₅ 330 μfd.
- C₆ 560 μfd.
- C₇ 0.001 μfd.
- C₈ 0.0018 μfd.
- C₉ 0.0027 μfd.
- C₁₀ 0.0039 μfd.
- C₁₁ 0.0047 μfd.
- C₁₂ 0.0068 μfd.
- C₁₃ 0.01 μfd.
- C₁₄ 10 μfd. 25-volt.
- C₁₅ 0.01 μfd. 400-volt.
- C₁₆ 0.01 μfd. 400-volt.
- R₁ 820 ohms.
- R₂, R₃ 150,000 ohms.
- R₄ 470 ohms.
- L₁ 1,200 turns No. 36 d.s.c. ½-in. dia., ½-in. long.
- L₂ 2,400 turns No. 36 d.s.c. ½-in. dia., ½-in. long.
- L₃ 0.25 to 0.5 henry.
- V₁ 6S17.
- V₂ 6F6 or similar tube.

THE recent interest of radio amateurs in supersonics has brought up the question of a simple means of producing and detecting supersonic sound waves. The magnetostriction rod lends itself very well to this problem. The following is a description of a magnetostriction oscillator which can form the transmitting end of a supersonic communications system. The receiving end can be another magnetostriction rod with suitable pick-up coil and amplifier. References to supersonic receivers can be found under the bibliography.

In Fig. 1, a magnetised rod is shown rigidly supported at the centre and having a coil wound around it. If now this rod is lengthened or shortened by applying tension or compression, a voltage will be induced in the coil during the deformation process. Allowing the rod to return to its original length will, of course, again induce a voltage, but reversed polarity. If, then, this rod is continually vibrated transversely, an a.c. voltage, the frequency of which will be the frequency of the vibrating rod, will be induced in the coil. One way to vibrate the rod is to allow sound waves to strike its ends. At one particular frequency, the rod will resonate and maximum induced voltage will be produced. If the rod is supported in the middle as shown, there will also be frequencies at every odd multiple

of the fundamental at which the rod will resonate.

The action just described can be reversed. A voltage can be fed into the coil and the rod will vibrate lengthwise at the frequency of the applied voltage. In this case, sound waves will be radiated from the ends of the rod. As before, maximum points of vibration, and consequently maximum sound intensity, will occur at the fundamental period of the rod and at every odd multiple thereof. This affords a convenient device for producing supersonic sound waves. The problem is then to set the magnetostriction rod to vibrating, preferably at its resonant frequency.

One method of producing oscillations in a magnetostriction rod is to allow it to excite itself in much the same manner of operation as a crystal oscillator. The oscillations will then occur at the resonant frequency of the rod or one of its harmonics. A circuit for doing this is shown in Fig. 2. The magnetostriction oscillator is essentially a tuned two-stage amplifier, the input of which is received from L₁, coupled to the vibrating magnetostriction rod, and the output of which drives the rod through L₂. The grid coil, L₁, and the plate coil, L₂, are shielded from each other and their polarity is such that if there were coupling between the coils it would be degenerative. Hence, the oscillator will oscillate only when the magnetostriction rod is in place.

The tuned circuit which determines the harmonic at which the rod will vibrate is composed of the inductance, L₃, and capacitors, C₃ to C₁₃. Electrical output may be taken from the plate of V₂ through the coupling condenser, C₁₆. V₂ may be a 6F6 or similar tube. A neon bulb is connected across the output to indicate the presence of oscillations.

If the rod were not magnetised it would tend to shorten every time a flux was set up in it, regardless of the direction of this flux. This would cause the rod to vibrate at twice the frequency of the exciting voltage. Therefore, in Fig. 2, some method must be provided for magnetically

polarising the rod. This is done with the aid of the push-button switch, S₁, which can be momentarily pressed. This operation causes a high current to flow through the coil L₂, magnetising the rod. The magnetic polarisation is maintained by the normal plate current through the coil.

The materials best suited for magnetostriction rods are the alloys of iron containing nickel. Common names for such alloys are Invar, Stoic Metal, and Nichrome. Of these, a Nichrome rod is the best oscillator. Rods from ⅛ to ½ inch in diameter are most easily handled. The velocity of sound in Nichrome is about 1.96 × 10⁵ inches per second, and so the following equation can be written:

$$(\text{Nichrome}) = 1.96 \times 10^5 / f$$

Since the rod is a half-wavelength long at its fundamental period of oscillation,

$$l = 1.96 \times 10^5 / 2f \\ = 9.8 \times 10^4 / f$$

where *l* is in inches and *f* in cycles per second. For example, the length of a rod whose fundamental frequency is 20 kilocycles is given by,

$$l = 9.8 \times \frac{10^4}{20 \times 10^3} \\ = 4.9 \text{ inches.}$$

With this oscillator it is possible to secure magnetostrictive oscillations over a range of from 5 kilocycles to 50 kilocycles. With one 5-kilocycle rod it has been possible to produce strong oscillations on all odd harmonics up to and including the ninth. The stability of the magnetostriction oscillator is remarkably good with no temperature compensation. By the combination of two metals having opposite temperature coefficients, one in the form of a rod pressed into a tube of the other, a temperature stability can be obtained which approaches that of a crystal. For supersonic work the end of the rod can be coupled into an exponential horn and directive effects obtained. If the frequency is relatively high, the horn becomes quite small (about 4 in. long at 20 kc/s.). For a more complete discussion, refer to the bibliography.

BIBLIOGRAPHY

- "Magnetostriction Oscillators," by G. W. Pierce, *Proc. I.R.E.*, Vol. 17, No. 1, p. 43.
- "Improved Magnetostriction Oscillator," by G. W. Pierce and A. Noyes, Jr., *Jour. Acous. Soc. Am.*, Vol. 9, p. 185, 1938.
- "Apparatus for Acoustic Research in the Supersonic Frequency Range," by A. Noyes, Jr., and G. W. Pierce, *Jour. Acous. Soc. Am.*, Vol. 9, p. 205, 1938.
- "Supersonic Measurement of the Directional Characteristics of Horns," by Stanford Goldman, *Jour. Acous. Soc. Am.*, Vol. 5, p. 181, 1934.

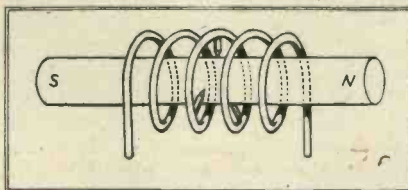
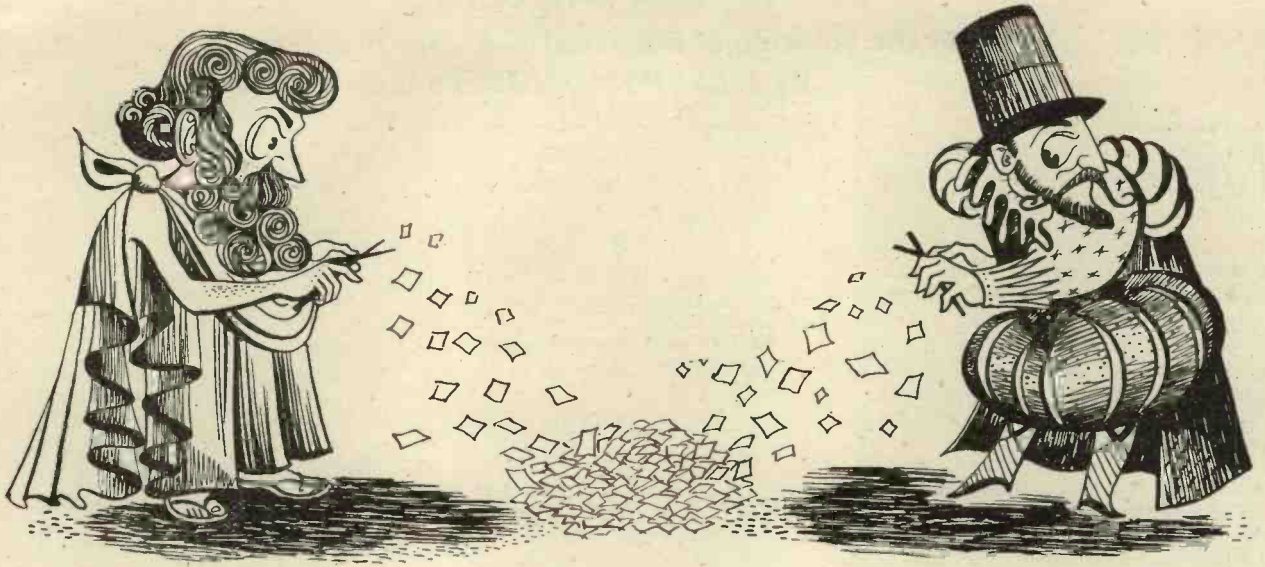

Fig. 1. Magnetostriction rod in coil.



William Gilbert had a word for it

Some 2,500 years before Distrene was made, a Greek philosopher, Thales of Miletus, noticed that when amber was rubbed together it attracted light objects. This phenomenon also intrigued Queen Elizabeth's physician, William Gilbert. He found that other substances, too, had this strange power of attraction. He called it 'electric', from the Greek word for amber—'elektron', hence 'electricity'.

Distrene (Regd.) is the name of the most successful insulating material for radio and high frequency work. Its electrical properties are outstanding; it also shows a remarkable resistance to the action of water over long periods. Its high efficiency may be judged from the data below—which, by the way, can be checked from working samples we will gladly supply on application.

BX DISTRENE (Regd.)

COMPRESSION STRENGTH	7 tons per sq. in.
SPECIFIC GRAVITY	1.06
WATER ABSORPTION	Nil
COEFFICIENT OF LINEAR EXPANSION	.0001
SURFACE RESISTIVITY (24 hours in water)	3×10^6 megohms.
DIELECTRIC CONSTANT 60—10 ⁶ CYCLES	2.60—2.70
POWER FACTOR UP TO 100 MEGACYCLES	.0002—0003

BX PLASTICS LTD. LONDON & ELSEWHERE

Matrix Algebra

And the Solution of Electrical Network Problems

By J. C. SIMMONDS, Ph.D.

Introduction

MATRIX algebra, which deals with manipulation of systems of linear simultaneous equations, was invented by the great pure mathematician, Cayley, over eighty years ago. For many years this algebra was of interest only to mathematicians, but, as has frequently been the case, it was at last realised that matrix algebra could be profitably employed in the solution of physical and electrical problems and it is now very widely applied. Like many mathematical tools, matrix algebra does not reduce the mechanical work, it simply reduces the amount of thought required by reducing the number of symbols and equations necessary to state the problem in mathematical form. This, as will be shown below, greatly facilitates the solution.

In electrical theory, matrix algebra can be employed usefully in the solution of networks and it is the purpose of this article to present a simple introduction to matrix algebra and its application to problems of this type.

To illustrate the need for some systematic means of reducing the number of symbols and equations in network problems first consider the simple circuit shown in Fig. 1. (For simplicity the circuit elements will be assumed to be resistances and the impressed voltage will be assumed a direct voltage). The equations relating the currents and the voltage are:—

$$E = I_1 R + R_1(I_1 - I_2) \quad (1)$$

$$0 = I_2 R_2 - R_1(I_1 - I_2) \quad (2)$$

Thus, the performance of a network with two meshes can be expressed by two simultaneous equations. If, in the general case, a network has "n" meshes and "n" impressed e.m.f.'s, then its performance can be expressed by "n" simultaneous equations of the following type:—

$$E_1 = R_{11}I_1 + R_{12}I_2 + \dots + R_{1n}I_n \quad (3)$$

$$E_2 = R_{21}I_1 + R_{22}I_2 + \dots + R_{2n}I_n \quad (3a)$$

In these equations the notation adopted for the circuit elements is that usual in network theory and the subscripts indicate the position of the elements in the circuit. Thus R_{11} means the total resistance in mesh 1 of the network, and R_{12} means the total resistance common to mesh 1 and mesh 2. To convert the simple case of resistance elements and direct voltages to the more general case of impedance elements and alternating

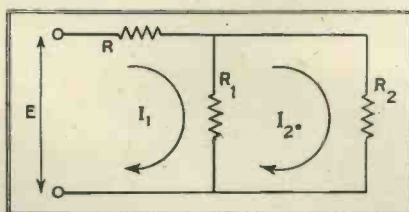

Fig. 1. Simple resistance network

voltages only a change of symbols is required.

It is clear, therefore, that any means that may be available to facilitate the manipulation of systems of linear simultaneous equations will be of use in network theory. If the number of symbols and equations can be reduced, then the labour involved in writing the equations will also be reduced. In addition, the meaning of the equations, which may otherwise be obscured, may be more easily determined. Matrix algebra was invented for this purpose and consequently an investigation of its properties is likely to be profitable.

Matrix Algebra

A matrix is an array of symbols and must not be confused with a determinant, which is a definite expression. To distinguish between the two, two vertical lines are sometimes drawn on either side of the matrix. Another way of denoting a matrix is to enclose the array in square brackets, as shown below.

$$\begin{bmatrix} a_{11} & a_{12} & \dots & \dots & \dots & a_{1n} \\ a_{21} & a_{22} & \dots & \dots & \dots & a_{2n} \\ \vdots & \vdots & & & & \vdots \\ a_{n1} & a_{n2} & \dots & \dots & \dots & a_{nn} \end{bmatrix}$$

This method will be adopted in what follows and more shortly may be written [a].

Unlike determinants, matrices need not be square; that is, in general the number of rows need not be equal to the number of columns. However, all matrices can be made square by filling in the missing rows or columns with zeros. The definitions given in the next column refer to square matrices.

By definition a matrix is zero only when all its elements are zero, and two matrices are equal only when every element of one is equal to the corresponding element of the other. Further, the sum or difference of two matrices is defined to be a matrix whose elements are equal to the sum or difference of corresponding ele-

ments of the given matrices. That is:—

$$\begin{bmatrix} a_{11} & a_{12} \\ a_{21} & a_{22} \end{bmatrix} + \begin{bmatrix} b_{11} & b_{12} \\ b_{21} & b_{22} \end{bmatrix} = \begin{bmatrix} a_{11} + b_{11} & a_{12} + b_{12} \\ a_{21} + b_{21} & a_{22} + b_{22} \end{bmatrix} \quad (4)$$

In matrix algebra ordinary quantities are called *scalars* to distinguish them from matrices, and the product of a scalar ϕ and a matrix is a matrix, every element of which is ϕ times the corresponding element of the original matrix.

It follows from these definitions that the laws of ordinary algebra hold for the addition and subtraction of matrices and also for the multiplication by a scalar quantity.

Multiplication of matrices of the same order, *i.e.*, with the same number of rows and columns, is defined in such a manner that the operation is similar to the multiplication of determinants. Thus, the product of two square matrices [a] and [b] both of the *n*th order, is a square matrix [c] of the *n*th order in which any element c_{pq} is formed by summing the products $a_{pi} \times b_{iq}$ for values of *i* from 1 to *n*. This definition is, perhaps, best illustrated by means of an example. The product of the two second order matrices [a] and [b] is a matrix [c], that is:—

$$[a] \times [b] = [c], \quad (5)$$

writing this in full gives:—

$$\begin{bmatrix} a_{11} & a_{12} \\ a_{21} & a_{22} \end{bmatrix} \times \begin{bmatrix} b_{11} & b_{12} \\ b_{21} & b_{22} \end{bmatrix} = \begin{bmatrix} (a_{11}b_{11} + a_{21}b_{21}) & (a_{11}b_{12} + a_{21}b_{22}) \\ (a_{21}b_{11} + a_{22}b_{21}) & (a_{21}b_{12} + a_{22}b_{22}) \end{bmatrix} \quad (6)$$

The arrow over the "a" matrix and at the side of the "b" matrix indicates the way in which elements are multiplied. Thus, to find the element c_{12} , elements along the first row of the "a" matrix are multiplied by corresponding elements down the second column of the "b" matrix. It is, of course, possible to define multiplication of matrices in other ways, but the definition given above is chosen because it leads to more useful results than other definitions. Using the rule for multiplication it is easily shown that the product [b] \times [a] is equal to:—

$$\begin{bmatrix} (b_{11}a_{11} + b_{12}a_{21}) & (b_{11}a_{12} + b_{12}a_{22}) \\ (b_{21}a_{11} + b_{22}a_{21}) & (b_{21}a_{12} + b_{22}a_{22}) \end{bmatrix}$$

Since matrices are equal only when all corresponding elements are equal, it is seen that $[a] \times [b] \neq [b] \times [a]$ or in other words, the multiplication of matrices is not commutative.

Now consider the matrix equation:

$$\begin{bmatrix} E_1 \\ E_2 \\ E_3 \\ \vdots \\ E_n \end{bmatrix} = \begin{bmatrix} R_{11} & R_{12} & \dots & R_{1n} \\ R_{21} & R_{22} & \dots & R_{2n} \\ R_{31} & R_{32} & \dots & R_{3n} \\ \vdots & \vdots & \ddots & \vdots \\ R_{n1} & R_{n2} & \dots & R_{nn} \end{bmatrix} \times \begin{bmatrix} I_1 \\ I_2 \\ I_3 \\ \vdots \\ I_n \end{bmatrix} \quad (7)$$

where the rows and columns of the E and I matrices can be filled in with zeros to make them square matrices of the same order as the R matrix. When the matrices on the right hand side of this equation are multiplied together the following equation is obtained:—

$$\begin{bmatrix} E_1 \\ E_2 \\ E_3 \\ \vdots \\ E_n \end{bmatrix} = \begin{bmatrix} R_{11}I_1 + R_{12}I_2 + \dots + R_{1n}I_n \\ R_{21}I_1 + R_{22}I_2 + \dots + R_{2n}I_n \\ R_{31}I_1 + R_{32}I_2 + \dots + R_{3n}I_n \\ \vdots \\ R_{n1}I_1 + R_{n2}I_2 + \dots + R_{nn}I_n \end{bmatrix} \quad (8)$$

It will no doubt be observed that all the elements of the product matrix, other than those in the first column, are zero and consequently have been omitted from the matrix. Now the corresponding elements of the matrices forming this equation must be equal and when they are equated the system of equations (3) is obtained. Thus, it may be concluded that this system of equations can be represented very simply by the equation:—

$$[E] = [R] \times [I] \quad (9)$$

This is certainly a very concise way of stating the system of equations, although alone it is, perhaps, of no great value.

Having now shown that systems of linear equations of the type met with in electrical network theory can be expressed concisely by means of matrix equations, it is natural to investigate the possible operations which may be performed upon matrix equations. For example, if it is possible to transform equation (9) to give $[I]$ in terms of $[R]$ and $[E]$ then the use of the matrix method will be greatly extended. This point will now be considered at some length.

Division of matrices has not been defined above and to perform the desired operation the inverse matrix must be introduced. This inverse matrix, distinguished by the index -1 as in $[a]^{-1}$ is defined by the equation:—

$$[a] \times [a]^{-1} = [1], \quad (10)$$

where $[1]$ is the unit matrix, that is, a matrix such that the elements along the top left to bottom right diagonal are all unity and all other elements are zero. The unit matrix in matrix algebra takes the same place as unity

in ordinary algebra. $[a]^{-1}$ the inverse of the matrix $[a]$ is such that the element common to the p th row and q th column is $A_{qp}/|a|$ where $|a|$ is the determinant formed from the elements of the "a" matrix and A_{qp} is the co-factor of the element a_{qp} in the determinant $|a|$. Thus, if

$$[a] = \begin{bmatrix} a_{11} & a_{12} \\ a_{21} & a_{22} \end{bmatrix} \quad (11)$$

$$[a]^{-1} = \frac{\begin{bmatrix} a_{22} & -a_{12} \\ -a_{21} & a_{11} \end{bmatrix}}{\begin{vmatrix} a_{11}a_{22} - a_{12}a_{21} \\ a_{11}a_{22} - a_{12}a_{21} \end{vmatrix}} \quad (12)$$

It will be observed that for the inverse matrix to exist the determinant $|a|$ must not be zero. When the determinant formed from the elements of a matrix is zero, the matrix is said to be singular. Thus, only non-singular matrices have inverse matrices. It should perhaps be pointed out that:—

$$[a]^{-1} \times [a] = [a] \times [a]^{-1}, \quad (13)$$

as may easily be shown by multiplication.

Now revert to equation (9). Multiply both sides of the equation by the inverse matrix $[R]^{-1}$ thus obtaining:

$$[R]^{-1} \times [E] = [R]^{-1} \times [R] \times [I]. \quad (14)$$

Now

$$[R]^{-1} \times [R] = [1] \quad (15)$$

and

$$[1] \times [I] = [I] \quad (16)$$

as may be easily seen by considering a low order matrix and multiplying out.

Therefore,

$$[I] = [R]^{-1} [E] \quad (17)$$

and it is seen that the desired transformation can be made by means of the inverse matrix $[R]^{-1}$. This is Cramer's rule expressed in matrix form. The matrix $[R]^{-1}$ occupies the same position as the admittance in a simple equation relating I and E , and is, therefore, frequently called the admittance matrix and is denoted by $[A]$. Therefore, equation (17) may also be written in the form:—

$$[I] = [A] \times [E] \quad (18)$$

Systems of equations of the following type are of frequent occurrence in network theory and it will now be shown how matrix algebra facilitates the manipulation of such systems of equations:—

$$y_1 = a_{11}x_1 + a_{12}x_2 \quad (19)$$

$$y_2 = a_{21}x_1 + a_{22}x_2$$

$$z_1 = b_{11}y_1 + b_{12}y_2 \quad (20)$$

$$z_2 = b_{21}y_1 + b_{22}y_2$$

In matrix notation these systems of equations are simply:—

$$[y] = [a] \times [x] \quad (21)$$

$$[z] = [b] \times [y] \quad (22)$$

From these two equations the relation between z and x is obtained by substituting for $[y]$ from equation (21) into equation (22).

This results in:—

$$[z] = [b] \times [a] \times [x] \quad (23)$$

This equation can be written more shortly as:—

$$[z] = [c] \times [x], \quad (24)$$

where

$$[c] = [b] \times [a]. \quad (25)$$

Expanding equation (24) it is seen that the relation between z and x is given by the equations:—

$$\begin{aligned} z_1 &= c_{11}x_1 + c_{12}x_2 \\ z_2 &= c_{21}x_1 + c_{22}x_2 \end{aligned} \quad (26)$$

The values of the "c's" are obtained by multiplying out $[b] \times [a]$ and equating elements of the matrix so obtained to corresponding elements of the "c" matrix. When these operations are carried through the following equations are obtained:—

$$\begin{aligned} c_{11} &= b_{11}a_{11} + b_{12}a_{21} \\ c_{12} &= b_{11}a_{12} + b_{12}a_{22} \\ c_{21} &= b_{21}a_{11} + b_{22}a_{21} \\ c_{22} &= b_{21}a_{12} + b_{22}a_{22} \end{aligned} \quad (27)$$

When the transformation is made in this way the work is a good deal less laborious than when the transformation is made by ordinary methods. This is, of course, particularly so when many systems of equations and unknown quantities are involved.

(To be continued.)

Electronic Industry.

... We know of one case where an electronic device was installed in a factory to control the flow of steam to a drier. The device failed after six months, and production was halted until a trained man could arrive to fix it. He found the trouble: someone had shut off the steam. It is easy to say that someone at the factory should have found the trouble, but they knew nothing of electronics and wisely left the whole system alone. In another plant we know of, the maintenance men did try to find the trouble. They started by taking a photoelectric cell apart. (They did, so help us!)

From the above cases, it is clear that the new electronics industry is going to need equipment of extreme reliability, plus an army of maintenance men who know their stuff. These men will be electronic specialists, as distinct from radio men as pattern makers are distinct from cabinet makers. The principles and the tools will be the same, but the job will be very different. It will be a good profession, busy, profitable and interesting.

W. A. READY, *Adv. of National Radio, Inc.—QST.*

A Resistance, Inductance and Capacitance Tester

By I. V. WHITE*

THE need for a Tester which would enable rapid checks of Resistance, Inductance and Capacitance to be made *in situ* having arisen, an attempt was made by the writer to evolve a suitable instrument satisfying the requirements detailed below, and a model was constructed which gave the results shown.

Circuit

It will be observed that the basic circuit for resistance measurements is the Wheatstone Bridge, capacitances and inductances being substituted for resistance ratio-arms for measurements of capacitance and inductance respectively.

The switches S_1 to S_5 are ganged on a common shaft. S_1 and S_2 reverse the end connexions of the potentiometer R for capacity measurements in order that these shall be in the same direction as the inductance and resistance measurements.

Switches S_3 and S_4 short-circuit the potentiometer R_s when resistance measurements are being made, and leave it in circuit as a differential balance for power factor on capacitance and inductance ranges.

Switch S_5 connects the various ratio-arms in the circuit.

Scale Shape

Between 0.1 and 30 the scale is nearly linear, and between 30 and 700 it is approximately logarithmic.

There is only one calibration for all measurements, the different ranges being obtained by manipulation of the ratio arm switch.

It is considered that the single calibration is a distinct advantage, as the possibility of errors in reading several scales is thereby overcome.

The length of the whole scale is very nearly 20 in., the calibration being made on a metal disk locked to the spindle of the potentiometer R . The locking of the disk eliminates errors due to relative displacement between the disk and the rotor of R .

The index, which is made of celluloid with a hair-line for taking readings, is capable of slight movement about a central position (by loosening the holding screws) in order to correct the calibration, should this become necessary.

The instrument was calibrated from local standards with the screen con-

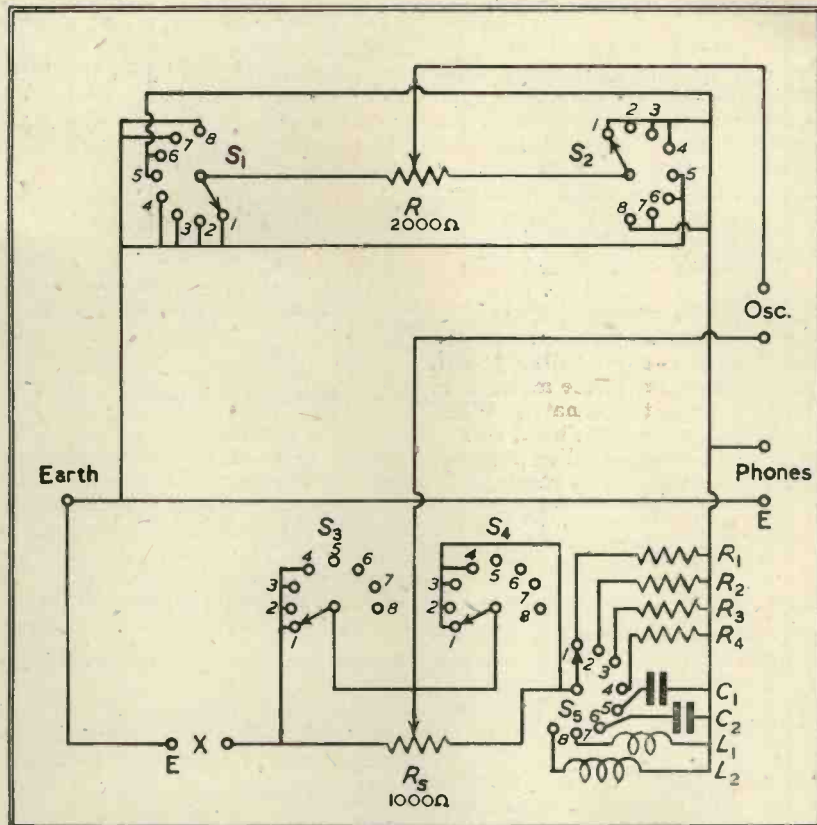

nected to a good earth. This earth connexion is important and should always be made when using the tester.

Components

The values of the components are shown under the figure. R and R_s are wire-wound linear potentiometers of the Berco type. R_1 to R_4 are non-reactively wound ratio arms. Composition resistances were used in the original model, but the stability of these is not good enough for long periods. Accuracy is 0.25 per cent. C_1 and C_2 are clamped mica condensers of any good make with an accuracy of 0.25 per cent., and L_1 and L_2 are air-cored inductances wound to the same accuracy. S_1 , S_2 , etc., are Yaxley type wafer switches.

The original model was enclosed in a wooden box measuring 12 by 8 by 8½ in. deep, and space sufficient to fit a buzzer, transformer and battery is available.

Ranges

Resistance on 4 ranges, 0.01 to 70 $K\Omega \pm \frac{1}{2}$ per cent. to 10 per cent. with useful indications up to 10 $M\Omega$.

Capacitance on 2 ranges, 10 $\mu\mu F$ to 7 μF ; ± 3 per cent. to 10 per cent. with useful indications up to 100 μF .

Inductance on 2 ranges, 10 μH to 7 $H \pm 3$ per cent. to 10 per cent. with useful indications up to 100 H .

These ranges were used on the

VALUES OF COMPONENTS

R	2,000 ohms.	C_1	0.01 μF .
R_s	1,000 ohms.	C_2	0.01 μF .
R_1	10 ohms.	L_1	10 mH .
R_2	100 ohms.	L_2	100 mH .
R_3	1,000 ohms.		
R_4	10,000 ohms.		

original model, but other ranges could be added if desired.

Remarks

The oscillator and phones used were of 600 Ω impedance as these were readily available, but other impedances could be used providing they do not depart widely from those mentioned.

If it were desired to calibrate the tester on the 50 c/s mains, a transformer giving about ten volts, as A.C. source for the bridge and an electronic tube could be incorporated as a balance indicator.

The accuracy is progressively better towards the lower end of the scale, where, between 0.1 and 30 Ω it is nearly linear. Between 30 and 700 Ω the scale shape is approximately logarithmic.

Above 700 Ω the error of reading is progressively worse, and readings may only be taken as approximate, the ratio arm switch being operated to bring the reading on to the portion of the scale between 0.1 and 700 Ω for measurements of ± 3 per cent. to 10 per cent. accuracy.

* P.O. Research Station.

METALASTIK BUSHES

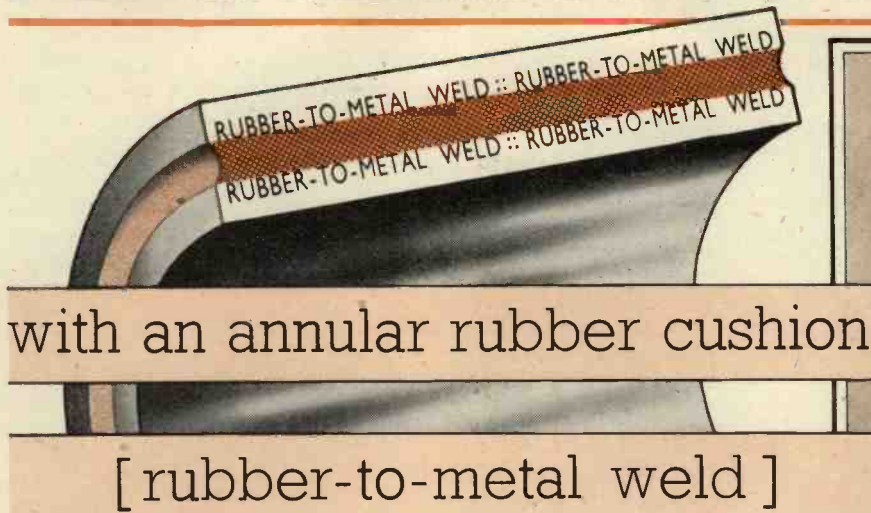

This elastic annulus is firmly "welded" to the metal, so that the rubber is not restricted in its action, to compression only, but is used in shear, in tension, in torsional shear, or in compression.

We can thus utilise the rubber in compression to resist forces in one plane, in shear to resist in another plane, and so forth, and we can use either natural or synthetic rubber.

We can adjust the rate of deflection in any plane to meet required frequencies, and can control the damping.

Some of the special-purpose bushes shown are used as pivot bearings, others have multiple surfaces to increase deflection capacity; all are free from wear and need no attention or lubrication.

- (A) Metalastik flexible mounting for motors, etc.
- (B) Metalastik special flanged bush for microphone suspension, etc.
- (C) Heavy-duty flanged bush for commercial vehicle engine, loaded in three ways.
- (D) Metalastik multi-concentric bush used as a spring, progressive or variable rate as needed.

The experience behind all this work is at your service.

METALASTIK LTD. - LEICESTER

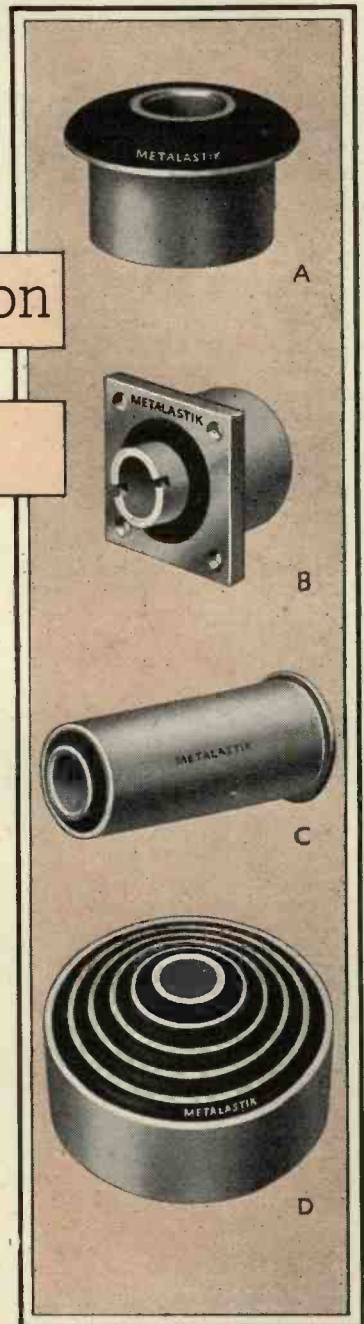

METALASTIK

SPECIALISTS IN REDUCING THE HARMFUL EFFECTS OF VIBRATION

Television After the War

The Case for Multiple Interlacing

By P. NAGY*

This article concludes the interesting discussion on Post-war Problems of Television which originated at an informal meeting of the I.E.E. Wireless Section and which has been continued in this journal

THE 405 lines pre-war standard is far removed from the real limit to the improvement of the definition of a television image.

The choice of the video and carrier frequency band and the transmission standard after the war should be influenced to a considerable degree by the technical advances since 1939, such as the efficient amplification of ultra-high frequencies and simplification of the generation and synchronisation of time bases. It would be idle to define an ambitious number of lines, should economical technical means not be available for its realisation. The television receiver of the future should be as simple as a good class radio receiver.

While above technical limitations should be heeded, at the present stage of development the definition is still well below the desirable limit. The sharper the picture the less is lost to the observer of the life-like detail of the original. While this is an obvious statement, it does not appear to be sufficiently appreciated. Life-like reproduction is required in sound reproduction, i.e., distortionless amplification of a band of frequencies from 50 to 10,000 cycles/sec. The same goal should be that of the television engineer, i.e., to approach the resolution of the eye.

Much has been published about "optimum" definition and band-width adopting certain viewing distances expressed in the height of the picture.^{1, 2, 3} It is interesting to note the growth of the "optimum" number of lines as function of "time"; the technical skill attained appears to have had a marked effect. Only a few years ago (1936), for example, J. C. Wilson writes in his excellent book¹: "Optimum fidelity is achieved by 260-270 lines" (page 430). To-day it is accepted that the "optimum" number of lines is above 500.

The method generally adopted for the determination of the optimum number of lines, namely, the disappearance of the line structure when viewed from the ideal distance, appears to be rather arbitrary. Assuming the ideal viewing distance as four to five times picture-height, it may be found by an inquisitive experimenter, that,

say, 800 black lines of one millimetre width, having a separation of one millimetre (i.e., line pitch 2 mms., picture height 1.6 metres), will truly merge together, viewed from the distance of 7-8 metres. When now a 0.2 mm. thick black line is drawn on white background, representing only 1/100 of the area of the picture element, it is distinctly visible by the average human eye and its width is recognised as being 0.2 mm. This experiment—which can be easily repeated by anyone—indicates that 800 lines should not be regarded as too ambitious.

The coefficient K of the definition-bandwidth formula (see later) is a rather "subjective" quantity. Baldwin³ "lifted this coefficient from their context" and found the following values:—

- | | |
|---------------------------------------|-------|
| (a) Kell, Bedford, Trainer (1934) | 0.64 |
| (b) Mertz, Gray (1934) | 0.53 |
| (c) Wheeler, Loughren (1938) | 0.71 |
| (d) Wilson (1938) | 0.82 |
| (e) Kell, Bedford, Fredendall (1940), | 0.85. |

(See also Bibliography¹ page 423.)

With increasing number of lines the requirement of equal definition in the horizontal and vertical directions loses its significance.³

Investigating the "subjective sharpness of television images," Baldwin³ arrived at the following conclusion: "Images of present (1940) television grade are within a region of diminishing return with respect of resolution." This result, while true, is misleading. It suggests, for example, that, by increasing the number of lines from 400 to 800, the relative gain in sharpness is small, when the required bandwidths are also compared. The fallacy of this conclusion can be better appreciated by making a comparison with sound reproduction: increasing the sound channel from, say, 4,000 c/s to 8,000 c/s the relative gain of good reproduction is small, but how many sound engineers would have the courage to-day to argue that a 50-4,000 c/s channel is quite sufficient.

When the definition of a television image is increased the required bandwidth increases with the square of the

number of lines; to avoid the effect of reflexions from the average town structures, the carrier frequency should be low and thus the bandwidth narrow. To assist these opposing requirements the introduction of multiple interlacing may be of considerable significance.

For example, 800 lines, 50 frames, fourfold interlacing is suggested by the writer. The following points should be investigated:—

1. Interline flicker;
2. Effect of the low (12.5/sec.) line repetition rate on movement;
3. "Crawling" effect;
4. Synchronisation.

1. It was recognised by the earliest workers⁴ that as the distance of the observer from the "source of flicker" is increased, a critical distance is reached for which the sensation of flicker disappears. That is, the smaller the solid angle between the eye and the source of flicker, the smaller is the "flicker effect." The double interlaced standard radiated from Alexandra Palace was based on the recognition of this fact. While 25 interruptions of the illumination of the whole picture field cause disturbing flicker of a well-illuminated C.R. Tube picture, 25 interruptions of the illumination of neighbouring lines cannot be recognised; i.e., the eye is less sensitive to interline flicker than to frame flicker.

If the line structure of the television image is dense and individual lines cannot be recognised by the eye, it is reasonable to assume that the critical interline frequency is below 25 cycles/sec.

The initial brightness of the luminous picture element, the illumination of the surroundings of the picture and the light storage or afterglow⁵ also affects interline flicker. The average afterglow of a bright C.R. Tube screen assists the elimination of interline flicker. Receiving systems employing ideal storage, i.e., persistence of illumination for one complete frame period with sharp cut-off at the end of the frame period, would perhaps allow the use of even a higher order of multiple interlacing.

* International Television Corporation.

Previous investigations of multiple interlacing are discouraging^{6, 7}; these, however, only consider low definition (240 lines) television images.

The adoption of quadruple interlacing for colour television has been recently suggested by Goldmark *et al*⁸ employing a primary-colour line repetition rate of 15/sec. (450 lines) and 10/sec. (525 lines); here again the discouraging statement is made: "the final decision" against quadruple interlacing "had to be made in view of the discouraging results, confirmed by other experimenters, in attempting to reach a satisfactory solution of the quadruple interlacing problem in general." It is assumed that the main deterrent was the difficulty in achieving accurate synchronisation using conventional time-base circuits.

2. The effect of the low-line repetition rate (12.5/sec.) on fast movement in the picture content should not be noticeable. Twenty-five frames/sec. reproduce satisfactorily the fastest movements. In the proposed standard 400 lines, i.e., half of the total lines, would be available for 1/25 of a second. The eye cannot and need not see a fast-moving object as sharply as one which is stationary; thus, 400 lines should be quite sufficient for the reproduction of movements.

It is also very doubtful whether the breaking up of the contour lines of an object moving horizontally, i.e., in the direction of scanning, would be observable.

3. Earlier investigators' of triple interlacing noted the disagreeable "crawling" of the lines. When the eye moves over the screen vertically downward at a certain constant speed, the line structure appears to break up into groups of three.

This effect would be very pronounced in the following scanning order of a quadruple interlaced scan:—

Lines 1, 5, 9... 2, 6, 10... 3, 7, 11... and 4, 8, 12...

There is, however, a perfect cure for the "line crawling" by employing symmetrically "scrambled" or "staggered" scanning sequence, thus:—

1, 5... 3, 7... 2, 6... 4, 8...

This is one good reason for the employment of quadruple and not triple interlacing.*

It is not possible to avoid "line crawling" by staggering a triple interlaced scan, for example:—

1... 3... 2... 1... 3... 2... 1... 3... 2... 1... 3... 2...

may be written thus:—

3... 2... 1... 3... 2... 1... 3... 2... 1... 3... 2... 1...

4. The real deterrent from employing multiple interlacing was the difficulty of synchronisation, using conventional means. The time base valve and principle described recently⁹ should be able to overcome the difficulty of synchronisation. For example, the very simple quadruple synchronisation signal standard described[†] should satisfy the necessary requirements of accuracy.

The bandwidth for the proposed system may be calculated:—

$f = \frac{1}{2} \cdot 1/i(a^n RK) \approx 3.7$ Mc./s. where i = coefficient of interlacing = 4, a = number of lines per complete frame = 800, n = frame repetition rate = 50, R = aspect ratio = 4/3, K = constant for equal definition in horizontal and vertical direction ≈ 0.7 .

The following table assists comparison of double and quadruple interlaced standards:—

If at 800 lines, quadruple interlacing, interline flicker is still observable, the definition could be increased to 1,000 lines; the bandwidth (5.8 Mc/s.) would be still below that of the 800 line, double interlaced standard.

* The coefficient of interlacing i (see later definition formula) should satisfy the following relationship:

$i = 2^k$
where $k = 1, 2, 3, \dots$

† *Op. cit.*, page 297.

1 J. C. WILSON, *Television Engineering*, 1937, Pitman London.
2 P. C. GOLDMARK, J. N. DYER, Quality in television pictures, *Proc. I.R.E.*, August, 1940.
3 M. W. BALDWIN, The subjective sharpness of simulated television images, *Proc. I.R.E.*, October, 1940.
4 T. C. PORTER, Contributions to the study of flicker, *Proc. Roy. Soc.*, May, 1902, pp. 314-315.
5 T. B. PERKINS, H. W. KAUFMANN, Luminiscent materials for cathode ray tubes, *Proc. I.R.E.*, November, 1935, p. 1329.
6 E. W. ENGSTROM, A study of television image characteristics, II, *Proc. I.R.E.*, April, 1935, pp. 306-7.
7 R. D. KELL, A. V. BEDFORD, M. A. TRAINER, Scanning sequence and repetition rate of television images, *Proc. I.R.E.*, April, 1936, p. 574.
8 P. C. GOLDMARK, J. N. DYER, E. R. PIORE, J. M. HOLLYWOOD, Color television, I, *Proc. I.R.E.*, April, 1942, pp. 163-164.
9 P. NAGY, M. J. GODDARD, The signal converter, *Wireless Engineer*, June, 1943.

Short-Time Contact from Slow Moving Gears

IN the May, 1943, issue of the *Review of Scientific Instruments*, M. L. Yeater describes an ingenious method of obtaining momentary electrical contacts from a comparatively slowly rotating gear wheel, such as in clock mechanisms.

On the shaft of the gear is mounted a roller arm of springy brass having a roller at its extremity. This roller passes over two contact studs arranged in pairs at any convenient point on the path of travel of the arm (Fig.)

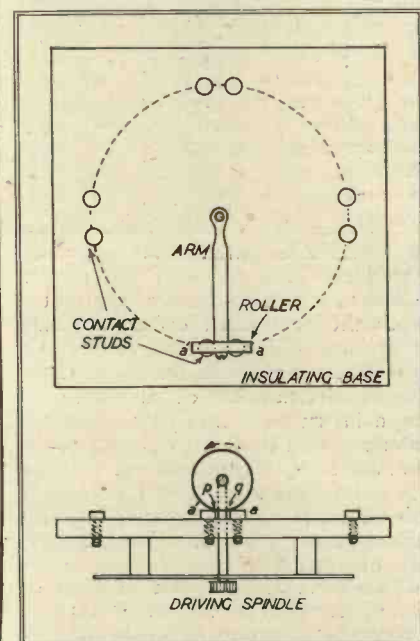

When the roller touches the contact a' after passing over a the circuit is made and the roller disk then revolves about p as an instantaneous centre, immediately breaking the circuit at q .

The time interval during which the contacts are shorted is governed by the time taken to open the gap k sufficiently to break the arc between the contacts, and this is given by

$t = ks/\omega, ru$

where t is the time during which the gap k lengthens, k is the gap, s the radius of the roller, ω , the angular velocity of the roller, r the length of the roller arm, and u the spacing between contacts.

New Words Section

"This science of Opti-onics is not optics; it isn't electronics, but it is a combination of both, combined with precision mechanical design."—(The President of *The Bell Howell Company*.) Quite.

Coefficient of interlacing i	Lines per complete frame a	Frame repetition rate/sec. n	Vision frequency band f
2	800	50/s	7.4 Mc/s
4	800	50/s	3.7 Mc/s
4	1,000	50/s	5.8 Mc/s

Characteristics of Decibel Meters

By JOHN H. JUPE

DB Loss or Gain	Voltage Ratio to "O" DB	Volts at "O" DB Based on			Power Ratio to "O" DB	Power in Watts (1 mW at "O" DB)	Power in Watts (6 mW at "O" DB)
		1 mW in 600 ω	6 mW in 500 ω	6 mW in 600 ω			
+10	3.162	2.449	5.476	6.0000	10.00	0.010000	0.06000
+9	2.818	2.183	4.881	5.347	7.943	0.007943	0.04766
+8	2.512	1.945	4.350	4.766	6.310	0.006310	0.03786
+7	2.239	1.734	3.877	4.248	5.012	0.005012	0.03007
+6	1.995	1.545	3.456	3.787	3.981	0.003981	0.02389
+5	1.778	1.377	3.080	3.374	3.162	0.003162	0.01897
+4	1.585	1.227	2.745	3.007	2.512	0.002512	0.01507
+3	1.413	1.094	2.446	2.680	1.995	0.001995	0.01197
+2	1.259	0.9750	2.180	2.389	1.585	0.001585	0.009509
+1	1.122	0.8690	1.943	2.129	1.259	0.001259	0.007553
0	1.000	0.7746	1.732	1.897	1.000	0.001000	0.006000
-1	0.8913	0.6902	1.544	1.691	0.7943	0.0007943	0.004766
-2	0.7943	0.6152	1.376	1.507	0.6310	0.0006310	0.003786
-3	0.7079	0.5483	1.226	1.343	0.5012	0.0005012	0.003007
-4	0.6310	0.4887	1.092	1.197	0.3981	0.0003981	0.002389
-5	0.5623	0.4355	0.9738	1.067	0.3162	0.0003162	0.001897
-6	0.5012	0.3882	0.8680	0.9509	0.2512	0.0002512	0.001507
-7	0.4467	0.3459	0.7736	0.8475	0.1995	0.0001995	0.001197
-8	0.3981	0.3083	0.6895	0.7554	0.1585	0.0001585	0.0009509
-9	0.3548	0.2748	0.6145	0.6732	0.1259	0.0001259	0.0007553
-10	0.3162	0.2449	0.5476	0.6000	0.1000	0.0001000	0.0006000

MANY communication engineers are familiar with the decibel as a unit and are aware that it is usually measured on an ordinary indicating instrument using a specially marked scale. Few, however, understand the characteristics of these instruments and how important they are with respect to correct use of the meters. An instrument of this class is generally spoken of as a decibel meter, but sometimes the terms, power level or volume indicator, are met with.

The basic requirement of such an instrument is that it shall be an A.C. voltmeter capable of measuring a varying A.C. voltage developed across a chosen load connected in the circuit under observation.

Up to this point it might be thought that moving iron, induction, electrostatic, dynamometer or thermal instruments would be satisfactory, but such is not the case, as it is difficult to make these in sensitive forms and most of them consume relatively large amounts of power. This makes them totally unsuitable for use in the high impedance circuits met with in communication equipment.

In actual practice only two types are used: (1) the thermionic voltmeter (rarely) and (2) the rectifier moving coil voltmeter (commonly). This latter type is the one referred to in this article.

The problem then, is to measure accurately, a varying A.C. voltage and the meters required to do this may be grouped according to whether average variations, medium speed variations within fairly narrow limits or high speed variations are likely to be

the subjects of measurement. Obviously two important factors in the design of such instruments are (1) speed of response, generally measured in milliseconds and referring to the rapidity with which the pointer assumes its new position after a change in the signal; (2) damping, referring to the amount by which the pointer swings past its position of final rest. Damping is generally measured as the angular change of the pointer from its initial overshoot above the final rest position, to the same point of final rest. For example, if the final position of rest of a pointer is 60 divisions on a 100 division scale and the first momentary overshoot is 75 divisions, the damping factor is 75-60, divided into 60; equals 4.

Quite clearly, for an instrument to be suitable for circuits with the greatest and most rapid changes in signal strength, high speed and heavy damping are required.

This is a difficult condition to obtain and can only be achieved in any degree by (1) using permanent magnets of the highest possible strength; (2) so designing the magnetic system that there is the maximum possible flux in the air gap in which the coil moves; (3) increasing the spring torque as much as possible; (4) reducing the moment of inertia of the moving system, by reducing its weight.

To calibrate a general purpose rectifier voltmeter as a decibel meter for use in circuits having rapid changes of signal strength will probably produce errors, owing to the slowness of the moving system in responding to peaks. The magnitude of such errors when the meter is

actually in use may amount to several decibels. Furthermore, owing to the probably large moment of inertia of the moving system, it will almost certainly overshoot the true values by considerable amounts; making the reading very difficult. This point regarding moment of inertia explains why so many decibel meters are of the "miniature" class. A large switchboard decibel meter of high accuracy and with high speed characteristics would be almost impossible to make.

The internal resistance of a decibel meter is generally kept fairly high, being perhaps of the order of ten times the load impedance, *i.e.*, the impedance across which the voltage developed is measured. The value quoted generally refers to the "O" position on the decibel scale, as the rectifier impedance changes slightly with the current passing through it.

To extend the ranges of these instruments is apparently simple, since they are essentially A.C. voltmeters. In practice, however, two points arise which require consideration. Firstly, since it is desirable to use the meter as near the "O" point on the decibel scale, additional ranges should be in low ratios to each other, *e.g.*, 2:1. Also, by adding series resistance the total resistance is increased and the instrument loads the circuit in a varying degree, according to the range used. This cannot always be tolerated and recourse must be made to switching methods which introduce "T" attenuators, so as to maintain the impedance of the measuring circuit constant. For indications of less than the normal "O" decibel level, there

is a limit in the downward steps of ranges, as the reduction of series resistance increases the load on the circuit and cannot be permitted past a certain point.

Decibel meters show the power level in terms of the voltage resulting from a given power being dissipated in a given load and as the decibel is merely a ratio, some reference level must be stated. In this country, 1 milliwatt in 600 ohms is common, whilst in the United States 6 milliwatts in 500 or 600 ohms is more usual. The voltages appearing across the respective loads in these cases would be 0.7746, 1.732 and 1.897 and decibel meters would have the zero marks on their scales at the points where these voltages would appear if the instruments were calibrated as ordinary A.C. voltmeters.

Useful data commonly used in connexion with power level measurements is given at the head of this article.

Electronic Music Group

In the July issue we invited readers who were interested in Electronic Musical Instruments to write to the Editorial Department with a view to forming a small discussion group for the interchange of experiences and ideas on their construction.

The response to this notice has already been sufficient to warrant the formation of a group and arrangements are being made to put members living outside London in touch with one another.

Further details will be published in this journal in due course, and in the meantime any other interested readers are asked to write Editorial Department as soon as possible.

One intending member writes:

"I have been interested for some time in this subject although I have not so far completed an instrument. I have made a preliminary 8-note percussion model imitating a piano in waveform. This incorporates a device giving 'touch-sensitivity' to the keys, i.e., a sharp blow gives a louder note than a gentle slow pressure. I have also started work on a 13-valve 12-note fundamental frequency oscillator, using transistor oscillations at 100 kC/s. and beating to give audio frequency notes, but have had to lay this aside for the time being.

"I have also experimented with a group of 3 tuning forks, self-maintained by a single 2-stage negative feedback amplifier, . . . the main advantage being cheapness and simplicity of construction. It has been found possible to maintain at least three forks from one amplifier, but it is not certain whether 12 could be maintained to produce a whole octave with only two valves" . . .

The Lubrication of Mechanisms and Automatic Devices

ONE of the problems associated with lightly loaded devices which operate only intermittently, as for example, fire alarms and automatic switches, is their satisfactory lubrication. If one uses an unsuitable oil or grease it may give rise to a film on the moving parts of the device which slowly hardens or becomes tacky. Then again, unless totally enclosed there will be a tendency for the pivots and bearings of such a device to collect dust which may again interfere with any prompt operation, particularly if the input energy to the bearings is small, as is often the case.

Another source of sticking in automatic devices and small mechanisms in general is the hardening of the lubricant in cold weather. The unsticking torque when the atmosphere is around freezing point may be sufficiently high to render the device inoperative or at least to reduce its sensitivity unduly.

Recently, there has been a widespread increase in the use of dry lubrication for such mechanisms. Bearing parts are dipped into a diluted dispersion of "dag" colloidal graphite in acetone or they may be sprayed or brushed with such a solution. The acetone being highly volatile evaporates rapidly at room temperature to leave a thin adherent and slippery film on the metal or rubbing face, whatever its composition. A careful examination has been made of the properties of this dry film from which it would seem that the starting friction, that is to say, the effort required to commence movement between two faces in contact, is at a minimum and in most cases lower than for oil or grease. The reason becomes clear if one thinks about the subject for a moment. Being quite dry, and such a film being an excellent lubricant, the viscous effects accompanying oil and grease are eliminated. Furthermore, such a film is unaffected by temperatures down to below freezing or up to several hundreds of degrees centigrade. If dust is excluded such a film would provide excellent lubrication for indefinite periods depending on the amount of use which the bearings undergo.

This technique lends itself admirably to the mass treatment of small parts on devices of all kinds. Further information can be obtained from E. G. Acheson, Ltd., 9 Gayfere Street, Westminster, London, S.W.1.

MELTON
METALLURGICAL
LABORATORIES
LTD.

Liquid Silver

Platinum & Gold Solutions

For Metallising
Mica Ceramic
Quartz etc.

Low Melting
Point Solder and
Non - Corrosive
Liquid Flux (A.I.D. Approved)

IPSWICH ROAD
TRADING ESTATE
SLOUGH, BUCKS.

'Phone : Slough 20992

Agents for Australia :

A. F. HARRISON & CO. PTY. LTD.
85 CLARENCE STREET, SYDNEY

The Golden Fleece

When Jason set out with his Argosy in search of the Golden Fleece he did so with no greater determination than we at Gardners when we embarked upon the building of a range of quality transformers in our search for perfection. Although every Gardner product bears the stamp of this determination it is prominent indeed in our Small Power Transformers up to 4 kva. When next you need this type of component and a "Golden Fleece" quality is a 'must' let your Argosy set sail in our direction.

We regret that at present Small Power Transformers are available for highest priority orders only.

QUALITY MAINS  TRANSFORMERS

GARDNERS RADIO LIMITED
SOMERFORD CHRISTCHURCH HANTS.

NOTES FROM THE INDUSTRY

Obsolescent Quartz Lamps

Messrs. Hanovia, Ltd., announce that after 31st August they will no longer be able to repair or supply any tilt-starting Hanovia quartz burners of the following types:—

Super-Kromayer and Kromayer, except Models V and VI.

Jesionek (all types).

C. S. Alpine and Modified Alpine Sun Lamps.

Masseurs' Universal Lamp.

Portable H.S. Lamps.

Advice will be given on the best way to maintain the equipment when lamps fall due for replacement. The London showrooms are at 3, Victoria Street, S.W.1.

Radio Industries Club

At the monthly meeting of the Radio Industries Club in July the guest speaker was Mr. Garro Jones, Parliamentary Secretary to the Minister of Production. In dealing with "Radio Research and Production before, during and after the War," Mr. Jones reminded the audience that research, development and production were inseparable, and that it was salutary to the industry to remember that it had its roots in University research and was born directly of the work of Clerk Maxwell, Lodge, and Rutherford.

The Institution of Electrical Engineers Wireless Section

The scrutineers appointed at the Section meeting held on May 5, 1943, have reported the result of the ballot to fill the vacancies which will occur on the Section Committee on September 30 next and the full Committee for next session will be as follows:—

Chairman: Mr. T. E. Goldup.

Vice-Chairman: Professor Willis Jackson, D.Sc., D.Phil.

Immediate Past Chairman: Mr. R. L. Smith-Rose, D.Sc., Ph.D.

Ordinary Members of Committee:

Mr. F. P. Best, M.Sc., B.Eng.

Capt. C. F. Booth.

Mr. C. W. Cosgrove, B.Sc. (Eng.).

Mr. W. T. Gibson, O.B.E., M.A., B.Sc.

Mr. H. G. Hughes, M.Sc.

Mr. H. L. Kirke.

Mr. E. C. S. Megaw, M.B.E., B.Sc.

Mr. O. S. Puckle.

Mr. J. A. Smale, B.Sc.

Mr. H. A. Thomas, D.Sc.

Mr. T. Wadsworth, M.Sc.

Mr. R. C. G. Williams, Ph.D.

Dr. N. Partridge Change of Address

Dr. N. Partridge informs us that his offices have now removed to 76-78 Petty France, S.W.1, and future enquiries should be addressed there.

Messrs. Taylor Electrical Instruments, Ltd.

Sales Policy

Messrs. Taylor Electrical Instruments, Ltd., have issued a short statement dealing with a difficulty that they are experiencing in their relations with the trade. Their firm sales policy is as follows: Test instruments of their manufacture are available to radio and electrical service engineers at Nett User Prices. Wholesalers are allowed a discount to enable them to sell to the above at the same prices. Dealers and engineers, however, may purchase through their wholesaler or direct from Messrs. Taylors, but in each case they pay the nett price.

No provision is made for dealers buying and offering instruments for re-sale. It has been noted that radio dealers are purchasing instruments at the nett price as if for their own use and are re-selling to local service engineers and others at prices above the list price. The ultimate purchaser is thus paying more than he need, since he is entitled to purchase through a wholesaler or direct from the manufacturers.

It is obvious that the blame for an excessive price will, in the mind of the ultimate purchaser, be laid at the door of the manufacturer, and Messrs. Taylors have asked us, therefore, to publish this brief statement with a view to making the position quite clear.

A nett trade price list of instruments is available on request from Messrs. Taylor Electrical Instruments, Ltd., Montrose Avenue, Slough, Bucks.

"Uno" Circuit Symbols

Messrs. A. West & Partners, makers of "Uno" letter stencils have now produced a series of circuit symbols in stencil form, of which an illustration is given. These cover most of the standard symbols in use in radio engineering together with a variety of telephone circuit symbols.

The set comprises six stencils, identified by the number given on the left hand side of the drawing and cost 33s. Single stencils are 6s. each.

Mycalex

We have received from the Mycalex Parent Corporation a new brochure describing the properties and uses of Mycalex insulation. Readers are referred to the issue of this journal for May, 1942, which gives a full account of the manufacture of this unique material. Copies of the brochure can be obtained from the Mycalex Parent Corporation, Cirencester, Glos.

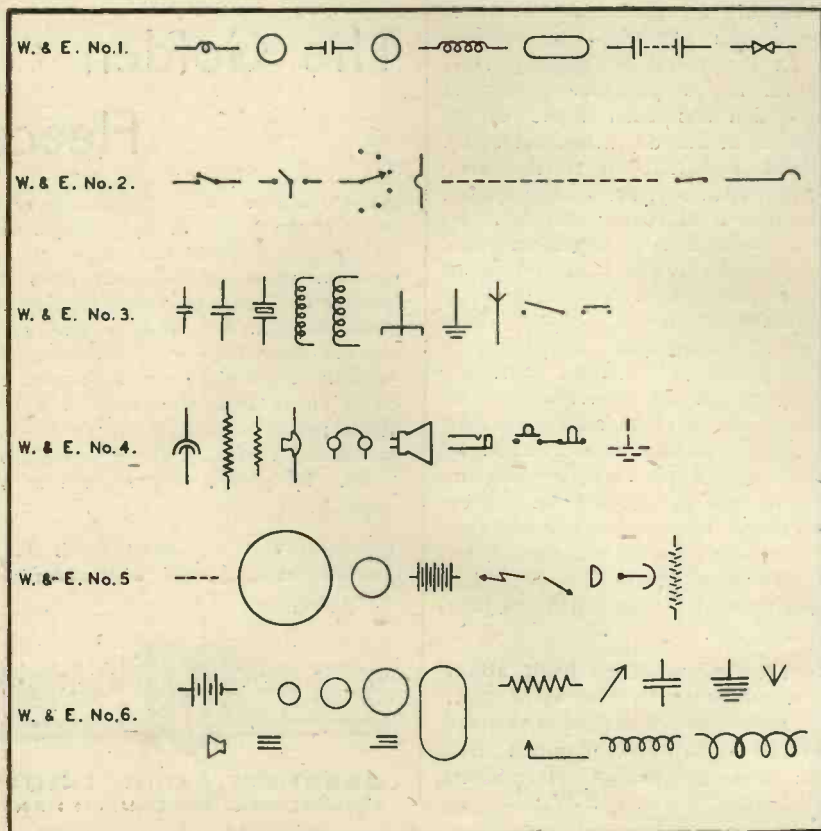

Callender

RADIO FREQUENCY CABLES



Part of our High Frequency Test Laboratories



We are fully engaged on war production and are manufacturing all types of low loss and low capacity cables for use at high frequencies.

We shall be pleased to make available the experience of our extensive research and technical organisations in connection with special cable problems directly related to the war effort.

CALLENDER'S CABLE & CONSTRUCTION CO. LTD. HAMILTON HOUSE, VICTORIA EMBANKMENT, E.C.4

All over the World

ABSTRACTS OF ELECTRONIC LITERATURE

MEASUREMENT

Measuring Coil Characteristics without an Impedance Bridge

(H. D. Brailsford)

A method is given whereby a cathode-ray oscilloscope may be used to measure inductance, impedance, power factor and effective resistance of coils. The principle involves connexion of the oscilloscope so that the pattern on the screen graphically compares the voltage across the unknown impedance in phase and amplitude with that across a non-inductive resistance. Two measuring techniques for the Lissajous figures produced on the oscilloscope screen are described together with the calibration of the instrument.

—*Electronics*, May, 1943, p. 86.*

An Instrument to Measure Minute Changes in specific Inductive Capacity of Cardboard and hence to determine its Water content

(S. D. Gardiner)

The theory underlying the method is given and the apparatus described. The arrangement consists of a high frequency low power oscillator loosely coupled to an acceptor circuit. A milliammeter shows an increase in current as soon as a coupled circuit is brought into resonance with the oscillator. The application of the unit to the rapid measurement of the water content in cardboard by recording changes in the specific inductive capacity is then described. Some practical results are presented and discussed.

—*J. Soc. Ch. Ind.*, May, 1943, p. 75.*

THEORY

Network Theory, Filters and Equalisers

(F. E. Terman)

In Part I the fundamental properties of networks are reviewed with particular emphasis on two and four-terminal networks. The use of reactive networks for impedance and matching is covered.

Fundamental network definitions and network theorems are reviewed. The general mesh equations of the network are given, together with their solution in input and transfer impedance. Properties of two-terminal reactive networks are presented in terms of zeros and poles from the view point of Foster's reactance theorem. Methods of synthesising any impedance realisable by two-terminal reactive network are given.

Reciprocal impedances are discussed, and the methods of deriving a reciprocal network are given.

The general properties of four-terminal networks are reviewed in terms of image impedance and image transfer constant. The alternate presentation on terms of iterative impedance and iterative transfer constant is also covered briefly.

The subjects of impedance matching and insertion loss are considered and formulas are presented for the mismatching factor and for insertion loss.

Properties of four-terminal networks based upon T , π , L , and lattice sections are summarised. The use of reactive T , π , and L networks for impedance matching is reviewed, and charts are presented for designing a matching network to meet any given requirements.

—*Proc. I.R.E.*, Vol. 31 (1943), p. 164.

Coupled Resonant Circuits for Transmitters

(N. J. Korman)

This paper discusses the design of coupled resonant circuits for use as interstage coupling units in transmitters. Simplifying assumptions are made which although they reduce somewhat the accuracy and scope of the treatment, result in extremely simple and useful relationships.

—*Proc. I.R.E.*, Vol. 31, No. 1 (1943), p. 28.

ELECTRO-MEDICAL

A Continuous Electronic Pulse-Rate Indicator and Recorder

(M. M. Schwarzschild and M. C. Shelesnyak)

A circuit is described which is operated by the cardiac action current impulses in which the reading of a meter is a nearly linear function of the pulse rate. The impulses are amplified and applied to a trigger tube which sets off a gas discharge tube discharging a condenser at each beat. The charge transferred at each beat is independent of the shape of the action current wave within wide limits. The meter, shunted by a large smoothing condenser, reads the average current and is calibrated in beats per minute. The instrument may be connected to any suitable type of recording millivolt meter to obtain a continuous record of rate. The device may be used for indicating or recording the rates of any quasi-periodic phenomenon, in the range of frequency from 2 to 400 per minute, if at each period an electrical impulse of the order of 1 mv can be provided.

—*Rev. Sci. Inst.* Vol. 13, No. 11 (1942), page 497.

INDUSTRY

Beryllium Windows

(Z. J. Atlee)

Although beryllium has been recognised as an ideal X-ray diffraction-tube window material for some time, its actual use has awaited its production in a form suitable for inclusion in a vacuum-tight structure. The development of a satisfactory window is described together with the secondary problem of joining the beryllium to a metallic bushing which, in turn, may be made a part of the glass or metal envelope of the X-ray tube. The absorption characteristics of beryllium and Lindemann glass are given and their merits compared. The construction and application of beryllium window types are discussed, an immediate need is the determination of the quartz crystal orientation by X-ray diffraction.

—*G.E.Rev.*, April, 1943, p. 233.*

Plating on Aluminium

(R. F. Yates)

Details are given of the Krome-Alume process for plating aluminium. Whereas all previous attempts sought to remove the oxide film on the aluminium, the new process makes anodic oxidation a primary step. The operations involved are: mild cleaning with sodium cyanide, rinsing, anodising, modification of the anodic film and plating. Test data are given for the adhesion of all types of films; examination shows that heating increases the tenacity of the film. The plating of duralumin alloys and the deposition of cadmium on aluminium are also discussed.

—*Metals and Alloys*, Dec., 1942, p. 1084.*

Mechanical Properties of Plastics at Normal and Sub-normal Temperatures

(T. P. Oberg, R. T. Schwartz and D. A. Shinn)

Results are given of tests carried out on several types of thermoplastic and thermosetting plastic materials as well as plastic-bonded plywood and resin-impregnated compressed laminated wood. Tensile, stiffness, fatigue, bend and impact tests were made and the many results are set out in tabular form. The properties of the materials as illustrated by their performance are discussed with the aid of graphs. The tests were carried out at three temperatures, viz., 78° F., 0° F., and -38° F. The main characteristics of each group of materials are also set out.

—*Mod. Plastics*, April, 1943, p. 87.*

* Supplied by the courtesy of Metropolitan-Vickers Electrical Co. Ltd., Trafford Park, Manchester.

SAVE PRECIOUS TIME—USE PRECIOUS METALS

ELECTRICAL CONTACTS IN PRECIOUS METALS OR PRECIOUS METAL ALLOYS

JMC electrical contacts are in demand for war service in all types of electrical equipment in all theatres of war, but we endeavour to maintain our advisory service to customers and give the benefit of our wide experience in the application of precious metals and their alloys to all kinds of contact requirements.

Enquiries should be headed "Contact Enquiry" and addressed to Head Office.

**JOHNSON, MATTHEY
& CO., LIMITED.**

73/83, HATTON GARDEN,
LONDON, E.C.1

Telephone: HOLborn 6989

71/73, Vittoria Street,
Birmingham

Oakes, Turner & Co., Ltd.
75/79, Eyre Street, Sheffield, 1

SILVER.	PLATINUM	PALLADIUM-COPPER
GOLD.	GOLD-SILVER	SILVER-COPPER
PLATINUM-GOLD-SILVER		PLATINUM-IRIDIUM
PALLADIUM-SILVER		PLATINUM-RUTHENIUM
		AND OTHER ALLOYS

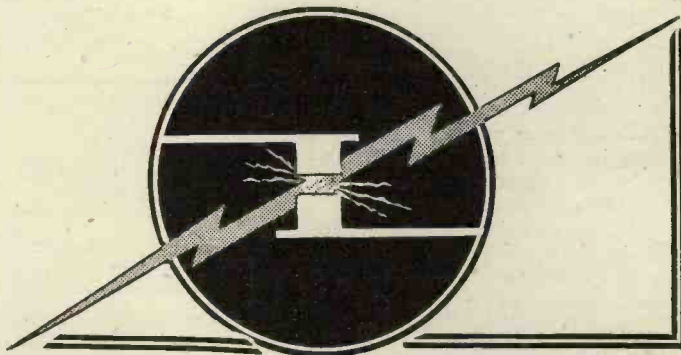

PAINTON

COMMUNICATION COMPONENTS

VARIABLE STUD TYPE ATTENUATORS

PAINTON & CO. LTD.

NORTHAMPTON

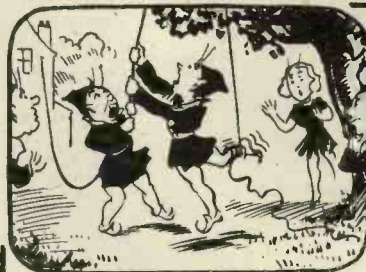

THE "FLUXITE QUINS"
AT WORK

"Now don't lark about!"
hollered EE

"This aerial's mixed up with
the tree

There'll be work for FLUXITE
When this wire is fixed right
But for goodness sake—leggo
of me!"

For all SOLDERING work—you need FLUXITE—the paste flux—with which even dirty metals are soldered and "tinned." For the jointing of lead—without solder; and the "running" of white metal bearings—without "tinning" the bearing.

It is suitable for ALL METALS—excepting ALUMINIUM—and can be used with safety on ELECTRICAL and other sensitive apparatus.

With Fluxite joints can be "wiped" successfully that are impossible by any other method

Used for over 30 years in Government Works, and by leading Engineers and Manufacturers, OF ALL IRONMONGERS—IN TINS—8d., 1/4 and 2/8. sk to see the FLUXITE SMALL SPACE SOLDERING SET—compact but substantial—complete with full instructions, 7/6.



ALL MECHANICS W/ L HAVE

The "FLUXITE GUN" puts FLUXITE where you want it by a simple pressure.
Price 1/6, or filled 2/6

FLUXITE

IT SIMPLIFIES ALL SOLDERING

Write for Leaflets on CASE HARDENING STEEL and TEMPERING TOOLS with FLUXITE also on "WIPED JOINTS." Price 1d. each.

FLUXITE LTD. (Dept. T.V.) Bermondsey Street, London, S.E.1

PATENTS RECORD

The Information and Illustrations on this page are given with the permission of the Controller of H.M. Stationery Office. Complete copies of the Specifications can be obtained from the Patent Office, 25, Southampton Buildings, London, W.C.2, price 1s. each.

RADIO

Systems for Radio Direction Finding

The circuit is shown in the diagram. The relaxation voltage is applied to the grid of the valve L_1 which is in parallel with a potentiometer P connected across the H.T. supply. Tappings from P are connected to the first and second anodes, the point of higher potential P_1 being applied to the second anode 6. A point P_2 near the negative end of the potentiometer is connected to the cathode so that this gives a negative bias to the grid G of the C.R. tube. A resistance R_1 is in series with the lower portion of the potentiometer up to P_2 in the grid-cathode circuit of the oscillograph, and also in the anode circuit of a valve L_2 to the input of which the detected signals are applied and produce a positive bias potential across R_1 in opposition to the negative potential of P_2 , and allow the electron beam of the oscillograph to flow. The voltages across P_2 and R_1 are so adjusted that the cathode beam is allowed to

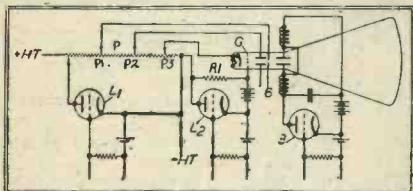

flow only during the maximum voltage values of the detected signal. The circuit using valve L_2 gives the spot a circular path.

The effect of applying the saw-tooth variation of voltage to the first and second anodes is that the second anode increases the electron velocity to a greater extent than the first anode alone, and hence a greater deflection. Also the spot will be brighter in the outer convolutions, due to the increased electron velocity, than at the inner convolutions of the spiral trace, but since the spot has a greater area to cover in unit time than when at the inner convolutions, where the electron velocity is less than at the outer convolutions, the illumination tends to be constant over the annulus.

—Standard Telephones and Cables Ltd. (communicated by International Standard Electric Corp.). Patent No. 554,251.

CIRCUITS

Impedance Matching Networks

Two electrical paths, one of which includes a pair of coupled inductors connected in series, with a shunt branch connected from a point between the inductors to a point in the other path. A condenser and resistance are connected in parallel, as shown. The values are chosen so that when the load with the larger impedance is connected the impedance measured at the other terminals is equal to the impedance of the other load over a specified range of frequencies.

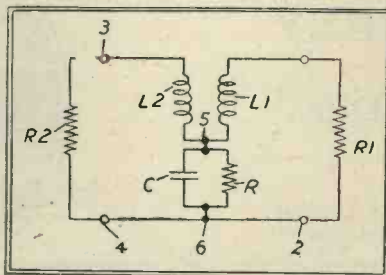

The network may be constructed in either the balanced or the unbalanced form. Condensers may be added between the coupled inductors to prevent the passage of d.c. In order to annul the effects of the leakage inductance and the stray capacities a shunt may be added to provide a low-pass filter section. To annul the effect of a negative reactive component which may be associated with one of the load impedances, a series inductor may be added to form another low-pass filter section.

—Standard Telephones and Cables Ltd. (Assignees of S. Darlington). Patent No. 554,329.

TELEVISION

Improvements in Television Systems

A television system in which a pick-up unit is connected to a main transmission unit by a form of cable, and the necessary synchronising pulses are produced at the main transmission unit and transmitted through the cable to the pick-up unit to control the scanning there. The picture-signal is transmitted back through the cable to the main transmission unit. Any synchronising pulses not delayed to a proper time relation to the picture signals received through the cable, are

balanced out at the main transmission unit.

—Marconi's Wireless Telegraph Co., Ltd. Patent No. 554,281.

Blocking Valve Oscillator for Television

Relates to a blocking valve oscillator that is particularly useful in television circuits.

As shown in the diagram, the anode of V_1 carries synchronising signals only, since the valve performs a synchronising separator function. These signals are fed to the winding 7 of the radio frequency transformer 8, which may have an air core, and two untuned windings 7 and 9 and a winding 10 which may be tuned by C_{11} so that it resonates at the frequency of the incoming synchronising pulse of carrier. These pulses are applied through the secondary 10 to the grid of the blocking oscillator valve, V_2 .

The anode is connected to winding 9 with such polarity as to feed energy back into the grid circuit by means of winding 10. In this way V_2 , in conjunction with transformer 8, forms an oscillator. R_{15} , C_{16} in the grid return lead causes oscillations of V_2 to charge up C_{16} to a point which will bias the valve to cut-off. V_2 then

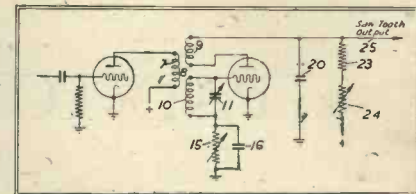

is inactive for an interval until the charge on C_{16} has leaked off through R_{15} to allow oscillations to resume, so starting a new blocking cycle. This pulsating flow of current in the anode circuit is used as a discharge mechanism across C_{20} which is connected to one end of 9, the other to the anode of V_2 .

R_{23} and R_{24} in series, serve to charge C_{20} from the H.T. supply during the blocked interval of V_2 . In this way C_{25} is made to carry a saw-tooth wave form which may be applied to deflection plates of a C.R. tube in the conventional way for sweep purposes, either for television scanning or oscillographs, etc.

—Standard Telephones and Cables Ltd. (Assignees of R. L. Campbell). Patent No. 554,588.

The glory of the future..

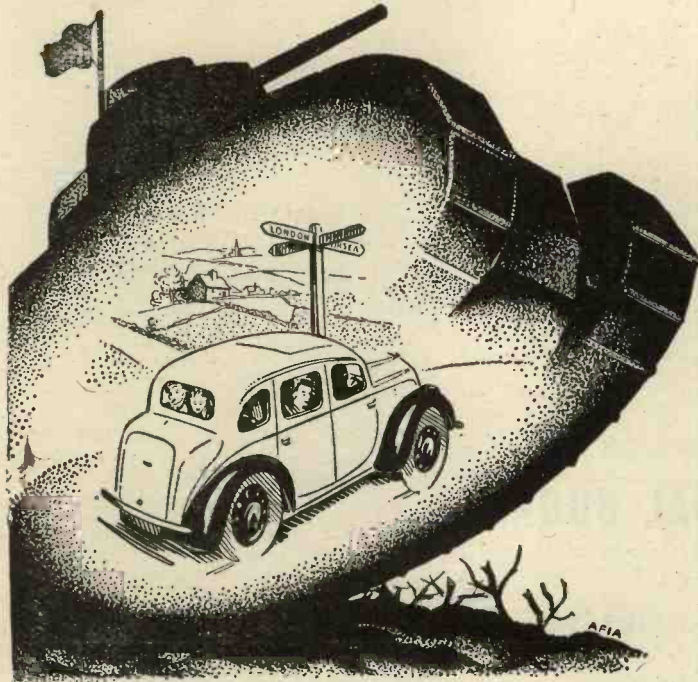

..when the tank gives pride of place to the "family 'bus" and engines of war to the instruments of peace, Goodmans will be able, once more; to give the connoisseur Loudspeakers that open up new possibilities in high fidelity re-production.



GOODMANS

Makers of

HIGH GRADE LOUDSPEAKERS

Priority Orders only can be accepted

GOODMANS INDUSTRIES, LTD., LANCELOT ROAD, WEMBLEY, MIDDLESEX

Ensure the most successful results



USE

B.I. CONDENSERS

BRITISH INSULATED CABLES LTD.,
Head Office PRES-COT, LANCs. Telephone: PRES-COT 6571.

BOOK REVIEWS

Mathematics—Its Magic and Mastery

A. Bakst. 780 pp. with Appendices. (Chapman and Hall 2/- net).

It is inevitable that any book dealing with mathematics from a popular angle should be compared with Hogben's "Mathematics for the Million," which was the forerunner. This, of course, does not imply that all other books suffer by comparison. On the contrary, Dr. Bakst's book is in some respects more thorough, and is written in a style all his own. A large section of the book is devoted to numbers and their theory before passing on to algebra and geometry, to finish up with spherical and "corkscrew" geometry.

(Our old friends the spider and the fly in the room appear as one of the problems.)

The reader's enjoyment of the text and comic sketches will probably be marred by the unorthodox placing of the dots in the decimals and in multiplying. After being used to seeing a central dot for the decimal point and a dot lower down for multiplication it is irritating to follow calculations in which the reverse convention is used. For example $94.88 = 82.88 + 12.88$ looks odd until one gets used to it.

Those who have forgotten their mathematics and those who "never

could do maths." ought to dip into the book at intervals. They would be pleasantly surprised at the interesting things there are in it. G.P.

Radio Engineering

Edited by Roy C. Norris (Odham's Press). 500 pp. 600 figs. 6/6 net.

This book has been written by a panel of authors with the object of giving a concise survey of the field of radio for those who are at present working on one or other of its branches. For this reason it should have a particular appeal to Service technicians whose acquaintance with radio as a whole may be limited and who are sufficiently interested in their job to want to know more about its possibilities.

The chapters include Radio in Aviation, Radio in Ships, Short Waves, Television, and, what is not

usually met in comprehensive books, a section on Radio Production Methods and Radio Servicing Equipment.

The whole book is exceedingly well illustrated by line drawings and sketches, and there is an appendix of useful data and a good index. Although this book was published earlier in the year, some copies are still available at technical bookshops and should be snapped up.

The Electron Microscope

E. F. Burton and W. H. Kohl. 225 pp. 110 line drawings and numerous plates. (Reinhold Publishing Co., U.S.A. 23/- English Price).

A timely book in view of the great interest taken in electron microscopy style and covers the subject completely from light theory and light at present. It is written in popular microscopes to the electron theory and electron lenses. The concluding chapters deal with the applications of the electron microscope and compound electron microscope and give over twenty excellent photographs of results which have been obtained. The text is very readable and is lightened by semi-humorous drawings by Dorothy Stone. Arrangements are being made by Messrs. Chapman & Hall to publish the book in this country.

TECHNICAL BOOKS

English and American Books on Radio and Electrical Engineering supplied from stock or obtained to order.

Please mention interests when writing

LENDING LIBRARY

Annual Subscription from One Guinea.

Details post free on request.

H. K. LEWIS & Co. Ltd.

136 Gower Street, London, W.C.1

Telephone: EUSon 4282 (5 lines)

PERMALI

**ELECTRICAL
INSULATION
to DCD WT 1000**

The **NEW INSULATION CO., LTD.**

Telephone:
Glos. 4419.

Write for publication
No. 31.

BRISTOL ROAD, GLOUCESTER

London Office: 40, BROADWAY, S.W.1.

Telegrams:
"Nico, Gloucester."

Telephone:
ABBey 6494.

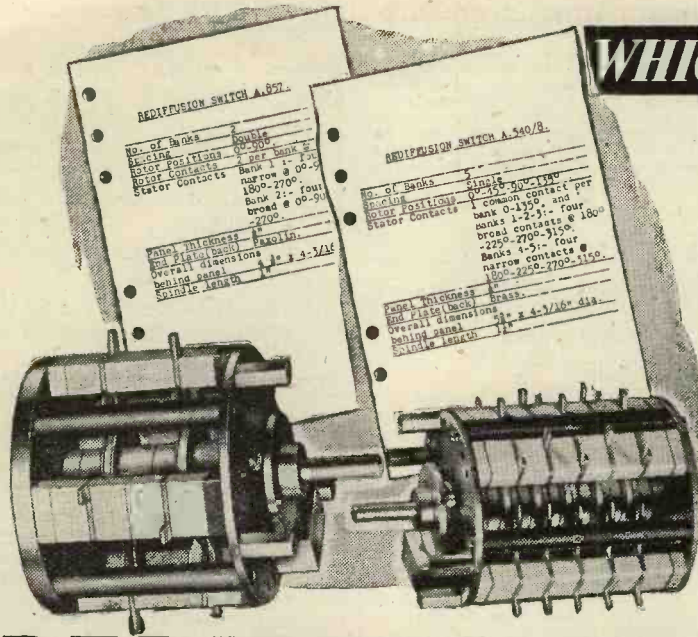

WHICH SWITCH..?

These Redifon, Type S.I., switches are built to a wide range of specifications, for switching radio frequency circuits at peak voltages up to 4,000 with currents up to 20 amps. A limited number can be made for priority users. Prices on application, stating the circuit requirements.



REDIFFUSION LIMITED

A Subsidiary of Broadcast Relay Service Limited

Designers and manufacturers of Radio Communication and Industrial Electronic Equipment

VICTORIA STATION HOUSE • VICTORIA STREET • LONDON • S.W.1 (PHONE VICTORIA 8831)

*On all the Seven Seas
Condensers are at work*



TRADE

HUNTS

MARK

The
Home of Condensers

ADVT. of A. H. HUNT LTD., LONDON, S.W.1B. EST. 1901

GALPINS ELECTRICAL STORES

"Fairview" London Road, Wrotham, Kent.
 TERMS: Cash with order. No C.O.D.
 Regret no Orders can be accepted from Elre or Northern Ireland.

ELECTRIC LIGHT CHECK METERS, well-known makers, first-class condition, electrically guaranteed, for A.C. mains 200/250 volts 50 cy. 1 phase 5 amp. load, 10/- each; 10 amp. load, 12/6, carriage 1/-.

1 K.W. TRANSFORMER, input 100 volts at 100 cycles, single phase, output 10,500 volts, centre tapped to earth. Price £4/10/-, carriage forward. **HEAVY DUTY CABLE**, V.I.R., and braided, in first-class condition, size 37/13, lengths 30 to 40 yards. Price by the length, 5/- per yard, carriage forward, or 7/- per yard for short lengths, carriage paid.

ROTARY CONVERTER, D.C. to D.C., input 48 volts; output 2,500 volts at 1 kW., condition as new. Price £10, carriage paid.

WATT WIRE END Resistances, new and unused, assorted sizes (four assortment), 5/6 per doz.; post free.

SOLID BRASS LAMPS (wing type), one-hole mounting, fitted double contact small B.C. holder and 12-volt 16 watt bulb, 3/6 each, post free, or 30/- per doz., carriage paid.

TUNGSTEN CONTACTS, 1/8 in. dia., a pair mounted on spring blades, also two high quality pure silver contacts 3/16 in. dia., also mounted on spring blades, fit for heavy duty, new and unused; there is enough base to remove for other work. Price the set of four contact, 5/-, post free.

220 VOLT DYNAMO 9 AMP. output by Lancaster Dynamo Co., shunt wound, speed 1,500 R.P.M., condition as new. Price £10, carriage paid.

KLAXON MOTORS, 220 v., D.C., 1/10 H.P. shunt wound, ball-bearing, fitted reduction gear giving speed of 700 r.p.m., high-grade job, condition as new. Price 50/- each, carriage paid.

MOVING COIL movements, needing slight repair, modern type, famous makers, deflection 5 to 10 m.a. Price 15/-, post free.

RIGHT ANGLE DRIVE, mounted in gun-metal box, all ball bearing, 1/2 in. dia. shafts, as new. 12/- each, carriage paid.

KLAXON MOTORS, as above, with right angle drive, but needing slight repair, mostly fields open circuit, not guaranteed, laminated fields, 20/- each, carriage paid.

Classified Announcements

The charge for miscellaneous advertisements on this page is 12 words or less 3/-, and 3d. for every additional word. Single-column inch rate displayed, £1. All advertisements must be accompanied by remittance. Cheques and Postal Orders should be made payable to Hulton Press, Ltd., and crossed, and should reach this office, 43, Shoe Lane, London, E.C.4, not later than the 15th of the month previous to date of issue.

FOR SALE

IN STOCK, Rectifiers, Accumulator Chargers, Rotary Converters, P.A. Amplifiers, Mikes, Mains Transformers, Speakers of most types, Test Meters, etc., Special Transformers quoted for.—University Radio, Ltd., 238, Euston Road, London, N.W.1. Ger. 4447.

LOUDSPEAKERS

LOUDSPEAKERS—We carry on. Sinclair Speakers, 170, Copenhagen Street, N.1.

LOUDSPEAKER repairs, British, American, any make, 24-hour service; moderate prices.—Sinclair Speakers, 170, Copenhagen Street, N.1.

MISCELLANEOUS

WE WILL BUY at your price used radios, amplifiers, converters, test meters, motors, pick-ups, speakers, etc., radio and electrical accessories. Write, phone or call, University Radio Ltd., 238, Euston Road, London, N.W.1. Ger. 4447.

WEBB'S Radio Map of the World enables you to locate any station heard. Size 40" by 30" 2 colour heavy Art Paper, 4/6, post 6d. Limited supply on Linen, 10/6, post 6d.—Webb's Radio, 14, Soho Street, London, W.1 Phone: GERrard 2089.

FULL range of Transmitting Keys, practice sets and other equipment for Morse training.—Webb's Radio, 14, Soho Street, London, W.1. Phone: GERrard 2089.

SYSTEMATIC RADIO SERVICING. A practical method devised and employed by J. Bull. Also a catalogue of many Radio Service Aids including "History of Faults," "Job Cards," "Valve Base Data Cards," and a Rectifier which will replace any of the Universal valves. Price 1s. 7d., post free. V.E.S. (A), Radio House, Melthorne Drive, Ruislip.

SITUATIONS VACANT

A.M.I.E.E., City and Guilds, etc., on "NO PASS-NO FEE" terms. Over 95% Successes. For full details of modern courses in all branches of Electrical Technology send for our 112-page handbook—FREE and post-free. B.I.E.T., (Dept. 337B), 17 Stafford Place, London, W.1.

PHYSICIST required on the Research staff of a firm making Aircraft components. Applicants must be graduates with Hons. Degrees in Physics and should have experience in electronics preferably with reference to Radio Frequency. Write stating age, experience and salary required to Box F.789. Willings, 362, Grays Inn Road, London, W.C.1.

WANTED

WE OFFER cash for good modern Communication and all-wave Receivers.—A.C.S. Radio, 44, Widmore Road, Bromley.

HANK BUSHES and screws to your specifications (Repetition Work). Quick deliveries. D.T.Co., "Electronic Engineering," Box No. 654.

FIRM of Electrical Engineers engaged on essential work in Earl's Court area require x Time and Motion Study and Estimating Engineer, x Senior Draughtsman (Chief) to take charge of Drawing Office and x Superintendent for Training School. Write with full details to Box 660, "Electronic Engineering."

RADIO

ENGINEERING AND TELEVISION

Complete Postal Courses of Instruction. Recommended to all who desire to obtain a thorough technical and practical knowledge.

Apply to—

BRITISH SCHOOL OF TELEGRAPHY LTD
 179, Clapham Road, London, S.W.9.
 (Estd. 1906)

R. K. Dundas.
 -- LIMITED --

Experimental and Aeronautical Engineers and Scientific Instrument Makers. Manufacturers of Precision Mechanical, Electro-Mechanical and Thermionic Instruments. Electro-Medical and Industrial Apparatus, Time Interval Measurement and Counters, DC Amplifiers and Recorders.

Specialized Design Enquiries Welcomed.

THE AIRPORT · PORTSMOUTH
 Telephone: 74874

ELECTRADIX RADIOS

214, Queenstown Road, Battersea, London, S.W.8
 (Call and see us)
 Telephone: Macaulay 2159.

IF ITS TRANSFORMERS OR CHOKES

Let the manufacturers of VARLEY products assist you.

SEND US YOUR ENQUIRIES.

Standard units available up to 1/2 K.W. or to your specification.

OLIVER PELL CONTROL LTD
 CAMBRIDGE ROW, BURRAGE ROAD, WOOLWICH, LONDON S.E.

LONDEX for RELAYS

The wide range of Londex Relays includes a variety of TYPES APPROVED

by MINISTRY AIR-CRAFT PRODUCTION, AIR MINISTRY & ADMIRALTY

Ask for details and leaflet SPN/EO

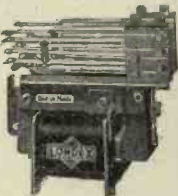

Multiple contact Relay LF.

LONDEX LTD

MANUFACTURERS OF RELAYS

207, ABERLEY ROAD, LONDON S.E.20

Great Possibilities for TECHNICALLY QUALIFIED ENGINEERS KEY MEN IN WARTIME AND AFTERWARDS

The finest posts and the majority of posts in this war are technical and when the war is over, the immense increase in technique and mechanisation created for war purposes will be applied to reconstruction and commerce. An age of great possibilities for qualified engineers is here. Study at home with The T.I.G.B. and take a Recognised Engineering Qualification such as C. & G., A.F.R.Ae.S., A.M.I.Mech.E., A.M.I.E.E., etc. in which examinations T.I.G.B. Students have gained 35 FIRST PLACES and hundreds of passes. Write now for "The Engineer's Guide to Success"—200 Courses—covering all branches—Aeronautical, Tele-communication, Mechanical, Electrical, Chemical, etc.



World's best choice of Courses in Engineering

THE TECHNOLOGICAL INSTITUTE OF GREAT BRITAIN
 160, Temple Bar House, London, E.C.4.

Precision Presswork



CLARKES (Redditch) LTD
 SINEW WORKS
REDDITCH
 TEL. 100 ENGLAND ESTAB. 1920

HEWLETT-PACKARD

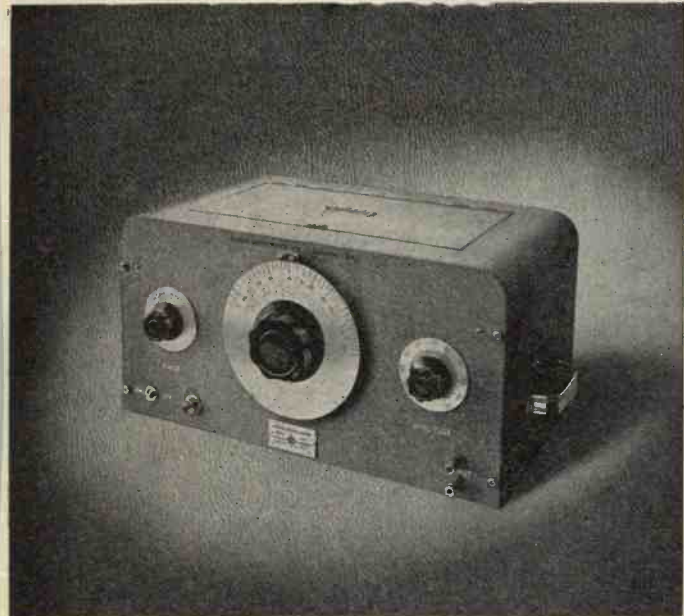

**LELAND
INSTRUMENTS LTD**

Resistance Tuned Oscillators
Model 200, covers the Frequency
Range of 7-200,000 cycles per second.
Write for full details of the series.
21, JOHN ST., BEDFORD ROW,
LONDON W.C.1.
TELEPHONE: CHANCERY 8765

CLOUGH-BREngle • BOONTON • FERRIS • BALLANTINE • HEWLETT-PACKARD

POWER PACKS TRANSMITTERS RECEIVERS *for priority contracts*

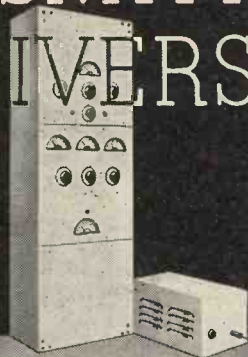

built to specification,
with precision, on time - by

WOODEN

TRANSFORMER CO.

THORNLEY, ST., WOLVERHAMPTON • PHONE. 22929

HIVAC
THE SCIENTIFIC
VALVE
BRITISH MADE

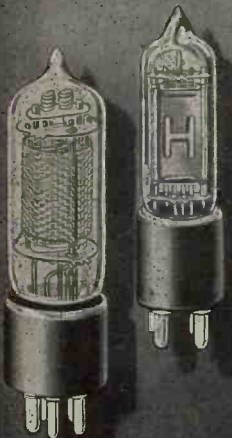

Specialists in
**MIDGET
VALVES**

HIVAC LIMITED
Greenhill Crescent,
Harrow on the Hill, Middx.

Telephone: Harrow 0895.

BASICALLY BETTER...



Air Insulation...

is the basic principle of
CO-AX LOW LOSS CABLES
Unequalled H.F. Properties

There is a CO-AX Cable for every H.F. Purpose

TRANSRADIO LTD. Inc. TELEQUIPMENT CO. 16 HIGHWAY-BEACONSFIELD

WEBB'S Radio

The centre for S/W equipment



If it is anything to do with short-wave radio you are most likely to find it at Webb's. Not that under present conditions we can supply everything, or always everybody, but there still is a very extensive (though short staffed) service available. We can still supply practically any short wave component at our Retail Sales Department, 14, Soho Street, and we print alongside a selection from the many items actually in stock.

Some features of Webb's Service

SERVICE OF COMMUNICATION RECEIVERS. We can now give restricted service on all types of Communication Receivers, but it is essential to communicate with us before despatching instruments.

SPECIAL PRODUCTS DEPT. For Official requisitions we can offer highly skilled facilities for the design and construction of specialized Radio Transmitters, amplifiers and kindred apparatus. The illustration shows a typical 75 watt telephony and morse transmitter.



Schools type Oscillator chassis view, Chassis is contained in a grey crackle cabinet.

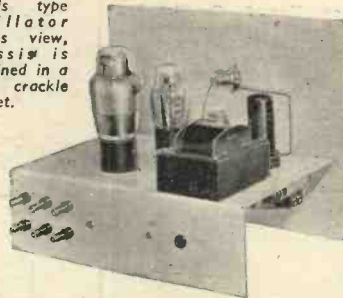

MORSE EQUIPMENT FOR CLASSROOM AND INDIVIDUAL PRACTICE. An exceptionally wide range of morse equipment is available.

Keys Include the new American type as well as a variety of Bar Type Keys of standard Post Office Pattern. A selection is listed here:—

Streamline Metal Key, U.S.A. pattern	6/6
G.P.O. Bar Type Practice Key	8/6
G.P.O. Bar Type Keys, first grade finish (2 contacts)	17/6
G.P.O. Bar Type Keys, first grade finish (3 contacts)	22/6
G.P.O. Bar Type Heavy Duty Operating Key (3 contacts)	28/6

Audio-Oscillators include a heavy duty schools model (operated from A.C. mains) with alternative outputs for 20 or 50 pairs of high resistance headphones or for 2 loudspeakers. It gives a note that is variable in pitch and volume and is priced at £7 10s., complete with valves. Two smaller oscillators for individual practice are available the Junior Oscillator £2 5s. employing 2 valves A.C. operated for up to three pairs of telephones, and Type B.1. 27/6, for battery use from 2 volt accumulator or 3 volt dry cell. Both give a pleasing audio note and are ideal for preliminary or advanced home practice. A wide selection of Headphones are usually in stock at prices from 17/6 to 57/6.

COMPONENTS FROM STOCK:—

HIGH FIDELITY Suspension Loud-Speakers, in piano-finish mahogany or dark walnut cabinet size 13½" square, 6" deep. Rola 10" Permanent Magnet unit, limited number available only. Quality reproduction plus pleasing appearance.

Price low impedance 2½ ohms £5 15 0
Or fitted with tapped transformer £6 5 0

KNOBS. Instrument knobs and dials in great variety available ex stock. A few only are listed. (All ¼" shaft fitting.)

2½" dia. fluted instrument knob	2/-
2½" dia. fluted instrument knob Eddystone 1076 with brass insert	2/6
1076 knob with 4" dia. satin finish scale (as Eddystone 1077)	6/6
Milled Edge Knobs 1½" dia.	1/9
Skirted knobs, 1½" dia. skirt with white indicator	1/6
Wheel knobs, black, or green, 1½" dia.	1/3
Johnson (U.S.A.) transmitting type handles—	
With 4" indicator scale (½" shaft)	4/6
With 6" indicator scale (½" shaft)	6/6

MICROPHONES

Rothermel-Brush D. 104 Crystal	£5 5 0
Rothermel-Brush D. 104 Crystal with control switch handle	£6 6 0
Rothermel-Brush D. 104 lapel Crystal	£2 10 0
Rothermel-Brush Crystal on heavy desk stand	£5 0 0
Moving Coil, highest quality with transformer	£5 5 0
Microphone Stands for M.C. Mike	£2 2 0

VALVES. We carry comprehensive stocks of all British and U.S.A. types. A limited number of the "sticky" types of U.S.A. tubes have just come to hand for distribution for civilian replacement purposes.

Additional charge of 1/- for postage and packing on orders below 10/-.

WEBB'S RADIO

14 SOHO ST., OXFORD ST., LONDON, W.1. Phone: GERrard 2089.

Hours of Business: 9 a.m. - 4 p.m. (Sats. 9 a.m. - 12 noon).