

Electronic Engineering

INCORPORATING ELECTRONICS, TELEVISION AND SHORT WAVE WORLD

PRINCIPAL CONTENTS

X-Ray Tube Cathodes
The Cathode Ray Oscillograph in Polarography
Electron Optics—Part III
The Cathode Follower—Part II
Voltage Regulating Transformers

21-FEB. 1943



The stars

look down . . .

. . . upon the sleeping villages and towns of England. Over the peaceful scene the moon mounts guard with watchful eye. Yet, at any given moment, should the necessity arise, the quietest country village can be in instant communication with the greatest city; can command its resources and enlist its help. Our products for many years have served in spreading human happiness and in forging links between men, and to-day we still proudly play our part in maintaining human fellowship.

DUBILIER
CONDENSER CO. (1925) LTD.

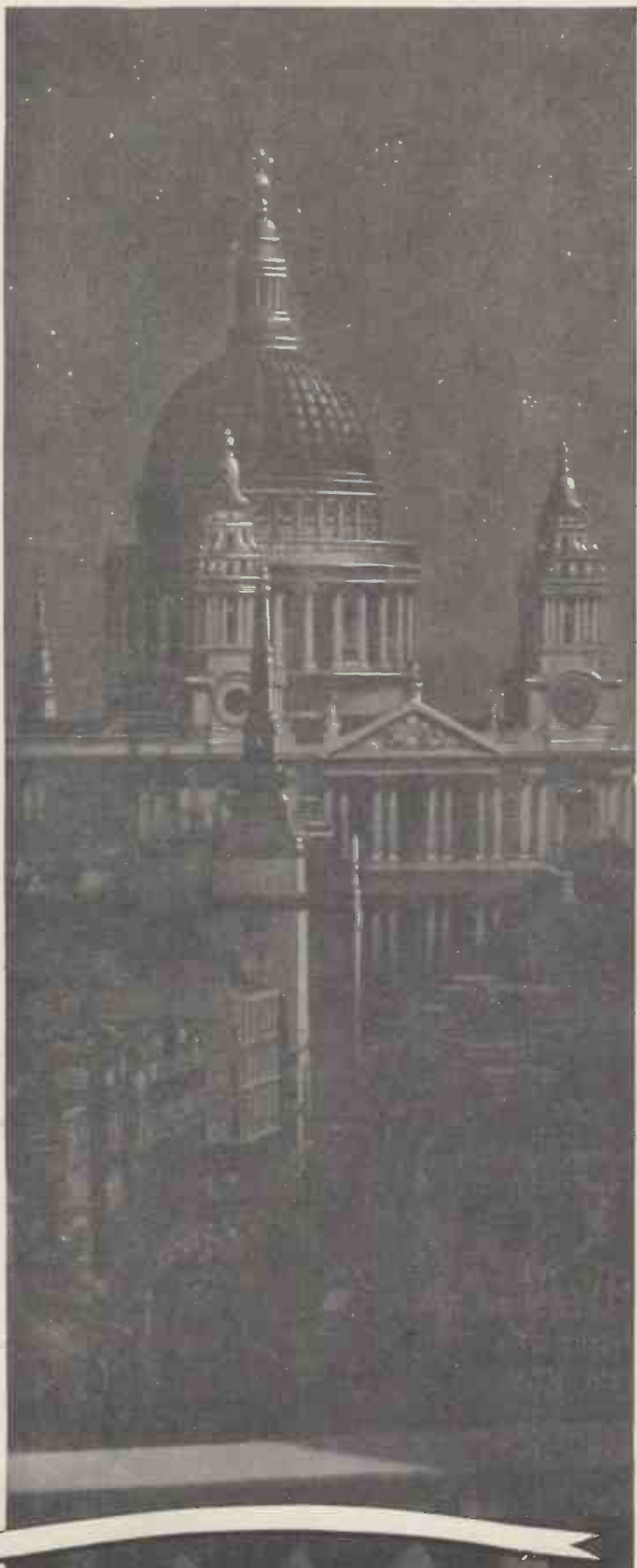

The fact that goods made of raw materials in short supply owing to war conditions are advertised in this magazine should not be taken as an indication that they are necessarily available for export.

Development and Research



INTENSIVE research is constantly proceeding in the Standard Laboratories and, wherever practicable, each new development is incorporated in every Brimar Valve leaving the Factory.

BRIMAR
(BVA)
VALVES

STANDARD TELEPHONES AND CABLES LIMITED, FOOTSCRAY, SIDCUP.

*Value proven
by long service*

**Osrām
Valves**
MADE IN
ENGLAND

for

INDUSTRIAL APPLICATIONS

•

ELECTRO MEDICAL
EQUIPMENT

•

THERMIONIC INSTRUMENTS
and TEST GEAR

•

VITAL COMMUNICATIONS
and WARNING SYSTEMS
ETC.

THE GENERAL ELECTRIC CO. LTD.

Magnet House, Kingsway, London, W.C.2



FREQUENTITE

THE PIONEER BRITISH-MADE LOW LOSS CERAMIC

THE OUTSTANDING properties of Frequentite—Low Loss and High Mechanical Strength—led to a demand which even before the war severely taxed our productive capacity. The needs of the fighting services have inevitably led to restriction in supplies for general industry, *but we can now meet all requirements*

promptly. Extensions to our plant, the employment of specialised new equipment, and progressive improvements in our manufacturing technique made during the past seven years, now enable manufacturers to obtain bulk supplies of the most intricate designs. Please write for Catalogue No. SP.10.

STEATITE & PORCELAIN PRODUCTS LTD.

Head Office and Works: STOURPORT-ON-SEVERN, WORCS. Telephone: Stourport 111. Telegrams: Steatite, Stourport.

Announcing

The "HYPERLOY" Series

A range of high-performance, space-saving **TRANSFORMERS** and **CHOKES** designed to meet the exacting requirements of modern Electronic and Communications equipments.

- Small in size.
- Weighing only 2 ozs.
- Meeting the most rigid Tropical Specification.
- Easily mounted in any position.
- Manufactured in a variety of windings to meet many diverse applications.

WRIGHT & WEAIRE LTD.

HIGH ROAD, TOTTENHAM, N.17

Telephone: TOTtenham 3847-8-9



STABILITY

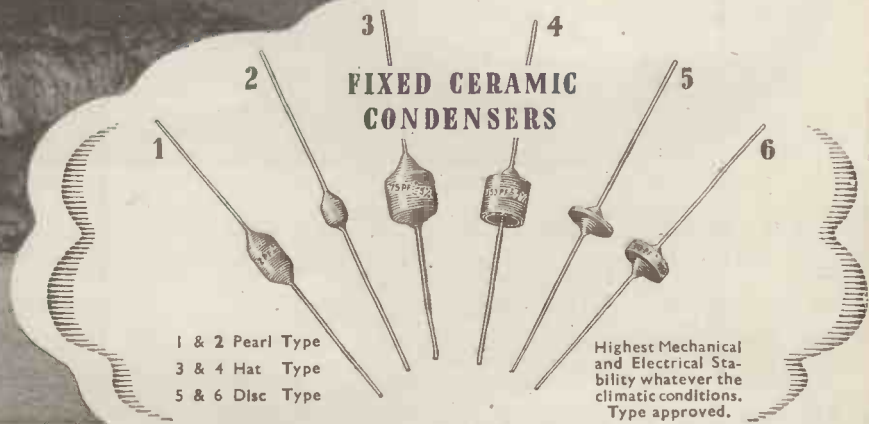
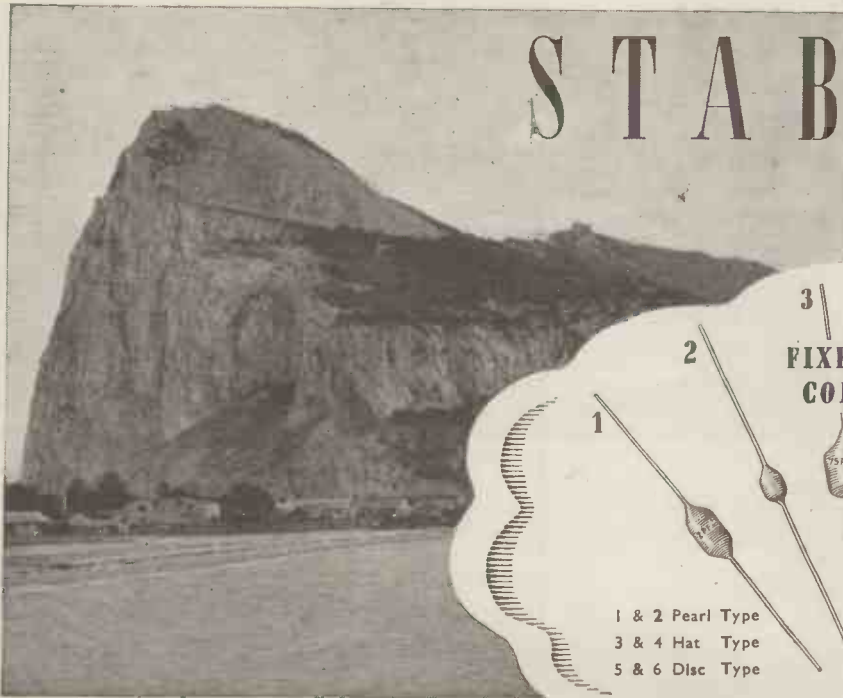

UNITED INSULATOR CO. LTD.

12-20 LAYSTALL STREET, LONDON, E.C.1

Phone: TERminus 7383

Grams: Calanel, Phone, London

*The
Pioneers
of low-loss
Ceramics*

SPECTRUM ANALYSIS

The exact composition of materials used in the manufacture of WESTINGHOUSE METAL RECTIFIERS is determined by spectroscopic apparatus, and spectrograms are prepared of specimens as required.

The illustration shows the arc method of excitation in use.

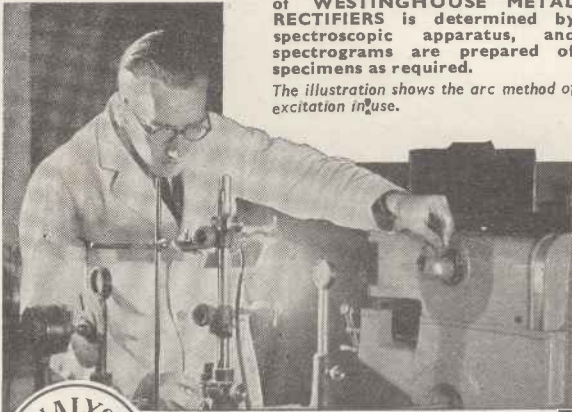

Behind the non-stop production of Westinghouse Rectifiers, our technical staff are ceaselessly at work. We sincerely regret that very limited supplies only are available, but we know that our customers will understand. To-day's intensive research, however, will release remarkable features of design when Westinghouse Rectifiers are again freely available to industry.

Westinghouse Rectifiers

WESTINGHOUSE BRAKE & SIGNAL CO. LTD.,
PEW HILL HOUSE, CHIPPENHAM, WILTS.



**TELCON
CABLES**

for
**HIGH
FREQUENCY
TRANSMISSION
and RECEPTION**

Full particulars of all Telcon Products from:
**THE TELEGRAPH CONSTRUCTION
& MAINTENANCE CO. LTD.**

Head Office: 22, Old Broad Street, London, E.C.2

Telephone: London Wall 3141

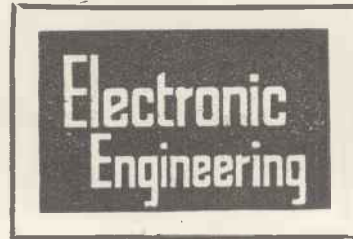

FEBRUARY, 1943

Volume XV.

No. 180.

CONTENTS

	PAGE
Editorial	363
X-ray Tube Cathodes	364
Some Simplified methods of determining the Optical Characteristics of Electron Lenses...	366
The Cathode Ray Tube in Polarography ...	367
Electron Optics—Part 3	372
The Cathode Follower Part 2 (Data Sheets 42, 43 and 44).	375
Voltage Regulating Transformers	384
Relay Repeater Circuit	387
The Soldering of Aluminium	388
Training Students in Receiver Servicing ...	390
Notes from the Industry... ..	392
Abstracts of Electronic Literature	394
Patents Record	396
Book Reviews	398

CONDITIONS OF SALE—This periodical is sold subject to the following conditions, namely, that it shall not without the written consent of the publishers first given, be lent, re-sold, hired out or otherwise disposed of by way of Trade except at the full retail price of 2/- and that it shall not be lent, re-sold, hired out or otherwise disposed of in a mutilated condition or in any unauthorised cover by way of Trade, or affixed to or as part of any publication or advertising, literary or pictorial matter whatsoever.



An Art

ONLY a masterly use of plant and materials will yield the best results. Nowhere is this crucial fact more fully appreciated than in the engineering industry.

When selecting the most suitable components or simplifying assembly there will be found a Simmonds product which will not only provide the ideal solution but will also pave the way to an improvement of the finished product. A sure step to success is to consult the Simmonds Organization.

S I M M O N D S

The Creative Impulse in
AERONAUTICAL, INDUSTRIAL & MARINE
Construction

THE SIMMONDS NUT · PINNACLE NUT · SPIRE NUT
SIMMONDS GAUGES, INSTRUMENTS AND CONTROLS
FRAM OIL & ENGINE CLEANER

SIMMONDS AEROCESSORIES LTD.
GREAT WEST ROAD, LONDON

A COMPANY OF THE SIMMONDS GROUP

PROPRIETORS :

HULTON PRESS LTD.,

Electronic Engineering

EDITOR

G. PARR.

EDITORIAL, ADVERTISING AND PUBLISHING OFFICES, 43-44, SHOE LANE, LONDON, E.C.4

TELEPHONE:
CENTRAL 7400

Monthly (published last day of preceding month) 2/- net. Subscription Rates: Post Paid to any part of the World—3 months, 6/6; 6 months, 13/-; 12 months, 26/-. Registered for Transmission by Canadian Magazine Post.

TELEGRAMS:
HULTONPRES LUD
LONDON.

Resistors

TWO things are often talked about in manufacturing circles; Simplifying Production and Standardisation. They are useful topics, as everyone has his own ideas of what can be done to Make Things Simple for the Retailer, but there are few who have been able to take a firm stand and say what they will and will not make.

Some years ago the R.C.A. issued a list of preferred values, which they claimed would serve the requirements of all modern receivers and reduce the large number of spares which had to be kept by the "jobbers." This was hailed as a step in the right direction in a field which badly needed cleaning up, but few other manufacturers followed suit and before the war were continuing to emulate Mr. Heintz and his 57 varieties.

The war perhaps aided manufacturers to do what they had hoped, but had not been able to do—it compulsorily limited the number of types they could make of all kinds of things besides valves.

Whether this compulsory limitation will be made the basis of standardisation afterwards is another matter—there is always the temptation to be just a little different from the other man. In fact it must be annoying to some manu-

facturers not to be able to cut their own special screw threads.

Nevertheless, war or no war, one section of the manufacturing community has made a sound move. The makers of moulded resistances have standardised a range of "preferred types" which cover all values of resistance normally required and are changing over to this range as quickly as possible.

It has often amused the engineer to hear someone demanding a resistance of exactly 1,000 ohms and see him fit without demur a standard product on which the tolerance is $\pm 20\%$. The technical jour-

nals are not blameless in this, as who has ever seen a circuit diagram with the tolerances on the values clearly stated? It may even come as a surprise to some readers to learn that the tolerance on fixed commercial resistors is 20% in some cases.

Taking the case just quoted, it is obvious that a nominal 1,000 ohms resistor could serve for any value between 800 and 1,200 ohms, and acting on this basis, the manufacturers and the Services have got together and produced a range of only 250 odd values which will cover all reasonable requirements and tolerances.

The scheme in its entirety will be described later, but the principal features are that 145 values will cover all resistances between 10^0 and 10^7 ohms with a 5% tolerance, 73 with a 10% tolerance, and only 37 with a 20% tolerance. The largest tolerance is the "preferred" one, and for the smallest, special permission is at present required before orders can be placed.

It must be mentioned that this scheme applies only to new developments and not to existing contracts or repeat orders. But a start has been made and it is to be hoped that similar schemes will meet with no resistance.

ELECTRONIC ENGINEERING MONOGRAPHS.

Owing to the demand for copies of the first Monograph on

"FREQUENCY MODULATION"

by K. R. Sturley

the initial printing order was exhausted within a few weeks of issue.

The publishers have now arranged to reprint a limited number, but owing to the paper restrictions it will not be possible to guarantee a further stock till after the war.

Will readers who have been disappointed in obtaining copies please write to the Circulation Dept., 43, Shoe Lane, E.C.4, without delay. A remittance for 2s. 8d. to include postage should accompany the order.

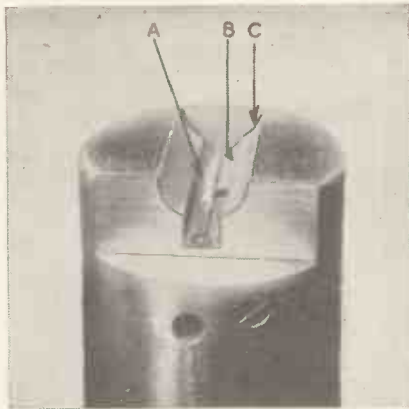

Fig. 6. Photograph of cathode showing "focus throat."

THE cathode end of the X-ray tube is no less important than the anode end, and which was described in a previous article† the following notes show the effect which it has on the performance of the tube. The cathode is always of the directly heated type and is therefore referred to as a cathode or filament indiscriminately.

The purity of the tungsten used to form the filament must be of a very high order if stability of operation is to be obtained. At a given current it must always reach the same temperature during its useful life. The current passed through an X-ray tube is almost completely temperature limited. The average medical tube will saturate round about 20 kV, so it will be seen that, provided the anode voltage is of sine form, a large amount of time per cycle is under temperature limited conditions. (Fig. 1).

To obtain accurate X-ray exposure of the film in radiographic work the operator must be able to ascertain accurately what the tube current will be during the exposure. This tube current is calibrated in average value against filament current settings, and for a given anode kV (which will determine the penetration) the exposure will depend on the milliampere-seconds (m.A.S.) The time of exposure is controlled by an electronic switch which is accurate to one impulse, i.e., .01 sec. at 50 c/s. It will thus be seen that the final accuracy depends on the stability of the filament emission.

Tungsten wire to be used in a tube cathode is carefully selected and subjected to spectrographic examination. Filaments for line focus tubes are spiral-wound, as A and B in Fig. 2, and ring-wound for round focus tubes, as C in Fig. 2. Filaments for tube

X-Ray Tube Cathodes

By A. G. LONG *

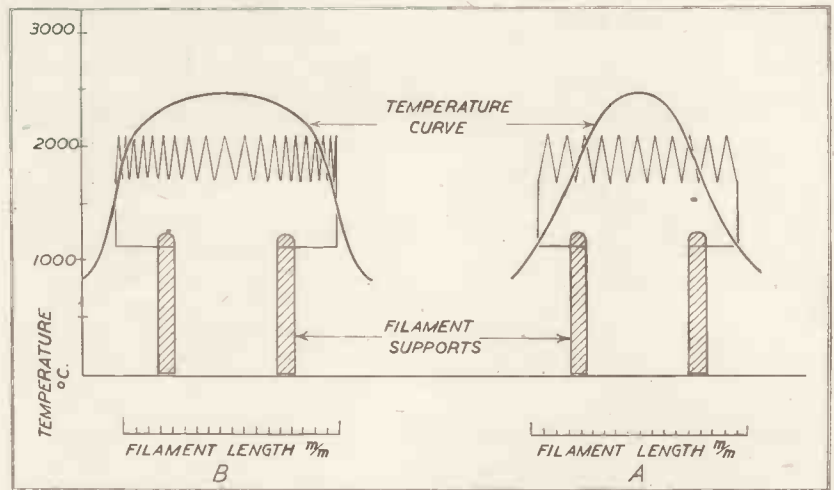

Fig. 3. Variation of temperature gradient along filament with winding pitch.

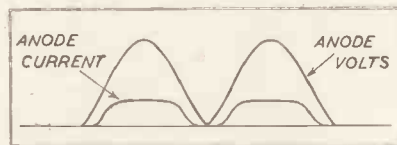

Fig. 1. Limitation of anode current in tube during cycle of anode voltage.

cathodes are spiralled on a special machine to ensure even winding tension and pitch control. The winding pitch is not arranged evenly over the length of the filament, but is closer at the ends, the reason being to offset end cooling due to support wires. Reference to A in Fig. 2 shows this method of winding. The end cooling due to filament support wires extends much deeper into the length of the filament than is generally supposed. A in Fig. 3 shows the temperature gradient along a filament which is wound with equal pitch, and B in

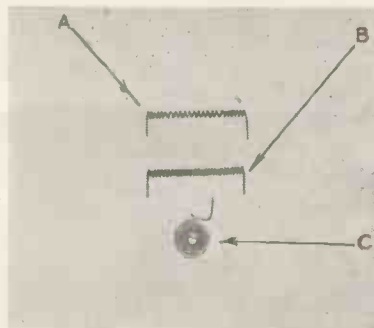

Fig. 2. Photographs of filaments: (A) Variable-pitch spiral (B) Uniform spiral (C) Ring wound for round focus tubes.

Fig. 3 shows the temperature gradient along the same size filament wound with close pitch at either end. The focal area bombarded on the anode is determined by the filament length in one direction, and, electron emission being a function of filament temperature, it will be seen how important it is to have balanced filament temperature. The importance of equal electron density over the bombarded area of the anode target was explained in the previous article,† and reference to Fig. 4 indicates how large a change in electron emission can take place with a relatively small change in filament temperature.

Tungsten is used in most X-ray tubes as the emitter, though Tantalum has been employed. Whatever the material used as the emitter, it must be very pure; otherwise, at the high field strengths used, instability will result as the emission is no longer a direct function of temperature. Unstable tube currents will also result from filament poisoning which may take place during the processing or during the life of the tube. If the latter occurs there is little hope of recovery.

Filament temperatures are tested by optical means, the principle of which is to match the brightness of the unknown against an adjustable known brightness and then correct for black body conditions; Fig. 5 shows such a test being undertaken. Surface condition of filaments has a large effect on the filament temperature for a given current density. The area of a filament with a rough surface will be

* Messrs. Newton & Wright, Ltd.
† *Electronic Engineering*, Vol. XV., No. 176, p. 188, 1942.

much greater than that of a filament of the same size, but with a smooth surface, therefore the heat radiated from the wire with the rough surface will exceed the heat radiated from that with the smooth surface. Filaments are conditioned in high vacuum before being fitted into the X-ray tube, and little change in surface conditions will take place during the life of the tube, except from evaporation.

In the writer's experience tube failures can be classified approximately as follows:—

Due to gas bombardment of the filament ¹	30%
Target release of gas leading to the above ²	20%
Due to excessive filament heat including target overload	20%
Due to normal filament life	10%
Due to filament deformation ³	4%
Due to target and mechanical failures	9%
Due to pinch, welds and sundry causes	7%

¹ Sputtering decreases the life of filaments in many cases much more than normal evaporation even in high vacuum due to the high voltage drop on the tube.

² Due in most cases to tube overload.

³ Due to bad shielding of the filament and too high an anode voltage.

The process of focusing in the X-ray tube is, in the main, electrostatic and is complex due to the fact that a number of electrostatic fields operate in a small space. Reference to Fig. 6 shows a tube cathode with one end cut away to expose the "focus throat" details. The major functions in connexion with the production of electrostatic focus will be understood by reference to Fig. 7

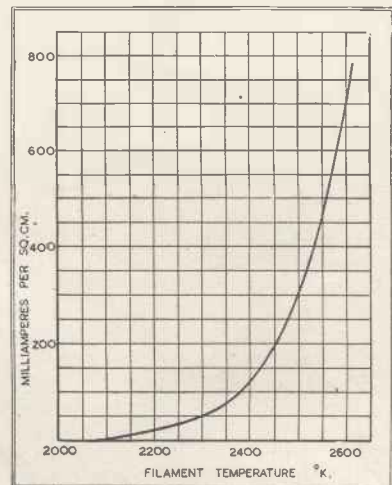

Fig. 4. Emission-temperature curve for filament.

which shows a section through the focus system of a tube cathode. Electrons are emitted in equal amounts for an equal temperature from all parts of the spiral filament. The main electrostatic field will be produced by the anode voltage, and the voltage gradient between the anode and cathode will, for the sake of simplicity, be considered as a constant value, *i.e.*, D.C. We can also consider the filament voltage to be D.C., the negative end of the filament being connected to the focus cup. Under these assumed conditions the action of electrostatic focus will be more readily understood. Electrons that are emitted from the front half of the filament, that is the half nearest the anode, will suffer little mutual repulsion due to electron charge, the reason being that the electron velocity is high due to a steep potential gradient between anode and cathode. In actual practice focus spread due to electron

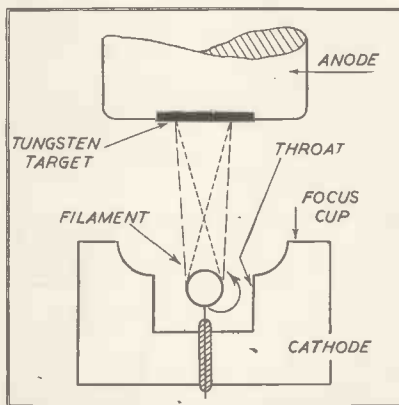

Fig. 7. Action of the focus throat on the electron stream.

charge is so small that the focus width is only a little more than the filament spiral diameter. The electrons that have their origin in this part of the filament are also very little influenced by the electrostatic forces of the focus cup. In practice the filament has to be mounted much lower in the focal throat to prevent distortion of the filament due to the high potential gradient, with the result that only about .2 of the filament area obeys this condition.

Returning again to the assumed conditions, we can see how the remainder of the electrons are influenced. Some of the electrons that are emitted from the back half of the filament migrate in the direction of the arrow in Fig. 7. Some of these electrons return to the filament, whilst others react to the focus throat and produce an electron beam which crosses the path of the electrons from the front half of the filament spiral. The electron beam is

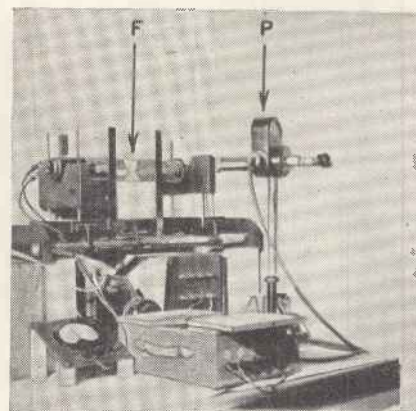

Fig. 5. Checking filament brightness with optical pyrometer.

thus made up of electrons from two sources, and the electrons that come from the back of the filament spiral are mainly influenced by the focus cup.

To produce a desired focal area the main factors to be studied are: filament spiral diameter, filament spiral length, width of focus throat, depth of the filament in the throat. Fig. 6 shows the actual positions for operation up to 100kV with a focal area of 3 mm. x 9 mm. Fig. 8 shows an early form of round focus in its focus cup. In some high voltage tubes it is desirable, for medical reasons, to suppress electron emission until the anode voltage during each half cycle has reached, say, 80kV. This is achieved by fitting the cathode with a very pure metal grid mesh and biasing this to a negative voltage in respect to the filament. In practice this bias is derived from a bias transformer, condenser, and resistance, in the cathode end of the tube. (Fig. 9).

To obtain knowledge of the size of the bombarded area and the loading balance in the bombarded area, use is

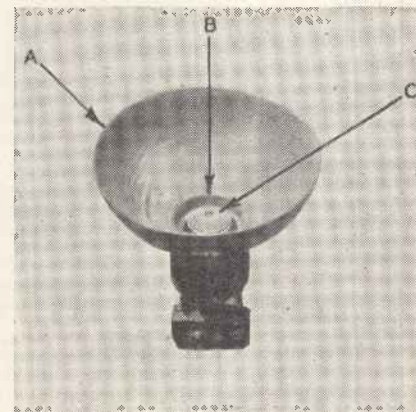

Fig. 8. Early form of round focus cap.

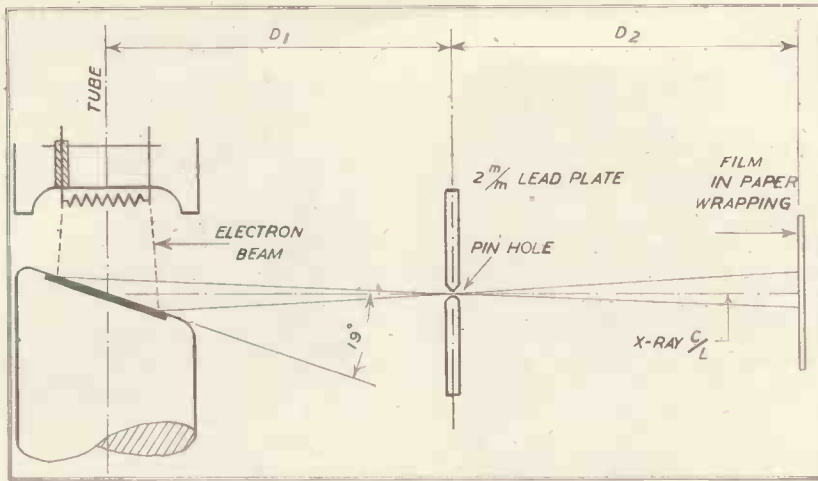

Fig. 10. Method of taking pin-hole X-ray picture.

made of a pin-hole X-ray picture, as shown in Fig. 10.

X-rays emitted from the bombarded area of the target are passed via the pin-hole in the lead sheet to the film. The film is wrapped in paper to prevent exposure to light. The general principle is much the same as taking a photograph with a pin-hole camera.

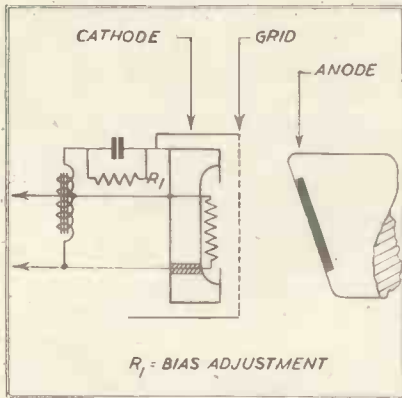

Fig. 9. Bias circuit for suppressing emission until the anode voltage reaches a given value.

If the distance from the tube target to the pin-hole is equal to the distance from the pin-hole to the film, the X-ray image is almost actual size. The X-ray picture will show the actual width of the bombarded area, but the actual length of the bombarded area is approximately three times the X-ray image length. The reason for this will be quite clear in Fig. 10.

The main purpose of taking X-ray pin-hole pictures is to gain knowledge as to the size of the bombarded area and to the loading balance in the bombarded area. The X-rays emitted from the bombarded area will be in proportion to the electron density.

Fig. 11 shows an actual X-ray picture of the bombarded area of a 6 kW

tube. The advantage of using line focus with a 19° target area is explained best by reference to Fig. 12.

The actual length of the bombarded area will be seen to be 10 mm., while the apparent length on the X-ray centre line is approximately 3.3 mm. This condition permits roughly three times the electron energy to be put into the area than would be permissible had it been 3.3 mm. actual.

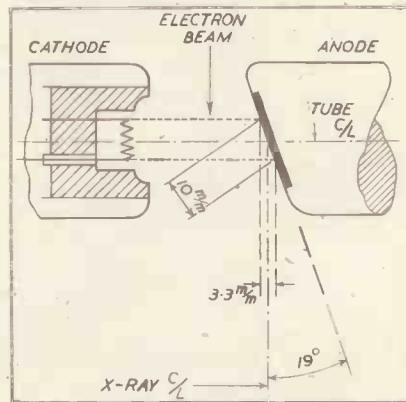

Fig. 12. Diagram illustrating the advantage of using line focus with a target area of 19°

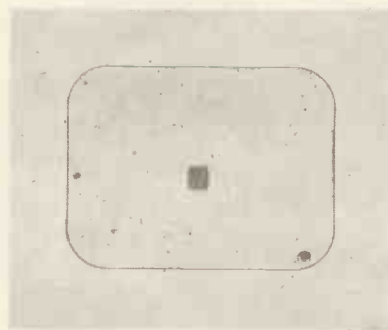

Fig. 11. Pin-hole X-ray picture of the bombarded area on the anode.

Simplified Methods of Determining Characteristics of Electron Lenses

K. Spangenberg and L. M. Field

Some new methods of calculating lens characteristics are proposed which are relatively simpler and more accurate than those previously suggested. The first is an extension of Salinger's method of joined circular segments applied to paraxial rays in fields with a rotational symmetry. This requires as information only the axial potential and derivatives thereof. This method is the computational equivalent of the original graphical method. A second method makes use of the action function which is approximated from the potential function. Electron paths are taken as normal to the lines of constant action. A third method replaces the convergent and divergent parts of the usual lens with equivalent thin lenses and the calculates the focal lengths by means of combination formulas applied to the two thin lenses. All calculating methods are, however, sufficiently long in application and indeterminate in accuracy that experimental methods of finding lens characteristics are preferred.

A new experimental method makes use of a demountable vacuum tube. Lens characteristics are determined from angular magnifications measured from the shadows cast by object screens illuminated by a point source of electrons. No moving screens are required nor is it necessary to generate rays parallel to the axis. By observing magnifications for all voltage ratios for two positions of the object screen enough data are available to determine the four cardinal focal distances for all voltage ratios. The results are considered more accurate and cover a greater range of voltage ratios than those reported by previous investigators. A graphical method has been developed for determining the spherical-aberration characteristics of the lens from the curvature of the object-screen images observed on the fluorescent screen.

The new form gives associated object and image distances and corresponding magnification for any voltage ratio. The relation between the four useful variables is thus given on one chart for each lens. In effect this new form is a graphical presentation of the complete solution of the lens equation which shows clearly the relation between the four associated variables and gives quantitative results which can be applied directly.

—*Electrical Communication*, Vol. 20, No. 4 (1942), page 305.

The Cathode-Ray Oscillograph in Polarography

By TUDOR S. G. JONES, B.Sc., Ph.D., A.I.C.*

The application of electronic methods to chemical analysis has resulted in a convenient and quick technique for the routine examination of certain compounds. The possibilities of polarographic analysis have not yet been fully explored, particularly in the biological field.

THE polarographic method of analysis, invented about 20 years ago by Jaroslav Heyrovsky,¹ of the Charles University of Prague received little attention. Interest in the method has lately been stimulated by work in America where an excellent monograph by two of the leading workers in the field, Kolthoff and Lingane,² has been published. During the 15 years of neglect, numerous papers by Heyrovsky and his pupils in the annual 'Collection of Czechoslovak Chemical Communications' testify to the energetic and inspiring leadership of the author of the method. The method is one of the really few significant advances in analytical technique in that it provides a new tool, not only for routine analysis, but also for the solution of abstract problems inaccessible to more conventional methods of attack.

The method consists, in essence, of the electrolysis of dilute solutions containing one or more electro-reducible or oxidisable substances, using two electrodes, one of which is large and non-polarisable and the other minute. This may be a rotating pinhead of platinum, or, more usually, a capillary tube from which mercury drops of about 0.5 mm. diameter issue every 2 to 4 seconds. The unique characteristics of the current-voltage (*c.-v.*) curves are sufficient to determine both the nature and the concentration of the substances present. The plotting of detailed *c.-v.* curves is, however, tedious and the method would have remained of academic interest only had not Heyrovsky and Shikata³ invented an instrument, called by them the polarograph, which automatically records, in a few minutes, the *c.-v.* curves of some half dozen reducible substances in one solution.

Recent advances, involving the measurement of the *c.-v.* curves by electronic means, have made possible the instantaneous visualisation of whole such curves. These advances form elegant examples of oscillographic technique, bringing polarography within the field of commercial electronics; they form the main subject of this article.

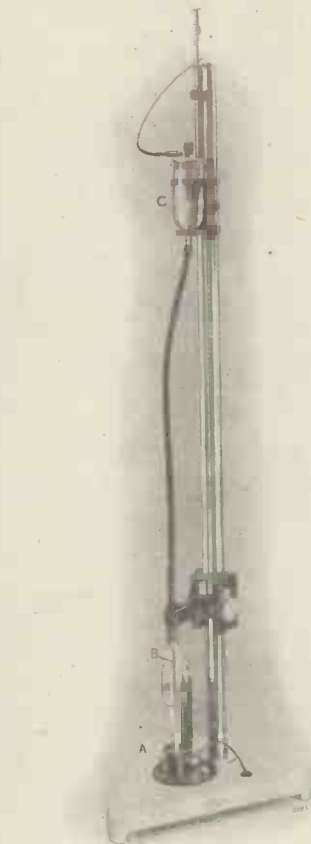

An electrolytic cell for polarography. The capillary tube B and the mercury reservoir C are fixed to a sliding carriage enabling the capillary to be removed without disturbing the setting of the mercury height. A platinum wire is sealed in the cell A for connexion to the measuring potentiometer.

(By courtesy of the Cambridge Instrument Co.)

The Polarographic Wave

In order to understand the special electrolytic process, it is necessary to consider what happens at the surface of mercury drops issuing from the dropping electrode (or other micro-electrode). The simple apparatus shown in Fig. 1 depicts a cell E, consisting of a dropping mercury cathode and a large quiet mercury anode, containing one or more substances in very dilute solution in the presence of a more concentrated "supporting electrolyte." An e.m.f. is applied to the cell by the potentiometer AB and the

current through the cell is measured by the d'Arsonval galvanometer G, with its damping and trimming resistance R₂ and the Ayrton shunt R₃ to control its sensitivity. The voltage applied to the potentiometer is controlled by the rheostat R₁ and measured by the voltmeter V.

Suppose one starts with zero potential between the electrodes and then the contact C is made to traverse the potentiometer AB. Then the current will take the course shown in abcde, Fig. 2. For the part ab, the current, called the "residual current," is very small and increases but slowly with increase in the applied e.m.f. At the point b, the "decomposition potential," the current suddenly starts to increase and the *c.-v.* curve becomes S-shaped, the current eventually assuming a limiting value parallel to the curve for the residual current. If the voltage is now gradually decreased, the curve is exactly duplicated in reverse. If there are more than one electrolyte present, the *c.-v.* curve consists of steps of similar form to the curve in Fig. 2, the horizontal portions being determined by the decomposition potentials of the several electrolytes and the vertical portions by their concentrations.

The reason why a limiting current is attained answers the question why the method is of use in giving the nature and concentration of the electrolytes present. In the layer at the surface of the mercury drop, there are, in general, two forces which cause ions to migrate to the electrode, (1) a diffusive force, proportional to the concentration gradient at the surface, and (2) an electrical force proportional to the potential difference between the surface and the solution. In the presence of the supporting electrolyte, whose decomposition potential lies suitably above that of the ion under consideration, and whose concentration is about 1,000 times that of the reducible ion, the electrical force will be restricted to a layer of extremely small thickness at the surface of the electrode. This electric force under these conditions plays little part in the migration of ions to the electrode. In the case of uncharged and dipolar substances, the

* Biochemical Department, Runwell Hospital, Essex.

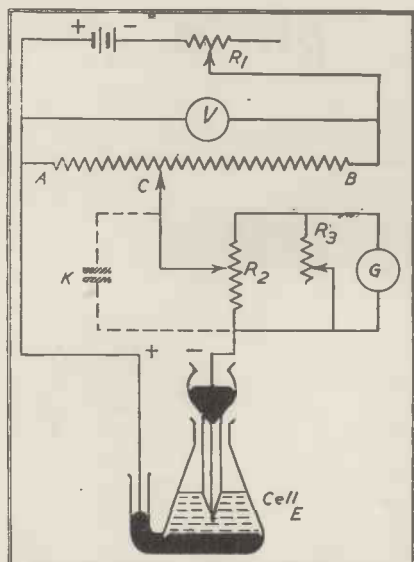

Fig. 1. Diagram of simple apparatus for polarographic analysis.

migration due to electrical forces is also negligible, the former even in the absence of a supporting electrolyte.

When the decomposition potential is reached, ions of the reducible substance begin to be discharged at the surface of the dropping electrode, thus depleting the layer in the immediate neighbourhood of the electrode. When a certain voltage is reached, the ions are discharged at such a rate that, in the layer under discussion, the concentration of reducible substance approximates to zero. The ions discharged are replaced by others from the bulk of the solution by a process of diffusion and according to Fick's law of diffusion, the rate of diffusion is proportional to the difference in concentration between the layer and the rest of the solution. When the surface layer is entirely depleted of electrolyte, the concentration difference is equal to the concentration in the body of the solution. The rate of discharge and hence the current will then be equal to the rate of diffusion into the layer and therefore proportional to the concentration. This is the explanation why, as the voltage is increased, a limiting current is obtained and the reason for the usual name "diffusion current." An important property of the *c.-v.* curve is its symmetry about a certain value of the applied voltage. As is seen from Fig. 3, the curve obtained with different concentrations of the same electrolyte are symmetrical about the same value of the applied voltage, at which half the limiting current is reached and which is called the "half-wave potential." This is independent of the concentration and is char-

acteristic of the electrolyte. A determination of the half-wave potential (p in Fig. 2) is therefore sufficient to identify the ion being reduced and the limiting (or diffusion) current (i_a in Fig. 2) will then give its concentration.

It will be noted that the curves are not smooth, but have oscillations superimposed on them, owing to variations in the drop size. The period and sensitivity of the galvanometer used determines the amount of the oscillation, which normally introduces no difficulty. When waves of small i_a are being recorded, the galvanometer sensitivity must be increased and oscillations become large and troublesome. These may be largely damped out by the simple expedient of inserting a suitable electrolytic condenser (K in Fig. 1) in

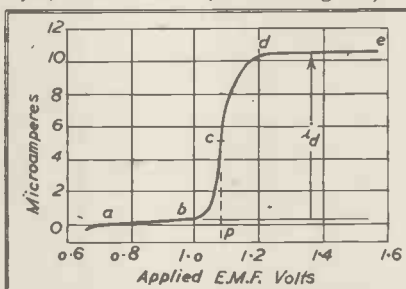
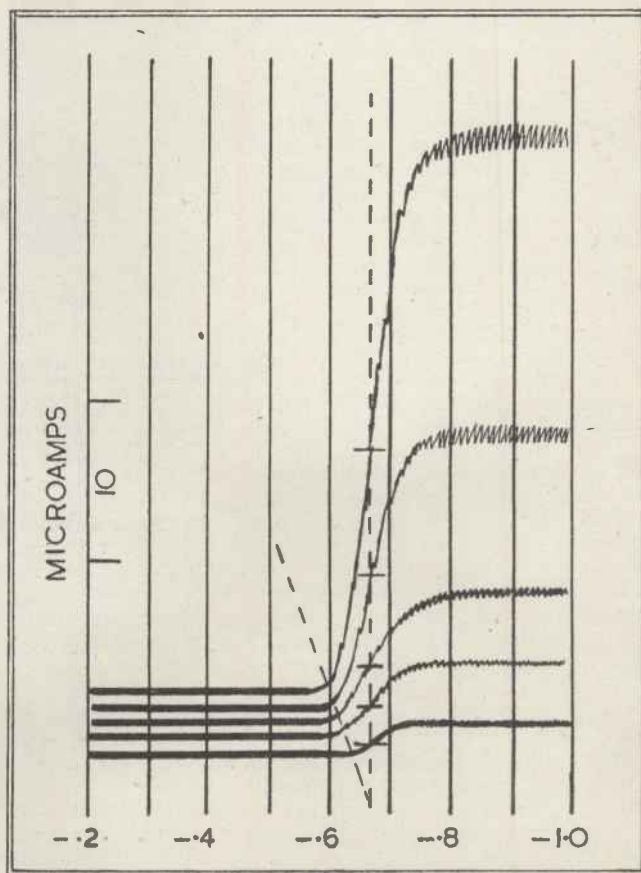

Fig. 2. (above) Variation of current through the cell with applied voltage.

Fig. 3 (right) Curves of current and voltage for different concentrations of electrolyte. The curves are symmetrical about a certain value of applied voltage.



parallel with the galvanometer circuit with due regard to polarity. The galvanometer can be assumed, for all practical purposes, to give the *average* diffusion current, which can be shown to be proportional to the concentration.

Since oxygen is reduced at the dropping mercury cathode, it is usually removed from the solution prior to the start of the electrolysis by a stream of nitrogen.

The residual current is partly due to discharge at the cathode of reducible impurities in the solution. In the measurement of i_a , the value of the residual current, at the voltage at which i_a is measured, has to be taken into account. This is done by extrapolation of the early values of the residual current as in Fig. 3 or by a separate determination on the supporting electrolyte in the absence of the reducible substance.

The Polarograph

The advance introduced by Heyrovsky and Shikata³ in 1925 which made polarography of practical use was the invention of an instrument, called by them the polarograph, for the automatic recording of current-voltage curves. The instrument is shown schematically in Fig. 4. In this figure, D is the electrolysis cell and

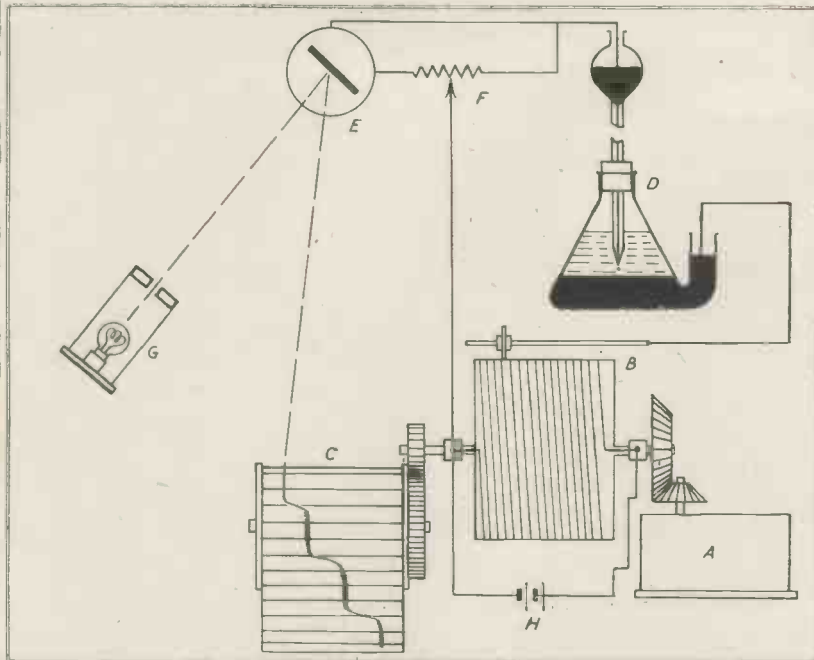

Fig. 4. Diagram of Heyrovsky's original polarograph with recording arrangement.

B the potentiometer bridge consisting of a cylinder of insulating material wound with a uniform wire of 15 ohms in 20 turns. Current for the bridge is supplied by the battery H and the total potential drop across the slide wire, indicated by a voltmeter, can be adjusted exactly to any desired value, usually 2-4 volts, by a regulating rheostat. More accurate adjustment of the bridge can be obtained by switching in a standard cell in place of the electrolysis cell and using the galvanometer E as a null instrument. The bridge is rotated by a small variable-speed motor. A roll of photographic paper is carried by cylinder C connected to the potentiometer by a system of gears, whose ratio is such that one revolution of the bridge corresponds to a lateral movement of about 1 cm. G is the galvanometer lamp which projects a thin vertical beam of light on the galvanometer mirror, which reflects it on to the paper cylinder through a narrow horizontal collimating slit; it thus appears on the record as a fine trace. Each time the recording drum moves round 1 cm. (100 or 200 mv. of applied e.m.f.), an auxiliary light is switched on and illuminates the entire slit so that a thin line is printed on the paper to mark increments in e.m.f.

Instead of using a galvanometer and a source of light, the current may be measured by inserting a known resistance in series with the cell. The potential drop across this resistance is measured by an automatic, ink-writing potentiometer on paper whose motion is controlled by the mechanism that applies the e.m.f. to the cell.

Oscillographic Methods

An early attempt to apply the cathode-ray oscillograph to the measurement of polarographic waves was that of Matheson and Nichols.⁴ The first circuit they used is that shown in Fig. 5. An alternating current of 1.5 volts, 60 c/s. from transformer B is biased with a d.c. potentiometer P, so that the voltage applied to the cell varies sinusoidally at 60 c/s. from 0.3 volts. The voltage across the cell, after amplification, controls the horizontal deflection of the cathode-ray beam. The voltage drop across a resistance R through which the electrolytic current flows is, after amplification, led to the vertical deflector plates. With a drop time of

1 sec. a series of curves of increasing slope and wave, of which the first three are shown in Fig. 6, are traced on the screen. It was found possible to cause capillaries to drop at a frequency equal to that of the current. The curve then appeared as a recurrent trace, shown in Fig. 7, of which the return portion indicated less than that of the forward portion.

In a second circuit, shown in Fig. 8, a linear voltage sweep was employed. The voltage across the condenser C was increased uniformly from 0 to 2.4 volts by the current through the variable resistance of 20,000 ohms. The periodic discharge of C by the rotating switch S, synchronised with the drop frequency, then reduced the voltage to zero for a new cycle. With a "sweep frequency" of 30 per second and the switch shorting the condenser half the time, the screen showed a picture as in Fig. 9 for a solution containing five ions. The traces resembled a Heyrovsky polarogram except for the large, parabolic residual current. Difficulty was sometimes experienced in synchronising the switch frequency with that of the drop. The amplifier used should have a uniform response for all frequencies and its phase shift should either be negligible or linear with frequency.

This noteworthy attempt does not depart from the principle of the Heyrovsky polarograph. The application of an entirely new principle in the detection and measurement of polarographic waves by two sets of workers will now be described. They are both based on the same property of the *c-v* curve.

A New Principle

Suppose a small alternating voltage is superimposed on the direct e.m.f. during the polarographic electrolysis. In the flat parts of the *c-v* curve, the alternating voltage gives a fluctuation

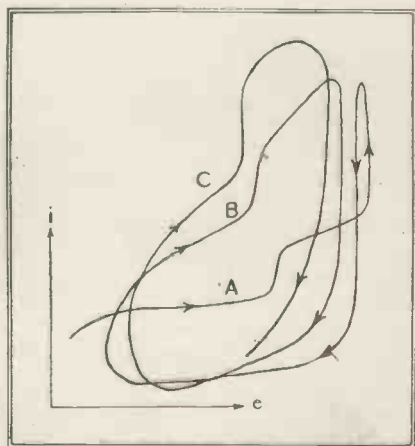
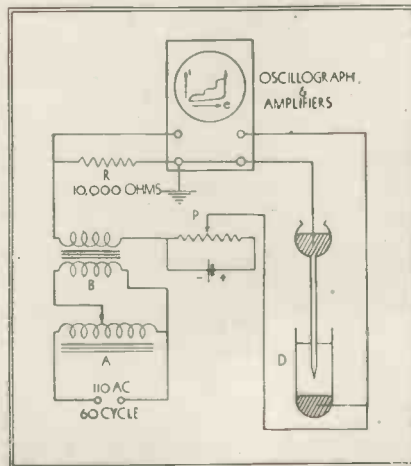

Fig. 5. (left) Matheson & Nichols circuit using a cathode-ray tube as a recording instrument, and Fig. 6 (right) curves obtained on the screen.

in the charge on the double layer at the electrode boundary surface. This entails an action like a condenser of about $0.1 \mu\text{F}$ and involves a mere shift in the value of the current. In the sloping parts of the curve, the waveform of the resultant current will be different from that of the applied e.m.f. by an amount dependent upon the departure from linearity of the $c-v$ response. At the half-wave potential for a given ion, the curve is strictly linear for a short length, and at this point the waveform will be preserved. The amplitude of the current will, of course, be altered in proportion to the slope of the $c-v$ curve.

An American Application

Müller, Garman, Droz and Petras⁸ used a circuit based on the principle just adumbrated and shown in Fig. 10. The potential is applied to the cell by the potentiometer P and measured by the voltmeter V. The alternating component is supplied by the transformer T₁ through the voltage divider R₁. The lead to the dropping mercury electrode is the primary of a high gain, low primary impedance transformer T₂, the secondary of which is connected to the vertical deflector plates of the oscillograph. The oscillograph must be provided with an amplifier of sufficient gain (factor of 3,000-5,000) to amplify the secondary voltage changes. The horizontal plates are driven by the usual sweep circuit and preferably provided with means for synchronising control.

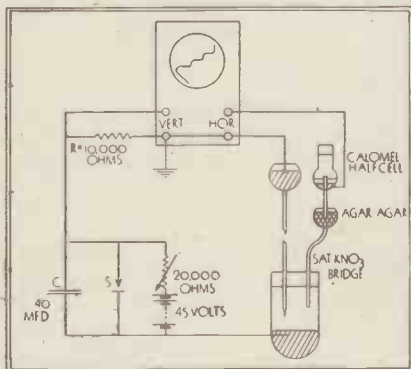

Fig. 8. C. R. Tube circuit using a linear sweep with discharging switch synchronised with the drop.

The applied d.c. potential is altered until the screen of the oscillograph shows a trace of the same form as that of the applied alternating voltage. The entire pattern disappears as the drop falls, but the interruption is only momentary. Fairly slow dropping rates should be used. The half-wave potentials obtained are nearly identical with those obtained by the conventional polarograph. The deflection

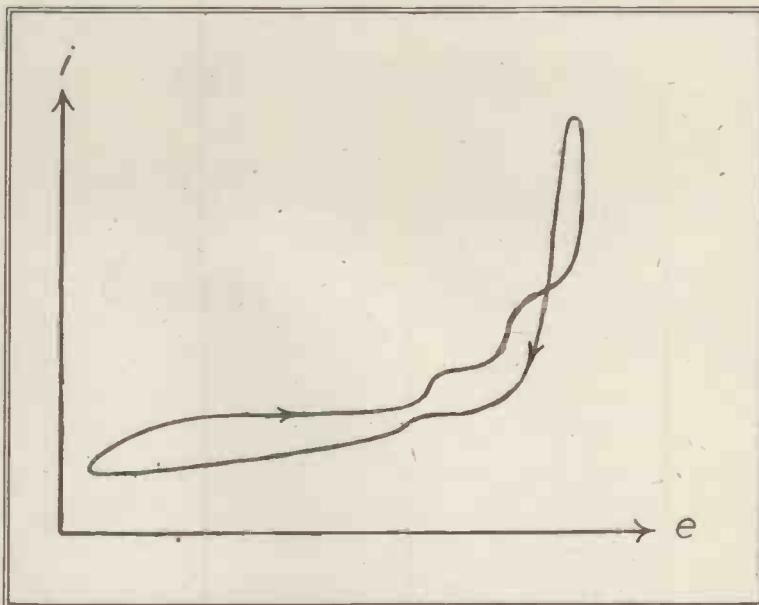

Fig. 7. Recurrent trace obtained by adjusting the dropping time of the mercury.

of the cathode-ray tube at the half-wave potential depends on the overall gain of the amplifiers, the value of the half-wave potential and the height of the Heyrovsky curve for the particular ion under consideration. The gain of the amplifier and the voltage of the alternating component are held constant for a series of determinations.

Another Arrangement

The Dutch workers Boeke and van Suchtelen⁹ used the arrangement in Fig. 11 for the determination of half-wave potentials. The same principle is employed, but in their arrangement the usual sweep circuit for the horizontal deflections is replaced by the imposition of the amplified oscillating potential through the condenser C and the rheostat R₁. The vertical plates are driven by the amplified potential drop over the resistance R₂, which carries the current through the cell. The direct potential difference is applied to the cell by the potentiometer P as usual.

The appearance of the screen for successive values of the applied c.m.f. relative to the $c-v$ curve is shown in Fig. 12. The symmetrical nature of *a* shows that the applied e.m.f. is smaller than the decomposition potential, but after this point is reached the trace becomes unsymmetrical (*b*). When the trace again approaches symmetry as the half-wave potential is reached, it is convenient to bring the current and applied e.m.f. in phase by adjusting R, and the trace then takes the form of a comparatively straight line (*c*). The potentiometer should now be adjusted very critically for the most symmetrical form of the oscillo-

gram. The traces *d* and *e* show the effect of changing the potential 0.2 volts higher and lower respectively than that of *c*. If the alternating voltage is rather high, the trace will appear as *f* with the linear portion in the middle. By decreasing the applied alternating voltage by adjusting R, and by increasing the gain, the oscillogram finally takes the form *c*. The position of R₁ is a measure of the concentration of the ion being determined. The trace disappears on the falling of the mercury drop and changes with the growth of the drop. The area, and therefore the current, changes only very slowly just before

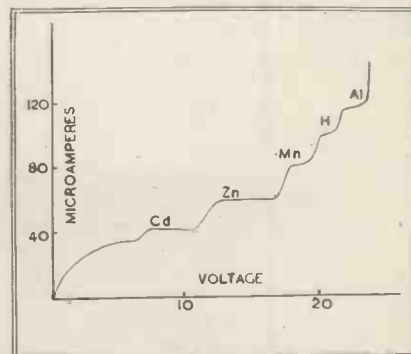
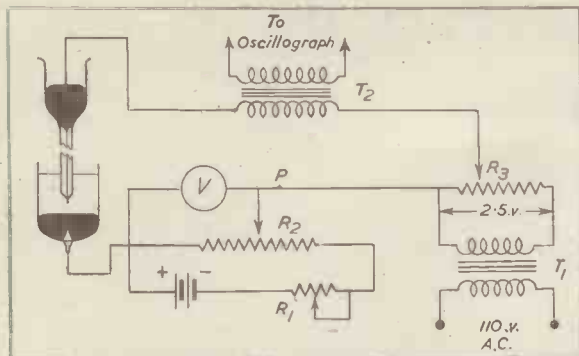

Fig. 9. Current-voltage curve for a solution containing 5 ions obtained with the method of Fig. 8.

the drop falls, and this facilitates observation.

The Alternating Current Bridge Method

Another method due to Boeke and van Suchtelen (*loc. cit.*) uses an alternating current bridge with an electron



ray tuning indicator (the Philoscope), and is illustrated in Fig. 13.

The bridge consists of the cell C_1 , the condenser C_2 and the resistance R_1 and R_2 . The direct e.m.f. for the electrolysis is taken from the potentiometers P_1 and P_2 and the alternating e.m.f. as the voltage drop across R_4 , regulated by the rheostat R_6 . The other corners are connected through an amplifying valve to the tuning indicator, the area of the luminous cross being proportional to the voltage on the control grid.

For the determination of the half-wave potential, the bridge is first brought into equilibrium by adjustment of R_2 with a small alternating voltage on R^* , the luminous cross being reduced to its minimum size. Observation is best done when the mercury drop is on the point of falling. The whole voltage scale is then run through and the points at which the luminous cross exhibits maxima noted. At these points, the equilibrium of the bridge is most disturbed and the conductivity of the cell a minimum for each ion present. For the determination of the concentration of the ions present, the conductivity of the cell at each half-wave potential is done by balancing the bridge by adjustment of

Fig. 10 (left, above) Alternative cathode-ray tube circuit developed by Muller et al.

Fig. 11 (right, above) Circuit for determining half-wave potential by simple potentiometer.

Fig. 13 (right) More complex circuit to compensate for the polarisation potential of the anode.⁶

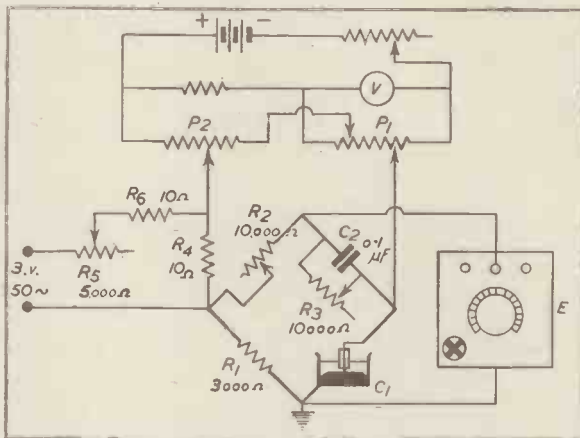
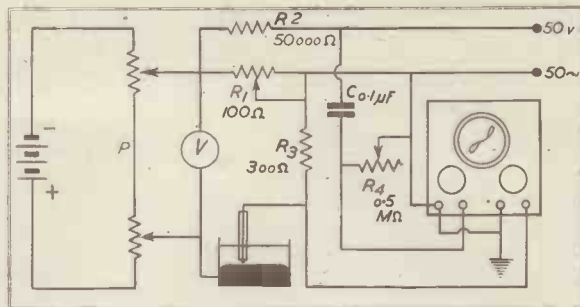

R_3 , which is then a measure of the concentration required.

In principle it is sufficient to use the simple potentiometer in Fig. 11, but in both circuits it is possible to use a more complicated potentiometer P_1P_2 as in Fig. 13. The portion P_2 is used to compensate for the polarisation potential of the anode, which for a given solution is practically independent of the total potential applied to the cell. By ensuring that a constant voltage always acts along P_1 (using the voltmeter V), it is possible to calibrate the

scale for any ion, so that the instrument becomes direct-reading.

Uses of the Polarograph

The polarograph finds many uses in industry, especially in metallurgy and in the control of processes where minute traces of metallic contamination are to be avoided. Its use in organic chemistry is still very much in its infancy and its application to biological chemistry is so far very disappointing. That this need not be so in the future is shown by some very recent work on the determination of organically bound arsenic used in the treatment of disease. It is possible by this means for the first time to differentiate between trivalent and pentavalent compounds.

BIBLIOGRAPHY

- 1 J. Heyrovsky, *Chem. Listy* (1922), 16, 256. *Phil. Mag.* (1923), 45, 303.
- 2 I. M. Kolthoff and J. J. Lingane. *Polarography*. Interscience Publishers, Inc., New York, 1941.
- 3 J. Heyrovsky and M. Shikata, *Rec. trav. chim.* (1925), 44, 496.
- 4 L. A. Matheson and N. Nichols, *Trans. Am. Electrochem. Soc.* (1938), 73, 193.
- 5 R. H. Müller, R. L. Garman, M. E. Droz and J. Petras, *Ind. Eng. Chem., Anal. Ed.* (1938), 10, 339.
- 6 J. Boeke and H. van Suchtelen, *Philips Tech. Rev.* (1939), 4, 213.

In addition, numerous references are given in ² above and in List 109, *The Cambridge Polarograph*, Cambridge Instrument Co.

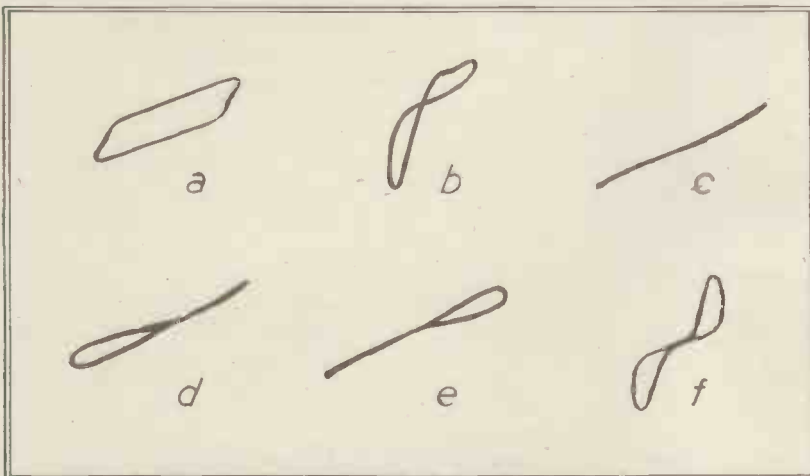

Fig. 12. Traces shown as the applied e.m.f. is varied relative to the current-voltage curve. The circuit is given in Fig. 11.

Electron Optics—Part III

A lecture delivered before the Electronics Group on October 31, 1942 — concluded from p. 337, January issue.

By D. GABOR, Dr.Ing.*

UNTIL recently electron optics was applied only to electronic devices with *steady* electromagnetic fields. As the electrons traverse most vacuum tubes in 10^{-7} — 10^{-8} seconds, no modification of the theory is required until the frequency exceeds 10 — 100 kc/s. The applicability of the formulæ of electron optics stops at this limit, but not the usefulness of electron optical ideas. I want to show that it is possible to treat "transit time devices" electron-optically, by what may be called "space-time electron optics," a new science which for the time being exists only in fragments. Instead of starting with a rigid definition, I prefer to begin with an example in which the connexion with the older "space electron optics" is particularly evident.

Phase Focusing.—While the fundamental problem of the older electron optics was to focus electrons in space, the first problem of the new branch is the focusing of electrons *in space and time*. Brüche and Recknagel seem to have been the first to consider the periodic production of concentrated groups of electrons as an optical problem,[†] as expressed in the name "phase focusing."[‡]

This process, which I prefer to call "space-time focusing" is illustrated in Fig. 18 by means of a graph in which a spatial extension is the abscissa, and time the ordinate. Such graphical timetables are familiar to every railwayman. A glimpse at them will tell whether the trains will collide or not. Our purpose is rather the opposite, we want the electrons to collide, or at least very nearly so. Rigorous focusing in space-time is impossible (unlike focusing in space), as the electrons will be dispersed by their mutual repulsion. The purpose is rather the production of strong periodic pulses by means of concentrated transient clouds of electrons. We shall see presently how these are utilised for the production of electrical oscillations with ultra high frequencies, but first I want to say a few words about a general method of treating problems of this kind.

* B.T.-H. Research Laboratory.

† I do not think this term a happy choice, as "phase" has already three different meanings in physics, and it would be very unkind to students of physics to add a fourth. Brüche & Recknagel's terms "geometrical" and "kinematical electron optics" are also rather unfortunate, as the customary antithesis to "geometrical optics" is "wave optics."

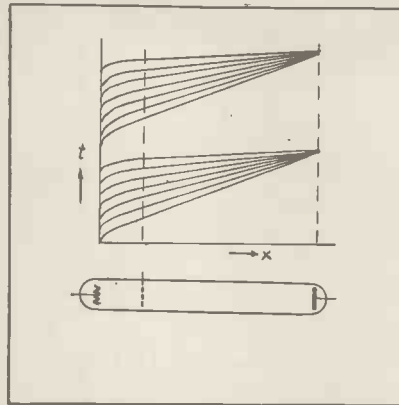

Fig. 18. "Phase focusing" according to Brüche and Recknagel. A periodic high frequent field of special curve form collects electrons which have started at different times at the cathode so that they arrive simultaneously at the anode.

The Refractive Index in Space-Time.—We have seen in the above example how easy it is to visualise a rather complicated process, if time is considered on the same footing with the geometrical co-ordinates. The question arises whether there is a corresponding advantage in the mathematical treatment.

The answer will be obvious to those who have studied at least the elements of Relativity Theory, and know how astonishingly simple the laws of physics become when expressed in a four dimensional form. In particular the laws of the electromagnetic field become so beautiful and symmetrical, as to make even the elegant vector representation of Maxwell's equation appear clumsy. But the space-time system used by physicists is not the system

$$x, y, z, t$$

but Minkowski's system

$$x, y, z, jct$$

where j is the imaginary unit, $\sqrt{-1}$. This is the natural system of physics, in which the four co-ordinates play perfectly symmetrical parts, and there is no doubt that it would offer also advantages for the development of four dimensional electron optics. But the imaginary time co-ordinate has the disadvantage that it can not be represented graphically, and therefore for the present I prefer to use the simple system x, y, z, t .

Hamilton's Principle for the motion of an electron in an electromagnetic field, specified by the electrostatic

potential V , and the vector potential \mathbf{A} can be written.²

$$\delta \int \left[\frac{1}{2}mv^2 + eV - \frac{e}{c} (\mathbf{A} \cdot \mathbf{v}) \right] dt = 0$$

The last term is the scalar product of \mathbf{A} and the velocity vector \mathbf{v} .

This can be written

$$\mathbf{A} \cdot \mathbf{v} dt = (A_x v_x + A_y v_y + A_z v_z) dt = A_x dx + A_y dy + A_z dz$$

The resulting expression under the integral sign can be interpreted as follows:—We define a four-dimensional vector \mathbf{Q} with the components

$$\mathbf{Q} = \left(-\frac{1}{2}mv^2 - eV, \frac{e}{c} A_x, \frac{e}{c} A_y, \frac{e}{c} A_z \right)$$

and interpret the integrand as the scalar product of \mathbf{Q} with the vectorial line element $d\mathbf{l}$, with the components

$$d\mathbf{l} = (dx, dy, dz, dt)$$

With these symbols Hamilton's Principle assumes the simple form

$$\delta \int Q_i dl = 0$$

This is an analogon of Fermat's Principle, and justifies considering Q_i , *i.e.*, the component of \mathbf{Q} in the direction of $d\mathbf{l}$ as the *four dimensional refractive index*.^{*} It is a function of position and direction in space-time. The restricting clause, "at a given total energy" (or "ballistic charge") which we had to use in three dimensions is here unnecessary, as the velocity and energy of the electron is given by its "direction" in space-time.

The above expression for the four dimensional refractive index is valid for all transit-time problems, so long as the electrons do not approach the velocity of light. In this case $\frac{1}{2}mv^2$ has to be replaced *not* by the relativistic expression for the energy, but by the relativistic Lagrange function.

$$- mc \sqrt{c^2 - v^2}$$

I think, however, that in problems involving very fast electrons it is more convenient to use the Minkowski system. Space does not allow to go further into these interesting problems. But I did not want to miss the opportunity to draw the attention of those interested in the theory to the advantages of the four dimensional representation. I think that it offers the natural framework for an attempt towards a unified theory of the various time devices, which for the time being seem to have little in common except the ending "-tron."

* A "kinematical" refractive index has been introduced by Brüche and Recknagel *l.c.* Their index is the third power of velocity, and valid only in certain restricted cases.

VELOCITY MODULATION.

For the present the simple graphical representation, already applied in Fig. 18, will be sufficient for an explanation of one of the most interesting of "transit time" devices, the *velocity modulation tube*, invented by W. C. Hahn and G. F. Metcalf.³ (Another device based essentially on the same principle, the "Klystron" invented by R. H. Varian and S. F. Varian,⁴ could be discussed in much the same way).

Fig. 19 shows a highly idealised velocity modulator tube with its space-time diagram. A steady beam of electrons traverses a tubular modulating electrode which forms two gaps with two apertured plates at either end of it. The two apertures are connected. If any D.C. potential were impressed on the modulator, the electron stream after passing it would exactly regain its initial velocity. But if we impress a high frequency potential on the modulator, and regulate the velocity of the electrons so that they traverse the space between the two gaps in approximately a half-cycle, some of the electrons will leave the space with a permanent gain, others with a permanent loss in energy. The average acceleration is, however, *nil*, therefore the impedance of the modulating electrode is infinite. (Voltage amplitude finite, but current zero).

The electrons now enter into a "drift space," and their adventures are immediately evident from the diagram. The fast ones will catch up with the slower ones, so that after a certain drift length there will result a very uneven distribution of density in the originally homogeneous beam. Here they traverse a modulator electrode, similar to the other. Let us imagine that on this, too, a H.F. voltage is impressed, of the same frequency, but with phase so chosen that it will slow down the electrons in the half cycle in which most of them pass through it. A (displacement) current will flow into this electrode, corresponding to the fluctuations of space charge in it, therefore, unlike the first modulator, this one will have a certain H.F. output. As it slows down the electrons in the average, it is evident that it takes energy out of the steady stream of electrons and converts it into H.F. energy. The tube is therefore a generator of H.F. oscillations.

The apparatus can be so designed that the electrons leave the second modulator at fairly uniform reduced speed. They can be slowed down almost to zero speed by a further retarding field, so that they convert only a small amount of kinetic energy into anode heat. This indicates that

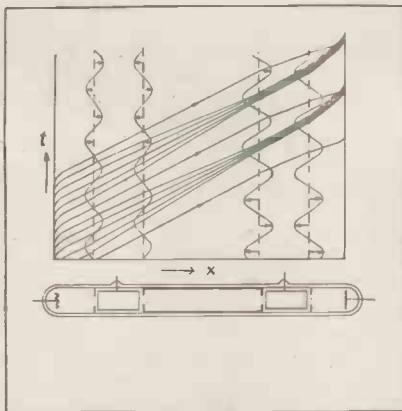

Fig. 19. Space-time diagram of electron trajectories in the velocity modulation tube.

the device can work as a highly efficient H.F. generator.

I want to draw your attention to the fact that Fig. 19 not only gives a clear qualitative illustration of these fairly complicated processes, but allows also a quantitative analysis by graphical or analytical methods.

The Betatron.—Finally, I want to say a few words on what is perhaps the most impressive of all modern electronic devices, the Betatron, developed by W. D. Kerst.⁵ (Fig. 20).

The idea of accelerating electrons in a circular orbit by electromagnetic induction is not new, it occurs I think first in an U.S. Patent of the Westinghouse Co. in 1925. But Kerst and R. Serber⁶ in a brilliant mathematical analysis found the conditions under which electrons could be driven round and round in a *stable* orbit. In Kerst's first Betatron, which is only 20 cms. in diameter they circle up to 200,000 times and acquire speeds corresponding to voltages of about two million

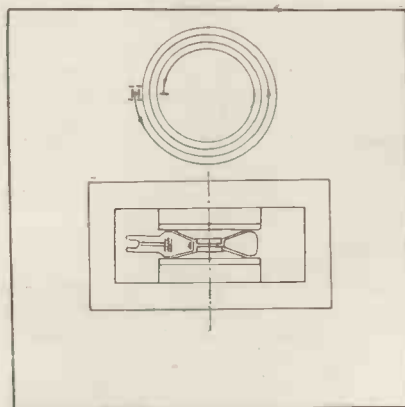

Fig. 20. The Betatron consists of an annular vacuum tube through which pulsates an alternating magnetic field of saw tooth wave form. Electrons injected on the outside at the beginning of a cycle spiral inwards until they reach a stationary orbit. (Not shown). Towards the end of the cycle the distribution of the magnetic field is distorted by saturation, so that the stationary orbit contracts gradually until the electrons hit a target where they produce very hard X-rays.

volts! This is almost a miracle as the vacuum is not exceedingly good, and the electrons must suffer at least ten thousand collisions. But the stability of the orbit is such, that even after collisions the electron continues almost unperturbed in its circular path, and we know that the energy loss suffered by very fast electrons in collisions is relatively insignificant. Actually certain deliberate perturbations of the equilibrium orbit are necessary to make the very fast electrons finally circle inward and then hit a tungsten target at which they convert their energy into X-rays, or really Gamma-rays.

I hear that since his first paper Kerst has realised 20 million volts⁷ (which already beats all radioactive elements!) and is working with the G.E. Co. on a Betatron which will produce 100 Mev "cosmic rays"!

I think it can be expected that soon the Betatron will be the best and cheapest source of Gamma-rays for cancer treatment. I do not know what more electronics could have done for humanity than to provide it with a new pleasure in Television, and to relieve its worst sufferings by what is at present probably still the best cancer cure!

Conclusion.—It would be pleasant to conclude this lecture on this triumphant note, but I must add a few critical words.

Up to now I have been using the word "electron optics" in at least three different senses. It is time to pick them apart, to make my conclusions as clear as possible. I want to make a division between the electron optical art, and the electron optical science, and I want to make a further division between elementary electron optical science, and what may be called "higher" or "precision" electron optics. I do not think that it will be necessary to give exact definitions, the meaning is clear enough.

We have seen that the achievements of the electron optical art are among the most wonderful of human material culture. We have also seen that the modern television tube and the electron microscope are the direct offspring of electron optical science. Yes, but we must also add candidly, that they have profited only from elementary electron optics. What can be called "higher electron optics" is now also mostly completed, but it must be admitted that up to now it has very little to its credit. The trouble was not so much that the experimenter could not realise its suggestions with the means at present available; if this were the only hitch search for new means could start at once. The trouble is, that up to now they were not wanted!

As this is a meeting of the Institute of Physics, an organisation which is not interested only in physics, but also in physicists, I want to express these conclusions in the form of a personal advice to the younger physicists and engineers who might want to specialise in electron optics:—

If you want to specialise in electronics, it is necessary, even indispensable for you to study electron optics. But do not expect that you will be able to make a profession of it! There is not the slightest evidence that the electronic industry will need specialised electron opticians, in the same way as the optical industry employs highly specialised lens computerers. Therefore do not specialise in electron optics to the extent that you will be able to do nothing else! Do not forget that every electronic device will have to take its place in some outer circuit, and that many problems which can be solved by electron-optical tricks can be solved also by the circuit engineer, and do not forget the lesson that both in the case of the television tube and in the case of the electron microscope it was the circuit engineer who proposed the more successful solutions. Therefore if you want to become specialists in electronic devices, you must at the same time become circuit engineers. The only case in which I would allow an exception is when there is *very* friendly co-operation between the electronic specialist and the circuit engineer!

- ¹ E. Brüche and A. Recknagel, *Zeitschr. f. Phys.*, 101, 459, 1938.
- ² Cf. e.g. W. Glaser, *ZS. f. techn. Phys.*, 17, 617, 1936.
- ³ W. C. Hahn and G. F. Metcalf, *Proc. I.R.E.*, 27, 106, 1939.
- ⁴ R. H. and S. F. Varian, *Journ. Appl. Phys.*, 10, 321, 1939.
- ⁵ W. D. Kerst, *Phys. Rev.*, 60, 47, 1941.
- ⁶ W. D. Kerst and R. H. Serber, *Phys. Rev.*, 60, 53, 1941.
- ⁷ W. D. Kerst, *Rev. Sci. Inst.* 13, 387, 1942.

CORRESPONDENCE

DEAR SIR,—In an interesting article, entitled "Electron Optics" (Part 2, January issue of *Electronic Engineering*), by Dr. Gabor, it is stated that when using electrostatic electrode systems "polarisation layers" of unknown origin occur, *i.e.*, the potential at the surface of the electrodes is different from the potential applied to the electrodes.

In the writer's opinion the occurrence of "polarisation layers" may be explained as follows:—

The surface effect is due to electrons or ions hitting the surface; it is assumed that capacitive and purely

electrostatic effects are minute. Unreliability of reproduction of the "charging-up" potentials of a metallic surface may be explained by secondary electron emission. When a very thin oxide or gas layer covers the surface of a metallic body a potential may exist between oxide (gas) and metal.

When electrons or ions fall on any substance, metal, semiconductor or insulator, secondary electrons are emitted. In accordance with the primary velocity of the electrons the secondary electron emission coefficient is either smaller or larger than one. In the former case the surface tends to reach the potential of the cathode, and in the latter the positive potential of the nearest electrode, *i.e.*, the electrode which contributes most to the acceleration of the primary electrons.

For example, an electrode of 100 volts relative to cathode has a tendency to charge up to several thousand volts if the neighbouring electrode is at such a potential. Most of these surface layers (oxides, gases) have a very flimsy structure which may change during the operation of the device, such changes would most likely be combined with a change of the secondary electron emission coefficient, thus giving cause for instability and difficulty in reproduction of the surface potentials.

If these effects are only of the order of one hundred instead of one thousand volts, it is due to the fact that the layers are semiconductors and thus the theoretical "charging-up" potential of the surface layer is reduced by leakage.

Matters are further complicated by the "polarised" nature of surface layers, which may conduct current in one direction only, similar to copper-oxide rectifiers or electrolytic condensers.

It is suggested that thorough degassing of the electrodes at high temperatures and the choice of right metals eliminates "polarisation."—Yours faithfully,

P. NAGY.

DEAR SIR,—Mr. Nagy's explanation of the action of a solid insulating or semi-conducting layer on a metal as an equilibrium between electron admission, secondary emission and leakage is well known and generally accepted. The assumption, however, that an adsorbed gas layer could act in a similar way appears unwarranted, and on the basis of our present knowledge very unlikely. The purpose of "degassing" is not so much to eliminate the adsorbed gas layers, but to destroy solid surface layers of oxide and the like, and also to prevent them from

being re-formed by gas liberated from the interior of the metal during operation.

Baking, however, is thoroughly effective only in the case of electrodes which are not in or near a straight line from the cathode. The most troublesome polarisation layers seem to arise from matter evaporated from the cathode, or emitted in the form of negative ions. An ideal solution would be a metal or any conducting material, which would absorb below its surface, or break up any coherent insulating layer which might try to form on it by condensation. I should be very interested in any suggestions relating to this problem.—Yours,

D. GABOR.

February Meetings

Institution of Electrical Engineers

Wireless Section

On February 3 at the Institution, a paper will be read by Prof. Willis Jackson on "The University Education and Industrial Training of Telecommunication Engineers."

On February 16, an informal discussion will be held on "Electronics in Industry." Both meetings commence at 5.30 p.m. Tea at 5.0 p.m.

London Students' Section

At a meeting to be held on Monday, February 1st, at the I.E.E., at 7 p.m., an address will be given by the President, Professor C. L. Fortescue, O.B.E., M.A., on "The Relation between Subsequent Career and the form of Preliminary Training."

Institute of Physics

On February 17th, at the Royal Institution, Albemarle Street, W., the annual general meeting will be held at 6 p.m.

This meeting will be followed by a paper by Dr. J. R. Baker (Department of Zoology, Oxford University) on "Freedom in Science."

Brit. I.R.E.

The next meeting will be held on February 19th at The Institution of Structural Engineers, 11 Upper Belgrave Street, S.W.1, when a paper will be read on "Industrial Applications of Electronics," by J. H. Reynier, B.Sc.

British Kinematograph Society

On February 17th, at 6 p.m., a meeting will be held in the Gaumont British Theatre, Wardour Street, W.1. Mr. A. E. Carrick will read a paper on "Set Design and Construction."

Tickets for non-members can be obtained from the Hon. Secretary, R. Cricks, Esq., Dean House, Dean Street, London, W.C.2.

The Cathode Follower

Part II. Performance at the Higher Frequencies

(Continued from p. 287 of the December issue)

By C. E. LOCKHART

IN the December issue the performance of the cathode follower circuit at low and medium frequencies was dealt with in detail.

A more generalised treatment which includes the effect of input loading due to electron inertia effects and no longer neglects the effect of inter-electrode-capacities, is developed in the present article.

As in Part I the equations are developed in terms of a generalised cathode impedance Z , and grid cathode impedance Z_g (Fig. 1a), and then solved in detail for the most common practical case when Z and Z_g , consist of a resistance and a capacity in parallel (see Fig. 2).

Fig. 2 illustrates the circuit considered where " R_g " represents the total grid input loading resistance at the frequency considered and the anode-cathode capacity C_{ac} has been absorbed in the capacity C_c . For simplicity the source of the input signal E_1 is assumed to have zero impedance.

General Relations

From equations (1) and (2) Part I we write

$$i_a = \frac{-E_o + \mu E_g}{R_a} \quad \dots (47)$$

where

$$E_o = (i_a + i_i)Z \quad \dots (48)$$

is the output voltage. From this:

$$i_a = \frac{- (i_a + i_i)Z + \mu E_g}{R_a} \quad \dots (49)$$

where i_i is the total current through the grid cathode impedance Z_g (usually R_g and C_g in parallel). This is given by:

$$i_i = \frac{E_g}{Z_g} \quad \dots (50)$$

Also

$$E_i = i_i (Z + Z_g) + i_a Z \quad (51)$$

$$\text{therefore } i_i = \frac{E_i}{Z_g + Z} \quad \dots (52)$$

From which i_a in terms of E_i is given by

$$i_a = E_i \frac{\mu Z_g - Z}{R_a (Z + Z_g) + Z Z_g (1 + \mu)} \quad (53)$$

Also expressing the total current through Z in terms of E_g we have

$$i_a + i_i = E_g \left(\frac{\mu + R_a/Z_g}{R_a + Z} \right) \quad (54)$$

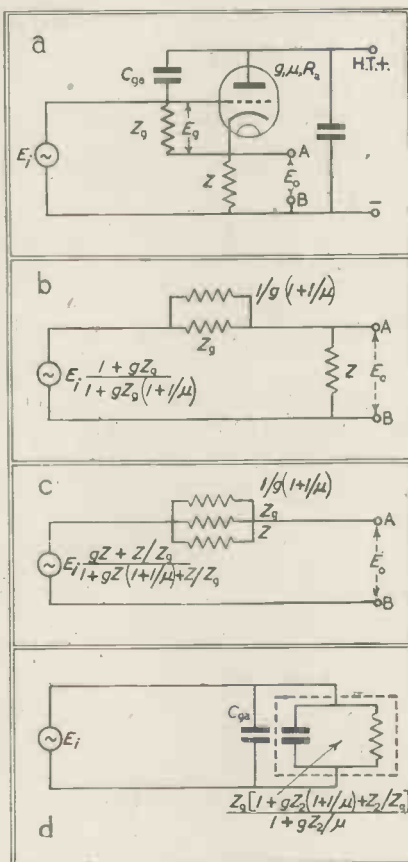

Generalised circuit of a cathode follower including the effects of a grid input loading impedance Z_g .

The equivalent circuits 1.c. and 1.b. can be used for calculating the output voltage E_o and the equivalent damping for any value of Z ; for any additional impedance connected across AB Fig. 1.c. should be used.

Fig. 1.d. represents the equivalent input circuit of a cathode follower, the symbol Z_2 being used to denote the resulting impedance of Z in parallel with any extra impedance across AB. When this extra impedance is omitted, $Z_2 = Z$.

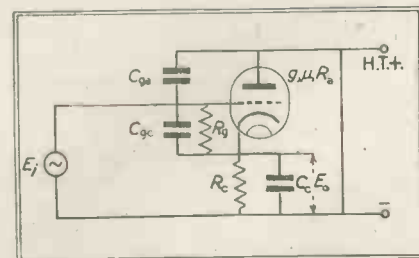

Fig. 2. Cathode follower circuit for a cathode load and grid-cathode load consisting of a resistance and capacity in parallel.

$$= E_g \left(\frac{g + 1/Z_g}{1 + Z/R_a} \right) \quad (55)$$

and in terms of E_1 we have:—

$$E_g = E_1 - (i_a - i_i)Z \quad (56)$$

and therefore

$$(i_a + i_i) = E_1 \frac{\mu + R_a/Z_g}{R_a(1 + Z/Z_g) + Z(1 + \mu)} \quad (57)$$

It should be noted that $gZ(1 + 1/\mu)$ may also be written in the form $gZ + Z/R_a$.

The output voltage E_o which is equal to $(i_a + i_i)Z$ is then given by

$$E_o = E_1 Z \frac{g + 1/Z_g}{1 + gZ(1 + 1/\mu) + Z/Z_g} \quad (58)$$

The volts E_g developed between grid and cathode and which are equal to $E_1 - E_o$ are given by the expression

$$E_g = E_1 \frac{1}{1 + gZ(1 + 1/\mu) + Z/Z_g} \quad (59)$$

For the input admittance A_i we have from (50):

$$A_i = \frac{i_i + i_{cga}}{E_1} = \frac{E_g}{Z_g \cdot E_1} + j\omega C_{ga} \quad (60)$$

and inserting the ratio E_g/E_1 from (59)

$$A_i = \frac{1}{Z_g} \frac{1 + Z/R_a}{1 + gZ(1 + 1/\mu) + Z/Z_g + j\omega C_{ga}} \quad (61)$$

For the output admittance A_o , we write the current i_o drawn from a fictitious voltage E_o applied across Z with no signal applied.

$$i_o = \frac{E_o}{Z} + \frac{E_o}{Z_g} + \frac{E_o + \mu E_o}{R_a} \quad (62)$$

and therefore

$$A_o = \frac{i_o}{E_o} = \frac{1}{Z} + \frac{1}{Z_g} + g \frac{1 + \mu}{\mu} \quad (63)$$

The anode A.C. resistance R_a' is given by

$$R_a' = \frac{v_a}{i_a} = R_a \left[1 + g \frac{Z \cdot Z_g}{Z + Z_g} \left(1 + \frac{1}{\mu} \right) \right] \quad (64)$$

As stated above, the source has so far been assumed to have zero impedance. A finite source impedance will modify the above relations in two ways: (a) The loading action of the finite input admittance will alter the value of the

open circuit signal voltage; this effect can be allowed for by defining E_1 as the grid-to-H.T. negative signal voltage under operating conditions (*i.e.*, the voltage that would actually be measured across the input circuit). (b) In deriving the previous equations the whole of the voltage E_o developed across Z was assumed to be fed back between grid and cathode. At the higher frequencies due to the finite value of Z_g the proportion of the voltage E_o developed between grid and cathode becomes also a function of the source impedance Z_s . Thus, if we take for example the output admittance A_o , a finite value of Z_s will modify equations (62) and (63) to

$$i_o = \frac{E_o}{Z} + \frac{E_o}{Z_g + Z_s} \cdot \frac{1 + \frac{Z_g}{Z + Z_g} \mu}{R_s} + E_o \frac{1}{R_s}$$

and
$$A_o = \frac{1}{Z} + \frac{1}{Z_g + Z_s} \cdot \frac{1 + \frac{Z_g}{Z + Z_g} \mu}{\mu(Z_s + Z_g)} \quad (65)$$

If we define the term "Transfer Impedance" as the impedance coupling the voltage E_o to the signal E_1 , then in the case of the "Cathode Follower" circuit it is equal to Z_g . The proportion of E_o developed across the signal source impedance Z_s is therefore

$$E_o \frac{Z_s}{Z_g + Z_s}$$

Cathode and Grid Loads

If for the purpose of this analysis we consider the cathode and grid load circuits Z and Z_g to consist of a parallel combination of a capacity and a resistance as shown in Fig. 2, then as derived in Part I. Z and Z_g may be expressed in the form

$$Z = \frac{R_c}{1 + j\phi_o} \quad \dots (66)$$

$$Z_g = \frac{R_g}{1 + j\phi_g} \quad \dots (67)$$

where $\phi_o = \omega C_c R_c = f/f_o$ and $\phi_g = \omega C_{gc} R_g$. By inserting the above expressions into the general relations we obtain the final equations. In order to save space the following system will be adopted wherever possible. The equations will be evaluated up to the rationalised complex form such as for example

$$E_o = E_1 \frac{A + jB}{C^2 + D^2}$$

The most usual way of expressing such relations is in the form of an absolute magnitude $|K|$ and phase angle of say γ so that

$$E_o = E_1 |K| / \gamma = E_1 \frac{\sqrt{A^2 + B^2}}{C^2 + D^2} / \gamma$$

where $\gamma = \tan^{-1} (B/A)$

The absolute magnitude form will be given on a later Data Sheet.

Equations for Anode Current, Cathode Load Current and other parameters are set out on the succeeding pages in full.

Input Admittance

In the expression for Input Admittance (Eqn. 80 on page), the real part of the expression represents the reciprocal of the input resistance R_1 . If $\mu \gg 1$ and $R_c/R_s \ll 1$, then the expression simplifies to:

$$R_1 \approx \frac{\left(1 + gR_c + \frac{R_c}{R_g}\right)^2 + \phi_o^2 \left(1 + \frac{C_{gc}}{C_c}\right)^2}{\phi_o^2 \frac{C_{gc}}{R_c C_c} \left\{ \frac{C_{gc}}{C_c} - gR_c - \frac{R_c}{R_g} \right\} + \frac{1}{R_g} \left\{ \left[1 + gR_c + \frac{R_c}{R_g}\right] + \phi_o^2 \left(1 + \frac{C_{gc}}{C_c}\right) \right\}} \quad \dots (81)$$

With similar limitations the input capacity C_1 given by the imaginary part of the Equation (80) is given by:

$$C_1 \approx C_{gs} + C_{gc} \frac{\left(1 + gR_c + \frac{R_c}{R_g}\right)^2 + \phi_o^2 \left(1 + \frac{C_{gc}}{C_c}\right)^2}{\left(1 + gR_c + \frac{R_c}{R_g}\right)^2 + \phi_o^2 \left(1 + \frac{C_{gc}}{C_c}\right)^2} \dots (82)$$

Output Impedance

From (63)

$$Z_o = \frac{R_c}{\sqrt{\left[1 + gR_c \left(1 + \frac{1}{\mu}\right) + \frac{R_c}{R_g}\right]^2 + \phi_o^2 \left(1 + \frac{C_{gc}}{C_c}\right)^2}} \quad \dots (83)$$

and

$$\gamma = -\tan^{-1} \left\{ \frac{\phi_o \left(1 + \frac{C_{gc}}{C_c}\right)}{1 + gR_c \left(1 + \frac{1}{\mu}\right) + \frac{R_c}{R_g}} \right\} \quad \dots (84)$$

Vector Relations

In the vector diagram Fig. 4 of Part I. an example of the vector relations for medium frequencies was illustrated and though the vector for the current through the grid cathode capacity was shown (leading the grid voltage vector E_g by 90°) its effect on the output voltage E_o and phase angle was neglected.

The effect of increasing the frequency (or ϕ_o) will be to increase the angle by which the output voltage E_o lags behind the total current through the load circuit Z . This angle β is given by:

$$\beta = -\tan^{-1} (\phi_o)$$

The total current through Z is ($i_a + i_i$) which consists of three components: the anode current i_a which leads the voltage E_s by a small angle, the grid-cathode capacity current i_{cgc} which leads E_g by 90° and the current i_{rg} through R_g which is in phase with E_g .

For a given value of E_g the effect of increasing the frequency to high values will be to leave the magnitude of the anode current almost unaffected, while i_{cgc} will increase in direct proportion to the frequency. The current i_{rg} will in general increase as the frequency squared as $R_g \propto 1/\omega^2 g$.

The net effect of including i_i (for

the frequency range where $\omega C_{gc} > 1/R_g$, is to reduce the phase angle θ as is shown in Fig. 3 and so improve the transient response. This can be seen by inspection of equation (77). The improvement in phase angle is however obtained at the expense of gain and when the frequency is increased sufficiently to make $i_i > i_a$ the gain is controlled largely by the magnitudes of R_c, R_g, C_{gc} and C_c .

Grid Loading R_g

To simplify this analysis the loading resistance R_g has been assumed (as stated in Part I) to be due only to electron inertia effects. For this condition R_g may be expressed as

$$1/R_g = \omega^2 g \cdot k$$

where k is a constant dependent on the electrode dimensions and operating conditions.⁶

In practice the loss resistance between grid and cathode is considerably affected by the electrode lead inductance.⁷ As a first approximation this will modify the value of k above, a complete analysis will be given at a future date.

Envelope Delay

The time delay t_1 of equations (26) to (29) and (79) expresses the amount of phase delay present. If, however, the envelope delay⁸ and⁹ is required we write $t_2 = d\theta/d\omega$ and differentiating equation (21) for θ gives

$$t_2 = \frac{1}{\omega} \cdot \frac{1}{(1+gR_c) + \frac{p_0}{(1+gR_c)}} \quad (85)$$

and in order to enable a generalised graphical representation to be made this may be written in the form

$$f \cdot t_2 = \frac{1}{2\pi} \cdot \frac{1}{(1+gR_c) + \frac{p_0^2}{(1+gR_c)}} \quad (86)$$

For the case of a distortionless system, that is when θ is a linear function of frequency, t_1 and t_2 are equal and constant.

Equivalent Circuits

The equivalent circuit of a cathode follower at high frequencies must be resolved into two parts. The first, which is employed for the calculation of the output voltage and the damping of the output circuit, is shown in Fig. 1, *b* and *c*. The second, shown in Fig. 1*d*, deals with the loading introduced by the cathode follower on the source of the input signal. The equivalent circuits when Z and Z_g consist of a capacity and resistance in parallel can be derived from Fig. 2.

LIST OF SYMBOLS

- A_i = Input Admittance of cathode follower.
- A_o = Output Admittance of cathode follower.
- C_{ac}, C_{ga}, C_{gc} = Anode - cathode, grid - anode, grid - cathode inter - electrode capacities respectively. (including electron loading)
- C_c = Total effective capacity across cathode load resistance R_c .
- C_i = Input Capacity.
- E_i = Input signal voltage between grid and H.T. negative
- E_o = Output signal voltage.
- E_g = Signal voltage developed between grid and cathode.
- The above voltages are assumed to be of sinusoidal form and must all be expressed on the same basis, i.e., in either r.m.s. or peak volts. The instantaneous value of the voltage is of the general form $e = E \sin \omega t = E \sin 2\pi ft$.
- $f = \omega/2\pi$ = Frequency of applied signal.
- $f_o = \frac{1}{2\pi C_o R_c}$, i.e., frequency in c/s at which $\omega_o C_o R_c = 2\pi f_o C_o R_c = 1$.
- g = Mutual conductance of a triode = di_a/dv_g .
- i_a = Signal component of the anode current.
- $[i_a + i_j]$ = Signal component of cathode load current.
- M = Relative amplification in db. = $20 \log_{10} \frac{E_o}{E_i}$
- $p_g = \omega C_{gc} R_g$.
- $p_o = \omega C_o R_c = f/f_o$.
- R_a = Anode A.C. resistance of a triode = di_a/dV_a .
- R_a' = Anode A.C. resistance of cathode follower.
- R_c = Resistance of cathode load in ohms.
- R_g = Grid to cathode electron loading resistance.
- R_i = Input resistance of cathode follower.
- t = Time in seconds.
- $-t_1$ = Time delay of signal of frequency f based on phase delay.
- = $\frac{\text{Phase angle in radians}}{2\pi f} = \frac{\text{Phase angle in degrees}}{360 \cdot f}$ secs.
- $-t_2$ = Time delay of signal of frequency f based on envelope delay = $d\theta/d\omega$
- v_a = A.C. voltage applied between anode and H.T. negative.
- Z = Impedance of cathode load circuit.
- Z_g = Impedance of grid to cathode.
- Z_i = Input impedance of cathode follower.
- Z_o = Output impedance of cathode follower.
- μ = Amplification factor = gR_a .
- ψ = Phase angle of i_a relative to E_i .
- ϕ = Phase angle of E_g relative to E_i .
- θ = Phase angle of E_o relative to E_i .
- α = Phase angle of total cathode load current relative to E_i .
- β = Phase angle of output impedance of cathode follower.

REFERENCES

- 1 The Marconi E.M.I. Television System A. D. Blumlein, C. O. Browne, N. E. Davis and E. Green. *Jour. I.E.E.* Vol. 83, p. 758, 1938.
- 2 The Cathode Follower. C. B. Lockhart. *Electronics and Television S.W.W.* November, 1940.
- 3 The Design of Wide-band Video Frequency Amplifiers, Part I. Data Sheets I-III. C. B. Lockhart. *Electronic Engineering*, June, 1941.
- 4 The Shunt loaded Tuned Anode Circuit Data Sheets XXIII-XXV. C. B. Lockhart, *Electronic Engineering*, March, 1942.
- 5 The grid-cathode capacity must include the increment due to space charge: see for example Gain Control of Radio Frequency Amplifiers—Its effect on input admittance, C. B. Lockhart, *Electronics and Television and Short Wave World*, August, 1940.
- 6 "Generation and Amplification of Microwaves," C. B. Lockhart, *Electronic Engineering*, August and September, 1941. (See extensive bibliography in latter issue).
- 7 The Causes of increase of the Admittance of Modern H.F. Amplifier Tubes on Short Waves, M. G. O. Strutt and A. van der Ziel. *Proc. I.R.E.*, August, 1938.
- 8 "Communication Networks," Vol. 2. E. A. Guillemin, pp. 99-106 and 490-498.
- 9 "Steady State Delay as related to Aperiodic Signals," R. V. I. Hartley. *B.S.T.J.*, April, 1941

1942, issue. Please correct the typescript accordingly.

Equation (3).—For E_1 read E_i . Complete brackets in the denominator.

Equation (6).—For g read g .

Equation (8).—The paragraph above should read: . . . A.C. resistance for voltage fluctuations v_a between anode and H.T. -ve . . .

Equation (10).—The denominator should read: $(1+gR_c + R_c/R_a)^2 + p_o^2$.

Equation (14).—Insert bracket (after square bracket [under root sign in the numerator.

Equation (22).—For p_o read p_o .

Equation (23).—For gR in the denominator read gR_c , and read R_c for R in the line below.

Equations (31) and (32).—For A read A_1 , and for i_{ga} read i_{cga} .

Equation (42).—Add minus sign in front of the expression for \tan^{-1} .

Finally, the expression μE_g should be deleted from the figures 1.b., 1.c., 2.b., 2.c.

Corrections to Part I.

It is regretted that the following typographical errors occurred in Part I of the "Cathode Follower" Data Sheet Supplement in the December,

Anode Current

From Eqn. 53:

$$i_a = E_i \frac{\mu \frac{R_g}{1+j\omega g} + \frac{R_c}{1+j\omega p_o}}{R_a \left\{ \frac{R_g}{1+j\omega g} + \frac{R_c}{1+j\omega p_o} \right\} + \frac{R_c R_g}{(1+j\omega p_o)(1+j\omega g)} (1+\mu)} = E_i g \frac{\left(1 + \frac{R_c}{\mu R_g}\right) + j\omega p_o \left(1 + \frac{C_{gc}}{\mu C_c}\right)}{\frac{R_c}{R_g} + 1 + g R_c \left(1 + \frac{1}{\mu}\right) + j\omega p_o \left(1 + \frac{C_{gc}}{C_c}\right)}$$

Rationalising

$$i_a = E_i g \frac{\left(1 + \frac{R_c}{\mu R_g}\right) \left[1 + g R_c \left(1 + \frac{1}{\mu}\right) + \frac{R_c}{R_g}\right] + \rho_o^2 \left(1 + \frac{C_{gc}}{C_c}\right) \left(1 + \frac{C_{gc}}{\mu C_c}\right) + j\omega p_o \left[\frac{R_c + C_{gc}}{R_g \mu C_c}\right] \left(1 - \frac{1}{\mu}\right) + g R_c \left(1 + \frac{C_{gc}}{\mu C_c}\right) \left(1 - \frac{1}{\mu}\right)}{\left[1 + g R_c \left(1 + \frac{1}{\mu}\right) + \frac{R_c}{R_g}\right]^2 + \rho_o^2 \left(1 + \frac{C_{gc}}{C_c}\right)^2} \dots \dots (68)$$

and

$$\psi = \tan^{-1} \frac{\rho_o \left[\frac{R_c + C_{gc}}{R_g \mu C_c}\right] \left(1 - \frac{1}{\mu}\right) + g R_c \left(1 + \frac{C_{gc}}{\mu C_c}\right) \left(1 - \frac{1}{\mu}\right)}{\left(1 + \frac{R_c}{\mu R_g}\right) \left[1 + g R_c \left(1 + \frac{1}{\mu}\right) + \frac{R_c}{R_g}\right] + \rho_o^2 \left(1 + \frac{C_{gc}}{C_c}\right) \left(1 + \frac{C_{gc}}{\mu C_c}\right)} \dots \dots (69)$$

Cathode Load Current

From (57)(66) and (67)

$$(i_a + i_i) = E_i \frac{g + \frac{1+j\omega g}{R_g}}{1 + \frac{R_c}{R_g} \cdot \frac{1+j\omega g}{1+j\omega p_o} + \frac{g R_c}{1+j\omega p_o} \left(1 + \frac{1}{\mu}\right)}$$

Rearranging and rationalising, we have:

$$(i_a + i_i) = E_i \frac{\left[\frac{g + \frac{1}{R_g} + \rho_o^2 \left(\frac{C_{gc}}{C_c R_c}\right)}{g + \frac{1}{R_g} + \rho_o^2 \left(\frac{C_{gc}}{C_c R_c}\right)}\right] \left[1 + \frac{R_c}{R_g} + g R_c \left(1 + \frac{1}{\mu}\right)\right] + \rho_o^2 \left(1 + \frac{C_{gc}}{C_c}\right) \left(g + \frac{1}{R_g} + \frac{C_{gc}}{C_c R_c}\right) + j\omega p_o \left[\frac{g R_c + \frac{C_{gc}}{C_c} + \frac{R_c}{R_g}\right] \left(1 + \frac{g}{R_g \mu} + g\right) + \rho_o^2 \left(\frac{C_{gc}}{C_c R_c}\right) \left(1 + \frac{C_{gc}}{C_c}\right)}{\left[1 + g R_c \left(1 + \frac{1}{\mu}\right) + \frac{R_c}{R_g}\right]^2 + \rho_o^2 \left(1 + \frac{C_{gc}}{C_c}\right)^2} \dots \dots (70)$$

and the phase angle

$$\alpha = \tan^{-1} \frac{\left\{ \rho_o \left[\frac{g R_c + \frac{C_{gc}}{C_c} + \frac{R_c}{R_g}\right] \left(1 + \frac{g}{R_g \mu} + g\right) + \rho_o^2 \left(\frac{C_{gc}}{C_c R_c}\right) \left(1 + \frac{C_{gc}}{C_c}\right) \right\}}{\left[\frac{g + \frac{1}{R_g} + \rho_o^2 \left(\frac{C_{gc}}{C_c R_c}\right)}{g + \frac{1}{R_g} + \rho_o^2 \left(\frac{C_{gc}}{C_c R_c}\right)} \right] \left[1 + g R_c \left(1 + \frac{1}{\mu}\right) + \frac{R_c}{R_g}\right] + \rho_o^2 \left(1 + \frac{C_{gc}}{C_c}\right) \left(g + \frac{1}{R_g} + \frac{C_{gc}}{C_c R_c}\right)} \dots \dots (71)$$

Grid-Cathode Voltage

From (57) we have:

$$E_g = E_i \frac{1 + \frac{g R_c}{\mu} + j\omega p_o}{\left[1 + g R_c \left(1 + \frac{1}{\mu}\right) + \frac{R_c}{R_g}\right] + j\omega p_o \left(1 + \frac{C_{gc}}{C_c}\right)}$$

Rationalising:

$$E_g = E_i \frac{\left(1 + \frac{g R_c}{\mu}\right) \left[1 + g R_c \left(1 + \frac{1}{\mu}\right) + \frac{R_c}{R_g}\right] + \rho_o^2 \left(1 + \frac{C_{gc}}{C_c}\right) + j\omega p_o \left[\frac{g R_c + \frac{R_c}{R_g} - \frac{C_{gc}}{C_c}\right] \left(1 + \frac{g R_c}{\mu}\right)}{\left[1 + g R_c \left(1 + \frac{1}{\mu}\right) + \frac{R_c}{R_g}\right]^2 + \rho_o^2 \left(1 + \frac{C_{gc}}{C_c}\right)^2} \dots \dots (72)$$

and the phase angle

$$\phi = \tan^{-1} \left\{ \frac{\rho_o \left[\frac{R_c}{R_g} + g R_c - \frac{C_{gc}}{C_c} \left(1 + \frac{g R_c}{\mu}\right)\right]}{\left(1 + \frac{g R_c}{\mu}\right) \left[1 + g R_c \left(1 + \frac{1}{\mu}\right) + \frac{R_c}{R_g}\right] + \rho_o^2 \left(1 + \frac{C_{gc}}{C_c}\right)} \right\} \dots \dots (73)$$

Output Voltage

From (58)

$$E_o = E_i R_c \frac{g + \frac{1+j\rho_g}{R_g}}{1+j\rho_o + \frac{R_c}{R_g} \left(1 + j\rho_g\right) + gR_c \left(1 + \frac{1}{\mu}\right)}$$

Rationalising and collecting terms:-

$$E_o = E_i \left(g + \frac{1}{R_g}\right) R_c \frac{\left[1 + gR_c \left(1 + \frac{1}{\mu}\right) + \frac{R_c}{R_g}\right] + \frac{\rho_o^2 C_{gc} R_g}{R_c C_c} \left(1 + \frac{C_{gc}}{C_c}\right) - j\rho_o \left[\frac{C_{gc} R_g}{R_c C_c} \left(1 + \frac{gR_c}{\mu}\right)\right]}{\left[1 + gR_c \left(1 + \frac{1}{\mu}\right) + \frac{R_c}{R_g}\right]^2 + \rho_o^2 \left(1 + \frac{C_{gc}}{C_c}\right)^2} \dots (74)$$

and the phase angle

$$\theta = \tan^{-1} \left\{ \frac{\rho_o \left[\frac{C_{gc} R_g}{R_c C_c} \left(1 + \frac{gR_c}{\mu}\right)\right]}{\left[1 + gR_c \left(1 + \frac{1}{\mu}\right) + \frac{R_c}{R_g}\right] + \frac{\rho_o^2 C_{gc} R_g}{R_c C_c} \left(1 + \frac{C_{gc}}{C_c}\right)} \right\} \dots (75)$$

as $\frac{R_c}{R_a} = \frac{gR_c}{\mu}$ and $\rho_o \omega C_{gc} = \rho_o^2 \frac{C_{gc}}{R_c C_c}$

Gain

As the gain is given by the ratio of E_o/E_i , the gain equations are identical with the above. In the case where $\mu \gg 1$, $gR_c/\mu \gg 1$, $gR_c \gg 1$, $gR_c \gg 1$, $C_{gc}/C_c \leq 1$ and $R_g > R_c$:

$$\text{Gain} \approx \frac{1 + \left(\frac{\rho_o}{gR_c}\right)^2 \frac{C_{gc}}{C_c} \left(1 + \frac{C_{gc}}{C_c}\right) - j \frac{\rho_o}{gR_c}}{1 + \left(\frac{\rho_o}{gR_c}\right)^2 \left(1 + \frac{C_{gc}}{C_c}\right)^2} \dots (76) \quad \theta \approx \tan^{-1} \left\{ \frac{\frac{\rho_o}{gR_c}}{1 + \left(\frac{\rho_o}{gR_c}\right)^2 \frac{C_{gc}}{C_c} \left(1 + \frac{C_{gc}}{C_c}\right)} \right\} \dots (77)$$

Relative Gain

As in Part 1, the relative gain M is defined as the ratio of the gain at frequency f to the gain at a very low frequency when ρ_o , ρ_g and $1/R_g$ all tend to zero. For the case when $\mu \gg 1$, $gR_c/\mu \ll 1$, $gR_c \gg 1$, we have:

$$M_{db} \approx 20 \log_{10} \frac{\sqrt{\left[1 + \frac{\rho_o^2}{1 + gR_c + R_c/R_g} \frac{C_{gc}}{gR_c C_c} \left(1 + \frac{C_{gc}}{C_c}\right)\right]^2 + \rho_o^2 \left(\frac{1 - \frac{C_{gc}}{gR_c C_c}}{1 + gR_c + R_c/R_g}\right)^2}}{1 + \left[\left(\frac{\rho_o}{1 + gR_c + R_c/R_g}\right) \left(1 + \frac{C_{gc}}{C_c}\right)\right]^2} \dots (78)$$

Time Delay

The time delay t_1 , evaluated from the phase delay, is expressed as before in the generalised form of $f_o t_1$, where

$$f_o t_1 = - \tan^{-1} \frac{\left\{ \frac{\rho_o \left[\frac{C_{gc} R_g}{R_c C_c} \left(1 + \frac{gR_c}{\mu}\right)\right]}{\left[1 + gR_c \left(1 + \frac{1}{\mu}\right) + \frac{R_c}{R_g}\right] + \frac{\rho_o^2 C_{gc} R_g}{R_c C_c} \left(1 + \frac{C_{gc}}{C_c}\right)} \right\}}{2 \pi \rho_o} \dots (79)$$

Input Admittance

From (61)

$$A_i = \frac{1}{R_g} \frac{1 + \frac{gR_c}{\mu} - \rho_o \rho_g + j \left[\rho_o + \left(1 + \frac{gR_c}{\mu}\right) \rho_g\right]}{\left[1 + gR_c \left(1 + \frac{1}{\mu}\right) + \frac{R_c}{R_g}\right] + j \left(\rho_o + \rho_g \frac{R_c}{R_g}\right)} + j \omega C_{ga}$$

$$= \frac{\rho_o^2 \frac{C_{gc}}{R_c C_c} \left\{ \left(1 + \frac{gR_c}{\mu}\right) \frac{C_{gc}}{C_c} - gR_c - \frac{R_c}{R_g} \right\} + \frac{1}{R_g} \left\{ \left(1 + \frac{gR_c}{\mu}\right) \left[1 + gR_c \left(1 + \frac{1}{\mu}\right) + \frac{R_c}{R_g}\right] + \rho_o^2 + \frac{C_{gc}}{C_c} \right\}}{\left[1 + gR_c \left(1 + \frac{1}{\mu}\right) + \frac{R_c}{R_g}\right]^2 + \rho_o^2 \left(1 + \frac{C_{gc}}{C_c}\right)^2}$$

$$+ j \frac{\omega C_{gc} \left\{ \left(1 + \frac{gR_c}{\mu}\right) \left[1 + gR_c \left(1 + \frac{1}{\mu}\right) + \frac{R_c}{R_g}\right] + \rho_o^2 \left(1 + \frac{C_{gc}}{C_c}\right) \right\} + \frac{\rho_o}{R_g} \left\{ gR_c + \frac{R_c}{R_g} - \left(1 + \frac{gR_c}{\mu}\right) \frac{C_{gc}}{C_c} \right\}}{\left[1 + gR_c \left(1 + \frac{1}{\mu}\right) + \frac{R_c}{R_g}\right]^2 + \rho_o^2 \left(1 + \frac{C_{gc}}{C_c}\right)^2} + j \omega C_{ga} \dots (80)$$

DATA SHEETS XLII, XLIII AND XLIV

The Cathode Follower—Part II

Data Sheet 42. L.F. Voltage Amplification of the Cathode Follower

The cathode follower circuit provides a power amplifier rather than a voltage amplifier, as the voltage amplification is always less than unity. The voltage amplification at very low frequencies is given from Eq. (22) when $\mu \gg 1$ by:

$$\text{Voltage Amplification} = \frac{gR_c}{1 + gR_c}$$

and this figure may be quickly read off from Data Sheet 42.

The amplification at higher frequencies can then be obtained from the curves on Data Sheet 39 (Part I).

Data Sheet 43. Band width of the Cathode Follower

Data Sheets 39, 40 and 41 (Part I) are only strictly accurate when $\mu \gg 1$ and $C_{gc}/C_c \ll 1$. When the last condition is not satisfied the full expressions given in the accompanying article should be employed.

However, when the above conditions are satisfied, the Relative Gain is only a function of the parameter $p_0/(1 + gR_c)$. (See Eq. (23).)

If we define the bandwidth as the frequency f_c at which the attenuation is 1 db, then we can write:

$$f_c = \frac{0.511 (1 + gR_c)}{2\pi R_c C_c} \text{ c/s.}$$

$$\text{or } f_c = 8.13 \times 10^5 \frac{1 + gR_c}{R_c C_c} \text{ Mc/s (87)}$$

when C_c is in $\mu\mu\text{F}$. and R_c is in ohms.

The bandwidth for any other attenuation level, such as 2, 3, can be obtained by multiplying f_c by a suitable constant as given on Data Sheet 43.

If we take for example a cathode load of 2,000 ohms and a capacity of $70 \mu\mu\text{F}$., with a mutual conductance of 5 mA/V. we can read off $f_c = 6.4$ Mc/s. For an attenuation of 2 db. the band width would be 6.4×1.5 or 9.6 Mc/s. An increase of the mutual conductance to 10 mA/V would increase the band width figures to 12.2 Mc/s. and 18.3 Mc/s. respectively.

Data Sheet 44. Grid to Cathode Voltage

As stated in Part I, the grid-cathode signal E_g increases with an increasing value of p (i.e., at higher frequencies) and it is therefore essential to check that the valve will not be overloaded at the highest operating frequency for the required value of output voltage E_o . Data Sheet 44 enables the ratio E_g/E_i to be readily calculated for dif-

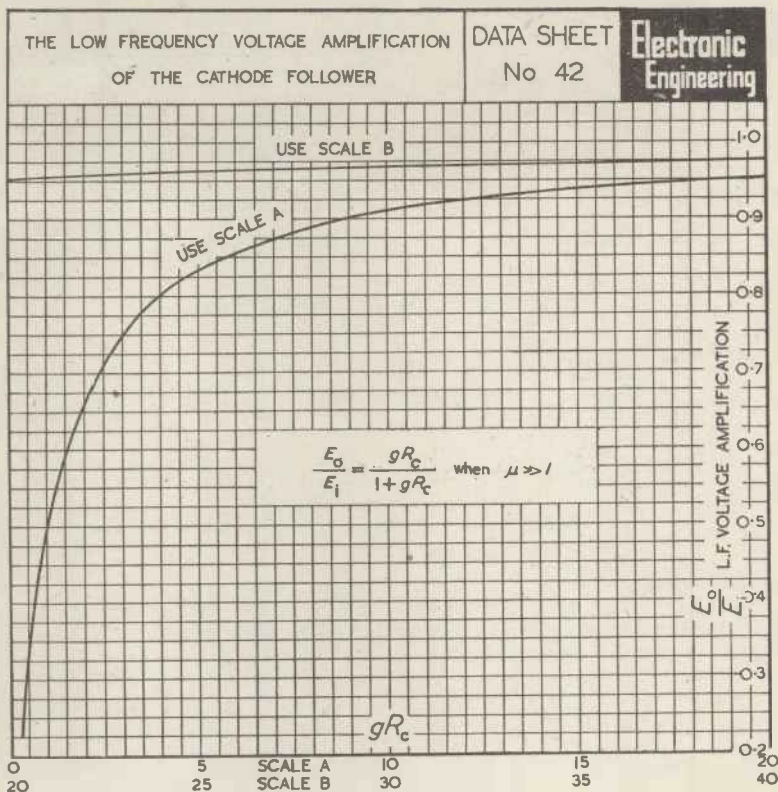

ferent values of frequency when once the value of gR_c and $R_c C_c$ is known.

The curves are based on the approximate formula (30) which is correct, provided that $\mu \gg 1$ and $C_{gc}/C_c \ll 1$, i.e.

$$E_g = \frac{\sqrt{[+gR_c + p_0^2]^2 + (p_0 g R_c)^2}}{(1 + gR_c)^2 + p_0^2} E_i$$

Taking the example worked out in Part I, where g is 5.0 mA/V $gR_c = 10$, $R_c C_c = 0.14 \times 10^{-6}$, $f_0 = 1.14$ Mc/s., we can read off the values for E_g/E_i on Data Sheet 44: (See below).

It will thus be seen that though the attenuation at 7 Mc/s is only just over 1 db, the grid-cathode signal voltage is increased approximately by $5\frac{1}{2}$ times over its value at low frequencies. When large outputs are required this increase might lead to severe overloading unless the operating conditions were suitably chosen. Thus, if the mutual conductance were

increased to 10 mA/V, making $gR_c = 20$, then E_g/E_i at 7 Mc/s. would be reduced to 0.284.

The result of including the effect of a grid-to-cathode capacity of $7.0 \mu\mu\text{F}$. (giving $C_{gc}/C_c = 0.1$) with $g = 5.0$ mA/V., is to change E_g/E_i for 7 Mc/s from 0.495 to 0.483 and justify the use of the approximate formula.

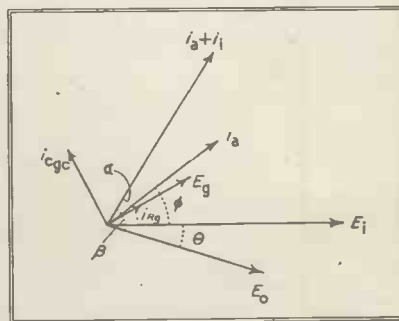

Fig. 3.

Applied Frequency f (Mc/s)	0	1	2	3	4	5	6	7
$p_0 = f/f_0$	0	0.88	1.76	2.64	3.52	4.4	5.28	6.15
E_g/E_i	0.091	0.12	0.18	0.255	0.325	0.395	0.45	0.495

Electronic Engineering

BAND WIDTH OF THE CATHODE FOLLOWER

DATA SHEET
No. 43

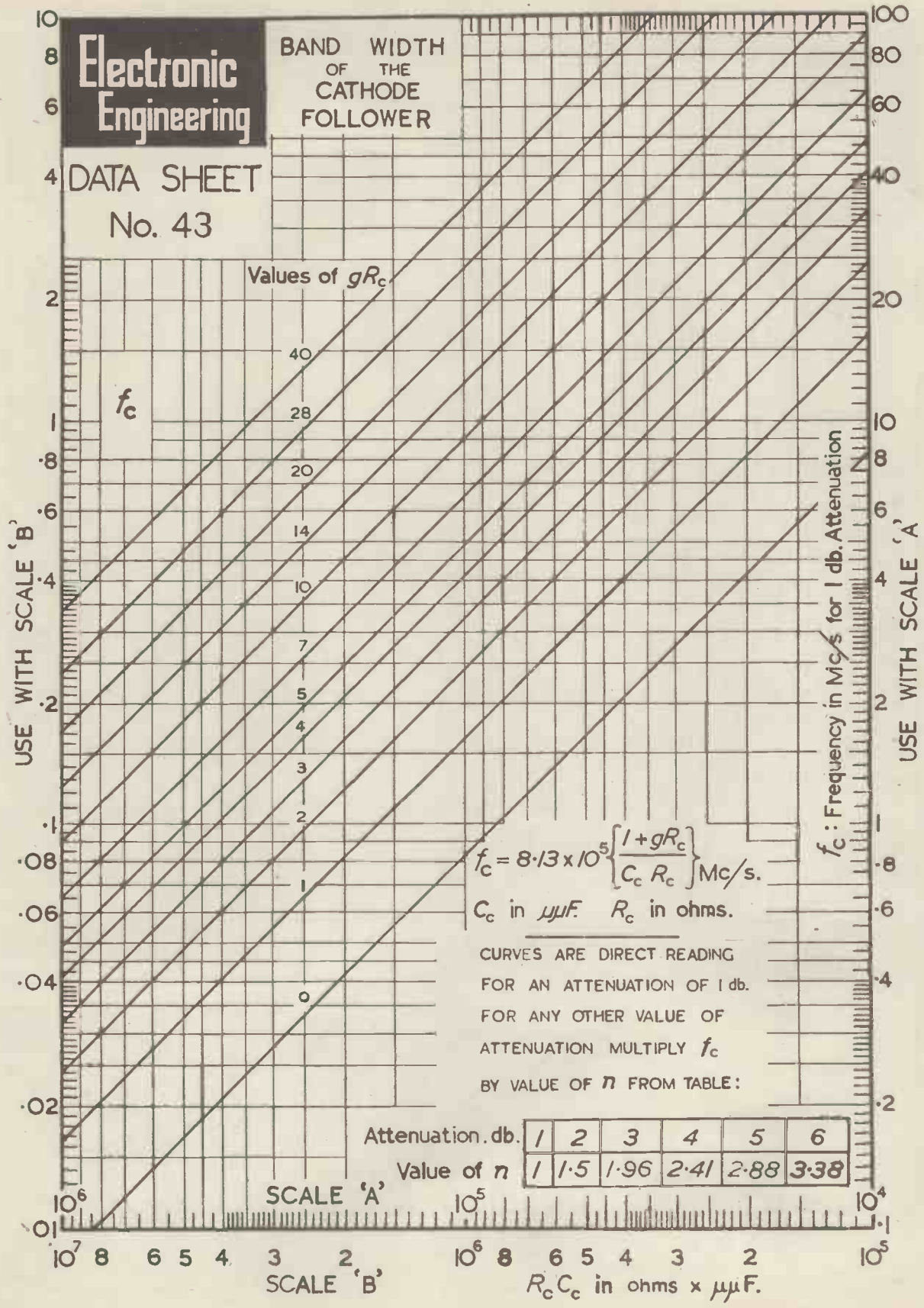

THE GRID CATHODE VOLTAGE OF THE CATHODE FOLLOWER

$$\frac{E_g}{E_i} \approx \frac{\sqrt{[1 + gR_c + \rho_0^2]^2 + (\rho_0 gR_c)^2}}{[1 + gR_c]^2 + \rho_0^2}$$

when $\mu \gg 1$ and $\rho_0 = 2\pi f C_c R_c$
 $R_c \gg R_c$ and $f_0 = 1 / 2\pi C_c R_c$

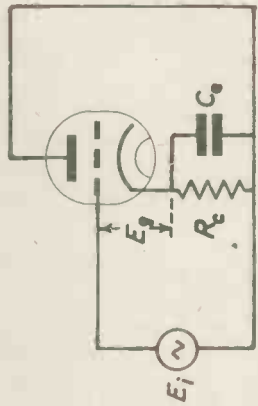
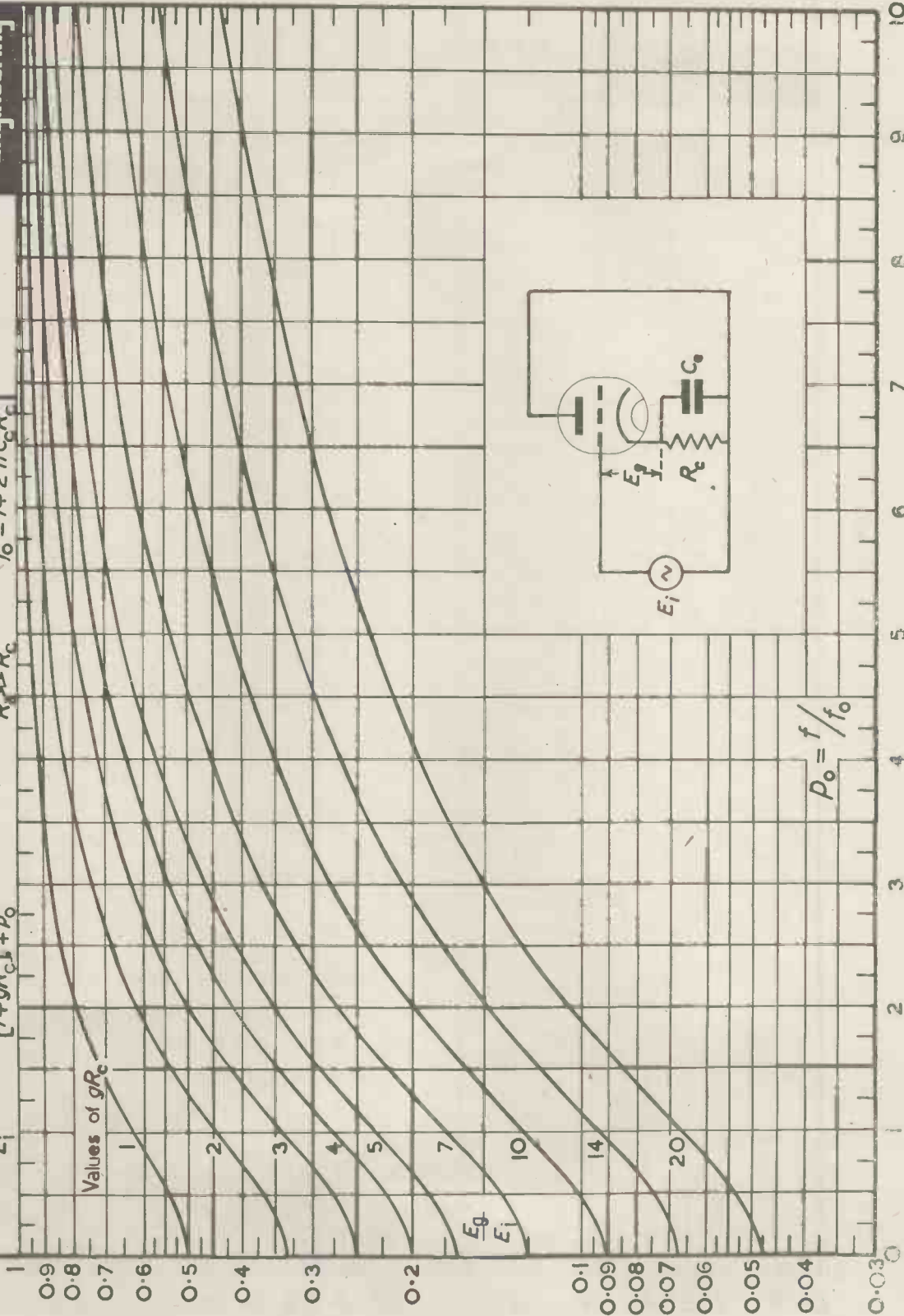

DATA SHEET
 Electronic Engineering
 No 44.

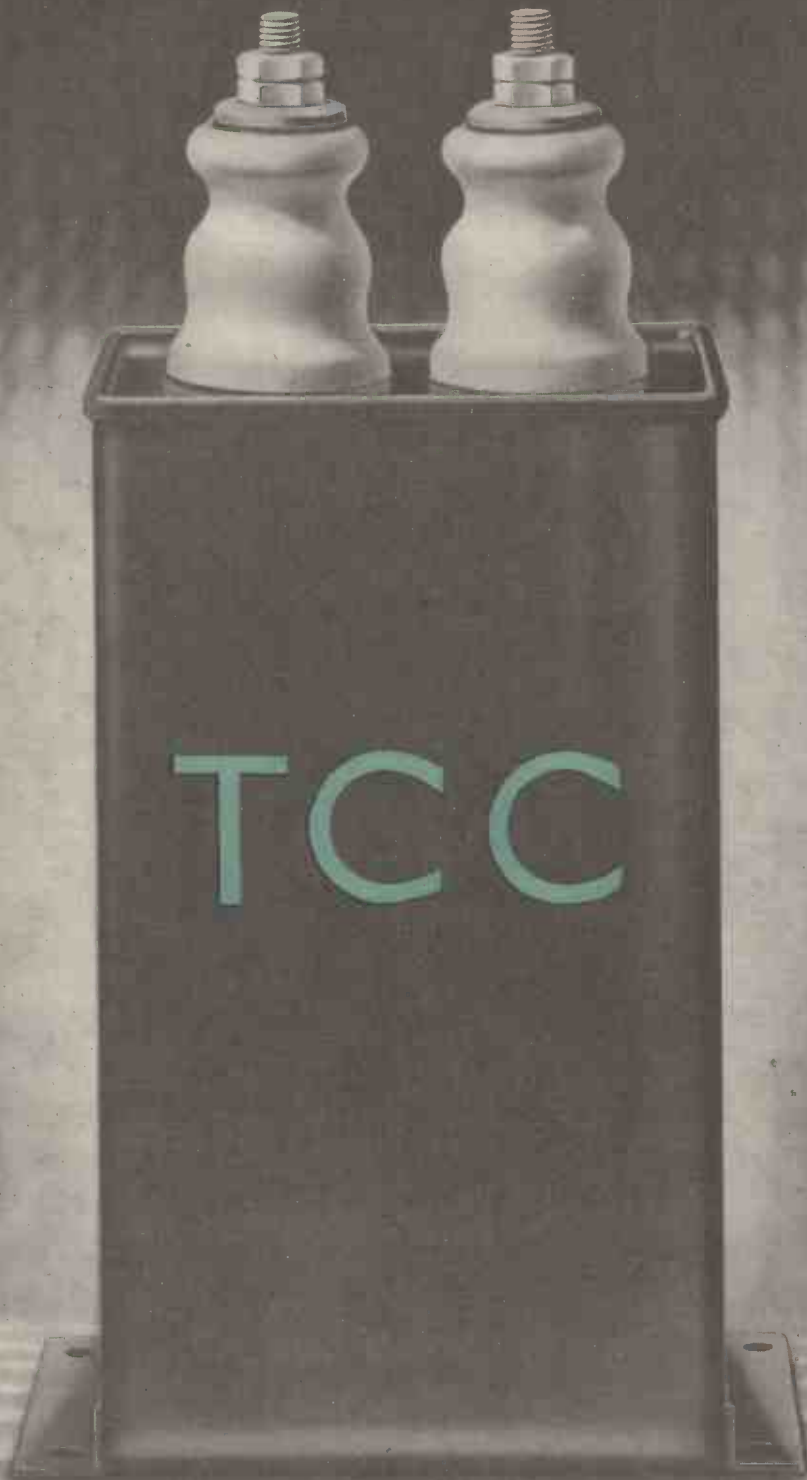

ADVERTISEMENT OF THE TELEGRAPH CONDENSER CO., LTD.

Voltage Regulating Transformers

A Review of some of the devices used in maintaining a constant voltage in Electronic Circuits.

By R. O. LAMBERT*

DURING the past few years several methods of voltage regulation have been used, a few of which have been thermionic, all giving various degrees of stabilisation dependent on the conditions under which they are used.

Probably the best known is the barretter tube, which although fundamentally a current stabiliser does actually regulate the voltage. The most common use of this form of stabiliser is in commercial "Universal" radio receivers and they have proved very satisfactory in this application. A filament, usually of iron wire, is mounted in a gas-filled tube and the temperature/resistance characteristic of the filament causes ballasting action. Its action is best noted with slow changes of input voltage, such as are experienced with the majority of supply systems.

An equally popular method of voltage regulation utilises a gas-discharge tube, best known as a neon stabiliser. It consists of two electrodes in a neon atmosphere between which a self-maintained discharge takes place. This

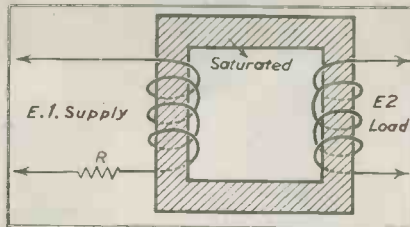

Fig. 1. Representing the simplest form of voltage regulated transformer.

such as signal generators, photo-electric apparatus and various other forms of test equipment. These must be capable of supplying constant results over long periods of time regardless of variations on overloaded supply systems, and also to a lesser degree to make possible their use in other factories without having to worry about changing the tap on the mains transformer.

One method which is being used to a large extent and gaining popularity is the voltage regulated transformer, capable of supplying the results required efficiently and relatively cheaply.

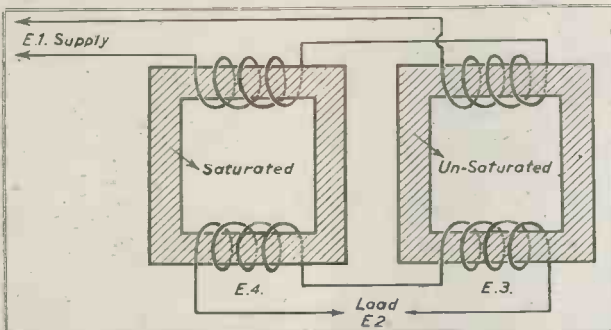

Fig. 2. Employing two reactors to obtain a regulated voltage output, one saturated the other working at normal flux density.

form of regulator is connected in parallel with the load, and any variation of the load current is absorbed by the neon. This regulator is effective with both momentarily fluctuating supplies and those varying slowly over several hours.

An arrangement utilising two thermionic valves, such as a triode and high-frequency pentode is also used in some forms of apparatus, but is naturally considerably more expensive than the other methods mentioned, as the triode has to be capable of passing the total load current required, and if this should be in the order of 100 mA. it requires a fairly large valve.

In recent years the requirements of the radio industry have called for really excellent regulated voltage arrangements for stabilising equipment

Practically all designs of voltage regulated transformers are based on magnetic saturation. Many arrangements have been and are being used, and the author intends reviewing several of these methods, rather than examining one single type.

One of the earliest patents is of German origin in the year 1910, but unfortunately it was not possible to find the principle employed. A further patent, also German, during the year 1920 covers the following arrangement, which although simple, operates very well. It consists of a saturating reactor, or transformer with resistance connected in series with the primary as shown in Fig. 1. Its operation is very simple. As the input voltage is increased the effective current increases considerably more than the effective voltage and this current passes through the series resistor,

thus preventing an increase in secondary voltage. In apparatus where a mains transformer is necessary, this arrangement probably constitutes the cheapest form of voltage regulation possible, whilst at the same time providing effective results. The earliest U.S.A. patent is apparently that of 1925 which is shown in Fig. 2. This consisted of two windings on separate cores, one saturated, and the other working at a normal flux density. As with the previous arrangement the effective current in the saturated reactor increases more than the effective voltage. The load is applied to the secondaries and the difference in voltage between the two windings remains constant over changes of supply voltage, dependent on the ratios of the windings. It is necessary to wind the individual primaries and secondaries very close together. If they are arranged on opposite limbs of the reactor, part of the primary flux fails to link the secondary. Actually if this condition is examined closely it will be found to assist regulation, although making calculation very difficult.

As is known, if two inductances L_1 and L_2 are connected in series, the total applied voltage necessary to send a current I through both inductances will be:—

$$\omega L_1 I + \omega L_2 I$$

As the two separate voltages are simply additive, each leading 90° on the current:—

$E = \omega(L_1 + L_2) I$ where $\omega = 2\pi f$ the same current I flowing through both inductances. The flux linkages for each coil are:

$$L_1 I \times 10^8$$

$$\text{or } L_2 I \times 10^8$$

with L in Henries and I in Amperes. The actual voltage induced in each inductance is:—

$$E = \frac{B \times 4.44 \times FNAK}{10^8}$$

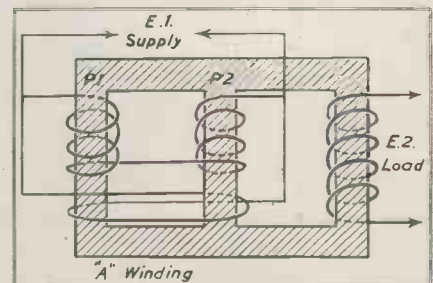

Fig. 3. Showing a method of overcoming leakage reactance. If winding 'A' is deleted flux will tend to flow through P1 and P2 limbs only and fail to link secondary.

where B = flux density
 F = frequency
 N = number of turns
 A = core area
 K = core stacking factor,
 which is $w/v.g.$

where w = weight of core in grams
 v = core volume in cu. cm.
 g = specific gravity

The above only applies when the two inductances are spaced sufficiently to prevent the flux of one linking the other.

A certain degree of regulation can be obtained, providing the supply voltage change to be expected is known. Using the B/H curve relating to the lamination material which it is intended to use, and calculating the expected current change it is possible to find the flux density variation, and the winding ratios required.

Many patents exist in connexion with similar arrangements to these, but it is not proposed to consider each of a similar type individually.

A U.S.A. patent of 1931³ is worthy of mention, and consists of an arrangement for overcoming leakage reactance, shown in Fig. 3. If the transformer is used without winding "A" the flux circulating in the two legs of the core upon which the primary is wound without passing through the third leg on which is the secondary winding. This condition is in effect the same as having a large leakage reactance in the primary circuit and the secondary voltage will vary rapidly with a change in load. The additional winding "A" is arranged so that its m.m.f. is in opposition to the winding P.2 and eliminates the flux in this leg whilst it is unsaturated and also aids the P.1 coil, producing saturation. It will be obvious that many arrangements can be developed from these examples.

One is particularly interesting, being more complicated and using non-standard laminations, the design and method of winding being shown in Fig. 4. A shell type core is used, somewhat more elaborate than the previous types mentioned. The centre limb is divided into three parts, A, B, and D, upon which are three windings, each connected in the primary circuit. The winding on the "A" limb is known as the additive winding, and is connected in series with the winding on the "B" limb (which is known as the subtractive winding), the two windings being connected to the supply voltage.

The so-called primary winding on the "D" limb has one end connected to the supply with one end of the additive winding. The other end of the

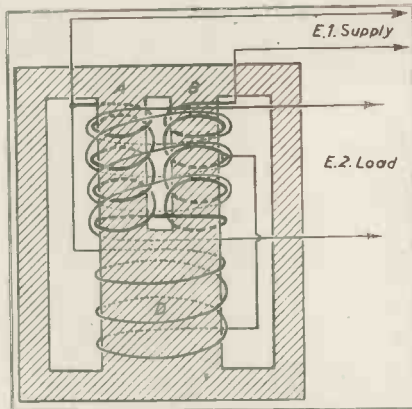

Fig. 4. Voltage regulated transformer as developed by the Ward Leonard Electric Corp. The secondary winding is shown dotted to avoid confusion.

"D" winding is taken to a tap on the subtractive winding. These windings are so arranged that the flux from the additive winding is practically in phase with the primary winding, and the flux from the subtractive winding is 180 degrees out of phase with the primary winding. As limb "A" is saturated an increase of supply voltage cannot cause an increase of voltage across the additive winding, therefore the increase in supply voltage will be shown across the subtractive winding, this increasing the tendency for flux to flow in opposition to the primary flux. The net flux-linking the secondary, that is the fluxes in "A" and "B" limbs, thus tends to remain constant. This form of regulator, however, is for constant load only, which also applies to the majority of the types already mentioned.

The design of a regulator for use with varying loads differs considerably from that shown in Fig. 4. The additive or "A" winding and the secondary winding are omitted, leaving only the "B" and "D" windings which are connected in series across the supply. The load is taken from the "B" winding and a condenser is connected in parallel with the "D" winding, making in effect an auto-transformer with the addition of a condenser which assists the regulation on varying loads.

Condensers are used to some extent in regulation devices, and one method, that of a saturating reactor in series with a condenser is covered by both U.S.A. and German patents.⁴

It is possible to modify the arrangement shown in Fig. 2 by adding an extra winding to the saturated reactor, or transformer, and connecting across this winding a condenser which assists the regulation during variations of load. The use of a condenser in parallel with the output reduces or eliminates the wave form distortion,

the effect and origin of which will be discussed later.

All the methods of regulation so far mentioned have adopted and been developed around the same foundation, namely, magnetic saturation. It is advisable at this stage to examine this more closely and note the disadvantages associated with saturated iron circuits. One of the points is that the temperature rise will naturally be higher than that experienced with normal working transformers. This objection, although serious, can be eased in several ways, mainly through careful design of the instrument in which the transformer is to be incorporated. To prevent burning of the insulation between windings it may be advisable to use glass covered "Empire Tape" and if necessary glass covered wire, which would greatly help to prevent breakdown.

With the methods so far mentioned the use of high flux densities and a closed magnetic circuit causes excessive voltage peaks to be induced in the reactor which are introduced into the circuit. As is known, the ohmic values of inductance vary between wide limits using a closed magnetic circuit, dependent upon the instantaneous values of the flux density in the iron. Whilst the current and therefore the flux, wave is passing through zero, the iron is un-saturated and the inductance of the reactor will be considerably higher than when the densities are in the order of 100 kilo-lines per square inch.

Saturation of the reactor iron causes a distortion of the current wave as it passes through zero, but this distortion does not affect the magnitude of the voltage peaks, the voltage distortion being determined by the variability of the magnetic circuit (that is, by the magnetisation curve of the reactor). A typical voltage distortion curve is shown in Fig. 5. Curve "A" corresponds to a flux density of 75 kilo-lines per sq. in. and curves "B" and "C" are with flux densities of 100 kilo-lines, curve "B" having a load current approximately three times that of the magnetising current, whilst curve "C" represents a load current equal to the normal magnetising current.

As has been shown, the voltage regulated transformer was originally based on magnetic saturation regardless of the fact of temperature rise, and output distortion. Very recently, however, other methods have been used which do not require excessive flux densities and which produce an output which can be readily calculated, taking into account the normal losses encountered with transformer design.

Of these methods, one which has frequently been used for supplying voltage to transmitters is worth mentioning. The transformer is designed in the usual manner with primary and secondary windings, with an additional winding on the primary. This winding is connected in series with the rectified output and the current passing produces a flux in opposition to that of the primary. Therefore, when the supply increases the flux linkage will increase, as will the secondary output. A greater current will then pass through the additional winding increasing its flux, which, will keep the total flux linking the secondary fairly constant, and will therefore, provide a constant output voltage within small limits. In practice it has been possible to maintain an output voltage of 1,500 volts + 2 per cent. with a supply voltage of 200 volts + 13 per cent. Naturally, the result is dependent on the material used for the core, and it is well worth spending time designing and constructing experimental transformers using various types of iron.

Non-Saturated Cores

A further development in constant output transformer engineering is very efficient and does not use the principle of magnetic saturation.

This form of transformer delivers a constant output, independent of transient or continuous variation of supply. This regulation is obtained entirely through special magnetic relations of the core and coil components, giving considerable improve-

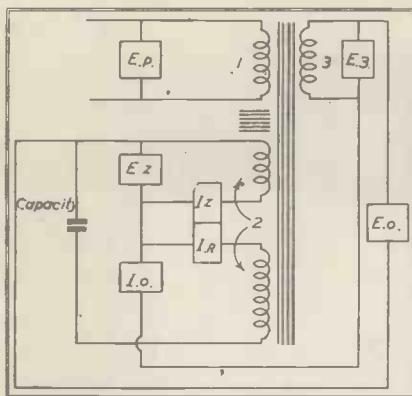

Fig. 6. A constant output voltage obtained through the use of a resonating electrical circuit and magnetic shunt.

ment in wave-form, size, efficiency and power-factor.

The operation of this type of transformer is based on a combination of electrical resonant circuit and a high leakage reactance magnetic circuit. The electrical circuit comprises three windings, as shown in Fig. 6, a primary winding (1), a resonant winding (2), and a compensating winding (3). The magnetic circuit is a closed core with shunts. The primary and compensating windings are layer wound, one over the other, on one part of the centre leg of the core. The resonant winding, across which is connected a condenser, is wound on the other end of the same leg but isolated from the primary and compensating windings by the magnetic shunt.

When an alternating current of low voltage is passed through the primary winding, the magnetic flux created in-

duces a voltage in the resonant winding. Because of the reluctance of the air gaps in the shunt path, this voltage approximates to the turns ratio voltage. With an increase in voltage across the primary more flux threads through the core structure. When this flux density becomes such that the inductive reactance of the resonant winding equals the capacitive reactance of the condenser at the frequency of the voltage, the resonant winding resonates as a series resonant circuit, the voltage across it rising rapidly to a stable, pre-determined value higher than the expected turns ratio voltage.

This has the effect of increasing the magnetic density in that portion of the magnetic circuit on which is the resonant winding, and of greatly reducing the relative reluctance of the shunt system, so that further variations in flux (produced by changes in the primary voltage) are largely absorbed by the shunt system. This results in a very small change of voltage in the resonant circuit, which is taken care of by the compensating winding.

The shunt system also operates to loosen the effective coupling between the resonant circuit and the primary winding, so that once resonance is attained, the primary is required to supply only enough energy to overcome the iron and copper losses to maintain the oscillation. Since the voltage across the resonant winding is stable, it may be used as the basis of a constant output voltage.

The output voltage is obtained by tapping across a portion of the resonant winding. The compensating

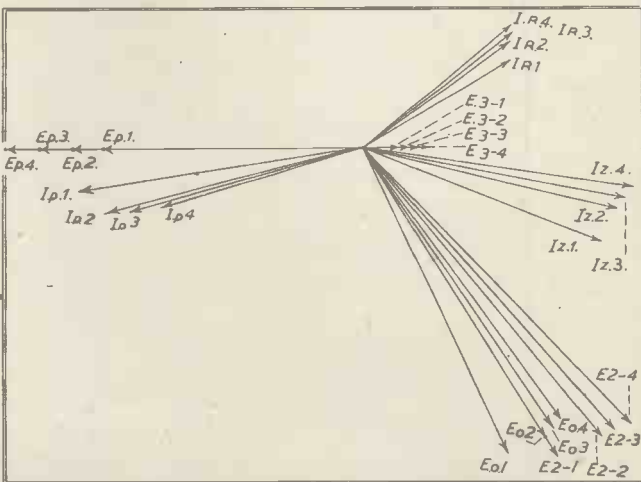
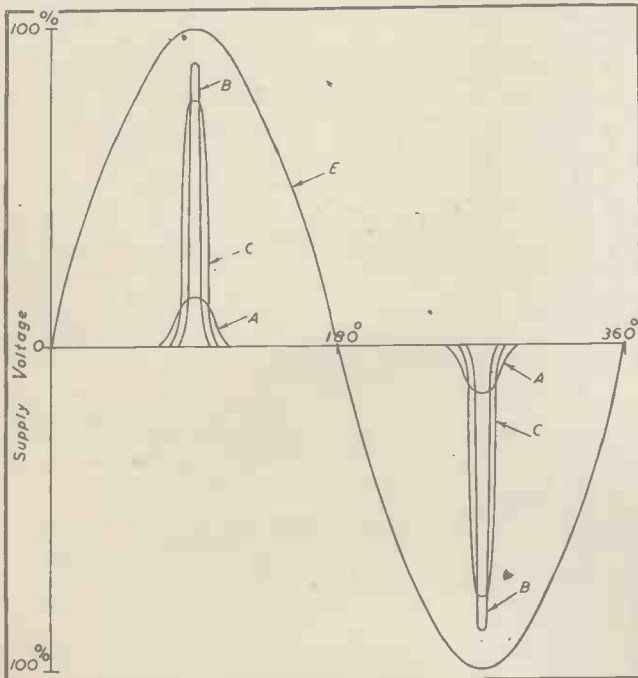

Fig. 5 (left). Showing distortion due to magnetic saturation. Curves A, B and C represent peak voltage values caused through saturation of a closed circuit reactor. Curve A: normal flux density of 70 kilo-lines per sq. in. Curves B and C: 100 kilo-lines per sq. in.

Fig. 7 (above). Fixed load variable supply. Vecto representation of transformer shown in Fig. 6. The four different values of voltage and current correspond to variations of supply.

winding is connected in series with the output and opposed to it.

Naturally, the compensating winding can be so proportioned to supply either a rising or falling voltage regulation, irrespective of variations of load, providing that the variations are below the maximum load for which the transformer is designed. A vector diagram showing the relations for a transformer of this type under full resistive load, and varying input conditions is shown in Fig. 7. The constant output is represented by E_o and shown as an arc about point o , each value of E_o being the resultant of the subtraction of the vector E_s from the corresponding vector E_2 . This also applies to the current vector.

With this type of transformer, the input current required under any given load condition varies inversely with the input voltage. Input watts, power-factor and overall efficiency are affected only by the load and are constant for given load conditions. Operating at full load, a power-factor of between 95 per cent. and 100 per cent. is to be expected, dropping to about 75 per cent. at half load.

Distortion of the output voltage wave-form with transformers of this type is very small, even at extremes of the operating range. With no-load conditions, the output wave-form is

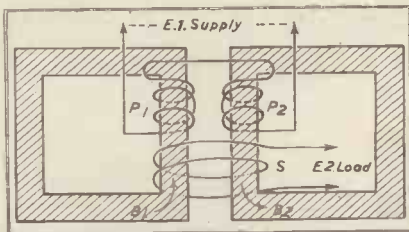

Fig. 8. Transformer using two different types of lamination material which enables B_1 and B_2 to increase equally.

flat topped and as the load is increased the wave-shape improves rapidly, becoming practically perfect at full load, and is not disturbed with the use of a reactive load.

Other possibilities lie in the use of two widely different types of lamination material. The transformer is constructed as shown in Fig. 8 using two separate reactors upon each of which is wound a primary winding, both being connected in series with flux opposing, and a common secondary wound over both windings, the secondary voltage being based on the difference of the two primary fluxes. Obviously the same lamination material cannot be used for both cores as the B/H curve is far from linear. For example, the flux in primary one would be arranged at about 65 kilo-lines per sq. in. and for primary two

a flux of 25 kilo-lines per sq. in., the actual flux linking the secondary being in the order of 40 kilo-lines per sq. in. The core materials employed would have to produce a linear flux change with a given magnetising current increase or decrease. Naturally, this only applies over a very small range as with a variation of + 12 per cent. on 200 volts supply the flux will only vary by approximately 15 kilo-lines per sq. in.

This article constitutes a fairly broad survey of the methods applied during the past few years to a subject which is interesting, and which is becoming more than ever a necessity in its use with present day and future electronic apparatus. Possibly many types have been omitted by the author, but it is clear that quite a large amount of development work remains to be undertaken to produce more simple and more efficient arrangements of transformer technique for the supply of a well-regulated voltage output.

References

- 1 German Patent 338,677; February 6th, 1920.
- 2 U.S. Patent 1,540,307; June 2nd, 1925.
- 3 U.S. Patent 1,812,299; June 30th, 1931. (Ward Leonard Electric Co.)
also: H.K. Kouyoumjian 1931; 1932; 1933.
- 4 U.S. Patent 1,942,535; January 9th 1934.
see also "An Automatic Voltage Regulator" Proc. Radio Club of America, May, 1929

WHEN the radiated frequency in a link transmission system is high it is desirable to employ in the repeater circuits the method of double conversion, since otherwise a sufficient degree of repeater amplification may be hard to attain. Amplification is thus obtained at a conveniently low frequency in a channel lying between a first and a second converter. If the same local source of oscillation is employed in effecting both frequency conversions so that the reradiated frequency is identical with the received frequency, clearly no difficulty of wander of the reradiated frequency can arise on account of wander of the frequency of the locally generated oscillations. It is not, however, always convenient to reradiate energy at a high amplitude level on the same frequency as that of the received energy, since in general with this procedure in order to overcome instability of the whole repeater circuit it is necessary to employ a neutralising scheme probably of a critical nature. Consequently, it is preferable if possible that the incoming and outgoing frequencies should differ by an amount sufficiently large for regeneration difficulties not to enter. Provided the frequency difference is not too large, this is not a step that necessarily demands abandoning the principle of the single

Repeater Circuit for a Relay Station

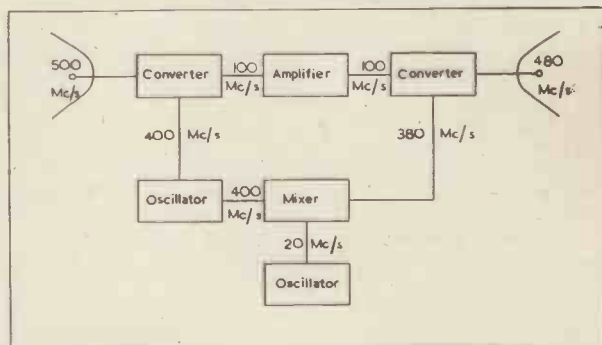

local source for more complicated methods of obtaining frequency stability of the radiated wave such as by generating local oscillations of highly constant frequency. The accompanying diagram shows a repeater circuit where the single source method of double conversion is applied with gain of great simplicity from the points of view both of frequency stability and of regenerative stability.

In this circuit the incoming frequency is 500 Mc/s and is reduced at once to 100 Mc/s for amplification by heterodyning with a local oscillation of frequency 400 Mc/s. After amplification at 100 Mc/s conversion back to a high frequency is achieved by heterodyning with an oscillation produced by mixing with the 400 Mc/s local oscillation, a further local oscil-

lation of comparatively low frequency, namely, 20 Mc/s, so as to produce a new local oscillation of frequency 380 Mc/s. In this way an outgoing carrier wave of 480 Mc/s frequency is generated. Any frequency variation in this carrier will arise from variation in the 20 Mc/s oscillator, but as the frequency of this oscillator is comparatively low and as on this account it may conveniently be stabilised by simple crystal control, a stable outgoing frequency is obtained. The stability with such crystal control is in fact entirely satisfactory. In a refinement of the circuit for reducing the wander of the 100 Mc/s intermediate frequency the 400 Mc/s oscillation may be generated by frequency multiplication of the 20 Mc/s oscillation.

The Soldering of Aluminium

Advantages of the Hard and Soft Methods

By O. EINERL, Dr.Eng., and F. NEURATH, Ph.D.

HARD soldering as applied to aluminium and its alloys is a process that has many advantages and is particularly applicable to the manufacture of thin-walled and small-sized articles, especially those which are mass produced. The working process is similar to that for the hard soldering of brass and copper. To shorten the working time a compressed oxygen blowpipe is also often used for aluminium. This procedure represents the transition between welding and soldering.

Generally, the best hard solders for aluminium alloys are themselves aluminium alloys (containing between 75 and 95 per cent. of aluminium), the m.p. of which must be below the m.p. of the aluminium alloys to be soldered. The usual solder alloys for aluminium are mostly of the following types:—

Silicon-aluminium alloys; *e.g.*, 95 per cent. Al, 5 per cent. Si; sp.gr. 2.65, m.p. 610° C., tensile strength 8.9 tons/sq. in.

Copper-aluminium alloys; *e.g.*, 8-12 per cent. Cu, balance aluminium; sp.gr. 2.90 melting range 540-620° C. tensile strength 7-11 tons/sq. in.

Copper-tin-aluminium alloys; *e.g.*, 95.5 per cent. Al; 4.5 per cent. Cu, 5 per cent. Sn; sp.gr. 2.95, m.p. 635° C. tensile strength 11 tons/sq. in.

Zinc-aluminium-silver alloys.

Zinc-aluminium-copper alloys, *e.g.*, 80 per cent. Zn, 12 per cent. Al, 8 per cent. Cu; m.p. 402° C., tensile strength 13 tons/sq. in.

The result of the hard soldering of aluminium depends on how far it is possible to remove the invisible oxide film from the surface of the aluminium alloy. As in welding, it is first of all necessary to clean the surface of the metal thoroughly. The removal of the oxide film is brought about by means of fluxes composed of chlorides, fluorides and bisulphates of the alkaline and alkaline earth metals.*

By adding lithium chloride or lithium fluoride the m.p. of these salt mixtures can nearly always be so far lowered that the m.p. of the flux is considerably below that of the solder, which itself must have a lower m.p. than the aluminium alloy to be soldered.

The reason for this is easily understood. It is a primary principle in the hard soldering of aluminium that first the flux, and afterwards the

aluminium solder, have become liquid, but never the aluminium alloy which is to be soldered.

It is, however, advisable to preheat the aluminium parts which are to be soldered. For thin sheets and similar articles it is best to apply the flux as a paste mixed with butyl alcohol or petroleum jelly with an addition of ammonium chloride, or better, trimethylenamine hydrochloride, and to fix it with a wire brush.

Technique

Perfect hard soldering requires the practice, skill and experience of a craftsman. When a temperature approaching that necessary for soldering is reached, the flux meets first, and dissolves the film on the surface of the metal almost instantaneously. Soon afterwards the aluminium solder melts, and its contact with the clean oxide-free surface of the object is no further impeded. The contact between the liquid solder and the solid parts of the aluminium alloy which are to be soldered initiates a diffusion of the alloy components of the solder into the aluminium which is to be soldered, and under the influence of continued heat treatment the joint becomes more and more uniform.

If the hard solder does not immediately and easily combine with the aluminium alloy, it is advisable to help with a knife blade, or a clean wire brush until the parts to be joined are equally moistened, whereupon a uniform quick diffusion can begin, thus effecting a good binding on all points of contact.

The silicon-containing aluminium solders are easiest to handle, and where the composition of the aluminium alloy makes their use possible, they are always the best. On completion of the soldering operation it is essential to remove all traces of flux. This can be done by brushing vigorously with hot water or by using a steam jet.

Soldering to other metals

It is also possible to join aluminium with other metals, such as copper, brass, and iron, by means of hard soldering.

For this purpose silver solder is used, although its m.p. is almost as high as that of aluminium, if not higher. A suitable silver solder has the following compositions: 50 per cent. Ag, 16 per cent. Cu, 16 per cent. Zn, 18 per cent. Cd, m.p. of 620° C. and flow point of 637° C.

The soldering begins on the copper wire, on which the silver solder runs well. The aluminium wire is then brought near, and as soon as the silver solder touches the aluminium a highly liquid alloy results, which joins easily with the aluminium.

The soldering of aluminium to iron is possible for both wire and sheets. The iron is first coated with a very thin layer of a good antimony-free tin-lead solder, after which the solder residues must be carefully removed. It is now possible, with pure aluminium wire and alkali-halide-containing fluxes, to obtain a good binding between the solder and the aluminium: an aluminium-tin-lead alloy is thus formed at the solder seam, the tensile strength of which improves as the aluminium content increases. It is therefore, advisable to remove as much tinning solder as possible from the iron before soldering the aluminium to it.

Soft Soldering of Aluminium

The soft soldering of aluminium is used for connexion work in electrical engineering, *e.g.*, for condensers and cables and for repairing faulty aluminium castings. The soldered joints are not moisture-resistant and, therefore, a moisture protection must be provided for joints such as those on cables not afterwards covered with an insulating mass. This is best done with a paint or varnish.

The American Bureau of Standards has recommended to use of the following lead-free soft solders for aluminium alloys: S.N.1: 78 per cent., Sn, 8 per cent. Zn, 9 per cent. Al, with an addition of 5 per cent. Cd; S.N.2: 69 per cent. Sn, 26 per cent. Zn, 2.5 per cent. Al, with an addition of 2.5 per cent. P.; S.N.3: 86 per cent. Sn, 9 per cent. Zn, 5 per cent. Al, with an addition of 0.25 per cent. P. Solders for soft soldering of aluminium with approximately the following compositions are on the market: 50-75 per cent. Sn, 25-50 per cent. Zn, 2-3 per cent. Cu, 0.4-1 per cent. Pb, and up to 0.5 per cent. Al. Fluxes for these soft solders consist largely of zinc chloride, ammonium chloride, and resin, or of a solution of 20 per cent. resin in 75 per cent. methylated spirit with an addition of 5 per cent. lactic acid (2-hydroxy-propionic acid, m.p. 18° C., b.p. 122° C.).

—*The Chemical Age*. Vol. 157. No. 1,219. November 7, 1942.

* Einerl and Neurath, *The Chemical Age*, April 4 and May 2, 1942, pp. 181, 235



MEASURING INSTRUMENTS, TUBES & VALVES

MULLARD

CATHODE RAY TUBE FOR OSCILLOGRAPHIC USE
3-Inch Screen

Heater	Vf = 4.0 V
	If = 1.0 A

Capacities
Modulator (G) to all other electrodes = 20 μ F

Either X plate to either Y plate = 3 μ F

Fluorescent Colour - Green

Deflection - Electrostatic for asymmetrical operation.

Operating Conditions

Va2	1,000 V
Va1	120-150 V
Vg1	0-15 V
Deflection sensitivity	200 mm/V
X and Y plates	EAE

The grid voltage should be adjusted to give the required light intensity. The voltage should never become positive or damage to the tube will result.

ECR30

CR60

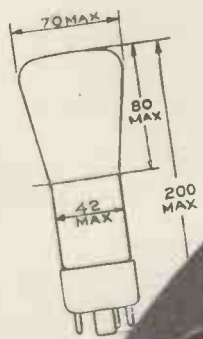
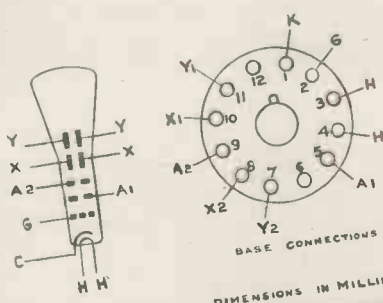

DIMENSIONS IN MILLIMETRES



MULLARD

A Valve for every Purpose

Training Students in Receiver Servicing

By G. N. PATCHETT, B.Sc.

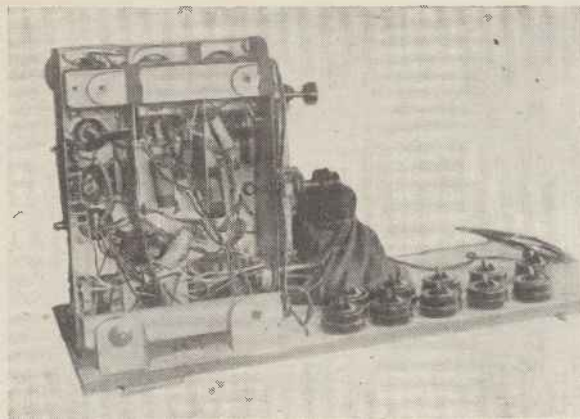

Fig. 2. Photograph of a 5-valve receiver fitted with fault switches. The circuit diagram is given on the next page.

THE following is a description of a system of training personnel in the servicing of sets by the deliberate introduction of faults, a method which has been found to be both convenient and very satisfactory.

A detailed description is given of the method applied to a commercial 5-valve superhet receiver, the circuit of which is given in Fig. 1. The photograph of Fig. 2 shows the arrangement of the set and faults.

The chassis is fixed vertically to a wooden baseboard in such a position that the components are easily accessible.

The faults are introduced into the circuit by switches mounted on the baseboard on the right hand side. Ordinary 5-ampere single pole tumbler switches have been found quite satisfactory.

Ten faults have been placed on the circuit and are indicated in the diagram as (F1), (F2), etc. The switches are connected to the required components by means of twin flex which passes underneath the wooden baseboard. Some of the switches are required to be normally open and others normally closed. These are shown in the diagram as

Normally closed	x
Normally open	o

The method of connecting each fault is as follows:

Fault 1. (F1). This is a normally open switch placed across the screen grid condenser C_1 . Actually, the switch is connected between the screen grid on the valve and earth.

Fault 2. (F2). This fault is to open circuit the screen grid resistance (feeding V_2). The original screen grid resistance R_0 is replaced by an open circuited resistance or a very high value resistance with the marking altered. The metallised type of re-

sistance can easily be open circuited by pulling off the lead cap and breaking the resistance inside and replacing the lead cap. In parallel with the open circuited resistance R_0 is placed a resistance R_0' of the correct value. This resistance is placed under the baseboard and connected to a normally closed switch (a tumbler switch fixed upside down).

Fault 3. (F3). This is an open circuit in the primary of the first I.F. transformer. The coil connexion is broken inside the can (the connexion of the coil to the soldering tag) and the normally closed switch connected by a length of flex.

Fault 4. (F4). This fault is an open circuit in the secondary of the first I.F. transformer. This is arranged exactly as Fault 3.

Fault 5. (F5). The fault introduced here is the short circuiting of L_{12} (such as a short on trimmer K). The normally open switch is here connected to the coil inside the coil can.

Fault 6. (F6). This is the short circuit of the primary of the first I.F. transformer. This is connected similar to Fault 5.

Fault 7. (F7). This is a short on diode condenser C_{10} . A normally open switch is connected across C_{10} .

Fault 8. (F8). This is an open circuit in the loud speaker field and is arranged by connecting a normally closed switch in series with the field. The actual connexion to the field is made on the loud speaker between the field and the terminal block.

Fault 9. (F9). This fault is arranged to open circuit the coupling condenser C_{15} . The original condenser C_{15} is made open circuit by taking out the wax at the end of the condenser and removing the internal lead and then replacing the wax. The correct value condenser C_{15} is connected in parallel by a normally closed switch, the condenser being mounted under the baseboard.

Fault 10. (F10). This is an open circuit in the smoothing condenser C_{21} . C_{21} is an aluminium can type of

electrolytic condenser. The open circuit is made by insulating the can from the chassis by a small insulating washer. A normally closed switch is arranged to short the condenser can to the chassis.

The flex leads are bunched together and brought underneath the chassis so that the switch connexions cannot be easily traced out.

It has been found that this method of placing faults in a set has many practical advantages from the students point of view as well as the instructor's:

The faults may be switched on in turn by the student without having to call on the instructor.

The change of reading on a meter produced by the presence of a fault can easily be seen by switching the various faults on and off.

The student cannot usually locate the fault as is often the case when faulty components or broken leads are introduced directly into the set, but has to make the prescribed tests, take meter readings and draw his conclusion as to the fault, from this information.

In addition the tests of the various components are made under working conditions, *i.e.*, as part and parcel of a working set which is quite a different proposition to testing them separately or when mounted on boards and is of infinitely more benefit to a student.

Furthermore, no damage is done to the set by this method of introducing faults in comparison to what is often the case when components are continually being soldered and unsoldered.

Where possible leads should be brought out from points which are not alive at R.F. or A.F. potentials so as to prevent interaction between the various circuits. Not much trouble has been experienced from this cause although the efficiency of the set is somewhat impaired. This does not normally matter so long as the performance is reasonable.

In conclusion, this system has proved very successful in practice and has been used many months by students. The sets are in use approximately 8 hours per day without requiring anything in the way of maintenance.

Circuit Diagram of Receiver.

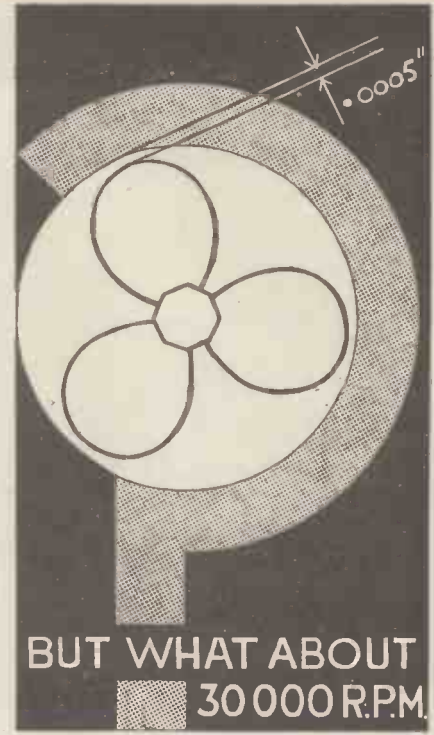
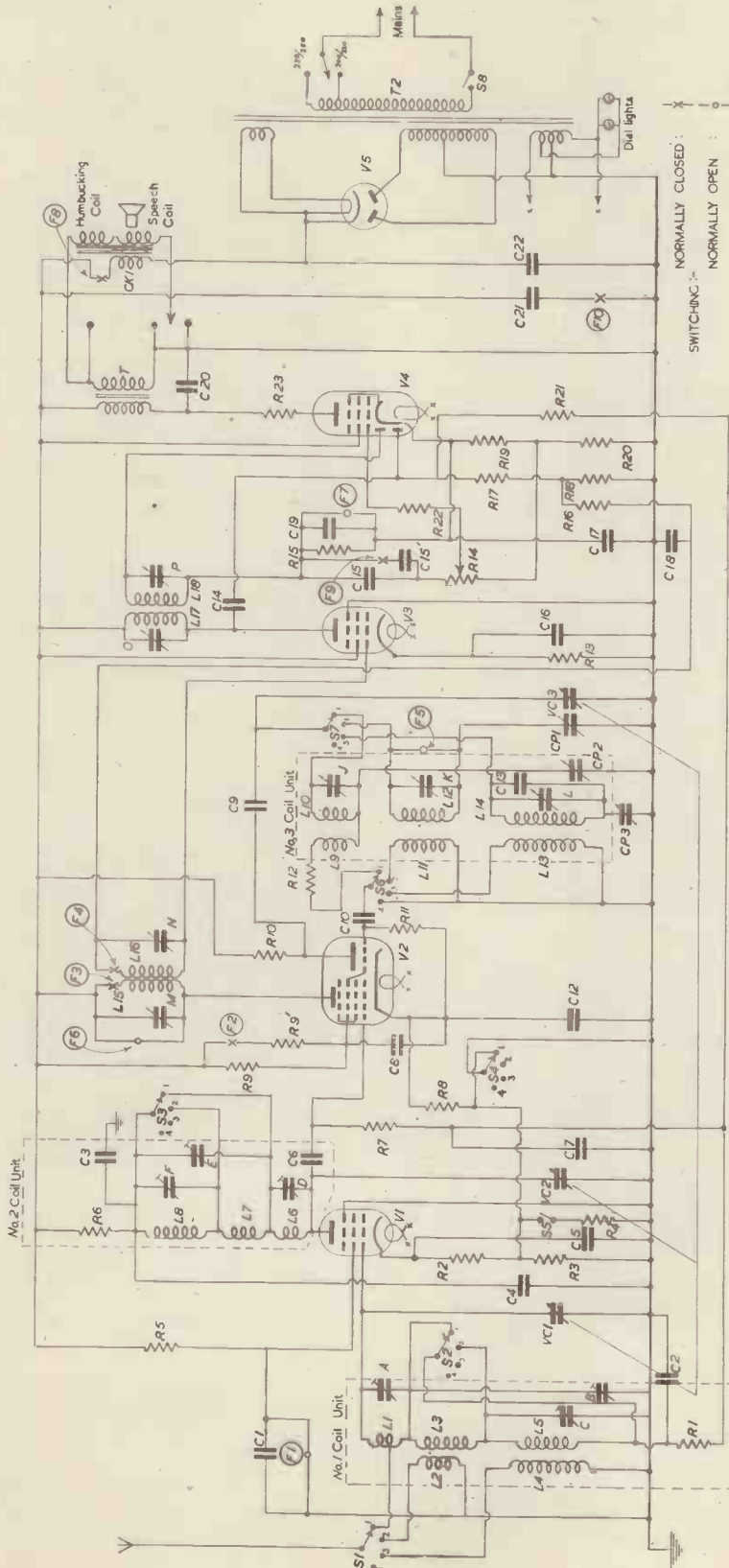

**BUT WHAT ABOUT
30 000 R.P.M.**

The measurement of small clearances between stationary parts is not a matter of great difficulty using ordinary mechanical methods, but at high speeds these methods tend to break down and electronic devices often provide the only solution. For instance the problem, rather diagrammatically portrayed, of blades rotating in a close fitting case, is easily solved electronically, by letting a flush fitting plug into the casing and measuring the electrical capacity between the plug and the blades as they pass. The final clearance indicator is calibrated conventionally in thousandths of an Inch or similar units.

It is just a matter of knowing how. Furzehill Laboratories, Ltd., have made it their business to know how and maintain a service of ever increasing value to the heavier industries. May we have your problem for consideration?

N.B.—Like most people we are rather busy just now and unless the matter is of great urgency we may have to keep you waiting.

FURZEHILL
LABORATORIES LTD.
BOREHAM WOOD
HERTS
TELEPHONE · ELSTREE 1138

NOTES FROM THE INDUSTRY

Keep It Going!

Murphy Radio's Useful Booklet

ANY thousands of radio sets could be put right to-morrow by their owners if they were told a few simple facts about the sets.

This is the theme of the booklet issued by Murphy Radio, Ltd., which is described as a handbook of helpful information for all listeners, compiled from the experience gained by radio dealers.

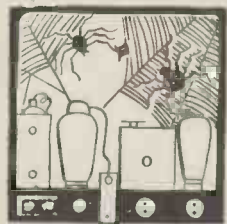

... blow out the dust, dead flies and spiders.

After a brief popular description of how a radio receiver works, the booklet describes the principal features of both battery and mains receivers, with a useful summary of what to do to keep them in efficient running order. Some of the points are illustrated with little sketches, of which a sample is given, others by proper diagrams and photographs.

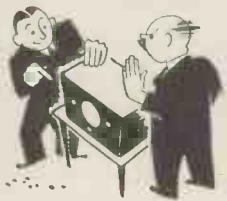

... if a friend approaches your set with a screw-
driver—shoot him

Practical hints on such jobs as replacing fuses, repairing flex, wiring lamp-holder adaptors, are given in a pleasantly colloquial manner, and the set-owner cannot fail to profit from the advice given.

A door-knob is a tough guy compared with the controls of a wireless set

Service engineers should be grateful to Murphy Radio for this book, which will save them valuable time and trouble in checking trivial faults. There is no attempt to "do them out of a job" and it should be accepted in the spirit in which it is written.

Copies can be obtained from Murphy Radio, Ltd., Welwyn Garden City, Herts, price 6d. each.



Don't prod it.

Metropolitan-Vickers Electrical Co. Research Activities, 1942

In the insulation field further attention has been given to the uses of woven glass fabrics and their impregnation. Insulating papers have been vigorously investigated and a "greenness tester" has proved most useful in determining the best temperature and winding speed for each batch of resin-treated paper. The drum is electrically heated to a specified temperature and a sample strip of paper wound on the drum: a weight in clamp form is attached to the loose end and the drum begins to unwind slowly by a motor drive: the paper is "ripe" when adhesion is great enough to drag the weighted paper into the drum slot; the revolutions of the drum indicate the correct time for the process.

Several new applications for "Metrosil" have been established, this material having the unusual characteristic that its resistance falls sharply and instantaneously with increase in voltage and that it has a negative resistance/temperature characteristic.

See also "A General Purpose Coil Turns Measuring Equipment." (J. W. Snelson and F. Brailsford). *Electronic Engineering*, Nov. 1942, p. 250.

Polykol Insulation

A new insulation material has recently been introduced by Ward and Goldstone, Ltd., under the trade name "Polykol." Although this material is not for general sale at present, it is thought that some information on it will be of interest.

Polykol is an improved insulation for applying to electrical conductors, rather than a substitute, inasmuch as it is claimed to have outstanding advantages for many purposes over rubber.

It will not flame, and can be used at temperatures up to 175 degrees F., thus having particular merits for flexibles, withstanding without deterioration the heat of half-watt lamps or the temperature at the terminal points on radiators.

From *The Wireless and Electrical Trader*, Dec. 1942, p. 553.

Service Racks

Messrs. A. C. Cossor, Ltd., have planned their range of instruments, whether for the laboratory or radio service for rack mounting and have made suitable racks available for the purpose. These racks have been designed in such a manner that two or more instruments can be mounted together to make an expanding instru-

ment panel. Detachable interchangeable feet, brackets and panels are used in conjunction with standard spacing of the fixing-screw drillings on the frame. An important point is that the instruments can be permanently connected up, a fact which ensures greater use being made of the gear with quicker results.

A limited number of racks are available from Messrs. A. C. Cossor, Highbury Grove, N.5.

Sir R. Watson-Watt on "Women In Radiolocation"

Addressing a New Year party given in London by the Women's Engineering Society to representatives of the three Services, Sir Robert Watson-Watt said that there would be radiolocation after the war and also radiolocation officers.

It was an operation for which the special qualities of women were absolutely right, and he said that an "Amazon Corps" was recruited as early as 1937.

Electrical Industries and the Red Cross

Many of our great national industries have already responded to the appeal of H.R.H. the Duke of Gloucester for the Red Cross and St. John Fund by organising appeals within their industries with gratifying results.

It was felt that the Electrical Industries should take part in this scheme and an appeal is now being launched with the widest support of the associations representing all branches of electrical activities, including electrical manufacturers, radio manufacturers, electricity supply undertakings, and wholesalers, contractors and retailers.

At the joint invitation of the associations Lord Hirst of Witton has consented to act as Chairman of the Appeal, and a personal letter from Lord Hirst is now being sent out to all units of the industries.

The initial working committee was formed under the chairmanship of Mr. V. Watlington, M.I.E.E. (Director of B.E.A.M.A.) with Mr. V. W. Dale (Business Manager of E.D.A.) and Mr. H. S. Pocock, M.I.E.E. (who initiated the appeal) acting as joint secretaries.

Donations should be sent to the Electrical Industries Red Cross Fund, St. James's Palace, S.W.1. The best method of contributing is by signing a covenant to subscribe annually for the duration of the war, which enables the Red Cross organisation to recover income tax on the contribution. Forms for the purpose can be obtained from the organisers.

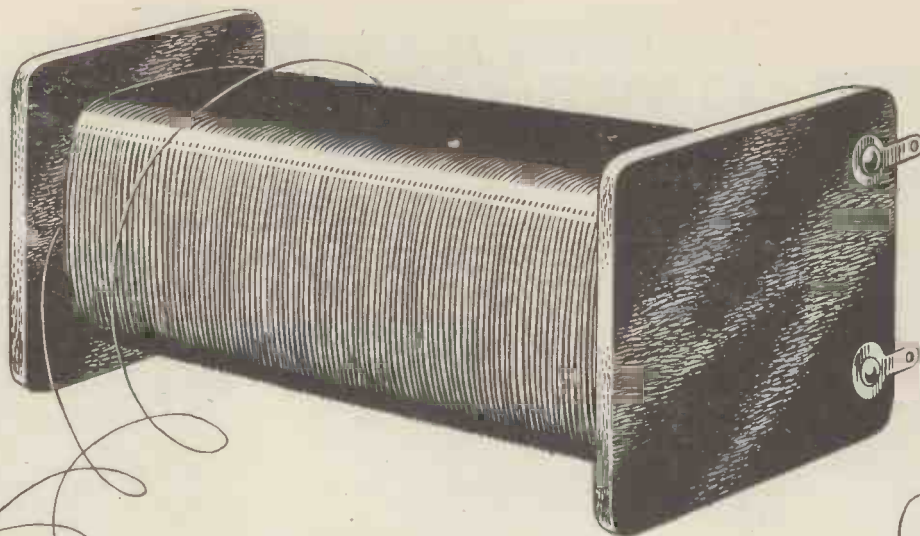

BAKELITE VARNISH

V11105

— the latest phenolic stoving varnish for insulated wires can be safely used with enamelled wire, cellulose acetate, silk, cotton, 'Nylon', 'Viscose' and 'Formvar'. Write for samples and detailed information to Bakelite Limited, 18 Grosvenor Gardens, London, S.W.1. Telephone: SLOane 9911

TREFOIL
BAKELITE  **PLASTICS**
REGD. TRADE MARKS

Pioneers in the Plastics World

ABSTRACTS OF ELECTRONIC LITERATURE

MEASUREMENT

A Frequency-Modulation Station Monitor

(H. R. Summerhayes, Jr.)

This paper describes the development, theory and characteristics of a frequency modulation station monitor developed in the general engineering laboratories of the G.E.C. The monitor measures mean carrier frequency with and without modulation and the percentage of frequency modulation as a percentage of 75 kc. deviation. In addition, it provides a flasher and alarm circuit for overmodulation adjustable from 50 to 120 per cent. and an audio frequency fidelity monitoring circuit. The paper begins with a discussion of the requirements for frequency modulation monitors and compares the problems involved with those involved in standard broadcast monitors. Several schemes which were examined for use as a frequency modulation monitor are briefly described, including counter and frequency division systems. The principles and design of the final monitor are discussed.

The last part of the paper is devoted to a discussion of the salient development problems encountered, to a detailed description of the circuit, and to a discussion of the over-all specifications of the commercial sample.

—*Proc. I.R.E.*, Vol. 30, No. 9 (1942), page 399.

The Measurement of the Temperature Coefficient of Capacitance of small condensers

(T. I. Jones)

A simple apparatus is described for use in conjunction with a dielectric test set for the measurement of the variation of capacitance of small condensers with temperature. Measurements at room temperature, -30°C . and near room temperature again can be carried out in the course of half an hour with an accuracy of $0.005 \mu\text{F}$.

—*Jour. Sci. Inst.*, Vol. 19, No. 11 (1942), page 166.

THEORY

Rate of Crystal Growth in Drawn Tungsten Wires as a Function of Temperature

(C. S. Robinson, Jr.)

Large single crystals can be grown in "218" and similar tungsten wires by vacuum heating at a constant temperature in the range of 1,900 K to 2,200 K. The growth can be followed by observation of the thermionic emis-

sion pattern using a cylindrical electron-projection tube with a fluorescent screen. The rate of growth is found to increase with temperature according to an exponential law. Crystal growth is slower in wires drawn to a smaller diameter, this can be explained by the small grain hypothesis. The perfection of crystals is discussed.

—*Jour. App. Phys.*, Vol. 13, No. 10 (1942), page 647.

Formulae for the Skin Effect

(H. A. Wheeler)

At radio frequencies, the penetration of currents and magnetic fields into the surface of conductors is governed by the skin effect. Many formulae are simplified if expressed in terms of the "depth of penetration," which has merely the dimension of length, but involves the frequency and the conductivity and permeability of the conductive material. Another useful parameter is the "surface resistivity" determined by the skin effect, which has simply the dimension of resistance. These parameters are given for representative metals by a convenient chart covering a wide range of frequency. The "incremental-inductance rule" is given for determining not only the effective resistance of a circuit, but also the added resistance caused by conductors in the neighbourhood of the circuit. Simple formulae are given for the resistance of wires, transmission lines, and coils: for the shielding effect of sheet metal: for the resistance caused by a plane or cylindrical shield near a coil: and for the properties of a transformer with a laminated iron core.

—*Proc. I.R.E.*, Vol. 30, No. 9 (1942), page 412.

INDUSTRY

Stability of Impregnated-Paper Insulation

(J. B. Whitehead)

Results obtained in the A.I.E.E. Engineering foundation research project on the stability of impregnated-paper insulation since its inception in 1936, are reported briefly. Some unexpected properties of impregnated-paper insulation have been discovered and findings pertaining to paper density, high stress internal ionisation as the origin of failure, and impregnation temperature versus dielectric strength and life indicate that further research in these fields is desirable.

—*El. Eng.*, Vol. 61, No. 11 (1942), page 554.

Solutions for Electrochemical Recording

(C. P. Fagan)

The preparation of some dozen solutions for electrochemical recording with varying characteristics is described.

—*Jour. Sci. Inst.*, Vol. 19, No. 12 (1942), page 184.

A New Telephone Set for the Hard of Hearing

(A. Heickmans)

Recently a new amplifying set has been developed which permits all the added equipment except a small $4\frac{1}{2}$ volt battery to be incorporated in the base of the telephone. The gain of the amplifier is adjusted by turning one of the switchhook plungers, and the amplifier can be disconnected by a second switch controlled by this same plunger.

—*Bell Lab. Record*, Vol. 21, No. 2 (1942), page 45.

Some Insulating Materials

(P. R. Dunn)

Insulating materials used by the electrical engineer are reviewed and their latest developments and applications described. Those considered include air and freon, ceramics, glass, textiles, paper, synthetic resins and rubbers. A general indication of the chemical constitutions of the synthetics is given.

—*Min. El. and Mech. Engr.*, November, 1942, page 55.*

Application of Vacuum Tube Oscillators to Inductive and Dielectric Heating in Industry

(J. P. Jordan)

A short review of the theory of inductive and dielectric heating together with a description of the vacuum tube circuits used and some of their applications.

—*Trans. Am. I.E.E.*, Vol. 61, No. 11 (1942), page 831.

Notes on Construction of Steatite

(H. Thurnauer and A. R. Rodriguez)

A review of the literature is given. A number of steatite bodies, which were given a varying number of firings were investigated by autoclaving and determining the water absorption in conjunction with microscopic and X-ray methods.

—*Jour. Am. Ceramic Soc.*, Vol. 25, No. 15 (1942), page 443.

* Supplied by the courtesy of Metropolitan-Vickers Electrical Co. Ltd., Trafford Park, Manchester.

MYCALEX

(REG. TRADE MARK)

*The All-Round Insulator
with many Virtues
and no Vices*



MYCALEX WITH COPPER INSERT

Here the copper is an integral part of the whole, through close adherence to the MYCALEX surround. Components of this type are in production for purposes where special conditions exist.

THE distinctive and special qualities of MYCALEX as an insulating material offer many opportunities for improved design and more efficient production of electrical equipment.

MYCALEX is consistent in temperatures up to 400° Centigrade.

It is tough and unaffected by water, gas or oil.

It is readily machined to fine limits.

It can be combined with metal parts as in the example illustrated above.

No designer should be without up-to-date data regarding the properties and performance of MYCALEX; it may solve his problem. Your enquiry is invited.

**MYCALEX LTD.
CIRENCESTER, GLOS.**



THE world-wide use of "AVO" Instruments is striking testimony to their outstanding versatility, precision and reliability. In every sphere of electrical test work they are appreciated for their dependable accuracy, which is often used as a standard by which other instruments are judged. There is an "AVO" Instrument for every essential electrical test.

The Model 7 Universal AvoMeter (illustrated) is a self-contained combination A.C./D.C. meter providing for 46 ranges of direct readings of A.C. and D.C. voltage; A.C. and D.C. amperes; resistance; capacity; audio-frequency power output and decibels. Any range instantly selected by means of two rotary switches. No external shunts or multipliers. 5-in. hand-calibrated scale with anti-parallax mirror. Dead beat in action. Current consumption negligible. Conforms with B.S. 1st Grade accuracy requirements. Automatic cut-out disconnects meter from supply in event of severe overload. Automatic compensation for temperature variations. Robustly built to ensure lasting accuracy.



Regd. Trade Mark

**ELECTRICAL
MEASURING
INSTRUMENTS**

Some delay in delivery of Trade orders is inevitable, but we shall continue to do our best to fulfil your requirements as promptly as possible.

Sole Proprietors and Manufacturers :

THE AUTOMATIC COIL WINDER & ELECTRICAL EQUIPMENT Co. Ltd.
Winder House, Douglas Street, London, S.W.1 Phone : VICTORIA 3404-7

PATENTS RECORD

The information and illustrations on this page are given with the permission of the Controller of H.M. Stationery Office. Complete copies of the Specifications can be obtained from the Patent Office, 25, Southampton Buildings, London, W.C.2, price 1s. each.

CIRCUITS

Broad Band Amplifiers

In the amplification of television signals, owing to the wide band of frequencies, to be transmitted, difficult problems arise in transformer design and trouble from delay distortion, particularly when feedback is used. These disappear or are greatly reduced by the use of a suitably designed amplifier passing a band down to zero frequency and provided with feedback connexions.

This invention describes a multi-stage valve amplifier with a connexion from the output to the input forming with the amplifier a negative feedback loop, the voltage transfer of which is large compared with unity and substantially uniform over the whole band down to and including zero frequency.

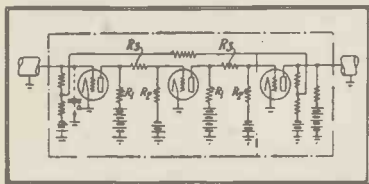

Operating potentials for anode and grid are supplied from a common battery having an intermediate point connected to the cathodes. The coupling between one valve and the next is carried out by connecting the anode of one valve through a resistance R_1 to the positive terminal of the battery, and the grid of the next through another resistance R_2 to the negative terminal of the battery. The anode and grid are also connected together by an additional path R_3 for conducting d.c. *Standard Telephones and Cables, Ltd.; (Assignees of H. Nyquist). Patent No. 549,272.*

A.F.C. for Wave-signal Receivers

This invention relates to frequency changing systems and particularly to a.f.c. in modulated carrier signal receivers of the superhet type, especially television receivers.

In a u.h.f. modulated carrier signal receiver, a frequency changing system is provided for deriving i.f. modulated carrier signals from selected received modulated carrier signals. This consists of an oscillator circuit which oscillates at any desired one of a number of different frequencies. A frequency correction circuit is coupled

to the oscillator circuit and includes a variable valve impedance so arranged to adjust the frequency of the oscillator circuit to the proper value for deriving the selected i.f. signals.

The phase angle tends to vary with frequency due to variations in the effect of electron transit time and so impairs the frequency correction of the oscillator. To eliminate this a compensating circuit is coupled to the frequency correction circuit. This is arranged to counteract any tendency of the phase angle to vary with frequency resulting from the selection of any of the different frequencies.

—*Hazeltine Corp. (Assignees of J. A. Rado). Patent No. 546,830.*

Variable Permeability Tuning Systems

To provide an improved variable permeability tuning system in a superhet for the oscillator and signal circuits to track accurately throughout a predetermined frequency range.

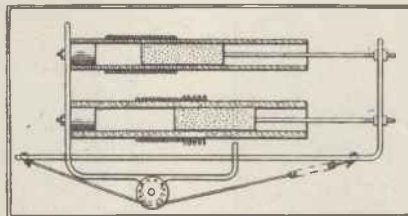

Two oscillation circuits, at least one including an inductance tunable by means of an iron core, are ganged so as to be conjointly tuned. Some of the turns of one coil are wound upon other turns so as to provide an additional layer which extends for only a part of the length of the coil. Substantially accurate tracking is therefore maintained between the oscillation circuits throughout the range of tuning adjustment. *Marconi's Wireless Telegraph Co., Ltd. (Assignees of W. F. Sands and P. F. G. Holst). Patent No. 549,359.*

Thermionic Valve Amplifiers

To improve the operation of pentode amplifiers at high frequencies by the elimination, partly or wholly, of the effect of the stray capacities associated with the anode circuit of the pentode valves. This is accomplished by connecting the suppressor grid of a pentode to some point in the amplifier, the alternating potential of which is equal to or nearly equal to

the alternating potential of the anode of the pentode. In this way the terminal of the capacity between anode and suppressor grid (which frequently is a large fraction of the total anode capacity) are maintained at nearly the same potential. Thus the current which would flow through this condenser is reduced to a very small value.

—*Standard Telephones and Cables, Ltd. (Assignees of M. M. Levy). Patent No. 548,424.*

THERMIONIC DEVICES

Thermionic Periodic Wave Repeaters

A periodic wave repeater to repeat only predetermined pulses of a wave including periodic pulses. This consists of a valve with its input circuit to receive the wave and an output circuit. An impedance arrangement degeneratively couples the circuit and applies to the input a voltage of the same phase as that of the output circuit. A frequency selector reduces the degenerative effect at the fundamental frequency and at least one harmonic frequency. The impedance may consist of a frequency selector tuned to resonate at the fundamental frequency and one or more harmonic frequencies, for reducing the degenerative effect of the impedance at such frequencies. This cleans the wave of unwanted frequency components.

Or it may alternatively include a reflecting time-delay circuit for altering the degenerative effect of the impedance to predetermined pulses.

—*Hazeltine Corp. (Assignees of J. C. Wilson). Patent No. 546,827.*

Valve Oscillator

A thermionic valve oscillator at a high or audio frequency in which the regenerative feedback path is comprised within the valve between the control grid electrode and the other electrode. A circuit external to the valve tuned to the desired audio frequency is connected across the same two electrodes when it is desired to generate oscillations of audio frequency. The tuned circuit, when connected, effectively short circuits the regenerative feedback path for high frequency and forms a feedback path for the tone frequency.—*Patent No. 546,029. Standard Telephones and Cables and J. D. Holland and D. D. Robinson.*



WAIT FOR IT!

—and then when normal conditions are restored, Reliance Potentiometers, incorporating our many years of experience, will again be available.

Until then National requirements must come first. If we can help you in this connection, we will. Therefore do not hesitate to write us.

RELIANCE

Manufacturing Co. (Southwark) Ltd.
Sutherland Road, Higham Hill,
Walthamstow. E. 17.
Telephone—Larkwood 3245

**SELENIUM
PHOTO
CELLS**



The "EEL" photo cell has no equal—in sensitivity and stability. They are made in standard sizes of 25, 35, 45 and 67 m/m. diameter and of 4 x 8, 11 x 18, 37 x 50, 22 x 40, and 17 x 43.5 m/m. in the rectangular. All cells are guaranteed (according to size) from 0.50 to 0.65 microamps per ft. candle per sq. c/m.

For full details write to:

EVANS ELECTROSELENIUM Ltd.
Bishops Stortford
Herts.



**THE SEAL OF
QUALITY**



**"The Colonel's
Lady—and
Judy O'Grady"**

These two charming persons may have been "sisters under the skin"; but whilst the more deadly are possibly all soul-mates it would not be wise to take it for granted that this generalisation applies equally to—transformers, for instance. Undoubtedly many of them superficially look equal to a Gardner, but beneath their metal 'skin' they are worlds apart. This 'class distinction' is noticeably marked in the case of Gardner's Small Power Transformers up to 4 kva. May we ask you then to consult with us when next you need this type of component and the specification stresses "The Colonel's Lady" aspect?

We regret that at present Small Power Transformers are available for highest priority orders only.



GARDNERS RADIO LIMITED
BOMERFORD · CHRISTCHURCH · HANTS.



Illustrated above:—30 watt
Amplifier with Radio

Available for Priority Work.

TRIX ELECTRICAL CO., LIMITED
65, Bolsover Street, London, W.1.
*Phone: EUS 5471/2. Grams: Trixadio, Wesdo, London.

RADIO BOOKS

EXPERIMENTAL RADIO ENGINEERING

By E. T. A. Rapson, assisted by E. G. Ackermann. Eminently suitable as a textbook for a three or four years' course in radio engineering at a technical college. Contains a number of experiments and methods of measurement, the majority of which may be carried out with standard laboratory equipment. 8s. 6d. net.

PROBLEMS IN RADIO ENGINEERING

By E. T. A. Rapson. A classified collection of examination questions set from time to time by some of the more important examining bodies in Radio Communication, together with some useful notes and formulae. Fifth Edition. 5s. net.

SHORT-WAVE RADIO

By J. H. Reyner, B.Sc. (Hons.), etc. This book deals with the developments and progress in the field of short wave radio telegraphy, giving comprehensive data and practical methods of application. Has been quoted as being "one of the finest short-wave treatises available." 10s. 6d. net.

PITMAN'S FOR RADIO BOOKS

There are over thirty books on all branches of radio in our Radio List. Write or call for our Technical Catalogue; you'll find in it all the books you might require.

39 PARKER STREET, KINGSWAY, W.C.2

PITMAN

BOOK REVIEWS

Learning the Radiotelegraph Code

J. Huntoon, of the Headquarters Staff of the American Radio Relay League).

(The American Radio Relay League, Inc. West Hartford, Connecticut, U.S.A., 25 cents per copy, post paid).

This booklet describes a unique method of learning the Morse Code based on the aural system of approach. The code is considered in the light of another language having its peculiar pronunciation and syllables. Fundamental sounds are learned first, then letter sounds are learned integrally instead of as separate dots and dashes; in fact, those terms are taboo and "dit" and "dah" have replaced them. The booklet includes much material on learning to send well, high speed operation, copying to typewriter, general operating data and code practice equipment, as well as a full set of lessons in learning to send and receive which are ideal for class instruction.

It is hardly necessary to remind readers that money may not be sent to the U.S. except through recognised channels.—Ed.

Aircraft Radio

(2nd. Edition). D. Hay Surgeoner. 154 pp. 40 plates, 24 figs in text. (Sir I. Pitman & Sons, 15/- net).

The author has considerably revised this edition of the book and has included descriptions of the later types of D.F. equipment and blind landing apparatus. Particular reference to the use of radio in war has been omitted, as most of the devices operate in civil aviation and are irrespective of the nature of the flying.

After dealing with the control of radio networks and international regulations, wave-length allocations, and the principles of communications systems, the book covers Directional Systems, Beam Approach, and Aircraft Equipment. There is also a chapter on airport and airway lighting which summarises a lot of useful information not found in other books.

The treatment is descriptive rather than theoretical, but gives a clear idea of the methods and apparatus in use. An excellent handbook for those who are working on war radio and want a good survey of the whole subject.

Temperature Control

A. J. Ansley. 124 pp. 80 figs (Chapman & Hall, 13/6 net).

As the author points out in his preface, the sources of information on this subject are widely scattered in the literature and are not generally accessible. There are a number of commercial devices on the market at the present time, but few laboratories have the means to invest in complete thermostatic equipment.

The book covers all the methods of achieving control of temperature—liquid expansion, vapour pressure, metal expansion and change of resistance, each method being illustrated with clear diagrams. Appendices of relays (too short) and galvanometers are included, together with tables of the usual constants.

This book might well form the first of a series on "Laboratory Technique," and should certainly be acquired by research libraries for reference.

Books received at time of going to Press: *Radio Receiver Design*, K. R. Sturley. *High Frequency Thermionic Tubes*, A. F. Harvey. (Both published by Messrs. Chapman and Hall)

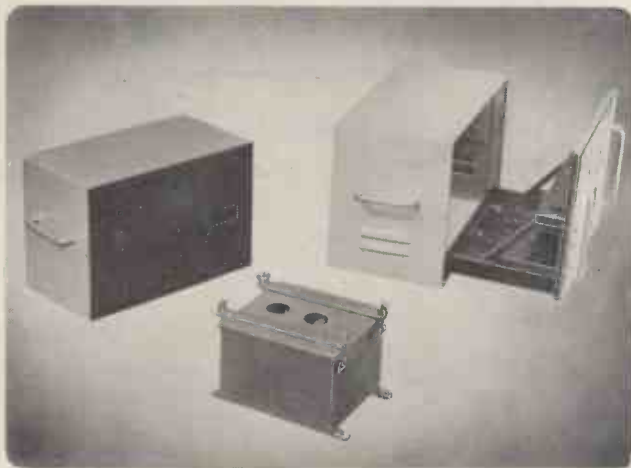

A skilled team of workers in an efficiently equipped modern factory produces to an unusually high standard all types of metal instrument cases, radio chassis, panels, brackets, boxes and other metal components. We are also able to undertake the design and manufacture of complete amplifying equipment for special requirements.

PRIORITY ORDERS ONLY

IMHOF'S

ALFRED IMHOF LTD, 112-116, New Oxford Street, London, W.C.1.

HIVAC
THE SCIENTIFIC
VALVE
BRITISH MADE

Specialists in
**MIDGET
VALVES**

HIVAC LIMITED
Greenhill Crescent
Harrow on the Hill, Middx.
Telephone: Harrow 0895.

PERMALI

ELECTRICAL
INSULATION
to DCD WT 1000

The NEW INSULATION CO., LTD.

Telephone:
Glos. 4419.

BRISTOL ROAD, GLOUCESTER
London Office: 40, BROADWAY, S.W.1.

Telegrams:
"Nico, Gloucester."
Telephone:
ABBey 6494.

Precisely!

for accurate
testing it
must be

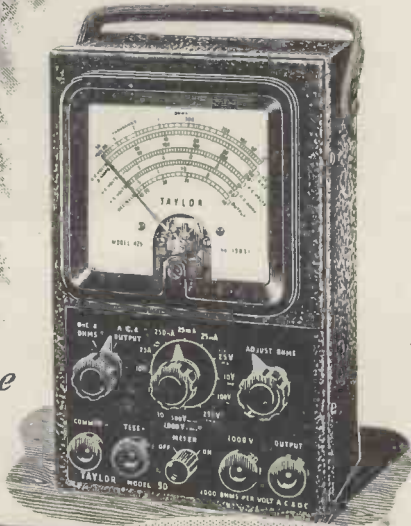

TAYLOR METERS

Write for complete details to:

TAYLOR ELECTRICAL INSTRUMENTS, Ltd., MONTROSE AV., SLOUGH, BUCKS.
Telephone: Slough 21381.

Greenwood



A 65-watt SOLON for general work

The SOLON is quicker, safer; constant heat is maintained at the point of the bit. All internal connections are in the bakelite terminal box—away from the heat. Complete with 6ft. HENLEY 3-core flexible.

Full details on request.

Supplies of the various models are only available for essential war work, of course, and due to heavy demands, it is necessary to order well in advance to avoid disappointment in delivery.



W. T. HENLEY'S TELEGRAPH WORKS CO., LTD.,
Engineering Department., Milton Court,
WESTCOTT, DORKING, SURREY.

Classified Announcements

The charge for miscellaneous advertisements on this page is 12 words or less 3/., and 3d. for every additional word. Single-column inch rate displayed, 1/.. All advertisements must be accompanied by remittance. Cheques and Postal Orders should be made payable to Hulton Press, Ltd., and crossed, and should reach this office, 43, Shoe Lane, London, E.C.4, not later than the 15th of the month previous to date of issue.

FOR SALE

IN STOCK, Rectifiers, Accumulator Chargers, Rotary Converters, P.A. Amplifiers, Mikes, Mains Transformers, Speakers of most types, Test Meters, etc., Special Transformers quoted for.—University Radio, Ltd., 238, Euston Road, London, N.W.1. Ger. 4447.

TELEVISION CHASSIS by Pye. Brand new, complete with tube and all valves. Limited quantity. £19 10s. each.—Imhofs, 112-6, New Oxford Street, W.C.1. Museum 5944.

LOUDSPEAKERS

3,000 SPEAKERS P.M. and energised 4" to 14", including several Epoch 18". Sinclair Speakers, 170, Copenhagen Street, N.1.

LOUDSPEAKER repairs, British, American, any make, 24-hour service; moderate prices.—Sinclair Speakers, 170, Copenhagen Street, N.1.

MISCELLANEOUS

WE WILL BUY at your price used radios, amplifiers, converters, test meters, motors, pick-ups, speakers, etc., radio and electrical accessories. Write, phone or call, University Radio Ltd., 238, Euston Road, London, N.W.1. Ger. 4447.

MORSE EQUIPMENT

FULL range of Transmitting Keys, practice sets and other equipment for Morse training.—Webb's Radio, 14, Soho Street, London, W.1. Phone: GERrard 2089.

RADIO MAP

WEBB'S Radio Map of the World enables you to locate any station heard. Size 40" by 30" 2 colour heavy Art Paper, 4/6, post 6d. Limited supply on Linen, 10/6, post 6d.—Webb's Radio, 14, Soho Street, London' W.1. Phone: GERrard 2089.

WANTED

WE OFFER cash for good modern Communication and all-wave Receivers.—A.C.S. Radio, 44, Widmore Road, Bromley.

RESEARCH ENGINEER required for development work in acoustics for factory in N.W. District engaged on Essential Work. Degree standard desirable. Please write stating full particulars to Box No. 650, "Electronic Engineering."

RADIO

ENGINEERING AND TELEVISION

Complete Postal Courses of Instruction. Recommended to all who desire to obtain a thorough technical and practical knowledge.

Apply:—

BRITISH SCHOOL OF TELEGRAPHY LTD.
179, Clapham Road, London, S.W.9.
(Estd. 1906)

FOYLES

BOOKSELLERS TO THE WORLD
New and Second-hand Books on Engineering and every other subject.
Books Bought.

119-125 Charing Cross Road, London, W.C.2
Tele: Gerrard 5660 (16 lines). Open 9-4 Inc. Sat

TRANSFORMERS

to customers' specifications or in accordance with standard list.

W. BRYAN SAVAGE LTD.
Westmoreland Road, London, N.W.9. Colindale 7131



TRANSFORMER DISTORTION

An abbreviated version of the original thesis by Dr. Norman Partridge on "Harmonic Distortion in Audio Frequency Transformers" is now available in booklet form. This has been reprinted from the September, October and November issues of "The Wireless Engineer." The subject is treated technically, at length, and from an essentially practical viewpoint. Copies can be obtained free of charge by professional engineers and technicians upon request. The shortage of paper prohibits distribution to interested amateurs.

N. Partridge

Ph.D. B.Sc., M.Brit.I.R.E., M.I.E.E.

King's Bldgs., Dean Stanley Street,
LONDON, S.W.1. Phone: VICToria 5035

ELECTRADIX RADIOS

NEW AMERICAN ROTARIES for Radio, fitted factory smoothers, 75 watts, 6v. D.C. input, 100 volts A.C., 50/60 cycles, £12. 110 watts, 110v. D.C. to 110v. A.C., 50/60 cycles, £14 10 0. 150 watts, 220v. D.C., 110v. A.C., 50/60 cycles, £16 10 0. Other Rotaries in stock up to 2 kw.



DIMMERS or RHEOSTATS with "off" 0 to 1 ohm and will carry up to 4 amps., for regulation on 6 to 12 volts, dimming or bank circuit battery charge model control, etc. One hole fixing for panels with bracket for other fixing. Hollow knob has socket for min. bulb glowing when circuit alive. New U.S.A. Aetna make, in carton, 2/6.

Worth 5/-. Large 40 amp. ironclad grid Rheos with heavy 10-stud switch to drop 220 volts to 45 volts. Size 33 in. x 16 in. x 14 in., £5 10s.; 11 volt. ditto, 16 in. x 14 in. £2 10s.

LIGHT AND RAY CELLS. Selenium Raycraft, 21/-; Electro-cell, self generating, 35/-. Raycraft Outfit with Relay, 42/-; Photo Cells for sound on film, G.E.C., £3 19 0. 10,000 ohm Relay, 22/6.

CIRCUIT BREAKERS. Ironclad triple-pole, overload trip; various ratings from 10 amps., 25/-, 200 amp. and 250 amp. S.P. overload trip switchboard type on slate panel, 13 in. x 12 in., £4. Double-pole 200 amp. ditto, £4 10 0. 300 amp. DP Ellison on slate panel, 13 in. x 16 in., £5 each. 1,000 amp. Coll Switches with overload trip, £6 each.

KNIFE SWITCHES. 100 amp. open type switches on slate panel, 24 in. x 18 in., with porcelain handle fuses, 42/6 pair. Output panel, 18 in. x 36 in. x 24 in., with 3 DP knife switches and fuses, 200 amps. and one 60 amps., £6 the lot.

SWITCHBOARD PANELS. Plain slate panels, any size promptly supplied. Fitted 1 1/2 in. thick enamelled slate panel with NCS Battery Automatic, 54 cell, 100 amp., only £3. Pair of 8-stud 100 amp. Battery Switches on slate panel, £4 10 0 each.

Many excellent Bargains in Electrical, Mechanical and Radio Apparatus available. Callers invited. Post enquiries should please be accompanied by stamped reply envelope.

ELECTRADIX RADIOS

19, Broughton Street, Queenstown Road,
Battersea, S.W.8.
Telephone: Macaulay 2159. Nearest Rly. Station,
Queen's Road, S. Rly.

GALPINS ELECTRICAL STORES

21 WILLIAM ST., SLOUGH, Bucks

Phone: Slough 20855. Terms: Cash with order

(Elre and Northern Ireland orders cannot be accepted.)

ELECTRIC LIGHT CHECK METERS, well-known makers, first-class condition, electrically guaranteed, for A.C. mains 200/250 volts 50-cy: 1 phase 5 amp. load 10/- each; 10 amp. load, 12/6, carriage 1/-.

ROTARY CONVERTOR, D.C. to D.C.; in 220 volts D.C.; output 12 volts at 50 amps. D.C., in bearing, condition as new. Price £10, carriage forward, or 17/6 passenger train.

ALTERNATOR, output 220 volts, 1 ph., 50 cycles at 180 watts, will give 1 amp. easily, speed 3,000 r.p.m.; self-exciting, condition as new. Price £8, carriage forward, or 15/- passenger train.

I.K.W. FIRE ELEMENTS, mounted, size 16 x 1 1/2 x 1 ins., for 220 volts A.C. or D.C., as new 8/6, post free.

POWER PACKS for smoothing, etc., consisting of two 300 ohm Choker and two 2 MF Condensers. Price 8/6, post free.

ROTARY CONVERTOR, D.C. to D.C., in 120 volts; Output 1,100 volts at 30 M/A, Ex R.A.P., new. Price 50/-, carriage paid.

HEAVY DUTY Knife Switches, D.P., D.T., quick break, 100 amps., in first-class condition. Price 20/-, carriage paid.

LOUD RINGING BELLS, working on 100 volt D.C., 8 in. dia. gong (bell metal), plated, waterproof, absolutely as new. Price 30/-, carriage 2/-.

D.C. MOTORS, 110 v. approx. 1/10 h.p., series wound, in perfect working order. Price 12/6 each, carriage 1/-.

HEAVY DUTY CABLE, V.I.R., and braided, in first-class condition, size 37/13, lengths 30 to 40 yards. Price by the length 6/- per yard, or 8/- per yard for short lengths, carriage paid.

1/2 WATT WIRE END RESISTANCES, new and unused, assorted sizes (our assortment), 6/6 per dozen, post free.

EPOCH SUPER CINEMA SPEAKER, 20 watt, 15 in. Cone, 15 ohm. speech coil, 6 volt field, (no energising), weight 65 lbs. Price £7 10s., carriage paid.

TECHNICAL BOOKS

English and Foreign Books on Radio and Electrical Engineering supplied from stock or obtained to order.

Please mention interests when writing

LENDING LIBRARY

Annual Subscription from One Guinea.

Details post free on request.

H. K. LEWIS & Co. Ltd.

136 Gower Street, London, W.C.1

Telephone: EUSton 4282 (5 lines)



EDWARD
Wilcox
& CO. LTD
For immediate acknowledgment quote our departmental symbol SD/AB.

Sliding-Interlocking vibration-proof contacts and comprehensive adaptability are characteristic interest to designers of unusual schemes in the unusual times.

Edward Wilcox & Co., Ltd., Sharston Road, Wythenshawe, Manchester.

ROLA

LOUD SPEAKERS

THE WORLD'S FINEST REPRODUCERS

TRANSFORMER LAMINATIONS

Core Widths $\frac{3}{16}$ " to $1\frac{1}{2}$ " (E's and I's.)

EIGHT STOCK SIZES

A Comprehensive Bulletin together with details of Associated Covers and Clamps with design data will be sent to manufacturers on request.

BRITISH ROLA LIMITED

MINERVA ROAD · PARK ROYAL · N.W.10 · WILlesden 4322

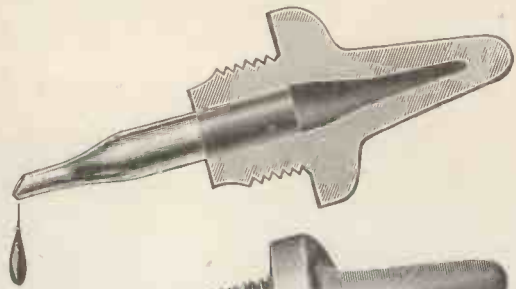

TRADE "UNO" MARK
WATERPROOF STENCIL INK
PATENT NO. 27170-33
BLACK

"UNO"
DRAWING INKS
are suitable for
every drawing
office use.

A. WEST & PARTNERS, LTD. 36 BROADWAY, WESTMINSTER, S.W.1

Great Possibilities for

TECHNICALLY QUALIFIED ENGINEERS KEY MEN IN WARTIME AND AFTERWARDS

The finest posts and the majority of posts in this war are technical and when the war is over, the immense increase in technique and mechanisation created for war purposes will be applied to reconstruction and commerce. An age of great possibilities for qualified engineers is here. Study at home with The T.I.G.B. and take a Recognised Engineering Qualification such as C. & G., A.F.R.Ae.S., A.M.I.Mech.E., A.M.I.E.E., etc. In which examinations T.I.G.B. Students have gained 32 FIRST PLACES and hundreds of passes. Write now for "The Engineer's Guide to Success" — 200 Courses — covering all branches — Aeronautical, Tele-communication, Mechanical, Electrical, Chemical, etc.



World's best choice of
Courses in Engineering

THE TECHNOLOGICAL INSTITUTE OF GREAT BRITAIN
160, Temple Bar House, London, E.C.4.

'ARDUX'

is a quick setting adhesive for mouldings and laminated plastics. No preparation of the surfaces is necessary. 'Ardux' is doing a valuable job in eliminating wastage and in reducing machining in the production of aircraft components. 'Ardux' can probably help you in your problem; May we show you how?

Aero Research Ltd., Duxford, Cambridge.

Telephone: Sawston 167-8

BASICALLY BETTER...

Air Insulation
is the basic principle of

CO-AX

LOW LOSS CABLES

Unequaled

H.F. PROPERTIES

FROM THE COMPLETE
RANGE MAY BE QUOTED:
Char Imped. ohms 75, 50, 34
Capacity p.p.f. 16, 31, 12
Dielectric constant

TRANSRADIO LTD. Inc. TELEQUIPMENT CO. 16 HIGHWAY, BEACONSFIELD.

"AFTER THE WAR" TELEVISION

With the coming of Peace, and backed by the Technical advances that have resulted from the war years, TELEVISION will again spring to life and offer opportunities, as never before, to the trained man.

Now is the time to prepare for this new "market." Our Home-study "Television" Course is comprehensive, up-to-date and suitable both for the amateur and experienced Radio Engineer.

We definitely guarantee
"SATISFACTION—OR REFUND OF FEE"

You are advised to send for details of this special Television Course immediately, to investigate its possibilities. Details will also gladly be sent of A.M.I.E.E. and A.M.Brit.I.R.E., Examinations and other courses in all branches of WIRELESS ENGINEERING, including particulars of our special SHORT WAVE and RADIO SERVICE COURSES which are in such demand—Free.

BRITISH INSTITUTE OF ENGINEERING TECHNOLOGY

Principal: Prof. A. M. Low.

337, Shakespeare House, 17/19, Stratford Place, London, W.1.

EDDYSTONE

COMMUNICATION RECEIVER

358x



In the 358X version of this famous receiver a Band-pass Crystal circuit is employed giving high selectivity and complete rejection of unwanted adjacent signals. Furthermore the double crystal circuit avoids the extreme "peaked" effect of the conventional crystal gate, allowing easier tuning and accommodating some frequency drift of the wanted signal. These advantages are readily appreciated by operators familiar with the hair-breadth tuning of the normal filter.

The "358X" may be inspected at 14, Soho Street, preferably by appointment.

EDDYSTONE COMMUNICATION RECEIVERS ARE AVAILABLE ON PRIORITY ORDER ONLY.

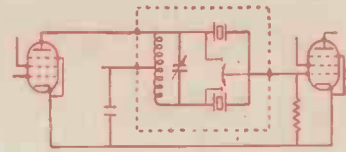

BAND-PASS FILTER CIRCUIT

Above is shown the fundamental circuit similar to that employed in the Eddystone 358X receiver. When in circuit the bandwidth is 300 c/s, front panel control allowing optional use of normal I.F. selectivity, bandwidth 5 Kc/s.

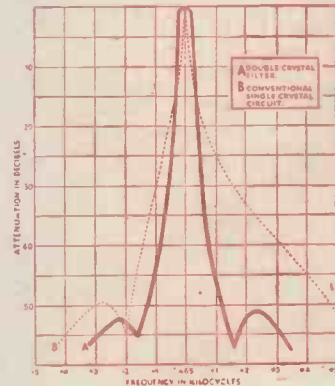

SELECTIVITY CURVE "A"

shows the steep sides and flattened top response curve of the Band-pass Filter. Compare the normal crystal gate (Curve B) with its typical sharp peak necessitating constant tuning adjustment with the slightest signal frequency variation: Note the symmetrical rejection given by Curve "A" as opposed to the uneven tall effect of curve "B"

WEBB'S RADIO

Hours of Business 9 a.m.—4 p.m. Saturdays 9 a.m.—12 noon.

14, SOHO ST. OXFORD ST. LONDON, W. I. Telephone. GERRARD 2089