

Electronic Engineering

INCORPORATING ELECTRONICS, TELEVISION AND SHORT WAVE WORLD

PRINCIPAL CONTENTS

Camera for C.R.O. Recording

Nature and Effects of Cathodic Sputtering

Practical Notes on Receiver Design—Part 1

Logarithmic Charts and Circuit Performance—Part 2

Data Sheets—Inductance of Rectangular and Polygonal
Coils

2¹/₂ JULY, 1942

POWER LEVEL INDICATORS

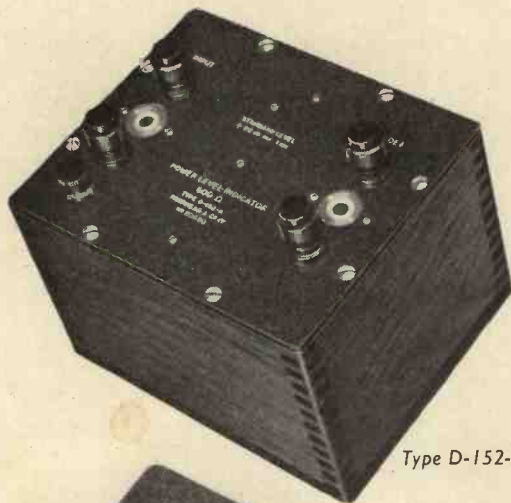

Type D-152-A

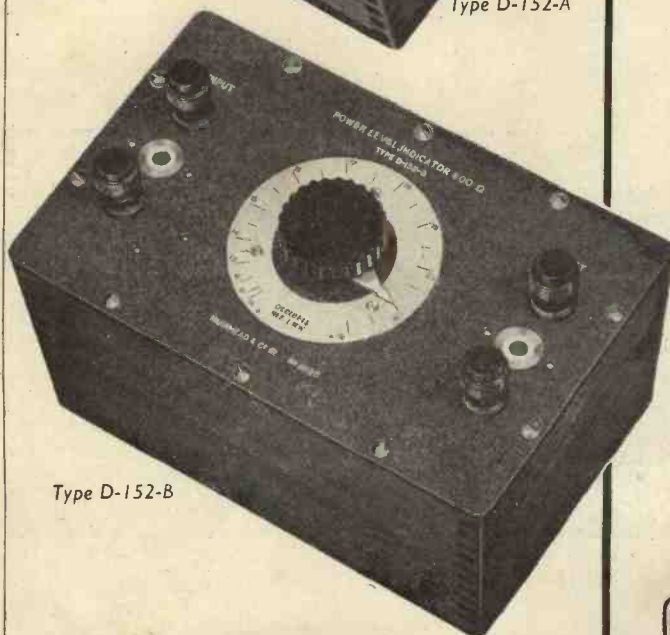

Type D-152-B

Power Level Indicators TYPES D-152-A and D-152-B

- ★ Embodying a simple resistance bridge, self-balancing at a pre-determined power level — Robust — Accurate — Inexpensive.
- ★ Type D-152-A indicates a fixed power level; D-152-B is variable over a limited range.
- ★ Equally accurate on D.C. or A.C. Accuracy is independent of wave form and frequency up to 50 Kc/s.
- ★ With A.C., telephones will indicate balance to better than 0.1 db; a reasonably sensitive galvanometer (e.g. 100-0-100 uA.) gives equivalent discrimination with D.C.
- ★ Cannot be damaged by overloads up to 1000%.
- ★ Indispensable to Transmission Engineers, Meter Manufacturers, and others requiring a standard power level.

MUIRHEAD

STANDARD TYPES

TYPE NO.	POWER INDICATION REF. 1 mW	INPUT RESISTANCES	DIMENSIONS	WEIGHT
D-152-A	+ 20 db \pm 0.1 db	600 Ω \pm 1%	6" \times 5" \times 5 $\frac{1}{2}$ "	3 lbs.
D-152-B	+ 10 to + 22 db \pm 0.2 db	600 Ω \pm 5%	8" \times 5" \times 5 $\frac{1}{2}$ "	4 lbs.

Full particulars are given in Bulletin B-540-A a copy of which will gladly be sent on request.

MUIRHEAD & COMPANY, LTD., ELMERS END, BECKENHAM, KENT.

Beckenham 0041-0042

FOR OVER 60 YEARS DESIGNERS AND MAKERS OF PRECISION INSTRUMENTS

C.R.C.M 495

The fact that goods made of raw materials in short supply owing to war conditions are advertised in this magazine should not be taken as an indication that they are necessarily available for export.

THE SIGN OF A



GOOD RECTIFIER

WESTINGHOUSE

Westinghouse reliability is acknowledged in all parts of the world.... and always will be.

Present demands on our resources are such that prompt attention cannot be given to every requirement; but, as only the best will serve, research and development have been intensified, and the resulting improvements will enable Westinghouse to maintain their premier position in the better world of to-morrow.

Westinghouse Brake & Signal Co. Ltd.,
Pew Hill House, Chippenham, Wilts.

F E R R I S



Model 33-A
CRYSTAL CONTROLLED
CALIBRATOR

A portable Line-operated Unit providing Standard frequencies generated by three Crystal-controlled Oscillators having fundamentals of 100, 1,000 and 10,000 k/cs.

Harmonics are, in general, useful up to about 20,000 k/cs.

Self-contained Detector and two-stage Audio Amplifier enables Beats with an external source of R.F. to be detected.

LELAND INSTRUMENTS LTD.

Full specification will be sent on request.

43 MECKLENBURGH SQ. LONDON. W.C.1.
TELEPHONE: TERMINUS 5689

Clough-Brengle • Boonton • Ferris • Ballantine • Hewlett-Packard

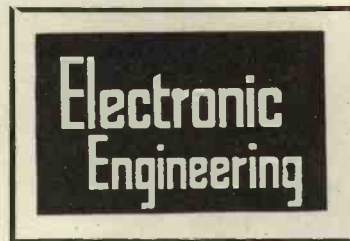

JULY, 1942.

Volume XV.

No. 173.

CONTENTS

	PAGE
Editorial	51
A Camera for Recording Low-speed Transients with a Cathode Ray Oscillograph	52
Logarithmic Charts and Circuit Performance (Part 2)	57
Cathodic Sputtering—Nature and Effects	61
Data Sheets, Nos. 32 and 33	65
Practical Notes on Receiver Design (Part I)...	70
Send Elements and Insertion Loss	75
Universal Shunts for Meters	76
Notes from the Industry	78
Playing Records with Large Radius Needles...	79
Differential Input Circuits—discussion	80
Abstracts of Electronic Literature	82
Patents Record	84
Book Reviews	86

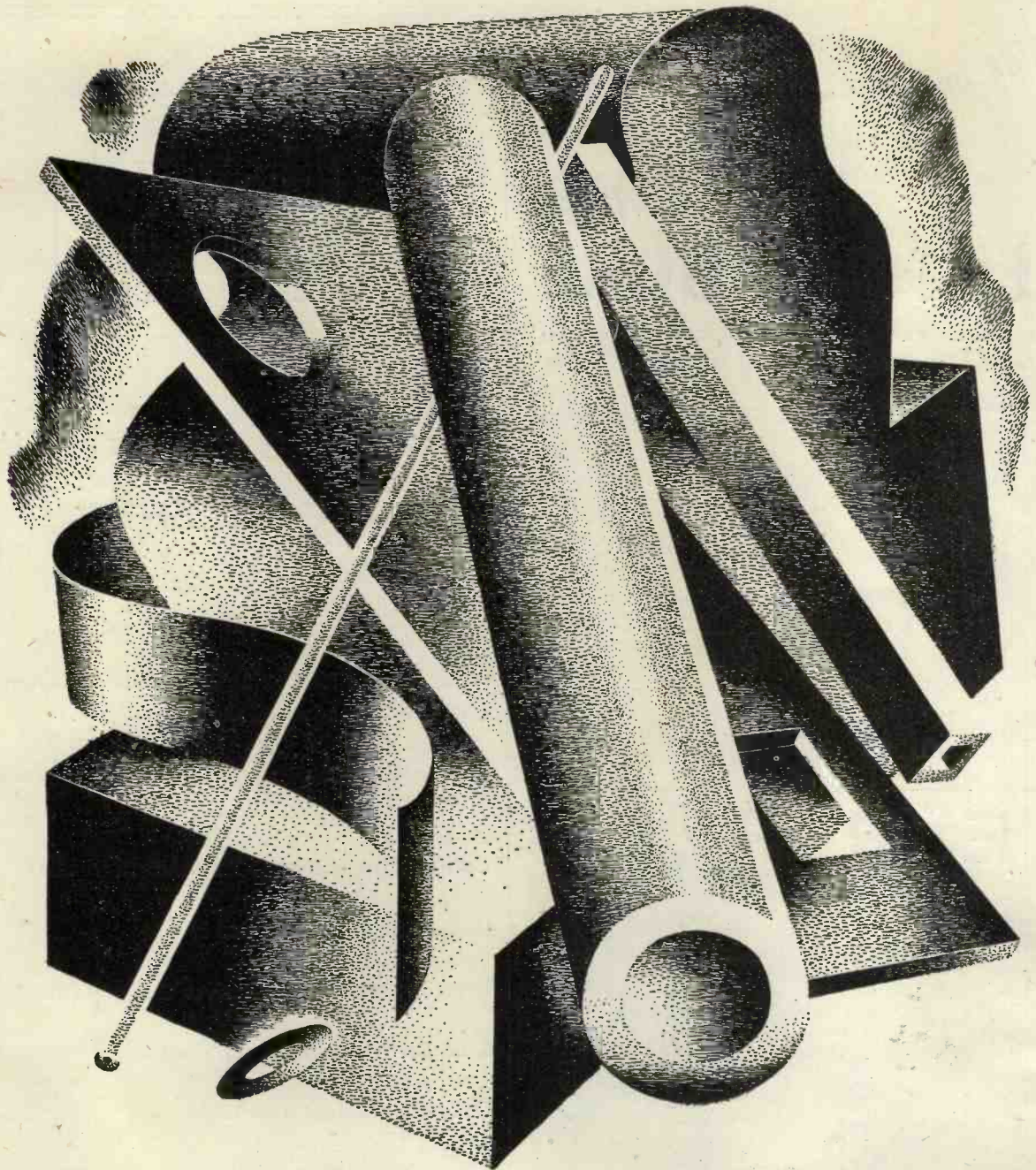

BAKELITE LAMINATED exists in a variety of forms, from wafer-thin sheets to blocks several inches in thickness. Its worth is being proved to-day in countless instances where vital issues depend on the quality of the equipment. Its unique combination of physical properties makes it indispensable where the highest possible efficiency is demanded. Bakelite Limited, 18, Grosvenor Gardens, S.W.1, will be glad to supply detailed particulars on request.

TREFOIL
BAKELITE  **PLASTICS**
 REGD. TRADE MARKS

Pioneers in the Plastics World

PROPRIETORS :

HULTON PRESS LTD.,

EDITOR

G. PARR.

Electronic Engineering

EDITORIAL, ADVERTISING AND PUBLISHING OFFICES, 43-44, SHOE LANE, LONDON, E.C.4

TELEPHONE:
CENTRAL 7400

Monthly (published last day of preceding month) 2/- net. Subscription Rates : Post Paid to any part of the World— 3 months, 6/6; 6 months, 13/-; 12 months, 26/-. Registered for Transmission by Canadian Magazine Post.

TELEGRAMS :
HULTONPRES LUD
LONDON.

ASLIB

THIS is not the name of a new anti-submarine device, but an abbreviation for The Association of Scientific Libraries and Information Bureaux, an organisation which deserves to be more widely known among workers in the electronic industry.

The first need of anyone undertaking research is to find out what has been done already, and this can only be accomplished by a wide search through the literature of the subject.

The enormous increase in the number of publications and periodicals of all kinds makes this search increasingly difficult to each newcomer in the field.

No student can hope to subscribe to all the particular periodicals he requires and the only resort is to the easily accessible scientific libraries such as the Patent Office or Science Library.

Even if these are combed thoroughly, there is still the possibility of some little-known source of information which may provide the missing link in the bibliography of the research in hand.

This is where the Association proves of value in providing a clue to just that extra source of information which is needed.

Founded in 1924, its object is to make resources of all the various specialist libraries scattered up and down the country available for general research by linking them to a common centre to which inquiries may be directed.

The principal medium through which this information is provided is the ASLIB Directory, a book containing references to all the sources of special data on various subjects in art and science. This is kept up to date by the issue of quarterly bulletins, which are circulated to members and which avoid the frequent re-issue of a bulky volume.

The Directory is not a bibliography of bibliographies, but merely a guide to tell the inquirer where he is likely to find a source of information which he may have overlooked or of whose existence he may not be aware.

In addition to being a clearing

house for sources of information, ASLIB has other activities, which include an annual conference at which papers on various aspects of library information are discussed. It also maintains a register of technical translators, and publishes a list of recommended books in particular subjects.

The Association has already a large list of members and associates, including representatives of most of the sources of information available, and they hope that scientific workers as a whole will take an active interest in the organisation, which was founded for their benefit.

Its scope is limited to Great Britain and Ireland, but it has relations with similar organisations in Europe and America and it is hoped that these relations will be broadened and strengthened after the war.

An individual or organisation, by paying a membership fee of £2 2s. per annum, becomes entitled to the full services of the Association.

It should be pointed out that ASLIB is not an information bureau in the usual sense of the word. Its staff is depleted by the war, in common with other organisations, and it would be imposing an unfair burden on them if they were expected to answer queries which could be solved by intelligent use of reference books and library lists.

The secretary, Miss E. Ditmas, M.A., will be pleased to give further information on inquiry at 31 Museum Street, London, W.1.

NO. 1 PRIORITY

All electronic engineers engaged on work of national importance are familiar with this phrase.

It also applies to paper salvage which is vital to the war effort. Waste paper is needed for munitions and even the smallest amount will help :

- 6 old books ... 1 shell carrier.
- 6 old bills ... 1 washer.
- 6 old letters ... ½ cartridge case.

Please sort all your files of records, catalogues and notes and add as much as you possibly can to the Salvage sack.

One day earlier makes all the difference.

Your local council will be pleased to collect bulky parcels at no expense to yourself.

NO. 1 PRIORITY

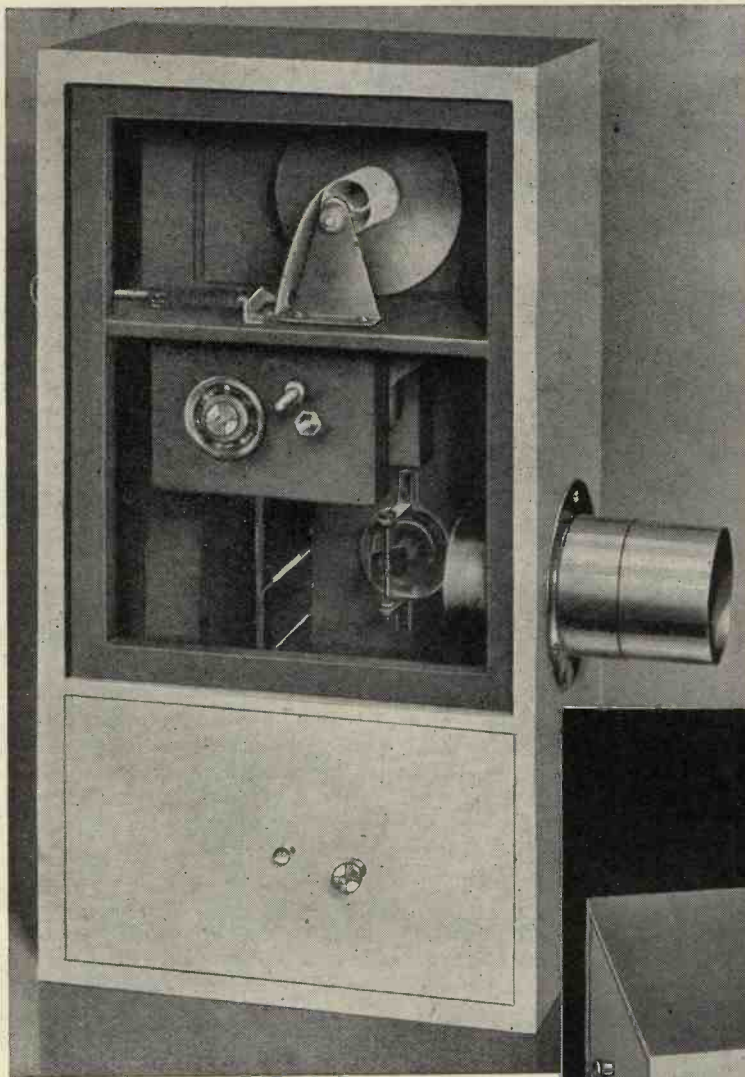

A Camera for Recording Low-Speed Transients with a Cathode-Ray Oscillograph

By G. D. DAWSON, M.Sc., M.B., Ch.B.*

(Above) Side view of camera with cover removed showing recording paper in position.

(Right) A view of the camera with motor drive attachment and gear box for varying speed of recording.

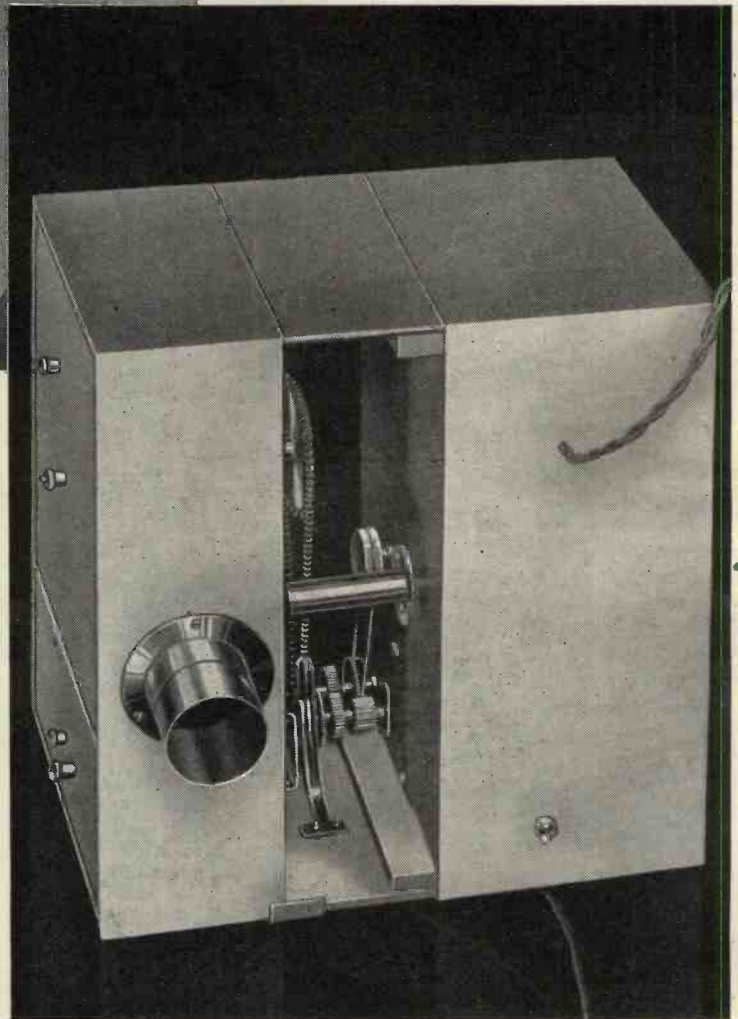

* The David Lewis Colony and Department of Electroencephalography, Manchester Royal Infirmary.

THE camera described here was designed to record low frequency phenomena lasting for comparatively long periods from a cathode-ray oscillograph. No suitable instrument was immediately available at a reasonable figure and it was decided to undertake the construction to incorporate several features which are not usually found in the less expensive commercial types. The requirements of the research in hand were as follows:—

1. The camera should be able to record for fifteen minutes at a paper speed of $\frac{1}{2}$ inch per second. A continuous run of 40 feet of paper was allowed for. The drive mechanism should be faultless and the take-up satisfactory up to a speed of six inches per second. Alternative rates of travel of $\frac{1}{2}$, 1 and 2 inches per second should be available.

2. A light-tight removable cassette was not considered necessary as the limit of 40 feet of paper would cover one experiment or group of experiments and the camera should then be easily dismountable to unload in a dark room.

3. Unperforated paper should be used. This gives about 35 per cent. greater recording area in the 35 millimetre size than the perforated type and is less expensive. To pay to have such a large useful recording area taken away seemed quite unnecessary under present conditions.

4. Condition 3 implies a friction drive. This must be in effect positive, but must not damage the paper or emulsion. The pressure of the drive should be easily adjustable.

5. The camera should be easily driven by a gramophone type motor, either clockwork or electric. With a high pressure friction drive this is difficult to attain unless ball bearings are used throughout the drive mechanism.

6. Before starting recording it should be possible to open the camera to check focusing with minimum wastage of paper.

7. Recording was to be carried out in daylight, without a screening tunnel, as observation of the tube during recording was necessary.

8. A time interval marker giving $\frac{1}{5}$ second intervals, with 1 second intervals emphasised, was needed.

9. A means of marking the ends of short records was necessary when continuous recording was not used.

10. Finally, the whole camera should be made from simple materials from stock wherever possible, and with the minimum of machining. The cost of materials including the lens should not be above £5 for the camera and £3 for the drive unit.

Paper Take-Up

To receive forty feet of paper at a maximum rate up to six inches a second either a large compartment for it to push into must be available or some positive coiling device must be provided on the receiving bobbin. The spring type of coiling device into which the paper is pushed is unreliable for over twenty feet or so of paper, and therefore to save space a positive coiling mechanism was used. The paper slips into a slot in the spindle (12) Fig. 1. This spindle is driven at the same speed as the drive shaft by the spring belt (19). It can be seen from the photographs that the paper is not wound tightly at first. The outside diameter of the coil is controlled by the rate the paper is fed into the winding compartment from the drive and it tends to remain constant. No slip need therefore occur in the belt (19) until the paper is packed tightly on the spindle (12). This occurs when approximately 25 feet of paper has been used. Above this length slip occurs in the spring belt. To unload the camera the paper is cut across just above the perforator (10) and after the spring belt is slipped off the pulley (20) it can be easily unrolled from the take-up.

The drive is carried out by a rubber disk about 1 in. diameter and $\frac{1}{4}$ in. thick (Figs. 2 and 3) which is sandwiched between two small gear wheels. The rubber disk presses on the back of the paper. The emulsion surface of the paper bears directly on the outer race of a large ball bearing (3). The pressure on the rubber swells it into the teeth of the gears and prevents any slip. The shaft carrying the rubber roller is mounted in bushes in the ball races (8) and (17). The ball-races used were old stock and ones of slightly smaller dimensions would be equally satisfactory. The large ballbearing (3) is mounted on an eccentric bush which is fixed by locknuts to the screwed rod (4) (Fig. 1). To adjust the drive pressure, the nut on (4) is unlocked and the screwed rod rotated by the lever (2) (Fig. 2). The use of ball bearings allows a pressure sufficiently high to make the drive quite positive, whilst allowing the camera to be driven by a clockwork or very small electric motor. There has never been any trace of marking on the emulsion of the paper due to high pressure although the bearing surface is plain unplated steel.

Drive Unit

The drive unit on which the camera rests contains a 78 r.p.m. synchronous motor, a bell type transformer for operating the time marker and signal lamps, and the time marker mechanism (Fig. 4). The motor spindle has an extension on which are $\frac{3}{4}$ in., 1 in., and $1\frac{1}{2}$ in. gears. (Fig. 5). These mesh with corresponding gears on a lay shaft which carries a sprocket giving a 1:4 reduction together with the drive sprocket on the camera. The driving chain is kept at the correct tension by a flat spring pressing against the slack or "return" side. (18). Gear changing is carried out by tightening the set screw of the appropriate gear on the motor spindle. The rubber drive roller is about $\frac{1}{2}$ in. radius when under pressure and thus gives a paper movement of 3.14 inches per revolution. When the two one-inch gears are tightened up and driving, a motor speed of 78 r.p.m. and a reduction by the sprockets of 1:4 gives a paper speed of almost exactly 1 in. per second. A $\frac{3}{4}$ in. gear on the motor and $1\frac{1}{2}$ in. on the layshaft gives $\frac{1}{2}$ in. per second and the other two gears give 2 in. per second. The motor spindle also carries a pulley to drive the time marker mechanism.

If focusing is to be easy it is essential to be able to view the image in the camera gate. For this reason the unexposed paper was placed in a light-tight compartment and fed to the gate through a velvet lined slit. The layers of velvet are kept gently touching by the pressure plate (13) (Fig. 2) the position of which is variable over a small range. The spindle on which the spool is mounted screws into a brass socket on the drive side of the case. A distance piece prevents the outer and loose flange of the reel from wandering when the camera is used vertically. An extension of the spool spindle (6) is used to secure the lid of the spool chamber, Fig. 2. To reload the spindle (6) is completely unscrewed and the reel taken out of the compartment. The outer flange is loose so the new roll with a 1 in. internal diameter standard core slips on to the spool.

Recording in daylight requires a very narrow gate. Otherwise if parts of the tube face are photographed which are not traversed by the spot there will tend to be a fogging of the background on the record and loss of contrast. The construction of the gate is shown in Fig. 5. When a new reel of paper is inserted the end is easily pushed through the gate from the spool chamber until it is picked up by the drive. If the edges and corners shown in Fig. 5 are bevelled this causes no trouble and the extra complication of an opening gate is quite

unnecessary. When the paper leaves the gate it is picked up between the drive rollers and then guided by the pick-up fork through the partition into the coiling compartment.

Lens

The lens used is a 3 in. effective focus f1.9 anastigmat. A number of these lenses were on the market a few years ago and they are occasionally still advertised in the photographic papers. It is mounted in a sliding focusing tube, an extension of which forms a deep lens hood. This hood just does not cause cut off when a 4 in. cathode-ray tube is being photographed at about 14 inches from the centre of the lens. The long hood and the narrow gate make it possible to get a completely black-and-white record when photographing with 500 volts on the anode of the tube a 50 c.p.s. wave of 10 cms. amplitude in normal daylight. The large aperture of the lens ensures adequate exposure at low H.T. voltages and thus simplifies greatly the deflecting circuits for use with the oscillograph. No shutter or cap is necessary for the lens as the camera may be left in strong daylight for long periods without more than one or two inches of paper in the gate becoming fogged. The definition of the Bausch and Lomb lens used is such that at the full aperture of f1.9 it will resolve one hundred lines to the inch on the recording paper with a well focused spot; the spot size is in fact the limiting factor. Where less critical definition is needed a much simpler lens could be used with a reduction in size, a probable increase in light transmission and a certain decrease in cost. The lens used here is very bulky and the whole camera was built round it, but with a smaller lens the camera could be reduced in thickness by at least 30 per cent.

Time Marker

As the camera is driven by a synchronous motor and the drive does not slip a time marker is really not necessary, but is a great convenience.

The spindle of the marker has a pulley on it (Fig. 4) of such size that when driven from the pulley on the motor spindle by a spring belt it rotates at exactly 60 r.p.m. The disk on this spindle has five perforations on it. Four of these are circular and the fifth is elongated in a radial direction. The marker lamp shown in Fig. 4 has a line filament, and an image of this filament is projected on to the edge of the paper by the lenses (16) and (14) and the inclined mirror (5). The filament is exposed every 1/5 sec. by the disk with more of the filament exposed by the enlarged aperture every second, giving an emphasised mark at that interval.

Focusing is carried out by sliding the tube carrying the lamp inside the tunnel between the drive unit and the lens (16) is of aperture f7.7 and effective focal length 3 inches. This was rather too long for the distances involved and was supplemented by a spectacle lens (14). It should be possible to fit a signal lamp also inside the drive unit to mark any required portion of the record. In the actual equipment this lamp was, however, mounted above the face of the cathode-ray tube on the amplifying apparatus and is operated from the same transformer as the time marker.

To identify short sections of the record a perforator is fitted in the camera at the top of the paper slide, consisting of a pivoted lever (10) operated by a knob (9) and held back by a coiled spring. On pushing the knob the end of the lever presses the recording paper against a backplate (11) which has a small hole in it opposite the perforating point, and the paper is punched accordingly. This device has one disadvantage in that it is mounted some 5 in. away from the gate and allowance must be made for the lag on the record. If, however, the perforator is made to work nearer the gate itself there is the risk that the notch in the paper may catch in the gate and cause tearing of the paper.

Another useful addition to the camera is the provision of an automatic indicator that the paper reel is finished. To arrange this a light brass strip (21) is mounted on an ebonite block (22) which in turn is secured just above the gate by two screws passing through it and the paper guide. The end of the brass strip presses on the paper below the driving roller, and is separated from contact with the paper guide by the paper when it is threaded through the camera.

The strip is connected to the signal lamp transformer and a lamp indicator through the sockets (23), the circuit being completed through the metal-work of the gate.

When the roll of paper is finished the strip makes contact with the guide and the lamp lights, showing that the end of the paper has passed through the camera.

The remaining drawings show the arrangement of gearing for driving the camera, which have been assembled in a separate unit. It is understood that the method of driving is left to the choice of the constructor as the camera unit is designed to be self-contained and minor modifications may be made to the drive mechanism without affecting its performance.

KEY TO FIGURES.

1. Stud for lid fixing nut.
2. Drive pressure adjusting lever. Rotates eccentric centre bush of ball race and alters drive pressure.
3. Ball race. Emulsion surface of paper presses directly on outer surface of this.
4. Locking nut for eccentric bush of (3).
5. 45° mirror reflecting time mark flashes on to edge of paper.
6. Fixing nut for lid of paper magazine. Stud to which this screws is a continuation of the paper spool spindle. This spindle screws out of a brass socket in the drive side of the camera for renewing the paper.
7. Narrow gate.
8. Outer ball bearing of drive spindle.
9. Perforator knob.
10. Perforator arm and point.
11. Counterplate for perforator to support paper.
12. Slotted spindle for paper take-up.
13. Plate pressing on velvet to adjust magazine exit light-trap.
14. Supplementary lens to shorten focal length of main time marker lens (16).
15. Pull off spring for perforator.
16. Time marker lens and shutter.
17. Drive side ball bearing of drive spindle.
18. Drive sprocket.
19. Spring drive belt to take up spindle.
20. Take up spindle.
21. Brass contact strip for indicating end of paper travel.
22. Ebonite Insulating block holding strip.
23. Sockets for connexion to lamp transformer.

A Direct Writing Oscillograph

The low frequency oscillograph employed in the Garceau Electroencephalograph has been made available as a separate unit for physical and industrial research and is known as the "Garceau Velograph."

It uses an electrically sensitive recording tape upon which a stylus produces a trace instantly visible as a well-contrasted dark line. This trace is permanent, requiring no processing or developing. The oscillograph element is said to be exceedingly rugged, using no crystals, permanent magnets, or moving coils.

Incorporated within the apparatus is a d.c. amplifier requiring an input of 30 volts peak-to-peak signal into a balanced impedance of 500,000 ohms for maximum deflexion of 1 in. peak to peak of the trace. The oscillogram is substantially linear with voltage and frequency over a range from 0 to approx. 74 c.p.s. It is critically damped by electrical means. The standard tape speed is 3 cm/sec. A power supply operating on 115 volts, 60 c.p.s. of approx. 130 watts incorporates the necessary rectifiers for the amplifier and polarising fields.

The instrument is a single channel model, but multiple instruments with up to 20 elements are available.

—(Electro-Medical Laboratory, Inc. Holliston, Mass.) Instruments, Vol. 15, No. 2, page 42. (1942).

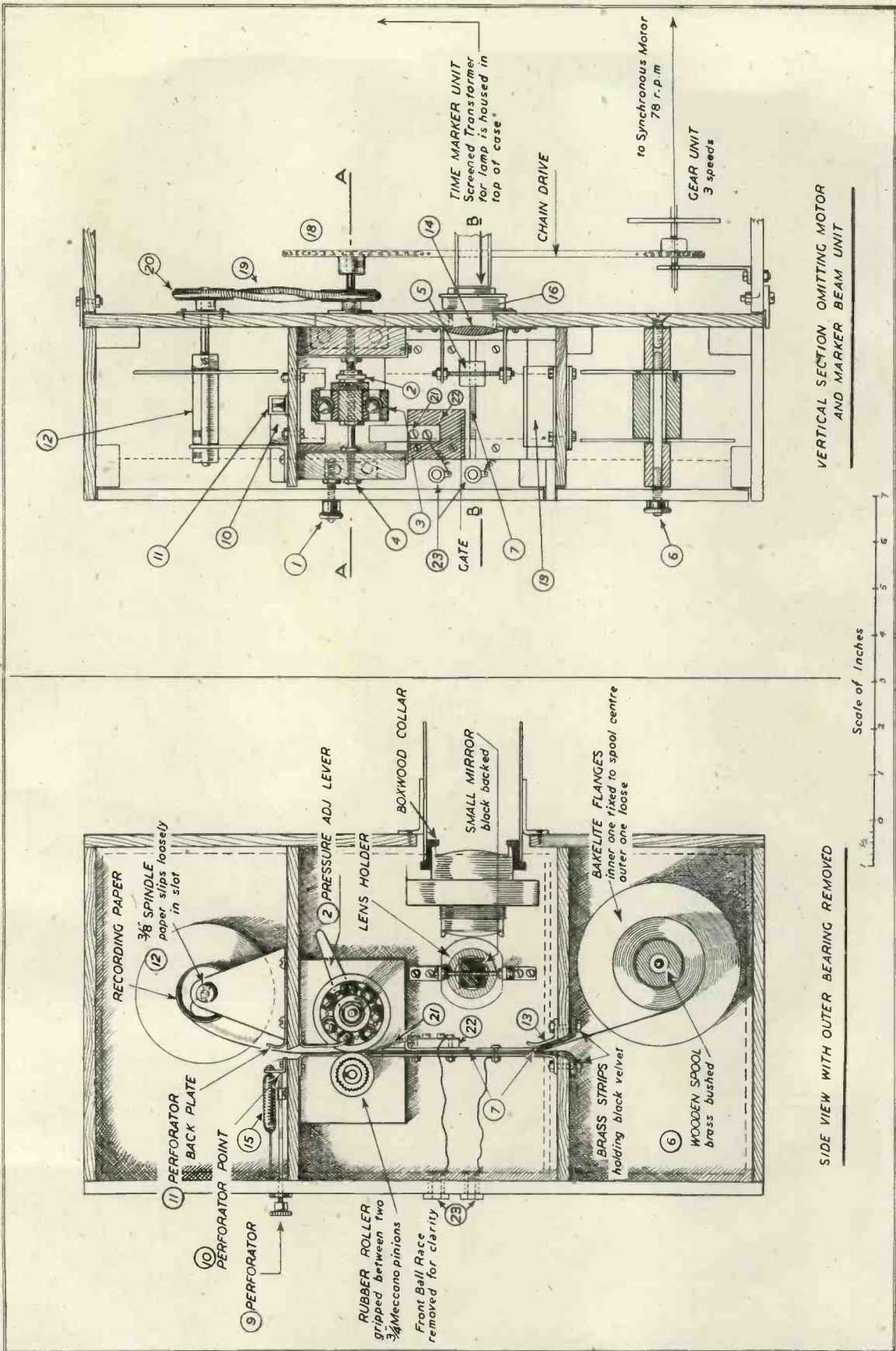

VERTICAL SECTION OMITTING MOTOR AND MARKER BEAM UNIT

SIDE VIEW WITH OUTER BEARING REMOVED

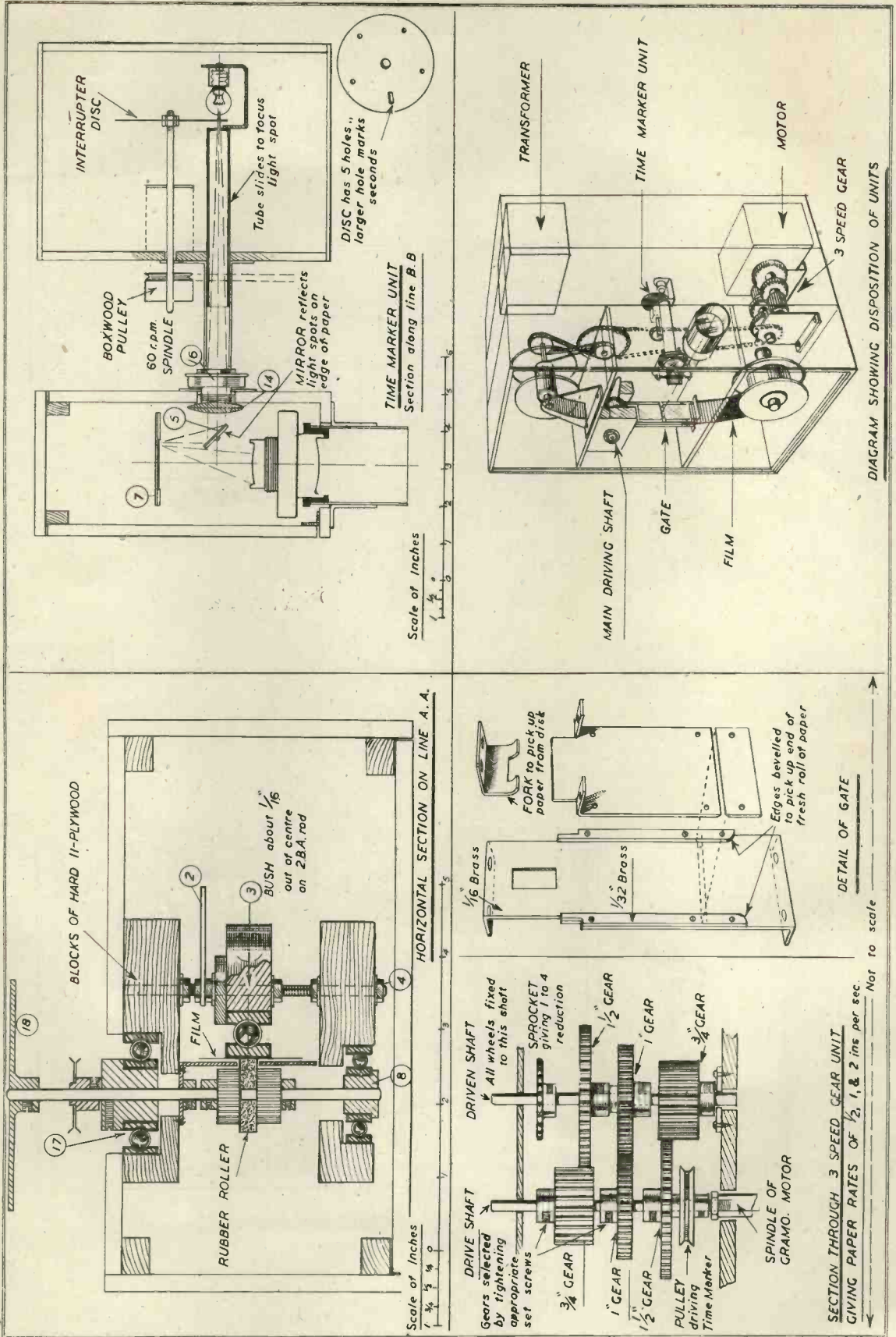

Logarithmic Charts and Circuit Performance

Part 2 By D. N. Truscott, Sc.D., Ph.D.*

In Part I of this article, which appeared in the May issue, the author described a graphical method of dealing with circuit problems using a logarithmic impedance-frequency chart. Further examples of circuits are given in this instalment, which should be read in conjunction with the chart given on p.744 of the May issue.

WE have already described a procedure to determine the impedance at all frequencies of the circuit resulting from the parallel connexion of two unlike circuit elements by the use of a standard curve whose position on the impedance chart is determined by the actual values of the two elements; but we have not dealt specifically with the procedure when the series or parallel connexion of two similar elements is required.

Parallel connexion of two similar elements

As far as the series connexion is concerned, there appears to be no simpler method than the mental addition of the two numerical values and the plotting of the sum as a line parallel to those of the components; this is obvious as two resistances in series remain a resistance.

In the case of parallel connexion we have to add the reciprocals of the values and take the reciprocal of the sum, an operation that can be done very straightforwardly, as will be shown, or which can be further simplified in detail by a slight modification of the direct method.

The method which will be described will be appreciated most easily by regarding the scales of the charts as forming parts of a slide rule. First we wish to find the reciprocals of the numerical values given; recall the slide rule "inverse" scale on which the numbers increase from right to left: to find the reciprocal of any number we set the cursor to the given quantity on the normal scale and read the reciprocal opposite it on the inverse scale. Applying this to the charts mark the numerical value of the element, then take a loose scale having the same scale of divisions as the scale of the element† and place it on the

chart so that it is parallel to the scale of the element, but with the numbers running backwards and then line up the ends of the scale with the unit and ten lines of the chart. The result of this is that we have exactly the condition of the slide rule with the inverse scale, and can read off the reciprocal of the quantity marked on the original chart on the loose scale.

We can do this with each of the two quantities involved, add figures read off the loose scale (which are the reciprocals) mentally and make a new mark on the chart opposite the value of the sum on the loose scale, this last operation automatically taking care of the second reciprocation. This method should be tried out and understood before proceeding with the

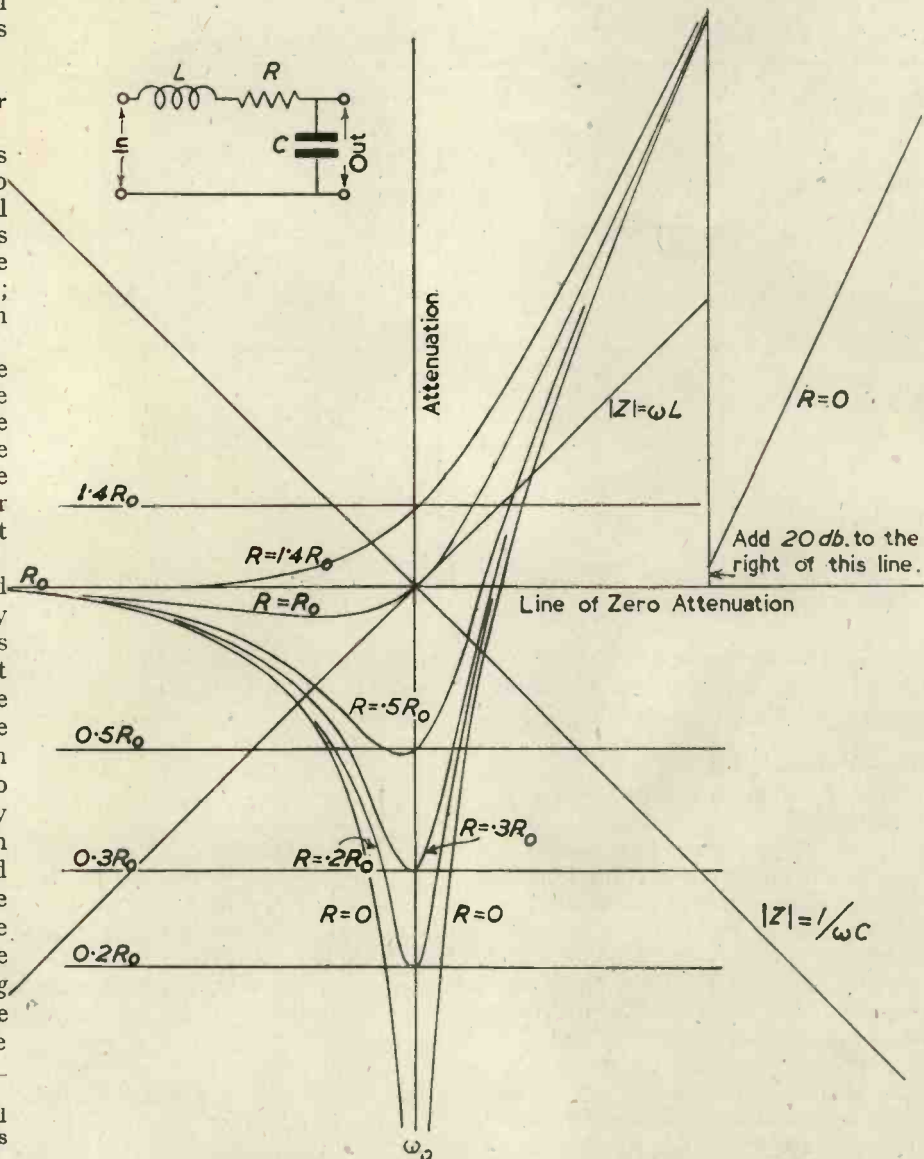
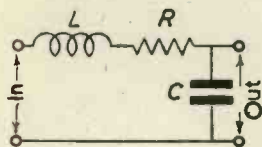
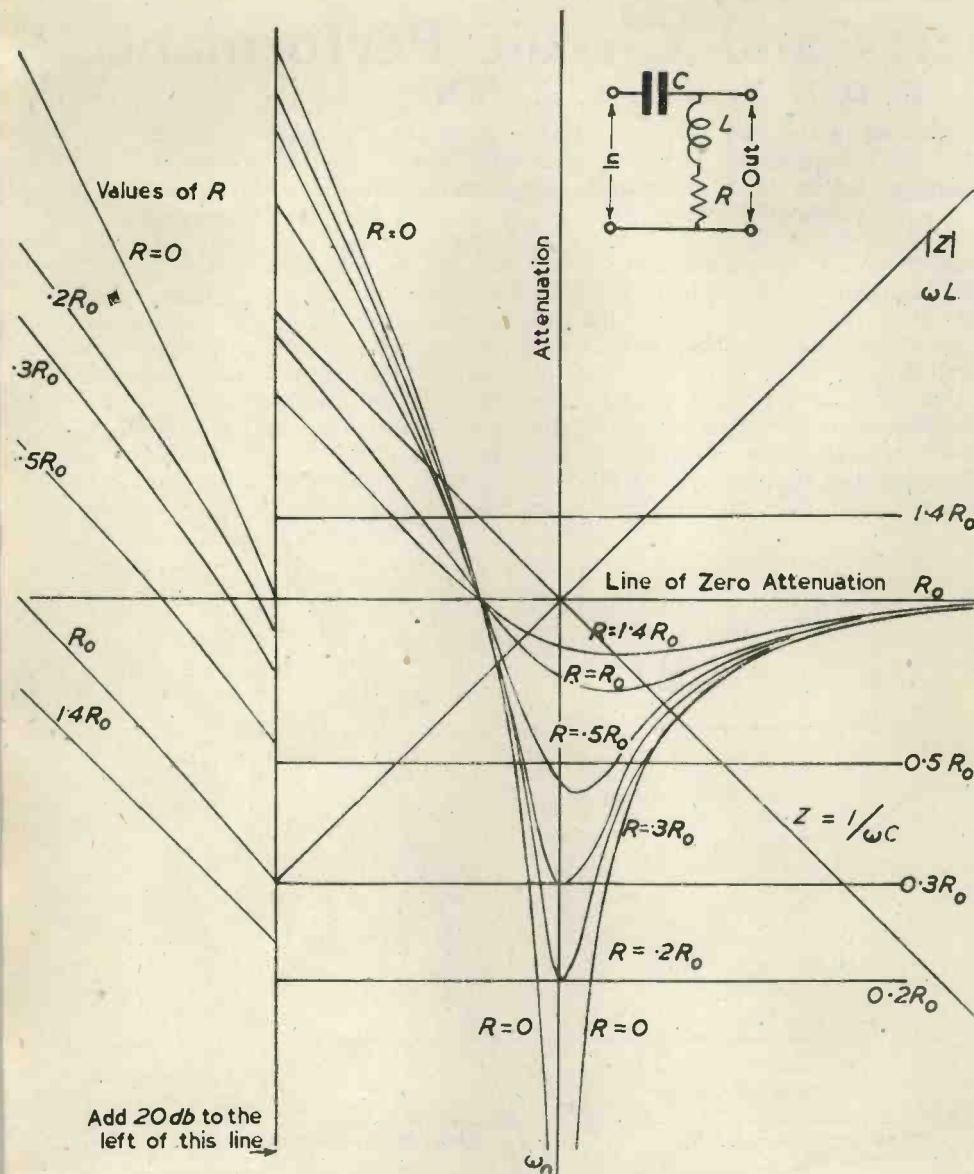

Fig. 8. Logarithmic Chart for attenuation of simple circuit shown, (scale as in logarithmic chart of Fig. 3, (Part I)).

* Ministry of Aircraft Production.

† One scale is required for resistances and a second for inductances and capacities whose scale length is 0.707 of the first, because the L and C lines are at 45° to the R lines.



In doing this on the charts we first mark R_1 and R_2 , next we place the loose scale on the chart exactly as described before, with the numbers running backwards compared to the original divisions of R to give us the reciprocals, but we place the unit division of the loose scale on the line corresponding to the greater of the two elements R_1, R_2 (say R_1). The mark on the scale opposite R_2 then gives us the ratio R_1/R_2 to which we add one and make a new mark on the chart at the point on the loose scale corresponding to this value; this represents exactly the left hand side of the equation, in which the negative sign is carried out by having the numbers on the loose scale running backwards, the finding of the ratio and adding one gives us the quantity in the bracket, and the taking of the logarithm of the whole is affected by the way in which the scales are divided. Placing the loose scale so that the end division (unity) corresponds to the value of R_1 effects the subtraction of $(\log R_1)$ from the right hand side.

Note.

The reader may be puzzled at first by the fact that we apparently add quantities by using logarithms, or at least logarithmic charts, and it should be made clear that this is not the case. It is because of the many advantages that follow from the use of charts having logarithmic scales of impedance and frequency in circuit work that we have had to devise simple methods of doing the addition of quantities which corresponds to the electrical connecting in series or parallel of resistances, etc. The standard curves of Figures 6 and 9 effect the addition for any two dissimilar elements in series or parallel, but where two resistances, capacities or inductances are involved as in the cases we have just described, the user has to perform the addition, though we have made this as simple as possible by a routine which breaks the process into its elements.

Figures 8 and 9 which are drawn to the same scale as Figure 3 (Part 1) give attenuation curves for two common circuit combinations.

Appendix (Examples)

A common problem is the compensation of an output which is not constant for different frequencies by an attenuating circuit. Take for example a gramophone pick-up giving the response shown in Fig. 10 (by the curve with circles marking measured points), on open circuit. It is desired to compensate for this over as wide a frequency range as is possible consistent with a maximum attenuation of 9 db at

Fig. 9. Chart for attenuation of simple circuit shown. (Scale as in logarithmic chart of Fig. 3. (Part 1). simplification described below because then the principles are the same in both.

Simpler Method

The objection to the basic method described lies in the need for mental addition of the two reciprocals, a step which admits a certain human element of error when the values are not integers, or contain two or more significant figures. The simplification that we shall describe is based on treating only the ratio of the two elements, choosing in effect as "unity" the value of the higher impedance, so that its reciprocal is unity, which can easily be added mentally to any other quantity to give the sum of the reciprocals.

Suppose we wish to evaluate R , the impedance of R_1 and R_2 in parallel;

$$\frac{1}{\frac{1}{R_1} + \frac{1}{R_2}} = R$$

$$\text{or } -\log \left(\frac{1}{R_1} + \frac{1}{R_2} \right) = \log R$$

which is the straightforward operation. In the simplified case we take R_1 as the unit thus; continuing from the last equation,

$$-\log \frac{1}{R_1} \left(1 + \frac{R_1}{R_2} \right) = \log R$$

and

$$-\log \left(1 + \frac{R_1}{R_2} \right) = \log R - \log R_1$$

500 c.p.s. The input impedance of the amplifier with which it is to work is high compared to 100,000 ohms.

If a series impedance is inserted between pickup and amplifier such that its attenuation follows the output characteristic of the pickup, the input to the amplifier will be level. The procedure is to redraw the output curve the permitted 9 db above the 100,000 ohm line which is chosen as a convenient output impedance. If, now, we consider the compensating circuit as a simple series connexion of an impedance Z_1 and make the total circuit impedance $(100,000 + Z_1)$ follow the redrawn output curve the result will have been achieved. This is effected by a series of approximations, using the standard curves already prepared (see dotted lines) and the steps are clearly shown by Figure 10.

Suppose now that there are objections to the use of the inductance 350 henries to compensate for the falling off in the bass (as there would be on account of stray capacity and cost) the same effect is produced by causing the impedance of the output Z_2 to rise and the alternative solution is given by the .01 condenser in series with Z_2 . The alternative solutions are given in Fig. 10 b and c.

The 100,000 ohm resistance is placed in series with the .0008 condenser to prevent the impedance of the series arm Z_1 from falling off continuously along the line marked .00058 mfd. With the series resistance it takes the course marked A B C D E, causing the attenuation to rise above 3,000 c.p.s. instead of approaching a constant value.

In case a more detailed explanation of the procedure is desired it is given below :

In solving a problem similar to the present the important thing to bear in mind is that the curves on the charts, though actual curves of impedance, are also curves of attenuation when the impedances are used as the elements of a potentiometer. We therefore set out to find the impedance curve which approximates to the given output voltage curve and then to read from the chart of Figure 5 the values of the impedance which give the desired curve. Applying this to Fig. 10, we draw the horizontal line at 100,000 ohms as representing a convenient output impedance. We are allowed 9 db. drop to this level and therefore draw the voltage curve of the pickup with its 500 c.p.s. point 9 db above the 100,000 ohm line.

Noting the general shape of the voltage curve and comparing with it the curves of Figs. 5 and 6, it will be seen that an impedance can be found to follow fairly closely along the region from 50-400 c.p.s. by having a total circuit resistance of 360,000 ohms, and an inductance of 350 henries. These two lines are drawn on Fig. 10 and the dotted line shows the resultant impedance. Turning now to the region from 500 c.p.s. upwards we find that with the same resistance of 360,000 ohms, a capacity of .00058 mfd will give a resultant curve fitting the original up to some 2,000 c.p.s. Note now that the 360,000 ohm line is the total impedance of the circuit. To obtain the series impedance we must subtract the 100,000 ohms already selected as output impedance. In order then to

obtain the total impedance curve marked A B C on the diagram it will be necessary to use a capacity of .0008 mfd as marked in a dotted line so that when added to 100,000 ohms it will follow the line A.B.C. This step is shown by the dotted line PR on Fig. 10.

The next step is to deal with the rise which occurs between 2,000 and 4,000 c.p.s. This may be done either by making the impedance of Z_1 rise or that of Z_2 fall. The latter is more convenient. There is a line marked on Fig. 10 of 7 henries which gives a resultant fitting reasonably well the rising characteristic subject to certain considerations which will be dealt with later. Notice that this line is actually in a direction so as to emphasise the rise and not to reduce it. This is because we propose to invert this line to get attenuation instead of gain about the 100,000 ohm line and have merely drawn it upwards so that we can see how well it fits the original curve. The inversion is done at a point L where the 7 henry line meets the 100,000 ohm line. This gives an impedance of .0007 mfd causing the output impedance to drop above 2,000 c.p.s.

Consider now the characteristic at high frequencies; the total impedance is following the line A B C and the output impedance the line M I K. These lines approach rapidly above 2,000 c.p.s. and therefore the attenuation is falling off here. This could only be prevented by maintaining the total impedance above the 100,000 ohm line. This is done by inserting a series resistance of 100,000 ohms to prevent the .0008 mfd condenser from taking charge. The

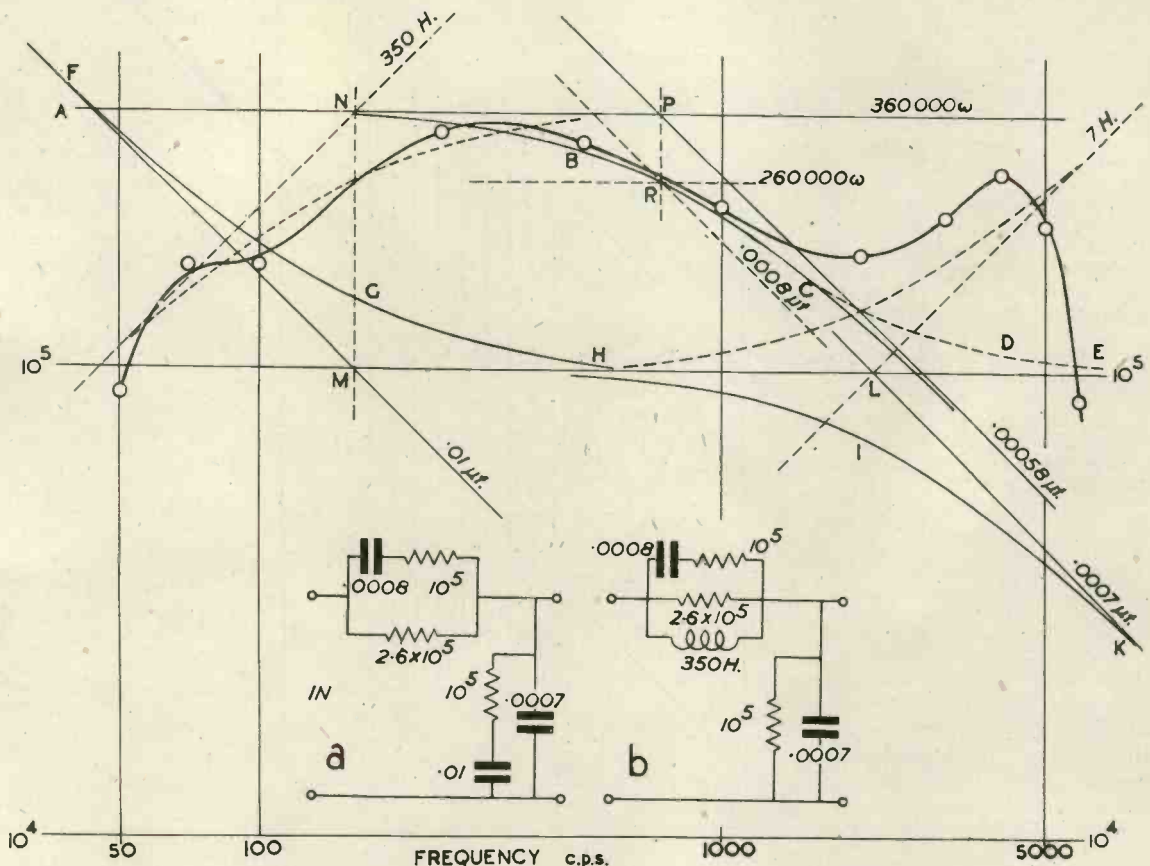
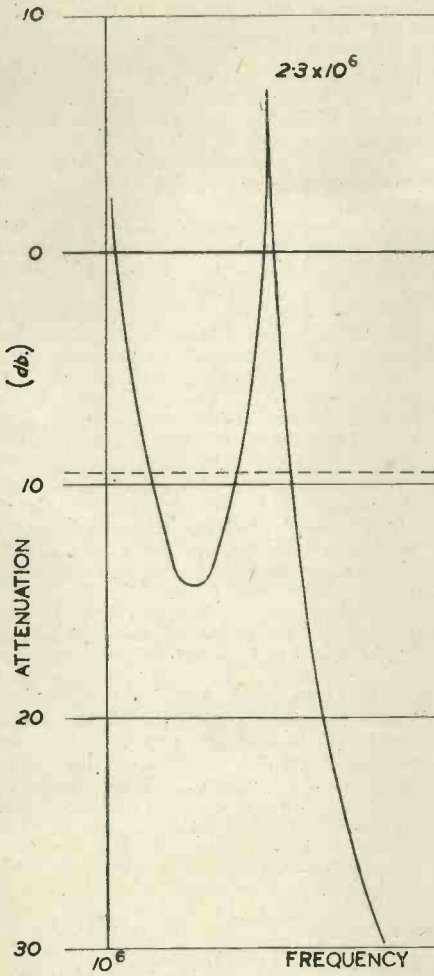

Fig. 10. a.b.c. Examples showing the determination of compensating circuit. (Not to the same scale as logarithmic chart of Fig. 3. (Part I).)



There are, of course, certain approximations in this solution which should be pointed out. In the first place, in the neighbourhood of the point F the total impedance has been assumed to be given by the line A N, whereas in point of fact it will have risen considerably above this because the horizontal line was obtained by assuming 100,000 ohm output. This may involve a small change to the capacity .01 mfd to effect complete bass compensation. In the region from 2,000 to 5,000 c.p.s. exact evaluation of the attenuation is difficult because it involves the addition of a number of curves. It is measured however within 2 db of the required characteristic and it will immediately be apparent that small changes in the two small capacities will enable any modification necessary to be made.

Analysis of Circuit Performance.

As an example, Figs. 11 and 12 show the steps in determining the attenuation of an aerial input circuit over a range of frequencies.

The grid circuit is tuned to 1 Mc/s. by the capacity 150 $\mu\mu\text{f}$ and the inductance 150 μH . The aerial coupling coil has inductance of 20 μH and there is mutual of 15 μH . The remaining elements are the standard dummy aerial.

Referring to Fig. 11, point B is the intersection of the impedance lines of the elements of the grid circuit. This circuit

attenuates voltages induced in the mutual inductance when the total impedance is greater than that of the capacity. The corresponding area is shaded vertically in the figure and at any given frequency the height of the shaded area gives the attenuation from the mutual inductance to the grid of the valve.

The next step is to determine the relation between the voltage at the source and that across the mutual inductance. The total impedance of the aerial circuit is given by the resonance curve about the point A given by the series capacity (100 $\mu\mu\text{f}$) and total inductance (45 μH). The voltage across the mutual inductance is $\frac{1}{3}$ rd that across the 45 μH , we may take the ratio as a constant attenuation and deal directly with the voltage across the 45 μH . This voltage exceeds the source voltage in the area shaded horizontally in Fig. 11, the vertical height of this shading gives the aerial circuit gain at any frequency. For the overall gain at the valve grid we have then to subtract the heights of the two shaded areas at various frequencies and add the constant attenuation of 3:1. This has been done with the result shown in Fig. 12, the crosses mark the points at which the graphical evaluation was made, the curve has not been determined elsewhere.

The interest of this example is the peak of overall gain at 2.3 megacycles due to the series resonance in the aerial circuit.

resultant total impedance follows the line A B C D E and the total attenuation will probably be within a reasonable distance of what is required. The circuit now stands as Fig. 10c and it will be realised at once that the 350 henry inductor would be impossible to realise in practice in view of the stringent requirements of stray capacity. We therefore revert to the diagram and note that if we were able to make the impedance of the output rise at the same rate as the impedance of the 350 henries cause the series arm to fall we should achieve the same overall effect. This could be done by taking that value of condenser which will give the same rise to the 100,000 ohm impedance when placed in series as the 350 henry choke caused the 360,000 ohm resistance to drop. To determine this value of capacity drop the line N M vertically and M thus determines the intersection of the required capacity with the 100,000 ohm line. The resulting impedance follows the line F G H I K and leads to the circuit shown in Fig. 10b.

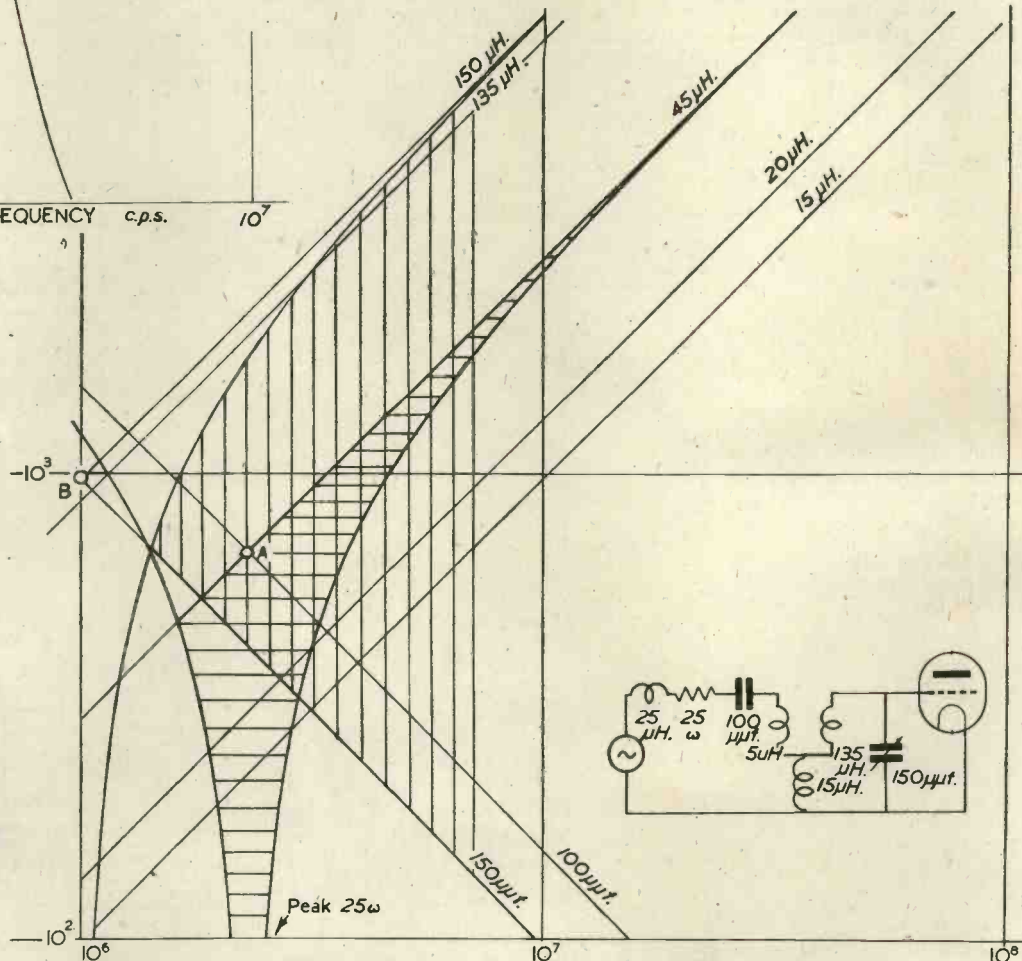

Fig. 11. (right). The determination of aerial circuit attenuation. (Not to the same scale as logarithmic chart of Fig. 3. (Part I).
Fig. 12. (above). The attenuation of an aerial circuit determined from Fig. 11.

Cathodic Sputtering

Its Nature and Effects

By C. P. HAIGH, B.Sc. (Hons.)

CATHODIC sputtering is a phenomenon occurring in discharge tubes when the cathode is bombarded by positive ions of the gas which have large values of kinetic energy. The action appears to be purely mechanical, the atomic ions are able to knock off atoms, or groups of atoms, from the cathode surface and so cause it to disintegrate. The effect is not to be confused with the vaporisation of the cathode material owing to the heat of the bombardment. Small particles are actually torn from the cathode by the incident ions, and normally these particles are deposited on the walls of the tube around the cathode, where blackening takes place.

Cathodic sputtering thus depends on the production of high energy positive ions within the discharge tube, and so it will only take place under conditions which present a powerful accelerating field to the ions. That is, conditions which favour large values of the cathode fall of potential such as glow discharges, and also small values of thermionic emission in hot cathode arcs. We shall proceed to discuss the former.

Consider a simple discharge tube consisting of two electrodes sealed into a cylindrical glass tube containing gas at a pressure of several millimetres of mercury. Application of a potential difference between the electrodes which is in excess of the breakdown voltage of the tube results in the formation of a glow discharge having the form shown in Fig. 1. Under special conditions an arc discharge may commence, but a glow discharge is more general.

Most of the fall in potential along the tube occurs in the space between the negative glow and the cathode—the so-called Crookes' Dark Space—and this steep potential gradient is known as the "cathode fall of potential." The potential distribution along the tube is also shown in Fig. 1. The normal cathode fall is characteristic of the gas and the material used for the cathode, and is independent of the current until the current is so large that the negative glow extends over the whole cathode surface. If the current is increased beyond this value the cathode fall of potential increases, giving rise to a region of abnormal cathode fall. Under these conditions positive ions proceeding to the cathode and passing through this steep potential gradient

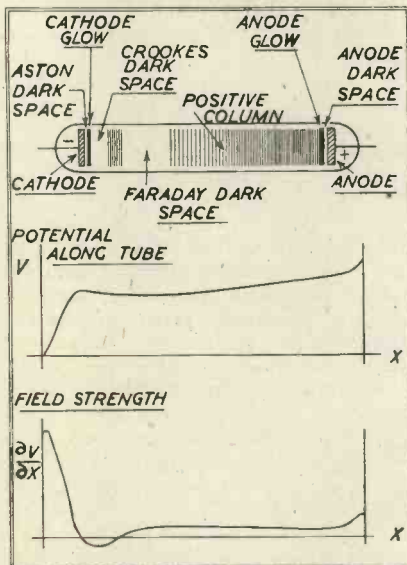

Fig. 1. Cold cathode discharge tube and characteristics. The distance between ordinates corresponds to the cathode-anode distance.

acquire a high kinetic energy and sputtering will take place. The best sputtering conditions, therefore, are those in which the cathode is entirely covered with glow.

The theory and mechanism of the discharge tube is well developed in many of the standard physical texts, and there is no need to go into further detail here.

Actually, the mechanism of sputtering is not well understood. It depends, as we have seen, on the impact of positive ions with the cathode, in which the sputtered metal is thrown off in considerable quantities. At lower ion energies the sputtered metal is largely in the atomic and uncharged form, and it has been demonstrated that particles coming from the cathode are neutral atoms at first, although they may subsequently acquire charges. Atoms detached with a cathode fall greater than 550 volts appear to be predominately positively charged.¹

The mass of the material, M , sputtered per second is given by an empirical relation

$$M = K(V_c - V_0) \quad \dots (1)$$

where V_0 and K are constants, and V_c is the cathode fall of potential. K is determined by the nature of the sputtered substance, the gas employed, and other physical constants of the apparatus. The dimensions of K are $M^{\frac{1}{2}}L^{-3}/^2T^2$. For most materials V_0 is considerably larger than the normal

cathode fall, values of V_0 ranging from 400 to 600 volts. It is obvious that V_c cannot be less than V_0 since this implies that no sputtering can take place. In order that M shall be positive we must work in the region of abnormal cathode fall where the current density is increased by covering the cathode with glow, and we have large values of V_c .

There is some evidence that with the higher values of V_c larger particles are torn from the cathode surface,² and it also seems apparent that gases such as helium, which are absorbed by the cathode material, do not sputter as effectively as those ions which cannot enter the cathode material. Some cases of abnormally vigorous sputtering are due to chemical interaction of the gas and the cathode surface.

It has been discovered that the rate of sputtering is not affected appreciably by the cathode temperature, but it does depend on the cathode material and the nature and pressure of the gas. Unfortunately, there is no simple relation between the amount of sputtering and the composition of the cathode, but we may write the following metals in ascending order of ease of sputtering:—

Mg, Al, W, Fe, Ni, Pt, Cu, Ag.

Thus, silver and copper are easily sputtered, whilst nickel and tungsten present more difficulty. It is almost impossible to sputter aluminium, and for this reason it is employed in sputtering apparatus where metal parts are required inside the discharge chamber. It is found that any metal present in the chamber—as distinct from the cathode—tends to take part in the action, and so it is important to use for any auxiliary parts a material which can only be sputtered with difficulty. In particular, aluminium is especially useful for constructing anodes.

In general, positive ions are more effective in the order of increasing atomic weight, as would be expected from the foregoing discussion. Argon, for example, is more effective than neon, but there are many exceptions to this rule, especially when we consider metallic ions. In particular, hydrogen is an outstanding exception which gives rise to abnormally large sputtering.

Güntherschulze has also shown that the sputtered mass M is governed by the relation

$$Mpd = C \quad \dots (2)$$

where C is a constant, p is the gas pressure, and d the separation of the electrodes. This expression is essentially the same as (1), but shows the variation of M with two measurable quantities which are assumed constant and form part of K in (1). p enters the expression since the mean free path, λ , is inversely proportional to the pressure, and this affects the diffusion of the sputtered metal atoms from the cathode. The value of C is directly proportional to the cathode fall of potential, V_c .³ Under certain conditions, and within a limited range, M is proportional to the energy dissipated in the discharge, and within this range we may conveniently estimate the mass of the deposit from a measure of the energy used in producing it, all variable factors being kept constant. Thus we have $M = kE$ where k is a constant of the apparatus which may be found from experiment, and E is the energy consumed. It is convenient to measure E in joules.

There is some similarity between electrolysis and cathodic sputtering, although this is by no means fundamental. The analogy will be discussed later when we have reviewed the practical aspect of depositing metallic films by cathodic sputtering.

Applications of Sputtering

As an applied science cathodic sputtering is still in its infancy, but there are now several industrial processes in which it plays a prominent part. The possibilities of sputtering have not yet been fully investigated, but there is no doubt that it will be more fully exploited in the future.

One effect of sputtering is a gradual clearing up of the gas in the discharge tube, the effect occurring to varying degrees with the different gases. In particular this absorption effect is least in the case of the inert gases, and this suggests a method—which has actually been employed—for the purifying of inert gases. The impure gas is sealed into a glass tube which contains electrodes of a chemically active material such as potassium or a liquid alloy of sodium and potassium. The gas pressure is maintained relatively high so that a substantial current passes through the gas during the discharge. The impurities are speedily removed, being absorbed mainly by the electrodes, and there is a negligible loss of inert gas. The method is obviously a small scale one owing to the small mass of gas which can be enclosed in an apparatus of reasonable size at the necessary pressure, which is not greater than 5 to 10 centimetres of mercury at the extreme. It is used, however, in discharge tube manufacture to remove traces of air which may have

leaked into the tube during sealing. The discharge must not be continued too long since the inert gas will be removed gradually, and so it is usual to determine when the offending gases have been removed by some spectroscopic method.

Deposition of Metallic Films

Since in cathodic sputtering we are concerned with a detachment of the cathode material it is obvious that if some control of the cathode disintegration were employed it might be possible to deposit the cathode material on a suitable base in a similar way to electrolysis. Actually, controlled sputtering is easily carried out, and the method is a most excellent one for coating surfaces with any substance which is not difficult to sputter. A wide variety of suitable apparatus is possible, but variation is mainly in detail, and it is proposed to discuss the basic requirements necessary to produce sputtered metal films.

The essential parts are shown in Fig. 2. B, is an air-tight glass chamber enclosing the anode, A, and the cathode, C, which are disposed as shown, leads to them being sealed

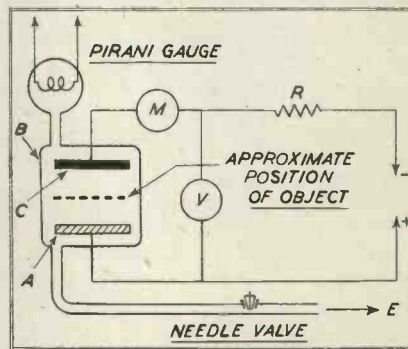

Fig. 2. Diagram of basic apparatus for sputtering.

through the glass walls. The anode is made of aluminium and the cathode of the material required as a deposit. The cathode need not be homogeneous, as in the case of expensive metals such as gold, where a gold plated aluminium cathode would normally be employed. The chamber is connected at E to an air pump whose efficiency depends upon the type of gas which will be used. The choice of gas is dependent upon the cathode material. For stable metals such as gold, silver, or platinum, air is quite satisfactory, and its use simplifies the process considerably. Other substances, such as carbon, oxidise easily in air as they come down in molecular form, and for these an inert gas must be used. If we can employ air, then the vacuum pump can be of the rotary type capable of producing a vacuum of 0.05 millimetres

of mercury which is as low a pressure as will be necessary in most cases. When an inert gas is employed the chamber must first be thoroughly pumped out before the inert gas is introduced. This requires a condensation pump as well as a rotary pump to produce the necessary fore-vacuum. There is then the added difficulty of introducing the inert gas, and maintaining the pressure reasonably constant throughout the process.

A Pirani Gauge is a convenient instrument for measuring the degree of vacuum in the chamber, and the instrument is sealed into the chamber at a suitable place. This type of pressure gauge is automatic over its entire range, is sufficiently accurate over a range of pressures which we are likely to employ, and as it possesses only a small inertia it is very suitable for indicating and measuring the small but fairly rapid fluctuations in pressure which occur in this type of work. The gas pressure is not very critical, and normally the gauge is regarded as an indicator of the approximate condition of the chamber before the discharge is started. A control of pressure is affected by means of a valve of the needle type which is incorporated in the vacuum system and enables fine adjustment of pressure, and compensation for pressure fluctuations due to heating and cleaning up of the gas.

The electrical circuit is simple consisting of a high resistance voltmeter, V, a current measuring instrument, M, a fixed series resistance, R, and a source of direct current supplying up to 1,000 volts. The resistance, R, is for stabilisation and has a value of several thousand ohms, largely depending on the size of the apparatus and hence the current flowing between the electrodes. A good general rule is that the voltage drop across R should be roughly a third of that across the chamber. This condition gives fairly steady currents.

The object to be coated is placed between the two electrodes with the surface to be coated facing the cathode. The gas pressure chosen is such that the negative glow lies wholly above the object, a consideration which determines the position of the object in the normal way. The current, and hence the rate of sputtering, is a function of the pressure which in its turn decides the position of the negative glow. The pressure is fixed so as to determine the rate of sputtering, and then the object to be coated is arranged to be on the anode side of the negative glow. The cathode must be at least as large as the object to be coated, but preferably somewhat smaller than the anode, although this is a matter for experiment.

The applied voltage and the current

depend largely on the speed at which the deposit is to be formed, although as previously stated, the applied voltage must exceed a minimum characteristic of the cathode material. The amount of cathode heating which can be tolerated must be taken into account, since the cathode must not approach melting point. In general, high rates of sputtering are desirable and it may be necessary in some cases to use a liquid cooled cathode. These problems, however, must be solved for the type of apparatus employed, and only general statements can be made here. In the case of gold, an anode to cathode potential of 800-1,000 volts is roughly correct, and the current should not exceed 1 ampere per square foot of the cathode surface.

During the discharge material is not only deposited on the object, but on the walls of the chamber and the anode, which means that the sputtered metal is not all usefully employed. The effect also complicates any absolute calculation of the mass deposited per coulomb on a unit area of the object surface, since each apparatus must be treated as a unique case. As a result of very careful investigation it has been found that for a given arrangement the mass per unit area per coulomb is always constant, and this enables an exact duplication of results to be achieved by a measurement of energy in a manner similar to that for electrolysis. The deposit on the chamber walls must be removed frequently since it is liable ultimately to produce a short circuit between anode and cathode.

Fig. 3 shows a practical form of the apparatus in which the anode forms the base and is earthed. The vacuum line is sealed through the centre of the anode, and two taps are provided, one to open the chamber to the pump, and the other to allow entrance of air when the process is complete. The Pirani Gauge and needle valve are not inserted directly into the chamber, but sealed into the external vacuum pipe as near to the chamber as possible. The cathode is the upper electrode and screws on to a threaded rod which is sealed through the top of the chamber. This chamber takes the form of an inverted glass bell jar made of pyrex or boro-silicate glass. The joint between the glass chamber and the aluminium anode is ground and made air-tight with vacuum grease. This construction enables the chamber to be removed easily for replacement of the object which is supported on glass blocks resting on the anode.

Notes on Technique

The pressure of the gas in the chamber is best found by experiment, subject to the condition that the negative

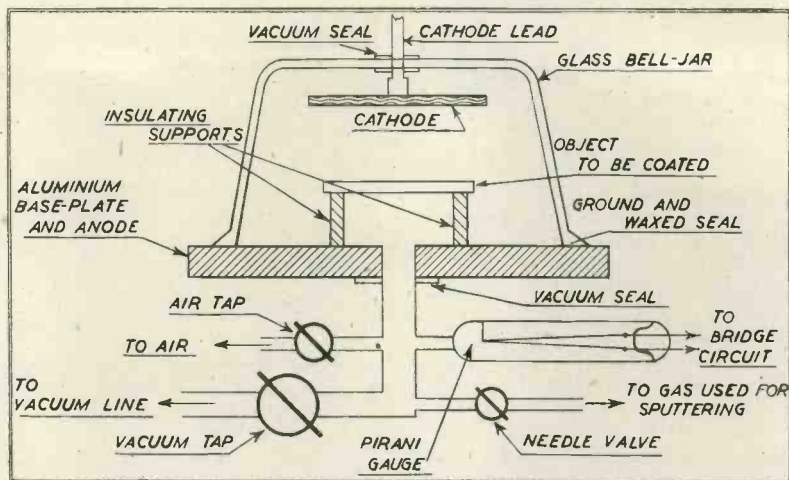

Fig. 3. A practical form of sputtering apparatus.

glow is nearer to the cathode than the object to be coated. A usual working pressure for a small chamber lies between 0.05 and 0.1 millimetres of mercury, but the normal procedure is to decide upon the current to be employed, and allow this to dictate the gas pressure and the position of the object with respect to the cathode. During the discharge the current may be maintained very constant by a slight manipulation of the needle valve if this is found necessary, but provided that the value of R is sufficiently large there should be no appreciable current drift.

The current through the chamber immediately the discharge begins is momentarily high, but this falls to a lower and more stable value during the first few seconds. In a calculation of the energy dissipated this initial current surge may be neglected.

In cases where undue cathode heating is encountered the sputtering can be carried out in a series of steps with a suitable interval between each to allow for cooling. Alternatively, a cooled cathode might be used, although this is usually a cumbersome procedure.

Comparison of the Method with Electrolysis

We are now in a position to compare electrolytic methods of depositing metals with those of cathodic sputtering. Each method has its own particular applications, and a comparison will enable us to see the best and most economical way of attacking any specific problem.

In electrolysis two electrodes are immersed in an aqueous solution of some salt of the metal to be deposited, and one electrode—the anode—is made of the same material. The second electrode or cathode, comprises the object to be coated and must have conducting properties or else be ren-

dered conducting by treatment, for example, with graphite. The amount of auxiliary apparatus required is small, and the whole of the deposit is formed on the cathode. The mass of the deposit can be estimated from a knowledge of the quantity of electricity used during the process, and the results obtained are dependable, easily reproduced, and simple to control within fine limits.

Cathodic sputtering requires no electrolyte, and the base on to which the film is deposited need not be conducting since it is independent of the electrodes. In addition, the method is clean, capable of fine control, and does not give rise to the evolution of poisonous fumes. Auxiliary equipment of an expensive nature is necessary, and there is the added disadvantage of working at low pressures. Broadly speaking it will only be economical to use sputtering in cases where we cannot resort to electrolysis, *i.e.*, cases where the object is non-conducting and the presence of a conducting film as an aid to electrolysis is undesirable, or where the object must not come in contact with water. Other specific considerations may also make the choice of sputtering essential. For example, the method is an excellent one for producing extremely thin metallic films, and although these can be formed electrolytically there is a danger of damaging them during subsequent washing and drying. Such a film obtained in a sputtering chamber requires no further attention at the end of the discharge.

It must be remembered, however, that there are other methods of depositing material coatings on surfaces, especially in the case of metals. These include vaporisation of the substance and condensation on the cold surface, painting with colloidal solutions, and chemical precipitation. The common silver surfaced mirror, for example,

may be made either by a vaporisation process or by chemical precipitation. Painting or spraying a surface is on a more macroscopic scale and yields results in a different category, and with a different field of application.

The quantitative aspect of electrolysis is summarised in the two laws due to Faraday. The first postulates a direct proportionality between the mass of the deposit and the quantity of electricity used in its formation, and gives rise to the "Electrochemical Equivalent" (or E.C.E.) of a substance, a term used to denote the mass of a substance deposited by unit quantity of electricity. The second law really states the relation between the E.C.E. of a substance and its chemical equivalent, and leads to a definition of a quantity of electricity, the Faraday, equal to 96,500 coulombs, which will deposit the equivalent weight in grammes of any substance.

There are no such simple relations in the case of cathodic sputtering. Subject to the condition that the gas pressure, applied voltage, and electrode spacing are kept constant, we may establish a similar law to the first law of electrolysis. That is, the mass of the deposit is directly proportional to the quantity of electricity used during the process; but it must be remembered that the electrolysis case is independent of any constant conditions.

There is some similarity in the two processes in that both require a minimum voltage to start the action, but whereas this is of the order of a few volts in the case of electrolysis, no sputtering will take place until the applied potential reaches several hundred volts.

The figures below are due to Güntherschulze, and show the mass of sputtered metal deposited in a discharge through hydrogen with a potential $V_c = 850$ volts. Owing to the extreme difficulty of collecting the whole of the deposit such measurements are made by determining the loss in mass of the cathode.

These values form a measure of a quantity analogous to electrochemical equivalent, but it is apparent from a mere inspection that in this case there is no simple connexion with the chemical equivalent. This is not surprising when we consider the mechanism underlying the two processes.

It is interesting to compare the

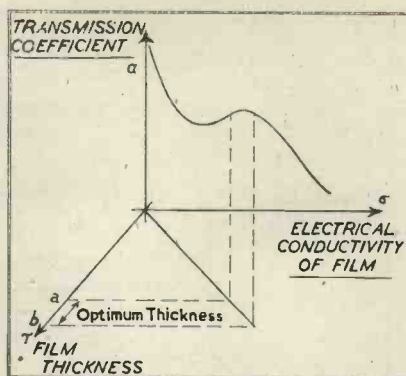

Fig. 4. Properties of conducting film in selenium barrier layer cell.

magnitudes of the E.C.E. and the analogous quantity involved in cathodic sputtering. Values of E.C.E. for the various elements are also shown in the table below, and we note that the E.C.E. is the larger in all cases. Thus 1 coulomb deposits 0.0011183 grammes of silver electrolytically, and 0.000205 grammes by sputtering. In this case electrolysis is more than five times as efficient as sputtering from an energy standpoint. Remembering also that only a proportion of the detached material obtained by sputtering forms a useful deposit, we see that the sputtering method may require ten or more times the quantity of electricity required in a voltameter to deposit a given mass of silver on a given surface. Silver, too, is one of the more favourable metals for cathodic sputtering. The question of energy is an important consideration when large amounts of material are to be deposited.

From the above discussion it appears that electrolysis has overwhelming advantages in the majority of processes, especially those on a more macroscopic scale. Cathodic sputtering would never be used for example for chromium-plating metal parts, but it has special applications which cannot be attempted successfully by any other method.

In conclusion it is proposed to discuss one industrial process employing sputtered films. This is the manufacture of photo-voltaic cells of the barrier layer variety. The make-up of these cells is well known, consisting of an iron plate A, on which is coated a layer of metallic selenium B. On the upper surface of this is formed the barrier layer

of selenium oxide a few molecular diameters thick. A forms the positive electrode, and the negative electrode takes the form of a translucent metallic film in immediate contact with the upper surface of the barrier layer. This film must obviously combine a high electrical conductivity with a low absorption coefficient, and for this reason it is usually of gold or platinum, and is deposited by cathodic sputtering in a manner similar to that previously described. The use of gold makes the spectral response of the cell approximate to that of the eye.

One interesting fact which arises is that there is an optimum thickness of this film as shown by the curve of Fig. 4. This shows the variation in the transmission coefficient, α , with the film conductivity, the latter being roughly proportional to the film thickness. The correct film thickness lies between the limits a to b, and it is found that the highest output is obtained from a cell with this particular coating.

An alternative method of producing the upper electrode is by vaporisation, but this may give rise to local heating of the delicate barrier layer, and cannot be controlled within such fine limits as the sputtered film. Electrolysis is ruled out since the cell must not be immersed in water, and painting or spraying cannot be employed owing to the fragile nature of the film required. The optimum film is only of the order of one micron thick, and so the method of formation must obviously be very sensitive. The extremely small size of the particles constituting the sputtered film does, however, introduce a complication in that the gold particles penetrate the minute interstices of the barrier layer giving rise to a partial short circuit which yields a low resistance cell. The effect of this is to reduce the voltage output of the cell considerably, and for such barrier layers vaporisation may appear to provide a better solution of the problem. The use of specially prepared barrier layers in conjunction with a sputtered film is undoubtedly the best and most efficient method.

BIBLIOGRAPHY.

- 1 Von Hippel—*Ann. Physik* 80, 672, 1926.
- 2 Kingdom and Langmuir—*Physical Review* 22, 148, 357, 1923.
- 3 A. Güntherschulze—*Z. Physik* 38, 575, 1926.

Metal	Mg	Ta	Cr	Al	Cd	Mn	Mo	Co	W	Ni	Fe	Sn	C	Cu	Zn	Pb	Au	Ag
Sputtered																		
Mass	2.5	4.5	7.5	8.0	8.9	11.0	16.0	16.0	16.0	18.0	19.0	55.0	73.0	84.0	95.0	110.0	130.0	205.0
E.C.E.	125.9	378.3	180.1 or 90.1	93.6	579.8	142.4	165.8	203.4	317.7	or 199.7	290.2 or 193.4	616.6 or 308.3	31.08	329.5	338.7	1071.7	681.2	1118.3

Units are 10^{-6} Grammes, Coulombs⁻¹

DATA SHEETS XXXII & XXXIII.

The Inductance of Single Layer Solenoids on Square and Rectangular Formers

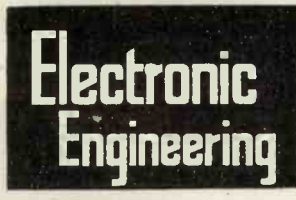

THE design of single layer-solenoids on circular formers was covered in Data Sheets Nos. 12 to 17. For frame aerials it is, however, general practice to employ either square or rectangular formers with the winding arranged either in the form of a single layer or a flat pancake.

For the same reasons as were given in the above Data Sheets, the majority of the formulae below are only highly accurate at very low frequencies.

The Bureau of Standards Circular C.74 gives the following formulae for coils wound with round wire of zero permeability.

and *B* will be found plotted on Data Sheets 12 and 13, or can be computed as follows:—

$$A = \log_e (1.745 S)$$
$$B = 0.336 \left(1 - \frac{2.5}{N} + \frac{3.8}{N^2} \right) \text{ to } 1\% \text{ for } N > 5$$

The above formula would give *B* a value about 5 per cent. too high for *N* = 4; for lower values of *N* the Data Sheet or tables of *B* must be consulted. *Flat Pancake.* Use equations (2) and (4) but take *a* = *a*₀ - (*N* - 1)*p* where *a*₀ is the length of the side of the square measured between centres of the two outside wires, (see Data Sheet No. 3) or *a* = *a*_i + (*N* + 1)*p* where *a*_i is the length of the side of the square measured between centres of the two inside wires. For greater accuracy replace 0.2231 by 0.2235 in Equation (2).

Rectangular Coils

Single Turn. (High Frequency).

$$L = 0.004 \left\{ (a_1 + a_2) \log_e \frac{4 a_1 a_2}{d} - a_1 \log_e (a_1 + g) - a_2 \log_e (a_2 + g) + 2(g - a_1 - a_2) + d \right\} \mu H \quad (5)$$

Single Layer.

$$L_s = 0.004 N^2 \left\{ (a_1 + a_2) \log_e \frac{2 a_1 a_2}{b} - a_1 \log_e (a_1 + g) - a_2 \log_e (a_2 + g) + 2g + 0.447 b - \frac{a_1 + a_2}{2} \right\} \mu H \quad (6)$$

as before $L_0 = L_s \left(1 - \frac{\Delta L}{L_s} \right)$ where

$$\Delta L = 0.004 (a_1 + a_2) N (A + B) \mu H \quad (7)$$
$$g = \sqrt{(a_1)^2 + (a_2)^2} \quad (8)$$

and *a*₁ and *a*₂ are the lengths of the two sides between wire centres in cms. *Flat Pancake.* Use equations (6) and (7) but take *a*₁ = *a*₀' - (*N* - 1)*p* and *a*₂ = *a*₀' - (*N* - 1)*p* where *a*₀' and *a*₀' are the lengths in cms. of the two sides of the rectangle measured between the centres of the two outside wires.

Data Sheet No. 32

The inductance of a square coil as given by equations (1) and (2) can be obtained from Data Sheet No. 32, where equation (1) is expressed as *L* = *aK*₁ and (2) as *L*_s = *aN*²*K*₂. The factors *K*₁ and *K*₂ are plotted against the parameters *a/d* and *a/b* respectively.

Example 1. To find the inductance of a single-turn square coil of 30 cm. (12") side, wound with No. 20 SWG wire: *d* = 0.914 mm. *a/d* = 30/0.0914 = 328 and therefore *K*₁ = 0.0457 and *L* = 30 × 0.0457 = 1.371 μH.

Data Sheet No. 33

In order to reduce the labour involved in determining whether or what order of correction is required for the term Δ*L*/*L*_s in equation (3) Data Sheet 33 has been prepared.

If we designate by "x" the required percentage accuracy, i.e., the value of Δ*L*/*L*_s as a percentage

$$\frac{x}{100} = \frac{A + B}{N \left[\log_e \frac{a}{b} + 0.2231 \frac{b}{a} + 0.726 \right]}{\log_e \frac{a}{b} + 0.2231 \frac{b}{a} + 0.726} \quad (9)$$
$$\frac{x}{100} \left[\log_e \frac{a}{b} + 0.2231 \frac{b}{a} + 0.726 \right] = \frac{A + B}{N} \quad (10)$$

Square Coil

$$L = 0.008 a \left[\log_e \frac{2a}{d} + \frac{d}{2a} - 0.774 \right] \mu H \quad (1)$$

$$L_s = 0.008 a N^2 \left[\log_e \frac{a}{b} + 0.2231 \frac{b}{a} + 0.726 \right] \mu H \quad (2)$$

$$L_0 = L_s - \Delta L = L_s \left(1 - \frac{\Delta L}{L_s} \right) \quad (3)$$

$$\Delta L = 0.008 a N (A + B) \mu H \quad (4)$$

where *a* = length of side of square to wire centre in cms.

d = diameter of bare wire in cms.

N = total number of complete turns.

b = *Np* = width of winding in cms.

p = *b/N* = pitch of winding in cms.

S = *d/p*.

Equations (2) and (6) are only accurate for small values of *b/a*.

In the above equations *L*_s is the "Current Sheet" inductance which is the inductance of a coil wound with turns consisting of infinitely thin tape lying edge to edge with an infinitely small separation between the edges. However, as in practice round wires with some separation are normally employed, a correction becomes necessary. This correction is shown in equations (3) and (4) by the term Δ*L*. In equation (4) the factor *A* takes into account the difference in the self-inductance of a turn of wire from that of a turn of the current sheet, while the factor *B* corrects for the difference in the mutual inductance between the turns of the coil and those of the current sheet. The factors *A*

For any given value of "x" the value of X representing the left-hand side of equation (10) can be plotted with *a/b* as a variable. Similarly, for any value of *S* = *d/p* = *dN/b* the value of *Y* = (*A* + *B*)/*N* can be plotted with *N* as a variable.

This procedure has been adopted in Data Sheet 33 where X is shown by the full line curves for values of *x* between 1 per cent. and 10 per cent. The value of *Y* when positive is shown by the full line curves and when negative by the broken line curves.

Example 2. To find the inductance of a 5-turn single-layer square coil of No. 20 SWG wire wound in a space of *b* = 1.53 cms. with *a* = 30 cms. Therefore *p* = 1.53/5 = 0.306 cms. and *S* = 0.0914/0.306 ≈ 0.3 *a/b* = 30/1.53 = 19.6. From Data Sheet 32 *K*₂ = 0.0297 and *L*_s = 30 × 25 × 0.0297 ≈ 22.3 μH and from Data Sheet 33 *x* = 100 Δ*L*/*L*_s ≈ -2.3 and so *L*₀ ≈ 22.3

$[1 - (-2.3/100)] \approx 22.8 \mu\text{H}$. Alternatively, we have from (4) $\Delta L = 0.008 \times 30 \times 5 (-0.647 + 0.218) = -0.515 \mu\text{H}$ (using Data Sheets No. 12 and 13) and therefore $L_0 = 22.3 - (-0.515) = 22.8 \mu\text{H}$.

Example 3. To find the inductance of a flat square coil wound on a slotted former with length of side of 22.8 cm. (9 in.) the winding consisting of 20 turns of No. 20 D.S.C. wire wound in a depth of 2.14 cms. $p = (2.14 - \delta)/20 = 0.102$; $S = 0.0914/0.102 \approx 0.9$; $b = 2.14 - \delta = 2.04$; $a_0 = 2.28 + 2(2.14) - \delta \approx 27$ cms. where δ is the diameter of the covered wire: 0.1 cms. approximately. Therefore $a = 27 - (20 - 1) \times 0.102 \approx 25$ cms. and $a/b = 12.25$.

$L_s = 25 \times 400 \times 0.026 = 260 \mu\text{H}$. From Data Sheet 32 it will be seen that x is a little over 1 and therefore L_0 will be just over 1 per cent. smaller than L_s .

Two Section Flat Pancake Coils

When building frame aerials for the reception of the longer wavelengths, the use of a single flat winding will necessitate fine wire being employed unless an excessive winding depth is permitted. A much better proposition is to employ two (or more) similar flat pancake sections connected in series and placed a short distance apart, as this will enable a reasonable winding depth to be maintained. To calculate the total inductance of two such sections placed q cms. apart (measured between wire centres), we first calculate the inductance of the single section as described above.

Next we calculate the mutual inductance between the two sections; the total inductance of the two coils in series is then given by

$$L_T = (L_1 + L_2 + 2M) \quad \dots (11)$$

Mutual Inductance between Two Equal Parallel Square Flat Coils.

$$M = 0.008 N_1 N_2 \left\{ a \log_e \left[\frac{a + \sqrt{a^2 + h^2}}{a + \sqrt{2a^2 + h^2}} \times \frac{\sqrt{a^2 + h^2}}{h} \right] + \sqrt{2a^2 + h^2} - 2\sqrt{a^2 + h^2} + h \right\} \mu\text{H} \quad \dots (12)$$

where N_1 and N_2 are the number of turns in the two coils and a is defined above for a flat pancake coil.

$$h = kb \text{ when } \frac{q}{b} \text{ is small} \quad \dots (13)$$

$$\text{where } \log_e k = \frac{q^2}{b^2} \log_e \frac{q}{b} + \pi \frac{q}{b} - \frac{3}{2} \left(1 + \frac{q^2}{b^2} \right) - \frac{1}{12} \frac{q^4}{b^4} \quad \dots (14)$$

When $\frac{q}{b}$ is not small, h will have to be calculated from

$$\log_e h = \frac{q^2}{b^2} \log_e q + \frac{1}{2} \left(1 - \frac{q^2}{b^2} \right) \log_e (b^2 + q^2) + 2 \frac{q}{b} \tan^{-1} \frac{b}{q} - \frac{3}{2} \quad \dots (15)$$

When $a^2 \gg h^2$ equation (12) reduces to

$$M \approx 0.008 N^2 a \left\{ \log_e \frac{a}{h} + \frac{h}{a} - 0.653 \right\} \mu\text{H} \quad \dots (16)$$

Example 4. To find the inductance of a square coil wound in two slots in the form of flat pancake sections with a separation of 0.625 cm. ($\frac{1}{4}$ in.) between wire centres, each section consisting of 29 turns of No. 29 SWG D.S.C. wire with $b = 1.25$ cm. ($\frac{1}{2}$ in.). The side of the square at the bottom of the slots is 23.65 cm. (9.3 in.). From this specification we have $q = 0.625$ cms., $b = 1.25$ cm., $p = 0.0431$ cm., $\delta = 0.0422$ cms., $q/b = 0.5$, $S = 0.345/0.431 = 0.8$, therefore

$$a = (23.65 + 0.042) + (29 + 1) 0.0431 = 25 \text{ cms.}$$

$a/b = 20$ from Data Sheet (32). $K_2 = 0.02985$, and from equation (14); $k = 0.62$; therefore $h = 1.25 \times 0.62 = 0.775$ cms.

$L_s = 0.02985 \times 841 \times 25 = 628 \mu\text{H}$
From Data Sheet 33 $x \approx +\frac{1}{2}$. $L_0 \approx 625 \mu\text{H}$.

As $a/h = 32.3$ we can use equation (16) $M = 0.008 \times 841 \times 25 (3.475 + 0.031 - 0.653) \mu\text{H} = 479 \mu\text{H}$.

Therefore the total inductance of the two coils connected in series with their fields adding is

$$L_T = 2(625 + 479) = 2208 \mu\text{H}.$$

If the coils were connected in parallel with their fields adding, the inductance would be $L_T = \frac{1}{2}(L_0 + M)$.

The above coil could be used as a frame aerial for reception on the long wave broadcast band with a 430 kc/s. I.F. where an inductance of 2,200 μH is required. Fine adjustment of the inductance is obtained by altering the separation of a portion of the windings.

When the frame aerial is required to receive the medium-wave band as well as the long-wave band, another flat

pancake winding is wound on the same former some distance from the long wave coils. The effective inductance required on medium waves would be 180 μH for the 430 kc/s. I.F. assumed. However, the inductance value used for the design of this third winding will depend on the method of connecting and switching used.

Supposing the coils are connected in such a manner that the long- and medium-wave sections are used independently, with the long-wave section shorted when operating on medium waves. Then when designing the medium-wave coil, the effect of the shorted long-wave coil must be allowed for; this reduces the inductance of the medium-wave coil by $(Mml)^2/Ll$ where Mml is the mutual inductance between the medium and long-wave sections and Ll the inductance of the long-wave section.

Mutual Inductance between Two Equal Parallel Rectangular Flat Coils.

$$M = 0.004 N_1 N_2 \times \left\{ a_1 \log_e \left[\frac{a_1 + \sqrt{a_1^2 + h^2}}{a_1 + \sqrt{a_1^2 + a_2^2 + h^2}} \times \frac{\sqrt{a_2^2 + h^2}}{h} \right] + a_2 \log_e \left[\frac{a_2 + \sqrt{a_2^2 + h^2}}{a_2 + \sqrt{a_1^2 + a_2^2 + h^2}} \times \frac{\sqrt{a_1^2 + h^2}}{h} \right] + 2 \left[\sqrt{a_1^2 + a_2^2} + h - \sqrt{a_1^2 + h^2} - \sqrt{a_2^2 + h^2} + h \right] \right\} \mu\text{H}$$

With single layer frame aerials the same procedure is employed. To calculate the mutual inductance between the medium-wave winding (1) and the long-wave winding (3) assume first that the space (2) between them is filled with a winding of as many turns per cm. as are used in coil (1) and calculate the inductance $L_{1,2}$ of coils (1) and (2) in series $L_{2,3}$ of coils (2) and (3) in series, $L_{1,2,3}$ of coils (1) (2) and (3) in series and L_2 of coil (2) alone. In the above calculations all three coils are taken as wound with the turns per cm. " n_1 " used in coil (1). If coil (3) is wound with " n_2 " turns per cm. the mutual between coils (1) and (3) is given by

$$M_{13} = \frac{n_2}{2n_1} \left(L_{1,2,3} + L_2 - L_{1,2} - L_{2,3} \right)$$

In the case of portable receivers, where large masses of metal are present in the field of the frame aerial, the constants of the frame have to be determined experimentally.

THE INDUCTANCE OF SINGLE LAYER SQUARE COILS

DATA SHEET
No. 32

0.045

K_1

0.04

0.04

0.035

0.03

K_2

0.025

0.02

SINGLE TURN COIL: WIRE DIAMETER 'd'.
MULTI-TURN COIL — MULTIPLY a/b SCALE BY 2

SINGLE TURN COIL — MULTIPLY a/d SCALE BY 2

MULTI-TURN COIL

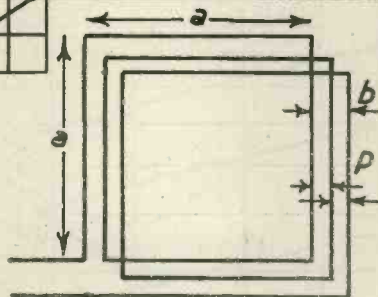

SINGLE TURN $L = a K_1 \mu H.$

SINGLE LAYER & FLAT PANCAKE $L_s = a N^2 K_2 \mu H.$

N = Total no. of Turns
 d = Wire diameter—cm.

FOR PANCAKE COIL

$$a = a_0 - (N-1)p$$

$$a = a_i + (N+1)p$$

All dimensions in cm.

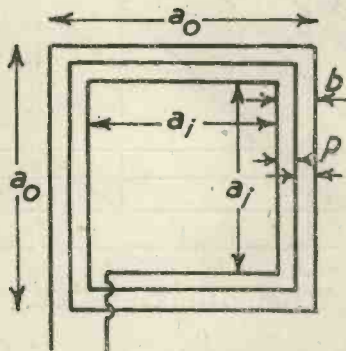

10
50

20
100

30
150

RATIO a/b
RATIO d/a

**Electronic
Engineering**

**DATA SHEET
No. 33**

CORRECTION FOR WIRE SPACING IN SINGLE LAYER SQUARE COIL

$$X = 0.01x \left[\log_e \frac{a}{b} + .2231 \frac{b}{a} + 0.726 \right]$$

$$Y = \frac{A+B}{N} \quad \begin{array}{l} \text{Full line when positive} \\ \text{Broken line when negative} \end{array}$$

For the correction factor $\Delta L/L_s$ not to exceed $\pm x\%$, $X \geq |Y|$

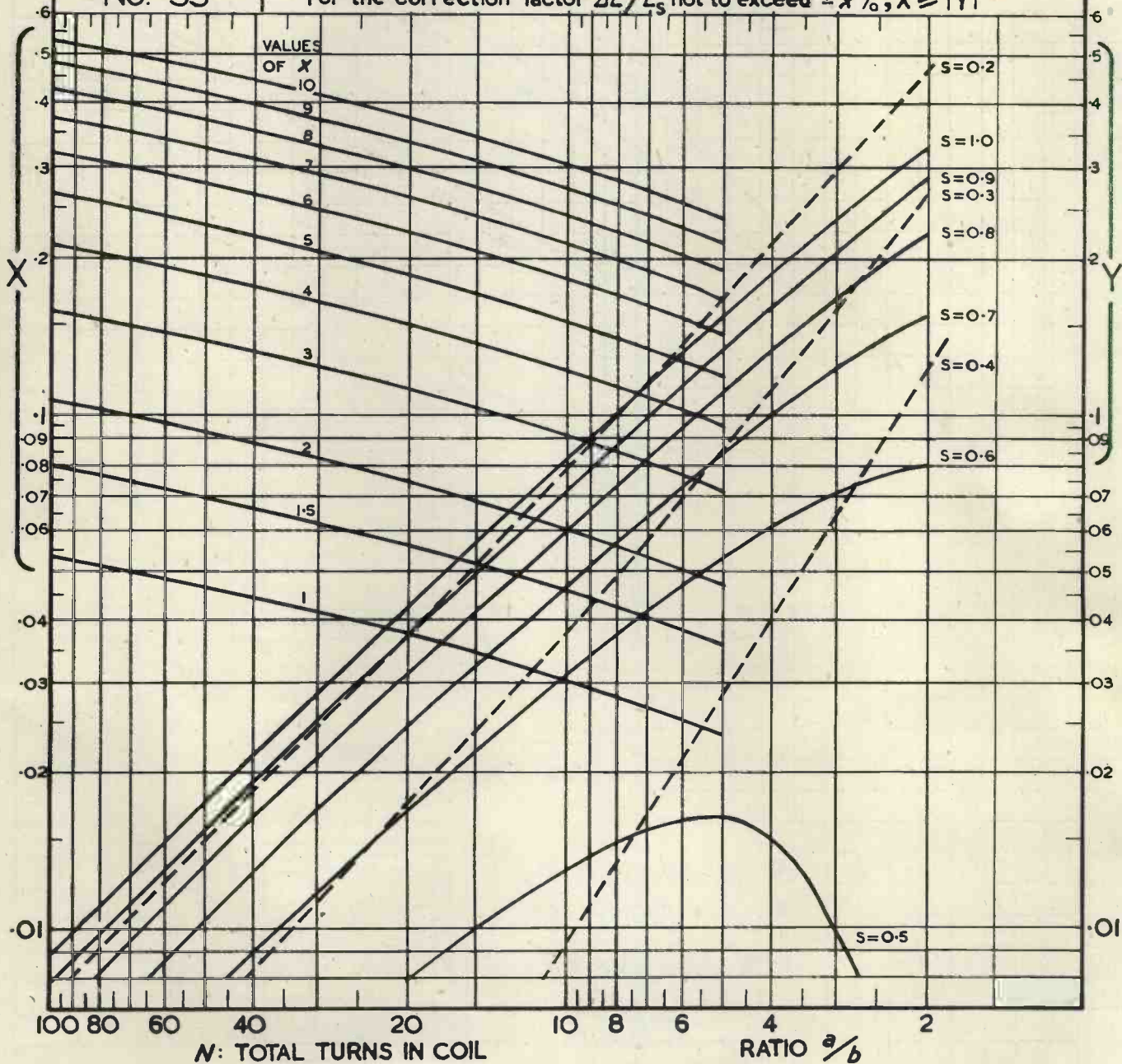

***Value proven
by long service***

**Osram
Valves**

MADE IN
ENGLAND

for

INDUSTRIAL APPLICATIONS

ELECTRO MEDICAL
EQUIPMENT

THERMIONIC INSTRUMENTS
and TEST GEAR

VITAL COMMUNICATIONS
and WARNING SYSTEMS
ETC.

THE GENERAL ELECTRIC CO. LTD.
Magnet House, Kingsway, London, W.C.2

Practical Notes on Receiver Design—Part I

By G. T. CLACK

THE average experimenter relies a good deal upon regular publications to furnish information when re-building or designing a radio receiver. Without exception a really interested experimenter will always consider a change or modification when there is a possibility of improved results.

To use a new idea or circuit to advantage, requires a certain level of knowledge as, more often than not, a modification of the recommended circuit or idea might be necessary before it can be successfully employed. Thus, a basic knowledge of the function of each component in the circuit of a receiver, and an ability to improvise will often produce better results than if instructions are followed unswervingly.

With this in mind, it is proposed to discuss to a limited extent a super-heterodyne receiver, emphasizing the practical side and various points which should prove helpful to those readers who are less experienced.

The type of circuit in mind is a very straightforward one, consisting of a single tuned input circuit feeding into a triode-hexode frequency changer, with

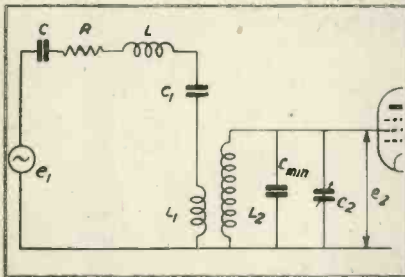

Fig. 1. Equivalent of typical aerial input circuit of a receiver.

one I.F. stage followed by a double-diode-triode R.C. coupled to a pentode output valve, in fact, a receiver representative of those in use to-day. Except for band switching, the input circuit shown in Fig. 1 is representative of the average receiver. The voltage e_1 is controlled by the characteristics and location of the aerial C - R - L , and the voltage e_2 , applied to the grid of the first valve is chiefly dependent upon the coupling factor of L_1 and L_2 .

When the aerial circuit is tuned to the same frequency as L_2C_2 , the voltage gain of the circuit will be high, and at a maximum, but at frequencies only slightly remote from this the gain will fall rapidly. Therefore, to preserve a more uniform gain over the band of frequencies covered by L_2C_2 , the aerial circuit frequency is kept outside the desired range. The series aerial capacity C_1 limits the effect of reflected

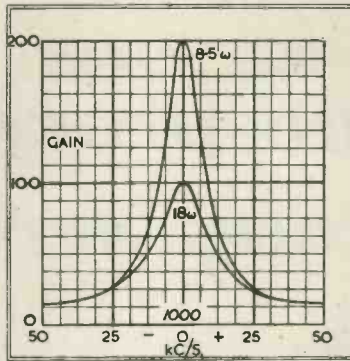

Fig. 3. Response curves of tuned circuits with differing H.F. resistances.

capacity varying the aerial circuit resonance with different types of aerials.

Owing to the wide variations in aerial characteristics a standard dummy aerial has been adopted for measurement purposes and consists of C -200pF., R -20 Ω , L -20 μ H in series (Fig. 1) for frequencies between 160-2,000 kc/s. This simplifies matters somewhat as all measurements for aerial circuit gain and selectivity are referred to known conditions across the input coupler L_1 .

Frequency Range.

To obtain suitable M.W. values as met with in current practice, the frequency range is first considered. As the requirements are 550 to 1,500 kc/s., giving a frequency range of 2.73:1, and frequency ratio being proportional to the square root of capacity change, then

$$\left(\frac{f_{\max}}{f_{\min}}\right)^2 = \frac{C_{\max}}{C_{\min}} = 7.5:1$$

In practice the capacity change should exceed this ratio as a small amount of overlap at each end of the band is necessary for production tolerances.

The first procedure is then to determine C_{\min} which consists of the minimum capacity of C_2 , the tuning condenser, C_s , the stray circuit capacity and C_0 , the self-capacity of the coil L_2 . The sum of these represents the fixed inevitable capacity permanently across the circuit which sets a limit to the highest frequency to which L_2 can be tuned. These capacities can be assessed, or measured as a whole by disconnecting L_2 at the "earthy" end, setting C_2 to minimum and connecting a capacity bridge across grid and chassis. The self-capacity of the coil will not be included in such a test, but can be measured as described later on.

Using a typical condenser for C_2 having a "swing" of 500pF., a capacity change of 8.7:1 is achieved if C_{\min} is about 65pf. The capacity of a good tuning condenser set to minimum is of

the order of 10-12pF. and this added to the circuit strays usually results in a total C_{\min} of 40-70pF. by the time wave-band switching is introduced. There should be no difficulty in obtaining a C_{\min} of less than 65pF. provided reasonable care is taken in the layout and selection of components.

The frequency range is now determined and this is calculated by dividing the highest frequency desired by the root of the ratio of C_{\min} to C_{\max} . Allowing 40 kc/s. for overlap on 1,500 kc/s. at the H.F. end of the band, and assuming a C_{\min} of 65pF. then:

$$f_{\min} = \frac{f_{\max}}{\sqrt{\frac{C_{\max}}{C_{\min}}}} = \frac{1540}{\sqrt{\frac{565}{65}}} = 520 \text{ kc/s.}$$

The value of the inductance L_2 is

found by $L = \frac{1}{\omega^2 C}$ becoming

$$L = \frac{1}{4\pi^2 \int_{\min}^2 C_{\max}} \text{ or } L = \frac{1}{4\pi^2 \int_{\max}^2 C_{\min}}$$

and will be 165 μ H when $f_{\max} = 1,540$ kc/s, $C_{\min} = 65$ pf. or $f_{\min} = 520$ kc/s, $C_{\max} = 565$ pF.

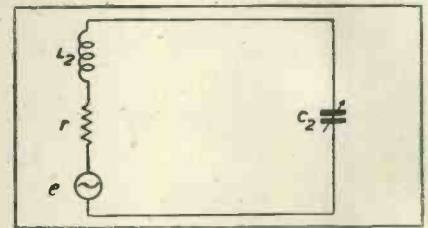

Fig. 2.

A more or less standard practice in this country is the use of a tuning condenser with a "swing" of about 480 up to 500pF., but there are some manufacturers who make a point of keeping the minimum capacity low and using a higher value of inductance with a corresponding decreased total capacity. Some values for a particular receiver were found to be 275 μ H for L_2 , and a capacity swing of 300pF., covering the standard broadcast band. With this higher L/C ratio it is possible to secure a higher circuit gain, but on the other hand, a lower L/C ratio is likely to be more stable.

A definite decision in favour of the slightly higher ratio for the M.W. band is difficult to make as there is very little difference observable under actual working conditions.

Q, R, & R_D .

Having obtained an approximate value for L_2 , the secondary circuit is

now considered as a series tuned circuit as any voltage injected into this circuit, L_2, C_2 , from the primary is represented as a voltage in series with L_2 and C_2 . (Fig. 1).

Then at a frequency $f = \frac{1}{2\pi\sqrt{LC}}$ the current in the circuit is obtained by $I = e/r$. Thus the voltage across $L_2 = i\omega L = e/r\omega L$, and across $C_2 = i/\omega C = e/r\omega C$, showing that the input voltage e_1 has been modified by $\omega L/r$ or $1/\omega Cr$. These ratios are commonly known as the circuit magnification or Q.

This resonant rise of voltage across L_2 or C_2 is therefore Qe , so, for a given inductance, Q is increased by reducing the H.F. resistance r of the coil. The curves in Fig. 3 are for two similar inductances, one of which has an H.F. resistance of 8.5 ohms at 1,000 kc/s, and the other 18 ohms at the same frequency.

It will be seen that the higher Q is, the more selective is the circuit, which in turn is less responsive to the higher modulation frequencies, thus affecting overall fidelity. The curves in Fig. 4 are for H.F. resistance of a particular coil, where I is the resistance calculated from a knowledge of Q, and II is the measured H.F. resistance.

The measurements were made at a number of frequencies using the circuit shown in Fig. 5. With the 40 ohm resistance short circuited a voltage (e), from a signal generator, was injected across the .05 ohm resistor, C was tuned for resonance and the voltage Qe read on the valve voltmeter. The shorting switch was opened, and the 40 ohm resistance was adjusted until the voltage Qe was reduced to half its previous value. The resistance introduced under these conditions is equal to the H.F. resistance r .

The resistance used was made up of two parallel lengths of 44 s.w.g. Eureka wire about 1 1/2 in. apart, mounted on a good insulator with a movable contact joining the two lengths. As the skin effect is less than 1 per cent. between 500-1,500 kc/s, the resistance was calibrated on a D.C. Wheatstone bridge. When introducing an external resistance into an H.F. circuit for such measurements it must have no self capacity and be non-inductive. The very slight difference in Curve II was probably due to a certain amount of stray capacity or inductance in the measuring circuit.

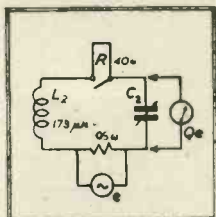

Fig. 5. Circuit used in obtaining the curves of Fig. 4. The resistance R is of special non-inductive construction with negligible self-capacity.

Now consider Fig. 2 as a parallel circuit, the R of the condenser branch being small and ignored, the impedance at resonance = L/Cr . By approximating and using $\omega^2 = 1/LC$ we obtain

$$Z = \frac{L}{r} \omega^2 L = \frac{\omega^2 L^2}{r} = Q\omega L \text{ also } \frac{Q}{\omega C}$$

Therefore, the impedance at resonance of a parallel tuned circuit is Q times the impedance of one of its branches. This is usually referred to as R_D and represents the equivalent resistance that is present between grid and chassis of Fig. 1 at the resonant frequency of the tuned circuit.

When calculating interstage gain of R.F. or I.F. circuits, the load impedance of the coil must be known and R_D represents this quantity.

Self Capacity.

The self capacity C_0 is distributed, but can be considered as a condenser in parallel with the inductance (Fig. 6).

The loss associated with C_0 is due to the dielectric of the wire insulation, coil-former and wax if used.

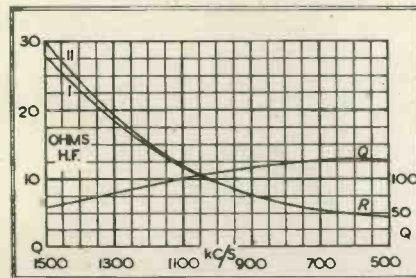

Fig. 4. Calculated and measured H.F. resistances of a coil.

The impedance of the coil can be considered as a rejector circuit having resistive and reactive components which are not the true resistance (omitting skin effect), and inductance as measured at very low frequencies, but the apparent resistance and inductance as measured at radio frequencies. In view of this, coils are usually measured for inductance at audio frequencies, invariably at 1,000 c.p.s.

As a matter of interest, these apparent values have been found to be

$$R_0 = \frac{r}{(1 - \omega^2 LC_0)^2} \text{ and } L_0 = \frac{L}{(1 - \omega^2 LC_0)}$$

The above equations for R_0 and L_0 hold for frequencies well below the resonant frequency of the coil, and in practice the coil will not be used near this frequency.

From the above, it will be seen that R_0 increases with frequency at a greater rate than L_0 , therefore self-capacity reduces Q as the frequency increases.

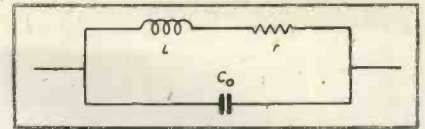

Fig. 6. Equivalent circuit for the self-capacity of a coil.

There are several ways of measuring C_0 , one of which is to add a known capacity C_1 , and note the resonant frequency, then add a further known capacity, once again noting the frequency, then:—

$$C_0 = \frac{f_1^2 C_1 - f_2^2 C_2}{f_2^2 - f_1^2}$$

If the frequencies are harmonically related, then the formula can be reduced to:—

$$C_0 = \left(\frac{C_1 - n^2 C_2}{n^2 - 1} \right)$$

Where n is the nth harmonic, e.g., if the 2nd harmonic were used,

$$C_0 = \frac{C_1 - 4 C_2}{3}$$

An absolute figure for C_0 is difficult to obtain as in the above method L is considered constant with frequency, which is not so, but at least we can compare self-capacities to assist in selection of the best type of winding to use.

In measuring C_0 , the procedure is to employ an oscillator, a standard calibrated condenser and a receiver as in Fig. 7 with "L" connected in the oscillator circuit.

Tune the receiver to any frequency at the L.F. end of the M.W. band, say 600 kc/s, and set the oscillator to this frequency by listening to the beat note heard in the loud speaker. Note the capacity, C_1 , as read on the standard condenser, and retune the receiver to 1,200 kc/s or thereabouts until the 2nd harmonic is received and brought to zero beat by careful tuning. Then decrease the oscillator condenser until the beat note is heard again and adjust it to zero beat. The second reading, C_2 , should be less than 1/4 of C_1 .

The receiver used in this test should be a regenerative T.R.F. to avoid complications; furthermore, the accuracy of this system is entirely dependent upon the calibration of the condenser used to tune "L." As C_{min} in Fig. 1 includes C_0 as well as other strays, an approxi-

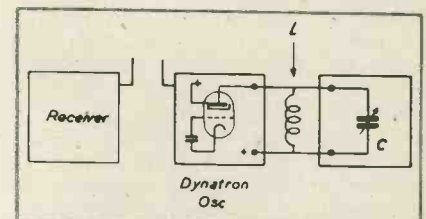

Fig. 7. Method of measuring self-capacity of coil L.

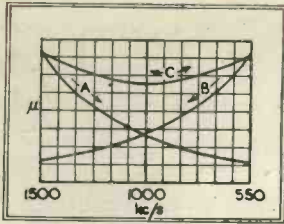
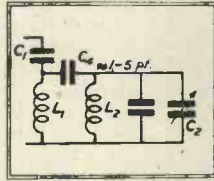

Fig. 8 (left). Variation of voltage across C_2 as a function of frequency.

Fig. 9 (right). The addition of a small condenser between L_1 and L_2 as in the figure below improves the curve to that shown in Fig. 8—C.



ate figure for this capacity is useful in the initial stages of design.

Couplers.

The next point is to consider the characteristics of the aerial coupler L_1 , and its effect upon L_2 .

As mentioned previously, it is undesirable to allow the A.-E. circuit to resonate within the desired frequency range, otherwise a reduction in overall efficiency will be experienced.

The following curves give an approximate idea of the voltage across C_2 for a constant input at varying frequencies (Fig. 8) where A is the voltage change over the band when L_1 is tuned to a frequency higher than 1,500 kc/s, B is for the same input, but with L_1 tuned to a frequency lower than 500 kc/s. It will be seen that the maximum transfer takes place as L_2C_2 approaches the resonant frequency of the aerial circuit.

An improvement on this (curve C) is to use a high-peaked coupler and introduce capacity coupling for the H.F. end by connecting a small condenser, C_c , between the high potential ends of L_1 and L_2 . (Fig. 9).

Mutual Inductance.

When mutual inductance exists between coils such as L_1 and L_2 , the secondary, L_2 , affects the primary L_1 , as though an impedance.

$$\left(\frac{\omega^2 M^2}{Z_2} \right)$$

were in series with it. The equivalent primary impedance is therefore:

$$Z_1 + \frac{\omega^2 M^2}{Z_2}$$

Separating the resistive and reactive components,

$$R_1 = r_1 + \frac{\omega^2 M^2}{Z_2^2} r_2 \text{ and } X_1 = x_1 - \frac{M^2 \omega^2 X_2}{Z_2^2}$$

Where r_1 and r_2 are the primary and secondary resistance, Z_1 and Z_2 are the primary and secondary impedance, x_1 and X_2 are the primary and secondary reactance and M the mutual inductance between the coils, in μH . As the aerial

circuit of Fig. 1 consists of an untuned primary and a tuned secondary, the effective impedance of L_1 is,

$$r_1 + \frac{\omega^2 M^2}{r_2} + j \left(\omega L_1 - \frac{1}{\omega C_1} \right)$$

(X_2 being zero at resonance.)

Once knowing the primary impedance at any particular frequency, a figure for overall gain can be obtained, i.e., the ratio e_1/e_2 , where e_1 is the voltage across L_1 , and e_2 the voltage applied to the grid of the first valve.

The induced voltage in the secondary is dependent upon the coupling and is given as $M\omega i_1$, and the voltage across

L_2 (or C_2) is $(M\omega i_1) \left(\frac{\omega L_2}{r_2} \right)$ which is

Q times the induced voltage as mentioned earlier. Therefore, the effective gain of the aerial circuit can be expressed as,

$$\frac{e_2}{e_1} = \frac{i_1 \left(\frac{M\omega^2 L_2}{r_2} \right)}{\left[r_1 + \frac{M^2 \omega^2}{r_2} + j \left[\omega L_1 - \frac{1}{\omega C_1} \right] \right]} = \frac{M\omega^2 L_2}{\left[r_1 r_2 + M^2 \omega^2 \right] + j \left[\omega L_1 r_2 - \frac{r_2}{\omega C_1} \right]} r_2$$

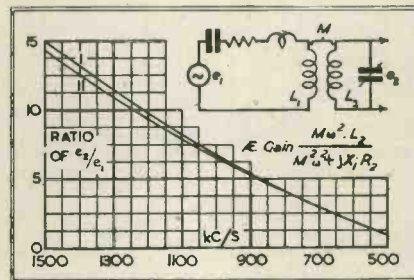

Fig. 10. Calculated and observed voltage gain of a coupled circuit shown.

As r_1 will be small and ignored in practice, the gain formula becomes,

$$\frac{e_2}{e_1} = \frac{M\omega^2 L_2}{M^2 \omega^2 + j X_1 r_2}$$

Using this formula the voltage gain for a particular coil was computed and represented by the Curve I in Fig. 10. Curve II represents the actual measured gain taken with a signal generator and a valve voltmeter, which showed that the calculated and measured values agree within reasonable limits.

During actual adjustments, a low capacity V.T. voltmeter, connected across C_2 , can be used to indicate resonance, gain and selectivity for different degrees of coupling between L_1 and L_2 . For a higher sensitivity the whole input circuit can be connected to the input of an H.F. pentode and the V.T. voltmeter resistance capacity coupled to the anode circuit.

As a guide, the following figures may be used for comparison and represent an average based upon measurements taken on selected coils of the type described in the text. Fig. 11.

This is for a single tuned circuit as in Fig. 1; the overall selectivity of the completed receiver being determined by the number of tuned circuits used, and in the case of a super-heterodyne the initial selectivity is set by the I.F. transformers.

I.F. Filter.

When designing aerial coils with high-peaked couplers, it is important to choose a primary inductance that will not resonate with the aerial capacity to a frequency near the Intermediate Frequency as a super-heterodyne receiver is particularly susceptible to interference at the intermediate frequency. Because of this an I.F. rejector circuit may be necessary when the I.F. = 465 kc/s. and a high peaked primary is employed. A series resonant circuit tuned to the I.F. frequency is connected across the input to the receiver as in Fig. 12.

The constants of the filter L_3C_3 must favour a sharply peaked response otherwise it tends to reduce the gain of the input circuit at frequencies towards the L.F. end of the range. (Fig. 13). In most cases, a receiver employing a filter of this type is fitted with a trimmer at C_3 to enable the maximum reject-

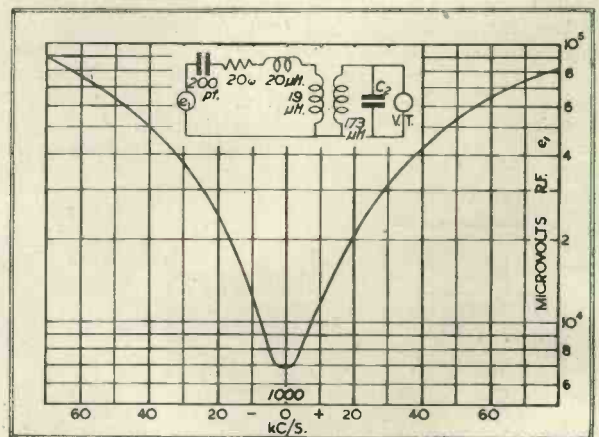
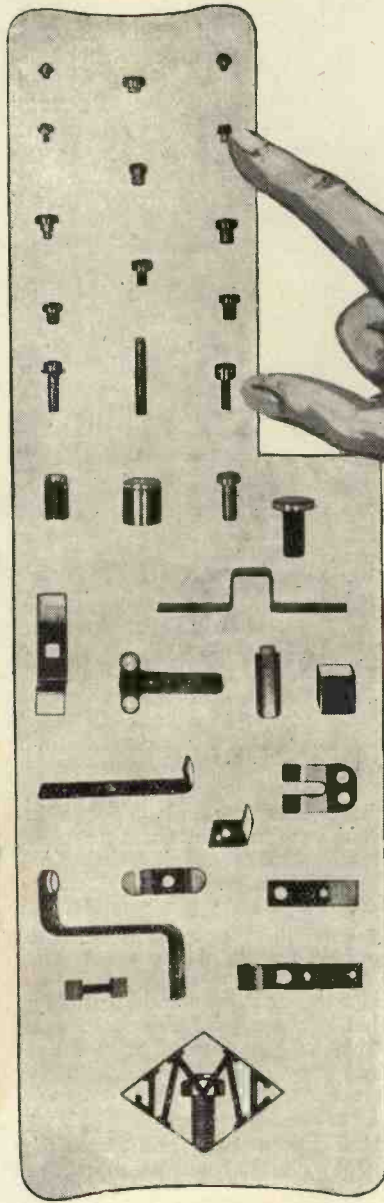

Fig. 11. Resonance curve of typical coupled circuit of which the values are given.

"Just the Contact for the Job"



Write for Booklet 112, giving details of J. M. C. contacts and contact materials.



The selection of suitable contact materials and types of contact, presents problems to designers in all grades of electrical engineering. It is accordingly our keen desire to be of service by presenting the fullest available information and guidance to those who seek assistance in determining the most suitable contact for a specific job. May we assist you?

JOHNSON, MATTHEY & CO. LIMITED

73/83, HATTON GARDEN, LONDON, E.C.1

Telephone : HOLBORN 6989

MYCALEX

(REG. TRADE MARK)

The Supreme Insulator

can be machined to fine limits. It is unaffected by temperatures up to 400° Centigrade.

It provides insulation in the face of extremes of climatic and operational conditions.

It is tough and is unaffected by water, gas and oil.



A fine example of milling from both faces, of one eighth-inch MYCALEX sheet; the centre diaphragm is only .007 ins. thick.

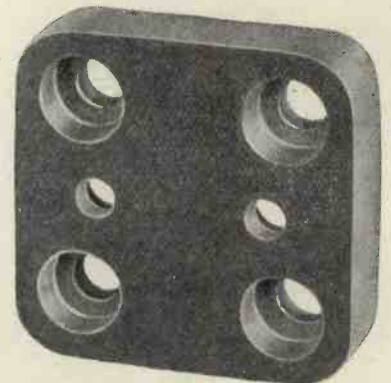

MYCALEX sheet, drilled and square-shoulder counter-sunk from both faces.

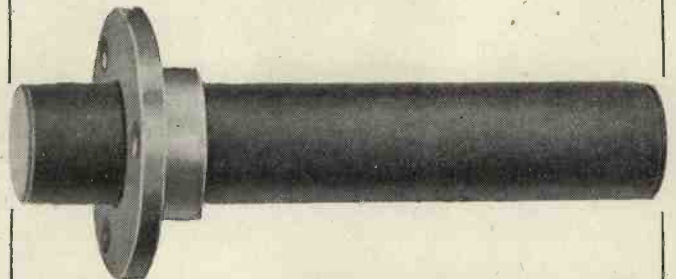

MYCALEX rod with an aluminium-alloy flanged support moulded on, to make a support assembly.

Mycalex Ltd., Cirencester, Glos.

tion to be obtained for any particular aerial.

Rejector attenuation should be at least -20db. with reference to the average sensitivity throughout the band. This value is easily obtained and represents an output power ratio of 100:1 between wanted and unwanted signals of equal amplitude.

With a low-peaked primary I.F. breakthrough is reduced to very low proportions and ratios of 40db. or better can be expected.

Winding.

The coil can be wound on a convenient size former, the type of winding controlling the amount of wire used and the self-capacity, C_0 . The aim is to use a winding where the flux-linkage between turns is high as this limits the amount of wire thus reducing the H.F. resistance, R .

Following general practice, the use of solid wire for frequencies less than 1.5 Mc/s. is discontinued, except possibly for couplers such as L_1 . Generally speaking, the use of a 1:1 length/diameter winding on a 1 in. former, wave-wound with 9, or more, strand Litz wire, should show a Q of 150-200 for a M.W. coil at 1,000 kc/s. The former material, presspahn, bakelite, glass, porcelain, etc., does not appreciably affect the Q of a coil at these frequencies, but on the S.W. band above 6 Mc/s. the losses will be higher and more attention must be given to the stability of the material for varying temperature and humidity changes.

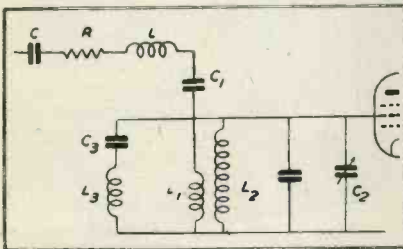

Fig. 12. Addition of an I.F. rejector circuit to the aerial coupling circuit.

The measured Q for a well-made S.W. coil, with a 1:1 winding ratio of 22 s.w.g. copper wire spaced one wire diameter between turns and wound on good quality bakelite, can be better than 350, but in practice the Q for both M.W. and S.W. coils will be less by the time they have assembled in a deck or can because of circuit losses and proximity of chassis or screens. Normal Q figures for both types, *in situ*, are more likely to be in the region of 140-180.

A very compact, yet efficient M.W. coil can only be achieved by wave-winding. The number of crossovers vary with different makes of coils and may be 2 or more per turn. A typical wave-winding sequence representative of current practice is illustrated in Fig. 14.

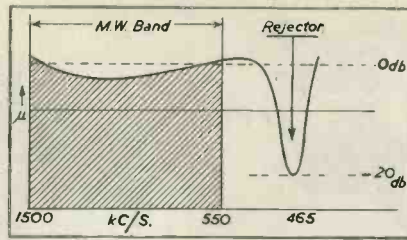

Fig. 13. Characteristics of the rejector circuit of Fig. 12.

The cam throw, *i.e.*, peak to peak gives the width of the winding. A modification of this, is to limit the cam throw, to say 1/16 in., and use at the same time a lateral feed, which as the coil is being wound has the effect of spreading the winding along the former instead of banking it. This type of winding is definitely superior to a solenoid or bank winding due to the lower H.F. resistance and distributed capacity. The Q at 1,000 kc/s for a particular coil wound as above was 200, after screening, as opposed to 140 for an ordinary banked wave-wind.

Summing up, the following may be used to provide a few comparative figures:—

C_0 of average M.W. coil = 6-15pf.

Q of average M.W. coil = 100-200.

R_{HF} of average M.W. coil = 4-20 ohms

R_D of average M.W. coil = 100,000/200,000 ohms.

It is usual to "fix" the winding when completed so that there can be no shift in inductance due to loose turns. The whole winding and former should be impregnated, but care must be taken to select the right type of wax or cellulose as with poor samples the Q can be seriously reduced. Where a receiver is to operate under exceptional climatic conditions then even more attention must be paid to such points as former material and perfect sealing of the winding. (See *Electronic Engineering* for September, 1941—"Receivers for Export").

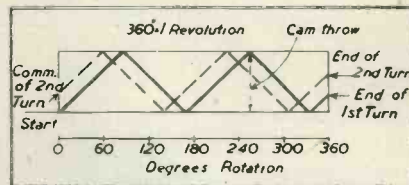

Fig. 14. Sequence in wave-winding coils for the M.W. band.

Most of the foregoing details apply also to the L.W. band. In the case of S.W., I.F. breakthrough is practically zero, but the serious trouble is with 2nd channel interference, which is best improved by using an additional H.F. amplifying stage ahead of the frequency changer.

An alternative is to increase the intermediate frequency so that the signal to

2nd channel frequency ratio is increased. With the input circuit tuned to 10 Mc/s. and an I.F. of 465 kc/s. the 2nd channel is only 10 per cent. off resonance. A higher intermediate frequency is used in cases where a receiver has been specially designed for S.W. work, but as most listeners use the M.W. frequencies, manufacturers employ the lower I.F. and reduce the S.W. interference to the lowest level possible.

For a simple S.W. input circuit as in Fig. 1, an average 2nd channel ratio would be about 4:1 at 10 Mc/s. An additional H.F. stage with a second tuned circuit will improve this by at least 5 times, thus giving an image ratio of 20:1.

Adjustments are made with a non-inductive 400 ohm resistor in series with the signal generator, as this is generally considered equal to the average aerial losses on short waves, and replaces the series C.R.L. circuit, illustrated in Fig. 1. The average aerial characteristics between 6-22 Mc/s. are such that natural resonance may take place at one or more frequencies within the desired wave-band. As a result of this, it will be found that a low-peaked loosely coupled primary situated at the earthy end of L_2 is necessary.

Foreign Radiolocation Patents

Methods for finding Targets especially for the determination of Aircraft Positions

These methods operate on the Back Radiation principle. A transmitter scans the explored space in two dimensions, while the back-radiation from a body in that space causes in a receiver an intensity variation of a cathode ray beam which is deflected in synchronism with the transmitter.

—D.R.P., 702,686, published February 13, 1941. A.E.G. Inventor, T. Elmquist.

Methods for the determination of the distance of reflecting objects, according to the back radiation principle

The wave length of a radiated beam is varied between two fixed values in successive half periods of a modulation frequency M . If the time interval between the transmission and reception of the reflected wave is a whole multiple of the modulation frequency, the beat amplitude in the receiver will be a minimum.

In order to obtain an exact result for the distance d , the minimum is determined for two adjacent values M, M' of the modulation frequency.

If the time interval is $\theta = 1/(M-M')$ then the required distance $d = U\theta/2$ where U = the velocity of propagation of the waves.

—D.R.P. 703,111, published February 28, 1941. Compagnie de Telegraphic sans Fil. Paris. Inventor, H. Gutton.

A Note on Send Elements and Insertion Loss

By J. C. SIMMONDS, Ph.D., M.Sc. (Eng.)

THE insertion loss of a four-terminal network may be defined in the following way. Referring to Fig. 1, the relationship between the power supplied to Z_s , the load impedance, from a generator of e.m.f. E_g and internal impedance Z_g , with the network inserted between AC and BD, as shown, and with A connected directly to C, and B connected directly to D, is the insertion loss of the network between impedances Z_g and Z_s . The logarithmic ratio of the power delivered to the load without the network inserted to the power delivered with the network inserted gives the insertion loss in nepers. Since by definition the impedance Z_s has the same value whether the network is in circuit or not, it follows that the insertion loss is also given by the logarithmic ratio of the squares of the voltages developed across the load.

Generally, the image impedances of the network under consideration are pure resistances and are equal to some value, say R ohms. Now in most practical circuits, reflexion losses are undesirable and to eliminate them the network is operated between resistances of value equal to R . Thus, to determine the insertion loss of the network in its associated circuit it is necessary to measure the loss caused by inserting the network between a generator of internal resistance R and a suitable voltmeter of resistance R . The voltmeter resistance R is commonly known as a



Fig. 1.

“receive element” and is conveniently produced by shunting a high impedance meter, such as a valve voltmeter, by a resistance of R ohms (usually R is of a comparatively small value, say a few hundred ohms or less). It is, perhaps, not so obvious how to produce the generator of the required internal resistance R . One method, which is used quite frequently, is to build up the known resistance of a source of e.m.f., e.g., a signal generator, to the required value by connecting resistances in parallel or in series with it. This method, although theoretically sound, is undesirable for the following reasons:—

(a) The internal impedance of most variable frequency generators varies with frequency and is generally only known approximately. (The insertion loss of net-

works is usually required over a range of frequencies).

(b) At high frequencies it may be difficult to produce the necessary series or parallel resistance.

An alternative and more convenient way to simulate a generator of internal resistance R is by means of a simple piece of apparatus known as a “send element.” The circuit of a type of send element for use with unbalanced circuits is shown in Fig. 2(a), which represents a generator of e.m.f. E and internal impedance Z (shown external

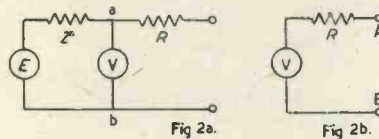

Fig. 2.

to E), whilst V represents a voltage indicator which, for the sake of simplicity, will be assumed to have a high impedance. The terminals A and B are taken to the network under test and the arrangement behaves exactly as though it were a simple generator of e.m.f. V with an internal resistance of R —see Fig. 2(b). Much confusion seems to surround this simple piece of apparatus and some difficulty appears to be experienced in deriving the equivalent circuit shown in Fig. 2(b). An endeavour will now be made to state and explain the difficulty.

Since the voltage indicator V measures the voltage between a and b, these two points may be regarded as the terminals of the source of e.m.f. V . It then follows from Thevenin's theorem that the circuit is equivalent to a source of e.m.f. equal to the open-circuit voltage across A and B, that is, V , and of internal impedance equal to the impedance between A and B when a and b are short-circuited, that is, R . Thus the send element circuit is equivalent to that shown in Fig. 2(b). The chief objection raised to this method of determining the equivalent circuit appears to be that any wave reflected back through the network under test must have presented to it an impedance $(Z + R)$ or some slightly different value if the impedance of the voltage indicator cannot be neglected. This is quite true, but the arrival of a reflected wave at ab causes the voltage V to be either increased or decreased and, since the voltage across ab is usually kept constant throughout an insertion loss measurement, the reflected wave makes some adjustment of the e.m.f. E necessary. This necessary adjustment of e.m.f. is

such that the voltage between a and b returns to the value it had with the network out of circuit and, therefore, has the effect of cancelling the wave. That is to say, upon arrival at ab the wave is completely absorbed, as it would be if the send element consisted of a resistance R connected directly across A and B. Thus, this line of reasoning when carried to its logical conclusion, leads to the equivalent circuit of Fig. 2(b).

If the reading of the voltage indicator is not kept constant throughout the measurement, the voltage V is either increased or decreased by the arrival of a reflected wave at ab, but since the modified value of V is taken as the generator voltage it is clear that the energy carried by the reflected wave is absorbed in the generator circuit. The argument applied to the case where V is constant can be applied even when it is not, for the voltage across ab can be assumed to be made up of a part due to the reflected wave, a part from the generator sufficient to give the actual voltage across ab and a further part from the generator equal, but opposite to the contribution of the reflected wave and which can be regarded as cancelling the reflected wave.

If the voltage V is maintained constant throughout the measurement the voltage across ab is obviously that which would be produced by a generator of zero regulation, that is, by one whose terminal voltage is not a function of the current and, consequently, is independent of the impedance into which it works. The only generator which satisfies this requirement is one which has zero internal impedance. Therefore, in these circumstances, the voltage V across ab can be regarded as supplied by a generator of zero impedance; the equivalent circuit of Fig. 2(b) thus resulting from this way of looking at the problem.

It is obvious from the above that if no reflected wave is transmitted back through the network the insertion loss is independent of the resistance, R , in the send element because the voltage V between a and b will have the same value with or without the network in circuit—no adjustment of E being necessary. To prevent any reflected wave travelling back through the network to the send element the network must be correctly terminated at the receiving-end, that is, by its image impedance. Thus, it is evident that the insertion loss of a four-terminal network is independent of the impedance of the sending generator so long as the network is correctly terminated at the receiving-end.

Universal Shunts for Multi-Range Meters

Some Factors Affecting Their Design

By E. B. SWIFT

ARTICLES have frequently appeared on the design and construction of shunts for low range meters, intended to enable them to be used for "universal" test instruments. The majority of these designs involve the use of multi-contact switching or straps between terminals, both of which are liable to introduce errors due to dirty contacts. Alternatively a number of separate

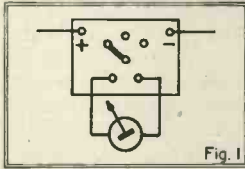

shunts have to be packed in the meter case with correspondingly increased weight and inconvenience.

If instead of separate shunts a universal shunt is made up, the above drawbacks to multi-range instruments disappear as it is only necessary to carry one shunt case and the switching can be done (in the case of switchboard meters) by means of a single-pole switch (Fig. 1) in the current circuit. With portable meters it is only necessary to change one lead to the shunt (Fig. 2). Hence variation of switch contacts will not affect the accuracy of the reading.

The universal shunt, which has been used with galvanometers for many years can also be applied to indicating instruments and

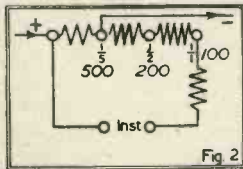

the terminals marked in actual values of current instead of ratios such as 1/5th, 1/10th, etc. Once this is done the shunt is no longer a universal one for the measurement of current, but can only be used with the movement for which it is designed.

Taking the universal shunt of Fig. 2, suppose that a current of $100\mu\text{A}$ is flowing when the instrument indicates full scale and call this scale reading 100. If we now switch to the $500\mu\text{A}$ range the indication would be 1/5th that given on the $100\mu\text{A}$ range or 20 divisions.

If an instrument with a different resistance is taken the 1/5th shunt would still reduce the reading by 1/5th, but we should not be able to read the true current—the readings are only comparative. This is because the shunt values being fixed and the full scale current being $100\mu\text{A}$, there can be only one value of resist-

ance for the instrument circuit to bring the instrument to the correct current indication.

Effect of Instrument Resistance

When a universal shunt is used with a moving coil instrument it should be noted that the resistance in the moving coil circuit is of constant value and hence the damping of the instrument is constant on all ranges. Sometimes when using a series of copper shunts across an instrument, those of low resistance tend to make the movement sluggish.

Design Data Required

In designing a universal shunt for a meter the following data must be obtained:

- (1) The resistance of the instrument to be shunted. Determine whether this is all copper or if part of it is due to material with a negligible temperature coefficient such as Manganin. The proportion of each should be found as this is required to determine the temperature coefficient.
- (2) The accuracy required for the shunted instrument, *i.e.*, whether to conform to B.S.S. 89 for first grade or sub-standard instruments. This affects the accuracy of the shunt adjustments, and, more important still, determines whether the temperature error of the shunted instrument is to be less than 0.11 per cent. per $^{\circ}\text{F}$. or less than 0.05 per $^{\circ}\text{F}$.
- (3) The current for full-scale deflection of the unshunted meter.

Temperature Coefficient

As a first approximation for first-grade instruments, the resistance in series with the moving coil should be at least equal to twice the coil resistance since the resulting temperature coefficient will be given approximately by:

$$\text{Coil Resistance} \quad \underline{\quad\quad\quad} \quad 0.238\% \text{ per } ^{\circ}\text{F}.$$

Coil plus Series Resistance

If the series resistance is twice the coil resistance, this expression becomes one-third of 0.238% or 0.0793% per $^{\circ}\text{F}$. which is within the limits allowable. Similarly as a first approximation for sub-standard instruments the series resistance should be at least four times the coil resistance, giving a temperature coefficient of 0.0476% per $^{\circ}\text{F}$.

The above formula for the

temperature coefficient can only be approximate as at this stage of the calculations the value of the various sections of the shunt will not be known. Once the figures are found the correct temperature coefficient for the combination of shunt and instrument can be calculated. This calculation is affected very much by the current distribution between the shunt and the instrument, as will be shown by later examples.

The true temperature coefficient is, however, always less than that found from the formula above.

The difference between the temperature coefficient as calculated from the formula above and that found from determined values of the shunt sections is shown in the examples given later.

Effect of Series Resistance

The introduction of a series resistance of the values given above will cause the voltage drop over the lowest current range of the shunt to be from 3-5 times that of the moving coil itself. As an illustration, take an instrument of 100 microamps. full scale deflection with a coil resistance (no series resistance) of 1,000 ohms.

The voltage drop at the instrument terminals for 100 microamps. is thus 0.1 v., but with a series resistance suitable for 1st grade accuracy it would be 0.3 v. For sub-standard accuracy it would have to be 0.5 v.

Should the circuit into which the shunts are connected be of such a character that the resistance of the shunt would impair its regulation (because of the higher voltage drop required by the shunted instrument) another method must be used which will be described later.

Examples of Universal Shunt

Taking the instrument referred to above, which has a full scale of deflection of $100\mu\text{A}$ and a resistance of 1,000 ohms (all copper). It is required to make a universal shunt for 250, 500 and $1,000\mu\text{A}$ for 1st grade accuracy.

For 1st grade, the resistance in series with the moving coil should be 2,000 ohms, making the volt drop over the coil and series resistance 0.0001

$\times 3,000$ or 0.3 v. This is also the volt drop over the lowest range of the universal shunt ($250\mu\text{A}$).

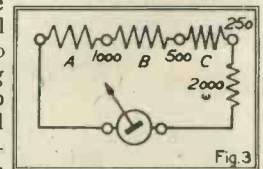

The resistance of the shunt is therefore: 0.3 divided by the current in the shunt, which is 150 μ A. Resistance is therefore 0.3/0.00015 or 2,000 ohms.

The arrangement is shown in Fig. 3, and the resistances can be tabulated as under:

Shunt	Resistance	
250	A+B+C	2000 ohms
500	A + B	1000 ohms
1000	A	500 ohms

The current to be carried is as follows:

Resistance	Current
A (500 ohms)	900 μ A
B (500 ohms)	400 μ A
C (1000 ohms)	150 μ A

It is advisable to use a current density of 800 amps./sq. in. for the shunt wires, which can be of any commercial wire with negligible temperature coefficient for 1st grade instruments.

For sub-standard work, Manganin should be used. In making shunts the size of the containing box is usually determined before the work is commenced; the depth inside need seldom exceed 1 1/2 in. A distance of 1 1/2 in. should be allowed between terminals and they should be mounted in a zig-zag to keep the width as low as possible. (Fig. 4). The bobbins should be as large in diameter as possible and as deep as possible allowance being made for the fastening rods and nuts which secure them to the underside of the panel. The diameter of the wire and length are estimated from wire tables in the usual way.

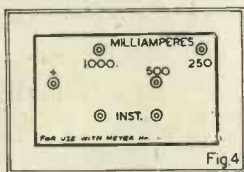

When using the above shunt, the resistance of the leads joining the shunt to the meter is negligible in comparison with the circuit resistance of 3,000 ohms.

Low Resistance Shunts

The next point to be considered is what is to be done if the circuit is such that a voltage drop of 0.3 v. could not conveniently be used. The shunt resistance can be kept as low as possible by not using a series resistance in the coil circuit and by using copper shunts. The volt drop across the moving coil then becomes .0001 \times 1,000 or 0.1 v., which is also the drop across the 250 μ A shunt.

The resistance of the shunt is then 666.66 ohms, and that of the 500 μ A shunt 333.33 ohms. The 1,000 μ A shunt is 166.66 ohms.

We now have an all copper circuit, so that the temperature errors of the

shunt and instrument should be negligible if care is taken to ensure the same current density in both the shunt and the moving coil.

It should be pointed out at this stage that with low resistances connected across the coil it may be too heavily damped and this should be checked as soon as the lowest value of shunt resistance is calculated. If the instrument is too sluggish a copper series resistance should be used in place of the series resistance used in the previous example and the values of the shunt re-calculated. Copper shunts must be left to attain a steady temperature before any adjustment is made on them: in general it is not advisable to use copper shunts for currents above 100 mA in 1st grade instruments and above 50 mA in sub-standard instruments.

Limitation of Shunt Values

The question arises that if the voltage drop of the shunt is made so much greater when using a series resistance in the coil circuit, why could not a shunt be made with negligible temperature coefficient and avoid the difficulty of adjusting copper shunts? The following example will show the disadvantages of such a shunt:

An instrument gives a full scale deflection for 10 mA and has a coil resistance of 20 ohms. It is required to make a shunt for 60 and 30 mA. The resistance of the shunt for 30 mA (20 mA through the shunt and 10 mA through the instrument) is then 10 ohms.

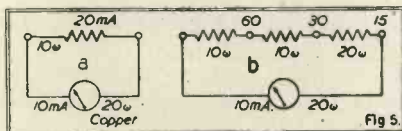

Fig. 5a shows the circuit conditions for the 30 mA. range.

In a shunt of this kind, the resistance values of the instrument circuit, and that of the lowest range of the shunt, determine the temperature coefficient of the combination.

For a rise of 100° F. the coil current drops to 8.63 mA and the temperature error = 0.137 per cent. per 1° F.

From above result the 30 mA. range of the shunt would have a temperature co-efficient greater than that allowed by B.S.I. for first grade instruments. A few simple calculations will show, that with a shunt of this type, as the ratio of Shunt Resistance/Instrument Circuit Resistance increases, so the temperature co-efficient of the combination decreases.

Therefore we must choose a shunt with a higher resistance than 10 ohms for the lowest range. To get a

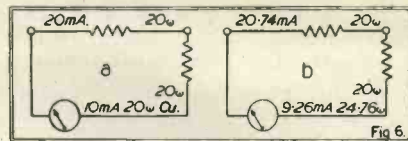

higher shunt resistance, we must have a shunt of lower current capacity.

The choice is naturally 15 mA, the next multiple to the 30 mA. For the 15 mA range we require a shunt of 40 ohms and the temperature co-efficient of the combination is 0.074 per cent. (see example), which is allowed by B.S.I. 1st grade specification. Thus we are compelled to include a 15 mA range in our universal shunt. (Fig. 5b).

The following examples show the difference between the temperature co-efficient as calculated. (a) from the formula before shunt values are found and (b) from determined values of shunt sections. Fig. 6 gives particulars of a 30 mA shunt.

By the formula the temperature co-efficient will be approximately 20/40 \times 0.238 per cent. per 1° F. = 0.119 per cent per 1° F.

Calculating from the known resistance values we get:

Coil resistance at 100° F. rise in temperature = 1.238 \times 20 = 24.76 ohms.

New coil current for this temperature = 30 \times 20/64.76 = 9.26 mA.

Temperature co-efficient in per cent. per 1° F. = 0.74 \times 10/100 = 0.074 per cent. per 1° F.

Fig. 7 gives particulars of a 500 mA shunt. As in the example above the value of the temperature co-efficient from formula = 0.119 per cent. per 1° F.

Calculating from the known resistance values we get:

Coil resistance at 100° F. rise in temperature = 24.76 ohms as before.

New coil current for this temperature = 500 \times 0.816/45.576 = 8.97 mA.

Temperature error in per cent. per 1° F. = 1.03 \times 10/100 = 0.103 per cent. per 1° F.

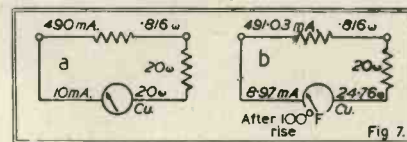

It will be seen that the correct temperature co-efficient of the combination of shunt and instrument is always lower than the approximate value given by the formula. Advantage of this fact, is shown better in the 30 mA shunt example, can be taken to reduce the amount of series resistance in the coil circuit, and thus reduce the voltage drop over the shunt, should circumstances make this necessary.

NOTES FROM THE INDUSTRY

British Standards Institution

The Institution has received a communication from the Minister of Production to the effect that His Majesty's Government recognise the British Standards Institution as the sole organisation for the issue, in consultation with any Government, professional or industrial bodies concerned, of standards having a national application.

The Institution has just issued a Specification on Exciter Lamps for 35 mm. projectors. (B.S.S. 1015).

At a meeting of the Cinematograph Industry Committee held in 1938, consideration was given to a request which had been received from the Cinematograph Exhibitors' Association for the preparation of a British Standard for exciter lamps for 35 mm. projectors. It was decided to appoint a technical committee to draft a standard and the present document is a result of their labours in which they were ably assisted by the Electric Lamp Manufacturers' Association.

The specification is divided into six parts, dealing with definitions, general procedure, requirements, selection of lamps for test, conditions of test and rejection respectively.

Copies of this specification may be obtained from the British Standards Institution, 28 Victoria Street, London, S.W.1. Price 2s. 3d. post free.

British Institution of Radio Engineers

The annual general meeting of the British Institution of Radio Engineers was held on Friday evening, May 29 at the Federation of British Industries, Tothill Street, Westminster, S.W.1. The chairman presented the annual report of the council.

In the course of the year, a Professional Purposes Committee had been established, on whose findings depended to a large extent the further developments of the Institution. This committee was concerned with the professional status of radio and electronic engineers. The programme committee had been able to plan their activities for the whole of next year.

The council elections for 1942/1943 were announced as follows: A. L. Beedle, A. G. Eggington, I. Grinstead, S. A. Hurren, W. B. Medlam, W. E. Miller, Sir Arrol Moir, N. Partridge, J. A. Sargrove, W. D. Snell, G. A. V. Sowter, and W. W. Smith.

At the conclusion of the business of the meeting, O. S. Puckle, A.M.I.E.E., introduced an informal discussion on the subject of "Time Bases," in which many members took part.

"Electrical Trading"

Mr. Owen Pawsey, editor of *Electrical Trading and Radio Marketing* is shortly to join the Ministry of Information as a technical censor. We wish him every success in his new undertaking.

Mr. Roy C. Norris, the present technical editor of *Electrical Trading and Radio Marketing* will become editor and combine the work of both.

Institute of Physics

At the annual general meeting of the Institute of Physics held on May 28, the following were elected to take office on October 1, 1942:—President, Prof. Sir Lawrence Bragg. Vice-Presidents, Dr. W. Makower and Mr. T. Smith. Honorary Treasurer, Major C. E. S. Phillips. Honorary Secretary, Prof. J. A. Crowther. Ordinary Members of the Board, Prof. J. Chadwick, Prof. J. D. Cockcroft, Mr. D. C. Gall and Mr. E. B. Wedmore.

Electronics Group of the Institute of Physics

The next meeting of the Electronics Group will be held in the Lecture Theatre of the Royal Institution, Albemarle Street, W., at 5.30 on Wednesday, July 8, when Mr. G. Parr will open a discussion on "Cathode Ray Tubes."

Particulars of the Group can be obtained from the Hon. Secretary, Dr. H. Lowery at the S.W. Essex Technical College, Walthamstow, E.17.

Institution of Electronics

At a meeting held in Manchester on May 1, at the College of Technology, three papers were read and discussed:

- (1) Review of Thermionic Emission Theory, by Dr. W. H. Taylor (Physics Dept., College of Technology).
- (2) Oxide Coated Cathodes, with special reference to Activation and Deactivation, by Dr. H. Moss (Messrs. A. C. Cossor).
- (3) Secondary Effects—Grid emission, interelectrode leakage, etc., by Dr. J. A. Darbyshire (Messrs. Ferranti, Ltd.).

The papers will be published in full in *Science Forum* which is the official organ of the Institution. Non-members can obtain a copy on application to the Secretary, Mr. A. H. Hayes, at 64 Winifred Road, Coulsdon, Surrey.

Information about membership of the Institution of Electronics may also be obtained from the Secretary or from the President, Dr. J. A. Darbyshire, Melandra, Kershaw Road, Failsworth, Manchester.

Ediswan Appointments

The Edison Swan Electric Co., Ltd., announce the election of Mr. P. S. Turner (Director of Associated Electrical Industries and of Metropolitan Vickers Electrical Co., Ltd.) to the board. Two other new directors of Edison Swan Cables, Ltd., are Messrs. R. J. Morris, Sales Manager, and Mr. F. Gale, Works Manager.

Mr. F. E. C. Miller, previously London Manager, is now Manager of Lamp Sales Department, and Mr. H. A. Mumford has taken over the office of London Manager.

Mr. J. W. Ridgeway, Manager of the Radio Division, has been elected chairman of the British Radio Valve Manufacturers' Association.

Honours

Congratulations to Mr. R. A. Watson Watt on the knighthood recently bestowed on him for his services as scientific adviser to the Government.

Mr. S. Butterworth, P.S.O. at the Admiralty, has been awarded the O.B.E., together with Mr. R. P. Browne, the hard-working secretary of the Radio Manufacturers' Association.

Obituary

We very much regret to record the death of three members of the Research Staff of Electrical and Musical Industries, Ltd., as the result of an accident, Messrs. A. D. BLUMLEIN, C. O. BROWNE, and F. BLYTHEN.

All three played a prominent part in the development of the E.M.I. Television system which was installed at Alexandra Palace, and readers will recall the paper which was read by Messrs. Browne, Blumlein and others before the Institution of Electrical Engineers in 1938 on the system.

Their loss will be felt not only by their colleagues in E.M.I. but by the industry as a whole.

The death is reported from Libya of COL. R. G. P. DENMAN, Royal Corps of Signals. With his partner, Mr. Beale, he was in practice as a consulting physicist and electronic engineer before the war, and was well known for his activities as Curator of the Radio section in the Science Museum.

Mr. Denman designed the "quality" receiver installed in the Museum and was also responsible for constructing one of the first logarithmic horn speakers to reproduce real bass, which was installed in the roof of his Kensington house.

Playing Records with Large Radius Needles

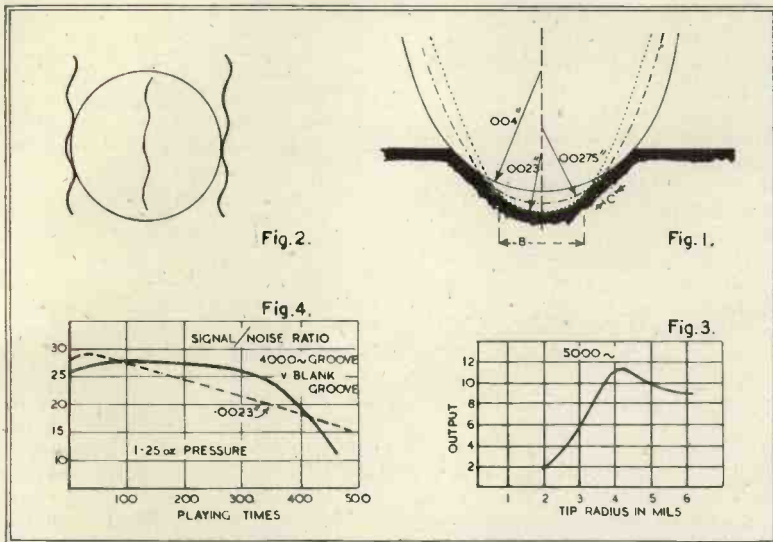

It has always been considered that a needle of as small radius as possible is desirable for efficient reproduction from lateral-cut gramophone records. This supposition has been based on the theory that the modulations are of equal lateral amplitude throughout the record groove, and it has therefore been assumed that a needle fitting closest to the bottom would penetrate the groove furthest and thus give greatest high frequency output.

J. D. Reid, in a recent paper before the Acoustical Society of America* has found that certain unexpected benefits can be obtained from the use of a needle point of large radius which makes contact only with the upper side walls of the groove on the record.

In Fig. 1, which is reproduced from his paper, an enlarged section of the groove is shown together with three sizes of needle tip: 0.0023 in., 0.00275 in., and 0.004 in. The bottom radius of the groove is 0.0022 in. and the width 0.006 in., the included angle being 88°.

It is seen that the greater area of contact (B in the diagram) is given by the smaller radius needle due to its fitting the bottom of the groove.

However, it must be realised that the least irregularity or lack of symmetry in the groove would reduce the area of contact to even less than that of a 0.00275 in. needle (C in diagram).

Fig. 2 shows an enlarged plan view of part of a modulated record groove with a 0.004 in. needle inserted. The modulations represent a sine wave of 7,000 c.p.s. as it would appear near the inside of a 78 r.p.m. standard record with a peak-to-peak amplitude of 0.0004 in. Obviously, the full amplitude cannot be traced by its radius point, and it would appear that

increased amplitude can be obtained by decreasing the radius of the needle, thereby dropping into the groove.

Fig. 3 is a curve showing the effect of a tip radius on electrical output for a constant frequency of 5,000 c.p.s. with 0.0002 peak-to-peak amplitude, other factors being unchanged. The increase of high frequency output results from the fact that high frequency modulations are not present in equal amplitudes throughout the depth of groove and are less at the bottom. This can be primarily attributed to stages in the record manufacture.

In the various processes the grooves are distorted by the chromium plating, which deposits a heavier coating on the raised surface (corresponding to the bottom of the groove) and in pressing, the raised portions (again corresponding to the bottom of the groove) are worn and distorted by the squeezing of the "biscuit" across the surface.

The curve of Fig. 4 is particularly interesting as showing the effect on the signal-to-noise ratio of the wider tip needle.

Two records pressed from the same stamper were completed by the same turntable under identical conditions, except for the needle tip radius. The upper solid line curve shows the improved ratio obtained with an 0.004 needle. Measurements made of the signal-to-noise ratio in the modulated groove, show that the large radius needle still has a superior signal to noise ratio at 500 playings.

Other curves show that there is an appreciable reduction in surface noise at 7,000 c.p.s. with the broader needle and that the tracking at 94 c.p.s. is more efficient.

*Jour. Acoust. Soc. Am., Vol. 13, No. 3, 1942, p.274.

Liquid Silver

For Metallising
Mica Ceramic
Quartz etc.

Low Melting
Point Solder
and Solder in
Paste Form

**MELTON METALLURGICAL
LABORATORIES LTD.**

IPSWICH ROAD
TRADING ESTATE
SLOUGH, BUCKS.

'Phone: Slough 20992

TAYLOR ALL-WAVE SIGNAL GENERATOR

(6.5 to 3,000 metres)

This instrument provides modulated or unmodulated Radio frequency signals for tests on all types of receivers.

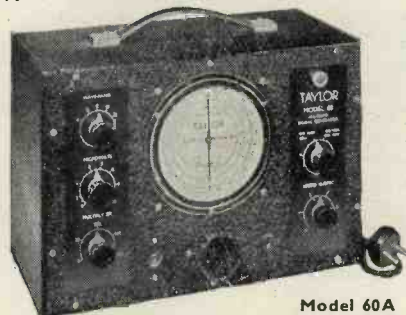

MODULATION. The Radio output can be supplied either Unmodulated or Modulated to 30% at 400 cycles, or modulated by an external audio generator.

SCREENING is very thorough.
FREQUENCY RANGE. Six wave bands covering from 100 Kc. to 46 Mc.

CALIBRATION. The dial is directly calibrated and no graphs or charts are required.

ATTENUATION. Both coarse and fine attenuators are supplied, both calibrated approximately in micro-volts and together giving a range of from 0-100,000 microvolts output.

Supplied complete with screened output lead, instruction book and frequency conversion table.

British Made by

TAYLOR

Phone: Slough 21383.

£14 - 14 - 0
Operates on 200/250 volts
A.C., 40/100 cycles

Electrical Instruments Ltd.
Sales and Service Dept.,
148a High Street, Slough,
Bucks.

Differential Input Circuits for Biological Amplifiers

Further Discussion

DEAR SIR,—I read with interest the article on "Differential Input Circuits" and would like to raise two questions with which I am in disagreement with the author.

Fig. 5a does not truly represent Offner's circuit, (see Fig. 3 in *Rev. Sci. Inst.*, Jan. 1937, p. 21), the real arrangement of which is given below:

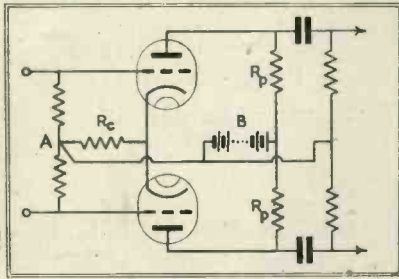

Fig. 1.

Fig. 5b is the same as Fig. 4 in Offner's article mentioned above, but it is strange that the batteries B are connected to the cathodes in that figure. Offner himself in describing the circuit says that R_{c1} should be twice as large as R_{c2} in order to give a proper negative bias to the first stage, which obtains a positive one from the cathodes of the following valves. The question is how this can be so when the batteries B are connected to the cathodes.

As regards the method of "in steps" calculation, it should be stressed that the evaluation of the effective resistance (formula 7)—let us call it xR_c —is done by means of subtraction of two relatively high values, namely E and E_c .

It follows, therefore, that they should be calculated with a minimum accuracy to two decimal places if we wish to obtain x accurately to 5-10 per cent. ($x \ll 1$ for 180° out-of-phase input voltages.)

If we take into account that the method of "in steps" calculation involves some reckoning with the slide rule till the values of E and E_c are reached, such accuracy is practically impossible to obtain and it is, therefore, far better to evaluate x straight away from a proper formula.

The second question is that it is impossible to calculate separately the currents of valves I and II (or in other words, their voltage drops on R_c) without knowing exactly the difference between them or the resultant voltage drop. Taking an example:

For 180° out-of-phase input voltages

When V_{g1} is positive, say, we obtain the voltages and currents shown in Fig. 2.

I have taken Offner's circuit, but when we put $R_{p1} = 0$ we obtain that of Toennies. When we assume the steady state conditions there will be on R_c a resultant voltage

$$e = I_1 R_c - I_2 R_c = e_1 - e_2 \quad \dots (1)$$

$$I_1 = \frac{\mu_1 (V_{g1} - e) - e}{R_{p1} + R_{p1}} \quad \dots (2)$$

$$I_2 = \frac{\mu_2 (V_{g2} + e) + e}{R_{p2} + R_{p2}} \quad \dots (3)$$

There is a rule saying that one can evaluate the particular currents when the electromotive forces are taken separately and the resultant current will be the vectorial sum of them. But here each electromotive force depends on its neighbour, namely, $\mu_1 (V_{g1} - e)$ depends on $\mu_1 (V_{g2} + e)$, therefore this rule cannot be here applied without a proper change.

In order to omit the difficulties I propose to apply another way of attack, namely, let us put

$$\frac{I_1 - I_2}{I_1} = x < 1 \text{ and } 1 - x = b \quad \dots (4)$$

$$e = e_1 - e_2 = R_c I_1 x \quad \dots (5)$$

then:

$$I_1 = \frac{\mu_1 V_{g1}}{R_{a1} + R_{p1} + R_c (1 + \mu_1) x} \quad (6)$$

$$I_2 = \frac{\mu_2 V_{g2}}{R_{a2} + R_{p2} - R_c (1 + \mu_2) \frac{x}{b}} \quad (7)$$

$$I_2 = b I_1 \quad \dots (8)$$

Generally speaking, it may happen that I_2 will be sometimes greater than I_1 . In such a case $x < 0$, $b > 1.0$, and the arrow for e will point to the opposite direction, but all the formulae will be still in force. Substituting 6 and 7 into 8 we will obtain a formula for "x."

For in-phase voltages we will have:

$$\frac{I_1 + I_2}{I_1} = y > 1 \quad y - 1 = c \quad \dots (9)$$

$$I_1 = \frac{\mu_1 (V_{g1} - e) - e}{R_{a1} + R_{p1} + R_c (1 + \mu_1) y} = \frac{\mu_1 V_{g1}}{R_{a1} + R_{p1} + R_c (1 + \mu_1) y} \quad \dots (10)$$

$$I_2 = \frac{\mu_2 (V_{g2} - e) - e}{R_{a2} + R_{p2} + R_c (1 + \mu_2) y/c} \quad \dots (11)$$

$$I_2 = c \cdot I_1 \quad \dots (12)$$

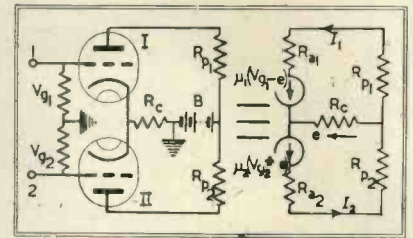

Fig. 2.

Here also y can be evaluated for every case. It should be noted that when one uses these equations, one is always in a position to check them by other formulae (e.g., I_2 can be evaluated by means of formulae 3, 7, and 8), and that does not apply to the "in steps" method, which gives quite different results, and one formula of it does not agree with the other.

By means of the equations given above it is possible to calculate very thoroughly the push-pull differential circuits, their advantages and disadvantages, and check them in the practice, e.g., it is possible to calculate for exact balance of currents and for triodes that the ratio:

Amplification
of 180° out-of-phase input voltages
= i
Amplification of in-phase voltages
and this is for triodes

$$i = 1 + 2k \frac{(1 + \mu_1)}{\mu_1} \quad \dots (13)$$

where in this case k is Goldberg's constant =

$$\frac{R_c \mu}{R_a + R_p}$$

calculated for one of the circuits. As we see k is really a constant for a given circuit and valve. When we take for μ a most common value, say, $\mu_1 = 30$, then we get a practical formula; λ when k is not greater than 10)

$$i = 1 + 2k (1.033) \approx 1 + 2k \quad (14)$$

But for various high μ pentodes we will get from other formulae

$$i = \text{from } 1 + 2.2k \text{ to } 1 + 2.4k \quad (15)$$

The expression "1 + 2k" bears other relations to the circuit, but this is no place to put them forward.

J. DEBSKI.

Enfield.

ELECTRONS IN ACTION!



With the aid of this Electron Microscope, one can actually observe the action of electrons being emitted from a heated filament. Like a moving picture, the emission characteristics of a filament are projected on a lens-like screen. Observations, thus made, enable Eimac engineers to maintain the enviable record of dependability and superior performance enjoyed by Eimac valves.

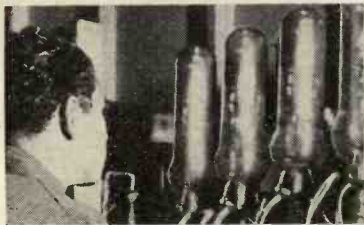

Before filament assemblies are sealed into the valves they are placed under a temporary vacuum and heated to much higher temperatures than normal. This vital test enables technicians to weed out faulty parts before valve is actually pumped.

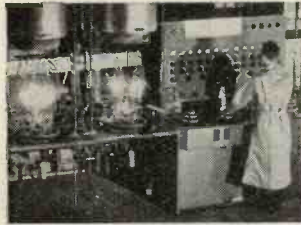

Hard vacuum is essential to preserve peak filament emission. Special pumps are built in the Eimac laboratories to fit the exact requirements of Eimac valves. During the pumping process, plate dissipation is run up to ten times normal. Valves that cannot stand this abuse never leave the factory.



Here is a special Emission Tester which enables laboratory men to ascertain the actual performance capabilities of filaments after the valves are completed. Under this test filaments are made to perform much more difficult tasks than could possibly be required under normal operating conditions.

MAXIMUM FILAMENT EMISSION ASSURED IN EIMAC VALVES

All Eimac valves are unconditionally guaranteed against valve failures resulting from gas released internally. No other valve carries such a guarantee. This guarantee plus the fact that leading engineers throughout the world use and recommend them provides ample reasons for you to consider Eimac valves for your application.

Follow the leaders to

Eimac
VALVES

Eitel-McCullough, Inc.,
San Bruno, California, U. S. A.

FOREIGN DIVISION:
FRAZAR & CO., LTD.

301 CLAY ST., SAN FRANCISCO, CALIFORNIA, U. S. A.

Eimac's unusual performance capabilities are receiving the enthusiastic acceptance in all branches of the service ARMY, NAVY, AIR CORPS.



EIMAC 450T

(In use by practically every major airline in the U. S. A.!)

Filament Voltage 7.5 to 7.7 Volts
 Filament Current (approx.) 12 Amperes
 Maximum Plate Voltage 6000 Volts
 Continuous Plate Dissipation 450 Watts
 Power output at 75% efficiency 1350 Watts

ABSTRACTS OF ELECTRONIC LITERATURE

CIRCUITS

A Stabilised Ionization Gauge Circuit with Valve Voltmeter

(J. Rainwater)

A complete control circuit for use with the usual triode ionisation gauge tube is described. A modified Ridenour Lampson¹ type circuit is employed to stabilise grid and anode voltage, as well as emission current. A simple valve voltmeter circuit permits the use of a relatively rugged 0.1 milliammeter to read anode current. Special provision is made for outgassing, and for leak hunting.

—*Rev. Sci. Inst.*, Vol. 13, No. 3 (1942), page 118.

Electronic Differentiation

(O. H. Schmitt and W. E. Tolles)

Electronic circuits are described which, over a wide range of frequency and wave form, generate output voltages accurately proportional at every instant to the time derivative of their input potentials. Three basic circuits are described which provide successively increasing accuracy of differentiation with attendant increased complexity of construction and delicacy of adjustment. Criteria are provided for choosing between the circuits for particular applications.

—*Rev. Sci. Inst.*, Vol. 13, No. 3, March (1942), page 115.

THERMIONIC DEVICES

An Electronic Voltage Stabilizer for 1 to 50 kv and 20 to 500 mA.

(L. G. Parratt and J. W. Trischka)

A description is given of the design and performance of an electronic super-degenerative stabiliser in the output of a d.c. high voltage supply. This stabiliser is proposed as a satisfactory and economical solution, alternative with the usual controlled motor-generator set, of the problem of obtaining very steady high voltage at rather large powers (1 to 50 kv and 20 to 500 mA in the present design). The device reduces the residual ripple from the filter as well as stabilises against fluctuations in the input voltage. The stabiliser, containing an 833 type valve with two stages of amplification in the grid circuit, is essentially a modification of the degenerative type of stabiliser but, taking advantage of grid current, the stabiliser may be adjusted to have positive, negative, or infinite stabilisation ratio. This device, using grid current warrants a new name, and is termed a super-degenerative stabiliser.

—*Rev. Sci. Inst.*, Vol. 13, No. 3 (1942), p. 17.

¹ L. N. Ridenour and C. W. Lampson. *Rev. Sci. Inst.* Vol 8, 162 (1937).

THEORY

The Effect of Space Charge on the Potential and Electron Paths of Electron Beams

(D. P. R. Petrie)

In this article the more important results of analyses of the effects of space charge in electron streams are collected from the existing literature and are presented in the form of curves and nomograms so that they can readily be applied to cases occurring in practice. The effects considered are:— the space charge limited current in plane and cylindrical diodes; the minimum potential; maximum current and increase of transit time in the screen-anode region of tetrodes; the minimum potential, maximum current, velocity distribution and divergence of a long flat beam between parallel plates and of a long cylindrical beam in a tube.

—*Electrical Communication*, Vol. 20, No. 2, page 100.

The Behaviour of Electrostatic Electron Multipliers as a Function of Frequency

(L. Malter)

A theoretical and experimental study of the frequency variation of transconductance of electrostatic electron multipliers. It is shown that the decrease of transconductance with frequency up to 500 megacycles, can be ascribed to spread in transit angle resulting from the emission velocities of secondary electrons and the varying paths of electrons through the stages of the multiplier. The spread in transit angle may be represented by an equivalent angle that is linearly related to the total transit angle unless the latter is quite large.

—*Proc. I.R.E.*, Vol. 29, No. 11 (1941), page 587.

MEASUREMENT

Electrical Measuring Instruments applied to Radiography

(Banner)

The application of measuring instruments to X-ray measurements is reviewed, as well as special features necessary for use at high voltage. Measurement of X-ray voltage and current is detailed, with especial reference to the difference in reading obtained by the different types of instrument (peak r.m.s. and mean values) when the circuit is not true d.c. Quantity instruments for measuring mA/sec. are dealt with, and notes provided on the use of a voltmeter or an ammeter for rectifier filament control.

—*Radiography*, April, 1942, page 50.*

New Instrument for Analysing Electrical Transients

(Rohats)

By flashing repeated images on the screen in regular succession and at definite intervals, the instrument described produces a resultant steady image for any designed length of time, though the event being measured may take place in a few microseconds. The instrument combines in a single unit a low-voltage surge generator, a sweep circuit and a cathode ray oscillograph.

—*G.E.C. Review*, February, 1942, page 121.*

Low Frequency Square Wave Analysis

(A. Preisman)

The square wave has been used as a means of testing the performance of video, and even audio amplifiers, both at the high and at the low frequency ends of the spectrum. The interpretation of the results, is, in general, by no means a simple matter, and it is the object of this article to suggest a relatively easy physical interpretation at the low frequency end of the spectrum.

—*Communications*, Vol. 22, No. 3, (1942), page 14.

INDUSTRY

Selenium Rectifiers for closely regulated Voltages

(Yarmack)

Following general details concerning selenium rectifiers for a.c./d.c. rectification, the design of such rectifiers is considered. The static and dynamic load characteristics of bridge connected selenium rectifiers, and the application of such rectifiers. (1) in a circuit now being widely used for automatic battery chargers, and (2) in battery eliminators for telephone and telegraph services are also discussed.

—*Electrical Communications* (1941), No. 2, page 124.*

Styramic for High-frequency Insulation

(Carswell and Hayes)

The characteristics of ceramic insulation are contrasted with those of polystyrene. A development of polystyrene, known as styramic, is described and the properties compared with those of other materials. It is claimed that styramic is superior to other plastics from the point of view of high frequency electrical insulation, is characterised by good electrical properties, is heat resistant and non-inflammable, these characteristics are explained in full.

—*Mod. Plastics*, February, 1942, page 68.*

* Supplied by courtesy of Metropolitan-Vickers Elec. Co., Ltd., Trafford Park, Manchester.

AVOID DANGER of H.R. or DRY JOINTS



MULTICORE SOLDERS LTD.
BUSH HOUSE, LONDON, W.C.2
Tel : 5583/4

The experiences of the leading manufacturers of Radio and Electrical Equipment have shown that only by using ERSIN MULTICORE SOLDER WIRE, which contains three cores of non-corrosive Ersin Flux (A.I.D. Approved), and the correct soldering technique, can they ensure that H.R. or Dry Joints are avoided.

If you are engaged on Government Contracts write for Technical information and free samples of Ersin Multicore. For the present, supplies of Ersin Multicore are restricted to such firms, and the Ministries.

IN THE NATIONAL INTEREST. *Even if you do not yet enjoy the advantages of Multicore; in the National interest endeavour to use an alloy containing a lower tin percentage. We are glad to give technical assistance in overcoming difficulties.*

● Specialised knowledge in the extrusion of plastics guarantees the technical excellence of Tenaplas Products. Although mainly used at the present time for Chemical and Electrical Insulation, the Tenaplas Process of Extrusion can be utilised with great advantage in many other branches of industry.

Our Service is at the disposal of all manufacturers interested.

TENAPLAS, LTD.
Head Office :
7, PARK LANE,
LONDON, W.1.

TENAPLAS

EXTRUDED PLASTICS

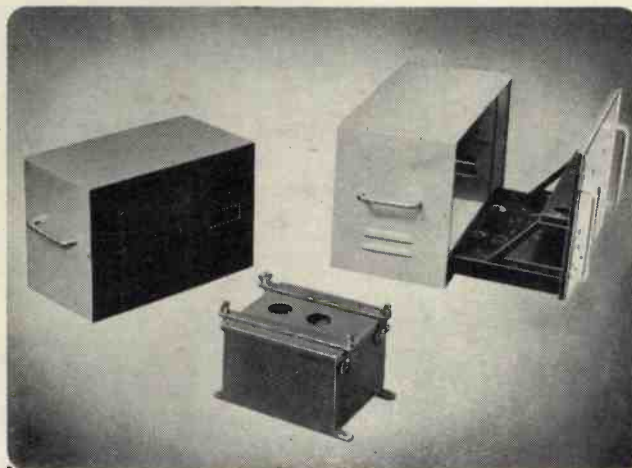

INSTRUMENT CASES

Our fully equipped modern factory produces all types of metal instrument cases, radio chassis, panels, brackets, boxes and other metal components. Complete amplifying equipments designed and manufactured for special requirements.

Enquiries to be addressed to our Head Office :—Alfred Imhof Ltd., 112-116, New Oxford Street, London, W.C.1

Museum 5944

IMHOF'S

PATENTS RECORD

The information and illustrations on this page are given with the permission of the Controller of H.M. Stationery Office. Complete copies of the Specifications can be obtained from the Patent Office, 25, Southampton Buildings, London, W.C.2, price 1s. each.

CIRCUITS

Improvements in Electric Periodic Wave Repeater: and Generators

The repeater system of the invention is particularly suitable for deriving from a given wave, a wave of submultiple frequency for use as a timing wave in a television-signal transmitter. It is also of particular value in oscillators for generating periodic pulses which are precisely timed by means of a delay network, the timing of which does not depend primarily on the materials utilised in the timing circuit.

The system comprises a relaxation oscillator which is timed by a pulse transmitted in one direction through a line or filter network operating as a delay network. A high vacuum valve 10 connected to discharge periodically and abruptly a condenser 11, which is slowly charged in the meantime from the battery.

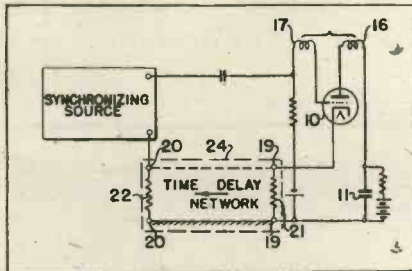

Valve 10 has a control grid, which is normally biased partially or completely to cut-off. In order that the circuit may operate as a conventional relaxation oscillator, a feedback coupling is provided by an inductor 16 in the output circuit of valve 10 inductively coupled to 17 in the input circuit.

Synchronising signals may be applied to the input circuit of valve 10. A feedback circuit comprising a delay network 24 is included between the output and input circuits of the wave generator. This delay network may be a smooth uniform transmission line or a smooth artificial line or a filter composed of lumped reactance elements, and is shown as a simple uniform transmission line of unbalanced form having input terminals 19 and output terminals 20. The transmission line is terminated in its image impedance at one or both of its pairs of terminals by means of resistors 21 and 22. The end 19 is connected in the cathode circuit of valve 10, while the end 20 is included in the input circuit of valve 10 in series with the source of synchronising signals.

—Hazelton Corporation. Patent No. 538,553.

Electron Discharge Valve Amplifiers

To provide improved amplifiers which adjust themselves automatically to take care of wide variations in the impedance of their load.

The network 13 through which the rectifier 12 is fed to the control grid of valve 11 is made up of resistance in series and condensers in shunt without any shunt conductance. A relay valve 15 has its cathode connected to the control grid of valve 11, its anode connected to the positive terminal of the source 5a, and its control grid connected to the anode rectifier 12. The rectifier then operates as a peak rectifier. Each time there is a peak signal in the primary winding of transformer 10, the control grid of valve 15 will instantaneously be driven positive with respect to its cathode, thus the valve will be rendered conducting. The valve will then pass current into the network 13 so tending to discharge the shunt condensers.

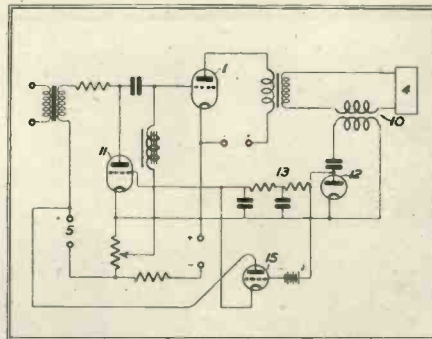

The rectifier 12 will be caused to develop a higher voltage when the impedance of load 4 is low than when the impedance is high. In this way, when the impedance of load 4 is low, rectifier 12 operates to supply sufficient current through network 13 to overcome the effect of the valve 15. If, on the other hand, the load 4 is of high impedance, then the voltage applied to the diode will be insufficient to supply the charging current required to overcome the discharging action of the valve 11, will not be appreciably affected.

The transfer ratio will not be increased, and contrast expansion whereby excessive voltages which might give rise to overloading would be applied to the control grid of valve is avoided.

—A. H. Cooper. Patent No. 539,859.

INDUSTRY

Improved Electronic Temperature Control System

An electronic control system which is automatically protected against failure of the control circuit, and which operates by means of variations in mutual inductance between degeneratively coupled coils. This is accomplished by means of an additional coil in the output of the oscillator circuit, which is untuned and consequently carries less current of the oscillatory frequency.

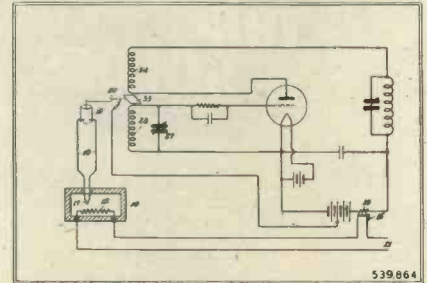

Assume that the temperature to be controlled in the furnace 10 is below the pre-established control point. The relative disposition of parts and polarity arrangement are such that a vane 35 carried by the pointer 20, will be outside the common field of coils 28 and 34. The related circuits will be in a non-oscillatory condition, and the anode current will have its maximum value. The unidirectional component of this current, passing through the winding of relay 15, will cause its contacts to be closed, energising from the source 11 the heating element 12, and tending to increase the temperature in the furnace 10. Upon an increase in e.m.f.

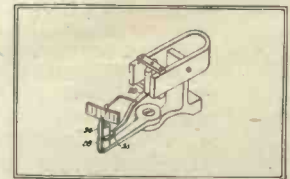

developed by the thermocouple 17 due to rising temperature, the deflection of the galvanometer coil 19 will cause the vane 35 to be carried into the common field of the coils 28 and 34, shielding one from the other and allowing an oscillatory condition to develop in the associated circuits. A consequent reduction in the magnitude of the anode current results with release of the relay 15, so de-energising the heating element 12.

—The Bristol Company, U.S.A. Patent No. 539,864.

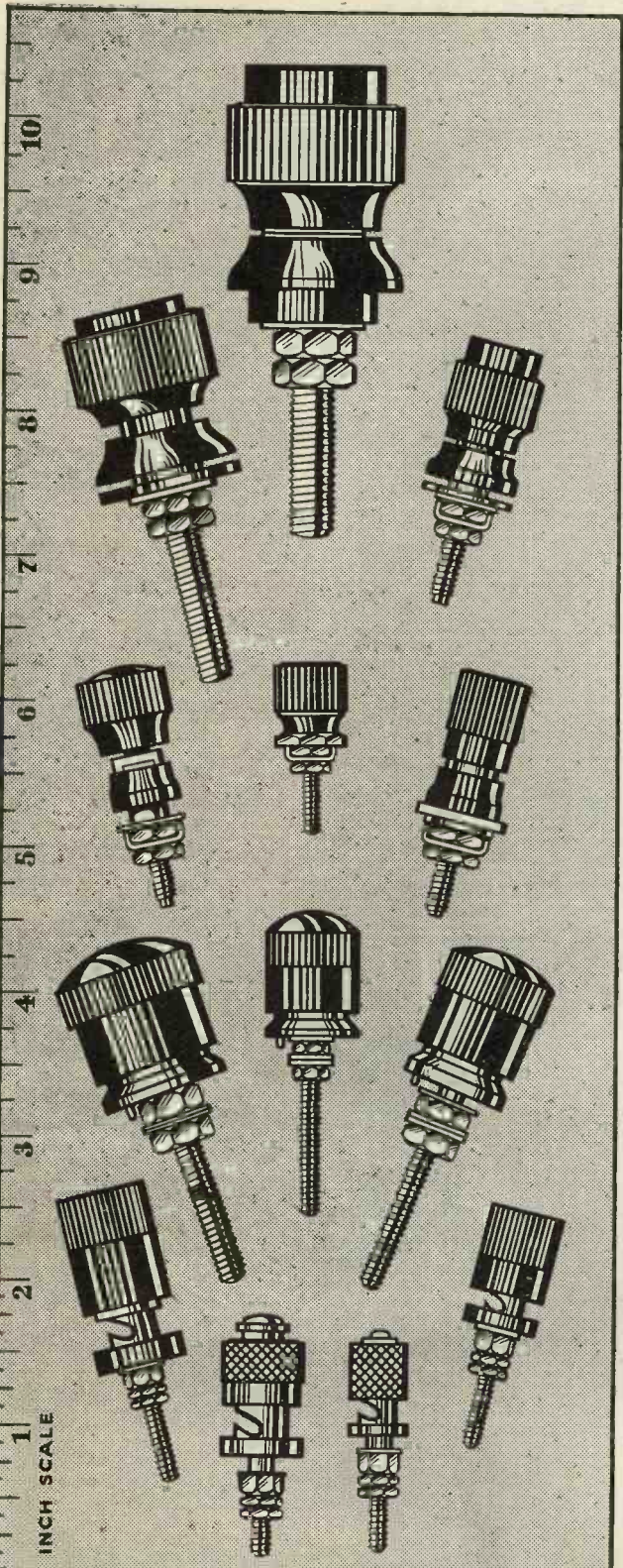

BELLING & LEE LTD

CAMBRIDGE ARTERIAL ROAD, ENFIELD, MIDDX

G.P. 5907

FIRE

Ask Yourself!

HAVE I A VALUABLE PLANT TO SAFEGUARD ?

WILL INSURANCE FULLY COVER MY LOSS ?

CAN I REPLACE IMMEDIATELY MACHINERY DESTROYED BY FIRE ?

CAN I REPLACE LOST PRODUCTION ?

SHALL I CONSULT THE EXPERTS *Yes*

The hazard of FIRE is always with you, waiting to get its merciless grip upon your works, your plant and equipment, your profits and your goodwill. So serious a matter calls for professional advice, given only after a personal investigation of your individual problem. Because there is literally nothing to compare with Methyl Bromide, we invite you to consult us and allow us to prove, by facts and actual demonstration, that Methyl Bromide alone can solve your fire protection problem.



THE NATIONAL FIRE PROTECTION CO., LTD.
 PETERSHAM RD., RICHMOND, SURREY.

Telephone: Richmond 2342-3-4.

BOOK REVIEWS

Theory of Gaseous Conduction and Electronics

F. A. Maxfield and R. Benedict. 483 pp. 241 figs. (McGraw Hill Co., London. 31/6 net).

The recruitment of large numbers to electronic engineering has evoked a spate of publications ranging from the elementary and practical to the profound and academic. This book falls midway between the two and possesses the faults and virtues of both extremes.

The first word of the title is the important one, and the value of its contents is essentially theoretical.

The practical applications are only sketchily treated, for example, the thyatron appears first on page 431, and the main application considered is to arc welding circuits.

For English readers the chief value of the book will probably be as an aid to understanding the relationship between theory and practice in American electronics. The jumping-off places are different in America, and this may account for certain differences in both technical and educational fields. A very valuable educational point in this book is the provision of problems for the reader to solve at the end of each chapter, and this feature will un-

doubtedly recommend it to teachers of electronic physics.

There will be little that is new to those actually engaged in electronics at the present day.

W.G.W.

Plastics in Industry

(2nd. Edition). By "Plastes." 241 pp. 55 plates in text. (Chapman and Hall. 15/- net).

The fact that a second edition of this book is required within nine months is evidence of the great interest in this subject which is being taken at the present time.

A fresh chapter on "Insulation" has been added, but the expectant reader is warned that this does not deal with electrical, but with heat insulation. On the other hand the tables of electrical properties are included in the chapter on the use of plastics in the electrical industry, and these add considerably to the value of the book as a work of reference.

The trade names of most of the plastic materials have also been added, together with a list of the literature of plastics.

When this book first appeared we recommended it as a most useful addition to the engineer's library and we cannot do better than repeat this re-

commendation. In spite of war-time conditions the printing and production are excellent.

Radio Circuits

(2nd. Edition) By W. E. Miller. 61 pp. 56 figs. (Wireless and Electrical Trader, 3/6 net.)

This book originally appeared under the title of "The A.B.C. of Radio Circuits" and is based on a series of articles which have appeared in the *Wireless Trader*.

The superheterodyne is the main theme of the book, although much of the information is applicable to straight receivers, and the author has dealt thoroughly with the circuit stage by stage giving numerous alternative forms of circuit in each.

Component values are given wherever possible and the whole treatment is practical and clear. A minor point is that the short waves do not appear to receive the attention which is their due, but students of radio will not find this a drawback as there is so much really useful information that they require.

With its very reasonable price this book should have a wide sale among trainees and beginners in the radio industry.

THE DIAGRAMS IN THIS JOURNAL ARE LETTERED WITH

"UNO"

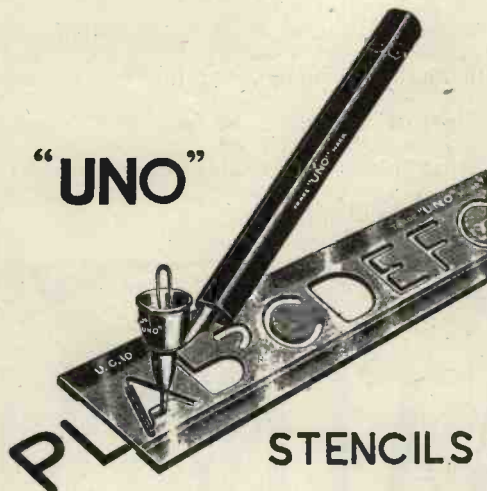

PL STENCILS

FOR LEGIBILITY & NEATNESS

A. WEST & PARTNERS, LTD.

36, Broadway,
WESTMINSTER

CONSTANT VOLTAGE

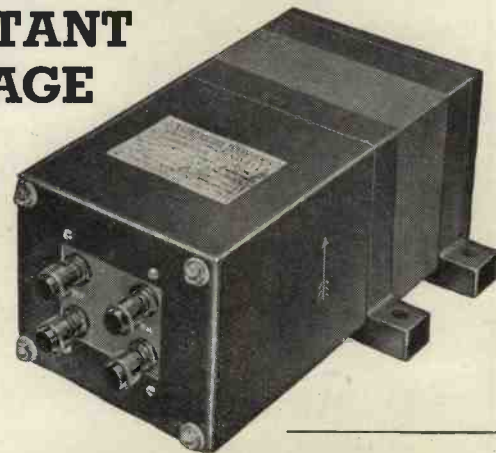

A NEW **ADVANCE** IN TRANSFORMER DESIGN

Line voltage variations of
 $\pm 15\%$ reduced to $\pm 1\%$

Stabilize your Electrical Instruments by using an
"ADVANCE" Constant Voltage Transformer

TYPICAL SPECIFICATION:

Input Voltage:	190-260 v. 50 c.
Output Voltage:	230 v. $\pm 1\%$.
Max. load:	150 watts.
		Input power factor over 90%.

Write for details.

Price on application.

ADVANCE COMPONENTS LTD.,

Back Rd., Shernhall St., Walthamstow, London, E 17

Telephone: Larkwood 4266-7

METALASTIK IN TORSION

A RUBBER WELDED TO METAL COUPLING DESIGNED TO TRANSMIT TORQUE AND ELIMINATE TORSIONAL VIBRATION.

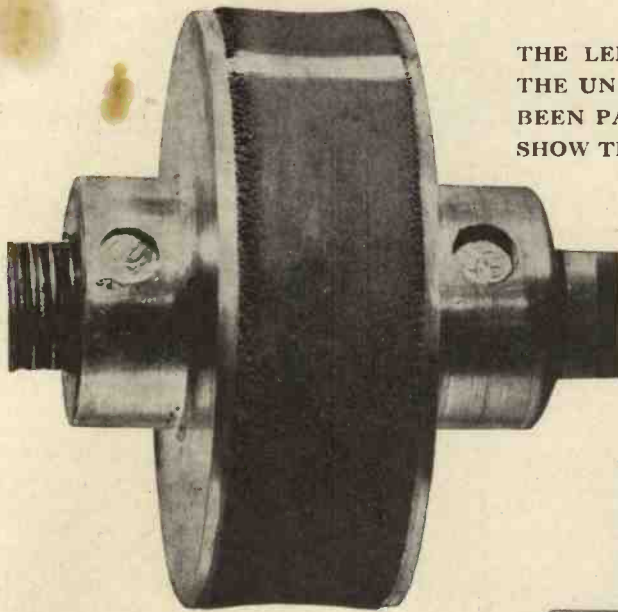

THE LEFT-HAND ILLUSTRATION SHOWS THE UNIT IN REPOSE, A WHITE LINE HAS BEEN PAINTED ACROSS THE RUBBER TO SHOW THE EXTENT OF THE DEFLECTION.

ON THE RIGHT THE UNIT IS SUBJECTED TO A TORSIONAL STRESS WITH A DEFLECTION OF 50° NO SIGN OF SEPARATION OCCURS. THE WONDERFUL METALASTIK 'RUBBER-TO-METAL' WELD WILL HOLD UNTIL THE POINT WHERE THE RUBBER ITSELF TEARS APART.

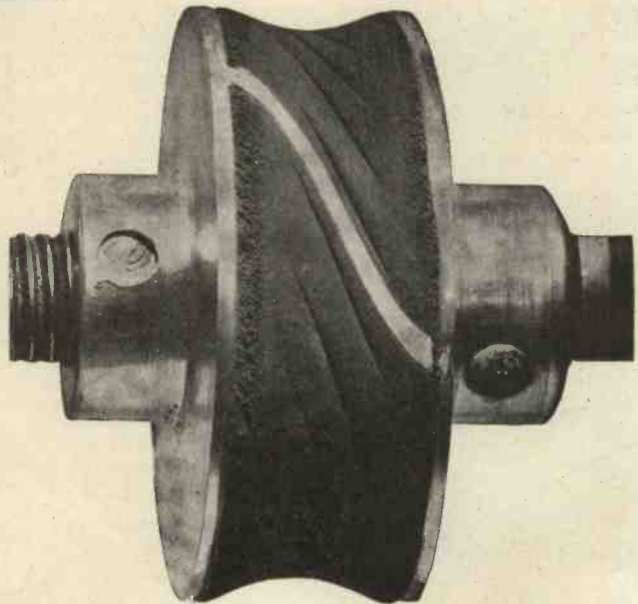

METALASTIK

ANTI-VIBRATION UNITS

METALASTIK LTD.
LEICESTER

A specialised service for short-wave radio



equipment

If there was anything new in British or American short-wave equipment you were certain to find it at Webb's. That was pre-1939. To-day; though the situation is vastly different, Webb's service in many respects is still unique. Some of the facilities it offers are described below (more comprehensive perhaps than one might expect) and amateur and priority holder alike will still find there the enthusiasm and helpfulness that has given Webb's a special place in the estimation of all short-wave workers.

RETAIL SALES AND MAIL ORDER DEPT. Despite staff shortages and other difficulties we are still able to offer practically any component required by the Short-wave enthusiast at our Retail Sales Dept., 14, Soho Street.

MAIL ORDER DEPT. If you are unable to call, post your requirements. Though also short-staffed this department provides an efficient and careful service.

SERVICE OF COMMUNICATION RECEIVERS. A restricted service can now be given on all types of Communication Receivers. Please do not despatch instruments without first communicating with us.

SPECIAL PRODUCTS DEPT. This Department offers very useful facilities for the construction of specialised equipment for transmission and reception. One of its recent productions—a 75 watt 'phone and C.W. Transmitter is illustrated.

NEW LINES are continually being introduced and among the latest is an American type Morse Key. This new Key, illustrated above, is very light in operation, well balanced and is priced at 8/6. Other lines include a 50 watt audio amplifier and an audio oscillator for Morse practice. This latter instrument, Type OA 1, is entirely operated from A.C. Mains, gives a 1,000 cycle note, and drives two pair of phones. Price £2 5s. od., including two valves.

BANDPASS CRYSTAL FILTER UNITS BY SIMMONDS AEROACCESSORIES LTD.

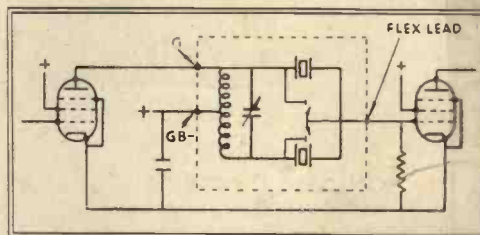

Circuit of Bandpass Crystal Filter.

The retail distribution of these units is being made exclusively through Webb's Radio. They are self contained units, occupy no more space than an I.F. Transformer and are suitable for use with practically any well known Communication Receiver. The general frequency is 465 Kcs but other frequencies are available to order. They are extremely simple to instal and phasing is unnecessary. We shall be glad to send full technical specification and details on request. Price 1/-.

A 75-watt 'phone and C.W. Transmitter constructed in Webb's Special Products Dept.



WEBB'S Radio

14 SOHO STREET, LONDON, W.1. Tel: GERRARD 2089. Open 9am to 5pm. Sats: 9am to 12 noon.