

ALL NEW RECEIVERS : PRICES & DETAILS

# Television

and *SHORT-WAVE WORLD*

OCTOBER 1938

No. 128. Vol. XI.

**COMPACT  
PORTABLE  
TELEVISION  
AERIALS**

**BUILDING  
CHEAP  
OSCILLO-  
SCOPE**

**SHORT  
WAVES**

**REMOTE  
CONTROL  
BY RADIO**

**SINGLE-VALVE 2-BAND TRANSMITTER**

**5-METRE CRYSTAL CONTROL  
RECEIVER FOR 5-8 METRES**

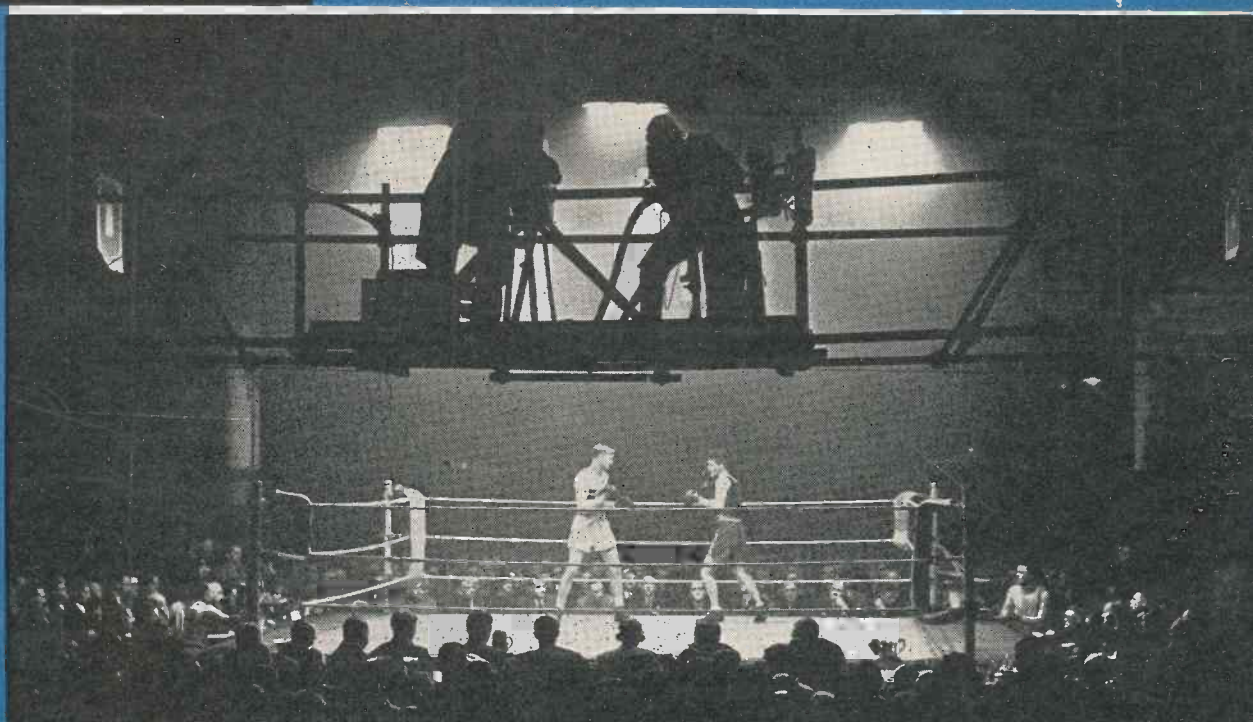

**TELEVISION MUST HAVE  
NEWS VALUE !**

BERNARD JONES PUBLICATIONS LTD.  
CHANSITOR HOUSE, CHANCERY LANE  
LONDON W.C.2.

THE FIRST TELEVISION JOURNAL IN THE WORLD





# NEW!

### TIME BASE

thyatron tube time base last year; and it is now mA for the medium-size. Voltages remain high. In the thyatron anode ion, when electrostatic of anode resistance and high for the scanning amplifier valves, may be obtained without n wave-form.

mA at 1,000 volts may be obtained H.150, used in voltage-doubler with an 20 mA. The voltage-doubler reservoir capacities should 0.4 to 0.5 mfd, each, and should be capable of withstanding at least 850 volts peak.

It will be noticed that by using the Westinghouse system for the above output, the transformer secondary winding is far safer from breakdowns, owing to the comparatively low voltage employed. Were a full-wave valve rectifier in use here, the requisite secondary voltage would be 1,000-0-1,000, totalling 2,000, or over three times that required when using the Westinghouse Metal Rectifier. In addition to affording greater safety from accidental shock, the lower potential between secondary windings, and between such windings and frame, results in a cheaper, smaller and more reliable transformer.

For outputs above 10mA it will be necessary to employ an additional pair of H.150 rectifiers wired in parallel with above; or to employ, alternatively, one of the larger output rectifiers as used for H.T. supply to receivers. If, upon grounds of economy in space, the extra pair of H types in parallel is preferred, the transformer should be designed to carry at least 50% extra current: the capacity of the voltage-doubler condensers should be doubled, and care must be taken to make all paralleling connections perfectly sound in order to avoid unbalanced resistance joints, as such joints would cause unequal distribution of the load. (See page 19.)

30

### H.T. SUPPLY TO PICTURE-SHIFT CIRCUIT

An output of 250 to 300 volts 4 to 5 mA is usually required for this circuit, and a suitable rectifier is the H.75, which may be used in the half-wave circuit shown below.

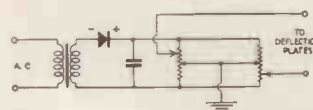

FIG. 28

### RESTORATION OF D.C. COMPONENT

The circuit shown below indicates a particular application where the use of metal rectifiers provides a marked saving in space, and in cases in which the C.R. tube anode is earthed, also an increase in safety. The use of valve rectifiers in the positions shown necessitates highly insulated heater windings, which would still be somewhat dangerous.

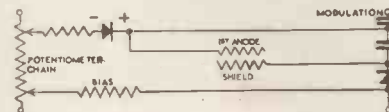

FIG. 29

It will be seen that this circuit provides double modulation to the tube (modulating both shield and 1st anode) and restores the D.C. component of the picture signal which normally is lost between the output of the video-frequency amplifier valve, and the shield of the C.R. tube.

31

The enlarged 1939 edition of "The All Metal Way" includes a special chapter on television as well as up-to-date information on all rectification problems.

Use the attached coupon and get your copy now.

COUPON

**WESTINGHOUSE BRAKE & SIGNAL CO LTD.**  
82, York Way, King's Cross, London, N.1.

Please send me "The All Metal Way, 1939." I enclose 3d in stamps.

Name .....

Address .....

T. 10 38

# NEW MAZDA

● Each month this page will contain data on special television valves developed by MAZDA engineers for use with MAZDA Cathode Ray Tubes.

## TELEVISION PENTODES

### TYPE S.P.41

A screened H.F. pentode of small dimensions for use in the I.F. and H.F. stages of vision receivers. The input loss is considerably reduced by the use of the Mazda Octal Base.

#### RATING

Heater Voltage	- - -	4.0
Heater Current	- - -	0.95
Max. Anode Voltage	- - -	250
Max. Screen Voltage	- - -	250
*Grid Bias	- - -	2.1
*Mutual Conductance	- - -	8.4
*Input Capacity ( $\mu\mu\text{F}$ )	- - -	15.5

\* under operating conditions.

Price 10/6

### TYPE S.P.42

A screened H.F. pentode for the output stage in a vision receiver.

#### RATING

Heater Voltage	- - -	4.0
Heater Current	- - -	0.95
Max. Anode Voltage	- - -	200
Max. Screen Voltage	- - -	200
*Mutual Conductance	- - -	9.0
at $E_a$ 200, $E_s$ 100, $E_g$ 0.		
Input Capacity at 10 mA ( $\mu\mu\text{F}$ )	- - -	13.5

Price 10/6

Full particulars of these and other Mazda valves will be sent on request.

*Mazda Radio Valves are manufactured in Great Britain for the British Thomson-Houston Co. Ltd., London and Rugby.*

# MAZDA CATHODE RAY TUBES

MAZDA CATHODE RAY TUBES are used by leading set makers and home constructors on account of their exceptional efficiency and brilliance.

The full range now includes 9" and 12" tubes electrostatically and magnetically focused. Write for full particulars to the Technical Service Department, 155 Charing Cross Road, W.C.2.



# TELEVISION

## and SHORT-WAVE WORLD

### Special Features

	PAGE
Some Different Television Aerials ...	589
The Design of a 30,000 R.P.M. Synchronous Motor .....	593
More Experiments in Supersonic Wave Light Modulation .....	595
1938-39 Television Receivers .....	598
Television at the Berlin Exhibition .....	606
Increasing Reception Range .....	610
A New Film Transmitter .....	613
A Portable Oscilloscope .....	618
A Single-valve Two-band Exciter ...	623
The Hallicrafter Sky Champion .....	626
5-metre Crystal Control .....	628
Carrier-type Remote Control .....	631
Experimental 5-8-metre Receiver .....	634

### TELEVISION AND SHORT-WAVE WORLD

**Proprietors:**  
BERNARD JONES PUBLICATIONS, LTD.

**Editor-in-Chief:**  
BERNARD E. JONES.

**Editor:**  
H. CORBISHLEY, F.T.S.

**Short-Wave Editor:** KENNETH JOWERS  
**Editorial, Advertising and Publishing Offices:**

Chansitor House, 38, Chancery Lane, London, W.C.2.

Telephones: Holborn 6158, 6159.

Telegrams: Beejapee, Holb., London.

Subscription Rates: Post paid to any part of the world—3 months, 3/6; 6 months, 7/-; 12 months, 14/-.

Published Monthly—1/- net.  
(On the first day of the month).

Contributions are invited and will be promptly considered. Correspondence should be addressed according to its nature, to the Editor, the Advertisement Manager, or the Publisher, "Television and Short-wave World," Chansitor House, Chancery Lane, London, W.C.2.

#### IMPORTANT

"Television and Short-wave World" is registered at the General Post Office, London, for transmission to Canada and Newfoundland by Magazine Post. Entered as Second-class mail matter, Boston, Mass.

## COMMENT OF THE MONTH

### This Year's Receivers: Facts and Figures

ON another page of this issue we give details and prices of all the commercial receivers at present on the market. An analysis of these particulars throw an interesting light on the position of television to-day, and it indicates very clearly what amazing progress is being made and the faith that manufacturers have in the future possibilities of television, even though when at the time their production programmes were made the public response seemed poor.

In all there are twenty-two firms who are manufacturing television receivers, and the number of different models available to the public is sixty-four. The introduction this year of small screen receivers has naturally had an effect on the averages of picture size and price. Excluding the large projection type instruments, the average screen size, taking the largest dimension, is 8½ inches; but the most general screen size, as reference to the table will show, is 10 inches by 8 inches. When price is studied in conjunction with screen size, it will be appreciated that it bears out a contention that we have repeatedly made in these pages—that price reduction is only possible at the present juncture by a reduction of picture size, and there is no indication of any other solution of the price question within sight. The average price, again excluding the projection receivers which are in a class by themselves, works out at £58 17s. 6d. This figure, however, does not exactly represent the price of a television receiver as such, for many models include all-wave radio and, in some cases, an autoradiogram in addition, features which would probably make a difference of 25 to 30 per cent. Thirty-two of the models listed include all-wave radio, twenty-six are television and sound only, and there are an additional seven of other types. Instruments in which the picture is directly viewed find more favour than the indirectly viewed type, for of the former there are forty-two, and only nineteen of the latter.

### Official Status for Radio Amateurs

THE most important aspect of the recently developed scheme to make use of amateur transmitters and experimenters in time of national emergency is that the British amateur will, in future, have a semi-official status on the lines of the American amateur fraternity.

Although the Post Office make a particular point of issuing licences for experimental use only it has been felt in many quarters that the many thousands of amateurs in this country should be employed to advantage by being trained so that they would be able to take their part in National defence when required.

The R.A.F. Civilian Wireless Reserve will ultimately consist of 7,000 amateurs who will be trained up to Service requirements. In this way the standard of operating amongst British amateurs should be greatly improved and while the country will have the services of 7,000 trained amateurs it seems that the amateurs themselves will also gain by this arrangement.

In future those who join the Civilian Wireless Reserve will have a special call sign and in time be affiliated to the R.A.F. Signal Section.

# SKETCHED AT THE SHOW

## NOVELTIES IN 1938-1939 DESIGN

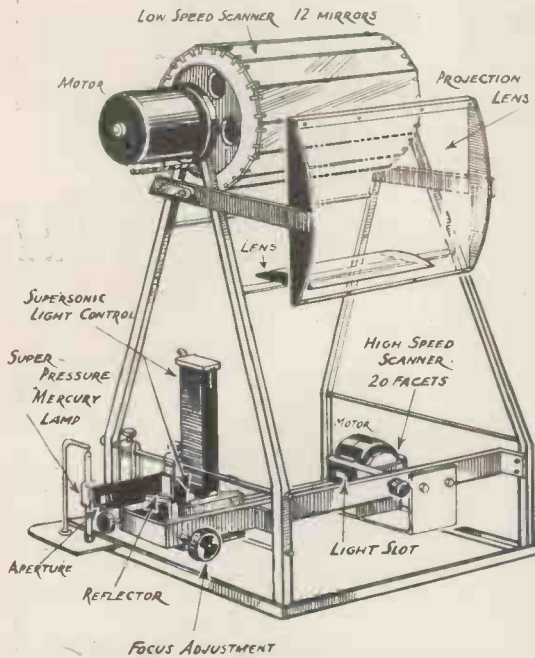

The optical layout of the Scophony Home Receiver as this sketch shows is quite simple and the parts used are surprisingly few.

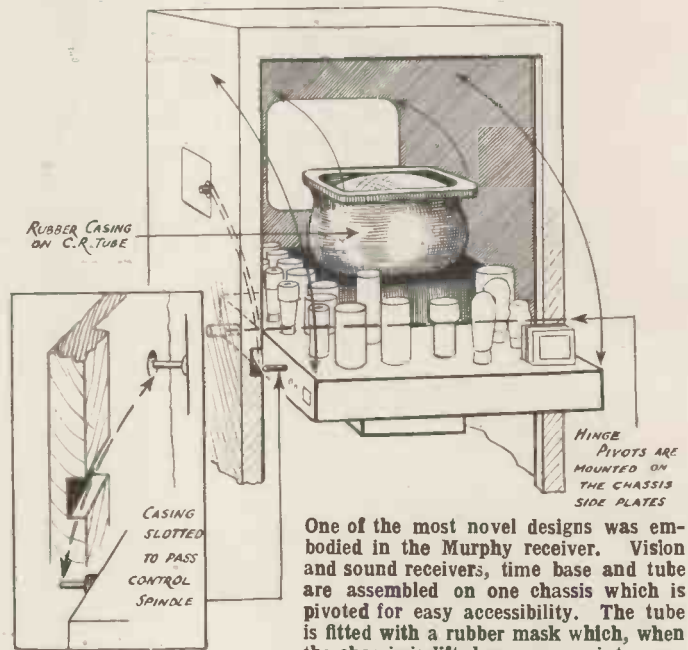

One of the most novel designs was embodied in the Murphy receiver. Vision and sound receivers, time base and tube are assembled on one chassis which is pivoted for easy accessibility. The tube is fitted with a rubber mask which, when the chassis is lifted up, comes into contact with the glass window.

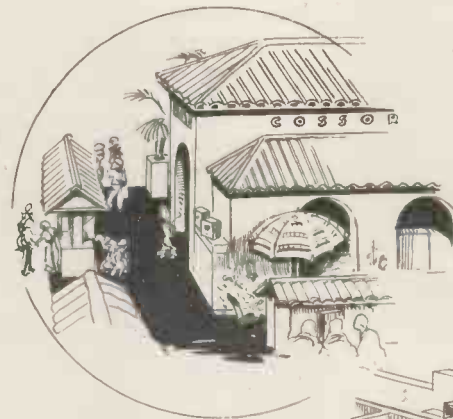
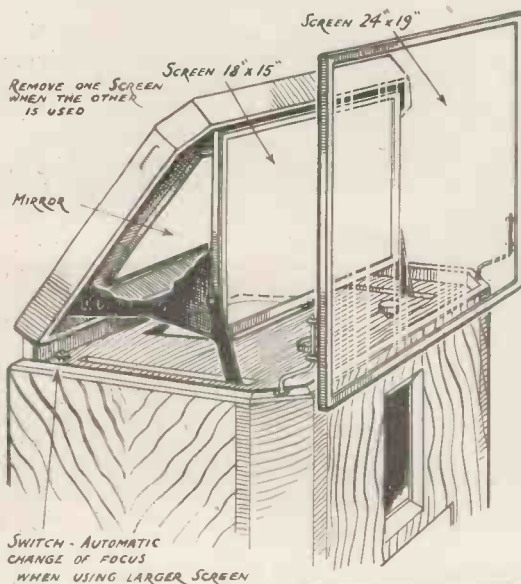

Two stand designs (left) Corsor go all Spanish. (Below) View of top deck of H.M.V. stand used as offices and fitted with a companion ladder as fire escape.

(Left) The novel arrangement for alternative screen size adopted by the Baird Company in their projection receiver. The large screen is entirely separate from the cabinet but the smaller one automatically comes into position when the lid is raised.

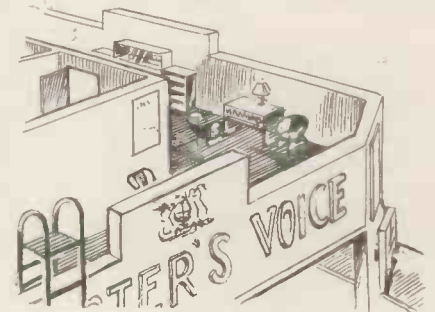

### THE TELEVISION SOCIETY

THE opening meeting of the Twelfth Session of the Television Society will be held on Tuesday, October 11, at 7 p.m., in the Physics Lecture Theatre, University College, Gower Street, W.C.1, when a discussion will take place on: "German v. British Television."

Readers who visited the television exhibition at Olympia are cordially invited to attend, and tickets of admission can be obtained from the Lecture Secretary—G. Parr, Esq., 68 Compton Road, Winchmore Hill, London, N.21, or from the General Secretary—J. J. Denton, Esq., 25

Lisburne Road, Hampstead, London, N.W.3.

The speakers will be:—L. Marsland Gander, Esq. (*Daily Telegraph* Radio Correspondent), E. H. Traub, Esq. (International Television Corporation), K. S. Davies, Esq. (Messrs. Murphy Radio, Ltd.), and others.

# SOME DIFFERENT TELEVISION AERIALS

## EFFICIENT DESIGNS OF COMPACT AND PORTABLE TYPES

By S. West

**T**HE conventional dipole aerial, with or without a parasitically excited second or even third element is becoming almost a familiar sight, and there is no doubt it is an efficient form of antenna to employ. Often, however, for various reasons, it is not convenient to install

all where a very compact arrangement is needed. Its efficiency is slightly lower than is that of a conventional vertical half wave wire.

Its form is admirably suited to portability and for rapid installation. The framework can conveniently consist of well-seasoned wood, varnished or

that it is possible actually to reduce the overall length of the wire as distinct from the methods indicated above for folding the antenna into a more compact form. This reduction is effected by resorting to an artifice to retain the correct electrical length. Figs. 3 and 4 indicate the manner in which this can be done. Reference to Fig. 6 conveys similar information.

No dimensions are given, for these will very largely depend, particularly in the case of the capacity-loaded arrangement, upon the height of the aerial from ground. However, it is quite a simple matter to arrive at the optimum dimensions with empirical tests.

In this connection the following information will be of assistance.

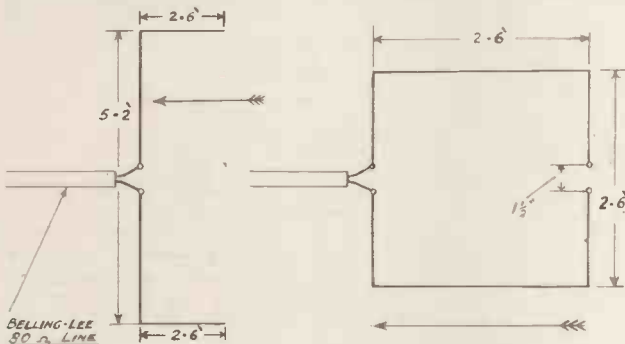

Fig. 1.—Diagrams showing two ways of folding a simple half-wave aerial.

an aerial of this type. Particularly is this so in the cases of radio dealers who may be called upon to give a demonstration at short notice.

Some information, therefore, on easily constructed compact, yet efficient, aerials will be of value.

The following notes indicate the desirable form these should take. They are each highly efficient, indeed

weather proofed in some similar convenient manner.

It should be observed that most forms of folded aerial tend to be somewhat directional, accordingly the directivity for each arrangement is indicated with an arrow in the respective diagrams.

Fig. 2 depicts a similar form of aerial. In this case, however, a reflector is included which increases the gain to a marked extent. This is an advantage where height cannot be secured or where comparatively low field strengths exist.

It might be as well to remark at this juncture why it is possible to fold an antenna in this manner with little sacrifice of efficiency.

The radiation from an energised wire is proportional to the current flowing in the wire. For a half-wave aerial, termed in technical parlance, a Hertz aerial, this current is at a maximum at the centre. At the ends where high voltage and thus low current exist, there is little contribution to the overall radiation. Thus it is possible to fold the ends of a "Hertz" into a convenient form without seriously impairing the efficiency.

In passing, it may be pointed out

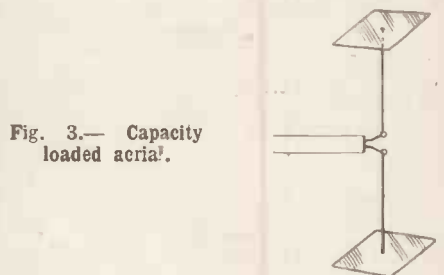

Fig. 3.—Capacity loaded aerial.

For the case of a capacity-loaded antenna the actual aerial can be of 12 S.W.G. copper wire to the ends of which are attached copper plates. The

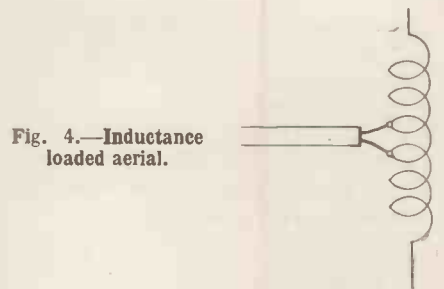

Fig. 4.—Inductance loaded aerial.

size of these plates is largely dependent upon the length of wire employed and to a lesser extent upon the height from ground.

That is to say, as the length of the

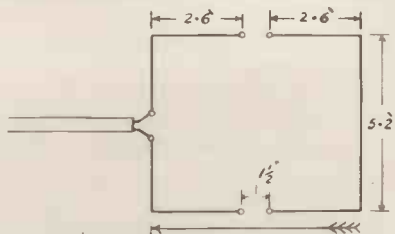

Fig. 2.—A folded half-wave aerial with reflector.

little difference in gain will be observed in a comparison between the arrangements described and the more conventional antenna; moreover, by reason of their compact form, they are admirably suited to temporary installation.

### Folded Aerials

In Fig. 1 is depicted an arrangement which is possibly the simplest of

## REFLECTORS AND DIRECTORS

wire is increased, the capacity plates area is reduced and, as the aerial's height from ground is reduced the capacity plate area similarly is decreased. For example, at a height of about 30 ft. a typical arrangement would be a wire approximately 7 ft. 8 in. in length at the end of which are capacity plates having an area of about 1 sq. ft. in each case.

No change is required to the form of feeder connection, and it is convenient to use Belling Lee 80-ohm transmission line.

It cannot be too strongly emphasised that the above is only an example. As already pointed out, it is not possible to give definite

loading inductance. Again, Belling Lee cable may be used, and as a rough guide for the approximate point of connection this can be  $1\frac{1}{2}$  turns either side of the centre of the inductor, i.e., the feeder is across three turns of the inductance.

It is convenient to use crocodile clips for the coil feeder termination whilst arriving at the best connection. Subsequently the lead may be permanently soldered into position.

### Reflectors and Directors

It can be noted that reflectors and directors for use in conjunction with either of these arrangements, that is

the complete arrangement can be effected.

Again, for aerials of the long-wire type, such as "Beverage" horizontal and vertical "Veeps" and similar types, where the aerial is intended for reception of vertically polarised waves, as is the case for the transmissions from Alexandra Palace, it is very convenient to be able to simulate earth conditions at some height from ground, thus rendering simpler the layout of such antennas and, perhaps more important, often considerably reducing their physical dimensions.

There is another form of folded antenna based upon the simple half wave arrangement as shown by Fig.

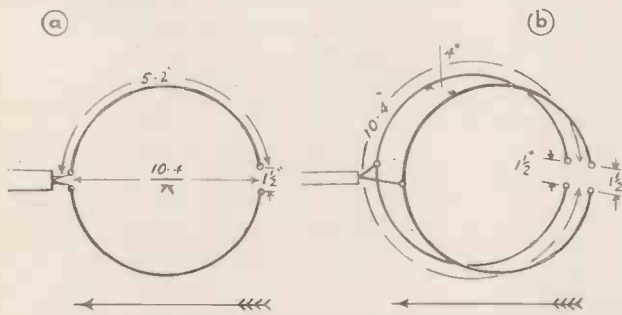

Fig. 5.—Circular aerials possessing good directional characteristics.

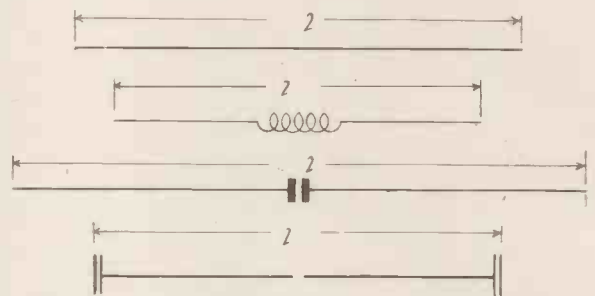

Fig. 6.—The above aerials all have the same electrical wavelength.

measurements for this type of aerial. So much will depend upon the nature of the soil above which the aerial is installed, and upon the proximity of trees, buildings, guy-wires and similar objects.

Probably the simplest manner in which to determine the optimum wire length is to decide upon the size for the capacity plates, then commencing with a wire length of, say, 9 ft. trim this until resonance at the required frequency of operation is reached.

For the case of the inductance loaded arrangement as depicted by Fig. 4, a typical arrangement for this would be an aerial having an overall length of approximately 6 ft. The inductance can consist of about 18 turns having a diameter of  $1\frac{3}{8}$  in. This loading is located at the centre of the aerial. Here again, it is necessary to trim the ends of the aerial to secure optimum results. It is preferable, therefore, to have these in the first instance somewhat longer than is likely to be necessary.

For this arrangement the feeder connection is made to a section of the

the capacity loaded and inductance types, can be similarly physically reduced in size. In each case the length of wire will be slightly longer for a reflector and shorter for a director, than that found correct for the aerial element.

The horizontal spacing will be, for a reflector 0.2-0.25 of a wavelength, for a director 0.25-0.375 of a wavelength.

Adding a reflector and, perhaps, a director will improve the power gain for the arrangement. Also, it will greatly increase directivity, thereby largely reducing undesirable interference pick-up.

Whilst on the subject of capacity and inductance-loaded antennas, it is of interest to note that this ability readily to provide circuits simulating various electrical characteristics is of enormous value in special types of antenna installation. For example, compact beam antennas are readily built up having any desired form of radiation characteristic. Considerable economies in the space required for

5. In the writer's view, however, it is not particularly easy to arrange unless heavy brass or copper wire be employed for its construction, thus rendering it self supporting. The arrangement has, however, quite sharp directional properties, and for this reason is of value.

An article such as this necessarily touches only upon the fringe of the subject of aerials. It is hoped, however, that sufficient information has been included to facilitate experiment with various compact aerials. Particularly will the arrangements depicted in Figs. 1 and 2 have appeal, for they are simple to construct, are easily portable and their efficiency is quite high.

An increasing number of these forms of aerial are likely to be used, for often space does not permit a normal arrangement to be installed. Moreover, due to troublesome reflections, it often is very helpful if the antenna possesses some directive discrimination and can be rotated to mitigate these reflections and other forms of interference.



# TELEVISION MUST HAVE NEWS VALUE!

A CANDID CRITICISM OF  
THE TELEVISION SERVICE  
—WITH SOME SUGGESTIONS  
BY THE EDITOR



**Q**UITE recently we have been told officially: (1) that it is now the avowed object of the B.B.C. to make television a great national industry, (2) that the staff at Alexandra Palace at present numbers approximately 400 (which includes 24 producers), and (3) that the old theatre at the palace is to be converted into a studio.

These points are of interest. The first indicates a definite change of attitude on the part of the B.B.C. towards television which hitherto has met with a great deal of opposition

at Broadcasting House. As the chairman of the Radio Manufacturers' Association Television Development Sub-Committee said recently: "It was amazing that all restraint had fallen from the B.B.C." The second and third points are likely to impress, and it is with regard to these that it will be interesting to speculate how they will affect the future development of television and influence the public to buy receivers.

During the first twelve months of the television service from Alexandra Palace the staff numbered something less than a hundred. Comparison of the programmes then and now, however, does not reveal any remarkable difference. That is, they were approximately the same type and the same ideas, generally speaking, obtained. Admittedly they were not so finished and the effects in general were not so good. They did not, in fact, come up to the same technical standard as at present, which was probably due to the then lack of experience in a new technique.

It would be useless to deny that the television entertainment so far offered to the public has, up to the present, made any considerable appeal and yet programme development proceeds, and apparently is intended to continue upon the same lines. The trouble is not with television; it is the comparison with the cinema. (The cinema can provide programmes of a standard that television can never

hope to attain even with an army of producers and the best studio facilities that could possibly be devised. A six-minute showing of a film is regarded as a very good day's work in a studio; how then is it possible, or even conceivable, that television programmes can be produced three or four times a week which have even a fraction of the entertainment value of a fifth-rate film? With television no retakes and no editing are possible and the money that can be spent on any one production compared with film production is a trifle.

## Costly Productions

There is a limited amount of money available for television, however it is spent, and the amount available in the future will inevitably depend upon public interest. The present indications are that this money is being spent on building up a ponderous machine that will have no other purpose or possibilities of providing programmes other than those of a type which up to the present have failed to create any real enthusiasm. Improvement will be effected with improved studio facilities, but it will never result in real entertainment as the cinema-going public regards it to-day.

Cabaret occupies a large proportion of programme time and, of course, it really comprises a series of variety turns. Variety as a rule is poor entertainment when shown by film and it suffers still more by the limitations of television. Revues almost come into the same category and in both cases repetition is unavoidable. Both are useful to a limited extent but it would appear that they largely account, both

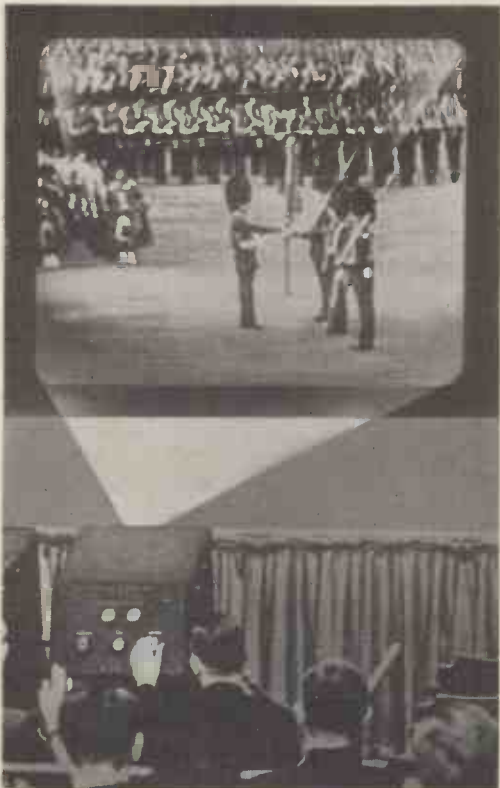

A successful O.B. Trooping the Colour as seen at the Baird projection demonstration.

# A CONTINUOUS PROGRAMME OF NEWS AND ENTERTAINMENT

directly and indirectly, for heavy expenditure which they do not warrant.

The Alexandra Palace staff have worked under difficult and arduous conditions. There have been difficulties on account of lack of space and lack of money. These troubles are being overcome; but when conditions are improved will there be any material increase in public interest? We think not so long as the same ideas prevail. When the service commenced we were told that it was not intended to imitate either the cinema or the theatre. It has done both—feebly, and it is probably due to the fact that the executives have been drawn from film and stage. Entertainment that is unsuited to the medium can never be an entire success. Whatever standard of perfection is attained in production and presentation it is bound to fail to make any real impression on the public particularly when in course of time the novelty interest wears off.

Television has its limitations despite the high degree of technical development that has been reached, and it is clearly necessary to recognise these limitations before embarking upon costly schemes to which it cannot do justice.

## Transmission Times

There is a promise of increased time of transmission and periods of four hours a day are mentioned. How are these hours to be filled if present ideas continue to prevail? They will either be surfeit or repetition and the machine must become more and more ponderous in order to cope with the increased demand. The B.B.C.

authorities must ask themselves: "Can we ever attain real success if present ideas and methods are allowed further to develop on the present lines?" "Can justice be done to a medium which is entirely unique and which has possibilities not possessed by any other?" The answers must surely be "No."

## Continuous Programmes

What is the alternative. Primarily the television service should be a utility service with a secondary backing of entertainment. Alexandra Palace should be on the air from 1 p.m. to 11 p.m. each day. It should transmit every item of interest that the Press is able to show in picture form so that whenever a viewer switched on he would be sure of some item of topical interest or some entertainment. The service should be such that no average person could afford to be without it. Repetition in each day's transmissions would not be of any consequence but the transmission times should be divided into periods and the newer matter presented as it became available with certain times devoted to entertainment. There should be something for most of the people all the time. The potential audience is immense.

## Red-Hot News

Actual happenings should be televised at the actual time whenever possible and films should be made for later transmission on the same day. There should be no difficulty in keeping the transmission going for the

period mentioned for present programme time limitations are almost entirely due to the time necessary for production and all which that entails. For the provision of such a picture news service recourse would have to be made to a large extent to films and it would be quite feasible to station film units in different parts of the country and rush the films through to Alexandra Palace. Up to the present outside broadcasts have been chiefly of events of national importance and considerable enterprise has been shown, but the O.B.'s have not been developed sufficiently. There are thousands of events which would lend themselves to a flash news service if accompanied by suitable commentary.

## Better Film Transmission

Film would of necessity play a large part in such a service and better methods of transmission than the present system should be employed; in fact even with the limited use of film at present an improvement is long overdue and the apparatus is available.

There would, of course, be difficulties in the provision of such a service, but the technical possibilities necessary for its development exist in the camera, film, facsimile radio transmission, television and rapid transit. If inspiration is to be sought it should be looked for from the daily Press and not the cinema nor the theatre.

Finally, there should be close cooperation between Broadcasting House and Alexandra Palace and a liaison department created with very wide powers which could effectively overrule any obstructionist ideas. Large sections of programmes from both departments lend themselves to joint transmission and closer cooperation, both as regards publicity and programme material, would ultimately be of incalculable value to broadcasting as a whole.

## Transmitting Chokes

High-frequency chokes for transmitting use are always important, so we are pleased to find that Premiers now have a choke which they are going to sell as a standard product. It was thought at first that amateurs might not appreciate the advantages of this choke so it was used only in their own transmitters. As, however, there has been a demand from amateurs, these chokes are to be marketed at 4s. 6d. They will carry 500 mA. and will operate up to 200 metres.



The mobile unit at Epsom for the Derby transmission.

OCTOBER, 1938

# THE DESIGN OF A 30,000-R.P.M. SYNCHRONOUS MOTOR

## A PROBLEM OF MECHANICAL-OPTICAL HIGH-DEFINITION TELEVISION

THE problem of driving a high-speed scanner in a mechanical optical type of receiver at a speed of rather more than 30,000 revolutions per minute and maintaining this in exact synchronism with the transmitter is no small one. It was, however, a problem with which Scophony engineers were faced, and it was the last of the many in the Scophony system to be solved. It had, of course, been possible to develop other parts of the system and prove their practicability by tying a

The speed, of course, must be so controlled that the polygon remains in synchronism with the line frequency of the received signal and the phase displacement with respect to the signal must be small. If the maximum permissible phase shift is equivalent to one picture element the phase shift must not be greater than

$$\frac{360}{500 \times 20} \text{ degrees or } 3\frac{3}{5} \text{ minutes of arc.}$$

however, be used with a reduction in the number of poles, but here another disadvantage arises. Any synchronous motor has a small residual phase variation with the supply frequency. This is of the order of several electrical minutes of arc. For a 40-pole motor supplied with 10,125 cycles, 18 electrical minutes can be tolerated, but at 506.25 cycles using a two-pole motor only .9 electrical minutes of arc phase variation is permissible. Further, all synchronous induction motors have a low efficiency and a widely varying impedance when running up to speed, so that it is difficult to match the motor to the driving valves.

### A Combination Motor

Finally, it was decided to separate the two functions required, and a design was evolved which comprised a high-efficiency induction motor and a high-efficiency synchronous phonic wheel on the same spindle. The induction motor is a two-pole squirrel cage motor wound to operate from a 3-phase supply at some 520 cycles. This section merely supplies the torque required to overcome friction and windage, and maintain the motor at approximately the correct speed.

Synchronism is obtained by means of a 20-pole phonic wheel, running in a 10-pole stator, and mounted on the same shaft. The winding on this stator is tuned to resonance at the signal frequency, and D.C. is passed through the winding of a valve equal to the peak A.C. current, so that the magnetic flux remains unidirectional. High-frequency iron is used in this section of the motor, and no pains have been spared to produce a unit with the minimum losses. At best the efficiency is of the order of 40 per cent. Both sections of the motor can handle an input of 50 watts.

Phonic wheel motors have a tendency to hunt, and considering the running motor as a stationary state oscillating about its mean speed, it is clear that the only damping the system can have is the change of torque with speed and the change of load with speed. The load is almost entirely composed of windage which varies about as the cube of the speed. This alone is insufficient to damp out

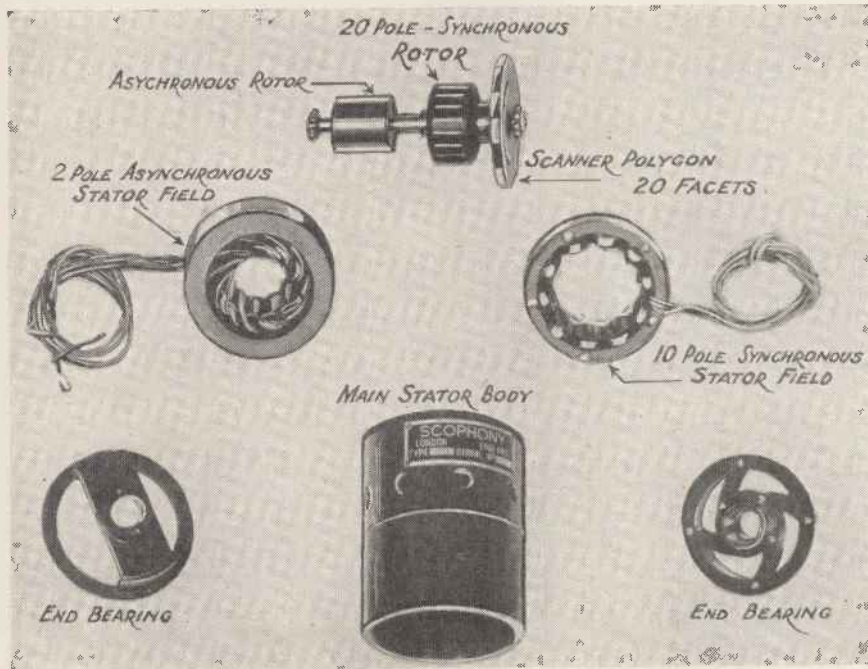

The chief parts of the Scophony high-speed scanner motor.

local transmitter and receiver together on the same mains supply, an arrangement which enabled the optical side to be developed under suitable conditions; a solution of the major problem was absolutely essential.

### 30,375 R.P.M.

In the Scophony system a 20-faced polygon is used as the high-speed scanning member. For 405-line definition and 25 pictures per second the speed of rotation, since there is no optical multiplication of scan in this system, must be  $\frac{10,125}{20}$  rev./sec., or 30,375 R.P.M.

There was also the question of driving, and it was concluded that the motor must be driven by valve oscillators using as small a power as possible.

Experimental work was conducted over a period of several months and several methods of solution suggested themselves. Firstly, a synchronous induction motor might be designed to operate from polyphase currents derived from the line frequency. For the actual line frequency (10,125 cycles), a 40-pole motor would be required. This, however, would be very cumbersome and expensive to build. A sub-multiple of this frequency of the line frequency might,

quickly any disturbance to the system and two effects are, therefore, used to increase the damping; (1) the induction section is designed to have a very rapidly falling torque/speed characteristic near synchronism; (2) the phonic stator is tuned to resonance when in synchronism.

Any change in phase, therefore, alters the inductance of the winding and so detunes it resulting in a reduction in A.C. current and consequently in torque.

### Mechanical Considerations

Ball bearings of a special type are employed, and in order to reduce noise and vibration these are mounted in rubber and the phonic wheel is

filled in with bakelite composition so that so far as possible all moving parts have smooth contours. Both from noise considerations and in order to lessen wear the rotor must be extremely accurately balanced dynamically. The accuracy required is of the order of 1 milligram-cm. No machines are obtainable commercially to balance these limits, and it was, therefore, necessary to develop one specially for this purpose.

A motor is in the course of development in which the two sections of the motor are combined. This will result in a lower moment of inertia of the rotor and correspondingly smaller power requirements for accurate synchronisation. It will also permit of a considerable reduction in size and consequently noise.

---



---

## THE B.B.C. DEPUTY-GENERAL'S TELEVISION BROADCAST

ON the eve of the radio exhibition (August 23), Mr. C. G. Graves, Deputy-General of the B.B.C., in the course of a broadcast talk, said:—

"Television is the most exciting subject in broadcasting to-day, but few can have realised the extent of recent progress. Some people regard the whole thing as a fairy story. Others, impressed by early experiments, and without later experience of viewing, talk only about its great future. Make no mistake about it, television is established in *this* country. Remarkable strides have been made in the technique of transmission, in the programmes and in receivers.

### Extension of Service

"The range of the present transmitter is proved to be greater than was expected. Although a thirty-mile radius is regarded as the service area of the station, many private viewers outside that area are receiving the programmes regularly and well. We are in touch with people near Northampton, in Norwich, Ipswich, Oxford, Tunbridge Wells, Brighton, Bournemouth and near Malvern, who get excellent reception.

"We are looking forward to the time when television can be extended to other parts of the country. The

problem of carrying the programmes to Birmingham, or some other important centre, either by cable or by wireless link isn't an easy one. At the present the B.B.C. is eagerly awaiting the result of experiments which the Post Office are to carry out. In any case, it will take time and money, but we know that difficulties *will* be overcome, so we can look forward ultimately to a national television service.

"Meanwhile, we have just procured a second mobile unit for outside broadcasts, which will be used at Olympia, and increase the number of outside broadcasts in the programmes. And we shall shortly be embarking on a scheme for the conversion of the old theatre at Alexandra Palace into a large television studio. Television is very costly in time and in money, but when that studio is complete we shall again extend the programme hours.

"In television, Great Britain, with its established home service, has a two-year lead on any other country. American and other foreign friends of ours are impressed by what has been done here. We are creating a great national industry."

Mention of "Television and Short-wave World" when corresponding with advertisers will ensure prompt attention.

### Television in Colour

TELEVISION in colour has been demonstrated by Baird, using a mechanical-optical system, but up to the present, and so far as we are aware, no attempt has been made to realise colour television by cathode-ray tube methods. Any such realisation is closely bound up in the production of suitable luminescent substances.

A television receiving apparatus could be constructed which is provided with three projection type cathode-ray tubes, the screens of which are made to fluoresce respectively in the three primary colours, red, green and blue-violet. Phosphors at present available reproduce the three primary colours with a fair degree of accuracy. The red primary is reproduced by zinc phosphate or a zinc cadmium sulphide, the green by Willemite and the blue by zinc sulphide with a silver phosphorogen.

Although these phosphors do not cover the entire range required, there is little doubt that, when a more exact match is required, suitable phosphors can be produced. At the transmitting end the scene televised is scanned through three colour filters corresponding to the three primary colours, using suitable photoelectric cells. The three images are reproduced on the three corresponding cathode-ray tubes and can be transmitted consecutively, the persistent visual impressions yielding the required combination. Colour balance can be controlled by variation of the current and/or voltage in each of the three tubes. The three televised images are combined by projection and thrown on to a screen.

(LEVY & WEST)

*How to Use the Cathode-ray Tube.*—This little book by J. H. Reyner explains in simple language the operating principles and the use of the cathode-ray oscilloscope. Primarily, it is intended for the radio service engineer and it will enable him to become familiar with the more general uses of the oscilloscope in testing radio receivers. The booklet, which contains 40 pages, with paper cover, is well illustrated and is priced at 1s. It may be obtained from the author at Furzehill Laboratories, Boreham Wood.

"La Kermesse Héroïque" ("The Heroic Sex") which will be televised in the afternoon of October 7 and the evening of October 11 won the French and the Italian awards for the best film of the year and had a record run at a West End cinema.

# MORE EXPERIMENTS IN SUPERSONIC-WAVE LIGHT MODULATION

By J. H. Jeffree

*This is the second part of the article describing simple experiments with the supersonic light cell. The experiments are of an elementary type which will enable an insight to be obtained in the principle of this class of light modulator.*

LAST month the operating principles of the supersonic cell were described together with the associated phenomena.

To use these phenomena for light modulation we can either make a slit in the screen, to let the central beam through, stopping the fringes, or else replace the screen by a wire

the waves. Turning the cell should weaken it, but, if there are errors in focusing and lining up may actually strengthen some parts, where the light was previously passing not quite parallel, to the wavefronts. By moving the cell, plus its lenses, bodily to or from the lamp a little, one gets varying

also be studied. A ground glass second screen shows these to best advantage.

## Modulation

It will now be of interest to demonstrate modulation. The additions to the oscillator have already been described (Figs. 7 and 9). Using a slit to begin with, in preference to a wire for sharpness of effect, we can pass through it, at will, either the central beam or a selected fringe, and get positive or negative modulation. The lens of Fig. 11 can now be moved further away, to a position where it focuses an image of the slit on any suitable second screen, via some sort of rotating mirror or mirror drum. Fig. 13 shows it arranged with a piece of mirror mounted on the spindle of a gramophone turntable as a "scanner."

On applying modulation to the terminals marked, from, e.g., a radio set, and rotating the mirror, a sound track will be traced, in light, on the second screen. Alternatively, one can dispense with this, and view the

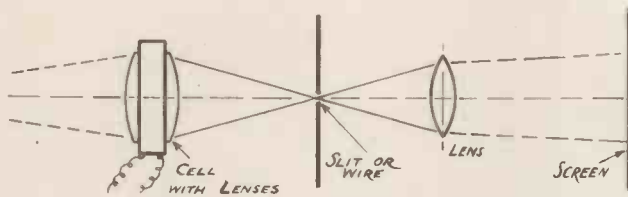

Fig. 11. Wave track demonstration.

to stop the central beam. Both methods are useful, and either enables us to project a direct image of the supersonic wave track on a further screen. For this we place, a little beyond the first screen or wire, a lens (4 in. to 8 in. focus is convenient) which can make an image of the cell on the second screen (Fig. 11). Stopping out the filament image by the wire will now obliterate this cell image, until oscillations are applied to the crystal: then, however, the fringe light forms (on the second screen) a bright image of the wave-track.

Using a slit instead, to pass the central beam, we get a bright image of the cell (and it is most effective if all stops are now removed from the latter); and now the wave track darkens when power is applied (Fig. 12).

In each case, an effect of rays proceeding from the crystal is usually seen. These might be due to crystal irregularities, but are more usually caused by irregularities of the electrodes stuck on to it.

When everything has been accurately lined up to start with the wave track will be seen to be stronger near the crystal end (it is inverted in the image, of course) since at the far end it is weakened by attenuation of

degrees of divergence or convergence of the light through it, without much affecting the focus on the first screen; and one may experiment in trying to find settings, of combined skewness and divergence of the light, at which the wave track is as uniform as possible right across, thus correcting the attenuation effect. Such corrections are useful in

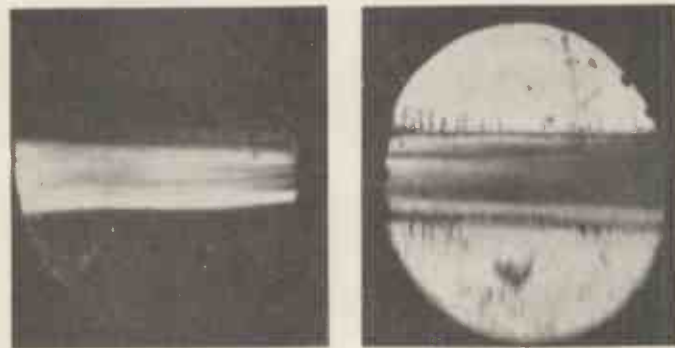

Fig. 12. Wave tracks. A—Light. B—Dark.

producing good picture quality in television.

The attenuation will be quite obvious with a 14 mc. crystal, but with 7 mc. it is not very marked.

The subtle colour effects obtainable along the track (apart from those due to lens aberrations!) can

slit direct via the rotating mirror and lens, focusing the latter to suit. Fig. 14 shows some sound tracks thus obtained, substituting the camera for the eye.

The use of a 30-line mirror drum or the like, here, makes possible, of course, the production of a patterned

area instead of a mere track, and very beautiful effects are obtainable with music and speech inputs, when actual picture signals are not available.

**Light Beam Signalling**

We may close this section by men-

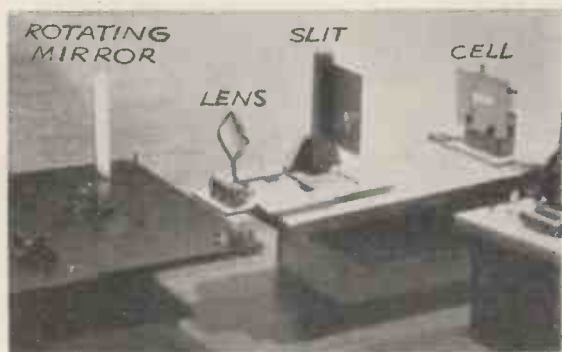

Fig. 13. Modulation demonstration.

tioning that the set up of Fig. 13 with the rotating mirror removed, is suitable also for light beam signalling and transmission. The last lens then simply focuses the slit on the distant station; the bigger and, in proportion, longer in focal length, one can have this lens, the more light one can put across to the receiving end.

It is not essential, when using the light relay for this purpose, to have a slit after it at all, since without it the filament image is still focused on the distant station, and the fringes go astray to either side and miss it. A slit would, of course, somewhat enhance the secrecy of distant communications by this method.

The general arrangement of such apparatus is shown by Fig. 15, and Figs. 16, 17 and 18 show simple apparatus suitable for loudspeaker reception over a few yards or so. For this purpose a two-stage R.C. amplifier suffices, with a couple of triodes, e.g., an MH4 or similar type in the first stage, and an output type in the second.

The cathode or sensitive surface of the photo-cell is connected direct to the first grid, and these are connected to "earth" through the photo-cell resistor R1 which is also the grid leak, and may be half a megohm. The photo-cell anode goes to the safety resistor R2, through which it receives the positive H.T. voltage. This resistor may be 5 megohms at least; it is there to ensure that even in bright illumination,

or if the H.T. is too high for the cell, no serious damage will result.

Gas-filled cells have a maximum permissible voltage, above which a discharge passes spontaneously, and with such a cell the voltage applied should be brought below this, for example, by adding a shunt resistor as shown dotted in Fig. 16. Other-

cell current, greatly lowering the sensitivity, so that the higher the photo-cell resistor, the less the permissible general illumination of the cell.

For this reason it is as well to exclude extraneous light as far as possible, for instance, by a couple of apertures, in line with the transmit-

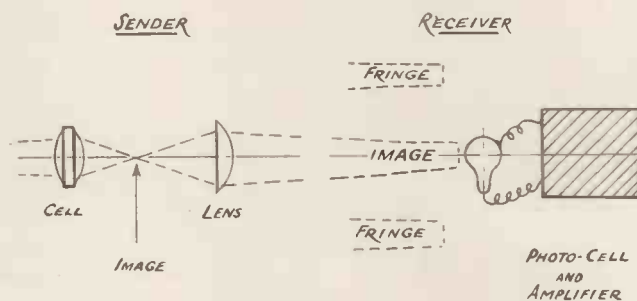

Fig. 15. Light beam transmission.

wise damage can be done, and in any case the cell will not function when such a discharge is passing.

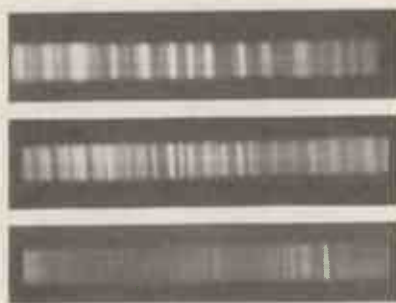

Fig. 14. Sound tracks.

With vacuum cells the applied voltage does not matter, within reason, so long as it is above 30 volts.

The higher the value of R1 the greater the sensitivity, but also the greater the positive potential applied to the grid of V1 for a given illumination. If this is enough to make the latter positive it will provide an alternative conducting path for the

ter, each being the size of the cell window; or by a "tunnel"; as in Figs. 18 and 19. In the photograph the cover of the cell and screen boxes has been removed.

An alternative way of applying the signals to the first grid is shown in Fig. 20, and has the advantage of avoiding variation of effective grid bias with general illumination. It is useful when higher sensitivity is desired, with a sensitive cell, in the presence of extraneous light. Naturally, the effective photo-cell resistor value is that of the two resistances in the grid circuit in parallel.

In case it should be desired to use such apparatus as the foregoing for long range communications by light beam, the methods of increasing range, from a few yards to many miles, may be mentioned briefly. In the first place, amplification may be increased a great deal in the receiver; with a little care in decoupling, a thousand-fold increase could be got by adding two more stages. The

Fig. 16. Simple photo-cell amplifier for sound.

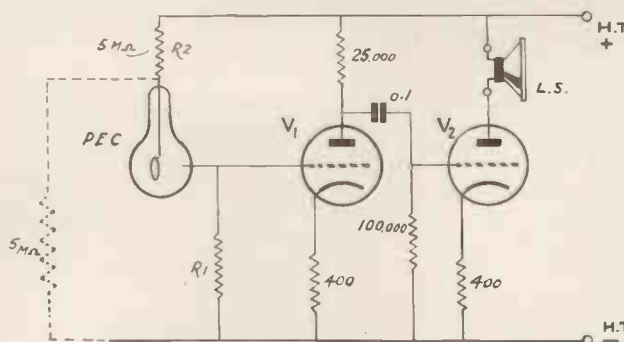

range increases as the square root of this gain, so that it would thus be magnified about 30 times.

Secondly, a collecting lens at the receiver, as large as possible irrespective of its focal length, increases light pick-up in the ratio of its own

put lens at the transmitter, in place of the small one of 8-in. focus or so, as hitherto assumed. Whatever its focus, that is the distance at which it must be set in front of the filament image to project the latter on to the distant station. If, with the existing

angles of divergence of light from this image, the area of the lens illuminated by it is then increased, the response at the receiver goes up in the same ratio, or the range goes up as the square root of it. A large telescope objective is most suitable for fulfilling this condition. One of 2 in. diameter and about 24 in. focus will nearly double the range, and larger sizes will increase it still

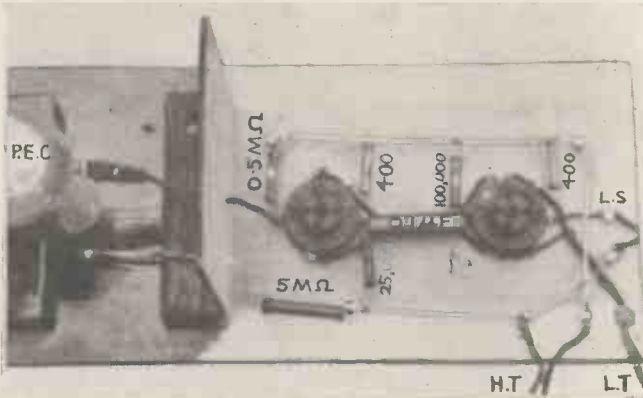

Fig. 17. Experimental photocell amplifier.



Fig. 18. Simple light-beam receiver.

area to that of the cell window (nearly); and the range is thus increased in the ratio of their respective diameters. A 6-in. lantern condenser lens, for instance, would increase the range four or five times. Fig. 21 shows the arrangement. The

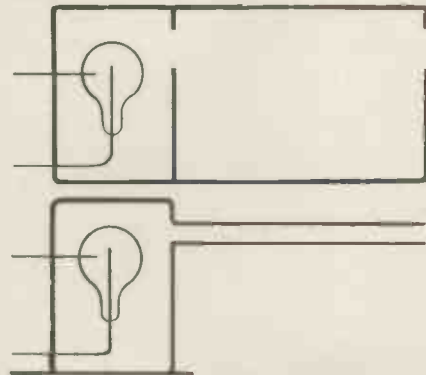

Fig. 19. Avoiding extraneous light.

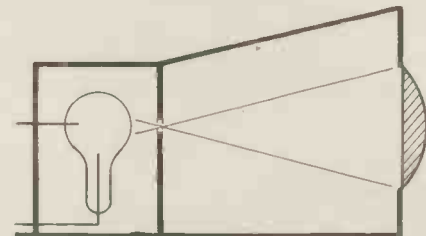

Fig. 21. Collector lens at receiver for increased range.

aperture in the screen before the cell should then be no larger than is needed to pass the focused spot of light from the transmitting station.

Thirdly, a long-focus lens of sufficient diameter can be used as out-

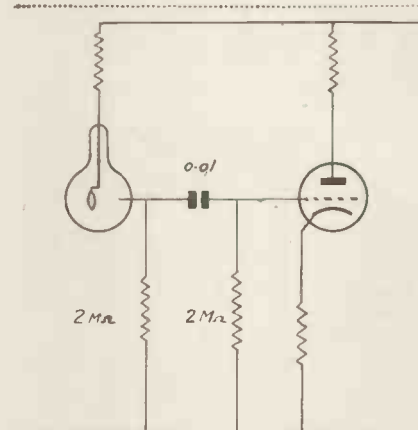

Fig. 20. Alternative way of connecting photocell

further in proportion to their diameter. Fig. 22 shows the principle of this.

Then, of course, an arc lamp may be substituted for the filament light source, with a slit, about one-fiftieth of an inch wide, in front of the positive crater, to give the required shape of source. It must run on smooth D.C., however, if speech or music are to be transmitted. A further three- to six-fold gain in range is thus practicable. These four measures together suffice to give a range of several miles.

Since the first instalment of this article, quartz crystals as there suggested, cut approximately, and operating at about 10 megacycles,

Fig. 22. Telescope objective at transmitter for increased range.

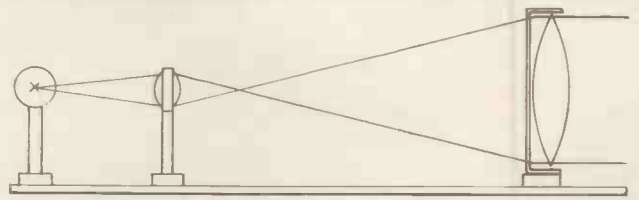

Light relay arranged as light beam transmitter.

have been made available by the firm supplying the synthetic resin containers also previously mentioned. These should be very convenient for supersonic experiments.

# 1938-39 TELEVISION RECEIVERS

## PRINCIPAL FEATURES & PRICES OF ALL COMMERCIAL SETS

PICTURE SIZE.	MAKER.	TYPE.	CABINET.	PRICE.		SYSTEM.
				£231	Rental	
24 ins. × 20 ins.	Scophony.	Sound and vision.	Console.	0 0		Mechanical.
6 ft. × 5 ft.	Scophony.	Sound and vision	—			Mechanical.
24 ins. × 20 ins.	Ekco.	Sound and vision	Console.	231	0 0	Mechanical.
22 ins. × 18 ins.	H.M.V.	Television sound, all-wave radio.	Console.	210	0 0	Cathode-ray projection.
22 ins. × 18 ins.	Marconiphone.	Television sound, all-wave radio	Console.	210	0 0	Cathode-ray projection.
24 ins. × 19 ins. or 18 ins. × 15 ins.	Baird.	Television sound, P.B. all-wave radio.	Console.	157	10 0	Cathode-ray projection.
18 ins. × 15 ins.	Pye.	Television sound, all-wave radio.	Console.	204	15 0	Cathode-ray projection.
18 ins. × 14½ ins.	Philips.	Television sound, all-wave radio.	Console.	126	0 0	Cathode-ray projection.
13½ ins. × 11 ins.	Baird.	Television sound, all-wave radio.	Auto-radiogram.	126	0 0	Cathode-ray indirectly viewed
13½ ins. × 11 ins.	G.E.C.	Television sound, all-wave radio.	Console.	73	10 0	Cathode-ray indirectly viewed
12 ins. × 9½ ins.	Cossor.	Television sound, all-wave radio.	Console.	50	8 0	Cathode-ray directly viewed.
10½ ins. × 8½ ins.	Ultra.	Sound and vision.	Console.	39	18 0	Cathode-ray directly viewed.
10 ins. × 8 ins.	Baird.	Television sound, all-wave radio.	Radiogram.	75	12 0	Cathode-ray indirectly viewed
10 ins. × 8 ins.	Baird.	Television sound, all-wave radio.	Console.	49	7 0	Cathode-ray directly viewed.
10 ins. × 8 ins.	Baird.	Television sound, all-wave radio.	Table.	46	4 0	Cathode-ray directly viewed.
10 ins. × 8 ins.	Burndept.	Sound and vision.	Console.	50	0 0	Cathode-ray directly viewed.
10 ins. × 8 ins.	Cossor.	Television sound, med. and long.	Auto-radiogram.	94	10 0	Cathode-ray directly viewed.
10 ins. × 8 ins.	Cossor.	Television sound, med. and long.	Console.	73	10 0	Cathode-ray directly viewed.
10 ins. × 8 ins.	Dynatron.	Television sound, all-wave radio.	Auto-radiogram.	173	5 0	Cathode-ray directly viewed.
10 ins. × 8 ins.	Ekco.	Sound and vision.	Console.	51	9 0	Cathode-ray directly viewed.
10 ins. × 8 ins.	Ferranti.	Television sound, all-wave radio.	Console.	63	0 0	Cathode-ray directly viewed.
10 ins. × 8 ins.	Ferranti.	Sound and vision.	Console.	52	10 0	Cathode-ray directly viewed.
10 ins. × 8 ins.	G.E.C.	Television sound, all-wave radio.	Console.	63	0 0	Cathode-ray indirectly viewed
10 ins. × 8 ins.	G.E.C.	Sound and vision.	Console.	38	17 0	Cathode-ray directly viewed.
10 ins. × 8 ins.	H.M.V.	Television sound, all-wave radio.	Auto-radiogram.	126	0 0	Cathode-ray directly viewed.
10 ins. × 8 ins.	H.M.V.	Television sound, all-wave radio.	Console.	84	0 0	Cathode-ray indirectly viewed
10 ins. × 8 ins.	H.M.V.	Television sound, all-wave radio.	Console.	63	0 0	Cathode-ray indirectly viewed
10 ins. × 8 ins.	K.-B.	Television sound, all-wave radio	Console.	57	15 0	Cathode-ray indirectly viewed
10 ins. × 8 ins.	K.-B.	Sound and vision.	Console.	46	4 0	Cathode-ray directly viewed.
10 ins. × 8 ins.	Marconiphone.	Television sound, all-wave radio.	Auto-radiogram.	126	0 0	Cathode-ray indirectly viewed
10 ins. × 8 ins.	Marconiphone.	Television sound, all-wave radio.	Console.	84	0 0	Cathode-ray indirectly viewed
10 ins. × 8 ins.	Marconiphone.	Television sound, all-wave radio.	Console.	84	0 0	Cathode-ray indirectly viewed
10 ins. × 8 ins.	Marconiphone.	Sound and vision.	Console.	63	0 0	Cathode-ray indirectly viewed
10 ins. × 8 ins.	Pilot.	Television sound, med. and long.	Radiogram.	68	5 0	T.65.
10 ins. × 8 ins.	R.G.D.	Television sound, all-wave radio.	Auto-radiogram.	136	10 0	Cathode-ray indirectly viewed
10 ins. × 8 ins.	R.G.D.	Television sound, all-wave radio.	Console.	94	10 0	382R.
10 ins. × 8 ins.	R.G.D.	Sound and vision.	Console.	78	15 0	382.
10 ins. × 8 ins.	Tannoy.	Sound and vision.	Auto-radiogram.	89	5 0	Cathode-ray directly viewed.
10 ins. × 8 ins.	Vidor.	Sound and vision.	Console.	42	0 0	Cathode-ray directly viewed.
9 ins. × 7½ ins.	McMichael.	Sound and vision.	Console.	63	0 0	Cathode-ray indirectly viewed
9 ins. × 7 ins.	Murphy.	Sound and vision.	Console.	65	0 0	Cathode-ray indirectly viewed
8½ ins. × 6½ ins.	Cossor.	Sound and vision.	Table.	47	5 0	Cathode-ray directly viewed.
7½ ins. × 6½ ins.	Baird.	Sound and vision.	Console.	39	18 0	Cathode-ray directly viewed.
7½ ins. × 6½ ins.	Baird.	Sound and vision.	Table.	38	15 0	Cathode-ray directly viewed.
7½ ins. × 6½ ins.	Marconiphone.	Sound and vision.	Console.	47	5 0	Cathode-ray directly viewed.
7½ ins. × 6½ ins.	Ultra.	Sound and vision.	Table.	29	8 0	Cathode-ray directly viewed.
7½ ins. × 6½ ins.	Beethoven.	Television sound, all-wave radio.	Console.	50	8 0	Cathode-ray directly viewed.
7½ ins. × 6 ins.	H.M.V.	Television sound, all-wave radio.	Console.	47	5 0	Cathode-ray directly viewed.
7½ ins. × 6 ins.	Marconiphone.	Television sound, all-wave radio.	Console.	47	5 0	Cathode-ray directly viewed.
7½ ins. × 6 ins.	Murphy.	Television sound, all-wave radio.	Console.	45	0 0	Cathode-ray directly viewed.
7½ ins. × 6 ins.	Murphy.	Sound and vision.	Console.	30	0 0	Cathode-ray directly viewed.
7½ ins. × 5½ ins.	G.E.C.	Vision only.	Table.	24	3 0	Cathode-ray directly viewed.
7½ ins. × 5½ ins.	Invicta.	Sound and vision.	Table.	32	11 0	Cathode-ray directly viewed.
7½ ins. × 5½ ins.	Pye.	Television sound, all-wave radio.	Auto-radiogram.	68	5 0	Cathode-ray directly viewed.
7½ ins. × 5½ ins.	Pye.	Sound and vision.	Table.	31	10 0	Cathode-ray directly viewed.
7 ins. × 5½ ins.	K.-B.	Sound and vision.	Table.	31	10 0	Cathode-ray directly viewed.
6½ ins. × 5 ins.	Marconiphone.	Television sound, all-wave radio.	Table.	36	15 0	Cathode-ray directly viewed.
5 ins. × 4 ins.	Cossor.	Sound and vision.	Table.	27	6 0	Cathode-ray directly viewed.
5 ins. × 4 ins.	Cossor.	Sound and vision.	Table.	24	3 0	Cathode-ray directly viewed.
6½ ins. × 5 ins.	H.M.V.	Television sound, all-wave radio.	Table.	38	15 0	Cathode-ray directly viewed.
4½ ins. × 4 ins.	Marconiphone.	Television sound, all-wave.	Table.	30	9 0	Cathode-ray directly viewed.
4 ins. × 3½ ins.	Pye.	Television sound, med. and long.	Table.	30	9 0	Cathode-ray directly viewed.
4 ins. × 3½ ins.	Pye.	Vision only.	Table.	22	1 0	Cathode-ray directly viewed.
4½ ins. × 4 ins.	H.M.V.	Television sound, all-wave radio.	Table.	22	9 0	Cathode-ray directly viewed.
4 ins. × 3½ ins.	Invicta.	Vision only.	Table.	22	11 6	Cathode-ray directly viewed.



# RADIO RETAILERS AND TELEVISION

## THE COMING OF A BIG NEW INDUSTRY

**D**URING Radiolympia a convention for radio retailers was called by the Radio Manufacturers' Association to discuss the marketing of television receivers and explain to the retailers the position of television to-day.

The speakers were:

- Sir Frank E. Smith, K.C.B., C.B.E. (Deputy Chairman of the Television Advisory Committee), chairman.
- Sir Stephen Tallents, K.C.M.G., C.B., C.B.E. (B.B.C. Controller of Public Relations).
- Sir Noel Ashbridge, B.Sc., M.I.E.E. (Controller of B.B.C. Engineering Division).
- C. O. Stanley (Chairman of the R.M.A. Television Development Sub-Committee).
- T. Rigby Taylor (a retailer).
- Major L. H. Peter, M.C., A.F.C., M.I.E.E. (Chairman of the Radio Manufacturers' Association);

and at the conclusion of their speeches other speakers from among the 1,500 retailers present expressed their opinions which were of a generally favourable nature.

### A Big New Industry

Sir Frank Smith said that all present were concerned with establishing a real television industry. "The Government," he said, "had now full confidence in the future of television and it could be expected that before long the Television Advisory Committee would be able to recommend an extension of the service to certain cities and towns in the provinces.

"Manufacturers were to be congratulated on their courage, for they had already spent hundreds of thousands of pounds in development and research."

He mentioned that the Alexandra Palace transmitter had now been in existence for over eighteen months, during which period 100,000 televisions should have been sold. In fact, not 10,000 were in use: why? We want the answer, he said.

The Television Advisory Committee had been in close touch with the R.M.A. and they were convinced that it was not quality of transmis-

sion, size of picture or the entertainment value of the programme that had held up sales. It was, he said, that the public did not realise what it was missing. If they could be made to realise this, there would be a satisfactory public response.

Sir Stephen Tallents said that at the B.B.C. they were convinced believers in the imminent success of a country-wide television service. A year ago the staff at Alexandra Palace was so hard-pressed that a holiday was arranged for them all in August, but to-day there were nearly 400 people at Alexandra Palace and the number of producers had been increased from twelve to twenty-four.

One of the chief problems was that of letting people see television, for when they did they would all become enthusiasts. He pointed out that a quarter of the population are inside the existing service area and represented one of the most prosperous sections of the community.

### Permanent Standards

Sir Noel Ashbridge emphasised the permanence of existing television technical standards and he said that apart from the guarantee by the Television Advisory Committee of no change within a certain period, it was his opinion that no change was likely for a great number of years. As far as wavelengths were concerned the recent Cairo Conference had confirmed the present television wavebands, and he emphasised that a great number of technical improvements could be made without changing the present transmission standards.

Very soon the B.B.C. would have an incomparably better studio with the latest types of equipment. He suggested that dealers must take particular care to fix aerials properly. As far as interference was concerned, local post offices would now deal with interference on television as well as on ordinary sound receivers.

C. O. Stanley, speaking on behalf

of the manufacturers, said that the R.M.A. a year ago had formed a sub-committee (of which he was chairman) to plan the development of the new industry and the fostering of television in the trade.

Television was a peepshow at Olympia two years ago; the public don't know that television is an entertainment and has been stabilised. It was up to the dealers to convert the public.

Referring to the recent broadcast of C. G. Graves, B.B.C. Deputy-Director General, he said that it was amazing that all restraint had fallen from the B.B.C.

The replacement market, he said, will one day be a television one, but they did not want it overnight. Some time in the future, the radio market would turn over to television and it was up to dealers to get the intermediate period under way. Every dealer was an investor in the radio industry and should take some hand in television propaganda in order to share in the eventual profits.

Manufacturers had worked with a common purpose and common point of view and had made losses over television. He addressed the convention in no state of artificial optimism and urged dealers to hasten the time when television would be profitable and big business.

### More Programmes

T. Rigby Taylor, speaking as a representative retailer, said that outside interference was one of the major problems, which applied both in home and showroom demonstrations. From the B.B.C. they wanted additional programmes—four hours a day—the cost of which might be covered by an additional licence. He suggested a closer tie-up between sound and television programmes and that the Regional and National programmes should be televised between 6 p.m. and 10 p.m. on alternate evenings, also that announcements of evening television programmes should be made in the news bulletins. Dealers must be prepared to undertake some pioneer work. Shop demonstrations were not good enough; home demonstrations were essential.

Please mention "Television and Short-wave World" when corresponding with advertisers.

# Scannings and Reflections



## DUKE OF KENT AT TELEVISION DINNER

A "FESTIVAL Television Dinner" is to be given by the Royal Photographic Society. H.R.H. the Duke of Kent, who is greatly interested in the work of the Society, is to preside at the dinner. In addition to H.R.H., the speakers will include the Rt. Hon. Leslie Burgin, Minister of Transport, and Mr. J. B. Priestley, the famous novelist. A special toast will be proposed from Alexandra Palace, and delivered through television sets at the banquet.

The technical arrangements for this unique event are being made by the Television Committee of the Radio Manufacturers' Association in collaboration with the B.B.C. Television sets will be placed before each group of guests, and they will be entertained during dinner by that evening's programme.

## THE TELEVISION STUDIO AT OLYMPIA

Approximately one-third of the visitors to Olympia visited the television studio, and it is probable that there would have been more but many were deterred by the sight of the long queue and the consequent amount of time needed to pass round.

## LARGE SCREEN AND COLOUR TELEVISION

During the course of a conversation at Radiolympia, Mr. J. L. Baird said, "I am working on two main lines of research. One is television in the cinema. We have already equipped three cinemas in London with apparatus which shows pictures on a screen 8 ft. by 6 ft. We cannot give public performances of the B.B.C. programmes in these places at the present moment because the B.B.C. claims that this would be an infringement of their copyright. We have applied for permission, but have been refused. I think it would be most helpful if this permission were given, because it would stimulate public interest in television, which would

ultimately lead to a wider demand for home television sets, and the possibility of meeting that demand at a lower price than is at present economically possible.

"Much research will be necessary before colour television is practical politics. The technical difficulties we have to overcome are a simplification of the complicated apparatus, a more natural colour and better definition."

## INTERNATIONAL TELEVISION MEETING

An international television meeting was held in the Physical Building of the F.I.T., 34 Gloriosastrasse, Zurich, 7, between September 19 and 21. A number of lectures were given, and among the speakers were Mr. L. M. Myers and Mr. E. H. Traub, who are well known in British television circles, and as contributors to this journal.

## TELEVISED TRAGEDIES

Two tragedies were recently televised in New York. One case was when experimental outdoor panning shots were being made from the R.A.C. building, and a typist fell from the window of the 11th floor of a building which came within the range of the camera. The picture of the unhappy event was, however, not seen beyond the control room, as the transmission was being made on a closed circuit.

The second case was when a deranged youth held New York in suspense for several hours by threatening to jump, and finally doing so from the 17th floor of a Fifth Avenue hotel immediately in range of a R.C.A. laboratory camera which faced the hotel. A photograph of this image, showing the jump, has been published in several New York journals.

## FOOTBALL MATCHES TO BE TELEVISED

The mobile television unit will again visit Arsenal Stadium on October 26, for televising the Arsenal

v. Rest of Europe Match. The game is being televised by the courtesy of the Football Association and the Arsenal Football Club.

Three cameras, which will be situated in the stand, should allow viewers to follow closely the run of the play. Close-ups will be given by the use of telephoto lenses. Transmission from Highbury to Alexandra Palace will be by radio link.

## MECHANICAL TELEVISION IN U.S.A.

Television with a mechanical scanner was demonstrated last month to members of the Institute of Radio Engineers by Kolorama Laboratories, at Irvington, New Jersey. A test news reel was projected upon a 3 ft. by 4 ft. screen from the rear. Images were said to be reasonably clear, and black and white; 225 lines were used, interlaced 2 to 1, giving 112½ lines per frame, with 24 frames per second. It is claimed by the company that when perfected the pictures will be comparable with 441 line systems, and as the frequencies employed will be consequently less, a much longer wavelength can be used giving greater coverage.

## RECEPTION IN THE WEST

The Alexandra Palace transmissions have been received in Taunton by Mr. G. J. Small, a wireless engineer of the town. Mr. Small has an experimental receiver. The Test Match was seen very clearly.

## THE NEW DIRECTOR-GENERAL AT OLYMPIA

Mr. F. W. Ogilvie, new Director-General of the B.B.C., and Mrs. Ogilvie, paid a visit to Radiolympia on September 2 and inspected the television studio. They were received by members of the Radio Manufacturers' Association, and at the end of the visit Mr. Ogilvie said that what had particularly struck them was that television had become a reality in the home and was now available at greatly reduced prices.

**DO YOU REALISE HOW GOOD  
TELEVISION RECEPTION IS TO-DAY,  
ESPECIALLY  
BAIRD TELEVISION**

**PROVE THIS BY ASKING FOR  
A DEMONSTRATION OF THE  
NEW BAIRD MODELS**

As the world pioneers of television, Baird Television Ltd., have been in the forefront of progress with every important development in television. Not the least of these is receiver design, for the very first set to show a real television picture was demonstrated by Baird in 1926. With new and up-to-date factory accommodation the company's technical resources have been

**BAIRD**  
**THE NAME SYNONYMOUS WITH TELEVISION**

widened and unequalled research facilities provided. This has culminated in the development of the finest television receivers for domestic receiving purposes. The new range of models has been graded to meet the varying needs of a rapidly expanding viewing public and each set is the best in its class that television has to offer to-day. See them in operation at the leading radio dealers—names and addresses furnished on request.

***Send for New 16 Page Catalogue***

**BAIRD TELEVISION LTD.**  
**Lower Sydenham, London, S.E.26**

Telephone: HITHER GREEN 4600.

Telegrams: TELEVISOR, FOREST, LONDON.



# G.E.C.

## CATHODE RAY MONITOR TUBES

**For oscillograph and other applications**

Two small high vacuum cathode ray tubes are now available, and will undoubtedly find many applications in radio servicing and industrial work where a visual means of studying transient or recurrent operations is required.

### TYPES AVAILABLE:

#### TYPE 4051

A small tube particularly suitable where economy in space is essential. Gives a brilliant spot without the necessity for high operating voltages.

#### INDIRECTLY HEATED CATHODE.

Heater Voltage .. .. .	4.0
Heater Current .. .. .	0.8 amp.
Accelerator Voltage (A <sub>2</sub> ) .. .. .	250 to 500 v. max.
Focusing Electrode (A <sub>1</sub> ) .. .. .	50 to 100 v.
Control Electrode (Modulator) .. .. .	0 to -20 v.

Screen : Medium persistence type, green fluorescence.

#### DIMENSIONS:

Maximum Overall Length .. .. .	160 mm.
Screen Diameter .. .. .	39 mm. (1½" app)

Separate connections to each of the four deflector plates.

**LIST PRICE 45/-**

#### TYPE 4081

Similar to type 4051, but with larger screen diameter, with only a slight increase in overall length. The short length models for economy in size of apparatus and facilitates shielding. Also suitable for use without the necessity for high operating voltages.

#### INDIRECTLY HEATED CATHODE.

Heater Voltage .. .. .	4.0
Heater Current .. .. .	0.8 amp.
Accelerator Voltage (A <sub>2</sub> ) .. .. .	400 to 800 v. max.
Focusing Electrode (A <sub>1</sub> ) .. .. .	80 to 200 v. max.
Control Electrode (Modulator) .. .. .	0 to -40 v.

Screen : Medium persistence type, green fluorescence.

#### DIMENSIONS:

Maximum Overall Length .. .. .	190 mm.
Screen Diameter .. .. .	70 mm. (2¾" app)

Separate connections to each of the four deflector plates.

**LIST PRICE 55/-**

There is an ever-expanding scope for the use of cathode ray tubes in all branches of industry. Enquiries regarding special applications will be welcomed.

**MORE SCANNINGS****DEMAND FOR RECEIVERS**

Sales of television receivers at Olympia, it was stated, exceeded expectations. Television, undoubtedly, was the feature of the show, and the demonstration aroused intense public interest.

Plans have been made by the manufacturers to produce the number of television receivers which a careful estimate indicates the public will require before the spring of 1939, and the television committee of the R.M.A. is confident that the public will not be disappointed in the matter of deliveries.

Mr. C. O. Stanley, Chairman of the Radio Manufacturers' Television Development Committee, said: "Compared with a year ago, the public interest in television has changed in character from a 'novelty' interest to the interest of people who wish to purchase."

**OVERTIME ON RECEIVER PRODUCTION**

Orders for G.E.C. television sets have come in so well that the factories at Coventry are working overtime. "At the outset of the Show we were able to supply sets on demand," a G.E.C. official stated, "but now we are having to have five to seven days' notice. If orders continue at this rate, we shall need from ten to fourteen days. All the original stock of two of our models are already depleted. These are the 37-guinea console model, and the 23-guinea vision-unit. A factor that has influenced sales is that people realise that prices are now so reasonable that they cannot be expected to fall again for a long time."

**RECEPTION IN YORKSHIRE**

The Alexandra Palace programmes have been received by Mr. Bagshaw, radio engineer, at Dore, near Sheffield, 160 miles from the Alexandra Palace transmitting station. Mr. Bagshaw has been investigating the possibilities of long-distance television for a considerable time. Dore Moor is almost an ideal site, as it is 750 ft. above sea-level and remote from roads and electrical interference.

**VISIT TO R.A.F. AERODROME**

The training of R.A.F. pilots will be televised by courtesy of the Air

Ministry, about the middle of October, when one of the B.B.C. mobile units will spend a day at an aerodrome near London. Viewers will then be able to watch fighter planes at close quarters and see pilots under instruction operating the controls.

**A BOXING BAN ON TELEVISION**

Mr. Sydney Hulls, promoter of the Jack Doyle-Eddie Phillips fight at Harringay in September, refused to allow the contest to be televised despite a cash offer from the B.B.C. Mr. Hulls said he regarded the televising of fights a serious menace to the boxing promoter as set-owners invite parties to watch these big events, and they are usually the people who can easily afford to pay for the best seats.

**OUTSIDE BROADCASTS AFTER DARK**

Outside television broadcasts have been largely confined to hours of daylight when, of course, most of the major sporting events are taking place, but the B.B.C. staff at Alexandra Palace realise that many set owners are not able to tune in during the day, and are therefore planning a series of outside events which can be included in the evening transmission.

One of the first was the Television Ball in the Pinewood Club on September 23 and 24. Later it is hoped to televise boxing matches from the National Sporting Club premises at Earl's Court, and to set up the cameras at Harringay and Wembley for ice hockey and similar sports.

**SCOPHONY IN U.S.A.**

Mr. Solomon Sagall, the managing director of Scophony, Ltd., is going to the United States at the end of this month to introduce Scophony television and with the intention of forming a Scophony Corporation of America, backed by American financial and cinema interests.

**FRENCH STANDARDISATION**

The French Minister of Radio has announced that the system of transmission employed by the television service in France will remain substantially unaltered until July 1, 1941.

**TELEVISION TELEVISION**

On October 22, viewers will be shown how the mobile units take their pictures 20 miles from the Alexandra Palace, transmit them to the control room at A.P. and then broadcast them.

**THE CINEMA AND TELEVISION**

The Cinema Exhibitors' Association are pressing for some concerted action regarding the use of films for television. The matter, it is contended, has assumed such importance that it will undoubtedly figure on C.E.A. branch agendas as a major subject of discussion. A proposal is on foot to approach the Kinema Renters' Society, newsreels and the television companies for the purpose of watching the interests of the kinema industry.

**BRITISH TRANSMITTER FOR RUSSIA**

The Scophony transmitter made to the order of the Russian Government was despatched last month. The apparatus comprises a complete high-definition film transmitter and special synchronising apparatus. It is to be installed in Leningrad.

**CRYSTAL PALACE MOTOR RACING**

Crystal Palace will again provide a thrilling outside feature for viewers on the afternoon of October 8. On that Saturday afternoon a stern struggle will be fought out between the well-known motor racing "aces" Arthur Dobson and B. Bira who is, of course, Prince Birabongse of Siam, while the Imperial Trophy Race will also be staged for Britain and Continental drivers. In both these events cameras will follow the progress of the cars as they hurtle round the track, and an effects microphone will be placed at each camera position to pick up the roar of the cars and convey the exciting atmosphere of such contests.

**"LONDON WALL"**

A cross section of life in a solicitor's office, together with the hopes and fears of those who work there, will be portrayed in the presentation of "London Wall" to be televised in the evening of October 8 and the afternoon of October 12. Production is by Michael Barry.

**AND MORE REFLECTIONS**

**MORE OUTSIDE BROADCASTS**

It is most gratifying to know that there are to be a greater number of outside broadcasts. It is hardly to be expected that cabaret shows and similar entertainments can be produced day in and day out to compete with films. Viewers' interest is always greater in productions that are of a topical nature or that cannot be seen at a cinema. Between October 22 and 28, there is going to be a festival of outside broadcasts.

On October 19, by permission of the Air Ministry, there will be a tour of the R.A.F. aerodromes at North Weald. The latest types of 'plane will be shown, some of them actually when travelling at high speed. Conversations between pilots and aerodrome officials will also be heard. This is the type of television programme which should do much to increase interest amongst the general public.

**SUN SPOT EFFECTS**

A taste of what may happen around 1940 was obtained on September 20 when all radio communication between South Africa and the outside world was interrupted for a period of three hours. During this time it was impossible to send or receive transmissions to and from South Africa even with highly concentrated beam aerials.

The Post Office are erecting a new station at Rochester while their American counterparts are also installing beam transmitters with aerials covering only a narrow arc. In this way, they hope to be able to counteract sun spot effects which may probably make short-wave reception over long distances particularly unreliable after 1940.

**USING MICRO WAVES**

The Post Office engineers have for a considerable time been experimenting with micro waves in an endeavour to find out just how reliable these transmitters would be for point-to-point communication. The results of their investigations have proved most interesting, not only from the point of view of communication, but also from the television angle. It is considered highly probable that the ultimate solution of television in this country will be a large number of widely separated stations in all parts of the country linked together by micro-wave inter-

mediate beam stations. This will overcome the need for expensive cables which so far have not proved entirely satisfactory for television relaying.

**TOPICAL TELEVISION BROADCASTS**

An excellent example of how television should be used was the transmission showing the return of the Prime Minister from Germany. The outside television units were rushed to the Airport and viewers were able to see Mr. Chamberlain step from the aeroplane and heard his first remarks on arriving back from his political talks with Herr Hitler. This type of broadcast is appreciated by viewers and it is to be hoped that it is only the first of many of a similar nature.

**NEW TELEVISION POST**

A new post is shortly to be created at Alexandra Palace with the title of Television Public Relations Officer. Under the jurisdiction of this office it is proposed to organise a staff of B.B.C. lecturers on television to undertake propaganda and to co-operate with dealers in order to increase the interest generally in this country.

**BRITISH v. AMERICAN VALVES**

Congratulations are due to British valve makers as a whole who are now showing what they can do in the production of special valves. For some considerable time high-slope valves designed primarily for television receivers have been exported to America for use in their experimental receivers. British cathode-ray tubes are also being exported to American amateurs owing to the fact that the average low-price American tube still produces a picture with a greenish hue. The highlight, however, of the British valve manufacturers' programme is the production of valves for the British transmitting amateur, which in many cases have characteristics equal to or above the level of their American equivalents.

**A TELEVISION STATION IN BRIGHTON ?**

Radio dealers in Brighton, Hove and other parts of Sussex are agitating for a television station to serve their area. It is explained that there is more than the usual amount

of interest in television in Brighton despite the fact that it is considerably outside the service area and only receivers in particularly good spots are capable of producing good pictures. It is only fair to point out, however, that the possibilities of a station in or near Brighton are remote, for such a station would dissipate half of its radiation over the English Channel.

**FRENCH TELEVISION**

The French Radio Minister, M. Julien, announced that transmission characteristics have now been arranged and will be unchanged until July 1, 1941. The French Radio dealers who were a little pessimistic about the possibilities of a service covering Paris have now changed their views and hope that before very long a large number of manufacturers will be in a position to supply television units. However, the possibility of British competition has not been disregarded for it is realised that the average British receiver can very easily be modified to pick up pictures transmitted from the Eiffel Tower. The transmission characteristics decided upon are as follows:—  
Vision wavelength, 6.52 m. (46 mc.).  
Sound wavelength, 7.14 m (42 mc.).  
Polarity of transmission, positive.  
No. of pictures, 50 interlaced per sec.  
No. of lines, between 440 and 445.  
Picture proportion, 5/4 width/height.  
Duration of line, synch. signals 18%.  
Duration of frame synch. signals 15 lines per interlaced section (about 7%).

**TELEVISION IN AMERICA**

N.B.C. representative in England, Fred Bate, puts forward the view that it will be many years before television is on a commercial basis in America. He thinks that as American listeners are far more critical than British listeners, owing to the enormous amount of competitive entertainment available, they will not appreciate the wonders of television until it is on a par with the best that the cinema can offer. His opinion is that the average American will not appreciate the difficulties that television designers have overcome in order to produce pictures of the present degree of perfection. Naturally there cannot be a service until it can be commercialised unless the broadcasting concerns feel particularly philanthropic.

# A NEW MASTER GENERATOR FOR SYNCHRONISING SIGNALS

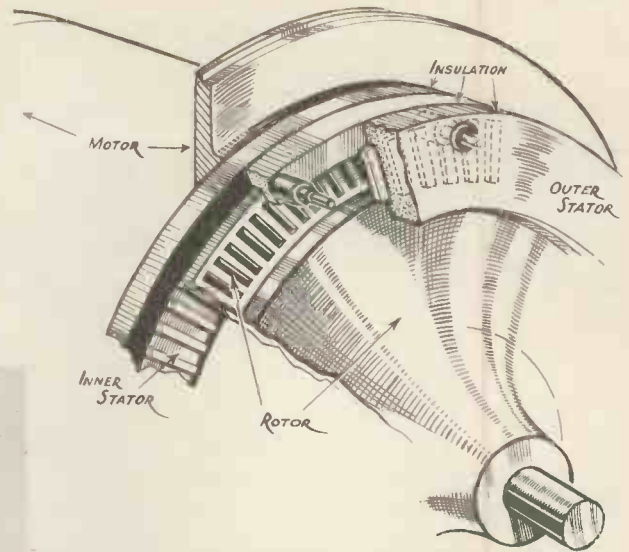
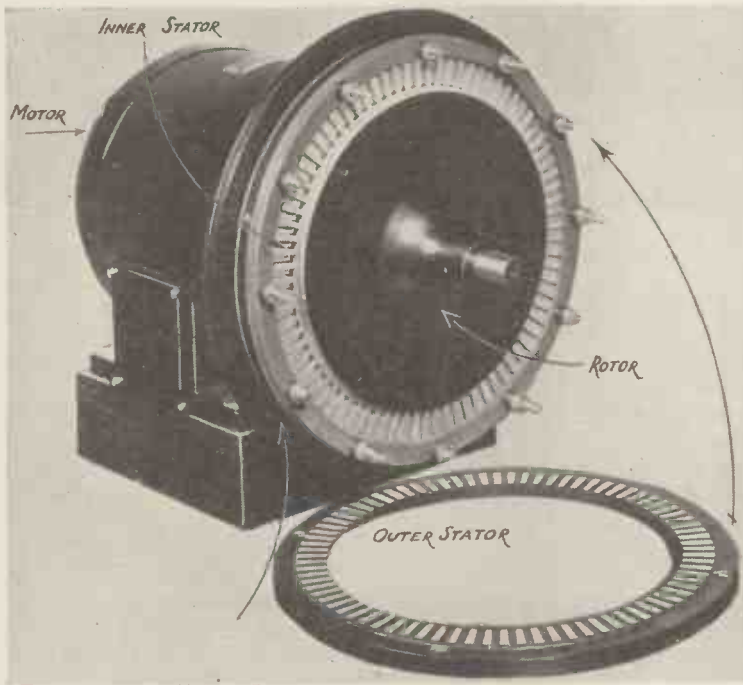

Diagram showing the working principle of the Master Generator.

The parts of the Synch. Signal Generator

frequency variation to about 10 cycles per second/per second at the line frequency, but the phase drift at frame frequency cannot be tolerated. In this case the frequency of the oscillations around the mean position is reduced, but the amplitude of these is increased.

## Mechanical Generators

The mechanical generator using the simple apertured disc suffers from mechanical irregularities in manufacture. For instance, a disc having 405 holes designed to rotate at 1,500 r.p.m. requires the angular spacing of the holes to be 6.4 seconds of arc for one element accuracy. Inaccurate placing of the holes results in the lines of the picture being displaced in time.

In addition to this irregular error, regular errors occur, due to holes in the disc not having been placed along an exact circle or the disc itself not running quite true on the shaft. When these errors are present the produced signal is not a single frequency, but a small band of frequencies (irregular placing) which are phase-modulated with a frequency which corresponds to the revolutions of the disc per second.

## A New Generator

A new type of generator, operating on novel principles, has been developed by Scophony engineers, this consists of a rotating disc carrying teeth on its periphery running between two stationary rings also

(Continued on page 615)

**A**CCURATE timing of the transmitted synchronising signals is essential for high-definition television systems. These signals usually are derived from a master generator working at line frequency or double line frequency, the framing pulses being derived from this frequency by sub-division. It is desirable that the frame pulses should be synchronised to the mains supply and show only negligible phase variations with the mains frequency. This is advantageous because smoothing requirements are then not so exacting.

To generate the master frequency, two methods are in general use. In one a free oscillator is used, automatically tuned so that the frame pulse, obtained by sub-divisions, remains in constant phase relation with the supply mains. In the second, use is made of an apertured disc with a lamp and photo-cell, the disc being driven by a synchronous motor from the supply mains.

## Electronic Generators

Signal generators employing electronic methods are made in two types. In one the time constant of the automatic tuning system is small (of the order of 0.2 sec.). This results in very fast and erratic phase modulation of the oscillator output.

There are several reasons for this frequency variation, one is that the automatic tuning system corrects the frequency of the master generator only if the phase difference relative to the mains frequency is of a certain minimum value. The correction acts only after a considerable displacement has taken place. In general the correction takes place quickly, and in the form of over-correction. The result is a kind of oscillation around a mean position.

In the second type of electronic generator a high time constant coupling is used. This reduces the fre-

# TELEVISION AT THE BERLIN EXHIBITION PART II

By E. H. Traub

*The first part of this article, published last month, dealt almost exclusively with the exhibits of Fernseh A. G. This second article, therefore, is devoted to a review of the other exhibits at the Berlin Radio Exhibition.*

## Telefunken

A NUMBER of transmitters made by this firm were installed in the Exhibition. Firstly there were some Iconoscope cameras in use on a ramp outside the hall for transmitting street scenes. The pictures received from these cameras were regarded by experts as being of extremely high standard of quality.

A new type of film transmitter was also working; this used a projection cathode-ray as scanner, similar in conception to the Cossor transmitter, which was shown at South Kensington last year, with the exception that



Interior view of the Telefunken "Block" receiver.

an Arcadia type of film projector was used to give optical compensation for the continuous film movement.

This transmitter is very simple in

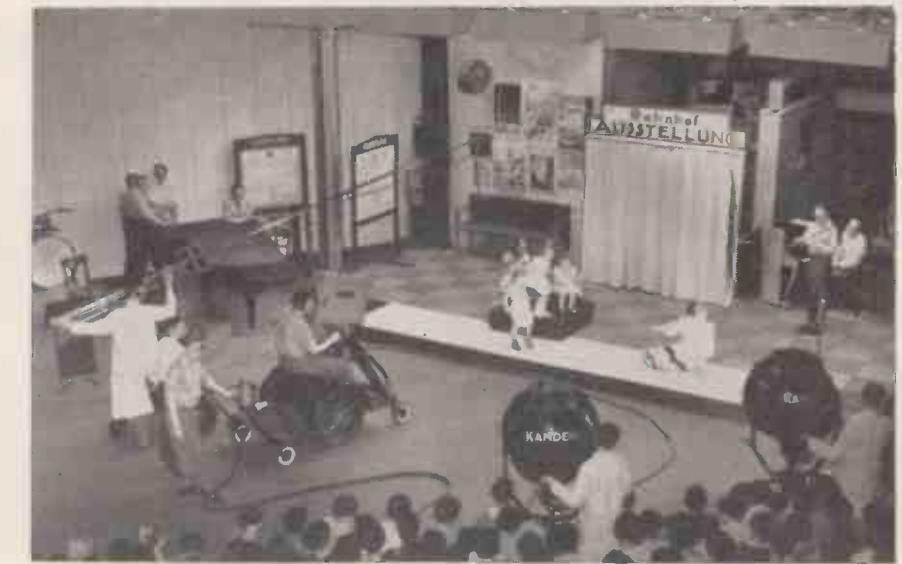

construction and gave excellent results. The adoption of this type of transmitter by Telefunken in favour of the Iconoscope film transmitter used hitherto is important; it means that Iconoscopes are now regarded in Germany as being unsuitable devices for film transmission. The writer, amongst others, has been stressing this for years, and it is gratifying to see that German technical opinion agrees with this view. One can only hope that the B.B.C. will at last take the hint and get rid of their very unsatisfactory Iconoscope film transmitters and install either a mechanical transmitter or some other form of electronic scanners, which are free from all shading errors inherent in the Iconoscope.

Another interesting transmitter of Telefunken was a spot-light transmitter for 441 lines, using a projection cathode-ray tube as scanner. It is a remarkable tribute to modern photo-cell technique that such a transmitter is at all possible to-day. Incidentally the pictures received from this transmitter were quite free from "noise."

A whole range of receivers were exhibited from the smallest type of home receiver up to the big screen projectors. Firstly there was the small table model home receiver, which was illustrated last month. This receiver is intended for cheap mass production and uses a 9 in. cathode-ray tube. The receiver is really a "vision unit," as no complete sound receiver is incorporated, but only a frequency changer, the output of which is fed into a standard radio receiver.

Another type of receiver was a standard upright model, which gave sepia pictures, which had, however, very good definition, interlacing and half tone values. An experimental model which was also demonstrated, had a cathode-ray tube over 2 ft. in diameter, giving a large bright black and white picture. This tube must be regarded as an amazing piece of glass blowing, as it was not unduly large in relation to its diameter; the anode voltage was 20,000. In addition to this a projection type of home receiver was shown, giving a picture 16 in. by 20 in., projected on to a white screen on the inside of the lid of the set. The picture on this, however, appeared to be rather soft and

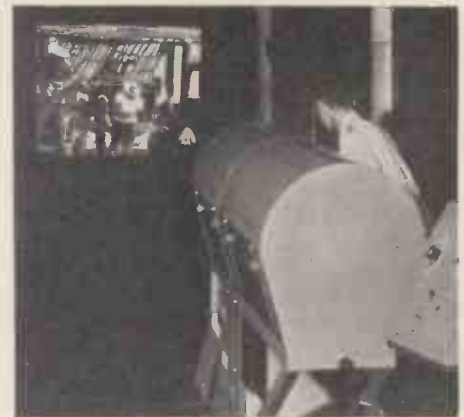

The Telefunken big-screen projector.

of no very great illumination. The so-called block receiver which was first shown last year, was also demonstrated in an improved form.

In a separate theatre set apart for this purpose three big screen pictures



## THE GERMAN POST OFFICE AND TELEVISION

were shown working side by side. These pictures were on an average about 5 ft. by 6 ft. in size. Two were projected from the front, and one from the back through a ground glass screen. Of the two projection types, one used a concave mirror, and the other a projection lens. The concave mirror picture was bright, but obviously not so well defined as the picture from the other two projectors.

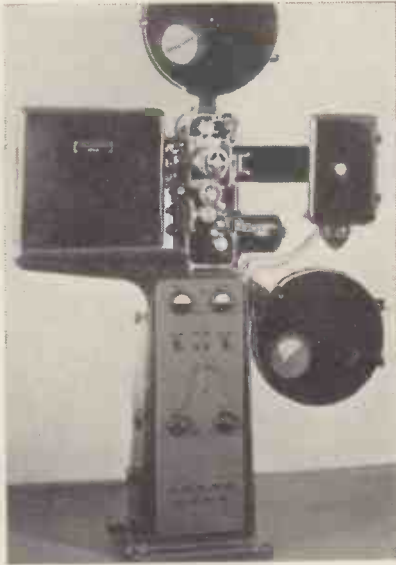

Fernseh film transmitter employing a Farnsworth image dissector.

The brightness of all these pictures was quite reasonable, and adequate for ordinary purposes.

### Lorenz

Two types of home receiver were shown by the Lorenz firm. One small, but extremely compact home receiver, used a tube about 13 in. in diameter, which was remarkably short for its size. Another model used a big tube about 18 in. in diameter, with the tube mounted upright. This model also included an all-wave radio receiver. The pictures were bright, but the definition did not come up to the standard of the pictures shown by Fernseh and Telefunken. In addition two big screen pictures were demonstrated. Of these it could only be said that both the definition and brightness were quite inadequate.

### Loewe

Loewe showed new models of their home receiver, which gave very good

pictures in all respects. (These pictures were operated from Loewe's own mechanical transmitter, using a disc. A remarkable feature about this receiver was the great compactness of the amplifying and other radio equipment associated with it. The home receiver was also shown in larger forms of cabinet, incorporating an all-wave receiver and gramophone. In addition a cathode-ray projection receiver was demonstrated giving a picture 16 in. by 20 in. The brightness and definition of this projected picture were very good. The picture, however, was rather blue in colour, and the screen rather directional.

### German Post Office

The Post Office stand contained a considerable amount of equipment, some of which was of great interest. First there was a model transmitting van, containing complete camera equipment for Iconoscope cameras, and also a low-power radio transmitter. The power supply was derived from a generator situated in a small trailer, which could be drawn behind the van. The interesting part about this equipment is, that it is possible to transmit pictures whilst the equipment is in motion. Inside the van everything is very compactly built, and as a whole this van is a fine engineering feat. A further item of technical interest at the Post Office stand was a demonstration of colour television. The system shown cannot be regarded as true colour television, as

the transmission was from a specially transmitted film in which alternate frames of the film were differently tinted. Technical details were not disclosed, but the receiver appeared to be a projection cathode-ray tube or possibly two tubes, the images of which were superimposed on the screen. In any case the results were not very impressive.

A Kerr cell was also demonstrated showing that it is possible to change the colour of light transmitted through the cell by varying the voltage. In addition to these above-mentioned items, the Post Office had in operation a number of transmitters, which had been bought from commercial firms, and also a number of receivers. Three receivers which had

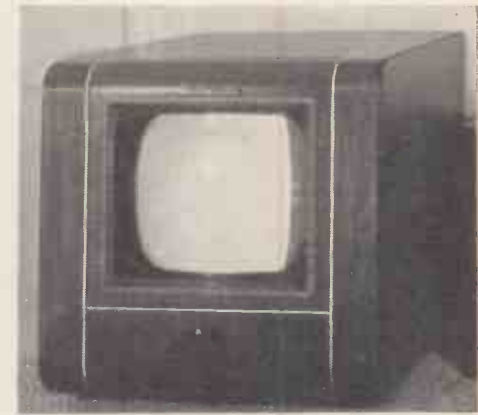

The Telefunken small home receiver

definitely been constructed in the Post Office were also shown working. The results on these, however, were such that it is really surprising that in 1938 pictures of such poor quality are demonstrated at a public exhibition.

There was also a television studio in the Exhibition, which was built in the form of a stage. The equipment used on the stage was supplied by Fernseh A.G. Televising took place practically all day, and as can be seen from the photograph, the public were able to have a good view of the studio in operation. It was, however, remarkable that only one camera was in use on the stage at a time, and also that the lighting system was extremely primitive; the results were not very good. It is quite obvious that in transmission technique the Germans have a lot to learn from the B.B.C.



Loewe home receiver.

# RECENT TELEVISION DEVELOPMENTS

## A RECORD OF PATENTS AND PROGRESS *Specially Compiled for this Journal*

Patentees: V. Zeitline, A. Zeitline and V. Kliatchko :: Farnsworth Television Inc ::  
Fernseh Akt. :: Radio Akt. and D. S. Loewe :: Schophony, Ltd. and H. W. Lee

### Focusing the Electron Stream

(Patent No. 486,294.)

THE Figure shows an electron discharge tube in which the light from an external object P is first projected on to a light-sensitive

### Incandescent Pictures

(Patent No. 486,373.)

Relates to a television receiver of the projection type in which the picture is reproduced on an incandescent screen S, which is formed of a large

### Electron Multipliers

(Patent No. 468,437.)

In order to amplify an electron stream of large cross-section, as is sometimes necessary in television, the first electrode T of the electron-

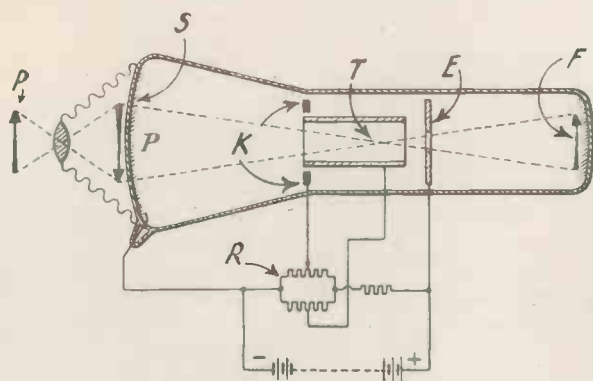

Focusing the electron stream. Patent No. 486,294.

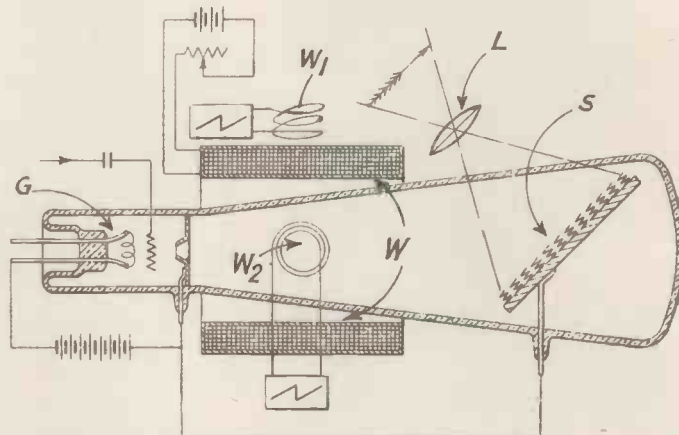

Producing incandescent pictures. Patent No. 486,373.

screen S so that a stream of electrons is produced. These are then focused by an electron-optical lens T and an accelerating electrode E on to a fluorescent screen F.

In such an arrangement the electrically-charged tube T, which serves as the electron "lens" acts rather differently upon the electrons which pass along its central axis to those which travel to one side or other of the centre. In other words, it is slightly "astigmatic" and therefore produces a correspondingly distorted image on the second screen F.

To remedy this, a ring K is mounted near, but slightly spaced away from, one end of the tube T, and carries a biasing voltage which can be varied by adjusting the tapping point R. The electrostatic field between the ring K and the end of the tube T tends to move the electron stream more towards the centre of the tube, and so removes the astigmatism without otherwise affecting the focal-length of the lens.—V. Zeitline, A. Zeitline, and V. Kliatchko.

number of extremely fine wire spirals extending a short distance above the scanning surface. The wires are originally less than one-thousandth of an inch in diameter, and, after being assembled, are subjected to treatment by hot sodium nitrate. This makes them much finer still, so that they will rapidly be raised to incandescence by the action of the electron stream. Also they cool rapidly by radiation, as distinct from conduction which would cause the details of the picture to "spread" and spoil definition.

The electron stream from the "gun" G of the cathode-ray tube is focused by an external magnetic coil W and is deflected by scanning coils W1, W2. Its impact upon the screen S raises the small spirals to red or white heat, according to the varying tone values of the original picture. The screen is set at an angle, as shown, so that the incandescent picture can be projected through a magnifying lens L on to an external viewing screen.—Farnsworth Television, Inc.

multiplier is made of metal foil, which is transparent to primary electrons P moving at high speed.

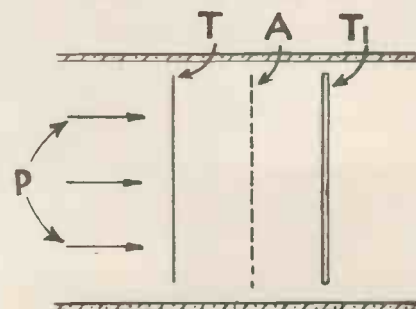

Electron multiplier. Patent No. 468,437.

As soon as the electrons get through, they are accelerated by a mesh anode A carrying a high positive voltage, and pass through it on to a "target" electrode T1, where secondary electrons are liberated. These, in turn, are subjected to the high positive voltage on A and pass back towards the first electrode T.

By the time they reach the latter,

their speed has dropped below the point at which that electrode is permeable. The impact, however, produces a fresh supply of secondary electrons, which are similarly attracted back to the target  $T_1$ . This to-and-fro movement continues until a large secondary-emission current has been built up inside the "enclosed" space between the target electrodes  $T$  and  $T_1$ , which are connected to an external tuned circuit.—*Fernseh Akt.*

### Intensifying the Picture

(Patent No. 486,750.)

An image of a picture is projected, in the first instance, on to a photo-electric cathode at the end of one limb of a three-legged tube. Electrons liberated by the action of the light are then projected by the action of an external magnetic field on to a second electrode, situated at the end of another leg of the same tube. This second electrode is coated with an emissive substance and is also indirectly heated, so that it produces a copious supply of secondary electrons.

The latter are finally projected by the action of the external magnetic field on to a luminescent screen located at the end of the third leg of the tube, where the intense stream of secondary emission produces a more brilliant copy of the original picture. Interference between the stream of primary and secondary electrons is prevented by the fact that they pass through the magnetic control field in opposite directions, and are therefore deflected away from each other.—*Radio-Akt D. S. Loewe.*

### Light-control

(Patent No. 487,240.)

The variation of light intensity likely to occur when televising an outdoor scene, for example as between bright sunlight and an "overcast" sky, is too great to be followed faithfully by the photo-sensitive devices at present known. Usually they are worked at full capacity in order to preserve the ordinary contrast values between the different details of each picture, so that there is no margin left to deal with the changes which occur from time to time in the average brightness or background illumination of the scene being televised.

In order to overcome this difficulty, the intensity of the light originally projected on to the photo-sensitive screen of a cathode-ray transmitter is automatically controlled, and attenuated when necessary, so as to leave the P.E. cells something in hand to follow, and changes in overall illumi-

nation. The method is applicable either when televising a prolonged out-of-doors event, or when transmitting from a cinema film.

In practice, a semi-transparent mirror is used to deflect some of the original light away from the sensitive mosaic screen of the cathode-ray transmitter. The deflected light is then applied to an auxiliary photo-electric cell, the amplified output from which is used to regulate the transparency of a Kerr cell placed in the path of the original light before it reaches the photo-sensitive screen. The Kerr cell thus acts as a "choke" on the original brightness of the picture and by keeping it within limits gives the photo-sensitive cells a chance to respond to any subsequent change in the general illumination.—*Radio-Akt D. S. Loewe.*

### Eliminating Mains Ripple

(Patent No. 487,242.)

Since the amplifying stages of a television receiver must be capable of

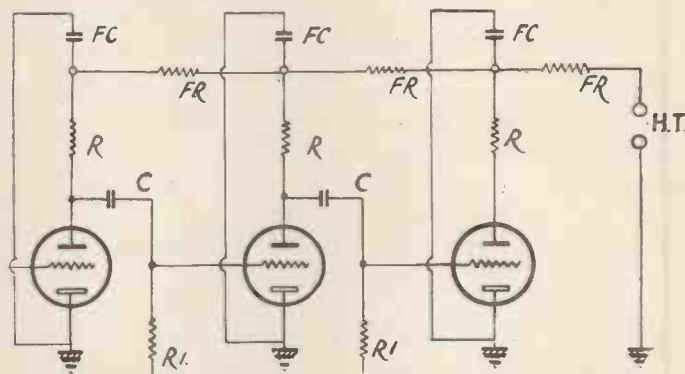

Method of eliminating mains ripple. Patent No. 487,242

handling frequencies at least as low as those used for "framing," that is, frequencies of the order of 25 cycles, they are peculiarly liable to be affected by any ripple or fluctuation in the mains-supply voltage. This produces unpleasant variations in the light intensity of the received picture.

The figure shows how this cause of disturbance can be eliminated. The ordinary resistance-capacity elements  $R$ ,  $C$ ,  $R_1$  coupling successive valves are combined with "graded" filter resistances and capacities shown as  $FR$  and  $FC$ . The values of the various elements are so chosen that any temporary increase in the anode voltage of one valve, due to fluctuations in the supply voltage, automatically produces a compensating drop in the voltage transferred across the coupling to the grid of the next valve. In this way the effect of any fluctua-

tions present in the H.T. mains-supply is automatically wiped out.—*Radio-Akt D. S. Loewe.*

### Rotating-drum Scanners

(Patent No. 487,318.)

In order to increase the angle through which a beam of light is thrown, as it passes over each mirror in a rotating-drum scanner, the light, after it has been reflected by one mirror, is passed through an optical system comprising a pair of lenses and a totally-reflecting prism, so that it is returned to another mirror—in advance of the first—on the same drum.

If each lens in the intermediate optical system has the same focal length, the angle of divergence of the ray as it leaves the second mirror will be twice as great as when it left the first.

By using an optical system with a magnification of less than unity, the angular deviation or "scanning angle" imparted to the original beam

of light can be reduced instead of increased. The arrangement will, for instance, allow the drum to be rotated at a lower speed than would otherwise be necessary to produce the same result.—*Scophony, Ltd., and H. W. Lee.*

In the July issue the number of a patent on Television by Secondary Emission, by H. G. Lubszynski, was given as 471,563. (This number should be 481,563.)

### Summary of other Television Patents

(Patent No. 484,099.)

A multi-stage electron-multiplier in which the resistance potentiometer for biasing the target electrodes is mounted inside the glass bulb.—*Marconi's Wireless Telegraph Co., Ltd.*

(Continued on page iii of cover.)

# INCREASING RECEPTION RANGE

By S. West.

*A description is given here of an efficient television pre-amplifier unit which is easily attached to normal television receivers and effects a marked improvement in the range; there is also a considerable reduction of interference with its use.*

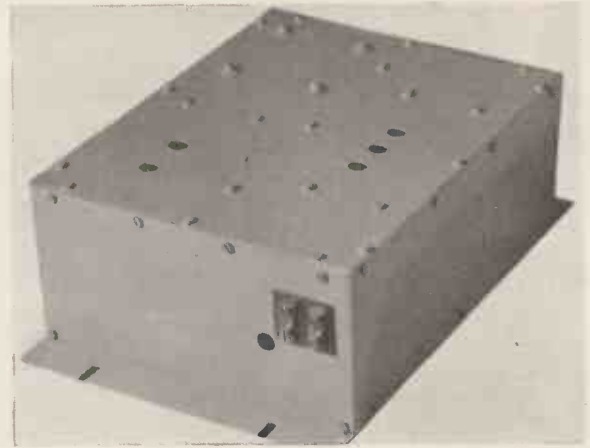

The pre-amplifier is quite compact.

IT is now generally appreciated that the service area for the television transmitter at Alexandra Palace is considerably in excess of the original conservative estimate. It is essential, however, if consistent reception is to be enjoyed at large distances, that sensitive apparatus be employed.

The writer has, over an extended period, conducted tests with various forms of pre-amplifiers, the object being to increase the range of the normal type of television receiver.

A pre-amplifier is a unit comprising one or more R.F. stages, preferably entirely self-contained, i.e., it includes its own power supply and is necessarily as compact as is possible compatible with efficiency. This latter consideration is dictated by the general desirability for installing the unit at a distance of several feet from the main receiver. This is in the interest of maintaining stable operation with any class of receiver.

The design considerations are somewhat conflicting. The arrangement must possess a comparatively broad frequency characteristic in order to admit both the sound and vision carriers without appreciable attenuation and the noise level must be low. At the same time if tangible benefits are to be derived the gain must be of fair magnitude. All these matters are not easy of achievement.

With a unit of this type evolved, extensive measurement tests revealed that to possess the above desirable points, consideration must be given to the question of ensuring the best match to the various types of receiver with which the unit is likely to be employed. If a mismatch exists a great deal of the good work is, so to speak, undone.

This problem in practice is not difficult of solution, for with the

majority of receivers, both commercial and home-constructed, ability on the part of the amplifier to feed efficiently into an 80-ohm or 100-ohm load only is required.

In the pre-amplifier to which these notes pertain a very simple device is employed entailing only the tightening of a screw to adjust the unit to suit the input of either of the general class of input circuits above-mentioned; furthermore, the adjustment takes care of arrangements such as those in which a concentric feed is employed with the outer shield earthed.

## How the Pre-amplifier is Used

A further advantage is derived from such an arrangement for, where it is conveniently possible to insert the pre-amplifier unit in the aerial feeder, the arrangements permit this to be done for any form of feeder whether it is of the concentric class of lead or the popular Belling-Lee transmission line.

For example, the feeder may enter an upstairs window, in which case the unit can be installed at this point, often effecting some desirable reduction of interference pick up because of this.

This reduction of interference is brought about by the fact that with the extra gain due to the pre-amplifier the gain control of the main vision receiver is operated at a lower setting, the signal strength on the feeder between the amplifier and the main receiver being at a materially higher intensity than the actual signal at the aerial. In brief it is the equivalent of providing a higher signal voltage in an imaginary aerial at the point where the pre-amplifier is situated.

With a unit designed which performed well under a number of stringent tests a great deal of consideration was given to the question of its final commercial form, from the point of view of the type of housing likely to prove most suitable for general use.

The essential need for a compact form has been already intimated. The question to be settled was whether it was desirable to render the unit waterproof, thereby permitting its installation almost anywhere.

It was finally decided that in view of the expense and difficulty in effecting this such a course was not warranted, especially as the information had been elicited from the extensive production tests that no very definite advantage was derived from installing the unit close up to the actual antenna.

Where interference is encountered it is sufficient to instal the unit in an upstairs room and from there the feeder can be brought in any convenient manner. This feed line between the pre-amplifier and main receiver can consist of either Belling-Lee transmission line or Telcon concentric feeder.

A standard unit on the lines indicated and shown by the photograph is now available. The price is £6 6s. complete with all valves. It is operated entirely from the mains, adjustment being provided to suit voltages between 200-250 volts at 50 cycles. The actual external dimensions are 9 in. by 7 in. by 3 $\frac{3}{4}$  in. To facilitate fixing, convenient lugs to take ordinary wood screws are arranged. The construction is very solid and the unit is finished in grey cellulose.

To give some indication of the capabilities of this unit it can be

(Continued on page 612.)

# Telegossip

## A Causerie of Fact, Comment and Criticism

By L. Marsland Gander

"TELEVISION is making very definite progress towards a national service." Major L. H. Peter, chairman of the Radio Manufacturers' Association, made this optimistic remark when I asked him the other day about sales of receivers. The Television Committee of the R.M.A. aimed at selling 15,000 televisors by next March. All the indications are that, wars and rumours of war permitting, this figure will be exceeded.

This is the most cheerful news of television I have written since the Alexandra Palace station began to transmit two years ago. Radiolympia aroused for the first time a buying interest which has caused the manufacturers to think in terms of mass production. And, speaking candidly, the demand has taken the manufacturers by surprise. Existing stocks of the new models have been sold.

Major Peter told me that he is preparing figures for the Television Advisory Committee which will give that body the most pleasant surprise it has had for a long time.

So far, so good. But are B.B.C. developments keeping pace? I say, without any attempt to allocate responsibility among the various parties—the B.B.C., the Advisory Committee and the Government—that unfortunately programme developments are not altogether keeping pace. It may be six months and it may be a year before the theatre at Alexandra Palace is converted into a studio. Yet this theatre was taken over by the B.B.C. soon after the Palace premises were first acquired two years ago. Chiefly for financial reasons the scheme of conversion has hung fire ever since.

### The New Studios

I believe, however, that in the meantime various alternative schemes for providing new studios elsewhere have been considered. Now that the money has been somewhat reluctantly and belatedly produced, the old patchwork policy of converting the theatre has been adopted once more. I thought we all knew by now that television presentation is going to cost a lot of money; the sooner that is acknowledged by all parties concerned the better.

I hear that the design of this theatre studio has now been approved and orders placed for the equipment. (The plan somewhat resembles that adopted for German film studios.

The whole floor is to be levelled, and the existing stage will be removed. Five separate "stages" (in the film sense) will then be arranged round a control unit. This unit will consist of a tiered structure where the sound and vision mixing will be done and from which the producers will be able to obtain a clear and uninterrupted view of all the individual stages. Besides the producers this control unit will provide accommodation for sound and vision "mixers" and technical operators.

I gather that the idea is to be able, if necessary, to use all five sets in one production. There may be some snags in the arrangement. For instance, the lighting on one may interfere with that on another. But the urgent necessity of the moment is to push on with the scheme and provide the programme makers with more studio accommodation.

Good progress has been made with the re-equipment of Studio No. 2. No date is yet given for its completion, but it should be ready fairly soon. Viewers think at once of extension of programme time when there is talk of extra studio accommodation, but the intermediate benefits will be more opportunities for camera rehearsals, leading to more finished productions. At present the only chance for a camera rehearsal is on the day of transmission. Many flaws and crudities could be "ironed out" with better rehearsal facilities.

Another forward step has been the acquisition of four rehearsal rooms at the B.B.C.'s publication department in High Street, Marylebone. Hitherto rehearsals have been conducted all over the place—at theatres, restaurants, in private flats, etc. These four rooms will not, of course, entirely settle the problem, but they will be a help.

### Central Control

In the meantime the new Central Control Room has actually come into use. During Olympia it was used to co-ordinate the programmes which during one afternoon came from several different sources—the Zoo,

Olympia and Alexandra Palace, for example. It should mean greater smoothness and celerity in programme presentation.

When the whole scheme of reconstruction is finished programmes will be fed into this control centre from the three separate studios and from any point on the television cable network throughout the London area.

The television studio at Olympia was rigged up in about three weeks. It was a rush job and a temporary affair, yet if there was a single breakdown during the whole exhibition I did not hear of it. But what I did hear was the jubilation among the B.B.C. staff at Olympia when it was necessary for Radiolympia to apologise for a breakdown at Alexandra Palace! So when slow motion development plans are under way at Muswell Hill I hope somebody will remember this story.

### O.B.'s.

The new mobile unit was used at the Oval for the Test match and the old one at Olympia. Afterwards the new vans were returned to Hayes for finishing touches and used again for the first time for the Centenary programmes from Euston Station. I mention this because I personally have not been able to distinguish much difference in the quality of transmission between the new and old and I wondered if other viewers had shared the experience.

I imagined that with two units at his disposal for outside broadcasts Mr. Philip Dorté would be hard put to it to find sufficient programme material of the right kind. However, he strenuously denies any difficulty and tells me that he has a long list of coming events sufficient to keep the vans fully occupied. It was enterprising to pack off one outfit to Heston at very short notice to televise the return of Mr. Chamberlain from his visit to Berchtesgaden.

(This sort of intensely topical transmission is worth half-a-dozen pre-arranged visits here and there.)

Though the B.B.C. is friendly with the Football Association, I understand that the Football League will in no circumstances permit the televising of Leagues matches. (The number of soccer matches which will be available will therefore be strictly

(Continued in third column of next page.)

**"INCREASING RECEPTION RANGE"**

(Continued from page 610)

stated that a number of tests have been conducted used in conjunction with various types of vision receivers. In every case the improvement was very marked.

These tests were extended to embrace all difficult examples. Where interference was bad considerable

served when connecting it to a T.R.F. type of receiver. Due to the efficient shielding and special output arrangements coupled with the care taken to ensure that no R.F. is permitted to emerge via the main connection perfect stability is ensured.

Two other types of unit are available. The first of these is a highly sensitive arrangement to permit the

**"TELEGOSSIP"**

(Continued from previous page)

limited, probably confined to charity games, internationals, and possibly (but by no means certainly) the Cup Final.

Speedway racing is ruled out because the lighting is not satisfactory for television. And, incidentally, this question of lighting outside broadcasts at night is causing a few headaches at A.P. To permit the televising of an item of such doubtful programme value as a visit to a Palais de Danse it was estimated that it would be necessary to provide 150 kilowatts of lighting—consisting of 30 five-kilowatt lamps.

Greyhound racing is out, not only for reasons of policy but also because of the same lighting problem. Certain boxing contests will be televised, such as the weekly N.S.C. bouts at Earls Court, but the promoters of big fights are now becoming shy of television and demanding terms which the B.B.C. is unwilling to concede. Hence the breakdown of negotiations to televise the Phillips-Doyle contest.

I hear that negotiations, likely to be successful, are proceeding for the televising of ice hockey from Wembley, Harringay and Earls Court throughout the season. In the meantime advance plans have been made for broadcasts from one place and another almost every day.

The Air Ministry has agreed to demonstrate the balloon barrage on October 27. Two lorries and trailers, carrying balloons, hydrogen cylinders and full equipment will proceed to the Palace grounds there to give a special performance. On October 28 there will be an A.R.P. demonstration, full details of which have not yet been decided.

I hear that the Radio Manufacturers are most anxious for the Government to press on with legislation to prevent interference with television and broadcasting. A new Radio Bill is in course of preparation bringing up to date the Wireless (Telegraphy Act of 1904 and incorporating special clauses to deal with the interference question. But we have been promised this Act so long that the manufacturers are getting restive. Interference in its various forms is one of the biggest snags in television reception particularly in districts outside the normal service area. Now television has begun to forge ahead something must be done to stop the interference.

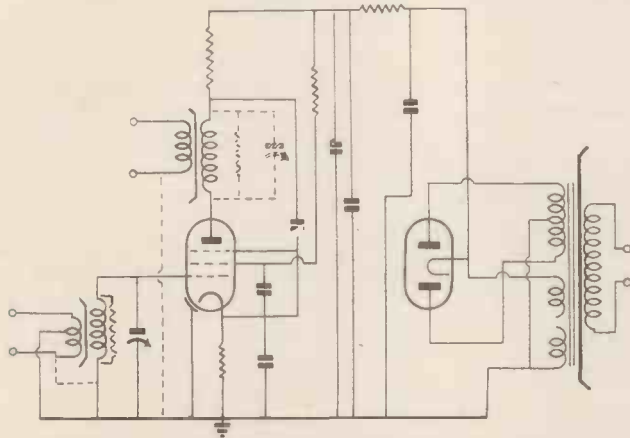

[A] comparatively normal arrangement; gain is with careful design about 17 db.

**SUITABLE  
CIRCUITS  
FOR  
PRE-AMPLIFIERS**

Single-stage circuits only are shown for purposes of simplicity.

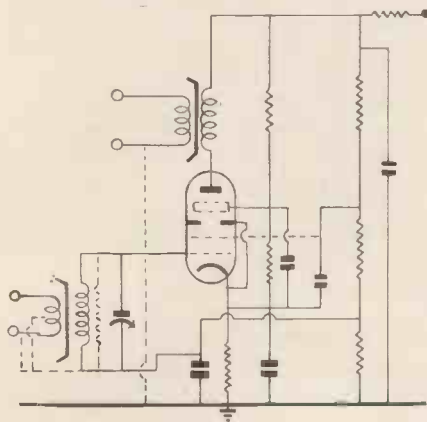

A high-gain arrangement, a worth while increase of signal is secured from a single stage using this arrangement.

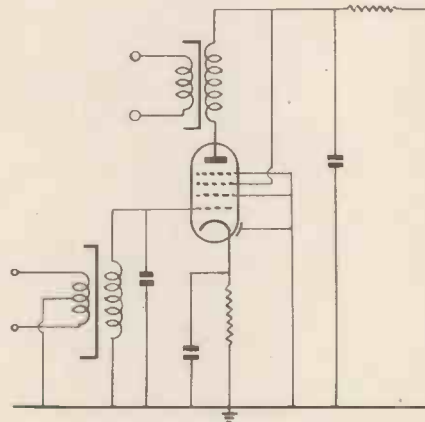

A low-gain pre-amplifier which possesses the merit of contributing practically no inherent noise and is therefore suited for use with high-gain vision units.

benefit was derived from the installation but the particular value of the unit lies in its ability, when used in conjunction with a normal vision receiver which is providing only thin pictures, to augment the weak signal tremendously, it being possible fully to modulate the tube resulting in excellent black and white pictures with the main receiver gain control reduced.

It is entirely suitable for use with all forms of vision receivers. No special precautions need to be ob-

use of normal vision receivers that ranges up to 100 miles. It is, in general, not suited for use with the T.R.F. type of receiver and is primarily intended to precede a super-heterodyne type wherein not more than 2 R.F. stages are included.

The other unit is intended for use in small flat installations or where it is desired to operate up to twelve receivers from a common antenna without detracting from the performance of each.

# THE NEW FERNSEH MECHANICAL FILM SCANNER

By K. Thöm

*A description of the Fernseh transmitter and a consideration of the technical problems involved in its design.*

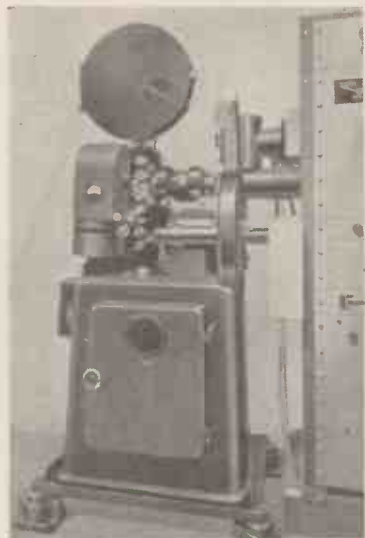

Fernseh mechanical film scanner for 441 lines.

THE mechanical scanner, with spiral hole disc, is the result of rather long and steady development. At the Berlin Radio Exhibition, 1935, the Fernseh A.C. showed a mechanical film scanner giving 320 lines, 25 frames, the highest definition obtained at that time.

The movable television camera of the German G.P.O., used since 1936 for transmitting news by means of the intermediate film method, is also equipped with a mechanical scanner by Fernseh A.G. At the Exhibition, 1936, Fernseh showed a scanner giving 375 lines, 50 frames/sec. The development led to the mechanical scanner of 1937 conforming to the new standard of 441 lines, 50 frames/sec. This was the first German mechanical scanner for the new standard.

## Description of Apparatus

Fig. 1 shows, schematically, the elements of the scanner and the optical paths. The A.C. fed lamp *a* has a rectangular field corresponding to the shape of the film. It is contained in an air and water cooled case. Through the condenser *c* and the correcting system *d*, a zone of the film window *f* is illuminated through a slit of the disc *e*. The film window is projected via a second optical correcting system *g*, and the objectives *h* and *i* on the spiral hole disc *k*. The disc rotates in the evacuated case *l*. The rays of light penetrating through *k* are focused on the secondary

emission photo-cell *n*, with the aid of a lens *m*.

Close by, above the system for light modulation, is a second optical beam (indicated at *o* and *m*) for generating the line synchronising impulses by means of holes in the disc *k* concentric to the spiral.

The parts *q* permit accurate adjustments of the size of the projection on the disc, and compensation of film shrinkage while transmitting.

## Scanning with Multiple Spiral

If a film containing 25 pictures/sec. is to be scanned with a 50-line system, each picture has to be scanned twice in  $1/25$  sec. The first frame contains the lines 1, 3, 5, 7, the second one the lines 2, 4, 6. As the intermittent film-movement as used in projectors involves too short scanning times, a continuous film-movement is used. To produce the interlacing the spiral of the disc rises during rotation in opposite direction to the movement of the film.

Owing to the large number of lines, the holes had to be arranged on a multiple spiral. A six-fold spiral was chosen. To expose only one spiral at

a time an aperture disc rotating with the velocity of the film was used.

Fig. 2 shows, schematically, the opposite motion of the film and aperture projection. The lens *q*, representing objectives *h* and *i*, reverses the direction of motion *r* and *s* of the film *t*, and the aperture disc *u* when projecting on the spiral disc, so that the film and spiral disc *v* move in opposite directions, and aperture disc and scanning disc *v* in the same direction.

The inner three-fold spiral scans with its holes 1, 3, 5 . . . 441 the whole film picture *l* in  $1/50$  sec., while the edge 2 of the picture moves from the middle of the film window to its lower edge. In the following  $1/50$  sec. the outer three-fold spiral (holes 2, 4, 6 . . . 440) scans the picture at the points not scanned so far, while one half of it moves outside the film window.

The motors for film movement, slit aperture disc and spiral hole disc are synchronous, fed from the same A.C. supply. The phase adjustment of the film is accomplished while running by a mechanical gear. The phase of the aperture disc motor is set by a rotation of the motor field coils.

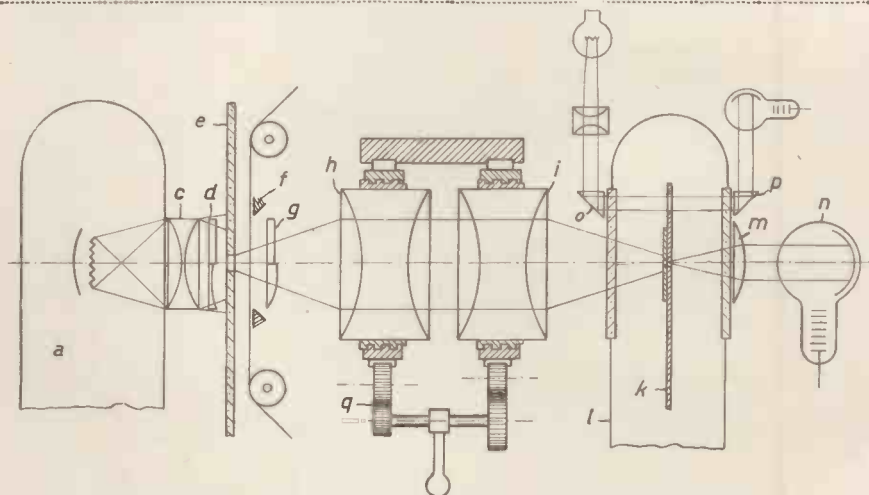

Fig. 1. Diagram of optical paths in mechanical film scanner for 441 lines

## The Scanning Disc and Its Holes

The dimensions and revolutions per second of the scanning disc have a lower limit mainly determined by the smallest dimensions of the scanning holes that can be produced alternately. The construction is based on the resolution in 441 lines and the number of picture points in a line corresponding to the shape of the picture.

Holes of 0.04 mm. diameter can be produced with sufficient accuracy. The accuracy of holes used for scanning is mostly influenced by ridge formation, i.e., canal-effect of the hole. By suitable choice of foils of thickness of a few  $\mu$  ( $10^{-3}$  mm.) and special apparatus, holes have been produced that differ not more than 2 per cent. in transmitted light, provided the angle of incidence does not

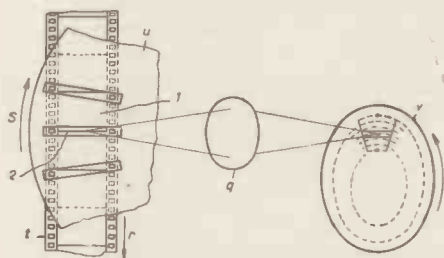

Fig. 2. Diagram of diversion of motion of film, aperture disc and scanning disc.

exceed  $40^\circ$ . The brightness differences produced by this variation are not visible in the picture, as they fall within the limits of the "Schrot effect," 1-3 per cent. the maximum amplitude of "White."

On the basis of  $B = 0.04$  mm. as width of scanning hole, the velocity of the picture point  $V_B$  is given by

$$V_B = \frac{B \cdot Z^2 \cdot n_b}{f}$$

where  $Z$  is the number of lines,  $n_b$  the number of ranges of picture,  $f$  a form factor which equals 0.808 for a line recess of 10 per cent., and a picture size of  $19 \times 21.5$  mm. The circumference of the multiple spiral  $U = V_B/n_b = 9.6$  m. A maximum permissible speed of 9,000 revs. per minute permits the use of a 6-fold spiral which necessitates a disc of about 50 cm. diameter.

To obtain a picture of good formation, and to avoid distortions inside and at the edge of the received picture the portions of the scanning holes must not deviate from their true theoretical value by more than a few

arc-seconds, and a few  $\mu$  in radial distance. A picture point corresponds to an angle of 32 sec. (The position of the holes is alternate to  $t$  5 in. in the actual disc that is, the largest inaccuracy can be  $\frac{1}{3}$  picture point, or for a received picture of  $38 \times 43$  cm. an inaccuracy of 0.3 mm., which is not perceptible in practice. The radial deviation can be reduced three times as much and is smaller than the error due to the running of the film.

A further source of errors is the deformation of the scanning disc during running which can, however, be compensated largely by choice of disc material, and taking the synch-pulses in the immediate neighbourhood of the hole that is just travelling across the film.

The scanning hole should be a square with sides of 0.04 mm. to produce equal resolution in both directions of the picture. However, as the human eye is less sensitive in vertical than in horizontal resolution, the use of a rectangular shape is advisable. The slightly smaller resolution in vertical direction is also justified because on account of the inter-line-vibration a certain minimum viewing distance is necessary. The resolution in line direction is considerably increased by a smaller width of the scanning hole. A very good picture reproduction is possible by the film scanner, described with a rectangular scanning hole which corresponds to a theoretical resolution of 600 elements in the direction of the line, and 370 elements in the direction of picture. Even with a frequency band of 2 megacycles this gives a better picture than the square scanning hole.

## Optical Picture Correction

The picture field on the scanning disc has a trapezoidal shape which is reproduced as square at the receiving end. This aberration would be hardly visible on account of the large diameter of the disc and the small angular distance between the holes; however, in interlaced scanning one line is produced by the inner set, the other line by the outer set of spirals. Fig. 3 shows the resulting error in exaggerated form. The distortion of the received picture is compensated by a simple optical system, through which the picture is projected on the outer three-fold spiral, enlarged to correspond with the average hole velocity. The same optical

system corrects the scanning paths of different curvature of both spirals. Fig. 3e shows the differently enlarged two halves of the picture.

## Film Shrinkage

The permissible film shrinkage amounts to 1 per cent., i.e., two films may deviate in picture height by 0.19 mm. max. As in the interlaced scanning, every picture is scanned twice, an opposite motion of the film to the scanning spiral is necessary. While the gradient of spiral is easily determined, the movement of the film depends on the shrinkage. The average shrinkage has been determined to 0.45 per cent.  $\pm$  0.2 per cent., i.e.,  $\pm$  0.038 mm. The height of a picture point of a line is 0.043 mm. (441 lines). The vertical resolution is,

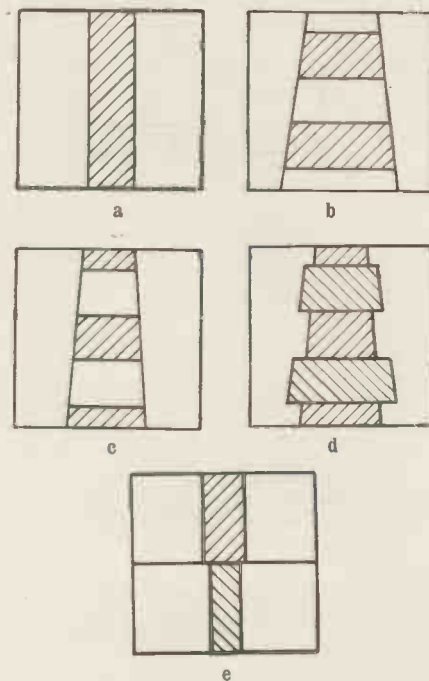

Fig. 3. Compensation of trapezoidal error.

- (a) Picture to be scanned.
- (b) First frame.
- (c) Interlaced frame.
- (d) Received picture without compensation.
- (e) Effect of compensating optical device.

therefore, reduced by 50 per cent. in practice. Fig. 4 shows the influence of shrinkage when reproducing a sloping edge. To compensate this error the projecting objectives of the new scanner are connected by a gear, thus enabling the adjustment of a picture of equal size on the scanning disc for every film by operating one handle.



**Brightness Compensation of the Interlace**

In interlaced scanning the brightness of the two interlaced frames which constitute each picture has to be nearly identical, otherwise "shimmer"

is produced that causes a considerable decrease in picture quality. On account of using a filament lamp instead of the arc, it has been possible—for the first time—to compensate for brightness difference between interlaced frames completely. This is done by the optical system *d Fj. (1)*. The previously mentioned different magnification of the two halves of the film window between film window and scanning disc produces uneven distribution of light and, therefore, uneven losses at the edge; these are compensated as well. The brightness compensation is helped materially by the use of fixed apertures and an appropriate condenser design.

Also, eccentricity in the mounting of either stator or rotor does not have any effect on the regularity of the signal.

In order to compare the maximum frequency variation of the Scophony generator with that of the other generators, tests were made using as a standard a magnetostriction oscillator having a stability of one part in several hundred thousand. Measurements of these records show the maximum variation recorded for the Scophony generator to be *less than 2 cycles per second* at 10,125 cycles. The variation is of the order of the variation of the mains frequency against absolute time represented by the magnetostriction oscillator. The maximum phase drift of the frame pulse derived from it is of the order of  $10^{-4}$  seconds or .5 per cent.

A transmitted signal with a very small rate of change is advantageous in the case of cathode-ray receivers, and is essential with mechanical receivers.

With the former, if the rate of change of the line frequency is small, the power required to synchronise the time-base at the receiver is also small, resulting in better synchronisation. Also, it is important that the horizontal and vertical scanning frequencies should be in a definite relation to each other, otherwise faulty interlacing will result.

The Scophony master synchronising generator can be made for any practical number of lines and can be added to any existing synchronising equipment.

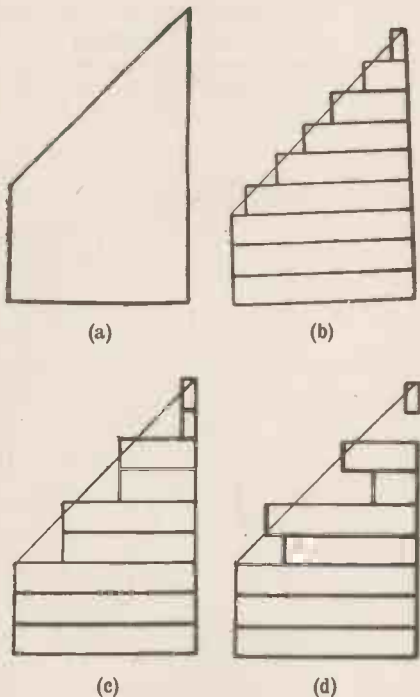

Fig. 4. Effect of film shrinkage

- (a) Picture to be scanned.
- (b) Reproduction with correct adjustment of picture size.
- (c) Reproduction with uncompensated film shrinkage of 0.15%
- (d) Reproduction with uncompensated film shrinkage of 0.3%

**"A NEW MASTER GENERATOR FOR SYNCHRONISING SIGNALS"**

*(Continued from page 605)*

having teeth. The working principle is the change in capacity of the stators when the rotor revolves. The teeth are cut on an optical dividing head to an accuracy of 6 seconds, but owing to the large number of teeth uniformly placed around the periphery of the disc, all simultaneously contributing to the output, any angular inaccuracies in the teeth cancel out.

Ensure obtaining "Television and Short-wave World" regularly by placing an order with your newsagent.

**NAMES AND ADDRESSES OF MANUFACTURERS OF TELEVISION RECEIVERS LISTED ON PAGE 598.**

- BAIRD TELEVISION, LTD.**, Worsley Bridge Road, Lower Sydenham, S.E.26. Phone: Hither Green 4600.
- BEETHOVEN ELECTRICAL EQUIPMENT, LTD.**, Beethoven Works, Chase Road, N. Acton, N.W.10. Phone: Willesden 2336.
- BURNDEPT, LTD.**, Light Gun Factory, Erith, Kent. Phone: Erith 3080.
- A. C. COSSOR, LTD.**, Cossor House, Highbury Grove, N.5. Phone: Canonbury 1234.
- DYNATRON RADIO, LTD.**, Perfecta Works, Ray Lea Road, Maidenhead. Phone: Maidenhead 1211.
- E. K. COLE, LTD.**, Ekco Works, Southend-on-Sea. Phone: Southend 49491.
- FERRANTI, LTD.**, Electrical Engineers, Moston, Manchester, 10. Phone (London): Temple Bar 6666.
- GENERAL ELECTRIC COMPANY, LTD.**, Magnet House, Kingsway, W.C.2. Phone: Temple Bar 8000.
- THE GRAMOPHONE COMPANY, LTD.** (H.M.V.), 108, Clerkenwell Road, E.C. Phone: Clerkenwell 1280.
- INVICTA RADIO, LTD.**, Radio Works, Parkhurst Road, N.7. Phone: North 3883.
- KOLSTER-BRANDES, LTD.**, Cray Works, Sidcup, Kent. Phone: Foots Cray 3333.

- McMICHAEL RADIO, LTD.**, Wrexham Road, Slough, Bucks. Phone (London): Temple Bar 6988.
- MARCONIPHONE COMPANY, LTD.**, Radio House, 210-212, Tottenham Court Road, W.1. Phone: Museum 4144.
- MURPHY RADIO, LTD.**, Broadwater Road, Welwyn Garden City, Herts. Phone: Welwyn Garden 800.
- PHILIPS LAMPS, LTD.**, 145, Charing Cross Road, W.C.2. Phone: Gerrard 7777.
- PILOT RADIO, LTD.**, 87, Park Royal Road, N. Acton, N.W.10. Phone: Willesden 7353.
- PYE, LTD.**, Radio Works, Cambridge. Phone (London): Holborn 5384.
- RADIO GRAMOPHONE DEVELOPMENT CO., LTD.**, Globe Works, Newtown Row, Birmingham, 6. Phone: Holborn 7360.
- SCOPHONY, LTD.**, Thornwood Lodge, Campden Hill, W.8. Phone: Park 9494.
- TANNOY PRODUCTS** (Guy R. Fountain, Ltd.), Canterbury Grove, W. Norwood, S.E.27. Phone: Gypsy Hill 1131.
- ULTRA ELECTRIC, LTD.**, Western Avenue, Acton, W.3. Phone: Acorn 3434.
- VIDOR, LTD.**, West Street, Erith, Kent. Phone: Erith 3080.

# Our Readers' Views

Correspondence is invited. The Editor does not necessarily agree with views expressed by readers which are published on this page.

## Cinema Comparison

SIR,

Your editorial (analysing the reasons why the demand for television receivers is not greater) exposes a serious defect: "... studio productions certainly do not bear comparison with the cinema."

Is not this the reason why the sale of television receivers is leaden-footed? If the standard of presentation is inferior to that of the cinema then a negative attitude to television is inevitable. Improve that standard and we have an improvement of the public's acceptance of television. A negative attitude becomes positive.

Until May of this year I had been away in the country for many months. On my return to London I was told by a "sound" engineer (now general manager of a film studio) to make it my business to see a demonstration of television and witness (a) its technical perfection, and (b) its obvious need for intelligent use of cinema technique. I saw one of their productions—a play. My friend was right.

G.A.C. (London, N.W.).

## Broadcasting and Television

SIR,

I read with great interest your editorial as I too am interested in the problem of the unpopularity of television. I have thought a great deal about this problem and, as you ask for a solution, here is mine. (The presence of broadcasting is the reason, according to my way of thinking.

There are two ways in which broadcasting helps to make television unpopular.

Firstly, there are very few people who sit down in front of a sound receiver especially to listen to a programme. The average person switches on his receiver, tunes in to the programme he wishes to hear and then picks up a popular magazine or newspaper and commences to idly turn over the pages reading little bits here and there and looking at the pictures. When viewing, one must

sit before the receivers and concentrate upon watching the screen and listening to the sound.

Now for the second way in which broadcasting has influenced television. In opposition to my first reason there is this. In the early days of broadcasting, one had to sit near the loudspeaker and concentrate to hear the programme to satisfaction. But people do not want to do anything like that to-day, because broadcasting has already been developed to as near perfection as possible. I think the average man can get all the enjoyment he wants from his radio. If he wishes to waste an evening he can go to the pictures or theatre. In the early days of broadcasting, however, there was only the theatre for good entertainment for the cinema was not developed to the extent that it is to-day. Thus, there was a much greater demand for receivers than there is to-day for televisors.

F. W. COSH (2CIT)  
(Bramley, Leeds).

## Poor Demonstrations

SIR,

I was particularly interested in the "Comment of the Month" article which appeared in the August issue of your magazine. I feel that every point mentioned has a good basis of fact. In answer to your question as to whether any reader could give the real reason for extremely bad television sales, may I add one thing which I feel sure has a good deal to do with it, i.e., lack of interest: at least that is what I have found with my friends. You ask them: "Have you seen a set working in the home or radio shop?" and they answer, "Oh, no, but I saw one about two years ago in a public demonstration (probably at the back of a large crowd) and I didn't think much of it." So many supposedly sane people judge a set on a few minutes' experience of viewing and under bad conditions.

I feel certain that the show will spread interest and enthusiasm. The B.B.C. and manufacturers have made a magnificent effort to popularise television. The price question doesn't come into it now.

But what did strike me at the show was that certain makers were selling combined all-wave radio and television sets with very small screens. Surely a bigger screen set, which only got vision signals and the accompanying sound, selling at the same price, would have been more appropriate? Ninety-nine people out of a hundred who are going to buy a television set already own a wireless and would much rather get a reasonable size picture than a very small one plus an all-wave radio. I was glad to see that only a few firms did this.

N. L. BENT (Harrow).

## Interference from Aircraft

SIR,

You may be interested to hear of my experiences in U.S.W. and television reception, in view of the fact that I live in Croham Valley, South Croydon, which valley is followed by the majority of aeroplanes leaving the airport—usually flying fairly low.

The interference is very serious indeed and can completely ruin a programme, particularly during the transmission of a play. I am referring, of course, to the interference caused by reflection of the signal and not to ignition interference, which, although noticeable, is not bad enough to matter if one can use an aerial with reflector in between the air route and Alexandra Palace.

The interference caused by reflection has the effect of giving alternately a very light and very dark picture, also a double picture and sometimes upsetting synchronisation. On sound the interference takes the form of very rapid fading.

I do not know to what extent the B.B.C. are aware of this interference, but it must have a very serious effect on the sale of television sets in Croydon or similar districts, especially if there are any 'planes flying overhead during demonstration.

ROGER F. C. CROWLEY,  
(South Croydon).

*The London Transmitting Society* have a very active membership for although membership is free intending members must obtain either a full call or AA call before they can be admitted.

In this way the club is made up of active members who are all doing good work in amateur radio. The Hon. Secretary would like to hear from intending members who should write to F. Bell, Esq., Colin Close, Colindale.

## Cinema Antagonism to Television

Antagonism of the cinema exhibitors towards television seems to be increasing. Film renters and the film producers are, it appears, somewhat less concerned than the exhibitors, but naturally lend a sympathetic ear to their customers. The General Council of the Cinematograph Exhibitors' Association is being urged to form a joint committee with other sections of the trade to check the efforts of the B.B.C. to obtain new films. A ban on the supplying of new films (except news reels) to the B.B.C. for television purposes has existed for some time, but now it seems some of the exhibitors are still dissatisfied and claim that in certain cases old films may be more successful than new ones.

The B.B.C. recently circumvented the ban by obtaining a French film, "Man of the Moment," starring Maurice Chevalier, a new film which had been exhibited in the West End but had not been generally released.

For obtaining a brand new feature film the B.B.C. deserve warmest congratulations.

There is urgent need for more good fiction films in the programmes and whatever may be the outcome of the present B.B.C. v. Trade battle the B.B.C. must obtain them somehow. Another French film, "The Heroic Sex," which won French and Italian awards, will be shown shortly.

### Transmitting Valves

There appears to be a revival of interest in low-power transmission. This interest has been so marked during the past year that the General Electric Company have produced a range of valves with 2-volt heaters of a type essentially for transmitting use.

The PT7 transmitting pentode, suitable for suppressor grid modulation, is priced at 20s. This valve has a 2-volt, 0.3-amp. heater and will stand 240 volts on the anode, with a dissipation of 3 watts. There is also a triode, type DET9, with a similar heater to withstand 250 volts on the anode with a dissipation of 3.75 watts. This valve, type DET9, is priced at 19s. Constructors could embody both these valves in portable and normal low power equipment knowing full well that they would obtain a high degree of efficiency. It is also very pleasing to find that a British valve maker can produce a valve in direct competition to the American manufacturers having slightly better characteristics and a much lower price. The Osram KT8

transmitting tetrode is very similar to the American RK-39. It has a 6.3-volt, 1.27-ampere oxide coated filament; will stand 600 volts on the anode and 300 volts on the screen with an anode dissipation of 25 watts. This valve can be used as a power amplifier, doubler, sub-amplifier, and even crystal oscillator. It is priced at 22s. 6d.

### The Television Trader

A booklet has been published by *The Wireless and Electrical Trader* to enable radio dealers and service engineers to acquire a knowledge of sales methods and service repairs applicable to television.

The booklet contains much information on receiver principles, and the tracing and curing of faults. Photographic illustrations of the waveforms encountered at various points in a typical receiver are given and the booklet will be found of real practical use.

It is priced at 1s., post free, and is fully illustrated with photographs and diagrams.

### Service and the Electrical Trades Union

Radio service engineers have decided to organise themselves in their own interests. As their work grows more complex with each successive year's technical development, so does their weekly average working time increase. A sixty-hour week, it is stated, is commonplace and, in winter, eighty-hour weeks are not at all rare.

Service engineers who are interested can obtain full particulars from W. Stevens, Area Official, Electrical Trades Union, 1-7 Rugby Chambers, 2 Rugby Street, W.C.1.

### Book Review

*The Perception of Light*, by W. W. Wright, D.Sc., A.R.C.S. (Blackie & Son, Ltd., price 6s.). This book is described as an analysis of visual phenomena in relation to technical problems and illumination. More plainly, it is a study of light sensations under different conditions of illumination, and deals with such matters as visual acuity, discrimination, contrasts, dark adaptations, visual limits, vision at night, in fog, theatres, cinemas, and television studios. All those who are interested in problems of vision and illumination, will find this book, which is non-mathematical, of value.

## Courses in Radio and Television

A SERIES of instructional courses have been arranged by The Polytechnic. The courses have been arranged to give those engaged or interested in radio, television or talking film work, a thorough training in the principles and technique of high-frequency engineering. Approved courses are recognised by the Institution of Electrical Engineers and the Board of Education for the award of the Ordinary National Certificate. The courses also prepare for the City and Guilds of London Institute examinations in radio communication. Full particulars can be obtained from the Electrical Engineering Department (Telecommunications Section), The Polytechnic, 307-311 Regent Street, London, W.1.

### Sudden Death of Q.S.T. Editor

It is with deep regret that we record the unfortunate death of Ross A. Hull, the well-known American amateur and Editor of the official A.R.R.L. organ Q.S.T. His death took place on Tuesday, September 6, as the result of coming into contact with a 6,000-volt supply cable when carrying out experimental work with his equipment.

American amateur transmitting stations were off the air on that date as a token of respect, but European stations were not aware of the tragedy until later in the week owing to bad conditions that existed.

### De-luxe Sound Equipment

A most interesting manual has been prepared by Sound Sales, Ltd., which covers all types of sound equipment. Amateurs who already know a little of the work done by this company will be very surprised at the full scope of the production of public address equipment.

A number of high quality amplifiers including a tri-channel arrangement are described in detail while there are also three very fine loudspeakers of the high quality type.

In the component section are many interesting items such as a four-band tuner, microphones, chokes, transformers of all kinds and variable selectivity I.F. transformers of the high "Q" type.

This booklet is of the utmost value to those interested in high quality sound reproduction, transmitting and all phases of general radio.

The address of Sound Sales, Ltd., is Marlborough Road, Upper Holloway, N.19.

# A Portable Oscilloscope

*The portable oscilloscope described in this article uses the new Osram 1½ in. cathode-ray tube, and has been designed on commercial lines. It is sufficiently compact to be carried in a service engineer's case and will be a useful addition to the experimenter's test bench.*

**I**N designing portable oscilloscopes the convenience of carrying is the principal factor in determining the layout. The majority of commercial types are self-contained, with the mains unit mounted behind the tube. This makes the even distribution of weight difficult to obtain, and with a "naked" tube, such as the Osram 1½ in., there is a risk of interference from the mains unit if special precautions are not taken to shield the tube.

By mounting the mains unit in a

mainly obtained by the use of miniature valves and in the original design R.C.A. all-metal valves were used in two positions. The introduction of the new range of Mazda miniature valves enables the supply circuit to be simplified as it avoids mixing 6-volt and 4-volt supplies. Alternative valve types are specified later in the article.

## Circuit

The complete arrangement including the power supply is shown in the cir-

sers for the tube supply are fixed in the tube unit, together with the resistance (5,000 ohms).

The 9-pin standard socket for the tube is shown at the right-hand top corner of the diagram with its connections to the H.T. chain and the deflector plate circuit.

## Time Base

This is of the conventional thyatron type using a pentode charging valve to

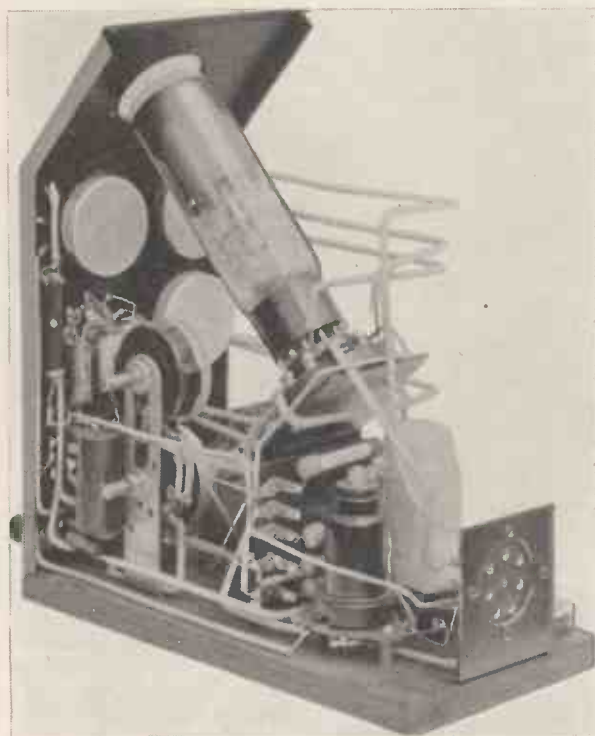

This photograph shows the compact layout of the components. The pre-set shift potentiometers can be seen on the left. The 7-pin holder at the back is for the H.T. connections.

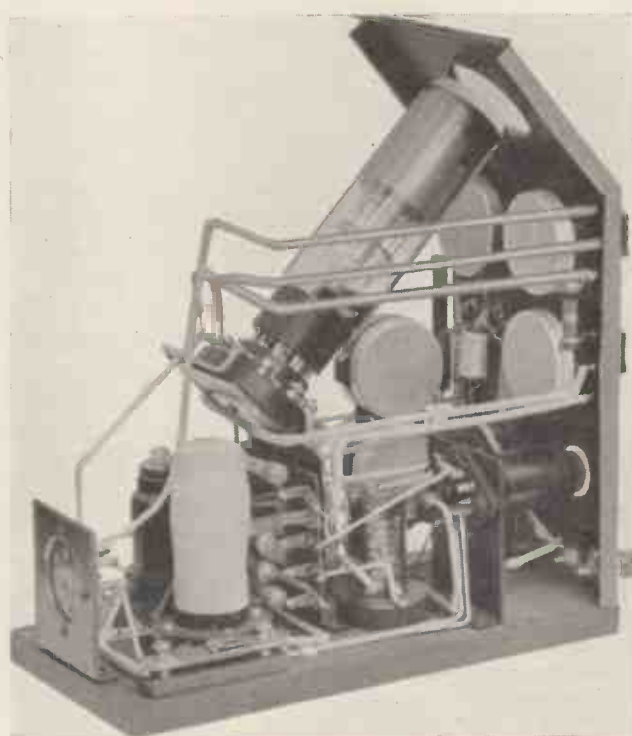

Another view of the baseboard showing the T.41 thyatron (metallised). Note the pentode amplifier mounted horizontally in the front of the baseboard.

separate box, the overall dimensions of the oscilloscope can be kept to a minimum, and the total weight is not appreciably increased. There is the disadvantage of handling two units instead of one, but this is outweighed by the fact that both are of the smallest possible dimensions and can be packed in an ordinary suit-case. The construction is also simplified owing to the absence of shielding, and, in this case, the mains unit can be used for other experimental work, which is of advantage to the experimenter.

Accordingly the tube and time base are fitted in a metal case with a multicore cable connection to the mains unit. The compactness of the oscilloscope is

ensured by the use of miniature valves and in the original design R.C.A. all-metal valves were used in two positions. The introduction of the new range of Mazda miniature valves enables the supply circuit to be simplified as it avoids mixing 6-volt and 4-volt supplies. Alternative valve types are specified later in the article.

The use of 4-volt valves throughout would enable a standard 350-0-350 transformer to be used, but in the circuit winding is shown for 6.3-volt heaters.

The centre tap of the H.T. is earthed as shown, and one side of the winding supplies the tube potential chain at the top of the diagram. The rectifiers are 1 volt, but any other 350-volt rectifiers may be used, corresponding allowance being made for the heater voltage.

The two 1 mfd. smoothing conden-

ensure linearity at the low operating voltage. The thyatron is the new Mazda T.41, which is small in dimensions and of low price. It is not intended for high working voltages, however, and the grid bias should not be increased to a high value in order to obtain a wide sweep. The bias is fixed by tapping from the potential chain feeding the screen of the pentode and gives a sweep of 1-1¼ in., which is ample for the tube.

The charging condensers marked C in the diagram are selected by a 5-way stud switch (Kabi or Bulgin) the shaft of which must be insulated from the front panel. The charging pentode is a 6J7 with the grid strapped to cathode,

Lay-out :: Controls

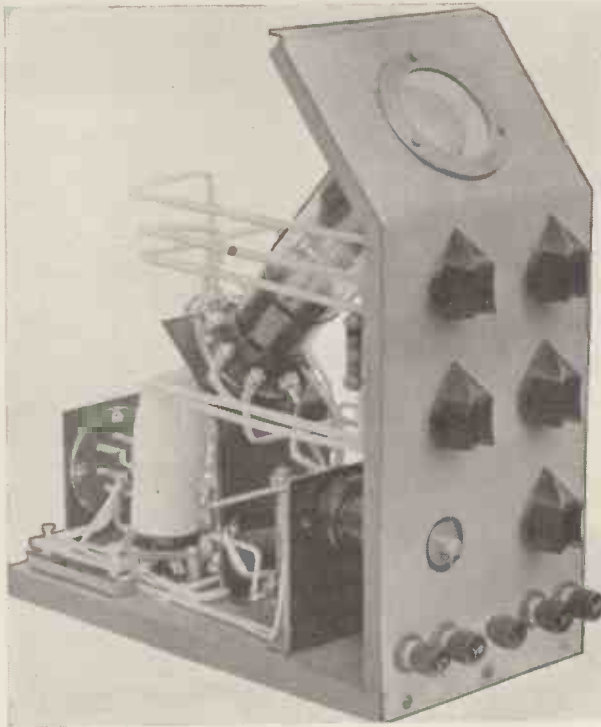

In this view of the front panel the grid cap of the amplifier can be seen projecting through the metal. A neat finish can be made by a ring round the tube aperture.

the impedance being controlled by the screen potential. The control of speed is remarkably smooth and flexible, a range of 10-150 cycles being obtainable on the first condenser tapping. The time base is sufficiently stable to hold the wave steady without extra synchronising, but if required a connection to the grid of the thyatron can be made from the point S through a condenser of .001 mfd.

This has not been included in the unit, but a socket can be mounted on the front panel for the purpose.

**Deflector Plates**

The connections to the plates are made from four terminals at the front of the panel. A double three-way switch enables the plates to be used separately for modulation measurements or with a time base. The third position of the switch inserts the amplifier on the Y plates, and the input is then transferred directly to the grid terminal of the valve. In the diagram the switch is shown in the "amplify" position, the time base being connected to the X plates. The Y<sup>2</sup> and X<sup>2</sup> plates are returned to shift potentiometers mounted inside the unit. These are set initially to centre the spot on the screen and then need not be touched. The two 1-megohm resistances marked with an asterisk need only be used if the rating of the potentiometers is insufficient for the full 350 volts to be applied. The Reliance potentiometers

will, however, stand the full working volts and the series resistances can be omitted.

The amplifier is a 6J7 mounted so that its grid projects through the front of the panel. This is particularly convenient in avoiding stray capacity loads on the circuit under test, but it must be remembered that the grid is open-circuited and cannot be connected through a condenser. A 2-meg. leak should be fitted externally when the circuit requires it.

**Layout**

The controls are mounted on an aluminium panel which is fitted to a 1/2 in. plywood base. The base and the front panel form a single unit which can be withdrawn from the cover for adjustment.

The top of the front panel is sloped

back to give a convenient viewing angle for the tube when on the bench. An angle of 45° has been chosen, but this is not important to a few degrees, provided that the tube socket is in alignment with the window in the front panel.

The photograph of the front panel shows the grid of the amplifier projecting through a clearance hole in the left-hand corner. The controls are as follows:—

- Tube
  - Bias
  - Tube
  - Focus
  - Amplifier
  - Grid
  - Time-base
  - Speed
  - Time-base
  - Condensers
  - Deflector
  - Plate switch
- Terminals: Y<sub>1</sub>, Y<sub>2</sub>, E, X<sub>1</sub>, X<sub>2</sub>.  
The drilling dimensions are given in

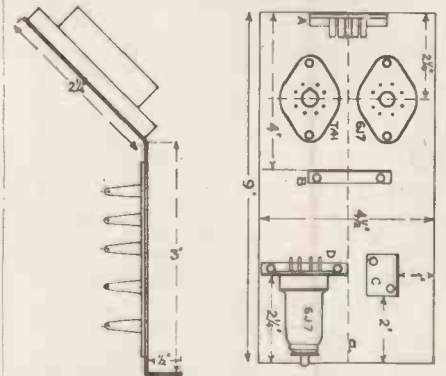

Mount for the tube (left) and layout of the baseboard (right). The lettered brackets are referred to in the text.

the sketch on the following page. The panel is marked out with the side flaps for bending as shown.

The holes will be 3/8th clearing for the Reliance potentiometers, and will be drilled to suit the insulating bushes in the two switch positions.

The terminals are also mounted through insulating bushes with the exception of the earth terminal which is bolted direct to the panel.

The layout of the baseboard is shown in the photograph and in the diagram

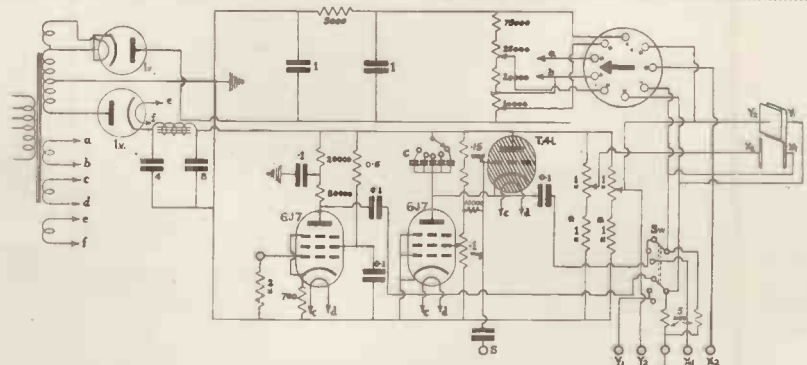

Circuit diagram showing the connections to the tube 9-pin holder. The H.T. supply unit is separate from the tube unit.

## Construction

of Fig. 4. The two time-base valves are at the rear of the baseboard and the 6J7 amplifier is shown horizontally.

The brackets marked are as follows:

- A. 7-pin chassis-mounting socket for input from H.T.
- B. Bracket holding tube socket.
- C. Bracket for shift potentiometers.
- D. Bracket for 6J7 chassis valveholder.

### Assembly

Before assembling the components, the brackets referred to above must be made and mounted. The dimensions are as follows:

- A. 2 in. by 3 in. aluminium sheet 1/16 thick, with a 1/2 in. flange bent at right angles for fixing to the board. The hole for the 7-pin chassis valveholder is drilled 1 1/8 in. from the top edge and is 1 3/8 in. diameter.
- B. This is shown in the separate drawing. The holder for the tube is a 9-pin baseboard or chassis-mounting holder. The position of this holder is important as the correct positioning of the deflector plates depends on it.

When viewed from the front the arrow between pins 4 and 5 should point to "1 o'clock." The drilling holes should be drawn with a file to allow rotation of the holder slightly in either direction.

The bend should be made to correspond with the angle made in the front panel, or the tube will not be in alignment with its window. At the back of the upright portion a Bulgin 5-way group board is screwed as shown.

- C. The bracket for the two shift potentiometers is a standard Bulgin type EH.9.
- D. This is also cut from 1/16th in. sheet aluminium and is 3 1/4 in. by 2 in. The centre of the hole for the valveholder must be carefully checked for alignment with the hole in the front panel, and it is best to match the two after the front panel has been drilled.

After the brackets with their holders have been made they can be screwed down on the baseboard and the preliminary wiring commenced.

The front panel should be assembled with its potentiometers and the wiring between the terminals and switches carried out as far as possible as it is difficult to get at the terminals later.

The resistances on the Bulgin group board are as follows, from top to bottom:

- 5,000 ohms smoothing resistance.
- 75,000 ohms tube resistance.
- 0.5 meg. screen resistance.
- 20,000 ohms decoupler.
- 80,000 ohms coupler.

The smoothing condensers for the tube supply and the decoupling condensers pack in front of the bracket.

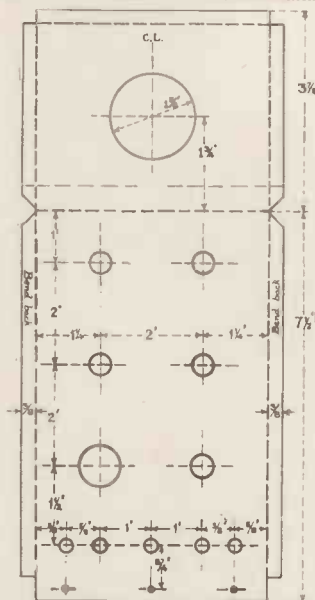

Drilling and bending dimensions for the front panel. This can be in 1/16" aluminium or sheet iron.

The 7-pin socket carries the following connections:

- 2—4 volt for the heater of the tube.
- 2—6.3 volt for the valve heaters.
- H.T. +ve. for time base and amplifiers.
- H.T. -ve. for tube.
- Common earth and tube H.T. +ve.

be wound from 22 s.w.g. Eureka, which is approximately 1.1 ohms per yard, or can be purchased ready made. The value of the required resistance is approximately 1.4 ohms, and the final adjustment should be made when soldering the end of the resistance to the valve socket connection.

An earth lead should be run from the socket on the 7-pin H.T. connector down the centre of the board. It will be found that a number of connections can be made easily when it is in this position. Do not forget to earth the metallising of the valves to the earth lead.

The leads from the deflector plate Y1 should be shielded to avoid direct pick-up from the time base. This is shown on test by a drooping of the time base line towards one end of the screen and if the trouble is experienced it can be cured by careful spacing and shielding of the Y plate leads.

### Components

In the case of components marked with an asterisk, it is possible to use alternatives, provided that they are of good quality. It is important that the condensers in the time base circuit be as specified, as inferior products will give irregular results.

In next month's article the testing of the unit will be described with the construction of the power pack.

The Mazda SP.41 can be substituted for the 6J7 in both the amplifying and time base stages if desired. In the latter case it may be necessary to alter the tapping in the potential chain sup-

### Components for A PORTABLE OSCILLOSCOPE

#### CHASSIS.

1 Metal chassis and wooden baseboard, to specification (Peto-Scott).

#### CONDENSERS, FIXED.

- 2—1.0-mfd. type 341 tubular (T.C.C.).
- 5—0.1-mfd. type 341 tubular (T.C.C.).
- 1—0.05-mfd. type 341 tubular (T.C.C.).
- 1—0.01-mfd. type 341 tubular (T.C.C.).
- 1—0.005-mfd. type 341 tubular (T.C.C.).
- 1—0.0001-mfd. type 341 tubular (T.C.C.).

#### HOLDERS, VALVE.

- \*1—8-pin type British octal (Clix).
- \*2—Type 8-pin American octal (Clix).
- \*1—9-pin type chassis (Bulgin).
- \*1—7-pin type chassis (Bulgin).

#### RESISTANCES, FIXED.

- \*2—5 mg. 1/2 watt (Erie).
- \*1—10,000 ohm 1/2 watt (Erie).
- \*1—2 megohm 1/2 watt (Erie).
- \*1—700 ohm 1/2 watt (Erie).
- \*1—0.5 megohm 1 watt (Erie).
- \*1—150,000 ohm 1 watt (Erie).

- \*1—100,000 ohm 1 watt (Erie).
- \*1—75,000 ohm 1 watt (Erie).
- \*1—80,000 ohm 1 watt (Erie).
- \*2—20,000 ohm 1 watt (Erie).

#### RESISTANCES, VARIABLE.

- 2—1.0 megohm type potentiometer (Reliance).
- 1—0.1 megohm type potentiometer (Reliance).
- 1—25,000 ohm type potentiometer (Reliance).
- 1—10,000 ohm type potentiometer (Reliance).

#### SUNDRIES.

- 1—5-way group board (Bulgin).
- 4 Pairs insulating bushes (Bulgin).
- 5 Instrument knobs (Bulgin).
- Wire and sleeving.

#### SWITCHES.

- 1—5-way (F. W. Lechner).
- 1 Ganged double three-way (F. W. Lechner).

#### TUBE.

1 Type 4051 (Osram)

#### VALVES.

- \*2—6J7 metal (Premier) or Mazda S.P. 41.
- 1—141 (Mazda).

It is immaterial how the connections are made to the pins, but it is suggested that the socket be mounted with pin No. 1 at the bottom, serving as the earth connection.

Since one of the valves is 4 volts it will be necessary to connect a series resistance in the heater lead. This can

plying the screen as the difference in screen current will affect the bias applied to the grid of the thyatron.

The heater winding "C.D." in the mains transformer should be specified as 4 volt instead of 6.3 volt and the series resistance in the heater of the T.41 can then be omitted.

# With the Amateurs

By G5ZJ

Some interesting information on the working of a new beam antenna by G6DT is contained in this article. The Johnson "Q" beam is also discussed. This particular aerial should be of particular interest to amateurs using low power.

**A**MATEUR activities at the present time seem to be concentrated on aerial design. Generally speaking the fact that the transmitter and power input is not the most important factor in establishing reliable long distance communication is quickly being realised. Even manufacturers are finding sufficient demand to design suitable



This is the well-known Australian amateur station VK3WA who is so well received in this country.

beam aerials which can be erected in the small space usually available to amateurs. This alone indicates how important the aerial actually is.

One of the most consistent experimenters with aerials in this country is R. T. Dealey, G6DT, who with comparatively low power is putting a most reliable signal into most parts of the world. In Australia G6DT is taken as a standard and should his signals drop below R8 or so, it is generally considered that conditions for reception are poor.

G6DT has made an amazing number of contacts with Australia and New Zealand, not by using extremely high power, but by paying more than the usual amount of attention to his radiating system.

I have listened with interest to Australian amateurs working G6DT and have been amazed at the consistency at which he is able to obtain reports of R9 on his telephony.

A short while ago I wrote to him regarding his obviously effective aerial system, and he has sent to me some interesting data which I am sure amateurs would like to know about.

The following is the gist of his last letter. The Australian station VK2XU, who is staying in this country helped G6DT to erect the extended double Zepp with reflector as described in the June issue of QST. It works extremely

well and is with the parasitic reflector to the east. In order to make the array bi-directional, he has added a half wavelength to the feeders so that the shorting bar can be moved to a point either side of self-resonance.

With this aerial system, VK stations in the morning simply roll in, while the vertical directivity appears to be much broader than that of a W8JK beam without any apparent loss in power. With this array, G6DT can transmit a signal into Australia before any other G station and remain in contact until most of the remaining G's have disappeared.

The following is quoted from his letter: "One morning last week I started at 6.30 B.S.T. and was still Q5 R5 at 11.23 B.S.T. To the east with the parasitic element acting as director I have worked VK several times at 22.00 B.S.T. obtaining R7-R8 reports. Also, stations in the far east are extremely good during the afternoon.

"I ran a series of tests with this antenna with GSDM in Southampton, but he could not observe any appreciable difference in signal strength whatever the position of the shorting bar on the parasitic system, this at a distance of 20 miles.

"This morning I was in QSO with VK3PE for one hour and twenty minutes testing out this aerial and here are the results, all the reports being the reading of his R meter.

Extended Double Zepp alone, R8.

Extended Double Zepp with Parasitic system and reflector, R9 plus.

Extended Double Zepp with Parasitic system as reflector, R7 plus.

"On the basis of 6db per R point it can be seen that director gives a 9db gain, while the front to back ratio is apparently 12db. However, some further tests with PK2WL are to be carried out to see if these results check up."

On 10 metres G6DT used a 60 ft. W8JK beam suitable for S. African reception, the following results were obtained:—

		His		Mine	
		R	S	R	S
Aug. 14	G.M.T.				
	15.03	ZE1JJ	c.w.	3 4 8	3 3 8
	15.39	SU1CH	c.w.	5 7 9x	5 7 9x
	15.58	SU1CH	fone	5 4/7	5 4/7
	20.05	PY2CK	fone	5 7/8	5 6/7
	20.20	Heard VP6YB	R4 fone		
	20.30	Heard W6DUC	R5c.w.		
Aug. 15	12.52	SU1CH	fone	5 5/7	5 5/6
	18.09	PY2CK	fone	5 6/7	5 7/8
	19.35	Heard LU1DJ	R4 fone		

This shows that the 10-metre band is rapidly opening up, while from other sources I have heard reports of Canadian and W6 phones being heard on 10 metres.

Just before going to press G6DT gave me some last-minute information on

the final tests made with his extended double Zepp. The spacing between elements has now been changed to one-eighth of a wavelength which, although giving slightly better results has not been accurately compared with the previous arrangement. During one test the elements were physically reversed, that is the system now acting as a director to South America and as a reflector to the Far East. So far this has not improved the results in fact, reports seem to be slightly worse in the South American direction, that is according to comparative Australian reports, but it appears to have improved matters as far as the Far East is concerned.

For instance at 21.30 B.S.T. on a night in September, VK2TR heard G6DT at Q4 R4 when he was working VP3AA on schedule within five minutes of completing this QSO he reversed direction by moving the shorting bar on the parasitic element and contacted VK2TR who gave QSA5 R9. It would appear that at one-eighth spacing the system is more efficient as a reflector, though probably this would not hold good if the spacing was still further decreased to one-tenth of a wavelength.

G6DT has during a period of 14 days made 165 phone contacts of which 119



The rotating antenna system used by VK3WA which is described in this article.

were with Australia. A new station worked was CP1BA in Bolivia using about 14,040 kc, while XZ2PB on a frequency of about 14,050 kc is using a rhombic aerial and does QSL.

## The New Beam

I was very interested to obtain some advanced information on the new Johnson beam aerial. The Johnson QM aerial in its conventional form has been in use at my station for quite a long time

## Radio VK3WA

and the results for such a simple aerial have been satisfactory. The new Q beam, however, has many advantages, and I prophecy that before long it will become extremely popular. It has one big advantage over the average beam

to a 6L6G working as a 20-metre doubler. This is link coupled to a 210, as an intermediate amplifier which is, in turn, link coupled to the Class C final an 802 operating with a D.C. input of 100 watts.

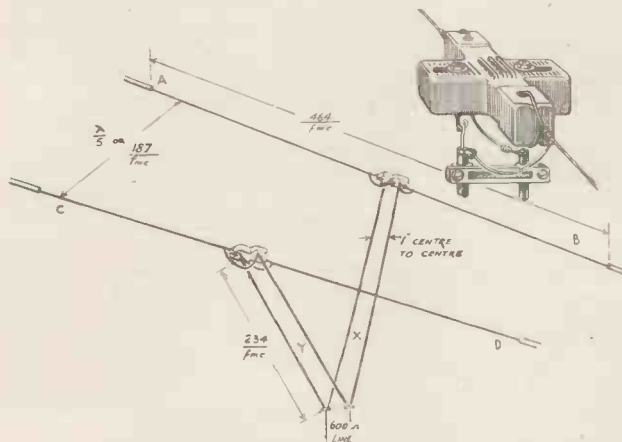

The new Johnson "Q" beam for which is claimed a 6 db gain on the harmonic and 4 db on fundamental.

aerial, for it is suitable for two-band operation. The Johnson Q beam is a matched impedance aerial giving a 4 db gain on fundamental frequency and 6db gain on the second harmonic. It is easy to construct, does not require any matching stubs that have to be carefully adjusted, and is only 30 ft. in length for 20 and 10 metres. It is fed with two parallel tube matching transformers which when connected in parallel provide an impedance of 600 ohms so that they can be connected directly to an untuned line of this impedance. The spacing between elements is one-fifth of a wavelength and it is fed 180 degrees out of phase.

G3GM was talking to me about really low power working in which he is particularly interested. During a recent test with G3GD, who was using an electron-coupled oscillator, he obtained an R7 report with an input of 4 watts. By decreasing the input to one watt the report was then R6, showing that low-power working is possible over quite wide areas in this country.

### VK3WA

A station which is heard and worked most consistently in this country is that of Warne A. Wilson, located in Ballarat under the call-sign VK3WA. Practically every morning, when his duties at the Ballarat broadcasting station permit, VK3WA can be heard on the 14 mc. amateur band around the 14 310 kc. mark giving a signal that is an example of consistency and quality.

VK3WA is an amateur station in every sense of the word, for it is home built throughout. The transmitter is a four-stage one consisting of a 59 tri-tet utilising an 80-metre variable crystal with a 40 metre output capacity coupled

The final stage is anode modulated by two 809 valves in Class B which are capable of delivering a comfortable 50 watts of audio.

A velocity ribbon microphone is used to excite a two-stage pre-amplifier which, with the microphone can be seen on the operating table left of the receiver. The speech output from this is fed via a 500-ohm line to the main speech amplifier. The pre-amplifier uses a 6C6, pentode connected, resistance capacity coupled to a 6C6, triode connected. The speech portion has a 6C6 triode connected feeding the drive stage of two 46 valves in push-pull.

The monitor, using a type 30 as a diode, can be seen on the right of the receiver. It is connected to a single turn loop placed near the final amplifier anode coil, and although designed for monitoring purposes can also be used as a field strength indicator when required.

The second illustration shows the rotatable aerial mounted on a 32 ft. lattice tower. It is designed purely for 20 metre working and consists of a half-wave driven element with a parasitically excited reflector and director with close spacing. The driven element is fed by two linear matching transformers and a 600 ohm line.

The superstructure is rotated from within the operating room by means of a horizontal crank and vertical rope drive to a reduction gear near the top of the mast. A light wooden rod from this gearing operates a pointer arranged to indicate on a great circle map the direction from which signals are at maximum. It is interesting to note that England in the early morning is worked in a direction 35 degrees south-east of Ballarat.

As a matter of editorial inquisitiveness I should like to know the purpose of the gun so carefully arranged on the wall over the operating table. Perhaps to shoot at sight any parasitic oscillations daring to trespass.

### A New Amateur Valve

The Mullard Company I notice have produced yet another valve specifically for amateur use. This valve, a TZ08-20, will very shortly be released. It has a standard four-pin base with the anode to the top cap and the following approximate characteristics.

- Filament voltage, 7.5.
  - Filament current, 1.1.
  - Maximum anode voltage, 750.
  - Maximum anode dissipation, 20 watts.
  - Amplification, 25.
  - Impedance, 8,070 ohms.
  - Grid-filament capacity, 5.5 mmfd.
  - Anode to filament capacity, 2.2 mfd.
  - Anode to grid capacity, 5.5 mfd.
- The minimum wavelength for which this valve can be used is 5 metres.

Everyone who is interested in short waves must know of Don Heightman, G6DH, who has done so well on ultra short waves. His company, Denco, of 234 Burrs Road, Clacton, have produced a most interesting range of plug-in short-wave coils, coil formers, high-frequency chokes and feeder spacers made on Trolitul low-loss insulation. Coils suitable for 2.5 metres upwards, are priced 3s.



Mullard have provided this new triode for amateur service. It electrically replaces the T-20.



With one coil this exciter will give 12-15 watts output on 40 and 20 metres. A larger coil can be used on 80 and 160 metres while there is an output of

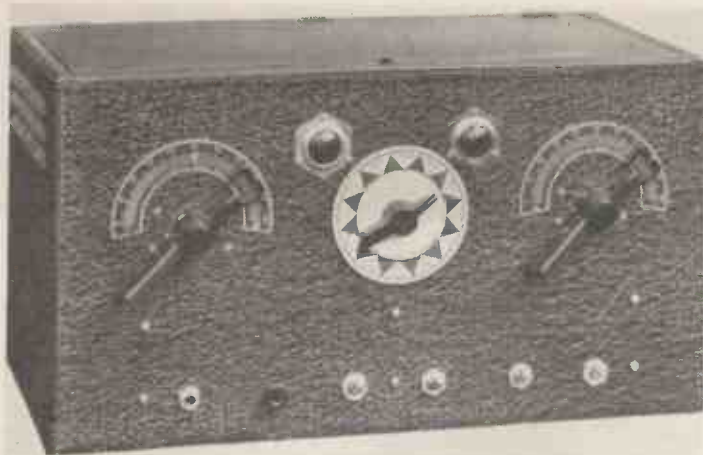

at least 5 watts on 10 metres with a 40 metre crystal. A single 6L6G is used with a built-in power unit.

## A Single-valve 2-band Exciter

VERY few British amateurs have a completely separate transmitter for each wavelength, while not too many of them have a transmitter covering two wavelengths. The average amateur arrangement is to have one complete transmitter with interchangeable coils and crystals so covering all wavelengths. This is fairly convenient, but maximum efficiency can only be ob-

mounted on the operating table alongside the receiver and is coupled by means of a link and a low impedance line to either the sub-amplifier or final stage of the transmitter in use.

For example, on 40 metres, there is sufficient R.F. to drive a T-20 for telephony working or a considerably larger valve such as a T-40 for CW operation. On 20 metres, I include a sub-amplifier

cabinet. It uses a single valve, the conventional 6L6G in a tri-tet circuit. Despite the fact that 450 volts are applied to the anode of the oscillator and a full 275 volts to the screen, there has not been the slightest trouble with excessive crystal current. Arrangements have been made for the inclusion of up to 12 crystals, all of which can be switched into circuit individually by

*An exciter of this type can be used in conjunction with several transmitters. The output is sufficient fully to drive valves of the T20 class to 20 M/A grid current. It is in general use at the QRA of the designer G5ZJ where it can be inspected.*

tained on one of the wavebands covered.

It is not an easy matter accurately to include switching arrangements so as to obtain the correct L/C ratio, so that the correct capacity condenser on 160 metres would be far too large on 10 metres and vice versa.

As the cost of transmitting valves for amateur use has been rapidly going down there is no reason why separate output stages should not be built for each waveband to be covered. An alternative is to have a sub-amplifier and final stage, and make this arrangement work reasonably well on two wavebands.

Providing an exciter is used that gives a high output and which can be switched for use on several wavebands, the need for a complete transmitter is overcome. In the past I have always endeavoured to have separate transmitters, but this means changing crystals because this component is still relatively expensive, while one generally becomes attached to a crystal of a given frequency.

In order to be able to make use of all my crystals, in the simplest possible way, I have built an exciter to give me up to 15 watts radio-frequency power on four wavebands, and at least five watts on the 10 metres. This exciter is

so that I have the equivalent of a complete three-stage transmitter. There is also sufficient output on 10 metres with this arrangement so that the one transmitter is quite suitable for three-band working. On 80 and 160 metres, capacity coupling is used, so that the same exciter is in continuous operation and can be very quickly coupled to the correct transmitter.

The exciter is built complete with its power pack in a standard Eddystone

means of a special Peto-Scott 12-point rotary switch.

On 40 metres the exciter can be tuned to the centre of the band and the crystal switched from the high frequency to the low frequency end without causing any appreciable loss in drive. In any case, the cathode control is flat so that should maximum output always be required, it is merely a matter of slight readjustment of the tank condenser.

Examine for a moment the circuit of

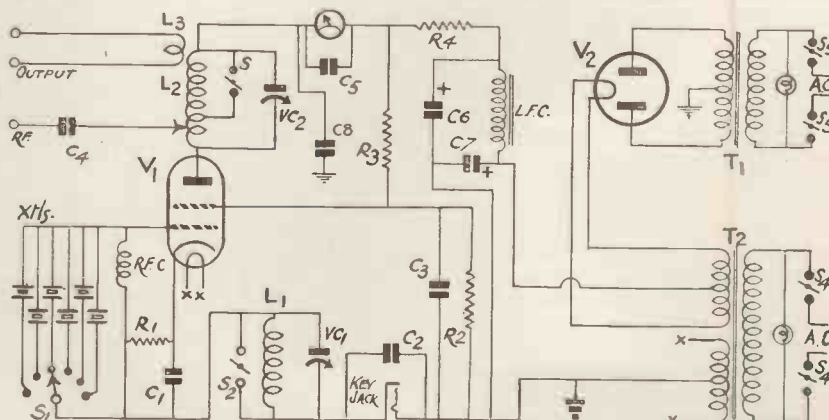

Any number of crystals can be used up to a maximum of 12. In the original exciter all the crystals were in the 40 metre band so as to give complete coverage. The M.A. metre is optional for a meter jack is included.

## Multi-band Working

the exciter, from which it can be seen that arrangement is fairly straightforward. However, it is essential that the cathode resistor  $R_1$  be included, which has a value of 300 ohms, otherwise the crystal current is practically doubled. It is also important that the screen current remain sensibly constant for should this rise above 300 volts there is likelihood

providing there is not too great a change from the original. I have found it an exceedingly good plan to buy crystals in pairs with a difference between them of about 5 kc. This is just sufficient to eliminate excessive QRM.

A point to notice is the method of transferring the R.F. output of the exciter to the following stage. On the

scale is of thick cardboard and calibrated with the frequencies it is intended to use. On the right is the control for  $VC_2$  which on the higher frequency bands has a capacity of 60 mmfd. This is rather on the high side, but maximum efficiency is not really necessary from the exciter and this capacity is also satisfactory on the lower frequency wavebands.

In any case should it be necessary to obtain the absolute maximum R.F. output and stability on 160 and 80 metres it is quite a simple matter to add a small parallel fixed condenser which can be mounted in the coil form.

At the bottom of the front panel are four switches and two jacks. The first jack is for the key and is in series with the cathode circuit and earth. The second jack is of the closed circuit insulated type and is for inserting an mA. meter for reading anode current. The first switch is across  $L_1$ , the second across part of  $L_2$ , while the final two switches are for the filament and H.T. transformer.

It was considered necessary to have separate transformers so that the exciter could be ganged up with the transmitter for switching purposes. It is always most satisfactory to be able to switch off all the high voltage transformers and to leave the filaments heated. At the back of the chassis, which can be seen from other illustrations, are two jacks, one of which takes the mains to the H.T. transformer, and the other to the L.T. transformer.

There are two dial lights on the panel mounted either side of the crystal switch. These are not the conventional indicators just to make the panel look pretty, but are actually wired across the primary of the filament transformer, and the primary of the H.T. transformer. The bulbs are the new Bulgin type with screw fitting and rated at 15 watts. They are vastly superior to the ordinary flash lamp bulb which do not have a very long life.



This view shows how the crystals are mounted on a sheet of Trolitul. In this way sockets can be used instead of the more normal crystal holders. The insulators are for link coupled or capacity coupled output.

of damage to the crystal. However, with 275 volts, the safest possible maximum, there has not been the slightest trouble with crystal heating even when inadvertently the cathode coil was left in circuit on 40 metres with a 40-metre crystal.

It can be seen from the diagrams that for fundamental operation the cathode coil  $L_1$  is short-circuited, while the switch across the anode coil  $L_2$  is left open. By short-circuiting approximately half of  $L_2$  and leaving the cathode circuit open the valve operates as a harmonic oscillator providing a really strong R.F. output on 20 metres.

With this circuit, owing to its high efficiency, there is also quite a satisfactory output on 10 metres, but this, of course, calls for a new coil in the anode circuit. However, the cathode coil need not be changed for three-band working.

Constructors will readily appreciate that by using a mixture of crystals covering various wavebands, the exciter can be almost instantaneously changed from one band to another. This, however, was not the original idea behind the design. Owing to the extreme QRM on amateur bands at the present time, I decided to purchase 12 crystals equally spaced over the 40-metre band. In this way, should interference be experienced on a transmission, the exciter can instantly be switched to the next frequency higher or lower. In this way at the receiving end there should not be any difficulty in locating the frequency

higher frequencies link coupling has been found quite satisfactory for a single turn link works excellently on 40, 20 and 10 metres. However, on 80 and 160 metres, capacity coupling has proved more reliable providing the condenser  $C_4$  does not exceed 100 mmfd. If link coupling is used on 80 and 160 metres, there will be too many turns on 80 metres if the link is satisfactory on 160 metres.

Refer to the illustration of the front panel. On the left is the control for the cathode condenser  $VC_1$ . This condenser has a capacity of 180 mmfd. which is essential for tri-tet working.

In the centre is the 12-point rotary switch with its hand-drawn scale. This

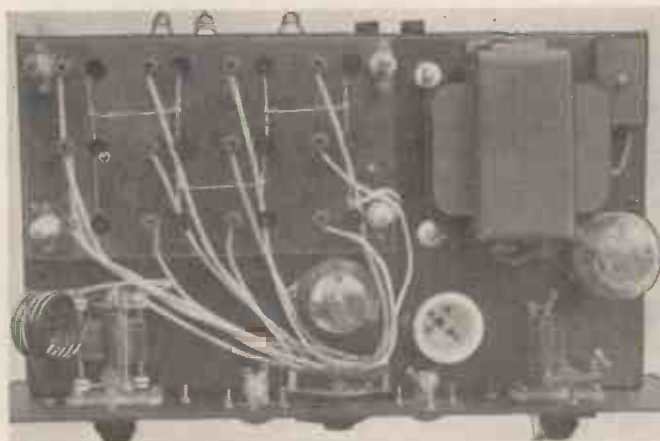

On the left can be seen the cathode tuning condenser with the coil connected across it. This coil can be cut out of circuit by means of a panel switch.

## Operating

As these bulbs are arranged, one lights up when the filaments are heated, the other being switched into circuit directly the H.T. voltage is applied.

Condenser controls are both small type Johnson handles which look most effective and are cheaper than most of the ordinary slow-motion drives.

Next refer to the plan view of the exciter. In the left corner can be seen a

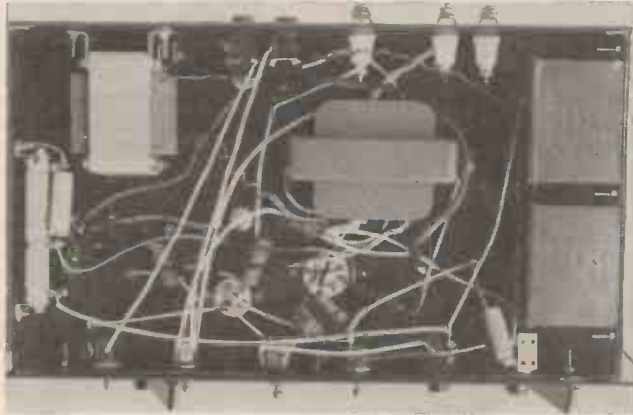

larger strip of Trolitul mounted on four stand-off insulators. This strip has been drilled to take 24 Clix sockets, so making 12 simple crystal holders. The grid side of these crystals are all joined together and taken to the grid of the 6L6G. The earthy side of the crystals are then wired to the 12 point rotary switch. This switch can be seen behind the 6L6G valve. Both the cathode and the anode condensers are mounted on Trolitul so that the spindles are isolated from the metal panel.

The cathode coil is soldered directly across the rotor and stator plates of VC1, while L2 is a plug-in coil of the new white Premier type which can be seen alongside VC2. In the right-hand corner of the chassis is the high voltage mains transformer, twin Bulgin fuseholder, and 5Z3 rectifier. In order to make quite sure that there will not be any chance of breakdown between the high-voltage winding and the chassis as the leads pass through the chassis, two feed-through insulators have been used to which are connected the 500-volt connections.

It is also important to remember that the dial-lights as they are wired across the mains must be carefully insulated from the earthed metal panel. Messrs. Bulgin supply suitable holders which will withstand well over the average mains voltage.

Next comes the components under the chassis. These may look rather difficult to inter-connect, but actually, as the components are wired singly no trouble will be experienced.

On the side of the chassis are mounted two 4 mfd. 800-volt working Dubilier

condensers. These are C6 and C7. Constructors can if they prefer use electrolytic condensers in this position providing they are of the 600-volt working type. But it will be appreciated that there is very little rise in the power unit owing to the potentiometer network, R2 and R3. This network although shown as two resistors is actually a Bulgin 40-watt 50,000 ohm resistor with a tap-

Under the chassis are most of the resistors and the smaller components from the power unit. A Bulgin 40-watt resistance is used as a potentiometer for giving a level screen voltage.

ping clip and this clip should be adjusted to provide a steady voltage of 275 to the screen of the 6L6G. This resistor is mounted on the side of the chassis above the rectifying valve holder. The smoothing choke is mounted on the rear end of the chassis,

while the remainder of the components are inter-connected in the wiring.

### Coils

After the exciter has been wired and checked, the next point is to build the two coils. For 40, 20 and 10 metres, the cathode coil consists of 5 complete turns of 14 gauge wire, 1½ in. diameter spaced the gauge of the wire. For 40 and 20 metres, the anode coil consists of 18 turns of 18 gauge wire, spaced accord-



This is one of the Premier coil forms which is used as an anode coil. It is already threaded and will take coil windings up to 40 metres.

ing to the threading on the former with a tap point 10 turns down from the H.T. end of the winding. In this way on 40 metres with the switch open, 18 turns are used, while on 20 metres with the switch closed, 8 turns are left in circuit.

### Components for A SINGLE VALVE 2-BAND EXCITER

#### CABINET.

1 Cabinet type 1034 (Eddystone).

#### CHASSIS.

1 Aluminium chassis, 15 ins. wide, 9 ins. deep, 4 ins. high, finished black (Peto-Scott).

#### CHOKE, HIGH FREQUENCY.

1—Type 1010 (Eddystone).

#### CHOKE, SMOOTHING.

1—L.F. 21S (Bulgin).

#### COIL FORM.

1—7-pin 1½ in. diameter (Premier Supply Stores).

#### CONDENSERS, FIXED.

1—.002-mfd. type 690W (C1) (Dubilier).

1—.006-mfd. type 601W (C2) (Dubilier).

1—.002-mfd. type 500 volt tubular (C3) (Dubilier).

1—.0001-mfd. type 620 (C4) (Dubilier).

1—.01-mfd. type 691W (C5) (Dubilier).

1—4-mfd. type LCG 800 volt working (C6) (Dubilier).

1—4-mfd. type LCG 800 volt working (C7) (Dubilier).

#### CONDENSERS, VARIABLE.

1—Type 942/180 (VC1) (Eddystone).

1—Type 1093 (VC2) (Eddystone).

#### HOLDERS, VALVE.

1—8-pin ceramic octal (Premier Supply Stores).

1—4-pin chassis American (Clix).

1—7-pin type chassis less terminals (Clix).

#### DIALS.

2 Johnson handles complete (Webbs Radio).

#### DIAL LIGHTS.

1 Type D35 (Bulgin).

1 Type D7 (Bulgin).

#### INSULATORS.

5 Medium size Johnson feed-through insulators (Webbs Radio).

4 Stand-off insulators type 1028 (Eddystone).

#### PLUGS, SOCKETS, ETC.

4 Closed circuit insulated jacks (Premier Supply Stores).

12 Insulated sockets type 11 red (Clix).

12 Insulated sockets type 11 black (Clix).

#### RESISTANCES, FIXED.

1—300-ohm type 100 watt (R1) (Premier Supply Stores).

1—50,000-ohm type PR41 (R2 and R) (Bulgin).

1—2,500 ohms type 15 watt (R4) (Premier Supply Stores).

#### SUNDRIES.

2 Coils quickwire (Bulgin).

24—6BA half-inch roundhead bolts with nuts and washers (Bulgin).

1 Fuseholder with twin 1 amp fuses type F19 (Bulgin).

¼ lb. 16 gauge enamelled cover wire (Webbs Radio).

1 Sheet Trolitul 8 x 5 x 3/16th ins. (Premier Supply Stores).

Quartz crystals type Valpey as required (Webbs Radio).

2 Strips Trolitul 1½ x 1 x 3/16th ins. (Premier Supply Stores).

#### SWITCHES.

2 Double-pole double-throw type S89 (Bulgin).

2 Type S80 (Bulgin).

1—12-point rotary (Peto-Scott)

#### TRANSFORMER FILAMENT.

1 Special transformer giving 7.5 volts c.t. 1 a. and

1 Ditto, 5 volts c.t. 2 a. (Premier).

#### TRANSFORMER, HIGH TENSION.

1 Special type giving 500-0-500 volts 12 om/A.

(Premier Supply Stores).

#### VALVES.

1—6L6G (Tungsram).

1—5Z3 (Radiographic).

# Hallicrafter's Sky Champion

FOR many years it has been our experience that unless a receiver is more than usually popular, one does not hear very much about its so-called deficiencies.

This applies not only to commercially built receivers, but also to those made by home constructors. Directly the number of sets built or purchased exceeds the average, one begins to hear

*We have carefully tested the new Hallicrafter Sky Champion from all angles and the results of these tests are fully discussed in this article.*

but a statement that will readily be agreed upon by amateurs who consider the specification of this receiver.

The instrument is made up of a 6K7 radio-frequency amplifier followed by a 6L7 first detector and mixer, a second 6K7 intermediate-frequency amplifier, 6Q7 double-diode-triode second detector, low frequency amplifier and A.V.C. control valve.

The output amplifier is an 6F7 high-slope pentode, while the three remaining valves are 6J5 high-frequency oscillator and a conventional 80 rectifier. Selectivity is of an extremely high order obtained by means of careful choice of coupling in the first two stages. The intermediate-frequency stage is also inherently selective owing to the use of an iron cored transformer in the input stage which embodies many novel schemes.

The radio-frequency gain control actuates on both 6K7 valves and consists of a variable resistor in the cathode circuit. In order that these valves operate under optimum conditions in each cathode is connected a separate bias resistor. The tone control circuit is in the grid of the 6F6 pentode in rather an unconventional manner.

Although an R meter has not been included provision has been made for a calibrated carrier level meter to be plugged into circuit by the operator. The carrier level meter is available as a separate component for use with this receiver and without any alteration to the set, gives an accurate indication of carrier strength.

Automatic-volume control is switchable so that when receiving telephony signals can be kept reasonably constant, while with the beat frequency oscillator in circuit the A.V.C. control can be switched off.

A feature which experimenters will appreciate is that the amount of coupling between B.F.O. and the anode of the I.F. valve has been carefully arranged so that while the oscillation is sufficiently strong there is not the usual



All the controls can be seen in this illustration. The band-spreading arrangements deserve special note.

quite a number of amateurs saying they don't like this and they don't like that until would-be buyers begin to gain a rather bad impression of the receiver in question. We realise, however, that this means the receiver has created more than the usual amount of interest and that most of the criticism is really hearsay.

A set that has beaten all records, and at the same time is in for a fair amount of criticism despite the fact that it is the most popular receiver in America and Great Britain, is the Hallicrafter Sky Champion.

The bulk of the criticism started owing to the extraordinary number of sets that have been sold. It is no exaggeration to state that of all the communication receivers, produced both in England and America, the Sky Champion is the biggest seller and the most popular.

It is impossible in one receiver to include every fitment that all amateurs need, hence some of the criticism, but these remarks apply equally as much to de luxe receivers costing £50 or so, as well as to the moderately priced Champion.

In order to satisfy ourselves regarding the performance of this set, we have been using one under normal working conditions for a considerable period and any criticism we could make would only be of rather a frivolous nature.

The Sky Champion is about the best value for money available at the present time. This is not just a point of view,

## The Valve Line-up

It is an 8-valve, 4-band superhet receiver, covering:—

Band 1—540 kc. to 1,800 kc.

Band 2—1.70 mc. to 5.75 mc.

Band 3—5.62 mc to 18.40 mc.

Band 4—17.00 mc. to 44.00 mc.

Separate coils are used to cover each waveband, while inductive coupling to the aerial permits of maximum signal transfer from each separate primary to the individual secondary coil in the circuit. In this way, unused coils are short-circuited to prevent any possibility of dead end and other losses.

The circuit of the receiver indicates to amateurs just what is given for £15.

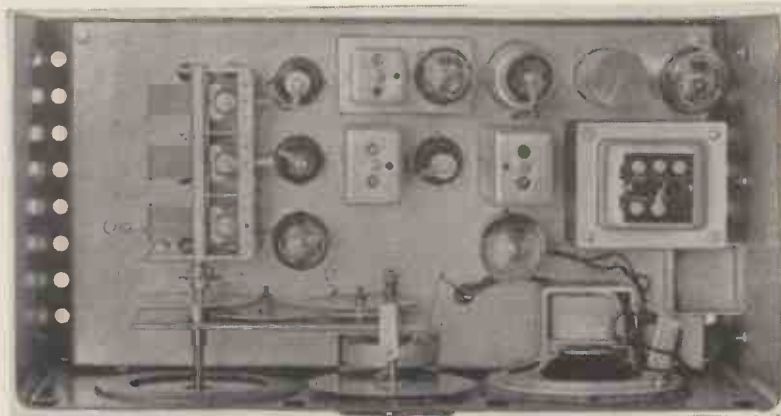

A novel system of gearing is employed which provides very smooth action without back-lash.

## Suitable for 60-metre Operation

amount of noise level introduced as might be expected.

A phone jack mounted in the anode circuit of the 6F6 is so arranged that no D.C. current flows through the windings and with the phones in circuit the

when the receiver is being used merely for communication purposes, we should have liked a greater signal level for reception of telephony stations. However, this criticism is more a matter of personal opinion.

in the tuning drive, but this has been overcome by the use of a more effective gearing system. The back lash in the first instance was not between drive and dial, but between dial and condenser. However, in the model that we tested and in other models that have been checked, back lash is unnoticeable even on the higher frequencies.

The design of the set is such that when receiving Morse code signals with the beat-frequency oscillator in circuit, there is no trace of drift, while movement of the receiver does not affect the stability of the note.

Reception on the 28-megacycle band is satisfactory, although a considerable rise in signal strength will be noticed by using a tuned aerial of the doublet type. Noise level is good, even on the habitually noisy 150-metre band. The receiver covers the new Civilian Wireless Reserve channel of 60 metres, and the 80-metre channel which is so often missed on low-priced receivers.

Considering that the Hallicrafter Sky Champion has most worth-while refinements and is moderately priced at £15, we consider it to be an extremely satisfactory instrument for amateurs.

We are indebted to Messrs. Webb's Radio, of 14 Soho Street, London, W.1, for their courtesy in loaning us a standard receiver with which to make our tests.

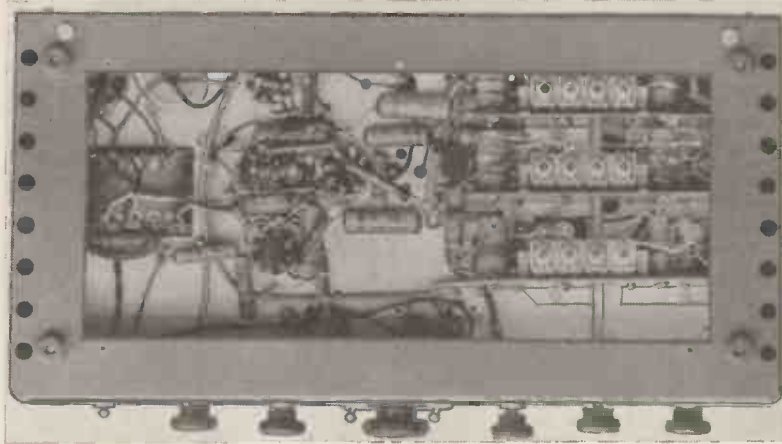

The bottom of the receiver can be seen by removing the baseplate of the cabinet. In this way trimmers can be re-set without having to take the receiver from its case.

loudspeaker is automatically disconnected. At this point we should like to mention that one of few criticisms discovered was that volume on headphones was rather less than was expected. And although this is of no disadvantage

In the later models of this receiver, which are now available in this country, slight modifications have been made in the mechanical features embodied.

In the first batch of receivers occasional models showed signs of back lash

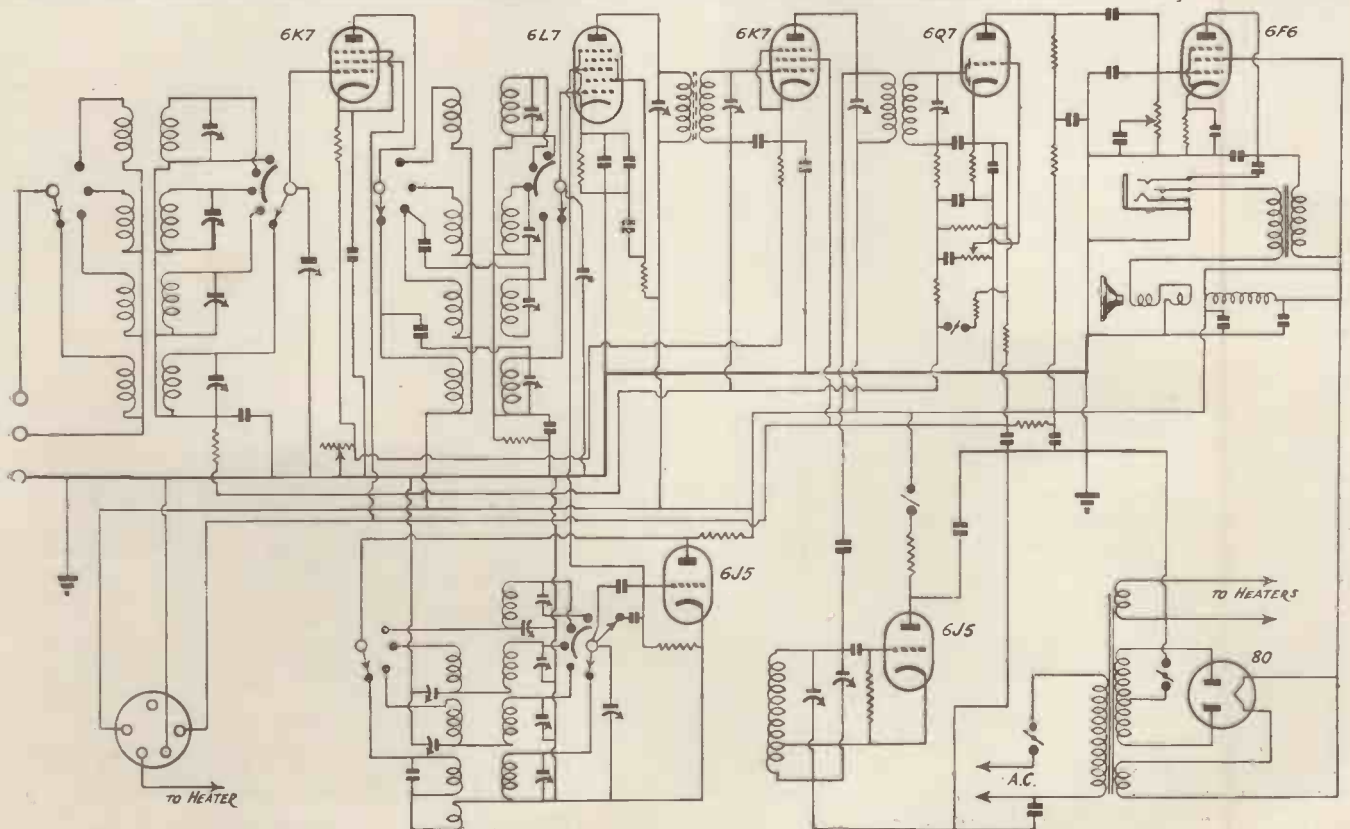

This complete circuit of the Champion shows how provision has been made for the inclusion of a carrier level meter.

# 5-metre Crystal Control

*This simple 2-valve 5-metre transmitter was used in last R.S.G.B. Field Day with good results. A Bliley 10-metre crystal is used with a tri-tet 802 oscillator. The circuit is very docile and straightforward in operation. It has been designed by Kenneth Jowers.*

WITH the introduction of robust 10-metre crystals amateurs can now assume quite a different outlook on the problems of ultra-high frequencies and crystal control.

While the ordinary 40-metre crystal can be used in harmonic oscillator circuits and if followed by several stages will provide a good output at 5 metres, a transmitter on these lines would not

A 40-metre crystal in a tri-tet circuit also worked very well, but even with this arrangement the equipment could hardly be called suitable for amateurs generally. For the last R.S.G.B. ultra-short wave field day, I designed a two-valve crystal controlled transmitter which gave a very healthy R.F. output.

It took no longer to build than a normal low-frequency transmitter and

minimum of components and does not require any separate bias unit. The manufacturers of the crystal recommended me to use an 802 pentode oscillator which, according to their calculations, gave maximum output for minimum crystal current. The 802 valve when used in the circuit I have chosen, provides an R.F. output of 2½ watts at 5 metres, which is just sufficient to drive a British valve, the ESW-20, as a straight final amplifier.

However, it is extremely simple to lose the bulk of this R.F. output unless the oscillator is carefully constructed. First of all, it is most important that the cathode circuit be completely screened from L<sub>2</sub>, L<sub>3</sub> and L<sub>4</sub>. To do this satisfactorily, I have mounted the cathode coil under the chassis across the rotor and stator plates of the cathode condenser. This cathode condenser is mounted in turn on a strip of Trolitul and arranged so that the spindle protrudes through the top of the chassis. In this way the cathode circuit can be adjusted quite easily and then left set. The anode coil of the oscillator circuit is on top of the chassis and mounted on two feed-through insulators, which overcomes the need for additional wiring to go through the chassis. The reverse side of the feed-through insulators are so arranged that they are close to the anode tuning condenser. In this way, wiring is kept rigid and short while the feed-through insulators act as fixed junctions to which can be anchored other components.

It was not found necessary to include a high-frequency choke in the anode circuit of the 802 oscillator providing a



All the components are mounted on this small chassis. The coils are of the Eddystone interchangeable type so that the unit can be used on 10 and 5-metres as required. The P.A. valve, an E.S.W.20, provides a high carrier power on 5 metres.

only be expensive, but also difficult to produce unless the constructor has had a reasonable amount of experience with multi-stage transmitting equipment.

There is a general feeling that the high-frequency crystals are fragile and are comparatively thinner than the normal 40-metre crystals. This is quite incorrect, for the modern 20-metre crystal is actually a 60-metre element, cut so as to oscillate at 20 metres. Similarly, a 10-metre element is in the first instance a fundamental crystal of 30 metres wavelength. From this it will be realised that there is no more difficulty in obtaining satisfactory oscillation with ultra-high frequency crystals than there would be with an element on 40 metres.

This point if fully realised should remove any doubts constructors may have on the possibility of satisfactory crystal control on ultra-high frequencies.

For a time I have been experimenting with 5-metre transmitting equipment with crystal control. The original experiments with an 80-metre crystal and twin triode doublers, although proving satisfactory was expensive and took up far too much space.

worked very well with the minimum of adjustment. The entire transmitter, less power pack, of course, was accommodated on a chassis 12 by 8½ in. with a sub-chassis 4 in. deep.

The circuit arrangement is rather an interesting one for it uses the very mini-

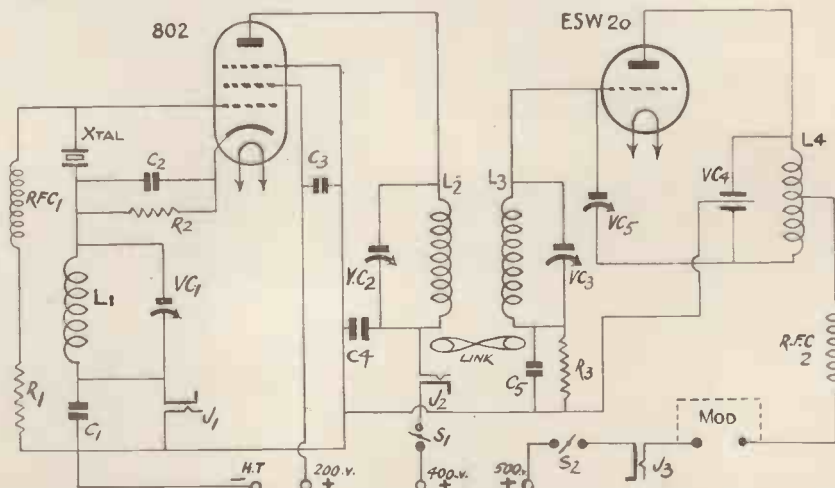

Component values must be adhered to if the transmitter is to work smoothly. Make a point of keeping the cathode coil out of the way of the remaining coils.

## 2½ Watts from C.O.

by-pass condenser is used having a capacity of .01 mfd. Also in the anode circuit is a toggle switch for breaking the H.T. supply to the 802 and a closed circuit insulated jack for inserting a meter when testing.

I strongly advise constructors to build

The 802 valve, with 400 volts on the anode and an absolute maximum of 200 volts on the screen, has an off-tune anode current of approximately 30 mA. When tuned to resonance the anode current drops to 12 to 14 mA. When fully loaded, the average standing

As with the oscillator anode, the grid coil is mounted on stand-off insulators arranged so that they come close to the tuning condenser.

It will be noticed that the rotor plates of the condenser are not earthed, owing to the fact that bias is obtained automatically by means of the resistor R<sub>3</sub> which has a value of 5,000 ohms with a 15-watt rating. This resistor is shunted by the condenser C<sub>5</sub> having a value of .01 mfd.

The only coil in this transmitter, which is home built, is in the ESW 20 tank circuit. This coil consists of six turns 1-in. diameter 18-gauge wire with a winding space of 1½ in. The coil is centre tapped and the tapping is anchored to one side of a feed-through insulator.

The neutralising condenser is a standard Eddystone component type 1088 with the main body removed. In this way the grid lead to the ESW20 is kept very short, as the neutralising condenser is mounted almost over the top of the valve holder. The anode lead is not quite so important, and goes directly to one side of the tank coil, as can be seen from the illustration.

Provision has been made for a switch in the anode of the ESW20, also a meter jack and two insulators for modulation. For C.W. operation, of course, these terminals are joined together.

Two 4-pin plugs and sockets are used to provide a means of transferring the filament and H.T. voltages from a separate power pack into the transmitter. This is a far more satisfactory method than using a long cable, for it provides a means of fixing the loose heater wires.

All tuning condensers, as can be seen from the illustration, are isolated from the chassis by means of Trolitul strips. In this way there is very little chance of breakdown.

The grid resistor is of the 1-watt type,

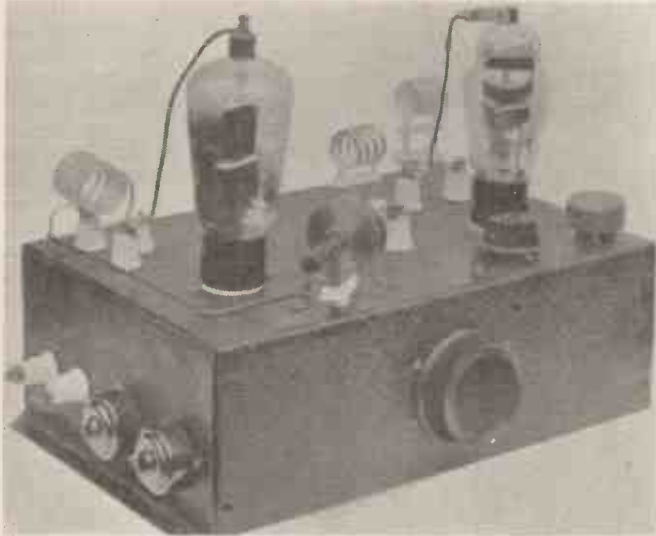

In this photograph can be seen the crystal, 802 oscillator, cathode condenser control, grid condenser control and the two anode and the grid coil.

the oscillator portion of this transmitter first and to get it working smoothly before worrying about the final stage. In many cases amateurs will find that 2½ watts on 5 metres can be very useful, so that if low power is going to be used the 802 on its own will make a most satisfactory transmitter. Components values are important, for if the wrong combination is obtained the relatively small output at 5 metres soon decreases.

For example, the cathode bias resistor and condenser, C<sub>2</sub> and R<sub>2</sub>, have a value of .01 mfd. and 400 ohms. The screen condenser has a value of .002 mfd. and should be connected by the shortest possible lead between screen and earth. Condenser C<sub>1</sub> is not so important, for it is merely to take up some of the key clicks; the value, however, should be .002 mfd.

### 10-metre Working

Although the coils can be home-constructed, I find it a great advantage to use the Eddystone plug-in coils, for different wavebands can be covered without difficulty. At this point it is well to mention that the transmitter as it stands with the correct coils will provide a very stable carrier on 10 metres, with a 20-metre crystal, or with a 10-metre crystal providing L<sub>1</sub> and VC<sub>1</sub> are short-circuited.

The cathode coil has six complete turns of 18-gauge wire spaced to cover a winding length of 4/5th in. with a diameter of ¾ in. The anode coil has a winding space of 1 in., a diameter of ¾ in. and a total of six turns.

anode current should be approximately 20mA.

Although the carrier power can be increased by increasing the screen voltage to over 200 volts, this cannot be recommended for the crystal current will rise very rapidly. It is also most important that the cathode condenser has a high capacity of 100 mmfd. This circuit should always be arranged to have high C with the minimum of inductance.

After the crystal oscillator has been adjusted satisfactorily, proceed with the building of the output stage. The grid tuning condenser is mounted underneath the chassis with the spindle coming through the back of the rear lip.

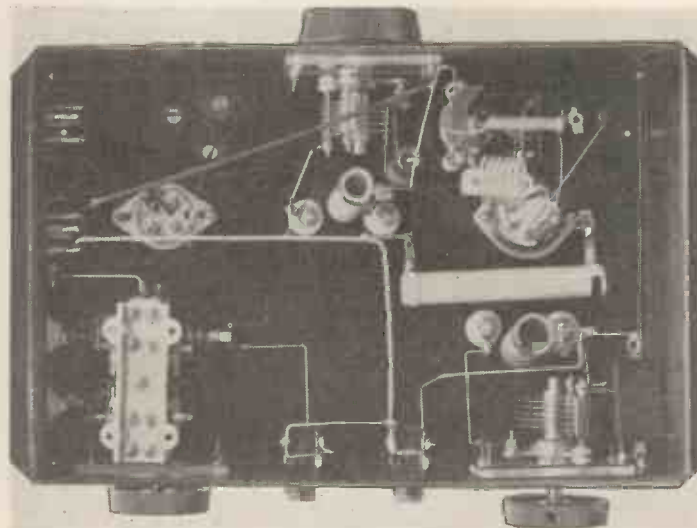

Most of the small components are mounted under the chassis in this manner. Notice how all of the variable condensers are mounted on Trolitul strip.

## Operating Conditions

the cathode resistor, R<sub>2</sub>, 4-watt rating and the grid resistor, R<sub>3</sub>, 15-watt rating.

On 5 metres the input to the ESW<sub>20</sub> valve should be limited to 10 watts, otherwise there will be insufficient drive. With this input there should be a carrier power in the region of 8

director will provide a much greater signal strength.

### P.O. Licence

Before constructors commence to operate this or any transmitter they must fully understand that a licence must be obtained from the Post Office. Full

designer, which can be obtained from any callbook.

## Legislation and Radio Interference

**I**N the September issue reference was made to the fact that legislation to prevent interference to radio was most improbable and that the most satisfactory means of reducing local noise level was to use some type of noise suppression aerial. We are now informed that there is a distinct possibility of legislation being introduced within the next year or so. This, however, will not mean the complete suppression of all noise, but only the reduction down to a certain pre-determined level.

This will mean that even when legislation is introduced, radio listeners may still have to use some type of noise suppression aerial in order to obtain completely noise-free radio reception. While the authorities propose to do all they can to improve radio reception, they intend that listeners should also help at the receiving end. Special noise suppression aerials of the type required have been produced by Messrs. Belling & Lee, Ltd., who also advise readers on individual problems.

It is always a wise plan to obtain the advice of experts in noise suppression equipment before buying any particular aerial for on short waves unless the feeder lines are of the low-loss type both signals and noise level will be reduced in volume.

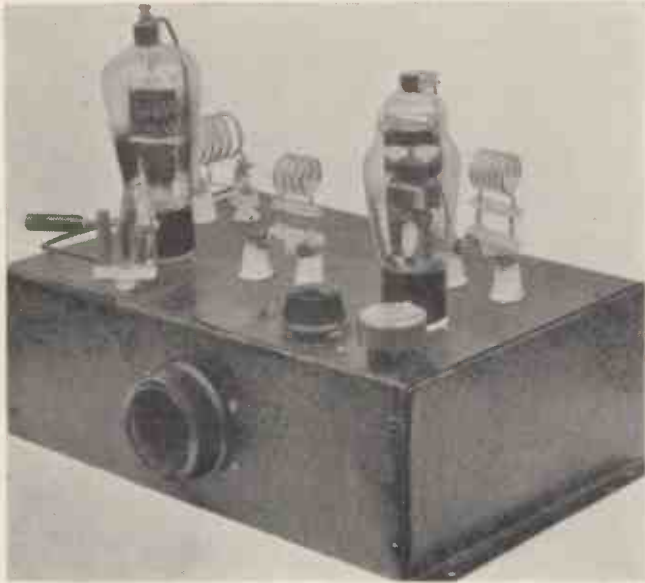

The plugs are for H.T. and filament supplies which are obtained from a separate power unit. On the side of the chassis are two insulators for modulation input.

watts. On 10 metres the input to the final valve can be increased to 20 watts as the drive is increased very considerably.

I cannot emphasise too strongly that the components must be very rigid and all wiring free from vibration. The radio-frequency chokes specified have been chosen from a number submitted and have proved to be the most satisfactory for use in this particular circuit. It is also important to use condensers of repute, for so many of the cheaper condensers available provide an extremely low resistance path.

It is recommended that a small beam aerial be used, such as the single section W8JK, which can be fed with 600-ohm line and link coupled to the final valve. This type of aerial can be made rotary and does provide the best possible means of radiation without going to considerable difficulty.

It will be noticed that the vertical type of aerial on this wavelength provides the greatest field strength up to 10 miles or so while at greater ranges the horizontal aerial is more satisfactory. The feeder line should be of the open spaced type with an impedance of 400 ohms unless the distance from the transmitter to the aerial is less than 10 ft. when the conventional 80-ohm cable will be more convenient.

There is no advantage in making the aerial longer than one wavelength for under general amateur conditions the half-wave doublet with reflector and/or

information, however, is readily obtainable from the Office of the Engineer-in-Chief, Radio Division, The General Post Office, Aldersgate, E.C.

No blueprint of this transmitter has been drawn, but the original instrument, which is at present in use, can be inspected at any time at the QRA of the

### Components for 5-METRE CRYSTAL CONTROL

#### CHASSIS.

- 1—Steel finished black, 12 ins. by 8½ ins. by 4 ins. (Premier Supply Stores).

#### CONDENSERS, FIXED.

- 1—.002 mfd. type 690W mica (C<sub>1</sub>) (Dubilier).
- 1—.01 mfd. type 691W (C<sub>2</sub>) (Dubilier).
- 1—.002 mfd. type 620 (C<sub>3</sub>) (Dubilier).
- 1—.01 mfd. type 691W (C<sub>4</sub>) (Dubilier).
- 1—.01 mfd. type 691W (C<sub>5</sub>) (Dubilier).

#### CONDENSERS, VARIABLE

- 1—.0001 mfd. type 1130 (VC<sub>1</sub>) (Eddystone).
- 1—40 mmfd. type 1129 (VC<sub>2</sub>) (Eddystone).
- 1—40 mmfd. type 1129 (VC<sub>3</sub>) (Eddystone).
- 1—160 mmfd. double-spaced type E (VC<sub>4</sub>) (Polar).
- 1—8 mmfd. type 1088 (VC<sub>5</sub>) (Eddystone).

#### COILS

- 1—6-turn type 1050 (L<sub>1</sub>) (Eddystone).
- 1—6-turn type 1050 (L<sub>2</sub>) (Eddystone).
- 1—4-turn type 1050 (L<sub>3</sub>) (Eddystone).
- 1—6-turn (L<sub>4</sub>) (Home constructed).

#### CHOKES, HIGH-FREQUENCY

- 1—Type 1011 (RFC<sub>1</sub>) (Eddystone).
- 1—Type SW68 (RFC<sub>2</sub>) (Bulgin).

#### CRYSTAL

- 1—10-metre quartz crystal type Bliley (Webb's Radio).

#### HOLDERS, VALVE

- 1—4-pin type Amphrenol (Webb's Radio).

- 1—7-pin type Amphrenol (Webb's Radio).
- 2—4-pin type chassis (VI) (Clix).

#### HOLDERS, COIL.

- 3—Type 1051 (Eddystone).

#### JACKS

- 2—Insulated closed circuit (Premier Supply Stores).

#### PLUGS, SOCKETS, ETC.

- 2—Plugs, type P15 (Bulgin).
- 2—Insulated sockets, type 11 (Clix).
- 2—4-pin plugs P36 (Bulgin).
- 6—1½-in. feed-through insulators (Webb's Radio).

#### RESISTANCES, FIXED.

- 1—30,000 ohm, type 1 watt (R<sub>1</sub>) (Erie).
- 1—400-ohm, type 4 watt (R<sub>2</sub>) (Premier Supply Stores).
- 1—5,000-ohm type 15 watt (R<sub>3</sub>) (Premier Supply Stores).

#### SUNDRIES.

- 4—Strips Trolitul, 1½ by 3/16 (Premier Supply Stores).
- 2—dozen 4 B.A. roundhead bolts with nuts and washers.
- 3—2-in. flat knobs (Jackson Bros.).

#### VALVES.

- 1—Type 802 (Webb's Radio).
- 1—ESW 20 (Ediswan).

Arrangements have been made for a ready-wired instrument or kits of parts to be obtained from Messrs. Premier Supply Stores, 167, Lower Clapton Road, E.5, or Messrs. Peto-Scott Limited, Pilot House, Church Street, Stoke Newington, N.16. Messrs. Webb's Radio, 14, Soho Street, W.1, can also supply all the components needed.



# Carrier-type Remote Control

This article written by the American engineer, L. C. Waller, is of particular interest to amateurs. It uses the new cold cathode valve which is now available in this country. We are indebted to the American publication "Radio Retailing" of Albany, N.Y., for this information.

THERE are numerous applications for a simple, sure-fire, remote-control switching system—especially for one where no additional control wires need be installed. A typical example is an "off-on" switch for a radio receiver. A system can be set up so that the receiver (or other electrical device) can be turned off or on from any point in the house, which is close to an A.C. outlet, provided the "con-

D.C. cathode current ..... 25 max. milliamperes.  
Typical operation with D.C. supply:—  
Anode-supply voltage (RMS) ..... 105-130 volts.  
A.C. starter-anode voltage (peak) ..... 70 max. volts.  
R.F. starter-anode voltage (peak) ..... 55 min. volts.  
Sum of A.C. and R.F. starter-anode voltages (peak) ..... 110 min. volts.

The OA4-G is also very useful as a voltage regulator in D.C. power supplies where the D.C. load current does not exceed about 20 milliamperes. In this service, the valve is used essentially like the 874 gas diode, except that the OA4-G valve drop is only 70 volts instead of 90.

### Valve Function

In normal operation, a relatively small amount of energy starts a glow-discharge between cathode and starter-anode. This discharge (ionised argon gas) produces the main discharge between cathode and anode. The anode current is of such magnitude that it will operate either a D.C. or an A.C. relay suitably connected in series with the anode and the anode-voltage supply. Thus, it is seen that the starter-anode serves to "trigger off" the main anode discharge. This is the design feature which makes the OA4-G adaptable to remote-control relay service.

As a remotely controlled relay valve, the OA4-G should find use in a wide variety of unrelated fields. Radio servicemen and radio amateurs will find numerous useful applications of this nature. The circuit of a typical relay arrangement is shown in Fig. 2. The operation of this circuit is quite simple. The starter-anode is supplied with a 60-cycle voltage from the bleeder R1 and R2 which is connected directly across the line. The voltage  $E_{R2}$  applied to P1, is adjusted to have a peak value of about 65 volts which is almost, but not quite large enough to

initiate a starter-anode discharge on the positive peaks of the line voltage.  $E_{R2}$  is, of course, in phase with the line voltage.

The A.C. line is also made to carry a small radio-frequency voltage, which is supplied by a simple oscillator (to be described later). The frequency of this carrier voltage can be in the order of 50 to 350 kilocycles. Referring again to Fig. 2, we note that inductance L1 and capacitance C1 comprise a series-tuned circuit shunted across the A.C. line. L1 and C1 have values such that they are series-resonant with the carrier frequency. At resonance, a relatively large R.F. voltage is built up across L1. This voltage, in series with the cathode and P1 as well as with the cathode and P2, adds to the 60-cycle voltage already applied to these electrodes. Thus, the starter-anode discharges and this in turn starts the anode discharge, operating the relay.

The inductance of L1, Fig. 2, is the same as L3, Fig. 3; namely, 75 turns of 26 dcc. on a 1½-in. form. For power-line frequencies in the order of 60 cycles and carrier frequencies of 100 kilocycles, the sum of  $E_{R2}$  and  $E_{L1}$  should be somewhat greater than 110 volts peak.

### Control Unit Design

The control oscillator employs a type 30, which is quite economical in filament and anode power. In Fig. 3 the valve shows an anode current of about 7 milliamperes. The anode input power is about 0.36 watt and the filament power is 0.12 watt. Resistor R4 is a 7.5-watt, 120-volt lamp, which limits the filament current of the 30 to the rated value of 60 milliamperes when the A.C. line voltage is 115 volts RMS. The lamp thus consumes 6.9 watts, making the total oscillator power consumption 7.38 watts. The 30 will deliver enough power to operate the OA4-G over A.C. lines in the order of 100 ft. long, more or less, depending upon the nature of the line. A typical

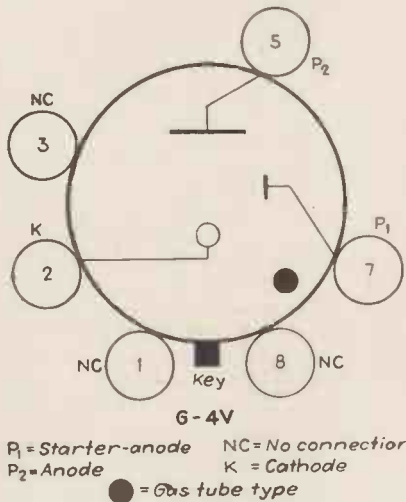

Fig. 1. Bottom view of socket connections of the OA4-G.

trol" outlet and the receiver are supplied from the same power distributing system.

A new glow-discharge relay valve, recently announced, is designed primarily for this remote-control relay service. The valve, type OA4-G, is a gas triode having a cold cathode (K), a starter-anode (P1) and an anode (P2). Socket connections for the octal base of the OA4-G are given in Fig. 1. Operating characteristics and maximum ratings are as follows:—

- Peak Anode Breakdown Voltage (Starter-anode tied to cathode) ..... 225 min. volts.
- Peak Positive Starter-anode Breakdown Voltage ..... 70 min. volts.
- ..... 90 max. volts.
- Starter-anode Current (for transition of discharge to anode at 140 volts peak) ..... 100 max. microamperes.
- Starter-anode drop 60 approx. volts.
- Anode drop ..... 70 approx. volts.

### Maximum Ratings and Typical Operating Conditions

#### RELAY SERVICE.

- Peak cathode current ..... 100 max. milliamperes.

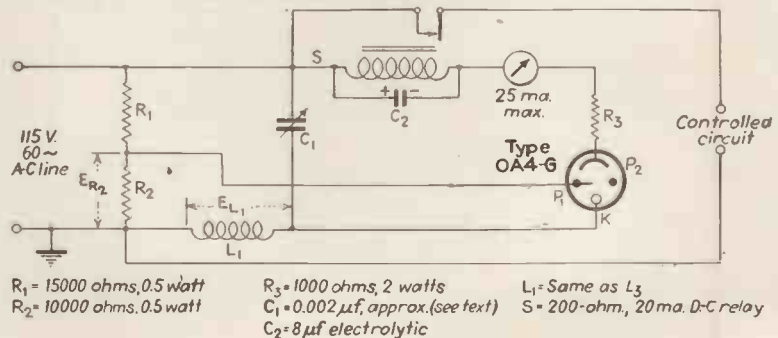
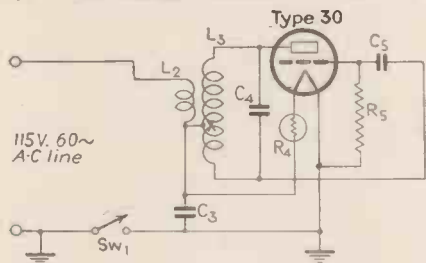

Fig. 2. Remote control relay circuit.

## Component Construction

house line was found to have an impedance of about 35 ohms at 100 kilocycles. At 300 kilocycles the operation frequency obtained with the circuit constants, shown in Fig. 3, the impedance of the same line was estimated to be about 12 ohms.



- $C_3 = 0.5 \mu\text{f}$  paper
- $C_4 = 0.002 \mu\text{f}$  mica
- $C_5 = 0.001 \mu\text{f}$  mica
- $R_4 = 7.5$  watt, 120 v. lamp
- $R_5 = 10,000$  ohms, 0.5 watt
- $L_2 = 3\text{T. No. 26 D.C.C. wound around } L_3 \text{ at point } x$
- $L_3 = 75\text{T. No. 26 D.C.C. on } 1\frac{1}{2}'' \text{ diameter form, } 142 \mu\text{h}$
- $SW_1 = \text{S.P.S.T. switch}$
- $L_3$  is tapped 25T. from the grid end

**Fig. 3. 300 Kc. control oscillator.**

The turns ratio of the inductances  $L_2$  and  $L_3$  can be determined by the relation

$$\sqrt{Z_p/Z_L} = N_p/N_L \text{ or } N_L = N_p \sqrt{Z_L/P}$$

- where  $N_L =$  number of turns on  $L_2$
- $N_p =$  number of turns on  $L_3$
- $Z_L =$  impedance of A.C. line at the carrier frequency
- $Z_p =$  operating (plate-load) impedance of the oscillator.

In the example under discussion,  $N$  is 75 turns,  $Z$  is estimated to be 12 ohms at 300 kc., and  $Z_p$  is obtained from the relation,  $Z_p = (225 E_b/I_b)$ , where  $E_b =$  oscillator plate voltage, RMS A.C.

$I_b =$  oscillator D.C. plate current, milliamperes.

Thus,  $Z_p = (225) (115/7)$ , or 3700 ohms for the circuit of Fig. 3.  $N_L = (75)$

$\sqrt{12/3,700} = 2.44$ , the required turns, for  $L_2$  to match a 12-ohm line. Actually, three turns were found to provide a suitable value of R.F. voltage across the line.

Care should be taken not to make the grid condenser  $C_3$  too large, because it must have a high impedance at 60 cycles to prevent the grid from swinging positive in phase with the plate voltage. Such an occurrence will result in the prompt demise of the oscillator filament. A value of 0.001 mfd. was found to be satisfactory, with a 10,000-ohm grid leak ( $R_5$ ). The type 30 oscillator, with correct impedance matching to the line, delivered from 70 to 100 volts peak R.F. voltage across  $L_1$ . This was measured by means of a cathode-ray oscillograph.

### Operation

The switch  $SW_1$  serves to turn the oscillator off and on, thus operating the remotely-located relay with a slight

time lag, due to the thermal inertia of the valve's filament. The relay can be keyed rapidly, if desired, by inserting the key or switch in the earth return of  $R_5$ , the grid leak. Opening  $R_5$  blocks the oscillations.

It is important to note that the R.F. pulse delivered to the line occurs only on the positive half-cycle of the line voltage, referred to as the oscillator filament. The "receiver" line plug must be inserted so that  $P_1$  and  $P_2$  swing positive with respect to the OA4-G cathode on the same half-cycle that the R.F. pulse is generated in the oscillator. If the "polarity" is connected incorrectly at first, reversing the line plug of either the oscillator or the relay unit will allow correct operation.

The relay used in the test set-up is a 200-ohm D.C. relay which operates on 15 to 25 milliamperes. The 8-mfd. electrolytic condenser ( $C_2$ ) is necessary to smooth out the pulsating direct current passed by the OA4-G anode (the OA4-G operates somewhat like a half-wave rectifier). An A.C. relay, or a D.C. relay with a shaded pole, will operate satisfactorily without  $C_2$ , and for that reason is preferable. In no case should the D.C. anode current exceed an average value of 25 mA. (as measured by a D.C. meter) or a peak value of 100 mA. (measured by taking a peak voltage reading across  $R_3$  with an oscillograph). The 1,000-ohm current-limiting resistor  $R_3$  will limit the peak current satisfactorily. A smaller value should not be used for  $R_3$ .

The variable condenser used to tune the series circuit of Fig. 2 consists of a 0.001-mfd. and a 0.00025-mfd. fixed mica condenser in parallel, shunted by a 500-1,000-mmfd. mica padding condenser. Correct resonance can be obtained by means of an oscillograph or by adjusting the trimmer capacitance till the OA4-G glows the brightest, indicating maximum started-anode and anode currents

### Voltage Regulator

The OA4-G is very useful as a voltage regular where the D.C. load current requirements are not severe. The circuit of Fig. 4 shows a typical application. A very constant voltage drop of about 70 volts is obtained across the OA4-G, regardless of variations (within limits) in the D.C. load current or in the A.C. line voltage. The circuit shown illustrates the use of the OA4-G to regulate the plate voltage of a 6J5 R.F. oscillator in a 10-metre superheterodyne receiver. This set employs a 6L7 mixer, the injector grid of which is driven by the 6J5. Prior to the installation of the OA4-G, the oscillation and mixer had a slight tendency to "pull" in step. The stable plate voltage provided by the OA4-G eliminated all traces of pulling, which was caused originally by the variation of the

cathode current in the A.V.C.-controlled R.F. and I.F. stages, and the resultant shift in oscillator plate voltage.

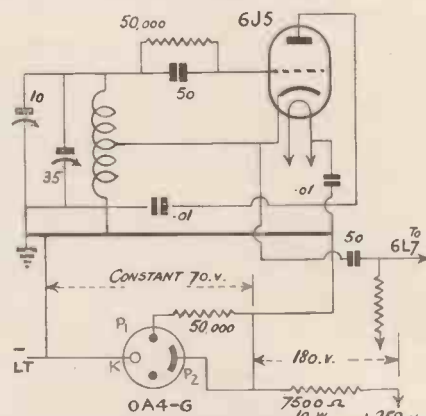

**Fig. 4. Voltage-regulator circuit for a 30-Mc. superhet oscillator. 160  $\mu\text{a}$  of D.C. grid current is obtained in the 6L7's No. 3 grid circuit. "Pulling" of the oscillator and mixer is reduced.**

If more than 70 volts are desired, two OA4-G's can be connected in cascade to provide 140 volts, three to provide 210 volts, etc. In any case, the series-resistor in the bleeder circuit should limit the average direct current through the valve to 25 mA. with no load circuit connected. The load circuit should not draw more than about 20 mA., or the OA4-G will cease to discharge and thus lose control.

### Surplus Equipment for Experimenters

A large number of components suitable for the experimenter and transmitting amateur are to be seen at the showrooms of Galpins at 75 Lee High Road, Lewisham, S.E.13.

Hot-wire meters of the low-reading type suitable for checking the aerial current from the average amateur transmitter can be obtained for as little as 4s. Low-current relays with platinum contacts cost 2s. while steel racks 40 in. high, suitable for housing a transmitter, are priced at 12s. 6d.

Those interested in learning the Morse code or in the construction of a reliable buzzer wavemeter should make a special note that Galpin can supply genuine Townsend high-note buzzers with platinum contacts for a shilling. These buzzers maintain the same note for long periods and operate from a 3-volt battery.

All kinds of small components are also available such as chokes, condensers and resistances and in many cases the cost is only a matter of coppers.

We advise those readers who are within a reasonable distance of Lewisham to call and see Galpins Electrical Stores.

# PREMIER 1938 / 1939 RADIO

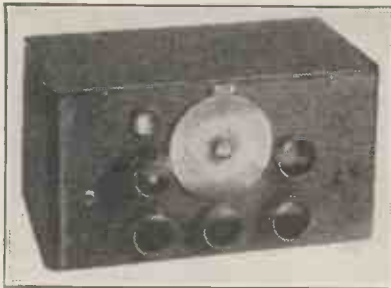

## NEW PREMIER 5 VALVE SUPERHET COMMUNICATION RECEIVER

Complete coverage from 12-2,000 metres in 5 bands. Separate Band-spread Condenser. Beat Frequency Oscillator. Phone Jack. Send-Receiver switch. Aerial Trimmer. Provision for single wire or Di-pole Aerial. International Octal Valves. For 200-250 v. mains (A.C.).

Built into Black Crackle Steel case, providing complete screening. 10½ in. Moving Coil Speaker in separate steel cabinet to match Receiver. Complete with all tubes and Speaker ..... **£8-8-0**

## PREMIER ALL-WAVE SUPERHETS

**A 5-Valve All-wave Superhet**  
Receiver chassis with moving coil Speaker. Wave range 16-50, 200-560 and 800-2,000 metres. Output 4½ watts. Fully illuminated scale with Station Names and Wavelengths. Automatic volume control. Tone control. Provision for gramophone input. Extension speaker sockets. International Octal valves. Complete with valves and speaker **£6-6-0**

**A 6-Valve All-wave Superhet**  
as above, but with R.F. Amplifier Stage, 4 wave-bands from 12 metres upwards, 10½ in. Moving Coil Speaker. With valves and speaker... **£7-19-6**

**A 10-VALVE DE LUXE SUPERHET RECEIVER CHASSIS**; with Rola G.12 energised moving coil speaker. Wave-range coverage from 5-2,000 metres in 5 bands. Two I.F. stages with sensitivity control. "Magic Eye" tuning indicator, Fully illuminated dial with station names and wave ranges. Automatic volume control, tone control, negative feedback, provision for gramophone input and extension speaker sockets. International Octal valves, giving an undistorted output of 15 watts. Complete **£15-15-0** with speaker and all valves ..... Price



## PREMIER MOVING COIL METERS

Guaranteed Accuracy within ± 2%

Model No. 2 (as illustrated), Bakelite Case, 3 in., by 3 in square, with Zero adjuster.

0-500 micro amps...	31/-
0-1 m.a. ....	25/-
0-10 m.a. ....	22/6
0-50 m.a. ....	22/6
0-100 m.a. ....	22/6
0-250 m.a. ....	22/6
0-1 m.a. movement with calibrated scale volts—ohms—m.a. ....	27/6

A complete range of Moving Coil Meters is now available from 17/6. Write for complete list.

## PREMIER MATCHMAKER UNIVERSAL MODULATION TRANSFORMERS

Will match any modulator to any R.F. Secondary Load. Triodes, Tetrodes, and Pentodes Class A. Single or Push-pull Class "AB1" and "B" in Push-pull or 500 ohms line input, can easily be matched to any of the following Radio Frequency final stages requiring modulation.

Triodes, Tetrodes or Pentodes operating under Class "A", "B", "BC" and "C" conditions either Single or Push-pull.

Totally enclosed in cast cases with engraved Panel and full instructions. Ratings are based on R.F. inputs.

50 watt, 17/6. 150 watt, 29/6. 300 watt, 49/6.

A new range of "Matchmaker" Universal Output Transformers which are designed to match any output valves to any speaker impedance are now ready.  
5-7 watt, 13/6. 10-15 watt, 17/6. 20-30 watt, 29/6.



## THE NEW PREMIER 10-15 WATT ALL-BAND TRANSMITTER

Designed by G2HK to meet the demand for a really compact self-contained T.X., which can be used for 'Phone or C.W. on all bands.

A 6L6 is used as a modulated oscillator in a Tritet circuit, allowing a fundamental and second harmonic operation, without coil changing, from any one Xtal. A 6C5 speech amplifier is R.C. coupled to a 6L6 modulator, giving approx. 9-10 watts audio. A 400-volt power supply with generous smoothing gives completely hum-free output.

Housed in steel cabinet, in black crackle finish, 12 in. x 9 in. x 8 in.

Complete with Xtal and Coils for 7 **£10-10-0** and 14 mc operation

Write to G2HK for details of all Premier Transmitters

## MORE NEW 1939 PREMIER PRODUCTS

A complete range of 7 High Fidelity P.A. Amplifiers for A.C. or A.C./D.C. mains operation. With the exception of the two 3-watt models, all Premier Amplifiers are supplied in Black Cracked steel cases, and incorporate the new Premier "Matchmaker" output Transformer, enabling any single or combination of speakers to be used.

6, 8/10, and 15-watt systems are provided with two separate input channels which can be mixed to any level. The 30- and 60-watt systems have 3 input channels. The built-in Pre-Amplifiers ensure that the gain is sufficient for any low level crystal or velocity microphone. The actual gain of the 6-, 15-, 30- and 60-watt amplifiers is over 100 decibels. Tone controls are also incorporated.

### PRICES

3-watt A.C. ....	£2 15 0
3-watt A.C./D.C. ....	£2 15 0
6-watt A.C. ....	£6 15 0
8/10-watt A.C./D.C. ....	£6 0 0
15-watt A.C. ....	£7 5 0
30-watt A.C. ....	£12 12 0
60-watt A.C. ....	£15 15 0

MAINS TRANSFORMERS. COMPLETE RANGE OF ALL TYPES AVAILABLE FROM STOCK. ANY SPECIAL TRANSFORMER WOUND TO ORDER.



## PREMIER SHORT-WAVE KITS

Are all sold complete to the last detail. All valves and coils are included as well as theoretical and wiring diagrams, and lucid instructions for building and working. Thousands are giving excellent results all over the world.

Each Kit uses plug-in Coils and the Coils supplied tune from 13 to 170 metres. All Kits are supplied with a steel chassis and Panel.

1 Valve Short-Wave Receiver or Adaptor Kit	17/6
1 Valve Short-Wave Superhet Converter Kit	20/-
1 Valve Short-Wave A.C. Superhet Converter Kit	22/6
2 Valve Short-Wave Receiver Kit	25/-
3 Valve Short-Wave Screen Grid and Pentode Kit	58/6

Have you had our 1938 Catalogue, Handbook and Valve Manual? 90 pages of Radio Bargains and interesting Data. Price 6d.

ALL POST ORDERS to:—  
Jubilee Works, 167, Lower Clapton Road, London, E.5. Amherst 4723.

# PREMIER RADIO

CALLERS to:—Jubilee Works, or 165 Fleet St., E.C.4. Central 2833 or 50 High St., Clapham, S.W.4. Macaulay 2381.

# An Experimental 5-8 Metre Receiver

*So that constructors may take advantage of the distinct possibilities of long distance reception on ultra short waves, H. F. MEASURES has designed this most interesting four-valve midget receiver.*

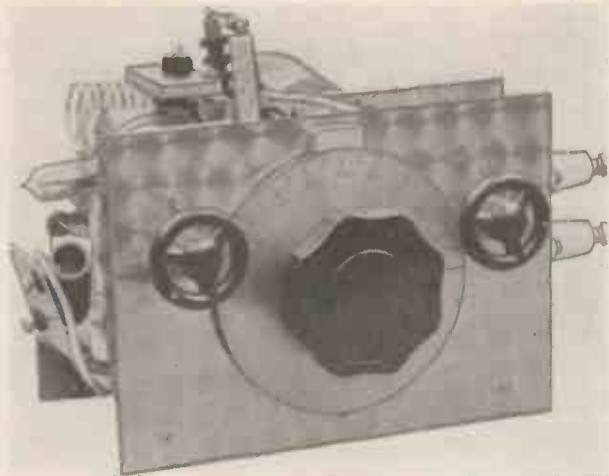

The panel layout is quite symmetrical; a precision dial of this type has been found essential.

more complications, it was apparent that very weak signals would have little or no effect upon the quench valve, and again the set would have lost its compactness and destroyed the original intention of the design.

By mounting the X.S.G. vertically in the ordinary manner, this conveniently meant a short anode connection to the 50 mmfd. pre-set condenser with the side of the screening providing a further safeguard against interaction in this portion of the set.

The grid H.F. choke necessitated mounting on a separate aluminium bracket as shown, and by using rubber grumets a really nice fixture was obtained.

To permit the close coupling of the coils one had to be mounted vertically and the other horizontally, both being supported on insulating pillars. The screen served a useful purpose here, since the reaction coil could be made adjustable by slotting the screen as depicted in the illustration without upsetting the appearance of the front panel.

Another point which arose through the compactness of the layout caused the writer to deviate a little from convention by the use of a larger reaction coil than grid coil, this being of course due to the damping again, but the ultimate results proved that this in no way caused uncontrollable oscillation, and the performance is surprisingly good. The earlier experiments with the detector stage showed that this would function fairly well with a three turn

IT was purposed firstly to prepare a receiver on as small a chassis as would be theoretically permissible whilst employing all metal construction, and in view of the considerable damping prospects, this proved no easy task. After numerous tests to approximate the losses and capacity to earth conditions for each component, it was realised that a saving factor not only lay in the benefits of short wiring, but by systematic positioning, the detector could be made to oscillate freely over the required band from 5 to 8 metres.

The L.F. stages necessitated very critical screening, and this alone became an arduous task, but one resulting in the complete elimination of hand capacity effects under normal operating conditions.

The detector anode choke had, for example, necessarily to be of the spaced winding type as the solenoid afforded just too large a field, this making it affect reaction to the extent of a complete cessation, due to the impossibility of positioning this component without damping.

The choke, therefore, is mounted vertically and its relationship, although critical, does not cause instable operation under different conditions of the receiver's use.

From the circuit diagram it will be seen that once again the choice of input resulted in the use of an untuned H.F. stage, thus the question of aerial resonance is overcome, whilst the coupling of different aerial systems permits more steady conditions during experiments, the reaction remaining very smooth although as may have been noticed, the grid leak is returned directly to positive L.T.

One of the many interesting conditions which arose during the preliminary tests concerned the manner in which the detector was to receive its L.T. supply, and as will be noticed that where it would seem that a short connection could have been made to the detector from the L.F. section over the top of the screen, the returns are kept severely apart for both the detector and the L.F. section by passing seemingly long leads through the chassis, direct to the X.S.G. This is mentioned as it bears upon the ultimate performance of the set.

Link coupling is employed between the X.S.G. and the detector grid coil, and the anode side is in immediate relationship to the grid side, with the free end of the link between the earthy end of the grid coil and the detector valve.

As the use of a super-regenerative circuit would not only have introduced

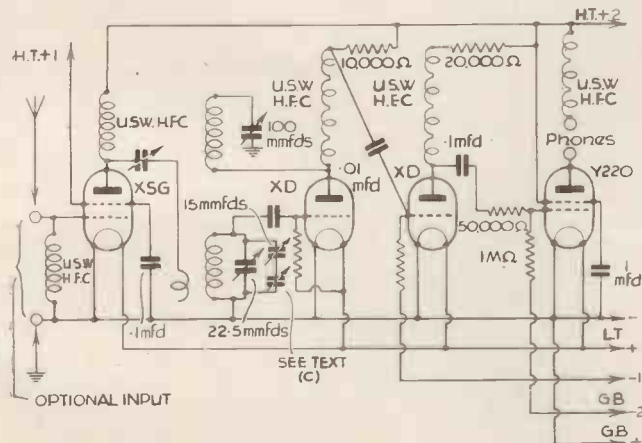

Left is the theoretical circuit of the receiver which embodies three Hivac midget valves with Y220 in the output stage.

Right can be seen the constructional details of the front panel.

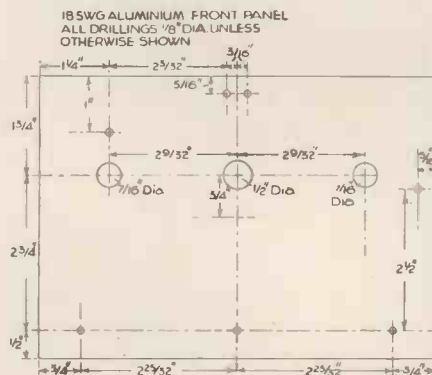

# MULLARD TRANSMITTING VALVES



TZ08-20

Transmitting valves to meet every requirement can be selected from the Mullard range comprising:—

- SHORT-WAVE TRIODES**
- SCREENED R.F. PENTODES**
- MODULATOR TRIODES**
- MERCURY VAPOUR RECTIFIERS**

Ask for a copy of the latest list of low and medium power transmitting valves.

TRANSMITTING  
DIVISION

**MULLARD WIRELESS SERVICE CO. LTD.**

225 TOTTENHAM COURT ROAD W.1

## G5NI

**THESE OFFERS CANNOT BE REPEATED. HURRY!**

- RME, 69 Stock-soiled demonstration model, only used in our Showrooms. One only ... 30 gns
- McMURDO MASTERPIECE III**, 12 tubes, High Fidelity Audio (12 watts), Speaker Air-tuned IFS, separate Beat Oscillator, Electrical Band Spread, cost over £60; one only ... £15
- NATIONAL SW45**, same as SW3, but 2 extra audio stages, complete with tubes. Callers only, come and pick yours. ... 50/-
- HALLICRAFTER Skybuddies**, brand new, 220-230 v. (black 1937-1938 model), makers' cartons ... £6 19. 6.
- HALLICRAFTER Sky Challenger I**, Xtal Model in makers' carton. 230 v. List £25. One only ... £18
- McMURDO MASTERPIECE II**, 12 tubes as III but different dial, cost £55. One only ... £10
- McMURDO WORLD-WIDE Nine**, as Masterpiece III but smaller audio stage. One only ... 8 gns
- TOBE**, Amateur Communication Receiver, 7 valves, with 180° band spread on amateur bands, beat oscillator, a.v.c., Complete in Cabinet and with speaker, stock soiled only, List £17 17s. 6d. ONE ONLY ... £12. 17. 6

\* All McMurdos are complete with High Fidelity Speakers.

## RADIOMART

G5NI (BHAM) LTD.

DIRECTORS: W. H. D. NIGHTINGALE L. NIGHTINGALE

## STOCKTAKING BARGAINS!

AT THIS TIME OF THE YEAR WE HAVE A NUMBER OF ODDMENTS WE HAVE DECIDED TO CLEAR, IN ORDER TO MAKE MORE ROOM FOR INCOMING STOCKS

- McMURDO 100 watt**, Phone Transmitter (uses RK20), cost £45., less tubes and Xtal. One only ... 17 gns
- UTAH 80 watt** 6L6 Transmitter, latest CW type, with tubes and Xtal (230 v.). ... £17
- G.T.C. 25 watt** 6L6 CW. Transmitter kit, complete with tubes, meter and Xtal ... £7
- GROSS CP60—100 watt** Transmitter Chassis, uses 47, 53 and 35 T, less tubes and Xtal, but with coils for 20 and 40 metres. ... £5 10. 0.
- GROSS CP55—100 watt** Transmitter chassis, uses 42, 6L6, 2-T. 20's coils for 10 and 20 metres, no tubes. ... £5 10. 0.
- GROSS CW25—50 watt** Transmitter chassis, uses 47, 46, 2-46s, coils for 20, 40, 80 and 150 metres (no tubes) ... £5 10. 0.
- All the above transmitters are brand new and unused.
- TAYLOR T.125**. List £4 15s ... £3
- TAYLOR T.155**. List £6. ... £4
- TAYLOR T. 200**. List £6 15s. One only ... £4 10. 0.
- RCA. 913 Cathode Ray Tube** and 855 gas filled trigger tube for same. List 54/-, the pair ... 37/6
- AMPEREX. HF.200**. List £8 ... £5. 17. 6d.
- AMPEREX. 211G**. List £7 10s. ... £2 19. 6d.
- AMPEREX. 841 carbon anode**. ... 17/6
- WESTERN ELECTRIC 211E** ... 15/-
- HOYT latest square millimeters**. Type 593. 7/3
- DITTO**, but moving coll. Type 591 ... 22/6
- HOYT 3½" R.F.** Antenna ammeters, ½, 1, 1½, 3 amps with zero adjusters ... 17/6
- GENUINE CRYSTAL MIKES** (Brush Crystal Unit) while they last, new. ... 39/6
- Chromium Stand for same ... 6/6
- RCA's latest 902 Cathode Ray Tube**, 2 in. screen. ... 55/-
- AMERICAN Smoothing Chokes** interleaved and shrouded 20 hy. 150 m/A. 350 ohms. ... 4/11
- AMERICAN Smoothing Chokes** interleaved and shrouded 20 hy. 100 m/A. 500 ohms. ... 4/11
- AMERICAN Smoothing Chokes** interleaved but not shrouded 100 m/A. 500 ohms. ... 3/11
- AMERICAN Smoothing Chokes** interleaved but not shrouded 50 hy. 150 ohms. ... 3/11
- AMERICAN Smoothing Chokes** interleaved but not shrouded 15 hy. 200 m/A. 200 ohms. ... 8/6
- FULLY SHROUDED 500-watt Auto Transformers**, 110-230 v. (cost £3) ... 29/6
- AMERICAN Mica .00015 Coupling Condensers**, 1,500 v. D.C. test ... 1/-
- RESISTORS**, 25-watt, 15,000, 10,000, 10,000 c.t., 5,000 tapped, 2,500 tapped. While they last. ... 1/-
- 10-WATT Wirewound** 400,500 ohms ... 9d.
- 10-WATT Wirewound** 1,500 ohms ... 6d.
- JOHNSON Type 211 50-watt. Ceramic Sockets** ... 4/9
- ROTARY Mains Toggle Switches** ... 9d.
- ROTARY Mains Toggle Switches**, but Mains Change-over ... 9d.
- 5-Metre Police Car Aerials**, fit on bumpers ... 20/-
- 5-Metre Police Car Aerials**, side of scuttle fixing ... 17/6

**THE SHORT-WAVE SPECIALISTS.** We are the oldest Distributors for BILEY, THORDARSON, TAYLOR TUBES, RME, BASSETT CONCENTRIC CABLE, HOYT METERS, COLLINS, NATIONAL, ETC.

Send us your enquiries. Large stocks carried.

44, HOLLOWAY HEAD,  
BIRMINGHAM, I.

Telephone: MIDLAND 3254.

## Layout and Construction

reaction coil in conjunction with a four turn grid coil, but the ultimate design could not be expected to permit this

quietly earthed together and to two points of the chassis, this resulting in absolute freedom from background

the front panel and the screen, whilst at the same time extra strength is given to the screen itself.

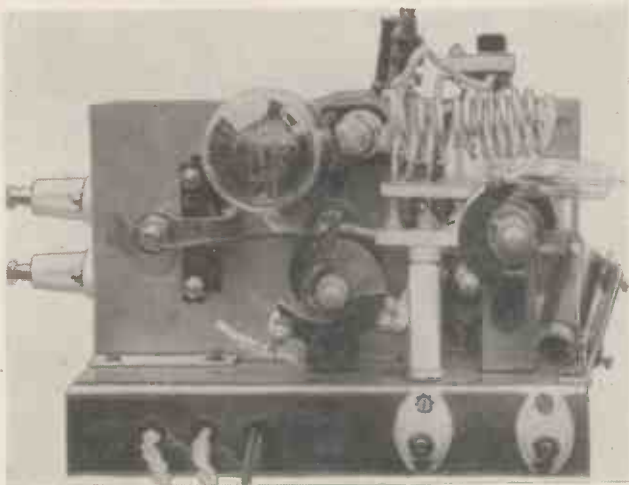

This view of the receiver gives a very good indication as to the overall dimensions.

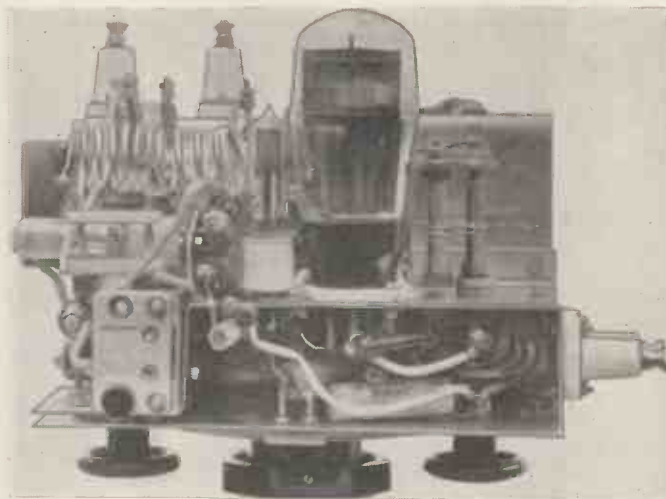

How most of the smaller components are fitted into the small space provided can be appreciated from this view.

condition when surrounding the R.F. section with components, however the efficiency of the detector is proved.

The anode choke of the X.S.G. is rigidly mounted on an insulating pillar directly underneath the reaction condenser drive, and rigidity is again obtained whilst wiring is facilitated.

A separate bracket is used for the pre-set condenser, and in thinking of easy adjustment when mounting this condenser, it was nevertheless apparent that hand capacity might influence the setting, strangely enough there is no difficulty here although so close to the front panel.

The bandspread condenser has a maximum capacity of 22.5 mmfds. and this in conjunction with the series coupled pre-set and band setting condensers provides an exceptionally easy control.

From the illustration it will be seen that the design throughout is free of trimmings, and no doubt that is the reason for its stable performance, and good quality on the television band; even the decoupling is left to the X.S.G. and Y220 screen grid condensers.

The phone terminals are kept well away from the R.F. side by once more using insulating pillars, and the earth and aerial terminals are likewise arranged.

One of the most important considerations lay in the method by which the earthing is arranged, and as at first it was thought that a copper or brass commoning bar would be essential, it will be seen on referring to the under chassis view, that a length of tinned copper wire proved sufficient, with the battery and chassis connections being made directly to this.

The variable condensers were ade-

quately earthed together and to two points of the chassis, this resulting in absolute freedom from background

noises due to high impedance earthing points. The Y220 in this particular model has the side terminal screen grid connection, but exception can be made here if a five-pin type be to hand.

By the precautions taken in the L.F. stages it was not necessary to employ choke filter output, the conventional series choke method being employed, and this stage is free from H.F. influence.

From the picture it will be noticed that two small brass angle pieces further clamp the phone output terminal panel, this being necessary for rigidity and prevention of crackle due to any possible movement between this panel,

The writer finds that it is a sound policy to be very free with the use of spring washers during the assembly of such a chassis as this, since not only will a rigid job result, but one giving a maximum degree of electrical continuity.

By incorporating epicyclic drives for the reaction and bandset controls, with the well known Eddystone slow motion drive, there is complete freedom from back-lash, and those used to U.S.W. will find that without the band set condenser a very good control can be effected.

No L.T. switch is included in the design and the only controls therefore are confined to the large attractive

### Components for AN EXPERIMENTAL 5-8 METRE RECEIVER

#### CHASSIS.

1—Aluminium to specification, 18 S.W.G. (Peto-Scott).

#### COILS.

1—Type ULCA (Eddystone).  
1—Type ULTI (Eddystone).  
1—Type ULTO (Eddystone).  
1—Type ULTA (Eddystone).

#### CHOKES, HIGH FREQUENCY.

3—Type CHM without metal caps (Raymart).  
2—Type CHP (Raymart).

#### CONDENSERS, FIXED.

1—50 mmfd. USW type (Dubilier).  
1—.01 mfd. type 350 volt D.C. working (Polar).  
3—.1 mfd. 350 volt D.C. working (Polar).

#### CONDENSERS, PRE-SET.

1—50 mmfd. (Cydron).

#### CONDENSERS, VARIABLE.

1—Type 900/20 (Eddystone).  
1—900/100 (Eddystone).  
1—15-mmfd. type 2140 Midget (Jackson Bros.).

#### DIAL, SLOW-MOTION.

1—Type DUMTR (Eddystone).

#### HOLDERS, VALVE.

3—Type V6 4-pin Midget (Clix).  
1—4-pin Midget (Clix).

#### HEADPHONES.

1—Pair supersensitive (Ericsson).

#### HOLDERS, COIL.

2—Type ULBA (Eddystone).

#### KNOBS.

2—Black wheel knobs (Webb's Radio).

#### PLUGS, SOCKETS, ETC.

3—Type No. 33 (black, red and yellow) (Clix).  
3—No. 3, GB red, GB black, GB green (Clix).  
2—No. 14 spade terminals, one black, one red (Clix).

#### RESISTANCES, FIXED.

1—10,000-ohm type 1 watt (Polar).  
1—20,000-ohm type 1 watt (Polar).  
1—50,000 (F $\frac{1}{2}$ ) (Dubilier).  
1—1-megohm (F $\frac{1}{2}$ ) (Dubilier).  
1—.25 megohms (F $\frac{1}{2}$ ) (Dubilier).  
1—4-megohm (F $\frac{1}{2}$ ) (Dubilier).

#### SUNDRIES.

4—Insulating pillars, type SM (Raymart).  
3—Insulating pillars, type M29 (Eddystone).  
2—Brackets, type E89 (Bulgin).  
2—Reduction drives, type ERD (Raymart).  
2—Flexible couplers, type FT (Raymart).  
1—Gross type P197 spring washers (Bulgin).

#### VALVES.

1—Type X.S.G. (ceramic base) (Hivac).  
2—Type X.D. (ceramic base) (Hivac).  
1—Type Y.220 four or five-pin (Hivac).

# ACCURATE Instruments for ACCURATE Testing



BRITISH  
MADE

**£3 10s.** in case, with high voltage leads, test prods, crocodile clips and instruction booklet.

DEFERRED TERMS IF DESIRED

Highly efficient testing facilities are provided by either of these models of the AvoMinor. Whilst moderate in price, they are precision instruments, made by the makers of the famous AvoMeter—the world's foremost combination testing instrument.

## The NEW High Resistance AvoMINOR

ELECTRICAL MEASURING INSTRUMENT

**20,000 ohms per volt**

A new instrument developed for the direct measurement of grid bias and television voltages and currents. It is an extremely sensitive D.C. Microammeter calibrated as a multi-range Voltmeter and Megohmmeter. Its six voltage ranges are all at 20,000 ohms per volt, the consumption at full scale deflection being 50 micro-amps. This sensitivity permits precision readings with negligible loading. Resistance measurements are provided for, an external source of D.C. voltage being required, and adjustment is provided for the actual voltage employed.

### The Universal AVOMINOR

Electrical Measuring Instrument

A precision meter for measuring A.C. and D.C. volts, D.C. milliamps, and ohms. It has 22 ranges. An accurate moving-coil movement gives a 3 in. full scale deflection. Total resistance is 200,000 ohms. Complete with instruction book, leads, testing prods and **£5 10s.** crocodile clips.

Leather case, 10".



● Write for fully descriptive literature to The Sole Proprietors and Manufacturers :  
The **AUTOMATIC COIL WINDER & ELECTRICAL EQUIPMENT Co. Ltd.**  
Winder House, Douglas Street, London, S.W.1. Phone : Victoria 3404-7.

## Selected and Specified for an EXPERIMENTAL 5-8 METRE RECEIVER



Three Resistances—one price : 120, 2,000 and 4,000 ohms.

**15/-**

## *Ericsson* SUPER SENSITIVE TELEPHONES

No wonder the designer of this Experimental 5-8 metre Receiver featured in this issue chose Ericsson Telephones as indispensable. They are simply perfect for the 100 per cent. functioning of this set.

Wonderfully sensitive, comfortable in wear and very pure in tone, they have come to be regarded as standard for the keen short-wave enthusiast's equipment.

Use them with your Experimental 5-8 metre Receiver.

At all good radio dealers. If you have any difficulty in procuring, write direct to :

**ERICSSON TELEPHONES, LTD., 22, Lincoln's Inn Fields, London, W.C.2**

Telephones : 6396 HOLborn

## Wiring

vernier dial and the two wheel knobs, giving an evenly balanced appearance to the front panel. The wheel knobs

touching, these turns finally being soldered together. One end (the winding end) of this condenser is con-

longer than 3 in. and this be pressed snugly down over the condenser.

For the link coupling the writer used a length of 16S.W.G. bare copper wire covered with sleeving and fashioned to the same diameter of the coils, but for one turn only.

The aerial conditions as previously mentioned are entirely optional, and where as one experimenter may require a half wave dipole type with characteristics suited to his locality, another will be able to operate very satisfactorily on an ordinary "L" type of reasonable length.

Good phone results on the television bands will be obtained equal in quality to normal broadcast reproduction to within a radius of 30 to 40 miles of the transmitter, but for any DX work the reader is advised to consider the directional properties of his aerial and its natural wavelength.

The receiver is quite adaptable for reception above the 5 to 8-metre bands without any adjustment to the wiring, the only consideration for the lower frequencies being in the value of C<sub>1</sub>, but it will be a simple matter to replace this component when required.

The coils for these different wavebands, it can be suggested, may be constructed on 1 in. or 1½ in. formers, the connections to the original coil sockets being made by stout gauge wire, the connections being kept well away from the adjacent components and as short as possible.

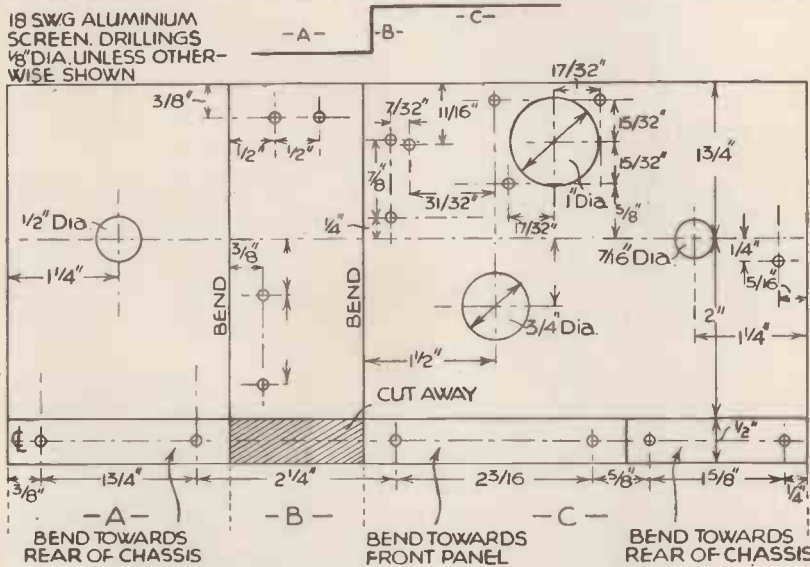

The dimensions and hole positions can be seen in this drawing.

necessarily overlap very slightly, the bandspread dial, but not to such an extent that it interferes with the tuning.

It will be found that the grid coil ceramic mount will actually touch the fixed vanes of the reaction condenser, but there will not be any pressure likely to cause trouble here if the drillings have been accurately carried out.

The filament sockets of this valve are wired directly to those of the X.S.G., the two leads being taken down through the chassis as previously mentioned, but being kept well away from the screen.

The 50 mmfd. fixed grid condenser is directly wired between the grid socket and the coil, the other end of this coil, of course, returning to the negative filament socket and the earth side of the bandspread condenser.

The grid leak must be mounted vertically and away from the choke which is similarly mounted, the ends of these components being taken directly to their respective sockets.

For the sake of rigidity a short length of 14 or 16 S.W.G. bare copper wire should be soldered to one end of the choke thus providing a strong point for soldering and holding the .01 mfd. condenser and 10,000 ohm resistance.

A short length of wire connects the anode socket of the detector to the near tag of the reaction coil, this completing the detector stage.

The next point which requires mentioning is the condenser "C," this comprises a 1½ in. length of 16S.W.G. bare copper wire over which is worked a length of sleeving, then 14 turns of 20S.W.G. tinned copper wire are wound over the sleeving with adjacent turns

nected to the fixed vanes side of C<sub>2</sub>, the other end (winding end) being taken to the fixed vanes terminal of C<sub>1</sub>.

The screen grid lead to the Y220 should be kept as short as possible and pressed well back to the screen after fitting the valve; the connection from the reaction coil to C<sub>4</sub> should be no

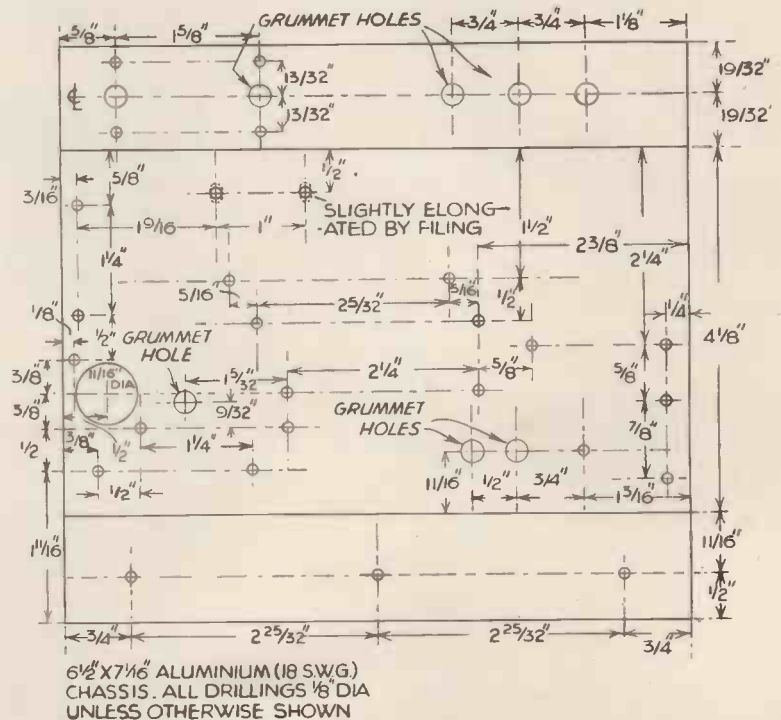

It is important that the chassis be accurately built in order to obtain results equal to those given by the original in instrument. This drawing gives the dimensions.



SOUND SALES

Special TRANSFORMERS

FOR USE WITH  
CATHODE RAY  
EQUIPMENT  
AND  
HIGH VOLTAGE  
TRANSMITTING  
APPARATUS

We illustrate our model Tel. EHT., for 200/240 volts at 40/100 cycles. Secondary output 1,753 volts at 20 mA.

PRICE

£2-18-6

Our New 56-page Catalogue includes many new products of special interest to readers of this journal. When sending for your copy, please enclose 6d. P.O. or stamps.

SOUND SALES LIMITED

Marlborough Road, Upper Holloway, London, N.19  
Phone: Archway 1661-2-3 (Contrs. to G.P.O., etc.)

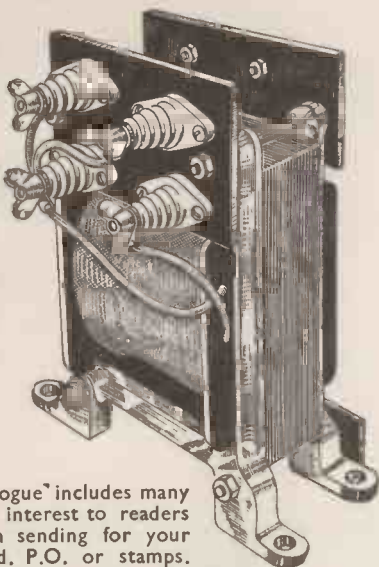

ELECTRON  
OPTICS IN  
TELEVISION

with Theory and Application  
of Television Cathode-Ray Tube

By I. G. MALOFF

Research Division, R.C.A. Manufacturing Co., Inc., Camden, N.J.

and

D. W. EPSTEIN

Research Division, R.C.A. Manufacturing Co., Inc., Camden, N.J.

299 pages, 9" x 6", illustrated, 21/- net.

In this book the authors develop the theory of electron optics from its fundamentals and cover its application in the design of the television cathode-ray tube, including an account of that part of the subject with which the authors have had first-hand experience at the Research Laboratories of the R.C.A. Manufacturing Company. From the book the reader should get an understanding of electron optics and be able to use electron optics in various problems of pure and applied physics. He also should get the basic principles of the design of television cathode-ray tubes and associated circuits. Most of the material has never appeared in book form and some of it has not been published previously.

The Introduction presents a brief description of a complete cathode-ray television system and a few applications of electron optics for the purpose of informing readers not already familiar with such systems and applications and also to clarify certain concepts and terms used in television.

Part I develops the theory of electron emission and electron optics. Although the theory of pure magnetostatic and combined electrostatic-magnetostatic focusing is developed, by far the greater part of the treatment of electron optics is limited to pure electrostatic lenses, particularly those involving two coaxial cylindrical electrodes. Part II deals with the problems encountered in designing tubes, practical and economical to construct, and capable of producing satisfactory television pictures when used with practical associated apparatus. Included are several approximate methods for solving in a practical way some of the non-linear-circuit problems connected with the design of apparatus associated with the television cathode-ray tube.

Chapter Headings

Preface	Defects of Electron-Focusing System of TCR Tubes
Introduction	Magnetostatic Focusing
PART I. ELECTRON OPTICS	PART II. TELEVISION CATHODE-RAY TUBE
Fundamental Concepts	The Electron Gun
Electron Emission	Deflection of Electron Beams
Analogy between Electron Optics and Light	Luminescent Screens for TCR Tubes
Motion of Electrons in Axially Symmetric Electrostatic Fields	Tube Classifications, Rating and Characteristics of TCR Tubes
Electrostatic Electron Lenses	Accessories
Electrostatic Lenses of Television Cathode-ray Tubes	Vacuum Practice
	Index

McGraw-Hill Publishing Co. Ltd.,  
Aldwych House, London, W.C.2

The  
SPENCER WEST Television Pre-Amplifier  
will reduce interference and increase the range of any Television receiver.

It is particularly suitable for use where low field strengths exist and a number of satisfied users have testified to the great improvement effected upon installing the unit.

It is entirely mains operated and is easily connected. The output circuit is such as to ensure an efficient match to all classes of receiver and to facilitate installation. It being only necessary to connect a feed line from the unit to the aerial terminals of the main receiver and plug into the mains.

PRICE complete with all valves and full operating instructions 6 gns.

SPENCER WEST, WORLINGHAM, Nr. BECCLES  
Telephone—Beccles 3159.

Engineers' Guide

Shows how to qualify in Television, Sound Recording, Radio Engineering and Servicing, Wireless Communications, etc., by studying at home with The T.L.G.B. Write to-day for this Great Guide containing world's widest choice of engineering courses and which alone gives the Regulations for A.M.L.E.E., A.M.I.R.E., A.M.L.T.E., etc.

THE TECHNOLOGICAL  
INSTITUTE OF GREAT BRITAIN  
160 Temple Bar House, London, E.C.4  
(Founded 1917. 20,000 Successes)

Free!



To Success

200 Courses



# New Amateur Equipment

*Some of the most important developments in short-wave amateur equipment are dealt with in this article by Malcolm Harvey*

This automatic sender designed by McElroy, the world champion telegraphist, can be hired as explained in the text. [ ]

**S**PEAKING as an ordinary amateur, there appears to be more than the usual number of sets, components and other gadgets available this year which have been designed specifically for the experimenting short-wave constructor.

One often hears of manufacturers producing this, that and the other for amateurs but in so many cases it generally turns out that the components in question are of the modified broadcast type which, although better than nothing, do not generally rise to expectations.

There are, however, several manufacturers who have produced items of exceptional interest and after carefully going round Radiolympia and also checking up on new season's equipment from all sources, I feel that amateurs should know about some of the more important items. For example, I was particularly impressed with the automatic Morse recorder handled in this country by Webb's Radio. This recorder, made by McElroy of Boston, can be added to any radio set that will produce an output of about 2 watts and will accept morse code transmissions up to 50 words per minute. It is purely automatic in operation and can be attached to a receiver and left operating for long periods.

Associated with this recorder is an automatic sender which operates on the light beam and photo-cell arrangement with ordinary tape on which can be linked the Morse messages to be sent. This automatic sender can be used for group teaching and it is being arranged that any responsible body will be able to hire the equipment for a nominal sum.

The high-light of the Exhibition was undoubtedly the new receiver produced by Eddystone. This company have on their staff a large number of active transmitting amateurs who are fully aware of the requirements of a set suitable for amateur communication use. Eddystone have taken a long time to

embody all the information supplied by these amateurs but have now produced their type ECR receiver which according to independent reports from people who really know, is a receiver out of the ordinary run of things.

panels and chassis of international dimensions. The complete relay rack is 25s. and the finish is exceptionally good.

For those who are not in a position to use a receiver of the expensive type,



This is the Eddystone answer to the multi-valve high-quality American communication receiver. The type is E.C.R. and the price 45 guineas

The ECR is a superheterodyne with 10 valves including rectifier, with a high-frequency stage, mixer, electron-coupled oscillator, two I.F. stages, double diode detector, beat frequency oscillator, audio amplifier and tetrode output. Switch coils cover 9.5 to 190 metres, that is 33 to 1.6 megacycles with a very sensible sensitivity level. The overall selectivity with the crystal out is approximately as follows:—

- 6 db. down at 3.5 kc.
- 20 db. down at 8 kc.
- 30 db. down at 12 kc.
- 40 db. down at 15 kc.
- 60 db. down at 21 kc.

With the crystal in and phased the band-width is at 20 db. down, .15 kc., and at 30 db. down .3 kc. The price is £45, which is not excessive considering the capabilities of this receiver and the fact that it also includes a calibrated signal strength meter marked in decibels.

The Eddystone rack is also of particular interest for it has been designed so that it can either be suitable for three chassis, or increased in height to 63 in. and suitable for standard relay

there is another most interesting communication set which will become very popular amongst amateurs. This is the 5V5 amateur set produced by Messrs. Premier. This receiver includes five valves and has complete coverage from 12 to 2,000 metres; there are three short-wave bands and an entirely separate bandspread condenser with a two-speed drive. Individual



For those who need a compact and reliable 5-metre transceiver, this Peto-Scott product can be recommended.

**"STANCOR" Swing Chokes.**

Cat. No.	Induct.	m/A.	Price
CI302	8/30	250	12/-
CI400	8/40	175	12/-
CI401	8/30	200	15/-
CI645	8/35	200	16/6
CI402	8/30	250	17/6
CI403	8/25	300	30/-

**Filter Chokes.**

CI515	50	15	4/-
CI362	15	40	4/-
CI277	15	50	4/-
CI003	30	50	5/-
CI002	30	75	6/6
CI420	30	80	12/-
CI001	30	110	7/6
CI421	25	140	12/6
CI410	20	175	12/-
CI411	18	200	15/6
CI646	20	200	16/6

**Modulation Transformers.**

A3811 89, 42, etc., to Sup-Grid RK25	...	4/-
A3323 PP. 42's, 45's, etc., to RK28, RK20	...	14/-

A WIDE RANGE OF THESE CHOKES AND TRANSFORMERS FOR EVERY PURPOSE ARE AVAILABLE AT REALLY KEEN PRICES—PLUS FIRST-GRADE WORKMANSHIP AND MATERIAL.

**Sole Distributors:—** **RADIOGRAPHIC, LTD.,**  
Dean House, 2, 3 & 4, Dean Street, London, W.1.  
66, Osborne Street, Glasgow, C.1.

**HALLICRAFTERS**

SKY BUDDY	...	£9
SKY CHAMPION	...	£15
SKY CHALLENGER	...	£25
SKY RIDER	...	£32
SUPER SKYRIDER	...	£39 10s.

**NATIONAL**

NC80X or 81X	...	£25
NC100X or 101X	...	£41 10s.

complete with HIFI speaker.

H.R.O. Junior.

H.R.O. Senior.

**ALL NATIONAL PARTS IN STOCK.**

- R.M.E. 69.
- R.M.E. 69 with noise silencer.
- R.M.E. D.B.20.
- R.M.E. 510X.

**HAMMARLUND**

**HALLICRAFTERS SPARES FOR ALL NEW MODELS**

**The M<sup>C</sup>CARTHY**  
**1939**  
**CHASSIS RANGE**

**M<sup>C</sup>CARTHY**  
*The Chassis Specialists*

**The M<sup>C</sup>CARTHY**  
**1939**  
**CHASSIS RANGE**

Receivers of rare quality—without frills—designed by the industry's leading designers—unequalled in the industry to-day. Truly "All-wave"—even the smallest—continuous coverage from 13 to 550 metres, and suitable for use in all parts of the world. The use of only the finest grade components obtainable, and first-class workmanship ensure a performance far above the average

RS639. 8 stages, 6 valves, 4 wavebands, for A.C. Mains.	...	£9 0 0
RS639U. As above, for A.C./D.C. Mains.	...	...
RS739. 9 stages, 7 valves, 4 wavebands, for A.C. Mains.	...	£10 17 6
RS739U. As above, for A.C./D.C. Mains.	...	...

PP739. 9 stages, 7 valves, 4 wavebands, push-pull output, providing 10 watts, undistorted, A/C. ... .. £11 11 0

PP939. 11 stages, 9 valves, 4 wavebands, push-pull output, providing 12 watts, undistorted. Noise suppression, variable selectivity, non-drift I.F. transformers, permeability tuned. Wave range 10-2,200 metres. A/C. £14 14 0

PP939U. As above, for A.C./D.C. Mains.	...	...
PP1939. The largest and most ambitious of all the McCarthy range, and probably the largest commercial receiver manufactured in Great Britain. This remarkable chassis has all the features of the De Luxe American receiver.	...	...

C.W. beat oscillator, interstation noise suppression, variable selectivity (valve operated), auto-expressionator, contrast expansion, with an output of four 6L6 beam pentodes in Class A parallel push-pull developing 25 watts undistorted output.

Built on a 14 gauge, bright aluminium chassis, ample mains equipment, magic eye, 12 in. scale, 6 wavebands, with continuous coverage from 4.5 to 2,000 metres. Price 32 guineas.

**THE DUAL UNIT ASSEMBLY**



Unit "A," Comprises a newly designed 5 stage, 4 valve, 6 channel "TUNING UNIT"—a complete and up-to-date superhet with R.F. amplifier, triode-hexode frequency changer, I.F. amplifier diode detector, optional bandwidth variation, A.V.C. Wave range 4.5 to 2,200 metres. Easily applied to any existing amplifier or audio unit, accurately aligned and ready for use. Complete with all instructions and circuit details, (less valves) ... .. £7 10 0

Unit "B," Intended for use in conjunction with Unit "A," but possessing versatile features which enable it to be readily used as a High Fidelity Amplifier for radio, gramophone or sensitive microphone. Undistorted output, 10 watts. Price complete with valves £11 10 0 The Dual Unit complete, makes an outstanding receiver, we claim that it is without an equal in commercial radio to-day. As such it must have a real appeal to the discriminating buyer

All McCarthy apparatus available on 7 days' approval against cash. Hire purchase readily available. For illustrated descriptive literature send 3d. in stamps. Abridged list free of charge. All enquiries to be addressed to the sole manufacturers and distributors:

**H. MCCARTHY LTD.,**

92, QUEENSWAY BAYSWATER W.2

Telephone: Bayswater 1102

## A Cheap Amateur Receiver

coils are used for each band which are of the Litz wound type while a high degree of selectivity has been obtained in the I.F. circuit by means of iron-cored coils. The valve line-up is 6K8,

cluded such as a compensating device for maintaining a constant frequency irrespective as to whether the instrument is being used to transmit or receive. The price complete with

in amateur constructed broadcast receivers or for public address work in conjunction with amplifiers. They have, for example, a 10 in. high fidelity recording loudspeaker which is conservatively rated to handle 6 watts input. It is priced at £3 10s. An extremely low figure. Another interesting loudspeaker is the P12PM, which includes a detachable diaphragm. It will handle a signal input of 20 watts and has a flux density of 13,000 lines per square cm. There is also an energised model of similar characteristics and the prices are £6 15s. for the permanent magnet model and £4 10s. for the energised model. I suggest as a matter of interest that amateurs get in touch with this company and obtain a copy of their new catalogue which gives a wealth of interesting data.

Raytheon Production Corporation of America have produced a handbook which includes as much information as many high-priced manuals. It covers all their transmitting valves with every possible detail the amateur is likely to require. It also gives information on modulation, how to measure the percentage, making the most of transmitting equipment, and in its 82 pages there is something to interest every constructor. This book is obtainable in England through Webb's Radio, 14 Soho Street, W.1., and is priced at 2s., post free.

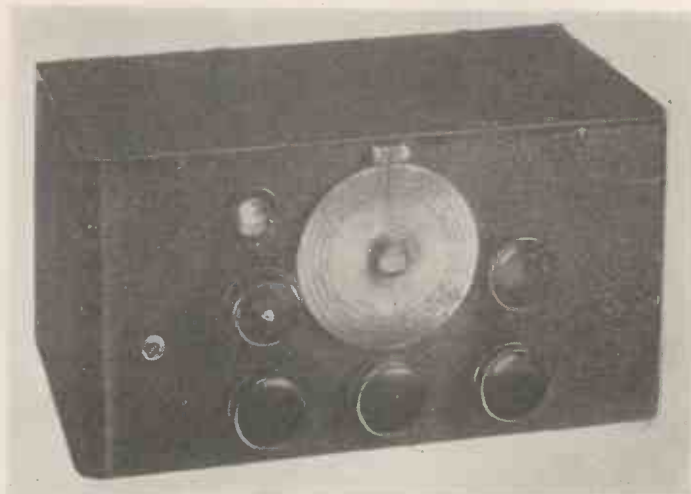

One of the cheapest communication receivers available for amateurs which has a full waveband coverage is the Premier 5V5. It costs 8 guineas and covers from 12 to 2,000 metres.

frequency changer, 6F7, I.F. amplifier and beat-frequency oscillator, 6Q7, second detector A.V.C. and first audio, 6V6, output tetrode and a 5Y3, full-wave rectifier. The 6V6 valve provides 4 watts output, while there is a phone jack and provision for an R meter. The price of this receiver is 8 guineas, which includes a separate moving-coil loudspeaker housed in an all-steel cabinet.

One of the new transmitters designed by Premier this year is capable of an input of approximately 120 watts between 28 mc. and 1.7 mc. It is built in the standard relay rack and complete with high quality modulator, all valves, crystal and coils is £60. At this price it is probably one of the cheapest in its class. Service engineers will also take particular interest in the new Premier oscilloscope using a 3½ in. tube. The price is 10 guineas, which is extremely cheap considering that the oscilloscope includes amplifiers for both horizontal and vertical deflection.

As 5-metre working is becoming much more popular I took particular interest in a new transceiver produced by Peto-Scott Co. This transceiver, of the conventional two-valve type, covers 5 to 7 metres, and is absolutely self-contained including accumulator, high-tension battery and a built-in microphone. This microphone can be seen behind the grill above the slow-motion drive in the illustration. Several novel features have been in-



This is a new Murphy receiver which has been modified to cover the 160-metre amateur and commercial waveband.

power supply and a pair of tetrodes is 11 guineas.

I have noticed that amateurs are not at all keen on building broadcast receivers, although most amateurs still construct their own short-wave receivers. The main amateur interest on the broadcast wavelength seems to be obtaining high quality reproduction. Goodmans Industries, Ltd., who are now at Lancelot Road, Wembley, Middlesex, have been known for many years as manufacturers of high-grade loudspeakers. This year, they have a range of instruments suitable for use

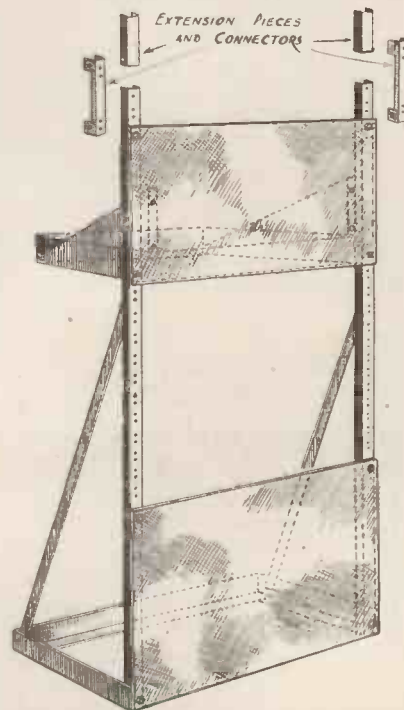

Eddystone's new rack is in two distinct sections so that as the transmitter grows additional chassis can be added to the rack.

**No-trouble PRESS - BUTTON  
ALL-WAVE**

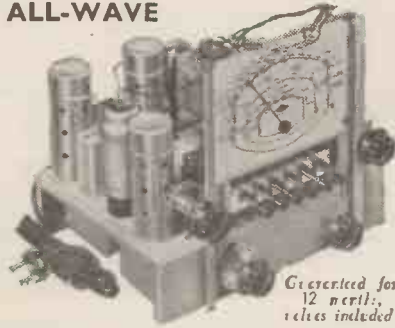

Guaranteed for 12 months, valves included.

**A.C. AND BATTERY CHASSIS**

- No fragility and complication of electrical systems
- Positive action
- Pre-set for 6 MW and LW stations,
- Settings instantly changeable without opening up set
- Manual tuning for all-world reception
- Exceptionally convenient terms,

**8-STAGE A.C. ALL-WAVE MODEL 909.**

**SPECIFICATION:** As illustrated. Advanced 6-valve 8-stage A.C. superhet, with 3-watt high-fidelity output. 4 Wave-ranges, 10-25, 22-65, 200-550, and 900-2,000 metres. Circuit: pre-R.F. selector coupled to R.F. amplifier transformer coupled to triode hexode frequency changer, bandpass I.F. transformer coupled to I.F. amplifier, bandpass transformer coupled to double diode triode providing rectification, A.V.C. and first stage L.F. amplification, resistance-capacity coupled to output power pentode. Illuminated, station-named calibrated dial. Six-station Press-Button Tuning. Manual tuning, 36-1 ratio Combined on-off switch and volume control. Tone control. Size 11 1/2 in. w., 9 1/2 in. h., 8 1/2 in. deep. Supplied complete with all valves, knobs, and escutcheon. Guaranteed, fully tested. Cash or C.O.D. Terms, 7/6 down and 18 monthly payments of 1/3. Matched speaker with 8 in. £8.19.6 cone, 2,500 field, complete with transformer, type C276, 27/6 extra.

**7-STAGE A.C. ALL-WAVE MODEL 908.**

**SPECIFICATION:** Modern 5-valve 7-stage A.C. superhet, with 3 wave-ranges: 18-50, 200-550, and 900-2,000 metres. Six-station Press-Button and Manual (36-1) tuning. Illuminated station-named calibrated dial. Combined on-off switch and volume control. Tone control. 4-position switch for 3 wave-bands and gramo. Circuit: R.F. amplifier, followed by triode hexode frequency changer bandpass coupled to I.F. Amplifier, followed by double diode output pentode giving 3 watts audio output. Full-wave rectifier, with smoothing circuit. Supplied complete with British valves, knobs and escutcheon. Guaranteed, fully tested. Cash or C.O.D. Terms, 7/6 down and 18 monthly payments of 10/-. Matched energised £7.19.6 speaker, complete with transformer, 19/6 extra.

**7-STAGE BATTERY ALL-WAVE MODEL 903.**

Sensitive 4-valve 7-stage circuit with filter to triode pentode frequency changer, Litz-wound transformer coupled to H.F. pentode as I.F. amplifier similarly coupled to double diode triode followed by output pentode. Wave range and chassis size as A.C. model. 6 station press-button and manual tuning. Station-name dial. Low H.T. consumption. Supplied complete with British valves, knobs and escutcheon. Guaranteed fully tested. Cash or C.O.D., £5/12/6 Terms, 5/- down and 18 monthly payments of 7/-. Matched £5.12.6 P.M. moving coil speaker, complete with transformer, 21/- extra.

● For the Short-Wave enthusiast  
**B.T.S. TROPHY 8 COMMUNICATION TYPE RECEIVER**

A new B.T.S. 8-valve A.C. communication receiver recommended for efficient short-wave reception. Wave range 10-550 metres with continuous bandspreading R.F. on all bands. B.F.O. with separate pitch control. A.V.C. and B.F.O. on-off switches. Phone pack. Designed for use with separate P.M. speaker. Housed with smoothing circuit in pleasing metal cabinet. Cash or C.O.D. Terms. Initial payment 12 Gns, of 15/6, balance in 18 monthly payments of 15/6.

**FREE** Send now for complete radio lists covering Press-Button and Manual control only Receivers and Chassis and short-wave apparatus all available at lowest cash prices and easiest of easy terms.

**PETO SCOTT Co. Ltd.** 77 (T.9.) CITY ROAD, LONDON, E.C.4  
Tel.: CLI 9875

**Full of Interest**

Illustrated constructional articles for building simple S. W. Receivers ● low and medium power Transmitters ● Amateur Communication Receiver Pre-selector ● Cathode-Ray Oscilloscope etc. From your Radio Dealer; W. H. Smith & Sons, or in difficulty send 1/2 to Stratton & Co. Ltd., Eddystone Works, Bromsgrove St., Birmingham London Service Webb's Radio, 14, Soho St., W.1.

**EDDYSTONE Short Wave MANUAL**



**BARGAIN TIME**  
AT  
**A.C.S. RADIO**

We list below a selection of second-hand and shop-soiled receivers at bargain prices. It will pay you to study this list carefully. Needless to say every receiver is rigorously tested to ensure perfect operation and all carry our usual guarantee. Full technical details sent on request.

National NC.100 and speaker, perfect condition	£25 10 0
Hallicrafters 1938 Super Skyrider SX16	£24 0 0
Tobe-Deutschmann Ham-band in cabinet, with speaker	£12 17 6
RME 69 Standard model, New, very slightly demonstration soiled	£31 10 0
Hallicrafters Sky Chief	£7 17 6
Hallicrafters 1937 Sky Buddy	£5 17 6
Hallicrafters 1937 Super Skyrider SX11, perfect order	£17 10 0
National HFC 5 and 10 metre converter, new	£6 6 0
Hallicrafters Sky Challenger I	£17 10 0

Also a large selection of all-wave receivers, consoles and table models. All the latest models in stock. Send for free catalogue of sets, valves, components, etc.

**A.C.S. RADIO** TECHNICAL G2NK  
MANAGER  
16 GRAYS INN ROAD, LONDON, W.C.1  
Telephone: HOLBORN 9894-5

**TELCON CABLES**

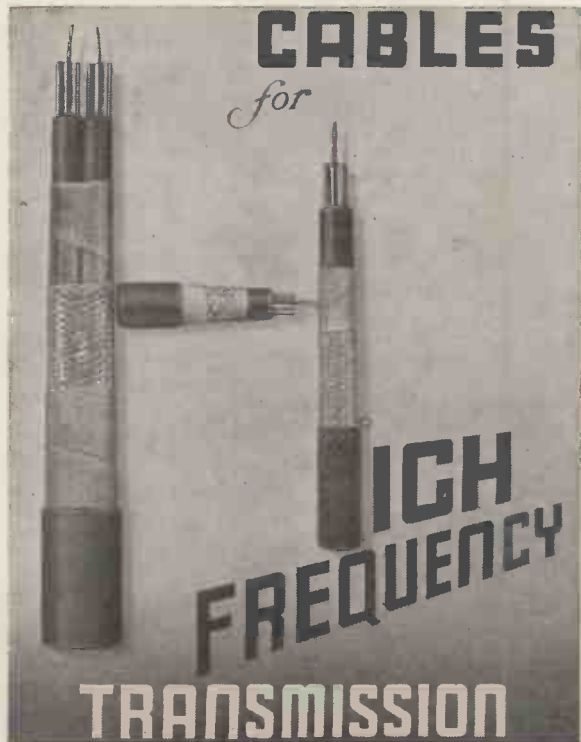

**HIGH FREQUENCY TRANSMISSION**

Full particulars of all TELCON PRODUCTS from:  
**THE TELEGRAPH CONSTRUCTION & MAINTENANCE CO., LTD.**  
Head Office: 22, OLD BROAD ST., E.C.2. Telephone: LONDON Wall 3141.  
Works: Greenwich, S.E.10. Telephone: GREENwich 1040.  
Telcon Cables were exclusively used for all Television Transmissions from Radiolybia.

## "Phased Antenna Systems"

IN the September issue on pages 580, 581 and 584 was an article under the above heading and credited to the well-known authority on antennas, Bryan Groom, GM6RG. This article, which was re-written from information supplied from GM6RG, deals in one section with the Diamond aerial in such a way that the original comments of the author are open to misconstruction.

GM6RG wishes it to be known that he does not consider the Diamond aerial to be unsatisfactory, on the contrary he knows, as do most amateurs, that this type of aerial is capable of giving probably the highest gain of any normal antenna. His remarks on this type of antenna, which are of considerable interest and should be read in conjunction with the article on page 580, col. 1, of the September issue, are as follows:—

"It is well known that for satisfactory DX operation a low angle of radiation is desirable, preferably sharply defined, so as to avoid the wastage of power if DX be the object of the transmission, which will take place if high-angle radiation is a good proportion of the total. Furthermore, if a wide vertical lobe is radiated, fading will be worse at the receiving end, due to mutual interference between signals

arriving from different angles. The diamond or "V" antenna has been upheld as the ideal in this direction, since, amongst other features, the angle of radiation can be so exactly controlled. The writer has had a good deal of experience with both of these types of antenna array, and has come to the conclusion that from the point of view of the amateur, who is not interested in point-to-point operation, these systems' disadvantages far outweigh their advantages. If for no other reason than that in order to obtain this really low angle, the array is of such dimensions that the horizontal pattern becomes very restricted, a most undesirable condition from an amateur points of view.

GM6RG also points out that his remarks regarding the diamond were:—

"It should be emphasised at this point that the diamond never gave the gain it should have done, for the reason that very early we had ascertained the disadvantage of the very narrow coverage of the large array and had widened it by altering the shape of the antenna from the ideal, to split the nose of the radiated beam, but even so it is good, much better than anything else we had used up to the time of these recent experiments."

We also wish to point out printer's errors, the first on page 580 in which the word "load" should read "lobe" and the second on page 584 in which the term "High Q array" is printed as "High cure ray."

Whilst it is true that none of these changes from the original article affect the description of the phased array the arguments were rather spoiled which we regret.

## POTENTIOMETERS

"RELIANCE" and RELIABILITY are SYNONYMOUS

For over 17 years we have specialised in the production of wire-wound and composition types of Rheostats and Potentiometers of precision.

The continual Specification of Reliance products is your guarantee of their unflinching efficiency.

Specified for the  
PORTABLE OSCILLOSCOPE

1.0 megohm Compo type 4/9

0.1, 25,000 and 10,000 ohm Wire Wound type 4/6

Folder T.S. Free

**RELIANCE**

THE PRODUCT OF  
SPECIALISED RESEARCH

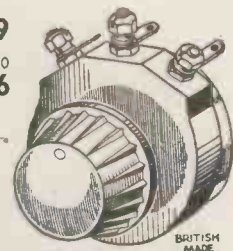

BRITISH  
MADE

**RELIANCE MANUFACTURING CO (SOUTHWARD) LTD**  
WESTBURY ROAD, LONDON E 17

## HIVAC "MIDGETS" and the 5-8 metre Receiver

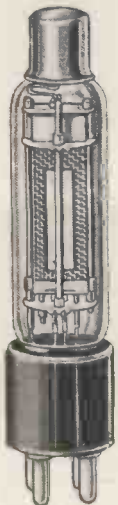

(Actual Size)  
"MIDGET" XSG

In addition to the excellence of design, construction and characteristics of the HiVac "Midget" valves, they allow compactness in assembly of components. The shortest possible wiring is secured without any appreciable ill effects through the close proximity of valve electrodes to any r.f. component. There are 4 HiVac valves used in the 5-8 metre receiver described in this issue. One "Midget" type X.S.G. and Two "Midget" type X.D ; the fourth valve is the HiVac Y220 which supplies the essential undistorted amplification.

- \* Midget Type XSG ... .. 15/6
- \* Midget Type XD ... .. 10/6
- Y220 Type ... .. 9/-
- \* With Frequentite bases, 6d. extra.

**HIVAC**  
THE SCIENTIFIC  
VALVE  
BRITISH MADE

THE HIGH VACUUM VALVE  
CO., LTD.  
113-117, Farringdon Road, London, E.C.1.

Send for details of  
HIVAC CATHODE  
RAY Tubes and  
Rectifiers.  
Ask for list "S.T."

## For Short and Ultra S/W Work !!!

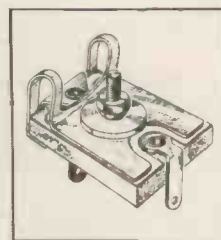

New 1938-39 Booklet "T.S." free on request.

CLIX COMPONENTS  
Specified for  
apparatus described  
in this issue.

In the recently published Catalogue of CLIX Components, amateurs and experimenters will find an excellent range of Frequentite (Ceramic) components for use in Television work and in all low-loss high efficiency circuits. Send for a copy now and please mention "Television and Short Wave World."

### TRIMMER CONDENSERS

Here is another component in which the use of "Frequentite" Ceramic is unrivalled. The unique design of vane permits the condenser to be suspended in the wiring without risk of disturbance through strain being thrown on the connecting leads.

Type	Price
TC 1 MIDGET 3-30 mfd.	6d. ea.
TC 2 MIDGET 4-50 mfd.	6d. ea.
TC 3 DOUBLE 3-30 mfd.	1/6 ea.

MIDGET, STANDARD AND OCTAL VALVEHOLDERS, PLUGS, SOCKETS, TERMINALS, INSULATED SOCKETS.

**CLIX**  
BRITISH MECHANICAL PRODUCTIONS LTD.  
79a Rochester Row,  
London, S.W.1.

# Radio Society Activities

## Exeter and District Wireless Society

H. A. Bartlett, of this Society, will be pleased to send full information on their forthcoming activities. His address is "Lendorie," Birchy Barton Hill, Exeter. The E. and D.W. Society has arranged a complete series of lectures, the next of which is October 3, and the annual subscription for members is 5s. with an entrance fee of 1s. 6d. There is also a special fee for members under 17.

## Bradford Radio Society

On October 11 there is going to be a most interesting lecture on television development given by an engineer from The Marconiphone Company. G6XL will be lecturing on October 26 on "Short-wave Workings," while G2QM will lecture on "High Efficiency Indoor Aerials" on November 23. The secretary of this society is S. Hartley, of 7 Blake Hill Avenue, Fagley, Bradford, who can supply full information to readers living in that area.

## Dollis Hill Radio Communication Society

One of the most active societies in the London area is the Dollis Hill, which started its winter season on September 6, when the president G6FK gave a lecture on "Aerials and Aerial Designs." On October 4 Mr. A. Turner, G2XO, will lecture on "Short-wave

Transmitters and Receivers," which will be followed on October 18 by a most interesting demonstration on the causes of interference and the suppression at the source and receiving end by J. Walters, of Belling-Lee. Meetings are to be held fortnightly at Braintcroft Road School, Walham Road, N.W.2, and visitors are always welcome. Membership fee is 2s. 6d. yearly, while details can be obtained from the Hon. Secretary, E. Eldridge, 79 Oxgate Gardens, N.W.2.

## Cardiff and District Short-wave Club

This band of amateurs have produced their own club periodical. In number 4 are a number of interesting articles by local amateurs and anyone living in South Wales would be well advised to join this society and take advantage of their excellent facilities. Full information can be obtained from the Hon. Secretary, 132 Clare Road, Cardiff.

## Edgware Short-wave Society

Two of the latest Hallierafter receivers were demonstrated at the last meeting of this society by Webb's Radio. Future lectures are to be given by representatives of A.C. Cossor, Ltd., and the Mullard Wireless Service Co. There will also be a discussion on "Ultra Short Wave Equipment" and finally a visit to the Walthamstow

Radio Society. The first annual dinner is to be held at Slater's Restaurant, Oxford Street, W., on November 26, when the guest of the evening will be John Clarricoates, G6CL, the secretary of the R.S.G.B.; the president of the society, G2A1, G5ZJ and many other well known amateurs will be present.

## Southend and District Radio and Scientific Society

Field days and ultra short-wave working are particularly looked after by this society. Their energetic secretary, J. M. S. Watson, G6CT, will be very pleased to supply any information on their activities if a card is sent to 23, Eastwood Boulevard, Westcliff-on-Sea, Essex. This season has been particularly successful, and it is hoped that the rapidly increasing membership will enable their activities to be still further increased.

## Eastbourne and District Radio Society

An interesting 5-metre evening was had by members of this society at their last meeting held in the Science Room at the Cavendish Senior School, Eastbourne. Readers who are within reach of Eastbourne should make a special point of getting in touch with the secretary for information as to the club's activities. The secretary is T. G. R. Dowsett, 48 Grove Road, Eastbourne.

### ★ AN INSTANT HIT! MEISSNER SIGNAL SHIFTER

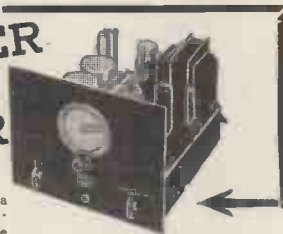

The Meissner "Signal Shifter" is a variable-frequency electron-coupled exciter unit which permits the amateur to move instantly to another frequency in the band when his signal is being QRM'd. Exceptional frequency stability superior to that of many crystals is obtained. The "Signal Shifter" eliminates one or two stages in the transmitter, as the power output is ample to drive a medium power R.F. amplifier or final stage directly on the frequency desired. Every amateur will be delighted with the ease with which this unique device permits him to slide into "holes" in the band, to make his QSO's 100 per cent. It's easily done with the MEISSNER "SIGNAL SHIFTER."

COMPLETE  
**£12-10-0**  
or  
**25/- DOWN**  
SECURES

Less Power Supply £10.0.0 (or 20/- deposit). Set of 3 coils for each amateur band 14/6 each set.

## SPECIAL

THE WORLD'S FINEST COILS.  
Multi Wave Coil Assembly. Air Tuned.  
Mono Unit Construction. 3.75-2,140 metres

The finest coil unit made. Entirely air tuned. "Alignaire" air dielectric trimmers. Embodies all coils, 5-range switch, shunt trimmers, series padders, A.V.C. by-pass condensers. The entire front end of receiver less gang condenser and tubes. 7.5-2,140 metres or 3.75-555 metres. List £5.15.0 each YOUR PRICE 80/6 CASH.

## Completely Assembled ALL WAVE TUNING UNIT

The entire front end of the Radio Receiver. Embodies the coil assembly shown above, together with gang condenser, 8-in. de Luxe band-spread drive, R.F. aerial and oscillator stages completely wired with leads ready for connection to 450 or 465 kc I.F. channel. 7.5-2,140 metres or 3.75-555 metres. List £10.7.6 each. YOUR PRICE £7.5.3 (or 14/- with order secures.)



Just Arrived!



# 2

## SENSATIONAL NEW LINES!

### The MEISSNER 7-station Push Button Tuner.



Easily affixed to any radio receiver, T.R.F. or Superhet. Connections to top of gang condenser only. The finest push-button tuner made in the States. Any seven stations may be tuned in and they will not "shift." Automatic release GET YOUR P.B. TUNER NOW, 7/6 Deposit secures (7/6 on delivery and 8 monthly payments of 4/6). Your Cash Price 47/6.

### A MARVEL IN RADIO DEVELOPMENT! MEISSNER Remote Control Push Button Tuner Permeability Tuned.

This unit may be used to control your main receiver from any distance, and gives you the choice of seven stations by merely pressing the buttons. Volume control and on-off switch incorporated. Stations set by merely rotating one small knob for each station. Unique permeability tuning ensures NON-DRIFT. Connects to A and E terminals of set. In beautiful two-toned cabinet, 5 1/2 x 9 1/2 x 1 1/2 complete with two valves, instructions, etc. Price £5.17.6 complete, or 12/- Deposit secures



### ● AN AMAZING BARGAIN!

6-Band Superhet R.F. Coil Assemblies. Completely aligned and balanced multi-wave coil assemblies, offered at a bargain price. This unit is undoubtedly one of the most efficient ever made to meet modern requirements. Special low loss construction employed throughout. Latest ceramic wafers used on switch. Complete with circuits, instructions, etc. R.F. coils on 5 bands. Coverage 4 1/2-13, 12-35, 34-100, 91-261, 200-557, 700-2,000 metres.

YOUR PRICE 49/- EACH. or 8/- Deposit secures (8/- on delivery and 10 monthly payments of 4/-).  
2d. STAMP brings complete illustrated lists per return post. SEND ORDER NOW. TERMS. Cash, C.O.D. or small deposit with order (where stated) secures delivery. Balance over 12 or 18 months. Post and carriage charges paid to your address.

4 1/2-2,000 metres.



## Anglo American Radio (and Motors) Limited

(Dept. SW.), Albion House, 59 New Oxford Street, LONDON, W.C.1.  
Telephone: TEMple Bar 3231.



**R.A.F.**

**Civilian Wireless Reserve**

*More detailed news of the recently formed Civilian Wireless Reserve is given in this article. It is hoped that the reserve will commence training on October 1st, when the exercises will be transmitted from the R.A.F. signal station at Cranwell. A special wavelength of 60 metres has been allocated for the sole use of this new group.*

A GREAT number of amateur experimenters have already enrolled in the recently formed Civilian Wireless Reserve which it is hoped before very long will be made up of at least 7,000 amateur radio operators who can be called upon to join the Royal Air Force Volunteer Reserve when required.

There seems to be a considerable amount of doubt as to the qualifications of amateurs and the work that they will have to do. The Civilian Wireless Reserve has been created for men in civil life who are prepared to devote part of their leisure to training purposes so that they will in time become efficient operators.

The organisation will be directly controlled by the Director of Signals, Air Ministry assisted by an instructional staff and a committee which will include certain members of the reserve. The country will be divided into areas, each area being in charge of a controller, also collected from members of the reserve who will act as liaison between headquarters and subordinate sections. In turn each area will be subdivided into regions, groups and districts.

Candidates who intend to enrol must

have attained the age of eighteen but not be above the age of 54 on the date on which the application is received. In exceptional circumstances where the candidate may have special qualifications, the maximum age limit may be exceeded.

**The P.O. Licence**

All candidates must be British subjects of pure European descent and only in exceptional circumstances will any departure from this rule be made.

Amateurs will be required to show that they have a reasonably good knowledge of wireless telegraphy and morse code and should preferably be holders of a G.P.O. transmitting licence, although there is no need to have had previous experience in the R.A.F.

There are, however, certain groups who cannot be enrolled which include disability pensioners, persons in civilian employment under the Air Ministry, registered medical practitioners, medical students, dental surgeons, dental students and members of His Majesty's Forces, regular or non-regular, police forces, prison services and members of fire brigades.

Candidates must also be prepared to give an assurance that they will be resident in the United Kingdom for a period of at least 5 years.

On enrolment members will be required to accept the following obligations:—

1. To place his services at the disposal of the Air Council in the event of an emergency.
2. To transfer to the appropriate section of the R.A.F. Volunteer Reserve when called upon to do so.
3. To undertake prescribed training.

Amateurs can be discharged from the Reserve for medical unfitness, unsatisfactory conduct, inability to reach the normal standard of efficiency or when his services are no longer required.

Training will, for the most part, be undertaken by the members at their homes on their own equipment and will consist of exercises broadcast from the R.A.F. depot at Cranwell. In addition lessons will be circulated to members from time to time on which these broadcasts will be based.

Members whose transmitters are used in connection with the training will be allotted special call signs. Exercises  
(Continued on page 648.)

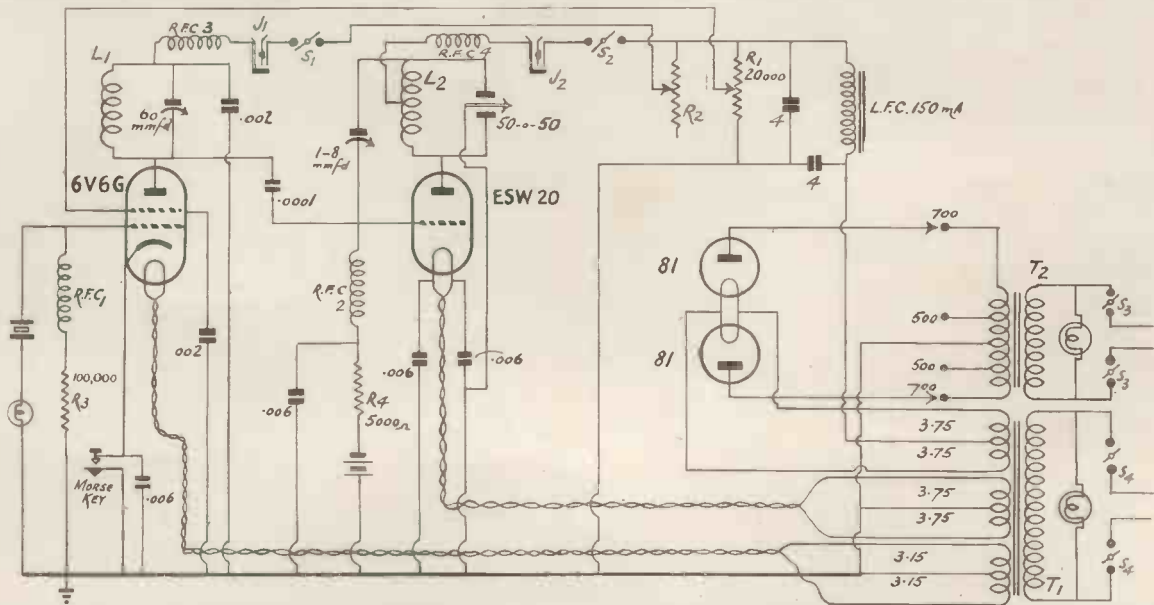

Quite simple equipment is required for taking part in the training and if the apparatus is correctly designed in the first instance will be suitable for inputs up to 25 watts. There is no need to make a separate transmitter for the 60 metre band for this circuit can be adapted by means of plug-in coils and a new crystal to operate on most of the recognised amateur bands. Full constructional details will be given in the November issue.



# GALPINS ELECTRICAL STORES

DEPT.  
E.J.G.

75 LEE HIGH ROAD, LEWISHAM, LONDON, S.E.13

TERMS: Cash with order or C.O.D. charges extra.

Phone: LEE GREEN 5240

**DIMMER RESISTANCES**, wound with Eureka wire, 500 watts, 15/-; 1,000 w., 20/-; 1,500 w., 25/-; 2,000 w., 32/6; 3,000 watts, 42/6. All fully guaranteed.

**PHILLIPS MAINS TRANSFORMERS**, input 200/250 v., output 3, 5 or 8 v., 25/50 a., 10/- each. C.F.

**RUBBER-COVERED FLEX**, 23/36 (single) 3/6 per 100-yard coil; G.P.O. Glass Top relays, only require contacts, 3/6.

**MAINS TRANSFORMERS**, input 200/250 v., output 350/0/350 v., 120 m/A., 4 v.-2½, 4 v., 5 a., C.T. 3/9 post free.

**MAINS CHOKES**, 30-hy., 150 m/A., 5/- each.

**CHARGING DYNAMOS**, shunt wound, 12 v., 8 a., 22/6; 25 v., 8 a., 35/-.

**ROTARY CONVERTOR**, input 12 v., output 900 v., 300 m/A., as new, D.C. to D.C., maker, Mortley Sprague, 50/6. C.F.

**WHEATSTONE BRIDGE**, 1 to 10,000 ohms, complete with super-sensitive Galvo; £3; ditto, less Galvo, 45/-.

**AUTOMATIC TELEPHONE DIALS**, numbered 0 to 9 and complete with full switching mechanism, price 1/6, post 3d.

**MODULATION TRANSFORMERS**, by "Standard Telephones," 2/6 each; multi tapped, 3/6.

**DOUBLE OUTPUT GENERATORS**, H.T. and L.T. 1,200 v. at 100 m/A., also 10 v. at 4 amps, 15/- each. C.F.

**QUARTZ TUBES**, size 10 in. long by 3/16 in. dia., price 5/- per doz. 1 only Quartz Tube 1 in. dia., 50 ins. long, fitted mercury filled bulb, complete in packing case, 25/-.

**WIRE WOUND RESISTANCES**, on stout mica, 7 ins. by 1½ ins., 4,000 ohms, 200 m/A., new, space wound, price 1/6 each.

**CHOKE COILS**, wound with 2 lbs. 30 gauge D.C.C. wire on genuine Stalloy stampings, complete with brackets, price 4/6. P.F.

**LARGE FERRANTI TRANSFORMERS**, from P.A. Power Amplifiers, Types A, D, OP, etc., as new and in perfect working order, price 4/6 each. P.F.

**TRANSMITTING VISUAL WAVEMETER**, in teak case, size 14 ins. x 7 ins. x 7 ins., range 9 to 16 metres, as new, 25/-.

**SMALL BATTERY AMPLIFIERS**, ex-R.A.F., one or two valve (less valves), price 2/6 each.

**LARGE SLIDER RESISTANCES**, worm and wheel control, 2,500 ohms, 200 m/A., price 15/-.

**STEEL CABINETS**, 40 x 24 x 16, make good transmitting racks, 12/6 each. C.F.

**EPOCH PUBLIC ADDRESS 20-WATT SPEAKERS**, 6-volt field, 15 ohm speech coil, 35/- each, C.F.; or without cone, 20/-.

**PHILIPS 10-WATT PRE-STAGE AMPLIFIERS**, single stage low imped. input, high output with valves, 505 and AC 084 for 200/250 v. A.C. mains, 30/- each.

**GENUINE TOWNSEND HIGH NOTE BUZZERS**, with platinum contacts, 1/- each.

**EX-R.A.F. MARCONI 1-VALVE TRANSMITTERS**, with tuning unit for speech, useful to the experimenter, 7/6 complete, less valves. C.F. (not sent C.O.D.).

**ELECTRIC LIGHT CHECK METERS** 200/250 v. 1 ph. 50 cycles, 5 and 10 amp, 6/-, post 1/-. Ex-R.A.F. Visual Wavemeters, 350 to 2,500 metres, 5/-. Silvertown highly sensitive Galvanometers, 6/- each. Ex-G.P.O. Glass Top Relays, approx. working current 1 m/A., 6/6 each. Westinghouse Rectifiers, 500 volts 250 m/A., in voltage doubler circuit, 20/- each. Sullivan Mica Condensers, 022 m/F, 7,500 v. Will separate into 5 x 01 m/F's, 2/- each.

**MAINS TRANSFORMERS**, all fully guaranteed. Philips 200/250 volt input 2,000/0/2,000 v., 150 m/A., with 2 L.T.'s output, 22/6. C.F. Savage, 200/240 v. in. 350 v., 500 m/A. output, 12/6. C.F. Philips 200/240 in. low voltage, 30/50 amp. out, 7/6. C.F. Voltage Changer Transformers, 200/250 v. to 100/120 v. or vice versa, 100 watt, 10/-; 150 w., 12/6; 250 w., 17/6; 500 w., 25/-; 750 w., 30/-; 1,000 w., 35/-; 1,500 w., 42/6; 2,000 w., 52/6. formers, suitable for rewinds, 200 watts 4/6; 500 w., 7/6; 1,000 w., 10/-; 1,500 w., 17/6. Zenith mains transformers, 220 volts input, 3,000 volts 25 m/A. out, 17/6; Weston 2½-in. scale 0 to 250 A.C. Voltmeters, 15/- each. Mains Power Packs, consisting of 2-30 hy. 60 m/A. chokes and 2 T.C.C. 2 mf. Condensers, 3/6 each; large Mains Chokes, 30 hy. 20 m/A., 5/- each.

**SPECIAL CLEARANCE OF SPARK COILS**, windings O.K. but ebonite slightly broken. Will work from 100/250 volt A.C. or D.C. mains. 12-in., 30/-; 10-in., 25/-; 8-in., 20/-. Also a few only brand new, 12 in., in mahogany portable case, 55/-. Condensers to suit primary, 7/6 each. All C.F.

**MAINS CONDENSERS**, T.C.C. 4 mf. 350 volt A.C. working, 2/6 each; Philips 1 mf. 4,000 v. working, 5/6; Muirhead, 1 mf. 2,000 v. working, 2/6 each; Standard Telephone, 1 mf. 400 v. working, 4d. each, 4 for 1/-. All new.

**WESTON EVERETT-EDGUMBE, etc., MOVING COIL MILLIAMMETERS** (all fully guaranteed). 0 to 3 m/A. and 0 to 50 m/A., 2½ in. dial, 15/- each; 0 to 500 m/A., 2½ in., 12/6; 0 to 5 m/A., 2 in. dial, 14/-; 0 to 25 m/A., and 50 m/A., 2 in., 12/6 each. Thermo Ammeters, E. Turner, 0 to 6 amp., 10/- each. Moving Coil Meter Movements for Recalibrating into Multi-range Meters, approx. 6 to 10 m/A., full scale deflection, 2½ in. dial, 5/- each; 4 in. dial, 6/6 each. Post 6d.

**EPOCH CINEMA MODEL MOVING COIL SPEAKERS**, 6 volt field, 15 ohm. Speech coil handle 20 watts, 35/- each, or without cone but with frame, 20/-; C.F.

**ZENITH WIRE-WOUND VITREOUS RESISTANCES**, .154 ohm, carry 8 amps., .6 ohm 6 a., .5 ohm 2.2 a., 7.6 ohm 1.75 a., 200 ohm 400 m/A., 750 ohm 170 m/A., 800 ohm 170 m/A., 2,500 ohm 250 m/A., 2,500 ohm 170 m/A., 4,000 ohm 79 m/A., 4,500 ohm 105 m/A., 5,000 ohm 71 m/A., 6,000 ohm 60 m/A., 10,000 ohm 40 m/A., 13,000 ohm 90 m/A., 15,000 ohm 70 m/A., 20,000 ohm 50 m/A., 225 ohm .500 m/A. Price from .154 up to 200 m/A., 1/6 each; the other values 2/3 each. Post 3d.

**ZENITH HEAVY DUTY CHOKES** 2/3 henry, 300 m/A., to 500 m/A., 300/3,000 cycles, as new, 22/6. Another 2.3 hy., 1,000 m/A., 20/-. Another 5 hy., 750 m/A., 20/-; C.F.

**EX-R.A.F. ROTARY CONVERTERS**, D.C. to D.C. 12 volts input, 500 volts 100 m/A. output, 20/-; ditto 750 volts output, 25/-. A few of each that need slight repair to brush holder, etc., windings O.K., 10/- each. Post 1/-.

**ELECTROSTATIC VOLTMETER**, reading 0-6,000 volts, 8-inch diameter, 50/-.

**NEW CARBON BRUSHES** for motors or dynamos, assorted sizes from ¼ square to ½ x ½, price 4/- per doz.

**G.P.O. RELAYS**, small size, low working current, silver contacts, 1/6 each.

**SLIDER RESISTANCES**, all as new, 90 ohm 4 amps, 25/-; 16 ohm 3 a., 10/-; 90 ohm 1½ a., 12/6; 1,100 ohm ½ a., 10/-; 30 ohm 2 a., 12/6; 12 ohm 3½ a., 8/6; 850 ohm ½ a., 15/-.

**X-RAY CASSETTS**, Aluminium frames, 10 x 8, 10/-; 12 x 10, 12/6; and 15 x 12, 20/-.

**BRAND NEW AMPMETERS**, reading 0-60 amp., moving coil, 6-inch dial, 12/6.

**SWITCHBOARD**, slate, size, 24 in. x 20 in., fitted four 6-in. dia. meters, 0-150 v. and 0-80 amp., A.C. or D.C., two switch arms each fitted 17 ½-dia. studs and sundry other fittings, price 35/-.

**VARIABLE RESISTANCE** in case 4 in. x 4 in., switch arm 11 studs, 20 ohms to carry 3 amps., 3/6 each.

**TELEPHONE CALL indicators**, 1,000 ohm resistance, 1/-; Dewar speak and ring switches, 1/- each; telephone plug with jack, the pair, 1/-.

**RESISTANCE MATS**, size, 24 in. x 24 in., resistance 600 ohms, to carry ½ amp., 5/-.

**EX-NAVAL TUNING INDUCTANCE** in case range 5 to 5,000 metres, 10/-.

**LARGE SWITCHARM** and 22 studs, mounted on ebonite, size 10 in. x 4 in., price 2/6.

**SULLIVAN TRANSMITTING CONDENSERS** variable, capacity .0005, large size ideal for short-wave work 7/6 each.

**VARIABLE INDUCTANCE**, wound on beramot, fitted 7-in. dial, range 50 to 100 metres, complete in mahogany case, price 2/6.

**½ H.P. D.C. MOTOR**, shunt wound, 3,000 r.p.m., ball-bearing, 220 v., in first-class condition.

**EX-G.P.O. AUTOMATIC DIALS** for selector station tuning, numbered 0 to 9 and complete with selector mechanism, 1/6 each; hand combination phones with finger switch, 4/6; Western Electric microphones, 2/6; microphone transformers, high ratio, 1/6.

**MERCURY BREAKS**, turbine type, in good condition, fitted 110/220 D.C. motor drive, 30/-; large mercury break motor, 12/6.

**ROTARY CONVERTOR**, 400 v. D.C. to 290 v., A.C., 6 kW, 50 cycle 1 ph., with starter, in first-class condition, £7 10s. 0d. Step-down transformer to any voltage required, £6.

**HEAVY-DUTY TAPPED CHOKE** in iron case (no oil), low henries, 750 m/A., for H.T., price 15/-.

**TRIPLE CONTACT KEYS**, solenoid action, low resistance, 3/6.

**SHILLING SLOT ELECTRIC LIGHT check meters** for 200/250 v. 50 cycle, single phase supply, 17/6 each.

**ROTARY CONVERTORS**, D.C. to A.C., in good condition, 100 v. D.C. to 70 v. A.C. 400 watts, 50/-; 220 v. D.C. to 150 v. A.C., 30/-. We can supply step-up transformers to suit (see prices under mains transformers).

**MORTLEY SPRAGUE HAND-DRIVEN GENERATORS**, two separate outputs, 800 v. at 30 m/A., also 6 v. at 2½ amps., brand new in cases, 30/-; a few secondhand guaranteed perfect at 25/-

**X-RAY TUBES**, 7-inch dia., tungsten targets, 12/6 each, packing free; Platinum targets, 17/6 each.

**EX-G.P.O. PEDESTAL TELEPHONES**, complete with microphone, hand earphone and automatic dial, 0 to 9, price 6/6, P.F.; Small wall-type ditto with microphone transformer and bell, can be used for battery working, 7/6, P.F.; wall bell-boxes with transformer to suit the pedestal phones, 3/6, P.F.

## The C.W.R. Wavelength

with aircraft and marine craft will be arranged, while the R.A.F. mobile W/T equipment will be periodically allotted to areas for exercises. Rallies are also to be arranged at various centres combined with lectures and exercises.

Members will be affiliated to R.A.F. units and will be required to become acquainted with wireless equipment in use in the R.A.F. by a visit to the various units. Opportunities will be afforded to those who are efficient to take

part in R.A.F. air exercises. Training allowances and training expenses will be granted, while members who possess a Post Office transmitting licence and reach the required standard of proficiency will be paid the sum of £2 per annum to compensate for the cost of maintaining their equipment. In addition, a free issue of crystals will be made suitable for the wavelength of 60 metres to be used. Applications should be made on form 2170 and forwarded to the Under Secretary of State, Air

come fully efficient so that constructors should build their transmitter with this in mind.

The suitable transmitter consists of a 6V6G crystal oscillator driving a small triode valve of the ESW-20 type. With 500 volts applied this circuit can be operated quite comfortably at 10 watts, while, by raising the voltage to 700, the input can be increased to 25 watts.

The suggested circuit shown has proved to be satisfactory and full constructional details will be given in the November issue. Further information, however, for those who are anxious to begin construction can be obtained on request.

It is hoped that this Civilian Wireless Reserve will not merely consist of a large number of amateurs doing little else but Morse practice and to overcome this possible effect in the scheme amateurs will be encouraged to carry out experimental work in conjunction with the R.A.F. and also to be in a position to inter-communicate on the special wavelength allotted to them of 60 metres.

Ministry (Signals C.W.R.) Kingsway, London, W.C.2.

Members in the first instance will require a receiver covering approximately the 60-metre channel and also a transmitter for C.W. operation with an input not exceeding 10 watts. It may, however, be necessary for slightly higher power to be available when the operator has be-



### PIEZO QUARTZ CRYSTALS

1.7 mc., 3.5 mc., and 7.0 mc.,  
Amateur Bands.

Standard Type Power Type  
15/- post free. 20/- post free

Q.C.C. 1938-39  
CATALOGUE  
will be sent you  
on request.

CRYSTAL HOLDERS:—  
Type A, Open Electrodes,  
4s. 6d. post free.

Type B, Totally enclosed and  
dustproof, 8s. 6d. post free.

THE QUARTZ CRYSTAL CO., LTD.  
63 & 71, Kingston Road, New Malden, Surrey.  
Telephone: MALDEN 0334

Read  
Television &  
Short-wave  
World  
Regularly.

"Television and Short-wave World"  
circulates in all parts of the world.



## TO AMATEUR RADIO

WILL HELP YOU OVER MANY  
DIFFICULTIES ENCOUNTERED  
IN OPERATING AN AMATEUR  
RADIO STATION

**64** PAGES FULLY ILLUSTRATED  
Receiving Equipment—Artificial Aerials  
—Monitoring—Using the Receiving  
Station—Construction of Transmitters—  
Frequency Measuring—Selection of Com-  
ponents—Morse Code—Useful Data—Pre-  
fixes—Important Trade Announcements.

GET YOUR COPY NOW  
WHILE STILL IN STOCK **3D**

BY POST 4½d.  
SPECIAL TRADE  
TERMS ON REQUEST

SALES DEPT. R.S.G.B., 53 VICTORIA STREET,  
LONDON S.W.1.

## TELEVISION DEVELOPMENTS

Are you keeping abreast of modern television developments? Whether amateur or professional you *must* be in touch with the latest trend of research.

The Television Society enables you to meet fellow workers in the field of television, both in this country and abroad.

Founded some 10 years ago The Television Society provides a scientific and non-partisan platform for discussion on all aspects of the subject. Meetings are held monthly during the session (October-June) and are reported in full in the Society's Journal which is sent free to all members.

The Society's activities are shortly being enlarged to meet the growing interest in the subject and members will have a unique opportunity of furthering their knowledge by contact with well-known television engineers.

Full particulars of membership qualifications may be had from the Hon. General Secretary:—J. J. Denton, 25, Lisburne Road, Hampstead, London, N.W.3.

## THE TELEVISION SOCIETY

(Founded 1927)

President: Sir AMBROSE FLEMING, M.A., D.Sc., F.R.S.

# WEBB'S

# RADIO



## WEBB'S APEX COIL FORMERS



Glazed Porcelain. Type "A," 5 in. x 2½ in., 24 grooves. Price 3/-  
Type "B," 3½ in. x 1½ in., 32 grooves. Price 2/-  
Jumbo Plugs for use with either type coil. 3d. each  
Jumbo Sockets, chassis mounting. 2½d. each

### EDDYSTONE LOW LOSS FREQUENTITE FORMERS

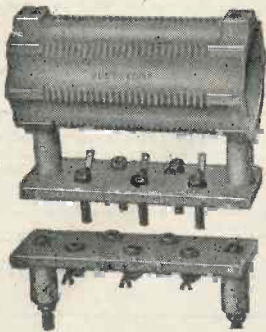

for transmitting and other high frequency apparatus. Size 5 ins. x 2½ ins., and may be mounted as illustrated or on Frequentite pillar insulators. Spiral grooves take 26 turns of wire up to 12 gauge; 14 holes are provided for leads and tapping connections. Each former is supplied with winding data for Amateur frequencies and is designed for coils up to 90 metres. No. 1090 Price 4/-

### LOW LOSS FREQUENTITE SUB-BASE

This is easily attached to the former by two bolts and Frequentite pillars. Helicly slotted power plugs give positive electrical contact and even fitting to ceramic is assured by lead washers. No. 1091 Price 3/6

### LOW LOSS FREQUENTITE BASE

Provided with Frequentite pillars for above chassis mounting. Heavy duty power type sockets give sound electrical connection. Leads are secured by heavy-gauge tinned, phosphor bronze self-locking soldering tags. No. 1092. Price 3/9

### WEBB'S APEX HEAVY STAND-OFF INSULATORS

Fitted with Jumbo socket and plug. Price 1/- each

### APEX AMERICAN TYPE

White glazed Porcelain, fitted with nickel-plated terminals (4BA).  
TYPE WA. Height 1½ in. Price 6d.  
TYPE WS. " " " " 4d.

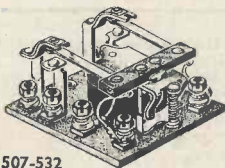

### WARD LEONARD RELAYS FOR AUTOMATIC CONTROL

Radio Frequency Relays. For antenna change-over. 507-521, -522 and -523 contacts are rated at 15 amps. 507-531 and -532 are rated 4 amps.

507-532

#### CONTACTS

#### COIL VOLTAGE.

Description.	Cat.No.	Poles.	Throw	Break.	Normal Position.		List Price	
					A.C.	D.C.		
Keying	507-507	Single	Single	Double	Open	7.5	2.5	23/-
"	507-508	"	"	"	"	—	6 to 8	23/-
Remote R.F.	507-510	"	"	"	"	110	—	23/-
Relay R.F.	507-531	Double	Double	Single	—	110	—	35/-
Relay R.F.	507-532	"	"	"	—	—	6	35/-

ALL LINES ADVERTISED HERE ARE INCLUDED IN OUR 50-PAGE CATALOGUE. POST FREE TO ALL "T. & S.W.W." READERS

## EQUIPMENT FOR ROYAL AIR FORCE W/T RESERVE

Special facilities for supplies of economical, efficient transmitters and receivers, keys and other components, are afforded by Webb's to potential members of the above. An economical transmitter, 10 watts C.W., for allotted frequency, will be available shortly.

**DISTRICT OFFICERS** should write for particulars of equipment for morse code work by groups.

### NEW McELROY STRAIGHT KEYS

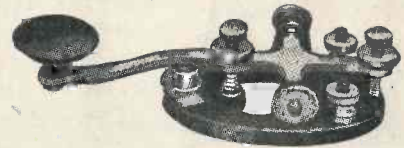

A range of keys just released by McElroy comprise four models which are bound to prove popular. They are all similar to photograph, and only vary in finish and detail.

The De Luxe model, chromium plate ... .. 15/-  
Professional model, in lacquered brass ... .. 12/-  
Commercial model, in black and chrome ... .. 8/6  
And the Amateur model, cadmium plate ... .. 6/6

### EVERY HALLICRAFTER RECEIVER in STOCK INCLUDING

The new five valve Sky Buddy, complete with speaker, at £9. 0. 0.  
Eight valve super Skyrider, Crystal Gate Model, at £32. 0. 0.  
The Sky Challenger II, which is fitted with the Image Rejector patented by Hallicrafters, at £25. 0. 0. AND OF COURSE—

### THE NEW SKY CHAMPION (EIGHT VALVES)

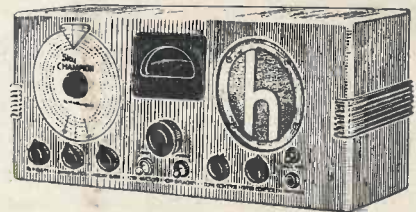

6.8 to 550 Mts. Built-in Loud Speaker. Beat Frequency Osc. for C.W. Reception.

110 to 250 volt A.C. input.

Price Complete ... .. £15. 0. 0.

### NEW JOHNSON "Q" BEAM ANTENNA

For two band operation.

Present owners of standard Johnson "Q" Antennae can easily convert to the new "Q" Beam by the addition of another "Q" of the same band. Space one-fifth wave from existing "Q"; feed both with common 600 ohm line.

Johnson 20 metre "Q" ... .. 39/6  
Johnson 10 metre "Q" ... .. 26/6  
Johnson 5 metre "Q" ... .. 27/6

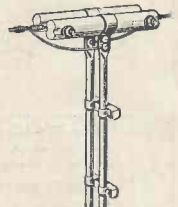

# WEBB'S RADIO

14, SOHO ST., OXFORD ST., W.1

(C. W. WEBB LTD.)  
BIRMINGHAM DEPOT—41, CARRS LANE.

Phone: GERRARD 2089  
ALL POST ORDERS TO LONDON.