

GREAT PROSPECTS OPENED UP BY CORONATION TELEVISION

Television

and *SHORT-WAVE WORLD*

1/-

MONTHLY

JUNE, 1937

No. 112. Vol. x.

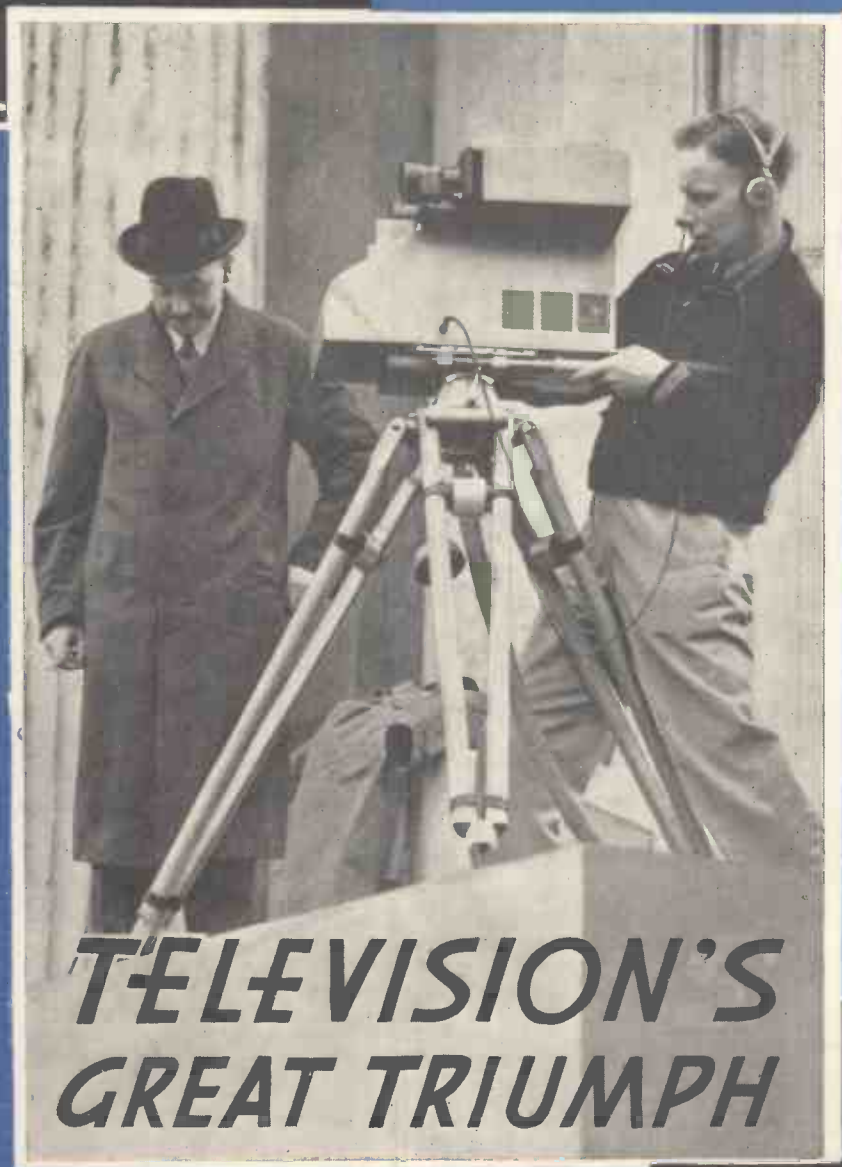

**TELEVISION'S
GREAT TRIUMPH**

TELEVISION
CAMERA
EXPLAINED

MIHALY-TRAUB
SYSTEM

GLOW-GAP
DIVIDER

FREE TELEVISION
EXHIBITION

NEW OSRAM
PHOTO CELL

SHORT-WAVE
SERIAL
EXPERIMENTS

SELF-
CONTAINED
SHORT-WAVE
RECEIVER

BERNARD JONES PUBLICATIONS LTD.
CHANSITOR HOUSE, CHANCERY LANE
LONDON W.C.2.

THE FIRST TELEVISION JOURNAL IN THE WORLD



"What's that you're constructing?"
asked Page,
"Is't a radio set or a cage?"
Now don't be a dunce,
Get some **FLUXITE** at once,
And you'll save yourself time, wire—
and rage!"

See that **FLUXITE** is always by you—in the house—garage—workshop—wherever speedy soldering is needed. Used for 30 years in government works and by leading engineers and manufacturers. Of Ironmongers—in tins, 4d., 8d., 1/4 and 2/8. Ask to see the **FLUXITE SMALL-SPACE SOLDERING SET**—compact but substantial—complete with full instructions, 7/6. Write for Free Book on the art of "soft" soldering and ask for Leaflet on **CASE-HARDENING STEEL and TEMPERING TOOLS** with **FLUXITE**

TO CYCLISTS! Your wheels will NOT keep round and true unless the spokes are tied with fine wire at the crossings and **SOLDERED**. This makes a much stronger wheel. It's simple—with **FLUXITE**—but **IMPORTANT**.

THE FLUXITE GUN

Is always ready to put Fluxite on the soldering job instantly. A little pressure places the right quantity on the right spot and one charging lasts for ages
Price 1/6.

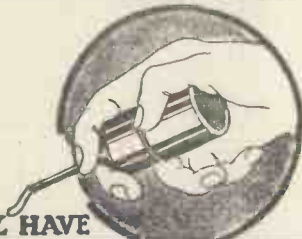

ALL MECHANICS WILL HAVE

FLUXITE

IT SIMPLIFIES ALL SOLDERING

FLUXITE LTD. (Dept. T.V.), DRAGON WORKS, BERMONDSEY ST., S.E.1

**100% RELIABLE - IF IT'S
ELECTRIC SOLDERING**

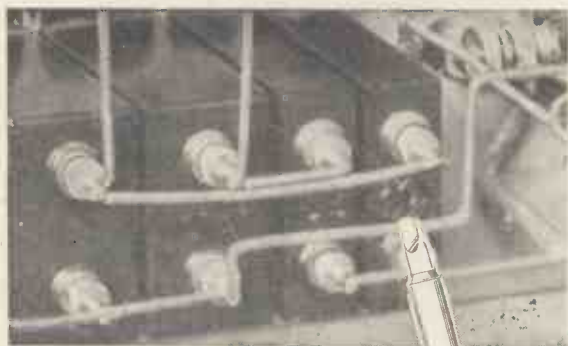

Every contact a neat, simple and lasting job—that's what Solon electric soldering gives you. Maintains constant heat where you want it—element clamped within the bit concentrates all heat at point.

8/6
DOMESTIC
MODEL
65 watts

Sold with Instruction Book
Resin-cored Solder, 6 ft. Flex
and Standard Lamp Adaptor.



W. T. Henley's Telegraph Works Co. Ltd., (Dept. Y4/78a/V.),
Holborn Viaduct, London, E.C.1.

334

323

321

322

Get to know about this Television Aerial System

Here you have a simple centre-fed half-wave aerial, to be terminated by a balanced input system at the receiver. It consists of two enamelled brass tubings of correct proportions to give maximum reception of the vision channel at 45 mc.

The tubings are mounted to a specially designed porcelain insulator, the whole being rigidly secured to a supporting member led away at right angles and ending with a cast flange to be bolted to the wall.

The aerial is not directional but it may be made so by the use of the Reflector—similar in construction to the aerial. The added advantage of the Reflector is the likelihood of considerable reduction of interference other than that coming from the same direction as the signal. When mounting the complete system (with the Reflector), the best plan is to use a masthead adaptor.

Fuller Information is given in the "1937 Catalogue of Suppression Devices." Write for a free copy.

These aerial assemblies are complete with mounting castings and insulators, but they do not include the Feeder (No. 336, per yard, 6d.)

No. 334.—Masthead half-wave aerial	45/-
No. 323.—Masthead half-wave aerial, complete with Reflector	65/-
No. 321.—Wall mounting half-wave aerial	35/-
No. 322.—Reflector for No. 321	35/-

BELLING-LEE
SUPPRESSION SERVICE

BELLING & LEE LTD.
Cambridge Arterial Road, Enfield, Middx.

CLIX

VALVEHOLDERS

Designers of radio and television apparatus know from experience that they can always find the correct and highly efficient type of valveholder among the Clix range—illustrated and described in Clix Valveholder and Strip Folder "S.W."

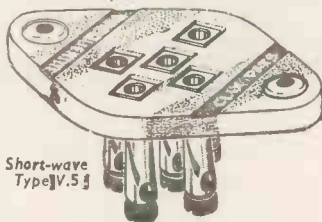

Short-wave
Type V.5

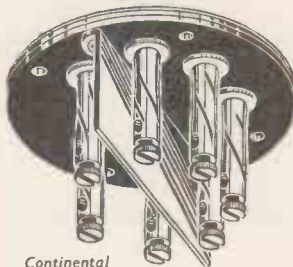

Continental
Type V.9

Here are two of the types chosen and specified for the **3 VALVE RECEIVER** and the **AC/DC. E.C.O. UNIT** described in this issue.

Type V5. 4-pin ... 8d.
5-pin ... 9d.
(without terminals)

Type V9. 7-pin
screened. 1/8d.

There are 3 Clix Folders illustrating Contact Components—Valveholders and Strips—Wall Plugs. Copies free on request to Dept. "S.W."

BRITISH MECHANICAL PRODUCTIONS LTD.,

79a Rochester Row,
London, S.W.1.



STABILOVOLT

THE SOLUTION
TO UNSTABLE
SUPPLY VOLTAGE

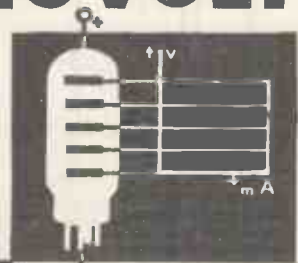

The Stabilovolt tube is a voltage dividing potentiometer and voltage regulator. The voltages tapped are independent to a precision of about .1% from the supply voltage variations, 1-2% from the varying current intensities tapped, .01% from one another. Currents up to 200 mA, voltages of unlimited values subdivided into parts of 70 volts each. Light in weight, small in size, simple and safe in operation.

Prices: Stabilovolt tubes from £1. 16. 0 to £62. Iron Barretters, for use with above, from 16s. to £1. 7. 6. Full particulars from:—

MARCONI'S
WIRELESS TELEGRAPH CO. LTD.
Electra House,
Victoria Embankment, W.C.2.

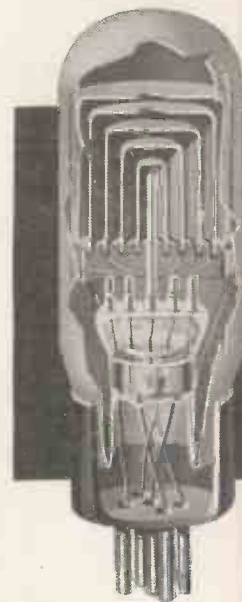

S2b

Specified 3 times in this issue

For efficient receiving equipment Erie Resistors are essential. This fact is illustrated by the regular specification of Eries by leading designers. This month Erie fixed Resistors are specified for the Self-contained 3-valve Receiver, the 7 metre Twin-Pentode Receiver, and the AC-DC E.C.O. Unit, all described in this issue.

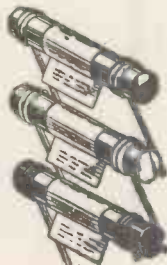

ERIE RESISTORS

FROM ALL DEALERS 1/- PER WATT, ALL VALUES

THE ERIE VOLUME CONTROL

The variable resistance that will never develop faults. All values. 5,000 ohms to 2 megohms

Price 3/6

with mains switch
5/-

Write for Erie Colour Code Chart, Post Free.

THE RADIO RESISTOR CO., LTD., 1, Golden Sq., London, W.1.

MAKE IT BRITISH!

The safe and sure method of converting your 110 Volt AMERICAN Receiver-Gramophone Motor or Loudspeaker for operation on 210, 220 or 250 Volt mains, is to "Step Down" your mains supply by using a "Sound Sales" Auto-Transformer.

This method cuts out the waste occasioned by the use of voltage dropping resistance leads.

The "Sound Sales" Auto-Transformer also enables you to "Step-up" from 110 volts to 250, if desired.

The 60-watt model will be found suitable for use with the majority of American apparatus.

Full details of these models and the range of "Sound Sales" Chokes-Mains Transformers—Power Supply Units—Microphone Transformers—Public Address Amplifiers, etc., will be supplied free if you mention this journal when writing to us.



60-WATT Type 15/- 100-WATT Type 22/-

Specified by the Experts

SOUND SALES

LTD.

Marlborough Road, Upper Holloway, London, N.19
Phone: ARCHWAY 1661-2-3. (Contractors to the G.P.O., etc.)

TELEVISION DEVELOPMENTS

A NEW LARGE DIAMETER TUBE FOR TELEVISION REPRODUCTION



**TYPE 12H
TUBE**

The Ediswan Type 12H tube has a screen diameter of 12" giving a television picture 10" x 7½" without distortion.

The screen is of special material giving a close approximation to a black-and-white picture.

Specification:

Indirectly heated high vacuum tube.
Heater Volts - - - 2.0
3rd Anode Volts - - - 6000
2nd Anode Volts - - - 1200
1st Anode Volts - - - 150-400
Sensitivity (mm./V.) - - -950/V*

*V = anode volts

List Price £15.15.0

● We also supply
HIGH VACUUM RECTIFIERS
GAS-FILLED RELAYS
MERCURY VAPOUR RELAYS
for Television Scanning
circuits.

ENTIRELY BRITISH MADE

EDISWAN RADIO VALVES

THE EDISON SWAN ELECTRIC CO. LTD.  155 CHARING CROSS RD., LONDON, W.C.2

R.E.299

USED BY ALL GOVERNMENT DEPARTMENTS

TELEVISION

and SHORT-WAVE WORLD

Special Features

	PAGE
The Mihaly-Traub System	324
The Television Camera	329
C.R. Tube Television	330
The Glow-gap Divider	332
The First Real Television O.B.	335
The Television Exhibition	336
Construction of Acorn Valve Receiver for Vision Signals	340
Osram Secondary-emission Photo-cell	343
Multi C.R. Tube Screen for Large Pictures	345
Guaranteed Receiver Circuit	351
Self-contained 3-valve Receiver	356
Programmes for Short-wave Listeners	360
6L6 60-watt Amplifier	362
Frequency Doubling Simply Explained	363
2-watt, 2-valve, 7-metre Receiver	365
Some Experiments with Aerials	367
An A.C.-D.C. Electron-coupled Oscil- lator	369
5- and 10-metre Reception	371

TELEVISION AND SHORT-WAVE WORLD

Proprietors :

BERNARD JONES PUBLICATIONS, LTD

Editor-in-Chief :

BERNARD E. JONES.

Editor :

H. CORBISHLEY.

Editorial, Advertising and Publishing

Offices :

Chansitor House, 38, Chancery Lane,
London, W.C.2.

Telephones : Holborn 6158, 6159

Telegrams : Beejapee, Holb., London.

Subscription Rates : Post paid to any
part of the world—3 months, 3/6;
6 months, 6/9; 12 months 13/6.

Published Monthly—1/- net.

(Last Wednesday in every month for
following month).

Contributions are invited and will be
promptly considered. Correspondence
should be addressed according to its
nature, to the Editor, the Advertisement
Manager, or the Publisher, "Tele-
vision and Short-wave World," Chansitor
House, Chancery Lane, London, W.C.2.

IMPORTANT

"Television and Short-wave World" is regis-
tered at the General Post Office, London, for
transmission to Canada and Newfoundland
by Magazine Post. Entered as Second-class
mail matter, Boston, Mass.

COMMENT OF THE MONTH

A Great Triumph

IT is impossible to over-emphasise the importance of the successful transmission of the Coronation procession. Undoubtedly it marks the commencement of a new era in television and indicates its true sphere of usefulness. Mr. Gerald Cock, the Television Director, was a true prophet when he said: "In my opinion, much of the fascination of television, and to a great extent its future, is bound up with actuality, a virtue which it alone possesses, and which the news reel, with its time-lag, misses." To those, who later in the day, saw a film of the procession, the truth of this was very apparent, for despite the obvious fact that the film was bound to be superior in technique, there was in the latter that lack of actuality which even with its shortcomings only television can give. There is that psychological difference in the knowledge that what is being seen is taking place at the very instant.

The possibilities which the success opens up are illimitable and it is to be hoped that the B.B.C. will make the very fullest use of them for it is to these outside broadcasts that the public will direct its attention. In television circles the phrase "Seeing the Derby" has become a cliché. It has provided an objective right throughout the course of television development and now we know that there is no obstacle or serious difficulty which need prevent this classic race being seen in the homes of scores of thousands of people. 1938 should most certainly see this dream of the television pioneers come true and in the meantime there are many events available, which though perhaps of lesser importance, will pave the way to this culminating triumph.

Post Office Help for Amateurs

ALTHOUGH the General Post Office have a monopoly on radio transmission and the issuing of licences to amateurs, it is not generally realised just how much assistance experimenters obtain from them. Rarely is an application for a transmitting permit rejected when genuine technical reasons are offered. Extensions to existing licences are also willingly given, providing a satisfactory explanation is supplied. Going even further in their help, the Post Office have arranged for amateur licence holders to have their permits extended after serving a probationary period so that they can use a higher power of up to 25 watts without giving any technical reasons for so doing. It can be taken for granted that any amateur station that has been licensed for six months or more can obtain a 25-watt permit. In the past any extension to licences had to be accompanied by a lengthy technical reason. However, this additional permit calls for an additional licence fee.

The Post Office also help amateurs in other ways. For example, during the summer months when a certain amount of work is done in the open, it stands to reason that amateurs would need some facilities for obtaining a temporary portable licence. It has now been arranged that any amateur can, by applying, be granted a permit to operate a 5-metre portable within 10 miles of any given Post Office.

THE MIHALY- TRAUB SYSTEM



These two photographs show the demonstration theatre and the radio laboratory of The International Television Corporation. In the foreground of the upper picture can be seen the first model of the home-type receiver.

NEW LABORATORIES DEVELOPMENT OF HOME RECEIVERS HOW THE SYSTEM FUNCTIONS

FROM time to time, ever since the Mihaly system of mechanical-optical television was first introduced, we have given details of the progress and the modifications that have been made in the original type of apparatus. These details were entirely concerned with laboratory models in the first case of the actual Mihaly system and latterly of the Mihaly-Traub system, which, though based on the former, now differs very considerably in several respects.

Originally this system was developed for 30 lines, and then later 90 and 120 lines, and each increase in definition made a great deal of intensive research work necessary both with regard to the scanning and optical equipment and the associated radio equipment. After successful results had been obtained on 180 lines, the next step would have appeared to be 240 lines, but a decision was made to tackle right away the more difficult problem of 405 lines. That this decision was a wise one is now apparent, for it has avoided the necessity of a further period of experiment and research.

Concurrent with this research for the provision of a much higher degree of definition, the problem of incorporating the laboratory apparatus in a commercial design has been tackled, and though the final design has not yet been reached, it has taken sufficient shape to indicate what form the commercial Mihaly-Traub receiver will take. Two receiver models are shown in one of the photographs on this page; one has a screen measuring 12 ins. by 15 ins., and the other 13 ins. by 16 ins., and as will be seen all the apparatus is con-

tained in cabinets which are approximately the same size as are used for housing cathode-ray receivers.

New Laboratories

In order that the development of the commercial receiver could proceed more conveniently it has been

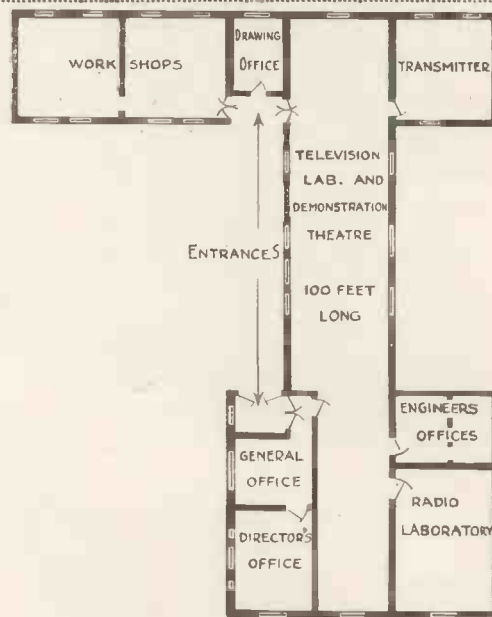

Plan showing the arrangement of the International Television Corporation's laboratories.

found necessary to equip new and larger laboratories. These now occupy the whole of the upper floor of Maidstone House, Berners Street, London, W., and as will be seen from the plan on page 322 comprise a demonstration theatre and television laboratory, mechanical workshop, radio laboratory, transmitting room and the usual offices. The mechanical workshop is equipped with machine tools so that all the parts required for development can be made on the spot. The demonstration theatre is 100 feet long and capable of holding a large screen as one objective of The International Television Corporation is the large-screen television pic-

ture suitable for large halls and cinema theatres, etc.

Further developments in the case of the home-size receiver are now mostly concerned with details and simplification so that it can be placed in the hands of the public with the certainty that it will work reliably and with no more skilled attention than the average domestic electrical device requires.

In the following pages a technical description of the Mihaly-Traub system is given, the information being based upon a lecture given by Mr. M. J. Goddard, one of the research engineers of The International Television Corporation, Ltd., before The Television Society.

HOW THE MIHALY-TRAUB SYSTEM WORKS

THE Mihaly-Traub system is a mechanical-optical system employing a combination of stationary and moving mirrors as a means of scanning television pictures. It is applicable to both transmitters and receivers, but in the following its application to reception only will be dealt with. For this system a light

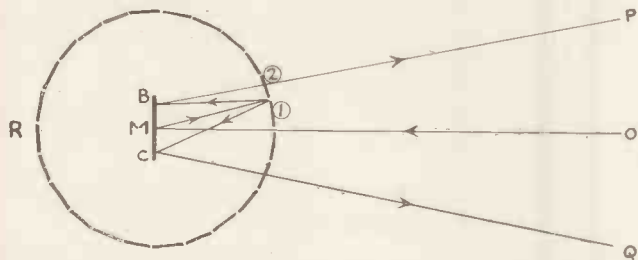

Fig. 1. Diagram showing the principle of the original Mihaly receiver.

source in the form of some electric lamp is employed, and the light from this is passed through a "light-valve" to which the signals received from the broadcast waves are applied in such a way that the intensity of the light leaving the cell is proportional to the strength of the signal received; the light is then made to traverse the screen in the form of a moving spot by means of the combination of stationary and moving mirrors.

The Original Receiver

The system was originally developed by Mihaly, but as will be seen it has undergone considerable modification since. Mihaly used a single rotating mirror M (silvered on both sides) (Fig. 1), and made the "drum" in the form of the stationary ring of mirrors R. Light incident from O strikes the mirror M, and is reflected to a given part of the mirror ring determined by the instantaneous position of M. Suppose at the instant considered it is reflected to the junction of mirrors 1 and 2. The light from 1 is reflected to B on the mirror M, and thence to P. That from 2 is reflected to C, and thence to Q. As M rotates, the light is scanned just as with a rotating drum, while the mirrors of R must now be tilted to produce the necessary relative displacement of successive lines (i.e., the so-called "frame-scan").

One difficulty with this original system was that of

adjusting the 100 mirrors of the ring to exactly the right position both laterally and vertically. This difficulty becomes still greater with higher numbers of lines, as also does the excessive size of the ring.

The Traub Modification

Traub has devised a system which reduced the difficulty of adjustment and increased the optical efficiency about 64 times, compared with Mihaly's arrangement. He replaced the Mihaly rotating mirror by a rotating mirror-drum, but a drum having comparatively few sides. Instead of the complete ring of stationary mirrors he used only a portion of the ring. Thus for a 100-line picture, a rotating drum with five mirrors and a ring of 20 stationary mirrors could be employed, as shown by Fig. 2.

The overall linear size of the system need only be about one-eighth that of Mihaly's system, or if the overall linear size employed is the same as in Mihaly's system, the area of the ring mirrors and therefore the illumination of the screen is increased 64 times.

In order to give a uniform scan all across the line,

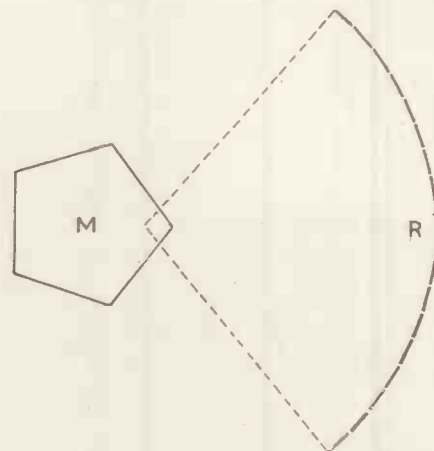

Fig. 2. Mirror combination for 100-line scanning.

the drum mirrors must be twice as large as the ring-mirrors. Thus in the 100-line system the drum mirrors would be 9.2 cm. wide, giving a drum about 15 cm. in diameter. The drum rotates once per picture; i.e., the speed of rotation is 1,500 r.p.m. This is not

INTRODUCTION OF FRAMING DRUM

impossible, and there are fewer components to adjust than in the Mihaly system, while the ring is smaller. This system is essentially the prototype of the present Mihaly-Traub scanner.

The Framing Drum

A great advance was made when a crossed drum was introduced to bring about the frame scan in place of the tilting of the mirrors of the ring and drum. The great advantage of this was that the product of the numbers of ring-mirrors and drum mirrors need no longer be equal to the number of lines. The product

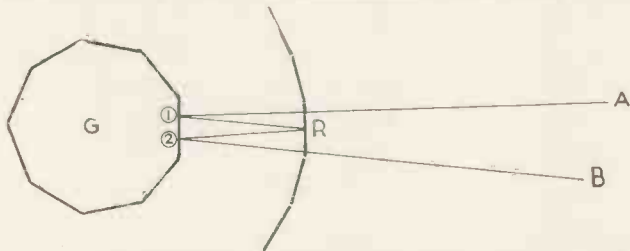

Fig. 3. Scanner for 405-line reception with path of light rays indicated.

can be decreased in a certain ratio, provided that the speed of rotation of the drum is increased in the same ratio. The diameter of the drum is now small (about 3 cm.); it can be made as a solid piece of glass, so that, once accurately made, it needs no adjustment.

A picture of 100 lines with satisfactory brightness can be obtained with quite a small scanning system. A tolerably satisfactory picture of 180-lines was, in fact, obtained in this way at the research laboratories of the International Television Corporation, but the brightness of the picture was less than the minimum desirable. The scanner employed was small, and the brightness could have been made sufficient by increasing the size of the scanner, but it was clear that the increase in size necessary for higher numbers of lines would still be prohibitive, so that it was necessary to have recourse to further improvements.

A New Light Valve

In the systems so far considered the solid angle of the cone of light converging on the screen, and therefore the illumination of the screen, is directly proportional to the size of scanner employed. If, however, the image of the source of light could be focused at or near the scanner, this would no longer be the case.

If an image is formed on any object, and an image of this is formed on a screen, no motion of that object will cause any motion of the image on the screen. Thus, if an image of the source is projected on to the scanner, and an image of this is projected on to the screen, no scanning motion will be produced on the screen. However, the introduction of a new light-valve obviated the necessity of forming an image of the source of light on the screen. It was then possible to focus an image of the source at or near the high-speed scanner, which could then be made small without reducing the illumination of the screen, and therefore, as far as the dimensions of the high-speed

scanner were concerned, a picture of adequate brightness could be obtained with any number of lines. With this system it has been found possible to construct a 405-line receiver giving a picture of adequate brightness.

The choice of 405-lines for the picture is very fortunate from the point of view of the Mihaly-Traub scanner. The combination of a nine-sided drum with five stationary ring-mirrors has been found very convenient, and for this combination the drum has to rotate exactly nine times per picture to give 405 lines, since $405 = 9 \times 5 \times 9$.

We may at the present stage pause to consider the advantage of this system over that employing two simple drums. It is clear that the Mihaly-Traub scanner could be replaced by a simple drum. However, the speed of rotation of the nine-sided drum in the Mihaly-Traub 405-line receiver is $9 \times 1,500$ or 13,500 r.p.m., while that of a simple nine-sided drum would be $45 \times 1,500$ or 67,500 r.p.m. Alternatively a simple drum rotating at 13,500 r.p.m. would require 45 faces. Thus for a given drum, the Mihaly-Traub system reduces the necessary speed of rotation, while for a given speed of rotation it reduces the number of faces required on the drum, and therefore the diameter of the drum for a given size of face. Furthermore the scanning angle for a 45-sided drum would only be half that of a corresponding Mihaly-Traub scanner, so that the distance from the scanner to the screen would be approximately doubled for the same picture size, thereby necessitating a much bigger cabinet.

Receiver Design

We may now consider the actual form of the lay-out of the optical system which is employed in Mihaly-

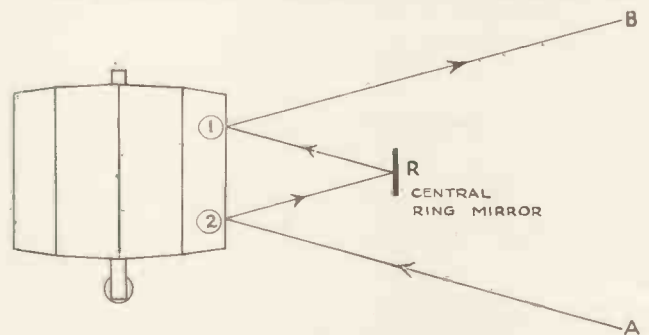

Fig. 4. Plan view of scanner showing path of light rays.

Traub receivers. The basic feature of the system is, of course, the high-speed scanner. This, as we have seen, consists, in modern 405-line receivers of a nine-sided polygon with five stationary ring-mirrors, as shown by Fig. 3. The light is incident from A on the polygon at 1. After reflection from a ring-mirror at R, it is reflected again at 2 from the polygon to B. Clearly if incident normally on the polygon, it would foul the ring-mirrors. It must, therefore, enter the system at an angle to the normal in the plane normal to the scan. It therefore describes a sort of W-shaped path through the system, as shown in Fig. 4.

INCIDENCE AND REFLECTION ANGLES

The angle through the system depends on the size of the cone of light which it is desired to pass through, which in turn depends on the angle which the lens immediately before the slow drum subtends at the high-speed scanner. For home receivers it is usually found that an angle of about 30° through the system must be used, i.e., the semi-angle of the W must be 30° .

The next essential part of the system is the slow drum. In this case the light has already started scanning in the plane normal to the scan of the drum, so it is not practicable to feed the light on to the drum at an angle in this plane. It must therefore fall obliquely in the plane of scanning of the drum.

The more oblique the incidence, the smaller will be the angle of convergence of the rays for a given size of drum-mirror. Therefore the direction of incidence is made as near radial as possible consistent with keeping the projection lens L (Fig. 5) clear of the reflected rays. In practice it is seldom found possible to reduce the angle of incidence below $37\frac{1}{2}^\circ$ to the radial direction of the drum.

The screen should be vertical, so the mean direction of the rays reflected from the slow drum should be horizontal. In designs, where it is possible, the axis of the high-speed scanner is made horizontal, as shown in Fig. 6, which gives an idea of the general arrangement. This would bring the light valve to V^1 and the source to S^1 . It is not practicable, however, to have any part of the system in front of the vertical plane of the screen, so a reflector is placed at Q, bringing the light-valve to V and the source to S. This brings the whole system to a compact form, which can conveniently be packed into a cabinet, as shown in the diagram. The mirror at Q may usefully be made concave, so that it replaces one of the lenses of the optical system.

There are certain other aspects of the problem of securing a serviceable lay-out which may be mentioned. It is desirable, from the point of view of the optical

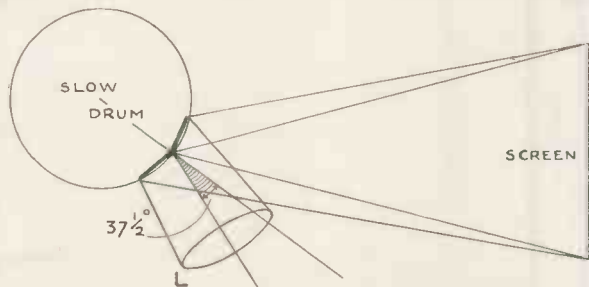

Fig. 5. Light incidence and reflection angles on slow drum.

efficiency of the slow drum, to make the angle of incidence of the light falling on the slow drum as small as possible consistent with the condition that the final projection lens does not foul the output beam. However, if the distance between the high-speed scanner and the slow drum is very large, the high-speed scanner may then fall in front of the plane of the screen. This would mean that the screen would have to be set back from the front of the receiver. From the point of view of the general appearance of the receiver this is undesirable, unless the amount by which the screen is set back is quite small. To overcome this difficulty, the angle of incidence to the slow drum may be increased, or the

distance from the slow drum to the screen may be increased (by increasing the number of mirrors on the drum), thereby throwing the screen further forward relative to the high-speed scanner.

Another factor which must be considered in deciding the position of the slow drum is the effect of this on the

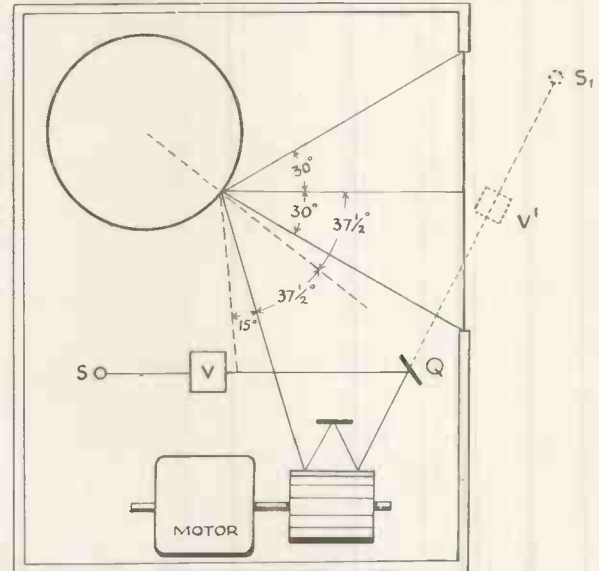

Fig. 6. Schematic arrangement of complete scanning gear.

external shape of the receiver. If the drum is brought further from the screen, then the depth from back to front of the set is increased, but the height is reduced, as the distance from the high-speed scanner to the drum is reduced. If the receiver is to be of the "portable" type, to stand on the table, then its height must not be too great. If, however, it is to be of the upright type to stand on the floor, then the available height of the cabinet will in all probability be ample to accommodate any optical system which is likely to be employed, so that the drum can be brought as near as possible to the screen to reduce the depth of the receiver from back to front.

Another factor which we have not so far considered in any detail is the scanning combination of the high-speed scanner. This determines the scanning angle in the plane of line-scanning. This angle must be made small enough to present a picture to the observer having tolerably uniform brightness all across. On the other hand if the angle is decreased too far, the distance from the scanner to the screen becomes excessive, and the overall size of the set is then increased. If the scanning angle of the high-speed scanner is increased, while that of the slow drum remains small, the distance between the two scanners may become insufficient. This is not, however, likely to happen in practice, as the scanning angle of the slow drum is kept as large as possible to give high optical efficiency, while that of the high-speed scanner has no effect on the optical efficiency, so it is kept as low as convenient consistent with a reasonably compact lay-out.

The angle at which the rays pass through the high-speed scanner can be varied. In general it is kept as small as possible consistent with the condition that the light does not foul the ring-mirrors, in order to reduce

SCANNER DESIGN

the axial length of the drum as far as possible. (This angle, however, has an effect on the scanning angle, and if it is necessary to reduce the scanning angle

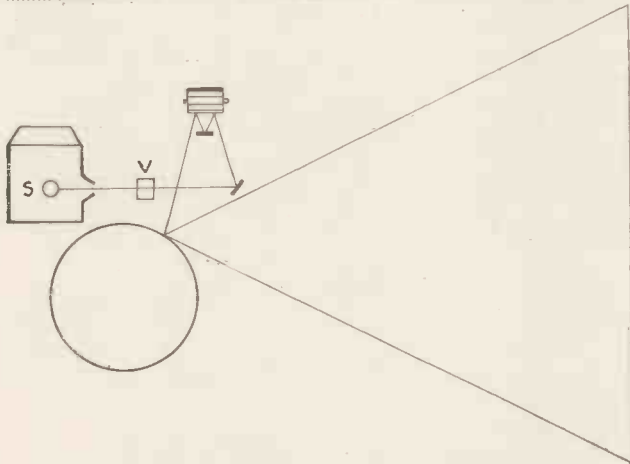

Fig. 7. Arrangement of scanners in large-screen receivers.

slightly, it can be done by increasing the angle through the high-speed scanner.

Large-screen Receivers

The lay-out of large-screen receivers is somewhat different. Here the slow drum is large, so it is kept as low down as possible. Accordingly light is reflected off the top of the drum to the screen so that the high-speed scanner is above the slow drum (see Fig. 7). Otherwise there is a close similarity between the systems for large and small screen work.

Scanner Design

It will be of interest to describe the design of the Mihaly-Traub scanner itself. For definiteness let us assume a drum of nine faces with five stationary ring mirrors. We will also assume, for simplicity, that the light passing through the system is parallel. The light incident on the drum must be just sufficient to cover two faces in the symmetrical position (Fig. 8). The centre of the circle on which the ring-mirrors lie is about half-way between the centre and the circumference of the drum. The arc formed by the ring-mirrors subtends an angle at the centre of the ring equal to twice the angle between consecutive faces of the drum (80° in the case which we have assumed). The radius of the ring is such that the light reflected from the ring-mirrors always falls on the operative face of the drum. If the ring is too large compared with the drum, this is not the case, while if it is too small the dimensions of the reflected cone of light are small compared with the drum and the incident cone of light, so that the system is uneconomical. The optimum radius for the ring is found by a graphical construction. It is such that the ring mirrors are about half the width of the faces of the drum.

For the light source, a Phillip's exciter lamp is usually employed for home receivers—either the 32-watt, having a filament 0.6 mm. wide or the 50-watt having a filament 1.5 mm. wide. Each lamp has a

filament about 5 mm. long. For larger receivers, arc lamps of convenient types are employed, depending on the screen size required.

All lenses are designed to be as free as possible from spherical aberration. Other lens aberrations are much less serious and can usually be ignored. Achromatic lenses are sometimes employed, but not so much because it is important to eliminate chromatic aberration but because these lenses can be more completely corrected for spherical aberration than non-achromatic lenses. Some special lenses have been designed with this in view. In particular, a lens is required on either side of the light valve, and for these special lenses have been designed which can be cemented to the outside of the cell, thus reducing the reflection losses, and yet giving almost complete freedom from spherical aberration.

By means of the Mihaly-Traub system, it is possible to design home receivers for 405-lines, interlaced scanning, giving pictures of adequate brightness up to 20 inches wide. Such models have already been constructed in the laboratories of the International Television Corporation, Ltd. Moreover, big screen projectors giving 405-line pictures 10 feet wide have been

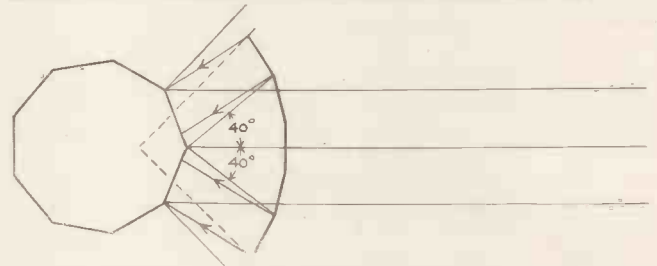

Fig. 8. Light incidence and reflection between ring mirrors and high-speed drum.

designed. High numbers of lines present no serious obstacles, as the system is capable of dealing with a definition up to 1,000 lines quite comfortably.

Delayed Switching

The problem in television and other high-voltage amplifiers is how to heat the filaments of the mercury vapour rectifying valves before the high voltage is applied.

As a general rule a thermal delay switch is included which can be of the valve or semi-mechanical types. In either case an expense is incurred which most television constructors feel to be rather unnecessary.

A scheme which transmitting amateurs use with success seems to be applicable to television amplifiers. A wide contact switch is connected in series with the centre tap to the H.T. secondary on the mains transformer. When this switch is open no H.T. is applied to the anode of the rectifying valve, but when the contact is closed full H.T. is applied.

As one side of the switch is at earth potential there is no danger of shock and the valve filaments can be switched on and after 60 seconds or so H.T. applied by making the contacts in the switch in the H.T. centre tap return lead. This scheme will save another half a guinea when building high-voltage equipment.

THE TELEVISION CAMERA

A SIMPLE EXPLANATION OF ITS WORKING PRINCIPLES, CAPABILITIES AND LIMITATIONS

THE following notes will give readers some idea how photographic and television cameras compare.

The knowledge that the word "camera" means "a chamber" will hardly help us to picture in our minds the various classes of modern apparatus which are now used. It was in the sixteenth century that the Italian, Battista Porta, discovered that by covering up a window with a shutter with a very small hole in it, that a picture of the scene outside appeared, upside down, on the wall opposite the window. The size of the hole is important. The smaller the hole, the clearer or sharper the picture, though at the same time, duller or less bright.

The next step in camera development was to use a glass lens instead of the small hole, and so was developed the "camera obscura." This form of camera consisted in its most developed form of a lens L (Fig. 1), built in a sort of revolving turret head roof. Light from the lens was reflected by the mirrors M, generally at an angle of 45°, so as to throw an image on to the top of a white table, which was placed in a darkened room. The result of all this was that an observer inside the room, could see a picture of the outside

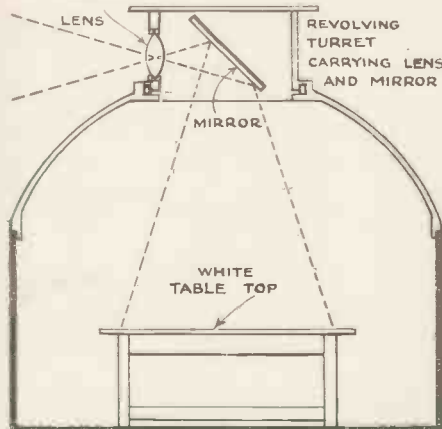
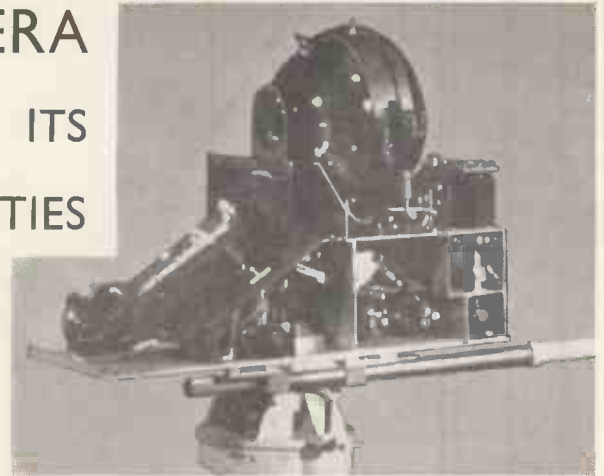

Fig. 1. Schematic diagram of camera obscura.

world, without himself being seen. The modern form of such an arrangement is the periscope.

The camera obscura existed for about a century before means were found of recording the images produced other than by drawing them in, a method of which many well-known painters of the times were accused of. In 1838, two Frenchmen produced the daguerreotype system by which optical images were recorded by the action of light, and this was followed by important improvements, resulting in photographs



The Marconi-E.M.I. television camera with the case removed.

on paper by Fox Talbot. Advance after this was rapid, though more in the preparation of sensitive materials, than actual cameras, F/8 being a fast lens for many years, which, employed with slow plate emulsions, necessitated long exposures, and therefore the first photographic cameras were those of the "stand" or "field" type.

Let us now take a big jump to the latest form of camera—that of television. Painted in a naval grey, on a rather massive stand, they look most imposing. Compared with the film camera the television camera is singularly free from external fittings, even to the lack of the lens hood.

The Lens

As the lens is the first necessity of all cameras, we will consider it first. The television camera lens is a 6.5-in. focus, working at F/3, and is mounted, as in a stand camera, on a vertical panel, which is moved in and out for focusing by the usual rack and pinion mechanism. A rising and falling front is not fitted. As the camera does not fold up, the bellows are only just sufficient to take up the necessary movement for focusing, it being, of course, absolutely necessary to have as much screening, in the radio sense as possible. In place of the film or plate is the photo-electric mosaic, which is enclosed in an evacuated glass vessel, in the scale of which, at the appropriate place is an optical flat, which is skilfully fused into the bulb, so as not to affect the optical image thrown by the lens on to the mosaic. Included in the evacuated bulb are the necessary electrodes to produce a focused electronic beam which scans the mosaic, the actual scanning forces being magnetic and produced by electro-magnetic coils external to the glass chamber. Below, and suitably shielded in small compartments are the various thermionic valves, which form the first part of the complex electrical chain.

Returning to the lens, many people have expressed some surprise at the relatively small F number, compared with some modern lenses. Actually the F/1.9 class of lens is only commercially used in the so termed "miniature" camera and cinematograph cameras, where the covering area, that is to say the image on the plate, is small.

Unfortunately, at present it is not possible to use a

DEPTH OF FOCUS IN TELEVISION PICTURES

mosaic of small dimensions, the reason being that an electron beam cannot be focused down to a sufficiently small area, though the present mosaic is sufficiently fine in the "grain" sense. From the photographic point of view, a small mosaic would greatly improve results, owing to the greater depth of focus obtainable with lenses of less covering power than that at present used.

Focal Depth

In practice a lens of $F/3$ of 6.5-in. focal length is in many people's opinion too large an aperture to give adequate depth of focus. As was recently pointed out

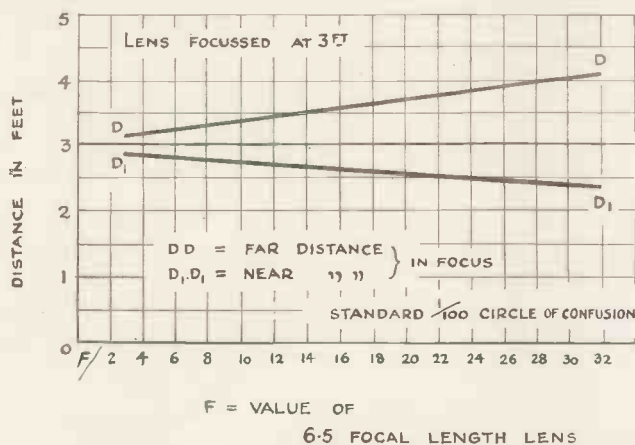

Fig. 2a. Graph showing depths of focus for different apertures.

in TELEVISION AND SHORT-WAVE WORLD, in the case of an object being focused 3 ft. away, then anything nearer than 2 ft. 11.5 ins. or further than 3 ft. 0.5 in. is out of focus, and even at 15 ft. there is only 22.25 ins. and 26.5 ins. latitude. It is interesting to note how the depth of focus would be improved if the usual cinema lens of 2 ins. focus could be used. In the case of an object 3 ft. away it would be sharp, as near as 2 ft. 4 ins. and as far as 4 ft., which means that one lens has a focal depth of 1 in. and the other 20 ins. focused on a given point. The advantage is, of course, proportional to all other distances. Figs. 2a and b show this depth of focus business graphically, both for depth at a given aperture (Fig. 2a), but different focal lengths, and different apertures for a given focal length (Fig. 2b). It will be seen that to get the same depth of focus at, say, 3 ft. the 6.5-in. lens must be stopped down to $F/32$ to equal the cinema 2-in. focus, and, of course, the 6.5-in. lens would be some 125 times slower.

Actually, television systems have not quite the same degree of sharpness as photography and as a result, the depth of focus problem does not appear quite as bad as one would expect. There seems little hope of improvement in this depth of focus problem, other than the increase of light in the studio and stopping down the lens. While this would certainly improve conditions for the lookers-in, the health and comfort of those in the studio would suffer.

There is a good deal of comment in some quarters as to this lack of depth of focus in television pictures, this as we have shown, must be so for the present, though

no doubt it will be overcome in time. The defect at present is often exaggerated by the wrong placing of artists for the existing limitations of the system.

View Finders

Of paramount importance in all cameras are the methods available for focusing and composing the scene to be recorded. Obviously, the best method is to be able to inspect the actual image thrown on the plate or film, or the substitute in the form of a ground glass plate. All photographic cameras of the more serious type are so constructed. In modern cinematograph cameras there are ingenious devices by which the operator can see the image on the actual film, while the camera is in operation. They are also fitted with a duplicated lens system and ground glass screen, the lens being optically matched with that of the taking lens to which it is mechanically geared. In the case of the duplicated lens system of viewfinder, the problem of parallax has to be overcome. In cinema and miniature cameras this is easily corrected, as the original error is not very great owing to the actual physical size of the lenses, and the areas they have to cover.

In the case of the television camera, the problem becomes somewhat more acute, owing to the large size of the lenses and areas covered. The type of viewfinder used in the television camera is somewhat similar to that of the cinema camera. A secondary lens is used which by a system of reflections projects the image on a ground glass, suitably hooded, at the side of the camera. The arrangement is shown diagrammatically in Fig. 3. It will be observed that the two mirrors and the lens are racked in and out with the taking lens, thus enabling focusing and composing to be carried out.

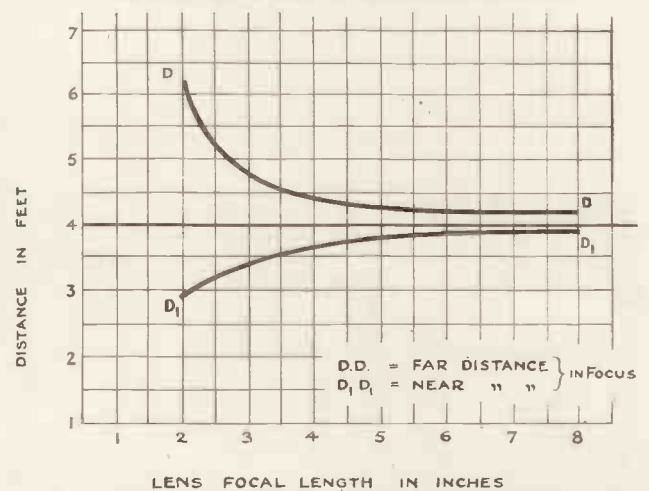

Fig. 2b. Graph showing depths of focus of lenses of different focal lengths. All lenses working at $F/3$ focused on a point 4 ft. distant. Standard 1/100 in. circle of confusion.

It is to be expected that certain focusing errors are unavoidable when working at close range, owing to the slightly different distances of the object to the two lenses.

A very important point about the design of the focusing and composing devices on a television camera are

TELEVISION AND CINEMA CAMERA COMPARISONS

that they have to be in operation for much longer periods of time than the photographic prototypes. Viewfinders of cinema cameras are nearly always inspected by one eye through an eye piece, which for periods of more than a couple of minutes becomes somewhat of a strain. Luckily, in the making of films, very few "takes" are for more than three minutes, and most far less. The television camera, however, is constantly in use for periods of twenty-five minutes or even more at a time, rapidly going from near and long "shots" many times, and for this reason the focusing and composing device must have as bright a viewing screen as possible.

The fact that the television camera is instantaneous to our slow senses obviously offsets some of its disadvantages. The result is seen at once, though not by the camera operator, and he must therefore be given instructions by phone from technicians and producers, which usually are of great assistance, especially in following the action of a complicated play.

Four cameras are used at Alexandra Palace, three on stands and one on a "dolly" truck. The latter is a small truck on which the camera is mounted, fitted with pneumatic tyres and pushed about the studio by manpower, the camera-man, of course, travelling on the truck.

So much for the mechanical-optical side of the television camera of to-day. In the future, anything may

happen. No doubt the time will come when robot-like cameras will go through their evolutions controlled entirely from some master control room, the studio as a whole being watched by a master camera.

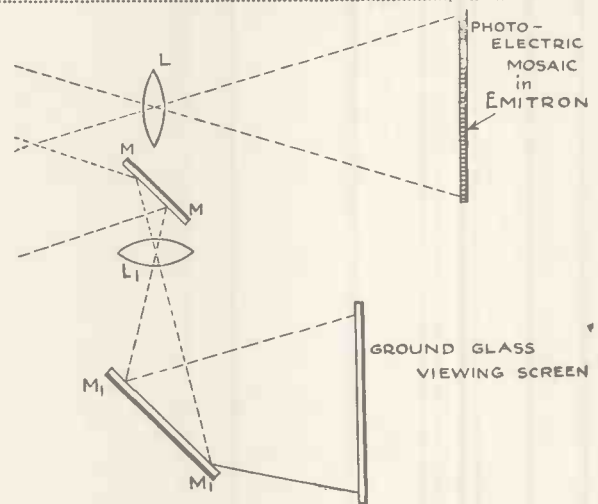

Fig. 3. Optical system of television camera.
L, Lens projecting image on mosaic. L1, Lens projecting image on viewfinder ground-glass. MM, Mirror reflecting light from scene to lens L1. M,M, Mirror reflecting light from L1 to ground glass screen. L, L1, MM and M,M, are all mechanically coupled.

THE FIRST CINEMA INSTALLATION

TO the management of The Odeon Cinema, Southgate, London, N., belongs the credit of being the first to instal a television receiver in the foyer of the cinema.

The event is of special interest for as Sir Michael Bruce, Bart., who represented the Odeon company said, the belief of the management is that television and the cinema will be

allies rather than rivals, an opinion which, coming from such powerful cinema interests, is of importance.

The inauguration ceremony was charmingly performed by Miss Anne Grey, the well-known film star, who wished the Odeon Company success in this new venture. An influential gathering representing film interests and well-known local guests including the Mayor of Southgate, Ald. H. F. Wauthier was present.

The object of the installation, which it is understood may be the forerunner of others is to provide entertainment for visitors waiting in the foyer. In this respect it has been entirely successful, and on Coronation Day a hundred special visitors were present who were loud in their praise of this latest cinema innovation.

No less than 32 cyclists will start on a 17½-mile road race in front of the television cameras on May 29. Some famous cyclists will take part, including at least three Olympic champions in J. G. Bone (Glasgow Wheelers), H. H. Hill (Sheffield Phoenix), and A. Bevan (Fountain C.C.). The circuit takes approximately 4 minutes to ride and it is hoped to televise the start and the finish of the first round.



The opening ceremony at the Odeon Theatre, Southgate. From left to right, the Mayoress, Mr. Elliott, the manager, Miss Anne Grey, the film star, the Mayor of Southgate and Lady Bruce.

THE GLOW-GAP DIVIDER

By J. H. Reyner, B.Sc., A.M.I.E.E.

Interesting details of a gas-discharge tube that maintains a steady voltage irrespective of current variation.

FIVE years ago the writer brought back from the Leipzig Fair an early sample of the glow-gap divider—an arrangement which was claimed to maintain the output voltage of a mains unit constant within

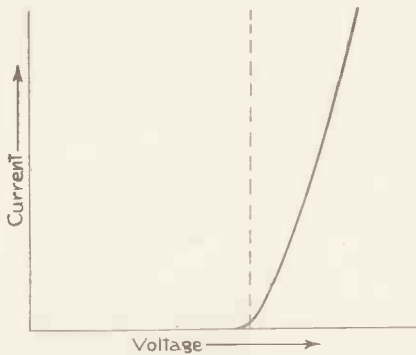

Fig. 1—Characteristics of neon Lamp.

close limits irrespective of current, and furthermore to provide tapings at suitable points without the aid of any external potentiometer network.

On test in the laboratory the device fulfilled these claims in a surprising manner, and it has in fact been in use ever since. This form of divider is available in this country. It is known as the Stabilivolt and is marketed by Marconi's Wireless Telegraph Co., Ltd., in various sizes

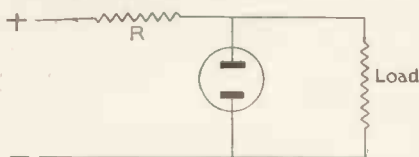

Fig. 2—Simple regulator circuit.

covering a wide range of current and voltage.

The inherent regulation of a neon lamp is well known. Fig. 1 shows the characteristics. No current at all will flow until the voltage across the lamp reaches a certain minimum value sufficient to cause ionisation of the gas. Once this happens the free electrons liberated by the electric field collide with further molecules of gas from which they liberate further elec-

trons and thus by a cumulative process a large current rapidly builds up. It is in fact necessary to include a series resistance to limit the current to a safe value, as otherwise the tube may be destroyed.

It will be clear that although the D.C. resistance of the tube may be somewhat high due to the high initial striking voltage required, the A.C. resistance is very low, for a surprisingly small increase in the applied voltage causes a rapid increase in the ionisation and the current grows considerably. In fact, the device acts like a condenser of very large capacity and may be used as such.

Fig. 2 shows a simple circuit. Voltage is fed to the tube through a suitable limiting resistance, while across the tube is connected the load. The current therefore divides partly through the tube and partly through the load. If the load resistance changes taking, say, a little more current, the voltage on the tube will be reduced because of the increased voltage drop on the series resistance R. But we have seen that a very small change in the voltage on the tube causes a large change in current and actually the tube current will fall off to an extent which allows the voltage across it to recover practically to the original value.

Now by proper design and the use of the correct mixture of gases at the right pressure the regulation obtained by this means can be made extraordinarily close, something in the neighbourhood of one or two per cent. drop only between zero and full load. But the Marconi Stabilivolt goes farther than this. It is possible by introducing additional electrodes between the anode and cathode of the tube to tap off voltage at intermediate

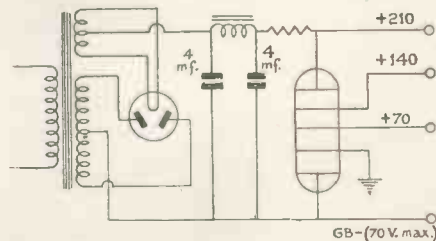

Fig. 4—Eliminator circuit with Stabilivolt control.

points. The voltage on each tap is dependent upon the ionisation potential which, in turn, is dependent upon the distance between the various elec-

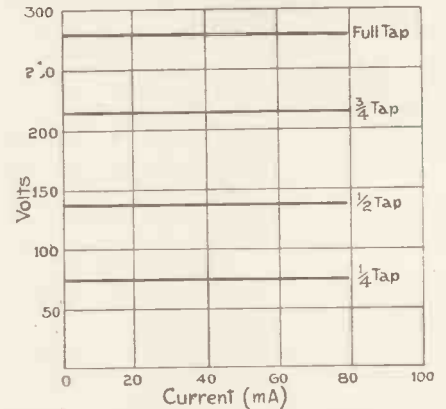

Fig. 3—Typical Stabilivolt characteristics.

trodes, and if we have equally spaced electrodes we get equal voltage tapings all the way up.

The practical form of tube utilises electrodes in the form of cups, which are mounted concentric with one another and all brought out to separate pins on a suitable base. With such a device we find that not only the total voltage but the voltage on the

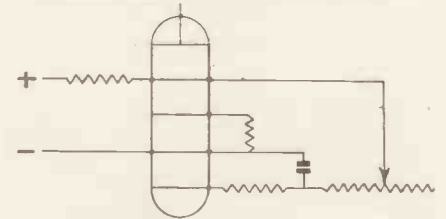

Fig. 5—Time base with constant H.T. control.

various tapings is also constant within the limits just specified irrespective of the current taken either from the whole output or from the tapping points, provided they are within the limits that the tube will stand.

This question of maximum current will be understood by reference to the simple explanation previously given. If there is no load in the external circuit, then all the current will be absorbed by the tube. As we com-

(Continued on page 384.)

BAIRD TELEVISION LTD.

WORLD PIONEERS & MANUFACTURERS OF ALL TYPES OF TELEVISION EQUIPMENT

BAIRD TELEVISION RECEIVERS

The Baird Receiver, Model T.5, is the finest set offered to the public. Although costing only 55 guineas it provides a brilliant black and white picture larger than that obtainable on any make of receiver now marketed. Among the factors contributing to the set's performance, are simple operation, wide angle of vision, high fidelity sound and excellent picture detail.

Free installation and one year's service.

Remember, Baird Receivers mirror the world! So place your order now.

PRICE 55 GNS.

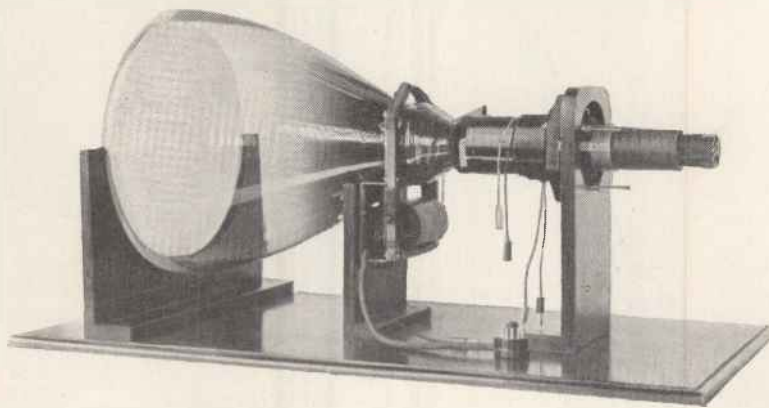

"CATHOVISOR" CATHODE RAY TUBE Type 15 WMI Complete with Electromagnetic Scanning and Focusing Equipment.

BAIRD MULTIPLIER P.E. CELLS

Baird Multiplier Photo Electric Cells are made in two main types. The first has a small cathode of 15 sq. cms. for use with a concentrated light beam, while the second has a large cathode of 250 sq. cms. for diffuse light.

The Baird Multiplier has a chain of electron permeable grid stages and current gain factors of the order of 100,000 can be obtained. Cathode sensitivity is approximately 30 micro-amperes per lumen and the good spectral response enables the cells to be used for infra red detection and infra red signal amplification. Details on application.

BAIRD CATHODE RAY TUBES

TECHNICAL DATA

TYPE 15 WMI.	
Heater volts	1.8 volts.
Heater amps	2.4 amps.
Peak to peak volts, between black and highlights	30 volts.
Maximum electromagnetic sensitivity	2 mm/AT.
Modulator/earth capacity	2 μ F (approx.).
Modulation sensitivity (slope)	6 μ A/V.
Anode volts	6,500 volts.
Maximum input power to the screen	3.5 milliwatts/sq.cm
Maximum anode current for high-lights still in good focus	100 μ A.
Screen colour	Black and white.

GENERAL

The Baird Cathode Ray Tube, type 15 WMI, has a hard glass bulb whose screen diameter is 38 cms., total length 74 cms., and neck diameter of 4.45 cms. Apart from manufacturing processes, stringent tests are made for electrical emission, tube characteristics, filament rating and screen quality, and following normal picture reconstitution under service conditions, the completed cathode ray tube is subjected to a very high external pressure test.

All "Cathovisor" Cathode Ray Tubes are completely electromagnetic in operation, a feature of outstanding advantage. Furthermore, not only is the electrode system extremely simple and robust, but due to the special form of cathode employed, a high intensity cathode ray beam is produced which results in a very brilliant picture.

The ideal tube for really large television pictures—12 in. by 9 in.—without distortion.

LIST PRICE, 15 GNS.

Head Office:

**GREENER HOUSE, 66 HAYMARKET,
LONDON, S.W.1.**

'Phone: Whitehall 5454

Laboratories:

**CRYSTAL PALACE, ANERLEY ROAD,
LONDON, S.E.19.**

'Phone: Sydenham 6030

MULLARD
TYPE E46-12
FOR TELEVISION

PRICE

15 GNS



Mullard

CATHODE RAY TUBES

Mullard have held for years a unique position as pioneers in the Radio industry. Mullard Master Valve reputation is upheld in the new field of Television by the Mullard Cathode Ray Tubes. TYPE E46—12 FOR TELEVISION. Double Electrostatic Deflection. Sensitivity 650/v. Maximum Anode Volts 6,000 v. Screen 12", White. PRICE 15 GNS.

A full list of Mullard Cathode Ray Tubes for Television and other purposes will be supplied upon application and we invite trade enquiries and queries.

Mullard Wireless Service Co., Ltd., Mullard House, 225, Tottenham Court Road, London, W.1

CVS-70

JUNE, 1937

THE FIRST REAL TELEVISION "O.B."

HOW THE CORONATION PROCESSION WAS TELEVISED

ALTHOUGH the televising of the Coronation Procession was not the first actual outside broadcast that has been made, it was the first to employ outside equipment and it differed very materially from the transmissions that have taken place within the precincts of the Alexandra Palace.

It brought into service for the first time the B.B.C.'s new mobile tele-

with this control room. The actual cameras are similar to those in use at Alexandra Palace.

The apparatus in the mobile control room is mounted on racks along the sides of the vehicle leaving clear a centre passageway for the engineers operating the equipment. Two picture-monitors are mounted at one end of the van and while one of these is used to monitor the picture which

small sound control room with all the necessary "faders" and amplifiers to deal with the four microphones which pick up the voice of a commentator and sounds associated with the scene being televised. The sound control room can be linked with Alexandra Palace by ordinary line.

Two Links with A.P.

The conveyance of the picture signals to the Alexandra Palace is possible by two methods. The normal channel is a special television cable having characteristics suitable for the transmission of the very wide band of frequencies which is involved. This cable has been laid by the Post Office from Hyde Park Corner to Broadcasting House and from Broadcasting House to Alexandra Palace, and forms part of a television cable at present being laid in the centre of London passing points of interest from which television broadcasts may be carried out later on.

In addition there is available an alternative channel provided by the second vehicle which contains a complete ultra-short-wave vision transmitter having a power of 1 kW for use with which a small easily erected aerial system has been designed. Picture signals from the mobile control room can be conveyed by means

(Continued at foot of page 339)



The mobile television control room used for televising the Coronation Procession.

vision unit. Owing to technical reasons which limit the length of the cable connecting the television cameras with the control room, previous television outside broadcasts have been confined to the grounds of the London Television Station at Alexandra Palace.

is being transmitted, the other allows the picture incoming from the second camera to be inspected to determine its suitability for transmission.

The vehicle is also equipped as a

The Mobile Unit

The mobile television unit was constructed to enable scenes at a considerable distance from Alexandra Palace to be broadcast. It has been designed and supplied to the order of the B.B.C. by the Marconi-E.M.I. Television Co., Ltd. The unit consists of three vehicles each the size of a large motor coach. The most important of these is a mobile television control room, shown by the photograph on this page, containing all the equipment necessary for the operation of three television cameras. Special multi-core flexible cables, which can be up to 1,000 feet in length, connect the Emitron cameras

Map showing the arrangements made for transmitting the vision signals from Apsley Gate to Broadcasting House and thence to the Alexandra Palace.

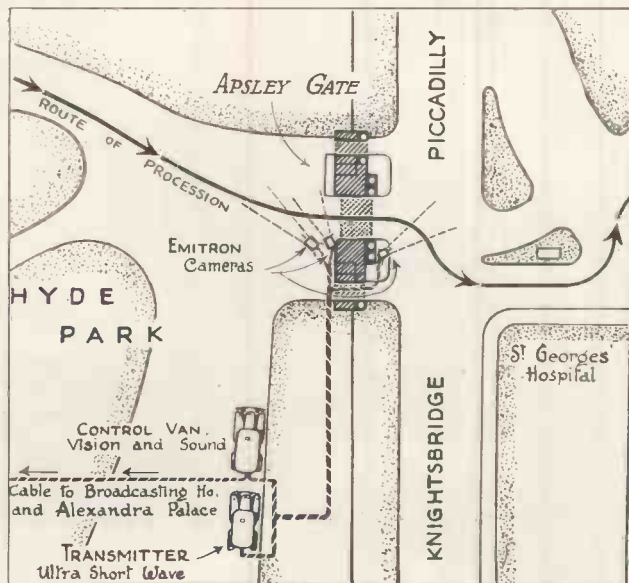



The Science Museum, South Kensington, where the Television Exhibition which is to be opened on the 11th of June will be held.

TELEVISION EXHIBITION

AT THE SCIENCE MUSEUM

OPENING JUNE 11TH, 1937

AS has been announced in previous issues of TELEVISION AND SHORT-WAVE WORLD, the first all-Television Exhibition ever to be held in this country is to be opened at the Science Museum, South Kensington, on June 10, by Lord Selsdon, Chairman of the Television Advisory Committee. The Exhibition is being held by the courtesy of Colonel E. E. B. Mackintosh, D.S.O., Director of the Science Museum, and has been organised by Mr. G. R. M. Garratt, M.A., in co-operation with a Committee composed of representatives of the B.B.C. and the leading television manufacturers. The Exhibition will be open to the public on June 11 and will remain open for about three months, so there will be ample opportunity for all readers to visit it.

The Science Museum is open from 10 a.m. to 6 p.m. on Mondays, Tuesdays and Wednesdays; from 10 a.m. to 8 p.m. on Thursday, Fridays and Saturdays and Bank Holidays; and from 2.30 p.m. to 6 p.m. on Sundays. Admission is always free.

Although readers of TELEVISION AND SHORT-WAVE WORLD have followed the technical development of television for a long period, the general public has remained surprisingly ignorant, and it cannot be denied that even to-day, the vast majority of the public have never seen a demonstration. To those entirely unconnected with practical radio, the development of modern television has seemed to have taken place very suddenly. It has made its debut in an advanced state of perfection, unheralded over a period of many years.

This apparently sudden develop-

ment of television has caused the wider public to regard it with some degree of hesitation and scepticism and it is with a view to demonstrating that television has now emerged from the experimental stage, to illustrate the general principles which underlie modern technique, and to foster the widest possible appreciation of television as a home entertainment that the forthcoming exhibition has been organised. The exhibition will incorporate a historic section dealing briefly with early proposals for television, and numerous exhibits will describe the developments of the past ten years. There will be a working demonstration of 30-line television using part of the apparatus which was employed by the B.B.C., there will be numerous demonstrations of cathode-ray apparatus and modern receivers will be used for reproducing the B.B.C. programmes.

In addition to the B.B.C. transmissions a local transmitter is being installed in the exhibition which will provide programmes from cinema films at intervals when there is no programme available from Alexandra Palace.

In addition to the cathode-ray receivers, one of which will be provided by each of the manufacturers, there will be demonstrations of large-screen television by Messrs. Scophony, Ltd., and the International Television Corporation, Ltd. It is not yet quite certain, however, that these two latter demonstrations will operate from the Alexandra Palace transmissions.

In connection with the exhibition a handbook has been compiled by Mr. G. R. M. Garratt, assisted by

members of the Executive Committee. The handbook contains a brief account of the early proposals for television, chapters on photo-electricity and light control, the cathode-ray tube and electron cameras. Further chapters describe the lay-out of the television transmitter, television receivers, aerials and feeders, and a general description of the London Television Station at Alexandra Palace. Copies will be on sale at the Science Museum on and after June 10, or may be obtained from any branch of H.M. Stationery Office, or from any bookstall, at the price of sixpence. A review of the handbook will be included in our next issue.

Low - Priced Apparatus for Constructors

To enable experimenters and amateurs to construct high-definition receivers, the Mervyn Sound & Vision Co., Ltd., are making a special offer of kits and units for building first-class high-definition apparatus. The prices of the high-grade components will enable many experimenters who have not yet built a television receiver on account of the cost to do so immediately. As an illustration, a double time-base can be purchased for 65s., while a power unit for this will cost only £6. The 4,000 volt exciter unit with a control panel now costs only £5.

Valves are not included in the kits, and experimenters will find that if one unit at a time is built it will be more convenient to purchase the valves when required. The I.F. transformers used in the vision receiver can now be purchased at 6s. each.

Scannings and Reflections



AN EXTRA TRANSMISSION

AS forecast last month, a decision has now been made to inaugurate a daily extra period of transmission lasting approximately an hour every weekday between 12.30 p.m. and 1.30 p.m. The purpose of this is to assist the trade in giving demonstrations at a convenient time of the day, and the B.B.C. emphasises that the transmissions are for this purpose only, and are not intended for the entertainment of home viewers. On this account the transmission will be a repetition daily of a film which has been specially produced by the B.B.C. surveying the activities of television since the service opened, about six months ago. It is perhaps rather unfortunate that it has been found necessary to use a film for these transmissions for, generally speaking, films do not transmit so well as actual studio scenes, though much depends upon the type of film.

REARRANGEMENT AT THE PALACE

Up to the present practically no use has been made of the space rendered available by the removal of the Baird apparatus from the Palace, so in order that certain re-adjustments can be carried out and an overhaul made to the transmitting gear, it has been decided, with the concurrence of the Television Advisory Committee and the approval of the Postmaster-General, that transmissions will be suspended for a period of three weeks commencing on Monday, July 26.

THE SUCCESS OF THE CORONATION TRANSMISSION

Despite the dull weather, viewers are in general accord that the Coronation Procession transmission was a huge success. At a distance of 18 miles from the Alexandra Palace our personal experience, using a G.E.C. receiver, was that it would have been difficult to have had anything better if one excepts a certain amount of dullness due to the bad light; and in any case this was a true portrayal of

conditions as they actually were. The pictures remained perfectly steady for the whole of the period and no adjustment whatever was made to the receiver.

It is interesting to note that the cinema news-reel men operating near the television cameras had to give up owing to lack of light.

CORONATION FACTS

Very full advantage was taken of the Coronation transmission, not only in London, but in places distant approximately seventy miles away. An Ipswich viewer said that both sound and vision were received perfectly, and from Rochester (Kent), also came a report of good reception. A viewer at Fleet (Hants), thirty-seven miles away, also saw the procession perfectly. At the Odeon Cinema, Southgate, a hundred people after seeing the procession on the receiver that has recently been installed there, stood up and cheered wildly.

The General Electric Company, in collaboration with their dealers, organised 200 viewing rooms throughout the reception area, embracing towns as far away as Brighton, a small charge being made in aid of hospitals and other charities. One dealer organised a special demonstration for cripple children unable to attend the L.C.C. parade on the Embankment. Television sets were installed in the open air for the first time, and at the Ranelagh Polo ground, where there was a set in a marquee. It is estimated that approximately 35,000 people witnessed the procession by television.

WHAT THE PRESS SAID

The Daily Telegraph.—The supreme triumph of television to date was marred only by a stroke of ill luck. At the moment televising was about to begin the visibility grew bad.

Such details as the emu's feathers in the Australian's slouch hats, and the plumes in the Guards' bearskins showed plainly on the screen.

— Good as the pictures were, sun-

shine would have improved them by 50 per cent.

The Evening Standard.—Nearly 50 miles away every one of us saw more of the procession than we would have done had we been in a 20 guinea seat on the spot.

The Financial Times.—It was the first outdoor event to be televised and was regarded in the nature of an experiment. Despite the adverse weather conditions the amount of detail clearly shown suggested that the future of television is almost unlimited.

THE ABBEY CEREMONY

Most of us have now seen the films taken inside the Abbey and we must congratulate the technicians who made it possible. It is indeed a pity that television was kept outside, but such is the penalty of instantaneous reproduction. Even if there had been a delay of ten seconds we believe the authorities would have allowed it. In the films there was an almost complete absence of "panning" shots, which indicates how the cine cameras were "camouflaged" and therefore completely immobile.

ITALIAN TELEVISION PROGRESS

Safar is the only firm in Italy with a television system of its own. It has obtained the contract for Italy's first television transmitter which is to be erected at Rome, and which is to be ready by February, 1938. It will be a 30 Kw transmitter. The number of lines employed will either be 405 or 441. The station will probably be placed in the grounds of the 1941 Universal Exhibition at Rome.

As in other countries, the great interest of the military authorities in certain applications of television makes it impossible for those concerned to publish all details of their work. It is therefore only possible to briefly outline the principles of the Safar system: It employs the full power of the transmitter for transmitting the synchronising impulses. This will improve reception on the fringe of the service area. (The Safar television receiver employs 15 valves; magnetic deflection is used both for

MORE SCANNINGS

the line and picture frequencies. Ironcore coils are employed for this purpose.

The Castellani "electric eye," the "Telepantoscope," is now being manufactured. The sensitised surface in the tube consists of very thin lines of a secret material treated with caesium and supported by a sheet of mica. In the present model, the picture is scanned by a small mirror-wheel, but it is intended to eliminate this mechanical method very shortly.

SECRETS

When we go to the Palace on various occasions we are very courteously treated, but we have never, nor has anyone else that we have known, seen under the cover of a camera. We must thank Mr. Cock for recently showing us one of these minor mysteries during his recent talk on televising the Coronation.

A NEW CAMERA

It is reported that a new camera is being developed by the Marconi-E.M.I. Co., which will be much more sensitive than the present ones employed. It is expected that with this camera the illumination intensity of the subject being televised need not be so great as at present, and therefore it will facilitate the televising of events where high intensity illumination is not possible. Also by permitting a smaller aperture to be used the depth of focus will be considerably increased and will make operation more simple.

A NEW POST OFFICE REGULATION

In the past, the G.P.O. have issued special licences permitting experimenters to use oscillators for test purposes. It has been decided that the ordinary receiving licence will in future be extended to include the use of modulated oscillators for the transmission of gramophone records, provided it is coupled to a receiver by wire and screened in such a manner as to prevent, as much as possible, radiation from the oscillator.

Providing the oscillator is not allowed to radiate and that the connecting link between oscillator and receiver is efficiently screened, there is no need to obtain a new licence for the oscillator. A special oscillator licence for use under different conditions to that stated above, costs 10s. per year.

THREE FRENCH RADIO EXHIBITIONS

The Spring Exhibition of the S.P.I.R. concludes on May 30. It is being held at the "Neo-Parnasse," 241, Boulevard Raspail, Paris. The Paris Fair Salon has had its finishing date fixed at June 7, while a special pavilion is being provided for radio exhibitors at the forthcoming International Exhibition, which opened on May 24 and is to last for six months.

TELEVISION AT OLYMPIA

The R.M.A. Exhibition to be held this year at Olympia between August 25 and September 4, will have a special radio theatre and section devoted to television demonstrations situated in the National Hall. In the Grand Hall Britain's foremost radio component and receiver manufacturers will have stands, while in the Gallery stands mainly for wholesalers will be allotted.

SOVIET TELEVISION

As an indication of the progress made by British television engineers, Messrs. Scophony, Ltd., are supplying a complete transmitting and receiving equipment to the Soviet Government. This equipment is to be erected in Moscow and includes two types of receiver; one giving a picture 24 ins. by 22 ins. and the other 5 ft. by 4 ft. for public viewing.

The order was placed after a technical delegation were given a demonstration of the definition and brilliancy obtained with this system.

AUSTRALIAN MOBILE TRANSMITTERS

A mobile transmitter housed in a railway carriage is in continuous use in Australia. The call-sign is 3YB and the station is licensed to radiate in any part of the State of Victoria, and automatically becomes the local station of the town visited.

Radio station 3YB has a rated input of 50 watts and works on 1060 kc., but despite its low power it is being picked up over very long distances. The reports received vary according to the location chosen, but several instances have come to light where the programmes have been received at distances greater than 1,000 miles.

BAD SHORT-WAVE CONDITIONS

Users of all-wave receivers should not be discouraged if they fail to receive the usual quota of short-

wave stations at present. During the past few weeks conditions have been so bad that some of our readers have gone to such lengths as sending their receivers back for overhaul. The American Federal Radio Commission declare that these bad conditions, at any rate as far as American stations are concerned, are due to the unusually bad electrical storms prevailing over North America.

Not only on 20 and 10 metres are conditions bad, but even on the amateur wavelengths of 40 and 80 metres. There is no indication when conditions are likely to improve, although it was expected that 1937 would prove to be an exceptional year for long-distance reception. Fortunately, this bad spell does not have any effect on television signals, even at long distances.

SHORT WAVES FROM SWEDEN

Unlike the majority of important European countries, Sweden has not paid any great attention to the beneficial effect of short-wave radio on their Nationals living abroad. For the past year or so Swedish short-wave transmissions have been undertaken by the semi-amateur station, SM5SX, which has been allocated the special frequency of 11,705 kc. The station can also be heard operating on the amateur band on 14,341 kc., and uses an input of 500 watts. Plans are being made to broadcast on 19 and 31 metres with more power and directional aerials, so that Swedish programmes will in the future have world-wide audiences.

A NEW BRITISH RECORD

Despite the fact that conditions have been so extraordinarily bad on the high-frequency bands, a new record has been set up by British amateur Fred Miles, in Kenilworth, under the call-sign G5ML, who is the first British amateur to work Hawaii with phone on 10 metres. Directly the conditions show any signs of improvement there is every possibility that the 10-metre band will again be used for consistent long-distance work in place of the existing congested 20-metre band.

A TELEVISION CENSUS

In order to gain some idea as to the number of people who saw the televised programme of the Coronation Procession, the B.B.C. have under consideration the possibility of a census. If it can be claimed that

AND MORE REFLECTIONS

there is a rapidly increasing interest in television programmes, the B.B.C. feel that they may be able to obtain a portion of the million pounds that is retained by the Exchequer every year from licence fees.

WHAT POWER FOR TELEVISION STATIONS ?

There appears to be some element of doubt as to the number of kilowatts needed to provide a reliable service area from television stations. It is known that 150 kilowatts are essential on long waves, 100 for medium waves, and 40 to 50 on short waves, but no real details are available regarding ultra short-waves.

The peak power applied to the Alexandra Palace station is 17 kilowatts, with a mean power of 10 kilowatts, and although reception is being obtained over a wide area, both the French and American authorities consider 30 kilowatts are necessary, and are building stations to handle this input. As it is output and not input that counts on ultra short-waves it may be that the B.B.C. are obtaining a higher degree of efficiency than their French or American colleagues, in which case 17 kilowatts will probably be sufficient. But it will be interesting to see just what sort of service area is obtained with the new Eiffel Tower and N.B.C. and Columbia stations.

AMATEURS AND THE ULTRA-SHORT WAVES.

It would be interesting to know the reason for the widely differing results obtained by American, Australian and British amateurs on 5 metres. In America the 5-metre band is used more like a telephone service up to 120 miles, while signals are often transmitted from the east to west coasts.

Australian amateurs feel very pleased if they can transmit signals up to 80 or 90 miles, despite the more open country and favourable conditions.

Twenty-five to thirty miles is the average in England on 5 metres, although the record stands at 220 miles with a solitary one-way transmission to America. This lack of success may be due to apathy on the part of British amateurs, for it cannot be due to power restrictions, which are not so important on the ultra-short waves.

TELEVISION INVENTIONS

The report of the Comptroller-General of Patents, which was recently issued, states that in the electrical field, the introduction of commercial television had given rise to the substantial increase over the previous year of 20 per cent. in the number of applications relating to television, and of 25 per cent. in those concerned with short-wave wireless generally.

For the second year in succession there had been a fall in the number of applications for patents concurrently with a rise in the number of complete specifications filed. In other words, the proportion of inventions considered worthy of prosecution to the complete specification stage had been increasing.

TELEVISION BY PART EXCHANGE

The demand for television sets is increasing rapidly, and many dealers in the London area are accepting old

wireless sets in part-exchange for television sets. This fact was revealed by a G.E.C. official. "We as a company do not offer any part-exchange terms," he explained. "That is left to the dealers themselves. Naturally, however, we offer every facility we can to dealers, and where a reasonable request is made we are always willing to arrange a demonstration of television reception in the house of a dealer's prospective customer. Our experience has been that where a demonstration is given, in nine cases out of ten a sale follows.

"A great many dealers are finding it well worth while to offer part-exchange terms, and the G.E.C. is receiving a large number of requests for demonstrations. Listeners whose old wireless set are accepted in part-exchange for television sets need not be without a wireless receiver, as a television set is available which also provides radio reception from practically every station in the world worth listening to."

"THE FIRST REAL TELEVISION 'O.B.'" (Continued from page 335)

of a specially screened cable to this transmitter and after radiation picked up on a small aerial situated on the top of the Alexandra Palace mast immediately above the main vision transmitting aerial. This aerial is connected to an ultra-short wave receiver, the output of which is applied to the main vision transmitter and broadcast in the usual way.

By the use of different wavelengths and special filter circuits, it is possible to avoid interference between the signals being received from the mobile transmitter and those being re-broadcast from the transmitters at Alexandra Palace.

In the case of the Coronation transmission this was a stand-by which it was not necessary to use, but it will be useful on future occasions at points not reached by the special cable.

The mobile control room and transmitter are designed so that they can be operated from electricity supply mains. In situations where suitable mains supply is not available, however, the power for these two units can be supplied by the third vehicle which contains a petrol-engine-driven generator. Special precau-

tions have been taken in the design of this generator-set, both in regulating the speed and governing of the petrol engine, and in the electrical control of the generator, in order that the supply of electricity shall be free from fluctuations which would adversely affect the operation of the television apparatus. Supply mains were available on the occasion of the Coronation transmission and it was therefore unnecessary to use this unit.

Two of the cameras employed were fitted with telephoto lenses to pick out the head of the procession as it came down East Carriage Drive. A third camera was installed on the pavement and provided close-ups of the Royal Coach and other important parts of the procession passing through Apsley Gate.

This first real television outside broadcast was a great success and it was marred only by the weather conditions. Actually the results obtained during the tests were much superior as the light was better. It marked a most important step forward in the progress of television by extending the scope of programmes beyond the confines of the studios and their immediate vicinity at Alexandra Palace.

THE CONSTRUCTION OF AN ACORN VALVE RECEIVER FOR VISION SIGNALS

Last month, we gave the preliminary details of an acorn valve receiver suitable for reception of the vision signals from Alexandra Palace. This we believe to be the first receiver of this type published. It is not claimed that it is superior to the more orthodox kind of receiver but it is of particular interest in providing an alternative design.

THE construction of a receiver on the lines of the preliminary details given in last month's issue can be undertaken in several accepted ways, the principal difference between it and a standard re-

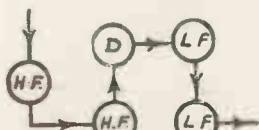

Fig. 1. Alternative layout schemes for short-wave circuit.

ceiver being caused by the small size of the valves and the necessity for careful wiring and screening. The object of the acorn valve being to minimise capacities, it is obvious that the performance of the receiver will be governed by the neatness and compactness of the assembly and wiring. To obtain the best results, three methods can be used:

(1) The valves can be mounted in a row, the signal proceeding directly through the chain from one end to the other. Each valve can be mounted in the centre of an upright

vantage that the chassis is unduly long and it is doubtful whether the receiver could be accommodated in a less space than 27 ins. by 4 ins. or 5 ins.

(2) A considerable saving in space can be made by "folding the circuit back on itself" as shown by the arrows in Fig. 1b. This increases the depth of the receiver from front to back but makes a more compact

looking job and saves overall length. The layout can be fitted in a single box with cross-screens, as shown in Fig. 2, but this is awkward to wire, particularly when the inter-screen connections are made.

(3) A very satisfactory adaptation of the second method is to employ separate screening boxes for each stage (or in some cases two stages) the connections between boxes being

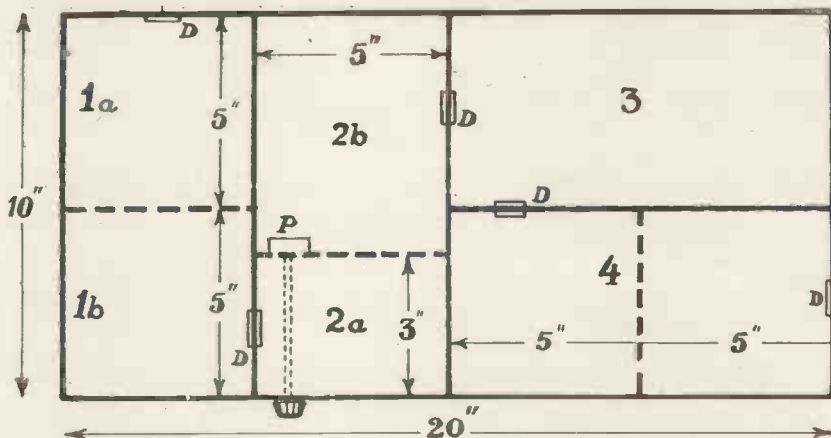

Fig. 2. Suggested layout for separate screening boxes. The points marked "D" are the bushes between the compartments.

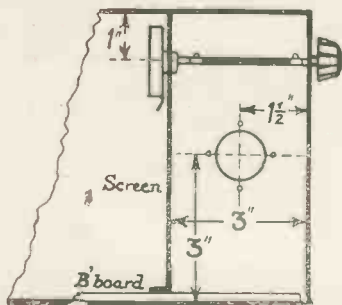
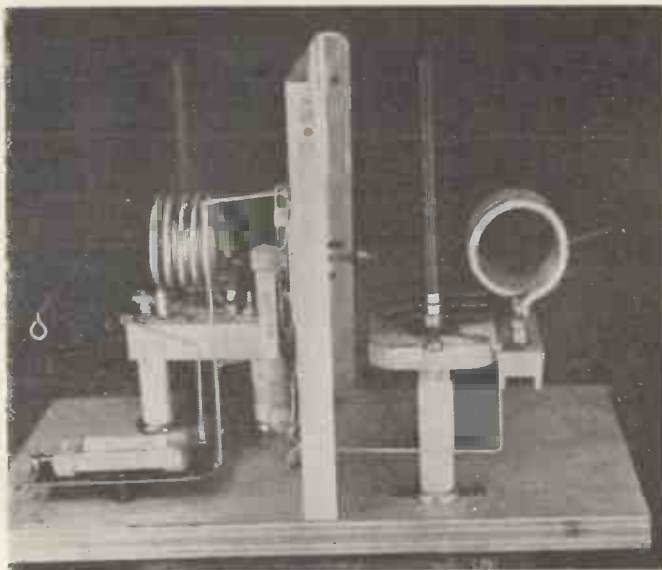

Fig. 3. Detail of the screen potentiometer mounting and hole for the insulating disc.

screen fastened to the main baseboard, the wiring then falling automatically into separate compartments. This system has the disad-

Fig. 4. The layout of the H.F. stage.



THE ACORN RECEIVER H.F. STAGE

made by short flexible leads. This allows additions and alterations to be made to the circuit without disturbing the whole layout, and if the components are mounted on separate baseboards they can be wired in the open and fitted in the boxes finally.

An experimental receiver on these

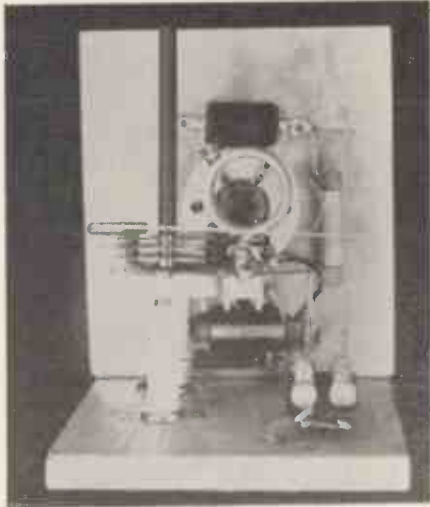

Fig. 5. End view of the H.F. stage.

lines has given excellent results on the television waveband and brief constructional notes are given as a guide for experimenters who may wish to adapt the construction for other purposes.

As shown in Fig. 2 the receiver is assembled in four aluminium screening boxes (obtainable to order from Peto Scott or Burne Jones), each measuring 10 ins. by 5 ins. by 5 ins. deep. Each box is fitted with a slip-on lid, which should be fixed with screws when the receiver is finally finished. For the layout as shown, three cross screens will be required which screw on to the baseboards and are also fastened to the sides of the boxes by 6 B.A. screws and nuts.

The depth of these screens will be 5 ins. less the thickness of the baseboard with a turned up flap $\frac{1}{2}$ in. wide for fixing the bottom edge.

The baseboards for the boxes must be cut to be a loose fit at the bottom and it is suggested that the clearance $\frac{1}{8}$ in. all round be allowed.

Dealing with the compartments as numbered in the diagram, 1a contains the aerial tuning circuit which is mounted as closely as possible to the first H.F. valve which is set in the centre of the cross-screen. On the other side of the screen is the tuning circuit in the anode of the

valve and the coupling unit. The connection between compartment 1b and the next (2a) is made through the insulated hole D, details of which are given later. The second H.F. valve is mounted in the middle of the screen between 2a and 2b, the detector stage occupying 2b. From this the output is fed to box 3 or through box 3 to 4. The inclusion of box 3 in the circuit was to enable a synchronising valve to be added to the detector circuit for television, but if the receiver is not used for this purpose it can be left blank, the connection being taken through to 4 as stated above.

Alternatively 3 can be used for the first L.F. stage and 4 for the second L.F. with an additional output valve for loudspeaker work.

Assuming two L.F. valves are accommodated in 4, the screen is used to separate the stages, the valves being mounted upright in each compartment. The coupling condenser can then be inserted in the screen through a hole giving ample clearance. The output is taken from the bush D on the extreme right of the box.

Bushing

The connections between the boxes and the input and output are taken

the line 3 ins. up from the bottom of the box, as shown in the sketch of Fig. 3. This sketch also shows the fixing of the screen potentiometer in box 2a. For the aerial and output leads a short length of 4 B.A. rod should be fastened with nuts on each side of the hole through the disc and leads soldered to the end of the rod inside the box.

H.F. Stage

The layout of the H.F. stage in box 1 can be seen from the photograph of Fig. 4. On the right hand side of the screen is the aerial-tuning coil and condenser, the latter fitted with an ebonite extension rod to come flush with the top of the screening box.

After the baseboard has been fitted in place clearing holes will be required in the lids to give access to these spindles.

The H.F. valve is partly concealed by the centre screen, but the lead to the grid is shown on the right of the screen.

To fit the valves in the screens, holes 1 in. diameter are drilled in the exact centre of the screen and the valveholder fitted so that there is a slight clearance all round when the valve is in place. The holder should

Fig. 6. View of detector compartment with side of case removed.

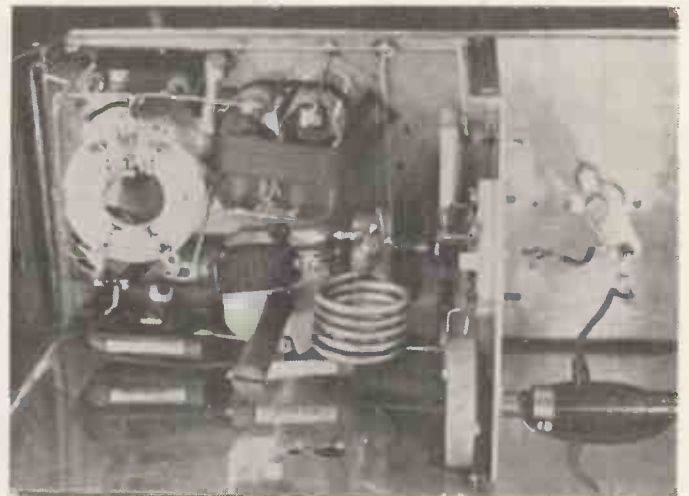

through holes in 2 in. diameter paxolin discs which are riveted or screwed into position in the sides of the boxes where shown by the markings "D" in Fig. 2. These paxolin discs can be obtained from Messrs. Bulgin, ready drilled. The hole in the box should be 1 in. to $1\frac{1}{4}$ ins. diameter to allow ample clearance between the lead and metal. Each hole is cut on

be mounted so that the heater contacts are towards the bottom of the box, the heater leads being taken straight up through a hole in the baseboard.

The anode tuner on the left is self-explanatory. All tuning coils and condensers are mounted above the baseboard on Eddystone insulating pillars, as shown, the coils being

CONSTRUCTION OF ACORN RECEIVER

soldered directly to the tags of the condensers.

The photograph of Fig. 5 shows the end view of this compartment, the acorn being seen through the tuning coil. In the foreground are the

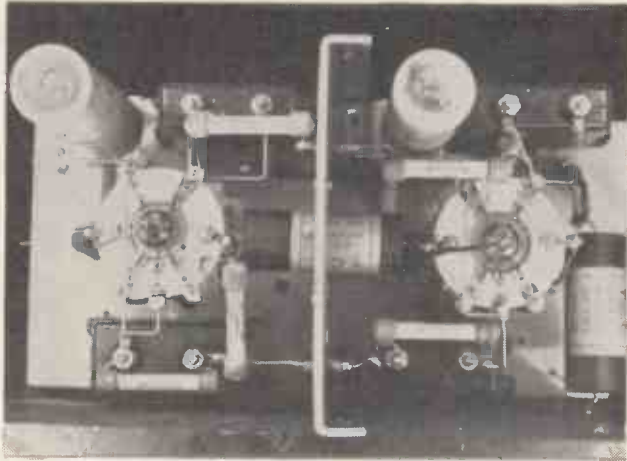

Fig. 7. The L.F. compartment showing the two L.F. valves.

Detector

The lead from box 1 passes through the disc to an Eddystone pillar in the centre of 2a compartment. This serves as an anchor for the lead to the grid of the second H.F. valve,

anode and screen resistances mounted on a piece of paxolin cut from a Bulgin component mounting strip. The input to the H.T. and the heaters of the valves is brought up through the baseboard with lengths of screened cable, the screening being soldered to the earthed wire inside the box.

Earthing

In short-wave circuits the utmost care should be taken in the earthing connections as the stability and efficiency of the set are greatly affected by bad contacts and stray wiring. All connections should be taken to a common point in each chassis as far as possible, and these points should be joined to each screening box and to each other by a short length of thick wire.

It is a good plan before commencing the wiring to screw a soldering tag on the side of each box and to lay down a length of 16-gauge wire along the baseboard. Where this wire passes under or through the screen it must be connected to another tag screwed to the metal. One of the earthing wires can be seen on the right of the screen in Fig. 4 and after the baseboard has been fastened in the box a lead is taken from this to the screw and soldering tag at the end of the box.

All the earthed wires in this compartment have been taken to the tag on the centre screen which is soldered to the other end of the wire shown.

which is mounted in the centre of the screen in exactly the same way as the previous one.

The detector valve (triode) is mounted on two Eddystone pillars in the centre of the 2b compartment and the lead from the anode is taken out through the side disc as stated above.



Fig. 8. Method of mounting the L.F. acorn.

The wiring of the H.F. valve and the detector are similar to that just described.

The photograph of Fig. 6 shows a view of the detector compartment with the side of the box removed. The batteries for the bias are in the

front of the photograph with the valveholder to the right.

The batteries can be fixed in place by a strip of insulating tape pinned down to the baseboard and are of the Ever-Ready 3-volt pocket lamp type.

The photograph of Fig. 7 shows the two L.F. valves mounted in box No. 4 with the coupling condenser inserted in the screen between them. One of the paxolin discs should be used to keep the condenser clear of the metal, the hole being enlarged for the purpose. If the outer case of the metal is in contact with the screen there is appreciable capacity to earth. Fig. 8 shows the mounting of the acorn viewed from the left hand end of Fig. 7 and the H.F. choke can be seen fitting against the pillar.

After the H.T. and L.T. leads have been threaded through holes in the bottom of the boxes the baseboards can be screwed down with two screws per box. The boxes can then be assembled on a hollow frame which allows the leads to be brought out to a terminal strip at the side or end. Each box must be joined to its neighbour by a soldered earth lead.

It will be noted that no provision has been made in the last box for the output feed condenser as there is barely room for a large capacity. At the sacrifice of some of the lower frequencies a $\frac{1}{2}$ -mfd. tubular condenser can be fitted through the screen in the same manner as the coupling condenser of Fig. 8, but it is preferable to use a larger one external to the box which can be bolted on the side. The tuning of the receiver is of the simplest and should present no difficulty. If a tendency to instability is noticed the value of the coupling condensers in the L.F. stages can be reduced slightly, but with efficient earthing this trouble should not arise.

Television Components

New List of Reduced Prices

Messrs. H. E. Sanders & Co., of 4 Gray's Inn Road, have issued an up-to-date list of reduced prices of components for television experimenters, which should greatly assist readers to build receiving apparatus at low cost. High voltage condensers and resistors, etc., have all been reduced. In addition, experimental apparatus for mechanical scanning can be quoted for at lowest prices. We advise readers to send for the new list of prices.

THE OSRAM SECONDARY-EMISSION PHOTO-CELL

SECONDARY-emission photo-cells have sensitivities comparable with or even greater than the gas-filled type of cell hitherto available and they have none of the disadvantages that are associated with the use of gas magnification. In fact they combine the good points of

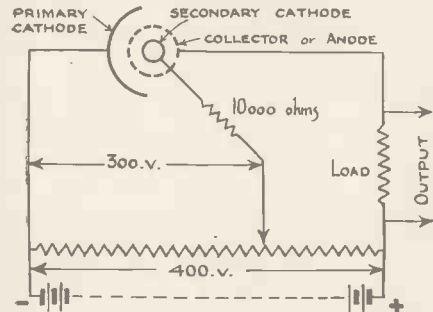

Fig. 1.—Typical circuit for use with secondary-emission photo-cells.

both the vacuum and gas-filled cells with the disadvantages of neither.

In addition to high sensitivity the absence of gas-filling ensures low noise level and a good frequency characteristic to interrupted light. Consequently secondary-emission cells are admirably suited for television transmissions and acoustic reproduction from film as well as for innumerable industrial applications.

The demand for photocells of high sensitivity with stable characteristics has led to the development of the Osram C.W.S.24 secondary-emission type cell.

The appearance and construction of the cell will be clear from the photograph and drawing, Fig. 1. The primary cathode is formed on the silver surface which is deposited on one half of the internal surface of the spherical bulb. The secondary cathode or target is formed on a silver tube which is supported in the middle of the bulb.

The collector or anode is also supported at the centre of the bulb and consists of a molybdenum spiral coaxial with and surrounding the secondary cathode.

Both primary and secondary cathodes are of the caesium on silver oxide type ($\text{Ag}-\text{Cs}_2\text{O}-\text{Cs}$). The collector and secondary cathode are mounted on separate pinches in order to reduce the capacity of the collector to a minimum.

The primary cathode is connected to the grid pin of the valve base, the secondary cathode to the anode pin, and the collector to a screw cap at the top of the bulb.

The glass envelope housing the electrode assembly is evacuated and the primary emission from the cathode impinges on another and secondary cathode which is termed a target from which secondary electrons are ejected by the impacts of the primary electrons. Each primary electron sets free several secondaries so that a magnification of the primary current is secured.

The secondary emission finally reaches a collector which is adjacent

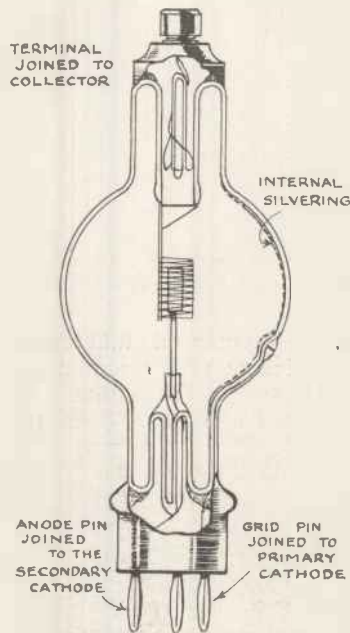
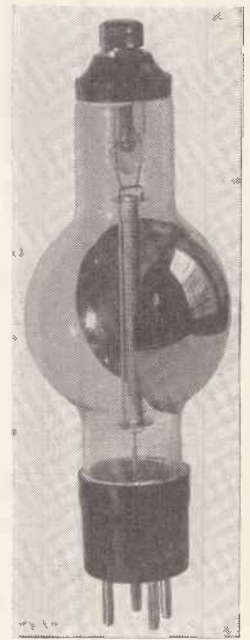

Fig. 2.—Constructional details of the Osram secondary-emission photo-cell type CWS 24.

to the target and which performs the same function as the anode in the ordinary photocell.

The collector is maintained at a positive potential with respect to the primary cathode (see Fig. 2). The secondary cathode or target is also at a positive potential with respect to the primary cathode, but at a negative potential with respect to the collector. It is recommended that the potential difference between the primary and secondary cathode be 75 per cent. of that between primary cathode and collector.

The Osram secondary-emission photo-cell type CWS 24.



The total voltage between primary cathode and collector (anode) may be anything up to 800 volts, but under most conditions a total voltage of 500 will be found to give sufficient output.

A safety resistance of 10,000 ohms is inserted between the source of potential and the secondary cathode. The load resistance, whose value will be determined by the purpose for which the cell is used is connected between the source of potential and the collector.

Primary Emission.—The primary emission of the cell after a preliminary ageing period during which it rises steadily from about $15 \mu\text{a}/\text{lumen}$ is of the order of $40 \mu\text{a}/\text{lumen}$.

Secondary Emission Coefficient.—This factor, defined as the ratio be-

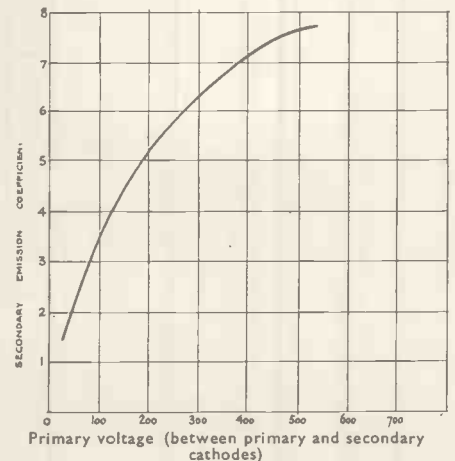

Fig. 3.—Variation of secondary-emission coefficient with primary electron voltage.

tween the number of secondary electrons emitted from the target in unit time and the number of primary electrons hitting the target in the same time, rises during the early period of

of the primary emission and the secondary emission coefficient for that voltage.

The variation in sensitivity with the voltage between primary and col-

Fig. 5 shows the variation in sensitivity with overall voltage when the potential of the secondary is 75 per cent. of the collector voltage.

Life.—Fig. 6 shows the variation in primary emission and secondary emission coefficient from a typical cell when out of circuit and when in service. During the life tests the overall voltage was 480 with an illumination which gave a total current of 5 to 5 μ a. For convenience in testing the values shown in Fig. 5, however, were measured with an overall voltage of 340.

Frequency Response.—Tests carried out with frequencies up to 1 mc. per sec. have shown that the response is consistent with that which would be expected from a vacuum type cell. The background noise is extremely low compared with that present in a gas-filled cell under fairly high gas magnification. It is what would normally be associated with a good vacuum

cell. The cell is manufactured by the General Electric Co., Ltd., and the price is £8.

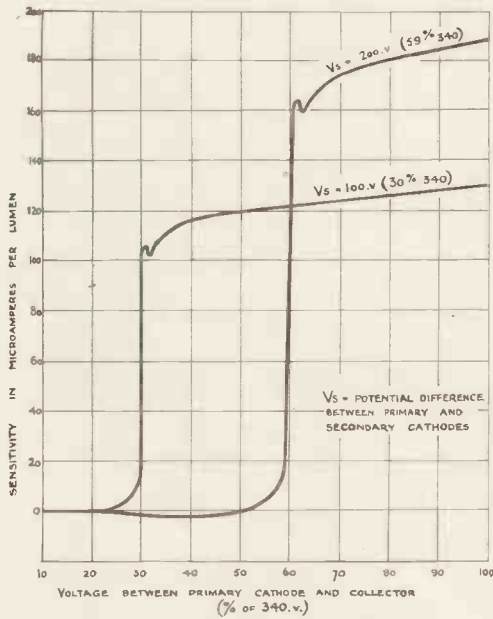

Fig. 4.—Variation in sensitivity between primary and collector for fixed values of voltage between primary and secondary cathodes.

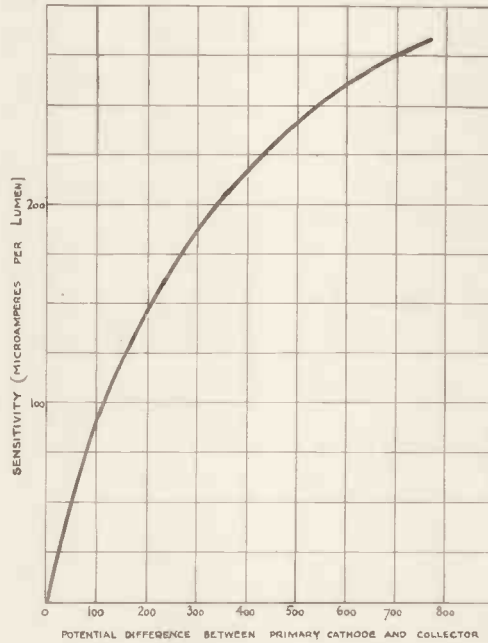

Fig. 5.—Variation of sensitivity when the potential of secondary is 75 per cent. of the collector voltage.

service for 250-volt primary electrons, from about four to a steady value of about seven.

The variation of the secondary emission coefficient with primary electron voltage is shown in Fig. 3.

Sensitivity.—The sensitivity at any given primary voltage is the product

lector for two fixed values of the voltage between primary and secondary cathodes, is shown in Fig. 4.

Fig. 3 is shown under conditions where the potential difference between primary and secondary cathodes is 75 per cent. of that between cathode and collector.

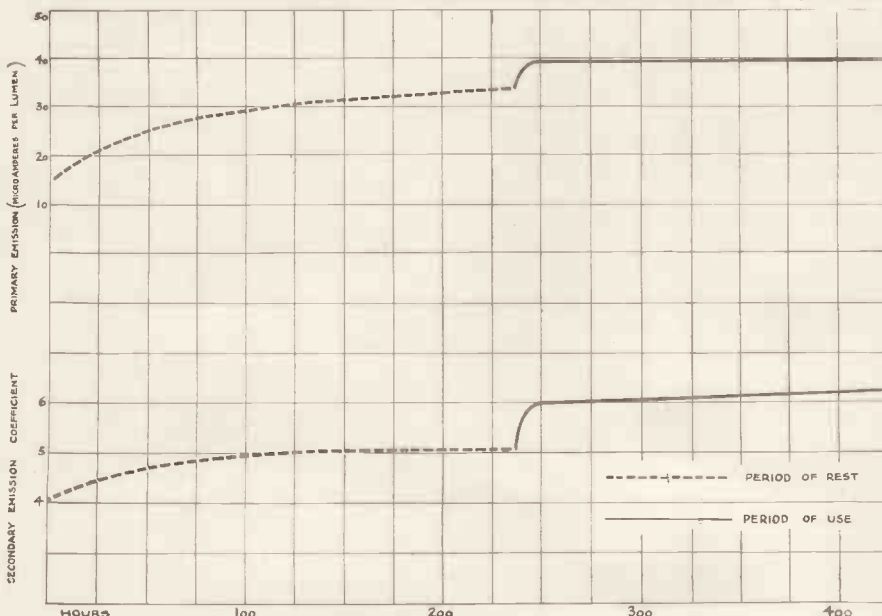

Fig. 6.—Variation in primary emission and secondary emission.

Short Waves from Australia

A new Australian station is now on the air with regular schedules, and its programmes are being received in this country quite well. This new station is situated at Perth, and has the call-sign of VK6ME. Its operating schedule for June is as follows:—

Wavelength 31.28 metres. (9,590 kcs.).

Daily, Monday to Saturday (inclusive): 10 a.m. to 12 mid-day.

For the month of June the Sydney station, VK2ME, wavelength 31.28 metres, 9,590 kcs., has the following schedule:—

Sundays—4 a.m. to 6 a.m.; 9 a.m. to 1 p.m.; 3.30 p.m. to 5.30 p.m.

The third Australian station, Melbourne, call-sign VK3ME, operating on 31.5 metres, 9,510 kcs., has the following week-day schedule:—

Daily, Monday to Saturday (inclusive): 8 a.m. to 11 a.m.

Reception reports from British listeners are welcomed, while confirmation cards are obtainable from Amalgamated Wireless (A'sia), Ltd., 47 York Street, Sydney, Australia.

A MULTI-C.R. TUBE SCREEN FOR LARGE PICTURES

By Morton Barr

Details of an ingenious scheme employing a light amplifier.

MANY people hold the view that the future of television lies as much in the cinema theatre as in the home. Whether this is so or not, there is little doubt that the time will come when "pictures by television will form part of the daily bill of fare at the cinema. (The difficulty is, of course, to produce pictures of sufficient size to cover the ordinary cinema screen, with sufficient detail and brilliance.

The use of cathode-ray systems seems, at first sight, to be barred by the fact that the size of the picture

Fig. 1. The first screen consists of a number of photo-electric cells, the current from which actuates a bank of simple cathode-ray tubes comprising the second and larger screen.

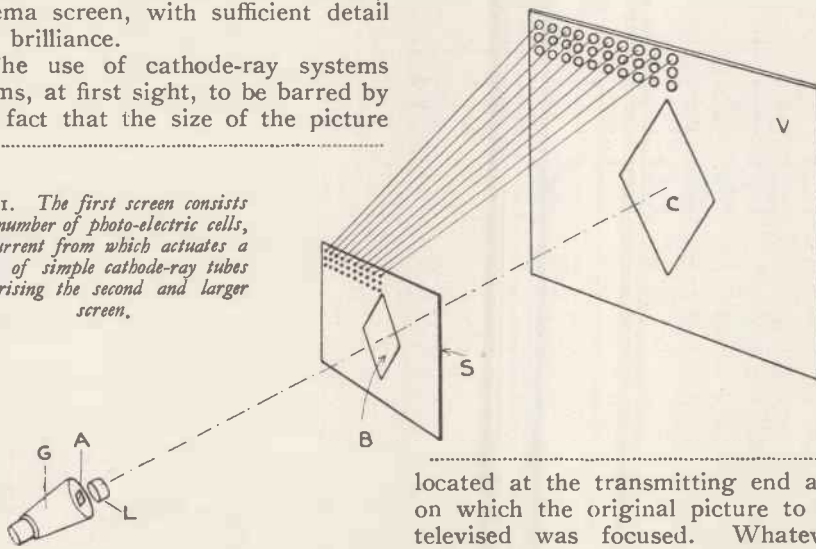

is necessarily limited by the size of the glass bulb, and that it is not possible to construct a tube of the dimensions required.

One possible solution of the problem is to receive the picture, in the first place, on a cathode-ray tube of normal size, but instead of viewing it direct, the picture produced on the fluorescent screen is recorded on a cinema film, which is immediately developed and fixed. The film is then passed through a standard type of optical projector, which magnifies it in the ordinary way up to screen size.

This scheme, which is, of course, an adaptation of the well-known "Intermediate film" system as used for transmission, is limited by the fact that the received fluorescent image is of poor light intensity and therefore is not well suited to make a clear-cut record on a photographic film. This naturally affects the detail and brilliance of the magnified image, when projected from the film on to a full-sized cinema screen.

An early attempt to produce a large-scale picture involved the use of a special "mosaic" viewing-screen built up of a large number of small lamps, each of which represented a single picture element. Each of the lamps was wired up to a corresponding P.E. cell forming part of a similar "mosaic" surface which was

least a light of equal intensity spread over a larger surface. In either case the result will be a larger image, having at least the same brilliance and definition as the original.

As shown in Fig. 1, the incoming picture signals are handled, in the first place, by a cathode-ray receiver C of standard size and make. The picture thrown on the fluorescent screen of the tube is next focused on to screen S built up of small photo-electric cells, each of which corresponds to a single picture element of the original.

This forms the light-relay, which is linked up, in a manner to be explained, to the final or full-sized viewing screen marked V. Here each picture-point is represented by a single source of light, which for the moment we may call a lamp.

Each part of the picture, as it first appears on the fluorescent screen of the cathode-ray tube, is projected by a lens L on to the bank of photo-electric cells, where it creates a current corresponding to a particular light or shade value. The resulting currents are passed on to the corresponding group of "lamps" comprising the larger viewing screen V, where they reproduce the same light effects, on a larger scale, as indicated by the diamond-shaped areas marked A, B, and C.

The real merit of the arrangement lies in the neat way in which the two

located at the transmitting end and on which the original picture to be televised was focused. Whatever variations of light and shade occur on the photo-electric surface were then automatically reproduced on the screen of lamps. (The idea, though elementary in principle, is almost impossible to carry out in practice on account of the complexity and cost of the apparatus required.

Quite recently the idea of using a large number of small lamps to form a viewing screen has again been put forward, this time in combination with a cathode-ray receiver. As already mentioned, the disadvantage of the cathode-ray tube, when it comes to producing large-scale pictures, lies in the fact that the fluorescent screen gives off too little light to allow of direct magnification by lenses.

This difficulty can, however, be overcome by introducing a suitable form of "light amplifier" between the fluorescent screen and the final viewing screen. For instance, if the fluorescent light is allowed to act on a photo-electric cell, the latter will generate a current which can be used to produce a stronger light—or at

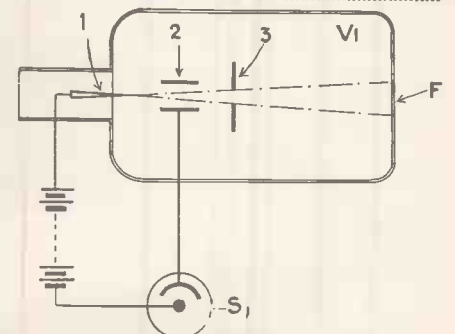

Fig. 2. Diagram showing how the elements of the two screens are linked together.

screens S and V are linked together. This is illustrated in Fig. 2, where the photo-electric cell marked S1 represents one of the bank of cells mounted on the screen S, whilst the

tube marked V₁ is one of the "sources of light" which go to form the viewing screen V.

Actually the tube V₁ is a small cathode-ray tube of very simple design. It contains only a cathode 1, a control grid 2, and an anode 3, the latter having a central aperture through which the electron stream passes, without deflection and at uniform strength, on to a fluorescent screen F. It must be borne in mind that each of the cells on the screen S, and each of the lamps (cathode-ray tubes) on the screen V, corresponds to a single picture element, so that each handles only a single spot of light. Although this spot will vary in intensity from time to time, as the

televised picture changes or "moves," there is no necessity for any scanning operation to be performed.

As the light falling on the P.E. cell S₁ changes, the potential on the control grid 2 is varied to regulate the intensity of the stream falling on the fluorescent screen F, and therefore the intensity of the light produced by the CR tube V₁. Since the screen F is uniformly illuminated it acts in exactly the same way as a lamp (or a point source of light) on the viewing screen V. In this way every change that occurs on the screen of the original cathode-ray receiver C, shown in Fig. 1, is repeated on the large-scale viewing screen V.

inside of the sphere and how the unit, the lumen, is derived. The area of the sphere is $4 = 12.57$ square feet. If we take one square foot of the interior, a difficult quantity to measure, although simple for our purpose, we can say that the illumination falling upon an area of one square foot in the sphere is one lumen. Similarly, the quantity of illumination which can be obtained from a uniform light source of one candle is 12.57 lumens.

It may be well to emphasise the importance of candle-power and its relation to luminous flux. The total flux

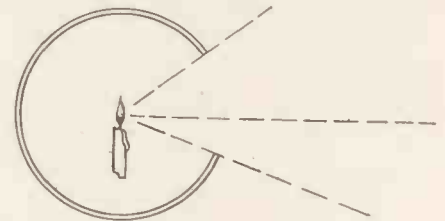

Fig. 2. Diagram explaining the lumen.

THE MEASUREMENT OF LIGHT INTENSITY

THERE are four fundamental concepts associated with light; the luminous flux, luminous intensity, illumination, and brightness. Luminous intensity is sometimes termed candle-power.

Luminous flux may be stated as the rate of flow of radiant energy evaluated with reference to visual sensation.

Luminous intensity, or candle-power, is the term used to indicate the solid angular density of the flux in a given direction. Let us assume, for instance, that we have a light source S, of one candle (Fig. 1) situated at a distance of one foot from a sheet of paper P. The intensity of light would be one foot-candle. If the strength of the light rays were the same in all directions the intensity of light at any point round the candle, at a distance of one foot, would be one foot-candle. If we were to enclose the light source in a sphere, with a portion of the wall cut away as illustrated in Fig. 2, providing that the reflection factor of the interior of the sphere is zero the intensity of light at one foot distant would still be one foot-candle. This brings us to the term lumen, which is the unit of luminous flux and is equal to the flux emitted in a unit solid angle whose average candle-power throughout the unit solid angle is one candle.

Referring again to Fig. 1, the intensity of illumination falling upon the sheet P is not even. The reason

is that the distances from the light source to the sheet are different. Let us assume that the sheet is one foot square, that it is perfectly vertical, and that, from an alignment point of view, the candle is situated in a horizontal plane with the centre



Fig. 1. Diagram showing how luminous intensity is determined.

of P. (The centre of P would be the nearest point to the light source. The corners of P would be the farthest away.)

It can be seen how difficult it would be to measure the quantity of illumination of a light source by any means in which angles or sides were involved. Since, however, the intensity of illumination from a light source must be readily calculated, it may be said that the method adopted is to imagine a light source in the centre of a sphere which has a diameter of two feet. The distance from the source to any point of the sphere is one foot, and, assuming an even distribution of light from the source, the intensity of illumination at any point on the inside of the sphere will be the same.

We now have to consider the

in lumens of a standard lamp (a lamp against which the intensities of other light sources are measured) is determined by obtaining the mean spherical candle-power, either directly or through measuring the mean horizontal, and multiplying this by 4. Candle-power, then, is always associated with a source, whether self-luminous or otherwise, and gives information regarding the luminous flux at its origin.

The Eddystone Dual-speed Tuning Dial

In the advertisement that appeared on page 315 of our May issue a printer's error unfortunately left out the most important piece of information regarding the type 1070 dual speed full vision Eddystone tuning dial. This dial is priced at 8s. 9d. and is suitable for mounting either on a panel or base-board. It is noiseless in operation even on the highest frequencies, while the tuning scale is divided into 100 graduations. In keeping with modern practice, the dial readings increase as the frequency increases. Full information regarding this dial can be obtained from the manufacturers, Stratton and Co., Ltd., Eddystone Works, Birmingham.

A correspondent is desirous of obtaining the November, 1933; January, March and April, 1934, and March and October, 1935, issues of "Television." If any reader can oblige we shall be glad to receive notification and the price required.

RECENT TELEVISION DEVELOPMENTS

A RECORD OF PATENTS AND PROGRESS *Specially Compiled for this Journal*

Patentees:—Radio Akt. D. S. Loewe :: G. W. Walton :: C. Lorenz Akt. :: V. A. Jones and Baird Television Ltd. :: The General Electric Co., Ltd., and L. C. Jesty :: L. R. Merdler and Baird Television, Ltd.

Synchronising Signals (Patent No. 460,709.)

PICTURE signals and synchronising impulses are both produced by a scanning disc which is provided with only one row of scanning holes—without the usual synchronising slot—and operates with only one photo-electric cell. This result is secured by illuminating the picture to be scanned by an additional source of constant light. The area of the doubly-lit surface is made smaller than the spacing of the scanning apertures, so that a photo-electric cell placed behind the disc records a complete disappearance of the lighting during a certain fraction of the total line period.

The intensity of the extra illumination is such that the current in the transmitting aerial falls to zero during these periods, thereby producing the synchronising impulses.—*Radio Akt. D. S. Loewe.*

Television Systems (Patent No. 460,721.)

In addition to transmitting the ordinary contrasts of light and shade that go to form details of a televised picture, it is desirable to be able to transmit the changes that occur from time to time in the average or "back-

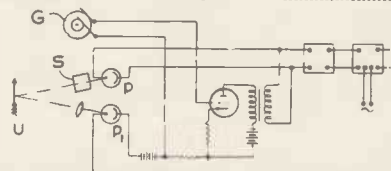

Method of transmitting average values of light and shade. Patent No. 460,721.

ground" brightness of the picture as a whole. Since such changes occur comparatively slowly, they produce currents which are too low in frequency to be handled by ordinary valve amplifiers, and their effect is accordingly lost in the received picture.

The figure shows how the difficulty

can be overcome. The photo-electric cell P is fed with picture detail signals from the object O through a scanning device S in the ordinary way. A second photo-electric cell P1 receives light direct from the object, so that it is affected by slow changes of illumination. The output from this cell is fed to a valve V, together with current from an A.C. generator G, and the two are modulated together. The result is a current which can be handled by subsequent amplifiers and used to control the background brilliance of the received picture. (The frequency of the current supplied by the generator G is a multiple and a half of the frame frequency so that it does not affect the viewing screen.—*G. W. Walton.*

Keystone Effect

(Patent No. 461,105.)

In a cathode-ray tube of the Iconoscope type, the photo-sensitive screen must be set at an angle to the main axis of the tube, in order to allow the picture to be focused on to it. This means that the electron beam used for scanning sweeps over the picture at an angle, instead of being always at right-angles to the surface of the screen.

In order to prevent this from producing a "keystone-shaped" picture, an extra correcting voltage is added to that normally used for the line scanning, thus producing a frame which is strictly rectilinear. In addition, means are provided for changing the focus of the beam as it moves up and down the picture, so as to produce a clear-cut spot both at the end nearest the cathode, and at the end furthest away from it.—*C. Lorenz Akt.*

Electron Cameras

(Patent No. 461,197.)

The picture to be transmitted is focused upon a photo-electric cathode C, and the resulting stream of electrons from the cathode is swept over a "line" anode A by the deflecting field from an external winding W.

The anode A consists of an array of separated conducting elements, which, in combination with a common earthed plate P, form a series of small condensers.

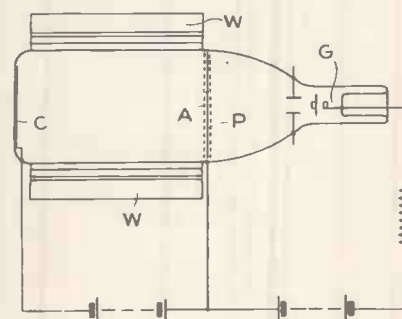

Electron camera. Patent No. 461,197.

The charges set up across the condensers form an "electric image" of the picture, and this is scanned or discharged by the electron stream from the gun G of the tube. The anode A consists of a strip of insulating material coated with metal which is formed or ruled with a series of lines so as to divide the metal into a large number of isolated elements.—*V. A. Jones and Baird Television, Ltd.*

Mosaic-cell Electrodes

(Patent No. 461,312.)

A mosaic-cell electrode for a cathode-ray tube consists of a very large number of globules of photo-sensitive material. Each globule acts as a minute photo-electric cell, which creates an electric charge corresponding to the light-and-shade value of the particular part of the picture projected on to it. In this way an "electric image" of the complete picture is built up, and is subsequently scanned by an electron beam for transmission.

The mosaic is formed by first coating a sheet M of mica with a thin film T of metal, as shown in Fig. 1. The metal is then separated into isolated strips S, Fig. 1a, by ruling a number of parallel lines L. Each

cell therefore is insulated from its neighbour. Finally a number of strips are assembled to form the completed electrode, as shown in part in Fig. 1b. The figures are drawn on a

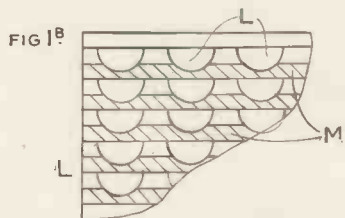
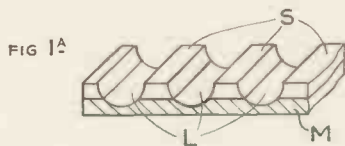
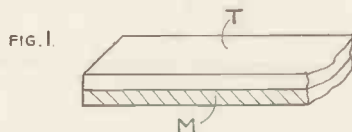

Construction of mosaic-cell electrodes. Patent No. 461,312.

greatly enlarged scale.—V. A. Jones and Baird Television, Ltd.

A Safety Device for C.R. Tubes
(Patent No. 461,374.)

Owing to the size of the glass bulb, and the high degree of the internal vacuum, it sometimes happens that the walls of a cathode-ray tube will collapse. Usually the fragments of glass are driven inwards by the external pressure of the air, so that there is little risk of injury or damage. But since some of the internal electrodes may be biased to several thousands of volts, it is necessary to

provide against any danger from this source.

Accordingly the high-tension circuits include a make-and-break switch which is kept in the "make" position by the pressure of the glass wall of the bulb. If the latter is fractured the switch promptly "opens," and the voltage supply is automatically cut off.—The General Electric Co., Ltd., and L. C. Jesty.

Sound and Vision Receivers
(Patent No. 461,983.)

In a superhet receiver for combined sound and pictures, employing a local-oscillator circuit of the Colpitts type, there is some difficulty in gangging the circuits to a single tuning-control. According to the invention a pre-set condenser is connected between "earth" and one end of the tuning inductance. This provides the necessary back-coupling and at the same time permits the tuning-range of the oscillator to be varied. Another pre-set condenser is connected across the tuning inductance and is used as a "trimmer" to bring the circuits into alignment.—L. R. Merdler and Baird Television, Ltd.

Summary of other Television Patents

(Patent No. 460,675.)

Combined sound and picture receiver in which an A.V.C. bias is applied to the grid of a valve in the sound channel as well as to a valve in the picture-signal channel.—The General Electric Co., Ltd., and D. C. Espley.

(Patent No. 460,741.)

System of scanning designed to

give high-definition pictures whilst using only a narrow frequency band.—E. Michaelis.

(Patent No. 461,105.)

Cathode-ray television "camera" with a photo-electric screen inclined to the main axis of the tube.—C. Lorenz Akt.

(Patent No. 461,128.)

Scanning system employing a single mirror which is vibrated simultaneously in two directions.—W. H. Priess.

(Patent No. 461,177.)

Method of preventing fog-formation on the picture due to the amplifiers used at the transmitting end.—Radio-Akt D. S. Loewe.

(Patent No. 461,434.)

Photo-electric cell utilising an electrode coated with a fluorescent material.—D. M. Johnstone and Baird Television, Ltd.

(Patent No. 461,629.)

Method of increasing the effective modulation sensitivity of a cathode-ray tube.—A. C. Cossor, Ltd., and W. H. Stevens.

(Patent No. 461,646.)

Improving the sensitivity of cathode-ray television transmitters of the Iconoscope type.—Marconi's Wireless Telegraph Co., Ltd.

(Patent No. 461,907.)

Provision of guard plates to prevent "trapezium" distortion in a cathode-ray tube.—Marconi's Wireless Telegraph Co., Ltd., and A. J. Young.

(Patent No. 461,999.)

"Smoothing" arrangement for the high-tension supply to a cathode-ray tube.—C. Szegho, W. P. Anderson and Baird Television, Ltd.

New Stentorian Loudspeakers

Messrs. The Whiteley Electrical Radio Co., Ltd., manufacturers of Stentorian loudspeakers, have made available a new range of instruments without their now famous tapped matching transformer. These loudspeakers are for use with receivers that need an extension loudspeaker having a resistance of 2 ohms.

Owing to the demand for this type of speaker where the special matching transformer is an unnecessary expense, this new range of eight speakers will fulfil an undoubted want. Prices and types have been fixed as follows:—

Standard Cabinet Speaker.	Equivalent Cabinet Speaker without Transformer.
37 SC ... 63/-	37 SX ... 52/6d.

37 JC ... 49/6d.	37 JX ... 42/-
37 CC ... 39/6d.	37 CX ... 35/-
37 BC ... 29/6d.	37 BX ... 24/6d.

The first three are suitable for use with the "Long Arm" remote control, and have the necessary volume control and push button incorporated.

A Low-resistance Filament Choke

An interesting type of smoothing choke has been introduced by A. F. Bulgin & Co., Ltd., of Abbey Road, Barking, Essex. This choke, type LF47S, is for use in circuits with condensers to form a noise suppressing unit. It is also very suitable in L.T. smoothing circuits.

It has an inductance of approximately .25 H with a load of .75 amperes, and has a D.C. resistance of between 6 and 6.25 ohms. The choke is assembled in

the new skeletonised form and is fitted with rubber-covered leads. Price has been fixed at 10s. 6d., which is subject to the percentage increase previously announced.

Octal Valve Holders

Two new octal valve holders are now available from Messrs. Eves Radio, of Old Mill Street, Wolverhampton. The first model has a low loss ceramic body with a metal mounting ring held in position by a spring washer. The holder can be riveted directly to the chassis or mounted above as required.

The second type is similar in principle but has a moulded body, but in both types the contacts are arranged automatically to form soldering lugs. In addition each lug is numbered to assist constructors when wiring the receiver.

TELEVISION IMAGES—

AN ANALYSIS OF THEIR ESSENTIAL QUALITIES

A Paper read by L. C. Jesty, B.Sc., A.M.I.E.E. and G. Winch, A.M.I.E.E. (Mem.) of the Research Laboratory of the G.E.C. at a meeting of The Illuminating Engineering Society.

THE authors of this paper gave a comprehensive survey of picture composition from the photographic and cinematographic points of view and then went on to deal with the practical limitations to the realisation of the ideal picture imposed by the characteristics of television systems. Unfortunately it has been found impossible to give an abstract of this paper with any degree of completeness owing to the inter-relation between the first part dealing with photography and cinematography and the second portion having particular reference to television images. It would be quite impossible to do justice to the authors' work without giving the paper in full. It will, however, be published in the Transactions of The Illuminating Engineering Society.

The authors defined the quality of a picture as being controlled by its contrast, brightness, definition, size, presentation, and tint. In the case of a moving picture, there is also flicker and allied effects. Of these definition is undoubtedly the controlling factor in television reproduction. Even when a basis of transmission is established (number of lines), the best use that can be made of the theoretical definition available is open to a number of practical and commercial solutions.

Dealing with television receivers, the authors said: Two controls are normally available to the user of a television receiver, for the control of the tone values of the picture. One of these governs the amplitude of the modulating signal applied to the cathode-ray tube or its alternative. It corresponds to the "volume" control of a radio receiver. The other control is for adjusting the steady potential of the modulating electrode, so that the signal from the receiver modulates it over the correct range.

The effect of the signal control of the receiver is to reduce the overall brightness of the received picture or pattern, without altering the gamma, and therefore the tone ratios. The effect of the bias adjustment is to alter the level of the tones in the pic-

ture, keeping their brightness differences practically constant. Adjustment of this control is comparatively critical, as will be seen, for misadjustment produces loss of detail in the blacks.

The authors remarked that in no system of picture reproduction hitherto available has it been possible to control the picture characteristics and observe the effect immediately. In this connection television is so far unique, and it is to be hoped that much will be learnt from it, to the advancement of picture reproduction generally.

Picture Brightness

The actual value of the brightness of the television picture is very important, in view of the particular conditions under which it has normally to be viewed. In order that adequate tone range shall be maintained in the received picture, a very important factor must be considered, namely, the brightness of the deepest black in the picture. Here, at first sight, television seems to offer an advantage over other picture reproducing systems, as the scanning spot can be completely blacked out by suitable adjustment of the receiver controls. Hence true black and infinite range should be obtainable. Unfortunately, this condition could only be realisable in practice, provided four conditions were perfectly attainable. These are:—

1. The black level at the receiver and transmitter must be correctly adjusted initially.

2. The black level of the signal must be absolutely maintained throughout the whole system for the duration of the transmission. Slow variations could, of course, be compensated for manually, but rapid variations, or local inequalities over the screen, cannot be so treated.

3. Light must not be reflected from the bright portions of the picture, back on to the black parts. Normally this can occur with any projected picture, by light from the picture being reflected back from the

walls of the room. In the particular case of the cathode-ray tube, as used for television reception, internal reflections can occur inside the bulb, and special precautions in the nature of non-reflecting coatings on the bulb, have to be used to reduce this to negligible proportions.

4. There must be no other source of light present, which can illuminate the screen.

Of the above items, 2 and 4 are undoubtedly the limiting factors at the moment, with 4 probably the most serious, particularly with the advent of summer "viewing."

With regard to 2, the chief trouble with the present transmissions, if a criticism may be offered, seems to be an apparent unevenness of illumination of the subject at the transmitter. It is believed that this is due to some non-uniformity of the photo-cell mosaic of the transmitting tube, and is more particularly noticeable on the film transmissions, where rapid changes of scene occur. This effect has not been noticed to the same extent on mechanical scanners, where the light source and photo-cell are the same for each picture point.

With regard to 4, television presents a special problem, as, in general, the picture has to be viewed under conditions of quite high general illumination, including daylight. Shielding the screen, for example, with a viewing tunnel will assist matters, but, unfortunately, such devices, if at all efficient, narrow the angle of viewing considerably, and should be considered with caution. Other devices have been proposed, and the use of fluorescent materials of low reflection factor will also assist.

Definition and Size

The definition of a television picture is so intimately linked with all the other characteristics, that it probably controls the final picture quality almost entirely.

It is the number of elements, or lines, into which the picture is divided, which controls the maximum

definition obtainable in the final picture. Defects or deficiencies in the whole transmitter receiver chain, can materially reduce the definition below this maximum figure.

The shape of the ideal scanning spot for use in both transmitter and receiver, would be a line, or at most a very narrow rectangle, whose height is equal to the line width, and breadth the minimum possible. Owing to the practical difficulties of obtaining other than symmetrical scanning spots (round, square, etc.), and also of increasing the brightness sufficiently, some loss of definition due to this aperture distortion has had to be incurred.

The exact significance of differences in definition has been the subject of much discussion. The limit of acuity of vision has been investigated for television line systems, and values between 0.5 and 1.5 minutes of arc have been obtained under various conditions, with a tolerable maximum value of about 2 minutes. A picture of limited definition has a correct viewing distance, dependent on this angle. If this correct dis-

tance is exceeded, then the eye of the observer is not capable of resolving all the detail in the picture, which is wasteful, and if the distance is reduced below the critical value, then lack of detail becomes apparent.

In order to make the maximum use of the definition available with a given number of lines, an exact knowledge of the dimensions, and light distribution, of the scanning spot at the transmitter and receiver must be obtained. For example, to a first approximation the light flux in the scanning spot is proportional to the square of its diameter.

This fact is of fundamental importance in television and has proved one of the most serious limitations from the commencement of the art. Thus, doubling the number of lines in a picture will halve the spot diameter, and reduce the light available at the transmitter and the brightness of the received picture, to one-quarter of its previous value.

With the present B.B.C. transmissions the brightness of the spot has to be some 200,000 times the required picture brightness. This diffi-

culty has now been overcome at the transmitter by the development of photo-electronic devices, such as the Iconoscope, the Emitron, and the electron multiplier; and in the receiver by the large screen, high-vacuum, cathode-ray tube.

Realising, therefore, that the effect of a television picture is produced both by high brightness, to give good contrast, and also by obtaining the maximum definition, the importance of knowing the exact brightness distribution of the spot becomes apparent.

The advantages of large pictures for the home would seem to be negatived somewhat, due to the considerable viewing distance necessary. As and when definition is increased, then advantage can be taken of this to produce larger pictures. Larger pictures will also require greater light output from the receiver in order to maintain brightness. The chief objection to the present size seems to be related to the comparative comfort with which a home cinema picture can be viewed by half a dozen people, but the real difference here is in the relative definition.

TELEVISION'S GUARANTEED CATHODE-RAY RECEIVER

OUR Guaranteed Receiver, which was described in the October, November and December, 1936, issues, and which has proved so successful and capable of providing steady, clear pictures considerably beyond the service area, has undergone certain modifications since the original design.

When the B.B.C. decided to utilise the single E.M.I. system of transmission, we considered that this was a convenient time to consider the possibility of reducing the price of the receiver without affecting the results in any way.

Considerable simplifications have been made to the time base, which has also resulted in a reduction in cost. In fact, this latter point now applies to each section of the complete receiver. By eliminating components and reducing the overall size of units, and making other modifications, the total cost of our Guaranteed Television Receiver is now very much lower.

As the design is so fool-proof and is backed by our guarantee, constructors now have a real reason for building their own television receiver.

From time to time modifications

have been introduced which are the results of our continual research on the original circuit. It must, however, be remembered that the circuit as first published gives excellent results, so that the receiver as originally built need not necessarily be altered. However, new constructors should take advantage of our latest ideas.

One of the big advantages of home construction is that the receiver can be kept up-to-date, which is a decided help in a rapidly changing industry such as television. Designs are continually being altered to incorporate new schemes which are only open to constructors.

We therefore advise our readers to construct this television receiver, not only because it gives really excellent results, but that improvements can be added after they have been found worth while in our laboratory.

It is now possible for readers to see the television pictures with a receiver that costs little more than the average all-wave radiogramophone. A television receiver is not difficult to build, even though the theoretical circuit shown opposite may give this impression at first glance.

The Units

Several units go to make up a television receiver and these can all be made separately and linked together after each unit has passed its individual tests. Constructors who feel that it is beyond their capabilities to build a television receiver should consider the difficulties from another aspect. Rather than gain the idea that a three-valve sound receiver is to be built and an 8-valve vision receiver, both of which embody fundamental radio principles. The power packs are very simple, even though they give high voltages, while the details given to constructors on how to build the time base were so complete that we do not consider any of our readers should have any difficulties.

The range of the signals from Alexandra Palace appear to be at least two or three times the original stipulated service area, so that those readers who may have the idea that they were too far from the station to enjoy television pictures should make further investigations or write to us for advice as to the possibilities of good reception. Remember that there is a guarantee with this receiver that you obtain excellent pictures providing it is built to specification. This guarantee is unique and should remove any element of doubt that constructors may have difficulty in building up the units with success.

CATHODE RAYS FOR TELEVISION— A 30-YEAR OLD IDEA

ALTHOUGH the use of cathode-rays for television is generally regarded as a very recent development, actually the idea is nearly thirty years old, though obviously at that time the carrying out of the scheme was impracticable. It was in June, 1908, that Mr. A. A. Campbell Swinton first suggested the employment of cathode-rays for scanning an image. Nearly a year later the Russian scientist, Professor Boris Rosing, put forward a somewhat similar scheme.

Campbell Swinton's original plan was made public in his address to the Rontgen Society in 1911, and he stressed the point that it was a suggestion only and not a practicable working scheme. That it contained the germ of modern development will be clear from the accompanying diagram and explanation.

The tubes in which the cathode-rays were used were the cold-cathode type, and deflection of the cathode stream was to be brought about by applying the varying fields of two electro-magnets placed at right angles to one another and energised by two alternating currents of widely different frequencies, say, 1,000 and 10 complete alternations per second. Some 100,000 volts, it was stated, must be applied for successful operation in securing a sharp point on the screen. D, D₁, and E, E₁, are electro-magnets which cause the vertical and horizontal movements of the beam, D and D₁ being fed from the same alternator, while E and E₁ are similarly fed from the same alternator G.

An interesting point is the small metallic screen J. This is "gas-

tight," and formed of a large number of very small metal cubes, each carefully insulated from the others. These cubes, it was suggested, would be of some metal such as rubidium

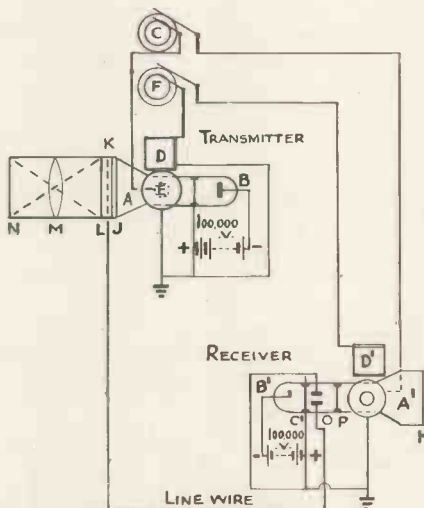

Campbell Swinton's suggested scheme for cathode-ray television.

(which is strongly active photo-electrically), so that they will readily release electrons when light is caused to fall upon them. On the other side of the screen is a chamber K containing a gas or vapour, such as sodium vapour, which is for the purpose of assisting conduction of the electrons across the space to the metallic gauze screen L, more readily in the case of light patches of the screen J than in the case of dark patches.

It was suggested that the apparatus would function in the following way.

A uniformly steady beam of cathode-rays is caused to scan one side of the screen J, while on the other side there is an image of the object, N, which it is desired to transmit. This image is projected by the lens M through the gauze screen L on to one side of the screen J.

As the cathode-rays scan the surface of J, they will impart a negative charge to each little cell in turn. In the case of those cells brightly lighted on the reverse side, the charge will pass away through (and be assisted by) the ionised gas in the chamber K, until it reaches the screen L. In the case of dark patches no further conduction will take place.

The Receiver

The proposed method of controlling the cathode beam at the receiving end as it passes through the metallic plate O is as follows. Just beyond this plate, and nearer the viewing end of the tube, a diaphragm P is fitted, so arranged that it will normally succeed in cutting off rays emitted from B₁, and so prevent them reaching the screen H unless they are slightly repelled from the plate O. The image signal coming through at any instant, in charging the plate O, allows the cathode beam to strike the screen H and momentarily produce a bright spot.

In the light of modern knowledge it will be appreciated that the scheme could never have worked in the form suggested and so far as is known no attempt was made to build apparatus to put the idea into practice.

Book Review

Electronic Television, by George H. Eckhardt (The Goodheart-Willcox Company, Inc., 2009 Michigan Avenue, Chicago).

This book is unique by reason of the fact that it deals with the subject of its title without any reference whatever to mechanical scanning; as its title implies it is devoted entirely to electronic methods. The book is

based upon the work undertaken in the laboratories of Farnsworth (Television Inc. and R.C.A.), and in its preparation the author has had the assistance of research workers of these two concerns. The book is divided into three parts. The contents of the first include a description of the Farnsworth system; secondary electron multiplication; the Farnsworth camera; the R.C.A. system, including transmission. Part II deals with electronic reception with des-

criptions of both the Farnsworth and R.C.A. systems. Part III is devoted to electron multiplication, electron microscopes, etc.

The book is a popular exposition of electronic television and the author has succeeded in making the general principles so clear that they will easily be understood by the non-technical reader. It contains 160 pages and is profusely illustrated with photographs and diagrams. The price is \$2.50.

STUDIO & SCREEN

A MONTHLY CAUSERIE on Television Personalities and Topics

by **K. P. HUNT**
Editor of "Radio Pictorial"

IT is known that about 3,000 television sets are in service, and it can safely be assumed that every one of these sets was in use on the occasion of the momentous Coronation broadcast.

This intensive use of all the available instruments is exemplified, for instance, in the demonstrations that were given by the G.P.O. in the Memorial Hall, St. Martin's le Grand. Six receivers were working and the Coronation was seen by as many as 500 people, mostly distinguished visitors, Post Office officials and their wives and friends, all of whom saw this great historic event in comfort.

No single broadcast since the beginning of the service in this country has done so much to publicise the B.B.C.'s work in television or generally to acquaint people with the wonderful strides that have been made, and to arouse in them a desire to possess a television set of their own.

The broadcast itself went off perfectly. The position of the cameras gave an even better view than was expected, and Mr. Gerald Cock, the B.B.C.'s popular television chief, said that if only it had been possible to use the telephoto lenses as was planned, he would have put out a picture which would have surprised many people even at Alexandra Palace. Unfortunately, the poor visibility on Coronation Day prevented the use of telephoto lenses and thus it was only possible to get a fleeting glance of Their Majesties by the near camera.

The original intention, I understand, was that had it been possible to use the telephoto lenses the King's head would have been held in the picture as a close-up for as long as 15 to 30 seconds. Even so, the view obtained was splendid and the details seen quite astonishing: it must now be quite obvious to every close observer that the E.M.I. camera is more sensitive than the human eye.

* * *

Freddie Grisewood, who did the commentary, has not been definitely transferred to the Television Depart-

ment as was stated in some of the daily newspapers. He was used for this Coronation broadcast as for some others, and will, I understand, be loaned on other special occasions, but in the meantime continues his principal work as announcer in the sound programmes. When the rehearsals were being held for the Coronation broadcast it was clearly evident that a commentator in television needs to talk in rather a different way from that usually employed in sound broadcasting. To begin with, Mr. Grisewood described far too much, just as if he were doing ordinary announcing, because in sound broadcasting obviously the announcer must describe everything as the listeners can see nothing. I

Pringle's old music-hall show on Coronation night, which was a great success. Albert Whelan, the well-known Australian entertainer, came on and as usual shed his gloves, hat and overcoat to the accompaniment of his well-known signature tune; while Arthur Prince and Jim was another familiar turn which came over extremely well.

Harry Pringle deserves especial congratulation on this show, for he certainly managed to invest the whole affair with the veritable atmosphere of the old music-hall. I understand that in the studio itself a wonderful transformation was effected, the place really being turned into a miniature old music-hall complete with boxes at the side, while the cameras

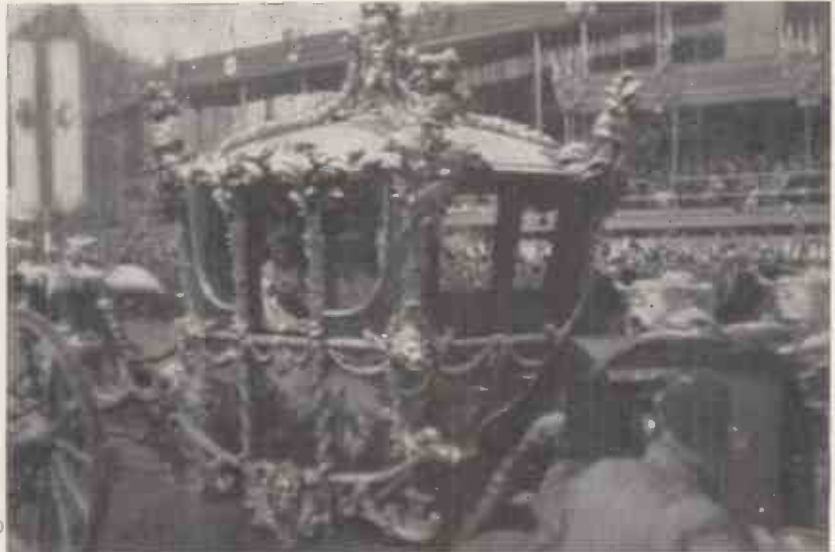

Televising their Majesties at Apsley Gate, Hyde Park Corner. This exclusive picture, taken at the spot, shows the television camera on the right. The operator is wearing headphones through which he received instructions from the control point in the mobile television unit situated behind the Park Keeper's Lodge, 100 yards distant.

believe this was pointed out to him, and he soon realised that in this new sphere listeners had eyes, so that when it came to the actual broadcast on Coronation Day he put up a remarkably good show, not saying too much and yet adding to the screen view just those vivid touches of description which were necessary.

* * *

Of the other Coronation broadcasts I must not forget Harry

themselves were very ingeniously placed.

* * *

There have been few changes of any importance at Alexandra Palace during the month, but interesting experiments in studio technique continue to be made. Mr. George More O'Ferrall has been responsible for some of these. As readers will remember, he went to Alexandra Palace as an assistant producer, but

PROGRAMME HIGH-LIGHTS

was promoted to the rank of producer within six weeks, and he seems to have a distinct future in this type of work.

One of the most interesting cases occurred in the broadcasting of "Twelfth Night" in which Miss Greer Garson, the brilliant young actress, appeared both as Sebastian and Viola. The figures of both were seen on the screen at the same time,



Elinor Shan who gave an original dancing display to viewers.

one being a full face view and the other a back view, and you may wonder how simultaneous photographs of the same person were possible, but I am assured that a tiny mirror in front of the lens was the complete explanation.



Greer Garson, who took the part of Lady Teazle in scenes from "The School for Scandal" in the recent television transmission.

Then again, in the broadcast of "Alice in Wonderland," also produced by Mr. O'Ferrall, a most intriguing piece of realism was introduced when Alice drank the potion which makes her grow smaller and smaller. This miraculous shrinkage actually took place before the eyes of

astonished lookers, the effect being produced by having one camera tracking up to the table while another was retreating.

Mr. O'Ferrall is very go ahead and ready to experiment, and in this respect I suppose is only excelled by Mr. D. H. Munro, the popular productions manager, who is the studio technique experimenter par excellence. I hear that Mr. Munro frequently works half through the night perfecting the details of his new shows, and certainly a great deal of the success of television up-to-date must be attributed to his indefatigable hard work.

As mentioned last month, Mr. Munro is now doing a good deal of production himself. One of his shows last month was "Les Patineurs," which was the most notable ballet show of the month. Mr. Stephen Thomas usually deals with ballet programmes, and I dare say it was because he was otherwise engaged that Mr. Munro took this show over. In "Les Patineurs" a white rubber floor was used, and it is interesting to note that this original rubber stuff is the same as was used in the old 30-line transmissions.

* * *

Another programme of interest to balletomanes was the appearance of Anton Dolin and Markova, but this happened to occur on Coronation eve and was not a very convenient day for many people to look-in. For this reason I personally missed it, although I had seen their show at the Kings, Hammersmith, during the same week.

Television now seems to be attracting many big artists. Among the many outstanding people who have made their bow to the television camera this month is Gracie Fields, the inimitable Lancashire comedienne. Franz Lehár was to have been guest conductor of the television orchestra on May 27, but unfortunately was unable to appear.

Gracie Fields' appearance in television was memorable at the Palace for another reason in addition to the excellence of her show: no fewer than 9,000 people came to Alexandra Palace from Rochdale, Gracie's native town. In fact, Ally Pally went all Rochdale!

A new trend in the television programmes was observed when "On Your Toes" from the Coliseum was

televised during the month. This again was one of Mr. D. H. Munro's brilliant productions, and was a whole hour presentation featuring all the principal stars from the Coliseum show, including the dynamic Eddie



Here is Joan Miller, the television Picture Page Girl.

Pola. Hitherto, the television broadcasts have always been composite in nature, and this programme must have caused many viewers to ask themselves whether they would prefer one continuous show of this sort, or



Joan Collier, who was seen and heard as Polly Peachum in the television production of "The Beggar's Opera" at Alexandra Palace.

the more usual collection of interesting snippets.

* * *

I hear that the B.B.C.'s television special demonstration film will be broadcast early in June, and that the time selected is 12.30 p.m. to 1.30 p.m. This film will run for about 40 minutes, but it should be pointed out that it is intended solely for the use of shops, dealers and demonstration rooms, and not for ordinary viewers. An ordinary viewer, of course, would soon become tired of the repetition; and apart from that, I think the B.B.C. itself realises that film is not
(Continued in 3rd col. of next page).

THE NEW VISION

SOME CONSIDERATIONS OF EYE STRAIN IN VIEWING

BY A FELLOW OF THE BRITISH OPTICAL ASSOCIATION

THE developments in any new form of vision are subjects for serious study to an ophthalmic optician. As a keen radio constructor, it is natural for television to attract one's attention. The combination of the two viewpoints tend to make one intensely interested in this new vision.

The chief practical objections to television made by viewers appear to be (a) the smallness of the picture, and (b) a somewhat nebulous type of eyestrain experienced after a short session of viewing.

I venture to suggest that these faults, if they can be so called, have a common optical link in the physical mechanism of the human eye.

Certain muscles are called into play when the eyes are focused on any object. The closer the object, the greater muscular effort will be required to focus it.

Relative Sizes

The eyes have also become accustomed to the relative sizes of standard objects. For instance, a man seen at a distance of twenty feet will appear to be of a certain size or, in geometric language, he will subtend a certain angle. A difference of a few inches in height between two men will not greatly affect the subtended angle. As the man approaches the observer, the angle will increase.

The human eye automatically links up the normal size of objects with the distance from which they are seen and it is apparent, therefore, that any violent change in this long-established co-operation between muscle energy and distance perception will create a feeling of strangeness. It has been observed that with larger screens, even though the picture quality is inferior, there is less strain on the eye than with a small screen.

Owing to the small size of the screen used in television, the eyes are forced to accept the image of a man which, according to its size should be about thirty feet distant, but which is only, say, three feet away. No adjustment of distance from the screen will compensate for the mechanical smallness of the image, so

the eyes are forced to exert energy to focus the screen to see an image which, according to its size, should not need this energy to focus it.

The link between size and distance at the cinema cannot be compared to that when watching television, as it is seldom that pictures are seen which destroy this peculiar optical coupling. The greater distance from the screen allows more latitude in the sizes of images projected. The same strange feeling is experienced, however, when there is a long period of close-up photography, the image then being far larger than the eyes expect it to be at a definite distance from the screen. Fortunately, very few "close-ups" last for more than thirty seconds.

The radio picture is acknowledged to be more prone to blurring than the projected cinema film. Any diffused image creates a strain on the eyes owing to their natural desire to see a clear picture. Eyes seeing a blurred image will try, by using their own muscles, to sharpen the focus. In the case of a blurred picture, no improvement can be made by muscular effort and the eyes have to receive the image in an unnatural state which they do under protest.

Sound and Vision

There is also the possibility that the faulty relation between the image size and the volume of sound emitted, presumably by that image, has an adverse effect.

The brain has been accustomed to the volume of a man's voice being produced by a full-sized man. The cinema is able to provide some regulation to retain this normal coupling, but television, as I have seen it, completely upsets one's conception of vision-sound relationship. The increase in volume needed when a "close-up" is transmitted should, of course, be provided at the transmitting end and does not appear difficult to arrange.

The faulty relation between size and sound should not produce any adverse physical effects, but the size and distance factor is bound to create a somewhat unusual feeling until one

has become thoroughly accustomed to it.

There is no harm in training the eyes in this new science. Those who normally wear glasses constantly and who are over fifty years of age may find it an advantage to use a special power of lens for seeing television.

"Studio and Screen"

(Continued from preceding page)

equal in technical excellence to the live programmes usually transmitted from the Palace.

The purpose of the film is to indicate the type and scope of television programmes and to give a representative idea to a prospective buyer of a set of the sort of material he can expect to see. In other words, this recorded programme shows the highlights of television up-to-date, and includes George Robey, Hore Belisha, the Television Orchestra, announcers, the "Zoo-Man," dance band interludes, and so on. It is an excellent idea, and should be a great help to the trade.

And writing about the trade reminds me to mention that the wireless exhibition this year may well be "Teleolympia" instead of "Radiolympia," for the B.B.C., I hear, is planning unique demonstrations which should be staggeringly impressive.

A New Valve for the Higher Frequencies

A new valve that is fast becoming a "standard" for high-frequency work is the Taylor T-55, a carbon anode triode with a ceramic base and mount. Although rated to have an anode dissipation of 55 watts, a pair in push-pull at 5-metres will give over 300 watts as class "C" amplifiers.

The following characteristics will give some idea of the performance.

Max. anode volts unmodulated D.C., 1,500 v.

Max. anode volts modulated D.C., 1,500 v.

Max. D.C. plate current, 150 M/a.

Max. D. C. grid current, 40 M/a.

Max R.F. grid current, 5 amps.

R.F. output, 168 watts.

This valve can be obtained from G₂NO, Eves Radio, Ltd., 11 Litchfield Street, Wolverhampton. Deliveries are from stock. The price is 45s.

A Reliable Circuit. Rugged Construction

to 9 metres Messrs. Eddystone were good enough to introduce a new coil in their four-pin range to link up with a similar coil in the six-pin range. This has enabled me to design a receiver tuning from a comfortable 9 metres right up to 170 metres, with the option

efficient as anything of its type, and yet when used as a transportable still retains that efficiency.

First of all examine the view showing the tuning controls and the remainder of the operating knobs. On the left, the first two small knobs operate air-

cluded, but as far as I am concerned it is only wired into circuit when the receiver is being used normally with a large accumulator.

Band Setting

The band-set condensers are used merely to take up any possible differences there might be in inductance between the 4-pin aerial coil and the 6-pin HF transformer. It is not intended that these condensers be used to make one set of coils cover two wave bands, for this would provide the wrong L/C ratio and decrease efficiency.

It may also seem unnecessary to some constructors that an I.F. volume control be fitted. Reference to the circuit however will show that the output valve is a new steep slope pentode, which can be easily overloaded, while at the same time, if the receiver is being used in an area where there are any amateur transmitting stations, it is useful to be able to keep volume level well down. I have also noticed that when tuning with maximum sensitivity one is likely unexpectedly to come across a powerful Morse station when the volume control is immediately wanted. Long distance listeners have also told me that they invariably have their receivers adjusted with low-volume level, and the detector circuit almost on the verge of oscillation.

Everyone will agree that the tone corrector is a useful accessory. Atmos-

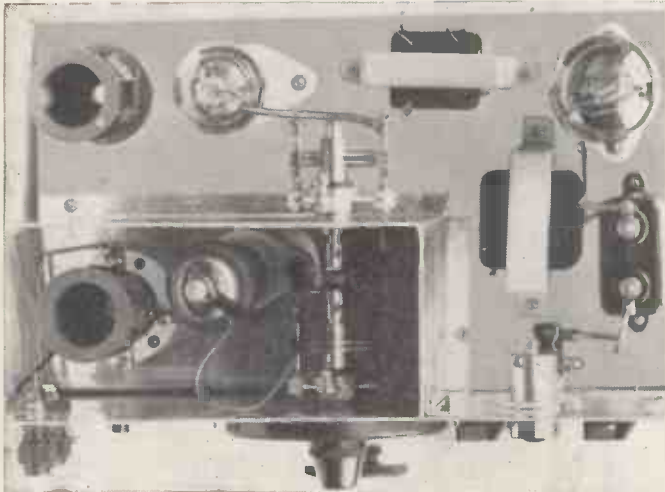

How the components are laid out can be seen from this plan view. The aerial circuit components are kept within the screened section.

of medium waves should high selectivity not be required.

The amateur bands are covered in five steps, from 9 to 14, 12 to 26, 22 to 47, 41 to 94, and 76 to 170 metres. The 170 metre top limit is rather elastic, owing to the fact that the band-setting condenser at its maximum capacity enables the circuit to tune to 180 metres with a very slight decrease in efficiency. Alternately, another coil tuning from 150 to 325 metres can be obtained, so covering the low-frequency amateur band with a good efficiency factor.

When the receiver was in its early stages of design the original idea was to make it suitable for efficient 10-metre reception, but when it was found that one or two 9-metre American commercial stations could be tuned in on the loud speaker, efforts were made to reduce straight capacity, so that 9-metre reception could be relied upon.

Variation in component layout and the shortening of one or two wires has made it possible for me to guarantee that the receiver will tune to 9 metres in every case.

All Refinements Included

As the receiver is being used for serious outdoor field-day work, every refinement of a standard home receiver has been embodied. I could not see just why the fact that the receiver was a transportable one would make it necessary for me to omit such refinements as band setting and variable tone correction, just to quote two examples. The net result of these deliberations has been to produce a receiver that is as

spaced midget band-set condensers. In the centre, beneath the main tuner is a slow-motion reaction condenser, and next to it is a potentiometer connected across the secondary of the L.F. transformer, acting as a volume control. Finally is the variable tone control, and combined with it the master on/off switch. An indicator light has been in-

Components for A SELF-CONTAINED THREE-VALVE RECEIVER

CABINET, PANEL, CHASSIS AND SCREEN.

- 1—Steel cabinet to specification (A.P.A.).
- 1—Steel panel to specification (A.P.A.).
- 1—Steel screen to specification (A.P.A.).
- 1—Steel chassis to specification (A.P.A.).

CHOKES, LOW FREQUENCY.

- 1—Type L.F.16S (Bulgin).

COILS.

- 1—Set type 959 six-pin (Eddystone).
- 1—Set type 932 four-pin (Eddystone).

CONDENSERS, FIXED.

- 4—.01-mfd. type tubular (Dubilier).
- 1—.0003-mfd. type tubular (Dubilier).
- 3—2-mfd. type BB (Dubilier).

CONDENSERS, VARIABLE.

- 2—Type 1013 (Eddystone).
- 2—Type 900/20 (Eddystone).
- 1—Type 957 (Eddystone).

DIAL.

- 1—Standard drive (B.T.S.).

DIAL LIGHT.

- 1—Type D9 (Bulgin).

HOLDERS, COIL.

- 1—Type 964 (Eddystone).
- 1—Type 1073 (Eddystone).

HOLDERS, VALVE.

- 2—4-pin type V5 less terminals (Clix).
- 1—5-pin type V5 less terminals (Clix).

RESISTANCES, FIXED.

- 1—1,000-ohm type ½-watt (Erie).
- 1—2-megohm type ½-watt (Erie).
- 1—500-ohm type ½-watt (Erie).
- 1—10,000-ohm type ½-watt (Erie).
- 1—20,000-ohm type ½-watt (Erie).

- 1—50,000-ohm type ½-watt (Erie).
- 1—500-ohm type 1-watt (Erie).

RESISTANCES, VARIABLE.

- 1—500,000-ohm type J (Dubilier).
- 1—10,000-ohm type B (Dubilier).

SUNDRIES.

- 1—Coil, screened wire (Bulgin).
- 2—Anode connectors type 1156 (Belling Lee).
- 24—6 B.A. counter-sunk bolts with nuts and washers (Bulgin).
- 3—yards 1 mm. flexible wire (Bulgin).
- 2—Coils Quick-wyre (Bulgin).
- 3—Wander plugs type 1276 marked HT+, HT— and HT+1 (Belling Lee).
- 1—Pair accumulator connectors type 1031 (Belling Lee).
- 2—Insulated terminals type B marked A. and E. (Belling Lee).
- 1—Insulated coupling piece type 1009 (Eddystone).
- 1—Jack type J2 (Bulgin).
- 1—Plug type P5 (Bulgin).
- ¼—lb. 22 enamelled wire (Webbs Stores).

TRANSFORMER, LOW FREQUENCY.

- 1—Type LF37 (Bulgin).

ACCESSORIES.

ACCUMULATOR.

- 1—Type PYV4 (Oldham).

BATTERY, HIGH TENSION.

- 1—120-volt type 13480 (Vidor).

HEAD PHONES.

- 1—Pair super-sensitive (Ericsson).

VALVES.

- 1—SG220SW (Hivac).
- 1—D210SW (Hivac).
- 1—PEN231 (Mazda).

9 Metres Upwards.

All Amateur Bands

pherics and local interference can be reduced by cutting off top notes while when conditions are bad signals can often be copied when the output circuit is adjusted to give the correct pitch.

The Lay-out

Refer to the plan view of the receiver. In the front compartment is the HF valve, band-spread condenser, and aerial coil. On the opposite side of the screen can plainly be seen the 6-pin H.F. transformer, with its reaction winding, the detector valve, again with top cap connection, and a midget intervalve transformer to one side. The L.F. pentode can also be seen with its associated choke filter output circuit. The choke is another midget component, but fully capable of handling the total anode current to the pentode valve, while at the same time retaining a high inductance.

Now that the reason for the set and the layout of the components has been explained, a few words on the circuit employed. The aerial is fed into the grid of an SG220SW valve. This is one of the special Hivac short-wave valves, with a low-loss base, and top-cap grid connection. This enables the grid and anode circuits to be completely separated, without any need for complicated metal screens. The actual grid coil is preset tuned, with a .000065-mfd. condenser, while the tuning is spread with

and with practically any length of aerial.

The screen voltage of the high-fre-

connected so that 3 goes to the anode of the H.F. valve and 6 to H.T. positive, and to a decoupling resistance

This angle view shows the low-frequency section and a close-up view of the controls. As mentioned in the text the indicator lamp is optional.



quency valve comes from a simple tapping, the resistance network having been omitted owing to it complicating switching and causing a slight extra drain from the high-tension battery.

of 1,000-ohms which is by-passed to the chassis through a .01-mfd. condenser. Pin No. 1 goes to the grid of the detector valve through a grid condenser of .0003-mfd. and a leak of 2 M-ohms. Pin No. 4 goes to earth, while across pins 1 and 4 are connected a .000065-mfd. band setting condenser and a .000015-mfd. spreading condenser.

The reaction winding is connected between pins 5 and 2. Pin 5 is the anode side, going to the detector valve, through a resistance of 500 ohms. The earthy side is connected to the stator plates of the reaction condenser.

High-frequency chokes rather worry me in a wide range receiver, for although nine samples out of ten will probably be free from resonances, the tenth one may cause certain blind spots which are hard to trace. To overcome this possibility in place of the choke a resistance of 10,000 ohms has been incorporated which has proved to be effective over the whole tuning range of the receiver.

The L.F. Stage

A combination of resistance and transformer coupling is employed in the low-frequency stage. The external anode impedance consists of a 50,000-ohm resistance, followed by a 20,000-ohm resistor for decoupling. The junction of these two resistors is taken to earth through a 2-mfd. condenser.

The output from the detector stage is fed into the primary of a midget intervalve transformer having a $\frac{1}{4}$ ratio

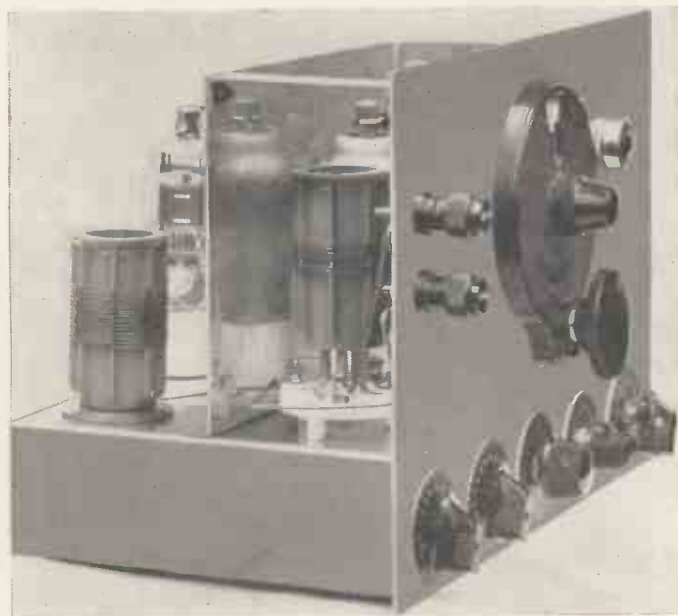

Both the aerial and H.F. coils can be seen in this illustration. Notice the heavy gauge wire used in the aerial circuit.

a .000015-mfd. condenser. The conventional aerial preset has been omitted in this circuit, for it was not required with the Eddystone coils, as the primary windings appear to give just the correct amount of coupling on all wavelengths

Coil Connections

The H.F. transformer is actually mounted in the detector stage, but the primary, joined to pins No. 3 and 6, is

A Full-size Blue-print and Special Offer

4. This transformer has a high primary inductance owing to the fact that there is no D.C. current flow through it, and as will be perceived from the circuit one end of the transformer primary is taken directly to chassis.

Across the secondary is the 500,000-ohm volume control, the centre point of which goes to the grid of the output pentode. This pentode valve has to be automatically biased as the voltage needed is very critical. A 500-ohm resistor between H.G. negative and L.T. negative provides this bias, and it is shunted by a condenser having a capacity of 2-mfd. This value of bias resistor

for the aerial coil should be arranged so that the aerial connection comes reasonably close to the aerial terminal. The plug for the head-phones or loud-speaker is dead on one side, and automatically makes contact through the metal panel. Similarly, with the indicator lamp. The centre pole is taken directly to L.T. positive, while L.T. negative is automatically connected when it is fixed to the panel. Mount the intervalve transformer and the output choke in the position shown, with the 2-mfd. condenser alongside the choke.

As the grid connections to both H.F. and detector valves are on top of the

120-volt supply, and this is well within the capabilities of the battery specified.

A Blue Print

A full blueprint showing point to point connections is in the course of preparation, and will be available before the next issue, which includes full operating details, is published. We advise readers to reserve a copy of this print for I anticipate, that as with the original receiver, the first printing will very soon be taken up.

All reservations for full size blue prints should be made to the Blue-Print Dept., TELEVISION and SHORT-WAVE WORLD, Chansitor House, 37/38, Chancery Lane, W.C.2. The cost of the print is 1s., which should accompany the order.

Complete kits of parts can be obtained from Messrs. Webb's Stores, in 14 Soho Street, W.1., or from the usual suppliers. I cannot too strongly emphasise that the components specified must be strictly adhered to, particularly the valves, otherwise the performance cannot be guaranteed. I feel sure this set could be made the standard for most enthusiastic amateurs needing a reliable trouble free receiver. For those who are interested in reception of long distance commercial stations broadcasting programmes, it should be remembered that all the popular channels are covered, including Shipping, Air Force, and British and American Police radios.

Although the 10-metre amateur band is at the moment rather dull, a number of stations have been logged on the loudspeaker while the other amateur bands are full of interesting stations originating from all over the world.

It is interesting to note that despite the fact that only three valves are used, the sensitivity is sufficiently good on the lower-frequency bands for me to record no less than seven 80-metre Canadian stations in one evening.

The lack of background noise is also most important, for on the 160 metre amateur band, I have been able to listen to stations with such a poor field strength that they were completely lost behind background noise on a multi-valve super-het.

Those constructors who build or heard my original band spread 3 will be able to appreciate the virtues of this new addition, which has all of the advantages and none of the disadvantages of the first design.

Arrangements are being made whereby, for the next few weeks, responsible amateur societies may have the opportunity of trying for themselves under working conditions the original model of this receiver. Club secretaries interested should get in touch with me as soon as possible.

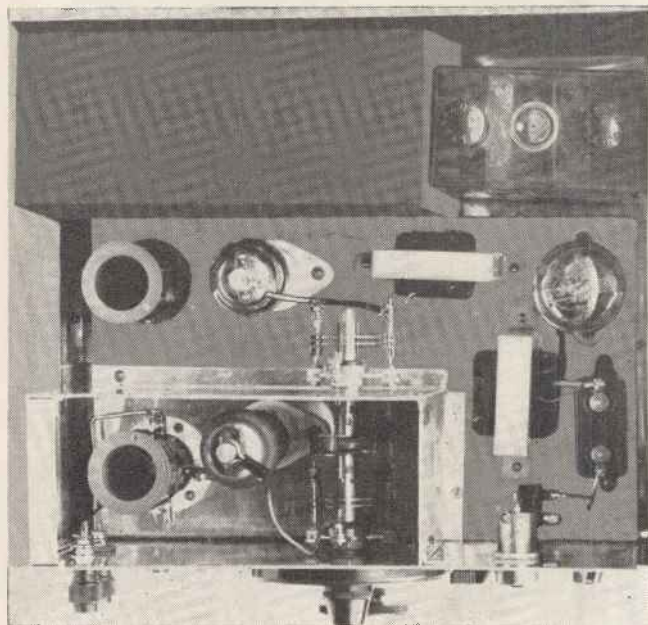

The receiver is housed in a metal cabinet that will also take the H.T. battery and accumulator. A 120-volt battery is used in this circuit while no bias battery is required.

is also suitable for the PEN 220 valve for those who need a higher output.

Tone Correction

The tone corrector is made up of a .01-mfd. condenser and a 10,000-ohm variable resistance, connected in series from the anode of the pentode to L.T. negative.

All H.T. feeds, with the exception of the screen of the high-frequency valve are connected together, and taken to the maximum voltage of the battery. The voltage applied to the screen has to be determined by experiment, but has an average value of 70 volts.

Construction

There are several points in construction which should be borne in mind. When the chassis and cabinet is obtained from the makers the panel, chassis and screen will all be bolted together. The first operation is to mount the panel controls and the two small condensers. The ceramic valve holder

bulbs the wires can be taken directly to the nearest point in the associated tuning circuit. This, of course, is the stator vanes on the band-spread condenser.

Careful Wiring

When wiring up, it is advisable to use 16-gauge wire as much as possible in the H.F. and detector tuning circuits. Also use the centre bolt fixing the H.F. screen as a common earth point, and take all earth connections to this one point. With very few exceptions, all connections can be soldered, and this is most important if the receiver is used for portable work. For some reason or other bolted connections invariably come loose. Similarly when using nuts and bolts in any part of the chassis, use shake-proof washers and lock nuts in order to prevent the components coming loose after they have had a good shaking up.

The total anode consumption of the receiver is a little under 8 M/a with a

Programmes for Short-wave Listeners

By A. C. Weston

PROGRAMMES from Europe have improved very much since the more important countries installed high-power short-wave transmitters for colonial service. The French Government have three stations which maintain almost a 24-hour service, and they relay quite a number of programmes from the normal medium-wave stations.

Lucien Goldy, who is well-known to



Hollace Shaw has just joined the Columbia Broadcasting System, and can be heard through New York from Monday to Friday at 12.30 a.m.

listeners of Radio Paris, is appearing with his orchestra at 2.30 p.m. on Saturday, June 12. The programme lasts for 90 minutes and is being radiated on 19.68 metres. A music-hall relay appears on the programme for June 25, which begins at 5 o'clock and is scheduled for 60 minutes. It is followed by another hour of gramophone records.

Listeners to Radio-Colonial will be able to hear no less than 15 news bulletins in 21 hours. These are all given in a minimum of three languages, generally Portuguese, English and French.

Philips, although they call their programme experimental, have definite schedules, and some really entertaining features. They have two stations, PHI, on 16.88 and 25.57 metres, and PCJ on 19.71 and 31.28 metres.

A special broadcast for Asiatic countries is scheduled for 11 a.m. on Sunday, June 13, through PHI. This same station has a variety programme from 12 until 2 p.m., after which there is a special broadcast for Africa at 6 p.m. through PCJ.

More Happy Programmes

Happy programmes are scheduled for June 15, at 8.30 p.m., through PCJ, and also at 5.30 through the same

In this article the times are given for broadcasts from Europe, America and Australia. American stations this month are transmitting a number of special programmes at times convenient for European listeners.

station. On Wednesday, June 23, at 1 o'clock, PCJ has a special variety programme intended for listeners in the Far East. This will last for three hours, so something really good should come along from this programme.

The Australian station, VK3LR, on 31.34 metres, is transmitting special programmes for British listeners every day from 12.45 to 1.45, the high-light coming at 1 p.m. Each Saturday they have "Swing's the Thing," a half-hour of recorded music, consisting of a parade of the world's finest swing bands and "hot" singers.

Programmes intended to popularise America and to give foreign listeners some idea of what they are missing if they haven't been there, are being broadcast every Monday at 11.15 p.m. These programmes are being sponsored by an American travel company and have as commentator Simmons Tours. The transmissions are also being sent out in Spanish at 10.15 p.m., and 6 p.m. in French. The best station for this transmission is W2XAF.

One of the most popular films of recent years has been "Brewster's Millions," featuring Jack Buchanan. It is being broadcast through Cincinnati, and features the famous Columbia stars, Jack Benny and Mary Livingston. This programme is on the 49.5 metre channel.

Starting April 18th, Rubinoff and his violin are to be broadcast from Holly-



Nine p.m. on Tuesday, June 8th, brings the N.B.C. comic, Pinky Lee.

wood via W2XE, Wayne. The programme will assume a new form, featuring famous guest stars from the film colony with a new orchestra of 35.

American baseball star, Babe Ruth, is starting a twice-weekly series over New York every Wednesday and Friday, at 1.30 to 1.45. Johnny Reed



Heard during the "Breakfast Club" every day at 2 p.m. is Walter Blaufass the veteran N.B.C. Orchestra Conductor.

King is the announcer for this programme, and he alone is worth hearing.

Ken Murray, the well-known film star, supported by Marlyn Stuart and Oswald, are being relayed every Wednesday from 12.30 a.m. from the Hollywood Playhouse. This programme is scheduled for 26 weeks, and is succeeding Burns and Allen, who have new listings through the same station, W2XE.

A new listing sponsored by the National Broadcasting Co., and relayed through Boundbrook, entitled "Our Neighbours," in which Jerry Belcher interviews families in their own homes, is quite a novel type of programme, and can be heard most Sundays at 6.40 p.m. on 16.87 metres. At 11 p.m. through the same station on 49.18 metres, is a feature entitled "Echoes of New York," in which the city's history is more or less put to music. Henry Hudson, who is well-known to short-wave fans, is Master of Ceremonies, while the whole programme is supported by Joseph Bonime's Orchestra.

Walter Blaufass conducts the N.B.C. Orchestra in the National Farm and Home Programme, and also during the Breakfast Club, every day at 2 p.m., while he conducts his "Homesteaders" every week-day at 6.30 p.m. Barry McKinley is now being featured in the

New Dance Bands and Variety from America

"Tic-Toc" review most Mondays at midnight, while at this same period during the week fifteen minutes is given to the "Easy Aces," featuring Jane and Goodman Ace. For the four Thursdays in June, at 9 p.m., through Boundbrook, "Club Matinee" introduces Harry Kogen and his orchestra, Robert Gately and the Doring Sisters, which is followed at 10 p.m. by the story of Mary Marlin, the Singing Lady, at 10.30 p.m., and finally Roy Campbell at 10.45. Then switch-over to 49.18 metres and hear Harry Kogen at 11.5 p.m., with a final News Bulletin from Lowell Thomas at 11.45 p.m.



Star Columbia Commentator is Paul White who was specially sent over to talk about the Coronation. His commentaries on all manner of topics can be heard through New York and Philadelphia.

Schenectady, which carries the N.B.C. programmes, is radiating from 3 p.m. until 11 p.m. on 19.56 metres, while there is an alternative channel on 31.48 metres, open from 9 p.m. until 5 a.m.

Here are some of the Sunday features for June, starting at 4 p.m. with "Paramount on Parade," 5.30 p.m. "Dreams of Long Ago," 6.30 p.m. "Thatcher Colt," and 9.30 p.m. "Smilin' Ed. McConnell." On the higher wavelength is a "Tale of To-day" at 10.30 p.m., Jack Benny and Mary Livingstone at 11 p.m., and "Manhattan Merry-go-Round" at 1 a.m.

Joe White comes on the air at 5 p.m. on Mondays, followed by "Words and Music" at 5.30 p.m., Lorenzo Jones at 8 p.m., and Music for the Moment" for fifteen minutes from 8.15 p.m. A new listing for June only is the "Three X Sisters," who have ten minutes from 10.35 p.m. On the higher wavelength on this day, "Little Orphan Annie" comes on the air at 9.45 p.m., Amos and Andy at 11 p.m., and the "Hour of Charm" at 1.30 a.m.

The main features for Tuesdays are "Words and Music" at 5.30 p.m., Personal Column of the Air, 6.45 p.m., Annette King 9.15 p.m., and Don Winslow of the Navy 10.30 p.m. Later on comes the Short-wave Radio Mail Bag at 11.35 p.m., Wayne King's Serenade

12.30 a.m., and an hour of variety with Fred Astaire from 1.30 a.m.

I notice Henry Bussy's Orchestra is scheduled for 8.15 p.m. on Wednesdays, while Cappy Barra and his Harmonicas have ten minutes from 10.35 p.m., Flying Time at 10.45 p.m., is a dramatic programme well worth hearing, while in direct contrast is Uncle Ezra's Radio Station at 11.15 p.m., for fifteen minutes.

Dick Fiddler's Orchestra is scheduled for 5 p.m. on Thursday, with "Words and Music" at 5.30 p.m., the N.B.C. Music Guild at 6 p.m., and Archer Gibson at his organ at 9 p.m. Rudy Vallee's variety hour, scheduled for midnight, will still be relayed, for his programme is being picked up from London, via the Post Office Station at Rugby. Also on Thursday evenings is Lanny Ross at 1 a.m., and an hour with Bing Crosby at 2 a.m.

Barry McKinley has fifteen minutes most Fridays at 10.15 p.m., while also on this day is Amos 'n' Andy again at 11 p.m., Lucille Manners at midnight, and Waltz Time at 1 a.m.

N.B.C. always provide a variety programme on Saturdays. Chasin's Music Series at 4 p.m., "Golden Melodies" 6.30 p.m., Week-end Review at 7.30 p.m., and "Top-Hatters" at 10.30 p.m. are a few that can be heard through Schenectady.

At 11.30 p.m., for an hour on June 15, there is an interesting programme from Zeesen, entitled "Songs of Various Nations," in which Elinor Jansen, who is a grand-daughter of Edward Greig, will play compositions from England, Spain, Sweden, Norway, France and Switzerland.

Listeners to Cincinnati on 49.5 metres will hear a number of programmes which are presented on Monday to Friday at definite times. For example, each Monday at 10.15 p.m. are Tommy and Betty. On Tuesday at 7.15 p.m. is



Frances Adair can be heard by Philadelphia on Saturday evening, when she is the featured singer with Russ Morgan's Orchestra.

the N.B.C. presentation "Ma Perkins." On Wednesday at 12.30 a.m. Mutual Broadcasting System sponsor "Music for the Family." On Thursday at 8.30 is "Follow the Moon," and on Friday at 11.30 p.m. comes "Lum and Abner," followed by "For Men Only" at 1 a.m. Kaltenmayer's Kindergarten is scheduled for 10 p.m. each Saturday, and this amusing programme is well worth hearing.

Columbia presentations for June include many well-known artists, who will appear at a given time for the whole of the month. Perhaps the most important is Guy Lombardo and his



Ben Bernie and All the Lads broadcast through Boundbrook every Tuesday at 9 p.m. Here he is during a recent broadcast with the famous American Actress, Ethel Barrymore.

Orchestra, scheduled for 10.30 p.m. each Sunday evening. This and all other Columbia programmes can be heard through W2XE, New York, or W3XAU, Philadelphia. Also on Sundays at 11 p.m. is Joe Penner, supported by Gene Austin, at 11.30 p.m. Rubinoff and his violin, supported by Virginia Rea for thirty minutes. "Five Star Revue" with Bill Johnstone, the Hollywood Reporter, is a regular feature at 6 p.m. each Monday, while the "Eton Boys" now have a further 15 minutes from 10.15 p.m. "News Flashes" can be heard at 5.15 p.m., while there is a programme by Jack Birch and his Orchestra at 6 p.m. Del Casino is back on the air at 10 p.m. on Tuesdays, while Howard Barlow introduces dinner music at 11.30 p.m. Victor Young is included in "Al Jolson's Show" at 1.30 a.m. every Tuesday, and this lasts for thirty minutes.

Another new listing is Jack Shannon with Leon Goldman's Orchestra at 9.30 p.m. on Wednesdays. Lily Pons has thirty minutes from 1.30 a.m. on June 2 and 9, after which this period is taken by Jessica Dragonette and Al Goodman on June 16, 23 and 30. On Thursday, June 16, Vincent Lopez has an unexpected fifteen minutes at 5.30 p.m., while at 11.30 p.m. on the same day Isham Jones is giving a special broadcast that is being relayed to Europe.

Frequency Doubling Simply Explained

By Kenneth Jowers

This is the second of a short series of articles explaining in a simple way the functions of various stages in an amateur transmitter. Next in this series will be the power amplifier stages.

IN the May issue on pages 309 and 310, some fundamental oscillator circuits suitable for the beginner interested in the construction of a low power transmitter were given.

It will be appreciated that a crystal oscillator is fundamentally a complete transmitter, for radio frequency output

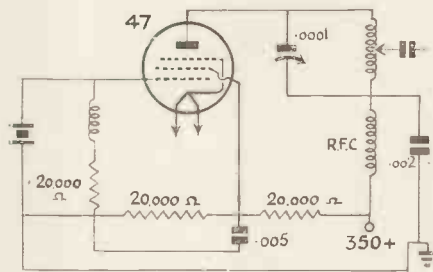

Fig. 1.—This pentode crystal oscillator is used as a basis for the details given in the article.

is generated, and if the output is correctly fed into an aerial, there would be a carrier, the strength of which would depend on the D.C. input to the valve plus the degree of efficiency obtained.

With normal straightforward crystal oscillator circuits, a carrier is only obtained on fundamental frequencies, that is to say, with a 40-metre crystal the anode circuit is invariably tuned to 40 metres. The simple C.O. circuits, however, must not be confused with the tri-tet circuit which has a multiple tuning arrangement, having both cathode and anode coils, so that one valve functions as an oscillator on one frequency, and also as a frequency multiplier. Briefly, this means that with a 40-metre crystal in the grid cathode circuit an appreciable output can be obtained when the anode coil is tuned to a harmonic such as 20 metres.

Broadly speaking the crystal oscillator stage merely provides a stable fixed frequency with a reasonable but comparatively unimportant R.F. output. The crystal stage is generally followed by a sub-amplifier to boost the output from the crystal, or by a frequency doubler if the transmitter is to be used on anything but crystal frequency.

The rawest amateur will know that if the anode circuit is tuned to double the frequency of the grid circuit, then the output is going to be very considerably reduced. For this reason, it is not recommended that straightforward crystal oscillator circuits be made to perform the double function of oscillator and frequency doubler. It is more satisfactory, and far more stable to use the crystal oscillator valve as a plain

generator of radio frequency and to have the anode circuit tuned to the same frequency as that of the crystal.

Consider for the moment a transmitter that is to be used on 20 metres. It is not a very good idea to buy a 20-metre crystal, for they are expensive, fragile, and do not give a very high output. A crystal should be obtained with a frequency that when doubled still falls within the allocated 20-metre amateur band. For example a crystal having a frequency of 7125 when doubled comes to 14250 Kc in the amateur band. If it is used in the crystal stage in any simple circuit such as Fig. 1, the anode coil and condenser provide a circuit tuned to a simple doubler circuit, such as Fig. 2 which would again have an input circuit handling a 7125 Kc. signal. V_{e1} and V_{c1} , however, are constructed and tuned so that they resonate at 14250 Kc, the stage acting as a frequency doubler.

With these two circuits a transmitter is obtained that can be used on 40 and 20 metres. On 40 metres all coils are tuned to 7125 Kc., giving a high output

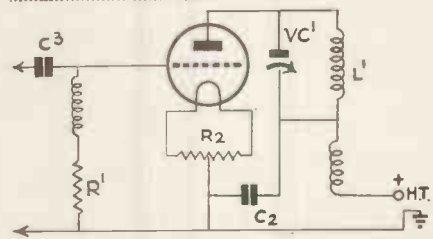

Fig. 2.—The simplest type of frequency multiplier or doubler, using a high impedance, high slope triode valve.

at crystal frequency in L_1 , but for 20-metre operation the crystal stage is left entirely alone, while L_1 having only half the number of turns tunes to 20 metres, or more accurately 14250 Kc.

As the circuit in Fig. 2 has an anode circuit tuned to double the frequency of the previous circuit, the output will naturally be lower than if it were tuned to crystal frequency. This is very obvious, so for that reason most transmitters consist of three stages having a power amplifier following the intermediate stage which can be either doubler or sub-amplifier. The purpose of the power amplifier is to boost the output of the frequency doubler, and to provide a high R.F. output for feeding into the aerial. This section, however, will be dealt with in detail in a subsequent article.

Consider the requirements of a frequency doubler. It should be capable of

producing very strong harmonics, and the main objective is to obtain the highest possible R.F. output by varying the constants applied to the valve to produce this requirement.

The valve, when used as a straight amplifier, is operated in what is known as Class B. Under such conditions grid bias is applied until, without signal input, anode current is reduced to zero. With frequency doubling, the valve is worked in Class C, with bias of a sufficiently high value in the order of two or three times cut-off value. In order to understand this, assume that 50 volts negative bias are required to reduce anode current to zero. Correct Class C frequency doubling conditions would call for at least double cut-off, that is 100 volts, at even triple cut-off, equal to 150 volts. The higher the bias applied, however, the greater the drive needed from the crystal stage to provide sufficient anode dissipation. Going to extremes, a point could be arrived at where the drive from the crystal would be insufficient to cause the anode of the doubler to take current.

Adjust the doubler until it take its rated anode dissipation, say 10 watts, with the greatest amount of bias it will handle. This will depend mainly on the amount of excitation provided by the crystal oscillator. So as mentioned in the previous article, draw as much drive as you can from the crystal, for then it is possible to obtain greater efficiency in the frequency-doubler stage.

The type of valve used with a doubler has a great bearing on the efficiency of the stage. Valves in Figs. 2, 3 and 5 are all of a similar type. A valve having a reasonably high impedance of between 8,000 and 16,000 ohms, with the highest possible slope or gain factor

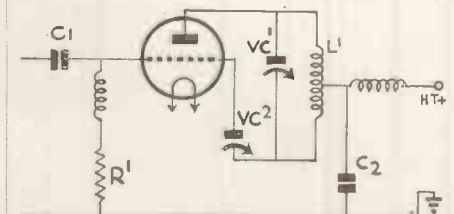

Fig. 3.—The introduction of regenerative causes a decided increase in efficiency.

will always be the best doubler. The PX4, having the low impedance of 830 ohms, with an amplification factor of 5, would be a most unsuitable doubler, for it would need high drive, and even then would not provide very much in the

Triodes : : Pentodes : : Push-push

way of R.F. output, despite the fact that the PX4 is one of the best valves of its class when used for the purpose for which it was designed.

A valve such as the ESW501 with an impedance of 10,000 ohms and amplification factor of 15 gives a greater output with a much lower input than the PX4. Of course this valve has rather high wattage dissipation, but is chosen as a guide owing to having such ideal characteristics.

Refer again to Fig. 2 which is the simple basic frequency-doubler circuit. With the majority of valves there is a

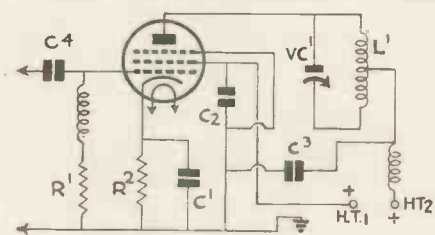

Fig. 4.—A pentode valve when correctly adjusted is a most satisfactory doubler. Only low voltage is required.

grid current flow so that a negative voltage is developed in the grid circuit owing to the current flow across resistance R1. This resistance should be increased in value in order to provide the correct amount of bias as previously explained.

If however the grid current is not high enough to provide triple cut-off voltage, then it can be augmented by the introduction of a bias battery in series with the earthy side of R1. C3, the coupling condenser between stages, has an average value of .002-mfd., which is quite satisfactory when it is tapped on the previous anode coil anywhere except at the anode end; when connected directly to the anode it is inclined to cause heavy loading and make the C.O. stage difficult to handle. The value also depends on frequency, so that any condenser between .0005-mfd. and .002-mfd. can be used. Naturally the higher the frequency, the smaller the condenser. The anode bypass condenser, C2 has a fixed value of .002-mfd.

A scheme that is very often used is shown in Fig. 3, where the conventional doubler circuit is increased in efficiency by the introduction of VC2, which allows of feed-back between anode and grid circuits. When correctly adjusted, this arrangement causes as much as a 25 per cent. increase in R.F. output without making any other difference.

Another advantage of this feature is that VC2 can be used as a neutralising condenser should the stage be modified for sub-amplifier work. This means that a transmitter can be built and used on more than one frequency without mak-

ing any modifications other than coil changing. VC2 has a variable capacity of up to 20 mmfd., the correct value depending on the coil L1, the tapping point, and valve used.

It has been discovered that the multi-electrode pentode type of valve will provide a much greater R.F. output on harmonics with a lower input, the only disadvantage being that care must be taken in supplying the correct screen voltage. A typical circuit is shown in Fig. 4, in which a pentode such as the 47 is used. R1 is not absolutely necessary, but has a value of 10,000 ohms for bias is obtained in this circuit by virtue of cathode current across R2.

During the experimental stages bias can be applied from a battery. When the correct voltage has been determined, the total cathode current can be measured, Ohm's law applied, and the correct value of auto bias resistance connected in series with the cathode.

It is again advisable to point out the disadvantage of this system. As the bias is commonly called free, it has to come from somewhere, and assuming 100 volts are required, these are deducted from the main H.T. supply, so that if the H.T. is low in the first case, it is not advisable to use cathode bias, but to depend on R1 plus an auxiliary battery if required. In such circumstances, R2 and C1 are omitted, the cathode being connected directly to earth.

A circuit that is very popular is shown in Fig. 5. This is the push-push circuit, with open grids and strapped anodes. The anodes are strapped because in a push-pull circuit harmonics are cancelled out, so that with a drive of 40 metres there will be practically no output at 20 metres.

However, the push-pull circuit gives a maximum of about 75 per cent. more R.F. output than a single valve, and with very little complication. Experience has shown that such a circuit needs an auxiliary battery for bias as shown in Fig. 5, which is shunted with a .0002-mfd. condenser. Twin chokes across the grids provide a more or less balanced circuit. L1 and VC1 are identical, as for other doubler circuits, although a slight reduction in tuning capacity will be noticed. This, however, does not affect the type of condenser, for the variation is so small that it is hardly noticeable.

This circuit must be link coupled to the previous stage, and if adjusted efficiently will be comparable to a conventional sub-amplifier. Bias should be about 3½ times cut-off value, but there should be sufficient drive to cause some grid current flow; if this should not be so, bias should be decreased.

Finally, to test the efficiency of the doubler stage, drive as hard as possible from the crystal oscillator, and tune the

anode circuit to resonance. The resonant point is indicated by a sudden drop in anode current which the percentage dropped indicates the approximate degree of efficiency. Assuming that the doubler takes 100 M/a when out of tune, it should drop to at least 15 M/a when

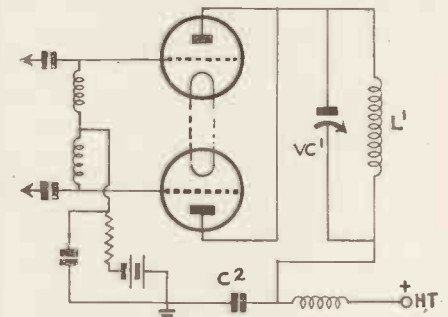

Fig. 5.—Push-push doublers gives an output almost equal to that of a sub-amplifier. Either two valves, or a twin triode can be used.

correctly tuned, that is the minimum current when tuned should only be 15 per cent. of the total current. So remember that the anode current should show the biggest possible dip, and adjustment should be made with components to obtain this.

“6L6 60 Watt Amplifier”

(Continued from page 362)

The valve is supplied with an 8-pin octal base, and consumes .9 amp. at 6.3 volts. The theoretical amplification factor is 135, with an anode impedance of 22,500 ohms.

Owing to the high anode current for this type of valve adequate cooling must be allowed. For, even under normal circumstances, the metal shell becomes extremely hot. Also in push-pull circuits of this kind, if the distortion content is to be kept down to the low level of 2 per cent., then the transformers must be carefully balanced. Suitable transformers are T1, type T 6,573, T2, type T5,741, T3, type T8,459, T4, type 8,458, T5, type 7,984, and T6, type 8,460, all Thordarson products.

From the anode of the first 6C5 to earth should be approximately 250 volts, and slightly over this figure from the centre tap of the primary of T3 to chassis. The total anode current in the final stage is approximately 100 M/a, without signal input, rising to a little over twice this figure at full 60-watt output.

The audio from this amplifier is sufficient to over-modulate a well-designed 100-watt transmitter, while owing to its small dimensions, low voltage and high quality, is ideal for feeding a large number of speakers for out-door work.

Pentode Detector :: 2-watt Output Pentode

taken through insulated sockets on the panel.

For a reaction winding, there are two turns of the same insulated wire, wound on the middle of the coil, one side going by as short a lead as possible

correct value can easily be obtained. This variable resistance can also be used as a volume control.

A section wound high-frequency choke is in the anode of the SP4B, and is by-passed on the high-voltage side

which, although not correct for the impedance of the SP4B, is the most satisfactory value with the low voltage available.

Normal resistance-capacity coupling is used between the detector and output centre. This latter valve is a PEN4VB, having the high slope of 10.0 mA/V. per volt, and giving maximum output with 250 volts on both anode and screen.

The correct bias for this valve is 5.8 volts calling for a cathode resistor of 145 ohms, but so as to reduce the total cathode current, the valve has been over-biased by the use of a 250-ohm resistor. This resistor is shunted with a 50-mfd. condenser to stop bass attenuation.

The resistance and condenser values are unusual in this R.C. coupled circuit, for the condenser has a capacity of .02-mfd., while the grid leak is 300,000 ohms.

In series with the control grid of the PEN4VB is a 5,000-ohm resistor, stopping any H.F. getting into the output stage. A further precaution is a 100-ohm



Tuning condensers are mounted directly on the miniature front panel. A separate power pack is needed and is connected by means of four-pin socket into the valve holder on the side of the chassis. Notice how the grid connections in the detector circuit are kept very short.

to the anode valve, the other side dropping down to one contact on a 60-mmfd. condenser. Actually, the reaction condenser consists of two 30-mmfd. postage stamp type mica condensers, mounted on ceramic insulation and wired in parallel. The grid tuning condenser is a similar unit, but of 30 mmfd.

The stage gain in a detector circuit drops off very quickly, unless the correct screen voltage is applied to the SP4B. In normal circumstances, this voltage could be obtained by means of a fixed potentiometer resistance network, having 25,000 ohms in the high-potential side, and 30,000 ohms on the earthy side. If other than 200 volts are given by the power pack, it will be advisable to use a 50,000 ohm variable resistance in the high-potential side of the resistance network, so that the

The few components needed are mounted in this way, all beneath the chassis. The wiring has also been kept to a minimum.

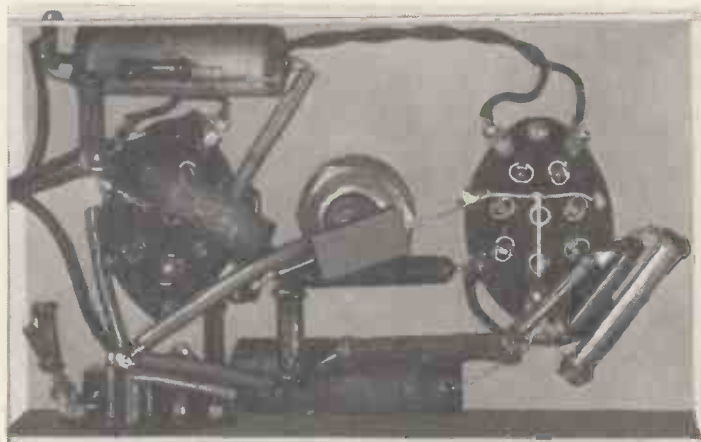

by a .0001-mfd. condenser. The external anode impedance is 50,000 ohms

resistor in the anode circuit, which is by-passed to cathode by a .002-mfd. condenser. It is essential that this resistor be connected directly to the anode pin on the valve holder without any extra wiring.

Loud-speaker connections are taken to a valve holder on the side of the chassis, and across the primary contacts is a resistance condenser network, to attenuate top notes. This tone corrector consists of a 10,000-ohm resistor and .01-mfd. condenser in series. A variable control can be made by using an adjustable resistance in place of the 10,000-ohm fixed resistance specified.

It is essential with capacity-controlled reaction that the H.T. voltage be absolutely smooth, for when the receiver is set near the oscillating point any increase in voltage will probably cause the receiver to go into oscillation

(Continued on page 372)

Components for

A 2-WATT 2-VALVE RECEIVER FOR 7 METRES.

CHASSIS.

- 1—Aluminium 6½ ins. by 4 ins. by 1½ ins. 14-gauge aluminium (A.P.A.).
- 1—Bakelite panel, 2½ ins. by 3½ ins. by 1/16 ins. (Peto-Scott).

CONDENSERS, FIXED.

- 1—.002-mfd. type M (Dubilier).
- 1—.0001-mfd. type M (Dubilier).
- 2—.01-mfd. type tubular (Dubilier).
- 1—.02-mfd. type M (Dubilier).
- 1—.0005-mfd. type M (Dubilier).
- 1—50-mfd. type F (Dubilier).
- 1—.5-mfd. type tubular (Dubilier).
- 1—8-mfd. electrolytic (Dubilier).

CONDENSERS, VARIABLE.

- 3—Type SW95 (Bulgin).

COILS.

- 3—Home-constructed to specification.

CHOKE, HIGH FREQUENCY.

- 1—Type 1011 (Eddystone).

HOLDERS, VALVE.

- 2—7-pin type V2, less terminals (Clix).
- 1—4-pin type V1, less terminals (Clix).

PLUGS, TERMINALS.

- 1—4-pin plug, type P9 (Bulgin).
- 2—Insulated sockets, type 12 (Clix).

RESISTANCES, FIXED.

- 1—500,000-ohm type ½-watt (Erie).
- 1—25,000-ohm type ½-watt (Erie).
- 1—30,000-ohm type ½-watt (Erie).
- 1—50,000-ohm type ½-watt (Erie).
- 1—300,000-ohm type ½-watt (Erie).
- 1—5,000-ohm type ½-watt (Erie).
- 1—250-ohm type 1-watt (Erie).
- 1—10,000-ohm type ½-watt (Erie).
- 1—100-ohm type ½-watt (Erie).

SUNDRIES.

- 1—Metal bracket, ½ in. by 2½ ins.
- 3—yards 1 mm. flexible wire (Peto-Scott)

ACCESSORIES

LOUD SPEAKER.

- 1—Type 37J (W.B.).

VALVES.

- 1—SP4B met (Mullard).
- 1—PEN 4VB (Mullard).

Some Experiments with Aerials

This practical article gives the results of some experiments carried out by a well-known transmitting amateur who has been endeavouring to determine the best type of aerial for long distance transmission and reception on 20 metres.

DURING the past year well over a thousand feet of good 14-gauge copper wire has been cut up and used in an endeavour to find a really satisfactory all-round aerial for 20-metre work. Results obtained make very interesting reading, and should be a considerable help to other experimenters who are in doubt as to the type of aerial they need to erect.

Choosing an aerial is perhaps the

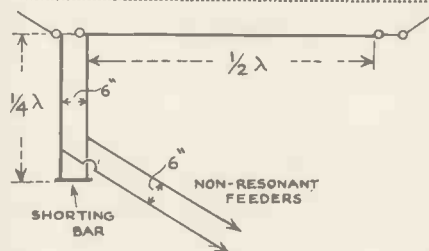

Fig. 1.—A simple half-wave radiator with quarter-wave stub section.

most difficult problem confronting the transmitting amateur for results are so varied and change according to location, so first of all, before giving any idea as to the results obtained, the location in which these experiments were made should first be detailed.

In no circumstances can a greater length than 99 ft. be obtained in one straight length. The poles are both approximately 40 ft. above ground, in free space, and not hampered by nearby buildings. In every instance the aerials have been N.W. to S.E., so that end-fed aerials were always essential, for North American transmission. Finally, as the transmitter was situated at one end of the aerial, it was always more convenient to use an end-fed aerial rather than a centre-fed.

Originally, a Zepp aerial was erected with a full-wave top and half-wave 600-ohm feeders. The radiation pattern was moderately good, but losses were high owing to standing wave on the feeders, which was quite understandable in view of the length, and the fact that no attempt was made correctly to match the impedance. There was also very considerable radiation from the feeders, despite the fact that they were accurately cut; for this reason B.C.L. interference was extremely high.

Such results were to be expected for the feeders should have been either quarter wave or three-quarters, but it so happened, as it will do in the majority of instances, that the quarter wave was too short, while three-quarters had to be carefully guyed, to keep the excess wire away from the house. However, the 49 ft. feeders practically eliminated the

standing waves and gave a high current reading at the transmitter end, so that tuning was simplified and local interference greatly reduced.

This aerial provided, according to reports, a concentrated radiation in Canada and North America, while at the same time from locals (by that is meant Europe and North Africa) consistently good reports were obtained.

Impedance Matching

While this aerial was quite satisfactory, it was only so because none of the constants or lengths were critical, so that variations up to 10 per cent. caused by local damping could be tolerated. Also, as a 600-ohm line was used, it could not possibly be linked at the point of correct frequency without some matching transformer. By adding a quarter-wave matching section at the end of the Zepp aerial, the correct type of transformer with a variable impedance was obtained. This quarter-wave matching section or stub has a shorting

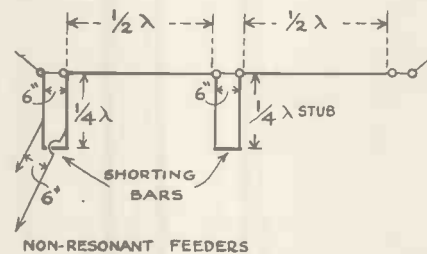

Fig. 2.—Two half-waves in phase give good broadside radiation.

bar at its end. At this point the impedance is negligible, arriving up to a high value at the point of connection of the aerial. Non-resonant feeders of between 72 and 600-ohms can then be connected across this stub at the point of correct impedance.

The aerial and stub length must be cut so that they are exactly to frequency, while the shorting bar of the end of the stub must be semi-adjustable, so that it can be moved up and down until true resonance at the transmitter frequency is obtained.

The system is fully indicated in Fig. 1, while the aerial and stub length can be calculated from the normal formula.

After this aerial had been carefully erected, actually it took over a week before correct matching was obtained, signal strength reports showed an average increase of one R strength, while stations were worked with much less difficulty and greater consistency. As is to be expected, the radiation was still

the same as with the conventional Zepp, so an experiment was tried by putting two half waves in phase, giving concentrated broadside radiation.

This aerial is shown in Fig. 2, where it will be seen that the stub section has still been maintained, but that there are two half-wave sections phased by a quarter-wave section.

Reports on this aerial indicated that the field strength in North America was essentially the same as for a two half-wave Zepp aerial, but a greater percentage of South American stations were worked over a limited period sufficiently well to indicate that good broadside radiation was being obtained. Where an aerial is erected N. to S., and broadside radiation is required for American transmission, two half-waves in phase, as in Fig. 2, are ideal.

Low-impedance Cable

During the winter months losses in the feeders became noticeable, particularly when water became frozen on the glass feeders. For this reason, and not for any particular desire for a more efficient radiator, the Belling-Lee cable was tried out. It could be matched very simply, providing the quarter-wave stub section with shortening bar was employed, and no trouble at all was experienced in eliminating standing waves, this being a point up on the conventional 600-ohm spaced lines.

With feeders up to 50 ft. in length, the efficiency was equal to the Zepp feeder; although this is not *theoretically* correct, no apparent losses were noted at 20-metres, until much greater length of feeder was employed.

As the transmitter was being used solely on the 20-metre band it was decided to erect a half-wave resonant 20-metre aerial, and to employ a Y match so as to obtain maximum results from the 72-ohm cable.

The conventional half-wave section

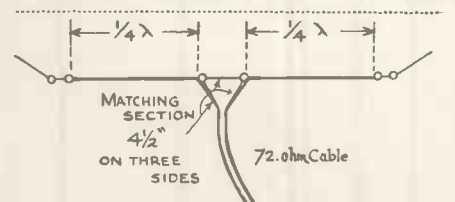

Fig. 3.—This type of doublet is particularly suitable for amateurs with limited space.

was erected, but centre-fed via a triangle of 4 1/2 in. sides, which with the location and aerial height previously mentioned, at the frequency to be used, gave almost perfect matching. Immediately an improvement was noticed over

72-ohm Cable :: Phasing Sections :: 5-Metres

all previous systems, while coupling to the transmitter was simplified. The 72-ohm cable was terminated in a single turn loop, and loosely coupled to the cold end of the tank coil, until maximum draw was obtained.

The first point made obvious was that local interference had greatly decreased, while the amount of band taken up, even with high power, was only approximately 25 per cent. of that when the Zepp aerial was in use. These two points in themselves were sufficient to warrant extensive tests with this type of aerial.

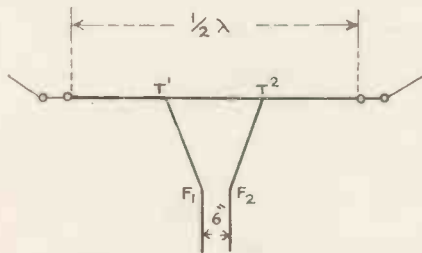

Fig. 4.—The true matched impedance aerial is worthy of experiment, for its radiation pattern does not always conform to theory.

Unfortunately a bad period for long distance reception arrived at this time, so that it was impossible accurately to obtain any comparison with other aerials; but three months proved sufficient to indicate that the radiation pattern was good, and that the aerial was suitable for omni-directional transmission.

This type of aerial draws very well and as no coupling coil or tuning condensers are needed, the losses are of a very low order as compared with the Zepp. It can safely be claimed that the average amateur with limited space will find the doublet with matched impedance to be very satisfactory, particularly as the losses in the feeders are so very low. The only drawback is that the aerial is a one-band affair, and for maximum efficiency, a single frequency aerial.

Wishing to compare this type of aerial with the two-wire matched impedance with 600-ohm feeders, a half-wave aerial of this kind was erected, to see how it compared with the doublet and 72-ohm cable.

This again is only suitable for single-band operation, and consists of a half-wave section with twin feeders connected either side of centre. The efficiency of the aerial depends entirely on the accuracy of feeder connection, for the impedance of the aerial varies from a very high value at the end to a low value at the centre. It will be appreciated from this that a point of connection must be determined to match up with the 600-ohm or whatever feeder is employed. The arrangement is

shown in Fig. 4, with tapping points shown as T1 and T2. The distance between these two tap points can be computed from the following simple formula:

$$T_1/T_2 \text{ (in ft.)} = 492,000 \times 0.24$$

The Y-section, that is from T1 to F1 and T2 to F2, must also be calculated by formula. This is as follows:

$$Y \text{ (in ft.)} = 147,000$$

Results with this aerial were highly satisfactory, with the exception that great care had to be exercised in eliminating losses when the feeder came near to a brick wall. So it can be safely assumed that the two-wire matched impedance aerial, and the half-wave doublet are approximately equal in radiating properties, but that the doublet has the advantage of a low-loss feeder.

Wishing to transmit a concentrated signal into a limited area, a horizontal V aerial was erected, again using 72-ohm transmission line. Full advantage of this aerial could not be taken owing to the usual amateur restriction of space, so that the open end of the aerial could not be wide enough to permit of a comparatively broad transmission to cover the whole of America. The aerial was designed to a frequency of 14,250 Kc. and was made up of two sides, each one and a quarter wavelengths long. The wires were brought to an apex, but with a gap of 6 in., while the transmission line was connected to a point approximately 6 in. from the end of each wire towards the apex.

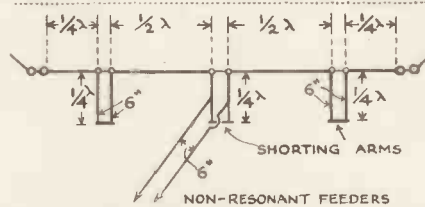

Fig. 5.—Two half-waves in phase, with phasing sections plus a matching stub make a most effective broadside radiator.

It was necessary to have at least a 90° angle, to obtain normal radiation pattern with this aerial, but it had to be reduced to 50°, owing to space limitations. This aerial, however, radiated a terrific concentrated signal, more or less in the required area, but instead of the transmission being straight from the centre of the V, it appeared to be more towards one side than the other, so that even though the V was pointed on North America, maximum results were obtained from Middle America and the Panama Canal zone. However, as this merely meant slight variations in angle, it is of no consequence.

As a guidance as to the efficiency of

this aerial, as compared with the Zepp of one wavelength, an R7 report with 50-watts on the Zepp could be obtained with 20-watts on the horizontal V.

For those who can erect a V with the correct constants the following data will probably be of help. For a frequency of 14,050 Kc. the limit allowable is two wavelengths, or 139 ft., while the angle should be approximately 75°. Method of feeding depends on the type of wire.

Although it was realised that phased aerials were a distinct advantage and simple to erect, they are not suitable when the aerial is E. to W., for they are essential broadside radiators.

The first experimental aerial erected is shown by Fig. 5, in which there are two half-waves and two quarter-wave sections with two quarter-wave phasing sections and one quarter-wave matching stub. A 72-ohm feeder was used for this aerial, and it is found that the correct point of match was almost at the end of the stub section. After the various stubs had been adjusted to resonance, the aerial was found to draw very well, and radiated a substantially strong broadside signal. Tuning, however, was comparatively flat, but when erected, E. to W., was ideal for North and South African, and even South American transmissions. With an input of 25 watts, the only aerial that permitted of South African contacts was this broadside radiator, and it was infinitely superior to two half-waves in phase.

All attempts at end feeding failed. Results were obtained, but the band spread was too great and losses were experienced in the feeders, so it was assumed that the correct point of match had not been found, but experiments are still being conducted with various types of feeder and matching sections to see if this arrangement can be perfected. Even so it must be realised that an end-fed radiator of this kind will not transmit such a symmetrical pattern as the balanced centre-fed radiator.

Standing waves along the feeder must be eliminated, and this can be done quite easily by tapping on a thermal amp-meter at various points along the line at equal distances between each point. Unequal currents indicate standing waves, and they should be eliminated by changing the tap point on the matching section, or by readjusting the quarter-wave section length.

Incidentally, this aerial was also tested on 59 mc. with great success, and radiated strong consistent signals with low inputs.

These notes are the results of practical experiments, and in many cases are at direct variance with accepted theories, but as in many other instances, theory does not always work out in practice when used under amateur conditions.

Construction :: Coil Data :: Operating

The switch in series with the H.T. supply can conveniently be linked to the original standby transmitter switch,

band and L₂ at 20 metres. In such circumstances, the coils will be approximately of the following dimensions:

ing on the recommended Eddystone coil former. The cathode section is wound in the same direction, consists of five turns of the same gauge wire, and the same spacing.

As a general rule, it can be assumed that the cathode tap is always made at one-third of the total number of turns, counting from the earthy end.

L₂, must, of course, tune to 20 metres, and this consists of eight turns centre tapped. The link coupling consists of a single loop of flexible wire around the centre of the coil, the free end being taken to the doubler grid circuit.

This arrangement would, of course, mean that the existing doubler in the transmitter would have to be neutralised for it is converted into a sub-amplifier. However, the neutralising can

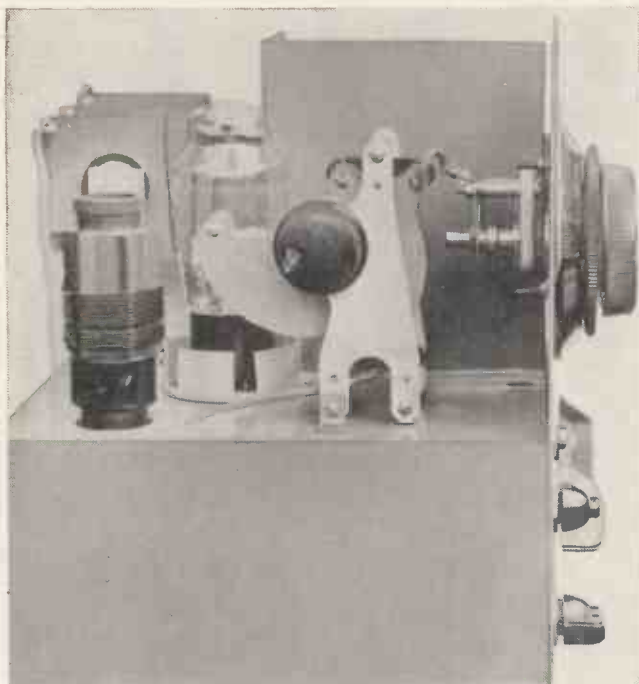

On the left is a view of the grid-cathode section, the preset condenser being mounted internally.

so that the transmitter can be cut off the air by means of a single make and break double switch. On the other hand it can be mounted on the front panel of the ECO unit, if this is more convenient.

Construction is quite straightforward, although it is essential that the anode circuit be carefully screened from the grid cathode circuit. The layout adopted enables the two circuits to be virtually isolated, although only one right-angle screen is needed. Refer to the plan illustration for the moment, where it will be seen that the valve, grid cathode coil, band-spread and band-set condensers are all in the left-hand half of the chassis. The high-frequency choke, anode coil and meter are in their own compartment and completely screened. Beneath the chassis is the anode tuning condenser, mains and standby switches, smoothing choke, smoothing condensers, and sundry resistances.

All the components in the grid cathode circuit have to be rigid, and carefully wired with the shortest possible lead, otherwise there is a possibility of unwanted frequency shifts, which would spoil transmissions. If possible, wire this section of the circuit with 14-gauge copper wire, particularly to the two condensers.

In no circumstances can L₂ be tuned to the same frequency as L₁, otherwise the M₄₃ valve will be ruined. If frequency control is required on 20 metres, then L₁ should resonate in the 40-metre

The grid section of L₁ will need 10 turns of 20-gauge enamel-covered wire, slightly spaced according to the thread-

be made to provide a certain amount of regeneration when the crystal is

(Continued on page 376)



Link coupling to the transmitter is used and a coupling made by a flexible wire in the manner shown.

Components for

AN AC-DC E.C.O. UNIT

CHASSIS, PANEL AND SCREEN.

- 1—zinc chassis 8 ins. by 8 ins. by 4 ins. (A.P.A.).
- 1—zinc panel, 8½ ins. by 10½ ins. (A.P.A.).
- 1—zinc screen 5½ ins. by 4½ ins. by 3 ins. (A.P.A.).

CHOKE, HIGH FREQUENCY.

- 1—Type 1022 (Eddystone).

CHOKE, LOW FREQUENCY.

- 1—50 m/a. 20 h. (Premier Supply Co.).

COIL FORMS.

- 2—4-pln type 936 (Eddystone).

CONDENSERS, FIXED.

- 1—.001-mfd. type tubular (Dubilier).
- 1—.002-mfd. type tubular (Dubilier).
- 2—4-mfd. type EC1 (Bulgin).

CONDENSERS, VARIABLE.

- 1—.0002-mfd. (Premier Supply Stores).
- 1—.00015-mfd. type VC15X (Raymart).
- 1—Two-gang type 2149 (Jackson Bros.).

HOLDERS, VALVE.

- 1—Chassis screened type V9 (Clix).
- 1—Chassis type V1 less terminals (Clix).
- 1—Type SW21 (Bulgin).

METER.

- 1—0-50-m/a. type F D.C. (Raymart).

VALVE.

- 1—Pentode type M43 (Ostar-Gantz).

RESISTANCES, FIXED.

- 1—10,000-ohm type 1-watt (Erie).
- 1—50,000-ohm type 1-watt (Erie).

RECTIFIER.

- 1—Metal type HT8 (Westinghouse).

5- and 10-metre Reception

A Unit for Experimental Work on the Five- and Ten-metre Amateur Bands.

By Austin Forsyth, G6FO

INCREASING interest in the higher frequency end of the radio spectrum—5- and 10-metre amateur bands in particular—is turning the attention of experimenters more and more in this direction, but in most cases difficulties arise when it comes to getting the standard short-waver to function at such frequencies.

Though it will usually be found that a receiver designed for operation over

For a 5- and 10-metre receiver, the extra apparatus required will usually be available from the average experimenter's spare-parts supply, while the cost and the components required can be minimised by using the L.F. stage of the existing short-wave (or any other) receiver as the audio amplifier.

Such a unit will necessarily consist of a two-valve arrangement, since an aperiodic H.F. stage is absolutely neces-

at an adjustment which provides the best loading of the detector grid circuit. The data for the R.F. chokes is given in the table of values. Note R.F.C.4 and R.F.C.5; these may or may not be necessary in different cases, but they help to reduce any possibility of interaction between V₁ and V₂, which can introduce curious effects at these frequencies. A further point to notice about the chokes is that the values of R.F.C.1 and R.F.C.3 are chosen to prevent any possibility of mutual resonance. De-coupling is also an essential factor in such a circuit and is provided for as shown in Fig. 1.

Correct Band Spreading

With regard to the grid circuit of the detector stage, some explanation is necessary. Though adequate spreading of the 5- and 10-metre bands is as important as it is on the others, if not more so, it is not advisable to have the usual band-spread and band-set condensers in a unit of this kind, since the two condensers required would in the first place introduce between them a lot of unnecessary metal in the grid circuit, while secondly the utility of band-setting is of doubtful value in view of the fact that if C₄ is correctly chosen, it will itself cover the 10-metre band in one 180-degree movement. It therefore follows that the 5-metre band will be covered by about half to two-thirds of the scale. This admittedly means

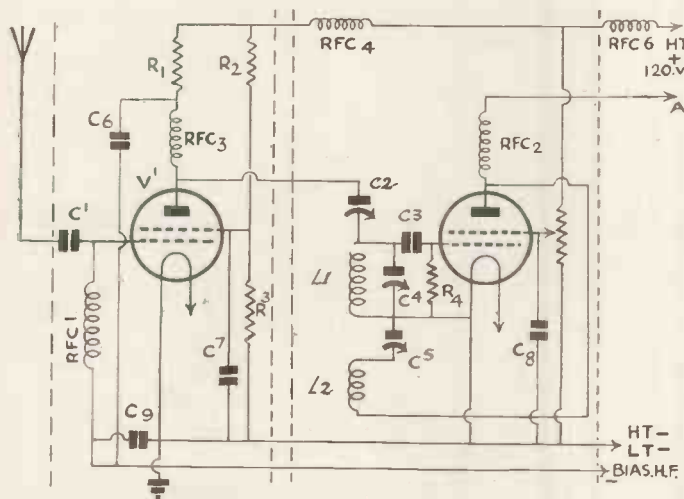

Fig. 1.—Suggested high-frequency and detecting unit for 5- and 10-metre bands.

the range 15-100 metres can be made to work in some sort of way on ten metres by using the appropriate coils in the detector grid circuit and keeping the H.F. stage (if any) aperiodic, very few such sets can be satisfactorily adapted for 5 metres. It is as well to consider a receiver designed specially for these bands—taken separately—if any serious work is contemplated on either the transmitting or receiving side. It is now well-known that while super-regeneration on 5 metres provides easy short-range reception of unstable signals with simple circuits, the future of 5-metre communication, coming to be recognised as quite possible over long distances, is bound up with stable transmitters and sensitive receivers capable of resolving weak signals. The next step after super-regenerative apparatus, therefore, is a straight receiver having good frequency stability, so that the experimental 5-metre crystal-controlled transmissions now being radiated by stations in different parts of the world can be received. However, for those interested in super-regenerative reception, it is worth mentioning that super-regeneration can be applied to the receiver to be described here by the simple addition of a quench unit.

sary for stable operation. Though there is scope for experiment by trying tuned input circuits, no apparent gain in signal strength at these frequencies can be expected with the H.F. stage untuned. Its function is simply to act as a buffer between aerial and detector grid circuit, which has the effect of improving stability and reaction control, taking out dead spots and minimising trouble due to aerial movement. For those who may not have operated straight sets at these higher frequencies, it should be mentioned that though an H.F. stage will completely nullify aerial swing at, say, 20 metres, it is not always so on 5 or even 10 metres, and it is advisable to keep the aerial and its supports as taut as possible.

Special Valves

A suitable circuit arrangement for setting up the H.F. and detector unit suggested is given in Fig. 1. This shows an aperiodic H.F. stage V₁, followed by a screen-grid detector V₂, using Hivac SG220.SW valves in both positions, the coupling between them being through the condenser C₂ which, though variable, is set for each band

Table of Component Values.	
R ₁	—10,000 ohms, 1-watt.
R ₂	—40,000 ohms, 1-watt.
R ₃	—50,000 ohms, 1-watt.
R ₄	—4 megohm grid leak.
R ₅	—50,000-ohm 2-watt potentiometer.
C ₁ , C ₃	—0.001 mfd.
C ₂	—0.0004 midget variable.
C ₄	—0.00025 midget variable.
C ₅	—0.001 mfd. midget variable.
C ₆ , C ₇ , C ₈ , C ₉	—0.01 mfd.
R.F.C.1, R.F.C.2	— $\frac{1}{2}$ in. diam. former wound with two sections of 15 and 30 turns respectively. Turns are slightly spaced, with $\frac{1}{4}$ in. between sections. Using No. 32 enamelled wire, length of former required will be $\frac{1}{2}$ in.
R.F.C.3, R.F.C.4, R.F.C.5	—One section of 50 turns, as above, slightly spaced.
L ₁ , L ₂	—for 10 m. 6 turns each No. 16 enamelled, $\frac{1}{4}$ in. diameter, turns spaced $\frac{1}{4}$ in. For 5 m. 3 turns each, as above.

sharp tuning on 5 metres, especially where weak signals are concerned, but by comparison it will be no sharper than when using a larger condenser to tune a weak signal on 20 metres.

A few words on the coils L₁ and L₂. On the higher frequencies below 10 metres, it often happens that even a rigid specification accurately followed will produce different results in individual cases. Therefore, while the coil

Getting the Best Results on Short-Waves

values given will in all probability come near enough to the 5- and 10-metre bands to permit them being found after slight adjustment, they cannot be guaranteed, particularly as some readers may introduce modifications which will have the effect of changing the inductance-capacity values in the detector grid circuit. Any adjustment of the inductance value which may be required can usually be effected by squeezing in or spreading out the coils a little.

Coil Building

The construction of the coils also calls for some comment. The two sets for the two bands must necessarily be made interchangeable, and the simplest way to do this is to mount them directly on C4 and C5, choosing for the purpose condensers which have terminal connections, such as the "J.B." series. It will be seen from the circuit diagram that L1 can be mounted on C4, while in the case of L2, one end goes to the fixed plates of C5 and the other can be taken to a small stand-off insulator suitably positioned near C5 to give the correct spacing—about $\frac{1}{4}$ in., which may require adjustment—between L1 and L2. The plate connection is, of course, taken from this insulator. The coils can be fixed in either the horizontal or vertical plane, whichever is most convenient for the connections of the condensers used.

Construction

The lay-out and assembly of the unit as a whole, are as important as the circuit itself; a suggested constructional form is given in Fig. 2. This shows a baseboard 6 ins. deep by 9 ins. wide, on which is laid a strip of aluminium the same size. The H.F. stage is built in the left-hand compartment, the screening walls being 6 ins. high. Notice that, as the elevation indicates, complete screening is not given, as in such an experimental lay-out it is not absolutely essential to start with, though after the unit has been got working properly, the ends of each compartment can be closed in and lids made for the tops. To equalise stray potentials and also to steady the screening walls, their top edges are connected together with stiff wire running parallel to the 9-in. edges, as shown. The joints must be well made, or they will be a source of noise.

The detector compartment, $5\frac{1}{2}$ ins. wide by 6 ins. deep, provides ample room for the mounting of all components in this part of the circuit. Condensers C4 and C5 are set back from the front of the baseboard on brackets, extension controls being used to minimise hand-capacity effects. The knob ends of the extension shafts are held

by an ebonite panel $5\frac{1}{2}$ ins. square. This size gives just enough room to mount an Eddystone 3-in. dial for C4 and a $1\frac{1}{2}$ -in. dial of the same make for C5, with $2\frac{1}{2}$ ins. between the condenser shafts, using Eddystone driving heads for slow-motion control. If control components of other makes are available, the panel dimensions may need altering to accommodate them.

The third variable, the potentiometer R5, can be mounted on a bracket at the back of the baseboard, as it will not require touching once set for the band on which the unit is being used. Similarly, the condenser C2 can be placed so that while it is accessible, its position is the best from the point of view of circuit efficiency. A stand-off insulator at the point where the lead from

tions being required to the latter; remove the lead from the plate side of the L.F. transformer primary and connect to A.

Operation

The operation of the 5- and 10-metre unit is exactly the same as that of any other S.W. receiver, but it requires more careful handling and the tuning will be rather sharper. First, with the 10 m. coils in, set the reaction control C5 about one-third in mesh and adjust R5 until oscillation is obtained. Then see if there is backlash on C5. If so, re-adjust R5 and also C2 till a point is found where the detector goes smoothly into oscillation. Then tune on C4 and C5 in the usual way.

The same procedure holds for 5 metres, but on this band it will probably be found that smooth oscillation is only obtained when C2 is set much nearer minimum than for 10 metres; R5 will also need re-setting.

A 2-watt 2-valve 7-metre Receiver

(Continued from page 366)

To prevent this an 8-mfd. condenser is connected directly across the main H.T. supply.

Construction is very simple. This chassis is made up from a piece of 16-gauge aluminium, $6\frac{3}{4}$ in. wide by 6 in. long, bent on two sides to provide a chassis $1\frac{1}{2}$ in. deep. The position of the detector valve holder is governed by the length of the grid condenser, for the control grid of the detector pentode must be as near to the grid coil as possible.

The position of the output pentode valve holder is also governed to a certain extent by the position of other components, for the anode and grid leads should be kept as short as possible. In the centre of the chassis has been mounted the 8-mfd. condenser, the metal case of which makes contact to the chassis. The length of the positive connection to this condenser is immaterial. Approximately 9 in. of wire will suffice to wire the entire receiver, for all resistances and condensers interconnect by their own wiring.

A four-way flexible cable is needed for L.T. and H.T., and this is terminated in a Bulgin 4-pin plug. No terminal strip is required, for the wires are soldered directly to the connection in the receiver.

The 200-volt supply, the total H.T. current, will be approximately 45 M/a.

Tuning range is approximately 6 to 8-metres, but it is not intended that the receiver be used for the reception of more than one station, for the controls are pre-set. It should also be remembered that a metal screw-driver cannot be used to adjust this type of pre-set condenser.

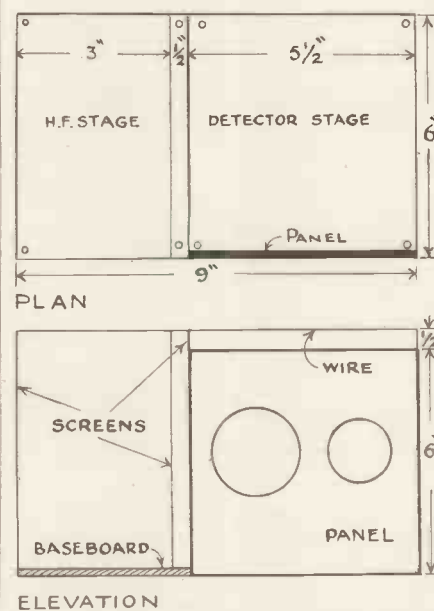

The top sketch is a plan view of a suggested chassis with an elevation view at the bottom.

the H.F. stage enters the detector compartment is the best place for it.

It should be remembered in arranging the various components that the valves specified have their grid connections to the top caps, which considerably facilitates lay-out. Though other screen-grid valves of the SG215 type can be used, and will give quite good results, the Hivac short-wave types offer distinct advantages at the frequencies for which this unit is intended. They give improved stability and easier reaction control, which are extremely important, and the sensitivity is also greater if the circuit is arranged to take full advantage of their design.

To get the unit working, it should be connected to the batteries of the existing receiver, only two slight modifica-

Heard on the Short Waves

By Kenneth Jowers

It seems that we are in for a very good ultra-short wave summer. The 20-metre band is becoming steadily worse, with the exception of rare spasms, while there has not been the influx to 10 metres generally expected.

During the past few weeks I have

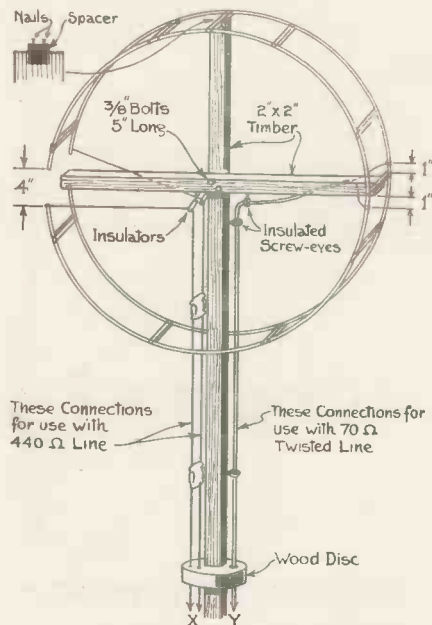

Fig. 1. The conventional Reinartz rotary beam aerial is built up on these lines and tests have shown the low-impedance cable to be an ideal feeder.

received considerably more than the usual number of letters dealing with 5-metre field days during the summer, and instead of these field days being the usual happy-go-lucky affairs with very simple apparatus, some of the groups are really erecting serious equipment.

The new converters of the vibrator type recently introduced by Bulgin seem to have taken a load off the mind of many designers, for they do provide a simple means of obtaining 250 volts at 50 or 60 M/a from a 6-volt accumulator. Two of these vibrators will be more than sufficient to drive the transmitter and modulator from one accumulator.

Aerials for portable use still seem to cause no little concern, designs varying from vertical di-poles plus a reflector to complicated phased beams of the Franklin type. One society have every hope of setting up some new records this summer and are using for an aerial the Reinartz rotary beam aerial which was introduced last year.

This beam aerial is certainly interesting and can be built to take up very little space. Its main virtue is not the fact that it is rotary, but that it is suitable for transmission and reception, will transmit a signal in a narrow arc and

can be fed with almost any impedance feeder.

The fundamental idea is illustrated in Fig. 1, and it can be seen just where the feeders are connected. Actually the illustration shows the connecting point for low-impedance cable of the new Belling-Lee type, or for the more conventional 440-ohm line.

Only 2 ins. by 2 ins. timber is used to make the frame, with some good heavy 14 gauge copper wire for the aerial. Ceramic spacers are not essential, but they do reduce losses and bars of the correct length are now obtainable.

The dimensions of the aerial for 5-metre operation are shown in Fig. 2, where the aerial has been drawn in ladder formation so as to give a true indication of the total length and diameter.

This aerial is, of course, suitable for 10 and 20 metres, but to my way of thinking it is a little bulky on the latter wavelength. However, a suggested aerial for 10 metres is shown in Fig. 3, and although I have not used it myself on this wavelength, I have some reliable reports as to its efficiency. I can, of course, vouch for its performance on 5 metres, where it has proved excellent for low-power work.

The diameter of the aerial on 10 metres is approximately 5 ft. 6 ins., rising to 11 ft. 2 ins. on 20 metres, the actual construction being shown in

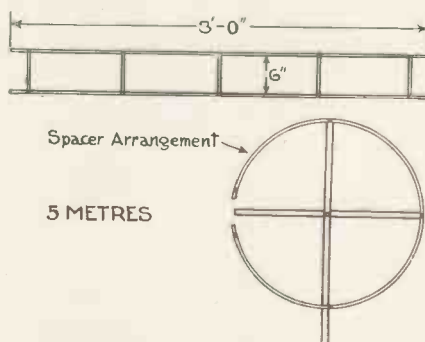

Fig. 2. Aerial length is most important. For 5 metres the middle of the band calls for an 8 ft. length with a 6 ins. space.

Fig. 3. For those, however, who feel they would like to try it on 20 metres, Fig. 4 shows the aerial length and construction.

VK2NO, in a recent letter, tells me that the Australians are very keen to improve on the performances put up by American amateurs on 5 metres. So far their maximum average distance covered is around 80 miles, which according to VK2NO is a fairly good performance. Apparently the local surroundings are not all that they might be. However, even if they have not as yet created any new world's records, they are progressing on the right lines with stabilised

transmitters of comparatively high power, plus super-het receivers. Incidentally some further information on this topic can be found on page 376 of this issue.

There have been several instances

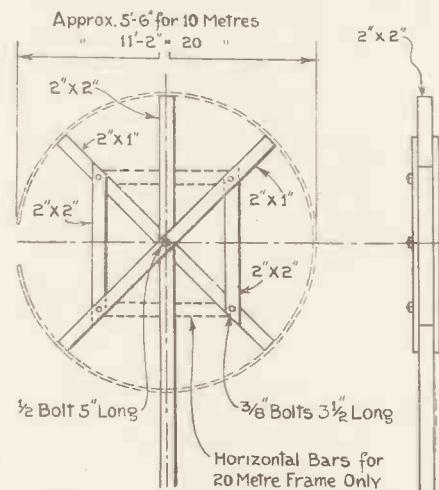

Fig. 3. The Reinartz aerial can also be used on lower frequencies and here are the dimensions for 10 and 20 metres.

where ardent experimenters have been able to log some amazingly good DX stations on 5 metres. I have been checking the report of American commercial stations heard in this country on the ultra-high frequencies, while many amateurs have logged stations, and in some cases even worked them two way from Morocco, Norway, Holland, Belgium and France. Actually, I believe that this list can be greatly increased.

There has not been the general use of 5 metres amongst British amateurs that I should have expected, for the G stations do like to have a band for local working. At one time 160 metres was used, so perhaps in the future the 5-metre band may take its place.

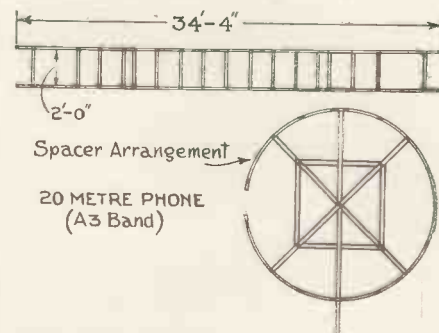

Fig. 4. A total length of 34 ft. 4 in. resonates in the centre of the 20-metre phone band, providing it is spaced as shown.

362 SPECIAL ANNOUNCEMENT

The 362 Radio Valve Co., Ltd., has been very gratified at the response of the British amateur at home and overseas to the tentative programme of Transmitting Valves introduced and tried out during the past year or so.

Unfortunately, it is impossible, unless unlimited finance is available, to do justice to the amateurs' needs, and at the same time conduct a progressive production of small Valves for ordinary commercial demands.

Consequently, we have had to choose between Commerce and what we are minded to call Progress, and have decided to "place all our eggs in one basket" by ceasing production of Broadcast Receiving Valves and Concentrating on a full-time programme of Transmitting Valves and other special Valves for the experimenter.

Although production will cease on Receiving Valves, we shall still have to clear our decks for action by dispensing our present stocks.

In future we must look to you, the amateur transmitters and experimenters, to make our rather daring change of policy a success, and therefore we are giving you an early opportunity to avail yourselves of the chance to purchase (while stocks last) 362 Receiving Valves at their clearance prices of two-thirds list price.

To give you the fullest benefit of the opportunity to obtain the pick of the types before the general public makes a rush, this announcement has so far been made only in those publications catering specially for the amateur and experimenter. It will become common knowledge early in June, so please make your reservations now, as the supply is, of course, limited.

If you have not already had one of our latest lists, we will send one by return of post. When a type has been cleared it will be withdrawn from our lists, but even so, we cannot, of course, guarantee delivery of other types, as stocks may be exhausted before your order is received.

NOW IT REALLY IS UP TO
YOU, AND YOU CAN RELY
ON US TO DO OUR SHARE.

The **362** Radio Valve Co., Ltd.
324/6 Liverpool Road, London, N.7.

TEL: NORTH 1853.



Why

use

Dubilier

Condensers?

Do you use them because you have found the new medium calls for components that are absolutely reliable? Do you use them because it necessitates condensers that can be trusted to do their own work without trouble—that will play their part in giving perfect reception? We hope you do.

But if you have not yet had the opportunity to use them for those reasons, we hope you will do so because they are specified by "Television" for all three of their receivers—a rather significant fact.

DUBILIER

DUBILIER CONDENSER CO. (1925) LTD.;
Ducon Works, Victoria Rd., North Acton, London, W.3



C. R. Casson 14

British & American Amateur Supplies

MORE NEW RELEASES BY
G2NO (H. R. ADAMS) and
WIJYN (TED McELROY) of
EVES RADIO LTD., Old Mill St., WOLVERHAMPTON

Authorised Distributors in England for
HALLICRAFTERS : TOBE : R.M.E.
TAYLOR : HARVEY : COLLINS

A few items from our list :—

HALLICRAFTERS SKY CHALLENGER :—9 tubes ; 1 stage
R.F. : 7.5 to 550 metres ; B.F.O. : Stnd. Bi. : 230 volt input.
Price complete, £23. Xtal Model, £25.

HARVEY U.H.X. 10 TRANSMITTER :—2.5 to 20 metres ;
'phone : CW : MCW : Separate power pack : Output down to 14 Mc.
approx. 25 watts. Price of TX only, £16/15/0. Price of TX
complete all bands, Tubes, Power Pack, etc., £36/0/0

HARVEY U.H.X.35 TRANSMITTER :—2.5 to 20 metres : RF
Line-Up : 42, RK25, 2/RK25's, RK37, Audio output 6L6's in Class B,
3 Separate Power Supplies, 6 Meters, Xtal Mike, Bliley Xtals. Price
of TX complete for one band, £82. Complete all bands, £110.

TUBES : Taylor T20, 18/6 ; T55, 45/- ; 886 Jnr., 7/6 ; 866, 11/6.

RAYTHEON (1st grade only) :—913 Cathode Ray, 37/6 ; 885
Trigger Tube, 16/6 ; 955 Acorns, now 26/6 ; 954 and 956, now 34/6 ;
6L6 and 6L6G in Raytheon only 7/6. All other Raytheons in stock.

New **CERAMIC TUBE SOCKETS**. All types. Octal, 1/3. Octals, 1/6
STEEL AND ALUMINIUM PANELS AND SUB BASES :—
Bases : 19" x 12" x 3", 17" x 12" x 2" or 3". All panels 19" long x
5", up to 16". All finished Black Japanned and Crackle.

1937 LITERATURE :—"ARRL" Handbook, 5/3. Maps, 4/6.
Jones Handbook, 7/- ; Antennae Handbook, 2/6 ; RCA Tube Data
Book, 1/3.

TOBE CABINETS for Amateur Seven Receiver 19/6

HALLICRAFTERS P.M. Speaker, 12" communication type... .. £3

UTC Modulation Transformers, VMI, 29/- ; VM2, 37/- ; VM3, 58/-

All Thordarson and UTC Transformers for 6L6 in stock.

FINEST AMATEUR STOCKS IN THE COUNTRY

SEND 4d. STAMPS FOR OUR LISTS

Phone your Orders to **G2NO** Personally :
Wolverhampton 20703

Office hours (for phone calls) : Mon., Tues., 9 a.m. to 7.30 p.m. ;
Wed., Fri., Sat., 9 a.m. to 8 p.m. ; Thursday, 9 a.m. to 1 p.m.

EVES RADIO LIMITED
OLD MILL STREET, WOLVERHAMPTON

Equip yourself with

Hund's
**PHENOMENA IN
HIGH-FREQUENCY
SYSTEMS**

642 pages, 9 x 6, 359 illustrations,
36/-

Henney's
**RADIO ENGINEERING
HANDBOOK**

850 pages, 7 x 4½, illustrated.
Flexible Binding. Second Edition.

30/-

Chaffee's
**THEORY
OF
THERMIONIC
VACUUM
TUBES**

652 pages, 9 x 6,
illustrated.

36/-

Terman's
**MEASURE-
MENTS
IN RADIO
ENGINEERING**

400 pages, 9 x 6, 208
illustrations,

24/-

Glasgow's
**PRINCIPLES OF RADIO
ENGINEERING**

511 pages, 9 x 6, illustrated,

24/-

These volumes may be obtained separately or
in **THE RADIO ENGINEERING LIBRARY**,
price £7 - 0 - 0 the set. Long credit terms
can be arranged where desired.

Mc GRAW-HILL PUBLISHING CO., LTD.

Aldwych House

London, W.C.2

A Mains-operated Short-wave Converter

Continued from May issue.

MAKE sure the filament inter-connecting wires are heavy gauge, otherwise there will be a possibility of voltage drop.

Obtaining high-tension supply is not

rect positions for the fixing holes, and in many cases the valve pins have shorted on to the edge of the chassis.

Readers will find a simple way of finding the correct positions for the

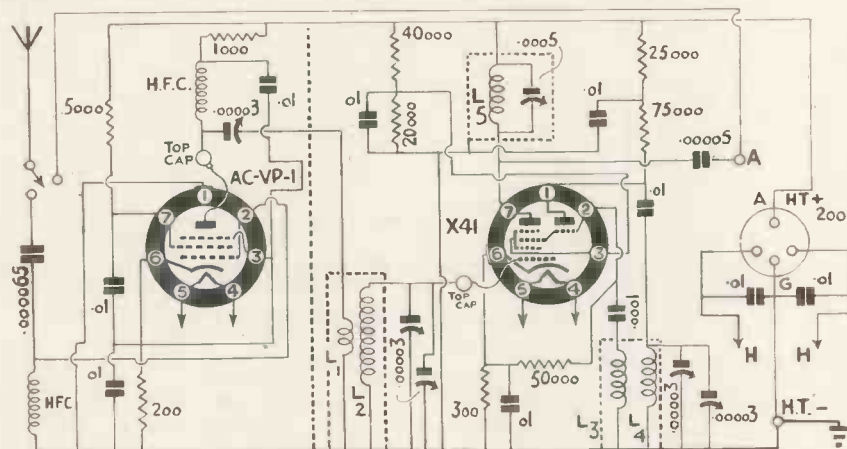

Full constructional details of this two-stage converter were given in the May issue. How to check the performance is given in the text.

quite so simple. The negative lead should be connected to the chassis of the main receiver, but a positive point will have to be discovered by reference to the circuit plan. As a general rule, however, an H.T. tap can be found on one side of the primary of the output transformer normally mounted on the loud-speaker chassis.

Check this voltage, however, for if it is higher than the recommended 200, a voltage dropping compensating resistance will have to be included in the H.T. feed.

Modulation hum, shown up as a background noise level at about 50 cycles, but only noticeable when a station is tuned in, may be noticeable unless the .01-mfd. buffer condensers are connected across the filament supply as shown. The value of these condensers is not critical, but .01-mfd. is a good average.

A zinc chassis specified is recommended owing to the fact that leads can be soldered directly to it, whereas with an aluminium chassis soldering tags have to be bolted down. Make a point of taking all earthy wires direct to one point for each circuit, unless, of course, it is essential that they be connected to cathode, as previously discussed.

One or two readers have commented on the difficulty in drilling large holes for valve holders, for they find that after they have accurately cut the large centre hole it is difficult to find the cor-

rect positions for the fixing holes, and in many cases the valve pins have shorted on to the edge of the chassis. When mounting the rotary switch in the aerial circuit, just check up that the rotor is actually insulated, for occasionally samples have been used with a live spindle, which would automatically short the aerial to earth.

Constructors will also notice that the new method of showing valve holders in circuit diagrams has been employed in this converter. When the valve holders are ready for wiring and the chassis is tipped upside down, the positions of the pins coincide with the valve holders drawn in this circuit. This overcomes the bother of checking up the correct pin connections.

Check the Current Flow

Finally, before the converter has actually been put into service, check the anode currents, for this will tell whether or not everything is fundamentally in order. With the 200-volt supply the anode current of the X41 is 1.2 M/a., with an oscillator anode current of 2 M/a. The total cathode current which includes anode and screen currents is approximately 5 M/a. In

the AC/VP1 circuit there is an average anode current of 5.5 M/a., and a screen current of 1.75 M/a.

It can be seen from this that the main receiver will have to be capable of supplying an overload of 16.45 M/a. at 200 volts and a filament voltage of 4 at 1.85 amperes.

A New Beam Power Output Valve

THE Mazda AC4/Pen, which has just been released is one of the first British beam power valves to make its appearance. Although its characteristics are similar to those of an output pentode, the name is not strictly applicable as it has no suppressor grid. The forerunner of the species, the R.C.A. 6L6 is described as a tetrode, and this is a more accurate term.

The suppression of secondary emission from the anode is effected by the space charge of the anode current, and the absence of the suppressor grid appreciably alters the shape of the characteristic in the region of low anode voltage. At high values of grid bias, and consequently low anode current, the kink in the $I_a - A_a$ curve tends to reappear owing to the fact that the anode current is insufficient to nullify the secondary emission. On the other hand, the knee of the curve is considerably improved and the kink is not noticed in practice if the anode current is maintained at a reasonably high value. When used in normal operation the mean anode voltage is of the same order as the screen voltage and the dynamic characteristic does not enter the "kink" region.

It is in the power output obtainable that the valve shows its superiority over the conventional output pentode, and $6\frac{1}{2}$ watts can be obtained with screen and anode voltages of 250. At this value of H.T. the input swing is 4.3 volts and the optimum load 3,400 ohms—a remarkable set of constants!

It is well known that the power output is mainly dependent on the load resistance and the makers state that this should be carefully chosen to keep the harmonic content below the accepted value of 5 per cent.

Correct Load Matching

As a guide to the value of load required, the effective impedance of the speech coil of the speaker can be taken to be equal to the D.C. resistance at 250 cycles. From the point of view of aural distortion the rise of the anode load at frequencies above 4,000 cycles is immaterial, as very few speakers will reproduce the harmonics of these frequencies. With an audio input having no attenuation up to 4,000 cycles the

(Continued on page 383)

Efficiency and Constancy of Output



WESTINGHOUSE

chosen again for the E.C.O. UNIT

An unvarying H.T. supply is necessary for constant and accurate calibration of an electron-coupled oscillator.

A Westinghouse Metal Rectifier never needs replacing..... its life is unlimited..... its output unvarying. That is why it is specified for the A.C./D.C. E.C.O. unit described in this issue. Use the coupon for full details.

WESTINGHOUSE BRAKE & SIGNAL CO., LTD.
82, York Road, King's Cross, London, N.I.

COUPON

Please send me a copy of "The All Metal Way, 1937," for which I enclose 3d. in stamps.

NAME.....

ADDRESS.....

Tel. June, 1937.

BOOKS ON TELEVISION AND WIRELESS

THE LOW VOLTAGE CATHODE RAY TUBE AND ITS APPLICATIONS

By G. PARR

CONTENTS: Construction and Operation. Focusing and Performance. Lissajous' Figures. Linear Time Bases. Other Time Bases. Applications to Radio Engineering. Industrial and other Applications. Television Reproduction. Photography. Appendix.
Demy 8vo., 187 pages, 76 Plates and figures. 10s. 6d. net.

TELEVISION RECEPTION

Construction and Operation of a Cathode Ray-Tube Receiver for the Reception of Ultra Short-Wave Television Broadcasting

By MANFRED von ARDENNE.

Translated by O. S. PUCKLE, A.M.I.E.E.,
Research Department A.C. Cossor, Ltd.

"Coming at the present time and from the pen of such a well-known authority as von Ardenne, this book supplies a real need, particularly as it has been adapted to English requirements to a very large extent."—*Television and Short Wave World*.

Demy 8vo., 140 pages, 96 illustrations, including 44 half-tone plates. 10s. 6d. net.

TELEVISION CYCLOPAEDIA

By ALFRED T. WITTS, A.M.I.E.E.

"As its title implies, this book contains definitions of terms commonly used in television practice and thus naturally includes expressions which originated in the fields of wireless and optics. The author wisely does not confine himself merely to definitions, and except in the simplest cases they are amplified by some description of the mode of operation of the circuit or apparatus."—*The Wireless World*.

Demy 8vo., 151 pages, 97 illustrations. 7s. 6d. net.

TELEVISION: THEORY AND PRACTICE

By J. H. REYNER, B.Sc. (Hons.), A.C.G.I., D.I.C., A.M.I.E.E.
M.Inst.R.E.

Second Edition, in active preparation. Demy 8vo. About 12s. 6d. net.

SHORT-WAVE WIRELESS COMMUNICATION

By A. W. LADNER, A.M.Inst.C.E.

Superintendent of Instruction, Marconi's Wireless Telegraph Co., Ltd., and
C. R. STONER, B.Sc. (Eng.), A.M.I.E.E.

Lecturer at Queen Mary College, London.

"This book is the best yet published on short-wave working, and should have a wide welcome from all interested in the technical aspects of wireless communication."—*The Electrical Review*.

Third edition, revised and enlarged. Demy 8vo., 469 pages, 11 plates and 248 figures. 21s. net.

TESTING RADIO SETS

By J. H. REYNER, B.Sc. (Hons.), A.M.I.E.E., M.Inst.R.E.

"This enlarged edition of a very useful book will be welcomed by those engaged in constructing new sets and those engaged in servicing sets already in use."—*The Electrical Review*.

Third edition. Demy 8vo., 250 pages, 115 figures, including 12 plates. 10s. 6d. net.

RADIO INTERFERENCE AND ITS SUPPRESSION

By J. H. REYNER, B.Sc. (Hons.), A.M.I.E.E., M.Inst.R.E.

"The full instructions contained in the first five chapters for analysing and suppressing interference at the listener's premises will be of considerable assistance to those whose work brings them into contact with this aspect of the problem."—*The Wireless Engineer*.

Demy 8vo., 138 pages, 10 plates and 55 figures. 9s. 6d. net.

CATHODE RAY OSCILLOGRAPHY

By J. T. MacGREGOR-MORRIS, M.I.E.E.,

University Professor of Electrical Engineering, Queen Mary College, London,
and J. A. HENLEY, M.Sc. (Eng.)

Demy 8vo., 262 pages, 151 figures, including 18 plates. 21s. net.

PHOTOCELLS AND THEIR APPLICATION

By V. K. ZWORYKIN, E.E., Ph.D., and
E. D. WILSON, Ph.D.

Second edition, completely revised. Second printing, with the chapter on the Photocell in Television revised and expanded. Crown 8vo., 363 pages, 188 figures. 15s. net.

A List of Standard Books on Wireless and Television may be had post free on application.

CHAPMAN & HALL, LTD.,
11 Henrietta Street, London, W.C.2.

AN INEXPENSIVE TELEVISION AERIAL



BULGIN DOUBLET AERIAL

WHY PAY POUNDS FOR 7-METRE AERIALS? THIS OUTFIT PROVIDES AMPLE SIGNALS WITHIN 25 MILES OF ALEXANDRA PALACE.

Actual experience with this di-pole aerial shows it to be an efficient receptor at ultra-high-frequencies. Top ends should be $\frac{1}{2}$ wave each; feeder more than $\frac{1}{2}$ wave-length. No more than usual care in erection is needed. It has been tested on television. **List No. L10 11/9**

FOR SHORT-WAVES & ALL WAVES

This Kit has been specially designed for short-wave work. It includes all insulators (note the efficient junction block), 12 feeder transposition blocks, 120 ft. of wire, etc. . . .

We specialise in experimenters' components. There is a wide range in our catalogue.

---SEND THIS COUPON NOW---

To Messrs. A. F. Bulgin & Co., Ltd.,
Abbey Road, Barking, Essex.

Please send me Catalogue No. 156 "M," for which I enclose 3d. stamps.

NAME

ADDRESS

(Block Letters Please).....

(M)

BIRMINGHAM RADIMART Short-wave Specialists (G5NI)

OFFERS THE LARGEST STOCK OF HAM GEAR IN THE COUNTRY

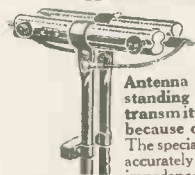

THE JONHSON Type "Q"

Antenna System has achieved outstanding success in high-frequency transmitters throughout the world because of its high efficiency.

The special quarter-wave tubing transformer accurately matches line and antenna impedances, and power is transferred with practically no losses even with very long lines. Due to these factors, the type "Q" will radiate TWICE as much power as the common non-matched antenna-feeder system. The "Q" may be installed on long-wire harmonic radiators as well as on the suggested half-wave doublet.

TYPE 10 Q for 10-metre operation 26/6.
TYPE 20 Q for 20-metre operation 39/6.

Deliveries from stock

RAYMART

Specified for the AC/DC. E.C.O. UNIT
TYPE VC15X Micro-Variable Condenser
15 mmfd. 1/4

TYPE F. D.C. Meter. 0/50 M/a 5/9
RAYMART

SHORTWAVE MANUAL AND CATALOGUE, 48 pages in all, 32 on receivers, transmitters, aerials, circuits, etc., etc., and 16 on a splendid range of shortwave components, 6d., or post free, 7d.

16 Page Shortwave Catalogue only 1½d.

RADIMART (G5NI)

44, Holloway Head, Birmingham, 1. Tel.: MID. 3254

A New 5-channel Receiver

IN the past the average all-wave receiver has been merely a broadcast instrument with a restricted short-wave channel of not always good efficiency. Less than two years ago a 4-channel receiver was introduced that really did enable listeners to receive short-wave programmes at entertainment value. Also instead of being capable of tuning in just a few of the stations, the wavelengths covered was from 12 to 80 metres, which at that time was ample for most purposes.

Recent developments in the short-wave world have shown that the ultra-high wavelengths of 10 metres and below offer considerable scope, so that a modern all-wave receiver should be capable of tuning between approximately 6 and 2,000 metres.

In the latter part of last year British amateurs showed that signals could be transmitted and received from all parts

Those who cannot afford a television receiver, but do not wish to miss some of the interesting programmes transmitted will find that half-way house is a 5-channel receiver. Admittedly quite a number of programmes are uninteresting unless accompanied by vision, but to counterbalance this, there have been, and are to be, some excellent programmes full of entertainment without vision.

At the moment we are using the new Pye 5-channel receiver, type QAC5, which is one of the most comprehensive and versatile receivers made by a British manufacturer. It consists of six valves and is for A.C. operation, and has no less than three short-wave bands in addition to the normal medium and long waves. The first short-wave band covers 24 to 66.7 metres, or 12.5 to 4.5 megacycles; band 2 from 11 to 28.6 metres, that is 27.5 to 10.5 megacycles; and the third band from 5.8 to 12.5 metres, equal to 51.5 to 24 megacycles.

Even with a long aerial theoretically unsuited for the reception of ultra short-wave signals, the television sound programme can be received at excellent loud-speaker volume with superb quality at a distance of 36 miles. We do not suggest that this is the limit of the 7-metre signals, but it does go to show that even under adverse conditions the third short-wave channel is most efficient.

Another feature which we appreciate is the fact that the tuning indicator operates most reliably on short-wave signals, which is a welcome change from the conventional neon-gas tuner only suitable for use with strong local broadcast stations.

Signal strength on the more popular American stations is colossal, varying from 2 to 2½ watts on the average. The new Perth station, VK6ME, was heard carrying out tests for a period of over half an hour, and although the signals were varying in strength when received, the automatic volume control operated so well that the output from the loud-speaker remained sensibly constant.

A four-point tone control is embodied which is most useful in eliminating heterodyne whistles and reducing background noise level when conditions are bad. An additional loudspeaker can be used either simultaneously or independently of the internal speaker, while amateurs will appreciate the fact that headphones can be plugged in in place of the loudspeaker, if required.

This receiver is ideal for amateur use as the selectivity is of an unusually high order. Listeners to programmes will also find it a comprehensive receiver and excellent value for money at 18 guineas.

Full information can be obtained from the manufacturers, Messrs. Pye Radio, Ltd., Radio Works, Cambridge.



Although this Pye 5-Channel receiver is unusual in design it is conventional in appearance.

of the world on 10 metres, a band which previously had been disregarded as far as commercial stations were concerned.

At the present time in America there are no less than six commercial broadcasters transmitting programmes on or about a wavelength of 9 metres, which is below the coverage of the average all-waver.

Any reader having an all-wave receiver with restricted short-wave channels is missing a very great deal, not only from these 9-metre stations, but from the other interesting transmissions that can be picked up below 10 metres. For example, we have heard quite a number of American Police Stations between 8 and 10 metres. Amateurs from all over the world are just above 10 metres, while the sound channel from Alexandra Palace can be received with a conventional aerial at quite a considerable distance from the transmitting station.



Just one year ago

Hivac produced three special short-wave valves which were designed to meet the definite needs of short-wave enthusiasts.

These valves have been greatly appreciated and extensively used by leading designers and many well-known experimenters in short-wave work.

The valves are of most rigid construction, therefore their excellence of performance is consistently maintained.

HIVAC VALVES ARE SPECIFIED FOR THE THREE VALVE RECEIVER DESCRIBED IN THIS ISSUE

- ★ SG220 SW - - 12/6
- ★ D210 SW - - 5/6

From all dealers or direct.



Note the Top Grid connection and Frequentite base as employed in the special range of Hivac valves for Short-wave work.

High Vacuum Valve Co. Ltd., 111-117 Farringdon Road, E.C.1

★ Incorporates the Best

in DIAL DESIGN for MODERN Short Wave TUNING!



No. 1070
8/9

The movement can be mounted from panel or baseboard.

The dial is noiseless in operation even on the highest frequencies.

The open vision scale is clearly readable and divided into 100 graduations. Half division marking ensures accurate settings of the indicator pointer.

The readings are arranged to increase as the frequency increases, which is in keeping with modern practice.

The movement is superbly smooth in action, without backlash on both the 20-1 and the 100-1 speeds.

The dial face fits on the front of the panel so that no large panel gap has to be cut unless it is desired to illuminate the scale from the back.

The dial can be used on panels up to 1/2" thick and takes the standard 1/2" spindle.

The escutcheon has a simple dignified appearance and is beautifully finished in oxidised silver relief.

EDDYSTONE FULL VISION DUAL SPEED DIAL

Sole Manufacturers: STRATTON & CO., LTD., Eddystone Works, Birmingham
London Service Depot: Webb's Radio, 14, Soho Street, Oxford Street, W.1

Selected and Specified for

A SELF-CONTAINED THREE-VALVE RECEIVER



Three Resistances—one price: 120, 2,000 and 4,000 ohms.

15/-

At all good radio dealers. If you have any difficulty in procuring, write direct to:

ERICSSON TELEPHONES, LTD., 67-73, Kingsway, London, W.C.2, Eng.

Telephones: 3271/3 HOLborn

SUPER SENSITIVE TELEPHONES

No wonder the designer of the self-contained Three-Valve Receiver featured in this issue chose Ericsson Telephones as indispensable. They are simply perfect for the 100 per cent. functioning of this set.

Wonderfully sensitive, comfortable in wear and very pure in tone, they have come to be regarded as standard for the keen short-wave enthusiast's equipment.

Use them with your self-contained Three-Valve Receiver.

A Cathode-ray Tuning Indicator

Constructors will find that the cathode-ray tuner described is ideal for use in short-wave receivers. It has many other uses and can be used for measurement of modulation percentage if a calibrated scale is drawn to suit the particular instrument in which the tuner is being used.

CONSTRUCTORS who wish to embody in their receiver a sensitive tuning indicator such as is seen on most American all-wavers, should give serious consideration to the new Mazda valve type AC/ME, which is virtually a miniature cathode-ray tube.

In the past most visual tuning indicators, while being satisfactory on strong stations, have not proved efficient on short waves, owing to the comparatively small field strengths.

The AC/ME tuning indicator consists basically of a hot cathode acting as a source of electrons which are attracted to a positively charged target coated with a fluorescent substance. Electrons impinging on the coated target cause it to glow and the extent of the fluorescent area is controlled by means of a cathode-ray electrode placed between the cathode and the target.

When the potential of the ray control electrode is increased from a low positive potential to a high positive potential, the area of shadow produced on the target is reduced.



The AC/ME cathode-ray tuning indicator is fitted with a 7-pin base and designed for horizontal mounting.

The ray control electrode is connected internally to the anode of the triode, and in use a high resistance is placed in the triode-anode circuit so that it operates as a resistance-coupled D.C. amplifier.

Owing to its high sensitivity it is one of the most reliable tuning indicators available, with perhaps as the one exception, the low reading micro-amp. meter. Signals with a field strength of R5 or more make a very big difference to the amount of shadow, which means that most readable signals can be tuned in by means of this indicator. This is a great advantage over the neon gas type of tuner, which was only suitable for measurement of strong signals.

The AC/ME tuner is similar in appearance to the conventional valve, being fitted with a 7-pin base and arranged so that it is mounted horizontally in the receiver.

The control grid of the AC/ME should always be controlled from the detector-diode circuit and not from the A.V.C. diode circuit, so as to enable visual tuning to be obtained below the delay point.

D.C. voltages applied to the grid will have to be applied via a tapped resistance so that the correct voltage can be obtained experimentally.

The heater of the AC/ME is designed to operate from a 4-volt A.C. supply and the transformer should be designed to supply this voltage under full load.

"A SELF-CONTAINED THREE VALVE RECEIVER"

DESCRIBED IN
THIS ISSUE—

Also—metal work for "A 2-watt Twin Pentode Receiver for 7 metres" and "An A.C., D.C., E.C.O. Unit."

Useful list of stock metal parts and aids to construction free on request.

CABINET
PANEL
SCREEN
CHASSIS

by

for
**ANYTHING
IN
METAL**

Write or
'Phone :



METALWORKS
171c, Battersea Park Road,
London . . . S.W.8

MACAULAY 4840

TELEVISION

We stock the Baird Televisor at 55 guineas, and the Corsor at 70 guineas, and offer Easiest of Easy Terms, and part exchanges for modern radio equipment.

AMATEUR COMMUNICATIONS

We specialise in all requirements of the Radio Amateur, including modern communication receivers, such as National, Hallicrafters, Hammarlund, etc., and a comprehensive range of components, valves, microphones, etc., including the complete Eddystone range. We offer a completely constructed range of Transmitters from £10-10-0, with a guaranteed performance, or can build any equipment to special order, or supply any desired kits, at competitive prices. Why not let us quote you without obligation?

A.C.S. Ltd. G2NK,

52/4, Widmore Road, Bromley, Kent. Technical Manager.
Phone: Ravensbourne 0156/7.

AMBITIOUS MEN

To ensure promotion take advantage of The T.I.G.B.'s authoritative home-study courses in **Television, Sound Recording, Radio Engineering & Servicing, Wireless Communications, etc.** Write TO-DAY for "The Engineer's Guide to Success"—Free—which gives full particulars—contains the world's widest choice of engineering courses covering all branches—and alone gives the Regulations for Qualifications such as **A.M.I.E.E., A.M.I.R.E., A.M.I.T.E., A.M.I.W.T., C. & G.,** etc. Training until successful Guaranteed.

The Technological Institute of Great Britain,
160, Temple Bar House, London.
E.C.4.

(Founded 1917. 20,000 Successes.)

Free!



SHORT-WAVE BROADCAST STATIONS

9-30 metres.

Wave-length	Frequency	Call sign	Location
9.494	31.600	W2XDU	New York
9.494	31.600	W4XCA	Memphis
9.494	31.600	W8XAI	Rochester
9.494	31.600	W8XWJ	Detroit
9.494	31.600	W9XPD	St. Louis
11.56	25.950	W6XKG	Los Angeles
13.93	21.540	W8XK	Pittsburgh
13.94	21.520	W2XE	New York
16.87	17.785	JZL	Tokio
16.87	17.780	W3XAL	Bound Brook
16.88	17.775	PHI	Huizen
16.89	17.760	W2XE	New York
16.9	17.755	ZBW5	Hongkong
19.43	15.440	XEBM	Mexico
19.52	15.370	HAS3	Budapest
19.56	15.330	W2XAD	Schenectady
19.62	15.290	LRU	Buenos Aires
19.65	15.270	W2XE	New York
19.67	15.250	W1XAL	Boston
19.32	15.230	HS8PJ	Bangkok
19.72	15.210	W8XK	Pittsburgh
19.75	15.190	ZBW4	Hongkong
19.76	15.180	RW96	Moscow
19.79	15.160	JZK	Tokio
19.80	15.150	YDC	Bandoeng
19.88	15.090	RKI	Moscow
20.04	14.970	LZA	Sofia
20.55	14.600	JVH	Nazaki
23.39	12.825	CNR	Morocco
24.39	12.300		Santiago
24.52	12.235	TFJ	Reykjavik
25	12.000	RNE	Moscow
25.21	11.900	XEWI	Mexico City
25.26	11.870	W8XK	Pittsburgh
25.29	11.860	YDB	Soerabaja
25.36	11.830	W9XAA	Chicago
25.36	11.830	W2XE	New York
25.42	11.800	JZJ	Tokio
25.43	11.795	HP5I	Aguadulce
25.43	11.795	OAX5B	Ica
25.45	11.790	W1XAL	Boston
25.49	11.770	DJD	Berlin
25.57	11.730		Saigon
25.6	11.720	CJRX	Winnipeg
25.86	11.600	COCX	Havana
26.09	11.500	PMK	Bandoeng
26	11.280	HIN	Ciudad Trujillo, D.R.
27.27	11.000	PLP	Bandoeng
27.93	10.740	JVM	Nazaki
28.14	10.660	JVN	Nazaki
29.24	10.260	PMN	Bandoeng
29.81	10.065	JZB-TDB	Shinkyō

Bideford and District Short-wave Society.

This Society, with a live membership of about thirty, has been making excellent progress. Premises have been obtained for a permanent club-room and apparatus is being installed for power supply, reception and receiver testing.

Two more "A.A." call-signs have been issued to members, and ultimately it is hoped to obtain a transmitting licence for the Society.

The Secretary, Mr. E. K. Jensen, 5 Furzebeam Terrace, Bideford, will be pleased to hear from prospective members and to give them all information.

GALPINS ELECTRICAL STORES

75, LEE HIGH ROAD, LEWISHAM, LONDON, S.E.13

TELE. : LEE GREEN 5240 TERMS CASH WITH ORDER OR C.O.D. ALL GOODS SENT ON 3-DAYS APPROVAL AGAINST CASH

SPARK COILS, 2 inch, complete with Condenser and all fittings, 17/6. Carriage forward. 8 inch, complete on stand with Condenser, 50/-, c/f.
 X-RAY TUBES with Tungsten Targets, 15/-; with Platinum Targets, 20/- each. Packing free. C/F.
 DYNAMOS, all fully guaranteed for lighting or charging. 12 volt 8 amp., 15/-; 12 v. 12 a., 17/6; 20 v. 5 a., 25/-; 20 v. 8 a., 32/6; 35 v. 6 a., 27/6; 25 v. 25/35 a., four pole, compound wound, slow speed, as new, 90/-; 100 v. 10 a., 70/-; 50/75 v. 6 a., 70/-. Carriage forward.
 CHARGING RESISTANCES or Shunt Regulators. Stud. switcharm type, 12/6 each, to suit your requirements. C.A.V. AUTOMATIC CHARGING CUT-OUTS, suit any voltage, 7/6 each.
 MOVING COIL and MOVING IRON Switchboard Meters. By well-known makers. Various readings, volts and amos., 12/6 and 15/- each.
 MOTOR BLOWERS, 1/2 h.p. D.C. Blowers, 4in. inlet and outlet, 110 v. D.C., 35/-; 220 v. D.C., 45/-.
 BULKHEAD ELECTRIC FANS, 12in. Blade, nickel plated, 100 volt only, laminated piec piece, condition as new, 10/- each.
 "NEWHOUSE" VACUUM DESICCATORS, Complete in case with gauge 40/-.
 LARGE MAINS TRANSFORMERS, windings not known, 1/2 kilowatt, 15/-; 1 kW., 25/-; 2 kW., 35/-, C/F.
 MOVING COIL METER MOVEMENTS for recalibrating into multirange, all-test Meter, 2in. dial, by well-known makers, 5/- each.
 EX-C.P.O. MAGNETIC RELAYS, working current approx. 2 mA., 7/6 each; post 6d. "Sullivan" Moving Coil Relay, in perfect working order, new condition, 45/-.
 ELECTRIC LIGHT CHECK METER, kilowatt hour, type, 200/250 volts, 50 cycles, single phase, for subletting garages, etc., in new condition, 6/-; post 1/-. Shilling Slot type, by Met.-Vic., 17/6. C/F.
 SULLIVAN TRANSMITTING VARIABLE Condensers, .0005 mf., glass case type, 12/6 each.
 EX-R.A.F. MORSE KEYS, fully adjustable, price 2/6. Post 6d.
 WESTERN ELECTRIC MICROPHONES, solid back type, very sensitive, 2/6 each.
 MICROPHONE TRANSFORMERS, high ratio, finest quality, 2/6 each.
 COSSOR EX-R.A.F. 2-VOLT GENERAL PURPOSE VALVES, as new, 3 for 2/6. Western Electric 2 m.f. Condensers, 9d. each. T.C.C. 2 m.f. Condensers, 1/-.
 Microphone Buttons, 9d. 20-30 H. Mains Chokes, 40-60 and 80 mA., 1/-, 1/6, 2/6 each. 1,000-ohm Earphones, 1/3 each; 2/- per pair. 1,000-ohm Bobbins, 6d. per pair. Small Horseshoe Magnets, 3d. each. .0003 and .001 Variable Condensers, 1/- each. Ex-R.A.F. Remote Control Panels, useful for components, 1/- each. Ex-R.A.F. Cutouts, 20 v. 3 a., with voltage regulator, 1/9 each. Belling 1 kW. Elements, 2/6.
 B.T.H. VARIABLE RESISTANCES, 250 ohms, 1 to 3 amos., 15/-, C/F.
 PERMANENT MAGNET MOVING COIL SPEAKERS by well-known makers, fitted volume tone control, magnificent reproduction, ideal for extension, speaker, 8/6 each. Post free. Complete in walnut cabinet, 14/-. Post free. A few only with slightly damaged cones, 4/- each.
 MORSE KEY and BUZZER SETS, complete, mounted on mahogany base, complete with sharp note buzzer, solid brass construction, high-grade long wearing contacts, 5/- each. Post free.
 ZENITH VITREOUS RESISTANCES, 3,000 ohms, 200 mA., 2/-; 2,000 ohms, 100 mA., 1/-; 1,000 ohms, 200 mA., 1/3; 120 ohms, 1/2 amp., 1/-. Post 3d.
 WHEATSTONE BRIDGE, 10,000 ohms; in first class condition, 75/-.
 WESTINGHOUSE H.T. RECTIFIERS, output 500 volts 250 mA., as new, 25/- each.
 AMERICAN, 10-Watt PUBLIC ADDRESS Amplifier, using 2 x 45's in push-pull for 100 to 250 volts A.C., in new condition, to clear, £5. C/F.
 EX-R.A.F. 2-Valve-Amplifier, battery working, less valves, 6/- each.
 4 ONLY. Five-Valve Transportable Receiver, complete with valves, by well-known makers, 17/6 each.
 ROTARY CONVERTORS, 1,500 Watts, 110 v. D.C. input, 110 v. A.C., 50 cycle single-phase output, 90/-.
 MARK III Star crystal set, carborundum and perikon detector, 300 to 2,000 metres. Buzzer tuned, as new, 45/-.
 EX-C.P.O. TELEPHONE BELL BOXES, complete with twin gong bell, transformer condensers, etc., 3/6 Post 6d.

"A New Beam Power Output Valve"

(Continued from page 378)

available output depends on the amount by which the anode load is allowed to rise between the limits 250 and 4,000 cycles. If this rise is 50 per cent., the permissible power output for a 5 per cent. limit of distortion will be reduced to approximately 75 per cent. of its original value.

The conventional resistance-condenser filter can be used in the transformer primary, but the values cannot be given with certainty as so much depends on the characteristics of both the speaker and the attenuation of the input circuit.

Working Data

The following are the operating figures of the AC.4/Pen.:

Heater volts, 4.0.
Heater current, 1.75 a.
Max. dissipation, 16 w.
Mutual cdctce., 11 x.
x at V_a 100, V_s 100, V_g 0.
Anode volts 225 250
Screen volts 225 250
Grid bias 7.0 7.8
Anode current 50 64
Screen current 11 13
Anode load 3,400 3,400
Input swing (r.m.s.) 4.0 4.3
Bias resistance 105 100

A similar valve for A.C./D.C. receivers, type Pen.DD.4021 is also available, the heater volts being 40 and the current 0.2 A standard 7-pin base is fitted, but the anode is connected to the top cap.

As the audio output is between six and eight watts, with 250 volts on both anode and screen, it enables transmitting amateurs to construct a low-voltage amplifier that will give more than sufficient output fully to modulate a 10-watt transmitter.

The price is being fixed provisionally at twenty shillings.

Short-wave Kits and Components

An interesting booklet has been compiled by Messrs. New Times Sales Co., of 56 Ludgate Hill, London, E.C.4, in which details are given of short-wave receivers and some new components for constructors.

Amongst the receivers described are a three-in-one short-wave kit which can be either an adaptor, converter or a one-valve receiver. It tunes from 12 to 94 metres and costs 25s.

A 2-valve band-spread receiver kit with the same waveband coverage is priced at 32s. 6d., and a straight three with two low-frequency stages at 37s. 6d.

The largest receiver in the series is a 4-valver with one high-frequency stage, costing 42s., while for long distance listening a 4-valver for mains operation is priced at 75s.

"The Glow-gap Divider"

(Continued from page 332)

mence to take load, the tube will be starved of current by an amount equal to that taken by the external circuit until ultimately the whole of the current flows in the external load and the tube is completely robbed. At this point the tube goes out and the self regulating properties disappear.

Any further increase in current will be accompanied by a rapid voltage drop due to the presence of the series resistance R, and the voltage on the tapings will disappear since the tube is no longer functioning. Therefore, it is necessary to limit the current to that taken by the tube under no-load conditions, and this limit is specified for the various classes of tube.

The characteristics of an STV280/80 divider are shown at Fig. 3. This unit has three subsidiary tapping points giving voltages of 70, 140, 210 and 280 from the negative end. The remarkable constancy of the voltage on each tapping will clearly be seen. Actually, a variety of types are made, ranging from the STV75/15, which gives a steady voltage of 70 volts with a maximum current of 15 milliamps. to the STV850/160 which, as the name im-

plies, will handle a supply of 850 volts with 160 milliamps. on the maximum tap. It has six subsidiary tapings of 145 volts each.

Fig. 4 shows the use of the device in a simple circuit, the most convenient being to use the bottom tapping of all for supplying grid bias, which it does very conveniently. Two Stabilovolt units in series may be used if very fine regulation is required, or alternatively, instead of the series resistance, a ballast resistance may be used which tends to keep the total current constant and this in turn assists the stabilising action since the additional load current can then only come from the Stabilovolt tube.

The use of a barretter in this manner is useful in looking after variations of supply voltage rather than variations caused by changing load. A point of considerable interest is that since the tube acts as a very large

condenser it automatically supplies a measure of decoupling, and in practice it will be found that an ordinary mains unit followed by one of these Stabilovolt tubes gives as satisfactory a result as an H.T. accumulator. A circuit which would be quite unstable due to back coupling (motor boating) on an ordinary mains unit or even on an H.T. battery will usually be found to be quite stable on a Stabilovolt-controlled supply.

There are a number of other interesting applications and readers who are interested should apply to the Marconi Co. for further particulars. One such circuit is shown in Fig. 5 where the unit is used to perform a double function. The middle two sections are employed to stabilise an H.T. supply at 140 volts. This supply is then used to provide a relaxation oscillation of the customary type by charging a condenser through a series resistance. Across the condenser is connected a discharge tube which, in this instance, is formed by the end section of the Stabilovolt. A similar oscillation could be generated if desired using the other end section thus providing a double time base which would be substantially independent of mains fluctuations.

OUR POLICY
The Development
of
TELEVISION



THE SECOND ARTICLE in this informative series appears in the May issue of the **T. & R. Bulletin**. Frequency Meters, Methods of Calibrating receivers, monitoring devices, are among the many subjects dealt with in this issue.

In addition authoritative contributions dealing with 28 and 56 Mc experiments, appear from D. W. Heightman, G6DH; P. Pennell, G2PL and J. N. Walker, G5JU.

The May issue of the
T. & R. BULLETIN

contains numerous illustrations in its 64 pages of Technical and General Information written by Amateurs for Amateurs.

ALL MEMBERS RECEIVE THE T. & R. BULLETIN POST FREE EACH MONTH. JOIN THE R.S.G.B.

Annual Fees: London 21/-, Provincial 15/-, Overseas 12/6

Write to-day for a copy of the current issue 1/- (post free). Full membership details will be enclosed.

The Secretary:

RADIO SOCIETY OF GREAT BRITAIN
53, VICTORIA STREET, LONDON, S.W.1.

Make Amateur Radio Your Hobby

THE TELEVISION SOCIETY

President: Sir AMBROSE FLEMING, M.A., D.Sc., F.R.S.

Founded in 1927 for the furtherance of Study and Research in Television and allied Photo-electric Problems.

Ordinary Fellows are elected on a Certificate of Recommendation signed by Two Ordinary Fellows, the Proposer certifying his personal knowledge of the Candidate. The Admission Fee for Fellows is half-a-guinea, payable at the time of election, the Annual Subscription is £1, payable on election, and subsequently in advance on January 1st in each year, but the Annual Subscription may be compounded at any time by the payment of Ten Guineas.

Any person over 21, interested in Television, may be eligible for the Associate Membership without technical qualifications, but must give some evidence of interest in the subject as shall satisfy the Committee. For Associate Members the Entrance Fee is 5/-, payable at the time of election, with Annual Subscription 15/-, payable in advance on January 1st in each year.

Student Members.—The Council has arranged for the entrance of persons under the age of 21 as Student Members, with Entrance Fee 2/6 and Annual Subscription 10/-, payable as above.

The Ordinary Meetings are held in London on the second Wednesday of the month (October to May inclusive) at 7 p.m. The business of the meetings includes the reading and discussion of papers. A Summer Meeting is usually held, and affords Members the opportunity of inspecting laboratories, works, etc. A Research Committee and the preparation of An Index of Current Literature are active branches of the Society's work.

The Journal of the Television Society

is published three times a year. All members are entitled to a copy; and it is also sold to Non-Members, at an annual subscription of 15/- post free.

Forms of proposal for Membership, and further information regarding the Society, may be obtained on application to the General Secretary, J. J. Denton, 25, Lisburne Road, Hampstead, London, N.W.3.

**JANETTE CONVERTERS
AND
PETROL ELECTRIC GENERATING PLANTS**

The generating plants are available with AC or DC outputs, suitable for operating amplifiers, radios, etc., whilst they have undoubted advantages over a rotary converter and batteries, where a large output is required for PA work.



The JANETTE ROTARY CONVERTER

These machines are in use throughout the world, and possess an unrivalled reputation for reliability and efficiency. We have practically every normal type in stock, with inputs from 32 volts upwards. They are available with all-wave filter, suitable for operating a radio receiver from 5 metres upwards.

Sole Distributor:
CHAS. F. WARD 46, Farringdon St. LONDON, E.C.4
Tel: Holborn 9703.



**PIEZO QUARTZ
CRYSTALS**

1.7 mc., 3.5 mc., and 7.0 mc.,
Amateur Bands.

Power Type Standard Type
20/- post free. 15/- post free

CRYSTAL HOLDERS:—

Type A, Open Electrodes
4s. 6d. post free.

Type B, Totally enclosed and
dustproof, 8s. 6d. post free.

THE QUARTZ CRYSTAL CO., LTD.
63 & 71, Kingston Road, New Malden, Surrey
Telephone: MALDEN 0334.

FOYLES

BOOKSELLERS TO THE WORLD
Stock of nearly three million new and second-hand volumes. Catalogues free on mentioning your interests.

119-125 Charing Cross Rd., London, W.C.2.
Telephone: Gerrard 5660(12 lines)

REDUCTION IN PRICE OF APPARATUS

We offer "MERYVN" UNITS IN KIT FORM
TIME BASE KIT LESS VALVES £3-5-0
POWER PACK KIT LESS VALVES £6-0-0
EXCITER UNIT AND CONTROL PANEL
for 4,000 VOLTS. KIT LESS VALVE £5-0-0
I.F. TRANSFORMERS SPECIALLY
CONSTRUCTED for VISION RECEIVER, PRICE 6/-each
SEND for NEW PRICES

H. E. SANDERS & CO., 4, Gray's Inn Road,
LONDON, W.C.1. Tele: Chancery 8778.

INDEX TO ADVERTISERS

A.C.S., Ltd.	382
Alert Radio Co.	Cover iii
A.P.A. Metalworks	382
Baird Television, Ltd.	333
Belling & Lee, Ltd.	Cover ii
British Institute of Engineering Technology	Cover iii
British Mechanical Productions, Ltd.	321
Bulgin, A. F. & Co., Ltd.	380
Chapman and Hall	379
Clix	321
Cossor, A. C., Ltd.	Cover iv
Dubilier Condenser (1925), Ltd.	375
Ericsson Telephones, Ltd.	381
Edison Swan Electric Co., Ltd.	322
Eves Radio, Ltd.	377
Fluxite, Ltd.	Cover ii
Foyles'	Cover iii
G5KA	Cover iii
Galpin's	383
High Vacuum Valve Co., Ltd.	381
Henley's, W. T., Telegraph Works Co., Ltd.	Cover ii
Marconi's Wireless Telegraph Co., Ltd.	321
McGraw-Hill Publishing Co.	377
Mullard Wireless Service Co., Ltd.	334
Premier Supply Stores	373
Quartz Crystal Co., Ltd.	Cover iii
Radio Resistor Co., Ltd.	321
Radio Society of Great Britain	384
362 Radio Valve Co., Ltd.	375
Raymart Manufacturing Co.	380
Sanders, H. E., & Co.	Cover iii
Sound Sales, Ltd.	321
Stratton & Co., Ltd.	381
Technological Society of Gt. Britain	382
Television Society, The	384
Ward, Chas. F.	Cover iii
Westinghouse Brake & Signal Co., Ltd.	379

**MISCELLANEOUS
ADVERTISEMENTS**

The charge for advertisements in these columns is 12 words or less 2/-, and 2d for every additional word. All advertisements must be accompanied by remittance. Cheques and Postal Orders should be made payable to Bernard Jones Publications Ltd., and crossed, and should reach this office not later than the 5th of the month previous to date of issue.

GUARANTEED TELEVISION PARTS as specified, all new; half price, Box 11.

MEASURING INSTRUMENTS ON LOAN. In response to numerous requests we would remind experimenters of our Loan Service of Measuring Instruments such as Wheatstone Bridges, Meggers, Standard Resistances, Sub-standard Condensers etc., at very low rates. Send us your requirements: H. E. Sanders & Co., 4, Grays Inn Road, London, W.C.1. 'Phone: Chancery, 8778.

ROTARY CONVERTOR, M.L. 200-220 volts D.C. to 230 volts A.C. 50 Cycles. Output 85 watts. Complete with smoothing unit, 43. Box X154.

TELEVISION; limited number Ediswan 10 in cathode ray tubes, used for demonstrations, excellent condition; £5 each. Furzehill Laboratories, Boreham Wood.

**PATENT AND TRADE
MARK AGENTS**

GEE & CO. (Estab. 1905), patents and trade marks throughout the world (H. T. P. Gee, Mem.R.S.G.B., A.M.I.R.E., etc.), 51-52, Chancery Lane, London, W.C.2 (2 doors from Government Patent Office.) 'Phone: Holborn 4547 (2 lines). Handbook free.

KINGS PATENT AGENCY LTD. (B. T. King, Patent Agent) 146a, Queen Victoria Street, London, E.C.4. **ADVICE, Handbook and Consultations free** Phone City 6161.

**COMMUNICATION RECEIVERS
1937 MODELS**

COMPLETE HALLICRAFTER RANGE
NATIONAL NC 100 X R.M.E. 69 etc.
LATEST PATTERSON MODEL - JUST
RELEASED. P.R.15. 15 VALVES.

Let us have your enquiries.

ALERT RADIO CO.

21 East Rd., London, N.1 Phone Clerkenwell 4871

AMATEUR RADIOTELEPHONY.

Latest work by Frank Jones (Author of Jones Radio Handbook)	3 3
Radio Amateur Newcomer	1 0
Jones Radio Handbook (You can't afford to be without this one)	6 6
"Antenna Handbooks." Full of hot dope on antennas that bring results	2 6
Radio Maps of the World (A.R.R.L.)	5 0
Log Books (A.R.R.L.)	1 8
Hints and Kinks (A.R.R.L.) This book is a time and money saver	2 6

All the above post free.

G5KA, 41, Kinfauns Road, Goodmayes, Essex.
Dept. "T."

TELEVISION.

A NEW COURSE OF INSTRUCTION.

We have pleasure in announcing that our new "Television" Course has met with remarkable success. The enormous demand for the Course has shown, beyond any shadow of doubt, that it fills that long-felt need which we anticipated when we went to such trouble and expense in its preparation.

We shall be happy to send full details of this special "Television" Course on request. Particulars are also available of other Courses in all branches of Wireless, Television, Talking Picture Engineering, etc., and of the easiest way in which to prepare for the A.M.I.E.E., A.M.I.W.T., A.M.I.R.E., etc., Examinations.

We teach by correspondence, and guarantee "NO
PASS—NO FEE." Our Technical Consultant is
Professor A. M. Low.

Send for full particulars to-day. Free and without obligation.

THE BRITISH INSTITUTE OF ENGINEERING TECHNOLOGY
337, SHAKESPEARE HOUSE, 17/19, STRATFORD PLACE,
LONDON, W.1.

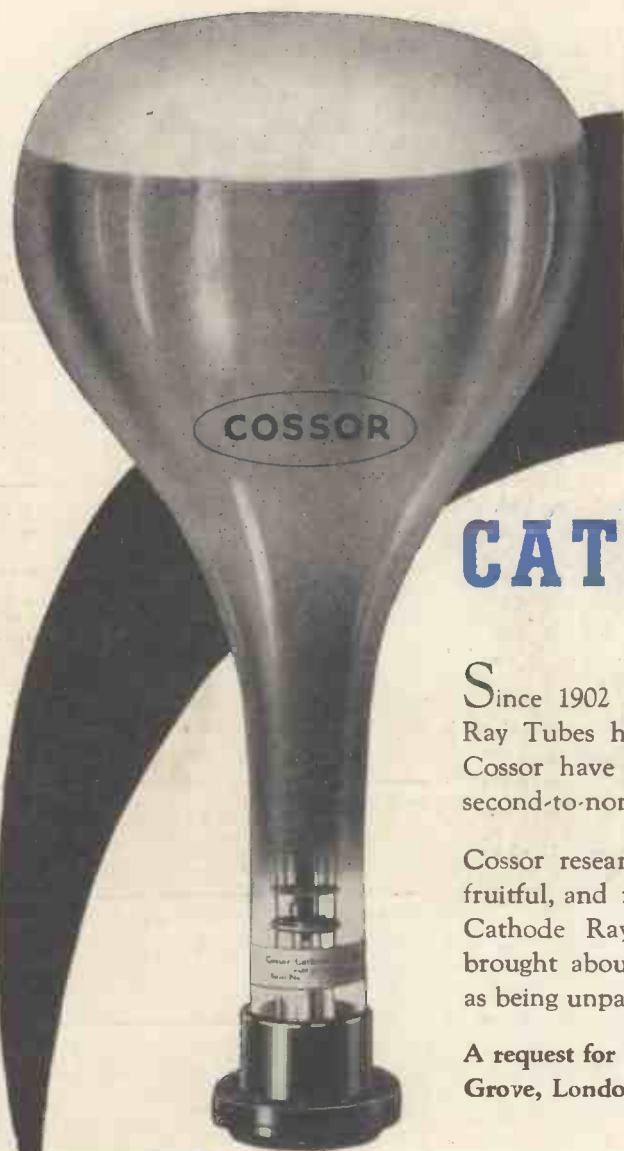

*from the most
comprehensive range
of*

CATHODE RAY TUBES

Since 1902 Cossor research in the design and practice of Cathode Ray Tubes has always kept ahead of the times. As a result to-day Cossor have available a comprehensive range of Cathode Ray Tubes second-to-none.

Cossor research in the field of Television too, has proved eminently fruitful, and results have amply justified their pioneer work in the use of Cathode Ray Tubes for Television. Progress in this sphere has brought about many types but the Cossor full range of tubes is admitted as being unparalleled in respect of quality, focus and brilliance.

A request for leaflet L.213 to Instrument Dept., A. C. Cossor Ltd., Highbury Grove, London, N.5, will bring full details and data of the range available.

from the
'WIRELESS WORLD'
Editorial 2.4.37.

"It was not until about thirty years later that the cathode-ray tube came to be regarded as an everyday instrument in the laboratory, although as long ago as 1902 Cossors, the valve manufacturers, were producing their first examples."

COSSOR

CATHODE RAY TUBES

A. C. COSSOR LTD., HIGHBURY GROVE, LONDON, N.5

ⓐ 1731