

SHORT-WAVE RECEPTION CONTEST—VALUABLE PRIZES

TELEVISION

THE FIRST TELEVISION JOURNAL IN THE WORLD

and **SHORT-WAVE WORLD**

MONTHLY 1/-

JUNE, 1936

No. 100, Vol. ix.

BERNARD JONES PUBLICATIONS LTD.,
CHANSITOR HOUSE, CHANCERY LANE,
LONDON W.C.2.

Special Short-wave Issue

**17-GUINEA ALL-WAVE
SET and THREE OTHER
PRIZES**

OFFERED IN

*World-wide Short-wave
Reception Contest*

See particulars on pages 352-353

**BUILDING S.W.
BATTERY FOUR**

**“QUEEN MARY”
S.W. TRANSMISSIONS**

**MANY ARTICLES ON
TELEVISION PROGRESS**

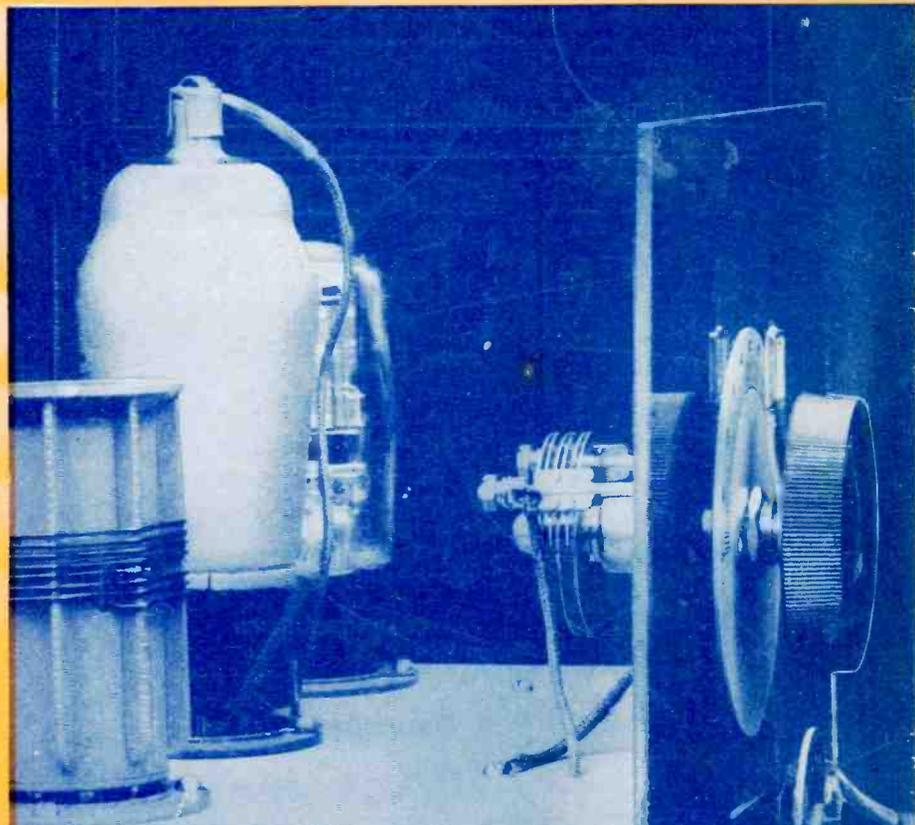

**AN
AMATEUR-BAND TWO**

A PRIZE IN OUR SHORT-WAVE CONTEST

(SEE PAGE 352)



A Listener named Timothy Tett
Said "FLUXITE'S" the thing for your Set
Since I used it I've found
My connections all sound,
So I'll 'long wave' its banner, you bet!"

See that FLUXITE is always by you—in the house—garage—workshop—wherever speedy soldering is needed. Used for 30 years in government works and by leading engineers and manufacturers. Of Ironmongers—in tins, 4d., 8d., 1/4 and 2/8. Ask to see the FLUXITE SMALL-SPACE SOLDERING SET—compact but substantial—complete with full instructions, 7/6. Write for Free Book on the art of "soft" soldering and ask for Leaflet on CASE-HARDENING STEEL and TEMPERING TOOLS with FLUXITE

TO CYCLISTS! Your wheels will NOT keep round and true unless the spokes are tied with fine wire at the crossings and SOLDERED. This makes a much stronger wheel. It's simple—with FLUXITE—but IMPORTANT

THE FLUXITE GUN

Is always ready to put fluxite on the soldering job instantly. A little pressure places the right quantity on the right spot and one charging lasts for ages
Price 1/6.

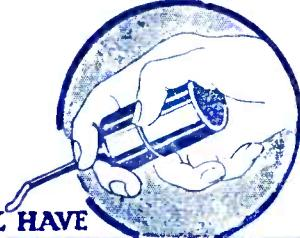

ALL MECHANICS WILL HAVE

FLUXITE

IT SIMPLIFIES ALL SOLDERING

FLUXITE LTD. (Dept. T.V.), DRAGON WORKS, BERMONDSEY ST., S.E.1.

A NEW RECTIFIER FOR CATHODE RAY TUBES

OSRAM U 16



PRICE EACH
20/-

The OSRAM U 16 is a Half Wave Rectifier Valve designed primarily to supply voltage to the accelerator, or anode of Cathode Ray Tubes. For this purpose it is capable of withstanding an anode voltage up to 5,000 volts R.M.S.

CHARACTERISTICS

Filament Volts	2.0
Filament Current	0.25 amp. approx.
Anode Volts R.M.S. ...	5,000 max.
Rectified Current D.C. ..	2.0 ma. max.
(smoothed with 0.25 mfd. condenser)	

Osram Valves

MADE IN ENGLAND

Adul. of The General Electric Co., Ltd., Magnet House, Kingsway, London, W.C.2.

12½ years old and still the world's best

"B"
TYPE
TERMINAL
No. 1001.
6d.



All Standard
Indications
and

TELEVISION,
CATHODE RAY ETC



"B" Type Terminal

NON-ROTATING name; bakelite insulated; anti-twist wedge on collar; black or walnut, white letters. Improved sub-connector nuts, 4B.A. stem. Insulation bush and washer. Cross hole and no thread in clamping gap.

Write for the
Complete Catalogue
Use the coupon.

BELLING-LEE

FOR EVERY RADIO CONNECTION

Belling & Lee, Ltd., Cambridge Arterial Road, Enfield, Middx.

Please send, post free, the complete Catalogue, "Radio Connections."

NAME

ADDRESS

Tel. 6-36.

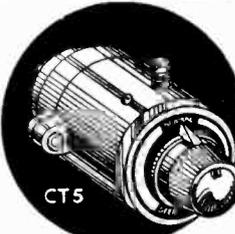

PERFECT TONE
Nothing is really perfect, and nine times out of ten a set's tone leaves something to be desired. There may be too much top or too much bass. Now you can control tone at will.

The Bulgin De-Luxe "Controlatone" simply connects across the speaker, or a transformer primary, and remove excessive treble or excessive bass.

has a middle "normal" tone position. Will remove excessive treble or excessive bass.

List No. C.T.5. Price 6/6 each.

ULTRA-SHORT COILS
"Ultra-short" technique is somewhat different from broadcast work. Stray capacities become important, and "skin effect" is noted. These coils have low skin resistance (they are silver-plated) and low-loss bases.

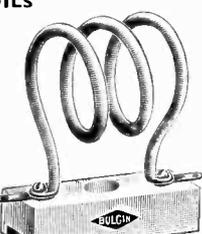

List No. S.W.30. 5-9 m. 2/3
S.W.31. 8-15 m. 2/6
S.W.32. 13-25 m. 2/9
Coupling coil for S.W.30 and 31.
S.W.33 ... 2/3

3 SETS ON ONE AERIAL—
The "COMMUNITY COUPLER"

Aerials tend to become less and less in these days. There are many occasions, however, when more than one set is needed.

With this Bulgin Coupler, you can use up to THREE SETS from one aerial.

All wavelengths from 20 to 2,000 m. are covered, and there is NO interaction. Complete with full instructions.

List No. C.41 ... 5/- each.

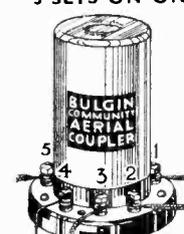

"STRIP-TRIMMERS"



Modern coils and ganged condensers require trimmers to ensure that ganging and matching, if not actual padding, is maintained. Single trimmer units have been used for some time, but these "collective" units will be found, in most cases, to be even more useful. Value 30 μ F. per section.

List No. S.W.100, 2-way, Price 1/6 each.
List No. S.W.101, 3-way, Price 2/3 each.
List No. S.W.102, 4-way, Price 3/- each.
List No. S.W.104, 6-way, Price 4/6 each.

THE MAGIC TOUCH

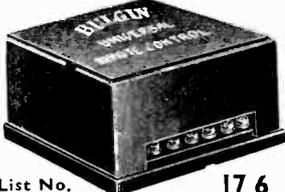

Just the touch of a button in any part of the house, in any room, from your armchair, and you can control your Radio at will.

List No. R.C.10. 17/6

The Bulgin Remote Control costs only 17/6. It works with any set, and consumes negligible currents. Simple little push-button units serve to operate it at a touch. May we send you full details?

List No. R.C.8. 2/- each.



RECOMMENDED
AGAIN & AGAIN

BULGIN
QUALITY RADIO
AND TELEVISION
COMPONENTS

COUPON

To Messrs. A. F. Bulgin & Co., Ltd.,
Abbey Road, Barking, Essex.

Please send me 100 page Catalogue No. 155 "M" for which I enclose 3d. stamps.

NAME.....
ADDRESS.....
(Block Letters Please)

A PILLAR OF LIGHT
for
TUNING INDICATION

Neon Tuning-Lamps are familiar to all. They introduce no losses, have no inertia, and give exact indication. There are many good types available. Fit one now to your mains set, with a

Bulgin Neon Holder.
List No. V.H.25, complete with fixing screws and walnut moulded escutcheon, as illustrated ... 1/3 each.
List No. V.H.26, holder only 6d. each.

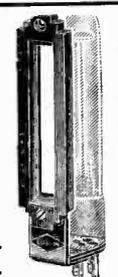

BASEBOARD TOGGLE SWITCHES

The high qualities and reliability of the well-known q.m.b. toggle switch are appreciated by all. This type can be ganged, with any number on one shaft.

UNIT TYPES

List No. S.80 B, S.P. on-off, 1/9 each.
S.81 B, S.P. 2-way, 2/- each.
35 shaft-rod : 3d. per foot.



List No. S.80 B.

SOUND SALES have for years—

produced power transformers for the leading Set Manufacturers not in ones and twos but in THOUSANDS. This has led to increased plant and a larger works. Further addition to our plant now enables us to offer the Home Constructor, chassis mounting high-grade power Transformers at a price which is extremely reasonable when quality is taken into consideration; for example :

MAINS TRANSFORMERS Type No. X.256.	PRICE	SUITABLE CHOKE	PRICE
Primary 210/230/250 v. H.T. Secondary, 250-0-250 v., 60 m.a. L.T., 2-0-2 v., 1 amp. L.T., 2-0-2 v., 3-4 amps.	17/6	Type No. H.36. 30 Henry at 60 m.a.	9/6
MAINS TRANSFORMERS Type No. X.3512.	PRICE	SUITABLE CHOKE	PRICE
Primary as above. H.T. Secondary, 350-0-350 v., 120 m.a. L.T., 2-0-2 v., 2-2.5 amps. L.T., 2-0-2 v., 4-5 amps. L.T., 2-0-2 v., 1 amp. L.T., 2-0-2 v., 1 amp.	30/-	Type No. H2512. 25 Henry, 120 m.a.	14/-
MAINS TRANSFORMERS Type No. X.356.	PRICE		
Primary as above. H.T. Secondary, 350-0-350 v., 60 m.a. L.T. 2-0-2 v., 2-2.5 amps. L.T. 2-0-2 v., 3-4 amps.	19/6		

May we send YOU further particulars ?

Specified by  the Experts

SOUND SALES LIMITED

Marlborough Road, Upper Holloway, London, N.17.
Phone: ARCHWAY 1661-2-3. (Contractors to the G.P.O., etc.)

VALVES for your RADIO

(Battery, A.C. Mains and Universal Types)

FOR BROADCAST or SHORT WAVES

FERRANTI CATHODE RAY TUBES

for TELEVISION and INDUSTRIAL USE
FINEST DEFINITION and LONGEST LIFE
Working Voltage 1000/6000. Cathode 1 volt, 3 amps.

FERRANTI LTD.
RADIO WORKS, MOSTON, MANCHESTER, 10



FERRANTI
VALVES

7 RECENT TELEVISION SPECIFICATIONS FOR SAVAGE MAINS TRANSFORMERS & CHOKES

Most radio engineers these days are agreed on one thing at least—the superiority of Savage “Massicore” Transformers and Chokes. There are three responsible factors :

1. *Generous design on sound principles.*
2. *Individual production by skilled work-people under close supervision.*
3. *Severe and thorough testing and checking for accuracy.*

“Television” designers signify their appreciation of these points by specifying Savage. You cannot do better than follow their lead.



W BRYAN SAVAGE LIMITED

WESTMORELAND ROAD, STANMORE, MIDDLESEX
Adjoining Queensbury Met. Station.
Phone : COLindale 7131 (3 lines).

“45 WATT AMPLIFIER” (Nov.-Dec. 1935)

Savage chokes required :
 1—45/C ... Price 19/-
 1—45/S ... Price 22/-
 1—45/F ... Price 19/-
 1—CC38M ... Price 11/-

Savage Transformers required :
 1—45/IV ... Price 35/-
 1—45/OP ... Price 45/-
 1—45/MT ... Price 85/-

“ADVANCE ALLWAVER” (Nov.-Dec. 1935)

1—Type M36M Savage Choke ... Price 11/-

“PRE-SELECTOR CONVERTOR UNIT” (March, 1936)

1—Savage Mains Trans. 250v. Type A ... Price 25/-

“ULTRA SHORT-WAVE SUPER” (April, 1936)

1—Savage Mains Trans. UHF8 ... Price 35/-

“5 METRE TRANSMITTER” (April, 1936)

1—Savage Smoothing Choke, Type C32M ... Price 16/-

“40 METRE TRANSMITTER” (May, 1936)

1—Savage L.F. Choke, Type LL36PG ... Price 17/6

“AC DC HIGH FIDELITY AMPLIFIER (May, 1936)”

Savage Chokes required :
 Mains Smoothing choke, C26DW ... Price 19/-
 Subsidiary Smoothing Choke, Y40M ... Price 7/6
 Anode Coupling Choke for 1st L.F., Y42M ... Price 7/6
 Savage Transformers required :
 Intervalve Transformer, PP2/IM ... Price 20/-
 Output transformer with split primary and output up to and including 100 ohms (specify output when ordering) ... Price 27/6

★ Prompt service on all “Television” specifications. Our standard list is useful and free. Send for your copy to-day.

USE

WESTINGHOUSE

METAL RECTIFIERS

AND “INSURE” YOUR POWER SUPPLY

No fragile filaments to burn or wear out. Nothing to break. No replacements. Constant output. You can rely on Westinghouse Metal Rectifiers.

“The All Metal Way, 1936” contains full details of, and circuits for use with, these reliable rectifiers. A 3d. stamp to Dept. T., will bring you a copy.

WESTINGHOUSE BRAKE & SIGNAL CO., LTD.,
82, York Road, King’s Cross, London, N.1.

TELEVISION

and SHORT-WAVE WORLD

Special Features

	Page
Television Announcer-hostesses	324
A New Photo-Cell "Watch Dog"	325
Television Demonstration at Hampstead	328
The Television Staff at the Alexandra Palace	332
Some New Ideas in Mechanical Synchronising	333
The "Queen Mary" Short-wave Transmissions	338
Short-wave Battery Four	339
A New Super-het Tuning Unit	342
Transmitting for the Beginner	343
Battery Short-wave Super-het	346
Short-wave Radio World	347
Modulation Measurement with Cathode-ray Tube	349
Amplified Absorption Wavemeter	350
World-wide Short-wave Reception Contest	353
A Portable Battery-operated Transmitter	356
More About the 40-metre 'Phone Transmitter	362
Mechanical Film Transmission	370

TELEVISION AND SHORT-WAVE WORLD

Proprietors :

BERNARD JONES PUBLICATIONS, LTD.

Editor-in-Chief :

BERNARD E. JONES.

Editor :

H. CORBISHLEY.

Editorial, Advertising and Publishing Offices :

Chansitor House, 38, Chancery Lane, London, W.C.2.

Telephones : Holborn 6158, 6159

Telegrams : Beejapee, Holb., London.

Subscription Rates : Post paid to any part of the world—3 months, 3/6; 6 months, 6/9; 12 months 13/6.

Published Monthly—1/- net.

(Last Wednesday in every month for following month).

Contributions are invited and will be promptly considered. Correspondence should be addressed according to its nature, to the Editor, the Advertisement Manager, or the Publisher, "Television and Short-wave World," Chansitor House, Chancery Lane, London, W.C.2.

IMPORTANT

"Television and Short-wave World" is registered at the General Post Office, London, for transmission to Canada and Newfoundland by Magazine Post. Entered as Second-class mail matter, Boston, Mass.

COMMENT OF THE MONTH

The Best Laid Schemes.

THE fact that the prophecy of a start with the high-definition television transmissions in the present month (June) has not materialised has led to a good deal of adverse comment, and it has been suggested in many quarters that a hitch has occurred in the B.B.C.'s plans with regard to television. We can assure our readers that no hitch whatever has developed and that all the preparations are proceeding according to plan—if not to time. The plain fact is that with an entirely new service and new technique the work entailed in preparation has been considerably greater than was foreseen, and as there was no precedent, any estimation of the time required could at the best be only a matter of guesswork in the first instance. From our personal knowledge we can say that the work at the Alexandra Palace is proceeding at an almost feverish rate and that the maximum number of workers which it is possible to employ are on the task. Quantities of material and gear are arriving almost daily, but the actual work of installation is very considerable and apart from such matters as the provision of foundations for the generators, etc., there is a vast amount of wiring to be done, much of it of a highly specialised character. Each day sees additions to the aerial mast and at the time of writing the top section is well on the way towards completion, though it must be remembered that when the structure is complete there still remains the erection of the aerial and the fitting of the concentric copper-tube feeders to carry the high-frequency current to the aerial, a task which will also entail a great deal of detail work and one that is likely to take a few weeks for its execution.

There certainly was a considerable amount of delay in the selection of the site and making a start generally, but it is quite unfair to say that there has been any slowing up since work on the conversion of the Palace was commenced. We have found it impossible to obtain any official statement regarding the date when the first transmissions will be put out, but we have been at considerable pains to obtain all the information which is likely to have a bearing on the matter and we feel that we shall be making a safe guess when we say that the first test transmissions will be put out at the end of August and that a start will be made with the public service four weeks later.

The Short Waves

THIS month's issue of TELEVISION AND SHORT-WAVE WORLD contains a larger number of pages devoted to short-wave interests than is normally the case. Two reasons prompted this—the fact that short-wave working is at its best at this time of the year, and our desire to obtain as much valuable data on the subject as possible. This latter we hope to secure as a result of the World-wide Short-wave Reception Contest which is announced on pages 352 and 353, and it will eventually be to the advantage of all readers interested in short-wave working if they will co-operate by entering the competition.

THE TELEVISION ANNOUNCER- HOSTESSES



Miss Jasmine Bligh (left) and Miss Elizabeth Cowell, the newly appointed television announcer-hostesses.

MISS JASMINE BLIGH and Miss Elizabeth Cowell are the choice of the B.B.C. to fill the posts of the much-talked of lady announcer-hostesses. Probably because the requirements appeared to demand such superlative qualities these appointments have received more publicity and have been the subject of more speculation than any other feature of the new television service.

Miss Bligh and Miss Cowell were chosen from among 1,122 applicants who answered the B.B.C. advertisement for this special appointment. The first selection was made from letters and photographs, and all applicants who were considered to have a possible chance were interviewed by a selection board. Of these the best four were given a sound audition and a final test by high-definition television confirmed that Miss Bligh and Miss Cowell, besides possessing the necessary qualifications of personality, tact and charm, had "photogenic" faces, suited to the television medium.

Miss Bligh is 22 and the daughter of the Hon. Mrs. Noel Bligh, and a niece of the Earl of Darnley. She has had a good deal of experience on the stage, and her sister is a film actress.

Miss Cowell is 23 and lives at Sidney Street, Chelsea, but her home is

near Cambridge. She has travelled abroad a great deal, and speaks three foreign languages. Both girls are close friends though only of short acquaintance, in fact they met a very short time before the appointments were made and at that time neither knew that the other was an applicant.

Hostess and Announcer

The decision to combine the posts of television hostess and announcer was only made recently, and as a result Miss Cowell and Miss Bligh will make their television appearances at the Alexandra Palace alternately. While one is announcing the other will be acting as hostess, the latter greeting the artists and helping them to become acclimatised to the unusual atmosphere of the television studios.

Both ladies have now actually joined the B.B.C. staff and are undergoing a course of microphone training at Broadcasting House. Mr. Gordon McConnel, the producer of musical comedy and opera, is instructing them, and a full-length mirror is being used in order that they can study their department. Until the television service at the Alexandra Palace begins, they will make frequent appearances before the microphone in programmes of light music in order to get accustomed to announcing. Television announcements

for the most part will have to be memorised, the speaker dispensing with notes before the scanner, though in the case of lengthy announcements it is proposed to use large written notices which can be read at a distance and will be out of the scanning area.

Contrasting Personalities.

Miss Bligh is a blonde and Miss Cowell a brunette, a contrast which was considered advisable. They will be required to use a blue and yellow make-up when televising. Although the suggestion has been made that some standard type of dress should be worn, in fact, a sort of uniform, this is improbable, and it is likely that dress will consist of ordinary day and evening wear with plenty of variety.

Television in Holland

Although there is no immediate intention of opening a public television programme service in the Netherlands a well-known radio firm is engaged on extensive television research and recently demonstrated 405-line television pictures with interlaced scanning.

This latest Dutch development proves that television activities are not restricted to those countries where television services are actually in operation or in preparation.

At Eindhoven, in Holland, the Philips company has a complete experimental ultra-short-wave television transmitter in its factory grounds. The aerials are situated on the roof of one of the high buildings. The transmitter has a power of approximately 400 watts and operates on a wavelength in the neighbourhood of 7 metres.

For direct television transmission an Iconoscope camera is used giving remarkable detail and accuracy. The Iconoscopes employed are manufactured by Philips in Holland.

Reception is by means of a cathode-ray tube receiver which for present experimental purposes has a bright green screen. A.A.G.

A NEW TYPE OF PHOTO-CELL "WATCHDOG"

By R. L. Ashmore.

Here is a description of a new type of photo-cell detector, which, unlike others, requires only one point for its operation.

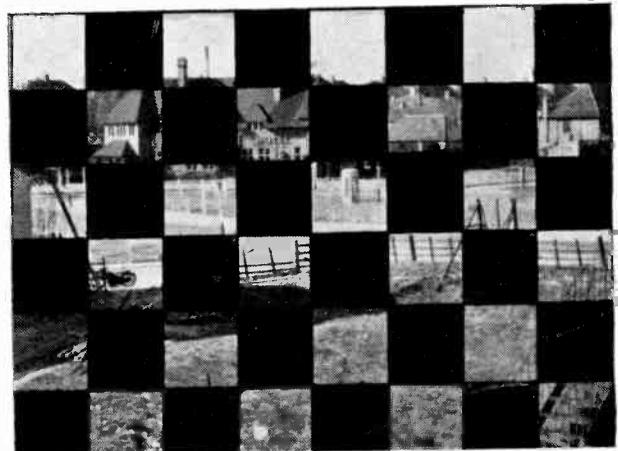
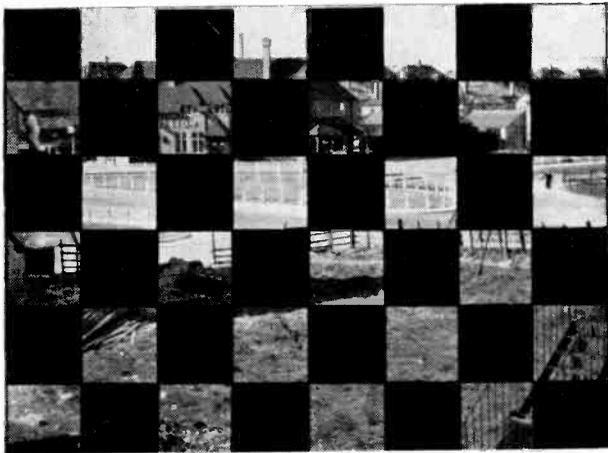

Figs. 5a and 5b.—The same scene as Fig. 4 viewed through a screen of transparent and opaque areas.

EVERY day the photo-cell is put to new uses, both in the worlds of commerce and science. In the former the "talkies" are perhaps its biggest employer, with light-operated switches a good second. Among the light-operated switch systems most are actuated by the shutting off of a beam of light by some opaque object passing through the beam, counting devices, measuring (such as the system which checks the height of vehicles about to enter the Mersey Tunnel) and burglar alarms are typical. These devices can work day or night, use invisible light and are very reliable. The general scheme of such systems is shown in Fig. 1.

The chief disadvantage of these systems is that they

require two points to operate—the light source and photo-cell relay, both of which may have to be carefully hidden, while in some cases the light source may have to be specially modulated so as to baffle those who may know of the position of the light beam and are out to cheat it. One of the latest arrangements of the photo-cell as a "watch dog" is most interesting and novel, and like so many of these sort of devices hails from the other side of the Atlantic. The apparatus has the great advantage that it only requires one point to operate from, which may be up to some miles if necessary; also it can be made to keep "an eye-on" large areas generally or specially selected ones.

In Fig. 2, A B are two similar areas, except that the

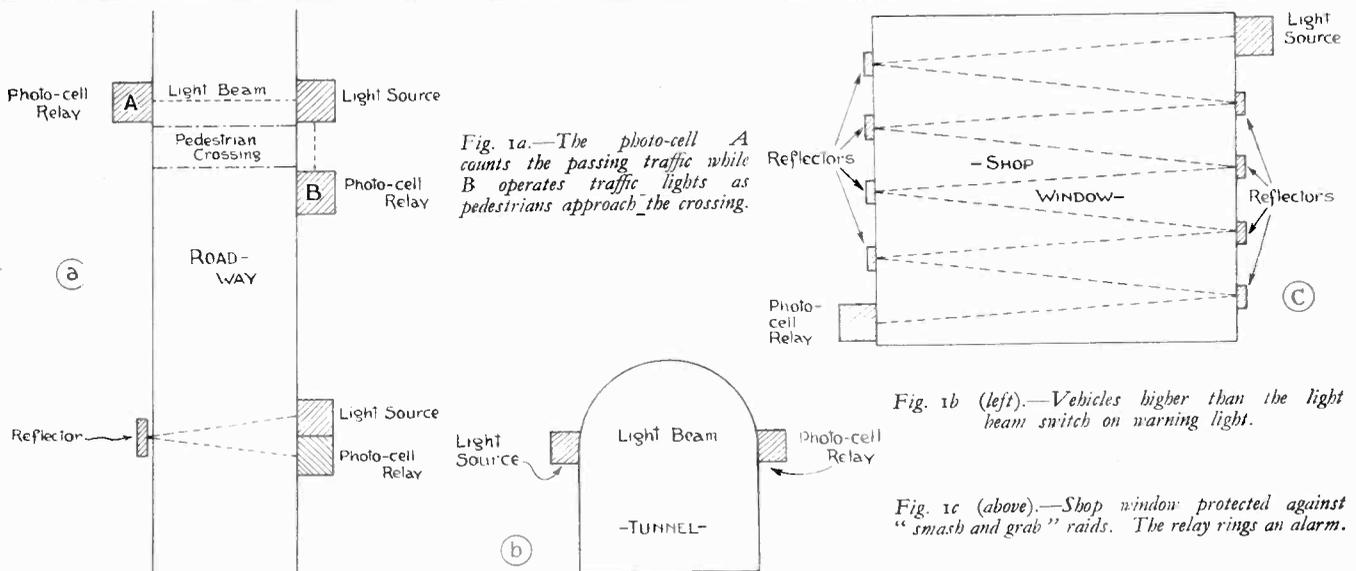

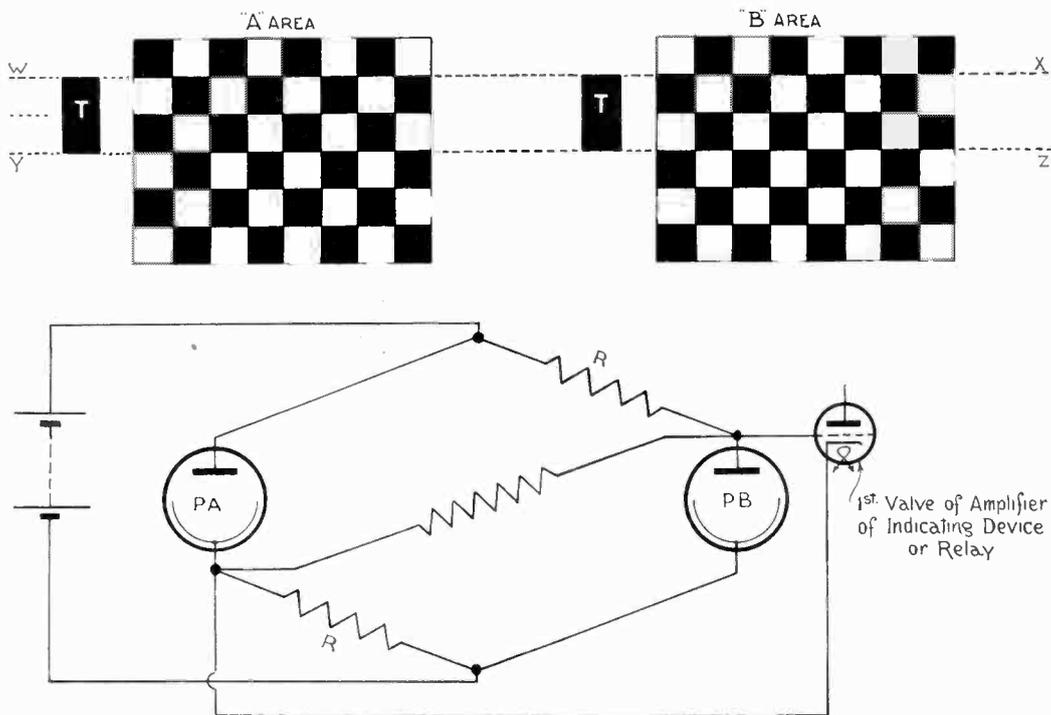

Fig. 2.—Diagrams explaining the action of the new photo-cell "watch-dog."

black and white squares are in opposite positions—B, the negative of A. If one collected all the light reflected from each of these two areas, provided they were evenly illuminated, the quantity of light would be the same and further if these quantities of light were directed into the two photo-cells, PA, PB, connected into the bridge circuit shown, the bridge would be balanced (it being taken that the resistances R R and photo-cells are of similar characteristics). Now supposing we slide the black areas marked T simultan-

ously from left to right along the dotted lines WXYZ; directly they enter the areas A and B the balance of the bridge will be upset, because from both areas the reflected light will be reduced and, owing to the position of the photo-cells in the bridge circuit, one helps the other to bring about a state of unbalance.

Once the areas T have travelled their own width across the black and white squares, no change will take place in the unbalanced condition of the bridge until they have passed out of the A and B areas, when the bridge will revert to normal. This state of affairs is brought about by the fact that the areas T are the same shape as the two black and white areas together. This effect is met in television scanning when the scanning area bears a similar relation to the detail areas being scanned—known to television engineers as zero frequency.

If, however, only half of the areas T traverse the black and white patches, say, the upper half, on first entering the areas A and B, only the photo-cell PA is affected as it is only this area from which the reflected light will have been altered. Further movement to the right will produce a change in both cells, PA, PB, and then PB only, the cycle of affairs being repeated across the black and white squares. This effect, of first one cell and then the other being affected, produces pulses across the bridge, the frequency of which is dependent on the speed of traverse of the moving area.

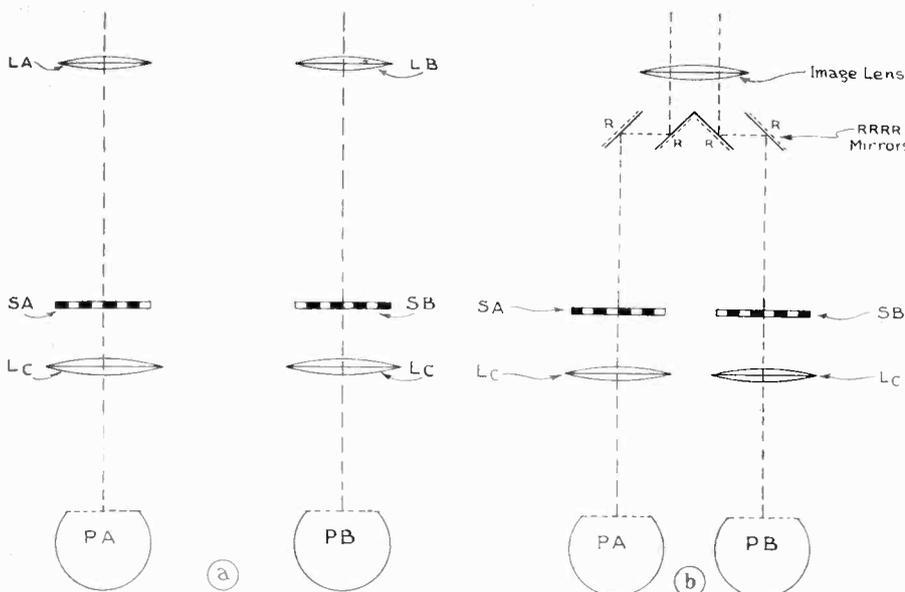

Fig. 3a and 3b.—Schematic diagrams of the optical system of the photo-cell "watch dog."

SPEED MEASUREMENT BY PHOTO-CELL

Now let us see how the results just described can be used to detect someone walking along a road some hundreds of yards away. Turn to Fig. 3a. Lenses LA, LB, form real optical images at once on the surfaces of SA, SB respectively, SA and SB being our areas A and B of Fig. 2, which in this case consists of a screen of transparent and opaque areas. The lenses Lc, Lc collect the light passing through these screens on to the photo-cells.



Fig. 4.—A "straight" photograph of the scene which was used for the experiment.

It is, of course, arranged that an identical image of the scene, under observation, is thrown on the two screens. In Fig. 3b only one image-forming lens is used which is somewhat of an optical saving. Where extreme sensitivity is required, however, this arrangement is not to be recommended as the total light on each screen is halved without considering mirror reflection losses.

Uses of the Photo-cell "Watch Dog."

Supposing the scene under observation is that of Fig. 4, the image of which falling on each screen SA, SB of Fig. 3a or 3b would appear like Fig. 5. In this scene, as in most others, the quantity of light passing through the screens would not be quite equal, so the bridge would have to be balanced by varying one of the resistances. Now if a car or bus passed along the road running across the picture, it would produce a strong alternating signal; on the other hand the pedestrian, who can be seen in the "A" picture (Fig. 5) on the right-hand side middle transparent area, would make a very small change in the balance of the bridge, with opaque and transparent areas of the side shown. If, however, the areas were of the proportions as in Fig. 6 the response from this pedestrian would be considerably increased.

Returning to Fig. 4, if one wanted to "watch" the telephone booth only, one would use a longer focus lens and so produce a larger image on the screens and at the same time place an opaque mask over both the A and B images so arranged that only the image of the telephone booth fell on the transparent and opaque areas; similarly any other part of the picture, such as the grass patch in the centre of the road merry-go-round.

In America such a device is used to sound a Klaxon

when people ignore the "keep-off-the-grass" notices in parks, etc. The device has also been used for spotting aeroplanes. A keen nature photographer is about to experiment with such a device; it will be readily realised that waiting for one's subject is most tedious, but with such an arrangement, directly any animal or bird moves or enters the predetermined field of vision, the camera can be made to operate.

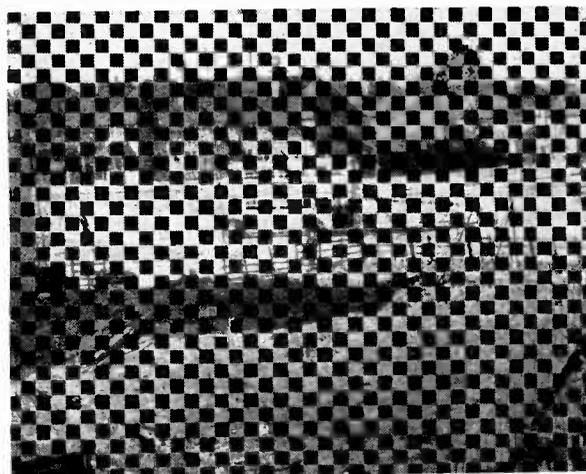

Fig. 6.—The scene in Fig. 4 as seen through one of the screens. A double-decker bus is passing in the middle of the picture.

Speed Measurement.

Another interesting thing about this device is that it can be made to respond only to objects moving at a given speed. For example, a car crossing the scene in Fig. 4 will produce a signal of given frequency depending on the speed of the car and the number or grain of transparent and opaque squares; a valve amplifier (which will be necessary anyway) may be made to peak only at the required frequency or to respond above or below a predetermined one, gives one even more useful applications of the system. Actually the speed of cars along the road in Fig. 4 has been measured by such a device, the signal frequency generated being read on a meter which can be converted to miles per hour.

Effect of Shadows

It may strike the thoughtful reader that surely such an arrangement would be susceptible to moving shadows such as in the middle distance in Fig. 4. Well, it is, but shadows move very slowly compared with most objects, which one would wish to record and unless the amplifier is of a D.C. nature this slow movement of shadows will not be recorded, the balance across the bridge will, however, be slightly upset.

Such a photo-cell "watch dog" as described will, of course, only function in the daytime, which in many cases is a drawback. On the other hand it is very hard to dodge even by the moving object being coloured the same as the background, but above all it will keep "watch" from a distance, even where its owner may never have found possible to go.

A TELEVISION-PHONE DEMONSTRATION AT HAMPSTEAD

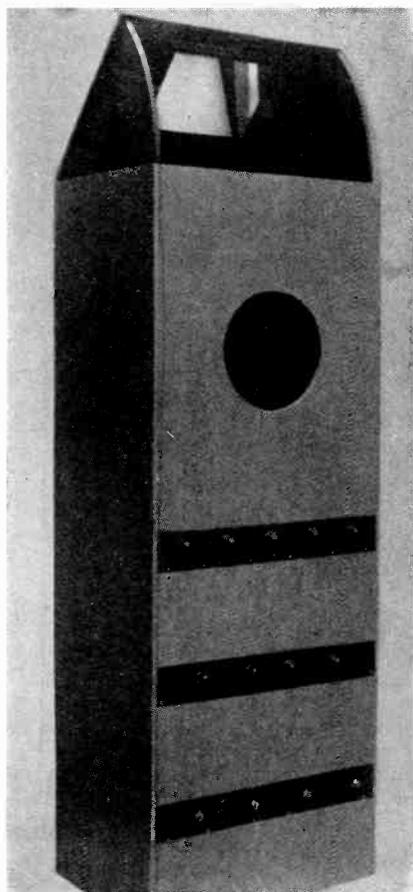

The television-telephone. This photograph shows the cathode-ray receiver.

MESSRS. JOHN BARNES & CO., of Finchley Road, Hampstead, are formally opening a new store on May 25 and are staging during that week a number of attractions, one of which is Mr. Reyner's Television Telephone, which has already been reported on in the April issue.

The equipment to be used for the present demonstration, however, constitutes an improvement in several particulars over the earlier type. Although the vision remains one way, a two-way loud-speaking telephone system is in use. In addition, the picture shape has been slightly altered and the angle of view extended, in consequence of which it is now possible to see the subject being televised walk into the picture, sit down and proceed to carry on a conversation.

As in the previous instance, 90-line definition is used which, as we pointed out then, gives quite satisfactory results for head-and-shoulder portraits. Added to this, the receiver is now fitted with a 10-in. cathode-ray tube

which gives a very pleasant image and the effect of seeing a person sit down in a chair and commence to talk, and to be able to speak back without consciously speaking into a microphone, creates a most uncanny sensation, and provides the remarkable foretaste of the television-telephone of the future.

Novel Synchronising

We understand that the equipment has undergone certain simplifications, one of them being that the synchronising signal is now superposed on the modulation in the ordinary way and separated out at the receiver by the use of a back-off valve. The grid bias on this valve is so adjusted that the modulation does not pass any current but the peaks caused by the synchronising signals trigger the time bases and lock the receiver with the transmitter. It is interesting to note that both high- and low-frequency synchronism is obtained in this way as a synchronous motor is not used to drive the disc which therefore runs at slightly less than 1,500 revs. per minute. It is therefore impossible to synchronise off the mains, but by correctly designed separating circuits it is possible to discriminate between the high- and low-frequency synchronising signals and apply them to the appropriate gas-discharge tubes.

The use of the 10-in. receiving tube has already been mentioned. Actually, one of the new Ediswan indirectly-heated CH tubes is being used, with the four-electrode construction having three anodes and the shield. The advantage of the three-anode type is that not only does it give better focusing and less interdependence between the modulation and the focus control, but it also gives a longer life owing to the lower potential gradient near the cathode.

The receiver itself is illustrated in

the photograph herewith and will be seen to be of modern line. The cathode-ray tube is mounted vertically at the top, the image being viewed through a mirror in the lid which is tilted at approximately 45 degrees. The two flanges on either side are to protect the tube from stray light, for although a brilliant image can be obtained which can be seen with the lights on, the impression is undoubtedly increased if stray light is prevented from reaching the tube.

The Controls

In front is the speaker, while the microphone is located separately in a position relatively close to the person viewing the image. The necessary controls are arranged in three tiers, each of the various sections being in units which are connected by plug and socket so that they may rapidly be withdrawn for inspection. The top tier contains the tube controls, i.e., focus, intensity and shifts. The second tier contains the time base controls, i.e., line and picture frequencies and amplitude controls, while the bottom tier contains the switches for the various portions.

An amplified time base is used, giving push-pull deflection which results in a maintenance of the focus over the whole of the picture, while it has the additional advantage that the size of picture can be adjusted without altering the scanning frequency (i.e., without affecting the number of lines). This is a very valuable property and well worth the slight extra complexity which it entails. As already explained synchronism is automatic and once the backing-off has been correctly adjusted, it is only necessary to alter the frequency controls in the horizontal and vertical directions. When the setting is approximately correct the synchronism takes charge and the picture locks.

Scannings and Reflections

By THE LOOKER

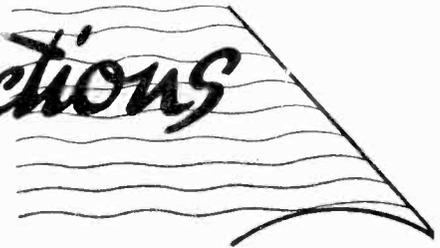

The Engineering Staff at the Palace

PROBABLY many of my readers will be surprised to learn that the engineering staff at the Alexandra Palace will total over ninety; and there is a prospect of this number being added to at an early date. Off-hand I do not know the number that were engaged on the old thirty-line transmissions but I remember that it was something less than a dozen; this vast increase gives some idea of the scale upon which the new service will be run. Of course, conditions are somewhat different to those of the old days for this staff will include both sound and vision engineers and in addition the staff required for the running and maintenance of the generators and also the wiring and lighting equipment. The Alexandra Palace will be a broadcasting station entirely complete in itself and will not have to rely in any way on the ordinary broadcasting service.

Old Friends

There will be several names among the engineering staff which will be familiar to those who used to receive the thirty-line transmissions. Mr. D. C. Birkinshaw, who had executive charge at Broadcasting House, will be the chief executive at the Palace. Mr. Birkinshaw, it will be remembered was originally on the B.B.C. Engineering Research staff, and he was on "loan" to the television department. His new title will be Engineer-in-Charge.

Two other names which will be familiar to old television lookers are those of Mr. T. H. Bridgwater and Mr. D. R. Campbell, who, I believe, will be known as studio maintenance engineers. Mr. Campbell, originally was responsible for the technical matters in presentation, lighting position and so on, and on Mr. Bridgwater fell the duty of seeing that the transmission was going over properly. I believe that they are to have similar duties at the Palace, but, of course, with greatly increased responsibili-

ties. Both are as keen enthusiasts as it would be possible to find and as they originally came from the Baird laboratories their experience has been the maximum possible in the new science.

The Aerial Mast

The Alexandra Palace mast has now become quite a landmark to those travelling from the north to the City. Its initial progress was very rapid, but those who pass the district frequently have noted that of late little appears to have been done and the fact that a flag has been placed on the top has led many people to assume that the structure has reached its final height. This idea is quite wrong, for the structure which is already in being is merely the first stage; from beyond this point the mast will become octagonal as was shown in the advance information of the Palace, which was published exclusively in the November issue of TELEVISION AND SHORT-WAVE WORLD of last year. There are two reasons for the apparent slowing up—one is the preparations which have to be made for the erection of the second stage (by the way a start has just been made with this) and the other is that now such a considerable height has been reached, work is only possible on the very calmest of days; with the slightest breeze all activities have to be suspended.

When the Service will Commence

I notice that the Postmaster-General in reply to a question in Parliament a few days ago as to when the new television service would start, said that the structural work was nearly completed and the installation was proceeding. Further, as soon as it was completed there would be engineering tests, followed in July by transmissions of experimental programmes. It might have been better to have qualified this statement by the word "hoped," for the executive staff at the Palace

are not quite so optimistic, and although they do expect to be getting down to "brass tacks" somewhere about the end of July, they appreciate that hundreds of little snags might arise which will require time and patience to eliminate. In any case we can most certainly expect the full service to be in operation by the time that we settle down to our plans for indoor winter entertainment, and after all this is what really matters.

Television and the Public

One cannot talk to the average "man in the street" without realising how woefully ignorant he is on all matters concerning television. Astonishing as it may seem, there are thousands and thousands who actually do not know that it even exists and a large proportion of the rest imagine that it is merely the plaything of a few enthusiasts. How they regard the fact that the B.B.C. is spending over a couple of hundred thousand pounds on it, if they do ever stop to consider this point, it is difficult to say. I think that it is up to all those who are interested in the development of television to do their utmost to educate their lesser informed friends in the progress that has been made, although even in this matter there is a difficulty as owing to the great amount of secrecy that has been preserved, I suppose there is quite a large proportion of the readers of this journal who have never seen a demonstration of high-definition television. To these, I might say, the quality and definition are now such that in outdoor scenes the minute ripples caused by insects lightly touching water, and also such objects as telegraph wires are plainly discernible.

A Chance for Inventors

Special prizes are to be offered for the design of television apparatus at the Concours Lepine, which is to be held in Paris in September. This is an exhibition intended to assist small inventors, and this year for the first time a special feature is to be made of television.

MORE SCANNINGS

Television in the Provinces

I think that it is safe to assume that once the London transmissions have been inaugurated there will be loud demands from the provinces for stations that will serve the larger populated areas of the country and that the B.B.C. may be compelled to make some move in this direction more quickly than is planned at present. Sheffield has already taken official action and at a recent meeting of the City Council a resolution was moved that the Town Clerk ask the British Broadcasting Corporation for some assurance that the claims of Sheffield will be considered when the Corporation's plans for a national system of television are prepared, and that opportunity will be given by the B.B.C. for consultation and collaboration with the Sheffield City Council.

I take it that provincial listeners will feel that because part of the licence money which they subscribe is being used for television they are equally entitled to some share of the entertainment. Additional stations will give opportunities of other systems being tried.

Films and Television

The question of films for television transmission is proving rather a big problem. As Mr. Gerald Cock said recently there will be no market for any films that the B.B.C. may make and their production will therefore be an expensive business. It is hoped to establish good relations with film interests in order that short excerpts of popular films may be given to illustrate film criticisms, but unfortunately film concerns are regarding television as a possible rival. Some of the news service films will be made by the B.B.C. and it is expected that others will be available from the film concerns. Work has already been commenced on one film which will portray the development of the Alexandra Palace under the title "Television Comes To London." The first exposure of this film was made when alterations were commenced at the Palace and the last will be made when the Palace is completed. It is expected to occupy a time of twenty minutes. The scenario has been personally written by Mr. Gerald Cock and the film is being directed by Major L. G. Bar-

brook, who is in charge of the film section of the television service. There is a double purpose in making this film, for, apart from it being used for transmission, the intention is to show it in cinemas throughout the country so that everyone will obtain some idea of the developments that have taken place.

Television in Holland

Reports of the television activities of the Philips Company in Holland have appeared in this journal from time to time, but very few details have been available. Recently this concern gave a demonstration of 405-line transmission with interlaced scanning, the apparatus employing the Iconoscope. No technical particulars have been published but it is believed that the apparatus is very similar to that of the Marconi-E.M.I. Company.

Aircraft Beam Stations and Television

I see that the point has been raised of the possibility of the television transmissions affecting the beam landing systems which are now becoming of such importance at airports. These must of necessity operate on a low wavelength of between six and nine metres. With the latter wavelength it is quite improbable that any trouble would be caused, and it seems likely, therefore, that some understanding will have to be arrived at in the case of airports which come within the television transmitting area. Actually this matter, which obviously is quite easy of settlement, has been advanced as an argument against television.

The Television Announcer-Hostesses

I had the pleasure the other day of meeting the two television announcer-hostesses who have now been appointed by the B.B.C.—Miss Jasmine Bligh and Miss Elizabeth Cowell. Both have very charming personalities and they are quite dissimilar—one (Miss Bligh) is fair and the other dark. Perhaps I cannot do better than repeat the "specification" that I wrote in the December issue when I said that the desirable qualifications must be a low-pitched voice, a remarkably good memory, charm, per-

sonality, "photogenic" features, a *tout ensemble* that will attract listeners of either sex and the ability to wear clothes to the best advantage. I should say that both these young ladies fill this specification admirably though, of course, with such a new technique only time and experience can prove whether all these qualifications, which it cannot be denied are somewhat exacting, will be revealed. It will be remembered that at first it was only proposed to have one woman announcer; this decision has now been altered and both are to have the dual title of announcer-hostess and take each duty alternately.

World-wide Interest

I receive quite a number of inquiries for television transmitting gear from abroad, particularly the smaller countries. Within the past few months letters have been received from Turkey, Czecho-Slovakia, Greece, Australia and India. I can only pass these inquiries on to suitable quarters and whether anything comes of them I am unable to say. I do know, however, that tentative proposals are being made in many of the smaller states and in this connection it is interesting to note that according to reports the Nizam of Hyderabad is planning to instal the first television station in India. The Nizam believes that the experience gained with it in a country like India will be of great research value.

The German Service

The Berlin television programme service, which was re-opened on January 15, has continued daily since then. Programmes of direct television and of films are provided from 8-10 p.m. and there is a weekly change of programmes. A correspondent in Germany tells me that as far as the general public is concerned they are only able to televise in the seven public televiewing rooms of the German Post Office in Berlin and in the one at Potsdam. He also says that at present about 100 television receiving sets are in operation in Berlin. Most of these have been bought by the authorities or by those organisations especially interested in the development of the new technique. The remainder are periodically loaned by the manufacturers to representatives of technical bodies and also of the technical press who

AND MORE REFLECTIONS

wish to gain first-hand impressions of the service. As the receivers are only available for A.C. mains people living in the number of districts of Berlin which only have D.C. current supplies are unable to televise. It appears likely that the first series of television sets which will really be offered for sale to the general public will not be available before the German Radio Exhibition. Entirely new types of receivers are at present being evolved to meet the requirements of a higher standard of definition which is shortly to be introduced.

Future German Developments

All publication of information regarding German television is subject to the sanction of the Ministries of Air and of Posts. Even the highly technical articles in scientific reviews have first to be passed by the authorities before they are published. In view of this strict control, which was imposed on August 6, 1935, information regarding the future development of the German television programme service is difficult to obtain. It is reported that the Post Office laboratories are at present experimenting with 324 to 375-line pictures with inter-laced scanning. In spite of the development of electron cameras in Germany, attention is still being paid to the intermediate film system and at the forthcoming summer Olympic Games in August events will no doubt be televised by the intermediate film method as well as by electron cameras.

Berlin-Leipzig Television Telephone

The television telephone service between Berlin and Leipzig which was in operation for the Leipzig Fair tests between March 1 and 7 has not been re-opened. It is understood, however, that it is shortly to again become available for general public service. During the seven days in March public interest was very great.

Speaking at a reception of foreign diplomats and press representatives in Berlin on Thursday, May 14, the Ministry of Posts Secretary of State, Dr. Ohnesorge, stated that the German Post Office were at present laying a cable from Hamburg to Munich which would enable distortionless transmission of frequency bands of up to 4 million cycles in width.

Television-Telephone over 600 miles.

The cable, connecting Hamburg-Berlin-Leipzig-Munich will be ready in April, 1937. It will be possible to arrange for three simultaneous television-telephone calls and one hundred simultaneous ordinary trunk calls by means of the new cable. Or it will be possible to link two television transmitters with two different programmes with 405-line definition! (2 million cycles each, roughly). Leaving out television it will be possible to make one thousand telephone trunk calls through this wonder-cable.

Dr. Ohnesorge, in opening the demonstration of television to the assembled foreign diplomats and press representatives, said that what could be seen here was the position of a year ago. Great strides had been made in the meantime, but it was not possible to demonstrate the new standards of definition nor the portable television cameras as yet as they were required in the laboratories. This utterance certainly seems to point to the fact that the German television engineers regard the present 180-line 25 frame per second television service from Berlin-Witzleben as a "standard of a year ago."

Short Waves and the Eclipse

On the morning of June 19, when a total eclipse of the sun will be visible in Siberia and Japan and a partial eclipse will be visible in England, special radio transmissions will be broadcast from Station G5CV, London, W4.

The wavelength (crystal controlled) will be 42.43 metres (7070 kc.) and the power will be 150 watts.

The transmissions, consisting of a 1,000-cycle tuning note interrupted at frequent intervals for station identification purposes (i.e., call sign, power, frequency, etc., in telephony) will commence at 4.15 a.m. and continue until 5.15 a.m. B.S.T.

Reports upon the reception of these signals with especial reference to any unusual variations in signal strength will be welcomed and all these will be acknowledged with the stations' QSL card. It is particularly desired to receive reports from the Eastern Hemisphere.

Reports, if they are to be of any value, must state accurately the times

when any unusual variations are noticed. They should be addressed to:—Mr. Douglas Walters, Station G5CV, c/o The Radio Society of Great Britain, 53 Victoria Street, London, S.W.

It is expected that at some time the transmission will exhibit night-time characteristics due to the moon obscuring the sun's disc and therefore restricting ultra-violet radiation and its consequent effect upon the height of the ionosphere.

Cairo, 1937.

The next Radio Convention to be held at Cairo in 1937 is to deal with the possibility of widening the amateur bands. In certain quarters it seems that there may be a possibility of allocating the old 30-metre band for special amateur use. The suggestion is that amateurs having special experiments of an important nature would be allocated this new band so as to be relatively free from interference.

Although the amateur bands are very congested, unless some new information is put forward there is going to be a great struggle before the amateurs get the widened wavebands.

The Pittsburgh Floods.

Amateur radio showed up to advantage during the recent floods in the Pittsburgh area. The A.R.R.L. headquarters at Hartford were completely under water and the fine transmitting gear there absolutely ruined. Five-metre receivers and transceivers were hurriedly put into use and a very good commercial service kept up until normal communications could be restored.

Even in the hands of non-technical operators some of the midget low-powered transceivers were able to transmit and receive messages to and from the local telephone exchange. Large towns actually organised 5-metre channels and handled normal traffic such as telegram and telephone calls in the usual way.

American Valves

British manufacturers are viewing with alarm the entry of all types of American valves into this country. For a long time now constructors have found that multi-valve receivers are expensive mainly because the valves cost as much as the actual receiver.

THE TELEVISION STAFF AT THE ALEXANDRA PALACE

Practically all the major staff appointments for the television service at the Alexandra Palace have now been made, including the lady announcer-hostesses on whose selection there has been so much speculation. There yet remains the appointment of the male announcer and the producer of feature programmes. Below we give brief particulars of the executive officers whose appointments have been definitely confirmed by the B.B.C. Mr. Gerald Cock, as has been announced in earlier issues, is Director of Television, and Mr. D. C. Birkinshaw Engineer-in-Charge.

MR. HYAM GREENBAUM (*Music Director*).

Mr. Greenbaum received his musical education at Brighton School of Music and the Royal College of Music, London. He joined the Queen's Hall Orchestra as Principal 2nd Violin in 1916 and remained in that position until 1925. He was Principal 2nd Violin and Pianist for Diaghileff Ballet from 1923 to 1936; has been music director and recording manager of a gramophone company, music director for various films, and held a similar position with C. B. Cochran productions for three years. He has conducted for the B.B.C. on several occasions during 1935 and 1936.

MR. STEPHEN K. THOMAS (*Producer*).

Mr. Thomas studied at the Royal College of Music and joined Nigel Playfair's Company at the Lyric, Hammer-smith, in 1918. He subsequently became stage director for Nigel Playfair and Dion Boucicault. He was technical and artistic adviser on lighting to the Exhibitions Division, Department of Overseas Trade, and superintended exhibitions in Toronto, Antwerp, Paris and Brussels. He has recently been stage director to the Camargo Ballet Society and has produced many plays, both straight and musical, in London, the provinces and abroad.

MR. DALLAS BOWER (*Producer*).

Mr. Bower was educated at Hurstpierpoint College and served with various electrical firms from 1923 to 1927. He afterwards turned his activities to sound film recording and has been identified with several of the leading film organisations in this country.

MR. HARRY PRINGLE (*Stage Manager*).

Mr. Pringle has had a varied stage career, playing and stage-managing in many types of show, pantomime, musical comedy, revue and variety,

MR. PETER BAX (*Stage Manager*).

Mr. Bax took up electrical engineering and stage lighting in 1919. From 1924 to 1930 he was assistant stage manager at Drury Lane and among other interests since then has undertaken an international season with C. B. Cochran. He designed scenery for "Mary Tudor" and has written a book on stage management.

MR. G. MORE O'FERRALL (*Assistant Producer*).

Mr. O'Ferrall was educated at Beaumont School and has been an actor, stage manager, stage director and producer. He has latterly had experience as an assistant film director in London studios.

MAJOR L. G. BARBROOK (*Film Assistant*).

Major Barbrook was educated at Rugby and Sandhurst. He retired from the Army in 1919 and from 1924 to 1928 was inspector of Gendarmerie in the service of the Albanian Government. Then for two years he was concerned with copper and oil production in America. In 1930 he entered the film business in Hollywood and Long Island. From 1931 to 1935 he was in charge of cinematograph arrangements for various expeditions in South America, France and Africa.

MISS JASMINE BLIGH (*Announcer-hostess*).

Miss Bligh is 22 years of age and has had three years stage and film experience. She is fond of open-air sports, with a preference for tennis, golf, squash raquets and riding. She has visited America, Italy and Switzerland and speaks French fluently.

MISS ELIZABETH COWELL (*Announcer-hostess*).

Miss Cowell is 23 years of age and has travelled extensively abroad. She speaks French and German and has considerable experience in mannequin work and has specialised in dress design and display.

JUNE, 1936

SOME NEW IDEAS IN MECHANICAL SYNCHRONISING

By W. R. FRANK, B.SC.

It may be argued that an investigation of synchronisation requirements for mechanical systems of scanning is not of great practical value at the present time in view of cathode tube development. The limit in mechanical methods of scanning has by no means been reached however, and for some purposes, such as scanning large cinema screens, they appear to be the only ones possible. The object of this investigation will be to work out the general conditions with which a suitable system must comply and to indicate necessary principles in its design.

FOR perfect scanning, the scanning points at transmitter and receiver must occupy the same positions relative to the picture boundaries at the same times. The two scanners should run at the same speed and also should be in phase. We are here more concerned with the first requirement since if our disc or drum is running at the correct speed, we can always

cannot be completely removed, but by suitable design it can be so reduced as not to affect definition.

The most usual method of synchronisation is to send out a strong pulse at the end of each line (Fig. 1). This pulse is applied direct to a toothed wheel synchroniser (Fig. 2), which, by exerting braking or accelerating torques at the ends of lines keeps the scan-

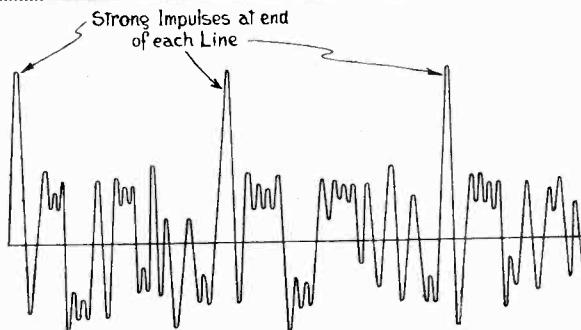
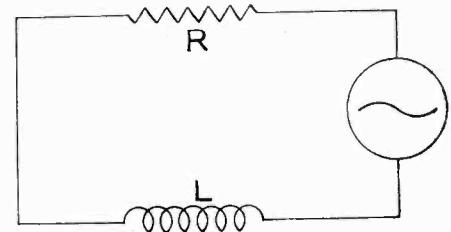

Fig. 1 (Left).—Graph showing the interposition of the synchronising signal at the end of each line.

Fig. 3 (Right).—An electrical analogy of inertia and friction. Inductance corresponds to inertia; Resistance corresponds to friction; Change in current corresponds to change in velocity.



frame the image by rotating the motor in the required direction. An idea of the nature of the problem is obtained when the requirements are worked out numerically. Roughly, the speed must not vary more than one part in two thousand from the transmitter and

ner running at the correct average speed. There is no control in the middle of the line, and for this reason the system is unsatisfactory when high-definition is required. Some form of continuous control is required. (Fig. 2.)

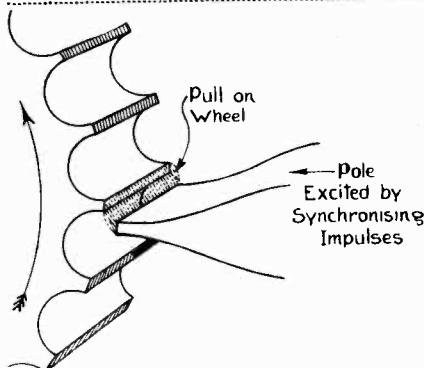
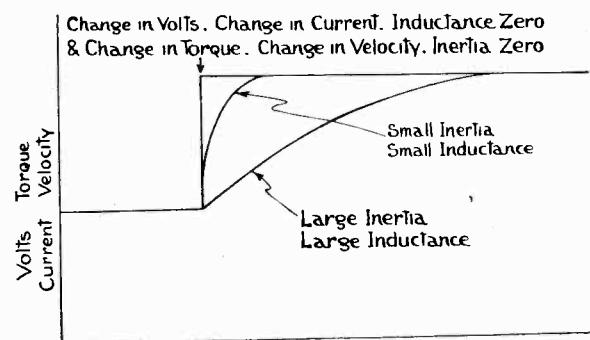

Fig. 2 (Left).—How the synchronising impulse is applied to the toothed wheel.

Fig. 4 (Right).—Diagram showing the effect of inductance on change of current as an analogy of the effect of inertia on the change of velocity.



between adjacent lines. This would be for a two-hundred-line square picture.

The efficiency of the system will be measured by the fidelity with which the receiving scanner follows variations in speed of the transmitting scanner. Let us assume that the transmitter is altering in speed, say, accelerating. The receiver will also accelerate, but with a slight lag behind the transmitter. If the transmitter is slowing down, then the receiver will also slow down, but again with a slight lag behind the transmitter. This lag is inherent in all systems, and

Since synchronising torque can only be obtained by an actual difference in position between receiver and transmitter scanning spots, we must ensure that such torque shall be as large as possible for very small differences. We therefore have our first design requirement. A powerful synchronising torque must be brought into play by the smallest error in the position of the scanning spot.

Any change in speed is opposed by a torque due to the inertia of the rotating system. Motor, disc or drum, and synchroniser, all possess inertia. The

THE SYNCHRONISING CONTROLLING FACTOR

torque required for any given rate of acceleration is proportional to the moment of inertia of the object being accelerated. If our scanner is to respond quickly to synchronising torque, we must keep down the inertia

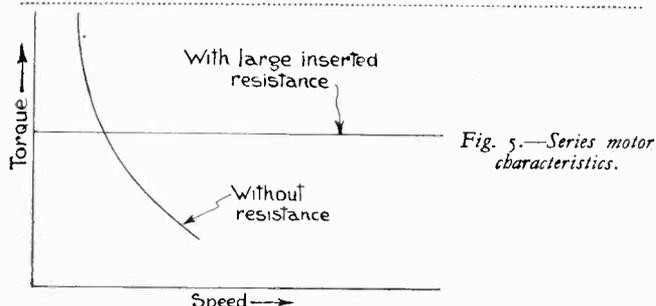

Fig. 5.—Series motor characteristics.

of all moving parts. This is our second requirement.

Change in speed also entails change in the mechanical damping of the system. If the motor drives the disc at some steady speed fixed largely of course by friction due to the air and bearings, then any change in speed will be opposed by change in this damping, which increases with speed. We must not, however, assume that mechanical damping must be reduced to a minimum. On the contrary, the damping must be made the controlling factor in the system, for this reason; that even though the inertia be reduced to a minimum, it will always cause the change in speed to lag behind the synchronising torque.

If inertia were absent then the speed would change instantaneously to its required value. We can never obtain this condition in practice, but it can be approached by increasing the damping. It will be noted that increase in damping also means increase in the synchronising torque required and also in the power output of the motor. A limit will be approached when further increase gives little advantage, because the increased weight of the motor offsets the extra damping. What really matters is the ratio

$$\frac{\text{Damping}}{\text{Moment of Inertia}}$$

which should be as large as possible.

The same point is well illustrated by the electrical analogy (Fig. 3) of a circuit containing inductance and resistance. Inductance and resistance have properties very similar to those of mass or inertia and mechanical damping. This can be seen if we substitute current for velocity. An inductance always opposes any change of current through it, a resistance, of course, opposes current in accordance with Ohm's Law. In this circuit, if the voltage be changed, then the current will also change, but will always lag behind the voltage.

The larger the ratio $\frac{\text{Resistance}}{\text{Inductance}}$ the more nearly will the current follow the voltage (Fig. 4).

Our third requirement then is that the ratio

$$\frac{\text{Total moment of inertia}}{\text{Damping}}$$

must be as large as possible.

A point often overlooked is that the electrical characteristics of the motor affect the synchronisation. Two types are in general use, shunt and series-wound D.C. or A.C. motors.

Assume that the synchronising frequency is increasing. Then the system is speeded up. Due to this increase in speed, the torque exerted by the motor actually falls, and the synchroniser, in addition to extra power required because of increased damping, has also to supply this loss in the motor. We require a motor which will give the same torque for all speeds over the range considered. This requirement is best met by a series-type of motor. The characteristic can be improved by putting a large resistance in series with the motor. This resistance ensures that, whatever the motor speed, the current taken, and consequently the torque exerted, are practically constant.

The effect of resistance on a series motor characteristic is shown in Fig. 5.

A type of motor very seldom used by the amateur, chiefly because a three-phase supply is not available, is the induction motor. A slip-ring induction motor, with leads brought from the brushes for speed control

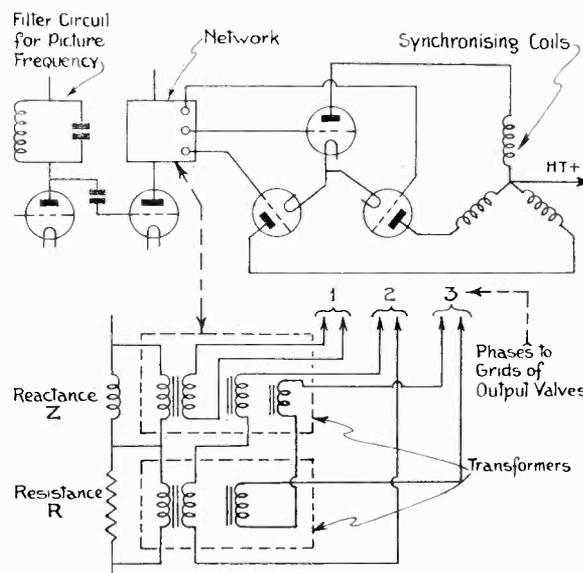

Fig. 6.—Circuit showing how three phases can be obtained from a suitably designed network.

by means of variable resistances, should be ideal from a television point of view. If run at well below synchronous speed, a series-type of characteristic can be obtained, there is no sparking to give radio-frequency interference, and a smoother torque than is possible with a commutator machine can be obtained.

We see, therefore that whatever type of mechanical scanning equipment we employ, we must satisfy these three fundamental requirements:

1. The ratio $\frac{\text{Synchronising torque}}{\text{Error in spot position}}$ must be as large as possible.
2. The ratio $\frac{\text{Damping}}{\text{Inertia}}$ must be as large as possible.
3. The driving motor must give constant torque for all speeds.

In addition to these requirements, economic considerations indicate that if the cost of the synchronising equipment is to be kept low, the synchronising

DESIGN FOR THREE-PHASE SYNCHRONISER

power must be small. For this reason the inertia of the system must be kept as small as possible.

Changes in conditions at the receiving end will place extra demands on the synchroniser. Such changes will occur in bearing friction and in the driving motor resistance. The design should ensure these being kept to a minimum. In the second case, which will be the more important, resistances with small temperature coefficients should be employed.

We shall now attempt to indicate in general a design incorporating the above features.

In commencing any design, the scanning mechanism should first be considered. It can be of any type, disc, mirror-drum, or mirror-screw, but it should have as small a moment of inertia as possible. Since we are not interested here in detail design of a scanner, but in the problem of running it at correct speed, we shall carry on to the next component, which should be the motor, and with it, since the two cannot be separated, some method for introducing extra damping.

To obtain as large a value as possible for the ratio

$$\frac{\text{Damping}}{\text{Inertia}}$$

the motor must have a larger inertia than the scanner, since the power output, which is proportional to the damping, is also proportional to the motor size. In practice, double the scanner inertia will be a practicable ratio.

To ensure that this increased motor power drives the system at the correct speed, the damping must be increased. Best results will be obtained by using variable damping as a speed control. The motor should always be run to give maximum torque, in fact, from the ordinary point of view it should be overloaded. The motor should be designed to give as high a value

as possible for the ratio

$$\frac{\text{Power output}}{\text{Inertia}}$$

The orthodox types are not built with this as a primary consideration, and consequently it is fairly easy to design motors more satisfactory in this respect. The rotor should be as light as possible, and special provisions should be made for keeping it cool. The three-phase induction motor lends itself to the requirements, since if a low rotor voltage be employed, insulation is not so important, and higher working temperatures are possible.

Damping can be controlled either mechanically or electrically. A mechanical control could consist of a disc running in oil. A less messy method is that employed in the ordinary domestic meter, a disc of copper or aluminium rotating between the poles of a strong magnet. Variable damping is obtained by moving the poles over the edge of the disc. With a disc scanner, the edge of this could be employed. This method gives easy control, and by employing strong electromagnets, very strong braking effects are possible, as all who have seen the well-known effects of Lenz's Law demonstrated will realise.

Having decided on the design of our scanner, the output of our motor, and the method to be employed for damping adjustment, we come to the synchroniser itself. It has been pointed out that the present type of impulse synchroniser is fundamentally unsuitable,

and that some form of continuous control is desirable. One method of obtaining continuous control is the synchronous motor principle. Since a single-phase synchronous motor does not give a smooth torque, a three-phase one is desirable. The required frequency can be filtered from the signal, and three phases obtained from a suitably designed network. Three valves are required to feed the synchroniser. A suitable circuit illustrating the principle is shown in Fig. 6. The size of motor and synchronising power required for any degree

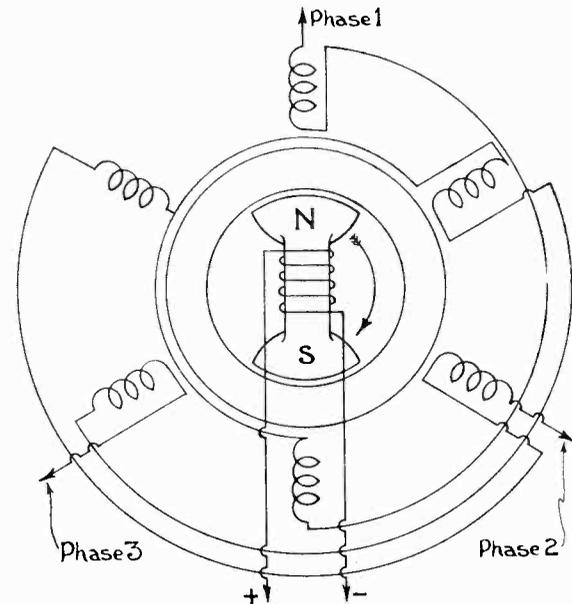

Fig. 7.—Three-phase synchroniser.

of definition is difficult to work out theoretically and can only be obtained by practical tests. Since the object of this article is to indicate principles, we must pass over detail design. In a later article the writer hopes to give details of a mechanical scanner now being developed.

For the benefit of readers not conversant with the three-phase synchronous motor, a brief description may be desirable. The arrangement is shown diagrammatically in Fig. 7, for a simple synchronous motor which would run at the frequency of its supply. Opposite poles are connected to the three phases of the supply, when a magnetic field actually rotates round the motor at the supply frequency. This field will push before it any pole of fixed polarity placed in its path. The rotor is designed to give two such poles in this case, and so rotates at supply frequency. Such a motor has a tendency to "hunt," which can be reduced by putting a shorted damping winding in the rotor pole faces.

It may be advisable to employ a higher frequency than the picture-frequency, when more poles would be necessary. This is because a change in the load would cause the rotor to lag to a different extent behind the rotating field. The lag measured in degrees as apart from the electrical lag will be less the larger the number of poles. Any harmonic of the picture-frequency can easily be obtained by suitable filter circuits.

FOR THE BEGINNER

SIMPLE FACTS ABOUT TIME BASES

POINTS ON THEIR OPERATION

By J. H. Reyner, B.Sc., A.M.I.E.E.

This article is supplementary to that which appeared in the March issue on the practical operation of time bases. The theory has been dealt with in a simple manner in the series of articles entitled the ABC of the Cathode-ray Tube which appeared in the September and October issues of last year.

THE gas-discharge tube is expensive and somewhat erratic in operation. With proper precautions this difficulty can be reduced to small proportion, but it is not surprising that numerous attempts have

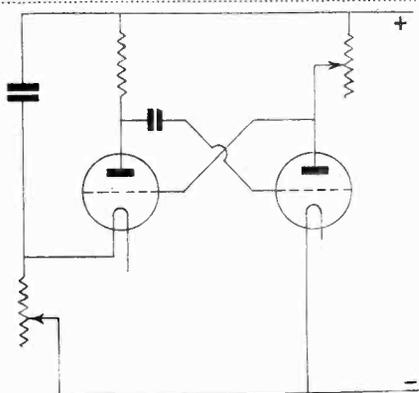

Fig. 5.—Puckle time base.

been made to dispense with the tubes in time-bases and to obtain the necessary action with ordinary hard valves.

It was explained in the preceding article that with the use of an ordinary valve, the rise of the anode current is not sharp enough to give the really rapid discharge which is essential. Various ways of doing this have been suggested, two of which are mentioned here. The first of these is the time base suggested by Puckle. It is a development of the multi-vibrator circuit and is shown in Fig. 5. A valve is connected across the condenser in the ordinary way. In the anode circuit of the discharge valve is a resistance of a few hundred ohms, and the voltage drop across this is applied to the grid of a second valve, the anode of which is connected back to the grid of the first valve.

An increase of current in the first valve causes a decrease in the grid voltage of the second. This causes a decreased anode current and hence the anode voltage rises and since this is connected to the grid of the first

valve this grid becomes more positive than it was before, so that the anode current increases. This causes a further decrease in the grid voltage of the second tube which, in turn, causes a further increase in the grid voltage of the first and so on. The current builds up very rapidly and discharges the condenser completely, after which the reverse action sets in and the arrangement re-sets itself ready for the next discharge.

The steady voltage on the grid of the first discharge tube is controlled by the anode resistance in the second tube, for this resistance and the second valve in series act as a potentiometer across the supply, rather in the same manner as the circuit of Fig. 3. This form of circuit works very well and if the values are suitably chosen quite a satisfactory fly-back can be obtained.

Another form of time base is one suggested by McCarthy. This is a surprisingly simple arrangement in which the sudden change of anode current when the discharge starts is utilised to continue the action. In the anode circuit of the discharge valve is a coil and this is coupled to

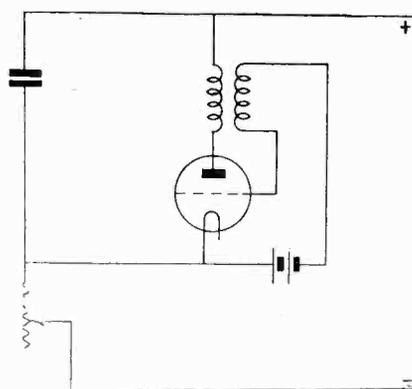

Fig. 6.—McCarthy time base.

a second coil in the grid circuit. The directions of the windings are such that an increase in the anode current

causes an increase in the grid voltage so that we have exactly the conditions we require and an anode current, once started, will grow larger and larger until the condenser is completely discharged.

Either of these circuits may be used with an ordinary series resistance

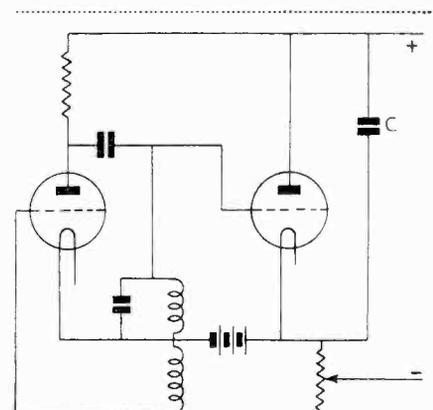

Fig. 7.—Discharge triggered by oscillating valve.

feed or with a constant-current device such as a screened pentode, this being immaterial to the operation.

Other forms of hard valve time base have been suggested and are really too numerous to discuss in detail. The Americans favour an oscillating valve which is operated under such conditions that the oscillation produced is extremely peaky in character. This gives the requisite sharp pulse of current required to discharge the condenser.

So far we have made the discharge self-controlled but it is not necessary for this to be the case. We can arrange an oscillating circuit in such a manner that it will trigger the discharge valve at the right moment. The grid of the discharge valve is over-biased so that no current flows. The voltage on the oscillating circuit, however, varies the grid above and below this mean value and by correct adjustment we can arrange that on

(Continued on page 384).

Special Short-wave Section

SOME OF THE CONTRIBUTORS

Basil Wardman, G5GQ
H. R. Adams, G2NO
W. Ingersoll, W9BHT
Lloyd G. Morse, W1CAA

Norman Brandon, 2BZN
John F. Lucas, 2BDN
Max. Buckwell, G5UK
Kenneth Jowers, G5ZJ

The Short-wave Amateur

SHORT-WAVE radio has never before presented such an interesting front. From every angle short-waves are coming into daily use. The ardent short-wave listener is now taking up transmitting and doing very good work. The short-wave listener, who in the past has only heard an odd station at irregular intervals, is now finding it possible to hear entertaining foreign programmes with great regularity. During the past year, due largely to the advertising by commercial set makers, a large number of all-wave receivers have been sold. These receivers have generally been used by ordinary broadcast listeners, and the effect of this has been to introduce many newcomers to short-wave

listening, and although perhaps some may have been disappointed at the results obtained on the short-wave side of their all-wave receivers, there have been many who find the thrills of short-wave listening somewhat similar to tuning the broadcast receiver of ten years ago.

It is agreed that a lot more interest was obtained when the receivers were inefficient and the broadcast stations had low power. Those who in the early days used two and three-valve sets with headphones and were accustomed to picking up all the B.B.C. relay stations and a number of out-of-the-way foreigners have found little to interest them for the last year or so owing to the high efficiency of a modern multi-valve receiver.

Short-waves now provide that additional interest. Transmissions can be picked up from all over the world. These transmissions are not always of the stereotyped kind, for very often broadcasts such as the landing of a record-breaking aeroplane, the arrival of Graf Zeppelin or broadcasts from ships at sea, aeroplanes in flight and similar broadcasts can also be picked up.

A topical example of this is the *Queen Mary*, which sails on May 27. In this issue the first article deals with the wavelengths and programme matter to be broadcast. Every owner of a receiver tuning below 70 metres should make a special point of following up

the progress of the *Queen Mary* on her maiden voyage.

We have endeavoured in this section to provide material for every type of short-wave listener, and also for the

teur. Although licensing regulations are fairly rigid, the number of licences being issued is steadily increasing. The majority of transmitting amateurs make the very best use of these experimental licences, although one or two do not seem to know what to do with them.

This is rather to be deplored. We have in mind a transmission heard on the 160-metre band. Two stations, about 50 miles apart, made long calls of three or four minutes' duration as if they were working some real DX. The tests consisted of altering the bias on the speech amplifier. From the way these tests were carried out it was obvious that a loudspeaker or meter on the end of the amplifier would have been more satisfactory and a lot quicker than putting out distorted signals over the air.

SPECIAL FEATURES IN THIS SECTION

The *Queen Mary* Short-wave Transmissions.

The Short-wave Battery Four
A New Super-het Tuning System
Transmitting for the Beginner
The Battery Short-wave Super-het
The Short-wave Radio World
Modulation Measurement with the Cathode-ray Tube

World-wide Short-wave Reception Contest
Short-wave Coils for the Constructor
A Portable Battery Operated Transmitter
Building the Power Amplifier Stage

non-technical and highly-technical transmitting amateur.

The full-fledged short-wave listener should make a special point of reading about the new super-het tuning system which is to be embodied in our first autumn receiver.



W9LXX operated by Alice R. Bourke at Chicago is one of the widely heard American stations. In addition to a fine phone and C.W. transmitter on the left the receiving section is right up to date.

The "Queen Mary" Short-wave Transmissions

A wonderful series of short-wave transmissions are to be radiated from the "Queen Mary" on her maiden voyage. Make sure of hearing these programmes with a short or all-wave receiver.

THIRTY-TWO different wavelengths are being used by the *Queen Mary* on her first voyage to America when she leaves on May 27. The wavelengths used will be divided up in the following way: 20 for short-waves, 11 C.W. and 9 for radio telephony, 7 for long-waves, 5 medium-waves.

Nine Aerials

For operation on these wavelengths there are at least nine separate aerial systems, comprising one main aerial, having a length of 600 ft., one auxiliary aerial of 150 ft., three short-wave aerials, three receiving aerials and one for emergency use.

This elaborate aerial system is made necessary by the variety of operations on board the ship involving the use of radio. Every modern device for the reception of wireless or radio telephone messages has been installed so that the *Queen Mary's* radio station will be comparable with the most modern land station and will be operated on similar lines.

Dual Radio-phone System

Not only will there be a ship-to-shore telephone service, but the equipment will be duplicated so that two passengers can speak simultaneously. For example, one passenger could be in communication with New York and the second with London or Paris.

Telephone booths are provided at suitable positions on the ship, but in addition 500 staterooms are connected to the main transmitter by telephone.

The receiving station of the *Queen Mary* is situated on the boat deck between the first and second funnels, so the control of the entire radio equipment is concentrated to this point. This radio room occupies an area of 800 square feet housing 8 operating positions, radio telephone exchange, the emergency installation and the telegraph office where passengers hand in cablegrams.

Typewriters and high-speed teleprinters for transmission have been installed, while telephones are available for linking up with the control bridge and other important positions.

It is interesting to note that the transmitters can be remotely controlled from the receiving station. Actually, the transmitting station is 350 ft. away from the receiving bay and is arranged for duplex transmission and reception.

This transmitting station consists of four high-power transmitters each capable of maintaining continuous com-

munication with both sides of the Atlantic and almost all parts of the world.

Each of the wireless operators on duty in the receiving station will have in front of him a dial similar to those on automatic telephones. With this dial he will be able to start up or shut

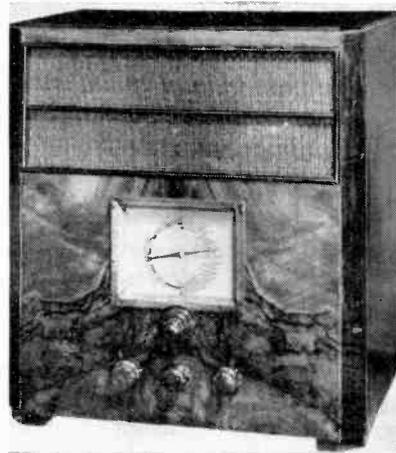

This Hyvollstar all-wave superhet is a fine receiver for broadcast or short-wave listeners. Although it only uses three receiving valves and a mains rectifier it is very selective. The short-wave tuning dial is marked in station names to enable those unacquainted with short-waves to find the long distance stations without difficulty.

down a transmitter 350 ft. away, increase or decrease power as required, and change to any of four frequency channels. Each of these operations take only a few moments to carry out, and indicators keep the operator

informed of the conditions under which the transmitter is functioning.

Elaborate precautions have been taken to prevent the radio equipment being put out of action through loss of power. The whole system is supplied by a special power plant, the dynamos in which are duplicated in case of breakdown. In the possibility of an emergency an entirely separate transmitter operated from large capacity wet batteries is available.

A series of programmes are to be broadcast from this ship from May 27 until June 1. Many of these are being relayed by all B.B.C. stations, but in addition the following broadcasts will be available to owners of a short-wave receiver.

All the programmes below are in addition to the large number already to be broadcast by the B.B.C., but there are also other daily programmes which can be received, either directly from the boat or through the Columbia Broadcasting System or National Broadcasting Co. Approximate details are as follows:—

The following call signs and wavelengths are being used:—

Queen Mary,

- GBTT, 95.5-16.5 metres.
- Columbia Broadcasting System, W2XE, Wayne, N.J. 13.94 metres, 16.89 metres, 19.65 and 49.02 metres.
- National Broadcasting Co., W8XK, Pittsburg, 13.93 metres, 19.72 metres, 25.26 metres, 48.86 metres;
- W3XAL, Boundbrook, N.J., 16.87 metres and 49.18 metres;
- W2XAD, Schenectady, N.Y., 19.56 metres.

Date.	Time.	Programme.
May 27	4-4.10 p.m.	Commentary and News.
May 27	5-5.15 p.m.	Feature programme.
May 28	5-5.15 p.m.	Feature programme.
May 30	5-5.15 p.m.	Feature programme.
May 31	4.30-4.45 p.m.	Dance music.
May 31	3.30 p.m.	Religious service.
May 31	6-6.15 p.m.	Talk Feature programme.
May 31	7-8 p.m.	
June 1	2 p.m.	Commentary on arrival at Ambrose Light.
June 1	3 p.m.	Arrival at Quarantine station.
June 1	4.30-5.30 p.m.	News and Commentary.
June 1	9.30-10 p.m.	Special broadcast by Sir Edgar Brittain from Radio City, New York.

Time.	Station.	Programme.
12-12.15 a.m.	Queen Mary and all C.B.S. stations	Columbia programme.
12.15-12.30 a.m.	Queen Mary and all N.B.C. stations	N.B.C. programme.
1.50-1.55 a.m.	Queen Mary and B.B.C. Empire stations	News and Commentary.
2-2.15 a.m.	Queen Mary only	News and Commentary.
9.30-10 p.m.	Queen Mary	Five minute news flashes.
10.45-10.55 p.m.	Queen Mary only	News commentary.

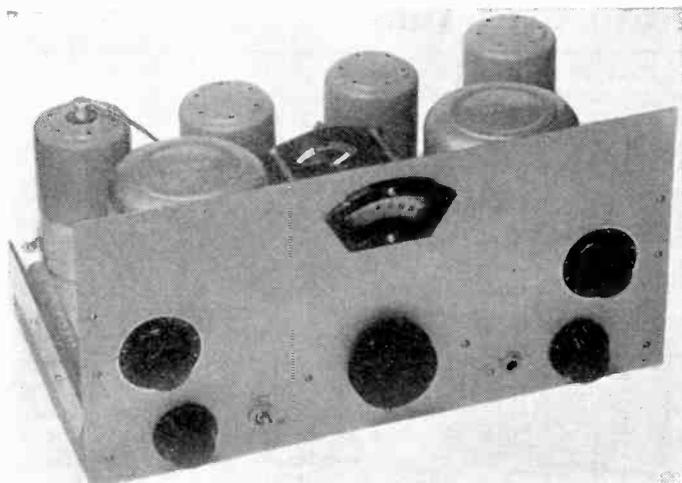

Stability is but one of the many fine features in this receiver. Trimmers are also available for accurate ganging of the two coils.

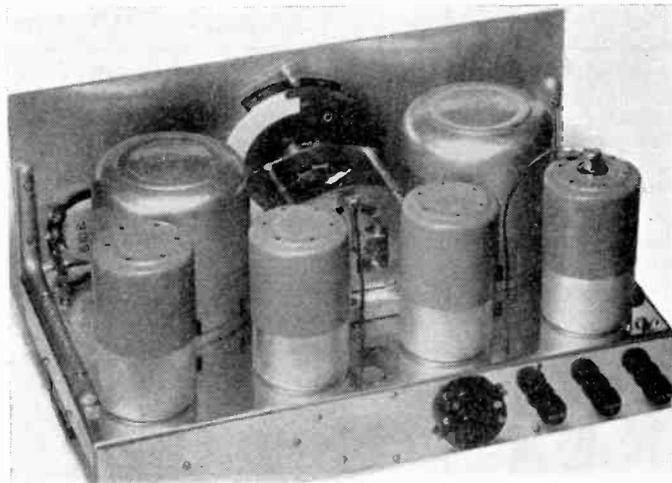

Shielding is very complete and owing to the use of cans for all valves the receiver has a very commercial appearance.

The Short-wave Battery Four

This receiver was designed in response to numerous requests from readers requiring a simply tuned short-wave receiver with high audio output.

HERE can be no question that the most popular receiver for all-round short-wave listening is the I-V-1 with a tuned high-frequency stage. This set seems to fulfil the demands of most of our readers inasmuch as it is suitable for general amateur band reception in addition to programmes from commercial broadcasters. It, however, has been agreed that for broadcast listening, that is reception of the American stations of entertainment value, a larger L.F. stage is necessary so as to give a reasonably high audio output.

We have spent several months on a

seem to be part of some badly designed receivers, have been entirely eliminated. Perhaps we can convey more clearly just what we mean by saying that this receiver is published in its present form only after having been in continual use at an amateur station for several months. The efficiency on all amateur bands is of a high level.

The theoretical circuit gives a bare outline of the valve line up. Going through it in correct sequence the following points will be noticed. The aerial coil has two windings, a primary and a secondary and owing to the use of two aerial terminals the input can

that the receiver is suitable for use with a doublet type of noise-suppression aerial.

The tuning condenser is of the .00016-mfd. two-gang type, one half being in the aerial circuit and the second half in the grid circuit. We are of the opinion that ganging coils in a receiver of this kind is too much of a problem for the average amateur. With almost all efficient ganging, a slight loss is bound to occur, and for this reason we have included balancing condensers so that odd coils can be used, the differences being made up by balancing condensers.

The first valve is an SP215, high-frequency pentode which in this circuit gives a distinct gain down to well below 20 metres; and owing to its high impedance enables the circuit to be made reasonably selective. Perhaps the fact that the valve has a slope of 2.3 m/a. per volt will enable readers to appreciate our choice of this valve.

Choke Design

We cannot stress too highly the importance of using the specified high-frequency choke in the H.F. stage. To a certain extent this governs the stage gain obtained. Also note that the screen voltage is controlled by means of a 100,000-ohm Erie potentiometer. This is mounted on the baseplate so that the screen voltage can be adjusted within very narrow limits, giving optimum operating conditions. The spindle of this potentiometer has been slotted so that the screen voltage can be varied by simply using a screw-driver to vary the potentiometer value. If any other type of potentiometer is used the spindle must be isolated from the resistance.

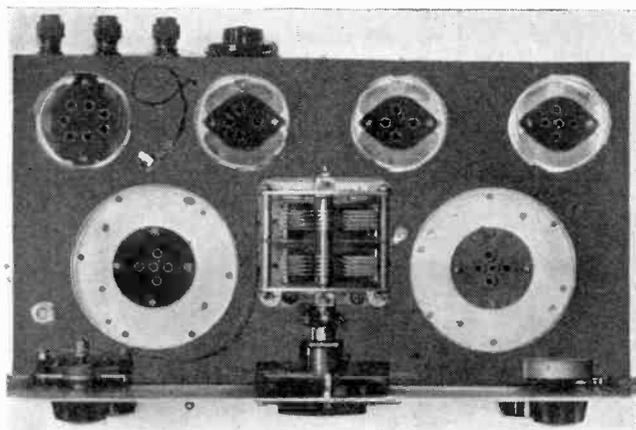

Most of the wiring is below the baseplate as can be seen from this plan view.

design of such a receiver so that it will be suitable for the merest novice, easy to operate and to cover all wavelengths from 12 to 200 metres.

All the little defects such as separate tuning controls, "pulling" between stages, rough reaction, slight instability and similar small complaints which

be connected to the primary coil or to the secondary coil through a 15-mmfd. condenser as required. This takes care of selectivity and damping on all wavelengths with almost any type of aerial. Also, as a matter of interest, the earthy side of the primary coil instead of being connected to earth can be left free so

up the negative wires underneath the chassis. All the earthy points in the H.F. stage should be taken to one centre point and then earthed directly to the earth terminal. Similarly with the detector circuit, bunch all earth wires together and join them up to the earth terminal in one fairly solid connection. The output choke, inter-valve transformer, and anode chokes are all mounted on the side of the chassis, but if there is any doubt as to the stability of the wiring the resistances and condensers should be anchored down instead of letting these smaller components be held in position by the wiring.

Power Supply

As regards power supply, 120-volts are ample, but if a mains unit is to be employed go up to 150 volts, for there is quite an appreciable increase in gain, though a rather large increase in anode current. This, of course, does not matter in the latter circumstances.

This receiver having been put through its paces so very thoroughly, will fulfil the demand of many of our readers who wish for trouble-free short-wave reception. Even the beginner with a little patience would be advised to consider a set of this kind rather than the ordinary two-valver. It will give plenty of stations, and what is more, ample volume. It has been our experience that broadcast listeners accustomed to 3 or 4 watts output from a medium-wave receiver are rather disappointed when they find the average short-wave set only gives about 200 milliwatts. The PEN220 gives almost ½-watt of audio, but by using a PEN220A, 150 volts H.T. and a bias resistance of 1,000 ohms the output can be pushed up to a little over 1,000 milliwatts, which is ample for general use. No blueprint of this receiver is available, but we shall be very glad indeed to help any reader with constructional problems.

The Eimac 150T

WE are very pleased to publish some details on the Eimac 150T medium powered radiation cooled triode. It has been so designed that optimum efficiencies can be realised at both radio and audio frequencies. The following characteristics give some idea as to what may be expected from this valve.

- Filament voltage (A.C.), 5-5.25 volts.
- Filament current, 10 amperes.
- Amplification factor, 13.
- Grid-plate capacity, 3.5 mmfds.
- Grid-filament capacity, 3.0 mmfds.
- Anode-filament capacity, 0.5 mmfds.
- Maximum rating on frequencies less than 40 mc. is as follows:—
- Maximum plate anode voltage, 3,000 volts.
- Maximum anode current, 200 ma.
- Maximum grid current, 50 ma.
- Maximum anode dissipation, 150 watts.

The following results can be realised under optimum circuit conditions and are suitable for 100 per cent. anode modulation.

- Anode voltage, 1,000, 2,000, 3,000.
- Anode current, 200 ma., 200 ma., 200 ma.
- Grid current, 35 ma., 35 ma., 35 ma.
- Grid bias voltage, -200, -400, -600.
- Power output (watts) 75 per cent. efficiency, 150, 300, 450.

A smaller version of the above valve is the 50T with the following characteristics:—

- Filament voltage (A.C.), 5-5.25 volts.
- Filament current, 6 amperes.
- Amplification factor, 12.
- Grid-anode capacity, 2 mmfds.
- Grid-filament capacity, 2 mmfds.
- Anode-filament capacity, .4 mmfds.
- Maximum ratings for all types of service on frequencies less than 56 mc.
- Maximum anode voltage, 3,000 volts.
- Maximum anode current, 125 ma.
- Maximum grid current, 30 ma.
- Maximum dissipation, 75 watts.

The following operating conditions are also given:

- Anode voltage, 1,000, 2,000, 3,000.
- Anode current, 100 ma., 10 ma., 100 ma.
- grid current, 25 ma., 25 ma., 25 ma.
- Grid bias voltage, -200, -400, -600.
- Power output (watts) 75 per cent. frequency, 75, 150, 250.

These valves have the anode leads brought out to the top of the bulb with the grid lead coming through the envelope on one side. This permits the use of a simple base and at the same time allows for very low inter-electrode capacity. The manufacturers claim that the 50T has the lowest inter-electrode capacity of any valve of a similar power rating. Other valves in this range are 35T, 300T and 500T. Full information can be obtained from Eves Radio, G2NO, 11 Lichfield Street, Wolverhampton.

SHORT-WAVE BATTERY FOUR.

CHASSIS AND PANEL.

- 1—Cadmium plated 14 ins. by 7½ ins. by 2 ins., 18 gauge (B.T.S.).
- 1—Aluminium panel 14½ ins. by 7 ins. by 16 ins., gauge (B.T.S.).
- 2—Copper screens 3 ins. by 1½ ins by ½ in., 20 gauge (B.T.S.)

CONDENSERS, FIXED.

- 1—.0001-mfd. type M (T.C.C.).
- 1—.0001-mfd. type 34 (T.C.C.).
- 1—.0003-mfd. type M (T.C.C.).
- 2—.001-mfd. type M (T.C.C.).
- 1—.002-mfd. type M (T.C.C.).
- 1—.003-mfd. type 34 (T.C.C.).
- 1—.01-mfd. type M (T.C.C.).
- 2—.01-mfd. type tubular (T.C.C.).
- 1—.1-mfd. type tubular (T.C.C.).
- 2—.1-mfd. type 250-volt (T.C.C.).
- 2—.2-mfd. type 250-volt (T.C.C.).

CONDENSERS, VARIABLE.

- 1—Air-spaced trimmer 25-m.mfd. (Polar).
- 1—Trimmer type SW95 (Bulgin).
- 1—Type 900/20 (Eddystone).
- 1—Type 900/40 (Eddystone).
- 1—Type 900/100 (Eddystone).
- 1—Two-gang type VC2 (Raymart).

COILS.

- 2—Sets type 4-pin (B.T.S.)

CHOKES, HIGH-FREQUENCY

- 2—Type 983 (Eddystone).
- 1—Type CHP (Raymart).

CHOKE, LOW-FREQUENCY.

- 1—HT15 (Wearite).

DIALS, SLOW-MOTION.

- 1—Type 2092 (J.B.).
- 2—Type 1P7 (Bulgin).

FUSE.

- 1—Wanderfuse 60M/a (Belling-Lee).

HOLDERS, VALVE.

- 1—7-pin type chassis (Clix).
- 5—4-pin type chassis (Clix).
- 1—5-pin type chassis (Clix).

PLUGS, TERMINALS, ETC.

- 3—Type B terminals marked A1, A2 and E.

- 2—Wander plugs, type midget HT +, HT — (Belling-Lee).
- 2—Spade terminals, type 1025, marked LT +, LT — (Belling-Lee).

- 1—Type P9 cable plug (Bulgin).
- 1—Plug-top connector type 175 (Belling-Lee).
- 1—Jack type J7 (Bulgin).
- 1—Plug type P38 (Bulgin).

RESISTANCES, FIXED.

- 1—500-ohm type 1-watt (Erie).
- 2—5,000-ohm type ½-watt (Erie).
- 2—10,000 ohm type ½ watt (Erie).
- 1—10,000-ohm type 1-watt (Erie).
- 2—100,000-ohm type ½-watt (Erie).
- 1—250,000-ohm type ½-watt (Erie).
- 1—3-megohm type ½-watt (Erie).

RESISTANCES, VARIABLE.

- 1—100,000-ohm potentiometer (Reliance).
- 1—5-megohm potentiometer (Reliance).

SUNDRIES.

- Connecting wire and sleeving (Peto-Scott).
- Quantity of 6BA nuts and bolts (Peto-Scott).
- 2—Panel brackets type PB3 (Bulgin).
- 1—Flexible shaft connector (J.B.).
- 1—Coil screened wire (Bulgin).
- 4—Valve screens (Colvern).
- 2—Coil screens (Colvern).
- 2—K/16 knobs (Bulgin).
- 1—K4 knob (Bulgin).

SWITCH.

- 1—Type S123 (Bulgin).

TRANSFORMER, LOW-FREQUENCY.

- 1—Type AF10 (Ferranti).

ACCESSORIES.

ACCUMULATOR.

- 1—Type DTG (Exide).

BATTERY, HIGH-TENSION.

- 1—Type 120-volt Popular Power (Ever-Ready).

LOUD-SPEAKER.

- 1—Type Baby (W.B.).

VALVES.

- 1—SP215 Met (Mazda).
- 1—HL2 Met (Mazda).
- 1—PT2 (Osram).
- 1—L2 (Mazda).

Surrey Radio Contact Club

Over thirty members attended a junk sale and discussion on aerials held at the Railway Bell Hotel, West Croydon, on April 14. A large number of active transmitters started the discussion, which was eventually joined in by all members present. Over twelve visitors were welcomed and altogether it was a most satisfactory meeting. The next meeting will be held at the Railway Bell Hotel on June 9, when a discussion on 56 mc. activities and the club's new transmitter will be held.

The New Radio Handbook

We have received a copy of the new Radio Handbook published by Pacific Radio Publishing Co., and handled in this country by G5KA, 41 Kinfauns Road, Goodmayes, Essex.

It is priced at 5s. 3d. post free, and we consider it to be very good value for money. Those who are interested in American transmitting valves will find a great deal of data such as wattage input, bias required, maximum dissipation, etc.

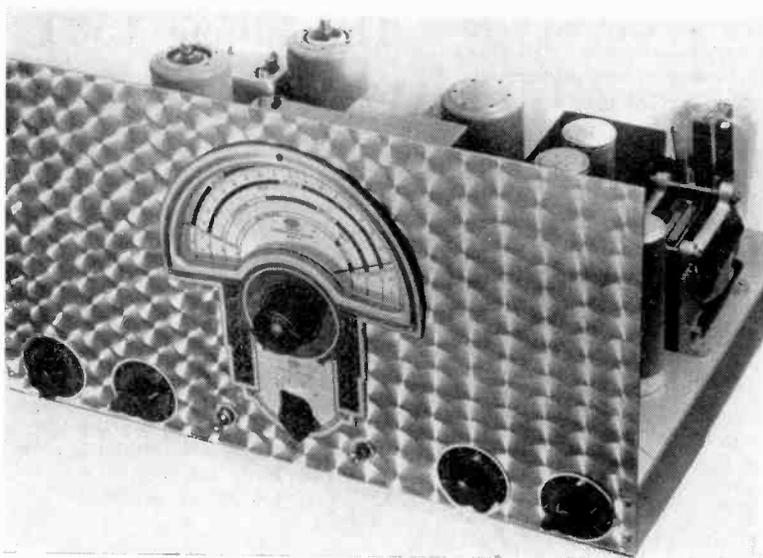

A New Super-hot Tuning Unit

First details of a new receiver incorporating the Tobe tuner which is yielding such remarkable results.

The main point of this tuner is the wide tuning range on the amateur bands. Here are some examples:— 20 metres $6\frac{1}{2}$ ins.; 40 metres $5\frac{3}{4}$ ins.; 80 metres $4\frac{3}{4}$ ins.; 160 metres $3\frac{3}{4}$ ins.

ON Page 288 of the May issue we described the Tobe kit receivers and gave some brief details of the marvellous new Tobe type H amateur tuner. Our experiments with a super-hot using this tuner have proved so satisfactory that we are giving herewith some advance details of the receiver which will probably be published in the August issue.

As we have already mentioned, this tuner forms the nucleus of a highly efficient communications receiver inasmuch as it includes accurately aligned R.F. and detector-oscillator stages, complete with band switching and trimmers.

The tuner has been designed to cover the bare amateur bands with only the slightest overlap to cover any small variations that might occur. Our receiver has been designed for strictly amateur use and to that end embodies most of the features only to be found in expensive commercial kits. The valve line-up is R.F. amplifier using a 6D6, a detector oscillator, a6A7, two stages of intermediate-frequency amplification with regeneration using valves of the low capacity VMP4G type. A double-diode-triode second detector AVC and L.F. amplifier uses an MHD4 to which is coupled a beat note oscillator of the electron-coupled type using an AC/HL.

Phone Jack

Provision has been made for a phone jack after the first L.F. amplifier, while an output pentode of the steep slope type gives an output of 3.4 watts. A special transformer giving an output of approximately 280 volts with filament secondaries to take both the American and British valves has been specially designed. It is a very small transformer and has the common centre taps and electrostatic screen internally con-

nected to its case. This makes wiring more simple, for as the transformer is bolted to the chassis, negative connections are made automatically.

The beat-note oscillator is semi-tuned to a frequency of 456 Kc. and is so arranged that when the beat-note is in circuit for C.W. reception the A.V.C. is automatically switched out of circuit.

Stage gain in the I.F. circuit is controlled by a variable cathode bias resistance which helps very materially to reduce noise level. R.F. gain can be adjusted by means of a variable resistance network.

Another point that will interest amateurs is the provision of a send-receive control. This takes the form of a toggle switch in the H.T. supply to the oscillator and has proved most effective in operation.

Complete Smoothing

So as the receiver is suitable for head-phone work the power pack has been very carefully smoothed. Two special Sound Sales low-frequency chokes have been embodied with 24-mfd. of smoothing. To overcome any possibility of serious voltage drop due to the use of two smoothing chokes, these chokes have a D.C. resistance of only 210-ohms each.

One of our readers, Mr. J. A. Jagers, BRS1847, has been using one of these tuners for some time. We have obtained from him a report on his results, and he has sent us a long letter which proves very conclusively that our findings with this receiver were not due to freak reception. During a period of three weeks he has received stations from all over the world, but first of all here are some extracts from his letter. "The test period has been spread over three weeks, during which time conditions were very poor, but even so, West Coast Americans have been coming in up to R9 plus. The model tuner I have

is the H. type with its super band-spread. The most striking feature is the extraordinary low noise level on all bands. For instance, this morning I heard about 20 W phones on 160 metres, which were, however, only QSA 2 to 3-readable until 7.30 in the morning, but just before sunrise the signals are R.9. During the period of review I have heard 300 G stations on 160 and 40 metres at an average strength of R8. For the price the set is the best value in radio I have ever come across.

"You may note in the list of calls K7VH who is up in Alaska, and since making the list out I have pulled in K7SCR. I understand that K7 on phone is a rarity in amateur radio.

"In the C.W. list you will note several seldom heard countries, including FK7AA in New Caledonia. The output is around 3 watts and it is uncanny to hear W6, W7, K6 and VE5 phone stations overloading the speaker."

This report speaks for itself, and should convince most amateurs that this is the star receiver for general use.

As a matter of interest just to show how complete is the band-spread we have measured up the amount of travel on four wavelengths. 20 metres spread $6\frac{1}{2}$ in.; 40 metres, $5\frac{3}{4}$ in.; 80 metres, $4\frac{3}{4}$ in.; 160 metres, $3\frac{3}{4}$ in. This makes tuning on 20 metres ridiculously simple.

We have not yet priced the kit, but complete, with all equipment, valves, etc., but not loud-speaker, it will probably be about £13 10s. This is very cheap for an 8-valve super even when compared with the inexpensive Americans, but even so in case some of the amateurs are more hard up than usual we are making special arrangements for really good hire-purchase terms. That will be dealt with later on.

A second model with a crystal filter is also going through the laboratory, and if any amateurs want some advance information we shall probably be able to give assistance.

(Continued on page 361).

JUNE, 1936

Transmitting for the Beginner

This is a second article of a series on the elementary principles of transmitter design. This article deals with the neutralised power amplifier

By Basil Wardman, G5GQ

THE first article in this series dealt with the general principles involved in the design of a transmitter. Now the individual stages are to be dealt with in detail.

The most important stage from the amateur point of view is the P.A. which

Class A in that it is designed to run into grid current. The valve is negatively biased until no anode current flows. This amount of bias is known as the cut-off bias.

If a sine wave is applied to the grid of this amplifier only half of the wave

R.F. stage in which case it is known as a Class B linear amplifier.

Class C

The Class C R.F. amplifier is a further development of Class B, the valve being excited over a portion of a half-cycle. In such circumstance the valve will have more resting time per cycle than the valve operated in Class B.

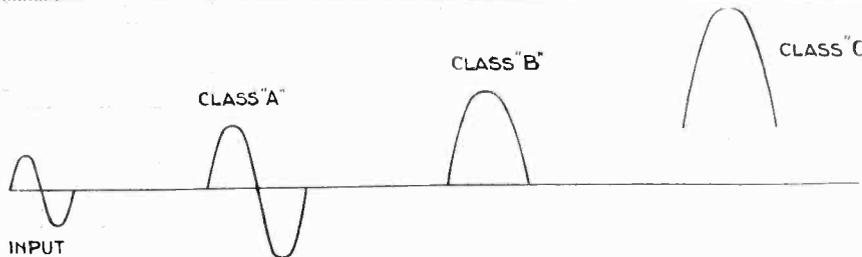

Figs. 1, 2 and 3.—On the left is Class A, in the centre Class B, and on the right Class C. The differences are all explained in the text.

supplies power to the aerial. The radio frequency amplifier which seems to cause so much trouble to the beginner is really quite simple and is almost exactly similar to the ordinary low-frequency amplifier with which most readers are already acquainted.

Radio frequency amplifiers are divided into three types, according to their mode of operation. These are called Class A, Class B and Class C respectively.

Class A

The Class A amplifier is our old friend the low-frequency amplifier with a name. The valve is biased to a definite point on its curve, takes anode current and if a sine wave is applied to its grid at exactly similar but amplified sine wave should be obtained from its anode circuit, as in Fig. 1. In no circumstance should a Class A amplifier be allowed to run into grid current otherwise distortion will occur. This type of amplifier is rarely used in the radio frequency section of a transmitter.

Class B

The Class B amplifier differs from the

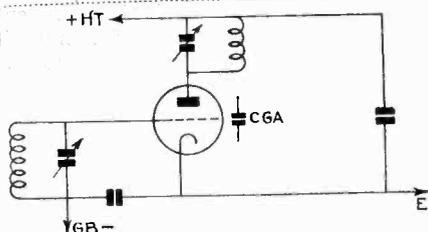

Fig. 4.—This illustrates the anode to grid capacity mentioned in the article.

appears amplified up in the anode circuit. For R.F. purposes this does not matter, but for L.F. purposes a Class B amplifier must have a valve to deal with each half of the sine-wave. The reason only half the wave appears in the output is that the valve is biased to cut-off, so when the wave is on the negative part of its cycle the valve is biased by it more negative and therefore does not act. On the positive half of the cycle the negative bias is reduced, the valve taking more anode current and producing half of the input wave in the anode circuit.

It should be realised that as the valve is inoperative during the negative half of the cycle it is resting during this period and is therefore able to handle twice as much power as the Class A amplifier. Similarly it will readily be understood that the peak anode current of the valve will be twice that indicated by the D.C. m/a. meter in the H.T. feed.

The main function of the Class B amplifier is that of a high gain stage. A gain of between 10 and 15/1 being possible, i.e., if a crystal oscillator supplying 3 watts of R.F. is applied to grid then between 30 and 35 watts would be obtained from its anode circuit at an efficiency of 60 to 70 per cent. In general it can be considered as the amplifier used—if needed—between the crystal unit and the final amplifier. In an L.F. amplifier its counterpart is the first L.F. amplifier which is a voltage high gain amplifier in contrast with the last L.F. stage which is a power amplifier.

The only time when a Class B amplifier should be the final one in a transmitter is when it follows a modulated

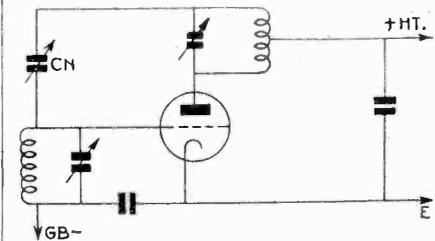

Fig. 5.—A neutralised circuit.

It is operated with a negative bias at least equal to double the cut-off voltage, hence as has been explained previously, as every volt of bias has to be made up by the drive unit, the gain in a Class C stage is not large, being usually about between 4-1 and 8-1 for triodes.

The amount needed in bias is not critical, it can be worked at three or four times cut-off provided sufficient drive is available. This gives an increase in anode efficiency due to operating over an even smaller part of the half-cycle. Efficiency is really limited by the actual design of the valve itself. On frequencies up to 14 mc. the anode efficiency should be up to 85 per cent., but at high efficiencies it is rather productive of harmonics and therefore should be used with a coupled aerial circuit or else a feeder network such as the Collins PI.

The peak current of a Class C amplifier is approximately 3-2 times the D.C. current reading.

Valve Rating

In describing the various classes of amplifier, mention has been made of peak current. In choosing a valve with a rating of say 80 m/a. maximum anode current, it should be remembered that a D.C. feed of 80 m/a. in Class B means a peak current of 160 m/a., or in Class C 260 m/a., so if long life is desired the valve should be chosen accordingly. Many valves are rated for peak anode current, but when in doubt the advice

Valve Data and Neutralising

of the valve manufacturers should be obtained, for both the D.C. reading and the peak current figure can be supplied.

Dissipation

The dissipation figure furnished by valve makers represents the maximum power the valve itself can dissipate—not the input. If a valve has 100-watts input at 85 per cent. efficiency (85-watts

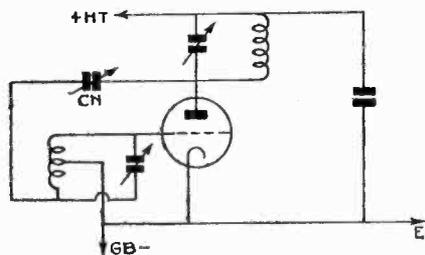

Fig. 6.—An alternative circuit for neutralising.

in the aerial not in the anode circuit) the amount of power lost in the valve itself will be 15 watts (100-85) and so in this case the valve must be able to dissipate 15 watts.

Measurement of Efficiency

Accurate measurement of efficiency is a difficult matter for the amateur, but a fairly good estimate can be made by putting sufficient input to the anode just to colour the plate red hot and then the input can be measured. The valve should then be allowed to cool (after switching off) the drive removed, bias reduced until with normal anode voltage applied the anode reaches the same colour as before, and the input carefully measured. This will give an approximate measurement of the amount of power being dissipated after which efficiency should be calculated.

This should only be done in the case of valves with nickel or molybdenum anodes—these are designed to run dull red, but blackened metal anodes or carbon anodes should never be allowed to show any colour at all. In these cases a valve with similar characteristics having a suitable anode should be substituted, the aerial feed current and valve input being adjusted to the same figure and the measurement made.

There are other methods, notably one using an artificial aerial circuit, but owing to the difficulty of obtaining high-wattage resistances with no self capacity or inductance they are usually very inaccurate at high frequency.

Neutralisation

If the anode circuit of a valve is tuned to nearly the same frequency as the grid circuit the valve will oscillate owing to power being fed back through the anode-grid capacity of the valve (CGA, Fig. 4). To prevent the valve

oscillating it must be neutralised. This is done by centre tapping the anode coil, earthing the centre tap *via* a fairly large condenser of about 0.01-mfd. and feeding the H.T. to the centre tap. Both ends of the coil will then be at high R.F. voltage, i.e., if a neon tube is coupled to the coil it should light at both ends but go out when near the centre of the coil. The R.F. voltage at the free end of the coil will be in phase opposition to the voltage at the anode end. This voltage should be fed back to the grid through a condenser CN, equal to the plate-capacity of the valve and will then neutralise the natural feed back. This is indicated in Fig. 5.

Various methods of neutralising by using a looped flash lamp indicator have been recommended, but at high frequencies the natural inductance of the loop will throw the circuit out of balance on its removal. The simplest method is to light the filament of the valve but without H.T. voltage applied, apply the load, that is coupling to the next stage or aerial coupling, apply drive from the crystal unit and place a m/a. meter to the grid bias lead of the valve to be neutralised.

A certain voltage will be developed between the grid and filament of the valve indicated by a reading on the meter. On tuning the anode condenser through resonance power will be absorbed by the anode circuit owing to the valve not being neutralised. The voltage between grid and filament should drop and the grid m/a. meter will show a reduced reading. The neutralising condenser should be adjusted until no deflection of the grid current meter reading takes place whatever the setting of the anode tuning conden-

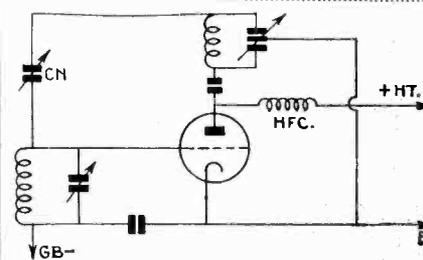

Fig. 7.—A split stator condenser gives an electrical centre. The disadvantages of this method are discussed in the text.

ser. The valve may be neutralised in exactly the same way by centre tapping the grid circuit as shown in Fig. 6.

Another neutralising circuit is shown in Fig. 7 in which the coil is electrically centre tapped by a split-stator condenser. The disadvantage of this method is that to get the condensers to act at an exact centre tap the capacity must be fairly large to minimise the errors due to construction. As the very worst loss in the anode circuit is a large

capacity (High C) this disadvantage can readily be appreciated.

In general, amplifiers must be neutralised for each band. Inquiry made at one large commercial station elicited the information that they could not neutralise the transmitter on all bands, but separate trimmers were used for each channel.

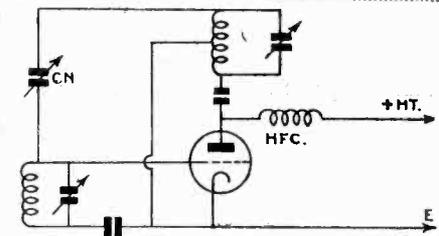

Fig. 8.—The parallel feed circuit has many advantages.

Complete neutralisation is most important as for maximum efficiency in amplifiers the grid and anode circuits should be tuned to the same frequency. In an oscillator for the greatest efficiency grid and anode circuits must be tuned to slightly different frequency. Therefore, if there is the slightest trace of feed back left in an amplifier it would tend to oscillate (even though it actually does not) and as the grid and anode circuits are in resonance efficient conditions for it to act either as an amplifier or an oscillator are lacking, and efficiency will be poor.

Series Feed

In Fig. 5 an amplifier is shown with the H.T. fed in at the centre of the coil. This is called series feed and it will be noted that the H.T. is fed in at a part where R.F. volts are at zero. The anode coil, however, is alive with D.C. volts.

In Fig. 8 the same circuit is shown with parallel feed. It will be noted that the H.T. is isolated from the coil by a fixed condenser. The H.T., however, is fed in at a point where R.F. volts are at maximum. As the H.T. supply is supposed to be at earth potential for R.F. this means that the choke is connected between maximum R.F. volts and earth. This means that the choke must be exceptionally good to prevent loss of R.F. to earth so it is advisable to use series feed to prevent this difficulty. In a similar manner it is advisable to use series feed to the grid through a separate grid coil rather than to place an R.F. choke between grid and earth.

Anode Circuit

For efficiency in a C.W. transmitter the anode tuner should consist of as

Practical Layouts

large an anode inductance as possible with a correspondingly small condenser. A reliable figure to work on is 20 turns of $\frac{1}{8}$ -in. copper tube of 3 in. diameter for 7 mc. and 10 turns of similar

rent taken when the valve is loaded with an aerial or similar load. Care should be taken in the choice of a tuning condenser. If ebonite insulation only grade A should be permitted. Even

coil when the transmitter is unloaded.

Layout

Layout is most important in the design of a neutralised P.A. Some designs advocate push-pull circuits, but I would not advise the beginner to touch them as not only has each side of the circuit to be balanced to the other, but also it has to be balanced to earth and although in theory it sounds easy, in practice it is much easier to balance just half the components required in a single ended amplifier. I anticipate plenty of adverse criticism of this statement, but I would like to call attention to the fact that a large number of push-pull amplifiers are fitted with small R.F. chokes connected to the grids to suppress ultra high-frequency parasitic oscillations, and I have yet to see such a choke in a single ended amplifier.

A good plan for building a neutralised P.A. is shown in Fig. 9. It will be observed that the anode tuning condenser and coil are treated as a separate unit. The lead from the anode to the coil is then cut to exactly the same length as the lead to the other end of the coil *via* the neutralising condenser. This disposes of the neutralised part of the amplifier. The grid coil must be well shielded from this part of the amplifier.

As far as possible the use of insulating material should be avoided, all panels, baseboards, screening, etc., being made of aluminium, brass or copper. Steel may be used providing it is copper-plated before the cadmium plating is put on, otherwise serious losses may occur.

Finally, all parts should be shielded as much as possible, a clearance of 3 in. being sufficient between coils and screen. Condenser spindles should be insulated from the dials by means of ebonite extensions, while the metal screening should be properly earthed so that it is impossible for the operator to receive a shock.

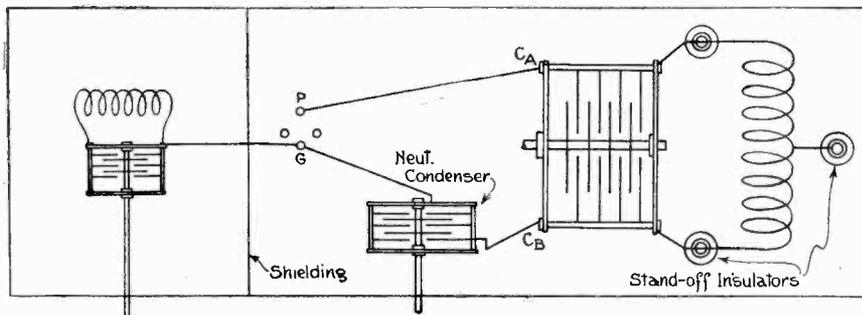

Fig. 9.—Build the neutralised P.A. circuit in this way.

tube in diameter for 40 mc. Larger sizes of tube have been recommended in the past up to $\frac{1}{2}$ in., but measurements indicate that the larger diameter tubing introduces losses, probably due to the greater self capacity and higher skin resistance. A feeder current of 0.3 amp. was increased to 0.33 amp. by substituting $\frac{1}{8}$ in. tube for $\frac{3}{8}$ in. tube.

For 14 mc. and 7 mc. the anode coil must be almost self supporting, bolted at each end to a stand-off insulator, with a third stand-off for fixing centre tapped lead.

On tuning up a neutralised P.A., if the aerial is removed it will be observed that when the anode circuit is in tune the plate current will be small, but on either side of the tuning point will rise rapidly to a large value. This is because a resonant circuit has a maximum impedance when it is in resonance. So the lower the losses in the circuit the lower will be the no-load current and the quicker will the m/a. rise on either side of the resonant point.

With triodes the no-load current should not exceed 1/10 to 1/6 the cur-

rent when the valve is loaded with an aerial or similar load. Care should be taken in the choice of a tuning condenser. If ebonite insulation only grade A should be permitted. Even

it should be cleaned at intervals. Losses do not show up very vividly on low power but they are still there. A case in point is that of a condenser which looked perfectly good on putting it into a high power transmitter on 14 mc. the ebonite insulation burst into flames. This would not have happened on low power, but losses would have been there all the same.

It is most difficult to give figures for the average 10-watt transmitter, but it is safe to assume that a grid current of 15 m/a. (through the bias battery, as the current will be greater with this shorted out) will be sufficient. On the output side with 500 volts H.T. and 10-watts input it should be possible to draw a $\frac{1}{4}$ -in. arc from the anode end of the

READ TELEVISION
& SHORT-WAVE WORLD
REGULARLY

Simple Inductance Tapping.

TO make a tapping on a tank coil is not quite as simple as it sounds. Crocodile clips do not always

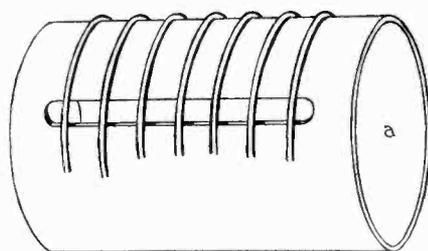

D

make a good connection as they only grip half the wire at a time. So for that reason most amateurs fall back on the old arrangement of soldering an L piece directly on to the wire.

Diagrams a and b indicate two other methods which can be used to advantage. A shows a conventional coil with a slot $\frac{3}{16}$ -in. or $\frac{1}{4}$ -in. wide cut along about $\frac{2}{3}$ of the former. In this way the tapping can be made from inside the coil by a crocodile clip, which will grip firmly on to the wire.

B shows the second method which looks better but is more difficult to carry out. Holes should be drilled in the former before the coil is wound and tapings actually made on the wire through the former.

It is quite a good idea to utilise the second method and to solder tapping points on to the wire through the holes. The mid-tap can then be made neat and tidy inside the coil former. Soldering the taps is quite an easy matter.—I.H.

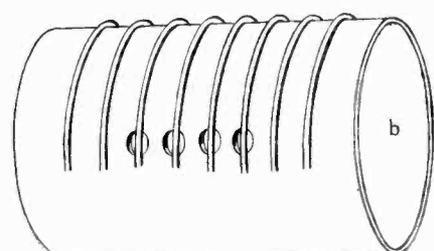

JUNE, 1936

The Short-wave Radio World

Semi-tuned R.F. S.W. Three

HERE are numerous variations of the 1-V-1 receiver which have proved entirely satisfactory, but we have not before come across a published receiver using a semi-tuned R.F. stage. In the *Sydney Bulletin*, VK2NO describes a receiver which has many

A Review of the Most Important Features of the World's Short-wave Literature

circuit is shown in Fig. 1. It can be seen quite clearly that the aerial coil

leak arrangement. Also cost comes into the argument, for a coil of this type can be made of almost any gauge wire with, or without, a former, while the three-point switch could be made from scrap material.

This arrangement of a peaked or semi-tuned stage gives a surprising R.F. gain without the trouble of an additional tuning control. The coil can be made to cover a wide band of frequencies, at any rate, between 20 and 80 metres. The method of obtaining regeneration is rather interesting, inasmuch as the coil and choke is in series with the anode supply. Regeneration being obtained by a variable condenser from the cold end of the reaction coil and earth.

For guidance, the R.F. grid coil should be to the following specification: 40 turns of 26 d.s.c. wire on a 1¼-in. former and tapped at 10, 18 and 30 turns from the aerial end.

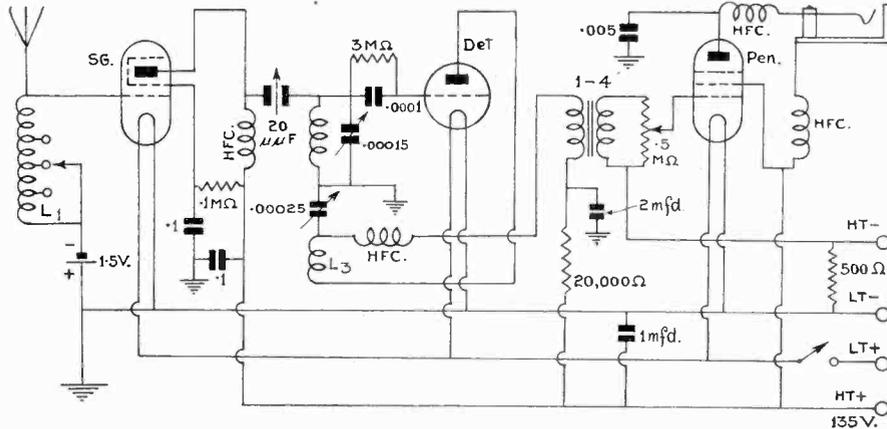

doubler circuit, while at the same time it gives an output comparable with a straight amplifier, making it feasible directly to feed the output from the doubler into the aerial. The circuit of this arrangement is shown in Fig. 2. The operation of the system is based on the idea that the common neutralised circuits reverse their usual function and supply regeneration when used as frequency multipliers. The grid circuit composed of Lg, C and L, together with Cd, which represents the valve inter-electrode and circuit wiring capacity, has two anti-resonant points. The lower of these is tuned to the fundamental by adjusting C. The other is tuned to a frequency near the second

Even though the electron-coupled arrangement is very stable in operation it is essential that it be mechanically sound for any vibration or movement of components will ruin the entire transmission. For that reason the coils are wound with $\frac{1}{8}$ -in. copper tube and the condensers double spaced to prevent as much as possible capacity change. The circuit as shown is suitable for an input of 6 to 10 watts, which although being quite small is capable of very good DX work on the 10-metre band.

10-watt High-fidelity Amplifiers

Many readers are convinced that resistance capacity coupling is essential

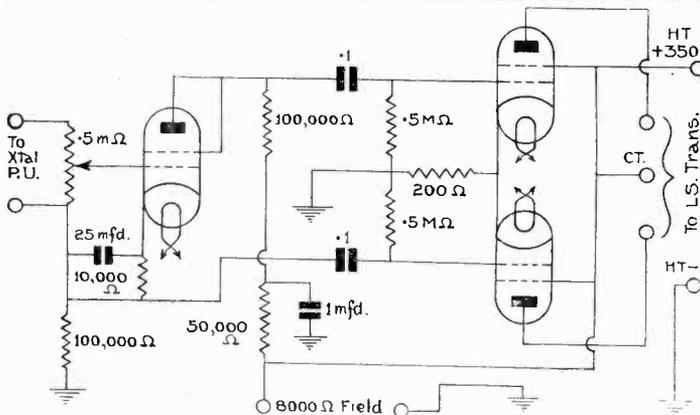

Fig. 5. — High quality is of great importance on the lower frequency bands. This amplifier will modulate a 20 watt carrier.

harmonic so raising the impedance of the grid circuit at the second harmonic and permitting sufficient voltage of this frequency to be set up to cause the required amount of regeneration. The change over from the conventional doubler to the new system is quite simple and is not at all costly.

10-metre Link-coupled Phone

The neglected 10-metre band is slowly coming into its own, particularly when summer time came into force, as the longer days are conducive to good DX. We give here some brief details of a very simple link-coupled phone transmitter designed by Frank Jones, consisting of a 59 electron-coupled oscillator link coupled to a 46 as a PA.

The speech amplifier and modulator consists of an AC/HL type of valve, followed by a 59 modulator or if more convenient an AC2/PEN. The circuit can be seen in Fig. 4. L1 is nine turns 2 in. diameter, $\frac{1}{8}$ -in. copper tubing. L2, L3, L4 are all four turns each, 2 in. diameter of $\frac{1}{8}$ -in. copper tubing. C1 and C4 have no English equivalents, but we suggest Eddystone type 900, 20-mmfd. capacity. C2 and C3 are both .0001-mfd. double spaced.

The low voltages employed in this complete transmitter should make it popular amongst English amateurs, for the complete equipment only requires 250 to 300 volts at about 100 m/a.

if high quality is to be obtained. In the current issue of *Wireless Weekly*, an Australian publication, is a circuit of an R.C. coupled push-pull amplifier giving an output of 10 watts. The circuit is fully shown in Fig. 5. It is suggested that a crystal type of pick-up be fed into the grid circuit of a 6C6 used as a triode. English users will find the Mullard 904V or 994V a very satisfactory substitute for the 6C6.

The coupling circuit between stages consists of two .1-mfd. condensers feeding into the grids of a pair of 42's. The common bias resistance is used and separate grid leak returns of 500,000 ohms each. At 10 watts output the quality is within 5dB between 50 and 8,000 cycles.

In place of the 42's valves of the AC2/PEN or N41 types will be satisfactory. This, of course, means the use of a lower bias resistance of the order of 45 ohms. Transmitting amateurs will appreciate that this amplifier will be suitable for microphone use and for modulating a carrier up to 20-watts.

Read

“TELEVISION AND SHORT-WAVE WORLD”

Regularly

R.S.G.B. Party

G5UK is organising another trip to Holland to take place next August Bank Holiday. The party will leave London at 8 p.m. on July 31 arriving Amsterdam August 1, Antwerp August 2, Zeebrugge August 3, and back to London 7.50 a.m. August 4. It has been arranged for accommodation on board for the entire trip so obviating the difficulty of arranging additional accommodation. The cost from London for the whole trip is 97s. 6d. Full details can be obtained from G5UK, Max. Buckwell, 19 Meadway, West-cliff-on-Sea.

Many readers will probably remember the trip last year to the Brussels exhibition, which was so much enjoyed. It is hoped that this year many more “hams” will make the trip and visit other stations which so far have only been worked over the air.

The Wolverhampton Short-wave Radio Society

This Society is one of the oldest in this country and dates back to many years before regular transmissions started. Amongst the present members are G2NO, G2NA, G2NV, G2NQ, G2OG, G5IQ, G5WO, G5WH, G6PC, G6UI, G6WF, G6NQ, 2BMB, 2BVZ, 2BPH, 2ABH, and 2BDO. This is certainly an extremely active membership, so those interested should get in touch with the joint secretaries, 2NO and 6UI.

Three extremely interesting general meetings have been held, the second including an exhibition of amateur gear. The last meeting was to hear a lecture and demonstration of cathode-ray apparatus arranged by the Ediswan Co.

The committee will be pleased to receive applications for membership, which should be addressed to Mr. R. Adams, G2NO, 11 Lichfield Street, Wolverhampton.

Due to limited accommodation, admission to the above lecture is by ticket only, which is free and can be obtained from G2NO.

Southend and District Radio and Scientific Society

It is regretted that in the April issue we incorrectly referred to the above Society as the South London Radio Society. We feel sure, however, that our readers will have noticed the discrepancy, for the Southend and District Radio Society is already well known amongst the amateur fraternity. We strongly recommend any readers who can go to Southend in time for the regular meetings to get in touch with the Hon. Secretary, F. S. Adams, of Chippenham, Eastern Avenue, Southend-on-Sea. This Society also has its own transmitting station under the call sign of G5QK.

Modulation Measurement with Cathode-ray Tube :-II

By G. Parr

This is the second part of the article published in the May issue. It tells in a very simple way what the patterns mean and how to make the most of the cathode-ray tube for checking purposes.

IN connecting the cathode-ray tube to the transmitter for checking the modulation it must be remembered that the deflector plates may impose a load on a tuned circuit at very high frequencies owing to "inter-plate"

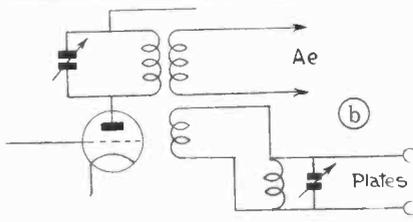

Fig. 1a.—Connect the tube in this way.

capacity. The figure for this capacity varies with the type of tube and socket used and may range from 1 to 10 mmfds. With gas-focused tubes the conductance of the inter-plate space may be appreciable at the frequencies used (160-40 metres) and, in addition, the deflecting voltage requires to be kept low.

A very satisfactory method of connecting the deflector plates to the radio frequency output is by means of a loose coupled coil which can be coupled in turn to a tuned circuit connected across the deflector plates, as shown in Fig. 1a. This enables the amplitude of deflection to be adjusted and avoids upsetting the tuning of the main circuit by the introduction of deflector plate capacity.

The connection to the modulator stage must be made to the final output and not to an intermediate stage or phase distortion will be introduced (see last month's article, p. 308).

A form of resistance potential divider connected to the anode circuit of the modulator through a capacity will be suitable (Fig. 1b). To obtain a steady

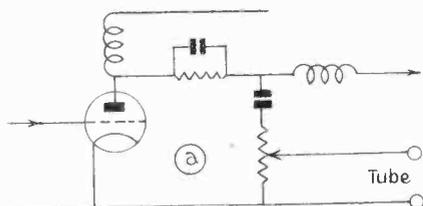

Fig. 1b.—This is the resistance potential divider mentioned in the text.

pattern on the screen an audio-frequency input must be supplied to the modulator of about 1,000 cycles. The wave-form need not be sinusoidal, although this is an advantage. Fig. 2 shows a simple arrangement which

gives a reasonably pure wave on low amplitudes and a strong second harmonic when the anode voltage is raised, which is sometimes of use for providing less ideal test conditions!

If the tube is now connected according to the diagrams and the carrier switched on, a vertical line should appear on the screen the amplitude of which is proportional to twice the peak-carrier amplitude. A small audio-frequency input is now applied to the modulator stage, which is then connected to the horizontal plates. The characteristic trapezium pattern (Fig. 3 (a)) should then appear on the screen, and the percentage modulation can be measured. If the modulation is increased to 100 per cent. the trapezium will alter to a triangle (3b) while over-modulation will prolong the apex of the triangle.

Any phase distortion will produce the truncated cylinder described in the last article, and if this is present it is useless to proceed with the experiment until the cause has been traced.

It more frequently happens that the

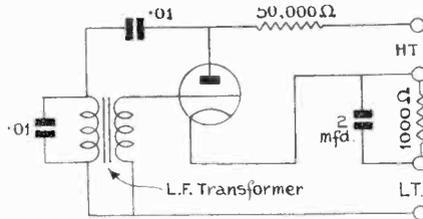

Fig. 2.—A circuit of this type gives a reasonably pure wave form.

figure on the screen is clear but far from trapezoidal in shape! If the reason for the formation of the trapezium has been fully understood it is not

some way reduced on the top half of the modulation envelope, and this can

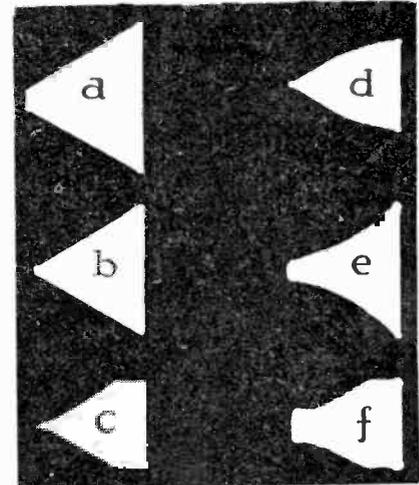

Fig. 3.—These are the patterns that will be obtained on the face of the tube. Read how they give an accurate report on transmitter performance.

only be due to falling off in carrier amplitude on the peaks of modulation—in other words, insufficient grid excitation in the radio-frequency stages. A similar shape of figure is shown in (d) in which the sides are curved, making it appear like a bullet. This is sometimes due to low emission in either the modulator or carrier stages, giving rise to saturation and preventing the carrier amplitude from rising with the peaks of the audio frequency. It is more probably due, however, to poor regulation in the H.T. supply circuit, as the reduction in carrier amplitude is gradual with increasing load.

If the sides of the bullet-shaped figure curve inwards instead of out-

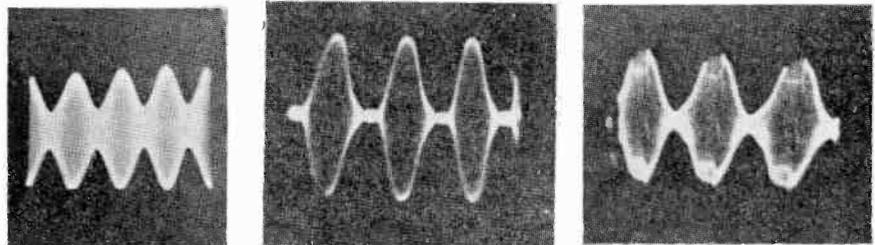

Fig. 4a.—Full modulation. Fig. 4b.—Over modulation. Fig. 4c.—Distorted wave-form.

difficult to deduce from the shape of the figure what is wrong in the transmitter. Take, for example, the pattern of Fig. 3c in which a trapezium is formed, but with the top and bottom cut off. The amplitude of the deflection is in

wards, as Fig. 3e, it is generally indicative of excessive reaction in the radio-frequency stages or of a tendency to instability, such as would be caused by imperfect neutralising. This figure

(Continued at foot of next page)

An Amplified Absorption Wavemeter

This new type of meter lends itself to amateur use, for in addition to being used as a frequency indicator it has undoubted scope for showing up poor neutralising. The experimental model was designed by G5ZJ who has not yet completed his tests, but so far results having been so satisfactory we are passing on the preliminary details for the benefit of other experimenters.

MOST amateurs at some time or other have used an absorption wave-meter. In fact, as far as I can tell a very big percentage of amateur stations at the moment use such a meter for almost every type of frequency measurement. Admittedly, it is very simple and does give a rough and ready guide to the frequency to which the receiver is tuned or to the band on which the transmitter is operating. It is also used extensively for picking out harmonics from the frequency doubler or tritnet oscillator. It has been my experience, however, that when used with a transmitter the neon bulb indicator is of little help, while the use of a m/a meter simply for one purpose does not meet with general approval.

I tried the effect of coupling an absorption wave-meter to a valve voltmeter purely to see whether or not I could obtain a more accurate indication of resonance. The idea worked fairly well on the lower frequencies but decreased in efficiency below 40 metres.

The original valve voltmeter in use was of the diode variety with a micro-ammeter reading rectified current. The main advantage of this arrangement was that no H.T. was required, but the majority will agree that the expense of the diode current meter is rather on the high side to warrant the exclusion of the H.T. battery. After several experiments a valve voltmeter, with the circuit shown on this page, was adopted. It is conventional, but there are one or two points of interest. First of all L_1 . This is a coil of the

required inductance. It is connected to two terminals on the metal case by means of a piece of rubber-covered twin wire. The tuning condenser, C_1 , is permanently in circuit. The idea of having L_1 floating is that it can be pushed inside the transmitter chassis when neutralising.

The whole secret of this meter is the condenser network, made up of the two condensers marked C_2 . These have a capacity of .000025-mfd. and are of the air-spaced type. By removing the two

is sufficient, but if the cabinet is made large enough to take a 60-volt battery there is naturally a great increase in sensitivity. My original cabinet was a steel one made by Burne-Jones and this is excellent for the purpose.

The valve voltmeter should be connected up with maximum H.T. and half the anode voltage applied to the screening grid. Grid bias is then increased until the anode current just drops to zero. The screening voltage must then be varied until a position is found where there is a slight rise in anode current. Bias should then be increased again to bring the current reading back to zero. Of course, it may happen that the correct screen voltage is obtained first try, but usually it is a matter for experiment.

When adjusted in this way directly a signal is applied to the grid of the S215 anode current flows, according to the strength of the signal. The advantages of this circuit will quickly be realised. With the absorption meter in circuit resonance is indicated by a maximum current reading. Slight traces of R.F. in a badly neutralised circuit can also be detected by a correspondingly small deflection on the anode meter.

Signal strength can also be measured by connecting terminals A and B in parallel with the loud-speaker. In this way small changes in field strength can be detected. There are a hundred and one other ways in which this meter can be put to good use, so I feel that it should be constructed by most serious experimenters.

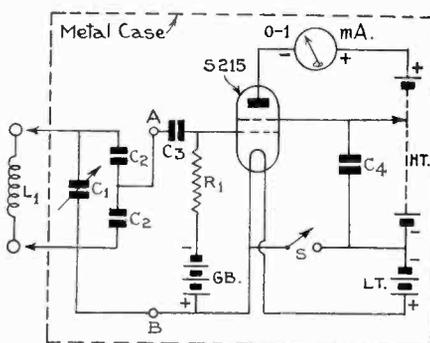

Circuit of absorption wavemeter

connections from terminals A and B the standard volt-meter is obtained for general use. So for that reason two shorting bars were used so the unit could be split into two sections when required.

The condenser, C_3 , has a capacity of .001 mfd. and the leak R_1 100,000 ohms. Normally 16 volts high-tension

most satisfactory figure for checking transmitter distortion as the shape of the pattern is independent of audio-frequency wave-form and frequency provided that the latter remains constant.

If the actual shape of the modulating wave is required the modulated output is taken to the vertical deflector plates as before, but the horizontal plates are connected to the usual linear time base set to a multiple of the audio-frequency wave.

A complete picture of the modulated carrier then appears on the screen as shown in Fig. 4a. A 100 per cent. modulation brings the carrier right down to the "zero line," while over-modulation produces gaps in the carrier as in Fig. 1b.

If the wave-form appears distorted,

as in 4c, the shape of the audio frequency should be checked by connecting the modulator output to the vertical plates and recording the wave in the normal way. A tracing of this can then be superimposed on the modulation envelope in order to see whether any distortion has been introduced subsequent to the modulator output.

If the wave-forms differ appreciably, the following may be suspected:

Grid excitation too low in the r.f. stage.

Strong harmonics in the modulator wave-form due to oscillation.

Tendency to phase distortion between the audio frequency and carrier stages.

These can be checked in a more positive manner by reverting to the trapezium figures.

"Modulation Measurement with Cathode-ray Tube"

(Continued from preceding page)

terminates in a long "tail" if the modulation is exceeding 100 per cent. and the excitation is too low.

3f shows a case where the carrier is not "swung" to the full extent on either the positive or negative half-waves.

This condition may arise in screen-grid amplifiers with a fixed screen potential or too high a screen condenser.

If any of these figures show a re-entrancy of the pattern giving broad streaks across the area, it is generally a sign of oscillation and it is preferable to check this by using the full modulated envelope pattern as shown later.

As said before, the trapezium is the

R.M.E. Transmitting Gear for Amateur Use

The following information has been received from W. Ingersoll, W9BHT, and indicates the trend of design in American transmitting apparatus

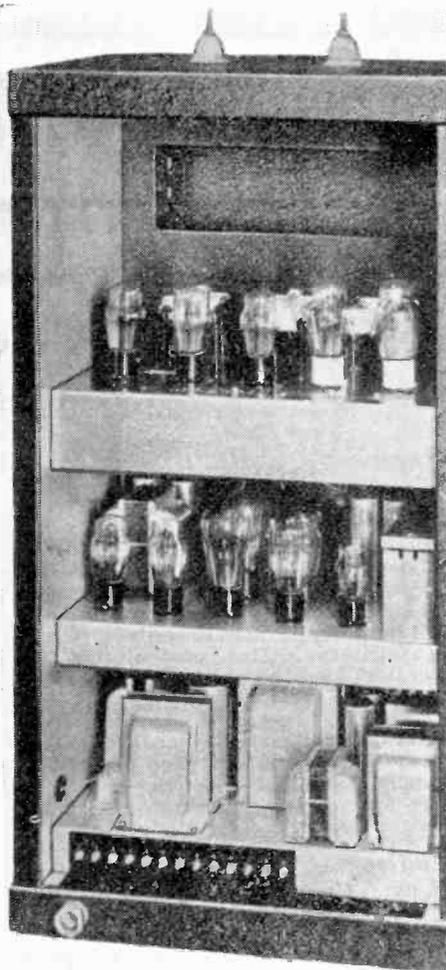

The construction follows standard practice. If all amateurs were to build in this way it would result in a general rise in efficiency.

R.M.E. Inc., of Peoria, Illinois, have introduced several new transmitters for amateur use which should be of great interest to G

stations. Picking a typical chassis at random, we illustrate on this page the model 3R9, which gives a very detailed idea as to the neatness and compactness obtained. As a straight C.W. transmitter, Class B modulated phone transmitter, or controlled carrier transmitter, the final stage can handle at least 100 watts. It is also suitable for use on the 10-metre band and to obtain maximum efficiency two distinct systems are available.

Firstly a 6A6 valve is used in the input stage with a 40-metre crystal, one doubling taking place in the 6A6, and the second harmonic (10-metre) is obtained through an ingenious plug-in stage, which not only gives a sufficient amount of 10-metre excitation to the buffer stage, but is so built and tuned that no adjustment is necessary over the 10-metre amateur band.

An alternative arrangement is the use of a 20-metre crystal requiring one doubler stage. This is obtained with the 6A6 C.O. doubler circuit. The 3R9 transmitter has incorporated in its circuit an efficient system for obtaining controlled carrier. This new system is quite original and is arranged so that frequency response is not effected, quality being the same for either carrier controlled or standard operation. Also the power output on audio peaks is almost equal for both systems. Another feature is that the transmitter can be changed from controlled carrier to conventional operation by the control of a switch.

The valve line up is 6A6 C.O. and doubler, 2 42's in push-pull as buffers, 2 801's in push-pull as amplifiers.

The frequency range is 1,700 to 30,000 kc. obtained by means of plug-in coils which can be changed from the front of the panel. The speech amplifier has a frequency range of between 100 and 10,000 cycles with a deviation of less than 1.5 Db. So as to conform with the latest American regulations, modulation is 100 per cent. maximum with an amplitude distortion of less than 5 per cent. at 100 per cent. modulation.

It is claimed that neutralising is permanent over all bands, although provision has been made for slight readjustments if necessary. The P.A. circuit is arranged for coupling to an EO₁ cable, but if a different system is employed space has been provided for an impedance matching network.

G stations will probably envy W9BHT who is using a model 5T5 in which the 50 T's are replaced with 150 T's for C.W. or controlled carrier operation. The input is 800 watts on any band. The valve line-up is very similar to the 3R9 and consists of 6A6 C.O. and doubler, push-pull 42's as buffers, two 801's as push-pull amplifiers and two 50 T's or two 150 T's in the final stage as required.

Amateurs will agree that the 3R9 transmitter certainly lends itself to amateur construction. An Eddystone rack could be used quite easily, while the various stages can be built on metal chassis in the usual way.

Radio Society Notes

Tottenham Short-wave Club

2BQY, L. Woodhouse, informs us that the Tottenham Short-wave Club recently held an interesting meeting, at which the President, Mr. Ballard, gave a lecture on Ohm's Law, explaining in full its application to various problems met in the course of receiver and transmitter construction.

Particulars can be obtained from the Secretary, 2BQY, 57 Pembury Road, Bruce Grove, Tottenham, N.17.

South Hants Radio Transmitting Society

The monthly meeting of the above Society was held in the Schoolroom, Outram Road, Southsea.

Mr. D. A. J. Hogg, 2BCM, described and demonstrated his single signal super-heterodyne receiver. Members were particularly interested in the methods by which extreme selectivity was obtained. A crystal filter circuit was described in full and created considerable interest.

The sensitivity of the receiver and band-spreading circuits drew favourable comments from members. The receiver was then given a thorough test by those present, and despite interference from a near-by trolley-bus service, gave a very creditable performance.

The Hon. Secretary is E. J. Williams, B.Sc., G2XC, "Rochdale," London Road, Widley, Portsmouth.

Bradford Short-wave Club

The membership of this Society is increasing very rapidly while many of

the members are joining the morse instruction class under the leadership of Mr. W. F. Buttery.

Club meetings are held every Friday at 7.30 p.m. in Bradford Moor Council School, Leeds Road, Bradford. The Hon. Secretary, Mr. G. Walker, 33 Napier Road, Thornbury, Bradford, will be glad to hear from intending members.

Westcliff Radio Activities

At the last meeting of the Westcliff Amateurs held at G5VQ there was a record attendance of 26, including members from Chelmsford and Witham.

The Great Circle DX Contest was discussed and results compared. As will be remembered this contest commenced on May 1 and terminates on May 31 at 24 hours.

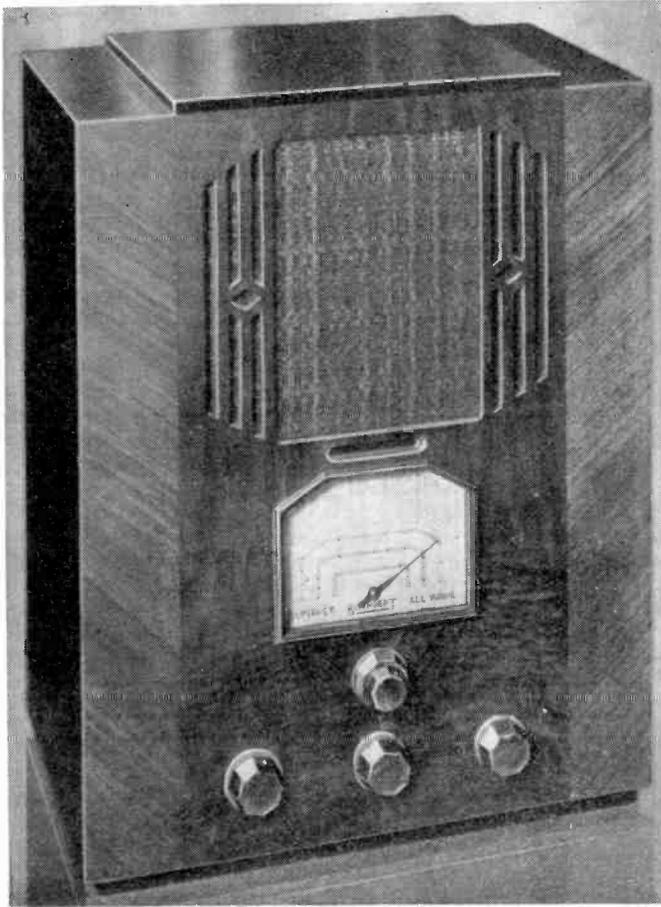

FIRST PRIZE

The Burndept all-wave super-het is fitted with a fine tuning drive while the short-wave tuning scale is calibrated with station names.

We Are Organizing

a National Contest to provide a fund of information on short-wave reception. It will enable all short-wave listeners to show just what their receivers will do and will determine who are the most successful short-wave operators.

Winners of the contest will be the readers who receive the greatest number of amateur and commercial short-wave stations, not including those situated within Great Britain, Northern Ireland and the Irish Free State.

Amateur stations are experimental broadcasters operating on the normal amateur bands. Commercial stations are those broadcasting actual programmes (i.e., Boundbrook, Montreal, Zeesen, Rome and Madrid, etc.) on allocated wavebands.

The listening period (May 31st to June 21st) has been arranged so that it includes four Sundays.

All reports will relate to phone stations and not to Morse stations. The inclusion of Morse stations would render the contest too simple, as it is possible to receive upwards of a hundred of Morse stations in a matter of thirty minutes.

Obtaining verification is in most cases an easy matter. Most amateur stations will send a QSL card to listening stations, provided the report submitted is of an interesting nature, and it is advised therefore that when sending reports to transmitting stations, the maximum amount of detail, such as exact time, wavelength, type of receiver, aerial system, in addition to the usual details regarding signal strength, quality, etc., be given. If reports are accompanied by an International Reply Coupon, obtainable at any Post Office, transmitting stations will be more disposed to reply.

World-wide RECEPTION

for Readers of "Television"

PRIZES

FIRST PRIZE.—A "Burndept All-Wave Super-Het" type 233 six valves and covering three wave-bands. It is fitted with special short-wave slow motion tuning dial with all bands calibrated in stations' names and wavelengths. The value of this fine receiver is 17 gns.

SECOND PRIZE.—The "Eddystone All-World Two" a special receiver for amateur use. Good features are band-spreading, resistance controlled reaction, and it is suitable for wavelengths from 10 to 200 metres.

THIRD PRIZE.—A fine 10 in. Terrestrial Globe, by "Geographia," mounted on a polished wooden pedestal. This globe is coloured and gives a good relative idea of the positions of the world's chief cities and towns. A most useful asset to the short-wave operator.

FOURTH PRIZE.—A short-wave tuning condenser by Jackson Bros., Ltd., with an insulated rotor, brass vanes and low minimum capacity. It is fitted with the new Jackson short-wave tuning dial having ratios of 8-1 and 150-1.

Let every amateur do his best to win one of these prizes!

The Entry Form

A model entry form is shown on page 378 and it is recommended that this style be used in order to facilitate checking. For example, the call sign should be in the first column followed by date and exact time. The exact time is most important for our checking purposes. A statement of the correct wavelength is not important, though in the case of amateur stations the waveband on which the station is heard, such as 20, 40 or 80 metres, etc., should be given, while with commercial stations the approximate channel such as 16, 19, 25 or 31 metres should be stated. There is no need to waste time listening to entire transmissions to obtain the wavelength used. Most commercial stations operate on a definite wavelength which can be obtained from published lists of short-wave stations.

A report will be regarded as being of more value if weather conditions are mentioned, including barometer readings if possible.

Short-wave CONTEST

on and Short-wave World."

RULES

1. The subject of the contest to be the reception by our readers of amateur and commercial short-wave stations situated outside Great Britain, Northern Ireland and Irish Free State.
2. The contest is open to all readers of "Television and Short-wave World" using a commercial or a home-built receiver.
3. The listening period to be between May 31st and June 21st inclusive. Competitors are allowed a further period of about 3 weeks for the purpose of completing their reports (obtaining QSL cards, etc.), the competition finally closing on Tuesday, July 14th, 1936.
4. The winners of the contest are the competitors who send in the fullest and most useful reports duly accompanied by verification (QSL) cards.
5. The names of the winners will be published in the August issue of "Television and Short-wave World" on sale on Wednesday, July 29th, and we shall give instructions for the prizes to be forwarded without delay.
6. All reports to be of phone stations—not of morse stations.
7. Obviously, reception is best restricted to countries from which cards are receivable within the time limit. (Note: every report must be authenticated by a QSL card.
8. Competitors should model their entries upon the style or form set out in the sample report given on p. 378.
9. Successful competitors to be prepared to furnish full details of their receivers for publication in "Television and Short-wave World" if so requested.
10. All entries must be received by Tuesday, July 14th, 1936, when the competition finally closes. They should be addressed to the Short-wave Editor, "Television and Short-wave World," Chansitor House, 37/38 Chancery Lane, London, W.C.2.
11. The Editor's decision is final and legally binding. All competitors in entering this competition give their particular assent to this rule.

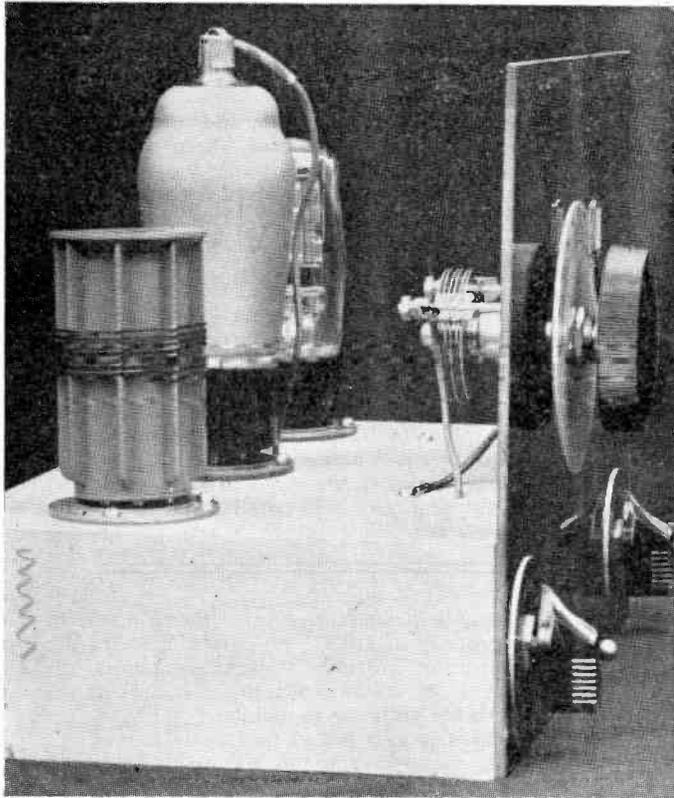

SECOND PRIZE

A new calibrated tank condenser is fitted to this two-valve receiver, so making easy band-spreading.

Watch these Details

It is important that at the foot of the last report page the following details be given: (1) the total number of verifications, (2) the type of receiver, whether home-built or commercial, (3) the number of valves, and (4) a few details as to the type of aerial used during the contest.

For guidance, short-wave stations for the purpose of this contest are deemed to be those operating below 175 metres and above 9 metres. This covers all amateur and commercial channels.

If the maximum number of stations are to be heard readers are advised to concentrate on the most suitable wavebands for the month of June. The lower wavelength bands will be more productive of long-distance stations during the daylight period, so readers are advised to concentrate on wavelengths between 10 and 20 metres.



THIRD PRIZE

A 10 in. globe of this type should be in every station.

The listening period is between May 31st and June 21st inclusive. _____

All entries with verification (QSL) cards must be received by July 14th. _____

Every station heard to be verified by Q.S.L. card.

S. W. Coils for the Constructor

Experimenters who wish to make coils for various wavebands will find this article a very good guide to the number of turns required for plug-in coils of the standard type

FOUR-PIN coil formers of the Eddy-stone B.T.S. or Raymart types can be obtained grooved to a standard pitch so that the turns of wire are always placed the same distance apart. This makes home-construction of short-wave coils very much more simple and enables us to give the approximate number of turns required for any given waveband.

Coils connected as shown in the illustration conform to the British standard, so as to be interchangeable with the commercial article. They can be used in almost any type of receiver, L₁ can be either grid winding, anode coil, H.F. grid coil or oscillator grid coil. L₂ can be a loose coupled primary in either the aerial or anode circuits, the anode coil in an oscillator circuit or a reaction coil in a tuned-grid circuit.

It can be seen from this that a coil of this type can be used in a super-het receiver, a simple one- or two-valver, or in H.F. stages.

Four coils will cover all wavelengths between 12 and 200 metres when tuned with an efficient .00016 variable condenser. Always use L₁ as the grid coil, using L₂ for reaction or as a primary. The 12 to 28-metre band requires four turns for L₁, 10 turns for 28-55 metres,

27 turns for 55-100 metres, and 35 turns for 100-200 metres. The first three coils should be space wound approximately 14 turns per inch with 22-gauge enamelled wire. As we have previously mentioned, the distance between turns is automatically made as the grooves are 14 per inch run. For those who wish to make their own coil forms, the diameter of the former across flanges is approximately 1½ in.

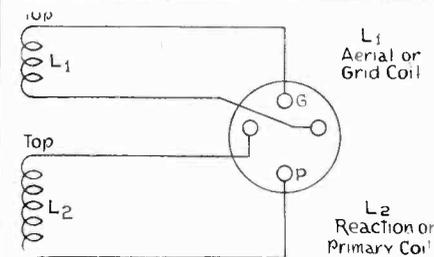

The connections shown are looking at the coil base. These are standard connections for this type of coil.

For L₂ there must be alternative windings. First of all consider L₂ when used as a primary. For 12 to 28 metres, three turns, 28 to 55 metres, 7 turns, 55 to 100 metres, 10 turns, 100 to 200 metres, 15 turns. When used for reaction wind on 3, 5, 9 and 12 turns respectively.

All windings are in the same direction. This is essential, otherwise the receiver will refuse to oscillate. The highest wavelength coil is close wound, there being no gap between turns, while it will probably be easier to wind this coil with 30 gauge enamelled covered wire. Also for the top band coil, both primary or reaction windings should be wound with 28 s.w.g. wire wound in a slot, approximately 3/16 in. away from the bottom end of L₁.

Of course, these windings are only approximate. Wiring, valve capacity and condenser construction will cause a variation in maximum and minimum wavelengths. However, these details are only intended as a guide for the experimenter. It is a simple matter to remove or add a turn or two so as to bring the tuning into the band which is required.

Additional selectivity can be obtained by reducing the number of primary turns. This is particularly important on the higher wavelength bands, but care must be taken not to take off too many turns, otherwise volume will suffer. On the lower wavelength bands if no reaction is obtained and the coil has been wound in the right direction, add 1 to 1½ turns. This will almost certainly cure the trouble.

The R.S.G.B. National Field Day

MOST of our readers are aware that the Radio Society of Great Britain are staging another of their annual field days for the week-end of June 6 and 7, 1936. This contest is open to the English, Welsh and Scottish districts in addition to Northern Ireland and the Irish Free State.

There are altogether 18 English districts, each of which are allowed two stations, Station A for 160 and 80 metre band, and Station B for the 40 to 20 metre band.

These stations are allowed to use 10 watts on the 160 metre band and 25 watts on the other three bands. This power supply has to be obtained from dry batteries, a rotary converter or similar source, for in no circumstances can the transmitter be connected to the public supply mains.

In years gone by some stations had the bright idea of connecting the aerial to a high chimney, or something similar, so this year, to prevent any one station taking such an unfair advantage the aerial height has been restricted to 45 ft. above ground level.

The apparatus must not be erected before 11 a.m. B.S.T. on Saturday,

June 6, and the station be operated from an occupied dwelling house. Most of the districts have now built up their equipment already for the great day, and some interesting portable transmitters have been evolved. District 14, which includes East London and Essex, have for one of their stations a completely portable transmitter designed by L. G. Pugh, 2BNR, and A. Leggett, BRS1647.

This transmitter consists of a Type 50 crystal oscillator coupled to a pair of 59's in push-pull with suppressor grid modulation. The maximum input is 25 watts, although for normal use this is restricted to 10 watts. A feature of the transmitter is that the valve heaters are wired in series so L.T. can be obtained from an 8-volt accumulator with a small dropping resistance in series.

Overseas amateurs do, of course, cooperate so that points have been allocated for different contacts. For example, with fixed stations outside the district but inside the British Isles, 1 point. A similar station, but portable, would equal 3 points. European fixed stations count 2 points, and European

portable stations 4 points. Extra fixed European stations 6 points. Extra European portable stations 12 points. B.E.U.R. stations 8 points. B.E.U.R. portable stations 16 points.

This contest has in past years proved very successful and has done much to show what amateurs can do with low power portable gear in case of emergency. Listening stations who are interested can hear the progress of the competition, but they are specially requested not to cause interference on the amateur band.

5-metre Transmissions

Readers will remember the tests carried out by Messrs. Stratton and Co., Ltd., on the 5-metre band last summer. Their experimental station G6SL will again be transmitting telephony between May 24 to May 31 inclusive, and on June 7. Tests will commence at 10.30 a.m., finish at 12.30 p.m. B.S.T. The transmitting aerial will be omnidirectional so listeners up to about 100 miles should be able to pick up the transmissions. The co-operation of all listeners will be appreciated.

JUNE, 1936



If you are going to buy a short-wave Radio Receiver.

Remember that for distant stations to be heard with entertainment value it is essential that they should be listened to on a receiver incorporating devices to counteract "fading" and to compensate for losses in musical frequencies during transmission. The design of an instrument to receive short-wave programmes has presented many difficulties, because reception is acutely affected by atmospheric disturbances. "His Master's Voice" Model 480 incorporates entirely new devices, which combat tendencies for ultra-rapid fading on short-wave bands, and compensate for any irregularities in quality of reproduction.

Independent experts after comparing the performance of Model 480 against other all-wave receivers, irrespective of price, state that the "His Master's Voice" receiver gives the most efficient results on short waves. *Prove this for yourself.*

THE MOST NATURAL REPRODUCTION.

To ensure that broadcasts on the short-wave bands, transmitted over many thousands of miles, may be heard intelligibly, and with the best possible quality, two tone controls are provided. They enable the reproduction of music and speech to be adjusted so that atmospheric interference is combated, and all types of programmes heard with the most natural reproduction. The tuning arrangements are extremely simple to operate. Four separate wavelength scales are shown on the easily-read illuminated aeroplane-type dial. The medium and long wavelength bands, besides being calibrated in wavelengths, also bear the names of the principal stations.

LARGE SIZE MOVING COIL SPEAKER.

The reproduction of this instrument sets a new high standard for its class. The large-size moving coil loud-speaker reproduces the three watts undistorted output with remarkable faithfulness. Furthermore, there is a good reserve of power for the operation of additional loudspeakers which may be connected to the back of the instrument.

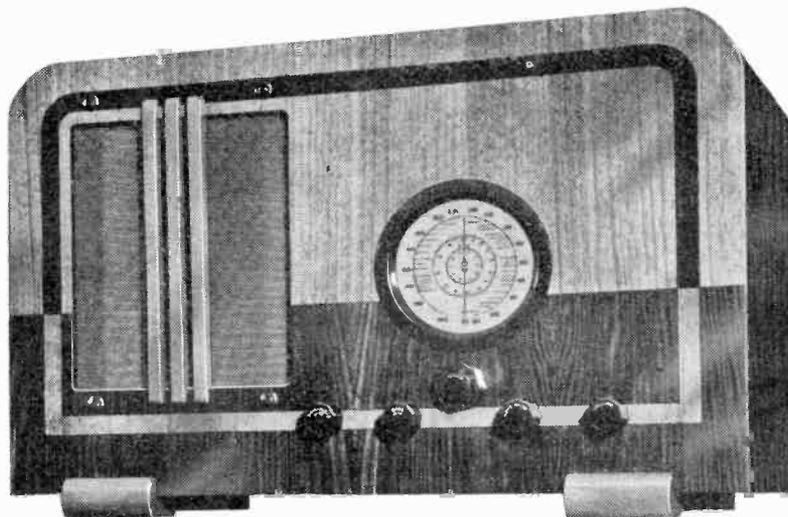

TWO-SPEED TUNING.

The short-wave band is divided into two scales calibrated in metres of 16.7 to 51, and 46 to 140. A special indicator shows the wave-band to which the instrument is adjusted. A two-speed tuning knob facilitates the location of all stations. The outer knob drives the main pointer across the wavelength scales, whilst the inner knob actuates a smaller pointer which traverses a "vernier" scale marked in degrees situated in the centre of the dial.

A BEAUTIFUL PIECE OF FURNITURE.

The instrument operates completely from A.C. electricity mains, and consumes no more current than an ordinary domestic lamp. Lovers of fine furniture will admire the beautifully proportioned cabinet of figured walnut inlaid with macassar ebony.

Model 480
ALL-WAVE
6 VALVE
SUPERHET
RECEIVER

17½
GNS.
OR BY HIRE
PURCHASE



BY APPOINTMENT

Note. The chassis of model 480 is also embodied in model 485 All-wave Autoradiogram.
PRICE 36 GNS.

"HIS MASTER'S VOICE" Radio

A Portable Battery-operated Transmitter

This transmitter for phone operation has been used to contact stations all over Great Britain. It was designed by Kenneth Jowers for use during the coming summer.

IT is not generally realised that quite long distances can be covered using a battery-operated low-power transmitter. On the 40-metre band I have been making experiments over a long period to find out just how much power could be reduced without decreasing range too severely. At 3 watts input

components not strictly necessary so as to keep weight down to the minimum. Also the shape of the two cabinets was given considerable thought, for this up to a point is more important than actual weight. For example, the battery box is 15 $\frac{3}{4}$ in. long by 8 $\frac{3}{4}$ in. high and only 4 in. in width. This box houses the special

the same time only measures 16 $\frac{3}{4}$ in. by 12 $\frac{3}{4}$ in. by 7 in.

Five valves altogether are used in both sections of the transmitter. These are used in the following way. First the actual oscillator. A 40-metre, that is 7 mc. crystal, is connected across the grid-filament circuit of an L2 triode valve. Grid bias to this valve is obtained by means of grid current flow across a 40,000-ohm leak in parallel with the crystal.

In the anode circuit of the L2 is a coil which when tuned by a .00016-mfd. split-stator condenser resonates in the 40-metre band. In the original circuit I used a standard condenser plus a high-frequency choke and .002-mfd. by-pass condenser. A few experiments showed that on the 40-metre band the choke was a passenger, while by using a split-stator condenser the by-pass condenser could be omitted as well. This resulted in a slight saving in weight.

The R.F. output from the L2 is fed into the grid circuit of the P220A power amplifier. Capacity coupling is used for this is simple and easy to get going particularly for the beginner. Other forms of coupling such as inductive and link are hardly worth considering with such simple apparatus.

Heavy bias is required on the P220A. A portion of this is obtained by means of the grid current flow across the 20,000-ohm grid leak, but the balance is made up from two 16-volt dry batteries.

A heavy gauge tank coil is mounted on two stand-off insulators and connected as shown in the circuit diagram. One side goes to the anode of the P.A.

(Continued on page 358).

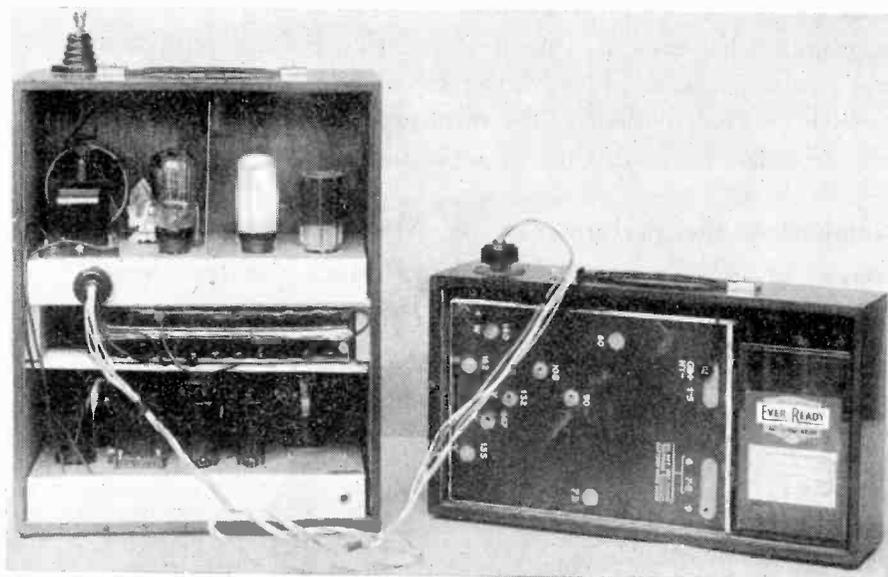

The battery box is coupled to the transmitter by a battery cord and two plugs. Both grid bias batteries are fitted under the transmitter chassis.

stations can be worked with reasonable consistency depending mainly on the number of stations working on the band at the time. But during a period of one month over two-thirds of the reports obtained gave 100 per cent. readable signals.

The portable equipment used in these tests has been of considerable service, for being made up of two separate units it is no trouble at all to rig up a station on the nearest high point when the weather is too hot to operate the usual fixed station.

In addition to easy portability the beginner, not wishing to incur much expense, can make up a portable of this type from apparatus that is probably already available.

The fact that no L.F. chokes or power pack have to be purchased is a very big advantage, while the use of battery valves means that some of the valves used in the receiving set can be borrowed for the short periods the transmitter is in use.

After having carried the gear for several miles I have eliminated all

175-volt high-tension battery and the 2-volt non-spill accumulator.

The transmitter and modulator is really much more portable than the battery box as regards weight, and at

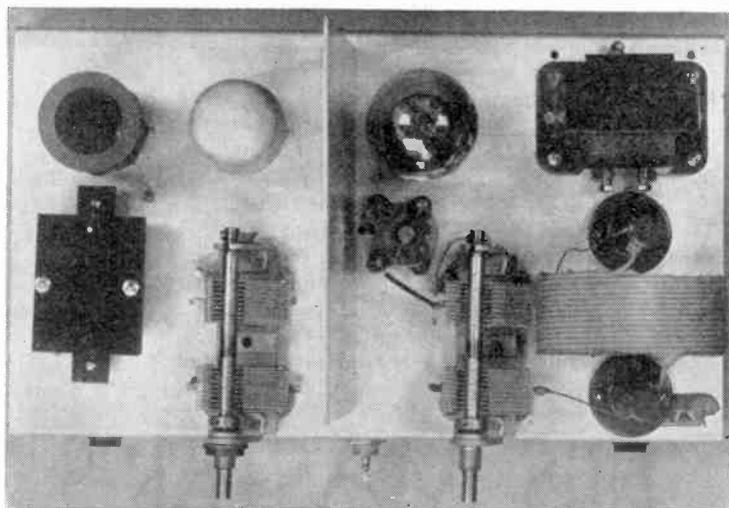

On the left is the enclosed crystal holder behind the C.O. anode coil. The P.A. tank coil is between two stand-off insulators.

and....
**SHE
SHALL
HAVE
MUSIC**



**A Portable
Radio Receiver
that you can REALLY carry about!**



£5 : 18 : 6

Weight only 14½ lbs.
Size 11¾ × 6¾ × 9½ ins.
No Bigger Than a Picnic Case
BURNDEPT LTD., ERITH, KENT

HERE is real summer-time radio at last . . . a receiver to take in the car, to carry on a picnic, to play in the garden—a receiver that has been designed by Burndept *especially for these purposes*. Even with all batteries, this Burndept Portable Receiver weighs only 14½ lbs., and measures only 11¾ × 6¾ × 9½ ins.—smaller than a picnic case or a small week-end case.

And yet . . . this Burndept Portable Receiver will give you a wide range of stations and really good tonal quality (Moving Coil Speaker). It makes outdoor radio at last really enjoyable . . . it extends all the pleasures of radio into the summer months at remarkably small cost.

Your local Burndept Dealer will gladly demonstrate it for you. Ask him . . . or in case of difficulty, write for his name and address.

BURNDEPT
The PORTABLE RADIO

“Portable Battery-operated Transmitter” (Continued from page 358)

one has to do is to plug the four-way cable from the battery box into the transmitter, attach the aerial to a nearby tree and to the stand-off insulator, and the whole equipment is ready to go on the air.

There are two points which must be dealt with very thoroughly. Construction and operation. First construction. Both units are mounted on aluminium chassis of the same size. The component layout of the modulator section can be seen from the illustration. There are three valves equally spaced with the pentode in the centre and the Class B valve to the left. A Class B driver

and the modulation transformer, the primary of which is connected to the modulator valve.

The under chassis wiring is again quite simple, and the approximate layout can be seen from the illustration. Notice also how the high frequency chokes are mounted in the wiring as are the grid resistances and by-pass condenser.

A four-pin valve holder is mounted on the lip of the chassis beneath the modulation transformer for the power supply connections.

The cabinet is supplied to size to take these two chassis, but one or two

Now for some brief operating details. Connect up the battery box and plug in to the socket on the chassis of the transmitter. Also apply $4\frac{1}{2}$ volts bias to the HPT220. Insert a milliammeter into the anode of the L2 oscillator and adjust the tuning condenser until the anode current drops to almost the lowest figure. It will probably read to 10 ma. when out of oscillation, dropping to 2 or 3 ma. when oscillating fully.

Remove the oscillator valve and measure the current of the P220A. With about 15 volts bias this will be about 20 ma. Bias should then be increased by experiment until this anode current is

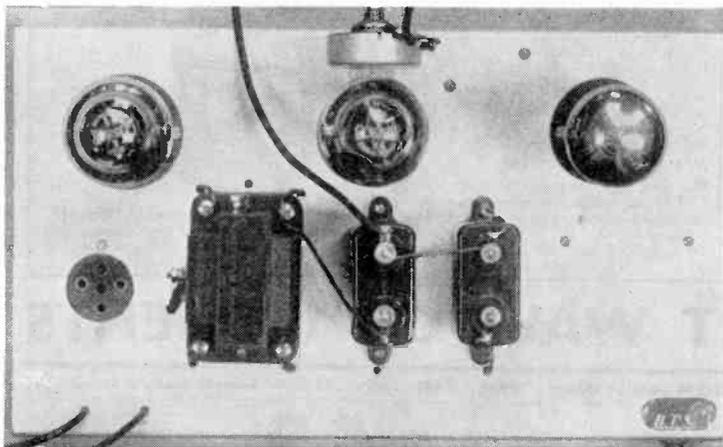

The components are mounted in this way. The open valve holder is a battery connection.

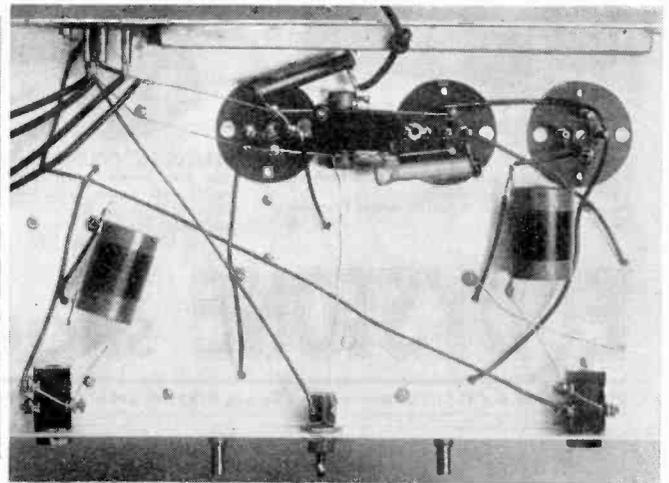

Most of the small components are mounted in the wiring.

transformer is mounted almost between the pentode driver and output valve.

Under-baseboard construction is not very important, but keep leads as short as possible. The microphone input transformer is of the midget type and is mounted close to the first valve-holder. All the grid leaks, resistances and smaller condensers are held in position by the actual wiring so that the entire modulator section can be built and wired in under an hour. Refer to the plan view of the transmitter. On the left-hand side is the enclosed crystal holder and behind it the 40-metre anode coil. Then comes the oscillator and the split-stator anode tuning condenser.

A small screen separates this oscillator stage from the following amplifier. On the right-hand side of the screen can be seen the P220A valve, neutralising condenser, the anode tuning condenser, stand-off insulators with coils between,

little additions have to be made. Two pieces of three-ply wood, 6 in. by 2 in., are screwed to the inside of the case with the top of the wood $7\frac{1}{2}$ in. from the top of the cabinet. The transmitter chassis is then fixed to these two supports, although a much firmer way of fixing is to glue a small piece of plywood across the width of the cabinet to the two supports, so making a platform.

A second platform must be made by glueing another strip of ply-wood across the bottom of the wooden supports so as to form a platform for the two grid-bias batteries. Just how this works out can be seen from the illustration.

On the outside of the cabinet is the stand-off insulator. The connection to this is made through the centre of the porcelain base and soldered to the bolt head. The other end of the connection being soldered to the correct tapping point on the anode coil.

reduced to zero. Put the oscillator valve back in its socket and according to the amount of drive and to the correctness of the anode tuning in the P.A. stage the P.A. valve will again take a certain amount of current.

An aerial of approximately 67 ft. total length should then be connected to the stand-off insulator on the transmitter cabinet. The tapping point on the anode coil must be adjusted one turn at a time until a point is reached where the anode current of the output valve makes a definite swing upwards. The point where the highest anode current is obtained is the correct tapping position. Of course, every time a different tap is made the P.A. stage must be slightly re-tuned.

Full operating details and other points of common interest will be dealt with in the July issue.

Messrs. Reliance Manufacturing Co., Ltd., of Walthamstow, are producing two distinct types of potentiometers suitable for radio and television apparatus.

The wire wound type, priced at 4s. 6d. is available in all values from 100,000 ohms to .5 ohm. This is the only range of potentiometers we have

so far tried where a 100,000-ohm wire wound unit is available.

A composition type, priced at 4s. 9d., is available in values from 5 megohms to 500 ohms and when used as volume controls in radio circuits is absolutely noiseless in operation. Power type wire wound potentiometers are avail-

able in 15 to 20 watt rating, varying in price from 6s. 6d. to 21s.

They are obtainable in all values from 5 ohms to 500,000 ohms, and this range includes the only 500,000 ohms wire wound potentiometer on the market.

All units are in dust-proof cases.

JUNE, 1936

"A New Super-het Tuning Unit"

(Continued from page 342).

Here is the list of phone stations received by BRS1874 on the Tobe tuner receiver on 20 metre phone between April 9 and May 3, 1936.

20 Metre Phone

- Philippines, KA1ME.
- Cuba, CO7CX, 2HY, 2LL, 2WZ, 2HY, 2KC, 6OM, 5RY, 8RQ.
- Venezuela, YV4AC.
- Nicaragua, YN1HS.
- Ecuador, HC1FG.
- Uruguay, CX1AA.
- Bermuda, VP9R.
- Barbados, VP6YB, 6FO.
- Panama, HP1A.
- Columbia, HJ3AH, HK3ER.
- British Honduras, VP1JR.
- Peru, OA4AA, 4AK, 4R.
- Dutch Indies, PK4AU.
- Mexico, XE1Q, 1H, 2AH, 2FC.
- Costa Rica, TI2AV, 2RC, 2EA, 2FG,

- 5JJ.
- Brazil, PY2BA, 2CK.
- Sudan, ST2FK.
- Egypt, SU1KG, 1RO, 1CH, 1TM, 1GP, 1RK, 5NK, 8MA.
- America, W1, W2, W3, W4, W8, W9 and W5, FBE, BQ, AHK, BMM, EHL, ZA, BDB, EUC, DUK, BEE, EPL, AKI, EFU, BGW, DNV, ETF, FMM, BQT, EBP, BQ, W6LR, LLU, BUQ, HEG, CC, ITH, JZH, ISU, ETS, BPX, CLS, NIT, FJ, GAT, ISH, FNY, LEN, SJ, LDZ, BWE, CFJ, HEH, AH, DTE, VYW, JYA, LLQ, JSS, IRX, CNS, ELS, BAY, BKY, LMD, CQG, CX, EBJ, CTV, BHF, BAE, DMM, LC, ISH, EIP, KSO, DEP, EFX, CFX, EMF, W7VS, FU, QC, IF, APD, CEO, DXT, DNP, FP, BUH, BFC, MD.
- Hawaii, K6CMC, KKP, GAS, JLV, KGA, GNW, FKM.
- Alaska, K7VH.
- Canada, VE1, VE2, VE3, VE4 and VE5JB, HC, PS, JK, DK, HU, ES, EH, M.A.
- Australia, VK2BW, YW, KM, VQ, TC, UC, RH, JA, NY, AB, NO, HZ, XS, KK, AP, 3AZ, OC, WW, 4VD, 5WG, IR, 6MW.

Inexpensive Crystal Holders.

We draw the attention of our readers to a very cheap and efficient crystal holder manufactured by A. C. Webb, G6WQ, of 10, Aberdour Road, Goodmayes, Essex.

This enclosed holder is made in several types varying in price from 4s. to 5s. 6d., which is considerably lower than the cost normally expected for this type of holder. The type A is for circular crystals, and complete with base is 4s. Type B for round or square crystals, 4s. 3d. Type C for plugging into vertical panel and for use with circular crystals, 4s. 6d. Finally, Type D, a special holder to take two or more crystals and suitable for use with an external switch are obtainable from 5s. 6d.

The Type C holder is a small type pattern for use in portable equipment. It can be used in almost any position, including edgewise mounting.

HIVAC

HARRIES

POWER OUTPUT VALVES

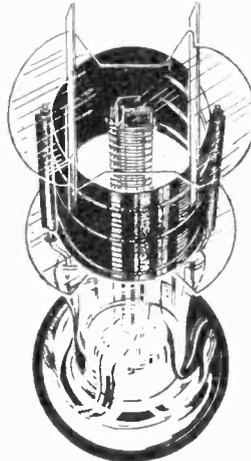

Illustration shows the "critical distance" between anode and outer grid, whereby the special characteristics are obtained.

HIVAC

Y220 : 10/6. Z220 : 10/6.
Hivac Valve Chart "T.S.W." Free.

Tremendous interest was created when the Hivac Harries Valves were introduced and demonstrated to numerous well-known radio technicians.

These valves employ the new HARRIES ANODE CRITICAL DISTANCE principle and give a greater power output and sensitivity with a much lower level of distortion. For normal loads and drives the distortion is as low as that of a triode.

"Triode tone and multi-grid sensitivity."

Y220. The HIVAC HARRIES POWER OUTPUT VALVE Y220 is a low consumption multi-grid type especially suitable for portable and other receivers calling for a considerable output power for the least possible high tension current consumption.

Z220. The HIVAC HARRIES POWER OUTPUT VALVE Z220 is a multi-grid type output valve capable of delivering considerable power and is therefore particularly well suited for working moving coil loudspeakers solo or in circuits employing quiescent push-pull. It is unusually sensitive and may therefore be driven directly from the detector.

Full Technical Data free on request.

HIGH VACUUM VALVE CO., LTD.,

113-117, Farringdon Road, London, E.C.1.

Designers Choose Clix

Because :-

All Clix components, in addition to giving perfect Contact, are easy to wire ; for instance, the centre socket of the 5-pin and two sockets of the 7-pin valveholders are made longer than the others ; this reduces the possibility of short-circuits and adds to the ease of wiring. The Clix range of Base-board and Chassis Mounting Valveholders includes the types illustrated. Ceramic Type V.5 was designed to comply with the essentials in short and ultra-short-wave work. Type V.1 is the Clix Standard type. The whole of the technical Press recommend them.

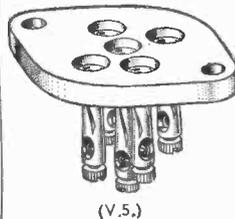

(V.5.)

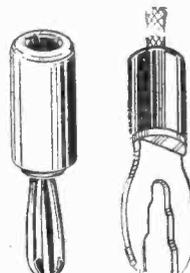

CLIX

Chassis Mounting Valveholders Specified for the **SHORT WAVE BATTERY FOUR**

and also for the **PORTABLE BATTERY-OPERATED TRANSMITTER.**

Ceramic Types :
4-pin, 10d. ; 5-pin, 11d. ; 7-pin, 1/2.
Standard Types :
4-pin, 8d. ; 5-pin, 9d. ; 7-pin, 1/-.
(All above fitted with terminals.)

CLIX WANDER PLUGS.
As specified ... 1 1/2 d. ea.

CLIX SPADE TERMINALS.
As specified ... 1 d. ea.
Folder "T.S.W." free on request.

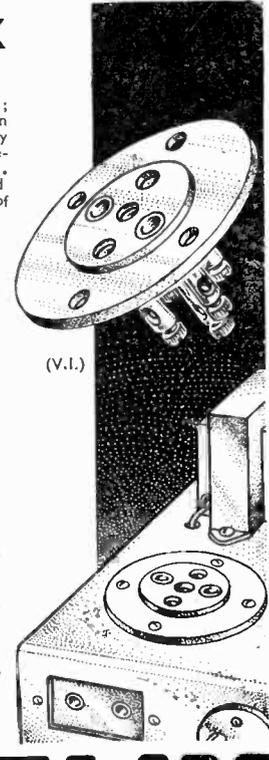

(V.1.)

LECTRO LINX LIMITED,
79a, ROCHESTER ROW, LONDON, S.W.1



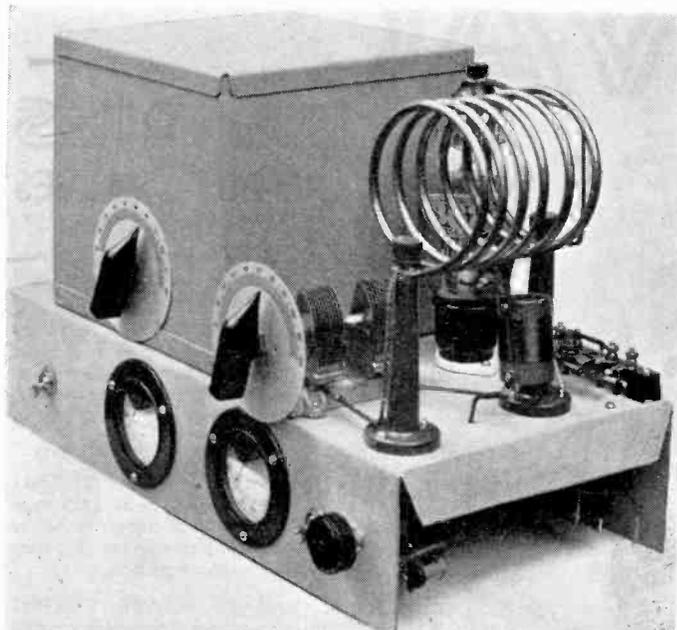

The coil shown is for 20 metres but for the 40-metre band the specified coil should be mounted in the same way.

More about the 40-metre Phone Transmitter

In the May issue we described a simple speech transmitter for the beginner. Several points have been raised by readers and these are dealt with in this concluding article

IT appears that the most difficult problem before the constructor is how to obtain 500 volts, the high tension required by the RFP15. First, if on D.C. mains it is not a practical idea to use a converter owing to cost, so that the maximum D.C. voltage should be applied with approximately two-thirds of the anode voltage applied to the screen grid.

On A.C. mains the problem is very easily overcome. A Wearite type "C" mains transformer is so arranged that with 250 volts on the primary the four secondaries give 500 volts and three separate 4-volt windings. A transformer of this type successfully overcomes all voltage problems.

In the original circuit a P/430 valve was used as an oscillator. There are still a number of these valves available, but it is now advisable to use the very latest valve, the Tungram 0-15/400, which is larger, more robustly constructed, and oscillates more freely.

When ordering the crystal from the Brookes Measuring Tool Co. the exact frequency required should be specified. It is suggested that the frequency be between 7,010 kc. and 7,288 kc. If later it is desired to double down to the 20-metre band the crystal should be chosen with that object in view. This means that the crystal must have a frequency somewhere in the middle of the band around 7,150 kc.

Connecting the microphone appears to be another minor problem. Most readers will use a carbon type microphone which is very sensitive and only requires a low energising voltage. An input transformer having a ratio of between 1 to 20 and 1 to 39 should be connected with the secondary across two terminals marked input. The

microphone is connected across the primary in series with a flash-lamp battery for energising. A simple make-and-break switch must also be in series with the battery so this circuit can be broken when the microphone is not in use.

For those who wish to use low potential heater valves in the modulator section several minor alterations will have to be made. First of all, the input valve should be of the AC/HL type fol-

lowing on the transformer secondary, the centre tap of this being joined to the positive side of the first 8-mfd. smoothing condenser. Naturally this amplifier is then only suitable for A.C. mains.

As the modulator valve only requires 250 volts high tension a heavy duty resistance should be connected in series with the centre tap of the rectifier filament wiring so as to reduce the H.T. applied to 250 volts. This resistance should have a value of a little over 5,000 ohms, but owing to variations use a Bulgin type PR10 having a value of 7,500 ohms. This is supplied with an adjustable clip so the voltage can be regulated as required.

It is most important that the aerial be cut exactly to length. The formula

Notice that the oscillator valve can be the new Tungram 0-15/400 instead of a P430. The screening grid circuit also merits attention.

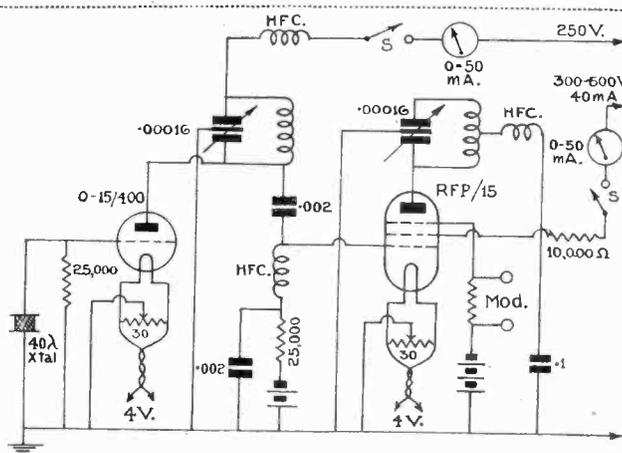

lowed by a PEN4VA pentode and an MU14 1DH rectifier. The circuit can remain fundamentally the same with the exception that the valve heaters instead of being connected across the mains have to be joined to 4-volt filament winding on the mains transformer.

The NG/50 rectifier circuit must also be omitted in favour of the MU14 full-wave valve which has 500 volts applied to each anode. Connect the filament of the MU14 to the 4-volt 2.5-amp. wind-

for this is as follows, $\frac{300,000}{7,200} = 41.7$

metres. 41.7 metres \times 1.56 = 65 ft. The only variable factor is the frequency which is determined by the crystal finally purchased. For those who wish to use a non-resonant transmission line a slightly different aerial circuit should be used. Connect a small eight or nine-turn coil up against the anode coil and tune in series with two condensers.

International Prefixes

AC	CHINA	K5
AC4	TIBET	K6
AR	SYRIA	K7
CE	CHILE	KA
CM	CUBA	LA
CO	CUBA (Pyone)	LU
CP	BOLIVIA	LX
CR4	CAPE VERDE	LY
CR5	PORT GUINEA	LZ
CR6	ANGOLA	MX
CR7	MOZAMBIQUE	NX
CR8	PORT. INDIA	NY
CR9	MACAO	OA
CR10	TIMOR	OB
CT1	PORTUGAL	OE
CT2	AZORES	OH
CT3	MADEIRA	OK
CX	URUGUAY	OM
D	GERMANY	ON
EA	SPAIN	OZ
EI	IRISH FREE STATE	PA
EL	LIBERIA	PJ
EP, EQ	PERSIA	PK
ES	ESTONIA	PY
ET	ABYSSINIA	PZ
EZ	SAAR	SM
F3, F8	ALGERIA, FRANCE, MARTINIQUE, MOROCCO, TAHITI	ST
F4	TUNIS	SU
F8M	MOROCCO	SV
FB8	MADAGASCAR, REUNION	TA
Fi	FR. INDO-CHINA	TF
G	GREAT BRITAIN	TG
Gi	NORTH IRELAND	TI
HA	HUNGARY	
HB	SWITZERLAND	
HC	ECUADOR	
HH	HAYTI	
HI	DOMINICAN REP.	
HJ, HK	COLOMBIAN REP.	
HL	SAINT HELENA	
HP	PANAMA	
HR	HONDURAS	
HS	SIAM	
HZ	HEDJAZ	
I	ITALY & COLONIES	
J	JAPAN	
K4	PORTO RICO, VIRGIN ISLANDS	

GUAM, HAWAII, SAMOA (U.S.)	ALASKA
PHILIPPINE ISLANDS	NORWAY
ARGENTINA	LUXEMBOURG
LITHUANIA	BULGARIA
MANCHUKUO	GREENLAND
CANAL ZONE	PERU
SARAWAK	AUSTRIA
FINLAND	CZECHOSLOVAKIA
GUAM	BELGIUM, BEL. CONGO
DENMARK	NETHERLANDS
CURACAO	NETH. INDIES
BRAZIL	SURINAM
SWEDEN	POLAND
EGYPT	SUDAN
GREECE	TURKEY
ICELAND	GUATEMALA
COSTA RICA	

TS	SAAR
U, UE, UK, UX	U.S.S.R.
V8	MAURITIUS
VE	CANADA
VK	AUSTRALIA
VO	NEWFOUNDLAND
VP1	ZANZIBAR
VP2	ANTIGUA, FIJI ISLANDS
VP3	GILBERT & ELLICE ISLANDS
VP4	BRITISH HONDURAS, TRINIDAD
VP5	CAYMAN ISLANDS, JAMAICA
VP6	BARBADOS
VP7	BAHAMAS
VP9	BERMUDA
VQ1	FANNING ISLAND
VQ2	NORTHERN RHODESIA
VQ3	TANGANYIKA
VO4	KENYA
VQ5	UGANDA
VQ8	ASCENSION, ST. HELENA
VR	BRITISH GUIANA, MAURITIUS
VS2, VS3	MALAYA
VS5	SARAWAK
VS6	HONG-KONG
VS7	CEYLON
VS8	MALAYA
VU	INDIA
W	UNITED STATES
X	MEXICO
XU	CHINA
YA	AFGHANISTAN
YI	IRAQ
YJ	NEW HEBRIDES
YL	LATVIA
YM	DANZIG
YN	NICARAGUA
YP	RUMANIA
YS	SALVADOR
YT, YU	JUGOSLAVIA
VV	VENEZUELA
ZB1	ALBANIA
ZC1	TRANSJORDANIA
ZC6	PALESTINE
ZD	NIGERIA
ZE1	SOUTHERN RHODESIA
ZK1	COOK ISLANDS
ZK2	NIUE
ZL	NEW ZEALAND
ZM	SAMOA (BRITISH)
ZP	PARAGUAY
ZS, ZT, ZU	UNION OF S. AFRICA

OUR POLICY
The Development
of
TELEVISION

B.T.S. ACKNOWLEDGED THE BEST

LISTEN in
PEACE

Cut out MAN MADE STATIC with the

B.T.S. ANTI-NOISE AERIAL OUTFIT

SUPPRESSES NOISE on ALL WAVEBANDS, IMPROVES SENSITIVITY and SELECTIVITY. For all Sets, A.C., Battery or D.C. and all Wavebands. Erected in 5 minutes. Nothing to assemble. 90% of the trouble experienced in all-wave reception is noise, which this amazing new all-British aerial abolishes, vastly improving reception on all wavebands. Outfit includes aerial transformer and, in addition, a special set transformer with wave-change switch for reception on all wavebands. This extra component will improve sensitivity and selectivity. Send for free descriptive folder.

25/-

From all Dealers.



SPECIFIED

SHORT WAVE Battery 4

1 cadmium plated ready drilled chassis	£ s. d.
1 Frosted aluminium ready drilled panel	10 6
2 ready drilled copper screens	7 6
2 sets of 4-pin Type E coils, 12-94 metres	2 0
	1 0

PORTABLE TRANSMITTER

2 cadmium plated ready drilled chassis	£ s. d.
1 cadmium plated ready drilled screen	17 0
1 Type "M" microphone ready mounted	1 6
	15 0

Insist on
B.T.S. Specified Components

AMERICA DIRECT

ON YOUR PRESENT MAINS or BATTERY SET with no alterations ... simply plug in the

B.T.S. ADABAND

BRINGS SHORT WAVES TO YOUR PRESENT SET

Brings scores of extra programmes from every part of the world. For almost any make or type of set. Single tuning control. 13-74 metres. Walnut veneered cabinet. Long and medium wave reception continued on present set without disconnecting.

MAINS Model
£6 : 12 : 6
H.P. : 15 monthly payments of 10/-

BATTERY Model
£5 : 5 : 0
H.P. : 15 monthly payments of 8/-
Send for free leaflet.



B.T.S. products are stocked by all good Radio Dealers.

If you have difficulty in obtaining any B.T.S. product, send name of nearest Radio Dealer with remittance for immediate delivery.

B.T.S.

BRITISH TELEVISION SUPPLIES Ltd.,
Faraday House, 8-10 Charing Cross Road, London, W.C.2
Phone: Tem. Bar 0134-5 Grams: Television, Lesquare, London

Building the Power Amplifier Stage

By G2NO

CONSIDER the grid circuit as the control circuit, for very seldom does the stage furnishing the excitation supply an over abundance of drive. In order that minimum power be wasted in the transfer from the plate circuit of the driver to the grid circuit of the amplifier, it is important that some consideration be given to losses that often occur in the grid circuit.

An independently tuned grid circuit coupled to the driver by a low-impedance line is the most efficient method of power transfer. By the proper matching of the low-impedance line to both the driver tank and grid tank it is possible for the grid circuit to assume the maximum voltage swing permissible by the supplied power regardless of the plate voltage of the driver stage. The use of a low-impedance line prevents capacity transfer back to the driver and permits of complete neutralisation within the amplifier.

The grid circuit tank condenser may have to withstand considerable voltage if the excitation power and bias voltage on the amplifier is high. This means that in all but extreme cases a double-spaced condenser must be used. This condenser should preferably be split-stator, which lends itself well to both push-pull amplifiers, if two valves are used, or to grid neutralising when only one valve is used. If a split-stator condenser is employed with a single valve the grid condenser can then be single ended.

Efficient Grid Coils

Do not use too small a diameter grid coil or too fine a gauge wire, for the grid coil should be designed to give maximum efficiency. Bias should be tapped on to the centre of the coil, if a split-stator arrangement is used, or to the earthy end if a single section condenser is used. An R.F. choke at either point is a questionable advantage as the chokes generally used by amateurs have similar characteristics, so if a choke is employed in the plate circuit there is a possibility that plate and grid chokes will resonate causing parasitic oscillations at low radio frequencies.

In order that the grid circuit be properly adjusted it is absolutely necessary that a meter be employed either permanently or temporarily in order accurately to determine the value of grid current and properly to adjust the circuit for maximum efficiency. It must be remembered that the grid circuit should always be adjusted for maximum grid current.

This article deals with the finer points of P.A. circuit design which are often overlooked. It should be studied by all interested in short-wave propagation.

The Anode Circuit

Anode circuit design is most important if optimum results are to be expected. Considerable confusion has existed regarding the proper choice of capacity for the amplifier plate tank condenser. Apparently there has been two distinct schools of thought, one leaning toward extremely low capacities, the other going to the higher extreme. Any tank circuit, regardless of

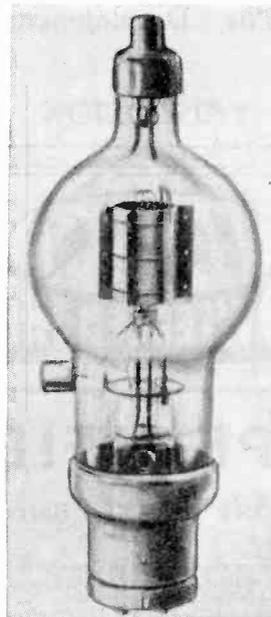

The Eimac 150T is a high efficiency triode valve with low interelectrode capacity. The grid contact is brought out to a side contact.

the inductance capacity ratio, has infinite "Q" at resonance providing there is no resistance in the circuit.

Where there is a finite value of resistance in the circuit it will be found that the circuit with the least capacity will have the highest "Q" when unloaded because the loss occasioned by the tank circuit resistance is a function of the circulating current. Couple useful resistance into the tank circuit and then the low capacity tank circuit loses its "Q" at a faster rate than the high capacity circuit.

If the coupling is carried beyond a certain point the high capacity circuit has more "Q" than the low-capacity circuit. It has been determined that for optimum conditions of performance the value of "Q" should not go below a certain minimum. The "Q" of the tank circuit should be higher for phone operation than for C.W. In the panel shown are given values of plate load with the lowest permissible capacity.

In order that the same capacity-inductance ratio be maintained it will be found that the size of the capacity will vary directly with frequency. If a constant plate current is maintained as the anode voltage is raised the value of coupling resistance becomes higher making it possible to use a smaller tuning capacity.

Summarising, the optimum value of capacity is determined by load, frequency, anode voltage and type of service. It is also undesirable to make the capacity any larger than necessary as excessive circuit losses will result due to the high value of circulating current. This type of loss makes itself apparent by heating of the tank circuit.

Low loss construction is essential with the tank coil. Valves operating at high anode voltages and at the same time lightly loaded require low values of tuning capacities so losses occasioned by circulation currents are of a low order. The low values of circulation currents makes the use of smaller sizes of copper tubing or even of No. 10 wire highly desirable, as losses occasioned by distributed capacities are less resulting in higher overall efficiency.

It is desirable that a tank coil fasten directly to the tank condenser. If this is not practical make the connecting leads between coil and condenser as short and heavy as possible. The dimension of the coil should be reasonably large with approximately 4 ins. as a minimum diameter in order to obtain the highest efficiency.

Neutralising

The comparatively low values of capacities that are used in valves operating at high anode voltages and lightly loaded, make the tank circuit susceptible to outside influences. When operating a valve under such conditions it is absolutely essential that neutralising be accomplished in such a manner that practically the same values of capacity and inductance be present in the neutralising branch as in the branch to be neutralised. To realise such a condition it is important that the anode for

(Continued on page 366).

HYVOLTSTAR

**ALL
WAVE
SUPERHET**

4 VALVE MODEL
Price 12 guineas (chassis)
15 guineas (Table Model)

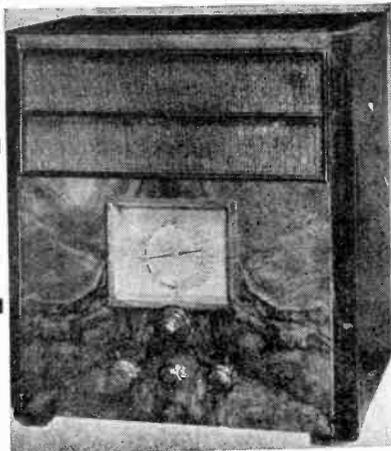

Three wave bands :
16.5-52 metres ; 200-560
metres ; 850-2000 metres.
Two-speed tuning dial
15/1 and 100/1.

The 4 valve circuit uses a pentagrid frequency changer, pentode I.F. amplifier, metal second detector, and power pentode. This receiver with calibrated short wave tuning dial and full A.V.C. is very suitable for use in the WORLD WIDE SHORT-WAVE reception contest. Provision is made for gramophone pick-up with internal Volume and tone control; sockets are also provided for an external loud-speaker. A reflex circuit—using one valve for two functions gives 4 valve performance with 3 receiving valves. This model, as all our other models is suitable for A.C. or D.C. mains without alteration—even on 100 volts D.C. plants. Write to-day for full particulars and prices of all our models.

Universal HighVoltage Radio, Ltd.
28/29, Southampton Street, Strand, W.C.2
Telephone: TEMple Bar 8608.

HAVE YOU ENTERED?

—for the great contest running in this issue of "Television." All you have to do is to receive as many short-wave stations as you can and get in the check cards. Among the magnificent prizes is one of the famous J.B. special Short-wave condensers and a Two Ratio Slow Motion Dial. Short Wave enthusiasts know this famous pair and their use is a sure road to success—hence their selection, as a prize in this contest, by Mr. Jowers.

*Send now for our latest illustrated catalogue of
Short-wave components.*

JACKSON BROTHERS (London) Ltd.,
72, St. Thomas Street, S.E.1
Telephone: Hop 1837



G 2NO

11, LICHFIELD STREET, WOLVERHAMPTON

Offers Tested and Guaranteed

AMERICAN RECEIVING AND
TRANSMITTING VALVES

at unheard of prices.
SEND FOR LATEST LISTS.



IN STOCK—

FULL RANGE RECEIVING—RK—EIMAC
AMPERIX.

IN STOCK—

HAMMURLUND - HALLICRAFTER PEAK
RECEIVERS.

IN STOCK—

NEW AMATEUR III BATTERY-OPERATED
SHORT WAVE RECEIVER £5 10 0 complete.

SEND STAMP FOR "T.S.W." LISTS.

A Powerful 2-valve Short Wave Receiver with Bandsread Tuning



**WAVE RANGE—
15.5/52 Metres.**

(Extra Coils to 200 metres)
Adaptable to A.C. for Low
Tension.

PRICE OF ASSEMBLY 67/6,
complete with Instruction
Book and Service Manual
containing theoretical and
practical circuits, point to
point wiring plan, wave-
range charts and full build-
ing data.

STAR FEATURES

- Calibrated Band Setting
- High Sensitivity—Low Noise Level
- Diecast Aluminium Chassis
- No Grid Bias Battery Continuous Bandsread Tuning
- Pre-Set Reaction—Potentiometer Gain Control
- Low Current Consumption.
- Simplicity of Construction



EDDYSTONE
ALL WORLD TWO

STRATTON & Co Ltd
Eddystone Works,
Birmingham.

London Service: Webb's
Radio, 14, Soho St.,
Oxford St., W.1.

"Building the Power Amplifier Stage"

(Continued from page 364)

the circuit to be neutralised occur at the electrical centre.

There are two systems for neutralisation in general use. One employs a split-stator condenser, the electrical centre being formed by the symmetrical capacity to earth realised by the use of a split-stator condenser. Neutralising voltage is fed from one end of the anode tank coil to the grid of the valve through the neutralising condenser. In this arrangement the grid condenser can be single ended. A split-stator condenser is used in the second method, the electrical centre being formed by the condenser. The neutralising voltage is fed from the opposite end of the grid tank to the anodes of the valve through the neutralising capacity.

When two valves are operated in push-pull a combination of the two systems is employed. In all cases where care has been taken to make every-

circuit. The proper loading of both sides of a push-pull tank circuit is another important consideration. Coupling to a two-wire transmission line should be effected symmetrically around the electrical centre of the tank coil. If a single wire feed is used with a push-pull amplifier a low impedance line should couple the anode tank to a second tank to which the single wire feeder is connected. This second tank will allow the proper impedance match as well as tending to eliminate undesireable harmonics.

Amplifier Types

The previous considerations hold good for all types of amplifiers, the real differentiation between the various amplifiers being in the amount of bias employed and the available excitation power. Different amounts of bias alter performances to such an extent that the amplifier classifications are designated in terms of ratios of anode voltage to

anode current cut-off is noted if 100 per cent. modulation is expected.

Tuning

It should be remembered that the grid circuit should always be tuned to cause maximum grid current. The anode circuit should be tuned to resonance, with anode voltage off, by noting the maximum deflection of the R.F. meter used for neutralising. Minimum deflection on the R.F. meter should be obtained by adjustment of the neutralising condenser. The anode tank circuit should then be re-adjusted until the R.F. meter shows maximum deflection. After this procedure has been repeated a few times it will be found that there is practically no indication on the R.F. meter regardless of the tuning of the anode tank circuit. This is the setting for correct neutralisation.

A flash-lamp bulb can be substituted for the R.F. meter, but will not permit of such an accurate adjustment of the neutralising condenser.

When neutralising is complete apply the anode voltage, and as the tank condenser is brought through resonance the anode current will drop to a low minimum value. If the precautions noted are observed the minimum anode current should be between 10 and 20 m/a. If the minimum of anode current is above these values there is apparently something amiss as some factor is limiting the value of no-load impedance of the tank circuit.

If maximum anode efficiencies are to be realised it is important that the no-load anode current be extremely low. If the optimum grid current is flowing through twice cut-off bias and the above precautions have been observed no difficulties should be experienced in coupling sufficiently to obtain maximum rated anode currents. Anode efficiencies at the higher anode voltages should be in excess of 75 per cent.

If less than optimum grid current is available it is advisable to reduce the value of grid bias until optimum current again flows. When excitation is insufficient it is possible to couple up to the point of maximum anode current without excessive heating of the valve or even an actual falling off of power output. Variations in aerial coupling and bias will result in a point of maximum power output with this limited amount of excitation. When excitation is insufficient to produce optimum grid current do not reduce the value below cut-off as this is the point of maximum power gain.

Power inputs are limited by anode dissipation and anode current readings. If the anode dissipation is low and maximum anode current ratings have been reached additional power input should only be accomplished by raising the anode voltage. Never increase the anode current above maximum rating.

minimum anode tuning capacities to be used with a single valve grid neutralised.

Frequency. 1,750 Kc.	Anode voltage.	Anode current. 200 M/a.	Minimum capacity. 200 mmfd.
1,750	1,500	200	100
1,750	3,000	100	100
1,750	1,500	100	100
1,750	3,000	100	50
3,500	1,500	200	100
3,500	3,000	200	50
3,500	1,500	100	50
3,500	3,000	100	25
7,000	1,500	200	50
7,000	3,000	200	25
7,000	1,500	100	25
7,000	3,000	100	12.5
14,000	1,500	200	25
14,000	3,000	200	12.5
14,000	1,500	100	12.5
14,000	3,000	100	6.5

thing symmetrical and the leads to the capacities short, it will be found that the capacity of neutralising condenser is approximately equal to the valve capacity. It is important to note that the minimum capacity of the split stator condenser to earth should be three to four times the capacity of the connected valve electrode to earth in order that the condenser has sufficient capacity to determine the electrical centre of the circuit.

In order to operate an amplifier at optimum efficiency it is important that the tank circuit when tuned to resonance represents a pure resistance into which the valve is to work. Standing waves on the transmission line will result in a change in power factor of the tank circuit resulting in an increase in valve dissipation. Unless the standing waves are completely eliminated it is imperative that some sort of buffer arrangement be used between the tank circuits and the aerial.

This buffer should consist of an impedance matching network to correct the errors in the transmitting line and reflect a pure resistance into the tank

bias voltage. A Class B amplifier is one in which the anode current is reduced practically to zero by bias. This amplifier gives maximum power gain with limited excitation powers. Over a good portion of the cycle anode current varies directly with the grid voltage. Class B amplification is used in radio-frequency linear amplifiers where modulation has been effected in a previous low-level stage.

A Class C amplifier is biased beyond the anode current cut-off point and noted for the somewhat higher anode efficiencies obtained. Greater grid driving power is necessary so the power gained is less. Where modulation is effected in the anode circuit of the amplifier bias voltage should be high enough so that a condition of twice

**READ TELEVISION
& SHORT-WAVE WORLD
REGULARLY**

PETO-SCOTT

Components, Kits, Receivers or Accessories for Cash or C.O.D. or on our own system of Easy Payments. C.O.D. orders value over 10/- sent carriage and post charges paid (Gt. Britain only). H.P. Terms are not available to Irish and Overseas customers.

SHORT WAVE 4

Kit "A" Cash or C.O.D. £8 16 6
Carriage Paid.
Or 12 monthly payments of 16/3.

Complete Kit of components including B.T.S. ready drilled chassis, panel and screens, less valves and speaker.

Kit "B" As for Kit "A" but including set of first specified valves, less speaker.
Cash or C.O.D., Carriage Paid, £10/14/6 or 12 monthly payments of 19/9.

	£	s.	d.
1 B.T.S. drilled cadmium plated chassis	10	6	
1 B.T.S. frosted drilled aluminium panel	7	6	
2 B.T.S. ready drilled copper screens	2	0	
3 Eddystone variable condensers, 20, 40 and 100 m.mfd.	13	0	
1 W.B. Baby speaker	1	2	6
4 Specified Valves	1	18	0

PORTABLE TRANSMITTER

Kit "A" Cash or C.O.D. £8 6 0
Carriage Paid.
Or 12 monthly payments of 15/3.

Complete Kit of parts including 2 B.T.S. ready drilled chassis and screens, less valves and cabinets.

	£	s.	d.
1 Peto-Scott specified cabinet 15" by 12" by 6 1/2"	1	0	0
1 Peto-Scott specified cabinet 15" by 8" by 3 1/2"	17	6	
2 B.T.S. cadmium plated drilled chassis	17	0	
1 B.T.S. ready drilled screen	1	6	
1 B.T.S. Microphone, Type M	15	0	
5 specified valves	2	10	6

PETO-SCOTT Co., Ltd., 77 (T. & C. City Road, London, E.C.1.
Telephone: Clerkenwell 9406/7.
West End: 62 (T. & C.), High Holborn, London, W.C.1.
Est. 1919.

RELIANCE

POTENTIOMETERS

Specified for the "SHORT-WAVE BATTERY FOUR."

These are the ones you need :
100,000 ohm, 4/6, .5 megohm, 4/9.

Illustrated Folder "T.S.W." of our complete range of Volume Controls and Potentiometers free on request.

RELIANCE MANUFACTURING CO. LTD.
Westbury Road, London, E.17



PIEZO QUARTZ CRYSTALS

A Q.C.C. 7 Mc. (40-m.) Crystal is specified by the designer of the PORTABLE BATTERY-

OPERATED TRANSMITTER.

Our new 1936 catalogue of short-wave transmitter and receiver components, sent post free for 1 1/2 d. stamp.

THE QUARTZ CRYSTAL CO., LTD.
63 & 71, Kingston Road, New Malden, Surrey
Telephone: MALDEN 0334.

Read

Television and Short-wave World

Regularly

Calls Heard

2BXL and 2BZN, New Barnet.
(20 metre phone.)

ZU6P, OA4AF, VE1DC, EA, CN, GZ, JK, VE2HY, GA, BC, VG, VE3BD, EO, EP, NX, BK, MJ, KF, JV, NF, EO, HC, W5ZS, EFI, BEP, ACF, AHK, BBG, ATI, W6LSW, W7BS, W9BDS, VOX, VK2BQ, JC, VK3MR, SU1RO, 1CH, 1RK, SU8MA, LU1EX, PY1CK, 1VQ, 2BJ, 2BA, TI2RC, 2AV, CO2RA, 7CX, CT2AV, CE1ER, NX2V, NY2AE, YN3AC, VS7RA.

(20 metre C.W.)

VK2HG, AN, KS, EZ, VK3GE, NY, JT, US, VX, MX, CA, VK4QA, VK5RR, ER, LB, VK6FO, VK7BX, BO, ZL1DV, ZL2FY, QM, ZL3GR, JA, HAF5C, 4K, YR5M, ZU6M, U8JB, U9AL, AV, MF, OE2CL, ZB1H, LU3FC, LU5AM, PY1DK, TI2AG, W4ANC, BGF, TR, W5RA, EXL, W6LD, CNE, ADP, AW, W9HUZ, ES3BY, VE4MY, LP.

W9DBC, J. Tomczyk, Minneapolis, U.S.A.

(28 metre C.W.)

D4ARR, F8CT, 8OZ, G2HG, 2MV, 2YL, 5BY, 5FV, 5VU, 6LK, 6RH, 6WY, 6ZM.

BERS195, E. W. Trebilcock, Tennant Creek, Australia.

(20 metre phone.)

G5QA, 6DL, 6WY, 5BY, 5LA.

(40 metre C.W.)

G2DQ, 2JU, 2NA, 2PL, 5IS, 5JM, 5IX, 5OJ, 6CW, 6NJ, 6OX, 6PY.

J. V. McMimm, Wellington, New Zealand.

(7 Mc. C.W.)

F88AD, G5GQ, G5TP, G6BQ, 6CJ, 6OX.

Frank C. South, Princetown, New Jersey.

(28 Mc. C.W.)

G5BO, 5BY, 5F3, 5IS, 5LA, 5QY, 5VU, 5WZ, 6DH, 6GS, 6IR, 6NF, 6QB, 6RB, 6RH, 6TT, 6WN, 6WY, 6ZV, 2HG, 2NV, 2PL, 2TM, 2YL.

W9JGS, Leonard Holmes, Wheaton, Illinois, U.S.A.

(28 Mc. C.W.)

G2HG, 5VU, 5UD, 6DH, 6NF, 6RH, 6WY, 6ZV, V15F, E18B, F8CT, F8WK, FA8CR, D4ARR, 4GWF, 4RVZ, OE1FH, OK1BC, 3VA, OA4B, OA4J.

BRS1784, M. G. Bourke, Jersey, C.I.

(28 Mc. Phone.)

W1, 2, 3, 4, 8, 9; W6DLY, W5BDV, OA4B, K4DDH.

(28 Mc. C.W.)

W1, 2, 3, 4, 5, 6, 8, 9, VE1, 2, 3, 4, CP1AC, CP5PZ, ZS1H, ZT6Y, LU9AX, OH7NF, U1BC, SU1SG, 1JT, G6RH, U9AV, U3AG, UH17ND, VK4EI, 4GK, XE1CM, U2NE, EA8AO, OA4J, UE3EL.

GALPINS ELECTRICAL STORES ALL GOODS GUARANTEED

DYNAMOS, all shunt wound, for lighting or charging, 100 v., 4a., 42/6; 220 v., 2 a., 50/-; 100 v., 10 a., 60/-; 50/75 v., 12 a., 65/-; 40 v., 14 a., 65/-; 12 v., 8a., 15/-; Aero Dynamos, 12 v., 8 a., 12/6.

CHARGING RESISTANCES or Shunt Regulator, stud and switcharm types, from 10/- to 17/6 each. A.C. DYNAMOS, self exciting, output 175 v., 2 kW., 45/-; Ditto, 200 v., 800 w., 50/-.

SHILLING SLOT METERS, 200/250 v., 50 cycle, single phase, condition as new, 17/6.

ELECTRIC LIGHT CHECK METERS, kilowatt hour type, 200/250 v., 50 cycle, single phase, for sub-letting, etc., 7/- each.

SLIDER VARIABLE RESISTANCES, suitable for dimming, etc., various sizes, 17/6.

2 1/2 KILOWATT PHILIPS TRANSFORMER, 200/250 v. input, 25, 50, 100 v. output, 25/-.

ONE KILOWATT TRANSFORMER, 200/250 v. input, output not known, good windings, 17/6.

G.P.O. GLASS TOP RELAYS, 7/6. G.P.O. Vertical Galvanometer, 5/6.

WESTERN ELECTRIC MICROPHONES, solid back type, 2/6 each.

R.A.F. MORSE KEYS, fully adjustable, 2/6. Larger Morse Keys, in aluminium case, 3/9 each.

PEDESTAL TELEPHONES, complete with auto. dial, 7/6.

G.P.O. WALL TELEPHONES, late type, magneto ringing (no magnetos), with automatic dials, 12/6 each.

FIRE ALARM TELEPHONES, complete in teak case, battery working, 15/-.

TRANSMITTING VARIABLE CONDENSERS, 0.005 mf., in glass case, 12/6 each.

AUTOMATIC TELEPHONE DIALS, 0 to 9, with switchgear, 2/-.

BROWN'S A TYPE ADJUSTABLE SINGLE EARPHONES, 2/- each.

MAINS CHOKES, 20 and 30 henry, 40, 60, 80 m/a, 1/3, 1/9, 2/6 each.

ROLA P.M. SPEAKER, type F6. List 39/6. Latest Ripple Cone, 21/-.

QUARTZ TUBES, 10 in. by 1/2, 7/6 per doz.

SHEET EBONITE, 12 in. by 11 in. by 3/8, 2/- per doz.

HAND COMBINATION TELEPHONES, complete 4/6 each.

FAN MOTORS, large size, 110 and 220 v., D.C., 5/- each.

R.A.F. AUTOMATIC CHARGING CUTOUPS AND VOLTAGE REGULATORS suit up to 20 v. dynamo, 2/6 each.

C.A.V. AUTOMATIC CHARGING CUTOUP, suit any voltage, 7/6.

MAINS RESISTANCES, wound with Eureka wire to carry from 1 to 5 am., s., 2/6 each.

TALKIE FADER, fitted Resistances, Switches, etc., 10/-.

LABORATORY CONDENSERS, 3 1/2 mf., fitted 10 knife switches, high voltage, 15/- each.

RESISTANCE MATS, 24 in. square, 600 ohm, 1/2 amp., wound with Eureka wire, 5/- each.

VALVES, 1,500 to clear, 2 v. dull Emitter, general purpose type only, by well-known makers, boxed as new, 1/- each; 3 for 2/6.

X-RAY TUBES by well-known makers, as new, 15/- each.

TWO INCH SPARK COILS, complete, 17/6 each.

MERCURY BREAKS, complete with motor 100/250 volt, 35/-; without motor, 25/- each.

DUPLEX TELEGRAPH KEYS, send and receive, 12/6.

VOLTMETERS, 0-40 v., Moving Coil, large size, 8/6.

10 AMP., THREE-WAY DISTRIBUTION BOARDS, in teak case, glazed, 10/-.

MORSE TELEGRAPH SOUNDERS, G.P.O., standard, 6/-.

ELECTRIC MEDICAL CONDENSER SETS, with motor, 50/-.

AUTOMATIC CHARGING SWITCHBOARD, Meters, Cutouts, etc., heavy duty, cost £65; size 42 in. 36 in., £7/10/-.

AIR PURIFIERS, motor driven, 110 and 160 v., D.C., 45/-.

ROTARY CONVERTERS, 110 to 250 v., D.C., D.C., 1/2 h.p., shunt, 15/-.

MOTOR BLOWERS, 4 in. outlet, 110 v. D.C., 35/-; 220 v., D.C., 45/-.

MOVING COIL MOVEMENTS for recalibration, high resistance, complete with pointer, 5/-.

WILSON WOLF DYNAMO, 50/75 volts 10 amps., 55/-.

VOLTMETERS, large size, 0-120 v., 15/-.

AMP METERS, large size, various readings, 15/-.

OR POST YOUR ORDER. Cash with Order or C.O.D. Closed Half Day Thursday. Trams and Buses pass the door. Nearest Station, Lewisham Junction.

Large Surplus. Stocks on View.

GALPINS

Dept. T.

75, LEE HIGH ROAD, LEWISHAM LONDON, S.E.13.

Top Band Frequency Register

MANY new stations have been added to this list during May. There are, however, still a number of stations whose frequencies are not listed, and we shall be glad to receive these in time for publication in the next issue.

Frequency.	Frequency
1726	G6GO
1730	6OK
1732	5ZJ
1736	5OO
1738	6ST
1740	5HO
1740	6WQ
1742	5WL
1748	5KV
1750	2WK
1752	2KL
1753	6KV
1754	6ZR
1754	6GO
1755	6PY
1756	2AO
1757	6YU
1759.5	5JW
1759.5	2KT
1760	5AR
1760	5BM
1762	2UJ
1762.5	2ZN
1764	5NW
1765	5ZQ
1766	6OO
1766	2WO
1766	5JO
1767.8	6LF
1768	6PL
1769	5GC
1769.5	5FI
1770	5PR
1773.1	5BC
1774	6SO
1774.5	6NU
1775	5KT
1775	6ZQ
1776.4	5YW
1777	2JG
1778	6SY

Frequency.

1780	6BO
1780	SZR
1780	5RI
1780	5BK
1780	6BO
1780	6HD
1781.5	5VS
1782	5RT
1784	5IJ
1785	6QI
1785.5	5ZT
1785.5	6IF
1786	5NP
1787.5	2XP
1788.5	2GG
1790	5MP

Frequency.

1790	5UM
1790	2SN
1791	5AK
1792.6	2QM
1794	5JU
1795	2UY
1800	6TL
1802.5	5LL
1802.5	2IZ
1805.9	2YW
1806	5MM
1808	5CH
1810	6BQ
1810	2LD
1810	5PP
1815	2DQ

Frequency.

1815	5OP
1818.5	2OG
1824.5	2WG
1824.5	6UJ
1830	5KG
1830	6WQ
1830	6QB
1831	5XR
1836.5	6RQ
1840	2JU
1844	6VD
1849	5CJ
1850	2CD
1850	5OC
1850	2HF
1850	2SR
1850	6UD
1850	6VD
1852	2KV
1857	6TQ
1857	2CF
1860	5IV
1860	6QM
1861	2KL
1862	6WY
1869	2PS
1869	5PB
1870	2PL
1870	2LC
1870	5RI
1870.5	2WT
1874.5	2XP
1875	6WF

Frequency.

1881	6FV
1884	5KJ
1888	2XC
1890	2MI
1893	5RD
1899	5XF
1900	2PK
1910	2NO
1910.5	2GG
1913.5	2UJ
1916	5VT
1916.5	2GZ
1920	6LZ
1921.7	2OV
1925	6CT
1925	6UU
1930	5OD
1935.5	2XQ
1936.6	5IL
1940	6PA
1950	6KD
1950	5GL
1950	5SZ
1954	2GG
1960	5UK
1961	5OQ
1961	2UJ
1965.5	5LL
1970	6UT
1975	6OM
1980	6KV
1988	5WW
1990	6AU

BINDING CASES AND INDEXES FOR 1935.

Binding cases and indexes for the 1935 volume of "Television and Short-Wave World" are now available. The cases are full brown cloth with stiff boards lettered in gold. The price, including the index, is 2/9 post free. Indexes may be obtained separately and the price is 6d. post free. Orders should be addressed—

BERNARD JONES PUBLICATIONS, LTD.,
CHANSITOR HOUSE,
37/38 CHANCERY LANE, LONDON, W.C.2
and should be accompanied by the remittance.

SPECIFIED FOR THE 40 METRE LOW POWER TRANSMITTER

(Described in the May Issue)

MAGNUM SCREENING BOX

(Type 1121. Price 5/-)

This box is supplied ready-drilled to designer's specification. Also specified for "Absorption Wave Meter" described in this issue.

BURNE-JONES & CO., LTD.
309/317, Borough High Street, LONDON, S.E.1.
Telephone: Hop 0495.

TELEVISION AND SHORT-WAVE WORLD KITS

**SHORT-WAVE BATTERY FOUR
BATTERY PORTABLE TRANSMITTER.
LOW-POWER MODULATOR
40 METRE LOW-POWER TRANSMITTER
ELECTRON-COUPLED BATTERY FREQUENCY METER
AMATEUR BANDS S.S. SUPER-HET**

Let us quote you the keenest prices for the above complete kits or any of the components. Comprehensive lists on application.

Scientific Supply Stores (Wireless) Ltd.,
128, Newington Causeway, London, S.E.1. Phone: HOP. 1800

"It is an ideal valve-tester"

for retail dealers and service men, as a check on any valve can be effected in a few minutes.

RADIOMETERS ALL VALVE TESTER

The above quotation is from "The Wireless World" test report of January 24th.

A necessity to all Service Men and Dealers. Brings a useful revenue from testing customers' valves and is a sure aid to valve replacement sales.

Descriptive Folder,
"T.S.W." Free

TYPE U. V. T.
Price

£8 - 8 - 0

H.P. Terms
available

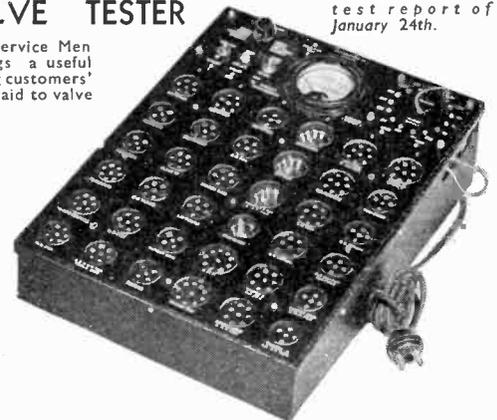

Entirely A.C. mains operated. Switching reduced to an absolute minimum. Tests British and American valves; Battery, A.C., D.C., or AC/DC types, including Frequency Changers, Diode types, Rectifiers, etc. Detailed Valve Data Book with each instrument.

As used by Marconi
Telegraph Co. Ltd.
(at home and abroad)

Obtainable from leading Wholesalers.

RADIOMETERS LIMITED.
DUNBAR WORKS, DUNBAR STREET, LONDON, S.E.27

Telephone:
STReatham
2241

THE TELEVISION ENGINEER

MECHANICAL FILM TRANSMISSION

THE
MIHALY-
TRAUB
SYSTEM

AN ANALYSIS
OF ITS POSSIBILITIES

By L. M. Myers.

This is the third and concluding article on film transmission by mechanical methods. The first and second articles which appeared in the March and April issues, dealt with the apertured disc and the Scophony system respectively.

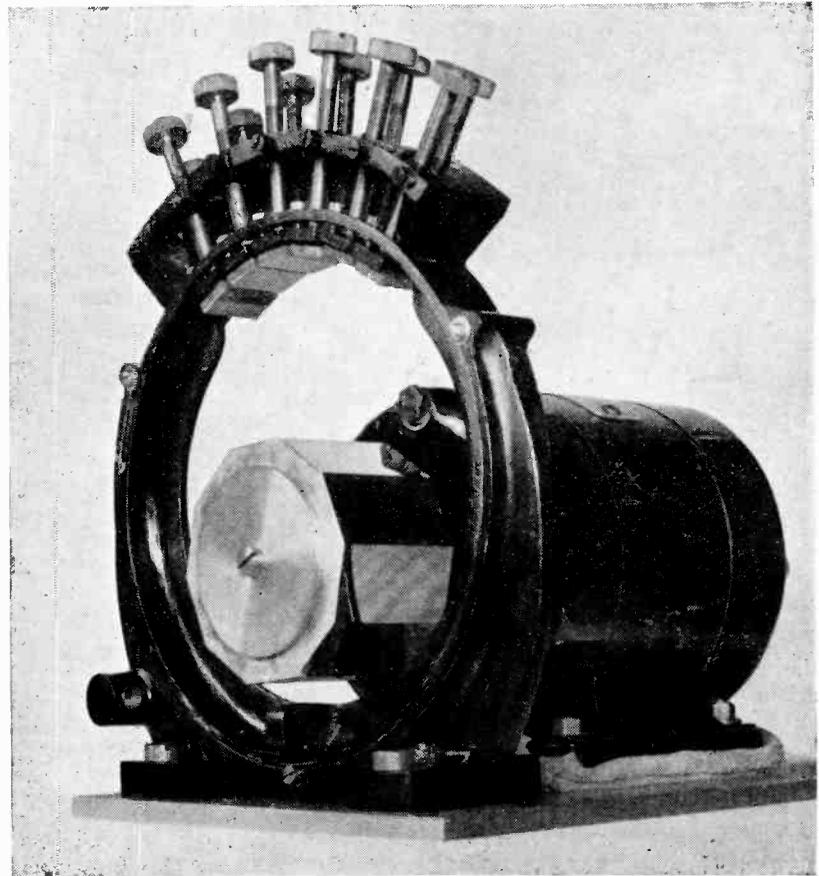

[Copyright photo, courtesy International Television Corporation Ltd. The Latest Mihaly-Traub Apparatus.

WE shall take as our final example of film transmitters the type embodied in the Mihaly-Traub system. Hitherto this system, which has been fully described elsewhere, has found employment in the projection of the image at the receiver end. It can be readily adapted, however, for the transmission of films and we shall show that of all known mechanical optical film transmitting devices, this holds a high place in the efficiency scale.

Briefly, the system comprises a central mirror drum and a number of stationary ring mirrors, the object being to increase the picture angle and at the same time to permit the use of a rotating drum of very small dimensions. Generally speaking, all known forms of orthodox scanning arrangements fall into two broad categories. The first class is represented by the aperture disc; the lens disc; the concave mirror disc; the aperture drum and the lens drum, the efficiencies of which are all identical.

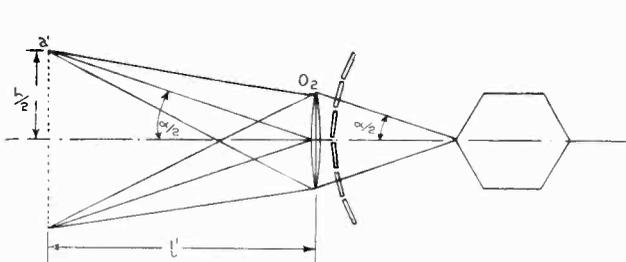
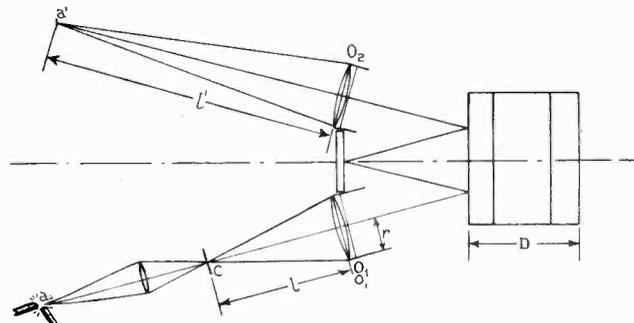

Fig. 1.—Schematic layout of Mihaly-Traub system shown in plan and elevation.



DEFINITION AND EFFICIENCY

To the second class belong all types of mirror drums comprising optical means whereby the scan is effected with the aid of a rotating mirror. Again, the optical efficiencies of all such systems are identical providing account is not taken of various modification, such as double reflection off the drum mirror as in the case of the Wilson device, as splitting the beam into more than two parts according to the system described by Dakin, in this periodical, or as in the present case of the Mihaly-Traub system.

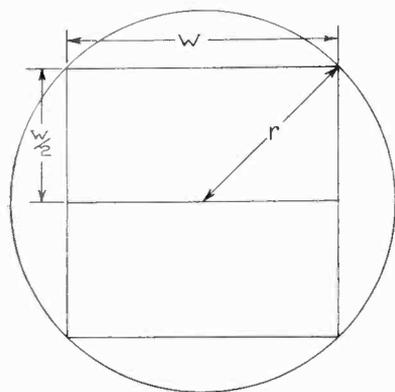

Fig. 2.—Diagram showing how the drum diameter is calculated.

Having thus relegated the Mihaly-Traub system to the second class, the question of comparative efficiency arises because, as pointed out by Kirschtein in that excellent, but unfortunately discontinued, periodical "Fernsehen" for 1931, page 98, when we arrive at about one-hundred line definition, the efficiencies of the two classes become equivalent and thereafter the efficiency of the aperture disc transcends that of the mirror drum. At that time, however, the Mihaly-Traub system was undeveloped. This system is many times more efficient than the aperture disc owing to the fact that the second power of the number of mirrors in the stationary ring comes into the efficiency expression.

Examination of Fig. 1, which illustrates the plan and elevation of the optical system in the Mihaly-Traub

arrangement, will give some rough idea as to the operation. Light from a source a is collimated by the first lens or objective O_1 and, in a parallel beam finds its way to the central mirror drum whence it is reflected to the stationary ring of mirrors. The light turns back here to reach a higher portion of the mirror on the central drum and after final reflection at this surface passes into the second objective at O_2 whereat the parallel beam is made to converge to the light spot on the film. The area of this light spot is a' and corresponds to an area a of the light source. In order to obtain a sharp light spot it will be first necessary to image the light source on an aperture, the latter being shown at C .

We can now proceed to derive the efficiency expression following on the usual lines by expressing the amount of light entering the first objective at O_1 in terms of the various constants of the system and then multiplying by the transmission loss factor to account for light losses on reflection and refraction throughout the system. This will give us the amount of light falling on the photo-cell when the film presents its least density. We can begin, therefore, by writing down the primitive expression

$$F = \beta a \omega$$

wherein F is the light flux in lumens.

B is the brightness of the light source in candles/cm².

a is the area of the light source.

ω is the solid angle subtended by the first objective at the light source.

Let n be the number of lines in the picture.

q be the number of mirrors on the stationary ring.

n_d be the number of mirrors on the central rotating drum.

p be the speed factor; i.e., the number of revolutions of the central drum necessary to complete one picture scan.

$$\text{Then } n = n_d \times q \times p.$$

L be the length of the image on the film in the direction of scan.

N be the number of elements.

K be the picture ratio; i.e., $K = \text{length-width}$.

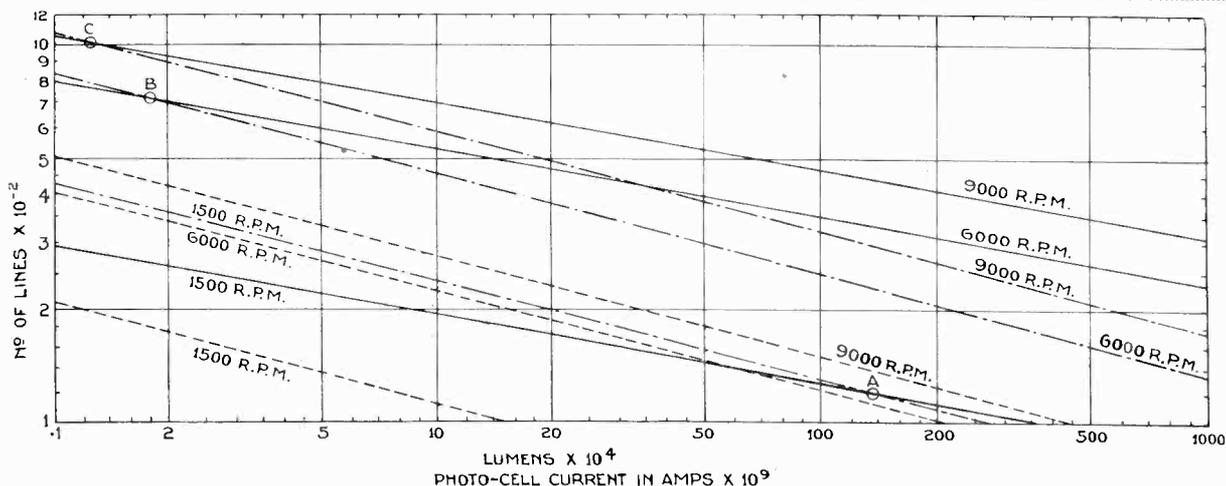

Fig. 3.—Graph showing the amount of light reaching the photo-cell with ten stationary mirrors and for various speed factors and definitions.

OPTICAL CALCULATIONS IN MECHANICAL SCANNING

Then $N = Kn^2$.

A be the area of the full scan; i.e., length-width.

$$\text{Then } A = \frac{L^2}{K}$$

D be the diameter of the central mirror drum.
W be the axial width of the central drum mirror.

r be the radius of the first objective.

l be the distance of the first objective from light source.

l' be the distance of the second objective from the image on the film.

a be the picture angle; i.e., the angle subtended by the film scan of the second objective.

As the light is parallel between the two objectives we can put for the area of the light source

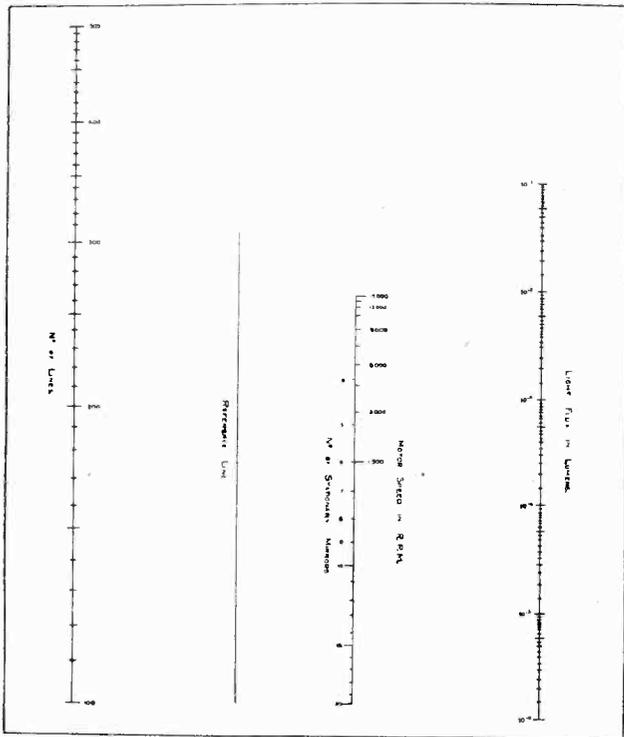

Fig. 4.—Nomogram showing the variation of optical efficiency for different parameters.

$$\frac{a}{a'} = \left(\frac{l}{l'}\right)^2$$

We can also write for the solid angle

$$\omega = \frac{\pi r^2}{l^2}$$

so that, on substitution, the primitive expression takes the form

$$F = \frac{B a^1 \pi r^2}{l^2}$$

Now the area of the light spot is equal to that of the

complete scan divided by the number of elements; thus

$$a^1 = \frac{A}{N} = \frac{L^2}{KN}$$

and

$$F = \frac{B \pi r^2}{KN} \left(\frac{L}{l'}\right)^2$$

Now $\left(\frac{L}{l'}\right)^2$ can be expressed in terms of the picture

angle. This angle is subtended at the central mirror drum by the length of the scan in the usual layout of the simple mirror-drum scanner, but here as parallel light travels between the two objectives, the picture angle is subtended at the optical centre of the second objective and the scan thus appears to arise at this point. The rotation of the central drum mirror for

one complete scan is, of course, $\frac{2\pi}{n_d}$ but the deflection of

the beam is twice this, so that after the first reflection from the central mirror drum, the angular deflection is 4π

— . After the second deflection this angle is increased n

twofold resulting in the new angular deflection $\frac{8\pi}{n_d}$. But

there are q mirrors on the stationary ring, so that the consequent angular deflection forming the final picture angle will be

$$a = \frac{8\pi}{n_d \times q} = \frac{8\pi p}{n}$$

as

$$n = n_d \times q \times p.$$

As this picture angle is supposed small we can put from geometry

$$\frac{L}{2l'} = \frac{a}{2} = \frac{4\pi p}{n}$$

because the angent of the half picture angle is equal to the angle.

From this expression it will be seen that

$$\left(\frac{L}{l'}\right)^2 = \frac{64\pi^2 p^2}{n^2}$$

whereupon, on substitution for $\left(\frac{L}{l'}\right)^2$, the expression becomes

$$F = \frac{64\pi^3 B p^2 r^2}{KNn^2} = \frac{64\pi^3 B p^2 r^2}{N^2}$$

We have now to express r in terms of the drum diameter and this can be accomplished on examination of Fig. 2. Assuming that it is required that the light spot brightness should be uniform across the whole scan, then the light cone from the first objective should cover exactly two mirrors at the most. From the geometry of Fig. 2, it will be seen that

$$r^2 = \frac{W^2}{2}$$

where W is the axial width of the central drum mirror and in accordance with the above requirement, the peri-

EFFICIENCY OF MIHALY-TRAUB SYSTEM

pheral width of the mirror should be half the axial width, so that the square formed by the two consecutive mirrors should fit into the circular light cone as shown. That drum diameter is now given by

$$\frac{W}{2} = \frac{\pi D}{n_d}$$

so that

$$r^2 = \frac{W^2}{2} = 2 \left(\frac{W}{2} \right)^2 = \frac{2\pi^2 D^2}{n_d^2} = \frac{2\pi^2 D^2 q^2 p^2}{n^2}$$

On substitution for r our efficiency expression becomes

$$F = \frac{128\pi^3 BD^2 q^2 p^4}{N^2 n^2}$$

On accounting for the transmission losses we first note from Fig. 2 that the area of the light cone is π times the area of one central mirror so that the above expression must be divided by π . Furthermore, the light reflected from the mirror drum on to the stationary ring mirrors, having, simultaneously, to cover two of the ring mirrors thus providing uniform brightness of light spot along the scan, must be halved. This reduces our efficiency expression to

$$F = \frac{64\pi^4 BD^2 q^2 p^4}{(Nn)^2}$$

Introducing now the transmission loss factor t , we have for the final expression

$$F = \frac{64\pi^4 BD^2 q^2 p^4 t}{(Nn)^2} \text{ lumens.}$$

To work out concrete examples we might put

$$B = 20,000 \text{ candles/cm}^2.$$

$$D = 10 \text{ cms.}$$

$$K = 4/3.$$

$$t = 0.1$$

and we find

$$F = \frac{7 \times 10^8 q^2 p^4}{n^6} \text{ lumens.}$$

It is difficult to draw simple curves for different values of n ; q and p so that we might, as an example, take a specific case wherein $q = 10$. This means that there will be ten mirrors on the stationary ring. For a 240-line picture there would have to be 24 mirrors on the central drum for a speed factor of unity, and 6 mirrors for a speed factor of 4 with a corresponding motor speed of 6,000 r.p.m. The full-line curves drawn in Fig. 3 give complete information as to the light reaching the photo-cell for 10 stationary ring mirrors and for various speed factors and picture definition.

Efficiency of Mihaly-Traub System

It is of interest to make some comparison between the efficiency of this system and the efficiency of the simple aperture disc and also that of the Scopphony arrangement. For this purpose the curves of Fig. 3 have been drawn, wherein the dotted lines represent the aperture disc efficiencies; the broken line, the Scopphony system efficiencies and the full line the efficiencies of the Mihaly-Traub film transmitter.

In order to avoid confusion, only three values of the

speed factor are taken, viz.: $p=1$; $p=4$ and $p=6$. It will be remarked that for $p = 1$, when the motor speed is 1,500 r.p.m., the Mihaly-Traub system is more efficient than the Scopphony system for picture definitions under about 140 lines. This point is shown as A on the curves. For a motor speed of 6,000 r.p.m., when the speed factor is $p = 4$, the Mihaly-Traub system becomes equal in efficiency at about 700 lines, below which the former system becomes more efficient than the latter. This is shown at point B.

Again at a motor speed of 9,000 r.p.m. the efficiency of the Mihaly-Traub system transcends that of the Scopphony system for definition below about 1,000 lines. The intersection of the two efficiency curves is due to the fact that the efficiency of one system varies inversely as the sixth power of the number of lines and that of the other as the fourth power. As the speed factor rises, the efficiency of the Mihaly-Traub system increases more rapidly than that of the Scopphony system owing to the fact that the efficiency of the former system varies directly as the fourth power of the speed factor and that of the latter varies as the second power only.

In comparing these efficiencies it must be strongly emphasised that only one value of the number of stationary ring mirrors has been taken. The value chosen was ten and if a lower value, such as five or six was taken, the efficiency would be decreased by the factors $(5/10)^2$ and $(6/10)^2$ respectively. In the former case as the efficiency is decreased by $1/4$, it will be seen that the efficiency of this system is equivalent to that of the Scopphony system at about 400 lines.

We are thus led to the conclusion that, from an optical efficiency point of view there is but little to choose between these two systems. Both are considerably more efficient than the aperture disc arrangement.

Disadvantages of the System

There will be some difficulty in obtaining the correct amount of picture definition from this system owing to the fact that in general practice, although the first objective may be amply corrected, the second objective cannot be fully corrected owing to its extremely great aperture ratio. Some considerable deflection of the light beam from the second reflection off the central mirror drum will have taken place by the time this parallel beam of light reaches the objective in question. Hence the necessity for an objective of large radius if no light is to be lost during the scan. As the number of lines increases, however, this deflection will become less and an objective with smaller aperture ratio will be all that is needed. No experimental results in this connection have yet been published so that the discussion cannot be amplified.

Means of Rapid Calculation

From the efficiency expression

$$F = \frac{7 \times 10^8 q^2 p^4}{n^6} \text{ lumens.}$$

we can construct a simple nomogram of the third class

JUNE, 1936

to give a visual account of the variation of the efficiency for different parameters of the optical layout. In Fig. 4 such a nomogram is given. To use this, a straight edge should be laid across the number of lines on the extreme left scale and the number of stationary mirrors on the ring which form the graduations of the second scale. Then the intersection of the straight edge with

the reference line R should be connected by the straight edge with the speed ratio scale which appears on the right of the number of stationary mirror scale. The intersection of the straight edge with the right-hand scale give the efficiency directly in lumens, representing the amount of light reaching the photo-cell when the film is least dense.

Addendum.

Since the three articles on film transmitters have been sent to press, information has come to hand warranting additional remarks and modifications.

(a) The Scopphony System.

It has already been indicated by Scopphony, Ltd., that the question of image distortion is by no means as serious as intimated and their optical designers must be congratulated in having obtained so good an image. It is also pointed out that the lenses mounted in the drum are cylindrical. In all probability this would mean a minified plan image of the light source (a filament lamp is used) so that a light source length exceeding that of the width could be turned to account. Supposing this minification is M' , then the efficiency of the system would be increased this much. Presumably the

factor M' might range from 2 to 10 depending on the design.

(b) The Mihaly Traub System.

Mr. E. H. Traub has pointed out to the writer that the light loss factor which was taken as 0.1 in his system as applied to film scanning should, in fact, be 0.5 because there are fewer refracting surfaces in his system when compared with the Scopphony system. This brings the efficiency up five times. In the article dealing with this system, it was stated that as no experimental results had been as yet published details as to the correction in the system were not available. The writer has been since informed that certain optical modifications in the optical layout for the film transmitters, as distinct from the receiver, successfully avoid serious optical distortion.

DIRECTION OF MOTION OF CATHODE-RAY SPOT

By J. H. HAYNES, in the Bell Laboratories Record

THE moving spot of light which generates the characteristic fluorescent patterns in a cathode-ray oscilloscope is usually vibrating so rapidly that it is impossible for the eye to detect its instantaneous

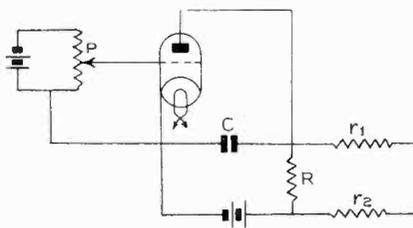

Fig. 1.—A gas tube relaxation oscillator used to provide a rapid succession of timed pulses.

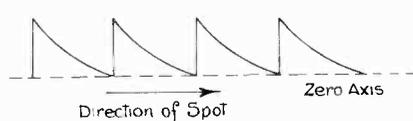

Fig. 2.—A saw tooth wave-form is obtained when the output of the oscillator is connected to a cathode-ray oscilloscope with a time sweep axis. The serrations point in the direction of motion of the oscilloscope spot.

direction across the condenser C until the critical breakdown voltage of the tube is reached at which time the condenser discharges. By properly choosing the values of R and C the condenser can be made to charge and discharge at rates varying from one to 20,000 times per second. If the output of such an oscillator is connected to a pair of plates of a cathode-ray oscilloscope and the other pair is made a time sweep circuit a saw-toothed wave like that shown in Fig. 2 results. The saw teeth, which are caused by the sudden increase of voltage across R when the condenser C discharges and the subsequent slow decrease as it charges again may be thought of as arrows pointing in the

direction of motion of the spot. Thus if it is desired to ascertain the direction of motion of the cathode-ray spot in any cathode-ray oscilloscope figure it is only necessary to connect the relaxation oscillator, tuned to the appropriate frequency, through suitable high resistance leads r_1 and r_2 , Fig. 1, and superpose the saw-tooth wave on the figure in question.

The appearance of an oscilloscope pattern without and with the relaxation oscillator is illustrated in Figs. 3a and 3b respectively. The direc-

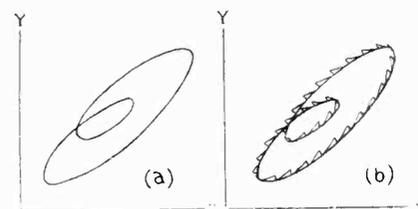

Fig. 3.—The oscilloscope pattern (a) is changed to that shown at (b) when the relaxation oscillator is applied, thus indicating in this case that the oscilloscope spot is actually rotating in a clockwise direction.

direction of motion. It is sometimes important, however, in experimental work that this direction be definitely known. This was the case recently on account of special conditions which had to be met.

A simple gas tube relaxation oscillator like that shown diagrammatically in Fig. 1 was constructed. This gradually builds up a potential differ-

tion of motion of the spot in this particular case was clockwise.

Because of its simplicity and adaptability it is felt that this method of determining the direction of motion of a cathode-ray oscilloscope spot may be applicable to a wide variety of circuits.

RECENT TELEVISION DEVELOPMENTS

A RECORD
OF
PATENTS AND PROGRESS
Specially Compiled for this Journal

Patentees: *Marconi's Wireless Telegraph Co. Ltd., B. Levin and N. Levin :: L. Gabrilovitch, V. Isnard, and R. Berthon. :: General Electric Co. Ltd., and L. C. Jesty. :: A. C. Cossor, Ltd. C. O. Browne :: J. L. Baird and Baird Television, Ltd.*

Light-Valves

(Patent No. 441,274.)

A light-valve of the Kerr-cell type is made highly sensitive by using, instead of nitrobenzene, an organic substance which is in the so-called "nematic" state, i.e., half-way between being a solid and a liquid. In this condition it is found to exhibit a comparatively high Kerr constant.

Examples of suitable organic substances are ethyl and methyl cinnamates. Methods of preparing these substances so that they will retain the required semi-solid state at normal temperatures are described in the specification.—(*Marconi's Wireless Telegraph Co., Ltd., B. Levin and N. Levin.*)

Television without Scanning

(Patent No. 441,896.)

It would be possible to dispense with scanning, and so avoid the necessity for synchronising the transmitter with the receiver, if each picture point on the image could be transmitted simultaneously with every other picture point, on a wavelength of its own. At the receiving end, each transmitted signal would, of course, have to be separately received and applied to illuminate the appropriate point on a viewing-screen.

Such a system is however impracticable, partly on account of the complexity and cost of the circuits involved, and partly because there is no room available in the ether for the enormous number of frequencies which would be required for transmission.

The inventors aim to simplify the problem by sending out a series of picture "points" simultaneously as independent modulations and sub-modulations on a comparatively small number of carrier-waves. These are received simultaneously on the differently-tuned circuits of a single aerial, and after rectification are applied to energise a bank of lamps

which serves as a viewing screen.—(*L. Gabrilovitch, V. Isnard and R. Berthon.*)

Cabinets for Picture and Sound Receivers

(Patent No. 442,323.)

In order to reduce the overall size of the cabinet containing a television receiver, the cathode-ray tube C is mounted behind a protecting sheet G of glass which, instead of being set vertical, is inclined at an angle, as

electrodes into two parts. These two parts are then anchored to fixed voltages of opposite polarity, whilst the fluctuating scanning voltage is fed solely to the remaining plates, both of which are located to one side of the main electron stream.—(*A. C. Cossor, Ltd.*)

Mirror-screw Scanning

(Patent No. 442,668.)

A mirror-screw S is used in association with a mirror-drum D, which

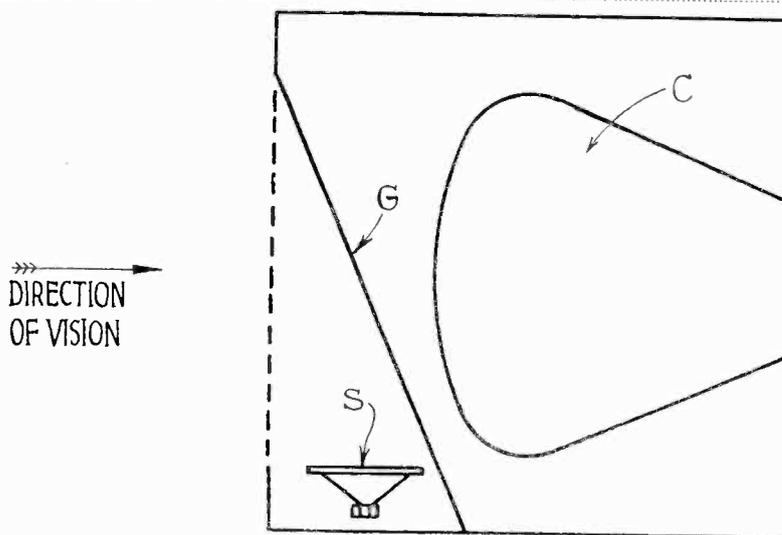

A method of housing vision and sound receivers. Patent No. 442,323.

shown, so as to leave an external space for the loudspeaker S. In this way the sounds from the speaker proceed straight into the open air instead of being muffled by the glass screen G, as they are when the speaker is enclosed.—(*The General Electric Co., Ltd., and L. C. Jesty.*)

Cathode-ray Tubes

(Patent No. 442,513.)

The so-called "origin distortion" or "white-cross" effect (produced on the fluorescent screen of a cathode-ray tube by the action of the scanning-voltages) is avoided by dividing one element of each pair of scanning-

rotates about an axis at right angles to that of the screw. Light from a source L, after passing through an aperture P, is focused by a lens L upon the viewing screen N. On its way it is reflected from the mirror-drum M so as to traverse the spiral length of the mirror-screw S, thereby acquiring the two component movements necessary for scanning.

If one-half of the mirrors on the drum D is set at a different angle to the other half, successive rays will be thrown on to the viewing screen, in slightly-displaced relation, so as to give interlaced scanning. The same

The information and illustrations on this page are given with permission of the Controller of H.M. Stationery Office.

JUNE, 1936

effect can be produced by inserting at the aperture P a disc D₁ with two segmental slots A, B as shown in Fig. 1A.—(C. O. Browne.)

Viewing Screens
(Patent No. 442,963.)

In order to increase the effect of the electron stream upon the viewing-

form an image of the object.—(H. G. Lubszynski and S. Rodda.)

(Patent No. 442,682.)

Cathode-ray tube circuit designed to give correct "framing" irrespective of any fortuitous changes in anode voltage.—(Marconi's Wireless Telegraph Co., Ltd., and A. J. Young.)

(Patent No. 443,012.)

Synchronising system in which the "leading edges" of both line and frame impulses are kept in phase.—(J. Hardwick and F. Blythen.)

(Patent No. 443,031.)

Separating the picture signals and synchronising impulses in a cathode-ray television receiver.—(T. M. C. Lance, D. W. Pugh and Baird Television, Ltd.)

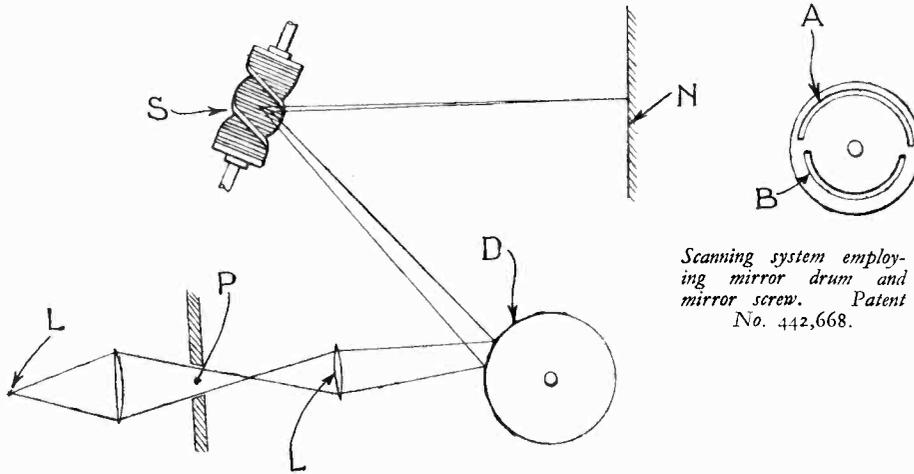

Scanning system employing mirror drum and mirror screw. Patent No. 442,668.

New B.S.I. Publications

THE British Standards Institution have recently published the Standard Specification for Radio Valve Bases and Holders, together with two new publications—Specification for inlet and outlet Connectors for Radio Circuits, and a Glossary of acoustical terms and definitions.

While the first two booklets are of interest to the manufacturer of radio components, the last will be of use to all radio experimenters and we recommend that they obtain a copy for reference. The definitions have been drawn up in consultation with the International Consultative Committee of Telephony and a short section on musical terms has also been included.

The definition of "noise" as "sound which is undesired by the recipient" will find agreement among many listeners who have thin party walls and inconsiderate neighbours!

screen of a cathode-ray receiver, the screen is initially brought to the threshold of incandescence by means of a separate heating current. As shown, the screen S is made as a "matrix," formed by bending a wire W into a number of convolutions arranged in a series of close-set rows. Current is supplied from a battery B and is adjusted so that the screen as a whole is just on the point of glowing. The impact of the electron stream is then sufficient to bring the picture out in incandescent form.—(J. L. Baird and Baird Television, Ltd.)

Summary of Other Television Patents

(Patent No. 441,969.)

Switching circuit for operating a bank of lamps which serve as a viewing screen for television.—(A. Karolus.)

(Patent No. 442,333.)

Television system utilising synchronising-impulses which are of "line" frequency, or a multiple thereof.—(Radio Akt. D. S. Loewe.)

(Patent No. 442,408.)

Tripping or control circuits for a television system using the so-called "gap" method of synchronisation.—(C. Lorenz Akt.)

(Patent No. 442,666.)

Cathode-ray television transmitter in which the object to be transmitted is first focused upon a photo-sensitive screen, which then emits electrons to

(Patent No. 442,686.)

Producing substantially-linear saw-toothed waveforms with a short "fly-back" period, for television scanning.—(L. R. Merdler and Baird Television, Ltd.)

(Patent No. 442,740.)

Relaxation oscillation generators for producing line and frame-scanning frequencies in television.—(Radio Akt. D. S. Loewe.)

Increasing the effect of the electron stream on the viewing screen. Patent No. 442,963.

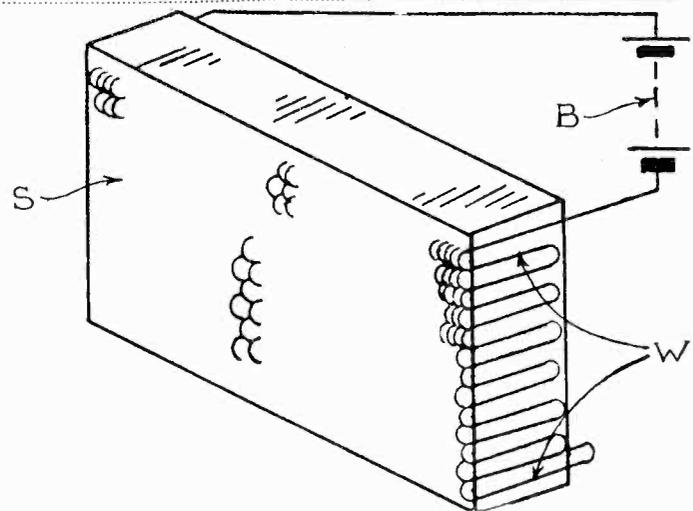

(Patent No. 442,938.)

Saw-toothed oscillation generator in which an impedance element is effective during each train, but is short-circuited during the interval between successive trains of waves.—(J. Hardwick and F. Blythen.)

Copies of the booklets are obtainable from the British Standards Institution, Publications Department, 28 Victoria Street, S.W.1, the price of the Glossary being 3s. 8d. post free, and that of the Specifications 2s. 2d. each post free.

SCANNING SEQUENCE AND LINE AND PICTURE FREQUENCIES

This article is an abstract of a paper by R. O. Kell, A. V. Bedford and M. A. Trainer, read before the Institute of Radio Engineers (U.S.A.). It considers factors which affect the apparent steadiness of television images, namely, line flicker, flicker of the image as a whole, alternating-current ripple in the deflecting circuits, alternating-current ripple in the video frequency signal, and various kinds of beating of the alternating-current ripple with the various scanning frequencies.

IT is well known that the frequency band required to transmit a television picture is proportional to the production of the picture detail and the frame frequency.

Cathode-ray Scanning

At present cathode-ray scanning gives the greatest promise for a television system. This involves, for example, the use of the Iconoscope as a pick-up device at the transmitter, and the Kinescope at the receiver. Both devices are similar in that an electrostatically-focused beam of electrons is deflected vertically by the magnetic field produced by a saw-tooth wave of current (Fig. 1), and horizontally by either a magnetic or electrostatic field produced by a saw-tooth wave of voltage of a much higher frequency (Fig. 1). The action of

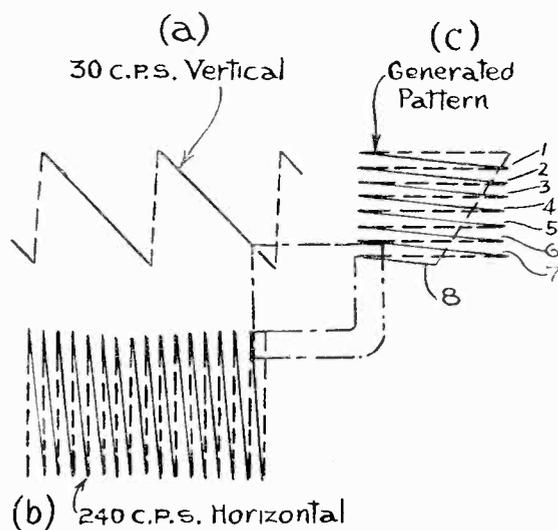

Fig. 1.—Generation of a progressive scanning pattern.

the two deflecting fields is to cause the light-sensitive screen of the Iconoscope or the luminescent screen of the Kinescope to be uniformly scanned by the electron beam, as shown in Fig. 1. In this as well as the following figures, the line frequency is shown as approximately 200 cycles to facilitate illustrating, while in practice it is about 7,000 cycles. The return path for each line is shown dotted. Alternating-current power-operated receivers contain (in the U.S.A.) 60-cycle and 120-cycle disturbances in the direct voltage supplies which operate the receiver. In sound reception this is called "hum" but in the present paper the term "alternating-current ripple" will be used since the term "hum" implies audibility.

A.C. Ripple

Alternating-current ripple in cathode-ray television shows itself in several ways. When superimposed upon the deflection of the scanning beam it produces the wavy edges as shown in Fig. 2a, in the case of the horizontal deflection, and causes the non-uniform spacing of the lines of the picture as shown in Fig. 2b, in the case of the vertical deflection. When the ripple exists in the cathode-ray anode voltage supply, it alters the stiffness of the beam as regards deflection and thereby modulates the deflecting influence of both the deflecting waves. This effect upon the horizontal deflection is shown in Fig. 2c. It should be understood that these effects operate not only to distort the shape and density of the scanning pattern, but also cause the misplacement of the details of the picture.

The presence of alternating-current ripple in the video frequency amplifier causes the pattern to vary alternately in brightness from top to bottom of the picture. (This effect is not shown in the figures.) Actually all these effects occur simultaneously, though for clearness they have been shown separately. We now reach a very important point in regard to the psychological effect of alternating-current ripple, i.e., whether the dis-

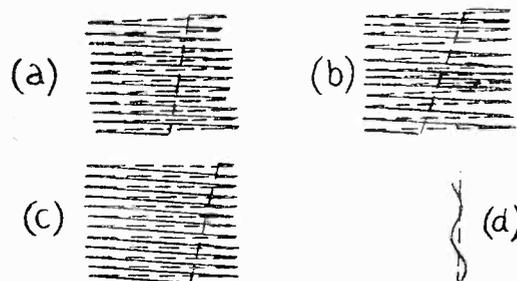

Fig. 2.—Effect of 60-cycle ripple on 30-cycle progressive scanning (a) ripple in horizontal, (b) ripple in vertical, (c) ripple in anode supply, (d) diagram of 60 c.p.s. ripple on 30 c.p.s. pattern.

tortion produced (ripple pattern) is stationary or moving with respect to the scanning pattern.

In the case of the 30-frame per second scanning, as shown in Fig. 2, the ripple pattern is stationary and hence is much less objectionable than if it were moving. That the ripple pattern is stationary is evident from a study of Fig. 2d, and the fact that thirty is a whole number submultiple of sixty. However, in the case of a twenty-four-frame per second picture with sixty-cycle ripple, the alternate frames have distortion and opposite phase (see Fig. 3). This is true since sixty divided by twenty-four is a whole number

EFFECT OF A.C. RIPPLE ON THE PICTURE

plus a half, which may be interpreted to mean that the ripple pattern passes over the scanning pattern twelve times per second (since twelve is one-half of twenty-

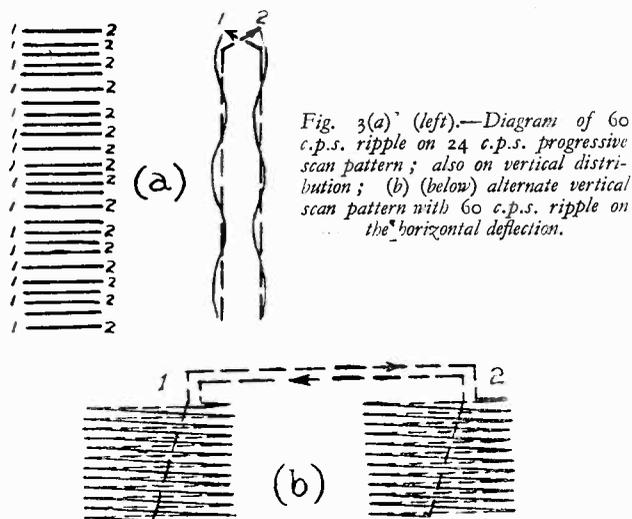

The figure shows clearly that the two vertical scanning cycles are required to make a complete cycle of motion of the beam. This is one of the worst conditions possible, since any element of detail in the picture jumps from one position to another position near by at a frequency of 12 cycles. This causes fatigue of the eye in so far as the observer is able or attempts to follow the elements of detail in their shifting of position,

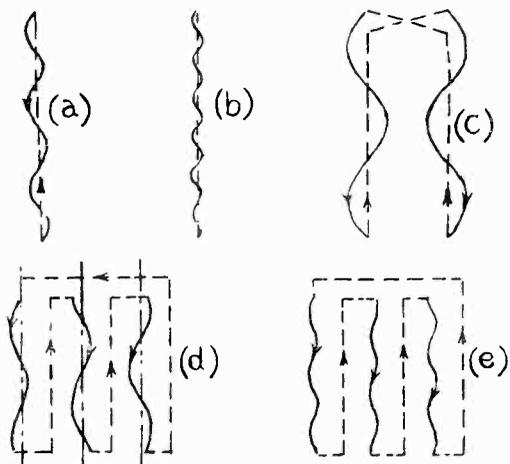

Fig. 4 (a and b).—Standing ripple patterns for various scanning conditions; (c, d and e) some conditions for moving ripple pattern that repeat in two or three vertical scanning cycles.

and a loss of resolution or blurring of the picture in so far as the eye fails to follow the shifting. The presence of sixty-cycle ripple in the picture signal also causes a twelve-cycle flicker of portions of the picture.

In case some picture repetition rate between twenty-four and thirty, say, twenty-seven, is chosen, the "ripple pattern" will drift upwards across the pic-

ture at the rate of about 60 cycles of ripple per second. At this rate, the eye would be able to follow the elements of picture detail so that no appreciable loss of resolution would be observed, but due to the propagation of the "ripple pattern" the picture would give an annoying effect of motion, similar to that experienced when viewing stationary objects submerged in water having waves on its surface. Figs. 4a and b show schematically some standing ripple patterns for various scanning conditions, while c, d and e show some conditions for moving ripple pattern that repeat in two or three vertical scanning cycles.

Picture Frequency

From the foregoing considerations and from tests, it seems desirable that the picture repetition rate be some integer submultiple of 60, such as 10, 15, 20 or 30. So far as continuity of motion in the picture is concerned, it is probable that 15 or 20 would be high enough,

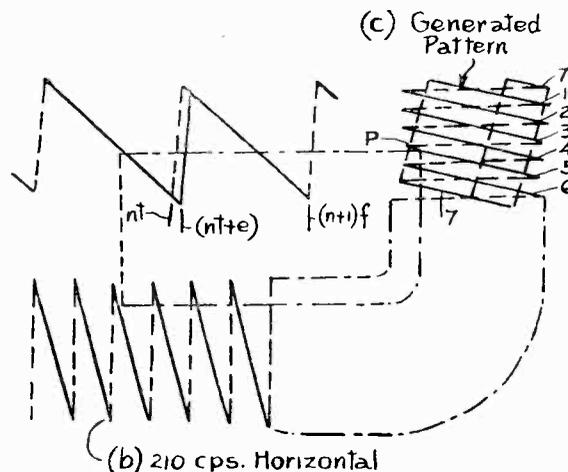

Fig. 5.—Generation of interlaced scanning pattern by odd-line method,

although the motion-picture standard is 24 per second. However, a much higher repetition rate is required in order to reduce picture flicker to a satisfactory level, and about forty-eight pictures per second would be required even if no allowance is made for increase in picture brightness by future development. Since 60 has no integer submultiple between 30 and 60, it would seem that the adoption of a repetition rate of sixty per second is required for operation from a sixty-cycle power source. Increasing the picture repetition rate and hence the frequency band in the ratio of sixty to fifteen to eliminate flicker may be giving flicker elimination the advantage in the compromise with picture detail. Yet numerous tests have shown that thirty frames per second is distinctly unsatisfactory in regard to flicker.

Odd-line Interlaced Scanning

At least a partial solution of the problem has been provided by interlaced scanning, in which alternate lines are scanned in successive vertical deflection cycles.

Interlaced scanning pattern must be obtained in

ODD-LINE INTERLACED SCANNING

cathode-ray television by electrical methods. The odd-line method, as the name implies, makes use of an odd number of horizontal scanning lines for each two vertical scanning cycles. For example, the condition now considered optimum for a video frequency band of 750 kilocycles is 243 lines in the complete picture, the frame frequency being thirty and the field frequency being sixty cycles. This makes the horizontal scanning frequency 7,290 cycles and the lines per vertical deflection cycle $121\frac{1}{2}$. The half line left over at the end of each vertical cycle causes the alternate vertical deflection cycles to start 180 degrees apart with respect to the horizontal deflection cycle. Fig. 5 indicates how this

One slightly objectionable optical effect is noticeable in interlaced scanning pictures when objects in the scene move more rapidly. If the motion is horizontal, the edges of the object appear to be jagged. This is due to the fact that a moving object is transmitted as a rapidly changing series of "stills" and that each alternate "still" is composed of only one set of alternate lines, and that each "still" is slightly displaced horizontally with respect to the one preceding. On the other hand the motion is actually portrayed more accurately by the thirty to sixty interlaced scanning than with thirty-frame progressive scanning since the moving object is shown in sixty positions per second in-



Fig. 6.—(a) 60 c.p.s. ripple in horizontal. 80 c.p.s. interlaced vert. (b) 60 c.p.s. ripple in vert. effect on line distribution. (c) 120 c.p.s. ripple in horizontal.

will produce the interlaced effect. The lines 1, 3, 5, etc., are scanned during odd vertical saw-tooth cycles, whereas lines 2, 4, 6, etc., are scanned during the even vertical saw-tooth cycles. The arrows in the figure indicate the path of the scanning beam.

Any one line is repeated only thirty times per second, but no line flicker is perceptible because of the extremely small area occupied by a single line, and because of the small angle subtended at the eye by a single line. Two or more alternate lines cannot co-operate to produce a thirty-cycle flicker by combining their area if the eye includes more than one line, the intermediate lines will be unavoidably seen and the eye is subjected to the sixty-cycle alternating light effect as produced by the picture acting as a whole.

One exception to this is possible but not probable and would occur when the subject matter of the transmitted picture chances to contain horizontal lines which agree in position with the scanning lines such as to cause alternate lines to be dark over an appreciable area of the screen. Tests with this method of scanning have proved very satisfactory from the point of view of flicker.

stead of thirty. This gain, however, is considered not to be of practical value.

When an object in the scene moves vertically, the apparent jagged edges of the object are not evidenced, but the entire object may appear to be transmitted by a system having only half the total number of lines. This effect is complete and at its worst only if the motion is at the rate of one line pitch per one-sixtieth of a second or an integer multiple thereof. This loss of detail in a moving object is largely offset by the well-known fact that moving objects require less resolution in order to be understood, and that the eye cannot resolve minute detail in moving objects.

The effects of sixty-cycle and 120-cycle ripple upon interlaced patterns is shown in Fig. 6. In the case of thirty to sixty-cycle interlaced scanning (Fig. 6) the effects are very much the same as for thirty-cycle progressive scanning. The lines are displaced according to the sine law horizontally as shown in Figs. 6 (a) and (c) and vertically as shown in Fig. 6b. However, adjacent lines of the even and odd vertical deflections are all displaced similarly so that slight fixed distortion of the picture is the only ill-effect. Such distortion may have a magnitude equal to several times the line pitch for a 243-line picture without being serious.

Suggested Type of Report for World-wide Short-wave Reception Contest

Call Sign.	Date.	Time B.S.T.	Wave-length.	Programme or call heard.	Weather conditions.	Notes on reception.
W2XAD	May 30th.	9 p.m.	19 m.	Dance band.	Fine.	Bad Static.
LA1G	June 1st.	4 p.m.	20 m.	Calling W9BHT	Wet.	Good conditions.

Total number of verifications, 127.

Type of receiver and number of valves: home built super 5 valves.

Type of aerial: inverted L in loft.

NAME.....

ADDRESS.....

The Bideford and District Short-wave Society.

This Society is continuing its meetings fortnightly on Mondays at the British Legion Headquarters, Bideford, throughout the summer, and a Field Day is planned shortly. Two Morse classes are held at each meeting, one for beginners and another for more advanced operators intending to qualify for an amateur transmitting licence. Three call-signs are held amongst the Society's own members, and there is much interest in this side of its activities.

THE PRINCIPLES AND PRACTICE OF ELECTRON OPTICS—V

By N. Levin, Ph.D., A.R.C.S., D.I.C.

This is the fifth of a series of articles describing in an easily understood manner the principles and practice of electron optics, a new branch of electronics which is becoming of great importance.

The Electron in a Magnetic Field

A BEAM of electrons moving through a magnetic field is subject to forces acting on it which can be arranged to focus the beam, or deflect it, in the same way as an electrostatic field can be arranged. However, the electromagnetic field differs from the electrostatic field in one important point. The force on an electron in a magnetic field is at right angles both to the direction of the field and the direction of motion of the electron. Hence a magnetic field parallel to the axis will exert a radial force, that is, a force acting away from or towards the axis, which will focus the beam but will not affect its velocity in the direction of motion.

In an electrostatic field the radial force is one component of the total force, the other being in the direction of motion. Therefore if we have a magnetic field to focus the beam, we must have an electrostatic force to cause the beam to move in the desired direction. Thus we can never have an electron-optical system in practice consisting entirely of magnetic fields, and we must always take into account the electrostatic field. However, there is no interaction between the two fields and we can therefore calculate the effects on the beam of electrons separately and add them up to give the final result. In practice it is found best to apply any magnetic field either for focusing or deflection in a uniform electrostatic field of zero intensity.

The Action of the Magnetic Field

A magnetic field parallel to the axis will not exert any force on an electron whose direction of motion is also parallel to the axis, but it will have an effect if the direction of motion is inclined to the axis. This occurs in practice because the electron beam is always of some finite width. The distortion of the image introduced by

this effect is only serious if the beam is made too wide. With a small angle beam symmetrically shaped round the axis the effect is negligible.

The action of the magnetic field on the electron beam is further complicated when we consider an electron moving at an angle to the axis. Considering the component of motion at right angles to the axis or the radial component, we can see that since the force on it must be at right angles both to the direction of motion and the direction of the field, the force must be in a direction at right angles to the $z-r$ plane. Thus if the plane of this paper represents the $z-r$ plane, then the force on the electron will be in the direction *through* the paper. Hence the electron will be constrained to travel in a circle at right angles to the $z-r$ plane.

Since the electron has a forward velocity it will actually travel in a spiral and the radius of this spiral can be calculated. If u is the angle the electron path makes with the axis, then the radial velocity is $v_r = v \sin u$, where v is the resultant velocity of the electron. The force on the electron travelling in the radial direction is $H e v \sin u$ and the centrifugal force

is $\frac{m v^2}{r}$, therefore

$$r = \frac{m v}{e H} \sin u$$

H being the strength of the magnetic field.

If the electron completes one cycle of the spiral in a time t , then

$$t = \frac{2\pi r}{v \sin u}$$

$$\text{or } t = 2\pi \frac{m e}{H}$$

The first point to be noticed is that this time is independent of the velocity or the direction of the electron. Hence if electrons start at the same instant from a point on the axis in a uniform or homogeneous magnetic field they will all come to the same

point further along the axis at the same time, that is they will be focused. Moreover, in a homogeneous magnetic field any line parallel to the field is an axis. Therefore an electron starting at, say, 5 millimetres above the central axis will come to a focus the same distance above the centre as it began. Thus an electron source can be focused by a homogeneous magnetic field without inversion or rotation and without magnification. The distance d from the starting point at which the focus will be formed is given by $v_z t$, where v_z is the axial velocity of the electron. Therefore

$$d = \frac{2\pi m e}{H} v_z$$

Now $v_z = v \cos u$ and if the angle u is very small, $\cos u$ is very nearly unity.

$$\text{Hence } d = 2\pi \frac{m e}{H} v.$$

Thus the quality of the image depends on the cosine of the angle the electron makes with the axis and only if this angle is small is the distance d practically constant and the distortion scarcely noticeable.

This property of the homogeneous magnetic field has been made use of by Farnsworth in his image dissector. In this, the light picture is transformed into an electron picture, in which the emission of electrons at any point of a photo-electric surface is proportional to the intensity of the light falling on that point. This electron picture is then focused by an homogeneous magnetic field produced by a current through a coil surrounding the tube. The plate on which the electron picture is focused has a small aperture in the centre allowing the electrons focused on that point to pass through it. The whole picture is then deflected in the usual manner and the picture is thus "scanned."

The focusing action of the non-uniform or inhomogeneous magnetic field is somewhat similar to that

of the electrostatic field with the addition of the rotating effect. If we have a short coil symmetrically wound round the axis and carrying a current, we then obtain the condition of a non-homogeneous magnetic field which will focus a source of electrons, the object plane and the image plane both being well outside the field of the coil.

Exactly as for the case of the electrostatic lens, we have for a cylindrically symmetrical field from Laplace's equation for the field distribution,

$$H_r = -\frac{r}{2} \frac{dH_z}{dz}$$

where H_r is the radial magnetic field strength and H_z is the axial field strength. The third direction, at right angles to the $z-r$ plane, is denoted by the angular measurement ϕ . We will consider only a narrow beam of electrons concentrated round the axis. The radial component of the field will exert a force at right angles to the $z-r$ plane given by $H_r e v_z$. The acceleration in the ϕ -direction is $\frac{rd^2\phi}{dt^2}$.

Therefore
$$m r \frac{d^2\phi}{dt^2} = H_r e v_z = \frac{-r}{2} \frac{dH_z}{dz} e v_z$$

Hence
$$\frac{d^2\phi}{dt^2} = -\frac{e}{2m} \frac{dH_z}{dz} v_z$$

Integrating, we get
$$\frac{d\phi}{dt} = -\frac{1}{2} \frac{e}{m} H_z$$

and
$$\phi = -\frac{1}{2} \frac{e}{m} \int_{-a}^z \frac{H_z}{v_z} dz$$

The integration is here carried out from the extreme left or minus infinity to the point z .

Substituting in this equation the value of the velocity v_z in terms of the electrostatic potential of the field in which the electrons are moving, that is, $eV = \frac{1}{2} m v^2$, we have

$$\phi = -\frac{1}{2} \sqrt{\frac{e}{2mV}} \int_{-a}^z H_z dz$$

assuming the potential V to be constant.

This angle ϕ of rotation of the electron depends only on the strength of the field and not on the value of r . Hence if this field does not vary in the neighbourhood of the axis, all the electrons starting in one plane will remain in one plane, but this plane will be rotated through the angle ϕ about the axis.

For the radial force on the electron we have two components, firstly that produced by the field H_z given by $H_z e v\phi$, and secondly that produced by the field H_r given by $\frac{mv\phi^2}{r}$,

where $v\phi$ is the component of the velocity of the electron in travelling round the spiral.

Now $v\phi = r \frac{d\phi}{dt} = -\frac{re}{2m} H_z$

Therefore the total radial force is

$$-\frac{re^2}{2m} H_z^2 + m \frac{r^2}{4} \left(\frac{e}{m}\right)^2 H_z^2 = m \frac{d^2r}{dt^2}$$

or
$$\frac{d^2r}{dt^2} = -\frac{r}{4} \left(\frac{e}{m}\right)^2 H_z^2$$

We must make precisely the same approximations for the magnetic lens

as we did for the electrostatic lens. Thus, since the field is assumed to be a short one, r is not changed appreciably, although the direction u is changed to u' . Also the axial velocity is supposed to be constant, that is $v_z = v = v'$, where v' is the final velocity.

Integrating the last equation, we get

$$\frac{dr}{dt} = -\frac{r}{4} \left(\frac{e}{m}\right)^2 \int_{-a}^z H_z^2 dz$$

$$= -\frac{r}{4} \left(\frac{e}{m}\right)^2 \frac{1}{v_z} \int_{-a}^z H_z^2 dz$$

Now, $v' u' = \frac{dr}{dt}$ and $-\frac{r}{u'} = f'$

where f' is the focal length of the lens.

Therefore

$$v^4 u^4 = -\frac{r}{4} \left(\frac{e}{m}\right)^2 \frac{1}{v} \int_{-a}^z H_z^2 dz$$

or taking the integration from the extreme left to the extreme right, that is from minus infinity to plus

infinity and substituting for $\frac{u'}{r}$,

we get

$$\frac{1}{f^4} = +\frac{1}{4} \left(\frac{e}{m}\right)^2 \int_{-a}^{+\infty} H_z^2 dz$$

Since $\frac{1}{2} m v^2 = eV$
or $v^2 = \frac{2eV}{m}$

we have
$$\frac{1}{f^4} = \frac{1}{8} \frac{e}{mV} \int_{-a}^{+\infty} H_z^2 dz$$

The physical meaning of this equation for the focal length of a short coil will be discussed in the next article.

The Empire Amateur Radio League.

At an enthusiastic meeting held at the Market Hotel, Birmingham, on Sunday, March 29, a new amateur organisation was introduced. This organisation is to be known as the Empire Amateur Radio League and has as its objects the furtherance of the amateur interests and technique.

The League at present is under the control of a temporary committee consisting of G5BY, G5BJ, G6SM and G5NI. It is intended that eventually the committee will consist of area representatives to look after all parts of the country and Empire.

A QSL bureau is under the care of G2LB. Incoming cards are handled for anyone lodging stamped addressed envelopes at G2LB's QRA, while outgoing cards are handled for members

only. Provisional membership subscription is 5s. per annum, and membership is open to all interested in amateur radio. Applications should be made to the Hon. Secretary and Treasurer, G2DV, Eric N. Adcock, 206 Atlantic Road, Erdington, Birmingham.

The Surrey Radio Contact Club.

At the last meeting of the Surrey Radio Contact Club, held on May 12, Mr. J. W. Paddon, G2IS, gave an interesting talk on his radio and talking picture experiences in America and Africa. He explained the licensing system in the United States and how the radio inspectors over there check the modulation of the amateur phone station, expressing the hope that perhaps this would happen some day on the Continent.

The talk was enjoyed by the 50 mem-

bers present, and a welcome was extended to the Chairman and members of the Thornton Heath Society who were visiting us that evening.

At the next meeting on June 9, Mr. Kenneth Jowers, G5ZJ, is giving a talk on his new amateur super-het, and on July 14 Mr. H. L. O'Heffernan is giving a talk on high-power 5-metre apparatus. Visitors are cordially welcome and should get in touch with the Secretary, Mr. E. C. Taylor, 35 Grant Road, Addiscombe. The meetings are held at the Railway Bell Hotel, West Croydon, at 8 p.m.

The club proposes to participate in the International 5-metre day, and those interested are requested to get in touch with the Secretary.

A section is also being formed for B.R.S. and A.A. members to take up Morse practice and to deal with matters concerning that particular section.

THE MULTIVIBRATOR

By G. Parr.

The circuit described in this article, though not new, is worth the attention of television experimenters as it forms the basis of several types of hard valve scanning circuit and in addition can be used for a laboratory oscillator.

THE circuit known as the "Multivibrator" was described by Abraham and Bloch as far back as 1919 as a useful method of obtaining a series of frequencies from an oscillatory circuit which was considerably more stable in operation than the ordinary retro-active valve oscillator. The characteristics of the oscillation produced, however, are such that the circuit has been used by research workers for producing a line scanning voltage in cathode-ray tubes, and it is this property which makes it chiefly of interest at the present time.

In its simplest form the arrangement of the circuit is shown in Fig. 1. Two R.C. coupled valves are cross-connected so that the output of the second is fed to the grid of the

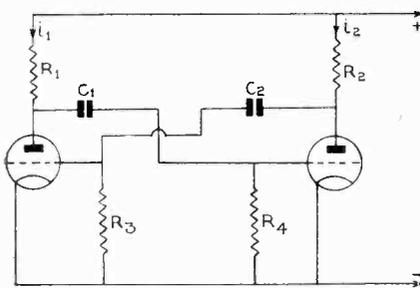

Fig. 1.—The Multivibrator circuit in its simplest form.

first. It can be imagined that such an arrangement would oscillate violently, but both the reason for the oscillation and the nature of the waveform produced are more complex than appears at first sight.

How the Multivibrator Operates.

To simplify matters, assume that the two valve stages are identical, with the valves accurately matched and the values of coupling condenser and grid leak the same in both. The anode resistances R_1 , R_2 are also assumed to be equal.

On switching on, equal anode currents i_1 and i_2 will flow in the two valves. However stable a circuit, there is always a slight fluctuation in

anode current due to variations in emission from the cathode, and in this case, as soon as the current flows one or other of the valves will experience a slight increase in current. Suppose it is V_2 . The potential drop across R_2 will suddenly increase and the drop across the valve will decrease to correspond, the sum of the two drops equalling the H.T. battery volts.

The drop in potential across the valve is applied to the grid of V_1 through the coupling condenser C_2 and this momentary reduction in turn affects the anode current of V_1 . The increase of current through V_2 is therefore followed almost instantaneously by a reduction of current through V_1 , but this reduction is greater than the original increase owing to the magnification of the valve.

Continuing, the reduction through V_1 lowers the potential across R_1 and increases it across the valve. This increase is handed back to the grid of V_2 through the coupling condenser C_1 in such a way that the original increase in current is now augmented by making the grid positive.

The action has now started, and the current through V_2 increases rapidly, its growth being accelerated by the change in grid potential caused through the fall of current in V_1 . The rise increases until the grid potential of V_1 becomes so negative that the anode current is cut off completely. At this stage the coupling condenser C_2 is fully charged and now commences to discharge through the leak R_3 and the impedance of the valve V_2 . The time taken for the condenser to discharge is proportional to the product of the capacity C and the grid leak resistance R and can be made as short or as long as required. As soon as the condenser potential has fallen to a low value the grid of V_1 allows current to flow again and this rise in current repeats all the cycle of changes which took place before in V_2 . Finally V_1 is passing a heavy current while V_2 is biased to cut-off. The condenser C_1 then discharges, and the cycle is repeated.

The action of the circuit has been aptly named a "spill-over"—in fact the circuit behaves in a similar way to a body in a state of unstable equilibrium, the least tilt in either direction causing it to fall over rapidly. It is purely a matter of chance which valve starts the action, but once started the swinging to-and-fro of the current goes on regularly at a rate which is determined by the time-constant of the components.

By making the coupling condenser of a very high value it is possible to watch the slow reversal of current by a milliammeter connected in the anode circuit of the valve. Another variation can be made in the timing by making one condenser and leak of lower value than the other. The oscillations will then take the form of

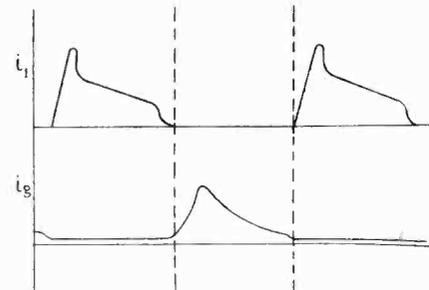

Figs. 2a and 2b.—Wave form of anode and grid currents in the circuit.

a short impulse followed by a longer one and continue to alternate in this way.

The wave form of the oscillation produced is important as this is utilised in the various adaptations of the circuit for linear scanning. The current through the anode resistance R_1 or R_2 takes the form shown in Fig. 2a, the rise being rapid at first and slowing down as the condenser C_2 or C_1 charges. The intervals between the waves are due to the time taken for the condenser to discharge. As the discharge takes place, the current through the leak circuit takes the form of Fig. 2b, a steep-fronted wave followed by a slow tail-off, the shape of the curve being governed by the resistance of the leak. If a

constant current circuit were substituted for the leak the wave would approximate to the familiar saw-tooth shape.

A feature of the circuit as an oscillator is its stability and the number of harmonics of a simple multiple of the fundamental frequency which are present. The frequency of the oscillation is not affected by variations in the supply voltage within wide limits, and if the circuit is driven or controlled by 50-cycle mains it provides a steady source of 100, 200, 400 cycles, etc., which can be stabilised by the mains frequency. It is usual to provide tuned filters in the output circuit if the presence of a number of harmonics simultaneously is a disadvantage. Connection to the external circuit may be made by means

of a coupling coil in series with one of the grid leaks, or the voltage across the leak can be applied to an amplifier in the usual way. The following values are suggested for an experimental oscillator:

$$R_1 = R_2 = 50,000 \text{ ohms.}$$

$$C_1 = C_2 = .0005 \text{ to } .01 \text{ variable.}$$

$$R_3 = R_4 = 0.1 \text{ meg.}$$

The grid leak may also be made variable if another adjustment of frequency is required. If it is required to lock the frequency to a master control, the source may be injected in one of the anode leads. Valves of the AC/P or AC/P1 type are suitable, although a smaller portable oscillator can be made to work satisfactorily from L2 battery-valves and 60 volts H.T.

in your magazine so that we could be in touch with our English friends as they come through here.

W. M. BOWMAN, President.

B.B.C. Short-wave Transmissions in France

SIR,

Last Sunday F8KE (Gamet) went to Cambrai with his 5-metre equipment to try Paris-Cambrai QSO about 120 miles. F8KE listened for seven hours. He heard the Alexandra Palace television, a G making duplex, faintly. He does not know exactly what it was but thinks it was tests with a motor car. (It appears likely that this was SW a transmission from Broadcasting house.—ED.)

He heard a BCL test from Rome on about 6 and 8 metres, sometimes R9; he wrote to the BCL staff of Rome to know what it was (probably tests for television transmitter), it is not supposed to be a harmonic.

Berlin Television Funkturn was heard W2 R4. A station calling IAU working duplex? on 7 and 30-metre television.

Receiver used was super regenerative quench type, by F8KC, A. Godefroy, with one coil instead of two. Valve 56 in one of the receivers and in the other an "Acorn" 955 triode using the same circuit (no quench coils used). The aerial was a doublet half-wave on a pole 6 metres above the roof, horizontal, with twisted flex line.

Tests will very probably be made again at Whitsuntide, so I hope that G's will be interested. For these tests and arrangements G's can write to me so that we could work properly.

RENAUD KOECHLIN (F8NZ),
20 Rue des Ecoles Paris V.

Short-wave Transmission.

SIR,

I am writing on behalf of several friends of mine to thank you for the article that you printed in this month's TELEVISION AND SHORT-WAVE WORLD, i.e., "The Complete Transmitter for the Beginner," and we hope that at some future date you will print a small article on how to incorporate a frequency doubler in the circuit. The type of article that you are printing now with regard to transmitting is filling a long-felt want, as the majority of articles in other journals are far too technical for the ordinary student.

J. W. BATCHELOR (Perranporth).

Our Readers' Views

Correspondence is invited. The Editor does not necessarily agree with views expressed by readers which are published on this page.

Ultra-short Wave Developments

SIR,

If "P.K.C." will put his objections to my article in more precise and less sensational form, I will be happy to

reply to them—categorically—through the medium of your columns.

"MICROWAVE" (London, S.W.).
(Ref.—The two articles reviewing contemporary ultra-short-wave developments.)

MERVYN

The Popular Television and Short Wave Specialists

SPECIFIED :

C.R. EXCITER UNIT, May issue, partly assembled, Kit ...	£3 12 6
Complete Unit assembled with valve ...	£6 0 0
High Definition Time Base Kit ...	£6 10 0
Control Panel, complete with resistance and condenser network for Ediswan C.R. Tube ...	£2 8 0

ACCURATE & RELIABLE COMPONENTS for Short-Wave Receivers and Transmitters, see note by Mr. Jowers in this issue.

Short-Wave Chokes, Type MSV710 ... 1/-

HIGH VOLTAGE CONDENSERS.

500 v., 2 m.f., price 6/4; 4 m.f., price 11/3; 4,000 v., 25 m.f., price 9/-; 2,000 v., price, 5/-.

Send for full lists, 500 to 6,000 v. D.C.

CONFIDENTIAL and EXPERIMENTAL APPARATUS BUILT TO ORDER—Address letter to Managing Director.

PART EXCHANGE.

We are prepared to accept your 30-line apparatus in part payment for Mervyn High Definition Apparatus.

Radio Dealers who have not already received Terms and Advance Lists should write at once.

MERVYN SOUND & VISION CO., LTD.

HOLBORN PLACE, LONDON, W.C.1.

Telephone—HOL 7709.

An Invitation from U.S.A.

SIR,

Some time ago several Seattle business men who, incidentally, are stockholders in the Farnsworth Corporation, conceived the idea of what they believe is the first Television Club in America, organised solely for the social side of this coming industry. Incidentally the charter members of this club, about 75, are all holders of Farnsworth Television Incorporated stock.

The aim and object of the club is to entertain television engineers and inventors as they come to our city and to keep one another informed as to the progress of television at home and abroad.

Some of us are subscribers to your magazine TELEVISION AND SHORT-WAVE WORLD, and the suggestion was made at a meeting the other evening for all to subscribe. I would ask you to publish this announcement

Our Policy
"The Development of
Television."

RADIO RECEIVING AND TELEVISION TUBES

Including Applications for Distant Control of Industrial Processes and Precision Measurements

By **JAMES A. MOYER**

Director of University Extension, Massachusetts Department of Education, Member of the Federal Commission on Radio Education; Member of American Institute of Electrical Engineers; Fellow of the American Association for the Advancement of Science; Fellow of the Royal Society of Arts, etc., etc.

and **JOHN F. WOSTREL**

Instructor in Radio Engineering and Supervisor in Charge of Industrial Subjects, Division of University Extension, Massachusetts Department of Education.

Third Edition—Just Published.
635 pages, 8 × 5½, 487 illustrations, 24/- net.

When the previous edition was published, the radio receiving tubes then in practical use had only two, three, or four elements. With the development and introduction into practical designing of tubes with five, six or more elements, combining in one tube the functions that were formerly performed by two or more tubes there were, of course, made available to the designer opportunities for obtaining results in radio reception that previously were economically impossible.

The introduction of all-metal tubes, by which the glass bulb of radio receiving tubes is replaced by a much smaller thin metal cylinder has made it possible for engineers to make their new designs more compact and safer in transportation than before.

In this revision the previous edition has been entirely re-written and re-set; information that is no longer of general usefulness to designers has been omitted, and emphasis has been given to the strictly modern types of tubes and their applications not only in radio receiving and television equipment, but also in other practical uses.

CONTENTS

Preface to the Third Edition.	Use of Vacuum Tubes as Detectors.
Preface to the First Edition.	Vacuum Tubes as Rectifiers in Power Supply Devices.
Introduction.	Use of Vacuum Tubes as Amplifiers.
Construction of Vacuum Tubes.	Use of Vacuum Tubes as Oscillation Generators.
Fundamental Electrical Relations.	Television Tubes.
Vacuum-Tube Action.	Industrial Applications of Vacuum Tubes.
Radio Meters and Measurements.	Appendix.
Testing Vacuum Tubes.	Index.
Vacuum-Tube Installation.	

McGraw-Hill Publishing Co. Ltd.
Aldwych House, London, W.C.2

THE TELEVISION SOCIETY

President : Sir AMBROSE FLEMING, M.A., D.Sc., F.R.S.

Founded in 1927 for the furtherance of Study and Research in Television and allied Photo-electric Problems.

Ordinary Fellows are elected on a Certificate of Recommendation signed by Two Ordinary Fellows, the Proposer certifying his personal knowledge of the Candidate. The Admission Fee for Fellows is half-a-guinea, payable at the time of election, the Annual Subscription is £1, payable on election, and subsequently in advance on January 1st in each year, but the Annual Subscription may be compounded at any time by the payment of Ten Guineas.

Any person over 21, interested in Television, may be eligible for the Associate Membership without technical qualifications, but must give some evidence of interest in the subject as shall satisfy the Committee. For Associate Members the Entrance Fee is 5/-, payable at the time of election, with Annual Subscription 15/-, payable in advance on January 1st in each year.

Student Members.—The Council has arranged for the entrance of persons under the age of 21 as Student Members, with Entrance Fee 2/6 and Annual Subscription 10/-, payable as above.

The Ordinary Meetings are held in London on the second Wednesday of the month (October to May inclusive) at 7 p.m. The business of the meetings includes the reading and discussion of papers. A Summer Meeting is usually held, and affords Members the opportunity of inspecting laboratories, works, etc. A Research Committee and the preparation of an Index of Current Literature are active branches of the Society's work.

The Journal of the Television Society

is published three times a year. All members are entitled to a copy; and it is also sold to Non-Members, at an annual subscription of 15/- post free.

Forms of proposal for Membership, and further information regarding the Society, may be obtained on application to the Business Secretary, J. J. Denton, 25, Lisburne Road, Hampstead, London, N.W.3.

JUNE 6th & 7th

NATIONAL FIELD DAYS

One of the greatest attractions of Amateur Radio is Field work. During the coming summer the **Radio Society of Great Britain** will organise National and local field day events.

NATIONAL FIELD DAYS take place on June 6th and 7th. Stations in all Districts will be operating portable apparatus—if you are interested in this fascinating side of Amateur Radio, you will be welcomed at the station nearest your home.

5 METRE FIELD DAYS are planned including an International Field Event in July when DX working is anticipated.



In the current issue (May) of the "T. & R. Bulletin" Mr. McL. Wilford continues his informative articles on Transmitting Design. A copy of the issue, together with membership details, will be sent to any address on receipt of P.O. for 1/-.

The Secretary, (Dept. S.W.10)

RADIO SOCIETY OF GREAT BRITAIN
53 Victoria Street, London, S.W.1.

"Simple Facts about Time Basis."

(Continued from page 336).

the positive peaks the grid voltage is reduced to zero, making the valve conduct and discharge the condenser C (Fig. 7).

Synchronisation

For television an important property of a time base is the ease with which it can be synchronised by suitable signals sent out from the transmitter.

The basic principle involved in synchronisation is that the circuit is adjusted so that it is ready to discharge at just about the right time. At the correct instant the synchronising voltages applied to the grid of the discharge tube start the discharge so that the actual firing point is controlled by the synchronising pulse and not by the time base itself.

All that is necessary therefore is that the time base shall be steady in character and that the frequency shall

not wander. For satisfactory synchronising the time base should be running just a little too slowly and the circuit must be such that once this adjustment is made its constancy can be depended upon. If the frequency wanders so that it may become too fast, then it will trigger before the synchronising pulse arrives and the synchronism will be lost. Conversely, one usually only applies just enough synchronism to lock the picture and if the frequency wanders so that it becomes much too slow, the synchronising pulse is unable to fire the tube at the correct instant.

The precautions necessary to ensure steadiness were detailed in the first part of this article. The only other matter requiring attention is that of the separation of the synchronising signal from the modulation. In order to avoid any peaks in the modulation from producing the synchronising impulse at the wrong time, the synchronising signal is made stronger

by some 30 per cent. than the strongest modulation signal.

The output from the radio receiver, therefore, is supplied not only to the cathode-ray tube but also to the time-base through a backing-off valve. This is a simple resistance-coupled amplifier heavily over-biased so that the modulation will not produce any current. On the peaks produced by the synchronising impulses, however, the grid runs just sufficiently positive to allow a small pulse of current to flow through the valve. This produces a voltage in the anode circuit which is applied to the grid of the discharge tube in the time base and thus maintains the synchronism.

So effective is this method, when properly adjusted, that synchronism ceases to be any problem at all. The slipping synchronism of 30-line days is no longer experienced and the picture will lock quite steadily over large variations in the setting of the time-base control.

**Apparatus for the
Experimenter**

We learn that Messrs. H. E. Sanders & Co., of 4 Grays Inn Road, London, W.C.1, intend to supply to amateurs and experimenters the latest components for high-definition television reception at low prices as in the past. New apparatus is now available. Our older readers will remember this firm as one of the pioneers in amateur television apparatus; in the past they have always been pleased to advise and assist constructors and this policy is to be continued. A useful handbook on high-definition television is available, price 2s. 10d. post free.

**Mervyn High-voltage
Condensers**

Special high-voltage condensers suitable for use in transmitting and similar apparatus are now available from Mervyn. These condensers are in three ranges from 1,000 volts D.C. working to 6,000 volts D.C. working. Prices are very low for the type of condenser while all are tested at three times the working voltage.

500-volt condensers are also available at low prices. As an indication, the 4-mfd. are listed at 11s. 3d.

A wire-end type H.F. choke suitable for all wavelengths from 7-95

metres is priced at 1s. This choke is completely free from resonance over its working range and can be recommended for use in most short-wave receivers.

The new Mervyn triode-hexode pre-selector convertor for A.C. mains is priced at £4 10s.

Several new lines interesting to the short-wave and television constructors are now ready and details can be obtained from the Mervyn Sound and Vision Co., Ltd., 4 Holborn Place, W.C.1.

**Lectures by Professor
Appleton**

Three public lectures entitled "Some Problems of Radio Communication" will be given by Professor E. V. Appleton, M.A., D.Sc., F.R.S., in the Fyvie Hall of The Polytechnic, on Thursdays, June 11, 18 and 25, 1936 (6.30-7.30 p.m.).

The synopsis is as follows: Lecture I—The thermionic valve and its uses. Lectures II and III—The propagation of radio waves over the earth and through the atmosphere. The fee for the course is 5s.

A Neon Test Prod

We have received from Messrs. A. F. Bulgin & Co., Ltd., a neon test prod. This new and useful compon-

ent incorporates a small neon lamp of special manufacture, and is also provided with an internal protective series resistance, which ensures that the lamp cannot be damaged under any conditions of use or misuse. The tester may be used to detect the live main of a supply for whether or no connection is made by a flexible lead to the terminal on the cap, it is simply necessary to grasp the tester in the hand, or, under conditions of extremely dry flooring, etc., to make a short connection to the internal tap terminal, which may then be held in the hand, and to connect the point of the prod to either main in turn, when the live main will give a glow in the internal neon lamp.

A test whether a supply is A.C. or D.C. may be made if the prod be connected across the supply mains. If the glow of the neon lamp is localised to one of the electrodes, then the supply is D.C., but if the glow is spread equally over both electrodes, then the supply is A.C. For continuity tests, this test prod may be used with a battery of 180 volts or more, or may be used with mains, or with current drawn from the H.T. secondary of a power transformer. Continuity will be shown through quite high resistances (of the order of megohms) owing to the fact that the current passed by the lamp for a satisfactory glow is exceedingly small. The price of this useful device is 9s. 6d.

JUNE, 1936

**USE YOUR PRESENT SET
FOR SHORT WAVES**

B.T.C. CONVERTER/ADAPTOR Kit 13/52 metres.
Supplied complete with aluminium panel, base, circuit & layout diagrams, is assembled in 30 mins:
Connect between aerial and your set. **20/-**
Or use as short-wave 1 valve receiver.
Mervyn A.C. mains Hexode Super Converter. **90/-**
Order with confidence from:---
BENNETT TELEVISION CO., Redhill, SURREY

THE "RADIO" HANDBOOK.

(Published by Pacific Radio, San Francisco).

See review of this latest Short Wave Manual in this issue. Contains everything you want to know about RECEIVERS, TRANSMITTERS, AERIALS, et etc.
Price 5/3 post free anywhere.

Write for details of other short wave publications:
G5KA, 41, Kinfauns Road, Goodmayes, Essex.

**NEW LINES AT
BARGAIN PRICES**

UNIVERSAL AMPLIFIERS.

6-8 Watts undistorted output

£6 10 0. Carr. Paid. Cash with order or C.O.D.

A.C. Double Push-Pull R.C.C. Coupled. **AMPLIFIER.**

Undistorted output 5-Watts.

£7 5 0. Carr. Paid. Cash with order or C.O.D.

We can supply **KIT** of parts for the **AMATEUR BAND S.S. SUPER - HET** at very competitive prices.

We can supply an equivalent for any British type of Valve at an appreciably lower price. These valves are Guaranteed for a period of 6 months from date of purchase and the performance to be in no way inferior to that of the original valve.

Send for comprehensive List "T.S."

CHAS. F. WARD,

46, Farringdon Street, London, E.C.4.
Telephone: Holborn 9703.

Constructors' Circle

Mr. Schlesinger, Hectorstr. 18, Amsterdam, Holland; W. A. Jackson, 55 Woodside Terrace, Dundee, Angus; John F. Morison, 11 Lauriston Place, Edinburgh; W. Eason, 6 Arundel Gardens, Watling Estate, Edgware; F. Baigent, 14 Nessus Street, Mile End, Portsmouth; A. E. Henbest, 33 Westbourne Road, Croydon, Surrey; Mr. Whatford, 69 Murston Road, Sittingbourne, Kent; S. T. Thwaites, 23 Illex Road, Willesden, N.W.10; Ralph E. Duplain, Victoria Street, Alderney; L. Farrar, 6 Granville Street, Elland, Yorks.; L. Pepperell, 84 High Street, Sheerness, Kent; J. G. Brown, 29 Glasgow Road, Strathaven; W. P. Green, 39 Alexandra Road, Ashton-under-Lyne, Lancs.; K. Allery, 40 Open View, Wandsworth, S.W.18; E. Nottingham, "Lyndhurst," Upper Poppleton, near York; R. Penson, Marden, Ash Hill, Ongar, Essex; E. G. Ackermann, 35 Shelley Crescent, Southall; G. Walker, 33 Napier Road, Thornbury, Bradford, Yorks.; N. U. Harvey, 90 Norton Road, Bourne-mouth; J. Tole, The Grounds, Whittingham, near Preston; R. Shaw, 25 Ramsey Street, Marshfields, Bradford; F. C. W. Ridler, 11 Princess Road, Kilburn Park, N.W.6;

CATHODE RAY EXCITER UNIT "MERYN" Kit as described in May issue of this Journal less valve £3-17-6.

CONDENSERS 4,000 volt Working, 12,000 Volt test, absolutely reliable 9/- Post 6d.
TIME BASE Kit for 240 and 405 lines with circuit Diagram, less valves £6-10-0.

Send for quotations.

H. E. SANDERS & CO.

4, Grays Inn Road, London, W.C.1.
Tel: CHANCERY 8778.

**MISCELLANEOUS
ADVERTISEMENTS**

The charge for advertisements in these columns is 12 words or less 2/-, and 2d. for every additional word. All advertisements must be accompanied by remittance. Cheques and Postal Orders should be made payable to Bernard Jones Publications Ltd., and crossed, and should reach this office not later than the 15th of the month previous to date of issue.

**BIRMINGHAM RADIOMART
SHORT-WAVE SPECIALISTS**

The largest mail order short-wave dealers specialising in quality equipment.

Proprietor, G5NI. Manager, G2AK. Staffed by experienced transmitting amateurs. Obviously we can serve you better.

AERIAL EQUIPMENT.—Raymart dipole kit comprising aerial wire, transposed line, screened transformer Flintglass insulators junction T-piece, 10/6. Raymart Insulators. Flintglass, 3in. ribbed 4d., 12in. porcelain locapacity, 1/6. Dipole T-Piece, 1/-.
Transposition blocks, 6d.; Ten, 4/6.

MICROVARIABLES.—All brass construction; latest ceramic insulation. The finest condensers made; 15mmfd, 1/4; 40mmfd, 1/7; 100mmfd, 1/10.

TRANSMITTING TYPE.—0.70 in. spacing, 15 mmfd (neutralising), 2/9. 40mmfd. Tuning 3/6. These are quality.

RAYMART SPECIFIED FOR THE "SHORT-WAVE BATTERY FOUR."

CONDENSER, Type VC2 (2 gang) .. 5/-
CHOKER, Type CHP .. 9d.
COILS, Type CA 11-25 metres .. 2/6
(2 sets) Type CB 20-45 .. 2/6
required) Type CC 44-100 .. 2/9

COILFORMS.—Moulded in RM4 natural loloos material, hollow resilient pins 1 1/2 in. diameter ribbed; identification disc in top. Four types, 4-pin, 1/6; 6-pin (standard or to fit 7-pin valveholders), 1/9; 7-pin (for bandspread tap), 1/10. Machine threading 2d. extra.

AMERICAN CERAMIC Sockets 4-pin, 5-pin, 10d., large 7-pin (for 59) 1/-; 50-watt, Air Ministry dielectric 4/6.

CERAMIC COILFORMS.—American 4 pin, 1/6; 6-pin, 1/9; transmitting grooved 5 by 2 1/2 in., 5/6.

TRANSMITTING RESISTANCES.—Electrad; all sizes to 50,000 ohms 25-watt, 1/9; 50-watt, 2/9; 75-watt, 3/6; 100-watt, 4/6; 25-watt, variable, 3/6.

ROTARY CONVERTORS.—EDC, £7 new; output 240v, 40ma., 6v. input 37/6. Izv. 25/-

MICRODISC DIALS.—Utility famous high reduction (list 8/6) 3/11. Litzwound 465kc. I.F.'s 5/6. Extension brackets, 3d. 2-speed reduction dials, 9d.

MAINS TRANSFORMERS.—Bayliss, etc. 350-350, 4v. 2 1/2 CT., 4v. 5 CT., shrouded, 12/6; tapped autos 60-watt, 9/6. HT8 or HT6, with LT, 12/6, with rectifier, 19/6. Westinghouse LT. transformers, 6/6.

SMOOTHING CHOKES.—Interleaved Stalloy CT. 2ohy., 120 ma., 250 ohms, 3/11. Lissen 20 hy. 100 ma., 2/11. 20 hy. 40 ma., 1/11.

POTENTIOMETERS.—Frost wirewound 10,000, tapered ganged to separate 50,000 (list 15/6) 1/6. Centralab and Igranite 25,000, 50,000, 1-meg., 1-meg., 2-meg., 1/6. With switch, 2/-

MILLIAMMETERS.—Flush 2 1/2 in., 5/9; super 2 1/2 in. 6/9; all ranges 25 ma., 10-amps. Visual tuning meter edgewise, 5/9.

MIDGET JACKS.—Igranite, 3d. Bellinglee safety mains plug and socket, 6d. Insulated terminals, anode connectors, 1d. 6 way battery leads and plugs, 6d.

A.C. VALVES.—Famous Continental ACVMP., ACHPT, VM5G., ACSG., ACH., ACHL., PT4., 4/6. ACPen, 5/6. Also rectifiers.

BATTERY VALVES.—Non-ring HF Detector, LF, 2/3. LP2., P2., 2/9; Supower, 3/3. Class B, 4/6. SG2., VM5G., 5/- HPT2., VHPPT., 5/6.

AMERICAN TYPES 50, 10, 27, 24, 35, 45, 2A5, 2A7,

56, 46, 77, 78, 42, 80, 81, 2525 6D6, 6C6, 4/6. Others, 6/6.

NOTE.—WE ARE AUTHORISED DISTRIBUTORS FOR TOBE, COLLINS, DEUTSCHMANN, HAMMARLUND, NATIONAL PEAK, UTC., AND CARRY LARGEST STOCKS OF AMERICAN EQUIPMENT. SPECIALISED SERVICE, G5NI., G2AK.



RADIOMART

Orders over 6/- post free. Enquirers must enclose stamp.

CATALOGUES. General catalogue gives hundreds of bargains. Short wave illustrated catalogue also gives diagram of efficient transmitter and receiver; each 1d. Pair 3d., post free. Dept. "T.S.W."

THE SQUARE DEALERS
19, John Bright St., 22, Summer Row; mail-orders:

Telephone: Midland 3254.

44, HOLLOWAY HEAD, BIRMINGHAM.

**PATENT AND TRADE
MARK AGENTS**

GEE & CO. (Estab. 1905), patents and trade marks throughout the world (H. T. P. Gee, Mem.R.S.G.B., A.M.I.R.E., etc.), 51-52, Chancery Lane, London, W.C.2 (2 doors from Government Patent Office.) Phone: Holborn 1525. Handbook free.

KINGS PATENT AGENCY LTD. (B. T. King, Patent Agent) 146a, Queen Victoria Street, London, E.C.4. ADVICE, Handbook and Consultations free Phone City 6161.

FOYLES

BOOKSELLERS TO THE WORLD
Stock of nearly three million new and second-hand volumes. Catalogues free on mentioning your interests.

119-152 Charing Cross Rd., London, W.C.2.
Telephone: Gerrard 5660 (12 lines)

INDEX TO ADVERTISERS

Belling & Lee, Ltd.	Cover iii
Bennett Television Co., Ltd.	Cover iii
British Television Supplies, Ltd.	363
Bulgin, A. F., & Co., Ltd.	321
Burndept	357
Burne Jones & Co., Ltd.	368
Edison Swan Electric Co., Ltd.	Cover iv
Eugen J. Forbat	365
Ferranti, Ltd.	321
Fluxite, Ltd.	Cover ii
Galpin	367
General Electric Co., Ltd.	Cover ii
G.2.N.O.	365
High Vacuum Valve Co., Ltd.	361
H.M.V.	355
Jackson Bros.	365
Lectro Linx, Ltd.	361
Mervyn Sound & Vision Co.	382
McGraw-Hill Publishing Co., Ltd.	383
Peto Scott	367
Quartz Crystal Co.	367
Radio Resistor Co., Ltd.	359
Radio Society of Gt. Britain	383
362 Radio Valve Co.	359
Raymart Manufacturing Co.	Cover iii
Reliance Manufacturing Co.	367
Sanders, H. E., & Co.	Cover iii
Savage, Bryan	382
Scientific Supply Stores (Wireless), Ltd.	368
Sound Sales, Ltd.	321
Stratton & Co., Ltd.	359 & 365
Television Society	383
Ward, Chas. F.	Cover iii
Westinghouse Brake & Signal Co., Ltd.	322

TELEVISION DEVELOPMENTS

A NEW LARGE DIAMETER TUBE FOR TELEVISION REPRODUCTION

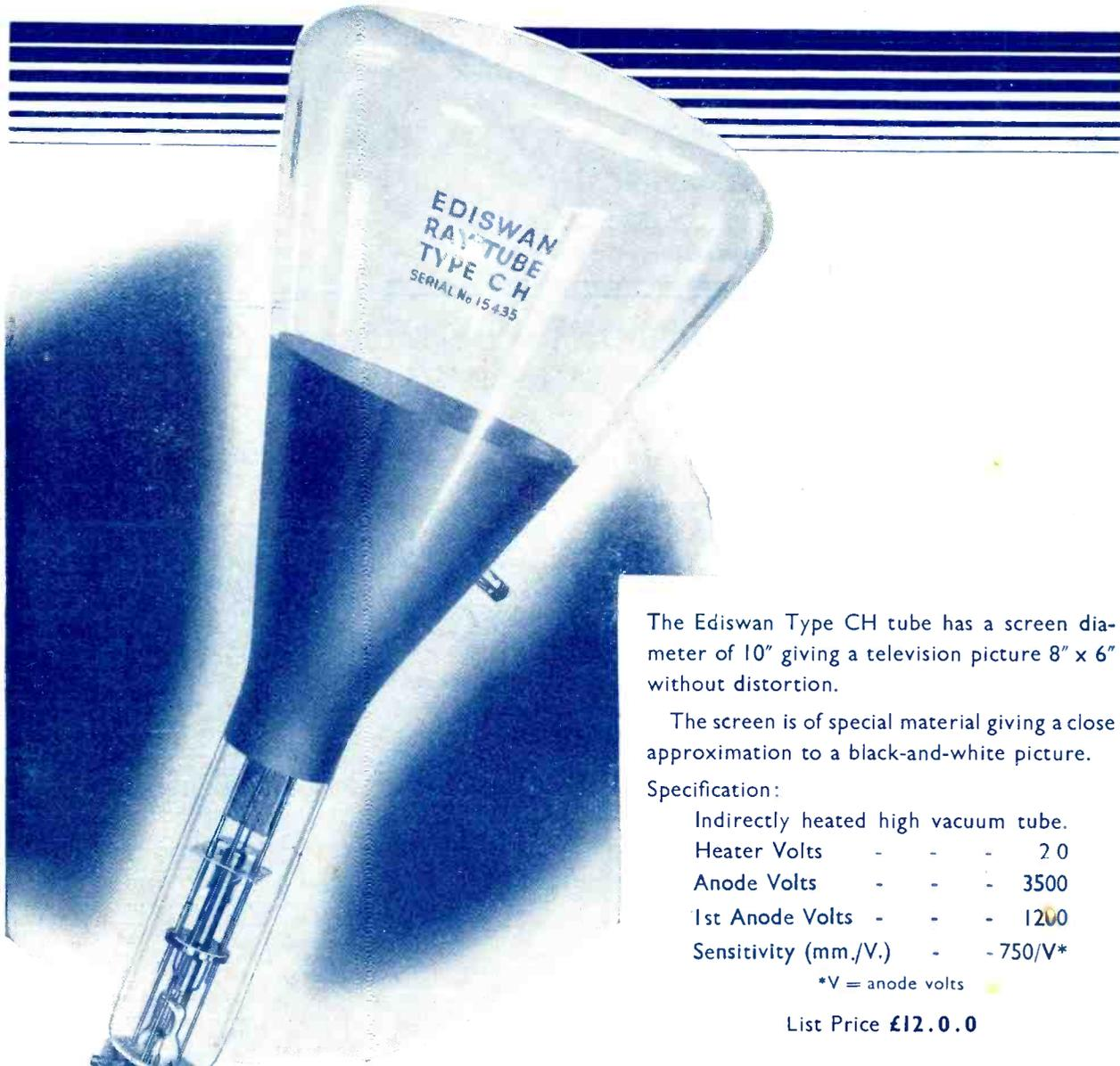

The Ediswan Type CH tube has a screen diameter of 10" giving a television picture 8" x 6" without distortion.

The screen is of special material giving a close approximation to a black-and-white picture.

Specification:

Indirectly heated high vacuum tube.	
Heater Volts	- - - 20
Anode Volts	- - - 3500
1st Anode Volts	- - - 1200
Sensitivity (mm./V.)	- - - 750/V*

*V = anode volts

List Price £12.0.0

● We also supply
HIGH VACUUM RECTIFIERS
GAS-FILLED RELAYS
MERCURY VAPOUR RELAYS
for Television Scanning
circuits.

ENTIRELY BRITISH MADE

EDISWAN RADIO VALVES

THE EDISWAN ELECTRIC CO. LTD.  155 CHARING CROSS RD., LONDON, W.C.2

R.E.280

USED BY ALL GOVERNMENT DEPARTMENTS