

PICTORIAL OUTLINE OF TRANSMISSION & RECEPTION

Television

and *SHORT-WAVE WORLD*

1/-

MONTHLY

FEBRUARY, 1937

No. 108. Vol. x.

THE CATHODE-RAY TUBE

SIMPLY
EXPLAINED
for the
BEGINNER

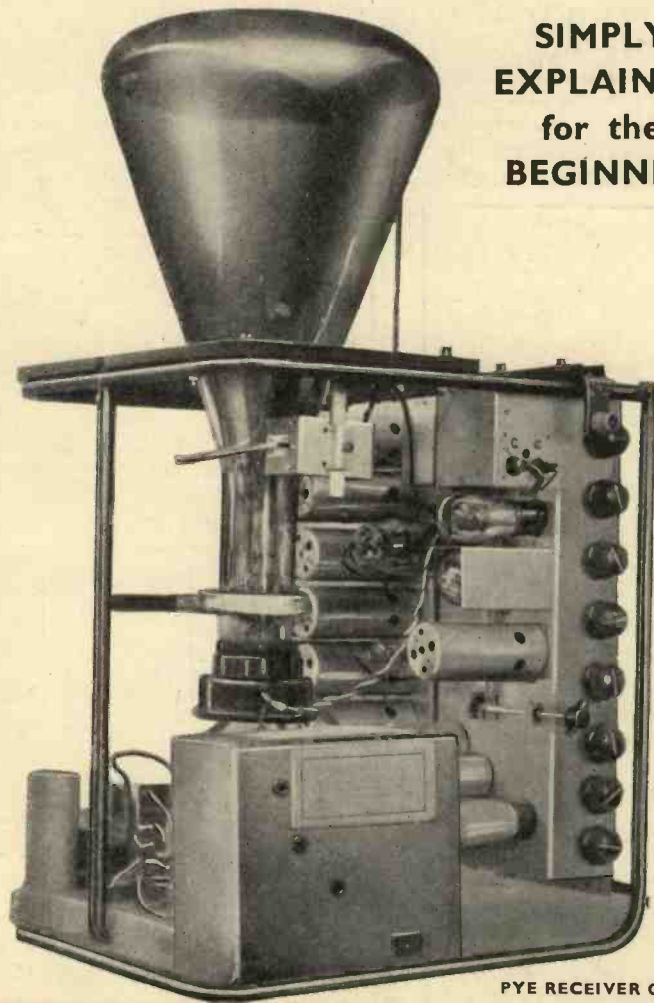

PYE RECEIVER CHASSIS

CATHODE-RAY TUBE :—

Articles
Diagrams
Pictures
Data

SHORT-WAVE
Experimenters'
Test
Equipment

£2-2-0 for an Idea

(page 88)

BERNARD JONES PUBLICATIONS LTD.
CHANSITOR HOUSE, CHANCERY LANE
LONDON W.C.2.

THE FIRST TELEVISION JOURNAL IN THE WORLD



**SPECIFY FERRANTI VALVES IN YOUR NEW SET—
FIT THEM AS REPLACEMENTS.**

Ferranti Valves are in use in hundreds of thousands, and some of the most successful World Radio Receivers use them. Full details are given in the new 27-page Valve Catalogue which may be obtained for 1½d. post free from
FERRANTI LTD., Radio Works, Moston, MANCHESTER, 10.

You've paid your Licence
You've got your Set
AND IF you've used FLUXITE—
You won't need a "VET."



See that FLUXITE is always by you—in the house—garage—workshop—wherever speedy soldering is needed. Used for 30 years in government works and by leading engineers and manufacturers. Of Ironmongers—in tins, 4d., 8d., 1/4 and 2/8. Ask to see the FLUXITE SMALL-SPACE SOLDERING SET—compact but substantial—complete with full instructions, 7/6. Write for Free Book on the art of "soft" soldering and ask for Leaflet on CASE-HARDENING STEEL and TEMPERING TOOLS with FLUXITE

TO CYCLISTS! Your wheels will NOT keep round and true unless the spokes are tied with fine wire at the crossings and SOLDERED. This makes a much stronger wheel. It's simple—with FLUXITE—but IMPORTANT.

THE FLUXITE GUN

Is always ready to put Fluxite on the soldering job instantly. A little pressure places the right quantity on the right spot and one charging lasts for ages
Price 1/6.



ALL MECHANICS WILL HAVE

FLUXITE

IT SIMPLIFIES ALL SOLDERING

FLUXITE LTD. (Dept. T.V.), DRAGON WORKS, BERMONDSEY ST., S.E.1

Protect your valves, set, and power supply

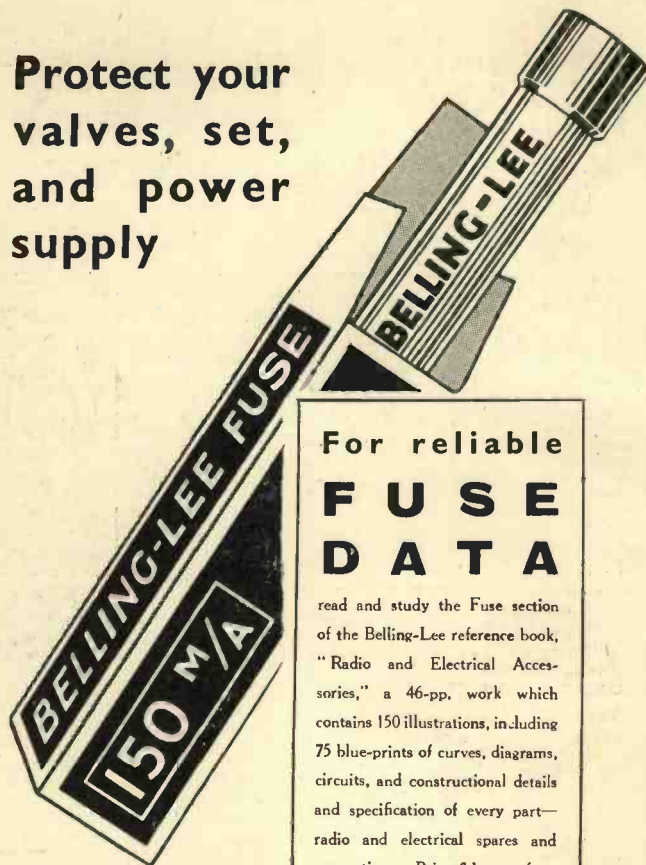

For reliable
FUSE DATA

read and study the Fuse section of the Belling-Lee reference book, "Radio and Electrical Accessories," a 46-pp. work which contains 150 illustrations, including 75 blue-prints of curves, diagrams, circuits, and constructional details and specification of every part—radio and electrical spares and connections. Price 6d. post free.



"Wanderfuse"—Contains 150 m/A fuse. No higher than wander plug. Black or red. No. 1028. Complete, 1s

Flex Fuseholder.—Can be inserted in flexible lead without the use of solder or tools. To take 1½-in. fuses. Complete with two 1-amp. fuses. No. 1037, 1s.



Scrufuse.—Six different ratings; colour coded. For use in standard midge "Edison Screw" (M.E.S.) holders designed for bulb fuses, over which it has decided advantages. 6d. each.



Single Open Fuseholder.—With 1-amp. fuse (1½-in. type). No. 1034, 9d. each.



Twin Safety Fuseholder.—Complete with two 1-amp. fuses. No. 1033, 2s. 6d.

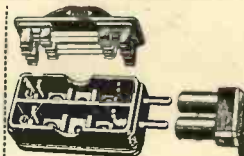

Fused Mains Input Connector.—B.S.S. 5-amp. standard. Complete with fuses (1-amp. unless otherwise requested). No. 1114, 3s. 6d.

BELLING-LEE
FOR EVERY RADIO CONNECTION

CAMBRIDGE ARTERIAL ROAD, ENFIELD, MIDDX.

TOGGLE SWITCHES

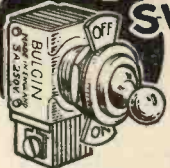

Made to withstand years of hard and regular usage and tested over and again to ensure the usual Bulgin perfection. These toggle on-off switches are ideal for all sets, radio-grams, eliminators, etc. Rating 250v. 3a. Complete with on-off plate.

List No. S.80.
Price 1/6 each.

STAND-OFF INSULATORS

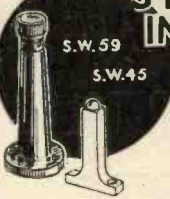

Useful universal components possessing the finest insulation properties and fitted with metal insert. For panel or baseboard mounting and suitable for holding lead-in wires, long spans of wiring, components, etc.

List No. S.W.45	Each 4½d.	List No. S.W.59	Each 1/-
List No. S.W.49	4½d.	List No. S.W.97	8d.

PADDER CONDENSERS



Mica-dielectric pre-set condensers comprised of springy plates, with the best ruby mica interleaved, fitted to a low-loss moulded "Micro-loss" base. For one-hole fixing and adjustable from either end.

List No.	Cap.	µF.	Price	List No.	Cap.	µF.	Price
C.P.2	0.00016	"	2/-	C.P.5	0.001	"	2/3
C.P.3	0.0003	"	2/-	C.P.6	0.002	"	2/6
C.P.4	0.0006	"	2/3	C.P.7	0.003	"	2/9

ULTRA-SHORT-WAVE COIL

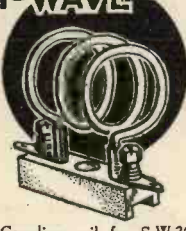

Suitable for the most exacting requirements both in receivers and in transmitters as tank coils. Wound with heavily silver-plated copper conductor. These coils are of practically "no-loss" construction.

List No.	Price	
S.W.30	5-9 m.	2/3
S.W.31	8-15 m.	2/6
S.W.32	13-25 m.	2/9

Coupling coil for S.W.30 and S.W.31.
List No. S.W.33 1/6 each.

RECOMMENDED AGAIN & AGAIN

BULGIN

QUALITY RADIO AND TELEVISION COMPONENTS

COUPON

To Messrs. A. F. Bulgin & Co., Ltd.,
Abbey Road, Barking, Essex.

Please send me Catalogue No. 156 "M" for which I enclose 3d. stamps.

NAME

ADDRESS

(Block Letters Please)

MAINS PLUG AND SOCKET



Bulgin Mains Connectors enable the mains to be used for all radio requirements with absolute safety. A third pin is provided for an earth connection to be made simultaneously. Terminals fitted to both parts.

List No. P.73 Three-pin type 2/3 each.
List No. P.74 Two-pin type. 2/- each.

FIVE WAY MULTI-SWITCH



The Bulgin multi-way switch for all modern wave-change purposes has five positions for two, four, six or eight poles and edge-on self-cleaning contacts. Any number of contact units may be used on the one rotating shaft.

TYPICAL ASSEMBLY. List No. S.122, S.150, S.153, S.154. Price 7/6 complete.

LOW-VALUE POWER RESISTORS



Excellent for meter shunts, etc., these ten-watt resistors are accurate to approximately ± 5 per cent. Wound on special formers, fitted with bands, soldering tags and terminals.

List No.	Chms	List No.	Ohms	List No.	Ohms
A.R. 2	2	A.R. 30	30	A.R.250	250
A.R. 5	5	A.R. 50	50	A.R.300	300
A.R.10	10	A.R.100	100	A.R.500	500
A.R.20	20	A.R.200	200	A.R.1K	1,000

Price 1/- each.

SPECIFIED twice in this issue



The unvarying choice of Erie Resistors by leading designers is illustrated again this month. For the Modulated Oscillator and the Valve-Volt Meter the specification is Eries. The reason is reliability time-proved and guaranteed.

All values 1/- per watt.

ERIE RESISTORS

ERIE VOLUME CONTROL.

The variable resistance with the unique Erie resistance element. Precision construction gives lasting reliability. All values, 5,000 to 2 megohms.

Price 3/6.

With built-in mains switch, 5/-.

Write for Erie Colour Code Chart, Post Free.
THE RADIO RESISTOR CO., LTD., 1, Golden Sq., London, W.1.

FRONT PAGE NEWS!

A truly valuable suggestion in the form of a New Year's resolution was included in our advertisement which appeared on

PAGE ONE

of the January issue.

Act on our suggestion now; it will add to your Television and Radio pleasure for 1937.

WRITE SOUND SALES AT ONCE and receive full details of our High-grade Transformers and Chokes of all types. "Real" Quality Amplifiers and Loudspeakers, etc.

Specified by  the Experts

SOUND SALES LTD.

Marlborough Road, Upper Holloway, London, N.19
Phone: ARCHWAY 1661-2-3. (Contractors to the G.P.O., etc.)

TELEVISION DEVELOPMENTS

A NEW LARGE DIAMETER TUBE FOR TELEVISION REPRODUCTION



**TYPE 12H
TUBE**

The Ediswan Type 12H tube has a screen diameter of 12" giving a television picture 10" x 7½" without distortion.

The screen is of special material giving a close approximation to a black-and-white picture.

Specification:

Indirectly heated high vacuum tube.
Heater Volts - - - 2.0
3rd Anode Volts - - - 6000
2nd Anode Volts - - - 1200
1st Anode Volts - - - 150-400
Sensitivity (mm./V.) - - - 950/V*

*V = anode volts

List Price £15. 15. 0

● We also supply
HIGH VACUUM RECTIFIERS
GAS-FILLED RELAYS
MERCURY VAPOUR RELAYS
for Television Scanning
circuits.

ENTIRELY BRITISH MADE

EDISWAN RADIO VALVES

THE EDISON SWAN ELECTRIC CO. LTD.  155 CHARING CROSS RD., LONDON, W.C.2

R.E.299

USED BY ALL GOVERNMENT DEPARTMENTS

TELEVISION

and SHORT-WAVE WORLD

Special Features

	PAGE
Large Screen Television	68
U.S.A. and the Problems of Television	69
From Studio to Picture	70
Electron Apparatus at the Physical Society's Exhibition	76
A New Method of Transmitting High Frequencies	79
Cathode-ray Tube for Television ...	80
Some Television Aerial Experiments	81
The History of the Cathode-ray Tube	85
Cathode-ray Tube for the Beginner	92
Magnetic Focusing of Cathode-ray Tubes	94
Universal Cathode-ray Tube Equipment	99
Test Equipment for the Experimenter	103
Pentodes for High Frequencies ...	106
Two-stage Single Booster	107
Navigation by Ultra-short Waves ...	110
Diode Valve Monitor Meter	111
Modern Amateur Communication Receivers	113
New Range of Valves for Constructors	116

COMMENT OF THE MONTH

A Suggestion to the B.B.C.

THE B.B.C. in their questionnaire (reproduced on another page in this issue) ask a number of questions and state that the answers provided by viewers will materially help in developing the television service. It is difficult to appreciate the relevancy of these questions, unless their objective is some form of census of viewers, for we can assure the B.B.C. that with any properly installed receiver there is no difficulty whatever in receiving the transmissions excellently anywhere within the service area of Alexandra Palace. Neither is there any difficulty in adjusting the receiver either for vision or sound, nor is car ignition interference of any serious consequence provided that in some cases steps are taken to minimise it. Every television receiver manufacturer takes care that the receiver is properly installed, and it can be assumed, therefore, that the most suitable type of aerial forms part of the equipment. It would appear that the only information of any value that will result is the location of receivers, and even this will not be conclusive proof of extended service range for, of course, conditions differ in different districts.

Comparisons of identical transmissions, however, that we have made with viewers in various districts indicate that there is a considerable amount of variation in the transmissions, and we venture to suggest that the B.B.C. would be doing viewers a real service and obtaining valuable information if they were to secure the co-operation of viewers in different parts who, immediately the programme was concluded, would report by telephone very concisely the results, the information received then to be broadcast either aurally or visually. Matters such as picture brightness, contrast, synchronising and definition would be important items of the reports.

Probably about half a dozen checking posts would suffice, and the procedure need only occupy a few minutes, particularly if the information was given in semi-coded form. This information would at once serve the purpose of removing any doubt from the minds of viewers regarding the correct functioning of their receivers, assist them in the proper operation and provide the transmission engineers with valuable data.

There is one further suggestion which we should like to make, and that is that when repetitions of programme matter are essential—and at this juncture this seems inevitable—that the repeated items are given in sequence. With this arrangement viewers would be saved the annoyance of switching on and off or waiting for the duration of the whole of the programme in order to see only a part.

TELEVISION AND SHORT-WAVE WORLD

Proprietors :
BERNARD JONES PUBLICATIONS, LTD
 Editor-in-Chief :
BERNARD E. JONES.
 Editor :

H. CORBISHLEY.
 Editorial, Advertising and Publishing Offices :

Chansitor House, 38, Chancery Lane, London, W.C.2.

Telephones : Holborn 6158, 6159

Telegrams : Beejapee, Holb., London.

Subscription Rates : Post paid to any part of the world—3 months, 3/6; 6 months, 6/9; 12 months 13/6.

Published Monthly—1/- net.
 (Last Wednesday in every month for following month).

Contributions are invited and will be promptly considered. Correspondence should be addressed according to its nature, to the Editor, the Advertisement Manager, or the Publisher, "Television and Short-wave World," Chansitor House, Chancery Lane, London, W.C.2.

IMPORTANT

"Television and Short-wave World" is registered at the General Post Office, London, for transmission to Canada and Newfoundland by Magazine Post. Entered as Second-class mail matter, Boston, Mass.

LARGE-SCREEN TELEVISION

SCOPHONY PROSPECTS : : GERMAN TECHNICAL VIEWS

BY THE EDITOR.

GERMANY was one of the first countries to experiment successfully in large screen high-definition television pictures. In August, 1928, Professor Karolus, of the Telefunken Company, the chief German radio and television concern in Germany, demonstrated at the Berlin Radio Exhibition a 100-line picture 1 m. square. In 1935 he showed another 100-line picture, this time the size was 4 m. square, and the brightness was very good indeed.

Professor Karolus has continued to concentrate on the large screen aspect of television and therefore his views about the future prospects in that direction are of considerable importance.

It is a matter of great pride to this country to know that Professor Karolus is of the opinion that certain methods for large screen pictures developed in this country, i.e., the Scophony methods, are most promising for commercial and practical ends.

Professor Karolus and Professor Schröter (director-in-chief of the Telefunken research laboratories and one of the leading German authorities on the subject of television) have recently delivered a series of lectures to the German Electrical Engineers at the Charlottenburg Technische Hochschule, Berlin, on various aspects of television, and the tributes paid by them to Scophony, the British television system, coming as it does from persons associated with one of the most important competitive concerns, are very significant, the more so if one bears in mind the existing ramifications of Telefunken in the field of radio. As far as we know Telefunken, Radio Corporation of America, Marconi-E.M.I. have an interchange of patents in the field of radio, and possibly also in the field of television.

It will be of interest to quote some extracts from the lectures referred to above.

Extract from the Condensed Synopsis of the Lecture by Professor Dr. F. Schröter, entitled "Physical Rules, Possibilities and Limits of Television" given on November 2, 1936.

(translation from the German)

" . . . By exciting supersonic waves with a piezo quartz in a cell containing liquid, the Debye-Sears optical effect can be produced. By modulating the vibration of the quartz with an input of 0.05 to 0.2 watt the changes of the diffraction grating can be used as a television light-relay.

The brightness of the pictures can be considerably increased by the Scophony method. This method consists of focusing the plane of the liquid waves on to the screen and in the compensation of the traversing motion with a scanner-drum.

With the aid of the Scophony system a high number of picture elements is simultaneously active, giving a storage or integration of light, similar to the working of the human eye. A good illumination (over 5 lux) is achieved on a large screen with 240 lines (100,000 picture elements)."

(the italics are ours).

Extract from the Condensed Synopsis of the Lecture by Professor Dr. A. Karolus, entitled "The Problem of Large Pictures in Television" given on December 14, 1936. (translation from the German)

" . . . We have heard the fundamental principles of the Scophony system in the lecture by Professor Schröter. A characteristic is to preserve or store the modulations along the full length of a line. The piezoelectric crystal, which is modulated by the transmitted signals produces in the liquid a compression wave

train, which travels and persists in time.

Alexanderson's Method

"The 'electrical focusing' of E. F. W. Alexanderson is in a sense related to the preceding method. In this case there are several light control cells at equal distances apart arranged in the scanning direction and not at right angles to it, and they are connected to one another by electrical time delay circuits. The signal corresponding to a definite picture element excites the cells in the order of their arrangement successively. The propagation speed in the cell is chosen in relation to the opposing scanning speed so that the consecutive flashes emanating from the same picture element coincide on the reception screen. According to this process each picture element could flash, instead of once per picture, several times rapidly in succession and the brightness could be correspondingly increased. This process would, however, require for a reasonable amplification degree an expense hardly permissible in practice, and is therefore greatly inferior to the Scophony method."

The Cathode-ray Tube and Projection

Professor Karolus further dealt in his lecture with the prospects of the cathode-ray tube for projected pictures, and pointed out, on strength of practical experiences to date in the various television laboratories, that projection by means of cathode-ray tubes presented great difficulties in achieving the desired results.

He then goes on to say in the synopsis:

"The principles of the cathode-ray oscillograph appear to be *hopeless* (our italics) for the creation of cinema-size television, even with the highest possible specific output in the luminous surface which could be achieved by electron-optical methods, more so as the experiments made in the laboratories of the General Electric Company, U.S.A., to use instead of fluorescent masses, thermal radiating materials (such as Auer masses or the like) failed completely."

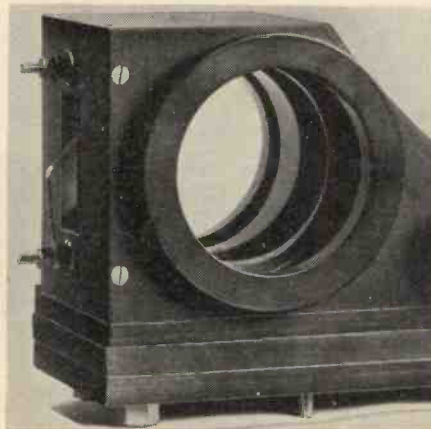

The Scophony light cell for medium-screen pictures

U.S.A. AND THE PROBLEMS OF TELEVISION

PROSPECTS FOR 1937—BY OUR AMERICAN CORRESPONDENT

A VERY large amount of interest in television in the United States now centres round the work of the Philco Radio & Television Corporation. For the past year this company has been making field tests from its experimental station in Philadelphia, using 345 lines interlaced and obtaining high definition pictures of an excellent quality ten miles from the transmitter. The tests have been

vision engineer of the Philco Radio & Television Corporation, in an interview with our correspondent, outlined five essential points that must be cleared up and settled before commercial television will be possible in the United States:

(1) Technical standards for television transmission will have to be approved by the Federal Communications Commission so that any receiver

vision, that is, in the 42-90 megacycle band.

(4) A source of programmes will have to be developed. In putting on a short sketch by television more is required in the way of costumes, rehearsal and stage properties than for any other known entertainment field. Actors can no longer read their scripts. Both appearance and voice will be necessary for the television star. The problem of giving the American people television programmes 365 days a year assumes staggering proportions.

(5) Reduction in the cost of television receivers.

Mr. David Sarnoff, president of R.C.A., said: "In co-operation with the industry, we have recommended to the Federal Communications Commission the adoption of 441-line definition as a standard for commercial operation. Our New York transmitter will be rebuilt to conform to the recommended standards. That also means building receivers to conform to the new standards of the transmitter. The necessity of synchronising transmitting and receiving equipment carries with it serious responsibilities. On the one hand, standards cannot be frozen prematurely or progress would be prevented; on the other hand, frequently changing standards would mean rapid obsolescence of television equipment."

The Farnsworth Station, in Philadelphia, will "go on the air" some time during the spring of 1937, and will open using 441 lines definition. Thus it will be seen that the United States is assured a standard television, one in which any receiver will receive any programme from any transmitter within range.

Probably one of the most interesting developments in television in the United States is the perfection of the image-dissector-tube in the Farnsworth pick-up camera to a sensitivity where powerful lights are no longer necessary in a studio. A new Farnsworth image dissector tube operates very well with only four 100-watt electric light bulbs as illumination for a picture of the head and shoulders of a subject, such as an announcer.

FIRST DETAILS OF THE PHILCO CAMERA

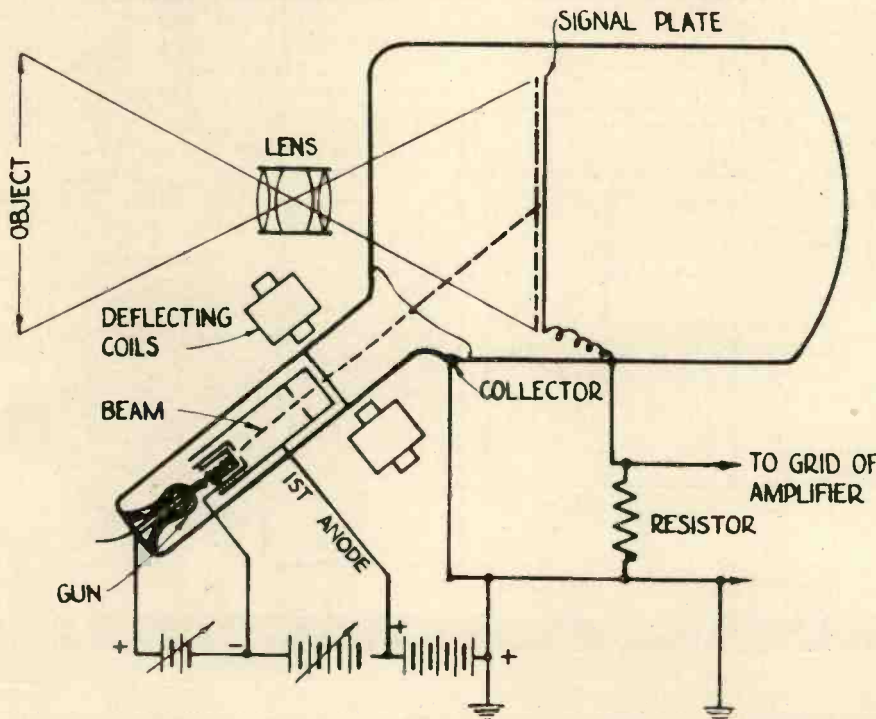

This drawing is the first published of the camera used by the Philco Radio and Television Corporation which has been so successful in the U.S.A.

temporarily discontinued, while improvements are being made in the apparatus, but in a short time the station will reopen using 441 lines interlaced. When the Philco station reopens, it is expected that it will be the first television station in the U.S.A. operating on the television standards proposed to the Federal Communications Commission by the Radio Manufacturers Association. In short, Philco will present the television that is proposed as the future standard for the United States.

Mr. Albert F. Murray, chief tele-

will receive any transmitter within range. The Radio Manufacturers' Association has drawn up a set of these standards which have been offered to the F.C.C. for its approval.

(2) The present limited range of television, averaging about 25 miles, will have to be increased. Key cities, such as New York, San Francisco, Philadelphia, Washington, Boston, etc., will have television first.

(3) Before there can be commercial television in the United States, the Government will have to issue commercial licences suitable for tele-

FROM STUDIO TO PICTURE—A PICTORIAL OUTLINE

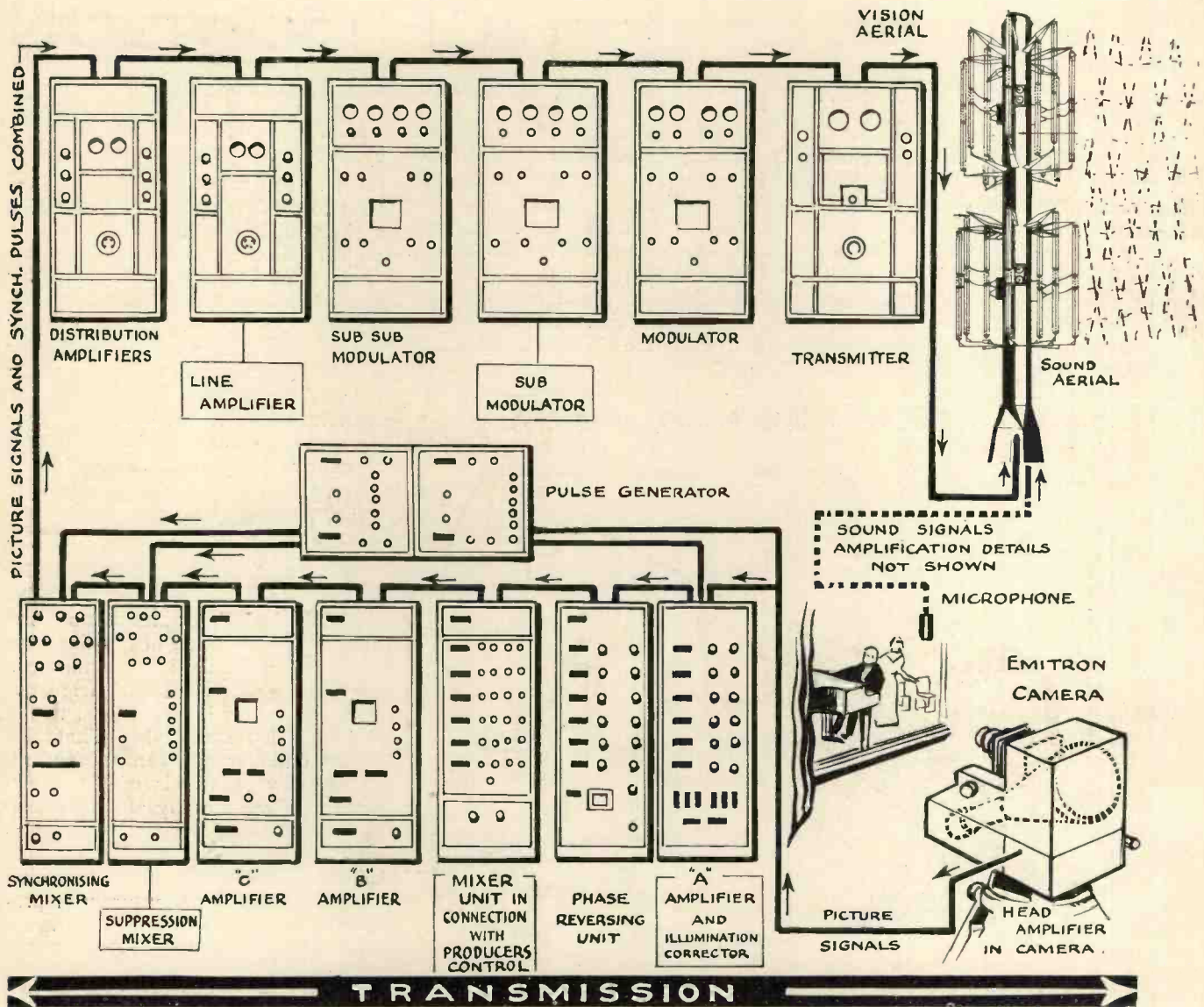

A SIMPLE EXPLANATION

The Camera

THE scene to be transmitted is focused through a lens system on to the sensitive plate of the Emitron Transmitting Camera in exactly the same way as the image is projected in a photographic camera. The camera converts what it sees into electric signals at once.

The camera has an electric memory, that is it will store up and retain a scene after that scene has ceased to be presented to it. If, for instance, after a momentary exposure to a scene, the lens is capped and the camera left for a period, it will, when switched on, faithfully transmit what it saw before the lens was capped.

The Head Amplifier

The picture signals from the camera plates are fed

straight into the head amplifier. This amplifier strengthens the minute signal from the photo-sensitive plate of the camera sufficiently for them to pass down as much as 1,000 ft. of cable until they reach the main valve amplifying equipment.

After passing through the multi-core connecting cable from the head amplifier in the camera, the picture signals enter the picture illumination corrector unit (one for each of six cameras). This unit arranges that any inequalities which may have developed in the picture signals, are corrected. By this means a faithful reproduction of the light and shade over the whole picture is ensured.

The Phase Reverse Unit

After this the signals enter the phase reverse unit. This unit has been provided because it is sometimes

OF ELECTRONIC TRANSMISSION AND RECEPTION

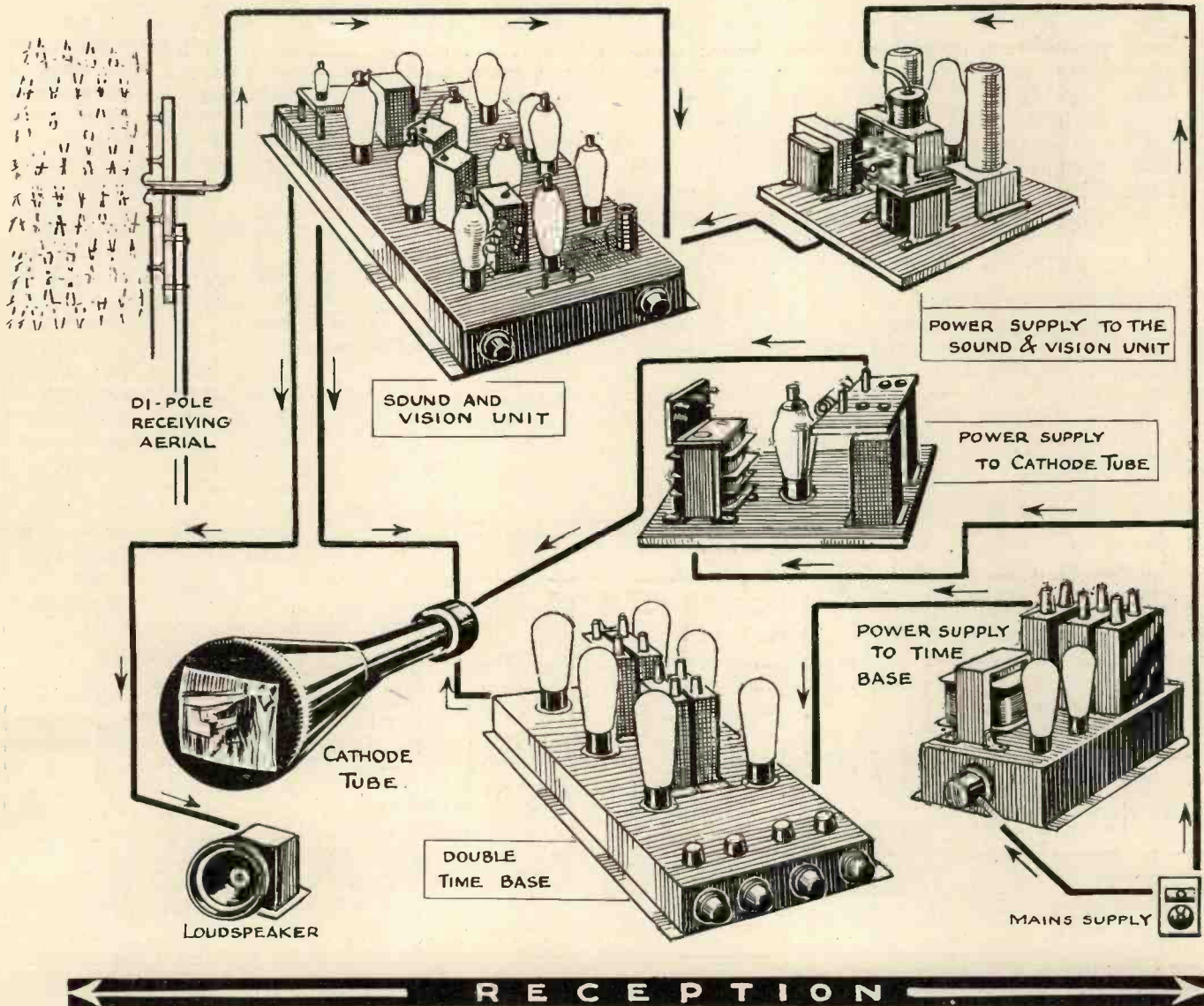

necessary to use either positive prints or negatives of films at will

The Mixer Unit

The foregoing description has dealt with one camera channel only. Six cameras can, however, be used and the mixer unit sorts out the picture signals from the six cameras by means of electric remote control from the programme producer's control desk. A producer can fade out from a close-up to a long-shot or other scene.

B Amplifier

Further amplification of the picture signals from the particular camera selected by the producer occurs in the B amplifier unit.

C Amplifiers

The partially cleansed and amplified picture signals are fed into the duplicate C amplifiers. In the C amplifiers further extraction of unwanted interference, due possibly to the situation of the camera, is effected in

addition to further amplification of the picture signal.

Suppression Mixer Units

The camera signal, which has now passed through two preliminary stages of interference reduction, passes into the duplicate suppression mixer units. Final removal of any interference from the picture signals is effected in the suppression mixer units (a five-stage amplifier).

Syn. Mixer Unit

The picture signals from the Emitron camera have now been amplified and cleared of any unwanted interference. It is now necessary to add to these picture signals the synchronising impulses which are to be transmitted with the picture signal. This is done in the synchronising mixer unit. As the picture signals pass through the synchronising mixer unit synchronising pulses from the pulse generator (see over) are added. The signal going forward to the transmitter

is now a combination of picture signal and synchronising pulses.

The Pulse Generator

The function of the pulse generator is to produce all necessary pulses and frequencies for picture synchronisation and the operation of the cameras throughout the system. The pulse generator is in two bays. In the first of these the basic frequencies are generated by multiplying the frequency of the supply mains or of a generator which can be independent of the supply mains. The second bay further amplifies and selects the correct pulses (which are multiples of those generated in the first bay) and amplifies, corrects and diverts them to whatever part of the system requires them.

Distribution Amplifier

The complete signals to be radiated are now fed to the distribution amplifier. Each of these duplicate amplifiers feeds a channel to the transmitter and in addition channels for monitor picture receivers wherever they are required.

Line Amplifier

From this point we are concerned only with the picture signals to be radiated as they pass into the amplifier. A number of these amplifiers may be used for accepting picture signals from mobile vans or outside broadcast points.

Modulator Units

Three modulator units follow. These three units raise the picture signals to high power, and consist of eight valves passing a high-power modulating signal to the vision transmitter.

THE RECEIVER

The Receiving Aerial

This consists of two copper tubes generally one half wavelength long and used as a di-pole with two feeder lines coming from the centre. This aerial picks up both sound and vision signals and passes them on to the receivers.

Sound and Vision Receivers

The vision signals are fed into the high-frequency stage of a multi-valve receiver which is capable of reproducing up to two million cycles. As a rule 9-10 valves are needed, which includes four intermediate frequency stages. Sound signals are at the same time fed into the first valve of a simple 4- or 5-valve super-het receiver which rectifies and amplifies before passing the signals into the loud-speaker.

Power Supply

A common unit provides high- and low-tension for both the sound and vision receivers. As the power pack is energised from A.C. mains the receivers are independent of batteries as grid bias is obtained automatically by means of cathode bias resistors.

The Cathode-ray Tube

The output from the vision receiver is fed into the cathode-ray tube on the end of which the picture is seen. The electrical impulses from the vision receiver are converted into light in the cathode-ray tube and are controlled by a double time base.

Double Time Base

The time base controls the formation of the picture both horizontally and vertically and synchronises the receiver with the transmitter. High-tension and low-tension for the energising of the time base are obtained from a special power pack.

The Time Base Power Pack

This pack is a simple unit giving high voltage at low current and is made up of two half-wave rectifying valves, a small transformer and three or so high voltage condensers.

Tube Power Pack

The final unit in the chain is the power pack for the cathode-ray tube. It supplies up to 5,000 volts according to the type of tube, but at a low current of about 2-3 ma. A half-wave mercury vapour valve is used in this circuit.

Television on Suppressed Side-bands

AT the last 1936 meeting of the Institute of Radio Engineers (U.S.A.) D. W. Epstein, of the R.C.A. Manufacturing Co., presented the paper "Sideband Suppression in Television Reception." Experience showed, the author said, that a better image often resulted if the circuit was tuned to one side or the other of the carrier, resulting in a partial suppression of one of the sidebands.

The increased detail obtainable under this condition was explained in this manner: The bandwidth passed by the receiver was narrower than that transmitted. By detuning, more "highs" were accepted by the receiver, at the expense of signal

strength, resulting in a more detailed image with a lower signal-to-noise ratio. Such detuning retained double side-band reception on the low (overall scanning line) frequencies, which were proportionately stronger than the highs.

If the receiver band-width is widened in the attempt to accept both transmitted side-bands fully, the gain per stage decreases in direct proportion to the band-width, necessitating more stages. Hence to make the most economical use of the band-width available at the receiver, single side-band transmission is highly desirable.

The effect of single side-band reception on frequency (fidelity) and phase response was examined theoretically and experimentally. The transmitter and receiver in the ex-

perimental set-up were equipped with rejector circuits which lowered the energy transfer in the lower frequency side-band. Among other things it was found that distortion in the second (linear) detector circuit under these conditions did not become serious up to the maximum modulation level of the transmitter (about 80 per cent.). Wave-form distortion in a television image due to the presence of second and third harmonics seemed, in fact, to be less serious than it is in audible reproduction.

Further research along these lines, it is thought, may materially alter the present concepts now current on television-band dimensions, since in the ideal case a given picture could be sent in half the band-width used for the usual double-side-band method.

Scannings and Reflections

STANDARD OF TRANSMISSION

THE decision of the Television Committee to employ two standards of transmission has been the subject of criticism from the very start. The two systems use different picture or signal standards, a point which this journal in common with all those who wish for the rapid progress of television deplore. It is now understood that a decision to use one standard is imminent and likely to be announced shortly after these notes are in print.

It has been obvious that both standards have their particular advantages and it would seem desirable that some compromise should be arrived at, though whether this is what the Television Committee have in mind we are not at present in a position to state. Certainly a picture frequency of 50 per second is desirable on account of flicker. As to the number of lines, the results given by 240 or 405 lines appear identical when transmitting films, which provide a good comparison as the subject matter in all news reels are of the same type. This points to the idea, which seems pretty common, that when electronic devices are used for scanning at both ends (transmitting and receiving) a higher number of lines is better than when the transmitting end is mechanically scanned. We would also hazard a guess that manufacturers would prefer sequential scanning as against interlaced. There is also the matter of mechanical receivers. Although an odd number of lines does not present an insuperable obstacle in the development of these—and they are being developed—matters would be simplified if a figure were used which would provide a more convenient multiple.

THE PROGRAMMES

There has been a noticeable improvement in the programmes and their presentation of late. The long periods of a picture of a clock, which rarely showed the correct time, are now gone and the blank screens never take more than one of the sixty minutes. Unfortunately those who

criticise rarely make any suggestions as to what will improve the subject of their criticism. Television is always compared with the cinema and comparison at the present time is most unfair. The programmes have, however, most definitely been very poor; we have yet to come across anyone who is interested in seeing muffin men, flower sellers, shrimpers and the like. There is also far too much repetition both in the case of artists and fifth-rate films. The "Picture Page," although all right in its conception, would bear revision in its presentation. The constant repetition with the very dummy-looking switchboard begins to jar.

"EFFECTS"

How many lookers realised that in the recent programme entitled "Paleface" an attempt was made, which was fairly successful, to superimpose the pictures from two sources. The scene was a Gainsborough picture, but unfortunately, the lady in the picture did not quite register in the frame and a short or double exposure effect resulted. Incidentally, in the same programme the artist's model scene was considered most daring—for the B.B.C.

FILM OF REALITY?

There is much controversy in television circles as to whether viewers prefer to look at a television image reproducing "live" artists in the studio or film. Actually, as both are just shadow images via television it seems that provided it entertains the origin does not matter. There is little doubt that the average film is superior to the average television studio fare from live artists, though, unfortunately, the majority of the films shown so far have been most uninteresting. It was possible, however, to make a comparison in the recent programme in which Sir Malcolm Campbell and his famous Bluebird were featured. One first saw the actual car with Sir Malcolm at Alexandra Palace and then a film during its record-breaking runs at Daytona and Salt Lake. Similar scenes such as close-ups of the car and Sir

Malcolm were in no way comparable, the film being vastly superior in every way.

FARNSWORTH TO COME ON THE AIR

The Farnsworth Television Corporation have announced that a studio has now been equipped with two electron cameras and transmitting gear erected with the object of putting out programmes in the near future.

Mr. A. H. Brolly, chief engineer of the Farnsworth Company, in his announcement for the company, said: "In our experimental broadcasting from the Philadelphia station, we plan to meet in every respect the requirements for television broadcasting, recommended to the F.C.C. by the Radio Manufacturers' Association Committee on television standards. This means that the picture that we will broadcast will have 441 lines and use interlaced scanning.

"The Farnsworth transmitter is located on one of the highest points in the Philadelphia area, and the studio has been located on the outskirts of the city purposely to try out the use of directional broadcasting to cover a populated area from the outskirts of a city rather than for the broadcast from a transmitter located in the centre of the city."

THE SERVICE AREA

The service area of the Alexandra Palace has proved to be greater than was anticipated. The G.E.C., for example, have already installed standard home sets in ten counties within an area embracing about a quarter of the population of the United Kingdom and covering more than 3,000 square miles. At each point reception is well up to standard.

Outside the 25-mile radius these installations include not only such places as Luton, Camberley, Dorking and Woking, but towns nearly 40 miles away, such as Reading (Berks.), East Grinstead (Sussex), Tunbridge Well (Kent), and the environs of Southend-on-Sea (Essex). In these fringe towns alone the popu-

MORE SCANNINGS

lation is more than 300,000. Exceptionally good results are being obtained in all these places. It will be remembered that at the inauguration of the first official television service ten weeks ago, Lord Selsdon said he would be unwilling to lay heavy odds against a Hindhead resident, 42 miles from London, viewing the Coronation.

MORE APPOINTMENTS AT THE PALACE

Mr. R. A. Rendall has been appointed Assistant Director of Television. Mr. Rendall joined the B.B.C. in 1928. He served for a short time as an announcer before entering the Talks Department, in which he worked in various capacities, including that of talks executive until 1934. In September of that year he became West Regional programme director, at Bristol. A year later he was seconded to the Palestine Government as adviser in broadcast programme organisation, and on the opening of the Palestine broadcasting service at Jerusalem, last March, he became action programme director. Mr. Rendall returned from Palestine recently, and has now taken up his new duties at Alexandra Palace.

Another appointment is that Mr. Reginald Smith, who has been appointed Assistant Stage Manager. Mr. Smith was educated at Clifton College and at Merton College, Oxford. On leaving the University in 1923 he joined the Oxford Repertory Theatre and has been in the theatrical profession ever since. He has also been associated with films and broadcasting.

An assistant has also been given to Mary Allan, the television make-up expert.

PROGRAMME TIME

The question is being discussed whether the present time of 9 till 10 for the evening programme is the most suitable. The consensus of opinion appears to be that it is not, and that an earlier time would be better. This hour breaks into the evening rather and upsets any other occupation. Obviously the time should be such that the city worker will have returned home and a suggested time is 7.30 to 8.30 or at the latest 8 to 9. These times, it is contended, in addition to not causing a dislocation of the evening, would

allow many to see part of the programme and also go out if they wished. An earlier hour would also be welcomed by demonstrators—and, we believe, the Alexandra Palace staff. There is, of course, the point to take into consideration whether an earlier hour would fit in with artists' appointments in other spheres.

5-METRE TRANSMISSIONS TO AMERICA

Now that the British amateur H. L. O'Heffernan, G5BY, has succeeded in spanning the Atlantic on 5 metres it seems possible that these very short waves may ultimately be used for interference-free long-distance transmission and reception.

G5BY's record-making transmission to America was first sent out on December 27, 1936, when it was picked up by W2HDX in New York. This record has now been confirmed, so once more amateur radio has proved its worth.

Although ultra-short waves are supposed to have a limited range, this theory will have to be revised for British amateurs have been heard in Morocco, France and other parts of the world when using the 5-metre waveband.

MODERN PIRATES

The modern definition of a pirate is a person who uses a radio transmitter without a Post Office licence to do so. With the increasing interest in short waves it is becoming more evident that there are many of these pirates at work.

The call sign G8WW is being used regularly, although this call sign has not been officially issued to an amateur. Readers hearing this call at great strength, indicating that the station is a local one, should immediately inform the local Post Office.

CAR RADIOS

There appears to be a subtle difference between a radio fixed to the car and a portable receiver permanently carried around on the back seat. For a car radio an additional licence must be obtained and to make sure one is purchased a policeman can now ask to see it along with all the other licences.

If a radio is not fixed, but is left on the seat it becomes a portable for which no additional licence is needed. This fine point makes a difference of 10s. a year.

TELEVISION RECEPTIONS FROM MOSCOW

The television department of the All Union Radio Committee, Moscow, has received a letter from a radio fan living in Birmingham, confirming reception of Moscow television broadcasts transmitted from Radio Station, RZS. This is a low-definition transmission.

TELEVISION RECEPTION AT 55 MILES

A particularly interesting case of long-distance vision reception is that of Mr. W. R. Westhead, Junior, Avenue Lodge, Dyke Road Avenue, Brighton. As a Christmas surprise item, Mr. Westhead took down by train a standard "Televisor" receiving set, model T.5, of Baird Television, Ltd.

A standard aerial was erected on a bamboo pole on the roof of Mr. Westhead's house, and it is interesting to learn that the picture seen on this set is most satisfactory. No trouble is experienced in synchronising, the signal strength being quite adequate for modulating the cathode-ray tube over its full range. Traces of car interference are, however, noticed, and to overcome this, Mr. Westhead, who is very interested in radio as a hobby, is carrying out a number of aerial experiments, including the fitting of a parabolic reflector in order to see what difference this will make to his results. The outstanding point to notice, however, is the enormous increase in the number of potential viewers which can be embraced with a service area of 50 miles' radius as against the original estimated one of 25 miles.

TELEVISION A PUBLIC EVENT

Elaborate preparations are being made at the Alexandra Palace for televising the boxing tournament of the Alexandra Amateur Boxing Club on February 4. This may be regarded as the first public event to be televised and particular interest attaches to it on this account. Also it is the first public event which has been advertised to be televised.

The Corpatact Manufacturing Company of Iver, Bucks, wish to advise all agents and clients who are interested in Corpatact devices that these can now be obtained direct from the manufacturer and patentee who is the owner of the registered trade mark "CORPATAC." All inquiries will have immediate attention.

AND MORE REFLECTIONS

A BLUE RIBBON FOR 5-METRE WORK

In France a "Blue Ribbon" is to be awarded to the amateur making the most headway in 5-metre research. So far four transmitting amateurs have held the trophy, all for covering long distances on low power.

The maximum distance covered to date is a little over 170 miles, from France to Corsica, with a power of 6-watts.

THE PYE TELEVISION RECEIVERS

The photograph on the cover of this issue of TELEVISION AND SHORT-WAVE WORLD shows the chassis of the Pye television receiver. Two models are made, one a de luxe instrument incorporating television, all-wave radio, and a radiogramophone with automatic record changer. The other model is for vision and sound only. The cathode-ray tube is placed vertically in the cabinet, the picture (size 10 ins. by 8 ins.) being reflected in a mirror in the lid. In order to handle adequately the unusually wide band of frequencies a "duode" speaker is incorporated giving life-like reproduction of both speech and music.

A demonstration of these instruments was given recently and the results left nothing to be desired, the picture being a very pleasing colour with remarkably good definition. It is hoped to give full technical details of the Pye receivers in an early issue.

BAIRD LARGE-SCREEN TELEVISION

It will be remembered that last month a complete description was given of the Baird super-screen system. A public demonstration of this was given for the first time on January 4 at the Dominion Theatre to a very large audience. It was, of course, inevitable that this should suffer to some extent by comparison with the cinema pictures which preceded it, but even so it was evident that the audience were very much impressed with the show.

As explained last month, the system is primarily intended for visual public address with head-and-shoulders close-ups of speakers, but the manner in which the demonstration was staged proved its suitability for

entertainment purposes. Although the programme was transmitted from a studio in the upper part of the Dominion Theatre it could equally well have been via radio. From a

technical point of view the remarkable things about the system are the absence of flicker with very low picture speed and the amount of light on such a large screen.

GRAPHITE COATING IN CATHODE-RAY TUBES

THE coating given to the inside walls of cathode-ray tubes in the earlier days of television used to be, for the most part, silver. This possessed certain disadvantages, notably its bright appearance, causing internal light reflection, which interfered with the image on the screen. A number of materials which could be used to provide this second anode and earthing screen were examined. After much research graphite coatings were selected by tube manufacturers, as for instance, Messrs. Ferranti, as conforming best to the requirements in mind. Such requirements are electrical conductivity, absence of light reflection properties, chemical inertness and the ability to adhere well to the glass walls of the tube.

Graphite in its ordinary form was for many reasons unsuitable. It was necessary to use colloidal graphite, known to the electrical industry as "Aquadag," a colloidal dispersion of the material in distilled water. Films could then be obtained which were homogeneous and had a maximum electrical conductivity. If one used ordinary finely powdered graphite, the particles might be too coarse to form a film which was internally homogeneous, or continuous. The flat particles of graphite should lie on one another like tiles, providing electrical continuity and minimum resistance to the passage of the current.

Properties

Such coatings have a black, matt appearance, which eliminates internal light reflection in the tube. Because the particles of graphite are extremely fine they adhere to the glass tenaciously and to one another. Being almost black and without lustre the coatings radiate heat well, and they are also chemically inert.

Formation

The method of forming the coating varies. One of the commoner meth-

ods is to close the end of the tube, which is fixed in a vertical position, with a stopper, and admit from a reservoir at a slightly higher level a solution of "Aquadag" in distilled water. The solution rises up the tube to the level which marks the end of the coating, and this might be from the neck right up to the fluorescent screen or short of that if desired. After the solution is withdrawn by lowering the reservoir the tube is dried and then heated to about 500° C. Another method of application is to brush on the solution.

The thickness of the coating is governed by the concentration of the "Aquadag" solution used. Messrs. Ferranti use more than one coating. A concentration sometimes used by manufacturers of tubes is one part of "Aquadag," which is in paste form, to two parts of distilled water. Certain refinements in the process are necessary, which have not been mentioned, such as the thorough cleansing of the glass walls before forming the coatings, but these are details which are left to individual users.

Loan Service of Accurate Measuring Instruments

The work of amateurs and experimenters is frequently handicapped because reliable measuring instruments are not available and their cost does not warrant purchase for temporary or occasional use. We learn that H. E. Sanders & Co., of 4 Grays Inn Road, have now a very comprehensive range of high-class instruments which they are prepared to let out on hire for short or long periods at extremely low rates. These comprise Wheatstone bridges, ohmmeters, meggers, standard resistance boxes, milliammeters, microammeters, etc., all of which are accurate and reliable. The fees charged for loan depend on the value of the instrument, and will be quoted on application, but they are much lower than the usual rates.

ELECTRON APPARATUS AT THE PHYSICAL SOCIETY'S EXHIBITION

THE 27th Exhibition of the Physical Society, which closed on January 7, had little to distinguish it from the previous exhibition of 1936 unless it was the greater proportion of new apparatus and exhibits. The space restriction compelled many manufacturers to omit much of their standard apparatus and overcrowding was noticeable in

The G.E.C. demountable Electron Microscope is shown diagrammatically in Fig. 1. This demonstrates how the electrons from a suitable source can be focused so that an electron image of the object is thrown on to a fluorescent screen. The lens system consists of two circular cupronickel diaphragms set 1 mm. apart, and having 1 mm. apertures. The

to be moved across the aperture of the lens. The microscope has been used for obtaining electron images of different oxide-coated nickel surfaces, and also for studying the crystal structure of metals.

On the Ediswan stand a long tube illustrated the principles of magnetic focusing. Opposite the "gun" of the tube a small screen is mounted on

Fig. 1.—The G.E.C. Electron Microscope.

- A Main lens, circular diaphragm with 1 B mm. aperture. (A and B set 1 mm. apart)
- C Cathode
- D Glass Pinch
- E Ground Glass Joint
- F Metal Bellows
- G Differential Screw for Bellows Adjustment.
- H Ebonite Cap
- I Heater and Cathode Leads
- J Pumping Tube
- K Fluorescent Screen
- L Circular Seal
- P Carbon Film on inside of bulb
- S₁ Potential Lead to B
- S₂ Potential Lead to A

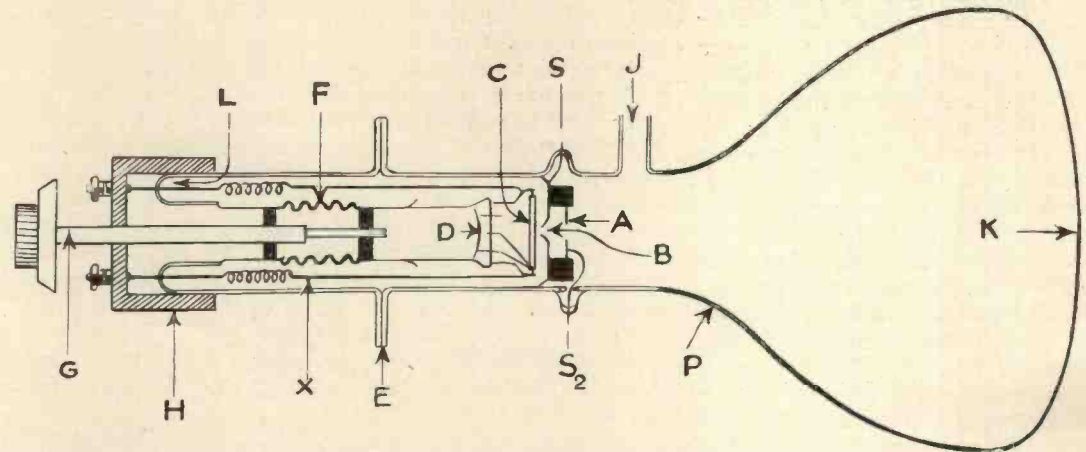

the Trade Section on the top floor of the Imperial College.

The first floor was also devoted to trade exhibits while on the ground floor there were some twenty stands devoted to research. Of these the most interesting to the television experimenter were the electron microscope of the General Electric Co., and the electron focusing demonstrations of the B.T.H. and Edison Swan Companies.

system acts as an immersion objective, whose focal length is controlled by the ratio of the potentials on the diaphragms. The magnification is altered by varying the distance of the object from the first diaphragm. This is accomplished by means of Tombak bellows attached to the object. The tube is continuously evacuated, and a large ground glass joint permits specimens to be rapidly interchanged, and also enables the object

a tube attached to a soft iron core. By means of an external solenoid the core, and hence the screen, can be moved to any distance from the focusing coil. The effect of varying the current through the latter can then be observed and the focal length of the system demonstrated.

The B.T.-H. Co.'s Electron Trajectory apparatus aroused a good deal of interest. This apparatus enables the potential lines in cathode-

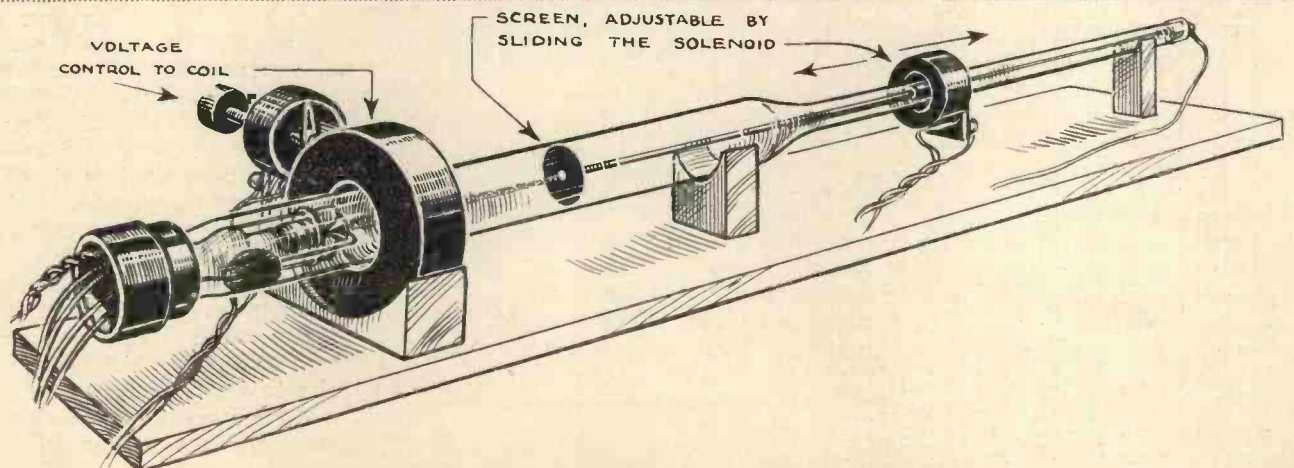

Fig. 2.—The Ediswan tube for illustrating the principles of magnetic focusing of cathode-ray tubes.

ray tubes to be accurately plotted by the use of a large scale model of the electrode system immersed in a conducting liquid. By means of a special probe electrode the paths of the electrons are plotted on a drawing board, the probe being coupled to the

shown in the photograph of Fig. 3. This is intended for measuring impedance of both condensers and inductances from .0001 to 20 μ F., and 0.1 mH to 200 H. In addition resistances of 1-200,000 ohms can be measured.

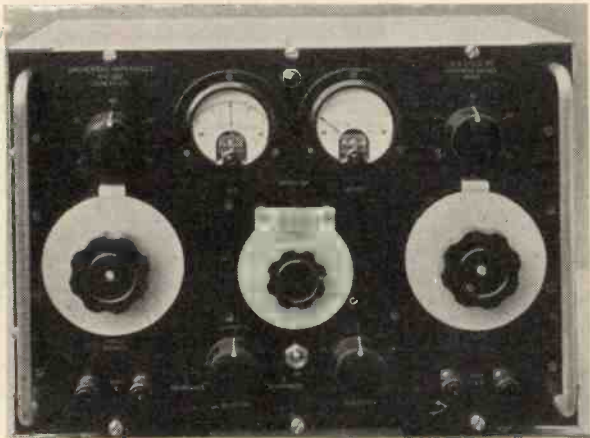

Fig. 3.—The universal impedance bridge of the Marconi-Ekco Co.

pencil by a pantograph. The use of such a device enables the behaviour of the electron beam in a cathode-ray tube to be predicted with ease and accuracy.

In the trade section both the Coscor Co. and the Ediswan Co. showed their 10 in. and 12 in. television tubes, particulars of which will be found on another page. On this floor the outstanding exhibit was that of Marconi-Ekco, who are now manufacturing a complete range of research instruments for general and special radio use. A typical example is the Universal Impedance Bridge,

To give examples of other test instruments shown by firms, we may note the Model E.665 "Selective Analyser" made by the Weston Instrument Co., and the new Valve Tester of the Automatic Coil Winder Co. The former is shown in Fig. 4 and comprises a universal test meter and a circuit selector. The two items are fitted in a neat carrying case and provide all that is necessary for fault finding (or "trouble-shooting," as our U.S. friends have it) in radio receivers. The remarkably wide range of the meter can be seen from the markings on the selector switch below

the meter. At the top of the panel is a multi-contact valveholder for direct testing of valves in the receiver. Considering the capabilities of the instrument, the price of £11 16s. 3d. appears very reasonable.

Among the valve exhibits were noted the new short-wave transmitters of the Standard Telephones and Cables Company. The one shown in Fig. 5 is the 30-watt triode for use on frequencies up to 750 mc., and has the following characteristics:

- Filament Volts, 2.0.
- Filament Current, 3.6 a.
- Max. Anode Volts, 450.
- Magnification, 6.5.
- Impedance, 2,700.

The anode-grid capacity is as low as 1.6 μ F. In addition to the above there are two new screen-grid tetrodes, Types 4278A and 4282B, with dissipations of 1 kW and 70 W, respectively.

Turning from the transmitting to the receiving side, the new Mazda Acorns were on view, with the high mutual conductance of 2.5 ma./V. These valves are similar in appearance to the American ones with a slight difference in pin spacing. Two applications of the acorns were demonstrated—a short-wave oscillator having a wavelength of 70 cm. and a probe voltmeter for use in receiver tests. In the latter, the acorn is mounted at the end of a long flexible lead which enables the grid pin to be placed directly on to the oscillatory circuit. The conventional slide-back

(Continued at foot of next page)

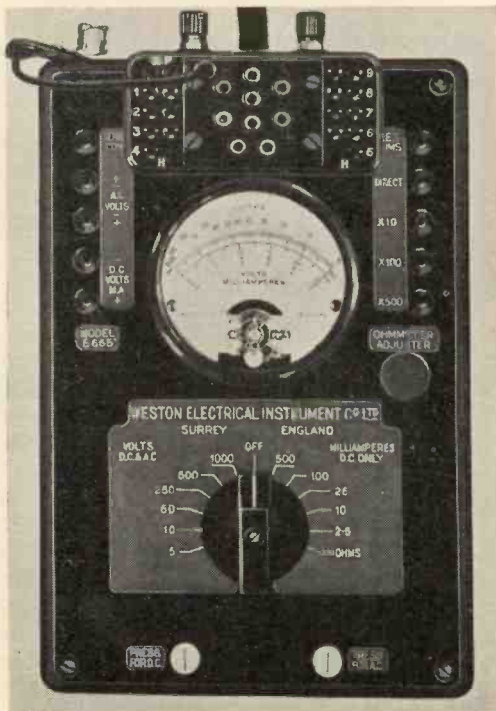

Fig. 4.—(Left). The Weston selective analyzer.

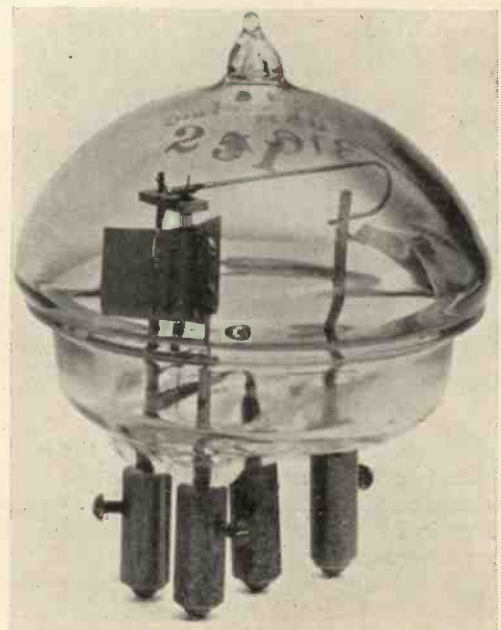

Fig. 5.—(Right). The Standard Telephones & Cables ultra high-frequency triode.

THE B.B.C.'s QUESTIONNAIRE

The B.B.C. have issued an appeal to viewers to report on various aspects of television reception and an invitation for suggestions for the programmes. For the information of our readers who are not in possession of receivers we publish below a copy of the letter which accompanies the report form and also a copy of the latter. In order to enable those who are only able to see the programmes occasionally we ourselves make a special request for opinions and suggestions on another page in this issue.

Dear Sir,

We much appreciate your response to the appeal made by the B.B.C. in a recent television programme, that those who possess television receivers should make themselves known to the B.B.C.

The successful development of the Television Service depends a good deal at this stage on the voluntary help of viewers; and in the hope that you may be willing to help us in this way, we venture to enclose a short set of preliminary questions to which it would be useful to us to know the answers.

More generally, we should be interested to know, if you could spare the time to tell us, what items in recent television programmes you or your friends have thought (a) the most successful, and (b) the least successful. You will, we know, understand that there are at present many practical limitations upon the planning, arrangement and quality of television programmes. We should, however, be glad to have any impressions which you have so far formed of the new

Service. We should also welcome any suggestions that you cared to make for future programme items, and would consider if they were feasible.

If you are able and willing to help us in this way, would you be so good as to fill in your answers to the questions on the enclosed form, adding, either on the back of it or on a separate sheet, any views you may care to express on the more general points mentioned above. An envelope, which requires no stamp, is enclosed for your reply, which will be treated as confidential.

Other points are likely to come up from time to time, on which we should appreciate information from viewers. If you answer this present enquiry we should propose, unless you ask us not to do so, to let you know of them as they arise.

Yours faithfully,

THE BRITISH BROADCASTING CORPORATION

B.B.C. TELEVISION SERVICE

VIEWER'S REPORT.

Viewers can materially help the B.B.C. in developing the Television Service by completing this form and returning it to Broadcasting House in the accompanying envelope.

1. What is the make of your television receiver ?	
2. How long have you had it in use ?	
3. Have you a special television aerial ?	
4. Please state : (a) the height of your aerial above the ground ; (b) the approximate height of your aerial above sea-level, if you know it.	feet feet
5. Are you experiencing any difficulty in adjusting your receiver (a) for vision ? (b) for sound ?	
6. Do you find that reception is upset when motor-cars pass your house ?	
7. Are you experiencing interference from any other source ?	

"Electron Apparatus at the Physical Society's Exhibition"

(Continued from preceding page.)

voltmeter circuit attached to the acorn allows measurements to be made on the circuit without disturbing it by the introduction of extra capacity.

In the upstairs section the resistances of the British Electrical Resistance Co. were noted. These are

wound on a toroidal former and have a substantial travelling contact. With a rating of 50 and 100 watts they are suitable for use as mains potential dividers. Details can be obtained from the firm at Queensway, Ponders End.

Space does not permit of more detailed reference to the remainder of the exhibits. Readers are strongly recommended to apply for tickets of admission to the next exhibition,

which takes place at the same period in 1938. It affords a valuable means of judging the quality of British instruments and the strides which have been made in the development of laboratory and commercial apparatus. The success of the exhibition is largely due to Dr. Laing, the organiser, and the Council of the Physical Society are to be congratulated on their stimulus to the work of the British instrument trade.—G.P.

A NEW METHOD OF TRANSMITTING HIGH FREQUENCIES

By L. S. KAYSIE

A REMARKABLE NON-CONDUCTOR "CONDUCTOR"

IN television—and for short-wave working in general—the ordinary earthed aerial is replaced by a suspended dipole, which is coupled to the receiving set by a two-wire transmission line or "feeder." The latter may consist either of a suitable length of twisted flex, or a pair of parallel wires kept a fixed distance apart from each other by a series of spacers.

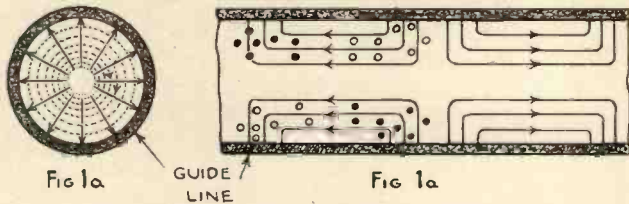

Figs. 1a and 1b. Transmission of an "electric" wave.

Another alternative is the "coaxial" type of feeder, where one conductor is made as a hollow tube which completely encloses the second wire. This is the basis of the so-called "snake" cable, which is also being used in high-frequency wired-wireless signalling for transmitting a number of different telephone messages simultaneously. In all these cases the high-frequency energy is transmitted from one point to another by two metal conductors, which between them provide a path both for the outgoing and "return" currents.

The Bell Telephone Laboratories have recently developed an unusual form of high-frequency transmission line or "guide," which is remarkable for the fact that it includes no metallic conductor in the ordinary sense of the word. The new "guide" consists essentially of a length of insulating material preferably of a higher dielectric constant than air, and of low conductivity. For instance, it may be made of rubber, or camphor, or of wax mixed with finely-divided mica.

There is, however, a definite relation between the diameter of the guide and the frequency of the current it will carry. A guide 6 cms. in diameter, for example, will transmit a carrier wave of 1,750 megacycles, modulated with television signals extending over a band of 2 megacycles. For higher frequencies the diameter of the guide is reduced, and vice versa.

The curious thing is that although the waves must travel forward through the guide in much the same way as they travel through open space—since both are dielectrics—they do not tend to radiate away. If the guide is made of the right diameter for the band of frequencies it is to carry, all the energy is confined to the narrow path so provided. Waves of a different frequency set up fields of force outside the guide, and gradually tend to leak away, in the same way as ordinary currents spread out from a metal conductor as their frequency increases.

Another point of difference between "guided" and "free" waves is that the former travel more slowly

than light. It is possible to select a dielectric for the guide which will transmit a wave at the velocity it possesses when travelling freely through the ether, but in general the speed is reduced in the guide-line.

As it would obviously be inconvenient to instal a long transmission line made only of wax, the insulating material is, in practice, protected by an external metal shield or tube. Experiments have, however, shown that the metal covering plays no essential part in the process of transmission. For one thing there is no external field, such as would be set up if the metal tube acted as an ordinary conductor. Moreover, a single metal tube cannot provide a "return" path corresponding to the second wire of the ordinary coaxial or parallel wire transmission line.

The theory is that the boundary which separates the dielectric substance from the surrounding air acts as a reflecting surface which prevents the wave from spreading outwards in all directions. This applies when the dielectric is used alone, without any protective covering. The metal sheath, when used, assists in confining the energy, but it does so in such a way that the electric fields produced are restricted to its inside surface. The well-known outside "skin" effect of the ordinary conductor, when carrying high-frequency currents, is not present.

Although it is not easy to get a mental picture of what goes on inside the guide, the nearest line of approach is to abandon the ordinary idea of a "go and return" circuit, and to imagine the waves travelling

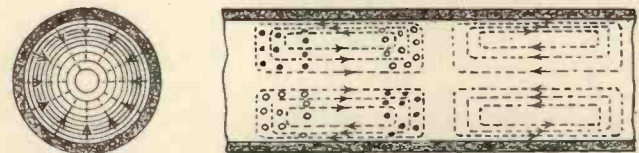

FIG 2a

FIG 2b

Figs. 2a and 2b. Transmission of magnetic wave.

forward as alternating fields of electric and magnetic force, in much the same way as they do when radiated through the ether.

Fig. 1a, for instance, shows the distribution of the lines of electric and magnetic force as seen in cross-section through the guide. The unbroken radial lines are electric whilst the dotted-line circles are magnetic. Fig. 1b shows the same wave-formation as seen in the direction of travel. The electric fields are produced along the length of the guide, each group being in phase-opposition with the one before or after it, as shown by the arrows. The corresponding magnetic fields are indicated in the left-hand "wave" by dots or circles. The dots show that the direction of the field is vertically down through the plane of the paper, whilst

(Continued on next page)

TABLE OF CATHODE-RAY TUBES FOR TELEVISION

Manufacturer.	Type No.	Dia. (mm.)	Screen Colour.	Focusing.	Deflection.	Filament.		Operating Conditions.				Modul.	Sensitivity †
						Volts.	Amps.	A ₁	A ₂	A ₃	G.B.		
† Baird Television	15 W.M.I.	375	White	Magnetic	Magnetic	1.7	2.4	6500	—	—	90	30	2
A. C. Cossor, Ltd.	3274 3272	256 305	White White	Electron Optical do.	Electrostatic do.	0.6* 0.6*	1.4 1.4	‡A ₂ do.	‡A ₃ do.	1-4,500 1-5,000	A1 do.	‡V _g do.	650V 820V
Edison Swan Electric Co., Ltd.	10H 12H	250 300	White White	Electron Optical do.	Electrostatic do.	2.0 2.0	1.5 1.5	150/400 do.	900/1,500 do.	3,500 4,000	100/250 do.	20 20	800V 950V
Mullard Wireless Service Co., Ltd.	E46-G10 E46-12 EM46-12	250 300 300	Green/Blue White White	Electron Optical do. Electron Optical	Electrostatic do. Electrostatic/ Magnetic	4.0 4.0 4.0	1.0 1.0 1.0	250 250 250	800 800 800	4,000 4,000 4,000	60 60 60	25 25	550V 550V
Ferranti	E46-15	350	White	As EM46-12, but with Magnetic	Magnetic	4.0	1.0	250 screen diameter	800	4,000	60	25	1,500V

* Directly Heated. † Sensitivity is expressed as K/V mm. per volt where V is the final anode voltage. ‡ Only available in receivers.

INTERELECTRODE CAPACITIES

Type No. (see above).	Final Anode-Grid.	Plates-Electrodes.	Inter-Plate.
3274	17 mmfd.	11 mmfd.	1 mmfd.
3272	do.	do.	do.
10H	15 mmfd.	15 mmfd.	4 mmfd.
12H	do.	do.	do.
E46-15	15 mmfd.	do.	4 mmfd.

"A New Method of Transmitting High Frequencies"

(Continued from preceding page)

the small circles show the "return" lines moving vertically upwards.

Several different kinds of wave can be generated inside a dielectric guide. In Figs. 1a and b the electric fields are aligned along the length of the guide. This is called an electric wave.

Figs. 2a and 2b show a magnetic type of wave by way of contrast. In cross-section, Fig. 2a, the magnetic fields are shown as dotted radial lines, and the electric fields are full-line circles. In Fig. 2b the magnetic fields are seen as closed circles which move along the length of the guide. In this case the "dots" and small circles show how the electric lines of force are interlinked with the magnetic lines.

The existence of these types of wave, and the relative distribution of the lines of force, can be verified experimentally by using a small "probe" of wire to explore the inside of the guide. The energy picked up by the wire—which acts as a small aerial—is first rectified by a crystal

detector and then applied to a sensitive meter, which shows how the field strength varies from point to point.

The last few years have been marked by a growing use of the ultra-short waves. The increasing number of broadcast stations operating between 30 and 70 metres is one sign of the times, whilst the new television service between 6 and 7 metres is another. In addition, commercial interests are now beginning to exploit the use of the so-called micro-waves which are measured in centimetres instead of metres. It is here that the new dielectric guide is expected to play a big part, when these "hyper-frequencies"—as they are sometimes called—come into their own.

Finally, there are distinct possibilities in its use as a trunk line for multiplex telephony. For instance, it could be made to transmit as many as four hundred different carrier-waves simultaneously, each modulated with telephony signals up to 5,000 cycles.

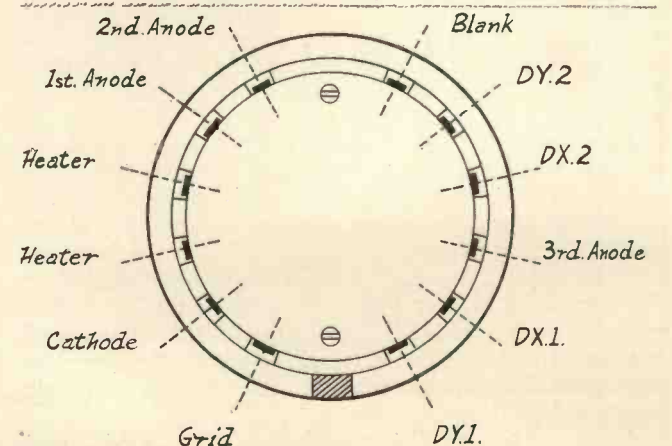

The G.E.C. tube base as used by Edison, G.E.C. and Standard Telephones and Cables

SOME TELEVISION AERIAL EXPERIMENTS

AN ACCOUNT OF PRACTICAL RECEPTION TESTS

THE B.B.C. in their television questionnaire ask among other things: "Have you a special television aerial? Please state the height of your aerial above ground, and the approximate height above sea level."

The matter of the aerial in television reception is an important one

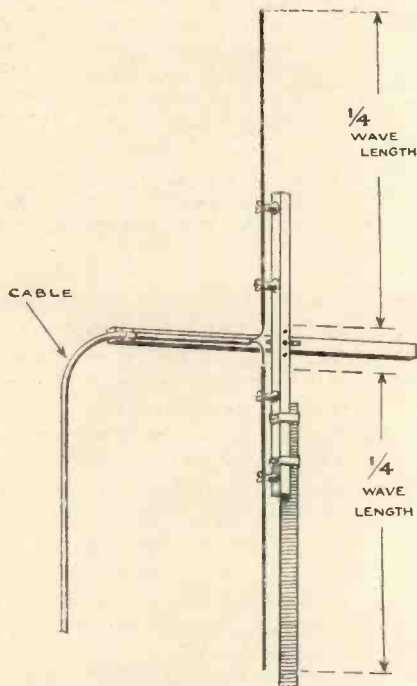

Fig. 1. The usual type of dipole aerial.

and we have therefore carried out a number of practical tests with different arrangements, and also obtained information from other users of television receivers in different districts. This latter was necessary because it is, of course, quite impracticable to move a receiver from one situation to another.

The first test was made with a dipole erected on the chimney stack of the house at a situation about eighteen miles from the Alexandra Palace. So far as actual reception was concerned this gave excellent results, but the height, which was roughly 30 ft. above ground level, was insufficient to be clear of interference from passing cars. It was also concluded that owing to the smoke from the chimney

and consequent deposit of soot on the insulators, which support the copper tubes of which the aerial proper consists, it would not be long before the aerial lost a great deal of its effectiveness. The aerial was not kept in this position for a sufficient length of time to determine what effect this would really have, but it would appear to be a factor which it is desirable to take into account.

Fig. 1 shows the type of dipole used and it will be seen that it consists of two pieces of wood of \perp formation with the two aerial units mounted on the vertical member and the lead brought off horizontally for a distance of about four feet. Each member of the aerial is approximately 5 ft. 4 ins. long with a gap of 2 ins. between them.

A Series of Experiments

It was known that at a distance of roughly four miles from the Alexandra Palace aerial height was of no importance and that quite good reception was obtainable with the aerial on the ground. It was decided; therefore, to make a series of experiments with the aerial at various heights and as a preliminary a test was made with it one foot above ground. Results with the aerial in this position and at a distance of 18 miles from the transmitter were practically negative. Only the faintest modulation was observable and the sound transmission could barely be heard with the volume control fully on.

The aerial was next raised to a height of 10 ft. and a very decided improvement was noticeable, though the picture was by no means fully modulated; it could be clearly seen, but it was entirely lacking in contrast and no adjustment of the contrast or brightness controls of the receiver had any effect whatever in improving the picture. Sound was roughly half normal volume with the control fully on.

During these tests a concentric feeder was used for the lead-in and it was thought desirable at this stage to try the effect of a twisted feeder, as

any decrease in efficiency would be more apparent with a low signal value. With a twisted feeder, which consisted of ordinary lighting cable twisted together there was a falling off of 20 to 30 per cent., and though the picture was discernible it was so faint and so lacking in detail as to be quite useless. There was also such a diminution in the volume of sound as to make it almost inaudible.

It was clear that with either type of feeder an aerial position such as this was useless, so it was decided to raise it another 10 feet, still retaining the twisted feeder. The total height to the centre of the aerial was then 20 feet, and a marked improvement was at once apparent, though the results fell far short of the original arrange-

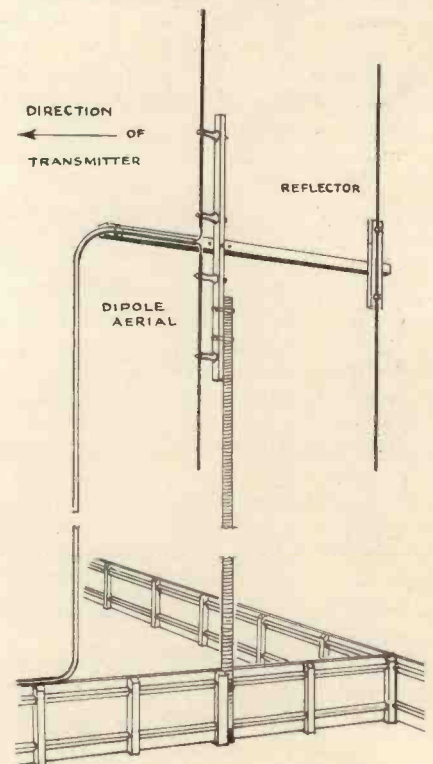

Fig. 2. Dipole with reflector.

ment with the aerial on the top of the chimney stack. The pictures were, however, moderately good and the volume of sound was ample, provided that the volume control was in the full position.

Tests were next made to ascertain the exact direction of the location of the Alexandra Palace, and it was found that even at a height of 20 feet the aerial was entirely screened by the house. As it was desirable to know what effect this screening had on reception, the aerial was moved bodily to one side so that there was no screening in the immediate vicinity, and once more a considerable improvement was noted. When the concentric feeder was substituted for the twisted type the results left little to be desired, though it was appreciated when operating the receiver that it was working with very little margin—that it was necessary to operate with the volume control nearly at maximum and rather critical tuning was essential.

It was now quite clear that the desiderata were height and freedom from screening, but it was decided to try whether a reflector would effect any further improvement before increasing the height still farther. Accordingly another \perp shaped frame was attached to the existing aerial framework and on this was mounted a copper tube of the same length as the aerial, its position being .25 of the wavelength behind the latter—in other words at a distance from the aerial of 2 ft. 8 ins.

The aerial was now moved to its original position in which it was screened by the house. Care was taken that the plane of the aerial and the reflector was in the direction of Alexandra Palace and a comparison made with the results obtained in this position previously. There was very little noticeable improvement and the conclusion was reached that if advantage is to be taken of a reflector, the aerial must be as free as possible from screening.

When the position was altered so that there was comparatively little screening it became evident that the use of a reflector gave decided advantages, but it was found that the directional effects were rather critical and that if particular attention is not given to this point the aerial is more effective without a reflector.

Importance of Height

Finally the aerial was raised to a height of approximately 35 feet so that it was entirely clear of the house,

and in this position there was ample input, which enabled the receiver to be operated with the volume control only one-third on even without the use of the reflector.

Some further observations with other receivers in different districts have been made and in every case it was evident that height is a very important factor, in fact in one instance with a receiver situated at the top of a large block of flats and about two hundred feet above street level it was possible to operate it without any aerial at all, though, of course, the results were rather indifferent. At another situation six miles from the Alexandra Palace and in the heart of London excellent results are being obtained with an ordinary dipole situated on a comparatively low roof, which is surrounded by very high buildings. Also at a distance of ten miles good reception is being obtained with an indoor dipole aerial which is on the first floor and therefore only about twelve feet above ground level. Attenuation appears to take place very suddenly and it is probable that at a distance of a mile farther away such an aerial location would be utterly useless. In another case thirty-two miles from the Palace ample signal strength is being obtained with an aerial thirty-five feet above ground level and without the use of a reflector; the addition of a reflector would almost certainly give an increase of ten per cent.

The Aerial and Synchronising

The opinion was formed that one of the most serious disadvantages of an inefficient aerial concerned the synchronising of the picture. In all cases where the aerial was not efficient trouble was experienced in this respect which necessitated frequent attention to the synchronising controls and particularly the line, even though the picture itself was reasonably good. With improved efficiency of the aerial this trouble entirely disappeared.

It is well known that the transmissions vary to some extent and therefore it is possible that apart from aerial alteration variations in reception would have taken place, but it appears that the tests may be taken as providing a rough guide.

It appears very desirable to prevent corrosion of any of the joints in the aerial system and these should therefore be covered with insulating tape over which Chatterton's compound is run in a molten state. With a joint made in this manner and ample metal-to-metal contact there is no necessity to solder.

The concentric feeder can be run in any manner; for instance, it can be secured to the side of the building or fence, but it should be fastened in such a way that it does not sway about with the wind. If it is in the open, preferably it should be as close to the ground as possible, in fact the best situation would be a few inches underground, though this would necessitate employing some sort of conduit. This situation will prevent pick-up on the feeder. A test for whether interference is being picked up on the feeder may be made by earthing it at intervals with wires not longer than six feet. If no reduction in noise results it may be concluded that the noise is being picked up on the aerial.

Summary of the U.S.A. Television Committee's Recommended Standards.

1. Frequency allocation :
Lower limit, 42 mc.
Upper limit, 90 mc.
An experimental band starting at 120 mc.
2. Channel width, 6 mc.
3. Spacing between television and sound carriers, 3.25 mc. (approximately).
4. Relation of sound carrier to television carrier, sound carrier higher in frequency.
5. Polarity of transmission, negative.
6. Number of lines, 440-450.
7. Frame frequency, 30 per second.
Field frequency, 60 per second, interlaced.
8. Aspect ratio, 4:3.
9. Percentage of television signal devoted to synchronising signals, not less than 20 per cent.
10. Synchronising signal, No recommendation. ("Serrated" vertical signal favoured by R.C.A. "Narrow" vertical signal favoured by Philco, Hazeltine, Farnsworth, General Electric Co.)

BAIRD TELEVISION LTD.

**WORLD PIONEERS & MANUFACTURERS OF
ALL TYPES OF TELEVISION EQUIPMENT**



PRICE 85 Gns.

BAIRD TELEVISION LTD. announce that special production arrangements enable them to guarantee that no delivery delay occurs on orders for "Televisor" Receiving Set Model T.5. The outstanding performance of this Receiver has been the subject of favourable comment by press and public alike.

"Televisor" receiving sets show a brilliant black and white picture 12" x 9" on the "Cathovisor" cathode ray tube, which is of unique design and guaranteed for a long life. On both systems of transmission these Sets give results unequalled in size, detail, brilliance and colour, with the accompanying sound. Operated from A.C. Mains, or D.C. Mains with a suitable D.C./A.C. converter. The controls are extremely simple for either system.

Authorised dealers who have qualified for a Baird Certificate of Proficiency, have been appointed within the service area of the B.B.C. television station. A complete list will be supplied on written application.

We are exhibiting at the BRITISH INDUSTRIES FAIR—Stand No. G.934 Olympia.

"TELEVISOR" RECEIVERS MIRROR THE WORLD

Head Office :

**GREENER HOUSE,
66, HAYMARKET,
LONDON, S.W.1.**

'Phone : Whitehall 5454

TELEVISOR

REGISTERED TRADE MARK

Laboratories :

**CRYSTAL PALACE,
ANERLEY ROAD,
LONDON, S.E.19.**

'Phone : Sydenham 6030

OF TECHNICAL IMPORTANCE

NEGATIVE FEED-BACK AMPLIFICATION FOR D.C.-A.C. CIRCUITS

Osram Valves

MADE IN ENGLAND

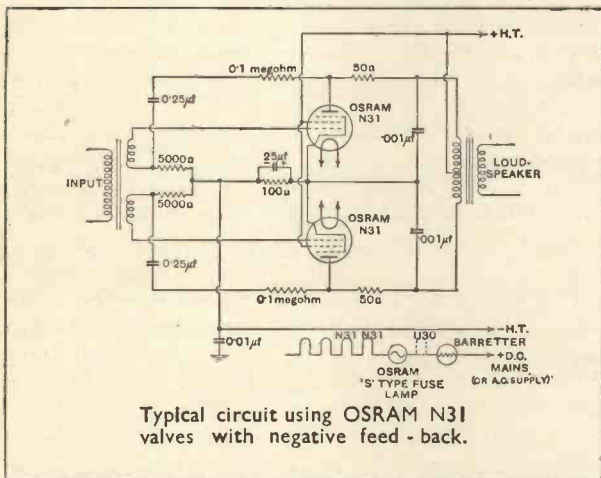

TYPE N31 HIGH SENSITIVITY OUTPUT PENTODE

"The development of the negative feed-back principle has made it economically possible to build a D.C. Mains Amplifier which is strictly comparable from the point of view of quality with the best A.C. apparatus"

"The chief advantage of the arrangement is to give a pentode performance which approaches that of a triode as regards quality of amplification."

The ideal valve for negative feed-back circuits is the OSRAM N31.

CHARACTERISTIC OF TYPE N31.

Heater Current	0.3 amp. or 0.6 amp.
Heater Volts	26.0 or 13.0
Anode Volts	200 max.
Screen Volts	180 max.
Mutual Conductance	10.0 mA/volt
Anode Current average	40 mA
Screen Current average	10.6 mA
Anode Dissipation	8 watts
Normal Grid Bias	-4.4 volts
Automatic Bias Resistance: each valve	87 ohms
Optimum Load (single valve)	5,500 ohms
Optimum Load (anode to anode, Low Loading Push-Pull)	7,000 ohms

Price each: 13/6

OTHER OSRAM 0.3 AMP. SERIES — RUN VALVES TO OPERATE WITH THE N31 ARE —

TYPE W31	Vari-mu Screen Pentode	12/6
TYPE X31	Triode-Hexode Frequency changer	15/-
TYPE H30	High 'mu' Triode	9/6
TYPE D41	Double diode	5/6
TYPE DH30	Double-diode-Triode	12/6
TYPE U30	Rectifier	15/-

Technical data on application.

OSRAM VALVES — DESIGNED TO ASSIST THE DESIGNER

Advt. of The General Electric Co., Ltd., Magnet House, Kingsway, London, W.C.2.

THE HISTORY OF THE CATHODE-RAY TUBE

AN ACCOUNT OF HOW IT WAS DEVELOPED

By G. Parr

TO many who are marking its acquaintance for the first time in television the cathode-ray tube appears to be something quite new, and they would probably be surprised to know that the name itself was used as far back as 1876. It is true that the modern high vacuum tube that is used in television is the result of intensive research over a period of a few years, but commercial tubes were available at the beginning of the century and the Cossor Co. can claim to have been making tubes for the past thirty years.

To find the origin of the name "cathode-ray" we

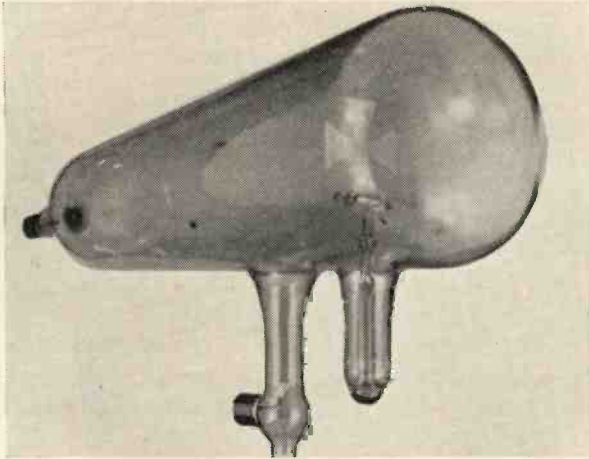

Fig. 1.—Crookes' tube with Maltese Cross to show the shadow cast by rays on the end of the bulb.

have to go back to 1859 when investigations were being made in this country and Germany on the behaviour of gases under strong electric fields.

The effects which occurred when a glass tube was connected to a high potential and gradually exhausted of air had been observed by Faraday and even earlier by Coulomb, and the familiar "Geissler tube" with

When the discharge passed between two electrodes in an exhausted glass tube it was noted that the glass in the neighbourhood of the cathode (negative electrode) fluoresced with a greenish colour. This effect was ascribed to a form of ray which proceeded from the cathode and struck the glass with sufficient energy to produce luminescence* and even heat. From this discovery the investigation into the nature and properties of these cathode rays proceeded rapidly, and it was Crookes (1879) who showed that they were not rays in the sense that we speak of light rays, but were actual particles projected at right angles to the surface of the cathode.

The tube which he used to show this had been copied many hundreds of times and can be bought at any scientific instrument makers.

A photograph of a modern copy of Crookes' tube, bought a few weeks ago, is shown in Fig. 1. The cathode is in the form of a concave disc, the anode being sealed in at the side of the tube, the side limb serving also for a support. At the end of the tube is a tiny Maltese cross cut from sheet metal and hinged so that it can be tilted into a vertical plane or dropped flat. When a discharge from an induction coil is passed through the tube the glass domed end fluoresces with a vivid green under the bombardment of the "rays," and if the Maltese cross is tilted up into the path of the rays a sharply cut shadow of the cross appears on the glass. It was this effect that demonstrated that the rays proceeded normally (i.e., at right angles to the surface) from the cathode and did not disperse in a manner similar to light in all directions. Incidentally, it is interesting to note that it was on a Crookes' tube that Professor MacGregor-Morris carried out the first experiments of focusing the rays with a magnetic field.

The fact that the rays were not only particles but



Fig. 2.—Perrin's tube which demonstrated the negative charge associated with the electron.

its ornamental glasswork and colour effects was the practical outcome of the early work on electric discharges at low pressures.

As vacuum technique improved and new types of pump enabled a higher degree of vacuum to be attained, new phenomena became visible which had hitherto been absent at lower degrees of exhaustion, and among these were the effects noted by Plücker and called by him "cathode rays."

carried a negative charge and hence gave rise to a current of negative electricity was shown by Perrin (1895) who caught them in a bucket at the end of a long tube (Fig. 2). The whitish ring round the edge of the hole is a coating of fluorescent material, presum-

* The words 'luminescence' and 'fluorescence' are sometimes used loosely to describe the same effect. Actually luminescence is the generic term covering fluorescence and phosphorescence.

COLD AND HOT CATHODE TUBES

ably to show whether all the particles have gone inside! A short distance from the cathode will be noticed a cup-shaped electrode with a small hole pierced in the centre to act as an aperture to concentrate the

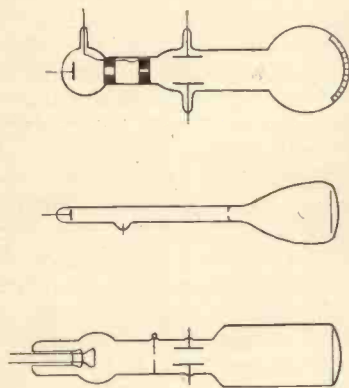

Fig. 3.—Three stages in the development of the tube. Top: Thomson's tube of 1897. Centre: Braun tube of the same period. Bottom: Wehnelt tube of about 1902.

rays into a thin pencil. In this we have the foreshadowing of a focusing action, although the true focusing devices were added at a much later date.

From then onwards a great deal of research was carried out by various workers, notably Sir J. J. Thomson (who celebrated his 80th birthday some weeks ago), and the first "cathode-ray tube" was produced for the purpose of carrying out accurate measurements on the properties of the cathode rays and their behaviour in magnetic and electrostatic fields. The term coined by Plücker survived the later discoveries of the true nature of the rays, and we still refer to them easily as "cathode rays" although "electron beam" would be more accurate. The word "electron" did not come into use until after 1890 when it was applied to these negatively charged particles by Dr. Johnstone Stoney.

In Fig. 3 we have outline drawings of three stages in the development of the primitive cathode-ray tube from the Thomson tube to the Wehnelt tube. In the Thomson tube two slotted apertures will be seen, mak-

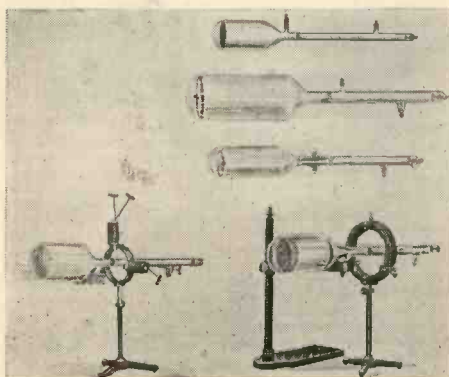

Fig. 4.—A page from a scientific catalogue of 1905 showing types of tubes available.

ing the beam in the form of a flat strip which passed between two electrodes in the middle of the tube. The glass domed end of the tube was not coated with any

fluorescent material and the position of the beam was shown by the green glow on the glass itself. A potential was applied to the two deflecting plates and the movement of the strip on the glass recorded on a rough scale marked on the surface.

The Braun tube shown in the middle of the diagram can be said to be the first laboratory form of cathode-ray tube for measurement purposes. It had the great improvement of the sheet of mica at the domed end which was coated with fluorescent material. In this tube an aperture of a simpler type was inserted just before the bulb portion.

At this time fluorescent materials were limited and the only experience in the use was gained through investigations on X-ray fluorescent substances. Willemitite, the natural form of zinc silicate, was one of the earliest used and persisted up to the most recent times, although it is now being displaced by more efficient substances giving a better colour of luminescence.

A great many of the early materials were quite unsuitable for later types of tube as they would not with-

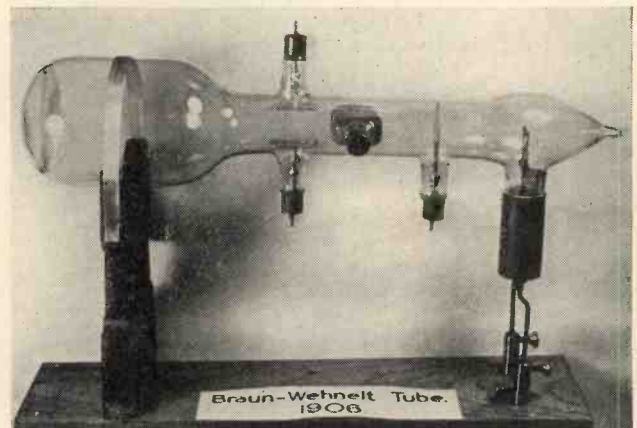

Fig. 5.—A Braun-Wehnelt tube of 1906 using a hot cathode.

stand the heating which is a vital part of modern high vacuum technique.

The photograph of Fig. 4 is a reproduction from a page in a scientific instrument maker's catalogue of 1906 and shows types of Braun tubes with stands and magnetic coils for deflecting the beam.

The fact that a magnetic field from a coil placed round the tube could improve the sharpness of the fluorescent spot was demonstrated about 1898 and this method of focusing was in common use about the beginning of this century.

A most important improvement in the tube was made in 1905 by the use of a hot cathode for emitting the electrons. This was introduced by Wehnelt, who also gave his name to the cylinder surrounding the cathode in the modern tube. The cold cathode tubes of Braun were quickly displaced by Wehnelt's hot cathode tubes, although they were crude compared with later forms of emitter and had an exceedingly short life. A flat platinum ribbon was mounted at one end of the tube and a spot of lime deposited at the centre. The whole platinum strip glowed red hot and the electrons emitted from the lime spot were attracted to a flat disc pierced

ELECTRON OPTICS AND THE C-R. TUBE

with a central hole to which the positive potential was applied. The imperfect vacuum in these early tubes gave rise to a great deal of trouble due to ionisation of the residual gas by bombardment from the electron stream. The ions formed would return to the cathode with considerable velocity and their impact caused pitting on the surface of the cold cathode discs and premature burnouts in the hot cathodes. The present-day manufacturer with the improved vacuum pumps at his disposal is still anxious about damage to the cathode

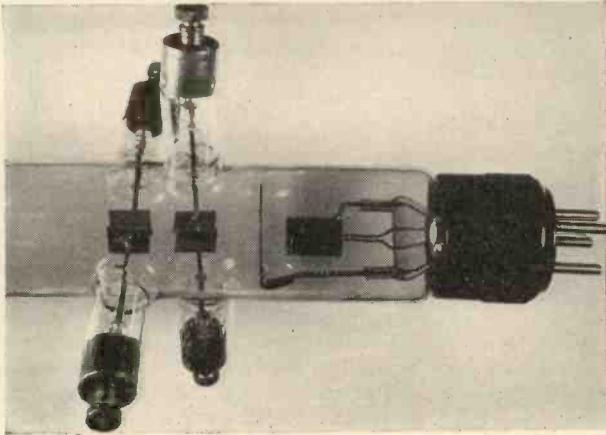

Fig. 6.—An early gas-focused tube showing the Wehnelt cylinder.

by positive ions and takes care to reduce the velocity of such as remain in the tube to a safe value by keeping the potentials low.

The photograph, Fig. 5, shows a Braun-Wehnelt tube of 1906 with its smart-looking stand and terminals for the filament supply.

Fig. 7.—A modern high-vacuum tube with a 6-in screen (Standard Telephones and Cables).



The next noteworthy improvement did not take place until fifteen years later when Van der Bijl and Johnson discovered the properties of a trace of gas in the tube in its improvement of the focusing. The earliest gas-focused tube was the Western Electric Type 4224, which may be considered the first successful laboratory tube having a reasonable life and with a sharply defined spot. The cathode was protected from ionic bombardment by enclosing it in a form of tube, extended to include a tubular anode. This electrode arrangement was responsible for the use of the word "gun" to denote the electron producing electrode system and it is only lately that the word shows signs of being dropped in favour of the more common valve terms, grid and anode.

In 1931 von Ardenne made the important improvement of surrounding the cathode with a negatively charged cylinder which served to pre-concentrate the electron beam before it passed through the hole in the anode, or accelerating electrode. This greatly improved the focusing properties and the "efficiency" of the beam, since before that time the simple apertures inserted in the path of the beam did no more than cut off part of the electrons travelling up the tube. With the introduction of the Wehnelt cylinder these waste electrons were guided into the main stream and contributed to the intensity of the spot. The focusing effect of the gas was controlled by the cathode emission and by the potential applied to the negative cylinder, and the von Ardenne tube made external photography of the fluorescent trace a practical success for the first time. In a book on the Cathode-ray Tube in Radio Research the authors state that "such advances as were made in recent years . . . owe much to the ingenuity, resource and unflinching friendliness of Baron Manfred von Ardenne."

The few years after 1932 saw the gas-focused tube firmly established as a laboratory instrument and its uses as a television reproducer were also being recognised. In 1933 the Ediswan Co. were giving regular demonstrations of 30-line reception with a small tube and commercial cathode-ray receivers were seen at the German television exhibition.

The whole of the theory and practice of focusing of electron beams was given a fresh outlook about this time by the researches of Brüche, Knoll and Ruska.

The theory involved in this branch of the science is outside the scope of this review of development and it is sufficient to say that the success of the modern high-vacuum tube is founded on the principle that the elec-

tron beam can be focused by electrostatic fields in the same manner that a beam of light can be focused by glass lenses. At the same time the efficiency of the magnetic field for producing the same effects has not been overlooked and present-day practice seems evenly divided between the two methods.

This account of the development of the cathode-ray tube cannot be concluded without reference to the foresight of Campbell Swinton who, when the tube was in its state of early development in 1908, predicted the use of "cathode rays" for scanning and for reproducing pictures on a fluorescent screen, and in fact laid the foundations of the modern high-definition television practice.

The photographs illustrating this article were kindly supplied by Mr. R. M. Weston, M.A.

WE ASK FOR . . .

PROGRAMME IDEAS AND CRITICISM

TWO GUINEAS FOR THE BEST LETTER

The B.B.C. is spending a considerable sum on television, and doubts arise in their minds as to whether the whole of the money is being spent wisely. Their difficulties are considerable. Just as they had to build up their broadcasting service without any precedent to guide them, now they are trying to build up a television service, again without a precedent. And their experience in sound broadcasting does not avail them over much.

Even the casual viewer finds in the B.B.C. television programmes much to criticise. There is as yet an amateurishness which shows itself chiefly in a lack of finish and in the failure to observe what would appear to the ordinary person to be obviously elementary things. But that, perhaps, is where the ordinary person has to beware. Things are not always what they seem and you can be sure that the practical and technical difficulties in the television studio are considerable. But it does not follow that the public appreciates or understands those difficulties and we are prepared to believe that the B.B.C., faced on the one hand with considerable expense and on the other with a body of criticism (much of it unfavourable), are wondering whether they are getting value for their money.

The B.B.C.'s Questionnaire

In an attempt to get direct information on this matter, they are inviting everybody who has a television receiver to inform them of the make of the receiver, its date, type and height of aerial, whether there are any difficulties in adjusting either sound or vision, whether reception is upset by motor cars or interference from any other source, and what they regard among recent televised items as the most—and on the other hand the least—successful! Details of this questionnaire are given on another page of this issue.

The B.B.C.'s questionnaire necessarily is addressed to the actual owners of receivers—a relatively small public most or all of which is embodied in the circulation of this magazine. It must be remembered, however, that in addition there is a large body of readers, apart from those who have the privilege of owning a set, who yet have facilities as viewers and who are accustomed to seeing television demonstrations, and who frequently have opportunities of forming their own opinions on matters in which the B.B.C. now show themselves to be highly curious. We ourselves

would be glad if the information that is being sent by our readers to the B.B.C. were sent to us as well. We should find it invaluable in adjusting ourselves to readers' requirements. But, in addition, we should like all our readers, whether replying to the B.B.C. questionnaire or not, to let us know their opinions of the programmes, not only the items that compose them, but the respective lengths of those items and of the programmes and the times at which they are transmitted.]

Cinema Comparisons

Of course, the reader will have to bear many things in mind, and we are sure he will avoid drawing the easy but misleading comparison that might occur to the man-in-the-street—that between the cinematograph and television. It is quite useless at the present time to compare these two.

The cinematograph industry has forty years of experience behind it. It has immense wealth. It is able to employ the services of the most highly-paid people in the world and can do this simply because it can distribute its films over the face of the world and draw profits from thousands of different localities—all with one original although considerable expenditure. It can afford to build up the most costly temporary settings and to rehearse its actors for weeks and even months. It can afford to take and re-take and yet again re-take scene after scene until its highly qualified directors are thoroughly satisfied with the result. One prominent British studio is satisfied if, with a day's camera work on the set, it can produce enough film for a few minutes on the screen. Should an accidental blemish show itself, that part of the film can be cut out, perhaps with no loss to the rest of the picture, or, if necessary, can be replaced. The original film is subject to cutting and editing, and there is absolutely no reason why the finished picture should be marred by a casual or accidental trouble of any kind.

But how very different with television. In the first case, the service is being paid for by the B.B.C. The B.B.C. is not "selling" anything to bring the money back. It cannot in any sense, at the present time, rival the methods of the cinematograph industry. It rehearses its programmes under the handicap of many limitations. Except within slight limits the television camera cannot go to the subject; the subject must be brought to the

television studio. There is, of course much rehearsal, but on severely economic lines, and should, during the actual studio transmission, the slightest thing go wrong in the presentation, it will be extremely difficult or perhaps impossible to put it right without drawing attention to it and thus making it worse.

The presentation is bound to owe something to the B.B.C.'s experience with sound broadcasting, but that itself is a doubtful advantage, inasmuch as sound broadcasting is for people who might as well be blind so far as the reception of the programme is concerned. Whilst the technique of television has gone forward amazingly recently, there has been very little opportunity for studio technique to perfect itself, and it is not unfair to say that at this moment programme presentation and programme material are a long way behind actual transmission technique.

Our Invitation to Readers

In spite of what we have said above, it is undoubtedly true that much can be done to improve the television programme and its presentation, and this is where we want our readers to help. Ideas are the things that count. Included in the readership of this magazine is the most competent body of television advisers in the world, and we should highly appreciate their going to the trouble of telling us what, after having considered all the known factors, they would do to improve the B.B.C.'s television programme. We should like their comments on the times of transmission, the length of programmes, the length of items as at present shown, on the question of repetition of pictures—chiefly of news and other feature films—and we should like them to indicate their ideal programme.

This is not work that we can pay for in the ordinary way, but merely to mark our appreciation of our readers' kindness, we offer Two Guineas for what we consider the most useful letter that reaches us. It is our intention to publish in "Television" selections of the letters received. May we ask that letters should be posted to us as soon as possible. They should be of any length, but, in general, we suggest they should not exceed a few hundred words. This is not a readers' competition, but rather an effort by which readers can further the development of television. Please see that letters are addressed to The Editor, "Television," 37, Chancery Lane, London, W.C.2.

RECENT TELEVISION DEVELOPMENTS

A RECORD OF PATENTS AND PROGRESS *Specially Compiled for this Journal*

Patentees :—L. R. Merdler and Baird Television Ltd. :: Marconi's Wireless Telegraph Co. Ltd.
H. M. Dowsett and L. E. Q. Walker :: J. C. Wilson and Baird Television Ltd. :: D. M.
Johnstone and Baird Television Ltd. :: Fernseh Akt. :: J. E. Keystone and L. F. Broadway
A. D. Blumlein

Television Receivers (Patent No. 454,945.)

Picture signals transmitted on one carrier-wave are received by the valve V, whilst the corresponding sound signals, transmitted on a different carrier, are applied to the valve V₁. Both these valves are back-coupled to act as super-regenerative

occur in the general illumination, or what may be called the "background brilliance" of the picture.

The cathode-ray transmitter shown in the figure is designed to meet this difficulty. The screen-electrode E consists of a glass plate which is coated on the side facing the "gun" of the tube with a fluorescent mate-

in addition there will be an extra emission due to the fluorescent light produced by the electron scanning beam, and this extra component is used to vary the amplification factor of a variable-mu valve. The latter in turn keeps the amplitude of the radiated carrier-wave in step with any slow changes in the background illumination of the picture.—Marconi's Wireless Telegraph Co., Ltd., H. M. Dowsett and L. E. Q. Walker.

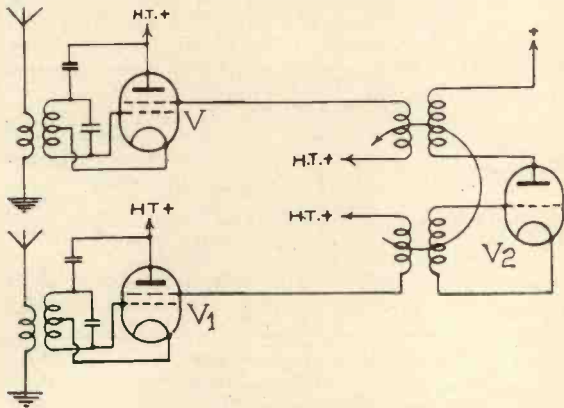

*Super-regenerative television receiver circuit
Patent No. 454,945.*

amplifiers, and both are "quenched" by the same set of oscillations from the back-coupled valve V₂. The quenching oscillations are fed from the plate circuit of V₂ to the amplifier V and from the grid circuit of V₂ to the valve V₁, the two leads being preferably decoupled so as to keep the system stable. The use of one common frequency to quench both amplifiers effects a useful economy.

If one of the valves V, V₁ is used to amplify the signals before frequency-changing, whilst the other valve amplifies them after frequency-changing, the system will remain stable even if no decoupling is used.—L. R. Merdler and Baird Television, Ltd.

Television Transmitters (Patent No. 455,356.)

One of the difficulties in transmitting television signals is to keep pace not only with the rapidly varying light value of each particular "point" of a picture, but also with the more slowly changing alterations which

occur in the general illumination, or what may be called the "background brilliance" of the picture.

The picture to be transmitted is

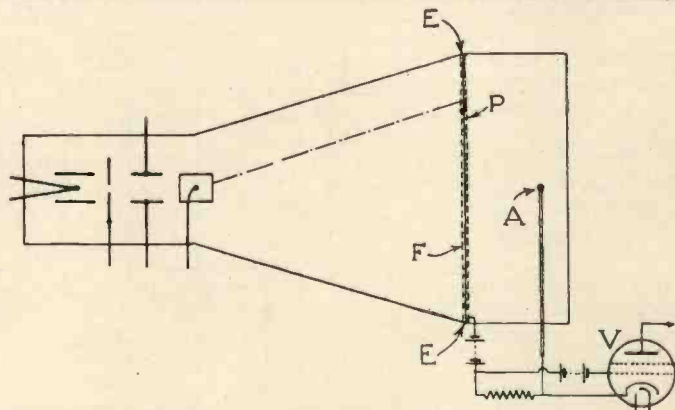

Television transmitter making use of fluorescent material. Patent No 455,356.

focused on the sensitive layer P, and simultaneously the fluorescent layer F is scanned by the electron stream from the gun. The anode A collects the electrons emitted from the photo-sensitive layer P, and these go to form the signal components. But in

by means of an external magnet M on to an electrode F provided with a central aperture A.

The incoming television signals are applied to a pair of plates N and swinging the stream to and fro, so that at one time more electrons pass

through than at another, according to whether the electron image of the cathode corresponds to maximum or minimum emission.—*J. C. Wilson and Baird Television, Ltd.*

to one or both of the saw-toothed oscillators, so that in the event of a breakdown in the time-base circuit, the electron stream is at once automatically "scattered" over a wide

The electron stream is first modulated at carrier-frequency by voltages applied from a generator O to a control electrode C. It is simultaneously modulated by synchronising-signals supplied from a source S to a second control electrode Cr. A slowly-varying voltage, corresponding to the overall changes in average "brightness" of the picture, may also be supplied to the second control electrode.—*J. E. Keyston and L. F. Broadway.*

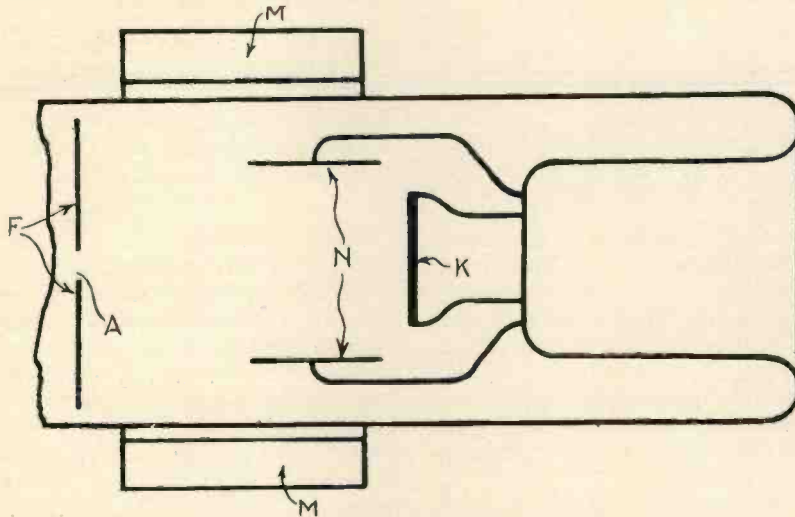

Electron camera employing intensity modulation. Patent No. 455,237.

Super-regenerative Receiver
(Patent No. 455,298.)

A pentode valve is used to "quench" the tuned circuit in a super-regenerative receiver. The pentode is shunted across the circuit to be damped, and local oscillations are applied either to its grid or anode, so as to swing the valve between two conditions. In one condition, it has a very high impedance, of the order of a megohm, whilst in the other the impedance sinks to 100 ohms. During the latter period, the valve operates to "quench" the super-regenerative circuits.

The same pentode may also be used to generate the local oscillations by back-coupling the grid to the screen grid.—*D. M. Johnstone and Baird Television, Ltd.*

Protecting the Screen
(Patent No. 455,479.)

It is not safe to let the scanning beam "rest" on the fluorescent screen of a cathode-ray tube, as it is liable to damage or burn it out. Should therefore the time-base circuit—which keeps the spot in constant motion—cease to function, for any reason, it becomes necessary either at once to throw the spot off the screen, or to take other measures to render it harmless.

According to the invention one of the magnetic coils used for focusing the electron stream is connected, in series with the high-tension supply,

area of the screen and its intensity reduced below the point at which it is likely to damage the screen.—*Fernseh Akt.*

Cathode-ray Transmitters
(Patent No. 455,555.)

In a transmitter of the Iconoscope or mosaic-cell type, the picture is first

Time-base Circuits
(Patent No. 455,858.)

Line synchronising signals are applied to the fourth grid of a heptode valve, at the same time as impulses of twice the line frequency are applied to the similar grid of a second heptode valve.

Longer impulses at framing frequency are simultaneously applied to the first grids of both the valves in parallel. The two valves constitute an electric "switch" arrangement, which is prevented from "changing over" except at the proper intervals, so that the different impulses are fed in correct sequence to the cathode-ray receiver.—*A. D. Blumlein.*

Interleaved Scanning
(Patent No. 455,972.)

Relates to means for ensuring the proper displacement between one set

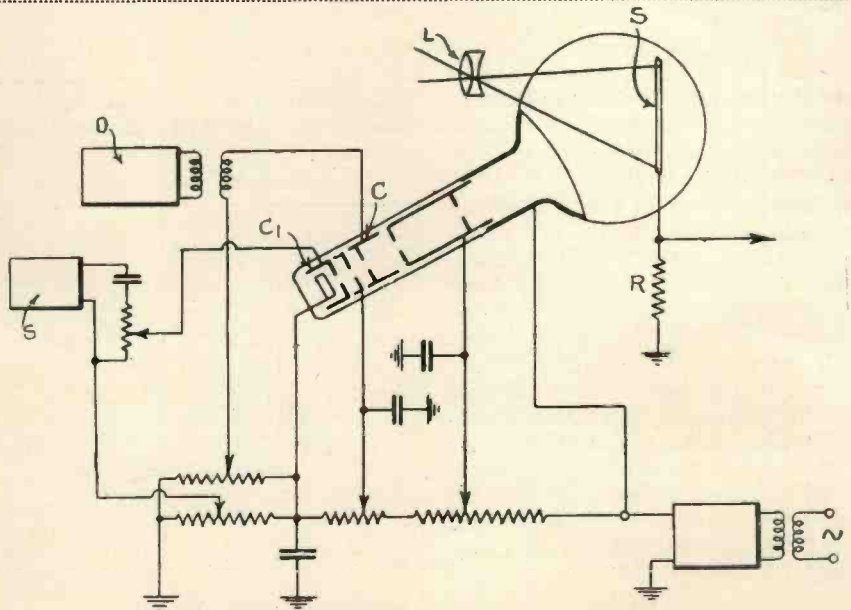

Modified Iconoscope transmitter. Patent No. 455,555

projected through a lens L on to the photo-sensitive screen S, where it is scanned by the electron stream to produce signal currents across a resistance R.

of scanning lines and the next, which is necessary to ensure that both sets of lines sandwich together, without overlap, on the viewing screen. In one arrangement a plate of glass,

which is slightly tilted so as to throw the rays slightly to one side, is interposed between the scanning spot and the picture during one scanning operation. During the next scanning operation, a second plate of glass, tilted in the opposite direction, re-

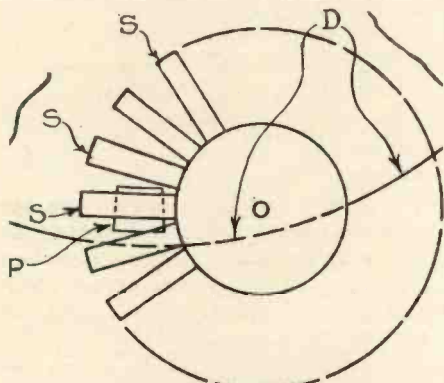

Mechanical interleaved scanning. Patent No. 455,972.

places the first, and so on, in rotation.

Or, as shown in the figure, a number of glass plates in the form of spokes S are rotated in front of the aperture P in the larger scanning disc D, so that for one set of scanning lines the light passes through one of the spokes and is therefore deflected slightly to one side, whilst during the second set of scanning lines the light passes without deflection through the open space between two of the spokes.—*J. C. Wilson and Baird Television, Ltd.*

Summary of Other Television Patents

(Patent No. 455,085.)

Scanning system suitable for a

cathode-ray television transmitter of the "mosaic-cell" type.—*H. G. Lubszynski and S. Rodda.*

(Patent No. 455,233.)

Method of producing a double-sided photo-sensitive electrode of the mosaic-cell type for use in a cathode-ray television transmitter.—*H. E. Holman.*

(Patent No. 455,267.)

Mains-supply unit, with ripple-balancing arrangement, for use with cathode-ray tubes.—*Radio-Akt. D. S. Loewe.*

(Patent No. 454,383.)

Method of deriving a television signal representing the average or overall brightness of the image to be transmitted.—*T. M. C. Lance and Baird Television, Ltd.*

(Patent No. 454,588)

Method of subdivided scanning, designed to produce signals having a wave-form which is both rectangular and saw-toothed.—*J. L. Baird and Baird Television, Ltd.*

(Patent No. 454,589.)

Scanning system in which an electron stream is used to "open" in succession a series of bi-refringent light-cells.—*J. L. Baird and Baird Television, Ltd.*

(Patent No. 454,937.)

Method of preparing light-sensitive "mosaic cell" screens, as used in a cathode-ray tube television transmitter.—*C. J. Whilems.*

(Patent No. 454,956.)

Shaping circuit used for correcting the "bottom-bend" effect in television transmitters.—*Marconi's Wireless Telegraph Co., Ltd., and W. S. L. Tringham.*

Television's Guaranteed Receiver for use in America

A NUMBER of inquiries have been received asking if it is possible to adapt the Guaranteed Receiver so that it is suitable for use in America with the different standards employed there.

Actually there should be no difficulty in adapting this receiver for U.S.A. standards, and the following is an outline of the necessary modifications. The first point is the excitation and control of the tube, and this data will be provided by the manufacturers of the tube.

American valves should be checked and the nearest types employed. The following details will be of assistance in this respect.

X41 Triode pentode. H.F. pentode

and separate triode can be used. MSP4 H.F. pentode, anode top cap. TSP4 H.F. pentode high-slope grid top cap.

D42 low capacity diode (dispense with capacity across load resistance). Rectifier normal "80" tube.

AC2/Pen output pentode (3 watts undistorted).

Mains transformers should be ordered to suit 110-volt mains and U.S.A. tube heaters.

The polarity of the pictures radiated in England is positive, therefore earth coil end of load resistance and connect diode cathode to grid of MSP4 output tube. This takes care of U.S.A. negative picture radiation and produces a positive picture on the C.R. tube screen.

Adopt the time base described in our January issue. Omit resistances R2 and R5 together with shorting

(Patent No. 455,375.)

Method of synchronising the frame and line scanning frequencies in a television receiver.—*E. C. Cork, M. Bowman-Manifold, and C. L. Faudel.*

(Patent No. 455,497.)

Multigrid generator of saw-toothed and flat-topped oscillations.—*E. L. C. White.*

(Patent No. 455,736.)

Focusing system of electrodes for increasing the sensitivity of a cathode-ray tube.—*N. V. Philips Gloeilampenfabrieken.*

(Patent No. 455,785.)

Scanning the background separately from the foreground of a scene to be televised, in order to make more effective use of the available range of signal frequencies.—*T. Vrabely.*

(Patent No. 455,797.)

Method of altering the size of the scanning spot, whilst still keeping it in focus, so as to be able to change-over from high to low definition in a cathode-ray receiver.—*The General Electric Co., Ltd., and L. C. Jesty.*

(Patent No. 455,899.)

Preparing light-sensitive electrodes, particularly those of the mosaic-cell type, as used in Iconoscope television transmitters.—*H. Heimann.*

Mr. W. H. Copeman, of 28 Henrys Avenue, Woodford Green, Essex, is desirous of obtaining copies of March, 1935, October, 1935, and January, 1936, issues. Will any reader who can oblige kindly send a postcard to the above address.

switches. The circuit will then be satisfactory for U.S.A. standards. Difficulty may be experienced with the triode amplifier tubes. Consult R.C.A. for equivalents to the British Mazda AC/P type. The R.C.A. gas-discharge relays are satisfactory.

Interlacing takes place automatically. It means that 60 pictures per second are transmitted and the resulting picture with a repetition of 30 per second are superimposed so that the scanning lines of one picture interlace with the scanning lines of the next. No special receiving apparatus or "sweep" circuits are necessary.

Coils to take care of the radio carrier frequency should be employed for the inputs and oscillator section. Exact data cannot be given, but as a guide remove two turns from the tuning circuit and one from the grid of the oscillator.

THE CATHODE-RAY TUBE FOR THE BEGINNER

Twelve months ago we published a series of diagrams explaining the working principle of the cathode-ray tube. Since that time certain modifications have been made in its construction and on account of this fact and for the benefit of new readers we are again publishing a set of diagrams which will provide uninformed readers with the necessary knowledge to understand this essential television component

THE electrode assembly of the cathode-ray tube resembles in many respects that of the ordinary valve: that is, there is a glass pinch which carries the filament, which is the source of electron supply; a

cylindrical electrode called the grid, which has a similar function to the grid of a valve; and an anode to which the electrons are attracted. Actually in most modern tubes there are three anodes, one serving to accelerate and the other two to focus the beam to a fine point on the end of the tube. In order that the electrons can reach the end of the tube, each anode is provided with a hole through which they can pass.

It will be clear, therefore, that the purpose of the electrodes so far described is to provide a beam of electrons and give these sufficient velocity so that they will strike the end of the tube where their presence is made visible by causing the specially coated surface to fluoresce.

For television purposes it is necessary to be able to vary the density of this stream of electrons so that the amount of light caused by their impact on the prepared screen will vary accordingly. This is the function of the grid, or Wehnelt cylinder as it is sometimes called, and it acts in the same way as does the grid of a valve.

Additionally, there are two pairs of plates called deflectors placed beyond the final anode, and if suitable potentials are applied to these it is possible to cause the electron beam to swing about in any direction and at any speed.

The important and elementary points to remember are (1) that electrons are produced by means of a filament which may be either directly or indirectly heated;



Fig. 1.—This is a photograph of the latest Ediswan cathode-ray tube electrode assembly. It is constructed as a complete unit before insertion in the neck of the glass bulb.

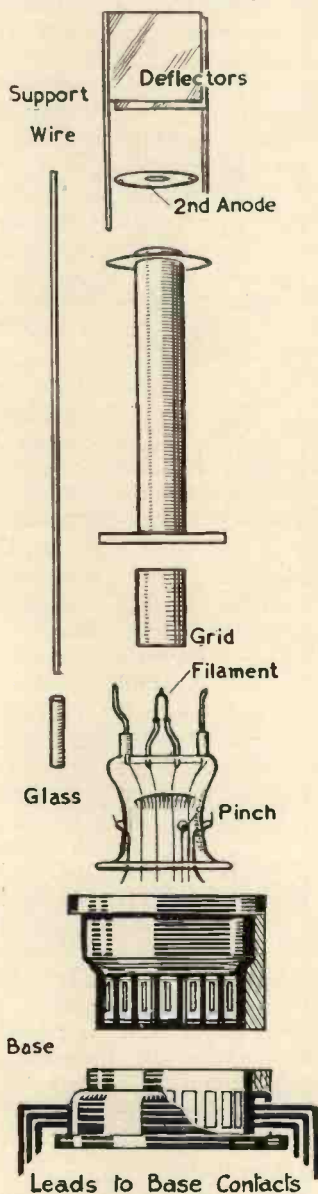

Fig. 2.—This drawing shows the various parts which constitute the electrode assembly. Leads from the several electrodes are brought down to the base which fits into a special holder.

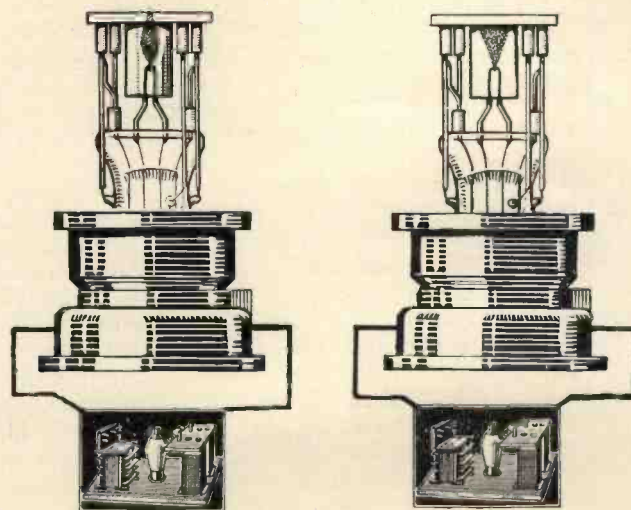

Fig. 3.—The low and high-tension supplies are provided by a power pack. When current is supplied to the filament and a positive potential to the first anode, electrons leave the filament and pass to the anode.

Fig. 4.—A negative bias applied to the grid has the effect of compressing the electron stream so that more electrons pass through the anode. Increased bias will have the effect of reducing or cutting off the beam entirely.

(2) that these electrons can be made to take a beam form; (3) that the density of the beam can be varied within very wide limits; (4) that the electrons composing the beam can be accelerated by using successive anodes to which high electric potentials are applied; (5) that the beam can be swung about at high speeds by applying potentials to suitably disposed deflector plates.

The photograph, Fig. 1, shows the complete electrode assembly of a modern cathode-ray tube, and Fig. 2 is a drawing of the various parts of which it consists. For the sake of clarity only two anodes are shown, but as mentioned before it is now customary to use three for tubes employed for television.

The successive diagrams show the stage-by-stage operation of the tube; it must, however, be appreciated that these operations take place practically instantaneously. Fig. 3 shows the electrons leaving the filament and passing to the first anode, some of which, owing to their high speed, pass through, though the majority pass to the metal of the anode and form an anode current as in the ordinary valve. If, however, a negative bias is applied to the cylindrical grid or control electrode, this will have the effect of compressing the stream of electrons and therefore more will pass through the hole in the anode and very few remain on the metal (Fig. 4). If the grid bias is increased considerably, the stream

will be cut off altogether and it is this property of the grid which is used to vary the intensity of the electron stream and so produce varying light on the screen.

After the electrons have passed through the hole in the first anode there is a tendency for the beam to diverge (Fig. 5) instead of remaining in a compact jet and it is necessary, therefore, to bring them together

(Continued in 3rd col. of page 96)

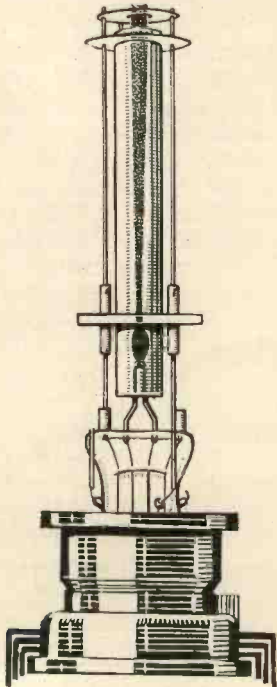

Fig. 5.—This drawing shows how the electrons having passed through the first anode tend to diverge and how the second anode has the effect of bringing them again into a compact jet.

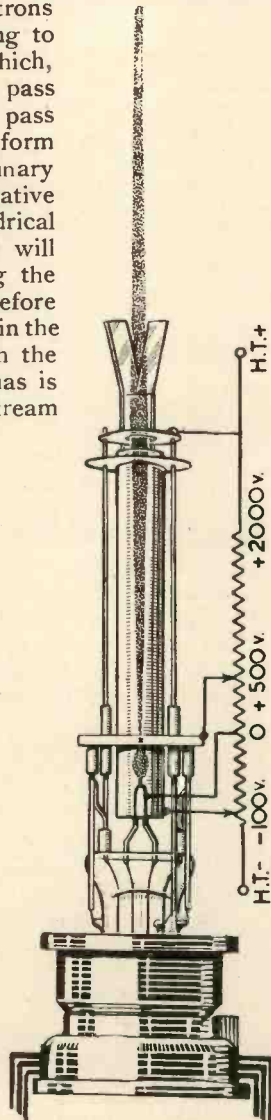

Fig. 6.—A chain of resistances are connected across the high-tension supply and tappings are taken to the various electrodes to provide the suitable potentials. These values vary according to the type of tube.

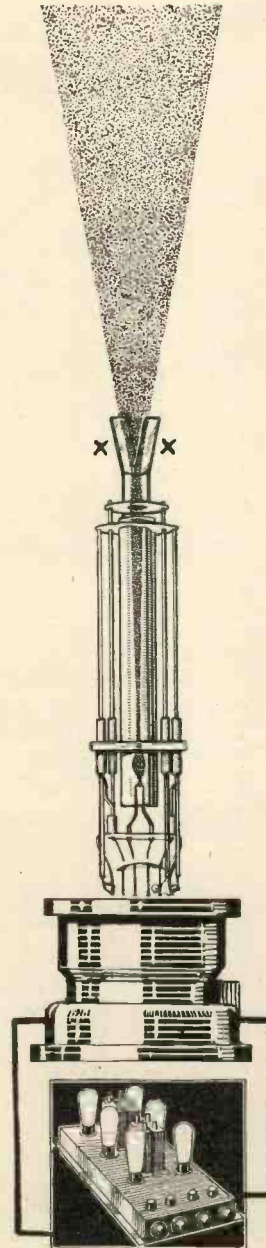

Fig. 7.—Here the beam is being acted upon by one pair of deflector plates X because of alternating potentials applied to the plates. The result is that the beam is caused to swing rapidly backwards and forwards in one plane.

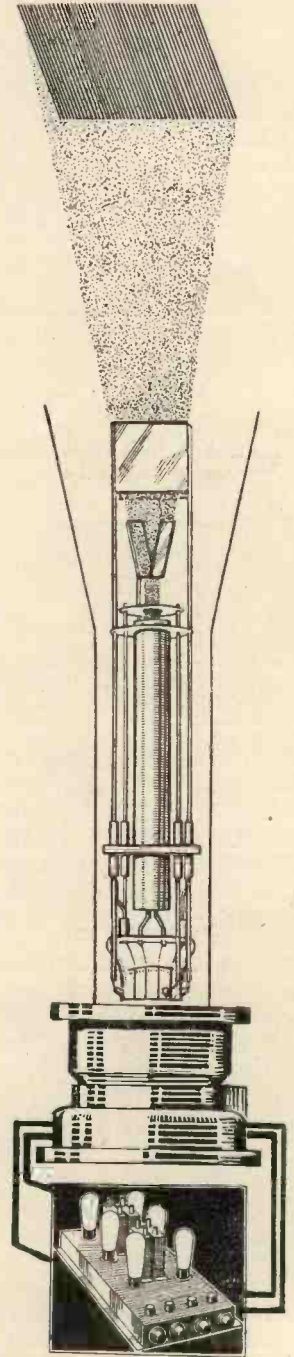

Fig. 8.—This drawing shows the beam being acted upon by both pairs of plates in such sequence that the screen is covered at regularly recurring intervals. The compound on the end of the tube fluoresces as the electron spot strikes it; owing to persistence of vision the effect is an evenly illuminated screen.

THE MAGNETIC FOCUSING OF CATHODE-RAY TUBES

By H. Wood, B.A., (Oxon.), Ferranti Television Research Laboratories.

Very little information has up to the present been published on the magnetic focusing of cathode-ray tubes, and this article, which is by an authority on the subject is therefore of considerable importance.

IN the three-electrode cathode-ray tube, the electron emission from the cathode is accelerated by a gun or anode at a potential of several thousands of volts and controlled by the Wehnelt cylinder at a small negative potential. The beam of electrons emerging from the final aperture of the anode is in the form of a narrow angled cone with its vertex within the anode. The

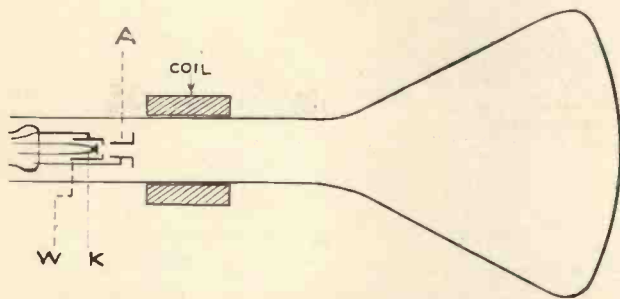

Fig. 1.—Diagram showing arrangements for magnetic focusing, A Anode. W Wehnelt Cylinder. K Cathode.

axis of the cone coincides with the axis of the cylindrical neck of the tube. The object of magnetic focusing is to collect this divergent beam magnetically in order that it may show as a very small intense light spot at the centre of the fluorescent screen. The spot can then be made to scan the screen by magnetic deflection.

This concentration of electrons is effected by sur-

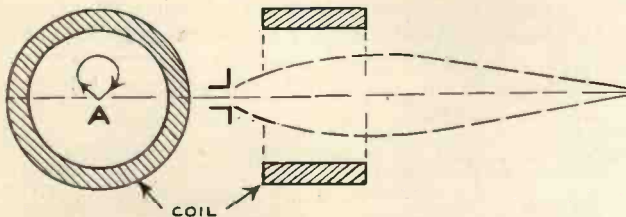

Fig. 3.—Spiral field along axis of coil.

rounding the neck of the tube in front of the anode system with a solenoidal coil (usually of about 200-300 ampere-turns) of suitable design (see Fig. 1).

The beam diverging from the anode is rotated by the action of the field of this coil and at the same time is made to converge. Adjustment of the coil current is made until the narrowest part of the beam, i.e., the part of greatest concentration is just upon the fluorescent screen.

A consideration of the field of the solenoidal coil (Fig. 2) shows us how this focusing is effected.

In the region within the coil the field is almost uniform and parallel to the axis. Outside the coil, the axial field gets weaker, but there is a radial component due to the curving of the lines of force away from the axis.

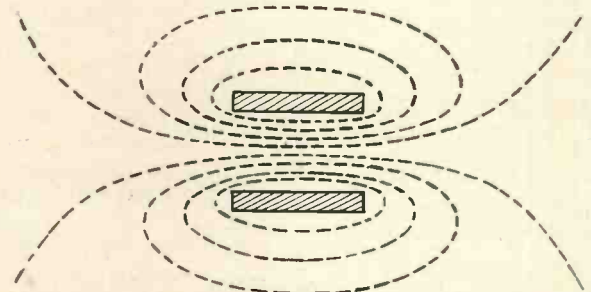

Fig. 2.—Magnetic field of solenoidal coil.

Let us now see what happens to an electron which is diverging from the anode A at a small angle to the axis. Due to its axial velocity in the radial field outside the coil, there is a magnetic force acting upon it, which causes it to move in a spiral.

Within the coil it still spirals because here it has a radial velocity in the uniform axial field. A complete mathematical investigation shows that when the electron has emerged from the field of the coil it is travelling

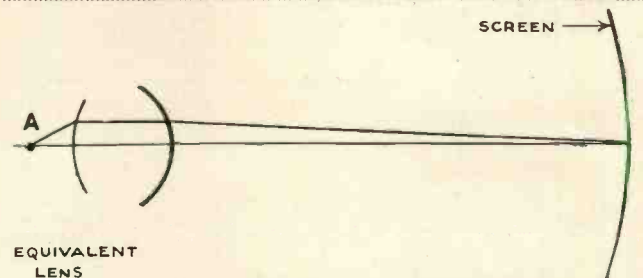

Fig. 4.—Simplified optical equivalent.

towards the axis and will meet it at the image position. Fig. 3 shows the complete spiral as seen along the axis of the coil.

It can also be shown that all electrons from the anode within a small angled cone meet the axis at the same point after they have passed through the field of the coil. The whole twist of the spiral executed by the electron in the field of the coil is less than one complete turn. If the field is considerably increased, the

ADVANTAGES OF MAGNETIC FOCUSING

electrons can again be made to focus at the same point. In this case, the spiral has one extra complete turn.

It should be noted that the scales in Figs. 2 and 3 are exaggerated in order to show the electron paths more clearly. The average practical values are:

- Anode to coil, 3 cms.
- Width of electron beam in coil, $\frac{1}{2}$ cm.
- Length of coil, 8 cms.
- Coil to screen, 40 cms.

In this working condition, the anode, though outside

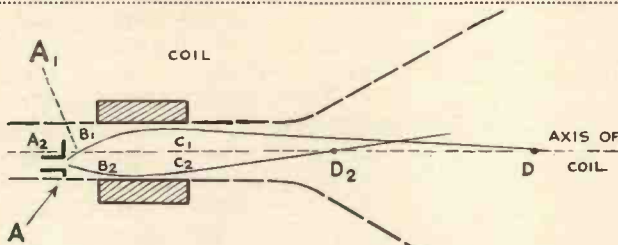

Fig. 5.—An exaggerated case of electronic astigmatism.

the focusing coil, is within its field. This is a lens system which gives extremely good electron concentration as a small spot on the screen. Its optical equivalent is a double convex lens with the surface nearer to the anode almost plane (see Fig. 4).

There are two major defects which may occur, both of which can be avoided by careful design and adjustment. The first is pure astigmatism and manifests itself in the same way that optical astigmatism does with glass lenses. With the magnetically focused C.R.

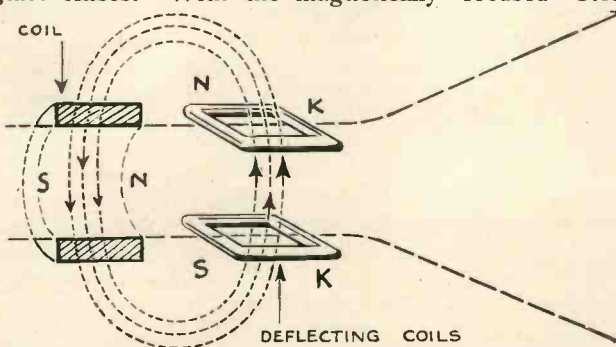

Fig. 6.—Arrangement of coils for horizontal deflection.

tube this defect can occur if the anode aperture is situated off the axis of the focusing coil. An exaggerated case is shown in Fig. 5.

The electron following the path AA_1, B_1, C_1, D_1 focuses as though it had come from an anode at A_1 on the coil axis and the one following path A, B_2, C_2, D_2 focuses as though it had come from an anode A_2 . The image on the screen changes shape as the focusing current is altered and there are two slightly different values of current giving maximum electron concentration. The appearance on the screen in each case is of a thin short line instead of a circular spot, the two lines being approximately perpendicular.

This astigmatism may result from either or both of two defects:

- (1) The anode is not situated centrally in the neck of the tube.

- (2) The axis of the coil does not coincide with that of the neck of the tube.

Fortunately (1) can be corrected by having a slight angular adjustment on the coil. It is extremely important that this defect be absent in tubes used for television receivers, as it causes loss of picture detail.

There is another type of astigmatism which occurs if a badly designed magnetic deflection system is used.

In Fig. 6 the coils KK are used for horizontal deflection and their return field is vertical in the region of the focusing coil. This causes a modification of the field of the focusing coil, making it no longer symmetrical about its geometrical axis. This effect is clearly at a maximum when the deflection is greatest, i.e., the spot is astigmatic at the ends of the scanning

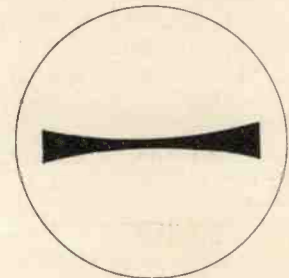

Fig. 7.—Effect of using a coil of which the field is not symmetrical about its geometrical axis.

line though anastigmatic at the centre. The appearance of a scanning line under these circumstances is shown in Fig. 7. This defect is absent if the deflector coils are suitably designed and positioned in order to have only a very weak field in the region of the focusing coil.

As an example of a magnetically focused tube there is the Ferranti which has been specially designed for magnetic focusing and scanning. It has a long cylindrical neck which can accommodate a focusing coil and deflection coils. This neck is made with the smallest possible diameter, consistent with tube strength, in order that the smallest focusing and deflection currents may be used. The electrode system comprises indirectly-heated cathode, Wehnelt cylinder and single anode. The anode has effectively three apertures and is specially designed to give a wide-angle beam suitable for magnetic focusing.

Advantages of Magnetic Focusing

- (1) The electrode system of the tube is very simple, thus making the tube less expensive.
- (2) The focusing coil is a simple solenoidal coil and can be made adjustable to prevent astigmatism—a very important factor in television tubes. In an electrostatically focused tube astigmatism, if it occurs, is a permanent fault as the focusing electrodes cannot be adjusted after assembly in the tube.
- (3) If magnetic focusing is used with magnetic scanning a considerable economy results as the scanning oscillators are much simpler and cheaper than those used for electrostatic deflection.
- (4) Altering the brightness of the spot does not cause such serious defocusing as in most types of electrostatic tubes.

Our Readers' Views

Correspondence is invited. The Editor does not necessarily agree with views expressed by readers which are published on this page.

90-mile Reception of A.P.

SIR,

I hope the following will be of interest to you. Since the beginning of October to the week ending November 14, I have received the Alexandra Palace programme daily. I have kept a log of signal variations during the time of listening, and on comparing them, the reception by night is of a higher level than in daylight. R7 was the average by daylight and R9 by night, with very slight fading. The receiver in use is a straight three-valve covering 2-10 metres to which is capacity coupled an indoor aerial fixed round three sides of the window frame. I have had reports verified from the B.B.C. This report is in regard to sound only, the vision C.W. being of about the same strength.

J. TAYLOR (Isle of Wight).

Extended Views

SIR,

I was interested to read under "Scannings and Reflections" in this month's magazine, of the chance use of a reflector to obtain extended scenes during an Alexandra Palace transmission.

If you will remember, this was suggested by Sir Ambrose Fleming in a lecture on television at the Imperial College of Science in January, 1930, and reported in that month's TELEVISION Magazine.

Personally, I have had no opportunity of experimenting in this line, but would like to hear other reader's opinions on this matter.

At present I am working on a radial scanning system using rotating prisms which could, I think, be used with advantage with the above.

B. WHATMORE (London, N.).

5-metre Activity

SIR,

I have noticed that amateur stations are again active on 5 metres, but it seems that little new is being discovered. The net results of most of the experiments seems to be interference to local broadcast listeners.

This is quite understandable in view of the obsolete methods employed in transmitting, such as shock excited circuits and hit-and-miss aerial arrangements. In many cases, principles adopted 12 years ago have revived, so I fail to see how any useful progress can be expected.

Transmissions from such apparatus are quickly lost and in any case can only be picked up with super-regenerative receivers, which are in themselves extremely noisy and are, therefore, quite useless for the reception of weak signals.

It is possible to construct a super-het receiver to cover the 5-metre band, so it seems a waste of time still to use pre-historic shock-excited transmitters. Why do not the Post Office insist on some orthodox frequency control such as crystal, electron coupling or master oscillator which would give stability, greater range of reception and, at the same time, eliminate any chances of interference to broadcast listeners.

How can anything but local reception be expected by simply coupling the transmitter to any old aerial and hoping for the best, which usually results in a maximum range of 2-3 miles.

In my opinion the only satisfactory aerial system for the ultra-high frequencies is one carefully thought out and mathematically correct. I suggest an aerial with four $\frac{1}{4}$ -waves in phase with reflectors. The whole system should be supported as high as possible above ground level on a wooden frame with means to alter its directional properties. This aerial must be fed by properly designed matched impedance feeders.

If the serious experimenter would work on these lines I feel sure that there would be considerable progress in 5-metre long distance reception.

J. E. NICKLESS, A.M.I.E.E., G2KT.

Trend of Invention

SIR,

During the year 1936, 35,900 Patents were applied for.

As regards the trend of invention, the Comptroller's report for 1935 refers to considerable activity in connection with the dyeing of leather, artificial resins, chemicals for treating textiles, photographic chemicals and drugs, and the development of synthetic methods of preparing sex-hormones. There was activity also in connection with devices for the detection of, and protection against, noxious and explosive gases. Development also took place in technical applications of modern discoveries in

physics, including transmutation of elements by bombardment with high-speed electric particles and short-wave radiation, the mercury discharge lamp, in which a relatively minute lamp gives an intrinsic brightness hitherto unknown in practice, and powders and other substances, stimulated to luminosity by radiation from an electric discharge. Trolley-bus control and telephone and railway-signalling relays also received attention. Television accounts for a large increase in applications, particularly as regards the development of cathode-ray receivers, the reduction of flicker by interlaced scanning, the transmission of cinema films, and short-wave wireless transmitting and receiving apparatus for use in television. In aeronautics marked development took place in gyroplanes.

In road vehicles the imposition of the speed limit resulted in a large number of applications relating to devices for limiting the speed or for providing indications and warnings for drivers and pedestrians.

GEE AND CO.,

Patent Agents (London, W.C.2.).

"The Cathode-ray Tube for the Beginner"

(Continued from page 93)

again, and this is accomplished by applying a high potential to the second anode, the compression actually being brought about by the electric field which is produced between the first and second anodes.

Fig. 6 shows the application of the potentials necessary for focusing the beam, and it will be seen that these are obtained by means of a chain of resistances across the high-tension supply.

The beam is caused to swing from side to side by applying a rapidly changing potential to one pair of deflector plates, as shown in Fig. 7. The scanning circuit, or time base as it is termed, to provide this changing potential is designed to produce the deflection regularly and uniformly in one direction whilst a second scanning circuit moves the beam in a direction at right angles. In Fig. 8 the beam is shown being acted upon by both pairs of deflector plates.

In operation for television purposes the signal from the receiver is applied to the grid of the tube whilst the beam is tracing the screen, and this modulates the intensity of the beam which is revealed as a varying intensity of light on the screen.

STUDIO & SCREEN

A MONTHLY CAUSERIE on Television Personalities and Topics

by K. P. HUNT
Editor of "Radio Pictorial"

INTRIGUING rumours of romance in the B.B.C.'s television studios at Alexandra Palace gained currency during the month. It was whispered that an engagement between Mr. Leslie Mitchell, the television announcer, and Miss Elizabeth Cowell, his colleague and hostess-announcer, might shortly be expected; and as this was the first hint that Cupid was at work in television surroundings, the story was, of course, embroidered rather freely.

I am assured that there is no truth whatever in these rumours. Elizabeth Cowell herself says that the idea is without any foundation.

"Everyone who looks-in to the B.B.C.'s television programmes, of course, sees me and Leslie Mitchell together quite a lot on the screen," she said, "and from this I suppose it is easily imagined we are always together. But as a matter of fact I don't see much of Leslie apart from work at the Palace. Whatever impression has got abroad is due simply to this association on the screen."

"Leslie and I are just good friends," she repeated emphatically.

* * *

I have had little opportunity during the month of enjoying much looking-in, but I saw several programmes a few days ago after a lapse of more than a fortnight. My impression was that the whole routine and presentation of the programmes at Alexandra Palace is, for want of a better word, definitely "slicker" than it was in the beginning of the new service. It is only natural that we should now begin to see the effect of the experience gained by the productions staff who, without shouting it from the housetops, have been learning by their mistakes all the time.

Perhaps the most significant development on the studio side is the rapid growth of multi-camera technique. This was brought out very well in "Anthony and Anna," in which no fewer than four cameras were used on the one set and the fading effects were extraordinarily impressive.

The use of scenery in television production, which I mentioned in these notes last month, is evidently an aspect of the studio work which holds great possibilities, and already we have seen further striking examples of what can be done. One case which comes to mind was Dallas Bower's production of "Burnt Sepia" in which there was a back-

ground of palm trees, and so on, forming a sort of scenic frame in front of which characters appeared. This scenery was taken care of by one camera, while a second camera was used for shooting the characters. The scenery looked most magnificent, but few lookers could have guessed that actually it was cleverly cut out in cardboard and probably cost no more than a few pence!

The man behind this development of scenery in television productions is Peter Bax, one of the stage-managers at the Palace, who, it will be remembered, made a preliminary but extremely successful attempt in this direction with the Canterbury Cathedral scenery. Following hard on the heels of this innovation he was also responsible for that particularly effective scene in the Armistice Day programme in which a great degree of realism was introduced in this man-



Judy Shirley.

ner, even to the smoke of the guns floating over a Flanders cemetery. We can look forward to many more interesting developments of this scenery idea in television production.

* * *

Mary Allan, television make-up expert, is still one of the busiest people at the Palace, and after hearing a story I was told last week I am quite ready to believe she is equal to anything. Mary was asked to make up a motorcar for television!

It was Campbell's "Bluebird," and although to ordinary sight this 30-foot long blue-coloured mechanical wonder makes a beautiful picture, when it was first tried out via television it was found that certain shiny metal parts on the car reflected the studio light and caused halation, in the same way that, when taking night pictures with a camera, a blur of light may occur if a source of light is included in the view. So to get over these difficulties, the make-up expert, Mary Allan, was called upon to demonstrate her art upon the car. She arrived complete with powder and paint, and, I understand, powdered all the light parts of the car.

* * *

Gerald Cock is already giving a good deal of thought to the possibility of televising the Coronation in May. He was one of a company including Sir John Reith and the Archbishop of Canterbury who recently made a tour of Westminster Abbey, and it is known that television plans in connection with the Coronation were the subject of the inspection. As far as I can gather, however, this visit was only with the object of going into the possibilities, and nothing definite has yet been decided as to whether the Coronation will be televised or not.

* * *

Mr. D. H. Munro, Productions Manager at the Palace, still seems to be the hub round which the actual programmes are turning, and it must be said to his credit that he has de-

A TELEVISION DANCE BAND

vised a marvellous system of team work in the studios. The whole thing works like clockwork, and there has been no hitch in the routine since it started, which is the greatest tribute one can pay to an organisation which is always growing and which presents fresh problems every day.

* * *

Cecil Lewis has sojourned to Italy prior to his Hollywood trip. I hear there was a touching little farewell party in his honour. Cocktails, and all that, and Cecil shook hands with everybody—about 60 people in all.

* * *

A programme which I was too late to say much about in these notes last month, because of the early Press day, was Harry Pringle's Christmas Eve Old Veterans' programme which was one of the most successful yet produced. It brought the greatest

ably fine effects, some of which were upward shots.

Another performer whose television appearance during the month was notable was Yvonne Arnaud who, by the way, is booked again for an appearance early in February. Her success as a television artist can be attributed not only to her undoubted cleverness and somewhat whimsical character, but to the wealth of stage and screen experience which stands her in such great stead, and which in fact was quite noticeable in her television performance at the Palace. Here is a little story I was told which illustrates what a tremendous asset this background of stage and film experience can be.

Yvonne ended her act about three or four minutes earlier than was expected, and on coming to the end she thought it was quite over. Resource-

piece combination billed as "Eric Wild and his Tea-Timers." The other five players also are drawn from the television orchestra, the combination of instruments being rather unusual, and consisting of xylophone, bass, guitar, cornet, trombone and clarinet. The unusual feature is that the combination contains no drums nor piano.

Eric himself is a Canadian who came over here last May with Billy Bissett. He is a Bachelor of Music of the University of Michigan, and does all his own orchestrations.

The Tea-Timers have appeared three times for viewers, with Judy Shirley and Anne Lenner as vocalists. These two girls are sisters. Both have attained prominence in sound broadcasting as crooners with dance bands, Judy mostly with Maurice Winnick and his band, while her sister is at present a main attraction in most of Carroll Gibbons' broadcasts.

* * *

Here is a spot of interesting news. A little bird has whispered in my ear that we shall soon see a regular television dance band, and that this is now being organised as a 10-piece outfit, with Eric Wild as leader. I also hear, by the way, that the television Tea-Timers will shortly be heard in one of Brian Michie's programmes.

As a popular television feature, "Picture Page" still seems to be in the ascendant. With the February 3 performance it will reach its 25th edition.

Cecil Madden, the producer, has been amusing himself by working out some statistics as to bulk artistic endeavour and dressing room turnover in the first 20 editions of "Picture Page" already televised.

He tells me there have been 162 programme items in the course of which Leslie Mitchell has interviewed 168 men, 90 women, 12 boys, 12 choir-boys, one elephant boy, six girls, one fairy, three accompanists, one Siamese cat, one Alsatian dog, one string of onions, one monkey, one Bond Street model, one tray of muffins, one box of herrings, one Guy Fawkes, and a silkworm!

* * *

On February 2, the League of Health and Beauty are to give another show which, if it is anything like the last one, will make good looking.



Eric Wild and his Tea Timers—the first television dance band—all the members of which are also members of the Television Orchestra.

number of telephone congratulations so far received at the Palace for any one programme. Harry deserves special commendation for his clever experiment in which he showed the audience clapping. This audience, by the way, was got together at the last moment, and included all sorts of people, who donned paper hats and were soon lost in the party spirit. "We quite forgot we were at a television show," one of them told me afterwards.

* * *

Sidonie Goossens, the famous harpist, made an exceedingly pretty picture on the television screen. To get the right effect they put her on a platform four feet high and, by using two cameras, got some remark-

ful Elizabeth Cowell stepped forward and in a wonderfully natural manner started talking to Yvonne—asking her if she would give another song, and discussing with her what it should be.

Now a newcomer to the show business, in these circumstances, would probably have been flabbergasted, and no doubt would have betrayed the fact to lookers. But not so Yvonne. In a flash she understood the purpose of the conversation, and acted up to it with superb aplomb.

Among other acts that deserve mention is Eric Wild and his Tea-Timers. Eric is a cornet player in the television orchestra, under Hyam ("Bumps") Greenbaum, but has scored a notable success with his 6-

A "UNIVERSAL" CATHODE-RAY TUBE EQUIPMENT

II.—FITTING THE UPPER RACK

This is the second article describing the construction of a complete cathode-ray equipment.

vertical plate (Y1) and the other the free horizontal plate (X1). The remaining plate of each pair is connected to final anode through a high-resistance potentiometer (R.6 and R.7) which is connected across the main H.T. supply and which serves to centralise the trace.

When operating, the free plates are always connected to final anode through two 5-meg. leaks (R.1 and R.8).

Two other terminals are connected to the grids of the respective thyratrons and are for synchronising the wave to the time base. One of these terminals is seen on the extreme right of the diagram marked "S."

Amplifiers

The single amplifying stage is operated from the same H.T. supply as the time base, but is decoupled by a 50,000-ohm resistance (R.11) and a 4-mfd. condenser (C.5). The valve used is a Mazda AC/P having a magnification of 10, but if further gain is required an AC/HL can be substituted without altering the bias resistance. The input to the valve is controlled by the grid potentiometer R.12, which is 1.0 megohm. This

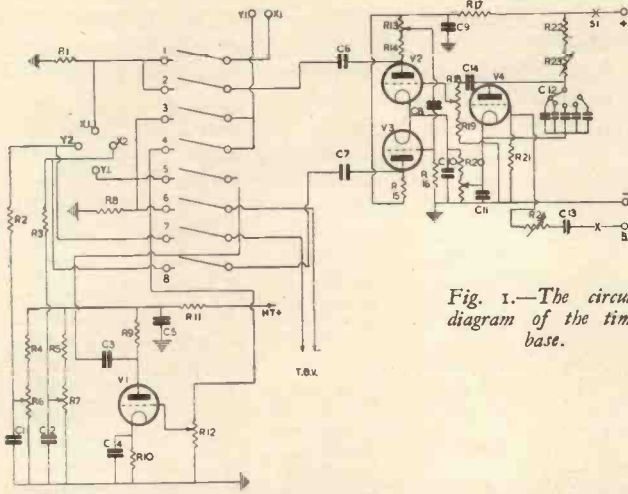

Fig. 1.—The circuit diagram of the time base.

THE top rack contains a double time-base circuit, adapting the tube to various investigations. The amplifying stage and changeover switch for majority of the work on the rack can be carried out before it is assembled to the front panel, and this makes for ease in wiring. The only connections which have to be added on the finished assembly are the leads to the various resistances on the front panel.

Circuit Diagram

The circuit diagram is shown in Fig. 1 and comprises two identical time bases adjustable in speed between 25 and 10,000 cycles per second, and amplifier with a stage gain of approximately 10. The latter is particularly useful when a low input is applied to the vertical plates, and has a constant amplification over a range of approximately 50-5,000 cycles.

Only one time base is shown in the diagram as the other is identical except for some component values. To distinguish between the two circuits where necessary the resistances, etc., are identified by the letters "H" for horizontal and "V" for vertical (see Figs. 3 and 4). The circuit is a conventional thyatron operated with paraphase connection between the amplifying valves, the variation in speed being made by adjustable condensers in the charging circuit (C.12, etc.). Fine adjustment of speed is by the variable resistance R.23. The thyatron is operated at semi-fixed bias, the cathode being connected to a tap in the main bias resistance R.20. This tapped resistance is mounted on the chassis and is adjusted from the back of the unit. The principal control of amplitude is by the resistance R.18 in the grid circuit of the paraphase valves and this has a series resistance R.19 with it in order to keep the load on the condenser circuit as high as possible. The anode resistance of the amplifier is tapped (R.13) and the grid of the second valve is fed from this tapping via C.8 and R.16, the grid leak. The output to the deflector plates is taken from C.6 and C.7. Similar connections to the vertical time base are shown marked "T.B.V." at the right-hand edge of the diagram and these will go to similar condensers (marked C.6V and C.7V in Fig. 3).

Input Terminals

For wave-form observations and similar work the input is applied to two terminals, one feeding the "free"

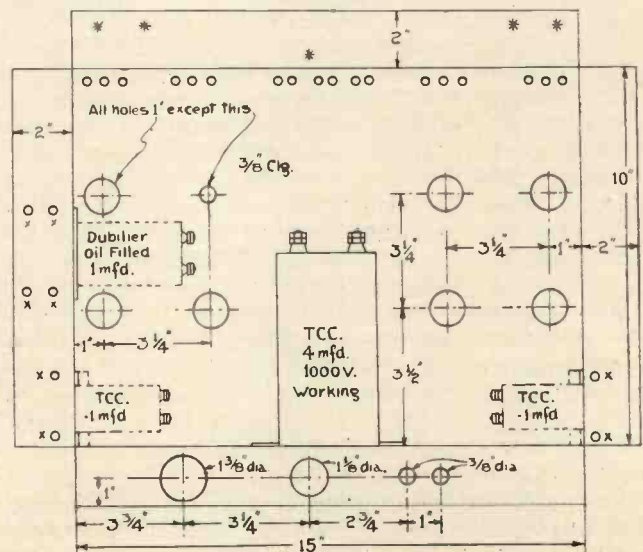

Fig. 2.—Drilling diagram of chassis.

value should be remembered when the tube is connected to high impedance circuits as it may form an appreciable load on the circuit.

A higher value of grid resistance is not desirable as there is a tendency to hum pick-up in the valve stage and alteration of bias with the small grid current flowing.

Changeover

Switch

This is a most useful adjunct to the unit as it enables a rapid changing of connections without the use of long leads. It is a 4-position 8-pole switch operated by a central insulated rod carrying a number of cams. These make and break the appropriate contacts in each position. The four positions of the switch perform the following connections:

base can be used for checking transient waves as they can be spread out over the screen surface as many times as required. Such a wave can be applied to the Y₁ input terminal, which is re-connected in the 4th position of the switch.

Suitable switches can be obtained from Messrs. Wright & Weaire or from Messrs. Burne-Jones, and the following specification will be required:—

Contacts.	POSITION.			
	1.	2.	3.	4.
1.	Closed.	—	—	—
2.	—	Closed.	Closed.	Closed.
3.	Closed.	Closed.	—	Closed.
4.	—	—	Closed.	—
5.	—	—	Closed.	—
6.	—	—	—	Closed.
7.	—	—	—	Closed.
8.	—	Closed.	Closed.	Closed.

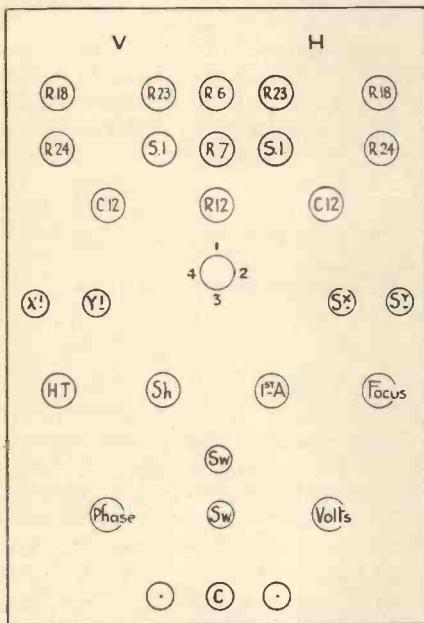

Fig. 3. Diagram of panel arrangement

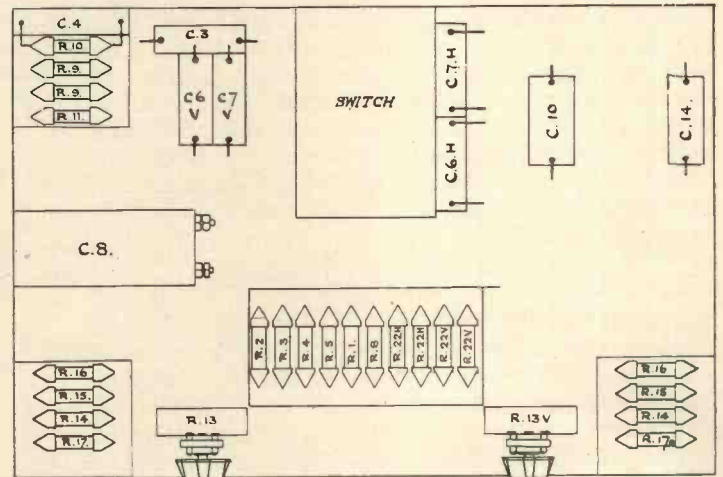

Fig. 4. Positions of main components.

Position 1. X₁ and Y₁ input terminals connected to X₁ and Y₁ plates. Time bases disconnected.

Position 2. Y₁ remains connected to its plate, but X₁ is connected to the horizontal time base through C.6 and X₂ through C.7.

Position 3. The Y₁ input terminal is connected to the grid of the amplifier, the output being connected to Y₁ plate. X₁ remains connected to the time base.

Position 4. Y₁ plate is connected to vertical time base through C.6V and C₂ through C.7V. X₁ and X₂ remaining connected as before, the tube is now connected for television scanning.

For special work where it is necessary to make contact with both plates the switch is operated in Position 1. The more common position is 2, where the time base is running on the horizontal plates and the input is direct to the Y₁ plate. The time base is cut off by the switch S.1 when not required.

If the input waveform is too small to give a good curve on the screen, the switch is turned to 3 and a tenfold magnification is obtained. As both time bases are adjustable for speed, the 4th position enables the linearity of either to be checked by drawing a single sawtooth on the screen. In addition the double time

Marking

Chassis

The drilling of the chassis is given in Fig. 2. This, however, does not show the fixing holes for the resistance racks and small components as these are best marked when the component is in position. Attention is drawn to this in the case of the condensers which are mounted flat under the side flaps, the holes being marked with an x in the drawing.

After the valveholder clearance holes have been cut, the holes for the output and input sockets at the back of the rack can be cut. Be sure that the chassis is the right way round when drilling—the front flap has no fixing holes at the edge.

The valveholders V₁, etc., can be fixed on the chassis with 6 B.A. screws or, better, small eyelets. These can be obtained from any leather goods supplier in small quantities and are considerably cheaper than screws when a quantity is used. A riveting punch can also be obtained from the same dealer.

The steatite valveholder at the centre of the back flap should be fixed with screws to avoid breakage if rivets are hit hard on it. The mains plug (back right) should be fitted inside the flap as in the case of the lower flap, leaving the pins projecting through the metal. It is a good plan to order this plug of a different colour.

(To be concluded next month)

OPERATING NOTES ON THE GUARANTEED RECEIVER TIME BASES

Our Guaranteed Television Receiver for Home Construction was described in detail in the October, November, December, (1936) and January (1937) issues. Two types of time base were described and the following article gives instructions for the adjustment and operation of these.

ADJUSTMENT OF TIME BASE NUMBER 1

IT is assumed that the time base unit and power pack have been wired up and tested for correct connections as already explained.

The preliminary adjustments should be made without the vision radio receiver switched on.

First of all the scanning field has to be set to the correct size and positioned correctly in the centre of the tube. Ignore for the time being the number of lines and frames per second, but set the picture width to 8 ins. by an adjustment to R19 and the picture height to approximately 6 ins. by an adjustment to R3. In cases where a variable resistance is used (R10 and 11 and R24 and 25) for the phase reversal they should be set at minimum and the preliminary picture size on the screen set to just over half the normal area. They should then be set so that the scanning area opens up to the correct size. The final setting may be made after a picture has been received.

Positioning the Picture

Having set the size of the picture, position it squarely in the centre of the screen by an adjustment to the shift potentiometers R15 and R16. Now with the radio receiver switched on and the grid bias on the cathode-ray tube adjusted so that the scanning field is just visible it is in most cases possible to see mains hum in the form of wide dark bands horizontally. In most cases this disappears when the cathode-ray tube bias is correctly set and the vision receiver is switched on.

These dark bands will serve as a guide in setting R2. One dark band means 50 frames and two dark bands 25 frames per second. An adjustment to R2 should be followed by an adjustment to R3 to maintain the picture height. As soon as the required number of dark bands have been obtained attention should be given to the line setting. This should be carried out during the reception of a transmission. The carrier is on and the synchronising signal is radiated at least twenty minutes before the programme. Choose this time to set the line time base.

Disconnect the synchronising leads while this is carried out but leave the modulation applied to the cathode-ray

must be applied to take control of the respective bases.

A start should be made with line connection only made, allowing the frame section to drift slowly on the screen. If the strength of signal is very great the scanning field will be materially reduced, so make an adjustment to the line synchronising potentiometer and see if the picture width can be brought back to normal. This should be possible on this control alone. In most cases the time base will pull into synchronism, but a slight adjustment should be made to R18 to see if any improvement can be obtained.

Now connect the frame synchronising lead and repeat the process to bring this base into step. In most cases a readjustment of the line control will be necessary.

If the picture carries through and starts to control the time base, it means the strength is too great; therefore, re-adjust the synchronising potentiometer until this position is corrected. In cases where a low setting does not produce the desired result reduce in value the series coupling condenser to a lower value and continue to do so as long as it is possible to hold the picture. If the picture still gets through add a 2 meg. fixed resistance between the vision output of the set and input of the time base and readjust the controls. This 2 meg. resistance is also necessary if the picture modulation is very much reduced when the synchronising leads are connected. A test should be made by disconnecting the leads and manually holding the picture while the tuning control and gain control are adjusted for the best quality.

These operations are not very difficult to perform, but it is, of course, necessary to observe the effect of each adjustment and so become familiar with the controls.

Bear in mind, finally, that when good adjustments have been made a slight touch to the gain control on the receiver can be used to bring the picture into synchronism on individual transmissions.

Dear Sirs,

I feel that I must congratulate you on the simplicity and efficiency of the alternative time-base circuit published in the January number of "Television."

Some months ago I wire up a very complicated and expensive circuit, which, when completed proved a hopeless failure.

I made up your design in about a quarter the time, and have at least two-thirds of the previous components to spare. Moreover, your circuit worked from the word "go," and worked well.

The "Yaster" is absolutely dependable—controllable in every way—and a dream of geometrical rectitude.

W.H.D. (North Harrow).

tube so that the result of adjustments can be seen.

Proceed as for the frame by making first an adjustment to R18 followed by a corrective setting for picture width to R19. Bear in mind that the large condensers C9 and C2, due to their large capacity, will create a short time lag, so make the adjustments to R19 and R3 *slowly*. Soon a position will be arrived at where the vertical synchronising band will ap-

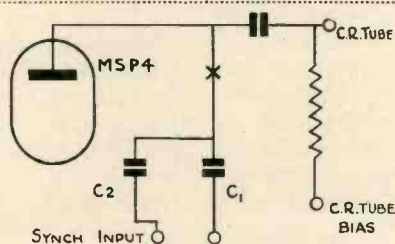

The time base synchronising feed arrangements.

pear sloped across the scanning field first one way and then the other.

Be content for the time with this preliminary setting and try an adjustment to the frame controls and get a better adjustment so that the horizontal framing impulses drift up or down the picture area slowly.

Proceed to operate the controls mentioned so that the effect of each can be appreciated.

Synchronising

Next the synchronising impulse

OPERATING THE ALTERNATIVE TIME BASE

After a final check of the wiring the C.R. tube can be inserted, making sure that everything is switched off first. On switching on a scanning field should appear on the end of the tube. There need be no concern about the size at this stage. First set the phase potentiometers at minimum. Each should at the same time be varied to verify that they are working. If everything is in order they should be set at minimum.

The next step is to set the relay bias potentiometer on top of the chassis to *just over half the size* of the size the final scanning field is to appear on the end of the tube. This should be carried out on both line and frame sections. Now with an insulated screwdriver (always use an insulated driver) open up the scanning field to the final size desired by turning the phase potentiometers. The next step is to centre the picture; referring to an earlier section of this article where the principle is explained (column 2, page 34). Decide if the picture scan is more than 10 per cent. out of centre. If so the best scheme to adopt is the potentiometer shift method.

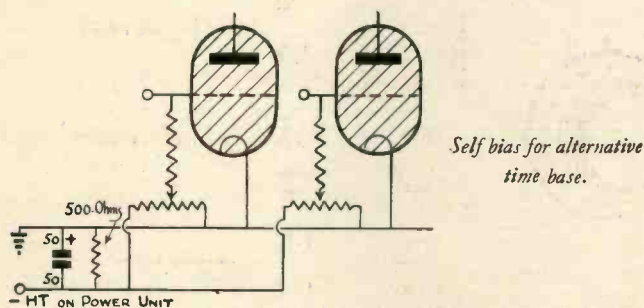

The deflector shift potentiometers are connected across the full H.T. supply with a fixed 2-meg, in series at the positive end. The centre connection is then taken to the end of the deflector leak that gives the required shift of the picture. This point is marked with an X on the circuit diagram. If the first deflector has to be connected to the shift potentiometer (an unusual requirement) an additional leak and isolating condenser is required to isolate the grid of the second valve.

Next, the number of lines and frames per second have to be set. It is only possible to adjust these when actually receiving a picture. The anode resistance chain and charging condenser have been used for both a 10 in. and a 12 in. tube. In both cases the voltage on the third anode of the tube was 4,000.

The anode potentiometers once set should not need to be touched for many months as in operating only the *two bias* controls, controlling the voltage applied to the gas discharge relay grids, needs attention. It will be found that once the synchronising pulse strength has been adjusted it will only be necessary to give a slight touch to these bias potentiometers.

It will also be found that under most conditions no adjustment of any kind will be necessary on the time base from day to day. When changing over from one system to the other a slight adjustment to these bias controls will be all that is necessary to bring in the picture.

Thus it is only necessary to have two controls, When the final assembly is mounted into a cabinet it will be found easy to attach a flexible coupling and length of rod so that the controls may be brought out to the front or desired position on the cabinet.

Synchronisation may be achieved by feeding part of the output signal from the radio receiver to the grids of the gas discharge relays. This is arranged by two variable resistances in series with each condenser. Suitable values are for the line, 100,000 ohms and a .1 condenser, while the frame may be 100,000 and .25 condensers. The circuit shows the exact scheme.

Connection to the grids is easily made by taking a thin rubber covered lead through the eyelet hole hold-in the gas discharge relay valveholder to the chassis.

With a signal being received the variable resistances in the anode circuits of the relays should be adjusted. It is best to start on the frame first. It will be found that by an adjustment of the bias control and the synchronising control the correct picture size can be maintained. It must be remembered that a slight adjustment should also be made to the anode variable resistance.

The same procedure should now be adopted to bring the line into synchronism. Very soon it will be possible to see what happens (it is not so much getting the "feel" of the controls, but "seeing" the effect, and it will be found quite easy to make these initial adjustments.

Earlier on it was pointed out that it was impossible to lose 5 per cent. to 10 per cent. of the line scan due to slow "flyback" and, of course, maladjustment of the line frequency. When the picture is synchronised make a very careful adjustment to the line bias control (it must be done slowly) and it will be seen that the actual synchronising band on the right-hand side of the picture can occupy three positions very close to each other. It will be noticed as a slight jump of the picture. Always try to set the picture on the centre position as it will be repaid by a large increase in picture detail and a corrective to slow "flyback."

While turning the control slowly you will then always know the correct adjustment and derive more pleasure from your experiments.

If the time base is completed during the E.M.I. transmission, the ganged switch should be positioned so that variable section R₂ and R₅ are short circuited before making adjustments. When changing over to the Baird transmission, R₁ and R₄ should not be touched, but all adjustments made to R₂ and R₅ so that when next going over to E.M.I. the setting previously made will not be altered. If it so happens that the first trial is during a Baird transmission it will be necessary to adjust these anode resistances three times before the adjustments are correct. This is due to the fact that R₁ and R₄ are in circuit during the Baird transmission and they will have to be altered when receiving E.M.I. However, these adjustments will not present any difficulty.

A point to bear in mind is that although the resistance values in the anode of the relays have been used on both 10 in. and 12 in. tubes, it may be found that they are either too little or too much when used with individual cathode-ray tubes. However, it is an easy matter to add or subtract a fixed resistance, although care must

(Continued on page 124)

Test Equipment for the Experimenter

A Modulated Oscillator

Amateurs will appreciate this new series of articles describing modern test equipment. The first two units have been designed by the technical staff of the Mullard Wireless Service Co., for general laboratory use.

EVERY experimenter and service man does at some time or another find the need for a reliable modulated oscillator giving a definite but controllable output at various impedances.

An instrument of this kind is comparatively expensive to buy and rather beyond the capabilities of the average amateur to design. Providing the circuit has been carefully thought out and all the initial difficulties eliminated, constructors will have no difficulty in following this design. The oscillator is entirely mains operated, so getting away from the bugbear of batteries and ac-

As we have previously mentioned, there are three wave ranges, but the same switching circuit can be utilised to extend the frequency range very considerably. The circuit switching arrangement is shown in Fig. 1, and if a Yaxley type of multi-contact switch is employed, at least five wave ranges can

- Range 1. $L_1=140$ UH. $C_6=50$ mmfd.
- Range 2. $L_1=900$ UH. $C_6=.0002$ mfd.
- Range 3. $L_1=5,000$ UH. $C_6=.0002$ mfd.

Coil Winding Data

With the paxolin former $1\frac{1}{4}$ ins. in

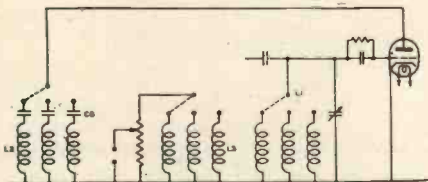

Fig. 1.—This coil switching idea is quite simple and lends itself to expansion. Extra coils can be added without trouble.

cumulators; has three wave ranges, two variable attenuators and provision for external or internal modulation.

Outputs Available

The low impedance output provides approximately 4 volts at 1,000 cycles and the high-impedance output circuit 10 to 15 volts at 10,000 cycles.

Fig. 3.—The general appearance of the modulated oscillator will do credit to the average amateur's workshop.

be covered without difficulty. As it is, the three wave ranges covered by this instrument completely overlap with the coils constructed, as suggested in the table. Actually the coils have the following inductances :

diameter, L_1 is wound in honey-comb fashion to about $\frac{3}{8}$ in. total width. L_2 is wound in three layers and separated from L_1 by approximately $\frac{1}{4}$ in. L_3 is wound on top of L_2 in a similar fashion. The actual windings are as follows :

Range	L1.		L2.		L3.		
	Turns	Wire	Inductance	Turns	Wire	Turns	Wire
1.	67	DSC 30	140 μ H	30	DSC 30	30	DSC 30
2.	150	30	900	80	30	40	30
3.	420	En 36	5,000	200	En 36	100	En 36

The condenser C_6 as shown in Fig. 1, has the approximate capacity of .0005 mfd., .0002 mfd., and .002 mfd., so that actually three condensers will be needed. In the case of the first two capacities it is advisable to make use of a semi-variable pre-set type of condenser so that it can be adjusted to the exact capacity required. The circuit of the complete instrument, shown in Fig. 2, is self-explanatory, but it will be seen that a triode valve of the Mullard 164V type is used as an oscillator

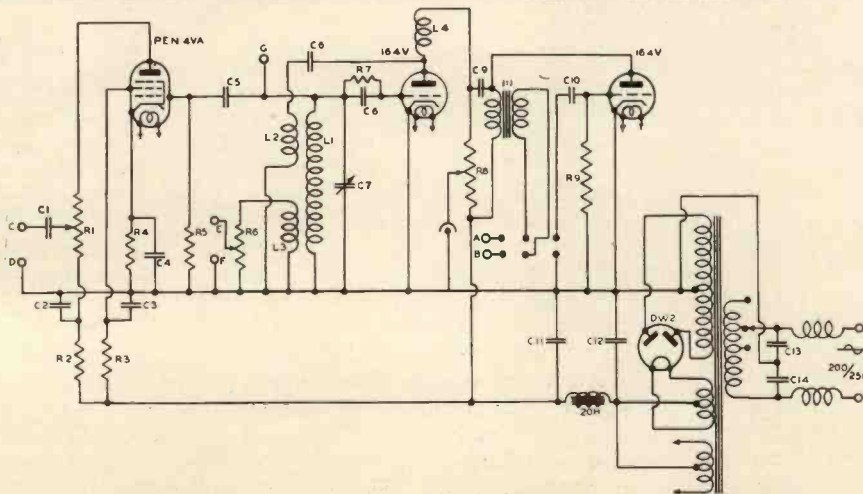

Fig. 2.—Conventional radio practice is observed with this circuit and the layout of components should be on similar lines to a receiving set.

followed by a PEN4VA amplifier. An additional 164V is used for modulation, but provision is made for external modulation in the manner shown.

A Screened Box

It is essential that the instrument be

the oscillator will maintain its calibration over long periods with sufficient accuracy for general test and service work.

A FOUR-RANGE VALVE VOLT METER

From time to time we have stressed

be made very reliable, accurate as regards calibration, and absolutely trouble-free.

A De-Capped Valve

The instrument shown in Fig. 4 is simple, consisting of a PM2A triode power valve, de-capped and fed by a small internal and low voltage power pack using a DW2 bi-phase rectifier.

Owing to the use of a directly-heated valve the instrument gives direct readings immediately on switching on. It is of simple construction and as it has a high input impedance is eminently suitable for high-frequency measurements.

A five-position switch is required which gives the following full scale ranges:

- Position 1. Full scale deflection 4.0 volts
- Position 2. " " " 10.0 volts
- Position 3. " " " 25.0 volts
- Position 4. " " " 100 volts
- Position 5. Safety position.

A further switch of the press-button or toggle type is needed to short the input terminals so as to release any charge that may have accumulated on the grid of the PM2A. It will be seen from the theoretical circuit Fig. 4 that the valve is used as an anode-bend rectifier, fixed bias being provided by the potentiometer, R1 and R2. In addition to this automatic bias is used, dependent on the voltage to be measured, the correct resistance value being selected by the multi-contact switch which must be of the special Yaxley type with low-loss construction.

**Components for
A MODULATED OSCILLATOR**

- CABINET.**
1—Sheet iron 12 x 7 x 8 in. (Peto-Scott).
- CHOKES, HIGH-FREQUENCY.**
1—Type 982 (Eddystone).
2—Mains chokes type HF16 (Bulgin).
- CHOKE, LOW FREQUENCY.**
1—20-henry (Bryan Savage).
- CONDENSERS, FIXED.**
3—.01-mfd. type 690W (Dubilier).
3—.1-mfd. type BB (Dubilier).
1—.00005-mfd. type 690W (Dubilier).
1—.0002-mfd. type tubular (Dubilier).
1—.002-mfd. type tubular (Dubilier).
1—.0001-mfd. type tubular (Dubilier).
1—2-mfd. type BB (Dubilier).
1—.2-mfd. type BB (Dubilier).
2—8-mfd. type 0281 (Dubilier).
- CONDENSERS, VARIABLE.**
1—.0005-mfd. type Popular Log (Jackson Bros.).
1—Type SW55 (Bulgin).
- COIL FORMER.**
3—6 in. lengths, 1½ in. dia., paxolin (Peto-Scott).
- DIAL LIGHT.**
1—Type D9 (Bulgin).
- HOLDERS, VALVE.**
1—4-pin type baseboard (Premier).
2—5-pin type baseboard (Premier).
1—7-pin type baseboard (Premier).

- RESISTANCES, FIXED.**
2—5,000 ohm type 1 watt (Erie).
1—10,000 ohm type 1 watt (Erie).
1—500 ohm type 1 watt (Erie).
1—1,000 ohm type 1 watt (Erie).
1—250,000 ohm type 1 watt (Erie);
- RESISTANCES, VARIABLE.**
1—10,000 ohm wire wound potentiometer (Reliance).
1—15,000 ohm wire wound potentiometer (Reliance).
- SUNDRIES.**
2—Terminals type B marked input (Belling-Lee).
4—Terminals marked output (Belling-Lee).
1—Terminal marked earth (Belling-Lee).
1—Plain 3 in. dial (Jackson Bros.).
1—Switch knob type K60 (Bulgin).
- SWITCHES.**
1—S80T (Bulgin).
1—Double-pole on-off, type S123 (Bulgin).
- TRANSFORMER, MAINS.**
1—Special giving:
250-0-250 volts 60 M/a. (B.T.S.).
2-0-2 volts 1A. (B.T.S.).
2-0-2 volts 4A. (B.T.S.).
- VALVES.**
1—Pen4VA (Mullard).
2—164V (Mullard).
1—DW2 (Mullard).

constructed in a screened container with tight fitting lid and a centre dividing screen, so that the actual oscillator can be in one section with the power pack in another.

Fig. 3 gives a good idea of the layout of the panel components. It is suggested that lugs be fitted to the rear of the case so that the instrument can be mounted on a wall and left connected for immediate use. A neon indicator has been included to show when the oscillator is operating. This indicator is connected across R8 which should be adjusted with the modulator off, so that when not oscillating the neon is just extinguished. The neon lamp should be of the indicator type with approximately 120 volts applied to it.

A filter is incorporated in the mains input side to prevent any output from the instrument finding its way into the supply lines. These chokes can be purchased ready wound, but the constructor will find that a suitable choke can be made from 200 turns of 28 D.C.C. wire on a 1 in. former.

The smaller components have all been numbered so that they can be identified with the following list. R1, 10,000 ohms; R2, 5,000 ohms; R3, 10,000 ohms; R4, 500 ohms; R5, 1 megohm; R6, 1,000 ohms; R7, 250,000 ohms; R8, 15,000 ohms; R9, 5,000 ohms; C1, .01 mfd.; C2, C3, C4, 1 mfd; C5, 5/25 mmfd; C6, see text, C7, .0005 mfd; C8, .0001 mfd; C9, 2.0 mfd.; C10, .2 mfd.; C11, C12, 8.0 mfd; C13 and 14, .01 mfd.

The suggested types for these components are shown in the separate list which gives all the components required.

If the suggested components are used,

the necessity for a valve volt meter for use in the laboratory by amateurs to check signal strength and by the service man during his daily work. Several designs have been published of battery-operated meters of this kind, but we feel that the time has come when A.C. operated instruments be used which can

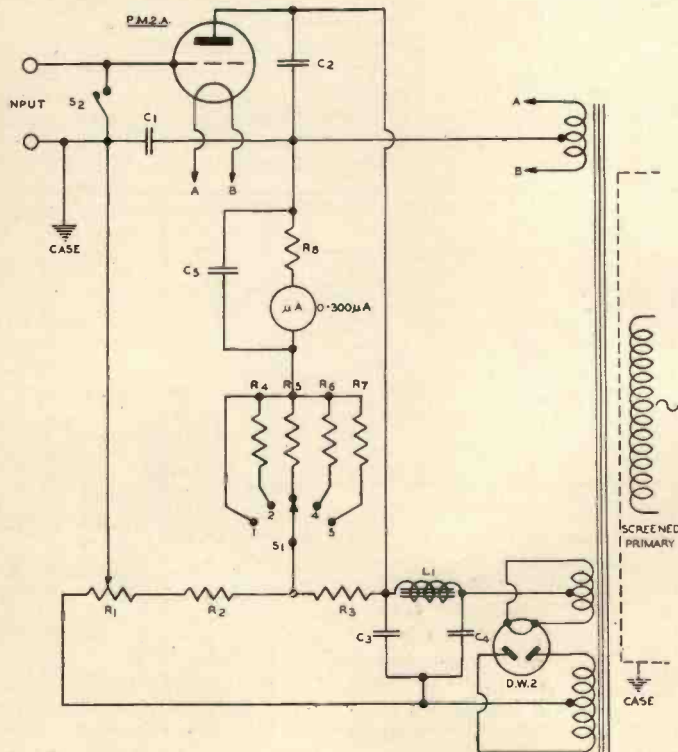

Fig. 4.—Owing to the use of a directly heated valve this meter gives a reading as the supply voltage is switched on. It is suitable for H.F. measurements providing the component values are strictly adhered to.

**The Special
Meter**

It is most important that the meter should have a wide open scale that is easily read and for that reason, we have selected a Turner instrument, model 23,

receiver output as differences in circuit are made.

When measuring the voltages across condensers, it will be necessary to shunt the input terminals with a resistance of between 1 and 2 megohms, otherwise the grid of the PM2A will not receive its required bias voltage.

for use in conjunction with the modulated oscillator, in ganging multi-circuit receivers and in many cases for the measuring of frequency response when the accuracy is not of too high an order.

One important point to remember is that the mains transformer should be of the screened type fitted with a screened primary winding.

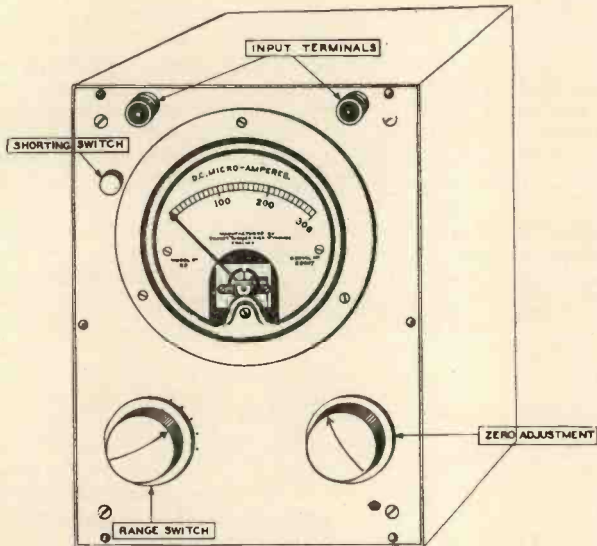

Fig. 5. — This meter lines up with the oscillator and forms the nucleus of a well-equipped laboratory.

having a full scale deflection of 300 micro-amps. The variation in resistance in this instrument is small as compared with the 20,000 ohms which remain in circuit on Range 1.

Short period fluctuations are damped out by the parallel condenser—50 mmfd.—and series resistance—2,500 ohms—in the meter circuit, but the value required for these components may need slight

For easy handling and portability it is recommended that the instrument be built into a metal case approximately 8 ins. by 6 ins. by 4½ ins., again with 4 lugs so it can be fixed to the wall along with the modulated oscillator.

A suggested layout is shown by Fig. 5, which gives the symmetrical appearance without making the internal layout a difficult one. Again the components

**The International Short-wave
Club**

Any reader interested in short-wave transmission and reception should get in touch with the secretary of this society, Mr. A. E. Bear, 100 Adams Garden Estate, S.E. 16, who will supply full details.

The London Chapter now meets every Friday evening at the new clubroom, 80 Theobalds Road, W.C.1. There is regular instruction in the theory and practice of television and radio transmission and reception, while plans are being made for a permanent club transmitter.

Those in the South Coast districts are invited to attend the meetings of the Brighton Chapter, full details of which can be obtained from the secretary, Mr. J. Bennett, 205 Braeside Avenue, Brighton, 6.

A northern Chapter with headquarters in Manchester has for a secretary, Mr. H. Wild, 1 Elm Street, Middleton, from whom all details can be obtained.

The Guernsey Chapter is giving amateur radio every attention with practical instruction at every weekly meeting. Further information can be obtained from F. S. Le Pavoux, 8 Upper Canichers, St. Peter Port, Guernsey, C.I.

**The Institute of Wireless
Technology**

At a special meeting of the Institute of Wireless Technology held recently, certain amendments respecting fees and subscriptions were passed, the result of which will be of great benefit to the younger members of the industry wishing to become student members or associates of the Institute. Full particulars of these amendments, with examination regulations and conditions of membership are contained in the revised syllabus which may be obtained from the Secretary of the Institute, 4 Vernon Place, Southampton Row, W.C.1.

At the January meeting of the London Section of the Institute of Wireless Technology, Mr. H. J. Barton-Chapple, B.Sc., M.I.W.W.T., A.M.I.E.E., will deliver a lecture entitled: "High definition Television." A limited number of invitations are obtainable by non-members and applications should be made to the Institute.

**Components for a
Mains Operated Valve-Volt Meter**

CABINET AND CHASSIS.

- 1—Metal cabinet 8 × 6 × 4½ in. (Peto-Scott).
- 1—Metal chassis 7½ × 5½ × 1 in. (Peto-Scott).

CONDENSERS, FIXED.

- 2—1-mfd. type BB (Dubilier).
- 2—2-mfd. type BB (Dubilier).
- 1—50-mfd. type 3004 (Dubilier).

HOLDERS, VALVE.

- 2—4-pin type standard chassis less terminals (Clix).

METER.

- 1—0/300 micro-ammeter type 23 (Ernest Turner).

RESISTANCES, FIXED.

- 1—1,000 ohm type 1 watt (Erie).
- 1—20,000 ohms type 1 watt (Erie).
- 1—25,000 ohm type 1 watt (Erie).
- 1—100,000 ohm type 1 watt (Erie).

- 1—500,000 ohm type 1 watt (Erie).
- 1—1 megohm type 1 watt (Erie).
- 1—2,500 ohm type 1 watt (Erie).

RESISTANCES, VARIABLE.

- 1—1,000 ohms wire wound (Reliance).

CHOKE, LOW-FREQUENCY.

- 1—30-henry (Sound Sales).

SUNDRIES.

- 2—Insulated terminals type B marked input (Belling-Lee).

TRANSFORMER, MAINS.

- 1—Special type giving:
 - 2-0-2 V 1A
 - 1-0-1 V 2A
 - 210-0-210 V 10 M/a (Premier Supply Stores).

VALVES.

- 1—DW2 (Mullard)
- 1—PM2A (Mullard).

further adjustment with any other type of meter.

On all but the lowest range the meter is practically free from variations due to mains fluctuations, while even on this range the variation is small and can generally be neglected, as readings are mostly comparative. Providing fluctuations do not take place when tests are being made small changes can be tolerated. The lowest range is most useful for noting small differences in

have been numbered and have the following values: R1, 1,000 ohms; R2, 1,000 ohms; R3, 20,000 ohms; R4, 25,000 ohms; R5, 100,000 ohms; R6, 500,000 ohms; R7, 1 megohm; R8, 2,500 ohms; C1, C2, 1.0 mfd.; C3, C4, 2.0 mfd.; C5, 50 mfd.

**A Useful
Instrument**

This type of instrument is invaluable in measuring the output from receivers,

Pentodes on the High Frequencies

The pentode valve has many advantages and providing it is used correctly can be of great value to the amateur. Some reasons for using the pentode are dealt with in this article.

SUPPRESSOR-GRID modulation is not the only virtue of the pentode valve, although this appears to be the sole reason for their popularity amongst certain amateurs.

While these valves do enable the C.W. operator to use phone with more or less the same input as on C.W., the efficiency is very little better than that of pure grid modulation. The advantage is that very little audio output is required in the suppressor-grid circuit to give a high percentage of modulation. Owing to this lack of efficiency,

plaint on the higher frequency bands. If pentode valves are substituted, not necessarily in the P.A. stage but in the preceding frequency doubler or sub-amplifier stages, then the amount of excitation available is greatly increased. A study of American circuits often brings to light the fact that three stage transmitters are often used for inputs of up to 1 kW. Compare this with some of the G stations which are unable to obtain sufficient drive on 20 metres with the normal low input.

Illustrated in this page is the theoretic

optimum R.F. output from the sub-amplifier or doubler.

A 15-watt sub-amplifier provides more than sufficient drive for an RFP120, so on the higher-frequency bands the pentode valve should be given every consideration.

While realising that an RFP120 is not every amateur's valve, the idea can be adapted for almost any wattage within reason. By using the appropriate crystal this three-section transmitter can be used on any band from 80 to 10 metres. It is hardly worth while employing even three sections on 160 metres. On this band several stations have found to their satisfaction that a single RFP15 crystal controlled and anode modulated gave ample R.F. output. It should also be remembered that at least two of the Dutch stations have used RFP60's on 80 and 40 metres with an input of about 40 watts. A single valve transmitter of this kind is not only cheap to build but can be most effective.

Coming back again to the point of efficiency, as most amateurs are using these pentode valves with suppressor-grid modulation, the efficiency is not much more than 30 per cent. as compared with approximately 26 per cent. with pure grid modulation. This latter figure may shortly be open to question for a new circuit has been evolved whereby the efficiency of a grid modulated stage can be increased to between 60 and 70 per cent., but for all intents and purposes so far as the British amateur is concerned, 26 per cent. is nearer the average.

For this reason it is quite obvious why pentode valves are not used to the same extent as triodes, but it should be realised that by modulating both suppressor grid and anode simultaneously in the correct proportions an efficiency of over 80 per cent. is obtainable.

This is not quite so good as with a normal triode but when other points are taken into consideration, such as the saving in drive and lack of neutralising, then there is every reason for the pentode to be more generally used.

The RFP120 is one of the largest British valves of its type available and has the following characteristics:

- Filament volts, 6.
- Filament amps., 3.
- Maximum anode voltage, 1,400.
- Maximum anode input, 200 watts.
- Maximum anode dissipation, 120 watts.
- Anode load, 10,000 ohms.
- Maximum screen voltage, 600.

(Continued in 3rd column of page 109)

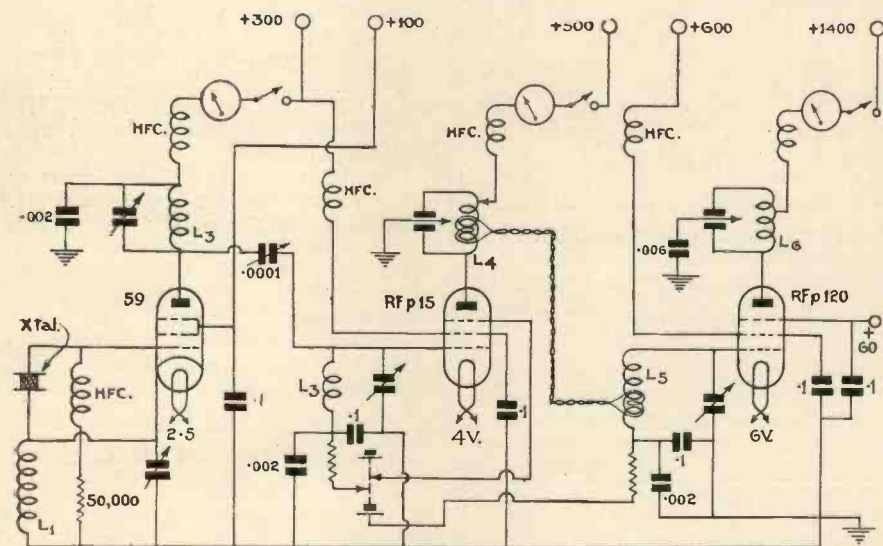

Although this circuit is for a high power transmitter the idea can be adapted for low-power working on almost any band.

however, the pentode valve is often condemned as being unsuitable for amateur use, although this is just the very reverse of what it should be.

Forgetting for a moment suppressor-grid modulation, there are several points about radio frequency pentodes that should be given some prominence. A low wattage valve is ideal as a frequency doubler and gives a high R.F. output even down to 14 and 28 mc.

When used as a sub-amplifier with the correct constants an efficiency of up to 80 per cent. can be obtained, which is not too bad when one considers how simple it is to get these valves working satisfactorily, and that no neutralising is required.

Most amateurs, by reason of cost, have to keep the number of stages in a transmitter down to a minimum. With triode valves needing a high input, insufficient excitation is a general com-

cal circuit of a three stage transmitter which can be operated with an input of 120 watts on 10 metres or up to 150 watts on the lower-frequency bands.

A 59 is used in the typical Tri-tet oscillator circuit with any suitable crystal. Generally the drive from this stage is too much for the following RFP15, so that the efficiency of the valve decreases. Unfortunately it is a feature of the pentode valve that over excitation causes a decrease rather than an increase in R.F. output. For this reason amateurs are rather inclined to apply too much drive without realising the peculiar characteristic of the valve, and to consider it inefficient owing to lack of output.

Link coupling between the 59 and RFP15 has not been used. It has been found much more satisfactory to use variable capacity coupling so that the amount of drive can be adjusted to give

A Two-stage Signal Booster

By Kenneth Jowers

Two stages of pre-selection will improve the performance of any receiver and if the I.F. gain is reduced the noise level will drop out of all proportion to the signal strength. The new Osram valves are used for the first time in this receiver.

ON those very rare occasions when I have discovered an amateur or short-wave listener completely satisfied with his receiving equipment, I have noticed that there has always

After several months checking, I find that by reducing the intermediate-frequency gain, and incidentally noise, and making up for the loss in signal strength by radio frequency gain, not only are

could possibly make an efficient two-stage pre-selector without experiencing difficulties, and while the possibility of instability was always present with the modern high slope pentodes, American

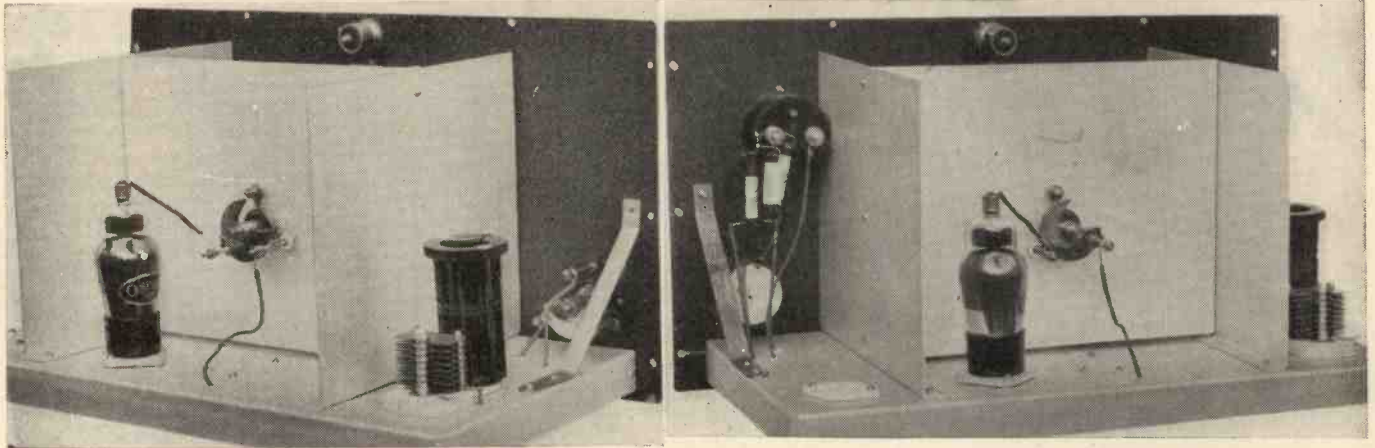

The grid connection is made to the top of the valve, so making a short connection to the tuning condenser.

A 4-pin plug carries the four cables from the power pack. A meter is a refinement that keeps an eye on the total current consumption.

been an effective radio frequency amplifying section. Most listeners have difficulties in some respects or other. Some of the commercial all-wavers are hopeless on the higher-frequency band. Others fail owing to the high inherent noise level and as the effectiveness of a receiver is mainly dependent on noise, then for real DX work the average commercial set is not too good.

Super-het or Straight ?

Some of the normal multi-valve super-hets designed for amateur use have four high-frequency stages and depend for their sensitivity on the gain from the intermediate frequency stages. This invariably means high noise level, so for that reason the old controversy as to whether a super-het or straight set is more suitable for amateur use, still persists.

Low Noise Level

After having tested most of the important commercial receivers and having built short-wave receivers of all kinds, I am firmly convinced that the noise level can be reduced very considerably if a good pre-selector is employed. This fact is recognised by most of our real go-ahead amateurs, but unfortunately the listening stations have not had the chance of comparing notes and gaining information on the most effective receiving circuits.

signals more easily readable, but long distance weak stations previously missed altogether are now being heard 100 per cent. effectively.

In many instances I have been able to hear weak stations on an all-wave receiver plus 2 H.F.'s when a commercial amateur band receiver of accepted efficiency has been completely devoid of signals. This point was proved most

valves of the 58 type were a solution to the trouble.

This meant special voltage filament transformers and new valve holders until the introduction by the G.E.C. and Marconiphone Cos. of a new range of valves, which are ideal for amateur use. Two of these valves, W42's, have been used in this pre-selector and they are suitable for two very good reasons.

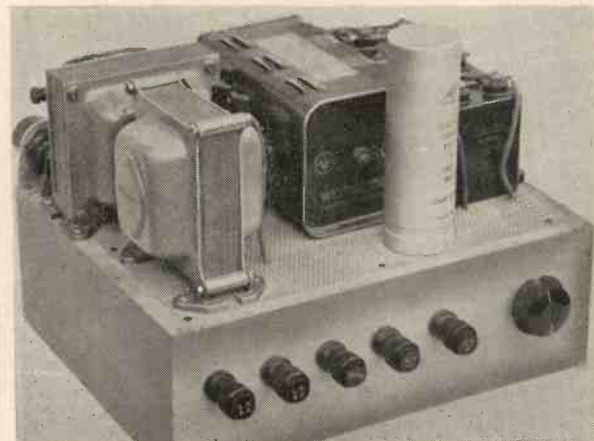

This compact H.T. supply unit can be used with all kinds of receivers. The H.T. and L.T. are brought out to terminals which are in turn connected to a four way cable.

conclusively during the past few months when the 20-metre band was so very poor at certain times of the day.

During discussions and lectures with amateurs it came to light that many of them were doubtful as to whether they

The slope has been reduced to 1.5 ma. per volt under conditions such as will be found when using this pre-selector. Also the grid connection is brought out to the top cap so that there is a nice short lead to the associated tuning con-

Standard Coils :: Transformer Coupling

denser and coil. In characteristics they are very similar to the American low-gain pentodes but they have standard 7-pin bases and 4-volt low consumption heaters.

The circuit for this pre-selector is shown in Fig. 1, where the aerial is fed into the primary of a standard 4-pin

fixed resistance is connected in the cathode circuit, while gain is controlled by means of a wire-wound 10,000-ohm series resistance.

The first valve is transformer coupled to the second for a definite reason. Actually the gain from a tuned grid stage with an effective H.F. choke would

increase in gain, but this is immaterial for the complete amplification from two stages is not required. What is needed is complete stability with a high degree of selectivity.

The W42 valve needs a maximum screen voltage of 125 and this is obtained by means of a 10,000-ohm resistance in series with the variable potentiometer of 50,000 ohms. The total screening current at optimum operating conditions is 3.8 ma. for the two valves,

Anode decoupling is most important and resistances of 1,000 ohms are connected in each anode leg and decoupled by .01 mfd. condensers. The total anode current of the two valves with minimum bias is approximately 15 ma., so that a power pack giving 20 ma. at 200 to 250 volts will be ample.

In the anode circuit of the second stage is an H.F. choke of the Raymart CHN type, which has proved most effective and can be connected in the wiring. Notice how both screens are by-passed with .1 mfd. condensers, the earthy sides in each case being taken to cathode and not to earth. With the remaining by-pass condensers and earthy points these are all taken to one contact in each circuit.

So as to overcome the trouble of coil matching, band set condensers of .0001 mfd. capacity are included. These are not ganged, so that odd coils can be used and lined up. Tuning is then carried out by means of the ganged 15 mmfd. band-spreading condensers, which are controlled by the major tuning drive.

Power Supply

The power pack, which in most circumstances will be necessary, is shown

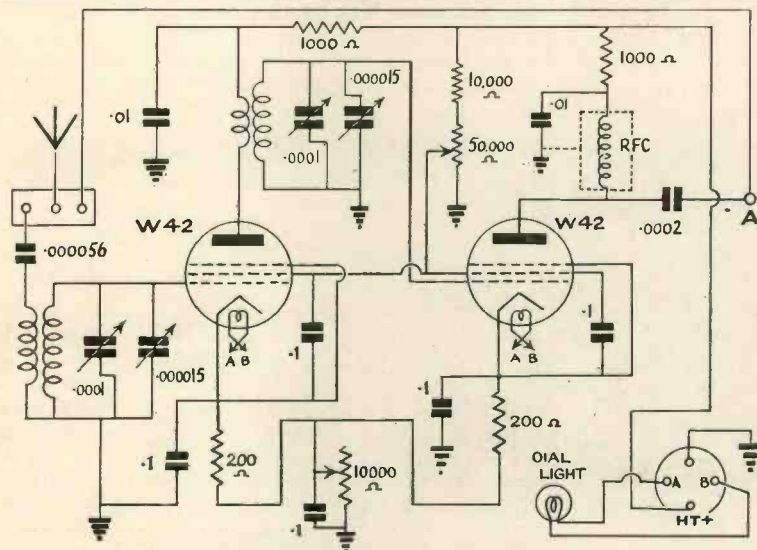

Two W42 pentodes are used in this circuit. These valves are of the new low gain type which are ideal for use in pre-selectors. Notice how both cathode bias and screen voltage are both variable.

coil through a 56 mmfd. air spaced pre-set condenser. It will be noticed that a change-over switch connects the aerial either to the pre-selector or to the standard receiver.

The W42 H.F. amplifier is so arranged that it always has a slight bias applied, so for this reason a 200-ohm

have been slightly higher, but there are no satisfactory means with such a circuit of obtaining extreme selectivity in a simple way.

With tuned transformer the primary winding can be reduced until the selectivity meets the requirements of the operator. There is, of course, a de-

Components for A TWO-STAGE SIGNAL BOOSTER

CABINET AND CHASSIS.

- 1.—Aluminium chassis 15½ × 8½ × 1 in. (Peto-Scott).
- 1.—Steel cabinet and panel type 1034. (Eddystone).
- 1.—Screen 8½ × 9 × 7 in. (Peto-Scott).

CHOKE, HIGH-FREQUENCY.

- 1.—Type CHN (Raymart).

COILS.

- 2.—Sets 4-pin type E (B.T.S.).

CONDENSERS, FIXED.

- 1.—.0006 mfd. type SW57 (Bulgin).
- 5.—.1 mfd. type tubular (Dubilier).
- 2.—.01 mfd. type tubular (Dubilier).
- 1.—.0002 mfd. type air spaced (B.T.S.).

CONDENSERS, VARIABLE.

- 1.—Type 900/100 (Eddystone).
- 2.—Type 900/20 (Eddystone).
- 1.—Type 1054 (Jackson Bros.)

DIAL.

- 1.—Type 1070 (Eddystone).

HOLDERS, VALVE.

- 2.—7-Pin ceramic chassis less terminals (Clix).
- 3.—4-pin type ceramic chassis less terminals (Clix).

RESISTANCES, FIXED.

- 2.—200 ohm type 1 watt (Erie).
- 2.—1,000 ohm type 1 watt (Erie).
- 1.—10,000 ohm type 1 watt (Erie).

RESISTANCES, VARIABLE.

- 1.—50,000 ohm type VM wire wound (Reliance).
- 1.—10,000 ohm type VG45 (Bulgin).

SUNDRIES.

- 12.—in. screened cable (Peto-Scott).
- 1.—Dial light with bulb type D9 (Bulgin).

- 24.—6BA round head bolts with nuts and washers (Peto-Scott).

COILS Quickwyr.

- 2.—Coils Quickwyr. (Bulgin).
- 2.—Panel brackets type 6 in. (Bulgin).
- 2.—Type 1027 pointed knob and dials (Eddystone).
- 1.—Ceramic shaft coupler (Bulgin).
- 1.—Type DM52 (Bulgin).

SWITCH.

- 1.—S98 (Bulgin).

VALVES.

- 2.—W42 (Osram).

POWER PACK COMPONENTS.

CHASSIS.

- 1.—Wooden 10 × 9 × 3 in. (Peto-Scott).

CONDENSERS, FIXED.

- 2.—4 mfd. type BB (Dubilier).
- 1.—8 mfd. type 0281 (Dubilier).
- 1.—2 mfd. type BB (Dubilier).

CHOKE, LOW-FREQUENCY.

- 1.—Type HT12 (Wearite).

TERMINALS.

- 2.—Insulated terminals marked HT positive and HT neg. type B₁ (Belling-Lee).
- 2.—Insulated terminals marked LY, AC, type B (Belling-Lee).

RECTIFIER.

- 1.—Metal type HT12 (Westinghouse).

RESISTANCE, VARIABLE.

- 1.—10,000 ohm type power (Varley).

SUNDRIES.

- 1.—Mains plug and socket type P21 (Bulgin).

SWITCH.

- 1.—Two pole toggle type S88 (Bulgin).

TRANSFORMER, MAINS.

- 1.—Special for HT 12 (B.T.S.).

Variable Cathode Bias and Screen Voltage

on page 107, and is connected to the pre-selector by means of a 4-way cable and plug. It will be noticed from the illustrations that the power supply connections are all taken to a 4-pin valve holder mounted on the right-hand side of the chassis. An 0/30 milliammeter is also connected in series with the main H.T. supply, but this is an optional refinement which we have found quite useful.

The chassis is 15½ ins. by 8½ ins.

made strictly to specification it should be entirely stable with maximum gain.

No Screening

There is no need to use coil or valve screens by virtue of the layout of the components, so this will also give constructors some indication of the complete stability of the pre-selector.

Care must be taken in connecting up the dial light. If this has an insulated case it can be connected across the en-

Pin connections for the W42 valve are unusual, so I am giving them in case constructors have any query regarding them. Viewing the valve base from underneath, Pin 1 is left blank, pin 2 anode, pin 3 suppressor grid, pins 4 and 5 heater, pin 6 cathode, pin 7 screening grid with the grid on top cap.

For DX Work

Any transmitting amateur or enthusiastic listening station with a super-het receiver will find this two-stage pre-selector of great advantage. It has been used in front of a receiver already using a single R.F. stage without causing instability.

Although one coil can be made to cover two wavebands, greater sensitivity can be obtained if the very minimum tuning capacity is used. The standard 4-pin coils specified are generally suitable without alteration, although the primary winding may have to be decreased in every case if extra selectivity is required. This primary winding, actually intended for reaction, can be adjusted without having to remake the coil, for the final turn is connected to the anode pin of the coil holder so that the total number of turns can be reduced from the bottom end.

As it is always better for maximum volume to be obtained when the volume control is turned fully to the limit of its travel it may be necessary in case of valve characteristic variation slightly to increase the value of the 10,000-ohm resistance in series with the screen voltage potentiometer.

A good idea as to the lay-out can be obtained from this plan view with the second stage almost totally screened. These screens are of heavy gauge metal which is most important on the high frequencies.

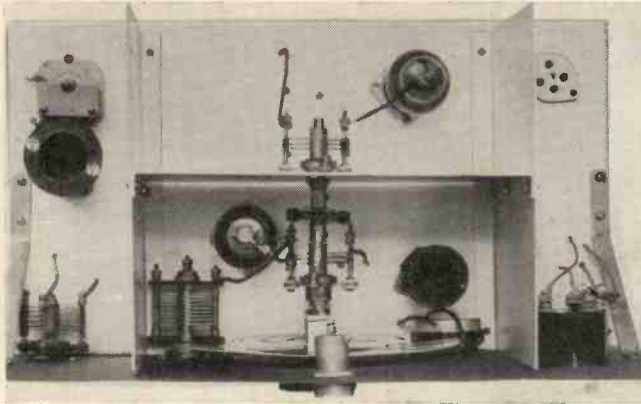

turned down on four sides approximately 1 in., and it is bolted to the panel supplied with the Eddystone steel cabinet. As this allowed the chassis to move slightly, panel brackets were also used so as to make the whole unit entirely rigid. Also notice the aluminium screen on which is mounted band-spreading condensers. This is of very heavy gauge metal and is absolutely

immovable, even should the receiver be roughly handled. tire 4-volt filament supply, but if the case forms one pole of the bulb then a single lead should be taken to one side of the filament supply voltage, so that 2 volts only are applied to the bulb. The second lead to the bulb is, of course, made automatically via the chassis.

Underneath the baseplate are mounted all fixed condensers and the two cathode bias resistances. The anode and

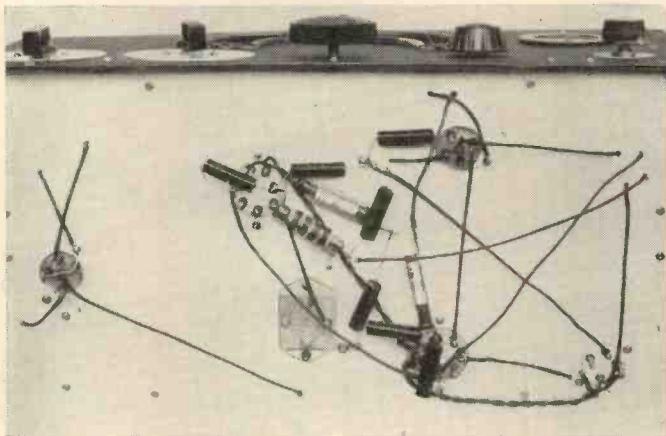

Most of the connections are below the chassis with the resistances and condensers mounted in the wiring.

By having so many variable controls, the pre-selector is absolutely fool-proof. There is no possibility of the unit being out of gang by virtue of the band-spread condensers. Instability, if any, can be counteracted by the use of a variable bias and a variable screen voltage control. Incidentally, if the receiver is

screen resistances are mounted in a block and connected to the milliammeter on the panel.

Aerial Coupling

On the left-hand corner of the chassis can be seen the 56 mmfd. input condenser, while the .0002-mfd. air-spaced coupling condenser is underneath the chassis next to its associated valve.

“Pentodes for High Frequencies”

(Continued from page 106)

Maximum screen dissipation, 30 watts.
Suppressor bias voltage, 60-80.

Speech input, 5 watts.

H.F. input, 15 volts r.m.s.

When used as a class C amplifier for C.W. work an input of 196 watts is obtainable with 1,400 volts on the anode, 60 volts on the suppressor grid and a negative bias of 90 volts. As a class C amplifier for phone use using 1,200 volts on the anode, zero suppressor grid voltage and 90 volts negative on the control grid, the input is limited to 120 watts.

Owing to the high slope and low inter-electrode capacity, the amount of drive required is kept to a very low level on all wavelengths. Also by virtue of its construction, the length of lead to electrodes has been kept down to an extremely low limit.

By using various combinations, pentode valves can be used in numerous ways, but invariably owing to their needing so little drive, the actual R.F. output into the aerial is greater despite the slight decrease in efficiency.

Navigation by Ultra-short Waves

Yet another use for the ultra-short waves is explained by Dr. A. GRADENWITZ in this description of the Obstacle Detector installed on S.S. "Normandie."

IN an endeavour still further to reduce the possibility of collision at sea the French line *Normandie* has been fitted with an obstacle detector—a radio operated device working on ultra-short waves.

This instrument, it is claimed, will detect the presence of any obstacle in the ship's course and as visibility does not enter into it at all it will function perfectly in fog and at day or night time.

Wave Deflection

It once and for all time does away with the possibility of collision at night by fast liners of the *Normandie* type. The idea is based on the fact that ultra-short waves are reflected if any obstacle is in a direct path to the wave. The composition of the material does not make any appreciable difference for

case of fog or negligible visibility the apparatus is invaluable and is a safe way of preventing accidents.

tained from the ship's 110 volt D.C. lighting plant through a D.C. to A.C. convertor.

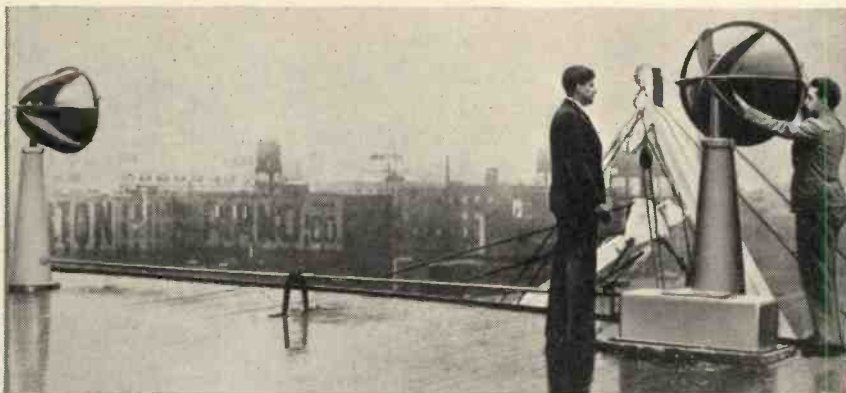

Fig. 3.—The transmitting and receiving projectors of the Obstacle Detector during tests in New York outer harbour.

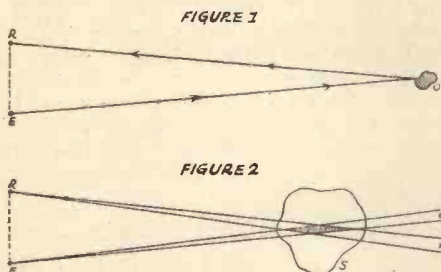

Fig. 1.—The transmitter wave goes from E to O, and in case of obstruction is reflected back to R. Fig. 2 shows how the course is covered to detect obstructions over a limited area.

metals, dielectric and half conductors give ample deflection.

Fig. 1 shows the way in which these ultra-short waves are used for signalling. The transmitter at E which uses centimetre waves radiates waves more or less in one direction owing to the use of a parabolic reflector.

Directly these waves come into contact with the obstacle at O they are reflected at an angle and picked up by the ceiver at R.

As the transmitter is so arranged that the receiver will not pick up any signals transmitted along the path ER, it is obvious that there will not be any pick up at the receiver R unless the direct wave from the transmitter is reflected back by some obstacle in the ship's course.

The receiver has been so arranged that it will switch on and put an alarm into operation immediately there is a wave reflection.

It will be realised from this that in

Beam Spread

Another characteristic of these ultra-short waves is the ease with which they can be controlled both at the transmitting and receiving ends. In addition these waves can be concentrated into narrow beams and transmitted to a given position with only a very small spread.

The shortest waves in general use are those on the *Normandie* equipment which are in the order of 16-centimetres. These can be concentrated by means of parabolic reflectors to within 5 degrees, so that by sweeping over a limited area a clear course can always be followed.

The Apparatus Used

The transmitter comprises an oscillator modulated at 7,500 cycles which generates a carrier with a wavelength of 16 centimetres. The transmitting valve is a triode, the grid of which is raised to a potential of 250 volts positive with the anode at 70 volts. The energy generated is transferred to an aerial 4 cms. in length, corresponding to a quarter wavelength, tuned and fitted inside a bulb in a similar way to a valve. The valve is in turn mounted in the interior of a parabolical mirror of 75 cms aperture and 12 cms focal distance.

The field intensity is reduced to half its original intensity by rotating the reflector 8 degrees either side of the maximum focal point. Power supply is ob-

For reception a similar valve to that used in the transmitter is worked as a detector, and is housed with the remain-

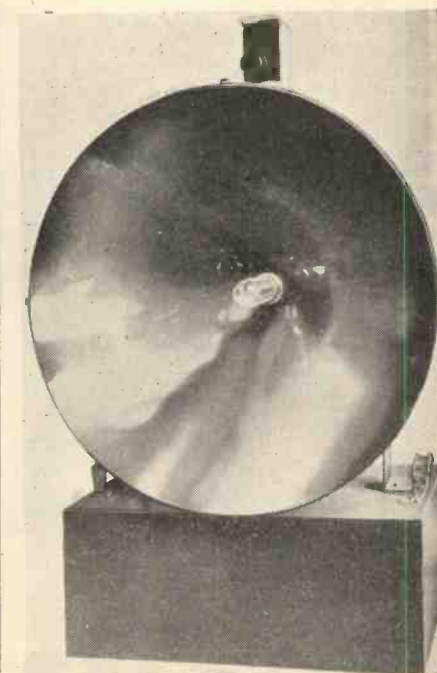

Fig. 4.—Reflector containing transmitting valve generating 16 cms. waves.

der of the circuit in a glass bulb. The whole is then fitted at the focus point of a parabolic reflector.

A Diode valve Monitor Meter

Any amateur station not able accurately to check transmissions or to determine the amount of increase in radiation after experiments have been made in the transmitter should invest in a meter of the type described in this article.

WE have been using for some time a diode monitor for checking the phone transmissions from our standard transmitter. Several difficulties were experienced immediately high power was used. In the first instance a Westector was not found suitable for we wanted a rectified current of at least 1 m/a, while in the second, using a battery operated valve as a diode, our calibrations did not remain accurate owing to the variations in filament voltage. Also, if a considerable amount of apparatus is in continual use, a reliable check cannot be kept if accumulators are to be used in the various pieces of apparatus.

A Valve Diode

For that reason we experimented with a new type of double-diode, the V914, manufactured by Ediswan. It is capable of giving a rectified current of no less than 4 M/a when both diodes are strapped together. The price of the valve is also very low, so that altogether the meter is very cheap to build. We prevailed upon Messrs. Bryan Savage to construct for us a special filament transformer at a cost of a few shillings, for the standard filament transformers would have raised the cost to an exorbitant figure.

The circuit is quite a conventional one in which a tuned circuit is connected across the diode-cathode circuit of the V914. A load resistance in the cathode of 2,000 ohms was found to be about the most suitable value and this is by-passed at both ends by .001-mfd. condensers.

If the meter is to be used merely to check the quality of transmission there is no need for a comparatively expensive milliammeter, but as one instrument can be used for two jobs, if the meter is in circuit, we think the extra expense well worth while.

When the maximum output there can be feed-back from the headphones to the microphone when the phones are not actually being worn.

The amount of R.F. current obtained depends, of course, on the actual input, but with an aerial 3 ft. long and

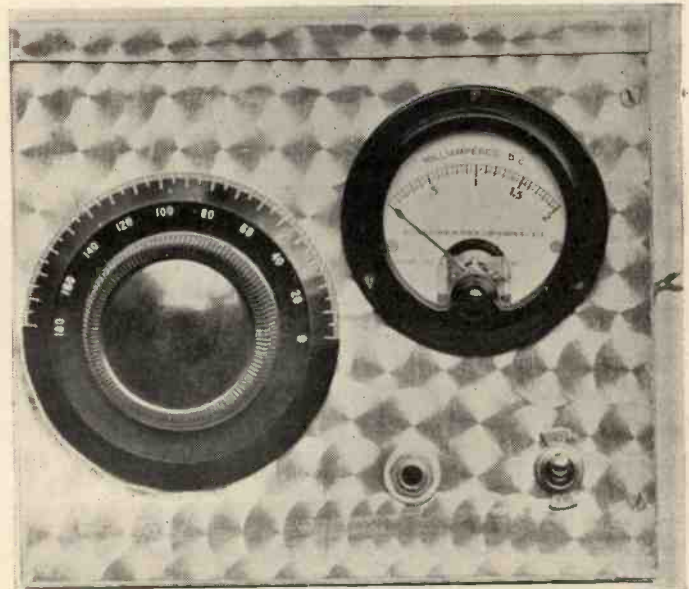

The meter in this instrument can be of any reading from 2-6 M/a, but should be fairly well damped to give a steady reading.

This meter is connected in series with the cathode-load resistance and earth with a pair of headphones in the earthy side. Although it is not shown, a toggle switch can be connected in parallel with the headphones to switch these out of circuit when not actually in use. Occasionally when the meter is giving op-

several yards from the transmitter, 4-5 m/a can be obtained at 20 metres with a 50-watt transmitter.

The actual aerial can be tapped directly on to the strapped diodes, but by using a primary winding as indicated, not only can a standard B.T.S. plug-in coil be used, but the meter will cover two wavebands without coil changing.

Two Coils Only

With a .00025 mfd. condenser, one coil will cover 20 and 40 metres and 80 and 160, although it would not entail very much difficulty to include a simple switching arrangement so that one coil would cover three or four amateur bands.

Use a Metal Box

The whole instrument is mounted in a metal box with a tight fitting lid. Constructors may not think this entirely necessary, but we have discovered that the meter will pick up a fair percentage of hum if it is unshielded, and as it is essential that the meter give a true indication of the transmission, this cannot be tolerated. Even with a metal container the instrument has to be carefully placed, otherwise a slight hum level can still be introduced.

A small wooden baseboard is used to

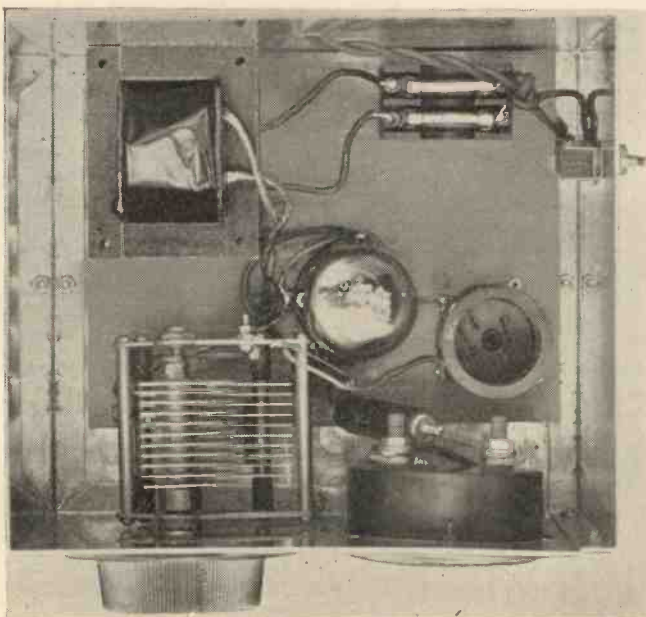

Some idea as to the lay-out can be obtained from this illustration. The filament transformer should have the core earthed to the metal cabinet.

Correct Input and Coupling

take the valve and coil holder, mains transformer and twin fuse holder, which is in the primary of the transformer. Both fixed condensers are of the tubular type and are mounted in the wiring with the cathode resistance.

The tuning condenser, meter, phone

160 metres is quite satisfactory, but a similar length of aerial on 20 metres provides less than 1 M/a of current. However, by increasing the number of turns on the primary of a 20-metre coil the current can be brought up to the required 4 M/a.

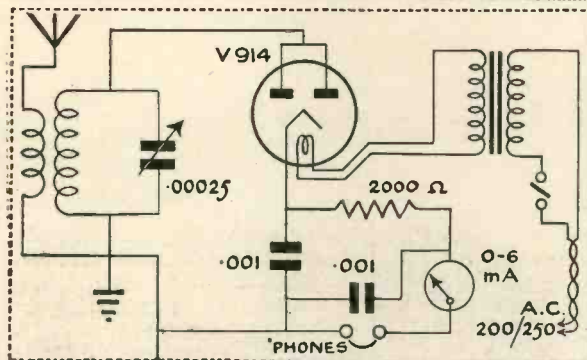

This is the circuit of the meter. To obtain the correct current reading the primary coil should be increased to give a greater reading and decreased to give a smaller reading. The correct number of turns must be determined by experiment.

jack and phone short-circuiting switch are all mounted on the front panel, while the on-off switch in the primary of the filament transformer is mounted on the side of the case.

Correct Coupling

Although the amount of rectified current varies very considerably from band to band, this can be adjusted by means of aerial length providing the total current is not too high. But a more effective scheme is to reduce the number of primary turns on the coil until the rectified current is the same for all wavebands.

For example, 4 M/a of current on

We have discovered that with less than 2 M/a the meter does not give a true indication of the transmission, while more than 4 M/a will tend to overload the V914 double-diode.

During our checks on different types of aerial we fitted one of these instruments in a field a short distance from the actual aerial under test. It unfortunately needs a long mains lead, but this defect is more than counterbalanced by the fact that we can get some indication as to whether the aerial is a better radiator or not. Of course there are so many other points which govern the efficiency of an aerial, but even so, a radiation meter of this kind is a considerable help.

A Radiation Meter

If possible, we recommend amateurs permanently to fit an instrument of this kind externally, but to use a pre-set condenser for tuning. A meter reading can be taken and if at any time alterations are made to the transmitter or radiating system, the effect on the meter can be quickly noticed.

The difficulty of obtaining mains supply can easily be overcome by the use of heavy cable. After trying various instruments of this kind over long periods with all types of detectors, we have come to the conclusion that the Westector is not entirely suitable for very high-frequency use, which is only to be understood as the makers suggest 200 metres as the lowest practical wavelength. Even on 160 metres the output from the average cold detector is limited to 2-3 M/a.

A crystal rectifier of the semi-permanent type is fairly satisfactory, but the crystals have a tendency to oxidise so that the output as measured on the meter is not constant, although the initial current is high compared with the output from the diode.

The Golders Green and Hendon Radio and Scientific Society

The practical design of a 5-10 metre receiver suitable for the reception of television sound signals was the subject of a lecture given before this society by Mr. D. N. Corfield, D.L.C.

Several points were agreed upon. Anode bend detection is preferable to a diode as there is a better signal-noise ratio and less damping of the I.F. circuit, particularly when the receiver is to be used on both 5 and 10-metre bands.

A triode-hexode is most suitable for use as a frequency changer as there is no frequency drift when tuning signal frequency circuits while it is a good oscillator and has a high conversion gain.

It was also agreed that a radio-frequency amplifier reduced the strain on the I.F. amplifier and also at the same time reduced hiss.

It was suggested that the cathode of the R.F. amplifier be taken to a tapping on the tuned grid coil to obtain a certain amount of regeneration. A 10,000-ohm resistance was also used in place of the conventional H.F. choke which was taken to a tapping on the following tuning coil. This reduces the damping effect and is also an aid to selectivity.

The radio and oscillator circuits are separately tuned, dial setting being arranged so that they are in step at the top and bottom of the bands.

Horizontal aerials should not be used as the television signals are polarised horizontally, also this type is very sensitive to local disturbances.

Full details of this society can be obtained from the hon. secretary, Lieut.-Col. H. Ashley Scarlet, D.S.O., 60 Pattison Road, Hampstead, N.W.2.

A New Valve for the Higher Frequencies

A new valve that is fast becoming a "standard" for high-frequency work is the Taylor T-55, a carbon anode triode with a ceramic base and mount. Although rated to have an anode dissipation of 55 watts, a pair in push-pull at 5-metres will give over 300 watts as class "C" amplifiers.

The following characteristics will give some idea of the performance.

- Max. anode volts unmodulated D.C., 1,500 v.
- Max. anode volts modulated D.C., 1,500 v.
- Max. D.C. plate current, 150 M/a.
- Max. D.C. grid current, 40 M/a.
- Max. R.F. grid current, 5 amps.
- R.F. output, 168 watts.

This valve can be obtained from G2NO, Eves Radio, Ltd., 11 Litchfield Street, Wolverhampton.

Components for A DIODE-VALVE MONITOR METER.

BASEBOARD AND CABINET.

- 1.—Wooden baseboard 5½ × 5½ × 3/16 in. (Peto-Scott).
- 1.—Steel cabinet finished grey type 1121 (Burne-Jones).

COILS.

- 1.—Set 4-pin type E (B.T.S.).

CONDENSERS FIXED.

- 2.—.001 mfd. type tubular (Dubilier).

CONDENSERS, VARIABLE.

- 1.—.00025 mfd. type 1040 (Jackson Bros.).

DIAL.

- 1.—3-pin plain (Jackson Bros.).

HOLDERS, VALVE.

- 1.—5-pin type V19 (Bulgin).
- 1.—4-pin type V19 (Bulgin).

METER.

- 1.—0.6 M/a type 506 (Weston).

RESISTANCE, FIXED.

- 1.—2,000 ohm type Ohmite (Graham Farish).

SUNDRIES.

- 1.—Jack type J2 (Bulgin).
- 1.—Plug type P38 (Bulgin).
- 1.—Fuse holder type F11 (Bulgin).

SWITCHES.

- 2.—Type S80T (Bulgin).

TRANSFORMER, MAINS.

- 1.—Special filament transformer (Bryan Savage).

VALVE.

- 1.—Diode type V914 (Mazda).

HEADPHONES.

- 1.—Pair super sensitive (Ericsson).

FEBRUARY, 1937

Modern Amateur Communication Receivers

The amateur has a wide selection of commercial receivers from which to choose. The merits of some of the more popular sets are discussed in this article.

DESIGNERS of American receivers for amateur communication use appear to have standardised on certain important refinements. We notice that most of the popular receivers of the better type all include a beat frequency oscillator, bandspread tun-

sensitivity, selectivity and utter reliability.

One of the most popular receivers in the current season is the RME-69, a 9-valve super-het covering five amateur bands with complete band-spreading. A feature included that we would like to

out decreasing signal strength to any appreciable extent.

This receiver is a ruggedly built job that will stand any amount of hard usage, and as it can be obtained either with a standard chassis and panel or suitable for relay rack mounting, it is



The RME69 is fitted with an R meter calibrated in R strengths and micro-volts input.



Most amateurs would like to own a Super-Pro with its two R.F. stages and crystal filter. As shown it is housed in a metal case.

ing and have at least one radio frequency stage. Also a crystal filter is generally fitted and in every instance is an optional refinement.

At the present time every American amateur receiver is good value for money, and it is very difficult to point out one individual instrument as being outstanding in its class. Price seems to be the limiting factor, but we feel that any of the receivers to be dealt with are fully capable of handling the present congestion and to give high

see more generally used, is the calibrated microvolt-R meter, so that accurate reports can be given as to signal strength.

The tuning range is no less than 9 to 550 metres with the amateur bands grouped for the minimum amount of tuning. A crystal filter circuit is included and, for a change, it does give a decided increase in selectivity with-

deservedly popular amongst the transmitting amateurs.

At the other extreme of the price range is the Super Pro, the king of communication receivers. Using no less than 15 valves it is the accepted standard by the American services for it covers four amateur bands with perfect band-spreading.

Two radio-frequency stages provide

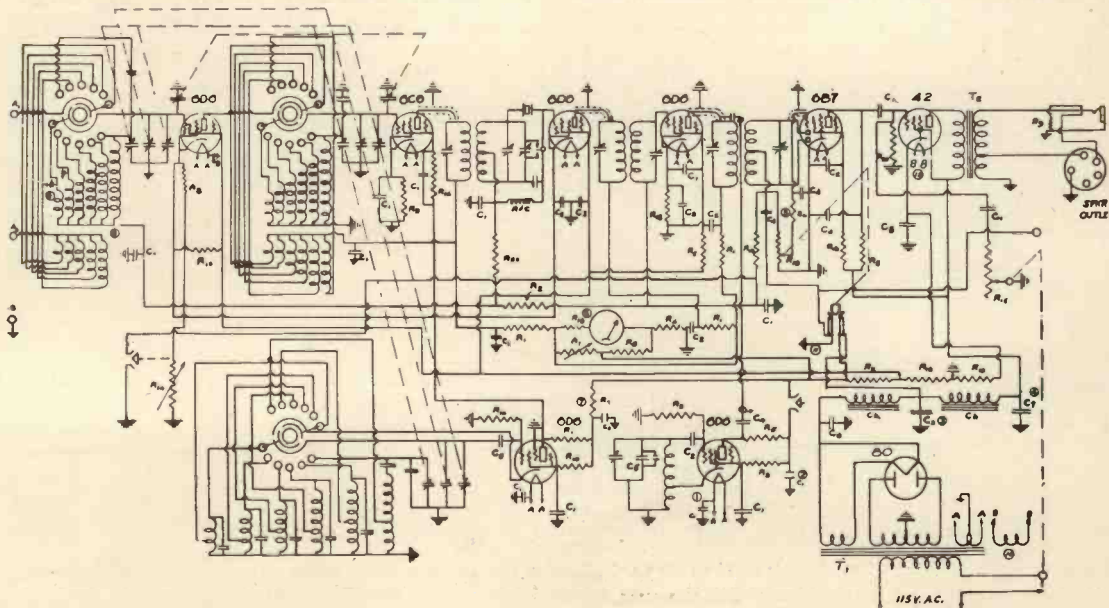

For those who are interested in American receiver design here is the circuit of the RME-69 one of the most popular sets of the season.

Receivers for Every Amateur Use

ample sensitivity, so much so that there is rarely need to use but a small percentage of the available gain from the three intermediate-frequency stages. As with the RME-69, a crystal filter is a most useful refinement, and as the selectivity is a variable factor, the crystal filter can be used for phone reception.

A beat-frequency oscillator is also a standard fitment, while the selectivity is of such a high order and the screening so perfect, that duplex working is extremely simple. The price, as is to be expected with a 15-valve receiver, is a trifle on the high side for those accustomed to British-built receivers, but the performance is above criticism.

With the increasing interest in ultra short-wave reception, the amateur is slowly realising that a special U.H.F. receiver is an essential part of every station. So far the most popular receiver for this work is the Ultra Sky-rider, which tunes from 3.76 to 53 metres. It covers four amateur bands, has one R.F. and two I.F. stages and uses no less than 10 valves, with a Lamb noise-silencing circuit in the I.F. stages. It is supplied with or without crystal as required. For reception of 5, 7, 10 and 20-metre bands it is ideal, while it must be remembered that the 40-metre band is also covered.

For the amateur with a limited purse, Hallicrafters have introduced two extremely new receivers in the Sky Buddy and the Sky Chief. The Sky Buddy is a 5-valve super-het covering 18 to 555 metres in three bands, with multi-electrode valves used so as to obtain maximum gain from the minimum number

of valves. This receiver is very low priced, but despite this it includes beat-frequency oscillator, band spread, switchable A.V.C., a built-in power

ments are beat-frequency oscillator, band spreading and a useful tuning indicator. The maximum frequency range is 17.6 mc., going up to .54 mc.

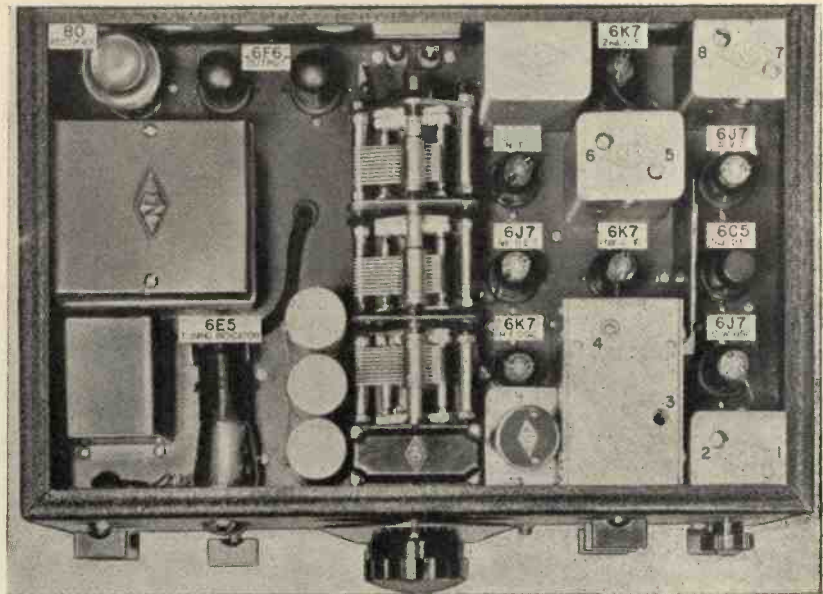

The National NC100X covers five amateur wavebands, gives an audio output of 10-watts and has an efficient crystal filter circuit.

supply and speaker, and provision for a doublet or straight aerial.

The Sky Chief, a slightly larger receiver with seven valves, covers four amateur bands and makes use of one radio-frequency and one-intermediate frequency stage. Amongst the refine-

This receiver is perhaps one of the most suitable for amateurs who cannot afford the multi-valve high-priced supers.

The NC-100X is reasonably well-known in this country and has been used by amateurs since its introduction. Details will be given next month.

Receiver Type	¹ NC-100X	¹ NC-101X	¹ One-Ten	² Sky Buddy	² Sky Chief	² SX-11	² S-10	³ Comet-Pro	³ Super-Pro	⁴ TOBE-7	⁵ RME-69
Min. Freq.	.54 Mc.	1.7 Mc.	30 Mc.	.55 Mc.	.54 Mc.	.535 Mc.	5.65 Mc.	.54 Mc.	.54 Mc.	1.8 Mc.	.55 Mc.
Max. Freq.	30 Mc.	30 Mc.	300 Mc.	16 Mc.	17.6 Mc.	40 Mc.	79.5 Mc.	30 Mc.	20 Mc.	14.5 Mc.	32 Mc.
Amateur Bands	5	5	4	4	4	5	4	5	4	4	5
R.F. Stages	1	1	1	—	1	1	1	—	2	1	1
I.F. Stages	2	2	Super-Regen Circuit	1	1	2	2	2	3	1	2
No. Valves	11	12	4	5	7	10	10	8	15	7	9
Crystal	Yes	Yes	No	No	No	Yes	No	Optional	Yes	No	Yes
Power Output	10 Watts.	10 Watts.	—	2.6 W.	2.6 W.	14 W.	4 W.	3 W.	15 W.	3 W.	2.6 W.
Signal Indicator	Yes	Yes	No	No	Yes	Yes	No	—	Yes	No	Yes
Band Spread	Yes	Yes	Yes	Yes	Yes	Yes	Yes	Yes	Yes	Yes	Yes
If Complete	Yes	Yes	Less Speaker & Power Unit	Yes	Yes	Less Speaker	Less Speaker	Less Speaker	Yes	Less Speaker	Yes
Power Consumption	105 W.	120 W.	—	40 W.	48 W.	125 W.	65 W.	—	—	40 W.	—
B.F.O.	Yes	Yes	No	Yes	Yes	Yes	Yes	Yes	Yes	Yes	Yes

1. National Co., Malden, Mass.
2. Hallicrafters Inc., Chicago.
3. Hammarlund Mfg. Co., New York City.
4. Tobe Deutchmann Corp., Canton, Ill.
5. Radio Mfg. Engineers, Peoria, Ill.

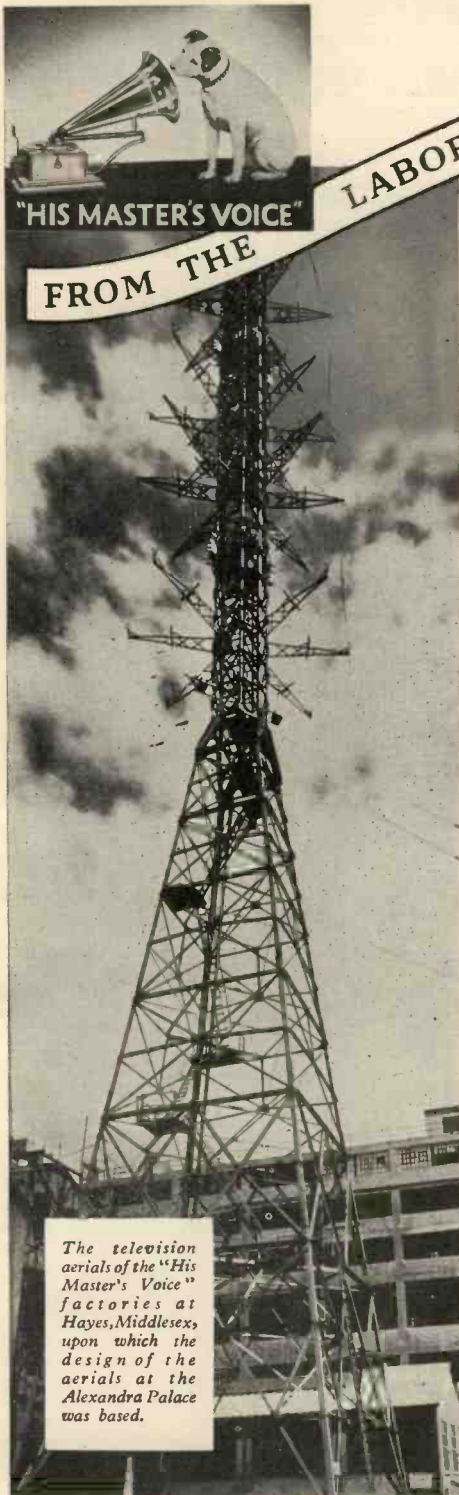

"HIS MASTER'S VOICE"
FROM THE

LABORATORY IN 1931 TO THE HOME IN 1937

"HIS MASTER'S VOICE"

The Pioneers of High Definition

TELEVISION

IN 1931 "His Master's Voice" gave the first demonstration of High Definition Television, and by High Definition is meant pictures with great detail.

"Television is only in the laboratory stage" said the "His Master's Voice" engineers, and for five years they worked in secrecy at Hayes, Middlesex, to bring Television to entertainment value for the home.

Now, with the installation at the Alexandra Palace of the Marconi-EMI system of Television, with its wonderful Emitron Camera, and absence of flicker, "His Master's Voice" engineers have reached their objective. At the same time they have designed the receivers illustrated on this page.

The "His Master's Voice" television receivers, Model 900 and Model 901, cost 120 gns. and 95 gns. respectively.

The circuits employed in both instruments for vision reception are electrically the same. Different sound receivers are incorporated. Model 901 has twenty-two valves in all, and has a receiver for the television sound transmissions only. Model 900 has twenty-three valves, including a five wave band all-wave receiver which enables the television sound programmes, or other broadcast programmes on the medium, long and short wave bands to be heard.

Both instruments have wide angle vision, that is, the pictures are seen in a mirror, and can thus be viewed by a number of people over a wide angle. No lens or other magnifying device is employed. 12" Cathode Ray receiving tubes are fitted which give a size of picture visually equivalent to that seen from the back seats of the average cinema.

The television aerials of the "His Master's Voice" factories at Hayes, Middlesex, upon which the design of the aerials at the Alexandra Palace was based.

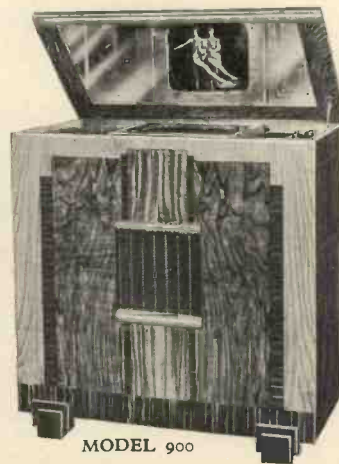

MODEL 900



MODEL 901

The "His Master's Voice" engineers who have designed these Television Receivers have devoted the same skill to the design of the new "His Master's Voice" All-Wave Radio Receivers and Radiograms. These Instruments give you the best reception of radio programmes from all parts of the world and cost from 9½ gns.

**FREE DETAILS OF 'H.M.V.' TELEVISION RECEIVERS AND
NON TECHNICAL EXPLANATION OF TELEVISION**

To "His Master's Voice," Television, 108T Clerkenwell Road, London, E.C.1.
I would like to receive your illustrated folder in colour, giving brief non-technical explanation of television and particulars of "His Master's Voice" television receivers.

NAME

ADDRESS.....

A New Range of Valves for Constructors

WE are pleased to be able to announce the introduction by the G.E.C. and Marconiphone Co.'s of an entirely new range of valves suitable for the home constructor. There are five valves in this range, sufficient

heater voltage has been maintained at 4 volts the current has been reduced from 1 amp to .6 amp. This means that the mains transformer can be reduced in size and that there is less possibility of voltage drop along connecting leads.

A high amplification factor triode type H42 has been introduced for use in the early stages of L.F. amplifiers. It is particularly suitable for R.C. coupling. The grid-cathode capacity has been kept very low as the grid connecting leads.

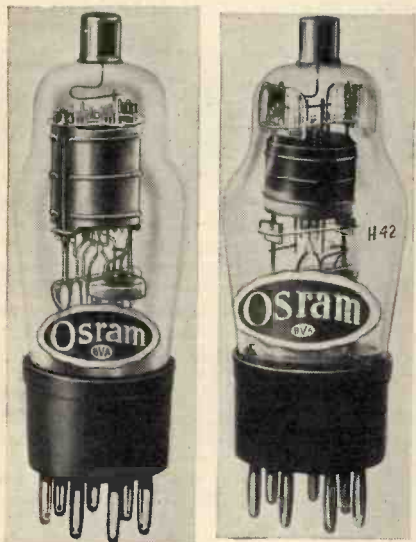

On the left is the X42 a variable-mu heptode with low inter-electrode capacity. On the right is the high gain triode with top cap grid connection.

for almost every type of receiver. The main virtue is extremely high order of reliability and characteristics close to the published figures. This has been made possible by embodying several new features and by special precautions in manufacture, closer tolerances have been made possible. A very high degree of consistency has been realised with these valves which should be greatly to the benefit of constructors of multi-valve receivers.

The heater wattage has been materially reduced with the exception of

Each of the new valves, with the exception of the output pentode, has the grid connection brought out to the top of the bulb, and although a standard 7-pin base is used, the connections are different from those used with standard pentode valves, etc. Another big advantage is the low value of grid cathode or input capacity which is permissible, so extending the tuning range for a given capacity of condenser.

The W42 is a variable-mu, H.F. screened pentode which operates with a screen voltage of 100 and a minimum grid bias of 3 volts. At these figures and an anode voltage of 250, the anode current is approximately 7.6 M/a and a screen current of 1.9 M/a.

With all the valves in this range no attempt has been made to secure a high value of mutual conductance, the aim being maximum stage gain with complete stability and a high order of con-



This is the N42 L.F. pentode with the W42 H.F. pentode on the right.

tion is made to the top cap. This feature prevents severe attenuation of the higher frequencies. Also the valve is entirely non-microphonic.

The heater current of the H42 is 0.6 amp and the valve has an amplification factor of 100 for a mutual conductance of 1.5 Ma/v when measured with 250 volts on the anode and -2 volts on the grid. With an anode load resistance of 250,000 ohms the stage gain is greater than 50 times.

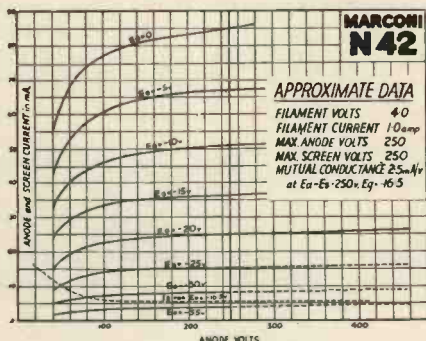

250 volts can be applied to both anode and screen of this pentode.

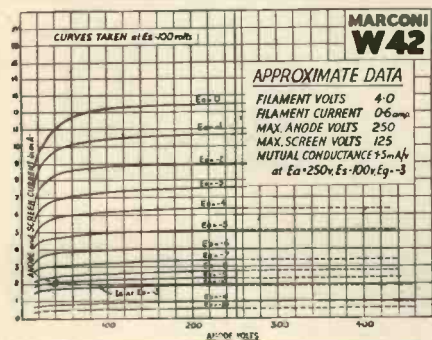

The W42 pentode is ideal for use in 2-stage amplifiers.

the output pentode which is maintained at 4 watts in order to give sufficient emission for a high audio output. In all other instances although the

sistency between valves. The mutual conductance is therefore rated at 1.5 M/a, but it should be remembered that this figure is obtained with 3 volts negative bias so that the actual stage gain with a suitable coil is as great as with many valves having a higher paper value of slope.

The X42 is a variable-mu heptode frequency changer with low inter-electrode capacity and economical in operation. It is suitable for use down to 15 metres on account of the short electrode assembly. It operates with a screen voltage of 100 and with a minimum grid voltage of -3, and under these conditions has a conversion conductance of 490 microhms, which is adequate for all normal purposes. A conventional type of tuned grid oscillator circuit is recommended with this valve.

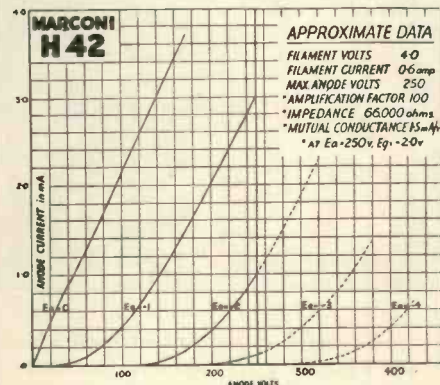

The H42 has an approximate amplification factor of 100.

A double-diode-triode type DH42 has a high gain triode section and is suitable for directly feeding an output pen-

(Continued on page 128)

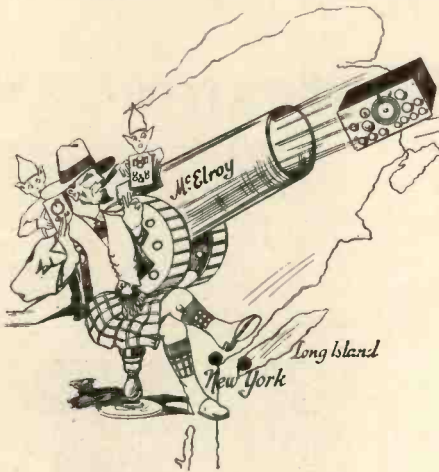

G2NO
H. R. ADAMS
WOLVERHAMPTON
and
WIJYN
TED. McELROY
BOSTON, MASS.



EVES RADIO LTD.

OFFER YOU SPEEDY EFFICIENT SERVICE ON ALL AMATEUR
RECEIVERS — COMPONENTS — TRANSMITTERS. BRITISH and AMERICAN.

New and Tried Components.

6L6-Glass or Metal Ideal EO (34 Watts RF) or class B.A.F. ...	7/6
THORDARSON CLASS B AUDIO TRANS. For 6L6 ...	28/-
RK.23 & 25. Still the best Pentode for U.H.F. ...	27/6
NEW RK.34-Twin Triode... ...	26/-
NEW RK.35-60 Watts R.F.... ...	50/-
TAYLOR T.55-170 Watts RF ...	45/-
TAYLOR 866 Rectifier ...	11/6
866A Rectifier... ...	27/6
WESTERN 316A (750 MG) ...	80/-

Amperex HF 100 Ultra HF.

Triode or Class B.Fil. 10 v. at 2 amps. mu. 23. Anode 1,500 v. RF. 200 watts.
Price : 57/-.

INCLUDE EDDYSTONE COMPONENTS IN YOUR ORDER. WE HAVE THEM ALL IN STOCK.

UTC DRIVER and CLASS B. TRANSFORMERS.

Type 30-46 or 59's to 46PP. ...	15/-
Type 34-46-59 or 6F6 to RF. Load...	18/-
Type 35-2A3 or 45 to 10's or 801's...	23/6
Type 36-210 and 801 to RF. Load ...	23/6
V.M.1. Mod. : Any Tube up to 60-watts. Class C ...	29/-
V.M.2. Any Tube to 120 watts ...	37/-
V.M.3. Up to 250 watts ...	58/-

BUILD FOR YOUR SHACK
A CATHODE RAY OSCILLOSCOPE

THE NEW MIDGET 913 Cathode Ray Tube.
Costs you 37/6
Operates on 250 v. and fits a valve-holder.
For complete Oscilloscope you need :—
913 Tube 37/6
Tube Base 2/-
Transformer 28/-
Rectifier and Base 6/6
Resistance. Cap. Kit 16/-
Complete Kit with Blue Print ... £4/10

SEND FOR DETAILS OF THE NEW HALLICRAFTERS & OTHER COMMUNICATION RECEIVERS

Phone Your Orders to :

G.2.N.O. Personally.
WOLVERHAMPTON 22886.
Office Hours :
(Phone Only Hi!!!!)
MON.-TUES.—9 a.m.—7.30 p.m.
WED.-FRI.-SAT. 9 a.m.—8 p.m.
THURS. 9 a.m.—1 p.m.
Phone after 7 p.m. for One Shilling.

Regular Stock Items.

McELROY Senior Key 35/-
The finest "Bug" made by our T. R. McElroy, World's Champion Telegraphist. (69 W.P.M. 1935 Brockton).

Regular Stock Items

HAMMARLUND COMPONENTS :

APC.50 Condensers	4/9
APC.100 „	5/6
SM. Midget 25 and 15 MMF. ...	3/-
50 and 100 MMF.	3/6
140 MMF.	4/-

HAMMARLUND PORCELAIN :

Tube Sockets all types	2/-
-------------------------------	-----

CARDWELL CONDENSERS :
Full range in stock including Split-Stator-Midget and Aerial Pads.

NATIONAL PRODUCTS :
Full stocks including :—

NAT. : Octal Tube Bases	2/-
RF. Chokes	2/3
NAT. : Acorn Sockets	4/9
NAT. : Oscilloscope Complete with Tubes... ..	£13/10
NAT. MC. 100 X	£39/10
RME. 69	£38/10
HRO. SENIOR	£48/15

METERS.

New HOWARD BUTLER Moving Coil. 2½ in. Flush or Projecting ... 25/-
(N.B.—These do not resonate at 7Mc.)
HOWARD BUTLER MOVING IRON 2½ in. Flush or Projecting ... 5/9
SEND 4d. FOR FULL LISTS.

G2NO ON THE AIR SINCE 1920—BUT—
Please respect License Conditions. Business cannot be discussed over the Air.
EVES RADIO LTD., 11 LICHFIELD STREET, WOLVERHAMPTON

Programmes for The Short-Wave Listener

By A. C. Weston.

Owners of all-wave receivers will find that there will be many more programmes to be heard on short-waves this year at times suitable for the English listener than ever before.

COLUMBIA, National and Mutual the three outstanding American broadcasting groups, are starting a number of programmes intended for reception in Europe at reasonable



Jack Miller leads Kate Smith's Orchestra. This is a popular act with American listeners.

hours, so listeners will not have to wait until last thing at night to hear typical American programmes.

Without question the most important series of broadcasts this year will be the Matinee relay from the Metropolitan Opera in New York. Popular operatic and screen favourites will be heard during these broadcasts, which are scheduled for 7 p.m. to 11.0 p.m. every Saturday night from Pittsburg.

I notice that Grace Moore and Gladys Swarthout are to be starred very frequently while many of the world's finest



Francis Langford is a regular broadcaster in the Hollywood Hotel programme, broadcast through Philadelphia.

voices have been picked up. This programme is the pride of the National Broadcasting Co., who are doing all

they can to make it acceptable to European listeners.

Every Friday from Boundbrook and Schenectady, Victor Moore and Helen Broderick are to be featured in a new type of comedy programme sustained by Buddy Rogers and his band.

A station heard on every receiver is Rome, which is on the air for nearly 18 hours a day. Listen to some of the variety from this station, for variety it is in every sense of the word. Not merely a collection of comedians, but a selection from the best items broadcast from the medium wave Italian stations. It is a good plan to switch on the receiver after 7 p.m. each evening to the 31-metre band and to check up on the programme from Rome.

Some Good Short-wavers

Boston	W1XAL	25.45/49.67
Huizen	PHI	16.88M.
Moscow	RNE	25.0M.
Paris	TPA2	19.68M.
Pittsburgh	W8XK	19.72M.
Pittsburgh	W8XK	25.26M.
Pittsburgh	W8XK	48.86M.
Rome	2RO	31.13M.
Schenectady	W2XAD	19.57M.
Schenectady	W2XAF	31.48M.
Zeesen	DJB	19.74M.

WLW, America's most powerful broadcast station, has a short-wave relay at Cincinnati with the call sign of W8XAL. Some good programmes can be obtained from this source, such as Harry Richman, supported by Freddie Rich, every Monday, Wednesday and Friday at 9 p.m.

Rubinoff is another star feature that comes on the air at 5.15 p.m. every Thursday. This is a very convenient time for English listeners.

The Five Star Revue, every Friday at 6.15 p.m., is a special Columbia presentation through their station W2XE in Wayne. In this revue are many well known stars, while guest artists come along without warning.

Jeanette Macdonald with Nelson Eddy are best heard through Philadelphia, from where they broadcast excerpts out of popular Broadway musicals. Wait up until midnight some Friday night and tune in this programme.

Tom Mix is still a firm favourite if fan mail is anything to go by. His broadcast every evening at 10.15 p.m. is to be a regular feature throughout 1937. He can be heard without much trouble over the General Electric stations at Schenectady.

Saturday night is one of the best periods of the week for American variety. At 8.30 p.m. is the week-end revue from Schenectady followed by Al Roth and his orchestra at 11 p.m.



This famous film star, Myrna Loy, needs no introduction. She is another of the artists heard in Hollywood Hotel.

from Philadelphia, with Saturday night Swing Club at 11.45 p.m. This programme features Bunny Berigan, who usually manages to persuade some interesting guest artists to come along and support him.

At midnight, when the B.B.C. has closed down, the "Saturday Night Party" from Cincinnati is too good to be missed. Jane Pickens, one of the Pickens' Sisters, is the M.C. of this half-hour programme, which takes the place of our "Music Hall" programme.

Organ Moods, from the Columbia



Listen to Al Jolson on Tuesdays at 10 p.m. supported by Martha Raye and Sid Silvers.

station Wayne, is just the type of programme people enjoy on Sunday afternoons. This feature comes on the air

(Continued on page 122)

PREMIER SUPPLY STORES

— THE LARGEST RADIO MAIL ORDER HOUSE IN EUROPE —

GET OUR QUOTATION FOR YOUR SHORT WAVE AND TELEVISION GEAR

Offer the following Set Manufacturers' Brand New Surplus Goods at a Fraction of the Original Cost; all goods guaranteed perfect; carr. paid over 5/-; under 5/- postage 6d. extra. Orders under 5/- cannot be sent C.O.D.

All Post Orders to— **Jubilee Works, 167, Lower Clapton Rd., London, E.5**

Callers, As Usual, to 20-22, HIGH ST., CLAPHAM, S.W.4 (Macaulay 2381) Phone: Amherst 4723
And 165 & 165a, FLEET ST., E.C.4 (Next door to Anderton's Hotel) Central 2833

Have you had our Giant Illustrated Catalogue and Valve List? Send 4d. in stamps for this amazing list of Bargains.

AMERICAN VALVES

HIGH-GRADE TRIAD for which we are sole British Distributors. The following types all 5/6 each: 2E5, 6E5, 2G5, 6G5, 6D7, 6E7, 6B6, 1A6, 1C6, 2A3, 2A5, 2A6, 2A7, 2B7, 6A4, 6A7, 6B7, 6C6, 6D6, 6F7, 00A, 01A, 11, 12, 15, 18, 19, 20, 22, 24A, 26, 27, 30, 31, 32, 33, 34, 35, 36, 37, 38, 39/44, 40, 41, 42, 43, 45, 46, 47, 51, 53, 55, 56, 57, 58, 59, 71A, 75, 76, 77, 78, 79, 80, 81, 82, 83, 84, 85, 89, V99, X99, 112A, 1V0, 5Z3, 12Z3, 25Y5, 25Z5, 6A6, 185R.

Also 6B5, High Gain Triode, will give 15 watts per pair in Push-Pull with only 300 anode volts, 5/6 each. All the new Metal-Glass Octal Base tubes: 6N7, 6L7, 6N6, 6A8, 6K7, 6I7, 6C5, 6Q7, 6F5, 524, 6D5, 6B6, 6H6, 6Z6 (at 6/6 each) 210 and 250, 8/6 each. 4-, 5-, 6- and 7-pin U.S.A. chassis mounting valveholders, 6d. each. Octal Bases, 9d. each.

EUROPA MAINS VALVES

Famous Europa 4 v. A.C. types, H.L., L., S.G., Var.-Mu-S.G., H.F.-Pens., Var.-Mu-H.F. Pens., 1, 3 and 4-watt A.C. directly-heated output Pentodes. Full-wave rectifiers, 250 v. 60 m.a. A.C./D.C. types. 20-volt 18 amp. S.G., Var.-Mu-S.G., H., HL., Power, and Pentode. All 4/6 each. Following Types. Full-wave rectifiers, 350 v. 120 m.a. and 500 v. 120 m.a. 2 1/2 watt indirectly-heated Pentodes. Frequency Changers, Octodes and Heptodes. Double Diode Triodes, all 5/6 each. 2 1/2 watt Directly Heated Triodes, 6/6 each.

BATTERY VALVES. 2 volts, H.F., L.F., 2/3. Power, Super-Power, 2/9. S.G. Var.-Mu-S.G., 4- or 5-pin Pentodes, H.F. Pens., Var.-Mu-H.F. Pens., 5/- Class B, 3/6.

PREMIER'S FAMOUS MAINS TRANSFORMERS

PREMIER wire-end type with screened primaries, tapped 200-250 v. Centre-tapped Filaments. Guaranteed one year. H.T. 8 & 9 or H.T. 10 with 4 v. 4 a. C.T. and 4 v. 1 a. C.T., 8/6. 250-250 v. 60 m.a. or 300-300 v. 4 v. 1 a., 4 v. 2 a. and 4 v. 4 a., all C.T., 8/6. 350-350 v. 120 m.a., 4 v. 1 a., 4 v. 2 a. and 4 v. 4 a., all C.T. 10/6. Any of these transformers with engraved panel and N.P. terminals, 1/6 extra. 500-500 v. 150 m.a., 4 v. 2-3 a., 4 v. 2-3 a., 4 v. 2-3 a., 4 v. 3-4 a., all C.T., 17/6.

Super-shrouded model, 21/- 500-500 v. 200 m.a., 5 v. 3 a., 4 v. 2 a., 4 v. 2 a., 4 v. 3-5 a., all C.T., 25/- (for use with 83 or 523 rectifier, cost only 5/6 to obtain 500 v. 200 m.a. smoothed).

500-500 v. 150 m.a., no L.T.'s, 12/6. 1,000-1,000 v. 150 m.a. no L.T.'s, 19/6.

SPECIAL OFFER. 350-350 v. 120 m.a. wire-end transformers with 4 v. 2 a. 4 v. 3-5 a., all C.T., 9/6 each.

AUTO TRANSFORMERS, step up or down, 60 watts, 7/6; 100 watts 10/-.

FILAMENT TRANSFORMERS, Tapped Primaries, 200-250 v. All secondaries C.T. 4 v. 3 a., 7/6; 4 v. 5 a., 8/6; 7.5 v. 3 a., 7/6; 6 v. 3 a., 7/6; 2.5 v. 8 a., 7/6; 6.3 v. 3 a., 7/6; 5 v. 3 a., 7/6.

SMOOTHING CHOKES, 25 ma. 2/9; 40 ma., 4/-; 60 ma., 5/6; 150 ma., 10/6. 2,500 ohms, 60 m.a. Speaker Replacement Chokes, 5/6. 250 m.a. Chokes, 21/-.

GIANT MULTI-RATIO OUTPUT TRANSFORMERS, 5 ratios—1:1, 1.5:1, 2:1, 2.5:1 and 3:1, 5/6 each.

COSSOR NEON TUNING INDICATORS, 3/6 each. .05 MICA CONDENSERS, 500 v. working 1/- each. .015 MICA, 1,000 v. working, 1/- each. 1 PAPER TUBULAR Condensers, 750 v. working, 1/- each.

PREMIER L.T. CHARGER KITS for A.C. mains, including Westinghouse Rectifiers and Tapped Mains Transformers. 8 volts at 1/2 amp., 14/6; 8 volts 1 a. 17/6; 15 volts 1 a., 19/-; 15 + 15 volts 1 a., 37/6; 15 + 15 + 15 volts 1 a., 50/-; 8 volts 2 a., 29/6.

TELSEN iron-cored screened coils, W.349, 4/- each. Electric **SOLDERING IRONS,** 200-250 v. A.C./D.C., 2/3.

LOTUS JACKS (and Jack-switches), all types, 1/- each. Lotus Plugs, 1/- each.

U.S.A. MIDGET 2-GANG (2 x .0005) CONDENSER with trimmers 3 1/2 in. wide, 2 1/2 in. long, 1/2 in. spindle, 3/4 in. long. 3/6 each.

SHORT-WAVE KITS

NEW 1937 1-VALVE SHORT-WAVE RECEIVER OR ADAPTOR KIT 13 to 86 metres without coil changing. Complete Kit and Circuit, 12/6. **VALVE GIVEN FREE!**

DE LUXE MODEL 14 to 150 metres, complete Kit with Chassis, 4 Coils and all parts, 17/6. **VALVE GIVEN FREE!**

SUPERHET CONVERTER KIT, 13/6. **S.W. SUPERHET CONVERTER,** for A.C. Mains Receivers, 20/- A.C. Valve given FREE!

NEW 1937 2-VALVE S.W. KIT, 13 to 86 metres without coil changing. Complete Kit and Circuit, 19/6. **VALVES GIVEN FREE! DE LUXE MODEL,** 14 to 150 metres, complete Kit and Chassis, 4 Coils and all parts, 25/- **VALVES GIVEN FREE!**

3-VALVE S.W. KIT, S.G., Det. and Pen., 42/- **VALVES GIVEN FREE!**

BAND-PASS TUNING PACK, comprising set of Telsen 3-gang iron-cored coils with switching, mounted on steel chassis with 3-gang condenser, illuminated disc-drive and 4 valve holders. 25/- the lot. All Mains or Battery circuit. **FREE!**

3-VALVE BAND-PASS KIT, 200-2,000 metres. Complete kit of parts, including chassis, all components, valves, M.C. speaker and wiring diagram. Battery Model, 50/- A.C. Mains Model, 70/-.

LISSEN ALL-WAVE COILS, 12-2,000 metres, complete with switching and wiring diagram. **Special Offer,** 6/11. 1936 **TELSEN** 3-gang iron-cored Band-Pass coils with integral switching, 200-2,000 metres, 12/6 set.

HIGH-GRADE Litz-wound I.F. Transformers with dual ceramic trimmers, 465 kc., 5/6 each.

PREMIER HIGH-FIDELITY P.A. AMPLIFIER KITS

3-WATT A.C. 2-stage AMPLIFIER for Mike or Pick-up. Complete Kit of Parts with 3 valves, 40/-.

7-WATT A.C./D.C. 3-stage AMPLIFIER. High-Gain, Push-Pull output. Complete Kit of Parts with 5 matched valves, 44 4s.

10-WATT A.C. 3-stage AMPLIFIER incorporating Phase-Inversion and Push-Pull Triodes. Enormous gain and straight line reproduction. Complete Kit of Parts, including 5 matched valves, 45 5s.

20-WATT A.C. 3-stage AMPLIFIER, suitable for largest dance hall. Employs new Giant Speech Transformer to ensure perfect reproduction. Complete Kit of Parts with 5 matched valves, 48 8s.

PREMIER TRANSVERSE-CURRENT MICROPHONE

Reisz pattern. Large output, exceptionally fine frequency response with low hiss level. Frequency range, 45-7,500 cycles, plus or minus 2DB, 30/- **Transformer,** 5/-; **Table Stand,** 7/6; **Adjustable Floor Stand,** 22/6.

ELECTROLYTICS. U.S.A., 4, 8 or 16 mfd. 530 v. peak, 1/9 each. Dubilier, 4 or 8 mfd. 500 v., 3/-; 50 mfd. 50 v., 1/9; 10 mfd. 50 v., 6d.; 25 mfd. 25 v., 1/- T.C.C. 4 or 8 mfd. 650 v., 4/-; 15 mfd. 50 or 100 v., 1/-; 50 mfd. 12 v., 1/- **Paper Condensers.** W. E. 250 v. working 4 mf., 2/-; 2 mf., 1/-; 1 mf., 6d.; 350 v. working 4 mf., 2/6; 2 mf., 1/6. Dubilier 500 v. working 4 mf., 4/-; 800 v. 4 mf. 6/-.

Wego 450 v. working, 2 mf., 1/9, 4 mf., 3/-; 700 v. working 2 mf., 2/-, 4 mf., 3/6.

Dubilier Oil-filled Condensers. Complete range in stock up to 3,000 volts working.

DIALS—Clarion illuminated S.W. slow-motion Dial with 2-in. knob, 2/- **Premier All-Wave 2-speed Dial,** full vision straight-line, dual ratios 10-1 and 150-1, 6/6, with escutcheon.

Potentiometers by well-known makers. All values up to 1 meg., 2/-; with switch 2/6.

TRANSFORMERS, latest type Telsen R.G.4 (list 12/6) 2/9. Lissen Hypermik Q.P.P. (list 12/6), 3/6.

OUTPUT TRANSFORMERS for Power or Pentode, 2/6; Multi-Ratio, 4/6; Push-Pull Input Transformers by prominent manufacturer 4/6 each.

ELIMINATOR KITS for A.C. mains. 120 v. 20 m.a., or 150 v. 25 m.a., 15/-, tapped S.G. det. and output. Complete kit with long-life valve rectifier (replacement cost only 2/-).

PREMIER H.T. KITS, all with Westinghouse rectifiers; tapped transformers and adequate smoothing. All Kits absolutely complete. 120 v. 20 m.a., 20/-; with 1/2 a. L.T. Charger, 28/-; 150 v. 30 m.a., 25/-; with 1/2 a. L.T. Charger, 31/6. 250 v. 60 m.a., with 4 v. 3 a. C.T., 30/-.

SHORT-WAVE COMPONENTS

SHORT-WAVE COILS, 4- and 6-pin types, 13-26, 22-47, 41-94, 78-170 metres, 1/9 each, with circuit. Special set of 3 S.W. Coils, 14-150 metres, 4/- set, with circuit. Premier 3-band S.W. Coil, 11-25, 19-43, 38-86 metres. Simplifies S.W. receiver construction, suitable any type circuit, 2/6. **COIL FORMERS,** in finest plastic material, 1 1/2 in. low-loss ribbed, 4- or 6-pin, 1/- each.

SUPER CERAMIC CONDENSERS, S.I.F. .00016, .0001, 2/9 each; double-spaced, .00005, .000025, .000015, 3/- each. All brass with integral slow motion. .00015 tuning, 3/9; .00015 reaction, 2/9. British Radiophone 2-gang .00016, 5/6.

H.F. CHOKES, S.W. 10-200 metres, 9d.; S.W. screened, 1/6; standard screened 180-2,000 metres, 1/6.

CERAMIC S.W. VALVE HOLDERS, 4-, 5- or 7-pin. Chassis type, 6d.; B.B. type, 8d.

GLASS AERIAL INSULATORS, 4d. each. **BEEHIVE STAND-OFF,** 6d. each. **SCREENED FLEX,** single, 3d. yd. Twin, 4d. yd.

METERS

MOVING-IRON flush type milliamper meters in 2 1/2-in. Bakelite Case, to read A.C. or D.C. Ranges, 10, 20, 30, 50, 100, 150, 250 and 500 m.a., also 1, 3, 5 and 10 amps., 6, 16 volts, all 5/9 each. 0-250 v., 8/6.

MOVING COIL METERS, 0-1 m.a., 2 1/2-in. flush Bakelite Case, resistance, 100 ohms, 18/6. Super model, 3 1/2-in. case, 22/6.

VOLTAGE MULTIPLIERS, any value, 1/- each. Tapped milliamper shunts for 10, 50, 100 and 200 m.a., 4/- each.

TELSEN MULTIMETERS, An extremely useful multi-range meter reading A.C. and D.C. Ranges, 8 v., 16 v., 240 v., 30 m.a. and 300 m.a., 8/6 each.

MOVING COIL SPEAKERS

MAGNAVOX. Mains energised. "154," 7-in. cone, 2,500 ohms 4 watts, 12/6; "152," 9-in. cone, 2,500 ohms 17/6; "152 Magna," 9-in. cone, 2,500 ohms 6 watts 37/6. Magnavox P.M.'s—"254," 7-in. cone, 16/6; "252," 9-in. cone, 22/6.

ROLA latest type P.M.'s, 18/6. **GOODMANS'** 8-in. mains energised, 1,000 ohms field, 10/6 each.

JENSEN P.M. Speakers, 10/6. R. and A. energised Speaker, 7 1/2-in. diameter, 2,500 ohms field. Pentode Transformer, strongly recommended, 11/6.

ENERGISING UNIT for any above energised speakers, 10/-.

MAGNAVOX "33," "33 Duodes" and "66" Speakers can always be supplied from stock.

GRAMOPHONE MOTORS

COLLARO Gramophone Unit, consisting of A.C. motor, 100-250 v. high-quality pick-up and volume control, 45/-; Collaro motor only, 30/-; Collaro Universal Gramophone Motor, 100-250 v. A.C./D.C., with high quality pick-up and volume control, 67/6; Collaro Universal Motor only, 49/6; **EDISON BELL** double-spring motors including turntable and all fittings, 15/-; **COSMOCORD** Gramo. unit, comprising A.C. motor pick-up and volume control (list 55/-), 35/9.

COSMOCORD PICK-UPS, with tonearm and volume control, 10/6 each.

PICK-UP HEADS only, 4/6 each.

TUBULAR CONDENSERS, non-inductive, all values up to 5 mfd., 6d. each.

Wire-end **RESISTORS,** any value, 1 watt, 6d.; 4 watts, 1/-; 8 watts, 1/6; 15 watts, 2/-; 25 watts, 2/6 each.

Reliable **MORSE KEYS** with Morse Code engraved on bakelite base, 2/- each.

Bakelite case **BUZZERS,** 1/6; Walnut case "Loud-tone," 2/6 each.

Super Quality lightweight **HEADPHONES,** 3/9 pair.

TELSEN BINOCULAR H.F. CHOKES, Bakelite case, 200-2,000 metres, 1/3 each.

TELEVISION RECTIFIERS for

H.T. & G.B. SUPPLY to CATHODE-RAY TUBES, TIME BASE UNITS, RECEIVERS, ETC., and DETECTION and A.V.C.

Specified again and again by designers in this journal . . . used by all the leading manufacturers of television receivers conclusive proof of the reliability and efficiency of the Westinghouse Metal Rectifiers. No matter in what circuit you may wish to use a rectifier, Westinghouse can provide a unit which will give you trouble-free service for years and years.

Remember a constant H.T. supply and distortionless detection are essentials to good pictures. Only Westinghouse can give them to you coupled with reliability.

Send 3d. for a copy of "THE ALL METAL WAY, 1937."



METAL RECTIFIERS
WESTINGHOUSE BRAKE & SIGNAL CO., LTD.
82, York Road, King's Cross, London, N.I.

MERVYN

produce a new and low priced amplified double
TIME BASE

Its very simplicity commends it for all serious work. Only first class components are used and constructional work is already completed; you have only the simple wiring to carry out.

By arrangement with "Television and Short-Wave World," full details on adjustment are given in this issue.

The low cost should enable everyone to build a reliable double time base.

Price £4 5 0 in kit form.

Standard valves and relays may be used and a list giving types are sent with every kit.

MERVYN the Television specialists are able to supply all television requirements such as vision receivers, sound sets, power packs, 4,000 volt units, control panel, and high voltage condensers.

Send your order to your dealer or direct to—

THE MERVYN SOUND and VISION CO., LTD.
4, HOLBORN PLACE, LONDON, W.C.1 Telephone: HOLborn 7709
Managing Director: **W. J. NOBBS, F.T.S., A.M.I.R.E.**

SIMPLICITY PROVED

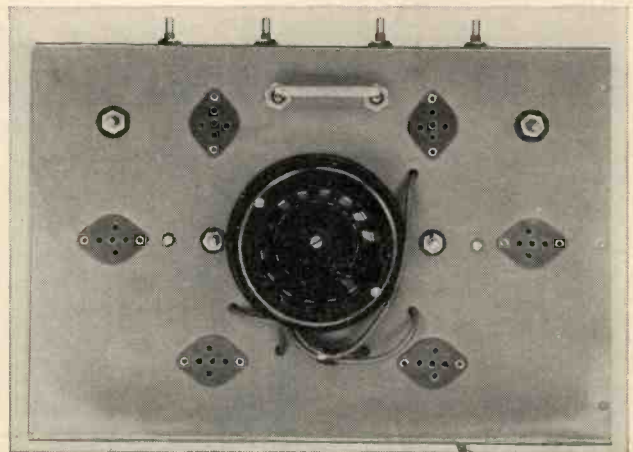

"I have just completed your new simplified Double Time Base, and I consider it a marvel of efficiency and cheapness." 14th January, 1937.

"For several months I have been trying out circuits infinitely more complicated and expensive, but none of them have worked with anything like such consistency as yours."

"It is the Time Base for the Television amateur!"

W.H.D.

This original and others may be inspected at our offices.

(Continued from page 120.)

Any pair of British valves, or in fact, almost any circuit giving an audio output of 400 milliwatts can be used to drive the 6L6's. A suggestion is that the Mazda ACP which will provide more than sufficient drive from a 250-volt power supply.

The class A-B input transformer is designed for a plate-to-plate load of 10,000 ohms into the class A-B grid. Bias for the output valves is taken from the bleeder resistance on the main H.T. supply but a low voltage level. The resistance is mounted on the actual modulator chassis and consists of a fixed resistance of 15,000 ohms and a variable unit of 1,000 ohms, both being of 10-watt rating.

Many amateurs will appreciate that the 6L6 valve can be driven from an existing amplifier so that the total cost of building a complete 60-watt modulator can be kept low. The following component values are suggested.

- R1 5 megohms.
- R2 .25 megohm.
- R3 50,000 ohms.
- R4 1 megohm.
- R5 2,500 ohms.
- R6 1,500 ohms.
- R7 750 ohms.
- R8 15,000 ohms.
- R9 1,000 ohms.
- R10 7,500 ohms.
- BC Mallory Bias Cell.

- C1 .5 mfd. 400 volt.
- C2 .02 mfd. 400 volt.
- C3 10 mfd. 400 volt.
- C4 8 mfd. 500 volt.
- C5 25 mfd. 50 volt.
- C6 8 mfd. 500 volt.
- T1 P.P. input 1-1 ratio.
- T2 P.P. inter-stage 1-1 ratio.
- T3 Driver transformer of suitable primary 1-1 ratio.
- T4 P.P. parallel 6L6's to R.F. load to carry class C current.

Programmes for the Short-wave Listener

(Continued from page 118.)

at 4 p.m. and is a good example of how the cinema organ can be adapted for popular music without introducing jazz effects.

Muriel Dickson stars in "Melody Matinee" from Boundbrook every Sunday at 6.30 p.m. In the words of the announcer: "This programme introduces a choice of the world's programmes."

A similar programme can be heard every Tuesday at 9.45 p.m. through Boundbrook when Andy Sanella introduces "Sweethearts of the Air." It consists of tuneful melodies played in a delightful manner with vocal refrains and sometimes poetry readings. Although poetry is not everybody's meat, when served up in this fashion I feel

sure it will prove popular over this side.

The formal opening of the American winter sports season opened with a relay from Lake Placid. A commentator puts over a fine picture of the Bob run, ski jumping and ice racing, and so popular was the relay that it is to be repeated over Schenectady from 2.30 to 3.30 p.m. every other Sunday.

Copenhagen specialises in outside broadcasts so make a point of listening to the short-wave relay through Skamlebaek on Friday and Saturday nights after 9 p.m. These times are a little elastic, but if you have to wait a little it will be well worth while.

A final item. Boundbrook on 16 metres have been putting out some surprise programmes during the afternoon from 3-4 p.m. They are not listed, but the programme is similar to the R.C.A. Magic Key broadcast every Sunday at 7 p.m.

British Phone to New Zealand

A good example of just what can be done with low-power phone is illustrated by the results being obtained by G6KV. This station has received a report from A listening station in New Zealand covering a period of no less than 4-months during which time G6KV was consistently heard at strengths of between R5 and R7.

Selected and Specified for

A DIODE-VALVE MONITOR METER

Three Resistances—one price: 120, 2,000 and 4,000 ohms.

15/-



Ericsson

SUPER SENSITIVE TELEPHONES

No wonder the designer of the Diode-Valve Monitor Meter featured in this issue chose Ericsson Telephones as indispensable. They are simply perfect for the 100 per cent. functioning of this set.

Wonderfully sensitive, comfortable in wear and very pure in tone, they have come to be regarded as standard for the keen short-wave enthusiast's equipment.

Use them with your Diode-Valve Monitor Meter.

At all good radio dealers. If you have any difficulty in procuring, write direct to:

ERICSSON TELEPHONES, LTD., 67-73, Kingsway, London, W.C.4, Eng.

Telephones: 3271/3 Holborn

STABILOVOLT

THE SOLUTION
TO UNSTABLE
SUPPLY VOLTAGE

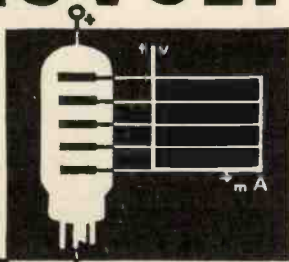

The Stabilovolt tube is a voltage dividing potentiometer and voltage regulator. The voltages tapped are independent to a precision of about .1% from the supply voltage variations, 1-2% from the varying current intensities tapped, .01% from one another. Currents up to 200 mA, voltages of unlimited values subdivided into parts of 70 volts each. Light in weight, small in size, simple and safe in operation.

Prices: Stabilovolt tubes from £1. 16. 0 to £62. Iron Barretters, for use with above, from 16s. to £1. 7. 6. Full particulars from:—

MARCONI'S
WIRELESS TELEGRAPH CO. LTD.
Electra House,
Victoria Embankment, W.C.2.

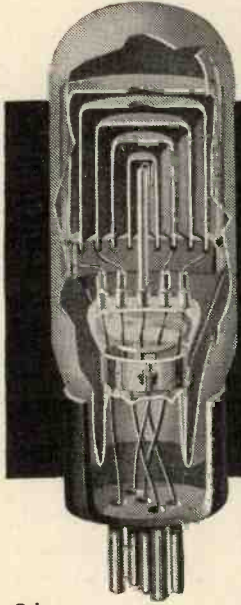

S2b

Do you possess this invaluable
mine of Information?

Henney's

RADIO ENGINEERING HANDBOOK

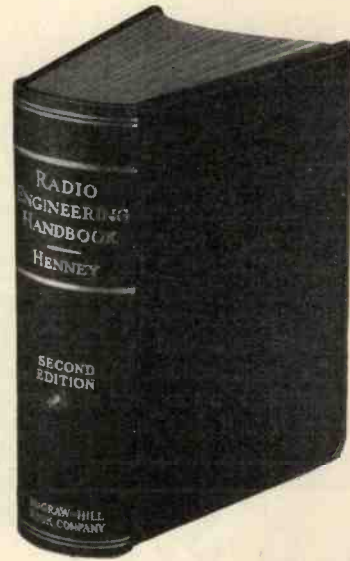

850 pages, 7 x 4½, many charts
and illustrations, 30/- net

"... a reference book which covers the whole field of radio engineering... can be thoroughly recommended."—*Radio Intelligence*.

"... a notable contribution to radio literature, and one fully to be recommended to every serious student of the subject, whether he be professional or amateur..."

—*Wireless Magazine*.

"An enormous amount of information in a concise form."—*Wireless World*.

"... a remarkable compendium of information of every kind relating to radio engineering." *Electrical Review*

"When an enthusiast begins to get advanced in his technical and practical knowledge of radio—and we know that many of our readers have reached this stage—the need is felt for some reference work which will give all the data that is likely to be required. The ground must be very wide, for no branch of radio must be overlooked. To those in search of such a work we would recommend the RADIO ENGINEERING HANDBOOK compiled by Keith Henry." *Popular Wireless*.

McGraw-Hill Publishing Co., Ltd.
Aldwych House London, W.C.2

AIRPLANE DRIVE

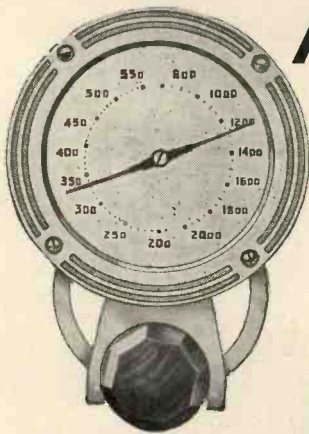

Large flush mounting scale with bold calibration. Escutcheon fitted with glass and supplied in Bronze or Chromium finish. Suitable for use with all J.B. condensers. (Cat. No. 2131). Dual Ratio Model (8-1 and 100-1), price 6/6.

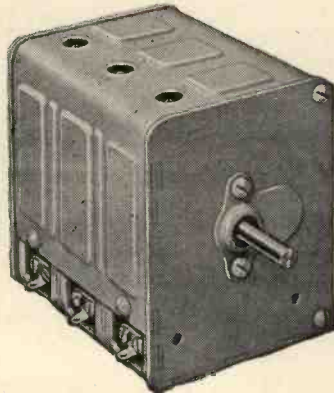

3-GANG "BABY"

This condenser is of very compact design, completely screened and with ball bearing spindle. Very smooth and reliable in operation. (1305. 3-gang baby. Type NT.) Price 15/-.



BOTH COMPONENTS WERE SPECIFIED FOR THE 4-VALVE ALL-WAVE SUPERHET DESCRIBED IN LAST MONTH'S ISSUE

JACKSON BROS. (LONDON) LTD.

72, St. Thomas St., S.E.1.
Telephone: Hop 1837

"Operating the Alternative Time Base"

(Continued from page 102)

be exercised to see that there is always at least 1 meg. fixed resistance in series at all times, otherwise there will be a danger of applying too high a voltage to the relays with consequent damage to them.

Self bias to the grids of the gas discharge relays may be obtained as follows.

A 500-ohm 1-watt resistance with a 50-mfd. 12-volt condenser across it should be taken one side to -H.T. and earth on the circuit diagram and the other side to -H.T. on the power unit. Thus the 500-ohm resistance is in series with the H.T. on the negative end. The condenser across this resistance is for smoothing and is necessary. The earth must be kept as shown in the circuit diagram.

The minus bias leads previously connected to the grid bias battery common to both sides should now be taken to -H.T. of the power unit and the battery dispensed with. It is advisable to conduct initial experiments with the bias battery.

Those who are on the same circuit A.C. mains as the transmission can experiment with mains synchronising for the frame frequency. Remove the usual synchronising feed and connect about 3 ft. of single lead to the grid of the frame relay. Hold the bare end between the fingers (there is no danger) and slightly adjust the bias control and the picture will usually jerk into synchronism. This is because A.C. mains hum is deliberately introduced to the grid of the relay. If the phases are correct it will only be necessary to bring the

lead from the relay close to a mains transformer. Even though not on the same A.C. mains as the transmitter it is worth experimenting for the experience gained.

Explanation of "Negative" Synchronism

As is usual, a positive pulse is required to be applied to the relay grid to provide efficient synchronism, and although the scheme outlined does apply a positive pulse, it does so in what might be termed a negative manner, as follows:—

As the relay approaches its "firing" point the relay grid is driven more negative by the arrival of a negative pulse (black in the picture) which is the synchronising signal. This prevents the relay firing, but immediately the synchronising pulse has passed the picture detail is being transmitted which, at its lowest value, is 30 per cent. of the carrier strength. Thus a strong positive pulse is applied to the relay, while it is in a critical state—a state we have automatically created. The relay then fires and any picture content will have no effect on the scanning.

It is, of course, necessary to apply just sufficient voltage to keep the grid in a more negative condition at the arrival of the synchronising pulse.

The value of the instantaneous picture signal immediately following the synchronising signal will not have any bearing on the relay firing point, as it will be clear that practically any positive signal immediately following the synchronising pulse will fire the relay. An advantage is that less strength is required and a valve can be dispensed with.

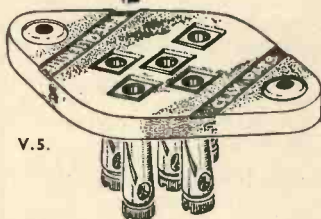

V.5.

CLIX VALVEHOLDERS

Two 7-pin 11d. each
Three 4-pin 8d. each
(Without Terminals)

As specified for the "Signal Booster"

Yours faithfully

LECTRO LINX LIMITED

79A ROCHESTER ROW. LONDON S.W.1

LOUD SPEAKER CONTROL PANEL

"A useful device and a valuable safeguard."

Vide: "Practical & Amateur Wireless," Sept. 12th, 1936.

"A useful device for fitting to a receiver so that an external loud speaker may be used in conjunction with the internal one, or without it, or the internal speaker used alone."

Vide: "The Wireless World," Nov. 27th, 1936.

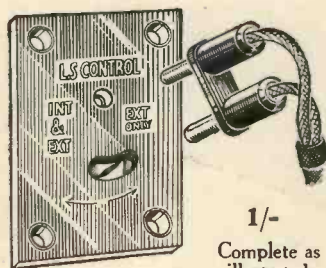

1/-

Complete as illustrated.

Folder "T.S." Free

Transformers for the Guaranteed Receiver

Will readers kindly note that all transformers for "Television's" Guaranteed Receiver can be obtained from W. Bryan Savage, Ltd., Westmorland Road, London, N.W.9.

Rotary Converters for Television

A.C. current is, of course, essential for the operation of television receivers, but in cases where A.C. mains are not available the difficulty can be overcome quite easily by the use of a rotary converter. Many installations of this nature are in operation in various districts where the mains supply is D.C. The Janette converter is an excellent instrument of this type and being equipped with a filter of exclusive design it is quite silent in operation and the results obtained are equal to those of mains supply. These converters can, of course, be used for a variety of purposes as, for example, radio, public address, gramophone amplifiers and neon signs. The Janette converter is marketed by Charles F. Ward, 46 Farringdon Street, E.C.4, who will furnish particulars of outputs and prices on request.

COMMUNICATION RECEIVERS

The New Hammarlund Super Pro, Model SP101X, with 8 metal and 8 glass tubes, power pack and Speaker	£70 0 0
National NC100, with power pack, valves and 10 in. Speaker in metal Cabinet	£35 0 0
National NC100X, with Crystal, power pack, valves, and 10 in. Speaker in metal Cabinet	£41 0 0
National AC.SW3, with valves, coils and power pack	£15 10 0
Ultra Skyrider, (3 to 51 metres) with noise silencer, valves and power pack	£34 0 0
R.M.E.69, with valves, power pack and separate Speaker in Cabinet	£41 0 0
Tobe Deutschmann Communication Set, for amateur bands only, with power pack, valves and speaker, built up	£17 10 0
A.C.S.-Kenco "Bug" Keys	£1 10 0
Johnson Q. 20 meter Antennae	£2 17 6
Shire Double-button Microphone on Desk Stand Spheroid Shure Non-Directional Crystal Microphone	£9 10 0
Amperite High Impedance Velocity Microphone	£7 7 0
Haynes Little Rig Checker, 200/240v.	£3 7 6

Also complete range of Raytheon and National Union Valves, and many bargains in re-conditioned receivers.

A.C.S. Ltd.

52/4, WIDMORE ROAD, BROMLEY, KENT.

*Phone : Ravensbourne 6156 (Two lines)
(20 minutes from Charing Cross).

HOURS—9 a.m. to 8 p.m.
Close Wed. 1 p.m.

★ Incorporates the Best

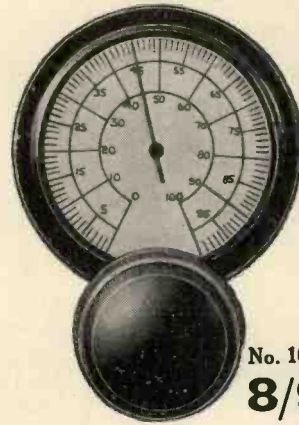

No. 1070
8/9

in DIAL DESIGN for MODERN Short Wave TUNING!

The movement can be mounted from panel or baseboard.

The dial is noiseless in operation even on the highest frequencies.

The open vision scale is clearly readable and divided in a new attractive manner into 100 divisions so that the indicating pointer has ample space for accurate settings.

The readings are arranged to increase as the frequency increases, which is in keeping with modern practice.

The movement is superbly smooth in action without backlash on both the 20-1 and the 100-1 speeds.

The dial face fits on the front of the panel so that no large panel gap has to be cut unless it is desired to illuminate the scale from the back!

The dial can be used on panels up to 1/2" thick and takes the standard 1/4" spindle.

The escutcheon has a simple dignified appearance and is beautifully finished in oxidised silver relief.

EDDYSTONE FULL VISION DUAL SPEED DIAL

Sole Manufacturers : STRATTON & CO., LTD., Eddystone Works, Birmingham
London Service Depot : Webb's Radio, 14, Soho Street, Oxford Street, W.1

For Television Equipment

the BEST

is only
just good
enough



Nowhere are really high-grade components more essential than in television equipment. That is why Television so frequently specifies Savage transformers and chokes for their circuits. You cannot do better than follow their lead. Here are this month's specifications :

DIODE VALVE MONITOR METER : Special Savage Mains Filament transformer, Price 8/6. MODULATED OSCILLATOR : Savage L34M 28 henry choke, Price 13/-. Special Savage Mains transformer, 250-0-250 volts 60 m/a, 2-0-2 volts 1 amp., 2-0-2 volts 4 amps., Standard type, 25/-. Manufacturers' type, 20/-.

Order your Transformers and Chokes from



W BRYAN SAVAGE LIMITED.

Westmorland Rd., London, N.W.9. Phone: COLindale 7131

362

HIGH EFFICIENCY POWER VALVES

ACPX4A (12.5 Watts)	9/-
PX25 (25 Watts)	20/-
PX25A (25 Watts)	25/-
PX50 (50 Watts)	50/-
PX100 (100 Watts)	£5/0/0

FULL DETAILS AND NEW BOOKLET ON APPLICATION

THE
362 RADIO VALVE CO. LTD.
324/6 Liverpool Road,
Highbury, LONDON, N.7.
TEL. : NORTH 1853.

BIRMINGHAM RADIOMART
SHORT-WAVE SPECIALISTS
(G5NI)

**OFFERS THE LARGEST STOCK OF
HAM GEAR IN THE COUNTRY.**

Everything an amateur requires, including the 'hard-to-get parts and transmitting valves.' A stamped addressed envelope will bring you an immediate reply with prices.

RAYMART



**SHORT-WAVE
MANUAL**
(48 PAGES)

This comprehensive Manual contains 48 ages of practical circuits and data on Short-wave Receivers, transmitters, modulators, transceivers, etc., including information on transmitting licences, "class B" modulation, aerials, etc

Price with Catalogue 6d. or 7½d. post free.

RAYMART SHORT-WAVE CATALOGUE
Enlarged to three times its previous size and now the largest, most interesting and valuable Short-wave Catalogue published but still only 1½d. Post free.

RADIOMART (G5NI)

44, Holloway Head, Birmingham, I. Tel. : MID. 3254.

Again Specified!

You can rely upon Reliance wire-wound Potentiometers of precision

Specified for the :-

MODULATED OSCILLATOR
1 each; 10,000 and 15,000 ohms.

VALVE-VOLTMETER one 1,000 ohms.

SIGNAL BOOSTER. One Type VM, 50,000 ohms.

All the above.
4/6 each.

RELIANCE

THE PRODUCT OF
SPECIALISED RESEARCH
Folder "T.S." Free

RELIANCE MANUFACTURING CO (SOUTHWARK) LTD
WESTBURY ROAD, LONDON E17

Read

**Television and
Short-wave World**

Regularly

Mobile Short-wave Equipment

By MALCOLM HARVEY

Amateurs who make a point of attending field days or any meeting of short-wave listeners, will appreciate the design of this simple mobile receiver that has been fitted to a motor-cycle.

ANYONE who has carried a short-wave receiver plus accumulator and the rest of the power supply will appreciate this description of a truly portable short-waver that has been attached to a motor cycle for general field-day work. The design, of course, is such that it lends itself to

valve receiver and use a midget 60-volt high-tension battery, but this cannot be termed entirely satisfactory, although there is no reason just why portable short-wavers should not be as effective as a fixed receiver operating from A.C. mains.

We have built a most efficient four-

This scheme lends itself to most types of motor-cycles but an alternative idea is to mount the entire equipment in cases on either side of the rear wheel.

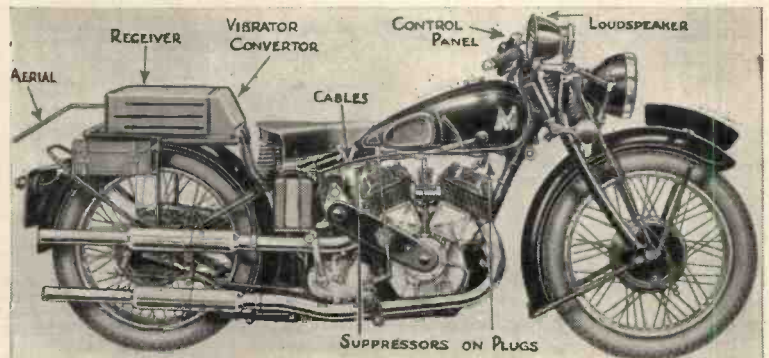

modification, so that it could even be fitted to a bicycle or, of course, a motor car.

One of the biggest problems that confronts the amateur who wants to listen to short-wave stations in various

valve super-het using A.C.-D.C. valves that are fed from a vibrator converter giving 250 volts at 60 ma. In turn this converter is energised from a 6-volt accumulator which is part of the standard motor cycle lighting set.

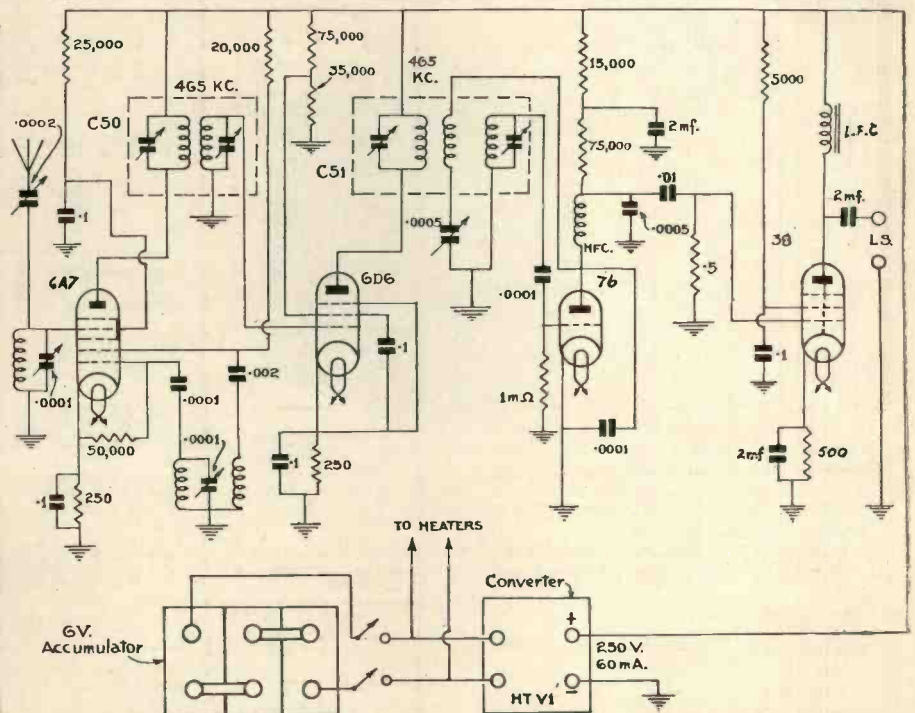

There is only one control in this circuit for the aerial and regeneration condensers are pre-set.

parts of the country is how to obtain the necessary power supply.

Most amateurs build a small two-

The illustration shows just how the receiver and accessories are mounted, but very probably modifications will

FEBRUARY, 1937

have to be made to suit different types of machines.

First of all, the receiver is mounted in a metal container 12 ins. long by 6 ins. deep and 6½ ins. in height. The vibrator convertor with its transformer and smoothing pack is mounted in a separate container bolted to the end of the receiver case. Six leads are needed, two for the accumulator, two for switching, and two for the loudspeaker.

The important part, at this juncture, is the receiver used. American valves have been used throughout, so the total current consumption can be kept to a low order. In the first stage is a pentagrid detector oscillator using a 6A7 followed by a 6D6 intermediate-frequency amplifier, 76 triode leaky grid detector and 38 power pentode output.

These valves consume only a little over 1 ampere filament current at 6 volts, while the total anode consumption is within the capabilities of the vibrator convertor so, to all intents and purposes, the receiver should be as good as one operating entirely from A.C. mains. The next point of importance is the chassis. This should be cut so that it is a loose fit in the metal case, for this chassis is mounted on thick rubber sponge so it is entirely independent of the main case which has to be bolted to the carrier of the motor cycle.

Controls, which consist of a midget two-gang condenser, a pre-set aerial series condenser and a pre-set regeneration control, are mounted on top of the receiver chassis. When the lid of the case is removed, all controls are exposed to view.

A volume control, consisting of a 10,000-ohm variable resistance, is connected across the loudspeaker. Also, as this control has a make-and-break switch as an integral part, volume and on-off control are mounted together.

The loudspeaker consists of a W.B. midget, which is mounted in an old motor cycle head lamp casing, which leaves enough room towards the back of the case to house the volume control and switch.

Construction of the receiver is quite a simple matter. The 6A7 is mounted horizontally with a screen across the

(Continued on page 128.)



OUR NEW CATALOGUE of Short-wave components. 24 pages fully illustrated. 1½d. post free.

THE QUARTZ CRYSTAL CO., LTD.
63 & 71, Kingston Road, New Malden, Surrey
Telephone: MALDEN 0334.

PIEZO QUARTZ CRYSTALS

1.7 mc., 3.5 mc., and 7.0 mc., Amateur Bands.

Power Type Standard Type
20/- post free. 15/- post free

CRYSTAL HOLDERS:—
Type A, Open Electrodes, 4s. 6d. post free.

Type B, Totally enclosed and dustproof, 8s. 6d. post free.

GALPINS ELECTRICAL STORES

75, LEE HIGH ROAD,
LEWISHAM, LONDON, S.E.13

Terms: Cash with order or C.O.D.

TELE.: LEE GREEN 5240

DYNAMO BY "CROMPTON," shunt wound, four pole, output 50/75 v. 25/20 amps., £4 10s.

TRANSMITTING VARIABLE CONDENSERS, .0005 m. glass case type, 12/6.

FLUORESCENT SCREEN, 17 x 14 in., framed, as new and complete with protected mounting frame, £3 10s. C/F.

X-RAY TUBES, new condition, with Tungsten Target, 15/-; with Platinum Target, 20/- C/F. Packing free.

EX-R.A.F. MORSE KEYS, fully adjustable, price 2/6. Post 6d.

WESTERN ELECTRIC MICROPHONES, solid back type, very sensitive, 2/6 each.

MICROPHONE TRANSFORMERS, high ratio, finest quality, 2/6 each.

ELECTRIC LIGHT CHECK METERS, Maker, "Ferranti," 1 kilowatt-hour type, 200/250 v. single phase 50 cycle, for subletting, etc., 6/- each. Post 1/-.

MULTIPLE SWITCH, with sensitive actuating Relay, as new, ex. automatic phones, 4/6 each.

VARIABLE RESISTANCES, 300 ohms ½ amp., 20 studs, small size, 12/6.

DYNAMOS for Lighting or Charging, all shunt wound, fully guaranteed, 150 v. 1 a., 17/6; 20 v. 5 a., compound, 30/-; all C/F.

CHARGING RESISTANCES or Shunt Regulators. Stud, switcharm type, 12/6 each, to suit your requirements.

C.A.V. AUTOMATIC CHARGING CUT-OUTS, suit any voltage, 7/6 each.

ISENTHAL VARIABLE RESISTANCE, to carry 10 to 15 amps., fitted 0 to 15 a/meter and Pilot Lamp, as new, 17/- C/F.

G.P.O. GLASS TOP RELAYS, Type B, highly sensitive, 7/6 each.

DUPLIX TELEGRAPH MORSE KEYS, send-and-recvie type, 12/6.

BRIDGE TYPE GALVOS., horizontal type, super sensitive, fully calibrated scale, price 7/6. Post 6d.

BELLING ELECTRIC FIRES, 200/250 volts 2 kW., 2- or 3-bar type, in good condition, 10/- C/F.

MOVING COIL METER Movements for recalibrating into multirange meters, 5/6 each.

DIMMER SWITCH for 12 volt control, suitable for regulating electric trams, 12 v. lighting, etc., 2/6 each.

R.A.F. CHARGING CUT-OUTS, also fitted voltage regulators, fully adjustable, suitable for 12 to 20 volt charging dynamos, price 2/- Post 6d.

EX-R.A.F. TRANSMITTER, 3 valve (no valves), in case 12 x 8 x 6, short wave approx. 10 to 50 metres, 10/- Post 1/-.

EX-R.A.F. MICROPHONE TRANSFORMERS, various ratios, high grade, 3/6; Ditto. without case, 2/6.

VENNER TIME SWITCH, 250 volt 20 amp., 45-day clock, £3.

HIGH-VOLTAGE CONDENSERS, ½ mf., 2,500 v. test, 2/6, post 6d.; 005, 30,000 volt, oil, 15/-; 1 mf., 2,000 v. working, 3/6.

MAINS LIGHTING DIMMERS, Slider type, Worm and Wheel drive, 1 kW., 25/-; 2 kW., 32/6.

B.T.H. VARIABLE RESISTANCES, 250 ohms, 1 to 3 amps., 15/- C/F.

ZENITH VITREOUS RESISTANCES, 3,000 ohms, 200 mA., 2/-; 2,000 ohms, 100 mA., 1/-; 20,000 ohms, 50 mA., 1/6; 1,000 ohms, 200 mA., 1/3; 120 ohms, ½ amp., 1/- Post 3d.

TEAK BOXES, size 10 in. x 10 in. x 10 in., covered with waterproof canvas, fitted carrying strap and folding aluminium stand, condition new and unused, suitable for tool boxes, mounting all test meters, portable wireless sets, etc., price 1/8. Post 9d.

MAGNETIC KEY, on base 3½ in. by 7 in., triple contact, solenoid action, low voltage working, 2/6. Post 6d.

MULTIRANGE METER, moving coil, 3½ in. scale, reading 0-50 and 0-500 mA., also 0-5 and 0-50 volts, 20/-.

MORSE KEY and BUZZER (high note), complete on mahogany base with terminals, long bar key, solid brass construction; not a toy, but a serious G.P.O. type Morse practice set, price 5/- Post free.

VISUAL WAVEMETERS, 350 to 550 metres, 6/6.

TWO-VALVE AMPLIFIERS, with valves, suitable for Microphone or Gramophone, 7/6.

P.M. MOVING COIL Loudspeakers, 8-in. cone, fitted tone volume control. By well-known makers, 8/6 each. Post 9d.; Ditto, in walnut cabinet, 14/- Post Free.

WORKSHOP FLEX, twin, tough rubber-covered and braided, 5, 10 or 15 amp, 36-yard coils, 4/- each. Post Free.

PETO-SCOTT

THE ONLY FIRM with 17 YEARS' EXPERIENCE

in supplying the specialised requirements of the Constructor.

DO YOU KNOW? That you can obtain all your radio requirements from us, no matter whether it be odd components, complete kits, receivers or accessories. We are the oldest established Radio-by-Mail house in the Country and our 17 years' experience in supplying the home constructor and serious experimenter is at the service of our customers. You may order from us with complete confidence.

A.C. VALVE VOLTMETER

KIT "A" Cash or C.O.D. £3:0:0 yours 6/6
Carriage Paid for

Deposit 6/6 and 11 monthly payments of 6.6. Down Complete Kit, comprising all parts to specified valves, including undrilled enamelled steel chassis and B.T.S. Mains Transformer, excluding micro-ammeter, valves and cabinet.

- Peto-Scott crackle-finished steel cabinet, complete with detachable front, undrilled ... 10/6
- 2 Specified Valves, Mullard DW2 and PM20A ... 16/6
- Ferranti 0-500 micro-ammeter, type 99F ... £3

MODULATED OSCILLATOR

KIT "A" Cash or C.O.D. £6:15:0 yours 12/6
Carriage Paid for

Deposit 12/6 and 11 monthly payments of 12/6. Down Complete Kit, comprising all parts to specified valves, including undrilled crackle-finished steel panel and cabinet and specified mains transformer, but excluding valves.

- Set of 4 Specified Valves ... £2 12 0

FINISHED INSTRUMENT

Ready built and tested Modulated Oscillator, comprising all components to specified valves, built and tested by Peto-Scott's expert technicians and supplied complete in cabinet with valves, but uncalibrated. Cash or C.O.D. Carriage Paid ... £11:11:0 or £2:2:0 down and 11 monthly payments of 19/-.

Peto-Scott 5-metre TRANSCIEVER KIT PORTABLE TRANSMITTER and RECEIVER

Battery Operated
Establish radio communication with your friends—there's tremendous fun and entertainment in it. Start building your Transciever NOW. Full Building and operating Instructions with every Kit.

KIT "A" £2 12 6

Cash or C.O.D. Carriage Paid. Or 5/- down and 11 monthly payments of 4/10. Comprising drilled steel chassis and black panel, all necessary parts, including microphone, less valves, cabinet and batteries.

- Sensitive Microphone in spring mounting.
- Telephone Jack.
- Specially Designed Transformers for 5-metre band.
- Entirely Self-contained (except aerial).

KIT "B." As Kit "A," but including 2 Mazda Valves, less cabinet, aerial material, headphones, batteries, etc. Cash or C.O.D., Carriage Paid, £3 9 0 or 7/6 down and 11 monthly payments of 6/3.

KIT "C." As Kit "A," but including Valves, portable cabinet, headphones, 5-metre Dipole Aerial Material, H.T. Battery, Accumulator, G.B. Battery. Cash or C.O.D., Carriage Paid, £5 12 6 or 12/6 down and 11 monthly payments of 10/3.

FINISHED INSTRUMENT

Peto-Scott 5-Metre Portable Transciever ready built and tested by Peto-Scott technicians, and supplied complete with valves, aerial outfit, all batteries, headphones and in portable cabinet, approx. 11 in. by 9 in. by 7½ in. Cash or C.O.D., Carriage Paid, ... £7 7 0 or 20/- down and 11 monthly payments of 13/-.

PETO-SCOTT Co. Ltd. 77 (T.12.), City Road London, E.C.1.
Telephone: Chisold 9875
West End: 62 (T.12.), High Holborn, London, W.C.1.
EST. 1919.

(Continued from page 127)

centre. On one side of the valve and on either side of the screen are mounted the grid and oscillator coils and the two-gang tuning condensers on the opposite side, both sections being mutually screened.

Small I.F. transformers are required and these, of course, must be screened and have easily adjustable padders. Bulgin type C50 and C51 will be suitable and are essential if regeneration in the I.F. stage is to be used. The anode of the 6A7 is coupled to a C50 transformer in a conventional circuit, but the 6D6 pentode feeds into a C51 transformer which has a spare winding that can be used for regeneration. It was noticed that a .0005-mfd. baseboard mounting pre-set condenser could be adjusted to increase the gain in the I.F. stage and left set, so increasing gain at all frequencies.

Without A.V.C.

It would have been possible to have used a double-diode-triode as a second detector to give greater audio output and also an appreciable A.V.C. action, but it was not thought that the increased cost and complications were worth while.

A simple resistance-capacity network couples the detector to the output pentode, and in this circuit the pentode

valve gives approximately 2 watts of audio.

The choke filter output circuit prevents D.C. current being applied to the loud-speaker and also prevents any possibility of breakdown in the wiring, which is fastened to the under-side of the petrol tank. A suitable choke in this output circuit is a midget Bulgin type LF39.

The aerial coil is a conventional four-pin plug-in, while the oscillator, which has both grid and anode windings, is an Eddystone 6-pin high-frequency transformer. These coils are both tuned with a two-gang .0001-mfd. condenser, although if the receiver is only to be used on amateur bands, it is well worth while using 25-mfd. coupled midgets.

"A New Range of Valves for Constructors" (Continued from page 116)

tode of the N42 type. This latter valve is of the indirectly-heated type and when used as a Class A amplifier has a power output of 3 watts with 7 per cent. total harmonic distortion. This is obtained with a grid input peak voltage of 16.5 and a load resistance of 7,000 ohms. Two such valves used in Class A-B will provide 5.5 watts with a total harmonic distortion of 4 per cent. *using automatic bias.*

Additional characteristics for these valves are as follows:—W42 requires a

bias resistance of 300 ohms, has an optimum load of 100,000 ohms and is priced at 12s. 6d. The H42 with an amplification factor of 100 and impedance of 66,000 ohms has an optimum load of 200,000 ohms and is proved at 9s. 6d. The triode section of the DH42 has an impedance of 58,000 ohms, an amplification factor of 70, giving a slope of 1.2 Ma/v and requires a bias resistance of 2,700 ohms. The optimum load is 200,000 ohms and the valve has been priced at 12s. 6d.

250 volts can be applied to both anode and screen of the N42 output pentode which has a mutual conductance of 2.5 m/a per volt and requires a bias resistance of 420 ohms. The optimum load of this valve is 7,000 ohms and the price 13s. 6d. A suitable rectifier for use with all these valves is the U12 which is rated for an output of 120 M/a at 350-0-350 volts. It is directly heated and in many cases will feed a D.C. type of moving coil loud-speaker when the field coil is used as a smoothing choke.

Eliminoise Cable

Owing to the rise in prices of raw materials Messrs. Belling and Lee, Ltd., have been forced to increase the price of their Eliminoise cable.

The price increase will be from 8d. to 10d. per yard, the rather big increase being due mainly to the large amount of copper used in the construction of this cable.

T E S T B E R U

Throughout the four week-ends in February amateur stations in all parts of the British Empire will be competing in the greatest amateur radio contest of the year.

CONTEST TIME IS THE TESTING TIME FOR ALL NEW RECEIVERS, TRANSMITTERS, AERIALS, AND VALVES.

If you are not yet a member of the R.S.G.B. the organisation responsible for this, and many other National and International events, make your application to-day.

THE T & R BULLETIN PROVIDES MEMBERS WITH UP-TO-DATE INFORMATION ON EVERY ASPECT OF SHORT WAVE RECEPTION AND TRANSMISSION.

A specimen copy of the January issue of the "T & R Bulletin," together with the 130 page, Fourth Edition of "A Guide to Amateur Radio," will be sent Post Free to all interested readers on receipt of Postal Order for 1s. 6d.



Address all communications to:—

Secretary (Dept. S.W.) R.S.G.B.,
53, Victoria Street, London, S.W.1.

THE TELEVISION SOCIETY

[President: Sir AMBROSE FLEMING, M.A., D.Sc., F.R.S.]

Founded in 1927 for the furtherance of Study and Research in Television and allied Photo-electric Problems.

Ordinary Fellows are elected on a Certificate of Recommendation signed by Two Ordinary Fellows, the Proposer certifying his personal knowledge of the Candidate. The Admission Fee for Fellows is half-a-guinea, payable at the time of election, the Annual Subscription is £1, payable on election, and subsequently in advance on January 1st in each year, but the Annual Subscription may be compounded at any time by the payment of Ten Guineas.

Any person over 21, Interested In Television, may be eligible for the Associate Membership without technical qualifications, but must give some evidence of interest in the subject as shall satisfy the Committee. For Associate Members the Entrance Fee is 5/-, payable at the time of election, with Annual Subscription 15/-, payable in advance on January 1st in each year.

Student Members.—The Council has arranged for the entrance of persons under the age of 21 as Student Members, with Entrance Fee 2/6 and Annual Subscription 10/-, payable as above.

The Ordinary Meetings are held in London on the second Wednesday of the month (October to May Inclusive) at 7 p.m. The business of the meetings includes the reading and discussion of papers. A Summer Meeting is usually held, and affords Members the opportunity of inspecting laboratories, works, etc. A Research Committee and the preparation of An Index of Current Literature are active branches of the Society's work.

The Journal of the Television Society

is published three times a year. All members are entitled to a copy; and it is also sold to Non-Members, at an annual subscription of 15/- post free.

Forms of proposal for Membership, and further information regarding the Society, may be obtained on application to the General Secretary, J. J. Denton, 25, Lisburne Road, Hampstead, London, N.W.3.

JANETTE CONVERTERS
AND
PETROL ELECTRIC GENERATING PLANTS

The generating plants are available with AC or DC outputs, suitable for operating amplifiers, radios, etc., whilst they have undoubted advantages over a rotary converter and batteries, where a large output is required for PA work.



The JANETTE ROTARY CONVERTER

These machines are in use throughout the world, and possess an unrivalled reputation for reliability and efficiency. We have practically every normal type in stock, with inputs from 32 volts upwards. They are available with all-wave filter, suitable for operating a radio receiver from 5 metres upwards.

Sole Distributor:
CHAS. F. WARD 46, Farringdon St. LONDON, E.C.4
Tel: Holborn 9703.

FOYLES

BOOKSELLERS TO THE WORLD
Stock of nearly three million new and second-hand volumes. Catalogues free on mentioning your interests.
119-125 Charing Cross Rd., London, W.C.2.
Telephone: Gerrard 5660(12 lines)

Sound Sales, Ltd.	65
Stratton & Co., Ltd.	125
Television Society	128
Ward, Chas. F.	Cover iii
Westinghouse Brake & Signal Co.	121

TIME BASE for GUARANTEED C. R. RECEIVER
The Latest Simplified Electrical Scanner assembly, can be inspected in Kit Form. Price £4 5s.
30 Line experimental apparatus always in stock, Discs, Neons, Drums, etc.
Kerr Cell Electrodes. Price 15/-.
Complete Disc Receivers for Experimenters. Price 35/-.
TEST CONDENSERS for TELEVISION RESEARCH.

Standard Condensers in Mahogany Polished Cabinet. 4 Banks from .125 mfd. to 8 mfd. Total 39.375 mfd. Highly Finished, New Condition, Complete with Plugs. Price £5 10s.
Send for Prices of Wheatstone Bridges, Meggers, Ohm-meters, etc
H. E. SANDERS & CO. 4, Grays Inn Road, London, W.C.1. Tele.: Chancery 8778.

INDEX TO ADVERTISERS

	Page
A.C.S.	125
Baird Television	81
Belling & Lee, Ltd.	Cover ii
British Institute of Engineering Technology	Cover iii
Bulgin, A. F., & Co., Ltd.	65
Burne-Jones	Cover iii
Corpact Manufacturing Co.	Cover iii
Edison Swan Electric Co., Ltd.	66
Ericsson Telephones, Ltd.	122
Eves Radio	117
Ferranti, Ltd.	Cover ii
Fluxite, Ltd.	Cover ii
Foyle's	Cover iii
Galpin's	127
General Electric Co., Ltd.	82
H.M.V.	115
Jackson Bros.	123
Lectro Linx, Ltd.	124
Marconi	123
Maynes, Ltd.	Cover iii
McGraw-Hill Publishing Co.	123
Mervyn Sound & Vision Co.	121
Mullard	Cover iv
Peto Scott	127
Premier Supply Stores	119
Quartz Crystal Co.	127
Radio Resister Co.	65
Radio Society of Great Britain	128
362 Radio Valve Co.	125
Raymart Manufacturing Co.	126
Reliance Manufacturing Co.	126
Sanders, H. E., & Co.	Cover iii
Savage, Bryan	125

MISCELLANEOUS ADVERTISEMENTS

The charge for advertisements in these columns is 12 words or less 2/-, and 2d. for every additional word. All advertisements must be accompanied by remittance. Cheques and Postal Orders should be made payable to Bernard Jones Publications Ltd., and crossed, and should reach this office not later than the 15th of the month previous to date of issue.

JOHN SALTER of Featherstone Buildings, Holborn, W.C. Pioneer, since 1927, of Television components, will be pleased to hear from old friends and new customers requiring up-to-date apparatus.

"REVOLUTIONARY." "Interesting." New detector theory, system, circuits, book. Post free 1/1d. D'Arcy Ford, Gandy Street, Exeter.

HIGH CLASS TELEVISION CABINETS made to specification. C. Mostyn Ltd., Cabinet Manufacturers, 8-9, French Place, London, E.1. 'Phone: Bishopsgate 8784.

MEASURING INSTRUMENTS ON LOAN. In response to numerous requests we would remind experimenters of our Loan Service of Measuring Instruments such as Wheatstone Bridges, Meggers, Standard Resistances, Sub-standard Condensers etc., at very low rates. Send us your requirements: H. E. Sanders & Co., 4, Grays Inn Road, London, W.C.1. 'Phone: Chancery. 8778.

PATENT AND TRADE MARK AGENTS

GEE & CO. (Estab. 1905), patents and trade marks throughout the world (H. T. P. Gee, Mem R.S.G.B., A.M.I.R.E., etc.), 51-52, Chancery Lane, London, W.C.2 (2 doors from Government Patent Office.) 'Phone: Holborn 4547 (2 lines). Handbook free.

KINGS PATENT AGENCY LTD. (B. T. King, Patent Agent) 146a, Queen Victoria Street, London, E.C.4. ADVICE, Handbook and Consultations free Phone City 6161.

FOR SALE

EXPERIMENTER (going duty abroad) offers **brand new Bargains** :—Two 12 Inch **CATHODE RAY TUBES** (Ediswan 12H) **unused**, in makers crates. Cost £15/15/0 each. £12/15/0 each or £25 two. Also thyratrons, valves, condensers resistances, power transformers, etc., etc. State wants, stamp. No callers.—**Capt. C. Moynes**, 39 New Oxford St. W.C.1
Also **S.W. TRANSMITTING VALVES.**

The Corpact Manufacturing Company beg to advise their numerous clients that they are specialists in the manufacture of all types of Capacity Operated Switch Gear, and undertake the design and manufacture of Electrical Mechanical equipment requiring expert staff. Specialists in Burglar Alarm equipment, manufactured under our own Patents. Enquiries invited. Advertising capacity operated switches a speciality. Only address :—**THE CORPACT MANUFACTURING COMPANY, IVER, BUCKS.**

Owners of the registered Trade Mark "CORPACT."

BINDING CASES AND INDEXES FOR 1936

Binding cases and indexes for the 1936 volume of "Television and Short-Wave World" are now available. The binding cases are full brown cloth with stiff boards lettered in gold. The price, including the index, is 2/9 post free. Indexes may be obtained separately and the price is 6d. post free. Orders should be addressed—

BERNARD JONES PUBLICATIONS, LTD., CHANSITOR HOUSE, 37/38 CHANCERY LANE, LONDON, W.C.2 and should be accompanied by the remittance.

TELEVISION.

A NEW COURSE OF INSTRUCTION,

We have pleasure in announcing that our new "Television" Course has met with remarkable success. The enormous demand for the Course has shown, beyond any shadow of doubt, that it fills that long-felt need which we anticipated when we went to such trouble and expense in its preparation. We shall be happy to send full details of this special "Television" Course on request. Particulars are also available of other Courses in all branches of Wireless, Television, Talking Picture Engineering, etc., and of the easiest way in which to prepare for the A.M.I.E.E., A.M.I.W.T., A.M.I.R.E., etc., Examinations.

We teach by correspondence, and guarantee "NO PASS—NO FEE." Our Technical Consultant is Professor A. M. Low.

Send for full particulars to-day. Free and without obligation.

THE BRITISH INSTITUTE OF ENGINEERING TECHNOLOGY
337, SHAKESPEARE HOUSE, 17/19, STRATFORD PLACE, LONDON, W.1.

"TELEVISION'S" GUARANTEED CATHODE-RAY RECEIVER

SOUND AND VISION CHASSIS (METAL) TO DESIGNER'S SPECIFICATION

Price 7/6

POWER PACK METAL PROTECTING CASE

Price 10/-

TIME BASE CHASSIS TO SPECIFICATION

Price 10/-

METAL SCREENING BOX (TYPE 1121)

Price 5/-

Specified for "Diode-Valve Monitor Meter" described in this issue

BURNE-JONES & CO., LTD.

309/317 Borough High Street, LONDON, S.E.1.
Telephone: Hop 0495.

MULLARD
TYPE E46-12
FOR TELEVISION

PRICE

15 GNS



Mullard

CATHODE RAY TUBES

Mullard have held for years a unique position as pioneers in the Radio industry. Mullard Master Valve reputation is upheld in the new field of Television by the Mullard Cathode Ray Tubes. TYPE E46—12 FOR TELEVISION. Double Electrostatic Deflection. Sensitivity 650/v. Maximum Anode Volts 6,000 v. Screen 12", White. PRICE 15 GNS.

● A full list of Mullard Cathode Ray Tubes for Television and other purposes will be supplied upon application and we invite trade enquiries and queries.

Mullard Wireless Service Co., Ltd., Mullard House, 225, Tottenham Court Road, London, W.1

CVS-70