

APRIL 1968

# TAPE

RECORDING MAGAZINE

2<sup>1</sup>/<sub>2</sub>

**THE MAGAZINE**  
for  
**CREATIVE ENTHUSIASTS**

**FEATURES BY**

John Borwick    Douglas Brown  
Fred Judd        Denys Killick

**PLUS—** TEST BENCH    MUSIC REVIEWS  
NEW PRODUCTS    CROSS TALK, Etc.

*Second class postage paid at  
New York Post Office, N.Y.*

**AUDIO FAIR  
'68**

OFFICIAL LIST  
OF  
**Exhibitors**



# 2 Hours of music with the first quintuple-play cassette from BASF



Actual size of cassette C.120

With the BASF Compact Cassette C.120 you can record 2 hours of music—an hour on each track. Beat, Jazz, Pop—anything you like! You could, for example, make up a small tape library like this:—

5 BASF Compact Cassettes C.60=5

22½ hours of music—from the smallest library



BASF United Kingdom Limited,  
5a Gillespie Road, London N.5. Tel: 01-226 2011.

hours playing time. 5 BASF Compact Cassettes C.90=7½ hours. 5 Compact Cassettes C.120=10 hours.

You can then have 22½ hours of music filed together—Music as you like it. A cheap and practical tape library in the minimum space.

Ask your dealer about the new BASF Compact Cassettes C.60, C.90 and C.120. And remember, every cassette comes with a handy reference index which enables you to make a note of each recording—and quickly find it when you want to play it.

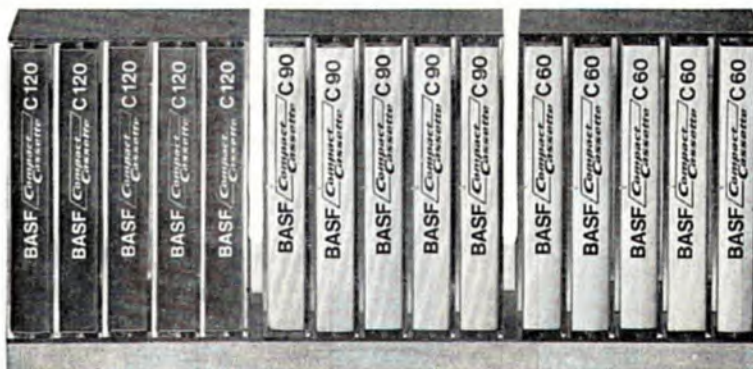

# Akai can think of 24 reasons why you should go for the new M9 stereo tape recorder

- 4-track stereo/monaural recording and playback.
- 3 speeds (1½, 3¼ and 7½ ips) plus 15 ips with 15 ips adaptor kit.
- 3 heads . . . CROSS-FIELD HEAD SYSTEM (Erase, recording playback and bias heads).
- Hysteresis synchronous 2-speed motor.
- High capacity 40W MUSIC POWER all silicon transistor amplifier.
- Shield Type head for high S/N ratio.
- Wide CROSS-FIELD frequency response.
- Sound on Sound.
- Automatic shut off, Automatic stop.
- Automatic pinch wheel release, Automatic lever release.
- Two lever system for sure operation and robust construction.
- Track selector knob for simple selection between stereo and monaural.
- Instant stop control with start button.
- Tape cleaner with release button.
- Recording mode switch.
- Tone controls.
- Bass switch.
- Equalizer for each tape speed.
- Tape shifter in fast forward/rewind operation.
- DIN jack, Stereo headphone jacks.
- Four digit index counter with reset button, VU meters.
- Finely oil-finished wooden cabinet.
- Vertical and horizontal operation.
- Universal voltage selector (from 100V to 240V; 50/60 cps).

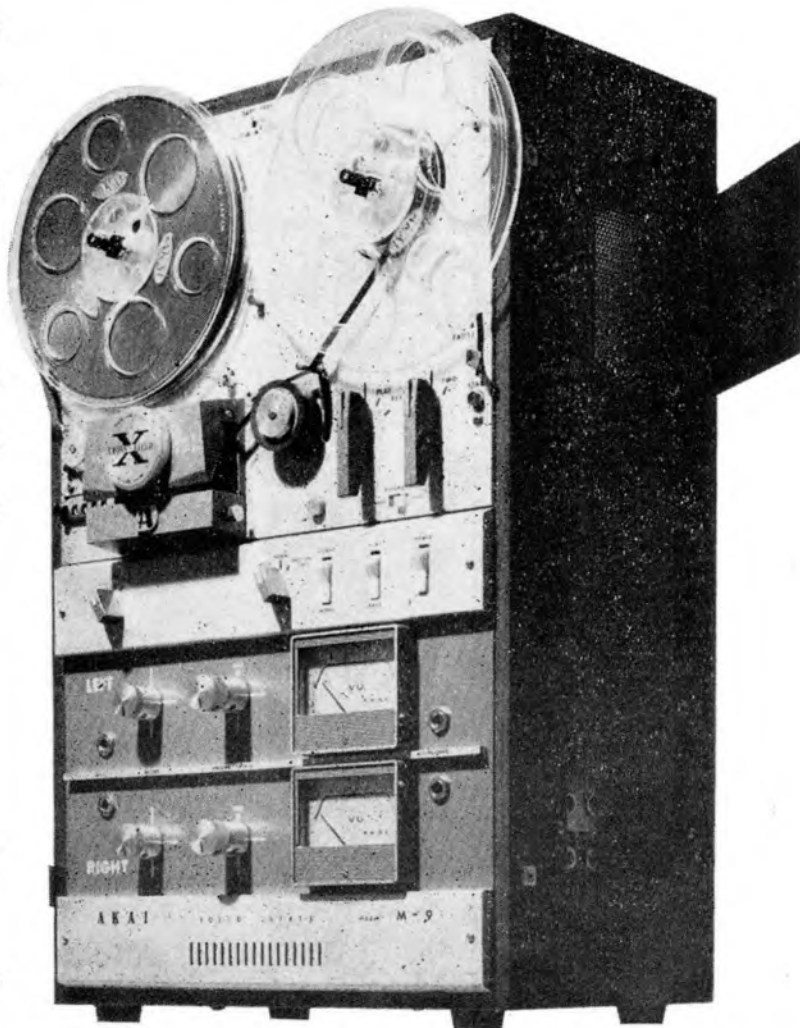

but you will probably choose it simply because it's the best.

## AKAI

 **PULLIN**  
PHOTOGRAPHIC

(A Company within the Rank Organisation)

To: PULLIN PHOTOGRAPHIC DEPT.  
11 Aintree Road, Perivale, Middx.

Please send me details of the TRM 4

NAME .....

ADDRESS .....

**IMMEDIATE DELIVERY!**

# K. J. ENTERPRISES

**EVERYTHING AUDIO!**

**BRITAIN'S PREMIER MAIL-ORDER RECORDING TAPE SPECIALISTS**

**IMMEDIATE 24 HOUR SERVICE ON ADVERTISED LINES**

**FULL CASH REFUND GUARANTEED**

**SEND TODAY AND SAVE!**

## BRANDED TAPES

**20% OFF**

**BASF—EMI—GRUNDIG—PHILIPS  
SCOTCH—AGFA—KODAK**

STANDARD PLAY	LIST PRICE	OUR PRICE
5" 600'	21/-	16/10
5½" 900' } Except	28/-	22/6
7" 1,200' } Agfa	35/-	28/-

LONG PLAY	LIST PRICE	OUR PRICE
3" 210'	9/-	7/3
(Not Scotch or Kodak)		
3" 300'	9/6	7/6
(Scotch only)		
3½" 300'	12/-	9/6
(Kodak only)		
4" 450'	14/6	11/8
(Except Kodak)		
4½" 600'	21/-	16/10
(BASF, Agfa only)		
*5" 900'	28/-	22/6
*5½" 1,200'	35/-	28/-
*7" 1,800'	50/-	35/-
8½" 2,400'	72/6	58/-
(BASF, Scotch only)		
10" 3,280'	85/-	68/-
(Agfa only)		
10" 3,600'	95/-	76/-
(BASF only)		
10½" 4,200'	112/-	90/-
(Agfa, BASF only)		

SCOTCH DYNARANGE (L/P)	LIST PRICE	OUR PRICE
5" 900'	32/3	25/10
5½" 1,200'	40/6	32/6
7" 1,800'	57/6	46/-
8½" 2,400'	83/6	66/10

COMPACT CASSETTES	LIST PRICE	OUR PRICE
C.60	17/6	14/-
C.90	25/-	20/-
C.120	33/6	27/-

Grundig Tape available only where marked with asterisk.  
Postage and Packing 2/-. ORDERS OVER £3 POST FREE

### FERROGRAPH TAPE—20% OFF!

Brand New. Fully guaranteed and in normal manufacturer's pack.	LIST PRICE	ONE	THREE	SIX
BN7 1,200' on 7" reel (Dynarange)	50/-	40/-	117/6	230/-
BN8 1,800' on 8½" reel (Dynarange)	71/-	57/-	168/-	330/-
BL7 1,800' on 7" reel (Dynarange)	70/-	56/-	165/-	324/-
BL8 2,400' on 8½" reel (Dynarange)	90/-	72/-	213/-	420/-

Post and Packing 2/-. ORDERS OVER £3 POST FREE.

### ILFORD TAPE NEAR HALF PRICE

A BULK PURCHASE OF PREMIUM GRADE, TOP QUALITY, POLYESTER MAGNETIC TAPE FROM ONE OF THE WORLD'S FOREMOST EXPERTS IN FILM COATING TECHNOLOGY, WITH FULL LEADER, STOP FOIL, POLYTHENE WRAPPING, AND IN ORIGINAL MANUFACTURER'S BOXES. AVAILABLE IN LONG-PLAY BASE ONLY AT THESE BARGAIN PRICES.

	One	Three	Six
900' on 5" reel	List Price 28/-	16/6	48/-
1800' on 7" reel	List Price 50/-	32/6	95/-

Please add 2/- P. & P. ORDERS OVER £3 POST FREE

### SENSATIONAL NEW HALF-PRICE OFFER!

A bulk purchase of top quality Recording Tape manufactured by one of the country's leading makers. A polyester based tape with superlife black coating. Polythene wrapped boxed and fully guaranteed. Available while stocks last in one size only.

1800' on 7" reel Long Play	Normal Value	ONE	THREE	SIX
	50/-	26/-	72/-	150/-

Postage and Packing 2/-. ORDERS OVER £3 POST FREE

### AMPEX TAPE 25% OFF

BRAND NEW, FULLY GUARANTEED & IN NORMAL MANUFACTURER'S PACK '500' SERIES AUDIO TAPE (MYLAR BASE)

TYPE	DESCRIPTION	LIST PRICE	ONE	THREE	SIX
541-9	900' L/P 5" reel	28/-	21/-	61/6	120/-
541-12	1,150' L/P 5½" reel	35/-	28/-	82/6	162/-
541-18	1,800' L/P 7" reel	50/-	32/6	96/-	189/-
551-12	1,200' D/P 5" reel	42/-	35/-	103/6	204/-
551-16	1,650' D/P 5½" reel	56/-	45/-	133/6	264/-
551-24	2,400' D/P 7" reel	72/6	55/-	163/6	324/-

'600' SERIES PROFESSIONAL AUDIO TAPE (MYLAR BASE)

	DESCRIPTION	LIST PRICE	ONE	THREE	SIX
641-9	900' L/P 5" reel	30/6	23/-	66/6	127/6
641-18	1,800' L/P 7" reel	52/6	39/6	116/-	226/-
651-12	1,200' D/P 5" reel	46/-	34/6	101/-	197/-
651-24	2,400' D/P 7" reel	80/-	60/-	177/-	348/-

Post & Packing 2/-. Orders over £3 Post Free

N.B.—OTHER TYPES & SIZES AVAILABLE INCLUDING THE INEXPENSIVE "WHITE BOX" SERIES

### SPECIAL OFFER COMPACT CASSETTES

**"MC 60"**

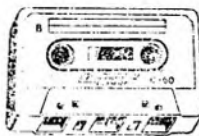

Compact Cassettes with 60 mins. playing time. Brand new and packed in normal plastic library box—available at this exceptional price.

NORMALLY 17/6 OUR PRICE 13/-

Standard pattern to fit Philips, Stella, Elizabethan, Dansette, Sanyo, etc.

3 for 38/3 6 for 75/- 12 for 144/-

Post & Packing 2/-

Orders over £3 Post Free

### BASF TAPE—30% Reduction

A SPECIAL OFFER OF THIS FAMOUS PREMIUM GRADE TAPE Brand new, boxed, with full leader, stop foil and polythene sealed. Multiples of three 4" size can be supplied in the BASF 3 compartment plastic library cassettes at no extra cost.

Type	Description	List Price	One	Three	Six
LGS 26	600' D/P 4" reel	25/-	17/-	49/-	93/-
LGS 26	1200' D/P 5" reel	42/-	29/6	86/-	166/-
LGS 26	1800' D/P 5½" reel	55/-	38/6	112/6	219/-
LGS 26	2400' D/P 7" reel	77/6	49/6	145/6	285/-

Post and Packing 2/-. ORDERS OVER £3 POST FREE.

### TRIPLE PLAY TAPE—40% OFF!

A large purchase from TWO world renowned manufacturers enables us to make this unique half-price offer. Brand new, fully guaranteed, premium grade Polyester Base Tape with FULL LEADER and stop foil. In original maker's boxes and polythene wrapped at these EXCEPTIONALLY LOW PRICES.

	List Price	One	Three	Six
450' on 3" reel Gevasonor	22/-	14/-	40/6	78/-
600' on 3" reel Gevasonor	27/6	17/6	51/-	99/-
900' on 4" reel Gevasonor	39/-	24/6	72/-	140/-
2400' on 5½" reel Zonal	90/-	55/6	165/-	324/-

Post and Packing 2/-, ORDERS OVER £3 POST FREE.

**20% off all Grundig and Philips equipment.**

SEND FOR LISTS OF OTHER TAPE AND HI-FI BARGAINS

**K. J. ENTERPRISES, (Dept. T), 17 THE BRIDGE, WEALDSTONE, MIDDLESEX (OPPOSITE HARROW & WEALDSTONE STATION) 01-427 0395 (CLOSED P.M. SAT.) REFUND GUARANTEE**

**FREE**

Our New Illustrated catalogue sent entirely free on request. Britain's most specialized comprehensive range of recording tape and accessories. 20,000 reels always in stock with reductions ranging up to 50%.

# New from Tandberg

## The Series 15

The new Series 15 combines Tandberg's world renowned qualities of faithful sound reproduction, reliability and compact modern design at a quite remarkably low price. It incorporates many superb features:—

- ★ Programme mixing facilities with separate controls for microphone and line inputs.
- ★ 10 watts output using an external speaker.
- ★ Volume control for monitoring whilst recording at loudspeaker level.

★ Loudspeaker selector switch providing choice of playback through internal speaker, or external speaker or both simultaneously.

- ★ Three speeds.
- ★ 4 digit illuminated counter with instant reset button.
- ★ Pause control gives instant stop/start.
- ★ Separate Bass and Treble lift and cut controls.
- ★ Signal to noise ratio 55db below maximum recording level.

★ Frequency response:—  
7½ ips : 30-20,000 Hz  
(± 2dB40-16,000 Hz)  
3¾ ips : 30-13,000 Hz  
(± 2dB50-10,000 Hz)  
1½ ips : 30-7,000 Hz  
(+ 2dB60-5,000 Hz)

Elstone Electronics Limited,  
Hereford House,  
Vicar Lane, Leeds 2.

# Tandberg

*move up to*

Series 15 from 69½ guineas.

# FRANCIS OF STREATHAM

## FOR A FAIR DEAL AND HONEST SERVICE

- ★ Minimum Deposit and no Interest or Service Charges on H.P. up to 18 months.
- ★ Free Service during Guaranteed Period.

EVERYTHING ADVERTISED IN STOCK

### MAINS RECORDERS

**AMPEX 753** professional Stereo Deck and Pre-amp. Transistorised. 3 speed. 4 Track. (Mics. extra.) **91**  
A special from Francis. gns.

Ampex 800 Series Stereo  
Ampex 1100 Stereo  
Ampex 2100 Stereo  
\*Akai 1710 Stereo  
\*Akai X-300 Stereo  
\*Akai 910 Mono  
\*Akai M.8 Stereo  
\*Akai 355 Stereo  
\*Beocord 2000 de luxe Stereo  
\*Beocord 1500 de luxe Stereo  
\*Brenell STB2 Stereo  
\*Brenell Mk.5/M Series IIII M.  
\*Brenell Mk.5 Series IIII Mono  
\*Ferrograph 633 Prof. Mono  
Ferguson 3230 Mono  
Ferguson 3224 Mono  
Ferguson 3232 Stereo 4 Tr.  
\*Ferrograph 631 Mono 2 Track  
\*Ferrograph 632/4 Stereo  
Fidelity Playtime 2 or 4 Tr. M.  
\*Grundig TK245 S/M pre-amp  
\*Grundig TK340 Stereo  
Grundig TK140 4 Tr. M 3 1/2  
Grundig TK120 2 Tr. M 3 1/2  
Grundig TK145 Auto 4 Tr. M  
Philips Cassette 3312 Stereo  
Philips 3310 Cassette Mono  
Philips 3575 St. 3 sp. 4 Track  
Philips 3576 M 4 Track 3 sp.  
Philips 4306 2 sp. 4 Tr. Auto M.  
Philips 4305 4 Tr. 2 sp. Mono  
\*Philips 4408 Pro. 3 sp. 4 tr. St.  
\*Revox 736 2/4 Tr. 2 sp. Stereo  
\*Revox 77 Stereo Transistor

Sanyo 929 4 Tr. 2 sp. St.  
Sanyo 939 4 Tr. 2 sp. St.  
\*Sanyo 999 3 sp. 4 Tr. St.  
(Speakers extra)  
\*Sanyo 800 3 sp. 4 Tr. St.  
PA/Deck  
Stella 462 Mono 4 Tr. 4 sp.  
Stella 463 Mono 4 Tr. 2 speed  
Stella Mains/Batt. Cassette  
\*Tandberg Ser. 6X St. PA & DK  
\*Tandberg Ser. 12 St. 3 sp. 2/4T  
\*Tandberg Ser. 8 St. 2 sp. 2/4T  
\*Tandberg Ser. 9 M 3 sp. 2/4Tr.  
Telefunken 200 Mono  
\*Telefunken 204 St. 4 Tr. 2 Sp.  
Telefunken 203 Ser. 50 M2/4Tr.  
Telefunken 201 Mono 4 Track  
Truvox 50 Series M 3 sp.  
Truvox R102 or R104 Mono  
\*Truvox PD102 or PD104 St.  
\*Uher Hi-Fi Spec. St. PA/DK  
2 speed 4 Track  
\*Uher Royal St. 4 sp. 4 Tr.  
Ultra 6212 Mono 4 Tr. 3 sp.  
\*Vortexion WVA 3 sp. 2 Tr. M.  
\*Vortexion WVB 3 sp. 2 Tr. M.  
\*Vortexion CBL 3 sp. 2 Tr. St.  
\*Wyndors Vanguard 3sp. 4Tr. M

### BATTERY MODELS

Akai X-IV 4 Tr. Stereo  
Loewe Opta 416 2 Tr. 2 sp. B/M  
Loewe Opta 450 Cassette B/M  
Philips EL3302 Cassette  
Philips 4200  
Sharp Batt/Mains 2 Tr. 2 sp. M  
Sony TC 800 2 Tr. 2 sp. M. B/M  
Stella 473 Cassette  
Telefunken 300 2 Tr. Mono  
Telefunken 302 4 Tr. 2 sp. M  
Uher 4000L 4 Tr. 2 sp. Mono  
\*Uher 4200/4400 2 sp. St.  
\*Microphones extra

### SPECIAL TAPE OFFER

Brand new Shamrock Tape.  
Top quality. Guaranteed.  
2,400; 7" spool ... 25/-  
1,800; 7" ... 21/-  
1,200 7" or 5 1/2" or 5" ... 15/-  
900; 5" ... 12/6  
600; 5" ... 10/-  
P/P 1/6 per reel. Orders for £3 or more sent post free.

### MICROPHONES, MIXERS

Hammond Condenser M100  
Grampian Reflector  
Grampian DP/4 Dynamic  
Reslo Ribbon  
AKG D.19C  
Eagle Mixer  
Hammond 5-way Mixer  
AKG K.50 Headphones  
Philips Pre-amp  
Microphones by ACOS, TELEFUNKEN, BEYER, FILM INDUSTRIES, also STANDS, BOOMS, etc.

### MAINS POWER PACKS

Philips, Stella or Cossor  
Telefunken 300 with cell  
Uher 4000, with cell  
PRE-RECORDED TAPES & CASSETTES by Columbia, H.M.V. and E.M.I. Bib and E.M.I. splicers. Matching transformers. Defluxers, etc., etc.

### Hi-Fi Dept.

- **AMPLIFIERS**  
Quad Rogers Leak Armstrong  
Tripleton Scott Truvox Nikko  
Goodman Ferguson Philips  
Arena Sinclair Tandberg  
"Huldra"
- **TUNERS**  
Quad Rogers Philips Leak  
Armstrong Tripletone Arena  
Nikko Arena Tandberg  
"Huldra"
- **LOUDSPEAKERS**  
Quad Rogers W.B. Kef  
Wharfedale Goodman Tannoy  
Lowther Leak Elac Truvox  
Ditton Philips
- **MOTORS, PICKUPS**  
Garrard incl. Thorens  
SP.25 401, etc. Tannoy  
Goldring Shure  
Connoisseur Empire  
Decca Sonotone  
SME Mk. II  
Philips BSR  
Ortofon Pickering  
Dual Euphonic  
All types of Diamond and Sapphire  
styli, stereo and mono, Microlifts,  
Garrard, Goldring and Acos Pressure  
Gauges, Disc Preener, Acos Dust Bug.
- **CABINETS** by Record Housing  
Clearview and G.K.D.

169-173 STREATHAM HIGH ROAD, LONDON, S.W.16

Between St. Leonard's Church  
and Streatham Station

01-769 0466/0192

Please note this is our only address ● Free Car Park in Prentis Rd.—2 mins. away  
OPEN ALL DAY SATURDAY—EARLY CLOSING WEDNESDAY

**GIFTS  
FOR AUDIO  
ENTHUSIASTS**  
or you may buy  
them for yourself

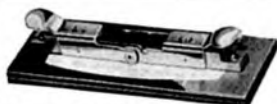

#### BIB RECORDING TAPE SPLICER

Invaluable for precise and easy splicing and editing of tapes and you can use those odd lengths of tape.  
Bib Tape Splicer is chrome plated, complete with razor cutter. Used by the professional studios. 18/6.



#### MODEL 8 BIB WIRE STRIPPER & CUTTER

Strips flex and cable without nicking the wire and cuts wires cleanly.  
Model 8 Bib Wire Stripper & Cutter is instantly adjusted for 8 gauges. 8/6. Model 3 is pre-set for any thickness. 4/-.



**BIB  
INSTRUMENT CLEANER**  
Cleans record players, tape recorders, metal, plastic and glass. Anti-static and non-flammable. Bib Instrument Cleaner. 4 oz. bot. 4/6.



**BIB TAPE HEAD MAINTENANCE KIT**  
Saves repair costs, ensures better recording and reproduction of reel and cassette recorders. Bib Tape Head Maintenance Kit has 2 each applicator and Polisher tools, 10 Applicator & Polisher sticks. Double-ended brush, packet of tissues and bottle of Bib Instrument Cleaner in plastic wallet. 12/6. Replacements available.



**BIB HOME ELECTRICIAN'S KIT**  
Electrical jobs are so easy if you have the Bib Home Electrician's Kit. In the plastic wallet are a Bib Model 8 Wire Stripper & Cutter, plastic insulating tape, plug size screwdriver, 5 and 15 amp. fuse wire, 3 Cable & Flex Shorteners and Ersin Multicore Tape Solder which melts with a match. 14/6.



**SIZE 15**  
Solder easily plugs and cables with 5 - Core Ersin Multicore Solder.  
Size 15 Dispenser contains 21 ft. of 60/40 22 s.w.g. solder. 3/-.



**BIB FLEX SHORTENER**  
Shorten without cutting, audio cables and flexes. Packet of 4 Bib Flex Shorteners 2/6.

All prices are recommended retail. Obtainable from most audio stockists. If in difficulty send cash with 2/- for postage and packing for orders less than 10/- and 2/6 for orders above 10/- (U.K. only) to:  
Bib Division, Multicore Solders Ltd., Hemel Hempstead, Herts.

# New from Tandberg

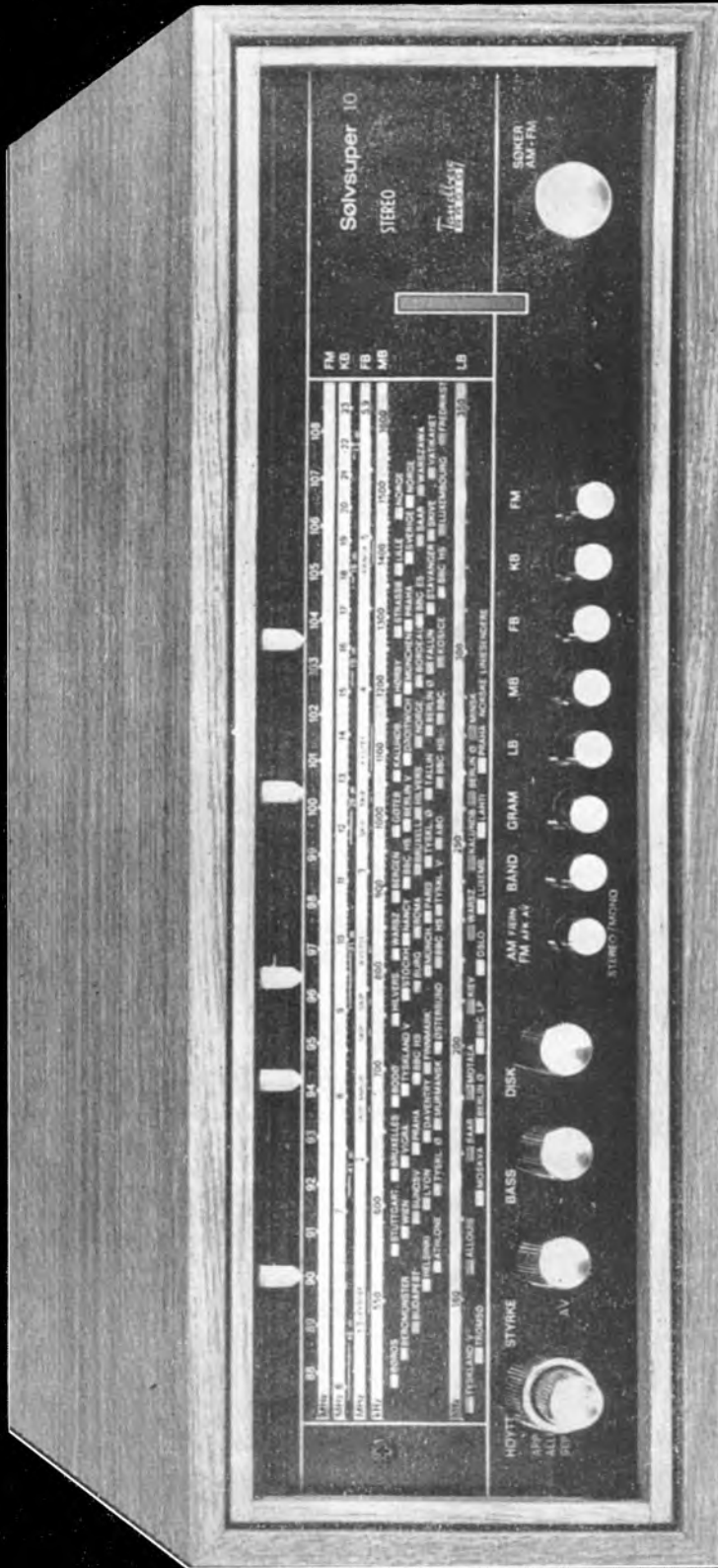

## Solvsuper 10.71 combined FM/AM Tuner and Stereo Amplifier

It's all there. Everything the heart of your Hi-Fi system should have. A 12 watt stereo amplifier. An exceptional FM/AM tuner with provision for a stereo reception decoder. Combined in an elegant low line teak case.

The Solvsuper 10.71 incorporates these features: —

- ★ 5 wavebands: long, medium, short, coastal and FM.
- ★ Automatic frequency control on FM.

- ★ Push button selection of wavebands, or external gramophone tape recorder etc.
- ★ Separate bass and treble controls.
- ★ Adjustable FM station indicators.
- ★ Separate gain controls on each channel.
- ★ Electronic beam tuning indicator.
- ★ 2 x 6 watts output.
- ★ 15" long x 9" wide x 5 1/4" high.
- ★ £65.0.0.

The Solvsuper is also available in two other versions: —

- 10.70 with a single built in speaker (mono) £57.0.0.
- 10.72 with two built in speakers (stereo) £71.0.0.

Elstone Electronics Limited,  
Hereford House,  
Vicar Lane, Leeds 2.

*move up to*  
**Tandberg**

\*See and hear Tandberg at the Audio Fair Stand 24, Demo Room 504

● **All on interest-free terms!**

Limited stocks of the Sensational **AKAI 3000D**

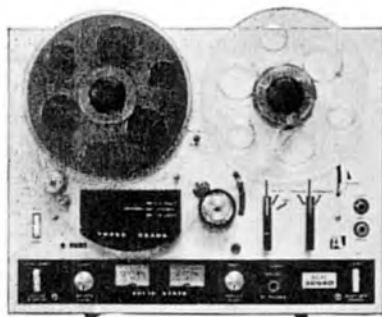

**PLUS—**  
Vinyl cover worth **£7.10.0!**  
**FREE!**  
with every **AKAI 3000D**

Superbly engineered, four tracks, two speeds Stereo Tape Deck Recorder. High quality, three-head system incorporates all-silicon transistor amplifier.

**81 gns. cash, or on interest-free terms, £21.6.0. deposit and 12 monthly payments of £5.6.3.**

**REW'S "buying know-how"**  
means pounds shillings  
and sense to you!

● **Delivery from stock!**

**NEW to this country—Fabulous AKAI M9**

**STEREO TAPE RECORDER**

This superb new machine, lavishly equipped with a wealth of facilities and capable of working to the very highest professional standards, is now in this country for the first time, and hard-to-get (we know—we bought most of the first available deliveries!)

Three speeds,  $7\frac{1}{2}$ ,  $3\frac{3}{4}$ ,  $1\frac{7}{8}$  i.p.s. Solid state, seven-inch reels, sound on sound facilities, automatic stop, automatic shut-off. Two Vu Meters and the famous cross-field head. Frequency response 30-23,000 c.p.s.  $\pm 3$ dB at  $7\frac{1}{2}$  i.p.s., 30-18,000 c.p.s.  $\pm 3$ dB at  $3\frac{3}{4}$  i.p.s. and 30-9,000 c.p.s. at  $1\frac{7}{8}$  i.p.s. Wow and flutter less than 0.15 per cent r.m.s. at  $7\frac{1}{2}$  i.p.s., less than 0.25 per cent r.m.s. at  $3\frac{3}{4}$  i.p.s., and less than 0.35 per cent r.m.s. at  $1\frac{7}{8}$  i.p.s. Signal/noise ratio better than 50 dB. Power output 8 watts per channel. For vertical or horizontal operation.

**£159 or on interest-free terms, £39.15.0. deposit and 12 monthly payments of £9.18.9.**



**SAVE 20 Gns.**

**REW'S price ONLY 86 GNS!**



List Price 106 gns.

**Telefunken 204E STEREO**

Special multiple-function switch controls six different functions gives greater operating convenience and flexibility of control. Two level, two volume and two tone controls and separate record and playback channels. Separate main switch allows pre-selection of all settings before record or playback. Mono and stereo—four track recording playback, frequency response at  $7\frac{1}{2}$  i.p.s., 40-18,000 c.p.s. Two built-in speakers, 6 Watts per channel output. Cash price 86 gns. or on interest free terms **£22.12.0 deposit and 12 monthly payments of £5.12.10.**

**SANYO D.C. 60 SOLID STATE STEREO AMPLIFIER/TUNER**

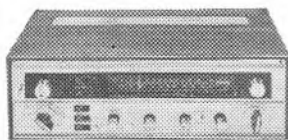

Superior to conventional vacuum tube equipment, this new Solid State F.M./A.M. Tuner/Amplifier, with fitted multiplex, features extremely low distortion and high output power. 87 gns or on interest-free terms **£22.17.0. deposit and 12 monthly payments of £5.14.2.**

**SANYO D.C. 434 Superlative output power. Minimised distortion. Stereo equipment for the really discriminating.**



Solid State F.M./A.M. Tuner amplifier with fitted multiflex incorporating high quality transcription unit. Gives A.M. and F.M. reception with supreme clarity and brilliance. Pick-up arm and magnetic cartridge.  $16 \times 16$  watts per channel. Speakers extra. **145 gns or on interest-free terms £38.2.0. deposit and 12 monthly payments of £9.10.3.**

**Gt. Britain's Largest Hi-Fi and Tape Recorder Dealers!**



**R-E-W (EARLSFIELD) LTD ★ LEADERS IN MAIL ORDER HI-FI ★**

● HEADQUARTER SHOWROOMS AND MAIL ORDER: DEPT. T.R.M. 266-8 UPPER TOOTING ROAD, LONDON, S.W.17. Tel.: 01-672 8267 or BAL 9175  
● WEST END SHOWROOMS: 146 CHARING CROSS ROAD, LONDON, W.1. Tel.: 01-836 3365 (opposite Astoria Cinema)



# THE MAN WHO PROVED OYSTERS CAN SING!



in music at the Pedagogic College  
y, has visited the Himalaya region  
From these trips, sponsored by  
as brought home with him some  
ic tape and about 1,200 Agfa-

ances and new knowledge  
to beuren. For the last 12  
estral festivals in Otto-  
y study-group founded  
everkusen was able  
sor Grad during a  
of an original form

difficult and  
high time to  
most of  
facilities  
ge their  
own  
in  
y

blow  
up into  
the misun-  
because ve-  
ually the cro-  
link out into  
fessor Grad w-  
Kenny is very  
by the Russia  
vn dog with th  
to several ra-  
"The crazy tap-  
iginal or partic-  
vered 7,600 m-  
osphere of a  
is sources. H  
its big Chinese  
t by his tape  
value of tape  
ly travelled  
to satisfy the  
rather first-hand  
ve countries." Dick  
daily problem-  
instances

record of it had probably never been made. It was held in the sparsely  
lit courtyard of a temple where several hundred members of this  
sect were gathered round the area reserved for the dancing gods in  
their magnificent robes and masks. I kept carefully to the dark  
background, which was rather unsatisfactory for recording purposes  
because the songs and instrumental tones of this ceremony were  
suppressed to some extent by the noise of the crowd standing and  
squatting in front of me. Then my interpreter and right-hand man  
(he had rendered me excellent services and was familiar with man-  
recording conditions from our close co-operation) came over to  
me and, showing me the official permit, led me to the front row  
hearing conditions high but imprecise. I held my microphone exactly  
I held my microphone high but imprecise. I held my microphone exactly  
until taking place between the master of ceremony and the  
and the master of ceremony and the fine mask, jumped up and  
and ran with me. I heard a fine mask, jumped up and  
attack was in clear view as a  
through, ran

and also recorded the "micro-sounds" of flies, prawns, moonbeams and falling snow! Extraordinary feats by an extraordinary man — nicknamed by his hundreds of friends as 'the crazy tapeworm'!

Read all about him in the latest issue of Agfa Magnetron Magazine. True stories like this technical features and a host of tips for the tape enthusiast can be found within its pages. Every issue also contains a wealth of information about the wide range of Agfa Magnetron tapes and useful accessories you can buy. It illustrates the benefits of low noise level without print-through, low distortion level, consistency, and the extreme tensile strength of all Agfa Magnetron tapes.

Get your FREE copy of the latest Agfa Magnetron Magazine, and hear for yourself the professional sound quality of Agfa Magnetron recording tapes.

**STAND 37 & ROOM 353**  
**at the AUDIO FAIR**



or write to Magnetic Tape Division, Agfa-Gevaert Ltd., Great West Rd., Brentford, Middlesex.

PROVED BY THE PROFESSIONALS

# AGFA MAGNETON RECORDING TAPES

ENTER NOW FOR THE  
**TELEX-VIKING**  
**STEREO STAKES**  
**WIN**



**VALUABLE HI-FI PRIZES**

**1st PRIZE** Pair of Viking 4400 stereo loudspeakers with built-in 60 watt IHF (30 watts per channel). Value £49 10s. Will improve the sound of any tape recorder, tuner or record player.

**2nd PRIZE** £25 worth of stereo tape records.

**3rd PRIZE** Telex COMBO headphones, value £13 10s.

**150 CONSOLATION PRIZES**

of 5" reels of RECOTAPE Professional grade, 1 mil Mylar-base recording tape.

**ENTER NOW . . .**

There is no obligation to buy anything, no skill involved. Enter as often as you like, each entry gives you a lucky number. Send today for FREE entry form. All applications must be in by 21st April, 1968.

**SEND TODAY FOR YOUR**

**FREE ENTRY FORM**

To **VIKING-TELEX STEREO STAKES**  
 Transatlantic Music Tapes (Distributors) Ltd.,  
 36 High Street, Salisbury, Wilts.

NAME .....

ADDRESS .....

DEALER'S NAME .....

ADDRESS .....

Application not valid without dealer's name and address.

**UP TO 50% OFF!**

**FANTASTIC SAVINGS**

We have a fantastic selection of tape recorders, new, shopsoiled and secondhand, showing savings on the manufacturers' list price of up to 50%. Our quoted prices are absolutely unbeatable, so why not call at any of our showrooms and see the fantastic savings that we, as Britain's largest tape recorder specialists company, are able to offer you by virtue of our ability to purchase large quantities and pass the savings thus obtained on to you! (Personal Callers only.)

- UNBEATABLE NO-INTEREST TERMS
- OVER 100 MODELS ON DISPLAY
- EXPERT STAFF EXPERT ADVICE
- GENEROUS PART EXCHANGES
- SAVINGS OF UP TO 50%

**THIS MONTH'S BARGAINS**

All supplied with 3 months' unconditional written guarantee (Note: M=Mono, S=Stereo, BP=Battery Portable, 4=4 track, 2=2 track)

PHILIPS EL3542 (M/4). List £66	OUR PRICE 18 gns.
OPTACORD 408 (BP). List £42. As new...	OUR PRICE 18 gns.
STUZZI TRICORDER (M/4) as new. List £79	OUR PRICE 25 gns.
BRENNELL MK 5 Series 1 (M/2). List £73	OUR PRICE 29 gns.
AKAI M68 (M/2). List £63. Perfect condition	OUR PRICE 29 gns.
FI-COR® 202A (BPM/2). List £72	OUR PRICE 29 gns.
GRUNDIG TK41 (M/2). List £90	OUR PRICE 32 gns.
BRENNELL MK 5 Series 2 (M/2). List £80	OUR PRICE 45 gns.
TELEFUNKEN 85KL (M/2). List £97	OUR PRICE 39 gns.
GRUNDIG TK41 (M/4). List £86. Perfect order	OUR PRICE 39 gns.
REPS R10 (M/2). List £62. As new...	OUR PRICE 35 gns.
SABA TK230 (S/4). List £99	OUR PRICE 45 gns.
FERROGRAPH 4A/N (M/2). List £87. Perfect...	OUR PRICE 45 gns.
BRENNELL MK 5 Series 3 (M/2) latest model. List £75	OUR PRICE 45 gns.
WYNDSCOR VANGUARD (M/4) latest model. As new. List £64	OUR PRICE 49 gns.
NATIONAL 750 (S/4). List £83	OUR PRICE 49 gns.
FERROGRAPH 88 (S/2). List £130	OUR PRICE 49 gns.
AKAI M6 (S/4). List £125. As new...	OUR PRICE 69 gns.
SONY 777 (M/2). List £160	OUR PRICE 79 gns.
SONY TC500 (S/4). List £110. Shop soiled	OUR PRICE 79 gns.
TELEFUNKEN 204E (S/4) latest model. Brand new. List £111	OUR PRICE 85 gns.
UHER ROYAL STEREO (S/4). List £132. Brand new	OUR PRICE 95 gns.
AMPEX 1100 (S/4). As brand new. List £160	OUR PRICE 99 gns.
AKAI M8 (S/4) latest model, brand new. List 125 gns.	OUR PRICE 109 gns.

PERSONAL CALLERS ONLY

**HURRY WHILE STILL AVAILABLE!**

**NoSound**  
 TAPE RECORDER CENTRES

82 HIGH HOLBORN, W.C.1 (200 yards Kingsway) CHAncery 7401  
 (Mon.-Fri. 9-6 p.m., Sat. 9-1 p.m.)  
 228 BISHOPSGATE, E.C.2 (opp. Liverpool St. Stn.) BISHopsgate 2609  
 (Mon.-Fri. 9-6 p.m. Closed Sat. Open Sunday 10 a.m.-2 p.m.)  
 242/4 PENTONVILLE ROAD, N.1 (200 yards King's X) TERminus 8200  
 (Half-day Thursday)  
 36 LEWISHAM HIGH STREET, LEWISHAM, S.E.13 LEE Green 2399  
 (Half-day Thursday)  
 360 KILBURN HIGH ROAD, N.W.6 (opp. Kilburn Tube Stn.)  
 (Half-day Thursday) MAIda Vale 1656  
 2 MARYLAND STATION, STRATFORD, E.15 MARYland 5879  
 Adjacent Maryland Point Station (Half-day Thursday)

# Eleven Sanyo world class models

**MR 929 Mk II** Brilliant new mains stereo/mono tape recorder, 4 track, 2 speed. Max. output 4 watts each, 3 watts undistorted. With full and empty spool, 2 dynamic microphones and speakers. About 72 Gns.

**MR 800** Vertical stereo/mono deck for the connoisseur. 3 Speeds. 4 tracks. Erase rate less than 65 dB. C About 69 gns.

**DC 60** Really beautiful solid state tuner/amplifier. FM/AM/FM stereo. 30 watts per channel. Noise filter, rumble filter, loudness, AFC. Frequency response 20 to 20,000 c/s. Range: AM 535 to 1605 Kc, FM 88 to 108 mc. FM distortion less than 1.0%. About 87 gns.

**MR 151** mains/battery stereo tape recorder, 4 track, 3 speeds. Sound on sound, sound with sound. About 65 gns.

**MR 999** A really magnificent mains stereo/mono tape recorder 6 watt x 2 output. 4 track. Sound on sound, sound with sound. About 97 gns. (Speakers extra).

**MR 801** Another excellent tape deck, 4 track, 3 speed. Sound with sound. With accessories. About 59 gns.

**DC 434** A wonderful solid state FM/AM/FM stereo tuner amplifier and transcription unit. 16 watts per channel. Response 20 to 20,000 c/s  $\pm$  1dB Range AM: 535 to 1605 Kc, FM 88 to 108 mc. Noise filter, rumble filter, loudness, AFC. About 145 gns.

**DC904** Stereo/tuner amplifier and record player with two built-in speakers. Optimum amplification and sensitivity on AM, FM/FM stereo. Response 60 to 6,000 c/s. About 75 gns.

**DC534** Stereo tuner/amplifier with record player. 12 watt per channel, optimum amplification and sensitivity on AM, FM/FM stereo. About 117 gns.

**MR 910** Stereo tape recorder with built-in speakers. Extraordinarily compact, yet with full fidelity. 4 track, 2 speed. Sound with sound. With accessories. About 69 gns.

**MR 939** Outstanding stereo tape recorder, 4 track, 3 speed. 7 watt per channel. Signal to noise ratio 45dB. Erase 65 dB. With accessories. About 89 gns.



MR 929 Mk II



MR 800



DC 60



MR 151



MR 999



MR 801



DC 434



DC 904



DC 534



MR 910



MR 939

*All prices subject to revision without notice.*

See and hear the full range of Sanyo Hi-Fidelity Products in Room 342 International Audio Festival and Fair, Hotel Russell, London, April 18-21.

# SANYO

RELIABILITY IS BUILT IN

# Sanyo puts you in the world class



## This is the new MR 910 stereo tape recorder with built in speakers

- Full fidelity
- Extraordinarily compact
- 4 track
- Sound with sound

**Tape speeds**  
7½ in/sec (19 cm/sec)  
3¾ in/sec (9.5 cm/sec)  
**Playing time**  
30 min x 2 at 7½ ips  
(stereo 7" 1,200 ft. tape)  
1 hour x 2 at 3¾ ips  
(stereo 7" 1,200 ft. tape)  
**Frequency response**  
50-15,000 c/s at 7½ ips  
50-10,000 c/s at 3¾ ips

**Power Output**  
Maximum 1.8W  
(each channel)  
Undistorted 1.5W  
(each channel)

**Speakers**  
Two 4" permanent  
built-in speakers.  
Voice coil  
impedance 8ohms.

**Weight**  
18lb. (8.5kg)  
**Accessories**  
Dynamic  
microphone x 2,  
7" (18 cm) full  
tape and empty reels,  
Patch cord x 2,  
Splicing tape,  
Reel stopper x 2  
Price: about 69 gns.

# SANYO

RELIABILITY IS BUILT IN

# Sounds Original



**In Room 355 at the Audio Fair, visitors will hear**

**original stereo recordings** made under **domestic recording conditions**. These stereo recordings were made using various pairs of Sennheiser microphones with a B. & O. tape-recorder. By changing the microphones at regular intervals during the recordings sensible comparisons can be made regarding the quality and characteristics of these microphones. Microphones such as the **MD 411 HLM** super cardioid will be compared with the studio dynamic **MD 421** and the **MKH 405 RF** condenser cardioid microphone plus various others from the Sennheiser range. These **original stereo recordings** will demonstrate the use of particular microphones in different recording conditions and illustrate some facets of recording technique. Any **questions** visitors would like to ask regarding these recordings will be answered in the above room by our Sound Engineers. On Booth 63 visitors will hear similar original stereo recordings to those mentioned above, but in this case play-back will be via Sennheiser's **stereo headphones**.

**Audio Engineering Ltd**  
33 Endell St. London WC2 836 0033

# whatever the make...

## 4-TRACK STEREO MONO

	Deposit £ s. d.	12 Monthly Payments £ s. d.	Cash Price Gns.
Philips EL 3312	14 15 0	3 11 8	55
Ferguson 3232	18 2 3	4 10 7	69
Sony TC200	18 18 0	4 14 6	72
Philips EL3555	19 13 9	4 18 6	75
Akai 1710	20 14 9	5 3 9	79
Tandberg 74	24 8 3	6 2 1	93
Sony TC260	24 0 0	5 18 4	95
Tandberg Series 12	27 11 3	6 17 10	105
Revov 736 2- or 4-T	31 4 9	7 16 3	119
Sony TC 530	31 12 6	7 18 2	120
Akai M8	32 16 3	8 4 1	125
Beocord 2000K DeLuxe	32 16 3	8 4 1	125
Beocord 2000T DeLuxe	33 17 3	8 9 4	129
Akai X300	48 11 3	12 2 10	185
Akai X355	62 14 9	15 3 9	239

## 4-TRACK MONAURAL

Ferguson 3224	6 11 3	1 12 10	25
Fidelity Playtime 4	7 1 9	1 15 6	27
Fidelity Playmatic 4	8 2 9	2 0 9	31
Elizabethan LZ34	8 18 6	2 4 8	34
Ferguson 3218	8 18 6	2 4 8	34
Telefunken 201j	9 17 0	2 8 4	37
Ferguson 3222	9 3 9	2 6 0	35
Philips EL4305	9 9 0	2 7 3	36
Grundig TK140	10 2 2	2 10 7	38½
Philips EL4306	11 0 6	2 15 2	42
Ferguson 3214	11 11 0	2 17 9	44
Truvox 44	12 6 9	3 1 9	47
Ferguson 3216	12 17 3	3 4 4	49
Tandberg 843	15 9 9	3 17 6	59
Philips EL3556	16 5 7	4 1 5	62
Truvox R104	23 7 3	5 16 10	89

**SPECIAL OFFER: SAVE £21**



## TELEFUNKEN 204 E

4-Track Stereo-Mono 'Recording/Playback' 3½, 7½ i.p.s.—Two 7" built-in speakers. Two 6 watts output stages. Transistorised. Multi-play facilities. Brand New. Guaranteed. Latest model. Current list price 106 gns.

**OUR PRICE 86 gns.**

£22.12.0 deposit and 12 monthly instalments of £5.12.10. Carriage and packing free.

## STEREO TAPE UNITS

	Deposit £ s. d.	12 Monthly Payments £ s. d.	Cash Price Gns.
Sony TC250A	14 19 3	3 14 10	57
Sony TC350	19 13 9	4 18 6	75
Akai 3000D	22 0 0	5 6 8	£86
Beocord 1500 DeLuxe	25 9 3	6 7 4	97
Tandberg 64X	33 18 0	7 10 0	118
Revov 77CS	36 19 0	9 1 8	139
Revov 77CSVV	41 19 0	10 8 4	159

## MAINS TWIN TRACK

Truvox R102	23 7 3	5 16 10	89
Brenell V/3 'M'	24 8 3	6 2 1	93
Ferrograph 631	24 18 9	6 4 9	95
Ferrograph 631/H	26 5 0	6 11 3	100

## SPECIAL OFFERS

### B & O FM. BEOLIT 500

**TRANSISTOR RADIO** Push-button selection of up to five FM Stations. 1.4 watts output. Large speaker. Can be used as Hi-Fi Tuner, Gram Amplifier, also Intercom. Brand new. Teak or Rosewood. Makers 12 months guarantee. List price 35 gns. **OUR PRICE 19 gns.** Post free.

**REPS M10** Latest 4-Track model. 10 watts output. Duo play etc. 2 year g'tee. Brand new. List price 69 gns. **OUR PRICE 59 gns.** Dep. £15.9.2. 12 payments of £3.17.6.

**INTEREST FREE H.P. TERMS. OPEN SATURDAY 6 p.m. FRIDAY 6-30 p.m. IF UNABLE TO CALL WRITE FOR BROCHURES. PART EXCHANGES. ALSO 18 AND 24 MONTHLY TERMS**

# THE RECORDER CO

(DEPT. T) 186-188 WEST END LANE, WEST HAMPSTEAD, LONDON, NW6

Telephone: 01-794 4977

**Where can you get a STEREO TAPE RECORDER with this spec., and at this price, but from HEATHKIT**

**ONLY £45 18 0 kit £55 10s.** Ready to us

FOR THIS SPECIFICATION

- ½ track stereo or mono record and playback at 7½, 3½ and 1½ ips
- Sound-on-sound and sound-with-sound capabilities
- Stereo record, stereo playback, mono record and playback on either channel
- 18 transistor circuit for cool, instant and dependable operation
- Moving coil record level indicator
- Digital counter with thumb-wheel zero reset
- Stereo microphone and auxiliary inputs and controls, speaker headphone and external amplifier outputs . . . front panel mounted for easy access
- Push-button controls for operational modes
- Built-in stereo power amplifier giving 4 watts rms per channel
- Two high efficiency 8 in. by 5 in. speakers
- Operates on 230V ac supply.



**The New Heathkit Stereo Tape Recorder** has built-in audio amplifiers and speakers giving you complete recording and playback facilities in one compact cabinet that's easy to carry from room to room or house to house. The kit is complete with a good quality moving coil mono microphone, 5½" spool of long play (1,200 feet) magnetic tape and one spare spool.

**Versatile Recording Facilities.** The Heathkit Recorder can record "live" from microphones or from auxiliary sources such as radio tuners, records, etc., and playback . . . in ½ track stereo or mono at either 7½, 3½ or 1½ ips. And you can make sound-on-sound recordings by playing back through one channel and recording through the other channel . . . stereo record and playback . . . mono record and playback on either channel.

**Other Features.** Two audio amplifiers produce 4 watts rms per channel into two high efficiency 8" x 5" speakers giving high quality sound in a portable instrument. Gives startling realism to stereo reproduction . . . jacks are provided for connecting to external speakers if required. Moving coil level indicator for visual monitoring of recorded signal level. Separate inputs and controls for microphones and auxiliaries, separate outputs for speakers/headphones and external amplifiers . . . all front-panel mounted for easy access. Ganged controls for easy operation. All transistor circuitry . . . your assurance of cool, instant operation and long, reliable life.

**So Easy to Build . . . the Heathkit way!** Simple step-by-step instructions and large pictorial diagrams in the manual show you where every part goes . . . tell you exactly what to do . . . guide you every step of the way. No special skills or technical knowledge required. Printed circuit board construction ensures speedy and easy assembly with consistent performance.

## See Britain's Finest Range of Electronics in the latest FREE Catalogue

To DAYSTROM LTD., Gloucester. Tel.: 29451 tick

**FREE BRITISH HEATHKIT CATALOGUE**

Please send Free Heathkit Catalogue to my Friend

Full details of Model(s).....

Name .....

Name .....

Address .....

Address .....

.....

(Block capitals please) ..... T.4

..... T.4

See Heathkit models at the Heathkit Centres—LONDON: 233 Tottenham Court Road, W.1. Telephone 01-636 7349. GLOUCESTER: Bristol Road. Telephone 29451. BIRMINGHAM: 17-18 St. Martins House, Bull Ring. Telephone 021-643 4386.

# LOOK SHARP! and hear the difference



## SHARP Model RD504 Portable Tape Recorder

An all-transistor solid state Tape Recorder. For operation by batteries or AC mains, twin track, two speeds. Superb recording and reproduction. Plug in to the mains. It automatically changes from batteries to its built-in AC power unit. Remote control switch on microphone allows full flexibility in use. Dimensions: 12" x 3 $\frac{3}{4}$ " x 9 $\frac{1}{4}$ " Complete with dynamic microphone, recording lead, earphone, batteries (6 x sharp UM—1) 5" tape reel, empty spool.

**Hearing's believing.** Come and talk yourself into a SHARP vivid sound tape recorder.

# SHARP



**SALES & SERVICE,**

16/18 WORSLEY ROAD, SWINTON, MANCHESTER. Tel: SWI 3232 (5 lines)

# 26GNS

*for further details & colour leaflet contact*

SHARP SALES & SERVICE  
16/18 WORSLEY RD., SWINTON, MANCHESTER

NAME.....

ADDRESS.....

.....

.....

.....

IRM 1

Bishopsgate  
Institute

# CITY

# TAPE RECORDER CENTRE

BISHOPSGATE

Liverpool Street Station

**228 BISHOPSGATE  
LONDON, E.C.2.**

Tel. BISHopsgate 2609

Opposite Liverpool Street Station

Hours of Business:

MONDAY TO FRIDAY

9 a.m. to 6 p.m.

Closed all day Saturday

**OPEN  
SUNDAY**

10 a.m. to 2 p.m.

At the City Tape Recorder Centre you can see one of the finest selections of tape recorders on display in London. Every leading make and model from Akai to Vortexion.

Many Special Offers of brand new 1968 models showing dramatic savings on the manufacturer's list prices! A wonderful selection of secondhand and shopsoiled models with savings of up to 50%.

We are easy to get to being almost opposite Liverpool St. Station (see diagram above) and remember we are the only tape recorder specialists in Gt. Britain open on Sunday!

Do your weekly rush shopping on Saturday with your wife and visit us on Sunday at your leisure!

- **GENEROUS PART EXCHANGES**
- **FREE AFTER SALES SERVICING**
- **UNBEATABLE SPECIAL OFFERS**
- **EXPERT STAFF EXPERT ADVICE**



Our manager Bob Hookings is a keen tape recording enthusiast. Bang & Olufsen's are his speciality, having used B. & O. equipment for several years his knowledge of this wonderful range is second to none. He is able to give personal callers his expert advice (please avoid telephoning) not only on B. & O. but on any other recorder suitable to your individual requirements and pocket.

**WHEN IN THE CITY — CALL IN AT THE CITY!**

**THE BANG & OLUFSEN SPECIALISTS**



## HOW TO CATCH A SOUND WAVE

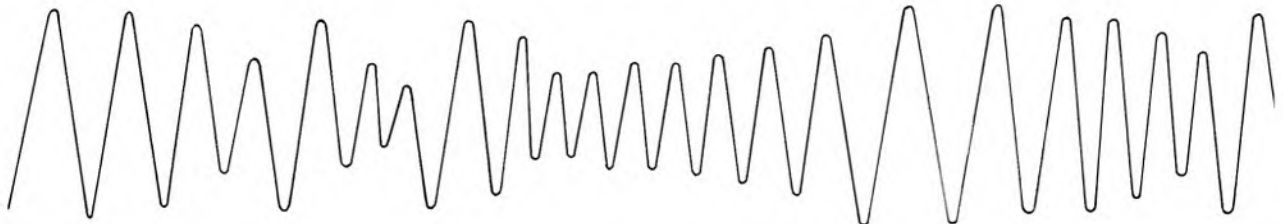

Our "Series Four" microphones will catch anything without damage or distortion. No need to use transformers, each microphone is multi-impedance and will work into 25 Ohms, 200 Ohms, 600 Ohms and 50K Ohms. Imagine how useful that is when you change recorders.

These four microphones have been produced to extract the last drop of performance from your recorder or P.A. System. Combining Lustraphone dependability with superb performance and exciting styling. These instruments will give you pride of ownership for years to come.

4.20 Dynamic Omnidirectional 4.30 Dynamic Cardioid  
4.40 Studio Ribbon 4.50 Professional Miniature Ribbon

See the "Series Four" Microphones at leading Hi-Fi dealers — or write direct to LUSTRAPHONE LTD for free illustrated literature giving full description and specification.

A comprehensive "Selection and Instruction" pamphlet is also available free on request.



**lustraphone**

**THE FOREMOST NAME IN MICROPHONES**

Lustraphone Limited,  
Regents Park Road, London N.W.1 01-722 8844



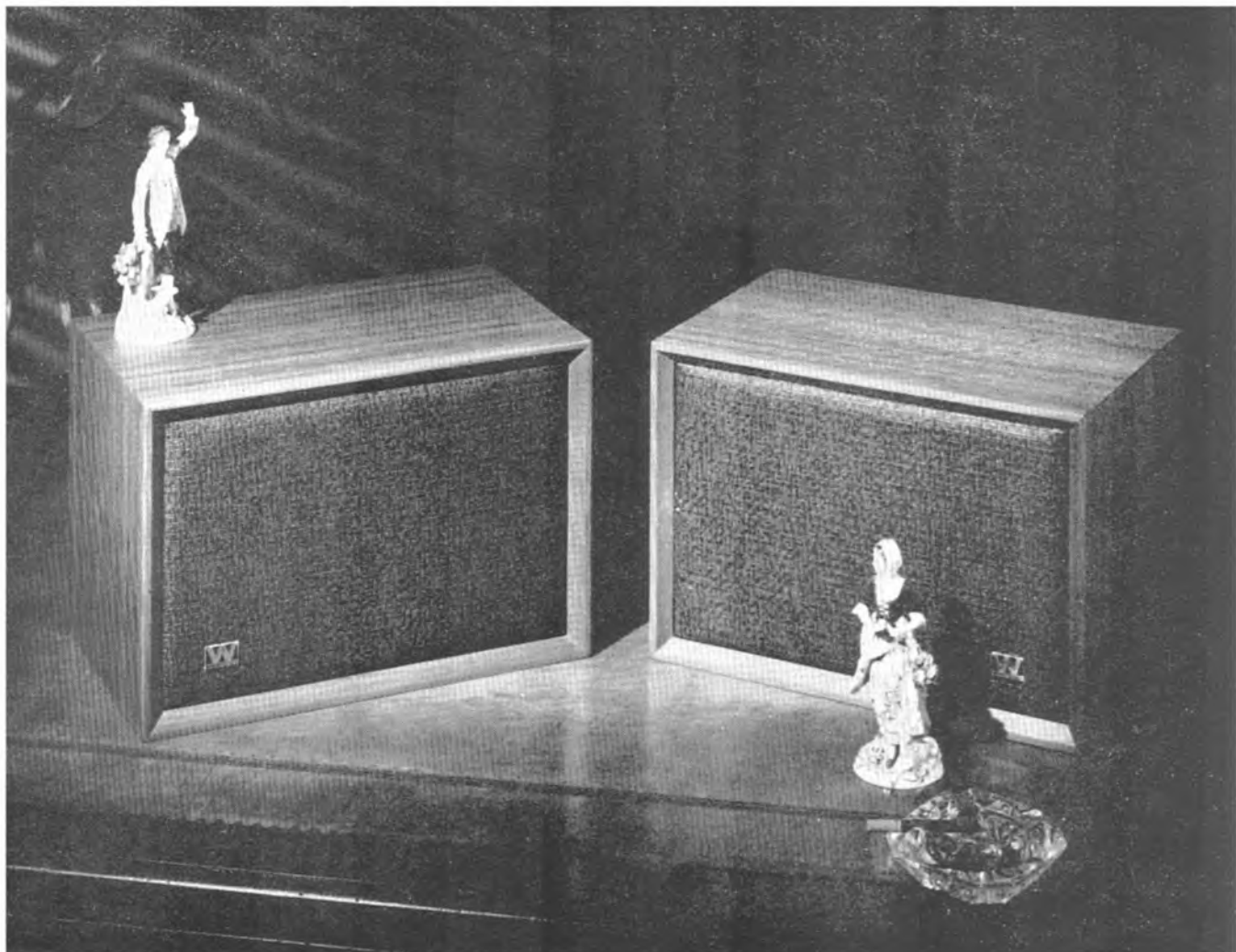

## High fidelity stereo starts with Wharfedale **DENTONS** at 30gns. per pair.

The new Denton speaker system brings stereo sound within the reach of everyone. Dentons are excellent operating at less than 10 watts from the existing amplifier in your record player or tape recorder. They are superb when driven by a high fidelity amplifier. Each Denton contains 2 Wharfedale speakers in a beautiful cabinet that is small enough to stand on a bookshelf or mantelpiece. Ask your dealer for a demonstration and prove its superior quality.

- The Dentons are sold in matched pairs for stereo.
- The cabinets are hand veneered and rubbed; each pair made from the same tree — perfect matching of both sound and appearance.
- Each cabinet has two speaker units with a carefully designed cross-over network.
- The dimensions are perfect for mounting on a shelf — so the Denton takes up virtually none of your precious room space.
- Size 9 $\frac{3}{4}$ " high x 14" wide x 8 $\frac{3}{4}$ " deep.
- Response: 65 Hz to 17,000 Hz.
- Finish: Oiled Teak or Polished Walnut.



RANK WHARFEDALE LTD., IDLE, BRADFORD, YORKS.



# VORTEXION



*High quality  
Audio Equipment*

*For the finest in their class*

**Semi-Professional Recorders, Studio Mixers**

*also*

**10-200 watt Amplifiers at <0.1% distortion**

**Visit us at**

**International Audio Festival  
and Fair**

**HOTEL RUSSELL**

**18th/21st April**

**Demonstration Room 334**

**Booth 2**



**VORTEXION LIMITED**

**257 - 263 The Broadway, Wimbledon, London, S.W.19**

Telephone : 01-542 6242/3/4 and 2814.

Telegrams : "Vortexion, London, S.W.19."

# now hike mike's got company...

## ... these 5 newcomers to the Audac range of integrated microphone transmitters

### Transmitter Type TX/65

for use in highest quality sound systems. Versatile in operation, general purpose use in entertainment industry.



**Hike Mike fitted with windshield and 'pop' filter**  
top quality, all purpose, omni-directional.



**High power separate transmitter unit** for professional use where an individual choice of microphone is required. Reliable and trouble-free operation up to ¼ mile distance.



**Transmitter Type TX/45**  
ideal for the solo entertainer. Uni-directional properties make it most suitable for operation in most difficult acoustic conditions.



**Transmitter Type TX/C**  
Same characteristics as Hike Mike, shape allows either hand or lavalier operation. General purpose.



**Like Hike Mike** each is completely cordless, contained in one neat unit, no bigger, no heavier than a torch. No following flex, no bulging pocket transmitter

## AUDAC RADIO MICROPHONE AND SOUND REINFORCEMENT SYSTEMS

AUDAC MARKETING COMPANY LTD/FOREST WORKS/CAREY RD/WAREHAM/DORSET/Tel: Wareham 2245

# TAPE

RECORDING  
MAGAZINE

Incorporating Tape Recording & Hi-Fi Magazine,  
and Stereo Sound Magazine

Vol. 12

No. 4

April 1968

### IN THIS ISSUE

Tape trends and tape talk	160
Douglas Brown	
THE FINE ART OF MULTI-TRACK	161
F. C. Judd	
Techniques—BATTERY PORTABLES	162
Denys Killick	
AUDIO FAIR '68	168
Official List of Exhibitors	169
Cross Talk	175
By Audios	
THE HOME STUDIO	177
John Borwick	
Test Bench—SENNHEISER MD411	179
DITTON 15	180
NATURE NOTES	183
Richard Margoschis	
MUSIC ON TAPE—	
Musicassette Reviews	184
7½ and 3¾ ips Stereo Reviews	185
New Products	186
Advertisement Inquiries Service	189

**COVER PHOTOGRAPH:** Equipment used by F. C. Judd, author of our present series, "The Fine Art of Multi-Track." On the right, a Lowery Hilton electronic organ, the main "music" source, and next to this (centre) a Ferrograph 632. To the rear of the Ferrograph can be seen the 20 watt amplifier/speaker monitor with built-in input mixing. Directly above is the second recorder, Revox R77 half-track stereo. On the left is the electronic rhythm unit designed and built by the author (see March issue of TAPE). Other equipment used in the system but not illustrated includes an electric guitar, a six channel mixer and two filtering units. The potentialities of such a system will be discussed by Fred Judd in forthcoming articles.

"TAPE Recording Magazine" is published on the third Wednesday in the month, by Print and Press Services Ltd., from Prestige House, 14/18 Holborn, London, E.C.1.

"TAPE Recording Magazine" is available by a postal subscription of 25s per annum (U.S.A. \$3.75) including postage, or it can be obtained at newsagents, bookstalls and radio and music dealers. In the event of difficulty, write to the Publishers at Prestige House, 14/18 Holborn, London, E.C.1.

Back numbers, if still in print, are available, at 2s. 6d. per copy.

Address all communications

**PRESTIGE HOUSE,  
14/18 HOLBORN, LONDON, E.C.1**

### EDITORIAL

01-242 4742

Publisher,  
R. DOUGLAS BROWN

### ADVERTISING

01-242 4851

Editor,  
DENYS G. KILICK

Advertisement Manager, VIVIENNE GOODING

# Tape trends and tape talk

By Douglas Brown

THE BBC has announced a new series of programmes to cater for audio enthusiasts, and it will include a special programme on tape recording. It will be the first time since the Sound programme went off the air two or three years ago that listeners will be offered practical guidance on how to secure the best of recording and of reproduction.

The programmes, under the general title "Better Sound," will be transmitted on four consecutive Fridays in May, commencing on May 3, in the Radio 3 Study Session. They will be repeated later in the year, when there will be two extra programmes to follow up questions asked or points made in the letters which, it is hoped, will roll in from listeners to the first transmissions.

I have discussed the series with the producer and others at the BBC who are anxious to see every possible encouragement given to amateur enthusiasts, and I particularly urge readers to follow the programmes—and to react to them by writing to the BBC. Over the years efforts have been made to persuade the BBC to give more air space to tape recording matters; quite rightly, they are influenced far more by the evidence of listener response to the programmes they have broadcast than they are by the pleading of interested parties such as myself!

The BBC announces its new programmes in this way: "The series are planned for home enthusiasts and those who use sound equipment as a teaching aid, or in amateur dramatics and so on. The aim is to help them to get the best out of their hi-fi equipment, tape recorders and radios. This will be done by giving information about the basic principles involved in the transmission, recording and reproduction of sound, and practical advice on the choice and use of different types of equipment."

The four programmes will deal, in general, with radio, the nature of sound and room acoustics, disc reproduction, and tape recording—the fourth programme on May 24. All programmes will be broadcast from 7 to 7.30 p.m.

Regular listeners to the old "Sound" programmes will hear again most of the best-known contributors to that series, both audio journalists and BBC experts.

\* \* \*

THE LAST BASTION has been stormed! Parliament has accepted the tape recorder as a respectable apparatus.

During the lively and prolonged debate on the government's measure to restrict immigration from Kenya, Hansard reporters were faced with the grim prospect of a shorthand-writing marathon going on right into the night. I have worked with the men who carry the responsibility of recording every word

uttered in the House of Commons (and the Lords) and I know they are capable of meeting any challenge.

But a session of the House which begins at 2.30 p.m. and continues through the night into the following day puts a heavy strain on any human being.

I can imagine the relief, therefore, with which they put aside their notebooks, though the MPs were still speaking, and switched on the tape recorders.

As the chamber is "wired for sound"—microphones hang discreetly from the ceiling to pick up speeches, and the sound is carried to tiny speakers in every seat (which is why Members can sometimes be observed sitting rather oddly, with one ear pressed close to a small grill in the bench behind them!)—there was no problem in putting a recorder into the circuit.

As the tapes came from the machines, a team of audio typists went to work on them and fed the manuscript to the printers who, each morning, produce the printed version of the previous day's proceedings.

\* \* \*

SOON AFTER these words appear in print the judges will assemble for final consideration of the tapes entered in this year's British Amateur Tape Recording Contest and The Tape of the Year and the various class winners will be decided. Judging takes place on March 20, winners will be informed immediately afterwards, and the presentation of prizes and trophies will take place—for the first time—at a special party at the Audio Festival at the Hotel Russell on the afternoon of Saturday, April 20.

The Federation of British Tape Recordists and Clubs will have a room on the first floor at the hotel and throughout the Festival weekend will provide opportunities for enthusiasts to hear playback of all the winning Contest tapes.

Tape Recording Magazine will be in Room 343 on the third floor and the Editor, Denys Killick, and I, hope to be able to meet many old friends and to make many new ones.

\* \* \*

IN THIS ISSUE we welcome back as a regular contributor Fred Judd, one of the best-known experts in the world of amateur recording. In the early years of this journal he was our Technical Editor; later he became editor of a rival publication.

The spool has turned full circle, one might say, and Fred Judd is back in our fold, writing each month.

Unfortunately, he is at present undergoing hospital treatment. We know readers will join us in wishing him a speedy and complete recovery.

We can now reveal the identity of our author as

## FRED JUDD

formerly Editor of *Amateur Tape Recording Magazine*



# THE FINE ART OF MULTI-TRACK

**I**N multi-track recording, or any recording where material has to be copied several times, the problem of hum and noise transference arises in no uncertain fashion. Now "noise", that is the hissing kind known as white noise, is virtually impossible to get rid of once it is on the tape. I pointed out in a previous part of this series that the ideal approach to the problem is to prevent it before it happens. Noise of this kind can be suppressed, but unfortunately the electronic equipment for doing it, known as the Dolby System, is not yet available for domestic use. A few large recording studios have it and it is frightfully expensive. There is a possibility of the system being employed in domestic recorders, and indeed it is claimed that one manufacturer in the USA has done so. Meantime this must remain a tape recording enthusiasts' dream.

Noise can only be kept to a minimum by using low noise equipment in the first instance, that is tape recorders and other audio equipment with a signal to noise ratio of around -50 dB. Watch out for magnetised record and/or replay heads and the possibility of erase voltage/record bias oscillators with a poor waveform, both of which can impart a high noise level to a tape. Noise cannot, as many suppose, be eliminated or even reduced with electrical filters since white noise consists of voltages of random frequency, phase and amplitude covering the whole of the audio frequency spectrum (see also parts 2 and 3 with regard to keeping noise at a minimum).

Another enemy of the audio enthusiast is hum, the source of which is usually the 50 Hz mains supply, and the causes many. Hum can be introduced by poor smoothing in HT supplies, mutual coupling between tape heads and nearby mains transformers, hum loops formed by long connections between equipment and poor earthing. Unfortu-



The author's studio for general recording, showing, left, Brenell deck for copying full-track or half-track with Rogers stereo amplifier below, centre, rack containing mixer, patching boards, small oscilloscope and on the right a Telefunken M24 full-track recorder with a Revox R77A half-track stereo machine below

nately a very small amount of hum pick-up, inherent in all audio equipment but otherwise of no consequence, can become a very large hum in the process of re-recording. For example, a minute amount of 50 Hz signal picked up by a tape replay head will be amplified more and more at each stage of re-recording. So a check should be made to make sure that hum is not being picked up from any external source, such as another nearby tape recorder or amplifier, etc.

Magnetic pick-ups used on electric guitars are also very prone to hum induction from mains transformers, and

accordingly one should work with such an instrument well away from a potential hum source. Some electronic organs do not always have well smoothed HT supplies and even though the signal may be taken from a high impedance output, the swell pedal for instance, there may be a small amount of hum present. A simple check on these sources can be carried out by making a short recording at  $3\frac{3}{4}$  ips and then replaying this at  $7\frac{1}{2}$  ips. Any 50 Hz hum will now be reproduced at 100 Hz and is more readily audible. In fact this is where hum can make itself

*Please turn to page 164*

IN THE SPRING A YOUNG MAN'S FANCY LIGHTLY TURNS TO

# BATTERY PORTABLES



Two famous pieces of equipment stand side by side. On the left is the time-honoured Boosey & Hawkes battery portable with hand-wound clockwork transport system. Next to it the aristocratic Nagra, one of the most famous of all professional battery recorders. Truly an historic meeting!

**L**IGHT flurries of snow are falling as these words are being written early in February. And yet the first day of spring will be here by the time they are read and Easter will have come and gone during the currency of this edition. Whatever climatic conditions we might either enjoy or endure one can at least be certain that the new green life of spring will encourage many to turn their thoughts towards the great outdoors.

Recording outdoors usually implies working with battery portable equipment, so this is an appropriate moment to consider the vices and virtues of such machines. This article is not going to include a catalogue and list of machines, facilities and prices. I believe it is far more profitable to consider the whole subject of battery portables in terms of design and function and to relate this to the probable requirements of the user. From thence on the reader can make up his own mind on the kind of specification that would be required in a battery portable that would ideally suit his own pur-

pose. The chances are, of course, that such a machine has never, and will never, be made. Usually the equipment one acquires is a compromise choice between what is needed and what is available. But working out the "ideal specification" can be most rewarding because at least actual requirements can be firmly established.

Before going any further we have to be quite sure we know the answer to one vital question: "When does one use a battery portable?"

The simple answer is: "When, for any reason, it is quite impossible to use mains powered equipment."

We have to face up to the fact that the overall recorded quality of work produced on battery machines will, generally speaking, be less good than that produced on mains equipment. I have had to qualify this statement because there are battery machines and battery machines—just as there are mains machines and mains machines! One would naturally expect better recorded quality from a battery

portable costing many hundreds of pounds than from a very low cost domestic mains machine. At the conventionally accepted price levels, however, mains equipment always has the edge on its battery equivalent.

The reasons for this are not very hard to see. Miniaturisation costs money. One of our most important requirements for good quality is speed stability. Speed stability calls for precision engineering and massive components. One of the prime requirements for truly portable equipment is smallness in size and weight. This is difficult and costly to achieve. So we are faced with the situation that one should expect to pay more—probably very much more—for battery equipment of a quality standard comparable to an existing mains machine.

The man who doesn't own battery equipment is in a very strong position if his lack forces him to transport his mains machine and to use it under difficult conditions. Remember there are such

*Please turn to page 173*

## Ferrograph, 1949-1967

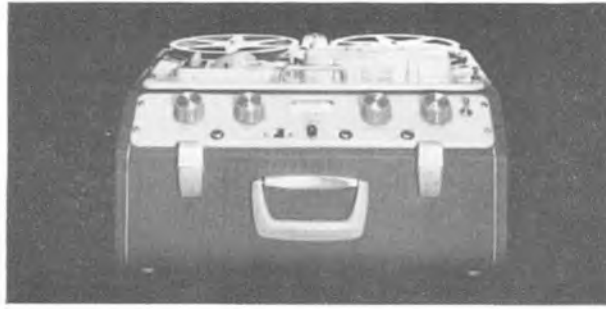

# Now, another major event

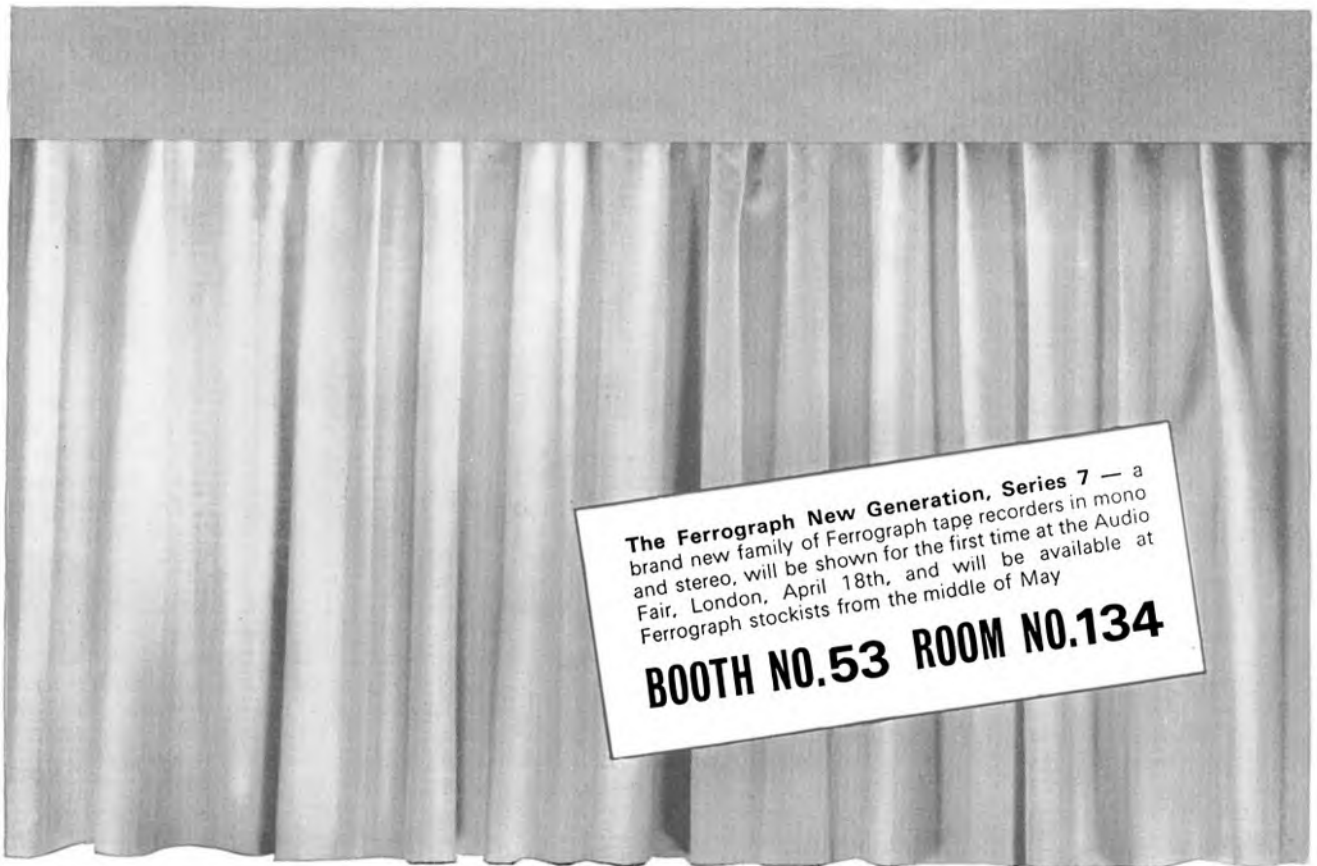

The Ferrograph New Generation, Series 7 — a brand new family of Ferrograph tape recorders in mono and stereo, will be shown for the first time at the Audio Fair, London, April 18th, and will be available at Ferrograph stockists from the middle of May

**BOOTH NO.53 ROOM NO.134**

# See the new Ferrographs unveiled at the Audio Fair

most obnoxious, i.e., when one is using "double speed" technique which I will be dealing with later.

### Hum Filters

Being of such a low frequency to begin with, 50 Hz hum can to some extent be filtered, but I hasten to add not without certain losses in the lower frequency range of music. Filters which could eliminate 50 Hz hum without interfering with other frequencies are quite beyond the reach of the amateur. They are extremely difficult to design and make for oneself and too costly to buy. If one is prepared to accept a compromise then the circuit in Fig. 2 will suffice for non-professional purposes. It is a very simple "high pass" filter and as the name implies it will pass higher frequencies. The attenuation at 50 Hz is approximately 30 dB and the "roll off" (where the filter begins to take effect) begins at around 200 Hz. This filter could be used in cases where the lowest fundamental pitch of the musical instrument being recorded is not too much below 100 Hz. For example the guitar where the lowest note is E at approximately 82 Hz.

This could apply to other musical instruments on the same basis, and I have used these filters in conjunction with an electronic organ as well as the guitar. I must, however, make it quite clear that such filters, being inductive, will to some extent affect the waveform of the musical instrument and consequently change the characteristic sound a little. Fig. 3 shows two ways of connecting the filter.

### Musical Arrangement in Multi-tracking

Although highly important in multi-tracking, musical arrangement is a difficult subject to deal with and has its own special requirements when used in conjunction with multiple recording. I can therefore only deal with it in general terms by outlining simple ideas that may at least be of some benefit to the novice. Trained and competent musicians will be able to work out arrangements for themselves.

It is one thing to play a tune on a musical instrument and quite another to play what amounts to the instruments of a small orchestra with an end result that is musically pleasing. A musical "arrangement" in its simplest form is a tune plus a rhythmic backing (percussion) and a chord and bass accompaniment. To this can be added counter melody, an introduction, an extended ending, an improvised or changed version of the melody or parts of it, fill-in passages, alterations to the basic chords of the music, the use of different instruments, or voicing of a single instrument, etc. Then there are the various audio and tape recording techniques such as half-speed recording

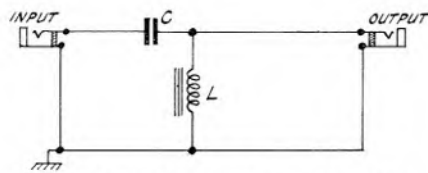

Fig. 2. A simple hum filter. The capacitor C can be .001 $\mu$ Fd to .005 $\mu$ Fd and the inductance L can be the primary winding of a small output transformer (secondary not used). The components should be built into a metal box

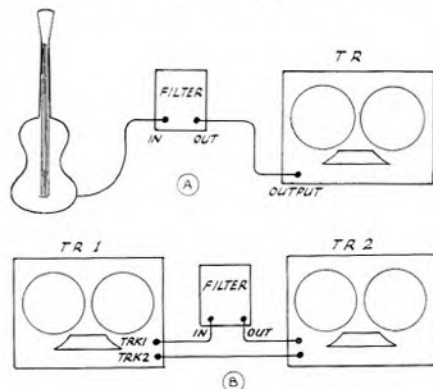

Fig. 3. Two methods of employing the filter. (a) In series with the output from an electric guitar or organ. (b) In series with the output from one track when using a half-track recorder. This technique will be explained next month

(playback at original speed), increased speed on final copying, reversed recording, sound echoed via a tape head, reverberation by line or plate, ring modulation and so on, all of which can mean a good deal of additional and often specialised equipment (see Fig 1).

Ideas for musical arrangements are best acquired by listening to recordings of small but good orchestras (not pop groups unless you favour this particular jangle and noise). Of course if you happen to be a competent musician and can read and transpose, the orchestrations for small orchestras provide readymade musical arrangements. On the question of "learn by listening," I suggest records by Les Paul, Wout Steenhuis, Rhet Stoller, Tommy Garrett and quite a few others who feature instruments like the guitar.

When you have only the tune and its chord backing to work from (popular sheet music) some careful analysis of the music will usually provide ideas for an arrangement. Many of the old popular tunes, such as *World is Waiting for the Sunrise*, *China Town*, *Whispering*, *Birth of the Blues*, etc., are ideal for those about to embark on multi-track. The melodies and chording are fairly simple and lend themselves to arranging for multi-track with guitar and organ. I have recorded all these tunes and the following arrangement of *World is Waiting for the Sunrise* may help to trigger off further ideas.

The tune is written in the key of C and my version consisted of a four-bar introduction based on the chording C, A7, D7 and G4 followed by two complete choruses plus an extended ending (2 bars) running from the last chord of C through F-minor and finishing on C natural 7th. A quick-step drum track (from the Ad Rhythm records) was cut as explained in part 2 for 70 bars. Against this was recorded the basic chording with the electronic organ at 7½ ips, the running speed of the recording. Next the bass was recorded (organ pedal bass) also at 7½ ips. Then followed a fairly rapid guitar counter melody over the first eight bars and again over eight bars starting from the last two beats of bar 16. This was repeated in each chorus but the guitar recording was done with the backing track running at 3¾ ips. Some tape echo was introduced on the guitar. At 3¾ ips, and therefore at half the normal playing tempo, quite complicated counter melody could be played on the guitar. This is where not-so-competent musicians like me can cheat a bit. Other parts of the melody were then completed with the organ, again using the half-speed technique, but this time to introduce an octave higher voice from the organ and not spectacular playing. The remaining parts of the melody were recorded at the running speed of 7½ ips. Various improvised fill-ins with different organ voices were also introduced, for instance in the "middle eight," and of course in the introduction and extended ending.

### Using the Electronic Organ

This very popular and modern musical instrument lends itself admirably for multi-track music because of the different "voices". It could be recorded via a microphone, but since it generates its notes electronically and employs amplifiers it can be connected directly (electrically) to a tape recorder. Some organs do have a "tape" output socket, and some feature an external amplifier output and also a headphone socket for quiet practice. The latter is not suitable for connection to a tape recorder since it is normally connected at the output amplifier (speaker stage) and may carry some 50 Hz hum. An external amplifier socket is suitable, but failing this an output can be taken from the swell pedal volume control. Unless you are familiar with the circuitry of the organ it would be wise to consult the maker regarding a connection of this kind.

Next month I will deal with double-track (stereo to stereo) re-recording techniques which are used by some of the professional multi-track artists. A few words on mixers may not come amiss either, as well as other extra equipment like some of the items shown in Fig 1.



**EMITAPE is not just  
the finest recording tape  
backed by the world's largest  
recording company....**

**EMITAPE is also *completely*  
British manufactured.**



EMI's exacting quality control ensures that you get perfect, clean recording results every time – there are four grades of Emitape in five reel sizes to suit all recording requirements.

*And* you have the satisfaction of knowing you're backing Britain by buying an all-British manufactured recording tape.

**Don't buy any tape – buy EMITAPE**



An EMI group product  
EMI TAPE LIMITED, HAYES, MIDDLESEX, ENGLAND

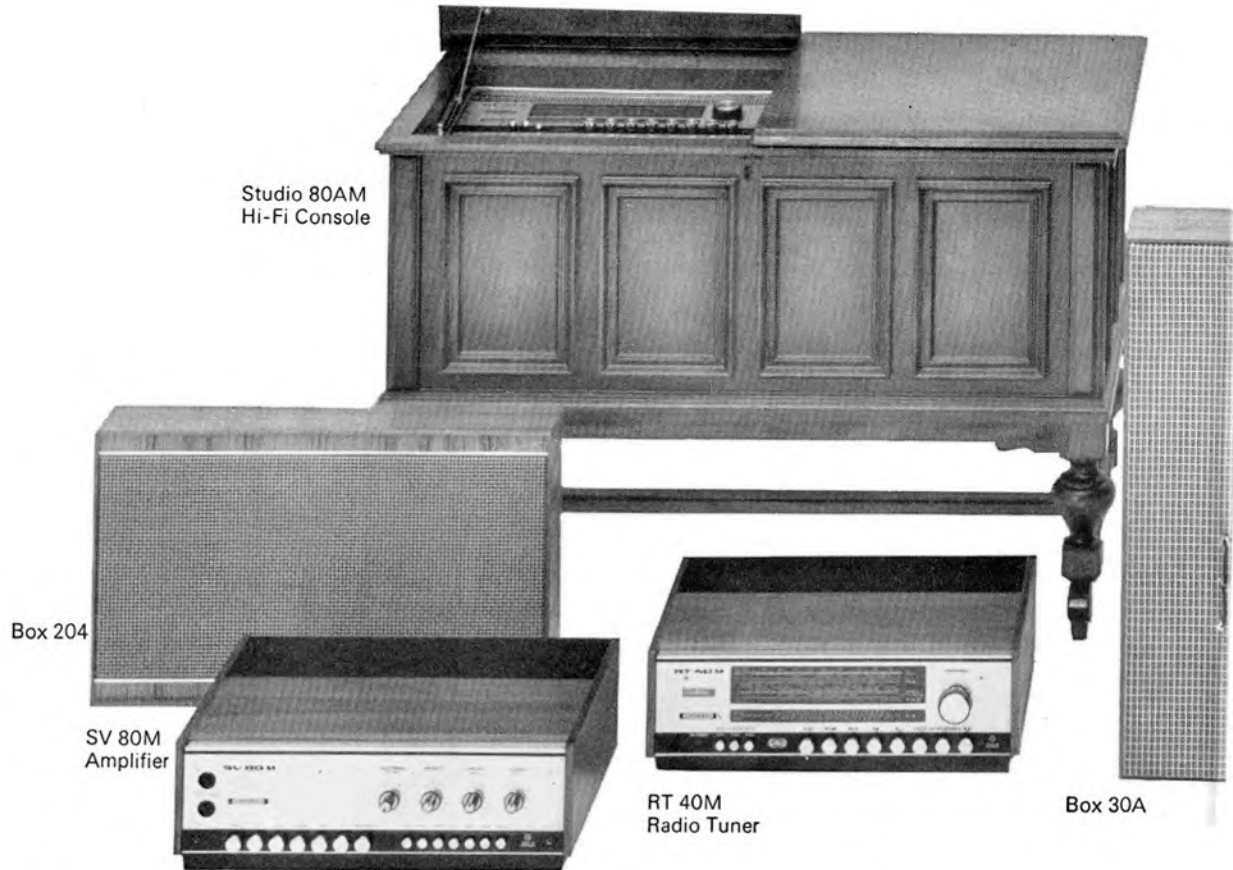

# This year, at the Audio Fair, you'll see a lot of Grundig...

**...if you can get through the crowds!**

April 18-21, at the Hotel Russell, London... your chance to see the full exciting range of Grundig Hi-Fi equipment, at the 1968 Audio Fair. There'll be a Grundig Booth on the ground floor (Booth No. 69), and you'll *hear* Grundig in action in our Demonstration Room on the sixth floor (Room 634). Feel free to browse around, taking a

close look at what must surely be the most comprehensive range of precision sound equipment ever offered by one manufacturer.

Our experts will be on hand to answer all your questions, so come along, we've a lot to show you.

We don't get crowds for nothing.



GRUNDIG, London, S.E.26

Studio 80  
Hi-Fi Console

Box 80A



TS 340 de luxe



TK 247 de luxe

Box 40A  
(above)

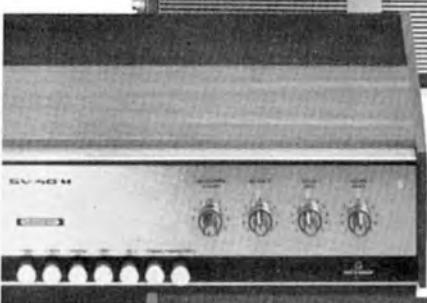

Box 203

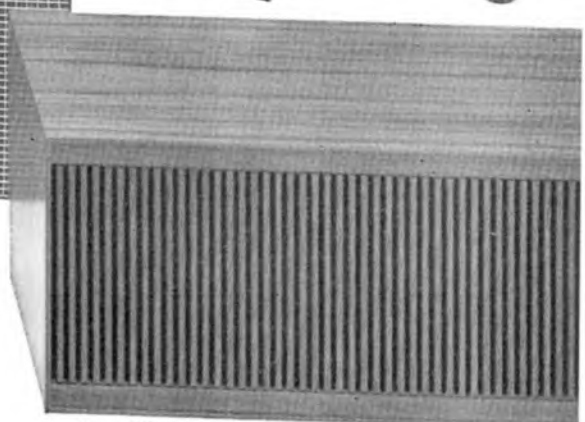
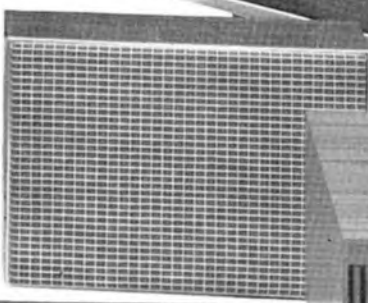

Box 425

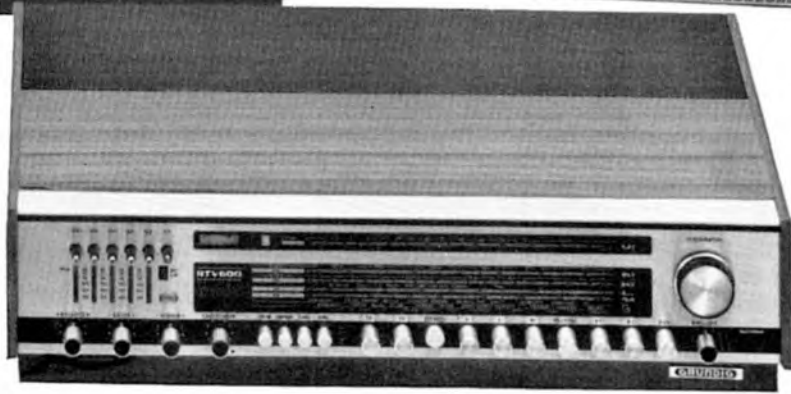

RTV 600  
Tuner/Amplifier

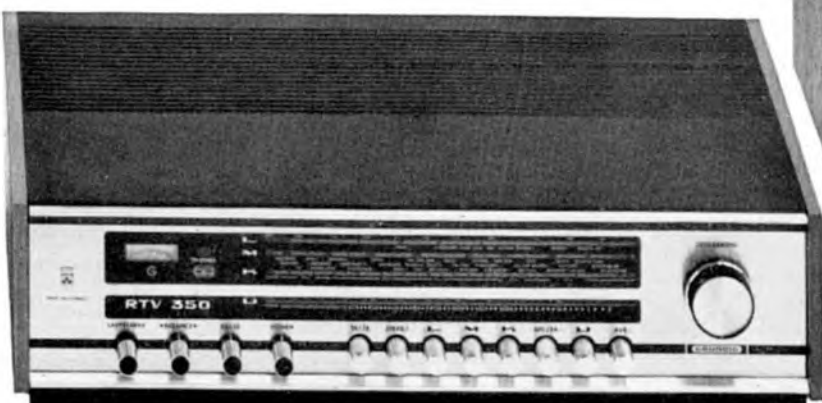
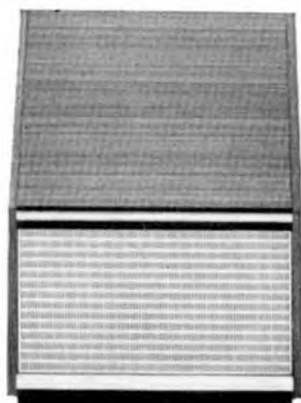

RTV 350 Tuner/Amplifier  
and 2 Box 19s

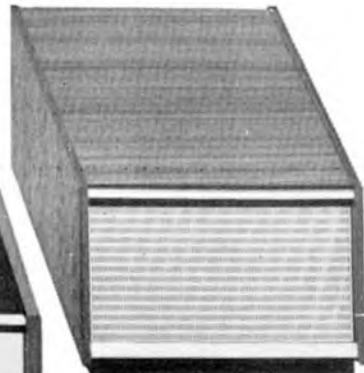

# AUDIO FAIR '68

RUSSELL HOTEL, LONDON, APRIL 18/21

**A**UDIO veterans will know exactly what the two words "Audio Fair" imply and do not need to be told either what to expect or how to get the best value out of their annual visit to the Russell Hotel. But every year more and more newcomers to audio learn of the existence of the Fair for the very first time. When it's all over they readily admit that their first visit to this annual event was a shattering experience—literally, and in more ways than one! So as usual we propose giving just a little advice on what to see, what to do and how to form reasoned conclusions from the wealth of demonstrations that will be available. But, firstly, let us explain our own coverage in Tape Recording Magazine.

This edition, cover-dated April, and on sale from Wednesday, March 20, contains a full list of exhibitors together with their demonstration room numbers. Our edition cover-dated May will be on sale from Wednesday, April 17—that is the day before the Fair opens its doors for the first time. Details of interesting products that will then be shown to the public for the first time will be published in that issue. Lastly, our June issue (on sale from Wednesday, May 15) will contain our "Audio Fair Retrospect," an authoritative comment and post mortem on all that the TRM staff saw and heard during the four days of the Fair.

It is our belief that the 1968 Audio Fair will be of outstanding interest because it will be made the occasion for unveiling some remarkable new equipment of British design and manufacture—equipment that may well establish this country's leading position against Continental competition.

When looking at new equipment and hearing it demonstrated for the first time—under the artificial conditions of the Hotel Russell bedrooms—how do we form an opinion as to its usefulness or value to us personally? Firstly, it must be remembered that the exhibitor will have spent a great deal of money to bring his products to the Fair in the first place, and because he has a vested interest in selling them his own side of the story is bound to be biased. He would be less than human if it were not. His

demonstration will have been carefully "arranged" so that his products may be heard in the best possible way.

Please note that in this context "arranged" has a sincerely honest connotation as opposed to "fixed," which may imply dishonest practices calculated to produce results that no owner could hope to achieve. "Arranging" is a perfectly legitimate and justifiable expedient involving the selection of the most suitable items for reproduction, the proper positioning of loudspeakers in relation to audience, etc. In fact it would be reasonable to conclude that an exhibitor who neglected this essential pre-requisite to his demonstration was singularly ignorant of the subject of good quality audio and therefore his product might be suspect. Dishonest "fixing" is fortunately something that is so rarely met with at the Audio Fair that it can be discounted by the visitor.

Printed specifications are quite another matter. Some might make claims that could never be substantiated by laboratory investigation, others will be a fair representation of what the manufacturer believes his product is capable, and then curiously enough there is a third category where the manufacturer's sense of honesty and fair play is so stringent (but uncommercial!) that he deliberately understates the attributes of his product. We must admit to a strong affection for this modest fraternity who prefer to give better value than their specifications suggest, rather than the breed who publish inflated figures and then hope and pray that their equipment might one day live up to them.

The visitor will find one subject deliberately ignored in most, if not all, of the literature with which he is burdened. We refer to service facilities. Glancing through a handful of pamphlets one could be forgiven for imagining that all this superlative equipment would run for ever without going wrong. This is just not true. Although good quality tape recorders are reliable pieces of equipment it must be appreciated that proper service facilities are essential, even for professional machines costing thousands of pounds. The best tape recorder in the world is nothing but an encumbrance

A limited number of complimentary tickets for the 1968 International Audio Festival and Fair are available to readers of "TAPE Recording Magazine." Each ticket admits two. Please apply by letter, enclosing a stamped and addressed envelope to:

TAPE RECORDING MAGAZINE  
Dept. A.F., Prestige House,  
14/18, Holborn, E.C.1.

Please do not include any other communications in the same envelope.

on those very rare occasions when it doesn't work.

The Audio Fair presents a golden opportunity to question the manufacturer's representatives on just what his service facilities are and how they can be made available to the private purchaser. In our opinion this is more important than all the specification tables or subjective listening tests in the world. The simple questions are:

"If it goes wrong, how can I get it put right, and how long (roughly) will it take to have it put right?"

Only if the answers to these questions are satisfactory should we investigate further.

The most convincing demonstration of any tape recorder is to hear it reproducing recordings—preferably live—that have actually been made on identical equipment. Even here there is a danger. Are we to form our opinions from the sound heard from the built-in speaker in the recorder case, are we to expect to listen to the recording being reproduced on an expensive, full-range speaker system driven from the extension speaker outlet, or should the demonstrator use a powerful mains amplifier as an accessory into which he feeds the signal from his line-out sockets and from which he drives a top-quality speaker unit?

Forming aural judgments is always difficult; the sound we hear is coloured to a greater or lesser extent by the speaker reproducing it and the room acoustics. However, we can be quite clear on one point. If we really want to hear all the sound that has been recorded on a given tape then the correct way to do it is to make use of both an external amplifier and full-range loudspeaker. Provided these items are properly chosen we shall then have the opportunity of hearing as much as one can hope to hear of what has been recorded. Further demonstrations using a full-range speaker driven from the external speaker outlet and then using no external speaker at all certainly provide information on the tape recorder as a playback mechanism, but, in the latter case, they could mislead in terms of recorded quality. Remember

*Please turn to page 170*

# THE EXHIBITORS AND WHERE TO FIND THEM

	Booth	Room No.		Booth	Room No.		Booth	Room No.
Acoustical Manufacturing Co. Ltd. <b>QUAD</b> ...	90	604/640	Dynatron Radio Ltd. <b>DYNATRON</b> .....	35	236/235	H. J. Leak & Co. Ltd. <b>LEAK</b> .....	54	104/137
A.E.G. G.m.b.h. <b>TELE-FUNKEN</b> .....	47	247/262	Elcom (Northampton) Ltd. <b>ELCOM</b> .....	78	249	Link House Publications Ltd. <b>HI-FI NEWS/TAPE RECORDER</b> .	81	244
Agfa-Gevaert A.G. <b>AGFA-GEVAERT</b> .....	37	317/318	Elizabethan Electronics Ltd. <b>ELIZABETHAN</b>	68	258	Lowther Manufacturing Co. <b>LOWTHER</b> .....	1	204/239/240
Akai Electric Corpn. <b>AKAI</b> .....	8	563/544/562	E.M.I. Ltd. <b>E.M.I.</b> .....	21	302/301	Lugton & Co. Ltd. <b>LUGTON</b> .....	—	250/251
<i>Pullin Photographic Ltd.</i>			Eugen Beyer Elektrotechnische Fabrik <b>BEYER</b> .....	58	254/215	Lustraphone Ltd. <b>LUSTRAPHONE</b> ...	79	145
Akustische Und Kino-Gerate Gesellschaft <b>AKG</b> .....	88	237/205	<i>Ficord International</i>			Marubeni-Iida Co. Ltd. <b>SANYO</b> .....	73	342/340
<i>Politechna (London) Ltd.</i>			Euphonics Corpn. <b>MINI-CONIC</b> .....	26	540	Minnesota Mining & Mftg. Co. Ltd. <b>SCOTCH</b> .....	60	347
Ampex Corpn. Inc. <b>AMPEX</b> .....	5	536/505/535	<i>Elstone Electronics Ltd.</i>			Medley Musical Ltd. <b>MEDLEY MUSICAL</b>	39	—
Arena Hede Nielsen Fabriker A/S <b>ARENA Highgate Acoustics</b>	34	156/114	Ferranti Ltd. <b>FERRANTI</b>	76	261	M. B. Mikrofonbau-Vetrieb G.m.b.h. <b>M.B. MIKROFONBAU</b> ....	41	—
Armstrong Audio Ltd. <b>ARMSTRONG</b> .....	80	537/539	Ferroglyph Ltd. <b>FERROGRAPH</b> .....	53	134/133	<i>Denham &amp; Morley Ltd.</i>		
Audio & Design Ltd. <b>AUDIO &amp; DESIGN</b> ...	65	356/314	N. & S. B. Field & Co. Ltd. <b>RECORD HOUSING</b> .....	29	442/443	Mullard Ltd. <b>MULLARD</b>	36	350/351
Audio & Record Review <b>AUDIO RECORD REVIEW</b> .....	—	246	Fisher Radio International Inc. <b>FISHER</b>	4	637/639	Multicore Solders Ltd. <b>MULTICORE SOLDERS</b> .....	62	—
Audio Technica Corpn. <b>AUDIO TECHNICA</b>	43	202/201	<i>Getz Bros. &amp; Co. Inc.</i>			Sinclair Radionics Ltd. <b>SINCLAIR</b> .....	46	248
<i>Shriro (UK) Ltd.</i>			Garrard Engineering Ltd. <b>GARRARD</b> .....	71	234/232/233	S.M.E. Ltd. <b>SME</b> .....	61	—
Badische- Anilin- & Soda-Fabrik A.G. <b>BASF</b> ...	55	149/162	General Gramophone Publications Ltd. <b>THE GRAMOPHONE</b> .....	—	444	Standard Telephones & Cables Ltd. <b>STC</b> .....	6	—
Billboard Publishing Co. <b>HIGH FIDELITY</b> ...	86	—	Goldring Mftg. Co. Ltd. <b>GOLDRING</b> .....	93	402/401	Stereosound Productions Ltd. <b>STEREOSOUND</b>	32	155
Boosey & Hawkes (Sales) Ltd. <b>JORDAN-WATTS</b>	30	448	Goodmans Loudspeakers Ltd. <b>GOODMANS</b> ...	45	434/432/433/405	A. R. Sugden & Co. Ltd. <b>CONNOISSEUR</b> ....	83	548/546
Brenell Engineering Co. Ltd. <b>BRENELL</b> .....	89	242/243	Grampian Reproducers Ltd. <b>GRAMPIAN</b> ...	38	141	Tannoy Products Ltd. <b>TANNOY</b> .....	67	547/550/551
Bosch G.m.b.h. <b>UHER</b> .	44	361	Grundig (G.B.) Ltd. <b>GRUNDIG</b> .....	69	634/633	Tape Recorder Spares Ltd. <b>TAPE RECORDER SPARES</b>	84	160/115
Braun A.G. <b>BRAUN</b> ...	57	253	Hansom Books Ltd. <b>RECORDS &amp; RECORDING</b> .....	66	—	Tandbergs Radiofabrikk A/S <b>TANDBERG</b> .....	24	504
<i>Ficord International</i>			Haymarket Publishing Group <b>HI-FI SOUND</b>	56	344	<i>Elstone Electronics Ltd.</i>		
BSR Ltd. <b>BSR</b> .....	70	259/216	Iliffe Electrical Publications Ltd. <b>WIRELESS WORLD/ELECTRIC-AL &amp; ELECTRONIC TRADER</b> .....	75	—	Tape Recorder Developments Ltd. <b>T.R.D.</b> .....	16	447/462
Cosmocord Ltd. <b>ACOS</b> .	77	217	Instrument Research Laboratories Ltd. <b>I.R.L.</b>	59	—	Technical Ceramics Ltd. <b>SONOTONE</b> .....	49	154
Decca Record Co. Ltd. <b>DECCA</b> .....	3	648/650	KEF Electronics Ltd. <b>KEF</b> .....	92	542/543	<i>Metro-Sound Sales Ltd.</i>		
Design Furniture Ltd. <b>DESIGN FURNITURE</b>	10	140/138						
Diamond Stylus Co. Ltd. <b>DIAMOND STYLUS</b> .	40	450/451						
Dual Electronics Ltd. <b>DUAL</b> .....	72	147/148						

Continued overleaf

## AUDIO FAIR '68

Continued from page 168

that recorded imperfections can often be masked owing to the inability of small internal speakers to handle the full audio range.

There are many other considerations to bear in mind. If we are looking for a machine to carry about then we shall need reasonable portability and a robust case; for static use at home we shall probably be more interested in styling and general appearance. Check on the type of input and output sockets provided. Are they standard? Of the standard plugs and sockets available ordinary phono plugs are probably the least desirable, continental DIN the most convenient and standard jack the most robust. Controls should be easily accessible and knobs should be large enough to permit accurate fine adjustment. Record level indicators must be visible and not recessed or obscured by other deck fittings. A tape recorder is a functional mechanism; when styling hinders operation it is evidence of lack of thought or knowledge on the part of the designer.

Apart from tape recorder demonstrations we have a very special interest in exhibitions of microphones and tape. Last year one firm gave live microphone recordings "before our very eyes" in bold demonstrations designed to prove the value of the product by comparison between the live and the recorded sound. Such courageous attempts are wholly sincere and should be of the greatest

interest to all enthusiasts. Next best is the playback of comparative recordings showing the differences between results obtained when using the various models in the catalogue. By listening carefully one can learn a great deal, particularly the very subtle differences in sound quality obtained from medium-low-priced microphones as compared to those in much more expensive categories.

Magnetic tape itself is probably one of the most difficult products in the world to demonstrate adequately. Results will be affected so much by the equipment used to record and play back that one cannot really draw any very sensible conclusions other than to assume that the sound quality heard is the very best likely to be possible when using that brand of tape under ideal conditions.

On the so-called hi-fi side we shall see and hear tuners, amplifiers, speakers and gramophone transcription units. Of these the radio tuner is the easiest to demonstrate. We shall be looking for a good, clean signal, free from distortion, background noise and drift. Some mush is inevitable in stereo reception so we shall ask for comparisons between the two if stereo should be being broadcast at that particular moment. But the results obtained from the best of tuners—particularly when working stereo—depend largely on the efficiency of the aerial to which they are connected. In the Russell Hotel facilities are not good in this respect and due allowance must be made.

Amplifiers, speakers and turntables are

all difficult products to demonstrate. Of these the component likely to influence the final sound most strongly is the loudspeaker. As we walk around the demonstration rooms we shall hear dozens and dozens of different loudspeakers. Owing to the fallibility of human hearing it will be found difficult, even impossible, to carry in the mind an accurate memory of one sound to compare with another. It is best to concentrate on no more than three different makes of loudspeaker and then to listen to them in turn with as short an interval between sessions as possible. If it is felt that definite conclusions have been reached on their relative quality this should always be confirmed later by asking for direct comparison trials at a local hi-fi specialist dealer's showroom.

Finally, do please spare a thought for the exhibitor. He will have spent a great deal of time and money and gone to a lot of trouble to present his equipment to you. He will not ask you to buy anything; all he expects in return is that you should have the patience to listen and the intelligence to ask sensible questions which he will be delighted to answer. The four days of the Fair can be an exhausting endurance test for staff. One never ceases to marvel at the way in which these good people tactfully and patiently handle their public right up to the last moment of the last day. In return we would ask *TAPE Recording Magazine* readers to give them the only payment we can—our sincerest thanks.

## Audio Fair Exhibitors

Continued

	Booth	Room No.
Ortofon A/S ORTOFON <i>Metro-Sound Sales Ltd.</i>	51	647
Oki Electric Industry Ltd. <b>OKI</b> ..... <i>Denham &amp; Morley Ltd.</i>	33	255
Parmeko Ltd. <b>PARMEKO</b>	82	358/315
Philips Hi-Fi <b>PHILIPS</b>	23	336/335
Philips Tape Recorders <b>PHILIPS</b> .....	25	337/339
Pioneer Electronics Corp'n <b>PIONEER</b> ..... <i>Swisstone Ltd.</i>	9	360/316
Print & Press Services Ltd. <b>TAPE RECORD- ING MAGAZINE</b> ....	—	343
Radionette A/sjeselskapet <b>RADIONETTE</b> ..... <i>Denham &amp; Morley Ltd.</i>	31	256/214

	Booth	Room No.
Rank Wharfedale Ltd. <b>WHARFEDALE</b> .....	87	502/501/ 459
Recordaway Co. Ltd. <b>RECORDAWAY</b> .....	20	—
Reslosound Ltd. <b>RESLO</b>	15	348/362
Richard Allen Radio Ltd. <b>RICHARD ALLEN</b> ...	27	642/644
J. Richardson Electronics Ltd. <b>RICHARDSON</b>	74	359
Rogers Developments Ltd. <b>ROGERS</b> .....	48	602/601
Rola Celestion Ltd. <b>CELESTION</b> .....	22	534/532/ 533
Sansui Electric Co. Ltd. <b>SANSUI</b> .....	28	159/118
<i>Technical Ceramics Ltd.</i> Sennheiser Electronics G.m.b.h. <b>SENNHEISER</b> .....	63	355
<i>Audio Engineering Ltd.</i> Shure Bros. Inc. <b>SHURE</b>	91	404/440/ 439/449

	Booth	Room No.
Teleton Elektro (U.K.) Ltd. <b>TELETON</b> .....	64	158
Thorens S.A. <b>THORENS</b> <i>Metro-Sound Sales Ltd.</i>	50	—
Trio Corp'n. <b>TRIO</b> .....	42	260
<i>Arnhold Trading Co. Ltd.</i> Truvox Ltd. <b>TRUVOX</b> ...	94	636/605
University Recording Ltd. <b>SLOT STEREO</b> .....	52	117
Vortexion Ltd. <b>VORTEXION</b> .....	2	334/333
Whiteley Electrical Radio Co. Ltd. <b>W. B.</b> <b>STENTORIAN</b> .....	85	304/305
K. H. Williman & Co. Ltd. <b>WILLIMAN</b> ....	—	346
Wilmex Ltd. <b>WILMEX</b> .	—	363
Willi-Studer <b>REVOX- STUDER</b> .....	19	663/662/ 646
<i>C. E. Hammond &amp; Co. Ltd.</i> Yamaha Europa G.m.b.h. <b>YAMAHA</b> .....	18	161/116



# YOU CAN KEEP YOUR SOUND

(If you put it in the business end of a London Microphone)

Keep it true to life, capture it without trouble even under difficult conditions, bring out the best of your recording equipment. Spend far less than on any other comparable microphone: The London Microphone range gives you quality sound reproduction; sensitivity; the specification you want for a huge variety of uses in tape recording, audio-visual productions and education. Special versions suitable for transistorised tape-recorders.



**LM 100 Dynamic Omni-directional microphone** available in a range of impedances including a version for transistorised tape-recorders (used by leading tape-recorder manufacturers). Retail price range £2.19.6-£3.14.6

**LM 200 Dynamic, cardioid microphone with balanced output**



Retail price range £4.14.6 -£5.9.6

Eliminates unwanted background and gives you good recordings even under difficult conditions.

Frequency range 50-15,000 c/s  
Impedance range 60 to 500 Ohms (and dual, 200 Ohm & 50 kOhm)  
Sensitivity (60 Ohm) 0.1 mV/ubar  
Supplied with 6 ft. twin-screened cable.  
Available with a choice of practical stands and adaptors.  
Ideal as replacements in existing recorders.

Please write or ring for details and specifications:

## London Microphone Co Ltd

182/4 Campden Hill Road London W8 Telephone: Park 0711  
Telex: 23894



# TELEFUNKEN

## The Powerful Partnership

**Stereo amplifier: solid state for a big solid sound.**  
**And a stereo tuner that really separates one channel from the other**

**V 201 stereo amplifier** A level of performance that far exceeds the modest price. 2 x 25 watts continuous output power; 26 transistors; wide frequency range, extremely low harmonic distortion. Wide range of accessory sockets. Painstakingly designed for the stereo enthusiast who demands the very best technical specification. Hear the V201 at good specialist dealers... a truly superb sound. Recommended retail price: £108.12.0.

**T 201 stereo tuner** A perfect partner to the V 201. A fully-transistorised, all-waveband tuner with particularly powerful FM sensitivity. Automatic tuner (AFC), FM stereo indicator and separate AM/FM tuning. Excellent separation of signals from stereo channels: cross-talk attenuation better than 26 dB at frequencies below 6,300 c/s, better than 20 dB below 10,000 c/s. Very high selectivity: watch the signal strength meter drop all the way to zero in between stations. Recommended retail price: £89.9.5. Both units are matched in teak and light matt walnut cabinets.

Write today for fascinating FREE colour booklet to AEG (Great Britain) Limited 27 Chancery Lane London WC2.

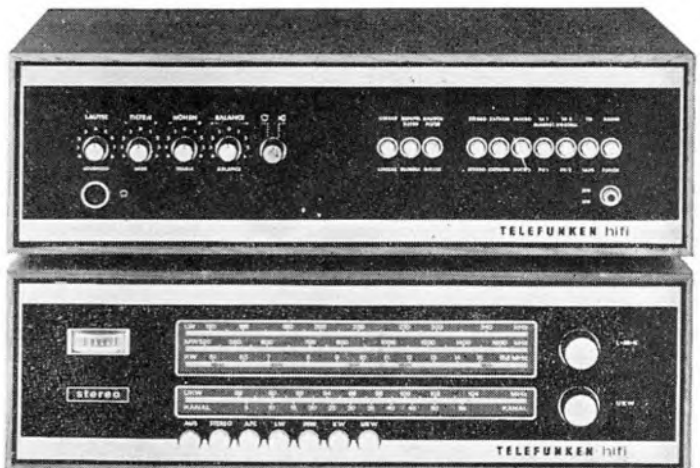

Slow  
slow  
quiet  
quiet  
slow

Quite.

'Scotch' Low-Noise 'Dynarange' tapes reduce background noise.

They also increase your dynamic range.

And improve your frequency response.

So you can reduce recording speeds if you want.

In fact you can *halve* them. Without losing quality.

So you save money, even though you pay a bit more.

Or you can exploit that increased dynamic range and improved frequency response.

And make the best recordings you've ever heard in your life.



202 STANDARD PLAY  
sizes: 5", 5½" and 7"  
203 LONG PLAY  
sizes: 5", 5½", 7" and 8½"

For Price List of the full 'Scotch' range with technical details, write to: G. C. Wride, Magnetic Products Division, 3M Company, 3M House, Wigmore Street, P.O. Box 1.E.T., London, W.1.

Scotch



3M

DYNARANGE

3M, 'Scotch' and 'Dynarange' are trademarks of Minnesota Mining and Manufacturing Company.



## TECHNIQUES

*Continued from page 162*

things as converters that will produce an accurate 50 Hz 240 volt supply from a 12 volt car battery. There is just no excuse at all for the chap who leaves his mains equipment at home simply so that he can save himself a little physical effort by using a lightweight battery machine. On the other hand it would take a team of pack mules to transport that same mains equipment, probably with converter and car battery, across 20 miles of open country!

Whenever thinking about battery portables the very first consideration is surely the recorded quality any given machine is capable of registering on the tape. Playback should be necessary only for monitoring purposes; the vital requirement is how well will it record?

The next and equally important aspects are those of size and weight. The answer here will depend entirely upon the kind of uses to which the machine will be put. The absolute maximum acceptable weight is around twenty pounds. Even this is much, much too heavy if the user contemplates travelling many miles on foot, probably with other essential items of luggage. For such applications the ideal weight would be around three or four pounds and the size not very much larger than a camera or pair of binoculars. Before anyone wastes time looking for such a machine let me hasten to add that there is unfortunately no such animal. The old Fi-Cord 1A, now out of production for many years, used to go at least part of the way towards solving the problem. It was very small and very light and recorded quality at 7½ ips could be up to broadcast standards. There has never been a comparable successor to this little machine.

Unfortunately designers tend to produce what they think the public wants; nowadays they believe that the public want a list of gimmicky features a mile long, so in go the gimmicks, up goes the price and up goes the weight. If only some manufacturer had the wit to produce a neat little box of tricks offering excellent quality at 7½ ips (as is easily possible nowadays) but not much else, there should be a big demand for it amongst both professionals and amateurs. The man who is working out in the field couldn't care less about chromium knobs, playback amplifiers or even fast wind facilities. All he wants is the best possible recording and to blaze with all the frippery.

Maximum spool size on my own ideal machine would probably be no larger than 3¼ inches diameter. In these days of exceedingly thin tapes it is far easier to extend the programme time by reducing tape thickness rather than by increasing

spool diameters. Five-inch tape spools require a relatively large tape deck and consequently a bulky and unmanageable machine.

I would want my machine to be operable in any position, but the most important feature would be the provision of a shoulder strap and accessibility of all controls when suspended in that way. The record level indicator must be a meter and this should be illuminated by an internal bulb. Electronic magic eyes are invisible in bright sunlight and unlit meter needles cannot be seen in the dark. The microphone plug and socket must be of the "self-locking" type so that once the microphone lead is connected there is no danger of violent movement dislodging it. As most battery recordings are destined for editing I would certainly record whole track and this would give the added advantage of a slight improvement in signal-to-noise ratio.

Lastly the power supply has to be considered. Nowadays there are such a variety of DC power sources available that one only has to consider battery life in relation to cost and weight to decide which would be the best type to use. Some kind of rechargeable cell has great advantages in economy, although it does restrict use over prolonged periods away from the charging facility.

It goes without saying that the case must be both light and robust without any brittle plastic fittings. One cannot expect it to be "water-proof" in absolute terms, but it must certainly be "shower-proof."

With such a machine one could take recordings at any time in any place. The snag is it doesn't exist—or if it does someone has forgotten to tell me about it. However, if we work from this specification the individual reader can add to it the features he himself would require, remembering that every facility added means more weight and more bulk.

Nowadays battery portables tend to be full-blown mains machines in miniature and one result of this trend has been the fallacious assumption by some people that it might be more useful for them to buy a "nice light little battery portable" rather than a standard recorder. Bearing in mind my previous remarks on the quality relationships between battery and mains machines this is obviously not a good policy. There are however a number of compromise hybrid equipments which offer both mains or battery operation without the use of additional accessories. Usually these are found at the lower end of the price bracket and cannot really be considered in terms of absolute quality. However they may well be useful appliances for those who are less particular in their requirements and a good

specimen will achieve a better frequency response and very much better signal-to-noise ratio than we would get from, say, a 78 rpm gramophone record in the good old days.

The newcomer to the great outdoors is the cassette machine. The smallest battery models are not dissimilar in size, shape and weight to the very early Fi-Cord 1A referred to earlier. Their one disadvantage from my point of view lies in the strict limitations on recorded quality at 1½ ips. Let us be quite clear about one thing. Operating speed and recorded quality are so tightly related that the one is easily confused for the other. The fact of the matter is that the operating speed on a battery portable just doesn't matter tuppence—or even the proverbial tinker's cuss. What does matter is that we should be able to achieve the quality that we today associate with either 7½ or 15 ips. There would be many advantages in working at slow speeds, even 1½ ips, if we could still maintain 7½ ips quality.

Impossible? Perhaps so, but did you note our editorial reference last month in Cross Talk to the latest developments in the tape manufacturing world? These announced the development of an entirely new magnetic tape which is claimed to be able to hold frequencies up to 20,000 Hertz at 1½ ips and also to reduce background noise. To me this is a sure indication of the future. I have no doubt at all that one day we shall be working outdoors getting good quality recordings using cassettes at 1½ ips.

It must come. I know the disadvantages. Tape built into a cassette cannot be edited. That doesn't matter at all—we shall just copy the cassette on to standard tape on the mains machine back at base and edit the copy. Against this minor disadvantage we have the enormous advantage of the convenience of cassettes. Have you ever tried lacing up quarter-inch recording tape on a portable spool-to-spool machine standing on a windy street corner in sub-zero temperatures? With icy fingers blue and numb from the cold this simple task becomes a near impossible feat. Cassettes would be a joy to use under these difficult conditions, and the recordist would willingly endure the inconvenience of having to make dubbed copies.

**Amongst the exhibitions running concurrently with and adjacent to the Audio Fair in the Russell Hotel will be: 68 Audio in the Tavistock Hotel, showing B & O, Sony and Radford equipment and Transatlantic Music Tapes (Distributors) Ltd. at the Morton Hotel showing Viking, Telex, CBS and RCA products.**

Is it possible for all  
these features to be concentrated  
in ONE tape recorder?



Yes, the BEOCORD  
has them all!

- Built-in 4-channel mixer section with twin slide potentiometres
- Records on 2 tracks. Plays back on 2 and 4 tracks.
- Trick recordings: Multiplay, sound-on-sound, synchro playback, echo
- Usable as microphone-amplifier during tape replay
- 3 tape speeds
- 2 illuminated recording level indicators
- Tape control lever
- 4 Bogen heads
- Monitoring
- Instant pause control
- Slack absorbers
- External impedance switches
- 3 replaceable pre-amplifiers
- DIN standard inputs and outputs
- Input and output sockets on base of cabinet
- 2 separate 8-watt output amplifiers
- Automatic stop for tapebreak and end of tape
- Sockets for two pairs of speakers
- Amplifier can be used with motor switched off
- Separate bass and treble controls
- Headphonejack
- Low-impedance microphone input, balanced
- Line input and output, (tape-copying channel)
- Tape index counter
- Voltage switch
- Fully transistorized

A highly advanced tape recorder with professional wow and flutter specifications, crystal clear reproduction, and ample volume output, the Beocord 2000 de Luxe is designed for the exacting audiophile who insists on unlimited possibilities in trick and sound-on-sound recordings etc. The Beocord 2000 de Luxe ranks among the five highest priced semiprofessional tape recorders in the world. It ought to be the highest priced of them all!



- for those who  
consider design and quality  
before price

Bang & Olufsen  
U.K. Sales Division  
Eastbrook Road  
Gloucester

London Showrooms  
70/71 Welbeck Street  
London W1

Solomon & Peres  
67/69 Ann Street  
Belfast 1

AT long, long last we have the beginnings of a real local broadcasting service. This column had campaigned strenuously for local radio and it would be interesting to speculate whether my efforts encouraged those responsible to establish this service or whether their decision to go ahead was made in spite of what I had to say on the subject. Probably the latter!

Now that several stations have been operating for a number of weeks it is possible to begin to form some conclusion about the value of the work they are doing. After all, a service as radically new as local broadcasting is in this country cannot base either policy or programmes on precedent. It must continually research to find out just what the public wants and then to work out the right way to give it to them. This must be a most exciting time for the individual station managers whose task it is to pioneer this unexplored territory where none have stepped before. One thing is quite clear. The local station will capture its audience only if its material is truly local in character. I have heard complaints of parochialism and amateurism. The first is surely complimentary rather than critical, whilst the second is something that can only be overcome with experience.

Very many—but not all—readers of *TAPE Recording Magazine* would class themselves as amateurs. In the strict sense this means nothing more than undertaking a project for love rather than for money. There is not the slightest reason why it should be regarded as synonymous with poor quality, inadequate knowledge and bad technique. Or if that must be the meaning of amateur then I can only say that a good many professional productions achieve nothing more than an obviously amateur standard.

Whatever their actual status might be, I like to think that readers of *Tape Recording Magazine* adopt a competently professional approach to all their recording activities. It doesn't take a master mind to relate this abundance of recording talent on the one hand with the almost insatiable demand of local stations on the other. Many otherwise thoroughly experienced and proficient amateurs might be too modest to consider their own work as being up to the standards required for broadcast transmission. So far as the national service is concerned they might well be right. But local radio is a totally different matter. The highest possible quality in terms of recorded sound is still required but this would be related to the local interest value of the recording. No one is in a better position to get interesting local material than the private enthusiast living on the spot.

So if you have a local station in your home area do think seriously about the

# CROSS

# TALK

## By Audios

opportunities that are now open. In an endeavour to assist, the British Federation of Tape Recordists and Clubs in co-operation with *TAPE Recording Magazine* is setting up an advisory service; interested persons should write either to the Magazine or the Federation when practical help will be given to get those recordings on the air.

*WHENEVER a number of audio enthusiasts get together it seems inevitable that sooner or later the conversation turns towards comparing the taking of sound recordings to the taking of photographs. Thousands upon thousands of words have been wasted on trying to prove that the two interests have much in common, and just as many have been spent in proving that they are utterly dissimilar! Can one draw a real comparison between photography and recording?*

*Of course the two occupations do have a very great deal in common, but this similarity is really superficial. As soon as we consider the two interests in practical detail we find that the fundamental driving force, the motivation that makes a man take a photograph or sound recording, is very similar; the divergence occurs in the difference between the solidity of objects seen and the transience of sounds heard. A building to be photographed is a concrete entity (often literally!) that can be touched, walked around, talked about with the quality of permanence. Even its photographic representation has a similar character; the picture can be hung on the wall, touched, walked around, talked about and will stay there until we choose to remove it.*

*There is no such thing as a permanent sound; as soon as we try to communicate about it—by speaking—we interfere with it. Consider the difference between walking around an exhibition of photographs, perhaps staged by the local photographic club, and listening to the playback of recorded sounds arranged by the tape club. In the first case we have a social activity where the exhibits can be discussed and compared as much as we wish. In the second we have to sit in complete and absolute silence, not daring to speak a single word.*

*So my conclusion is that the biggest difference between the two is that photography is social whereas sound recording is anti-social. Had you ever thought of it in that way? To my mind this entirely accounts for the successes of photographic clubs, exhibitions and contests which always attract more public attention than their sound equivalents. Does anyone have any ideas for making sound recording more social? Solve that problem and you've solved one of the greatest difficulties under which we are labouring.*

I WAS delighted to receive an invitation to attend the second anniversary celebrations of the London Tape Studio. This very fine establishment is under the control of the Inner London Education Authority and was originally founded to provide facilities for London school teachers to get together and learn about tape recording and microphone technique. Much of the credit in this enterprise must go to Geoffrey Hodson, Senior Inspector of Drama, and occasional contributor to this Magazine.

The studio and control room are housed in a school in the West End of London and were declared open on February 17, 1966, by Frank Gillard, Director of Radio from the BBC. The control room, 11 feet by 8 feet, houses two tape recorders, one a Ferrograph and the other Vortexion. Both are high-speed versions. Modified Vortexion mixers have been built into a control desk beneath a double glass observation window looking straight into the recording studio itself. The entire unit is modelled on the BBC pattern and provides both talk back and fold back.

In congratulating all those who have put so much unstinted work into this project I can only ask plaintively why on earth the authorities do not provide a number of studios of this calibre for the use of all those many classes of persons who would derive inestimable benefit from them? Tape recording is still in its infancy; by the time it reaches its majority this idealistic state of affairs could have come about—but it won't unless those who want to see the establishment of "semi-professional" studios constantly and loudly demand them.

WHO records stereo? I would give a lot to know the answer. It is generally accepted in the trade today that mono is dead. Undoubtedly the demand for good class stereo equipment exceeds the demand for its mono equivalent. So what do people record?

Dubbing from ordinary commercial discs is illegal and so must be discounted. This leaves us with stereo radio. Apart from the fact that the service is at present very limited in its coverage the quality is often disappointing even with the very best tuner. The level of background noise rises alarmingly as compared to mono reception and the only way to improve matters is to use a properly designed aerial.

So if we don't record from discs and we can't accept the quality we get from radio we are forced to conclude that the only other stereo recording must be live, using microphones.

But playing back is quite a different matter. A great deal of stereo equipment can be kept in almost constant use reproducing commercial stereophonic tape records. And this, I am forced to conclude, is the use to which most stereo tape recorders are put—apart from those owned by the sturdy band of pioneers who really do undertake live stereo recording. Which, by the way, is not nearly so difficult as some might think. Why, even I have achieved some small degree of success with my own stereo recordings. That should be encouragement enough for anyone!

IF any reader would care to write to me enclosing in his letter the sum of two guineas I will be pleased to supply him by return of post with my own specially designed Audio Fair Survival Outfit (patent pending). The useful items neatly packed in sound absorbent polystyrene include a sub-miniature bottle of brandy, tin of cornpads, bottle of aspirins, set of earplugs and a lapel badge that says, "Please, I can't stand any more."

# UHER

## the ONLY tape recorder for YOU...

### 4000 REPORT SERIES Three different models of the Uher 'Report' are now available:

#### 4000 Report - L

As illustrated. Specification: 2 Tracks conforming to international standards-2; Tape reels diam.-5"; Tape speeds (ips)  $\frac{1}{2}$ , 1, 3, 7 $\frac{1}{2}$ ; Frequency range (cps) 40-4,500/40-10,000 and 40-16,000/40-20,000; Dynamic volume range (db) 40 at  $\frac{1}{2}$  ips, 46 at 1 ips, 50 at 3 ips, 52 at 7 $\frac{1}{2}$  ips; Wow and flutter (max  $\pm$ %) 0.2% at 7 $\frac{1}{2}$  ips; Recording mono; half-track; playback mono half-track; Power output one watt.

Monitoring via headphones or speaker; VU meter + three digit tape counter; tape stop-start remote control, collectorless motor controlled by 8 transistors; power supply from 6V, 12V, 24V car battery, from rechargeable accumulator or 5 flashlight cells 1.5 Volt; 17 transistors.

Microphone, radio, pick up input: 1V at 15 Kohms and 2V at 4ohms. Weight 6 lbs (approx). 121 gns.

#### 4200 Report Stereo

Affording all the advantages of the successful 4000 Report-L in size, style and specifications—plus stereo. 146 gns.

#### 4400 Report Stereo

Again with all the advantages of the 4000 Report-L—plus stereo and maximum economy of tape on four tracks without deterioration of reproduction quality. 146 gns.



#### 724 L Stereo

Specification: 4 Tracks conforming to international standards-4; Tape reels diam.-7" Tape speeds (ips) 3 $\frac{1}{2}$ , 7 $\frac{1}{2}$ ; Frequency range (cps) 40-14,000, 40-18,000; Dynamic volume range (db) 45 at 3 $\frac{1}{2}$  ips, 46 at 7 $\frac{1}{2}$  ips; Wow and flutter (max  $\pm$ %) 3 $\frac{1}{2}$  ips 0.2, 7 $\frac{1}{2}$  ips 0.15. Recording mono and stereo; Playback mono and stereo; Power output. 2 x 2 watts; Microphone, radio, pick up inputs, output 1V at 15 Kohms and 2.8V at 4ohms. Weight, 20 lbs (approx.) 97 gns.

DISTRIBUTED IN U.K. BY

# BOSCH

The range of UHER tape recorders and accessories available in the U.K. satisfy the requirements of every amateur and professional enthusiast.

## ...when quality is your first concern

... always ask for UHER tape recorders and accessories. Quality is the simple, single aim behind their manufacture. Their production is also the sole pre-occupation of the UHER Company, whose specialisation has led to many outstanding developments, including the first application of printed-circuit techniques in tape recorder manufacture. For further details contact BOSCH LIMITED, UHER Division, Rhodes Way, Radlett Road, Watford, Herts. Telephone Watford 44233.

# BOSCH

has established a universal reputation for quality backed by continuous research, development and over 80 years of manufacturing experience. 85,000 BOSCH employees are universally engaged in the research, manufacture, distribution and service of BOSCH products. These include an impressive range of domestic appliances; radios; stereograms; tape recording equipment; automotive accessories and safety equipment; electric tools; hydraulics; language laboratory and closed circuit television systems... all of which are marketed in the U.K. by BOSCH LIMITED... a member of the BOSCH GROUP.

# DUBBING TRANSFERRING & MIXING

By JOHN BORWICK

**P**ROFESSIONAL studios spend lots of time and effort in various recording operations where microphones are not involved. Here are some of them:—

**Dubbing**—copying by re-recording in the same medium.

**Transferring**—copying by re-recording in a different medium: e.g. from tape to disc.

**Mixing**—combining two or more recordings into a composite recording.

**Reducing**—mixing from a multi-track recording to produce a mono or stereo master.

## Dubbing

It is absolutely imperative that you should be able to make tidy, accurate, copy tapes to order. Just think how limited a home photographic studio would be if it could supply only one print of a photograph. Or, carrying the analogy a stage further, if every print had to copy the *whole* negative reel—practice shots, downright bad shots and all. No, a photographer is expected to supply only the best photographs and, by masking in his enlarger, to compose each photograph for maximum impact.

Very often, then, in tape dubbing we can actually improve the recording—by removing false starts and blemishes, re-aligning disparities in level, re-balancing bass and treble, etc. But let's start at the beginning with the equipment set-up needed for producing an *exact* copy tape—leaving the operational techniques till next month.

Figure 1 shows the basic set-up. The tape to be dubbed is replayed on Machine A and re-recorded on Machine B. I have drawn two identical machines to symbolise the desirable situation where the replay outlet exactly matches the record input in terms of impedance and sensitivity. (Well, a far-seeing recorder manufacturer would surely plan for the occasional enthusiast buying *two* of his machines, or for two owners getting together for dubbing purposes and so ensure that the replay and record sockets match each other—or would he?).

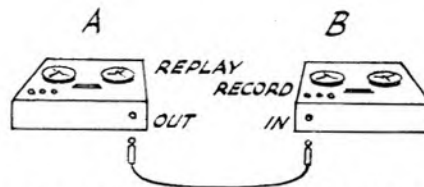

Fig. 1. The simplest set-up for dubbing using two machines with matched replay and record sockets

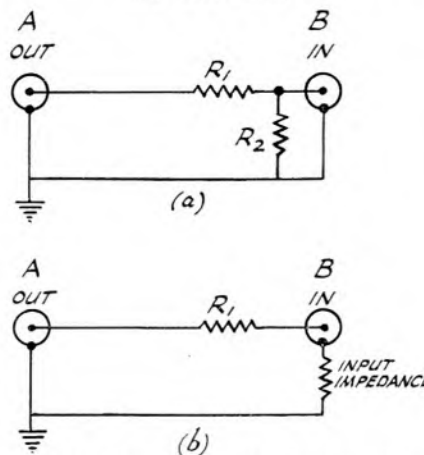

Fig. 2. To attenuate the signal use (a) a pair of resistors to form a voltage divider, or (b) a single resistor if the input impedance of machine B is sufficiently low

This question of matching is important, but not absolutely critical. Most recorders have, in addition to the External Speaker socket (rated at anything from 3 to 15 Ohms, according to the impedance of the built-in loudspeaker), a low level outlet. This by-passes the recorder's power amplifier stages and may generally be assumed to possess less inherent distortion. It also by-passes the volume and tone controls which is a good thing if we are simply seeking an exact copy. We have problems if we want to introduce bass or treble filtering, because these controls are always, or nearly always, inoperative in the record mode.

The rating of this low level outlet is usually about 1 Volt at anything from 1,000 to 100,000 Ohms. If you have a recorder with an input socket whose voltage and impedance ratings are roughly in agreement with this, then the simple arrangement of Fig. 1 will work well. A slightly lower voltage rating is all right—you will just have to use a low setting of the record gain control. But if the input rating is much below 100mV you have too much gain and it may be necessary to attenuate the incoming signal to avoid overloading the recorder input.

Knowledgeable readers will be able to design attenuators of their own. But the simple approach shown in Fig. 2a is all you need. Make  $(R_1 + R_2)$  equal to, or somewhat higher than, the output impedance of Machine A and choose  $R_2$  to be that fraction of  $(R_1 + R_2)$  which will

reduce the signal in the required ratio. For example, if a 1 Volt 100,000 Ohms outlet is being matched to a 0.1 Volt recorder,  $R_1 + R_2 = 100,000$ ,  $R_2 = 10,000$  Ohms and so  $R_1 = 90,000$  Ohms.

If, into the bargain, the input impedance of Machine B is about 10,000 Ohms you do not need  $R_2$ : simply insert a 90,000 Ohms resistor in the live lead (actually the nearest preferred value of resistor is 100,000 Ohms). Always fit attenuator components of this sort at the *receiving* end of the cable. If the connector is a standard phono plug, your job is very easy. Tape Recorder Spares Ltd. market ready-made attenuator/adaptors which consist of a phono socket to plug adaptor with in-built series resistor of assorted values.

I introduced Fig. 2 as a means of cutting down the *voltage* in any required ratio but we have seen that it can simultaneously be used to give a measure of *impedance* matching—particularly when feeding from a high to a low impedance. In general the opposite situation, feeding from low to high impedance, presents few problems so long as the impedance ratio is not greater than say, 10. However, a common example of a large ratio is when the External Loudspeaker socket is used to feed into a high impedance. If the loudspeaker is still in circuit, then at least the amplifier continues to be correctly loaded. But this arrangement suffers from the drawbacks that variations in effective impedance with frequency will introduce distortion, and the actual volume of sound from the loudspeaker may be too high or too low for comfort when the required recording input level is set. Where the signal has to be taken from an external loudspeaker socket, therefore, it is best to arrange that the built-in speaker is switched off (if this is not already ensured by the use of a "break jack") and replaced by a fixed resistor (see Fig. 3a). Where a break jack is fitted, you must similarly ensure that plugging in the Record lead again presents the appropriate low resistance to the amplifier. This is illustrated in Fig. 3b. The resistor should be equal to the nominal speaker impedance and, since it will be dissipating most of the power in the signal, of equivalent wattage. To avoid momentarily leaving the amplifier unloaded, it is best to throw the switch or insert or withdraw the plug only when the amplifier is switched off.

## Using a Separate Amplifier

The low level outlet we were discussing earlier is often called a "hi-fi" output to signify not so much its greater fidelity as its suitability for connection to a separate, or "high fidelity" amplifier. As will become evident in my future Chapter on monitoring, I am strongly in

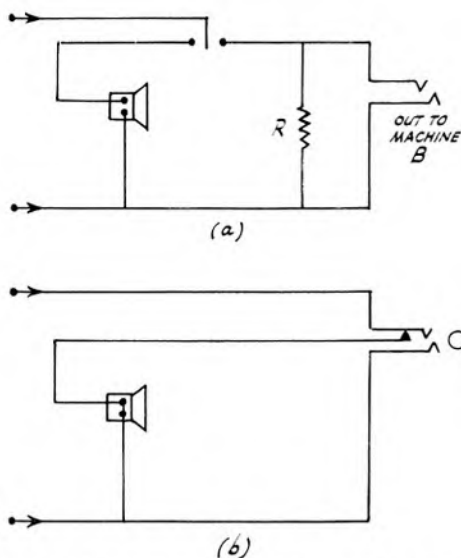

Fig. 3. When recording from an external speaker socket it is best (a) to substitute an equivalent resistor R for the built-in speaker. Alternatively (b) if a break jack is fitted the resistor may be wired externally

favour of the home studio being equipped with a first-class amplifier and loud-speaker system. Assuming this is so, we can substitute for Fig. 1 the more flexible arrangement shown in Fig. 4.

I like this much better. Machine A is now treated as a simple source into the amplifier, to be amplified and monitored under precisely the same conditions as the gramophone or radio inputs. Again it will doubtless be the low level output of the hi-fi amplifier which we shall connect to Machine B. And, if the amplifier and Machine B are designed for instant comparison of the input and off-tape signals, then we really are bidding fair to producing top quality recordings.

Since Machine A is virtually acting as a replay unit only, it may be asked whether a tape deck will suffice instead of a full-scale recorder. Well, this is a definite possibility—provided you do not need Machine A as a stand-by recorder either in the home studio or on outside assignments. Many high fidelity amplifiers have "tape head" inputs with the necessary sensitivity and equalisation to permit direct connection to a simple tape deck. Take care, however, to check the impedance rating and the equalisation provided—normally the CCIR characteristics for the 7½ ips speed only will be incorporated. Also, beware of trying to

run the head signal over more than a few feet of screened cable.

Alternatively, you can use a tape deck plus a small pre-amplifier: suitable units include the Wal-gain, Shure and Eagle.

A marginal point in favour of making Machine A a replay-only unit is that the risk of accidental erasure of valuable master tapes (yours or somebody else's) is removed.

### Transferring

In professional circles, the operation of transferring, which we defined at the beginning as re-recording in a different medium, is usually from tape to disc. But very few home studios will possess disc-cutting equipment and we can take the term to apply to tape recording from disc or radio (plus perhaps a television receiver or telephone adaptor).

A glance at Fig. 4 will show that a set-up which includes a hi-fi amplifier is ready-made for this kind of transfer—at a click of the input selector switch. Even if no suitable amplifier is available, individual connection of a record player, radio or radio tuner to a tape recorder should present few problems. The only really tricky source is a low output magnetic pickup cartridge. This resembles the replay head of a tape deck in produc-

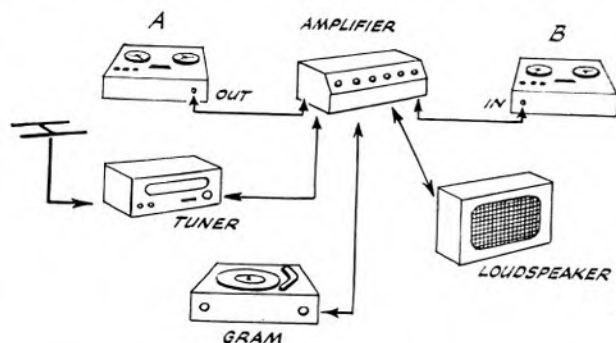

Fig. 4. Adding a hi-fi amplifier and loudspeaker permits quality monitoring and recording from tape, disc or radio with a minimum of fuss

ing a signal of only a few millivolts and requiring equalisation. However, the pre-amplifiers I recommended for tape head boosting are also suitable for magnetic pickups, having built-in equalisation to the standard RIAA gramophone record characteristic.

I strongly recommend that when the question arises of choosing gramophone or radio equipment for the home studio that you go for the best you can afford. The advantages in robustness and speed stability of a transcription type turntable, the accuracy obtainable with a transcription pickup arm and cueing device, the quality and low record wear with a modern magnetic cartridge—these are all essential to our home studio requirements.

Similarly, a good quality FM tuner with appropriate aerial is essential for radio work. The ordinary AM broadcast bands should be used only for receiving overseas stations or if you are very badly placed for FM reception.

### Copyright Warning

Nothing I have said in this article in any way absolves you from the legal restrictions by which the **Copyright Act, 1956** and the **Dramatic and Musical Performers Protection Acts, 1958 and 1963** entitle copyright holders and performers to prohibit their works to be published, performed in public or recorded.

In particular, where I have referred to transfer of disc recordings to tape, I assume that such discs are your own copyright or you have obtained the necessary permission prior to tape recording. In the case of commercial gramophone records, this permission is rarely granted and, if it is, the full royalty on the musical works is still payable to the Mechanical Copyright Protection Society. The BBC and other broadcasting organisations permit the recording of radio and TV (sound) programmes "for private purposes" but this does not include programmes which contain separate copyright material such as commercial gramophone records.

Many readers of *TAPE Recording Magazine* will know that the Federation of British Tape Recordists and Clubs have reached an agreement with MCPS whereby clubs and individual members may, on payment of a small annual fee, make recordings of musical works. But it must be made clear that this refers to the recording of live performances, **not** gramophone records or broadcasts—except where the separate permissions of the mechanical copyright holders has also been obtained.

Next month I shall cover the correct operational procedures for all types of recording.

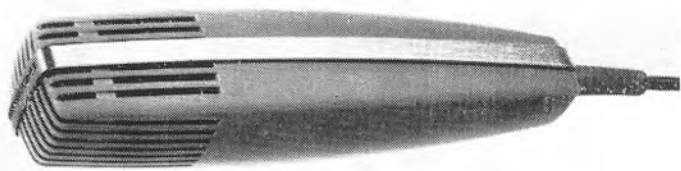
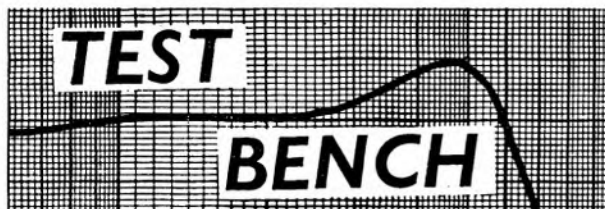

# SENNHEISER MD 411 HLM

## MANUFACTURER'S SPECIFICATION SENNHEISER MD 411 HLM

Acoustic mode of operation: Pressure gradient.

Directional characteristic: Super-cardioid.

Side attenuation at 120°:  $\geq 20$  dB—2 dB.

Directivity index:  $\geq 3.5-0.2$ .

Frequency range: 50 c/s to 12,000 c/s.

Tolerance limits: To Hi-fi standard DIN 45 500.

Sensitivity at 1 kc/s: M 0.25 mV/ $\mu$ bar;

H 1.25 mV/ $\mu$ bar; L 0.12 mV/ $\mu$ bar.

Impedance: M 800  $\Omega \pm 15\%$ ; H 25 k  $\Omega \pm 20\%$ ; L 200  $\Omega \pm 20\%$ .

Pin connections: case to screen—

	M	H	L
Switch to M	1 & 2	—	—
Switch to HL	—	1 & 2	2 & 3

Output plug: Mas 30 (Continental 3 pin).

Cable socket required: Mak 30 S (Continental 3 pin).

Dimensions: 140 x 38 x 38 mm.

Weight: 8 ozs.

Weight of stand: 2 ozs.

Price: £15 14s.

Distributors: Audio Engineering Ltd.,  
33 Endell Street, London, W.C.2.

**M**ICROPHONES have much in common with loud speakers. Both are "transducers"; that is, they convert one form of energy into another. The loud speaker converts electrical energy to sound energy whereas the microphone operates in reverse by converting sound to electrical energy. The basic requirement for "high fidelity" is to approach as closely as possible to the original sound. Both microphones and loud speakers have an unfortunate tendency to exert their own characteristic "coloration" which as a departure from the original is contrary to the principle of high fidelity.

However, good audio practice invariably resolves itself into a compromise of some kind. Whereas loud speakers are used in the static controlled conditions of the listening room microphones have been developed to operate in all manner of adverse situations. Many of these are highly specialised instruments.

The microphone now being reviewed is the Sennheiser MD 411, a medium-low cost dynamic cardioid which the manufacturers claim to be "hyper-directional," an attribute that would improve recorded quality

under excessively reverberant conditions. The ability to discriminate against unwanted sound is also extremely useful to the amateur as it enables him to avoid picking up too much extraneous noise (traffic, trains, aircraft, etc.) which can otherwise only be excluded by providing an adequately sound-proofed studio.

The MD411 arrived securely packed in an exceptionally smart and thoroughly padded presentation case. Made from black plastic, and fastened by a zip running all round three sides, it offers complete protection against dust and mechanical impact. The microphone itself, neatly styled in a light fawn, hard gloss, plastic, is fitted with some 7 or 8 feet of cable. This cable is permanently connected within the sealed plastic housing and cannot be detached from the microphone head, a method that has presumably been adopted to avoid the cost of providing the usual three-pin connectors.

A table-stand (which snuggles securely down in the foam insulating material of the carrying case) is also supplied. Although manufactured from featherweight plastic it is of extremely ingenious design. The three legs, each fitted with a tiny anti-scratch pad, hinge back to form a low tripod with a vertical clip which pushes into a slot on the underside of the microphone casing. A large knurled knob beneath the apex of the tripod can be unscrewed to detach the clip entirely from the tripod. The thread thus revealed at the base of the clip is of standard size for screwing directly on to conventional studio or portable microphone stands.

This versatility of fixing is most important, since it means that the MD411 can be mounted in any way the recordist wishes. Concealed at the bottom of the fixing slot in the microphone housing is an impedance switch. This can only be operated by means of a screwdriver and so is completely secure. When the switch is turned to the position marked HL and the conductors (colour code white and red) are taken to pins 1 and 2 in the plug the instrument is high impedance. With the same switch setting connection to pins 2 and 3 (colour codes red and blue) converts to low impedance. With the same wiring as for high impedance (conductors to pins 1 and 2, colour code white and red) the microphone can be converted to medium impedance—800 ohms—merely by turning the switch to position M. It therefore follows that this one instrument can be used to suit many required input impedances. The distributor encloses full instructions—together with circuit diagrams to make this point quite clear.

Tests were carried out with the microphone in its low impedance condition and mounted on a studio-type stand. The

claimed response is from 50 Hz to 12,000 Hz to the DIN specification 45 500 which requires a top lift of about 3 dB within the range 2,000 to 10,000 Hz. Rear discrimination is claimed to be 18 dB which may be regarded as very satisfactory. Starting with voice recordings comparisons were made with a much more expensive instrument of known response characteristics up to 20,000 Hz.

First impressions were of smooth quality free from boominess or other falsely emphasized low frequency content. Direct comparison with the sound produced from the more expensive microphone used as a standard revealed subtle coloration in the MD411 version that can best be described as "mechanical hardness." It is only by such comparative tests that small differences in sound quality can be detected, and the decision as to whether they are acceptable or not is a matter of opinion on the part of the prospective user. There is no doubt whatsoever that the MD411 *does* produce its own individualistic character of sound. In inferior microphones this change could be so gross as to be wholly unacceptable—in extreme cases even rendering the voice unintelligible. It must be clearly understood only a small overall quality change is being referred to here; intelligibility is of course beyond question.

Encouraged by results with speech, further recordings were taken, this time of piano and solo vocalist under reverberant conditions. At once the value of the microphone's directional properties became apparent—the recorded acoustic was not dissimilar to that found in a fairly bright studio. Piano tones came over extremely well but the same hardness was detected in the rendering of the female vocalist as had been found on male speech.

It is not felt that laboratory tests of either microphones or loud speakers are of as much value as subjective user tests, but an effort was made to confirm the manufacturer's specification. After making due allowances for unavoidable room acoustics and the idiosyncrasies of the loud speakers employed, results very similar to the specification were recorded. They could not be exactly reproduced other than in an anechoic chamber. In fact the response was found to usefully extend to 14,000 Hz which exceeds the manufacturer's claims.

One feature which disappointed was the extreme sensitivity of the microphone housing and cable, both of which will register alarming clonks or bangs if handled during recording. This effect is commonly found in all instruments whose directional properties depend on an internal acoustic labyrinth,

*Continued overleaf*

## TEST BENCH

Continued from page 179

but it must be said that the MD411 was particularly sensitive in this respect. Because of this limitation the MD411 cannot be recommended for use with battery portable machines when the microphone invariably has to be hand-held. This stricture does not apply when the instrument is mounted either on its table-stand or on a studio stand.

To summarise it can be said that the quality of which the MD411 is capable of attaining falls short of what one might expect from a studio-class instrument in the £50-£100 price bracket. Bearing in mind the

retail price of £15 14s. the quality it does attain is exceptionally good—certainly up to the generally accepted amateur standards of high fidelity. Its shortcomings will be revealed by direct comparisons of recordings of the same sound sources taken on far more expensive instruments.

The value of the cardioid directional pattern to the amateur cannot be stressed too strongly; this advantage is increased in the case of the MD411 due to its excellent rear discrimination. The convenience of choice of impedance may be a boon to some who would otherwise have to use line transformers to match the input impedances of different pieces of equipment. The stand mounting arrangement is simple but effective. A de-

tachable microphone cable would have been preferred and should have been provided at this price level, but the distributor states that the length permanently fixed is correct for high impedance use.

I would be happy to use this microphone for either speech or music applications where either the ultimate limits of professional quality were not required or where I was having to work under extremely adverse acoustic conditions. It should also be mentioned that a pair of MD411s could be ideal for stereophonic recording thanks to their strongly directional properties. An interesting and versatile instrument offering good value for money.

D.G.K.

# CELESTION DITTON 15

**I**N our reviews of loudspeaker enclosures we are attempting to do no more than offer unbiased subjective assessments. Of all the components in the audio reproducing chain the loudspeaker is not only the least efficient (in terms of converting electrical energy to sound energy) but it is also the component likely to exercise the greatest influence (distortion?) on the final sound heard.

The word "distortion" has been tentatively included above simply because the strict definition of distortion is *any* change, other than amplitude, occurring in an audio signal. Now if we reproduce the same piece of music through different kinds of loudspeakers we shall hear widely different versions of the same sound. If we accept "fidelity" as meaning absolute truth then the loudspeaker enclosure which can honestly lay claim to the term has not yet been manufactured.

After which depressing introduction let me hasten to add that in spite of their technical drawbacks loudspeakers are very necessary to the audio enthusiast—without them he would hear nothing. If it's any consolation, a theoretically "perfect" loudspeaker would require an equally "perfect" acoustic provided for it in the listening room. . . . All we can really do is to say that we like the sound produced by this model or we dislike the sound produced by that, and in every case give the reason why.

Having stressed the thoroughly personal approach to this problem we will proceed to take a close look at the Celestion Ditton 15. This is a unit of extremely interesting design, embodying a hitherto little used principle to overcome the limitation of all small speaker enclosures in reproducing low frequencies. The speaker manufacturer is faced with two conflicting requirements: Modern living demands ever smaller "boxes" but an increased awareness of the value of full frequency range reproduction by the purchasing public must be satisfied. During the last few years enclosures have shrunk dramatically—so too has the low frequency content of the sound heard.

The size of the Celestion Ditton 15 enclosure is 21 inches x 9½ inches x 9¼ inches. This could be regarded as a medium-small free-standing or bookshelf enclosure. It

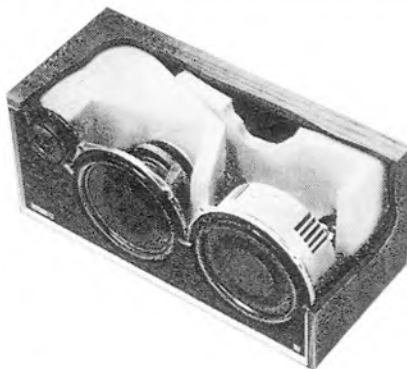

might be reasonable to expect a lower limit of around 60 or 70 Hertz from such a design. In the present case the manufacturer claims, and listening tests prove, that a genuine 30 Hertz is usefully reproduced.

The Celestion Ditton 15 could be regarded as standing somewhere between the infinite baffle and reflex types of enclosures. The former are carefully sealed to make them absolutely airtight so that no sound can creep around the back of the cone to produce a cancelling effect, whereas the latter are provided with a carefully tuned open port to produce a reinforcing effect. Construction of the Ditton 15 follows normal infinite baffle techniques and a cursory glance gives the impression of an IB enclosure housing a tweeter and two 8-inch main drive units. It is soon apparent however that the second of these 8-inch circular cut-outs does not accommodate a loudspeaker at all; instead it is fitted with what the manufacturer describes as an Auxiliary Bass Radiator. The A.B.R. consists of a specially designed, free-moving rigid membrane which is excited only by the energy dissipated within the enclosure by the main 8-inch radiator. It is arranged in such a way that it effectively reinforces low frequency sound emission from about 80 Hz downwards.

Apart from this singularly original feature the construction generally follows good audio practice; the cabinet itself is absolutely rigid and the front panel on which the tweeter, 8-inch bass unit and A.B.R. are mounted is a satisfactorily sturdy grade of plywood. Internally the damping of both the main transducer and the cabinet itself have received special attention; large chunks of specially shaped plastic foam material fill a large proportion of the internal space. The front cover is of the conventional sound transparent material.

Proceeding to user tests it was first noted that the quoted impedance is 4 ohms and the power handling capacity claimed to be 15 watts. At one time "Hi-fi" amplifiers offered a standard 15 ohms audio output. Modern transistorised amplifiers dispense entirely

with an output transformer and provide a direct drive at much lower impedance. It is for this reason that many well-known loudspeaker manufacturers have begun to produce 4 or 8 ohm versions of what used to be strictly 15 ohm models. Power handling capacity is somewhat enigmatic. The fact is that all small loudspeaker enclosures tend to be relatively inefficient and so require proportionately more power to drive them. This explains the current vogue for exceptionally powerful amplifiers (at one time we used to believe 10 watts to be more than adequate for ordinary domestic conditions) driving reluctant little bookshelf speaker enclosures. In terms of efficiency the Celestion Ditton 15 was found to be slightly better than average.

Subjective listening tests immediately revealed the thoroughly practical value of the A.B.R. With plenty of clean bass direct comparisons made other enclosures of roughly similar cubic capacity sound somewhat thin. The mid-range was firm without being over-bright and the top was free from harsh, unpleasant, edge. First impressions were of a thoroughly acceptable overall sound that was not likely to tire the listener.

After completing an involved series of comparative tests against enclosures across a very wide price range original opinions were modified by one small reservation. It was noted that the Ditton 15 does have a tendency to introduce slight coloration, but because this appears to be uniform throughout the whole of the audio frequency spectrum it does not obtrude or become objectionable. Extremely difficult to put into words this can best be described as an apparent increase in reverberation time—music reproduced by this enclosure seems to have been recorded in a more reverberant studio or acoustic than one would have judged to be used from the sound produced by comparative units. This stricture must not be taken too seriously neither must the description be interpreted too literally. As was stated at the beginning of this review all loudspeakers produce (or reproduce!) their own characteristic sound. The deviation noted in the Ditton 15 is slight and would only be revealed by careful comparative analysis.

Summarising it can be said that this very unusual design is fully justified, offering as it does a wider frequency response than one expects to find from such a small cabinet. A pair of these enclosures will fit well into modern decor and will provide a standard of reproduction that can assure the owner of unlimited listening pleasure through the years.

**Manufacturer:** Rola Celestion Ltd., Ferry Works, Thames Ditton, Surrey. Price £28 11s. 6d.

D.G.K.



# Our 105gn stereo is the best under 120gns.

## So is our 55gn model.

Whether you spend 105 gns. or 55 gns. depends on you. On whether you want our stereo tape recorder N4408 at 105 gns. or our stereo cassette recorder EL3312 at 55 gns. The main thing is that you'll get the tops of its type either way.

The tape recorder N4408 is the machine for the specialist. Facilities include 4 tracks, 3 speeds and automatic tape positioning

device. Outstanding quality through two 6 watt amplifiers, can be operated in either the horizontal or vertical position.

The Cassette recorder EL3312. Facilities include simple cassette loading and semi-automatic ejection, tone and balance controls for stereo playback through two independent matching speakers. Price includes stereo microphone, two speakers and direct recording lead.

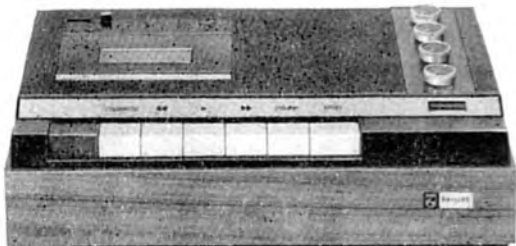
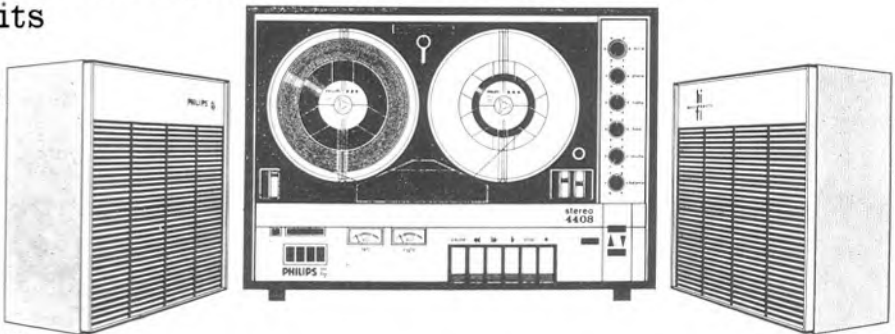

**Model N4408.** 105 gns. For best results use Philips Low-Noise tape on calibrated reels, packed in rapid-reference Library Boxes.

**Cassette Model EL3312.** 55 gns. Records on 60 minute (C60, 17/6) and 90 minute (C90, 25/-) Compact Cassettes.



## PHILIPS Stereo Recorders

Philips Electrical Ltd. (Dept T4), Century House, Shaftesbury Avenue, London W.C.2

# tapes

**The Four Tops**  
The Four Tops Live  
Tamla Motown TA-TML11041

**Nat King Cole**  
The Beautiful Ballads  
Capitol TA-T2820

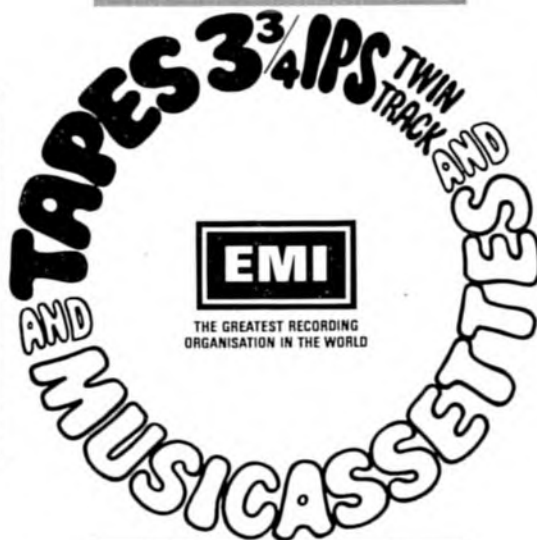

**The Beach Boys**  
Wild Honey  
Capitol TA-T2859

**Stevie Wonder**  
I Was Made To Love Her  
Tamla Motown TA-TML11059

# musicassettes

**Diana Ross & The Supremes**  
Diana Ross & The Supremes  
Greatest Hits  
Tamla Motown TC-STML11063

**Franck Pourcel**  
Pourcel Today  
Columbia TC-SCX6209

**Shirley Bassey**  
Twelve Of Those Songs  
Columbia TC-SCX6204

**The Four Tops**  
The Four Tops  
Greatest Hits  
Tamla Motown TC-STML11061



# NATURE NOTES

FOR APRIL

BY RICHARD MARGOSCHIS

IN February I suggested a tripod might be used to support a parabolic reflector; I would like to elaborate on this point. Such a set-up has distinct advantages when: (a) you are fairly certain of the direction from which your sound will come, (b) the angle of acceptance of the reflector is sufficient to cover it, (c) you are staying in one location and the reflector is a heavy one. It is not at all easy to move a reflector about quickly on a pan and tilt head without making noises which will be recorded, and an undoubted disadvantage is the fact that the tripod must be a stout and heavy affair. It is an extra piece of equipment which has to be carried about; not so easy when you are already cluttered up with recorder, reflector, binoculars, etc.

On the other hand, if the reflector is light, such as the one I described in the October 1967 issue of *TAPE*, there is no reason why you should not carry it on a short handle, a practice which offers much greater mobility, especially under difficult conditions such as woodland undergrowth where a tripod is nothing but a nuisance. A light reflector can be carried in a comfortable position at your side, and with a little practice will be ready for instant use. It can be held above the hand with the elbow bent at right angles or suspended from the hand with the arm outstretched. The latter is less tiring but rather more difficult to manipulate.

This is my standard practice, but I do find difficulty in holding the reflector steady for more than a few minutes. Quite recently I have overcome the difficulty by using a monopod, easily made out of a broom stale, and find no trouble in holding the reflector for periods of up to an hour, and yet it can be easily and quickly re-directed. However, the movement of the support on a hard surface, especially grit, causes considerable noise to be recorded through the stale; the toe of your shoe is a much more suitable surface on which to rest it. Which of the three methods of support is best must be dictated by circumstances. I always use one of the handles unless I am going to be at one spot for a long time and want the reflector at a distance from my observation point; then the tripod is essential.

By April bird song will be working towards its climax. Among the many calls to be heard there is little doubt that the one bird whose call cannot be mistaken is the Cuckoo, and before the month is out somebody will have laid claim to having heard "the first cuckoo of Spring," but I doubt if the Editor will offer a prize for the first such claim made to him! The adult bird is an overall grey above, barred with white spots beneath, and has a long tail with white tip and spots; the flight is direct and with a fast wing movement. The characteristic call may be delivered either in flight or from a perch and it can be heard over a great distance. There are variants such as "cuck-cuck-oo" and other interesting and strange sounds made by this summer visitor, but you need to be near the bird to hear them properly. They are generally produced when the bird gets excited, sometimes in flight and often when hopping around on the ground or from bush to bush, and take the form of a series of cackles and chuckles usually preceded and rounded off by the familiar "cuck-oo".

The female has an entirely different call, generally described as a "bubbling" note, which is one of those very difficult sounds to record simply because it comes without warning and, in my experience anyway, is rarely repeated immediately. When a baby cuckoo has left the nest of its foster parents—the bird's habit of using the nests of other species in which to lay its eggs is well known—it has

a persistent cheep which can be heard over a long distance and by which the baby entices other birds to feed it. So on the whole this well-known bird, which some say is not so common now as it used to be, can provide quite a challenge to the recordist.

April will also see the beginning of the influx of warblers and one of the first to arrive will be the Chiffchaff which, like the Cuckoo, has a call which gives its name. His presence is first given by the rather penetrating and monotonous song repeated over and over again, "chiff-chaff . . . chiff-chaff . . . chiff-chaff," but if you get close to him you will find that he also uses some less audible notes. When the "chiff-chaff" call has ceased you will hear a low "Chirrup . . . chirrup . . . chirrup," and for a while might have difficulty in believing that it is coming from the same bird because when "chiffchaff" starts again it sometimes sounds as if it overlaps the "chirrup." The bird is small, greenish brown above with pale underparts, a thin dark beak and dark legs, and might be seen darting from branch to branch as it delivers its song. Its call note is a plaintive "hooet" which can be mistaken for other warblers, in fact visually it is very difficult to tell from the Willow Warbler; its song is the distinction. It will be with us from now until September but will not be heard much in August.

When out in the field on a recording expedition serviceable clothes are a necessity; clothes that can stand up to rough usage. Remember also, that you are likely to have to stand about for long periods, often in very cold conditions, so warmth is another essential ingredient; several layers of light woollen garments with a suitable wind-proof overjacket is the ideal. If you leave your bed before daybreak keep your pyjamas on as a warm foundation—patience is impaired if you stand about shivering.

I would like to draw the attention of all nature lovers to "Wild Life Review," a monthly B.B.C. programme transmitted on Radio 4 (the Home Service). The next edition will be on Sunday, March 24, at 4.45 p.m. and I hope to take part myself by talking about "Wild-life Sounds," a newsletter circulating three or four times a year with a tape of members' work. This is a new project and as soon as space allows I will tell you more about it.

## Leda Tape

FULLY GUARANTEED ☆ STRONGLY BOXED

Size Base	Standard		Long		Double		Triple	
	P.V.C.		P.V.C.		POLYESTER		POLYESTER	
3"	150'	2/3	225'	3/-	300'	4/3	600'	8/9
4"	300'	3/9	450'	5/-	600'	8/3	900'	12/6
5"	600'	8/3	900'	9/9	1200'	15/3	1800'	22/6
5½"	900'	10/-	1200'	12/3	1800'	19/3	2400'	28/6
7"	1200'	12/3	1800'	17/3	2400'	21/9	3600'	38/6

Factory Fresh. Superb Quality. Leaders, Trailers and Stop Foils on all sizes 5" and above. We supply many local authorities and professional recording studios. May we supply you? P. & P. 2/6 per order. S.A.E. Full Lists.

LEDA TAPES (T), 30 BAKER ST., LONDON, W.1

# MUSIC CASSETTE

## REVIEWS

**VIVALDI. Concerti for Various Solo Instruments. Moscow Chamber Orchestra conducted by Rudolf Barschai. Philips CPC 0023, 40s.**

This is a charming collection of delightful baroque works, beautifully recorded and performed. The programme comprises: *Concerto in B Flat Major for Violin, Cello and Strings, P. 388, Concerto in A Minor for Two Oboes and Strings, P. 53, Concerto in G Major for Two Violins and Strings, P. 132, Concerto in G Major for Two Violins and Strings, P. 132, Concerto in C Major for Oboe and Strings, Opus 8, No. 12, P. 8 and Concerto in G Major for Strings, "Allah Rustica", P. 143.* The soloists are Eugene Nepalo, oboe, and Eugene Smirnov and Andrey Abramov, violins.

They, together with the Moscow Chamber Orchestra, display the discipline and dedication we have come to expect from Russian musicians. Chamber music of this kind is essentially of an intimate and personal nature and as such makes the most exacting demands on recording engineers and the recording medium. In this album justice has not only been done but may be plainly heard to have been done; the sweet tones of violin and oboe convey realistically an impression of participation in an early eighteenth century musical evening. Strongly recommended.

**THE SWINGLE SINGERS with the MODERN JAZZ QUARTET. Philips CPP 1048, 40s.**

Why have the Swingle Singers suffered a waning popularity? Their early successes promised great things ahead; in fact they have not quite happened. But then today popularity is not necessarily achieved by brilliance of performance or technique—two attributes which the Swingle Singers constantly display in every item they produce.

This recording is undoubtedly one of their very best. It has been honoured by an equal endeavour on the part of the engineers resulting in an album of great originality and distinction. The only qualification that must be made relates to the audible wow that is unavoidably present in some of the long sustained vibes notes. The bell-like resonances must reveal the slightest trace of short-term speed instability which at the present state of the art we are bound to suffer at 1 7/8 ips. However, everything else in this album is so good that this single imperfection need not detract from enjoyment.

The programme includes *Little David's Fugue, Air for G String, When I am Laid in Earth, Vendôme, Alexander's Fugue, Three Windows and Ricerar à 6.*

The sleeve notes comment on the significance of the fact that the Modern Jazz Quartet and the Swingle Singers have so much in common that together they are bound to produce truly outstanding work. In this they have succeeded brilliantly. With impeccable precision and exactitude we are treated to a display of musicianship that can leave the listener quite breathless with admiration. Probably far too good to achieve wide popularity I have nevertheless no hesitation at all in strongly recommending it.

**PETULA CLARK. These are my Songs. Pye CYP 172, 40s.**

To reproduce this music cassette is to invite Petula Clark herself to step right into the room. With excellent recorded quality the typically English personality of Petula is projected for our pleasure and entertainment. The numbers she has chosen are: *This is my Song, Groovin', I Will Wait for You, San Francisco, Eternally, Resist, Don't Sleep in the Subway, Imagine, Love is Here, How Insensitive, Lover Man and On the Path of Glory.*

Never coarse or vulgar (either musically or morally) her sincerity is captivating. And what a refreshing change that makes from some of our more brash "lady" vocalists whose claim to the courtesy title is as tenuous as it is to the professional accolade.

The treacly effervescence that masquerades as a sleeve note is entirely irrelevant and serves only to distract. In all other respects this album offers extremely good value.

**P. J. PROBY. In Town. Liberty LBC 83018. 40s.**

Handkerchiefs at the ready for a real tearjerker. Not that it was P. J. Proby's emotional problems that first set me a-sobbing, but rather the imperfections in the recording. When my ears had ceased to revolt at the repetitious distortions—which at times are quite awful—I settled down to "enjoy" this artiste's particular brand of doleful misery. Perhaps the fans will rave; my own feeling was one of nausea.

The album includes: *What Kind of Fool Am I, To Make a Big Man Cry, No Other Love, We Kiss in a Shadow, People, It Ain't Necessarily So, Some Enchanted Evening, Come Back to Me, Walk Hand in Hand, If I ruled the World, Maria and I Could Write a Book.*

In building up his repertoire from the most popular items from the most popular shows, Proby was taking no risks at all. Unfortunately the listener stands in deadly peril of developing chronic melancholia from the smothering deluge of self-abnegation recorded by this artiste.

**TONY BENNETT'S GREATEST HITS. CBS 40-62821, 40s.**

A shaky piano introduction is followed by one of the nastiest voice acoustics we have endured for a long time. Drunk with his own power the man on the echo control knob has forced on our ears more and yet more unpleasant and unnecessary reverberation. Tony Bennett has a pleasantly musical voice which the engineers have succeeded in transforming into a cacophony of whistling sibilants.

All the numbers are not quite as bad as this. Our echo man (probably at gun-point!) does manage to exhibit a certain grudging restraint here and there, although his presence is always felt throughout the entire album. All of which is a great shame because the Bennett voice is much too good to suffer electronic mutilation in this way.

The programme includes *I left my Heart in San Francisco, I Wanna Be Around, Quiet Night of Quiet Stars, When Joanna Loved Me, The Best is Yet to Come, Who Can I Turn To, The Good Life, A Taste of Honey, This is all I Ask, Once Upon a Time, The Moment of Truth and If I Ruled the World.*

As the album progresses the vocalist's instinctive warmth breaks through incompetent recording techniques with commendable persistence. An album that will give pleasure to those who would find pleasure in Tony Bennett anyway.

**CHAQUITO AND THE QUEDO BRASS. World Beaters. Fontana CFP 4017, 40s.**

An album of innocuous mood music, well prepared, well recorded and well performed. In a programme of established favourites that will offend no one the Quedo Brass live up to the literal interpretation of their name—"Quiet."

Nowadays such products betray greatest originality in the choice of programme and this collection is no exception in that respect. The items comprise: *Mexicana, Berlin Melody, Vous Qui Passez Sans Me Voir, April in Portugal, Il Silenzio, Swiss Miss, Walk in the Black Forest, Spanish Eyes, Winchester Cathedral, Plaisir d'Amour, Moscow Nights and Milord.*

The originality of this choice lies solely in the unarguable selection of such confirmed favourites as will assure inevitable financial success.

The sleeve-notes suggest that this sound "seems destined to spread smoothly and swiftly around the world like a pat of fresh butter spread over a slice of crisp hot toast." Bowing to the obviously superior descriptive powers of the sleeve writer what more can I do than thoroughly recommend it to all who are in the market for this particular brand of buttered toast? Seriously, recording is good—dare one suggest too good for such musical wallpaper?

**JOHN WALKER. If You Go Away. Philips CPP 1056, 40s.**

This album subscribes to the current vogue for submerging the solo voice beneath a surging tide of sound. In *The Right to Cry*, the first number of the collection, one can only approve the technique as offering a merciful release to the listener. If only this lad would stop working so hard at his affectation of sincerity he might discover that he can sing. As it is he succeeds in producing a very forced, and false, superficiality which makes no impact on the listener other than irritation, which might be registered as mild or extreme depending upon temperament.

The collection comprises *The Right to Cry, So Goes Love, Reaching for the Sun, An Exception to the Rule, Good Day, If you Go Away, Yes I'll Hang my Tears out to Dry, It's all in the Game, Nancy, It's a Hang-up Baby, Pennies from Heaven and I Don't Wanna Know.*

Some of the instrumental sounds are absolutely excellent, although all too soon they are masked by a persistent sugary backing. One is left with the impression of a good amateur performance which unhappily can only be regarded as a poor professional effort. Far too many vocalists are selling amateurism for hard cash when they should be paying out themselves to learn how to do their jobs. This state of affairs is bound to continue so long as enough public are foolish enough to give these hollow entertainers their support.

## SUBSCRIBE TO TRM

and receive your monthly copy by post for 1 whole year (12 issues). Send 25s. (U.S.A. \$3.75) by postal order or cheque today.

**25/-**  
U.S.A.  
\$3.75

To: TAPE RECORDING MAGAZINE, Prestige House, 14-18 Holborn, London, E.C.1

Name.....

Address.....

## MUSIC ON TAPE

### 7½ & 3¾ ips STEREO

**BEETHOVEN.** Symphony No. 8 in F Major, Opus 93, Symphony No. 9 in D Minor, Opus 125, the Berlin Philharmonic Orchestra conducted by Herbert von Karajan. Ampex DGP 8807 4-track stereo 7½ ips. 119s. 4d.

Once again Herbert von Karajan and The Berlin Philharmonic delight us, this time with the last two of the great series of nine Beethoven Symphonies. Such nobility of thought, such grandeur of musical expression, is encompassed in these nine works as to leave the mind both uplifted and humbled at one and the same time. Deutsche Grammophon have performed a monumental task in recording them and we owe a great debt of gratitude to Ampex for making them available to us on tape.

The contemporary musician tends to regard Beethoven with jaundiced ear and eye. "What more Beethoven, yet again?" One can, perhaps, sympathise. There is a grave danger of neglecting vast stores of rich composition by allowing him to dominate the concert platform. Yet such is the stature of the man that he continues to dominate whether we like it or not.

Ideally the music library should contain copies of all nine symphonies. If I were limited to one tape only then the choice—a very difficult one—would resolve itself with this double-play album. The reason for the increased price is because it is the equivalent in programme content of two, full-length, long-playing discs.

The No. 8 in F is Beethoven's most concise work in symphonic form. Exhibiting transparently lucid thought it overflows with musical ideas and dramatic situations. For me the Eighth epitomises its composer's towering genius. His last and most monumental symphony of all was to be written five years after the Eighth, in 1817.

We have heard some truly glorious sound in this series, particularly in the No. 8. With the Ninth we have the culmination of all effort; the great finale that renders superfluous any gratuitous words of mine. With full-blooded orchestral tone the Ninth closes a book of staggering musical prodigy—a book whose pages have been gilded anew by this brilliant edition. Very strongly recommended.

**BRAHMS.** Symphony No. 1 in C Minor Opus 68 and Symphony No. 2 in D Major Opus 73. The Berlin Philharmonic Orchestra conducted by Herbert von Karajan. Ampex DGK 8925 4-track stereo 7½ ips. 119s. 4d.

Often described as the last of the great classical composers, Brahms' First symphony has been referred to satirically as "Beethoven's Tenth." Such a comment is not wholly undeserved since it pays tribute both to its musical antecedents and also to its undoubted value.

In outward appearance and domestic habit both composers had something in common. Unkept and eccentric, each in his own way was absorbed with the craft of music making. And to both that implied the mastery of the most complex of all musical structures.

Brahms' first symphony was completed in the composer's forty-third year. Its first

*Equipment used for review tapes: Amplifiers—Quad valved and Wharfedale transistorised. Loudspeakers—Celestion and Jordan-Watts. Tape Recorders—Akai 3000D and Tandberg 64X.*

performance was in the famous concert hall at Mannheim and was soon followed by others in the leading musical centres of Europe. In the present double-length recording Herbert von Karajan conducts the Berlin Philharmonic in a polished and thoroughly professional version. Perhaps, if it has a fault, too polished and too professional. Brahms was greatly influenced by the romantic school but the true feeling of romanticism tends to be obscured in Karajan's interpretation. This is purely a matter of opinion and others might disagree. Recorded quality is well up to the high Ampex/DGG standard with unobtrusive background noise and good stereo spread. The wide dynamic range of this work has been handled by the engineers with effortless ease; the strings are treated with particular delicacy.

The musicologist will claim that Brahms' First symphony is the most perfect example of intellectual power expressed in symphonic form. To the less technical it is a powerful composition of immense impact whose triumphant message is sounded loud and clear in the trumpet calls of its inspiring finale.

The Second symphony on Side 2 was composed in 1877 and the sleeve notes recall the fact that Brahms himself dubbed it his "new lovable monster." Far from being monstrous it is another example of perfection in symphonic composition that will appeal to layman and musical technician alike. This is an album of great value and is strongly recommended.

**EXOTIC INSTRUMENTALS/WAIKIKI**  
AFTER DARK. Hawaii Calls. Capitol Y2T 2515 4-track stereo 3¾ ips. 110s.

This double-play album, total duration more than 62 minutes, takes us on an hour's trip to "The Islands" via all the conventional vehicles. With twelve numbers a side our visit seemed to me to be a good deal longer.

Tape speed is 3¾ ips and the sound quality is frequently boomy and heavy with a trace of wow and distortion on sustained bell-like notes. Stereo is good, but frequency response appears to be somewhat limited. At times tempi are approaching the funeral so all in all we can hardly offer unqualified approval!

Undistinguished though it might be, the collection has at least one merit in offering protracted background sound of the most inoffensive kind. Reproduced in this way the recording imperfections would pass unnoticed and it would certainly demand no attention at all from the "listeners."

Those who conclude that this review damns with faint praise could well be right, but much depends upon personal taste and requirement. Actually some high frequency sound does manage to break through here and there to cheer things up a bit so the enthusiast for Hawaiian music might be less depressed than I was. After giving the tape a fair crack of the whip by playing it over several times I reluctantly came to the conclusion that I might eventually even begin to like it!

## YOUR LOCAL DEALER

### LONDON

## Masseys Centre of Sound

West London's Hi-Fi Tape Recorder Specialist  
—Demonstration Room with Comparator

APPOINTED FERROGRAPH DEALER

AT  
**CHISWICK, W.4**

Accessories, All Kinds—Servicing—Pre-Recorded  
Tapes Mono/Stereo

121-123 High Road—10 a.m.—7 p.m.

◀ TEL: CHI 2082 ▶

(not closed for lunch)

## TAPE RECORDER HI-FI CENTRE (SHEEN) LTD.

—The Centre for—

FRIENDLY HELP—SALES—SERVICE  
DEMONSTRATIONS ANY TIME—ALL PRE-  
RECORDED TAPES—STEREO—MONO  
LANGUAGES—DANCE—JAZZ—SHOWS  
CLASSICS, etc.—2 and 4 TRACK—STOCKISTS  
OF ALL MAKES AND MODELS OF RECORDERS  
AND HI-FI—Add sound to your movies with  
Synchrodek—WE ARE STOCKISTS OF  
SYNCHRODEK

TERMS—EXCHANGES, ETC.

3/4 STATION PARADE, SHEEN LANE,

SHEEN, LONDON, S.W.14

(Opposite Mortlake Station, S.R.)

Showroom: PROspect 0885

9 a.m.—6 p.m. Closed Wednesdays.

## Lee Electronics

### THE TAPE RECORDER & HI-FI AUDIO SPECIALISTS

400 EDGWARE RD., LONDON, W.2 (PAD 5521)

London's leading Stockists of High-Fidelity and Audio Equipment. Many bargains in new and reconditioned equipment.

SEND FOR FREE LISTS OF RECORDING TAPES, RECORDERS, AMPLIFIERS, ETC.

APPOINTED B. & O. AGENTS

- ★ TAPE RECORDER HIRE
- ★ TAPE TO DISC 78 & LP
- ★ RECORDING STUDIO
- ★ TAPE RECORDER REPAIRS
- ★ SALES—EXCHANGES

## MAGNEGRAPH

1, Hanway Place, London, W.1.

Tel.: LANgham 2156

**YOUR LOCAL DEALER**

**THE SOUTH**

**THE SOUTH WEST  
TOM MOLLAND LTD.**

Invite you to visit their well-equipped Demonstration Theatre and compare all the leading makes of Hi-Fi and Tape Equipment at 110 CORNWALL ST., PLYMOUTH Telephone 69285  
Immediate delivery to ALL Areas

**MUSICASSETTES**

Send 6d. in stamps for comprehensive catalogue, part-exchange details and library service.

All makes of cassette machines are supplied at cut-cash prices.

Blank cassettes, Carrying cases, Language Courses, etc.

**ALL MUSICASSETTES REVIEWED  
IN THIS MAGAZINE ARE AVAIL-  
ABLE FROM US BY RETURN POST**

**THE MUSICASSETTE SUPPLY COMPANY  
13, Angel Street, Worcester.**

For Jiffy-fast Postal Service

**THEATRE ORGAN  
DISCS and TAPES**

**ORGAN OF THE MONTH CLUB**

brings out a new Theatre Pipe Organ record each month.

Our discs are playable on Mono or Stereo equipment. Approx. 38 minutes playing time 31/6d.

7½ i.p.s. 4 track stereo tapes 41/7d.

Full details from:

**CONCERT RECORDING**

P.O. BOX 2,  
ROTHWELL, KETTERING, NORTHANTS

**Grampian**  
for good  
**SOUND EQUIPMENT**  
GRAMPIAN REPRODUCERS LTD  
Hanworth Trading Estate, Feltham, Middlesex

**NEW PRODUCTS**

**A WELCOME  
NEWCOMER  
FROM REPS**

THE name of Reps will be well known amongst enthusiasts as one of the smaller British manufacturers of good quality, medium price range equipment. They now announce their new model M 10, described as a "no-compromise machine designed up to a specification rather than down to a price." Using eight valves instead of transistors, the new recorder is available in either half-track or quarter-track versions, both mono.

Maximum spool diameter is seven inches and the tape transport system offers three speeds, 1½, 3½ and 7½ ips. Total wow and flutter is claimed as 0.15 per cent at 7½ ips and 0.25 per cent at 3½ ips. Frequency response curves are claimed at 40-16,000 Hz plus or minus 1 dB at 7½ ips, 40-10,000 Hz plus or minus 2 dB at 3½ ips and 50-6,000 Hz plus or minus 3 dB at 1½ ips. Signal-to-noise ratio is given as minus 55 dB for the half-track version at 7½ ips or minus 50 dB quarter-track at the same speed. The extension speaker outlet is claimed to deliver 10 watts RMS into 15 ohms and the equipment has its own internal 9 x 5 inches elliptical monitoring speaker. The manufacturers emphasize the fact that the power output stage is push/pull and the claimed 10 watts RMS does not refer to "speech and music conditions" where full power is available only for peak sounds, thus making the machine particularly suitable for use in large rooms or halls. Hum level is claimed to be of an exceedingly low order and the record level indicator is in the form of an unusually large 2½-inch moving coil meter. Automatic stop and a three digit tape position indicator are also provided.



Prices of the M10 including tape, spare spool, microphone and screened recording lead are 59 guineas for the two-track model or 69 guineas for the four-track version with simultaneous replay of two tracks.

An interesting accessory is a 10-inch diameter, high flux loudspeaker, enclosed in a strongly constructed cabinet to match the tape recorder. Cost complete with ten yards of cable and plug ready connected is 15 guineas inclusive of purchase tax.

Reps (Tape Recorders) Limited, 11, Colville Road, Acton, London, W.3.

**SECOND SONY VTR**

LATEST newcomer to the video recorder market is the Sony Model CV-2100 CE dual standard video tape recorder. This machine is the second in the range of Sony video tape recorders, the first being Model CV2000 405 line recorder.



The complete system comprises one Model CV2100 CE video recorder, one 19-inch monitor Model CVM2000 which also doubles as a normal dual standard TV receiver, and one model CVC2000 CE 625-line camera kit. The recommended retail price of the complete system is £685.

The machine itself operates at a tape speed of 11½ ips on the helical scan principle by means of a rotating two-head system. The facilities include still frame, sound dubbing, duplication of tapes, automatic or manual sound and vision level control.

The programme time available on one spool of ½-inch recording tape is 40 minutes and the rewind/fast forward times are quoted at 7 minutes. Included in the comprehensive price are all necessary accessories including a spool of video tape, microphone, microphone extension lead and substantial carrying case.

Sony U.K. Division, Eastbrook Road, Gloucester.

**GARRARD AUTO**

LATEST release from Garrard Engineering Limited is their new auto turntable Model 2025 TC. The modern appearance of the unit is due to the black and silver finish, the slim-line pick-up arm and careful attention to styling detail.



At a recommended retail price of £8 19s. 11d., plus £1 12s. 2d. purchase tax, this four-speed record changer incorporates a cue and pause control which is an unusual feature within this price range. Up to eight records of the same speed and stylus setting may be played automatically, size selection being entirely automatic.

Garrard Engineering Limited, Newcastle Street, Swindon.

## A GADGET FOR MOTORISTS

AN ingenious product designed for the mobile enthusiast is the stereo-tape Car Caddy. The product is basically a container which provides easy storage for either fifteen four or eight track cartridges, or forty-two cassettes. Designed to fit all motor cars without special installation, it also features a comfortable arm-rest for the driver. Special polyfoam partition pads protect the tapes from both shock and heat whilst the contents are within arm's reach.



The Car Caddy is claimed to be ideal for photographic equipment and is provided with a snap-on handle to make the unit portable. The case is fabricated out of high impact polypropylene in a black morocco leather textured finish. Washable and weather-proof, it offers 500 cubic inches of storage space and has a small extra compartment for coins, driving glasses, etc. The accessory is marketed complete with memo-pad, pencil, partition and plated handle. Price to be announced but full prices and catalogue from:

Morhan Exporting Corporation, 458, Broadway, New York City, 10013, U.S.A.

## MAINS/BATTERY FROM SHARP

DESIGNED to meet the demand for reasonably priced spool-to-spool battery equipment, the new Sharp Model RD505 offers additional facilities to the RD504.

As with other machines in the Sharp range the RD505 may be operated direct from the mains power supply without the need for additional converters or alternatively it can be run from dry cells that fit neatly within the case. Basically a half-track two-speed equipment, the frequency response at 3½ ips is claimed as 120-6,000 Hz and at 1½ ips 120-3,000 Hz. Signal-to-noise ratio is given as better than 40 dB and wow and flutter less than 0.4 per cent WRMS.

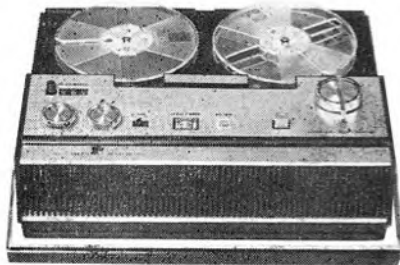

Record level indication is by a meter which also serves as a battery monitor. Monitoring is by internal dynamic speaker but a power outlet is provided giving a maximum of 1 watt with a claimed 0.8 watts distortion free.

Accessories include dynamic microphone, AC power cord, empty reel, 5-inch spool of tape, earphone and connecting cord and the retail price is £32 11s. This new machine will be released to the trade on April 1.

Sharp Sales and Service, 16/18, Worsley Road, Swinton, Manchester.

## GRUNDIG ACCESSORIES

UNTIL now Grundig (Great Britain) Limited, the sole U.K. concessionaires for Grundig products, have merely made available accessories for their equipment as requested. But now this firm, a member of the Bunting Estates Group, are setting up a special accessories division to handle equipment for tape recorders, dictating machines, radios and radiograms.

According to their survey of the market, both consumer and industrial, an average of £10 is spent on additional purchases of accessories for an average £40 tape recorder. Grundig will therefore offer a wide range of accessories designed not only for their own products but also suitable for competitive makes. The items will include such accessories as tapes, microphones, loudspeakers, stereo decoders and mixer units.

Grundig (Great Britain) Limited, London, S.E.26.

## TECHNOMARK LTD.

THE marketing of Bang and Olufsen and Sony equipment by Debenhams Electrical and Radio Distribution Co. Limited over the past two years has now resulted in the evolution of a completely new company, Technomark Limited, to handle quality audio and video products.

The new company commenced trading on 1st February and to the Bang and Olufsen and Sony products already handled by Debenhams were added the prestige audio and allied products manufactured by Radford Limited of Bristol.

Radford amplifiers and loudspeakers have earned a well-deserved reputation at the very top of the audio market. These will be supplemented by new designs including an integrated 30 watt per channel stereo amplifier using cross-over-distortion free complementary symmetry circuitry and this will be available to appointed Radford dealers only from March 1.

The new company has already undertaken a further building programme at its Gloucester headquarters and an enlarged service department and warehouse extension are going to reinforce their sales activities.

All future inquiries for Bang and Olufsen, Sony or Radford equipment should be addressed to:

Technomark Limited, Eastbrook Road, Gloucester.

### CORRECTION

The prices quoted in our New Products section last month for the Beomaster M and K models were incorrect. Current prices are £105 for the 1400M and £120 for the 1400K. Our apologies to readers and the distributors.

## YOUR LOCAL DEALER

### THE NORTH

CHESHIRE

**CHARLESWORTH'S**  
OF CREWE LTD.

Tape Recorder  
and Hi-Fi Specialists

Head Office: 14 Hightown, Crewe, Tel. 3327  
Hi-Fi CENTRE: 28 HIGHTOWN, CREWE.  
Technical Division: 19 Ludford St., Crewe.

## TAPE RECORDER CENTRE (HALIFAX)

stock all the best  
Tape Recorders, Hi-Fi Equipment,  
Tape, Pre-Recorded Tape, etc.

**REVOX**  
SPECIALIST

30 King Cross Street, Halifax  
Phone 66832

## CUSSINS & LIGHT LTD.

YORK'S LEADING RADIO  
TV & ELECTRICAL STORE

Visit our First Floor  
TAPE RECORDER  
CENTRE

LARGEST RANGE  
OF RECORDERS  
& ACCESSORIES  
IN THE NORTH

KING'S SQ.  
YORK



## Any MUSICASSETTE

BY RETURN POST

Our catalogue lists every available Musicassette in detail. Send for your FREE copy now (enclose 6d. stamp for postage)

**LIBRARY AND PART EXCHANGE SERVICE AVAILABLE**

For double quick mail order service send to:

**GRAMO-TAPES LTD.**  
Newport Crescent, Middlesbrough.

## CLASSIFIED ADVERTISEMENTS

**Rate.**—One shilling per word; box numbers, 2s. 6d. extra. Payment with copy, which should be sent to Advertising Department, "TAPE Recording Magazine," Prestige House, 14-18, Holborn, London, E.C.1.

### NEW EQUIPMENT

TAPE RECORDERS SAVE FROM 30 per cent to 60 per cent on the original price. Large stocks of second-hand, new, shop-soiled machines. All guaranteed. Obtainable on our **NO INTEREST TERMS**. Best part exchange allowances on your existing equipment. **CALL, WRITE, PHONE** today for free list. Quotation and details. Our Mail Order covers the whole country.—R. E. W. Earlsfield Ltd., 266, Upper Tooting Road, London, S.W.17. BALham 9174-5.

**LARGEST CASH DISCOUNTS** on brand new audio equipment. Factory sealed, guaranteed, large stocks at unbeatable prices. Appointed dealers for leading makes; send for quotation: N.V.R., 36, Front Street West, Bedlington, Northumberland. Phone 3533.

### FOR SALE

BLACKBURN has Lancashire's leading Hi-Fidelity/Tape Recorder stockists and Electronic Engineers at HOLDINGS AUDIO CENTRE, MINCING LANE/DARWIN STREET, BLACKBURN (Tel 59595).

**£200 Shaub-Lorenz Hi-Fi 126 tracks, 46 hours tape recorder, and V.H.F. 4-wave radio for £65. New unused. 01-445 9581 or 01-445 2825.**

**MINIFLUX** 4-Track stereophonic/monophonic record / playback heads. List Price 6 gns.—Special Offer 55/- each. **MINIFLUX** 4-Track stereophonic/monophonic Ferrite Erase Heads. List Price £3 10s.—Special Offer 32/6 each, or supplied together (one of each) at £3 17s. 6d. **SKN4** 1-Track stereophonic record/play heads for Transistor Circuits 55/- each. Also 1-track and full-track monophonic Ferrite Erase Heads complete with technical specifications. S.A.E. for details. **LEE ELECTRONICS**, 400 Edgware Rd., Paddington 5521.

**30 per cent OFF BASF TAPE.** LP 7-inch reel 1,800 ft. 33s. 3d.; DP 7-inch reel 2,400 ft. 52s. 6d. P. & P. 5s. per order. **W.S.L.**, 104, Norwood High Street, S.E.27.

**GEE'S RECORDING TAPE and AUDIO ACCESSORIES** cost LESS! Send 1s. for illustrated catalogue. **Gee Bros. Radio**, 15, Little Newport Street, London, W.C.2. Gerrard 6794.

**20% CASH DISCOUNT** on Hi-Fi equipment, Radiograms, Radios, Tape Recorders, Cameras, Typewriters, etc. Join England's largest Mail Order Club now and enjoy the advantages of bulk buying, send 5s. for membership card, catalogues, price lists or s.a.e. for free quotation and leaflets. **C.B.A.** (Dept. A5), 40, Cassio Road, Watford, Herts.

**REVOX F.36 Stereo Tape Recorder** (private), perfect condition, little used. Cost £115, sell for £70. **GRUNDIG** latest TK 6L Mains/Battery portable recorder, cost 69 gns., sell 45 gns.—**Dumville**, 01-722 3314 daytime.

### REPAIRS

**OUR MODERN SERVICE DEPARTMENT** equipped with the latest test equipment including a wow and flutter meter and multiplex Stereo Signal Generator is able to repair Hi Fi and Tape Recording Equipment to manufacturer's standard. **TELESONIC LTD.**, 92, Tottenham Court Road, London, W.1. 01-636 8177.

### TAPE DUBBING

**E.R.S. RECORDS: TAPE/DISC** Vari-groove High Level Recordings with **WIDE FREQUENCY RANGE**. Top quality pressings. 162, **SHIRLAND ROAD**, LONDON, W.9.

**RAPID Recording Service.** Records made from your own tapes (48-hour service). Master discs and pressings. Recording Studio — Demo discs. Mobile recordings, any distance. Brochure from: 21, Bishops Close, E.17.

**J. & B. RECORDINGS.** Tape/disc. Cheap pressings. Quality recording. 14, Willows Avenue, Morden, Surrey. Mitcham 9952.

**JOHN HASSELL RECORDINGS.** Tape-to-Disc Service using latest high level disc-cutting system. Quality pressings made. Studio with Bechstein Grand Mobile unit. 21, Nassau Road, London, S.W.13. RIVerside 7150.

## PLEASE MAKE USE OF THE ADVERTISEMENT INQUIRIES COUPON OPPOSITE

Complete details of products in which you are interested, fill in your name and address, fold and post. No stamp required.

## WIMBLEDON'S TAPE RECORDER CENTRE

**SKILLED TAPE RECORDER REPAIRS** carried out by expert personnel of many years' experience backed by extensive test equipment—Wow & Flutter Meter, Audio Valve Voltmeter, Audio Generator, Oscilloscope, etc. with final test performance figures quoted if required. Ferroglyph specialists.

**Tape Recorder Centre TEL-LEE-RADIO 220 The Broadway, Wimbledon, S.W.19. 01-542 4946**

# ENGINEERS

## Opportunities in tape-recording

The Tape Manufacturing Company, a subsidiary of the E.M.I. Group, is expanding its activities and has immediate vacancies for:-

### APPLICATIONS ENGINEER

To investigate and evaluate the performance of magnetic tape on new types of professional and domestic recorders. Applicants should have a sound knowledge of recording techniques, and hold a minimum qualification of O.N.C.

Commencing salaries and staff benefits are good,



Applications, giving concise details of qualifications and experience to:-

**M.L. WATERS · GROUP PERSONNEL DEPT · E.M.I. LIMITED · BLYTH RD · HAYES · MIDDLESEX**

### AUDIO MAINTENANCE ENGINEER

To maintain and modify test equipment and tape recording equipment used in the evaluation of magnetic tape. Applicants should be aged 20-40, and have some experience in the recording field.

### DEVELOPMENT ENGINEER

To design transistor and logic circuits, and be able to advise on the maintenance and repair of a wide range of test equipment including tape machines. Applicants should hold an H.N.C. qualification, and have some experience of this type of work. A knowledge of tape-recording and audio and video equipment would be a definite advantage.



**YOUR TAPES to DISC**, 7 in. 45—18s., 10 in. LP—48s., 12 in. LP—55s. 4-day postal service. Top professional quality. S.a.e. photo leaflet: **DEROY STUDIOS**, High Bank, Hawk St., Carnforth, Lancs.

## TAPE EXCHANGES

**FRIENDLY FOLK ASSOCIATION**, Torquay (Est. 1943). Social introductions, Pen-friends, Book-lovers, Stamps, Photography, Tapesponding. Members 100 countries.

**MAKE INTERESTING NEW FRIENDS**. Trial introductions free. VCC, 34, Honeywell, London, S.W.11.

**THE LONDON TAPE RECORDING CLUB** had its tenth birthday last year. Our meetings, held monthly in the Charing Cross area, are lively, creative occasions, and prospective new members will be welcome. Please write for details to: The Secretary, Mr. C. Clements, 36 Hubert Road, London, E.6.

Join **TAPEMATES INTERNATIONAL** and exchange tapes with friends throughout the World. Club and recording booths 6 p.m.—10.30 p.m. Tuesdays, Thursdays and Saturdays. 6, Holland Park Avenue, London, W.11.

**FAR AND WIDE RECORDING CLUB**, Eccles, Maidstone. Details free.—SAE.

**THE FIRST STEP** to worldwide tapetalking is to **WRITE** to: WWTT, 35, The Gardens, Harrow.

## MISCELLANEOUS

**ALWAYS BE CAREFUL** (and money wise) before buying quality equipment. Send your requirement list to **AUDIO SUPPLY ASSOCIATION** for evaluation and quotation. See below . . . . .

**HIGHEST CASH PRICES** offered for good quality Tape Recorders and Hi-fi. See our advert page 148 this issue. R.E.W., 266-8, Upper Tooting Road, London, S.W.17.

**IF QUALITY MATTERS** consult first our 65-page, photographically illustrated catalogue (5s. 6d.) and equipment housing guide (1s. 6d.). Members enjoy unbiased advisory service, preferential terms (cash only, no H.P.). Membership 7s. 6d. Our Associates also manufacture records from your own tapes, or record the Master at our studios (Steinway Grand). Bulk terms for choirs, fund-raising. Please specify requirements. **AUDIO SUPPLY ASSOCIATION**, 18, Blenheim Road, London, W.4. 995 1661.

## TAPE RECORDS

**ABSOLUTELY EVERY AMERICAN 4 TRACK STEREO TAPE** released in America can be obtained through our special postal service. For complete and up-to-date catalogue of all releases send only 3s. to: **MUSIC U.S.A.**, 146 Lower Baggot Street, Dublin 2, Ireland.

Every pre-recorded tape available in Britain is listed in the complete **TELETAPE** catalogue at 1s. 6d. post free.

Vast selection of Mono and Stereo tapes. Send now for your copy by return to: Mail Order Dept., **TELETAPE Ltd.**, 11, Redvers Road, London, N.22, or call at our Marble Arch or Shaftesbury Avenue Showrooms.

Four-track Stereo Tapes are expensive! Join the **W.S.L. Stereo Tape Library** and enjoy every tape for only a few pence per day. **Worldwide Service**. Send 9d. postage for full details to: 104, Norwood High Street, London, S.E.27.

## PUBLICATIONS

**NOW IN ITS SECOND REPRINT**, Alan Beeby's informative handbook **SOUND EFFECTS ON TAPE**. Invaluable to all dramatists and recording enthusiasts. Tells in practical terms not only what to do but also how and why. 3s. 6d. post free. Remittance with order to **Print & Press Services**, Prestige House, 14-18, Holborn, London, E.C.1.

## EDUCATIONAL

**LEARN WHILE YOU SLEEP**: GCE and Professional subjects. Languages, etc. Free booklet from **THE SLEEP LEARNING ASSOCIATION**, 14 Belsize Crescent, London, N.W.3. Tel.: SW1 6160.

## VACANCIES

**EDUCATIONAL TAPE RECORDINGS**. An unusual and interesting vacancy exists for a keen tape recording enthusiast who would like to turn his hobby into a full-time job. We are looking for a man having a basic, but not necessarily extensive, knowledge of foreign languages, and having also a certain mechanical aptitude to carry out editing and mass recording of taped educational programmes, using novel and specialised equipment. Salary will be in accordance with age and experience. Applicants should write, with full details of previous experience, to: **T. C. Halvorsen, A-V Sales Manager**, Bell & Howell Ltd., Great West House, Great West Road, Brentford, Middlesex.

## TALKING BOOKS

**GENUINE HERON HUNTER TALKING BOOKS**. Save 50 per cent shop prices (brackets) by obtaining direct. Principal mail agents. "Alice in Wonderland" 1100 ft. (57s.), 19s. 6d.; "Peter Pipkin" series Nos. 1, 2 and 3, 300 ft. (16s. 11d.), 5s. 11d.; "Peter and Dolphin" 600 ft. (19s.), 12s.; "Mountain on Fire" 1100 ft. (18s.), 12s. 6d.; "Pied Piper" 400 ft. (20s. 6d.), 9s. 11d.; "Ghost Stories" 1100 ft. (37s.), 19s. 6d. Twin track 3½ ips. Lengths approx. Spools 5-inch or 7-inch, 1s. 6d. Strong storage boxes for 5½-inch, 4s. dozen. Cash refunded if not delighted.—**School Films**, Steel Cross, Crowborough, Sussex.

# ADVERTISEMENT INQUIRIES SERVICE

I should like further information about  
Messrs ..... 's advertisement  
on page..... of *TAPE Recording Magazine*  
about..... (product)  
NAME.....  
ADDRESS .....

April 1968

*This is a special service for readers of "TAPE Recording Magazine." It enables you without cost to get fuller information about those products in which you are particularly interested. Fill in one coupon below for each inquiry, with your name and address in block capitals in each case. Then cut out the whole of this section, following the dotted line, fold as indicated overleaf and post to us.*

I should like further information about  
Messrs ..... 's advertisement  
on page..... of *TAPE Recording Magazine*  
about..... (product)  
NAME.....  
ADDRESS .....

April 1968

I should like further information about  
Messrs ..... 's advertisement  
on page..... of *TAPE Recording Magazine*  
about..... (product)  
NAME.....  
ADDRESS .....

April 1968

I should like further information about  
Messrs ..... 's advertisement  
on page..... of *TAPE Recording Magazine*  
about..... (product)  
NAME.....  
ADDRESS .....

April 1968

I should like further information about  
Messrs ..... 's advertisement  
on page..... of *TAPE Recording Magazine*  
about..... (product)  
NAME.....  
ADDRESS .....

April 1968

**A MAJOR BREAKTHROUGH IN TAPE-LEARNING ECONOMICS**

At last we are able to offer a recorder which is not only ideal for Tape-Learning and Therapy and gives excellent results on music but is at the same time at a sensationally low price—only 25 gns.

Send now for our latest free catalogue of Complete Tape-Learning Kits and accessories including our special Induction Tapes, Pillow Speakers, Time Switches, etc., etc., together with latest Press Reports on this Vital New Subject.

**THE INSTITUTE OF TAPE-LEARNING**

Dept. TRM, 153, FELLOWS ROAD, SWISS COTTAGE, LONDON, N.W.3.  
01-722 3314

**MAILWAY LOW COST TAPES**

Supplied in strong Boxes with free length of leader.  
Fully guaranteed.

7" Mylar 2400 ft.	21/-	5" Mylar 1200 ft.	16/6
7" Mylar 1800 ft.	16/3	5" Mylar 900 ft.	11/3
7" Mylar 1200 ft.	11/6	5" Mylar 600 ft.	9/6
7" Acetate 1800 ft.	12/6	5" Acetate 900 ft.	8/6
7" Acetate 1200 ft.	10/-	5" Acetate 600 ft.	8/-

Post and Packing 2/- per order. Send S.A.E. for Tape and Accessories Catalogue to

"MAILWAY", 1, Icknield Street, Dunstable, Beds.

**The Berean  
Forward Movement**

(NON-DENOMINATIONAL)

Loan of over 1,000 reliable expositions of the Bible available on tape (3½ ips) for cost of postage only. For Bible Study groups or private meditation. Supporting literature also available. Details from: Miss R. Hammond (TRM), Burwood, Blofield, NORWICH, Norfolk. NOR 84Z.

**RAPID RECORDING SERVICE**

L.P.s. from your own tapes. (48-hour service)

Master Discs and pressings.

Recording Studio.

Mobile Recordings.

Associated Company—

**EDUCATIONAL RECORDINGS LTD.**

Is your mind managing you??

Do you often find it difficult to make decisions?

Do you brood over your troubles?

Send now for Psycho-tape No. S.T./1 "Mind Management."

Twenty other tapes on self-improvement.

Publications:—

"Sleep-learning, Its Theory, Application and Technique."

"Mental Power Through Sleep-suggestion."

"How to Get What You Want" by Sidney N. Bremer.

Brochures from

**RAPID RECORDING SERVICE (Dept. TRM)**

21 Bishops Close, London, E.17

CUT ALONG DOTTED LINE

POSTAGE  
WILL BE  
PAID BY  
PRINT AND  
PRESS  
SERVICES  
LIMITED

THIRD FOLD HERE

TAPE RECORDING MAGAZINE,  
PRESTIGE HOUSE,  
14-18 HOLBORN,  
LONDON, E.C.1

BUSINESS REPLY FOLDER  
Licence No. ND 922

SECOND FOLD HERE

NO POSTAGE  
NECESSARY  
IF POSTED  
IN GREAT  
BRITAIN OR  
NORTHERN  
IRELAND

FLAP A

FLAP B

FIRST FOLD ALONG THIS LINE

Fold along lines as indicated and then tuck Flap A into Flap B

THIS IS THE  
FABULOUS  
**JORDAN WATTS**  
MODULAR  
HIGH-FIDELITY  
DRIVING UNIT

*the cleanest, clearest,  
most natural sound you can buy.*



See us on Stand No 30 at the **AUDIO FAIR**  
Demonstration Room No.448

Manufactured by:  
JORDAN WATTS LTD.,  
Benlow Works, Silverdale Road,  
Hayes, Middx.

Distributors:  
BOOSEY & HAWKES  
(SALES) LTD.,  
Deansbrook, Road,  
Edgware, Middx.

World Exports:  
K.H. WILLIMAN & CO. LTD.,  
Blackford House, Sutton,  
Surrey, England.  
Tel: Melville 1491  
Cables: Tiger, Sutton, Surrey

*Jordan-Watts Loudspeakers - The voice of high fidelity*

**ILIFFE  
BOOKS**

**THE TAPE RECORDER**

Second Edition

by C. G. NIJSEN

This book has been specially written in clear, simple non-technical language for the rapidly growing band of enthusiasts for whom the tape recorder is as indispensable as a radio, a record player or a camera. It shows how the best possible results can be obtained from a recorder, whether it is used for pleasure or education purposes.

In this second edition a chapter on cassette recorders has been added explaining the principles and the advantages of this system for the user who above all wants "simplicity of operation".

Because of its practical approach, this book, by an author with many years of experience in all branches of sound recording, will be easily understood even by those new to the subject, and will assist all those reading it to improve the standard of their recording.

172 pp. approx., illustrated, 18s. net, 18s. 11d. by post.

obtainable from leading booksellers

**ILIFFE BOOKS LTD.**  
42, RUSSELL SQUARE, LONDON, W.C.1

**NORTH  
WEST  
LONDON  
TAPE RECORDER  
CENTRE**



**TELEFUNKEN  
SPECIALISTS**

**COMPLETE RANGE IN STOCK**

Akai, Ampex, B & O, Brenell, E.M.I., Elizabethan, Ferguson, Ferrograph, Grundig, Loewe-Opta, National, Nusound, Philips, Reps, Revox, Sanyo, Sharp, Sony, Truvox, Uher, Van Der Molen, Vortexion, Wyndson, etc., together with a wonderful range of Tape Accessories

Easily the most accessible Tape Recorder Centre in N.W. London. Situated opposite the Classic Cinema and Kilburn Tube Station (Bakerloo line). Bus routes 1, 6, 8, 8a, 16, 28, 31, 176, 187 pass near or by the door. Choosing a tape recorder? Nothing could be easier than a visit to the North West London Tape Recorder Centre.

Personal, expert advice . Generous part exchanges  
Easy hire purchase terms . Free after sales servicing

**360, KILBURN HIGH ROAD,  
LONDON N.W.6**

Telephone: 01-624 1656

Open 9 a.m.-6 p.m. Monday to Saturday

Half-day Thursday

# MUSIC CASSETTES

The only cassette system featuring recordings for everyone  
**POP ■ JAZZ ■ FOLK ■ SPOKEN WORD ■ CLASSICS**  
 THIS MONTH'S EXCITING NEW RELEASES INCLUDE:



**SHAKESPEARE**  
**Romeo & Juliet**  
 with Claire Bloom,  
 Dame Edith Evans,  
 Albert Finney and Full Cast  
 (2 cassettes) **CCS0802**



**SHAKESPEARE**  
**The Merchant of Venice**  
 with Hugh Griffith,  
 Dorothy Tutin, Harry Andrews  
 and Full Cast  
 (2 cassettes) **CCS0801**



**NATIONAL BRASS**  
**BAND FESTIVAL**  
 Royal Albert Hall, London  
**CYP178**



**LONG JOHN BALDRY**  
**Let The Heartaches**  
**Begin**  
 including title song and  
 I can't stop loving you, etc.  
**CYP179**

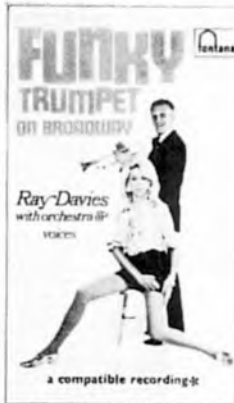

**RAY DAVIES**  
**Funky Trumpet on**  
**Broadway**  
 including The Look of Love,  
 You Only Live Twice, etc.  
**CFP4024**



**RAY CONNIFF'S**  
**Hawaiian Album**  
 with the Ray Conniff Singers  
**40-63106**



**MANFRED MANN**  
**Up The Junction**  
 Original Soundtrack Recording  
 from the Paramount film  
**CFP4026**



**HITS OF**  
**FRANK SINATRA**  
 including Strangers in the  
 Night, Somethin' Stupid  
 (with Nancy Sinatra), etc  
 (EP Cassette) **MCR200**

CAEDMON



For full details of other Musicassette releases, please write to:  
**Musicassette Department**  
**Philips Records Limited**  
 Stanhope House  
 Stanhope Place  
 London, W.2